

# Electronic Design<sup>®</sup> 16

VOL. 22 NO.

FOR ENGINEERS AND ENGINEERING MANAGERS

AUG. 2, 1974

**Stay on guard with panel meters.** Whether you choose analog or digital, problems are sure to rise. Though the analog has had 80 years of refinement, pointers still

bend, meters still drift. The more complex and younger digital unit brings new troubles: unreliable meters and ones that overheat and die. To sort it out, start on p. 60.





## Ultra reliability in ultra-miniature transformers...

### ...and they're off the shelf!

PICO Electronics' patented construction combines mass production with the utmost in reliability to produce the smallest possible transformer.

These little giants handle up to 600 milliwatts at 1 KHz and 1.5 watts at 10KHz. They cover the frequency range of 300Hz to 250KHz. Primary or Secondary impedances of 3.2 ohms to 250K ohms. Pulse applications .05 $\mu$ s to

100 $\mu$ s. Construction can be TO-5 plug-in, insulated flexible leads or flat pack ribbon style.

Size variations from  $\frac{1}{4}$ " dia. x  $\frac{1}{4}$ " ht. to  $1\frac{1}{32}$ " dia. x  $\frac{1}{2}$ " ht. Special designs with  $\frac{1}{4}$ " dia. and .180" ht.

Pico Electronics is a Q.P.L. source. All transformers are hermetically sealed in a metal case and in strict compliance with MILT-27 specifications. Every Pico device has the added reliability feature of being

guaranteed for 25 cycles of thermal shock (MIL-STD-202D, method 107C).

Industrial and Commercial designs are also available for maximum economy.

*Over 600 standard transformers to choose from... Delivery—stock to one week... specials take a little longer—9 days.*

**Send for free 36 page catalog.**

## PICO Electronics, Inc.

50 South MacQuesten Pkwy., Mt. Vernon, New York 10551 • Telephone 914-699-5514

# YOU HUM THE TUNE, EXAR PLL WILL SING IT



 XR-2567



 XR-210



 XR-215



 XR-567

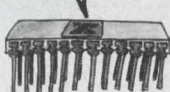

 XR-S200



 Exar PLL

We have the broadest chorus line of Phase Lock Loop circuits available today. Take a brief look at our ever-expanding PLL line:

The XR-210 is designed for FSK Modulation and Demodulation and features a self-contained output logic driver, compatible with RS-232C requirements.

Use the XR-215 for FM or FSK demodulation, frequency synthesis and filter tracking. It has a 5V to 26V supply range and 0.5 Hz to 35 MHz frequency bandwidth. What's more, it's bipolar logic compatible.

The XR-S200 is a do-it-yourself building block. With this you design your own PLL circuits by selecting external connections and components. You get instant pro-

totypes with minimum fuss and costs.

Moving right along . . . the XR-567 PLL is designed for tone and frequency decoding. It has a bandwidth adjustable from 0 to 14%, sinks up to 100 mA of load current and has a logic compatible output. Our dual version, the XR-2567, is a real hummer with even better temperature tracking and matching characteristics. Power supply rejection is improved by an order of magnitude over the single version. The dual outputs can switch up to 100 mA at 26 volts.

All together now. We would like to send you the complete musical score on our PLL products. Our data sheets are good and they're filled with applications data. Write now, write.

## EXAR SPEAKS YOUR LANGUAGE

R-OHM CORPORATION  
EXAR INTEGRATED SYSTEMS  
P.O. Box 4455  
Irvine, CA 92664  
Telephone: (714) 546-8780  
TWX: 910-595-1721

**Rohm**  
QUALITY · RELIABILITY

R-OHM ELECTRONICS GMBH  
EXAR INTEGRATED SYSTEMS  
Mühlenstraße 70  
4051 Korschenbroich  
Telefon (02161) 298 05  
Telex 852330 rohm d

MEMBERS OF THE INTERNATIONAL R-OHM GROUP

INFORMATION RETRIEVAL NUMBER 2

# Thinking wirewound?

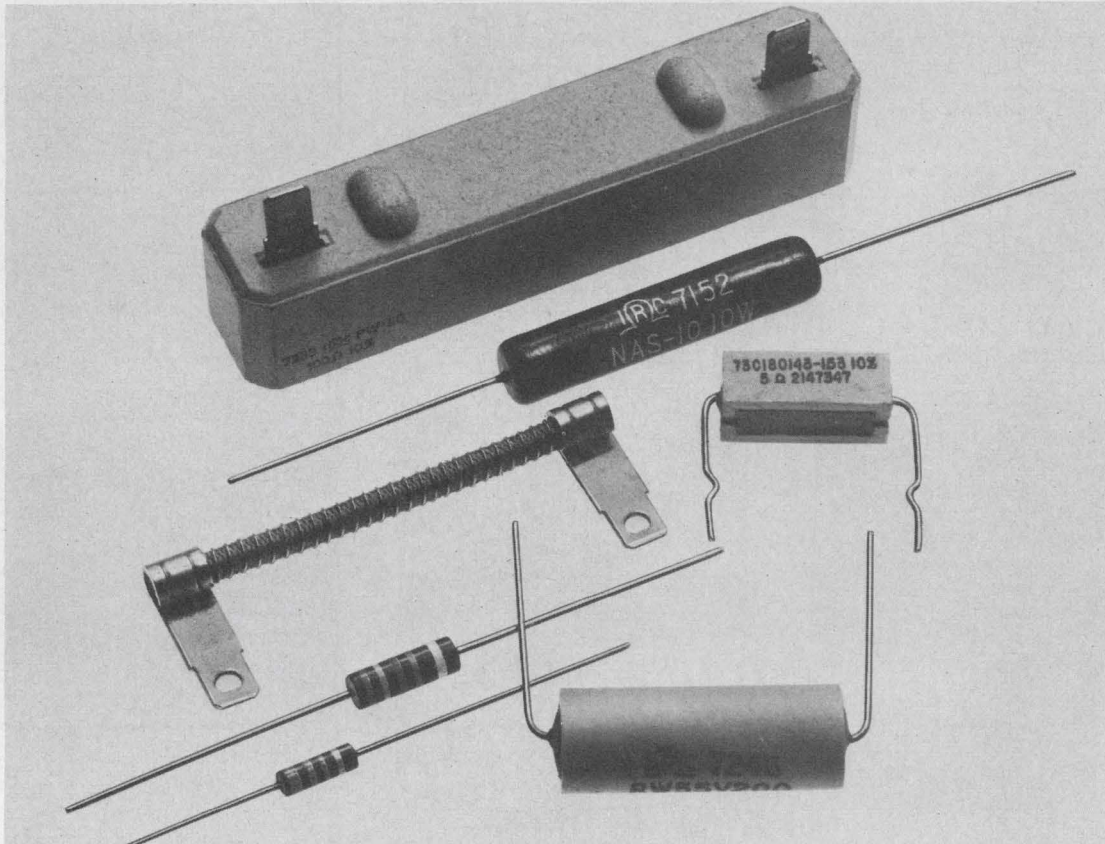

**For optimum cost/performance ratios,  
see TRW/IRC—at the design stage.**

Why? Because we offer just about *every* type wirewound that's commercially feasible. So we can help you find the most for your money. Or more for less money. For example:

**Watts/inch consumer types.** For appliance, automotive, heater circuitry. To 6 w/in. Terminal options.

**Machine insertable molded units.** Often a carbon comp. replacement. Offer smaller size, lower resistance range, lower cost.

**Ceramic insulated power.** *The* standard for general purpose power—2 to 50 w. Fusing capabilities, special TC's available.

**Fusible/flameproof units.** Rated at 2 w., but won't burn or burn board under faults of 4x to 1000x rated power (or 1000 v, whichever is smaller). Special fusing characteristics if you wish.

**Axial and radial power.** ½ to 250 w., fixed or adjustable. Unmatched for power density/precision. Broad special design capability here.

**Complete resistor choice.** Understand, TRW isn't *locked in* to wirewounds. If we think your design will fly better with, say, precision film, we'll suggest it. In fact, TRW offers a total resistor capability—carbon comp., thin-film, Metal Glaze™, wirewound, networks.

For specs and application data on *wirewounds*, contact your local TRW sales representative. Or write TRW/IRC Resistors, an Electronic Components Division of TRW, Inc., 401 N. Broad St., Philadelphia, Pa. 19108.

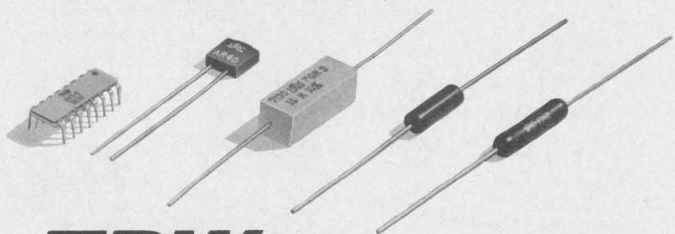

**TRW<sup>®</sup> IRC RESISTORS**

---

## NEWS

- 33 **News Scope**
- 36 **Silicon-on-sapphire devices:** They're not yet making it in LSI circuits . . . but wait till next year.
- 42 **Study of internal laser damage** may lead to smaller devices.
- 44 **Nuclear ILS for aircraft** proves safe and sound in feasibility tests.
- 46 **And now, liquid magnetic bubbles** for displays.
- 55 **Washington Report**

---

## TECHNOLOGY

- 60 **FOCUS on panel meters:** Covers both analog and digital meters and zeros in on the problems a designer faces when he must select an APM or DPM.
- 76 **Which LCD is best?** With a choice among dynamic-scattering and field-effect types, operating in reflective or transmissive modes, the designer must know the tradeoffs.
- 84 **For tough measurements, try IAs.** Instrumentation amplifiers offer three big advantages over simple, multiple op-amp instrumentation circuits.
- 90 **Are your humidity readings valid?** Most test chambers are so poorly instrumented and serviced that major errors occur and engineers aren't aware of them.
- 96 **Get notch Qs in the hundreds** with a switched RC filter and a few op amps. A single resistor varies Q without effect on center frequency.
- 104 **Learning to wear two hats on the job:** the designer's and the project engineer's. Section manager tells why it's necessary in small companies.
- 110 **Ideas for Design:** Start a logic circuit in the proper mode when power is turned on or interrupted . . . Biphase waveforms generated by shift-register circuits . . . Frequency doubler covers wide frequency range for asymmetric square waves.
- 118 **Design Decision:** 16-bit d/a converters don't need thermal matching of critical components.
- 120 **International Technology**

---

## PRODUCTS

- 123 **Instrumentation:** Autoranging 80-MHz counter is industry's least expensive.
- 128 **Integrated Circuits:** Quad IC timers squeezed into a 16-pin plastic DIP.
- 132 **Data Processing:** 5-MHz bandwidth attained with CRT deflection system.
- 150 **Discrete Semiconductors:** LED panel lamps match incandescents at less current.
- 141 **Modules & Subassemblies**
- 144 **Packaging & Materials**
- 154 **Power Sources**
- 156 **Components**

---

## Departments

- 59 **Editorial:** The good boss
- 7 **Across the Desk**
- 158 **Evaluation Samples**
- 158 **Application Notes**
- 160 **New Literature**
- 165 **Bulletin Board**
- 170 **Advertisers' Index**
- 172 **Product Index**
- 174 **Information Retrieval Card**

**Cover:** Photo by Joe Petrovic, courtesy of Western Instruments, Inc.

# From CPU 8080 Microcom

Intel's new 8080 n-channel microcomputer is here — incredibly easy to interface, simple to program and with up to 100 times the performance of p-channel MOS microcomputers.

Best of all, the 8080 is real — in production at Intel and available in volume quantities, today. It's also available through distributors along with a growing line of peripheral circuits and a new version of the Intellec 8, a program and hardware development system for the 8080,

all supported with software packages, design documentation and manuals, and backed by more than 100 man years of microcomputer expertise.

The 8080 is the inevitable successor to complex custom MOS and many large discrete logic subsystems. It is the industry's first general purpose n-channel microcomputer and the first high performance single-chip CPU, with extremely simple interface requirements and straightforward programming. It runs a full instruction cycle in 2 microseconds.

As such, the 8080 extends the economic benefits of Intel's p-channel microcomputers to a new universe of systems that need fast, multi-port controllers and processors. These systems include intelligent terminals, point of sale systems, process and numeric controllers, advanced



# to software, the puter is here.

calculators, word processors, self-calibrating instruments, data loggers, communications controllers, and many more.

You can use 256 input and 256 output channels, handle almost unlimited interrupt levels, directly access 64 kilobytes of memory, and put many satellite 8080 processors around a single memory.

Interfacing is minimal and design is easy with the 8080 because all controls are fully decoded on the CPU chip itself and inputs and outputs are TTL compatible. There are separate data, address and control buses.

The 8080 microcomputer has 78 basic instructions, including the 8008 set plus new ones that make possible such features as vectored multi-level interrupt, unlimited subroutine nesting and very fast decimal and binary arithmetic.

Program development for the 8080 can be done either on a large computer using the Intel software cross products (PL/M systems language compiler, macro-assembler and simulator), or on an Intellec 8 development system with a resident monitor, text editor and macro-assembler.

The new 8080 product family includes performance matched peripheral and memory circuits configured to minimize design effort and maximize system performance. Large, low cost RAMs, ROMs, PROMs and I/O devices are available now and we will soon announce other 8080 LSI support circuits.

The 8080 is easier to use and more economical than any high performance microcomputer in sight. It's here now, in volume, from the inventors of the micro-computer and the people who lead the industry in production and design support.

Intel Corporation, 3065 Bowers Avenue, Santa Clara, California 95051.  
(408) 246-7501.

INTEL 8080	RAM MEMORIES		
	8101	256 x 4 STATIC	AVL: 3RD Q
	8111	256 x 4 STATIC WITH COMMON I/O	AVL: 3RD Q
	8102	1024 x 1 STATIC	AVL: NOW
	8107	4096 x 1 DYNAMIC	AVL: NOW
	ROM MEMORIES		
	8308	1024 x 8	AVL: 3RD Q
	8316	2048 x 8	AVL: NOW
	PROM MEMORIES		
	8702	256 x 8	AVL: NOW
	8704	512 x 8	AVL: 4TH Q
	8604	512 x 8	AVL: 4TH Q
	PERIPHERAL CIRCUITS		
	8205	1 of 8 DECODER	AVL: NOW
	8210	4K RAM CLOCK DRIVER	AVL: NOW
	8212	8 - BIT I/O LATCH	AVL: NOW
8216	BI-DIRECTIONAL BUS DRIVER	AVL: 3RD Q	
8201	COMMUNICATIONS INTERFACE	AVL: 4TH Q	

INTEL 8080 PRODUCT FAMILY

**intel**® Microcomputers. First from the beginning.

# FLAT INTERCONNECTS YOUR COMPLETE SOURCE

Ribbon Cable / IC Interconnects / Custom Harnesses

You're sold on flat cable, now buy it at its best. Precise, compact cable packages to fit your specifications perfectly, computer-loomed for unmatched versatility by Woven Electronics.

Handling ease of independent non-bonded leads speeds production, cuts cost, while technical characteristics outrank other flat cable forms.

Make Woven your source for jumpers, continuous rolls, special harnesses, all your interconnect needs.

## WOVEN ELECTRONICS

P.O. Box 189 Mauldin, South Carolina 29622  
803/963-5131



**Vice President, Publisher**  
Peter Coley

### Editors

Editorial Offices  
50 Essex St.  
Rochelle Park, N.J. 07662  
(201) 843-0550  
TWX: 710-990 5071  
Cable: Haydenpubs Rochellepark  
**Editor-in-Chief** George Rostky

### Managing Editors:

Ralph Dobriner  
Michael Elphick

### Associate Editors:

Dave Bursky  
Jules H. Gilder  
Morris Grossman  
Seymour T. Levine  
John F. Mason  
Stanley Runyon  
Edward A. Torrero  
Richard L. Turmail

### Contributing Editors:

Peter N. Budzilovich  
Robert Wollins

### Editorial Field Offices

#### East

Jim McDermott, Eastern Editor  
P.O. Box 272  
Easthampton, Mass. 01027  
(413) 527-3632

#### West

David N. Kaye, Senior Western Editor  
2930 West Imperial Highway  
Inglewood, Calif. 90303  
(213) 757-0183  
Northe K. Osbrink, Western Editor  
112 Coloma St.  
Santa Cruz, Calif. 95060  
(408) 426-3211

### Editorial Production

Marjorie A. Duffy

### Art

Art Director, William Kelly  
Richard Luce  
Anthony J. Fischetto

### Production

Manager, Dollie S. Vieblg  
Helen De Polo  
Anne Molfetas  
Christopher G. Hill

### Circulation

Manager, Evan Phoutrides

### Information Retrieval

Peggy Long

### Promotion

Manager, Walter G. Salm  
Karen Kerrigan (Reprints)



## across the desk

### High-level languages not always the best

The remarks of Hewlett-Packard's Van Diehl concerning the virtues of higher-level languages may apply to an end-user, but aren't as applicable to the turnkey system builder (see "Take-Your-Pick Software is Making the Mini Mighty, but Watch Out—It Costs," ED No. 9, April 26, 1974, p. 79). The cost of a sophisticated programmer is a one-shot cost at system development time. That "few thousand dollars" of course will be multiplied in every unit sold (unless the total projected market is one unit).

Self-assemblers that run on very small computers can negate the need for time-sharing compilers in businesses that have no other computer requirements. Although the usefulness of compilers increases as system size grows, as memory shrinks and processors become less powerful as they approach the low end of the spectrum, the assembler's compact and fast code is increasingly necessary.

*Rich Herzog*  
Software Designer

Continental Design  
7723 Convoy Ct.  
San Diego, Calif. 92111

### He'd give atom waste a place in the sun

With reference to the controversy on how to dispose of nuclear waste: Surely the safest and most obvious solution is to send it via

rocket to the sun. In fact, it might be useful for the Atomic Energy Commission to require a commitment and funding for such disposal by companies that apply for a license to produce commercial nuclear fuels. The waste would be packaged in cement or other appropriate container for the nose cone of a rocket that would be aimed at the sun's orbit—thereby assuring that our biosphere would not be contaminated over many years with materials having half-lives of thousands of years.

These views are my own and do not reflect any policy of the company for which I work.

*Ralph S. Gobel*  
Senior Technical Writer  
Atlantic Research Corp.  
Alexandria, Va. 22314

### Class-D amplifier: How does it work?

The operation described for the pulse-width modulator in "Boost Audio-amplifier Efficiencies" (ED No. 8, April 12, 1974, p. 96) is in error. So, too, are the waveforms in Fig. 2 of the article.

The UJT, in conjunction with current source  $Q_1$  and  $C_2$ , produces a saw tooth with a linear ramp. This is injected at the inverting port of the comparator ( $A_2$ ). Comparison of this ramp to the audio input ( $A_1$ ) yields a PWM output from the comparator by shifting the leading edge of the pulse with-

*(continued on page 8)*

Electronic Design welcomes the opinions of its readers on the issues raised in the magazine's editorial columns. Address letters to Managing Editor, Electronic Design, 50 Essex St. Rochelle Park, N.J. 07662. Try to keep letters under 200 words. Letters must be signed. Names will be withheld on request.

# Thin-Trim<sup>®</sup> capacitors



 Tucked in the corner of this Pulsar Watch is a miniature capacitor which is used to trim the crystal. This Thin-Trim capacitor is one of our 9410 series, has an adjustment range of 7 to 45 pf., and is .200" x .200" x .050" thick. The Thin-Trim concept provides a variable device to replace fixed tuning techniques and cut-and-try methods of adjustment. Thin-Trim capacitors are available in a variety of lead configurations making them very easy to mount.

 A smaller version of the 9410 is the 9402 series with a maximum capacitance value of 25 pf. These are perfect for applications in sub-miniature circuits such as ladies electronic wrist watches and phased array MIC's.

Johanson Manufacturing Corporation,  
Rockaway Valley Road., Boonton, N.J.  
07005. Phone (201) 334-2676, TWX 710-  
987-8367.

*Johanson*

MANUFACTURING CORPORATION

## ACROSS THE DESK

(continued from page 7)

in a cycle while maintaining a fixed position for the trailing edge. Revised waveforms for Fig. 2 are shown; the output  $B_3$  was correct. The linearity of the oscillator ramp is important to minimize distortion.

Also, the long-term thermal stability of the circuitry, as shown, is questionable. When output-power losses and efficiencies are considered, it should be pointed out that the 50% duty cycle referred to occurs only under no-signal conditions, though the results of the calculations appear reasonable.

A. F. Eberts  
Engineering Leader

11 Flintlock Dr.  
Long Valley, N.J. 07853

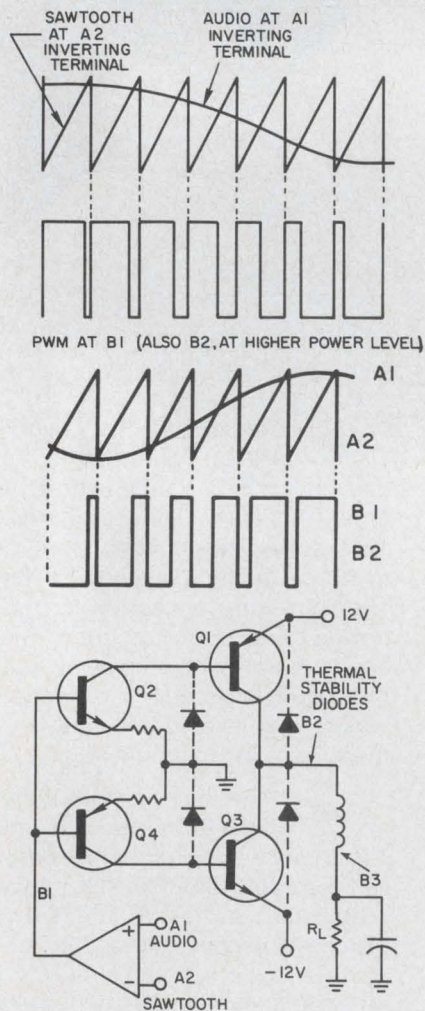

## The author replies

In the original article I didn't emphasize the waveforms of  $A_1$  and  $A_2$  of the op amp. Apparently the description was too vague.

As shown here in the waveform diagram, the op-amp saturates at its positive extreme when the audio signal ( $A_1$ ) at the noninverting terminal is more positive than the ramp signal ( $A_2$ ) at the inverting terminal. Conversely, if  $A_2$  is more positive than  $A_1$ , the op amp saturates in the negative direction. Thus, as shown, the leading edge of the pulse train at  $B_1$  is always fixed, while the trailing edge varies as a function of the audio amplitude.

Note that the PWM wave has the inverse relationship to that predicted by Mr. Eberts. Note also that in Fig. 2 of the article the waveform  $B_1$  was shown with a 50% duty cycle (zero audio signal) but the saw tooth was not. It isn't the comparison of  $B_1$  and  $A_1$  that produces  $B_2$ , but rather the comparison of  $A_1$  and  $A_2$  that produces  $B_1$ . This, in turn, produces  $B_2$ . Except for their power levels,  $B_1$  and  $B_2$  have identical waveforms. There was, however, an error in the caption, which said: "Without the input signal,  $f_c$  consists of a 50% duty-cycle square wave (point  $B_2$ )." The point referred to is  $B_1$ . Furthermore, with an input signal, both waveforms should have been the same as that shown for  $B_2$ . I apologize for this slip; I should have caught it when I checked the article prior to publication.

It may be possible to improve the circuit's thermal stability by adding diodes, as indicated in the accompanying partial schematic. However, I'm still evaluating this technique.

W. V. Subbarao  
Assistant Professor

North Dakota State University  
College of Engineering and  
Architecture  
Fargo, N.D. 58102

## Swap those charts

One of our authors, Petre Sturzu of Fairchild Semiconductor, has pointed out some errors that crept into his recent article "Use CAD to Optimize Broadband Amp Design," (ED No. 10, May 10, 1974, pp. 92-99). The Smith chart shown as Fig. 10b in the article should have been Fig. 9b. The corrected version of Fig. 10b is shown below. Also two of the schematic dia-

grams were incorrectly drawn. Fig. 3a and Fig. 4a should have been drawn as shown here.

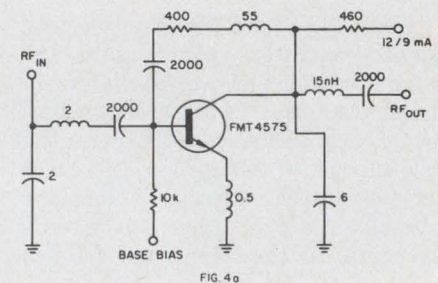
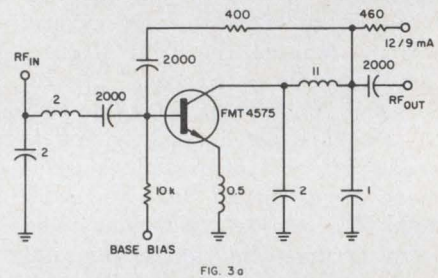
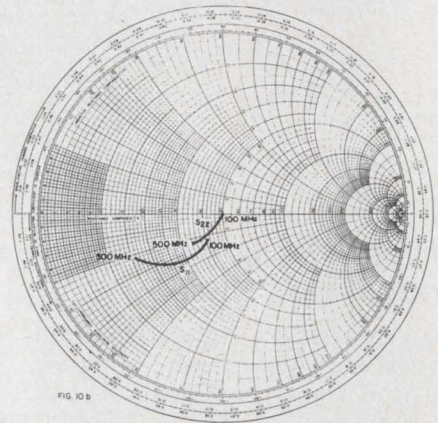

## Some handy antidotes to fires in the home

In reply to Kenneth Willoughby's letter in the May 24 issue ("Is There a Solution to Fires in TV Sets?") I would like to say thanks for the information. Further I would like to reply to his invitation to readers to submit their ideas on prevention of fires. Here are mine:

1. Fire in the wall switch: Switch to mercury switches. The "little fire" or spark is contained in a small hermetically sealed bulb.
2. Fire in a wall plug: Change to molded plugs.
3. Fire in a TV set: Use transistor TV sets only and clean dust out periodically. And purchase an electrostatic precipitator (electronic filter). This is expensive—\$200—

(continued on page 26)



# MEASUREMENT COMPUTATION

innovations from Hewlett-Packard

# NEWS

AUGUST, 1974

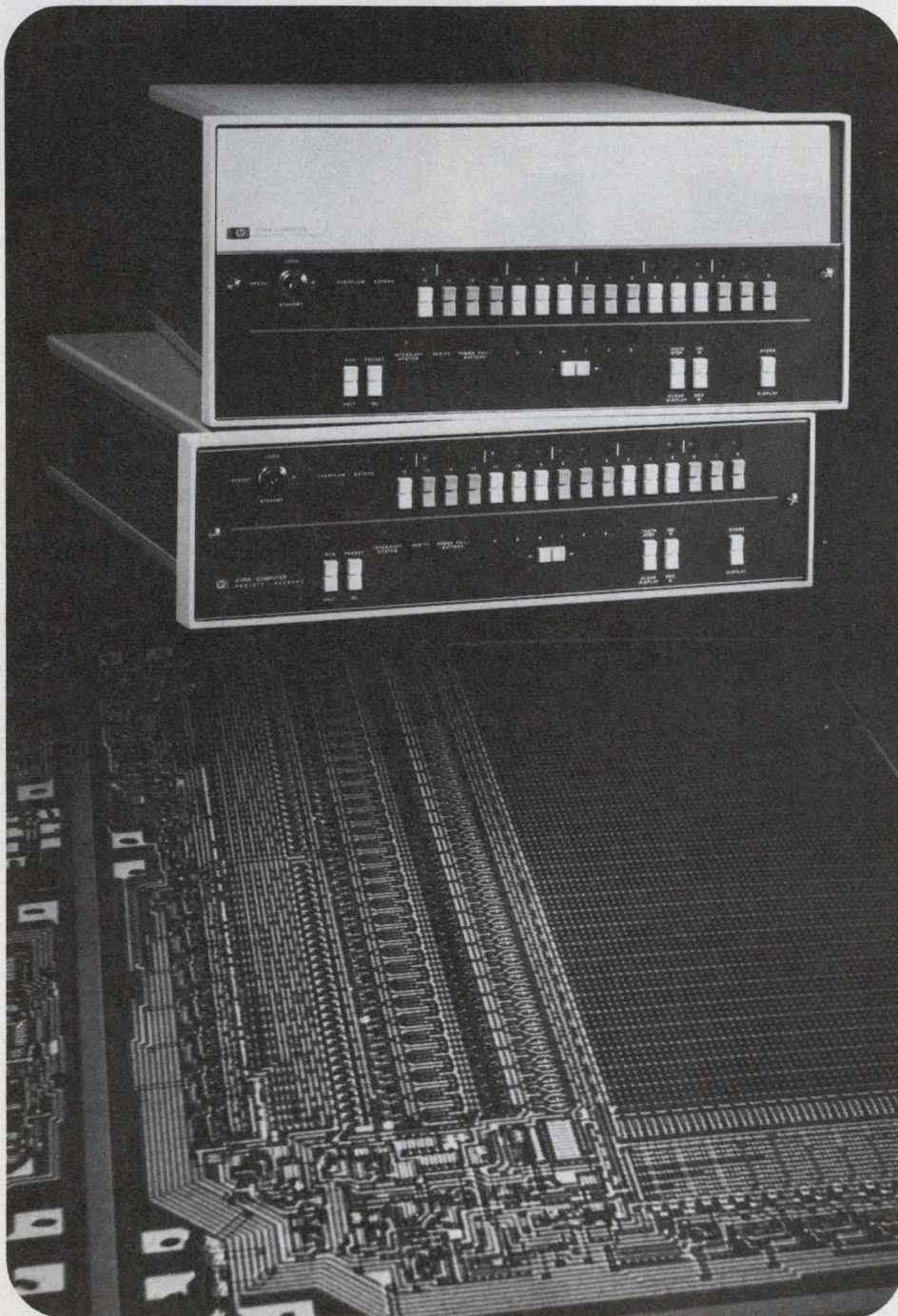

## in this issue

They're here!  
Green and yellow LEDs

Take a new look  
inside your circuits

New high-frequency  
scope for fast logic

New minicomputers combine  
MOS memory with user  
microprogrammability

This enlarged mask shows all the circuitry  
packed into HP's tiny 4K memory module, only  
1 in. by 0.5 in.

HP introduces a totally new mini-computer family, 21MX, featuring MOS semiconductor memory systems and user-microprogrammability. Using 4K random access memory (RAM) components, up to 16K words of memory are provided on a single 8 in. (20 cm) square module. When combined into memory systems, these modules are faster, cost less, weigh less, consume less power, and are more reliable. For example, the mean time between failures is estimated to be 2 to 15 times better than that of conventional core memories.

Transcending the limitations of conventional hardware logic, the 21MX is fully microprogrammable, giving you greater control over the processor and

*(continued on page 3)*

## Compact bench x-ray finds "hidden" circuit defects

Now, you can look inside circuits to detect problems such as registration, porosity, broken wire, and weak welds. HP's automatic, compact 43805A x-ray unit fits right on your workbench and makes these problems immediately visible. It's radiation-shielded for operation in populated areas.

This test device is easy to use. The machine itself tells you what voltage to set and shuts itself off automatically. The unit has an adjustable output voltage from 10 to 110 kVp with 3 mA current, ensuring good contrast over a range of object thicknesses and densities. High definition prints can be

produced in seconds using Polaroid or standard wet film.

Use x-rays to pinpoint defects in welds, castings, and small intricate devices. You can quickly view misalignment, inclusions, missing elements and poor fabrication in printed circuits, micro-logic elements, contacts, relays, resistors, encapsulated components and connectors. Quality control, batch inspection and production studies are available from HP.

*To learn more, check the HP Reply Card.*

Smaller than .001 in., these broken wires (upper corner) in an integrated circuit are shown by x-rays.

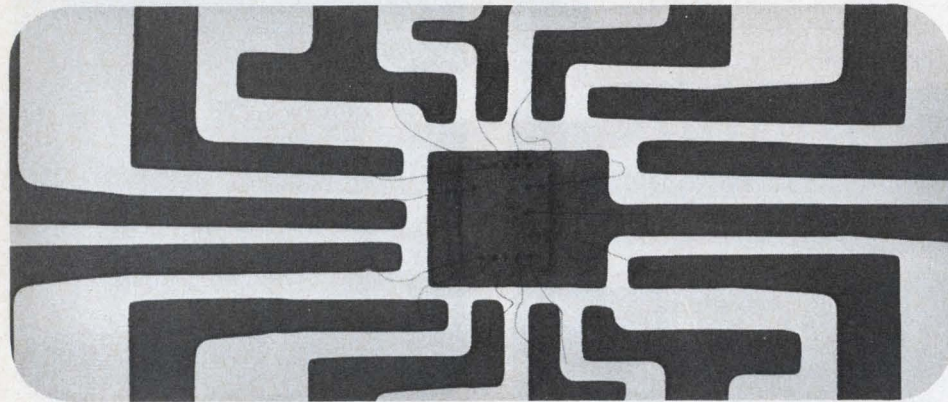

## New low-cost card reader enhances HP calculators

Need a low-cost card reader for your HP 9800 series calculator? The new compact, hand-fed 9870A card reader

is designed specifically for such data or program input. It reads standard 96-character Hollerith code on either pencil-marked or punched cards. Cards may also be custom-designed to suit various applications.

The 9870A weighs just 18 oz. (0.5 kg). It's small and quiet enough for desktop use in any business environment. The power required for operation is supplied from the calculator.

Cards may be used to input patient histories, shipping and receiving orders, field research data, and any statistical analysis.

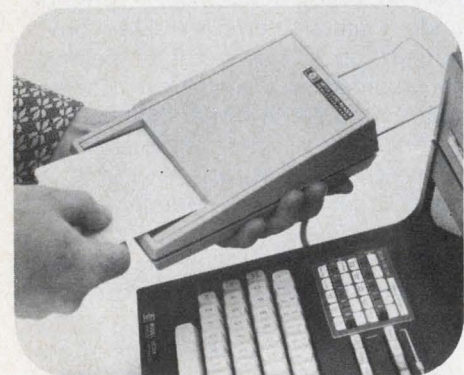

The 9870A is a simple, inexpensive way to add card-reading capability to your HP desktop calculator.

*For details, check the HP Reply Card.*

## Train and gain with HP's logic lab

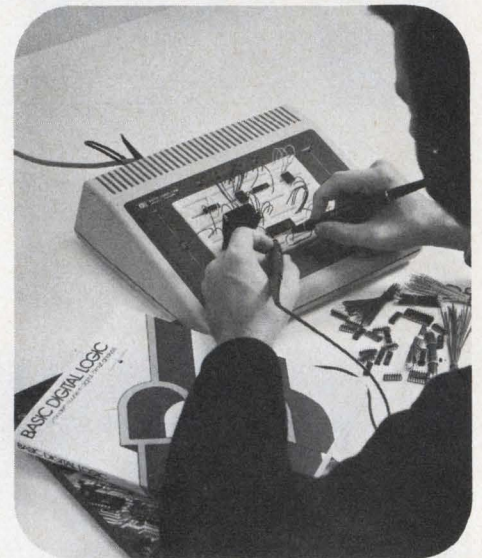

No grueling soldering or unsoldering—the plug-in breadboard uses solderless connection techniques.

Here's a simple way to upgrade yourself or your technicians to the new digital technology. Designed for hands-on learning, the 5035T logic lab is a complete self-paced or classroom course in digital electronics with a textbook, lab workbook, fully equipped portable laboratory, and proven digital test instruments. You learn to assemble functioning digital circuits using the breadboard, components, and interconnecting wiring—all supplied with the logic lab.

Simply place the breadboard in the lab station mainframe. All essentials needed to stimulate the circuits are built-in: power supply, logic state indicators and programmers, and pulse sources. You can verify circuit operation using professional digital test instruments—the HP logic probe, logic pulser and logic clip. You not only learn how to troubleshoot, but also see visual evidence of circuit behavior so that you can make sense of interactions. If you stop in the middle of assembling or testing, the logic lab is always ready for the next user. You can easily remove a breadboard and replace it with another without disturbing the circuits.

*Simply check the HP Reply Card for more information.*

## Three new sensors increase RF power level measurements

Three new thermocouple power sensors extend the capability of HP's precision 435A microwave power meter to higher power levels, lower frequency ranges, and 75 $\Omega$  system measurements.

- For higher power levels in the 10 MHz—18 GHz frequency range, use the new 8481A opt H01 sensor whose power range is 30  $\mu$ W to 3W. Its SWR is impressive: <1.2 to 8 GHz, <1.3 for 8 to 12.4 GHz, and <1.5 over 12.4 to 18 GHz.
- For power measurements at lower frequencies, the new 8482A sensor covers 100 kHz to 4 GHz. SWR is <1.18 from 300 kHz to 2 GHz, and <1.3 from 2 to 4 GHz. Power range is 0.3  $\mu$ W to 100 mW (-35 to +20 dBm).
- Measurements in 75 $\Omega$  systems are no problem for the new 8483A sensor. Power range is -35 to +20 dBm, over a frequency range of 100 kHz to 2 GHz. Above 600 kHz, SWR is <1.18.
- For general purpose use, the popular 8481A sensor covers 10 MHz to 18 GHz in frequency, and 0.3  $\mu$ W to 100 mW (-35 to +20 dBm) in power. Its SWR is <1.18 at 30 MHz to 12.4 GHz, and <1.28 from 12.4 to 18 GHz.

Need a power meter for field tests? The 435A options include an internal rechargeable battery pack and long cables to operate any of the above sensors up to 200 feet from the meter.

For details, check the HP Reply Card.

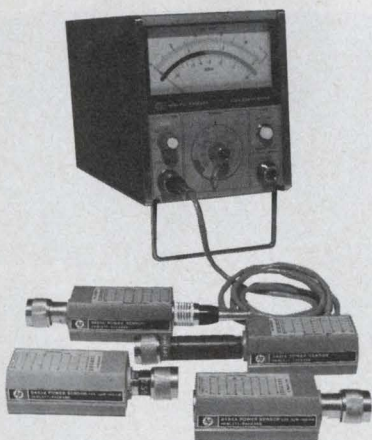

Each sensor has very low SWR which means reduced mismatch error—hence, better overall measurement accuracy.

## New amplitude/delay distortion analyzer meets CCITT specs



With increasing use of audio channels for transmission of non-voice traffic (such as data or facsimile), parameters like attenuation and delay distortion acquire a new significance. While voice traffic is relatively immune to these distortions, they can cause errors in data transmission.

The International Telegraph and Telephone Consultative Committee (CCITT) has specified an instrument for

the measurement of envelope delay distortion and attenuation distortion on audio channels, and HP's new 3770A portable amplitude/delay distortion analyzer meets these requirements.

The 3770A measures envelope delay distortion ( $\pm 10$  mS), attenuation distortion ( $\pm 40$  dB), and absolute level (+10 dBm to -50 dBm) over the frequency range 200 Hz to 20 kHz. It's easy to use, highly accurate, and ensures repeatability of results. The sender and receiver are contained in a single portable unit. The sender provides both manual adjustment of the measurement frequency and single or continuous sweep, within digitally set sweep limits. The sender output level is calibrated to permit measurements of channel loss. A telephone/monitor facility is provided to allow communication in 2 or 4 wire modes over the channel under test.

For more information, check the HP Reply Card.

(continued from page 1)

processing speeds. Firmware microprograms such as HP's Fast FORTRAN Processor enable programs to run 2 to 30 times faster than possible with conventional programming techniques.

The new minicomputer family is modular so you can design a system to fit your needs. Choose one of two HP 21-M microprogrammable processors, then select from two HP 21-X memory systems:

- The M/10 processor is only 5 $\frac{1}{4}$  in. (13.3 cm) high, can contain 32K 17-bit words of memory, and has 4 powered I/O channels within its mainframe.
- The M/20 processor is 8 $\frac{3}{4}$  in. (22.2 cm) high, will be expandable to 64K later this year, and has 9 powered I/O channels in the mainframe.

Floating point firmware, memory parity, extended arithmetic unit (EAU), and power fail detection are standard. Both processors have control store addressing space for 4096 24-bit words, four times greater than the 1024 of earlier core units. As for compatibility, any program written for the earlier HP 2100 systems will run on the new HP 21MX series. All 2100 peripherals and

interfaces are compatible as well.

MOS memory technology enables HP to offer semiconductor memories with 650 ns cycle time:

- The HP 21-X/1 is a high-density memory that comes in 8K and 16K 17-bit word modules.
- The HP 21-X/2 is a medium-density memory system that you can purchase in 4K and 8K 17-bit word modules.

The unique 21MX power system functions even in substandard electrical conditions. Line voltage can fluctuate up or down 20% without danger. In the event of a total line failure, the power fail recovery system will sustain the integrity of a 32K memory system for at least two hours.

At the moment, availability is restricted to purchasers ordering 5 or more processors.

To learn more, check the HP Reply Card.

## New high-speed plotter augments HP time-share systems

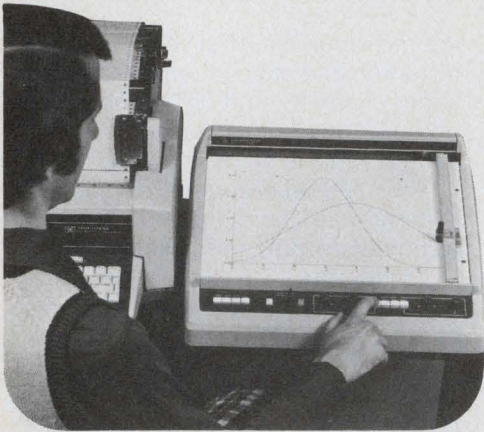

Now, you can quickly view a graphical solution to your problem instead of interpreting long lists of numbers or wrestling with bulky printouts.

Now, you can plot up to 7 vectors per second in any direction with HP's new high-speed digital plotter. This new 7203A x-y plotter works with an HP 2000C or 2000F time-share system and operates in parallel with your terminal so you get both graphs and printouts. The new plotter accepts bit-serial ASCII data at the rate of 10 or 30 characters per second.

You can plot graphs on any size paper up to 11 by 17 in. (28 by 43 cm). Unlike the "staircase" drawings from incremental plotters, the 7203A draws a

clean, smooth, continuous line. If there is an error in data transmission, that point is omitted and the next correct point is plotted. Four colors of ink are available, and the pens are disposable for convenience. Simply snap out an empty pen, and snap in a new one.

A picture may well be worth a thousand numbers.

To learn more, check the HP Reply Card.

## New super-fast CRTs increase display area

Two new large-screen CRT displays maintain crisp, sharp traces regardless of position on the screen, changes in writing speed, or z-axis modulation. Linear writing speed is a super-fast 10 in/ $\mu$ s (25.5 cm/ $\mu$ s). More than 4096

characters can be refreshed on the screen in less than 5 ms. Yet power consumption is extremely low—only 100 W, compared to 500 W or more on older style displays.

Model 1317A is the largest CRT display that can be mounted horizontally in a standard 19 in. (48.3 cm) equipment rack. Ideal for instrument systems, it fits flush with the front panel yet gives you up to 65% more display area than commonly used CRTs. The other new model, 1321A, is even larger, a 21 in. (53.3 cm) diagonal display that's especially useful for highly detailed computer graphics. Several options, including different phosphors and contrast filters, are available.

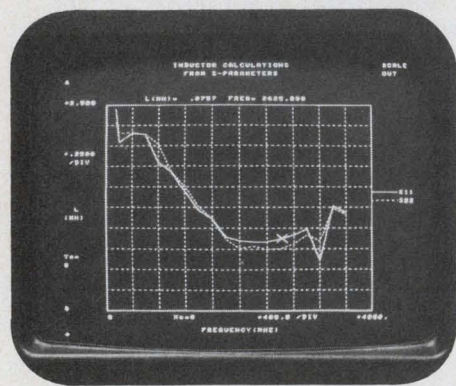

With point plotting time of <math><200\text{ ns}</math> per point, the new 1317A produces a graph like this, in sharp focus, within milliseconds.

Simply check the HP Reply Card for more information.

## Now, measure microwave pulses automatically

The new 5354A automatic frequency converter for HP's 5345A counter brings innovations to pulsed carrier frequency measurements in DME and ATC navigation and identification systems, surveillance radar, ECM and even microwave ovens. It's accurate and automatic; no external equipment is needed. For example, measure a clean 1  $\mu$ s wide pulse to 4 digits simply by applying the signal to the input.

External gating helps position the measurement so that you can measure the entire pulse except leading and trailing edges that may contain anomalies. Thus, maximum useful resolution is achieved. Or, the external gate can be narrowed to 20 ns and positioned within the pulse to measure frequency profiles, such as within a chirp radar signal.

Another innovation, frequency averaging, increases resolution for repetitive pulse trains by averaging separate measurements made over many pulses. Blind spots are eliminated, and true averages are guaranteed.

You can also obtain external gating and frequency averaging above 4 GHz with the 5345A counter by using the 10590 plug-in adapter and existing HP 5245L counter plug-ins.

For details, check the HP Reply Card.

The 5354A frequency converter brings the accuracy and convenience of automation to microwave pulse measurements.

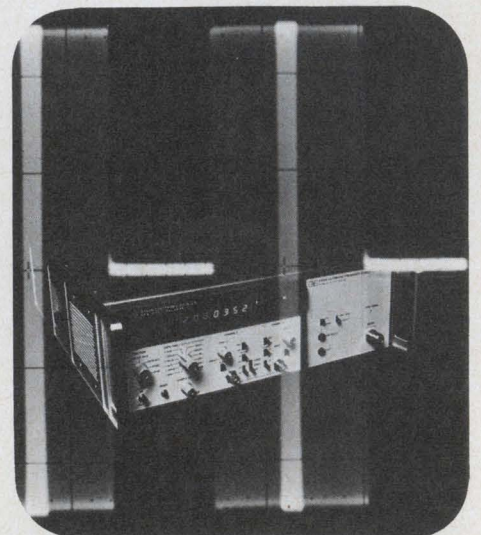

## Two new options extend pulse generator applications

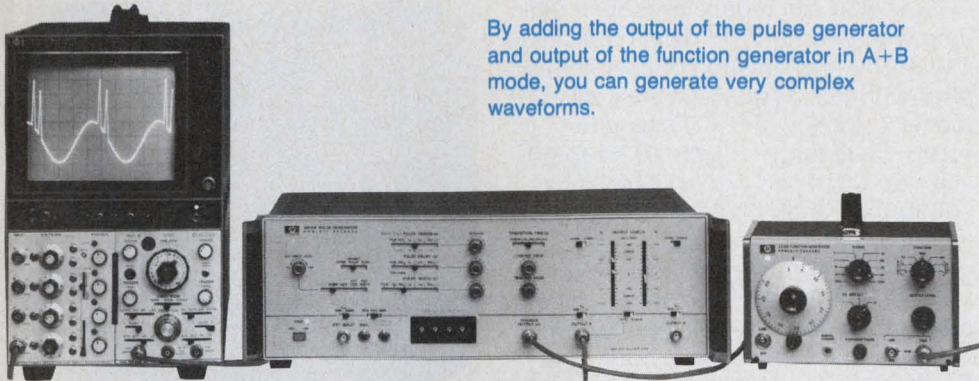

By adding the output of the pulse generator and output of the function generator in A+B mode, you can generate very complex waveforms.

Two new options expand use of the versatile 8015A pulse generator: one option lets you use the 8015A with another generator to achieve higher output voltages, and the other option provides a third output that delivers TTL-compatible pulses.

The 8015A is a dual-output generator capable of testing CMOS, low-threshold MOS and most high-threshold MOS logic, as well as TTL, HTL and discrete circuits. Each output produces pulses as strong as 16V, or you can combine outputs for a 30V range, from -15 to +15V.

Option H01 lets the 8015A outputs be used as linear amplifiers, from dc

to 60 MHz (+1 to -3 dB). With separate access to each output amplifier, you can use one as the normal pulse generator output and connect the other to any external signal generator.

Option H04 provides a third output that delivers fixed TTL-compatible 4.6V pulses while you can vary all other pulse parameters from the front panel controls. This option adds greater operating convenience and prevents TTL circuit damage by accidental changes of output amplitude.

For more information, check the HP Reply Card.

## New meter measures high capacitance automatically

Measuring high capacitances of electrolytics and tantalum capacitors is faster and easier with the new 4282A digital high capacitance meter. Ideal for inspection and manufacturing, it measures capacitance from 10 nF to 1 F, dissipation from 1.0 to 10 with 0.001 resolution, and the product of capacitance and equivalent series resistance (ohm-farads). Reading rate varies from 0.3 to 2 seconds. You can even use the 4282A as a 3-digit voltmeter to 600 V.

Measurements appear on the LED display. Capacitance and dissipation factors are displayed alternately—you don't have to reset the panel switches or use two different instruments. Four test frequencies are available: 50, 60, 100 and 120 Hz. The 4282A is remotely programmable, and you can attach a printer to document results.

To learn more, check the HP Reply Card.

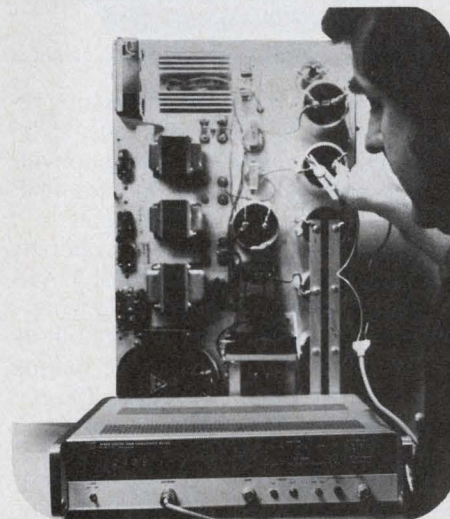

Here, the 4282A digital meter checks some tantalum capacitors.

## Precision power supply doubles as a DVM

DC calibrators, reference sources, and high performance lab supplies are just a few traditional uses for HP's 6114A/6115A precision power supplies. Here's a little trick that lets you convert these supplies into nulling digital voltmeters with accuracy better than 0.025% + 1 mV. The setup includes a galvanometer, like so:

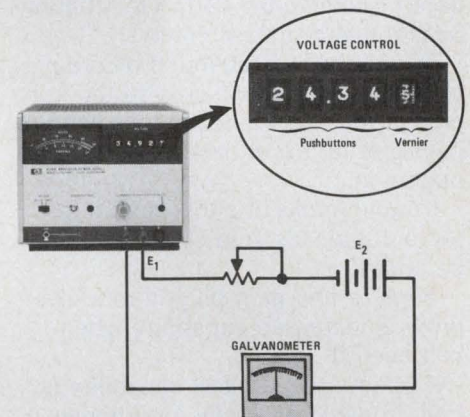

When the galvanometer reads 0, then unknown voltage  $E_2 = E_1$ . Just read the unknown voltage off the 4-digit pushbutton switch and fifth-digit vernier control.

These 40W supplies feature output voltage accuracy of 0.025% + 1 mV, with 5-minute cold-start warmup. Both models use four-digit pushbutton switches for fast, accurate voltage setting, with a fifth-digit vernier providing 200  $\mu$ V resolution. Model 6114A provides 0-20V at 0-2A and 20-40V at 0-1A. Model 6115A provides 0-50V at 0-0.8A and 50-100V at 0-0.4A. These supplies also have constant voltage/constant current operation, front-panel mode indicator, built-in overvoltage protection, high speed, and remote programming capability.

For details, check the HP Reply Card.

## Now you can record weeks of data continuously and unattended

The two-channel 7402A oscillographic recorder is a low-cost proven instrument with dual 50 mm channels, stainless-steel pens, and a new instant dry ink system. Now, several new options customize the 7402A for continuous long-term measurements.

For all those unattended recordings, attach an optional take-up to the front of your recorder. It neatly rolls enough paper for up to 58 days of continuous operation.

Timing marks at either minute or second intervals, and event marks can be added.

High or low gain plug-in modules provide increased capability when you need it.

Since remote control capability is built-in, you can easily incorporate the 7402A in a computerized data system.

*For details, check the HP Reply Card.*

Simply slip the option module into the main frame—it's that easy to adapt your 7402A to long-term measurements.

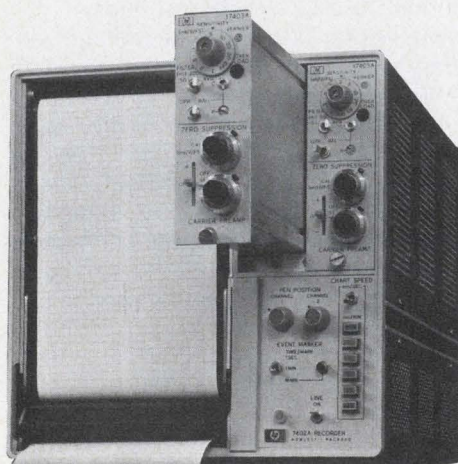

## Make faster, error-free voice and data measurements

Now, you can reduce telephone test time with two new HP digital test sets. The 3551A transmission test set complies with Bell System requirements; model 3552A, with CCITT requirements. Frequency range is 40 Hz to 60 kHz. Both test sets are lightweight (13 lb/6 kg) and portable—ideal for field as well as bench use.

Suddenly all other methods are old-fashioned. Now, you can make voice, program or data circuit measurements with just one instrument. Check tone level, noise level and frequency at the same time you send tone. Autoranging speeds your measurements; you know immediately if your levels are too high or too low, insuring correct readings every time. And you can measure amplitude and frequency directly into the impedances with which you work.

The digital LED readout displays level or frequency of either the input



or output. Either test set can be powered from an ac line or rechargeable batteries.

*For more information, check the HP Reply Card.*

## New D/A converter and remote digital display for HP counters



Two new accessories provide analog output or an extra digital display.

Even in this digital world, analog records are useful to show trends. HP's new 59303A digital-to-analog converter lets you make a strip chart from HP 5345A or 5340A counter outputs or other ASCII-output devices. It operates directly with the new super-fast 5345A counter and any compatible logging device such as the 7155A portable recorder or a CRT. This fast DAC outputs a voltage accurate to 0.1% in 30  $\mu$ s, from your selection of any three consecutive digits in an ASCII data string.

It's convenient to use, too. Hook up the recorder, and calibrate it simply by turning the DAC's concentric knob to "calibrate." Then select the digit trio.

There's no need for auxiliary equipment to shift zero or change the polarity. If you have an HP 9820A/21A calculator, you can operate the DAC under remote control as all functions are programmable.

Another useful counter accessory is the new 59304A display that shows 12 digits in scientific notation or fixed point. Use it anytime you want the counter display reported at another location on the interface bus.

*To learn more, check the HP Reply Card.*



## High-value signal generator for every bench

Although it's usually thought of in terms of receiver testing, the venerable HP 608 VHF signal generator has also enjoyed widespread use as a bench delivering good quality, calibrated-level test signals. This same order of signal quality for general purpose applications can now be obtained with the all solid-state HP 8654A which is 1/5 the 608's size, 1/4 its weight, and priced considerably lower.

The 8654A covers 10-520 MHz with +10 to -130 dBm output power (automatically leveled to  $\pm 1$  dB over its en-

tire frequency range). Internal modulation tones (400/1000 Hz) are included for calibrated AM as well as simple FM. The unit can also be externally modulated.

The 8654A's carrier stability is comparable to that of the older 608—typically <20 ppm/5 minute period after warm-up. And the other facets of signal purity are compatible with most general-purpose applications.

For more information, check the HP Reply Card.



The 8654A offers high value for general purpose bench use.

## HEWLETT-PACKARD COMPONENT NEWS



Green: 2½ times brighter than our standard T-1 red LED.

Yellow: 6 times brighter

The new red: 6 times brighter

### Brighten your displays with new red, yellow and green LEDs

Three new LEDs give you an interesting choice of colors and luminous intensity many times brighter than our standard T-1 red lamp. All have a 180° viewing angle, good on-off contrast ratio, and a low price tag.

The new green lamp (5082-4984) uses gallium phosphide to generate a typical luminous intensity of 2 mcd at 20 mA.

Our new yellow lamp is *really* yellow. The 5082-4584 offers 2.5 mcd typical at 10 mA.

Red has an output 6 times brighter, thanks to non-saturating gallium arsenide phosphide. With intensity of 2.5

mcd at 10 mA, the new 5082-4684 red LED is unbeatable.

With these new LEDs, Hewlett-Packard has significantly advanced the state-of-the-art. The design achieves maximum light output by minimizing absorption losses. By using a transparent substrate chip instead of an absorbing substrate, HP has increased coupling efficiency by as much as a factor of 18. Light rays directed downward or rays reflected from the top surface are not absorbed; they are reflected back to the top surface, increasing light output.

Compare these new LEDs with other

GaP and Ga(As,P) devices. At 10 mA, the red and yellow lamps emit approximately 10 times more light than conventional red Ga(As,P) devices. At this same drive current, they generate about 4 times as much light as typical red GaP (Zn,O) LEDs. At 10 mA, the new green lamp produces over 3 times the luminous flux of standard Ga(As,P) red devices.

To learn more, check the HP Reply Card.

## New high-frequency scope brings new accuracy to fast digital measurements

The 1720A uses color-coded pushbuttons for easy operation—blue for display modes, green for triggering, and gray for secondary features.

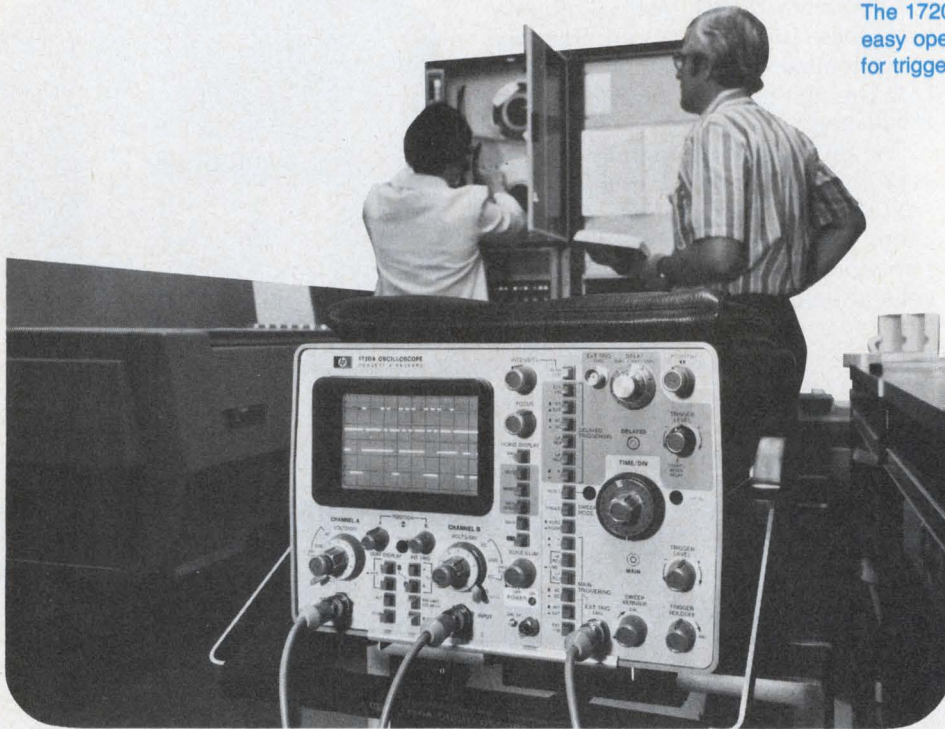

Our new high-frequency oscilloscope is designed especially for systems using fast logic—computers, peripherals, and high-speed digital communications equipment, as well as high-frequency RF applications. The new 1720A has two channels with 10 mV/cm deflection factors, sweep speeds

to 1 ns/cm, frequency response to 275 MHz, and a practical price to fit your budget.

Accuracy specs are unequalled in its class: calibrated sweeps are accurate to  $\pm 3\%$  from 0° to 55°C (only 2% in the 100 ns/cm to 20 ms/cm range)—specified over the full 10 cm of horizontal

deflection. Differential time measurements are within 1% for most applications.

Switch-selectable 50 $\Omega$  or 1 M $\Omega$  inputs offer maximum flexibility. The 275-MHz bandwidth is maintained in both impedance modes from 0° to 55°C and when the amplitude verniers are in use. The 1720A requires only 1 cm of vertical deflection for stable triggering to 300 MHz (only 0.5 cm to 100 MHz). The internal trigger sync take-off point is immediately after the attenuator which maintains a stable display regardless of changes in position, vernier or polarity controls. The  $\times 10$  magnifier offers increased measurement flexibility in all sweep speeds by letting you expand any portion of the waveform without using the delayed sweep.

*For more information, check the HP Reply Card.*

**HEWLETT**  **PACKARD**

East-20010 Century Blvd., Germantown, MD 20767, Ph. (301) 428-0700.

South-P.O. Box 2834, Atlanta, Ga. 30328, Ph. (404) 436-6181.

Midwest-5500 Howard Street, Skokie, Ill. 60076, Ph. (312) 677-0400.

West-3939 Lankershim Boulevard, North Hollywood, Calif. 91604, Ph. (213) 877-1282.

Europe-Post Office Box 85, CH-1217 Meyrin 2, Geneva, Switzerland, Ph. (022) 41 54 00.

Canada-6877 Goreway Drive, Mississauga, Toronto, L4V 1L9, Ph. (416) 678-9430.

Japan-Yokogawa-Hewlett-Packard, 1-59-1, Yoyogi, Shibuya-ku, Tokyo, 151.

# The new Keithley Model 168 autoranging DMM... ...vive la différence!

There really is a difference in Digital Multimeters, and once you've experienced Keithley's 168 you'll know why we say *vive*! If you're tired of "general-purpose" promises that turn into run-of-the-mill

performances; if you want that bit extra that'll make your job easier, then *vive la différence*... here's the DMM for you! Send for our DMM Selector Guide or call us for demo now. **Phone (216) 248-0400.**

**AC VOLTS  
DC**  
**AMPS  
OHMS**

**5 functions**

100  $\mu$ V to 1000 V dc  
100  $\mu$ V to 500 V ac  
0.1  $\mu$ A to 1 A dc  
0.1  $\mu$ A to 1 A ac  
100 m $\Omega$  to 20 M $\Omega$

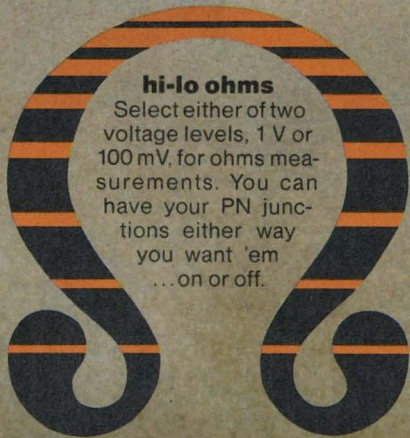

**hi-lo ohms**

Select either of two voltage levels, 1 V or 100 mV, for ohms measurements. You can have your PN junctions either way you want 'em ... on or off.

**two-terminal input**

Simple to connect. You can't get it wrong. Eliminates the word "whoops" from your vocabulary. Saves temper, too.



**options & accessories**

Rechargeable batteries that you can install anytime. An RF probe for high frequencies. Test leads. A 50-amp current shunt too.

**price**

Enough said? Order one... or two... or three now!

**\$299<sup>00</sup>**



**automatic ranging**

You just connect the signal and push the function. The decimal point pops into position automatically and the display is direct reading. That does save time!

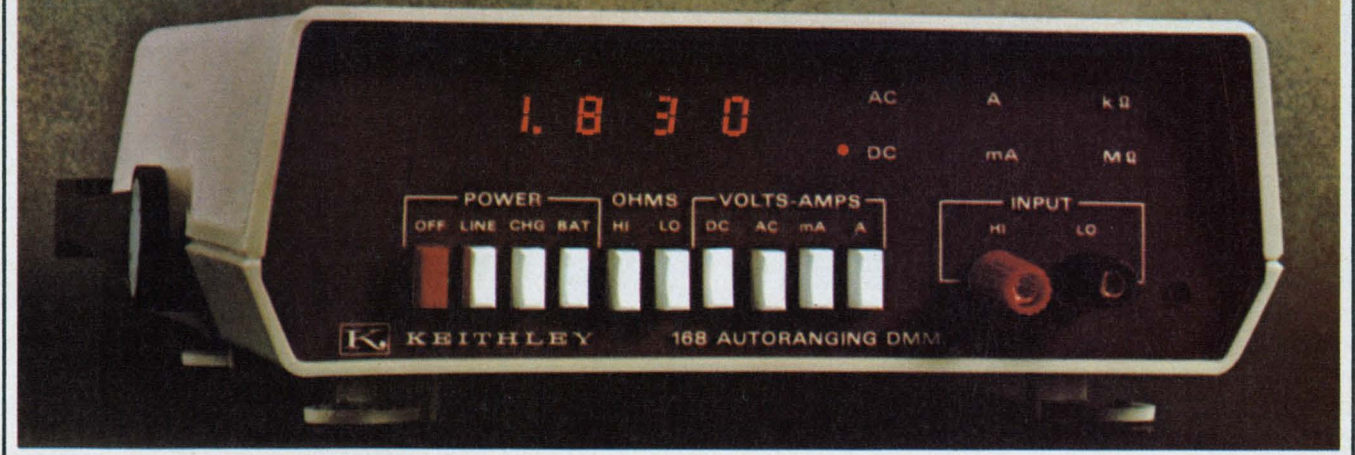

See and use the new Keithley Model 168 at WESCON 74, Booths 2808/9.

**KEITHLEY INSTRUMENTS**  
U.S.A.: 28775 AURORA ROAD, CLEVELAND, OHIO 44139  
EUROPE: 14, AVENUE VILLARDIN, 1009 PULLY, SUISSE

INFORMATION RETRIEVAL NUMBER 7



...when one has a sure thing it is hard to resist showing off a little. Just as the royal flush is a guaranteed winner in poker, Futaba parts mean the same certainty for most major Japanese manufacturers. Precision manufacturing and reliability of performance are two reasons. Another great reason is constancy of supply. No matter how good parts are, this means nothing if they are not available when needed. With modern, high-capacity manufacturing facilities, this is where Futaba holds a real winning hand. Futaba parts—just ask for them.



Standard keyboard switches and key tops available from FUTABA stock for instant keyboard layout on your mounting plate.

**OTHER FUTABA PRODUCTS:**

- Press die sets.
- Mold bases for plastics.
- Material feeders for press work.
- Automatic stopping devices for automatic machinery.
- Radio control for hobby aircraft, race cars, etc.

**WE DON'T MEAN  
TO SHOW OUR HAND, BUT...**



**"FUTABA—THE BRIGHT PRODUCER"**

● For additional information, please contact:

**FUTABA INDUSTRIES U.S.A.**  
630 West Carob Street, Compton, California 90220, U.S.A.  
Phone: (213) 537-9610 Telex: 69-1227

**FUTABA ELECTRONIC INDUSTRIES LIMITED**  
Super Bldg., 1-11-5, Sotokanda, Chiyoda-ku, Tokyo, Japan. Phone: 255-5881  
Telex: J26532

# In the time it takes to read this sentence, our new 300 ips DC Capstan Motor can accelerate from 0 to 3840 rpm and stop, over 18,000 times.

The MICRO SWITCH 500VM Series DC Control Motor that can match 300 ips, .3" IRG high-density (6250 bytes) tape drive systems for speed.

It can accelerate from 0 to 3840 rpm in .66 milliseconds. Rewind at 12,000 rpm. And do it time after time, hour after hour.

Part of this ability comes from its low inertia, hollow-rotor construction. There's no rotating iron core. So you get acceleration and deceleration rates in excess of 900,000 rad/sec<sup>2</sup>.

The cooling has been optimized for maximum efficiency: .33°C/watt, with forced air.

The precision bearings are double-sealed for smooth operation, long life, and minimum shaft run-out.

It also has high servo stability—its first frequency resonance is above 3800 Hz., outside of most servo bandwidths.

And, even though it's brand-new, you can be sure that the 500VM Series Motor is a reliable motor. Its design is based on the years of experience MICRO SWITCH has gained with all the other motors in the VM line.

And those include motors used in line and serial printers; image handling systems; film drives and special photo processing equipment; optical and electronic inspection systems; and NC for machine tools. All of them with hollow-rotor construction. All of them available with capstan, capstan manifold, and digital or analog tachometer.

If you'd like more information on any of them, you can get the address and telephone number of your nearest MICRO SWITCH Branch Office by calling, toll-free, 800/645-9200 (in N. Y., call 516/294-0990, collect).

They can show you virtually any DC Control Motor you might need. Including the one that high density digital tape drives have been waiting for.

MICRO SWITCH products are available worldwide through Honeywell International.



**MICRO SWITCH**

FREEMONT, ILLINOIS 61032

A DIVISION OF HONEYWELL

easy does it

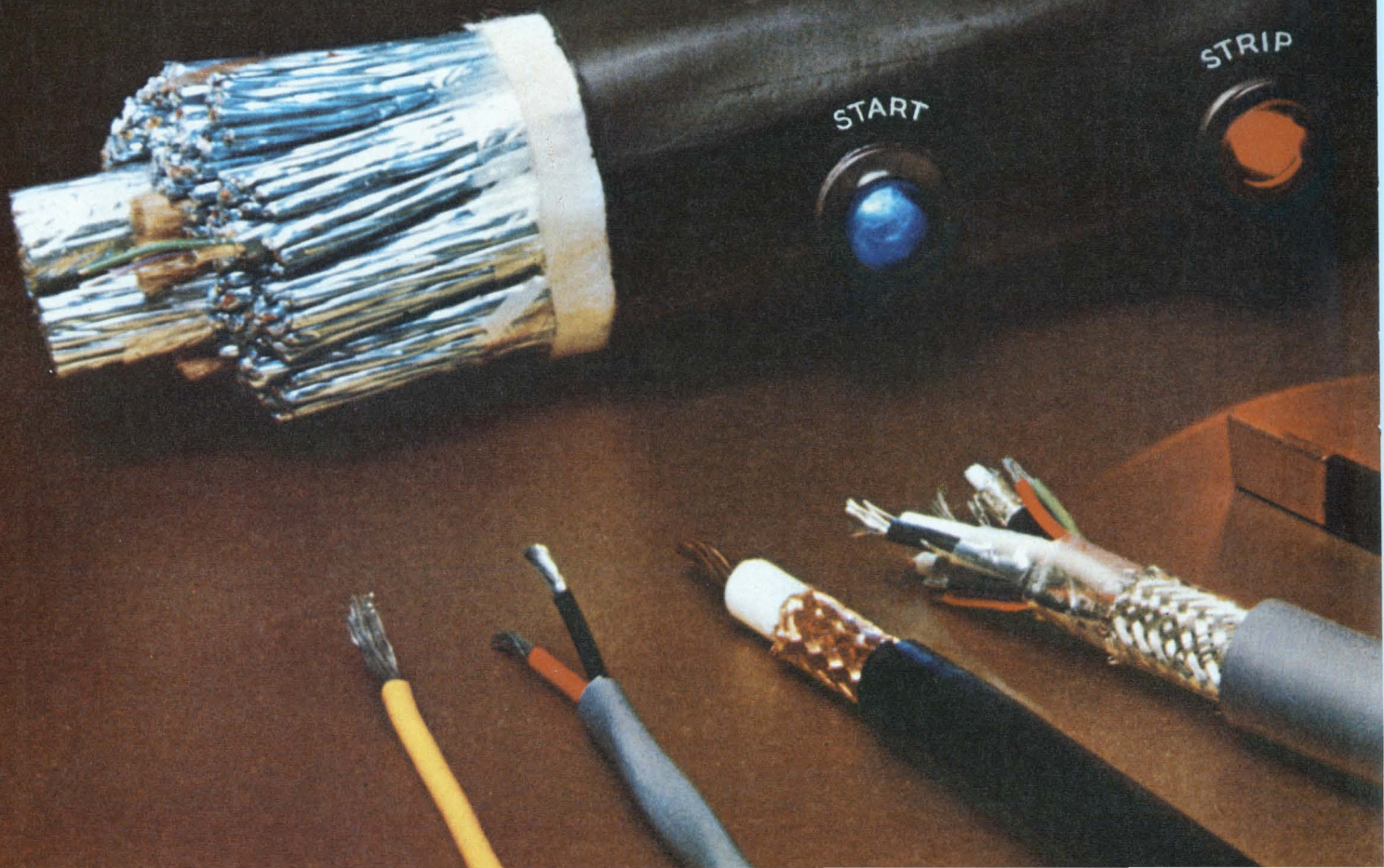

A pushbutton system for instant cable installation? It's not here yet, but a Belden wire, cable and cord specialist does have the know-how and product capabilities that can save you time and money all down the line. An important point, if you consider that cable usually costs far less per foot than the man-hours of the people installing it.

Your Belden specialist knows a lot about wiring assembly techniques: harnessing, termination and stripping methods. He can give you definitive answers on what jacketing, insulating or shielding options deliver the best reliability, safety and installation economy. He can tell you what

the trade-offs are. And their cost. He also offers a complete service package: standards; custom designs; one source for all your wire, cable or cord needs. Quality cable answers that combine the best of performance and installation ease. Talk to him about it. You won't find a better source for understanding or results.

If you have a problem and would like "right now" answers, call:  
(312) 681-8920, Electrical Division  
(317) 966-6681, Electronic Division  
(312) 887-1800, Transportation Division  
Or write Belden Corporation, 2000 South Batavia Avenue, Geneva, Illinois 60134.

H-1-3

**BELDEN** 

INFORMATION RETRIEVAL NUMBER 234

HARNESS

TERMINATE

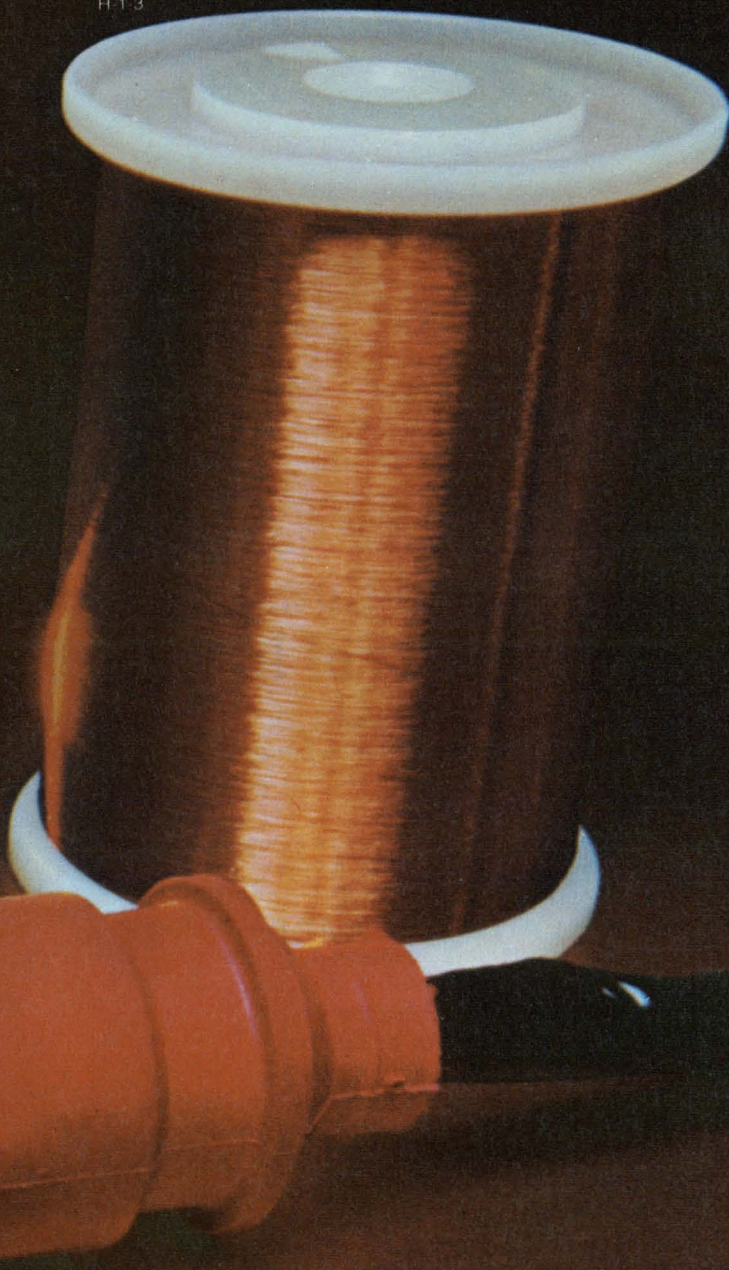

# Locate the IC you need ... fast



## ... with Integrated Circuit Parameter Retrieval ... your in-plant source of IC suppliers and data sheets.

Consider your IC data-search and retrieval problems a thing of the past. Forget about time-consuming catalog searches, missing data sheets and worries about inadequate or outdated IC information.

Now, there's a modern, efficient way to locate IC suppliers and their catalog data... VSMF® IC/PR Service. This microfilm service puts current IC manufacturers' catalogs right in your plant and makes it easy for you to locate needed data sheets in seconds. Comprehensive indexing cuts your search and retrieval time dramatically by taking you directly to the device you need... by functional description or by number. Microfilm cartridges assure you of data integrity by preventing data-sheet removal. You have quick access to major IC suppliers' products to help you speed design and locate alternate sources. And you get an instant copy of any data sheet you need.

**IC/PR saves you time and space.** It gives you a broader base of IC suppliers and products to choose from. And it keeps you completely current on IC products with automatic updating every four months. In addition, you get telephone data-assistance when you can't locate the item you need. So find out how this unique IC service can speed your design process.



Contact Information Handling Services,  
Box 1154, Englewood, Colorado 80110.  
Phone (303) 771-2600 Ext. 239.



**Information Handling Services**  
An Indian Head Company



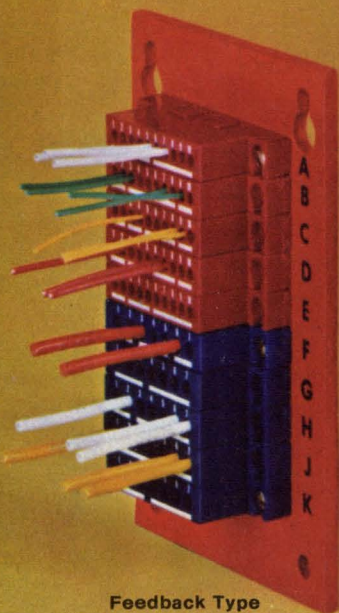

Feedback Type

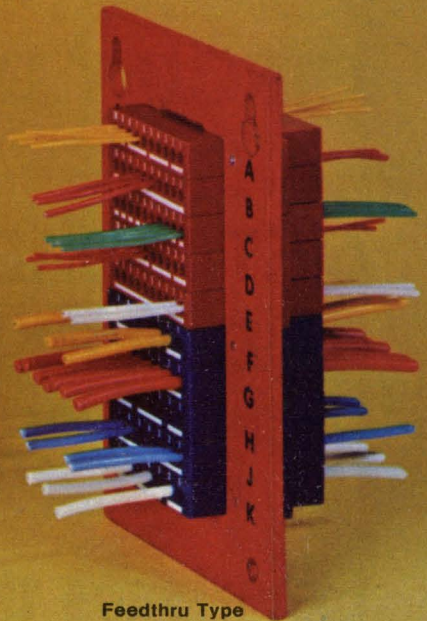
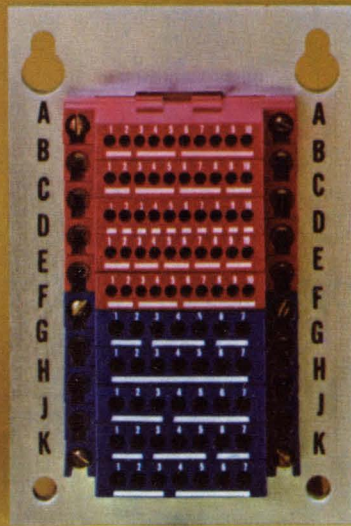

Feedthru Type

**Plate-Mounted Terminal Blocks.** Appleton Programming Terminal Blocks are offered in Feedthru and Feedback types to provide electrical continuity program bussing for input/outputs as required for your application. Size 16 blocks (color coded blue

and rated at 13 Amps) accept 16, 18, and 20 AWG stranded wire, and provide up to 15 contacts per square inch. Size 20 blocks (color coded red, rated at 7.5 Amps) accept 20, 22, and 24 AWG stranded wire, and provide up to 21 contacts per square inch.

## Low-cost Appleton Programming Terminal Blocks — complete selection of bussed or individual circuits.

**Individual Terminal Blocks.** Available in same sizes as plate-mounted groups, for chassis mounting. Made of high-strength glass-filled thermoplastic dielectric, U.L. Rated SE-O. Appleton's unique one-piece socket contact design provides uninterrupted circuit through all bussed positions, for consistently low mv drop. Molded interlocks on each block facilitate multiple stacking.

### Off-the-shelf delivery!

You can order Appleton's low-cost Programming Terminal Blocks from stock to meet your application needs for interconnection, bussing and signal distribution, test points, patch boarding and similar applications. For information, call (312) 327-7200, or write Appleton Electric Co., Electronics Division, 2950 N. Paulina St., Chicago, Ill. 60657.

4-219

INFORMATION RETRIEVAL NUMBER 13



# APPLETON®

**Easy insertion/removal of pin contacts.** Standard plastic tool permits simple insertion or removal of pin contacts for disassembly or programming circuit changes without disturbing other program functions. Highly reliable crimp wire termination pin contacts are used. Crimping is accomplished with standard industry-accepted manual or semi-automatic tools.

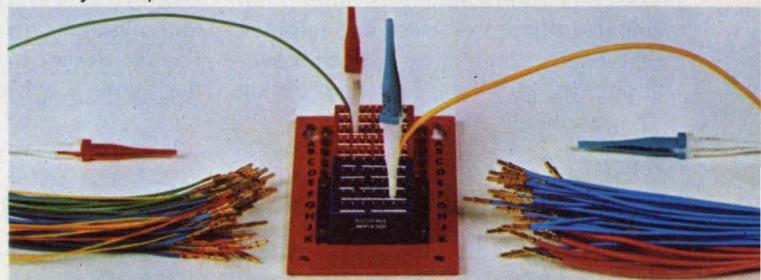

**Optional environmental sealing.** All Appleton Programming Terminal Blocks are available with optional rubber wire sealing grommets to seal out dirt and moisture.

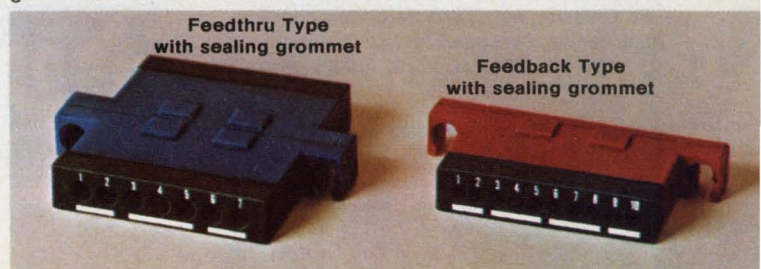

Feedthru Type

Size 20

Size 16

Feedback Type

Feedthru Type with sealing grommet

Feedback Type with sealing grommet

# CIRCUIT DESIGNERS...

## GET MORE VERSATILITY AND FLEXIBILITY IN YOUR BREADBOARDING.

Experience the convenience of

# MULTI-COMP<sup>®</sup> DIP Multiple-Section

## Ceramic Capacitors

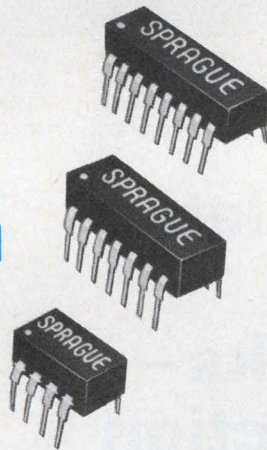

Breadboarding is a lot easier with Sprague Multi-Comp Monolythic<sup>®</sup> Ceramics. They readily plug in and out of standard DIP sockets for fast changes during experimentation. They come as 4-, 7-, and 8-section capacitors, in popular most-frequently-used capacitance values. By connecting capacitor sections in parallel, you can obtain

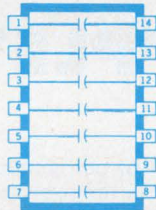

practically any value your circuit needs. With a few Multi-Comp capacitors on hand, there's no need to keep heavy stocks of individual capacitors for breadboarding purposes. There's less soldering and unsoldering, too.

**And when your final capacitance determinations are made, you can either stay with DIP Multi-Comps, or switch to Sprague Single-Section Monolythic<sup>®</sup> Capacitors, which have the same layer-built construction and the same electrical characteristics.**

**GET THE DIP HABIT —  
TRY MULTI-COMP<sup>®</sup> MONOLYTHIC<sup>®</sup> CAPACITORS IN YOUR NEXT  
BREADBOARD DESIGN — THEY'RE READILY AVAILABLE FROM  
YOUR SPRAGUE INDUSTRIAL DISTRIBUTOR!**

For more information, write or call  
Ed Geissler, Mgr., Specialty Components  
Marketing, Sprague Electric Company,  
347 Marshall Street, North Adams, Mass. 01247.  
Tel. 413/664-4411.



THE BROAD-LINE PRODUCER OF ELECTRONIC PARTS

INFORMATION RETRIEVAL NUMBER 14

## ACROSS THE DESK

(continued from page 8)

but not impractical. Fires are more expensive and less practical.

4. Fire started when plugging in or unplugging appliance (electric coffee pots, waffle irons, etc.): Install a switched outlet with a mercury switch.

If Mr. Willoughby and every other screwdriver owner did these modifications, we might have 30-dB fewer fires.

Paul J. Christie  
Design Engineer

208-27 15th Rd.  
Bayside, New York

## Card puller available from two sources

The printed-circuit-card extractor referred to in Across The Desk ("Who Manufactures This Card Puller?," ED No. 11, May 24, 1974, p. 14) is available from Branem Industries, Inc., Box 56, Greene, N.Y. 13778. A similar product is also available from E. H. Titchner, 1 Titchner Place, Binghamton, N.Y.

## CAMAC pamphlet can be yours

Many readers called us when they failed to obtain the CAMAC pamphlet described in the "Focus on Data-Acquisition Equipment" (ED No. 12, June 7, 1974, p. 77). The Government Printing Offices were called. The TID numbers given in the Focus are correct but incomplete. The full document number and cost for each are as follows:

Y3AT7:22/TID—25875, \$0.65

Y3AT7:22/TID—25876, \$0.60

Y3AT7:22/TID—25877, \$0.75

Y3AT7:22/TID—26488, \$2.75

Copies of the CAMAC specifications are available from the Government Printing Offices, Washington, D.C. 20402.

ELECTRONIC DESIGN 16, August 2, 1974

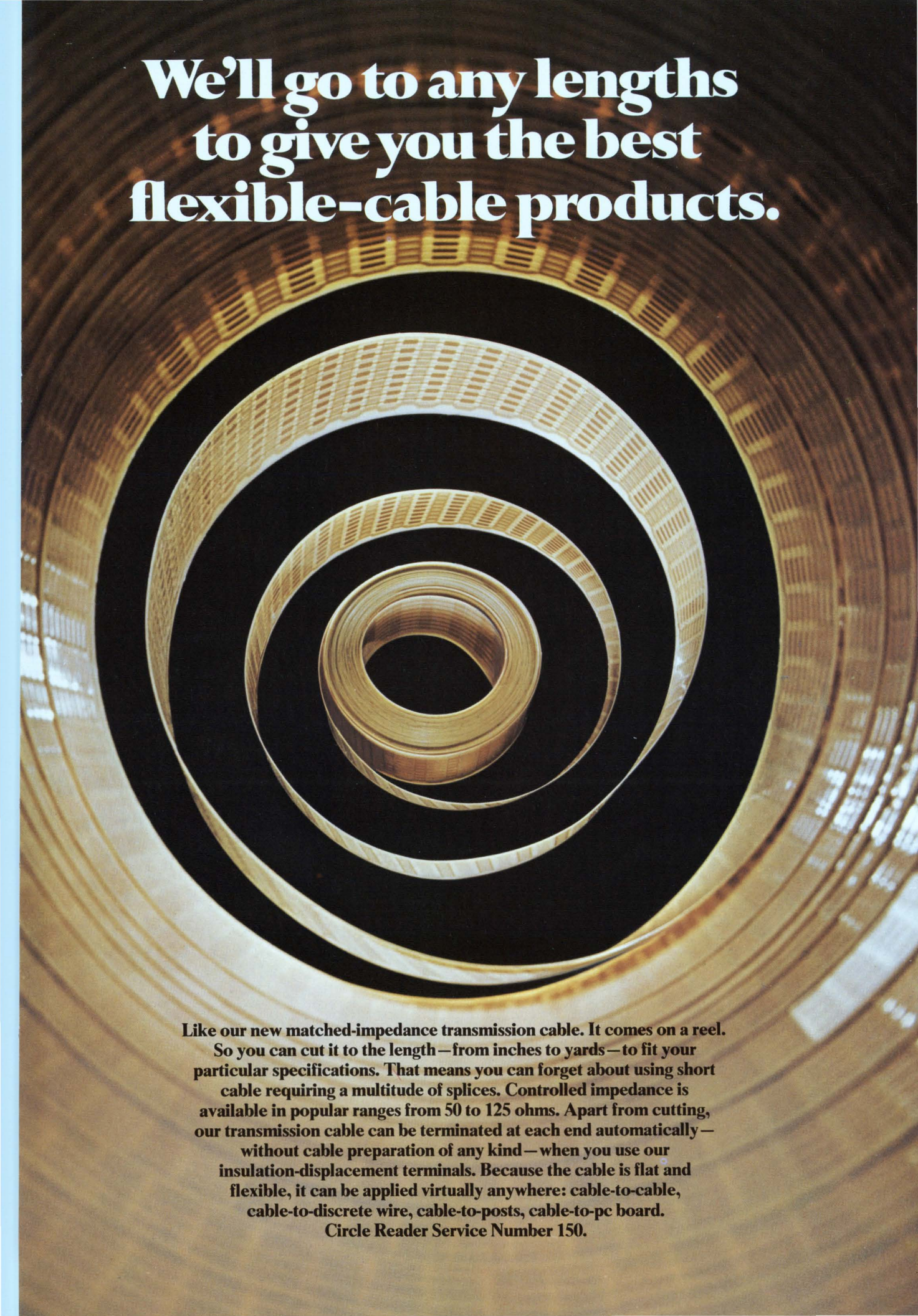

**We'll go to any lengths  
to give you the best  
flexible-cable products.**

Like our new matched-impedance transmission cable. It comes on a reel. So you can cut it to the length—from inches to yards—to fit your particular specifications. That means you can forget about using short cable requiring a multitude of splices. Controlled impedance is available in popular ranges from 50 to 125 ohms. Apart from cutting, our transmission cable can be terminated at each end automatically—without cable preparation of any kind—when you use our insulation-displacement terminals. Because the cable is flat and flexible, it can be applied virtually anywhere: cable-to-cable, cable-to-discrete wire, cable-to-posts, cable-to-pc board.

Circle Reader Service Number 150.

# Total capability: from cable to terminating equipment.

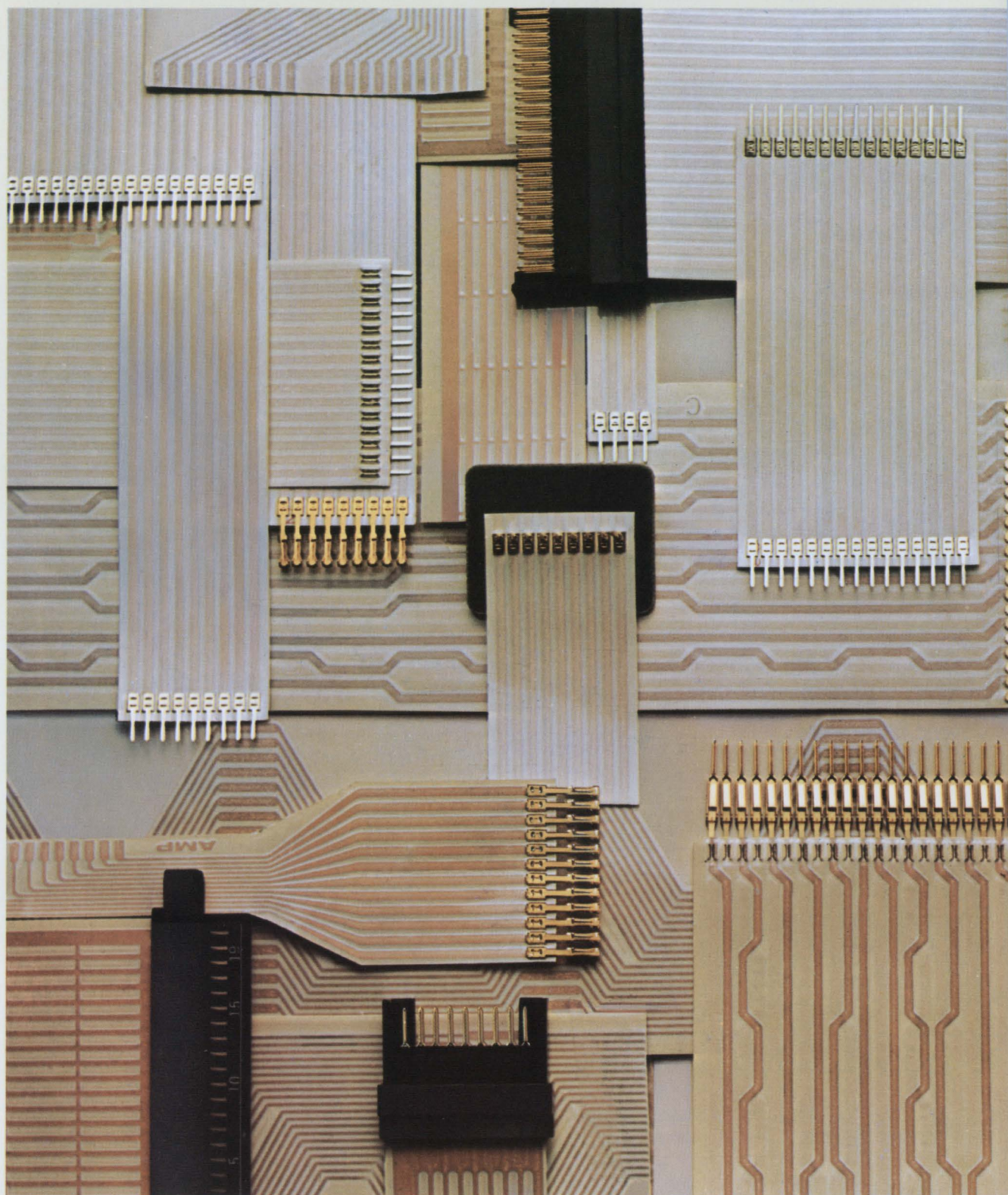



## **We do it all, so you can have it all.**

From one reliable manufacturer. Whether it's *parallel conductor cable*, pre-terminated jumper assemblies, or *flexible circuit patterns*, which give you compactness plus efficiency. In widths up to 22".

## **A totally new idea in cable.**

We can also offer power and signal circuits, plus matched-impedance circuitry, on one cable. But best of all, we designed this unique "*combination*" cable to be cut incrementally.

## **The automatic way to low applied cost.**

We also supply application machines for flat cable assembly in your plant. At the lowest possible applied cost to you. And at the highest production rates possible. They're fast, reliable and easy. No need to prepare the cable. Just cut to length and our machine does the rest—economically.

# Are you still terminating leads on round-conductor flexible cable one at a time?

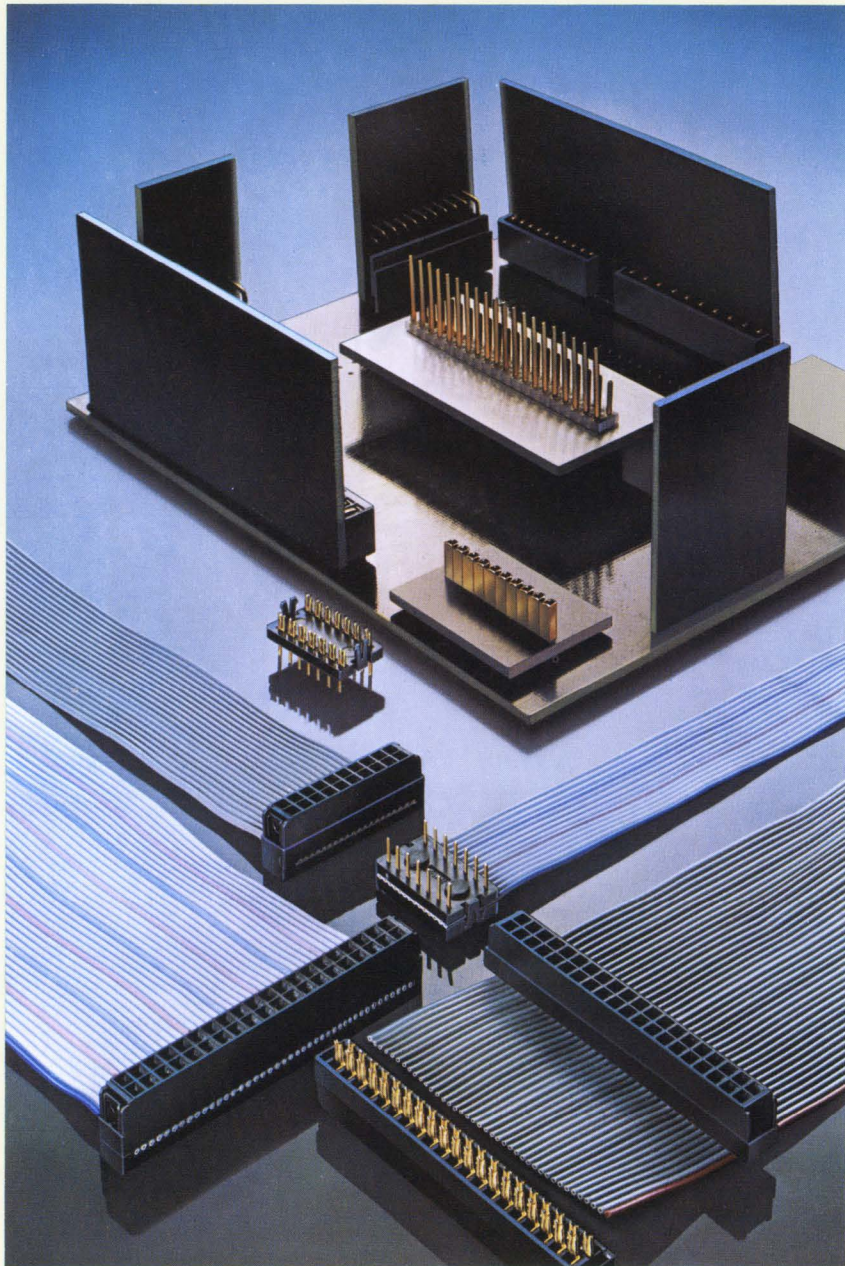

If you are, then it's time to be using AMP latch connectors. They let you terminate all leads simultaneously. Without pre-stripping or soldering.

These connectors are available in 10- to 60-position receptacles. And can mate with true .100 grid, two-row patterns of .025<sup>2</sup> posts. Inspection is simple—even during termination.

Our fork-type contacts provide redundancy and each locks into the cover for maximum point-of-contact pressure and cover retention.



Dual camming and latching beams on AMP contacts provide possible 4-point contact and positive locking for each connector cover.

Our versatile bench press terminates AMP latch connectors (Circle Reader Service Number 151) in seconds. And you can interconnect to pc-board spring sockets, DIP headers, directly to the board itself—or wherever high-density interfacing is required. Strain reliefs can be snapped on after termination and assembly.

AMPMODU post headers are available to accommodate AMP latch connectors. Our complete line includes single- and double-row, straight-through and right angles on .100", .125" and .150" center lines.

All in all, we have the experience and know-how to do just about everything for you. From cable to connectors to headers to terminating equipment. You can even have our cable with all connectors assembled and ready to plug into your equipment. So call (717) 564-0100 for more information. Or write AMP Incorporated, Harrisburg, Pa. 17105.

AMP and AMPMODU are trademarks of AMP Incorporated.

**AMP**  
INCORPORATED

# BOURNS trims more circuits than anyone else in the world!

## here's why...

### NOBODY KNOWS MORE ABOUT TRIMMERS THAN WE DO

Marlan E. Bourns, President of Bourns, Inc., invented the modern miniature TRIMPOT® trimming potentiometer. This company pioneered the industry, and has maintained its leadership position for over a quarter of a century.

### WE GIVE YOU WHAT YOU NEED

Bourns has the broadest line of trimming potentiometers in the industry. We produce just about any type, shape, size, style you're likely to need. We make them more readily available via a large factory inventory . . . and 91 stocking distributors.

Ready to simplify your specifying? Standardize on Bourns "Top Twenty" . . . they cover 90% of your application requirements. Write for our Top Twenty Designer's Portfolio.

### YOU CAN DEPEND ON BOURNS

Trimming potentiometers are the *most* cost-effective method of adjusting, regulating and controlling circuits . . . and they will remain so for the foreseeable future. Bourns is the *most* capable, straightforward and reliable supplier of trimming potentiometers. Depend on Bourns.

QUALITY, SERVICE, VALUE — Bourns is No. 1

... you can depend on it!



BOURNS, INC., TRIMPOT PRODUCTS DIVISION • 1200 COLUMBIA AVENUE, RIVERSIDE, CALIFORNIA 92507

INFORMATION RETRIEVAL NUMBER 131

# HOW TWO MOS RAMS STACK UP AGAINST EIGHT.

It's a rout: compare two 256 x 4, five-volt ion-implanted, N-channel silicon gate static MOS RAMS. With 16 pins and bus-structuring. Against eight 1024 x 1's. It's no contest, no two ways about it. The 256 x 4 is the greatest savings device to come across the board in read/write organization. And here's the byte. You get an eight-bit word with only two IC's instead of eight. Why pay for more than you need? The 256 x 4 organization gives you no wasted bits. And an industry standard package saves you board space, design time and money.

Presenting the 2606 static MOS RAM. The first one out had to be fast. The 2606 gets it done in 750 ns access time. Its bus structuring means simpler input/outputs, and no interface and support logic. And this RAM fits right into the scheme of new bus-oriented systems to come. Throw in total TTL compatibility with no clocks required, and your 256 x 4 package is complete.

The 2606. Your distributor has inventory now. Buy some today. And while you're at it, send us the coupon. We'll get you more information on our new 256 x 4's—and other MOS memories. From Signetics, first again.

**ADD IT UP.  
NOW TWO IS MORE  
THAN EIGHT.**



**signetics**

Signetics MOS  
P.O. Box 3004-39  
Menlo Park, California 94025 (408) 739-7700

Let's have the complete specs and technical data on your new 256 x 4 N-channel: The 2606.

Name \_\_\_\_\_  
Title \_\_\_\_\_  
Company \_\_\_\_\_  
Address \_\_\_\_\_  
City \_\_\_\_\_ State \_\_\_\_\_ Zip \_\_\_\_\_  
Telephone \_\_\_\_\_

Signetics Corporation, a subsidiary of Corning Glass Works, 811 East Arques Avenue, Sunnyvale, California 94086 (408) 739-7700.



# VACTEC optoelectronics

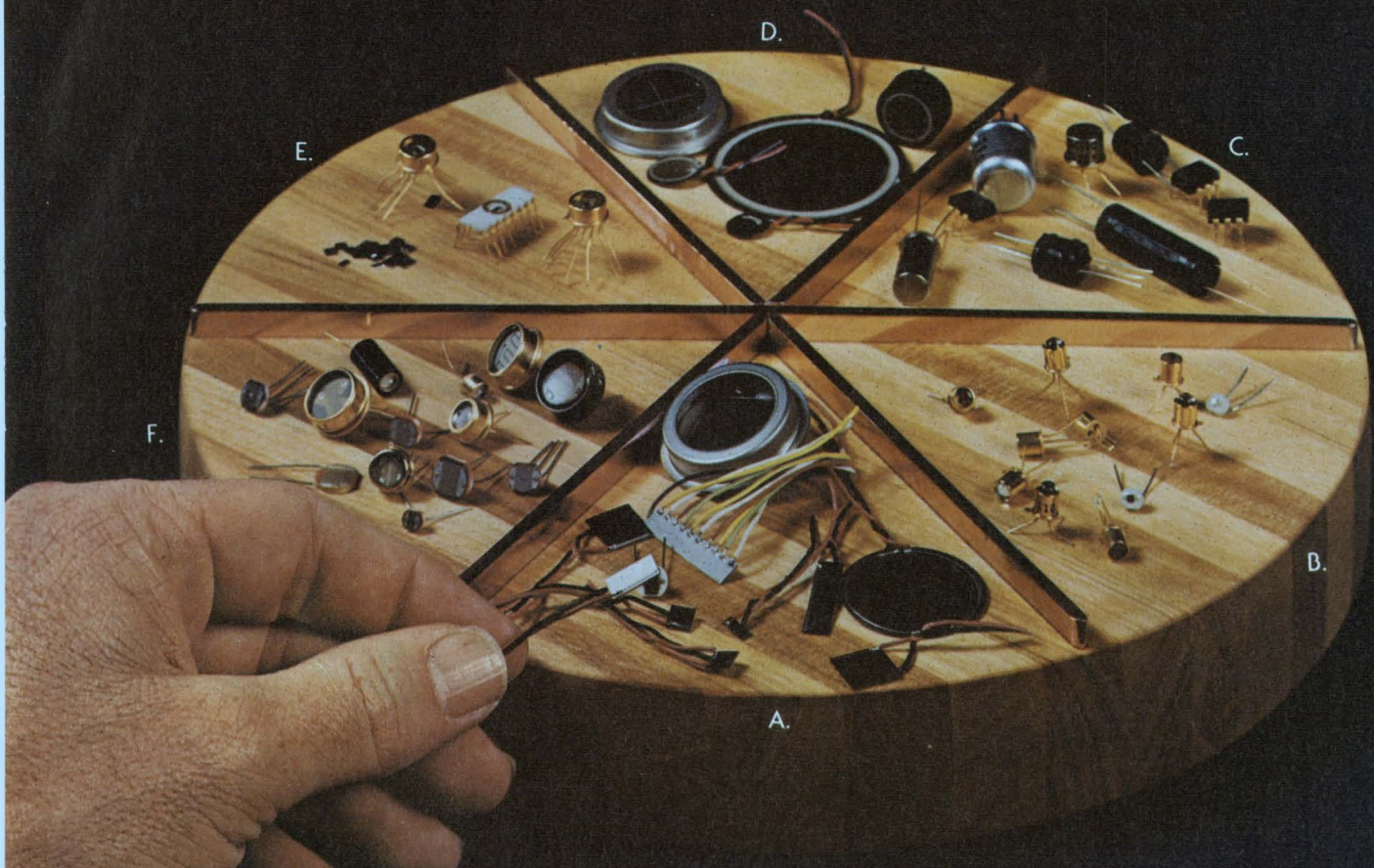

## New High Speed Silicon Photovoltaic Cells

Ten times faster with excellent linearity, high temperature stability, and high low-light sensitivity.

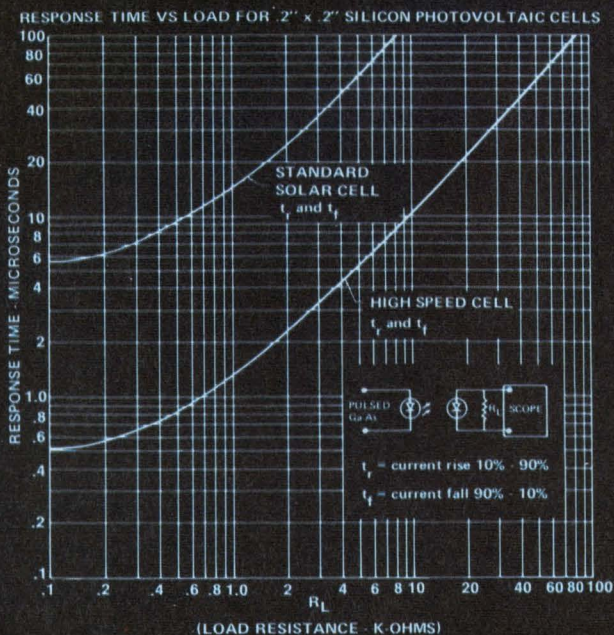

## THE INDUSTRY'S BROADEST LINE:

- A. Standard and high speed silicon photovoltaic cells.
- B. Phototransistor and photodarlington.
- C. Opto-Couplers (three types).  
LED/Photoconductor  
LED/Phototransistor  
Lamp/Photoconductor
- D. Selenium photovoltaic cells.
- E. C-MOS and Bi-polar custom I-C's.
- F. CdS and CdSe Photoconductors.

Write today for more details.

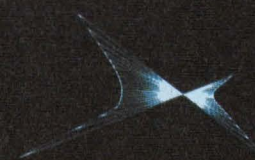

Vactec, Inc.  
2423 Northline Industrial Blvd.  
Maryland Heights, Mo. 63043  
Phone (314) 872-8300

# TRW Darlingtons tame variable speed ac motors



## New low-cost replacements for SCRs in variable frequency ac motor drives

TRW's high-speed power Darlingtons have tamed the variable speed ac motor. Their high voltage and high current ratings make them an ideal replacement for SCRs and associated commutating circuitry in inverter circuits.

Now you can design lower cost ac motor control systems that deliver higher performance and greater efficiency. Specifically developed for use at switching frequencies to 20KHz and higher, TRW power Darlingtons are offered with a variety of current and voltage

ratings to satisfy a range of design requirements:

$I_C$ (Continuous)	$V_{CEO}$ (Sustaining)
10 A	350V, 400V and 450V
15 A	300V, 350V and 400V
20 A	300V, 350V and 400V

TRW power Darlingtons are mounted in the standard TO-3 package and are stocked in depth at TRW Power Semiconductor distributors.

For additional information and applications assistance, write TRW Power Semiconductors, an Electronic Components Division of TRW Inc., 14520 Aviation Boulevard, Lawndale, California 90260. Or call John Powers (213) 679-4561.

## **TRW** POWER SEMICONDUCTORS

**These products are available through the following authorized distributors:**

Almo Electronics  
Bell Industries  
Cramer Electronics Inc.  
De Mambro Electronics

Electronics Marketing Corp.  
Elmar Electronics Inc.  
Hall-Mark Electronics Corp.  
Harvey-Michigan Inc.

Lake Engineering, Ltd.  
Liberty Electronics  
Pyttronic Industries Inc.  
Rochester Radio

Semiconductor Concepts Inc.  
Summit Distributor  
R. V. Weatherford Co.  
Westates Electronics Corp.  
Wilshire Electronics

## Ultimate interface studied: A mind-reading computer

A computer system that "reads minds"—the ultimate in man-machine interfaces—is being developed at Stanford Research Institute, Menlo Park, Calif.

Described as a biocybernetic, or automatic biologically controlled communications system by an SRI researcher, Rebecca Mahoney, the device monitors and identifies patterns in human electroencephalographic signals (EEG) that are associated with language. Once these patterns are identified, she says, they are used to control the operation of laboratory equipment.

In explaining how the system works, Mahoney notes that a subject is shown seven words—right, left, up, down, near, far, and stop—and is told to say each to himself. As the subject says each word, his EEG pattern is recorded and stored in the memory of a Digital Equipment LINC 8 computer. The Stanford researcher points out that each person has a unique EEG pattern response to specific words.

After all seven word patterns, called templates, are stored in the computer, the words are again shown to the subject. As he says them to himself, this time the EEG pattern is compared with his templates previously recorded in the computer memory, and the test match is chosen. The new signal is then averaged with the original template, and an output signal, indicating the word, is generated.

Instead of indicating the word that the subject saw, the computer could be programmed to use the signals to operate a different piece of equipment for each word.

"Originally we were going to interface with a TV system, so that the motion of a TV camera could be controlled," Mahoney says. "That's why those specific words were chosen. But the camera equipment had to be moved to another location."

Commenting on the accuracy of the system, the researcher notes that the computer's recognition of specific words varies between 60% and 100%, depending on the word. The words "up" and "stop" are most easily recognized by the computer, while the words "near" and "far" are the most difficult.

Funds for the project are being provided by the Advanced Research Projects Agency, which is sponsoring a large biocybernetics program designed to make man and machine more efficient.

The long-range goal of the Stanford project is to link man's creativity with the speed and memory capacity of a digital computer. By doing this, Mahoney notes, it may be possible to eliminate the need for punch cards, teletypewriters and other means currently used to enter data into a computer.

For the short range, Mahoney thinks that within a few years a biocybernetics communication system will be feasible for aircraft pilots. In this application, most of the meters in a cockpit would be replaced by a CRT display. When the pilot wanted specific information—like altitude—he would just think about it, and the information would be displayed on the screen.

### Data display competes with AT&T terminal

In the culmination of a development program started nearly two and a half years ago, International Communications Corp. of Miami has entered the communications display market with the 40+ Data Display System.

Currently a leading manufacturer of medium and high-speed modems, ICC's system is designed to compete with American Telephone and Telegraph's Dataspeed 40 dis-

play terminal. In fact, the 40+ designation implies that the ICC product has more features than the AT&T version.

The ICC 40+ consists of three modular sections: a controller logic module, a display monitor on a swivel and a stand, and a keyboard logic module. The system features a firmware-programmable microprocessor with up to 8 k of random-access memory and up to 8 k read-only memory.

The firmware is divided into five categories: keyboard; displayed monitor data entry; a forms control that enables the form generation for controlled data entry by the user; local off-line printing, and self-diagnostic features to isolate system failures. Communication modes include dial, dedicated or DDS networks. The speeds offered are synchronous at 1200 bps or asynchronous at 2400 bps.

The company says small-quantity deliveries are scheduled for the fall of this year and early 1975.

### Mm waveguide heralds bigger phone capacity

AT&T will soon begin testing an eight-and-a-half-mile stretch of millimeter waveguide in northern New Jersey. If the high-capacity link proves satisfactory and the Federal Communications Commission approves, it will be incorporated into the company's New York-to-Philadelphia telephone system by the early 1980s.

The 2-1/2-inch tube, buried four feet underground, initially will be capable of carrying 230,000 telephone conversations at the same time, with an ultimate planned capacity of a half million.

The waveguide tube permits voice, data and television signals in the form of billions of coded pulses to flow through a controlled atmosphere at the speed of light. The frequency band of the waveguide system is 40 to 110 GHz—a greater bandwidth than all the combined "through-the-air" radio frequencies now authorized for common-carrier use.

These coded signals are able to travel relatively long distances with little loss of energy. They require amplification only once every 20 to 25 miles. Some coaxial-cable systems require amplification every

one or two miles.

To develop the millimeter waveguide and to learn how to manufacture it, a team of scientists and engineers at Bell Laboratories and Western Electric had to overcome a number of technical challenges. For example, imperfections in the roundness and straightness of the waveguide can reduce or distort the flow of radio signals through it. Also, it must follow land contours and route curves with a minimum of signal losses or distortions.

To meet design objectives like these, Bell scientists developed two types of steel-packeted waveguide. One, called dielectric waveguide, has a thin inner layer of copper lined with a dielectric material. The other, helical waveguide, has an inner helical winding of insulated copper wire, impregnated in epoxy. A combination of both types is used to keep losses low.

## LED on miner's cap warns of radiation

A personal radiation detector that can be mounted on a miner's cap has resulted from the development of a new family of low-voltage, surface-barrier alpha-particle monitors.

Developed by Arthur D. Little Inc., Cambridge, Mass., for the U.S. Bureau of Mines, the monitor—called the Alpha Alarm—measures the radioactivity in a uranium mine or other hard-rock environment by means of a flashing (safe) or steady-on (dangerous) LED placed at the front of the miner's cap.

Available surface-barrier detectors—silicon overlaid with a thin aluminum window on the order of 50 micrograms/cm<sup>2</sup>—required 60 to 90 V for operation, could not withstand the humid environment in the mines and were easily destroyed by chemical contamination, says Donald Lindsay, A. D. Little health physicist.

"We reviewed the manufacturing process for surface-barrier cells and developed our own techniques," he reports.

The new cells operate at 6 V, and consequently can be powered by the batteries in a miner's lamp. The cells are also substantially more resistant to the mine environment.

The alpha radiation is monitored, Lindsay explains, because it is the dangerous air contaminant. The problem stems from the fact that any mine has had in the geological past some amount of uranium 238. As a result, radium is present. Radium decays to radon 222, which is a rare gas with a 3.8-day half life.

Two of radon's short-lived decay products, with a half life on the order of minutes, are the alpha emitters of polonium 218 and polonium 214. These alpha decay products readily attach themselves to dust particles. If this dust exceeds certain contamination levels, its inhalation can produce lung cancer.

The Alpha Alarm electronics, designed by Martin Cohen of A. D. Little, detects the individual alpha particles that strike the detector and integrates the count at a very low rate—less than one count per second. The circuit keeps a running average of the counts, so that any time the count rate gets above 20 counts within a half minute, the LED, which has been flashing with the impact of each alpha particle on the detector, remains on continuously, indicating a dangerous condition.

The electronics provides selective measurement of airborne particles. And it rejects a constantly accumulating noise level caused by those particles that attach themselves to the surface of the detector. For this purpose, a pulse-height selector has been incorporated to limit the response to those particles below 7 MeV. The level from alpha particles that attach themselves to the detected surface is 7.7 MeV.

## Spurious radio noise viewed as health peril

Electromagnetic pollution harms not only the performance of communications systems but people's health as well, the recent IEEE International Symposium on Electromagnetic Compatibility was told.

"We are paying a price, generally recognized by the public, for the effects of man-made radio noise," James F. Lynn, an EMC consultant, said in a paper on "Proliferation of Electromagnetic Pollution, or Look What We're Doing to Ourselves." "The man-made sources of

electromagnetic radiation have been increasing at a rate of about 20% per year for the past 35 years. Thus we are exposed on all sides to increasing amounts of non-ionizing radiation."

The medical community has become increasingly concerned about electromagnetic interference for two major reasons, Lynn observed. First, sensitive medical electronics equipment must be carefully shielded to prevent reception of undesired signals or radiation of its own energy to other equipment. The result is increased costs for vital hospital apparatus.

Researchers at the University of California San Francisco Medical Center, Lynn noted, have found that cardiac pacemakers can be disabled by signals from fm and television transmitters. This finding may lead to the redesign of some pacemakers.

The second major concern of medicine, Lynn said, is that electromagnetic radiation levels in large cities may directly affect the human body. He gave some examples of biological effects produced by electromagnetic fields.

"A frequency of about 30 MHz can kill any bugs in a loaf of bread, he explained, "and the microwave oven frequency of 2450 MHz can damage human tissues. At a frequency of about 10 GHz, ants align their antenna in a parallel with the electromagnetic field, and the wings and legs of chickens will extend when irradiated by about 18 GHz."

Some electromagnetic pollution may be unavoidable, the consultant said, as the radio spectrum is saturated with more broadcasting, communications and telemetry signals. This leads to such problems as cross-channel interference between services and the saturation of the air-traffic control system over large cities.

But other interference sources are clearly avoidable, he continued. The leakage of signals from cable television systems, because of damaged cables or faulty shielding or improperly adjusted transmitters, can be halted, Lynn noted. And interference generated by electric power-distribution systems, railroads, automobiles and electrical equipment may require the redesign or replacement of noise-generating parts, he said.

# SerenDIP-itous reminder

## A versatile family of solid state DIP relays

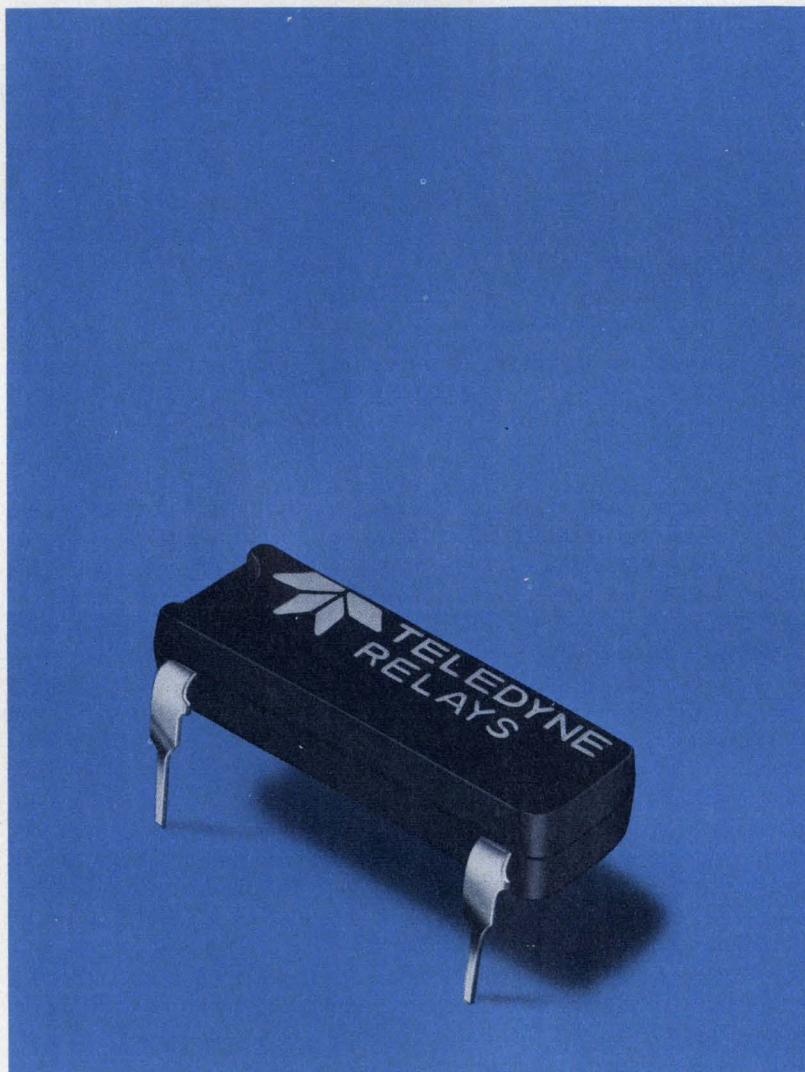

Serendipity is a gift for finding valuable or pleasant things you hadn't looked for.

Teledyne, the world's largest maker of solid state relays makes serendipity for engineers — We make SERENDIP®s.

The SERENDIP® family includes four kinds of solid state DIP relays for different jobs. They up-grade, with all the advantages of solid-state — total input/output isolation, low-level logic input compatibility, fast response time, no "contact bounce" (drive IC's directly), and long life dependability. All this in low profile TO-116 DIP packs with equally low cost.

About those different jobs. The 640-1 features bi-polar output, AC or DC up to 50v/80Ma, with low ON resistance — 2 ohms typical. Use it for isolated line drivers and data couplers, A/D converters, modulators and demodulators.

The 641 is a small AC powerhouse — 1 AMP Triac output, 140 or 280 VAC with a 10 AMP surge rating. Try it for lamp or inductive load control — solenoids, motors, transformers, etc. And the 641 is now UL recognized.

The 643's are DC versions capable of switching up to 60v/400Ma or 250v/100Ma. They actually exceed current and voltage switching capabilities of opto-isolators. In communications, use them for keyer switching — or as telegraph relays.

Finally, the 644 is a low offset voltage unit that solves switching problems in instrumentation applications. Use it for low level transducer signal switching, series choppers, scanners, sample-and-hold, multiplexing, etc.

The SERENDIP® family — a pleasant reminder from Teledyne Relays. Ask your rep or distributor, or call us.

 **TELEDYNE RELAYS**

3155 West El Segundo Boulevard Hawthorne, California 90250  
Telephone (213) 973-4545

INFORMATION RETRIEVAL NUMBER 17

# SOS devices: Not yet making it in LSI...but wait till next year

Silicon-on-sapphire technology is not as yet a major factor in the LSI arena, but the large amounts of money and effort being pumped into it indicate that the widespread commercialization of SOS is imminent.

While SOS can be used with most of the semiconductor technologies—PMOS, NMOS and CMOS—much of the early work is expected to be in CMOS. Several CMOS/SOS devices are now available, and more are expected to make their commercial debut in 1975. Industry sources indicate that while 1-k RAMs, microprocessors and 4-k ROMs will appear by mid-year, high-volume quantities are not anticipated before 1976.

Why all the interest in CMOS/SOS? The answer is simple: It is close to an ideal technology. According to Al Feller, an engineer working with SOS at RCA's Advanced Technology Laboratory in Camden, N.J., the technique is intrinsically capable of yielding higher density. Another plus is a reduction in the number of masks needed, compared with standard CMOS. And the masks are simplified as well, Feller says. This is so because, with sapphire, it is possible to eliminate the guard bands that normally isolate p devices from n devices in CMOS. The smaller and simpler devices made possible by use of SOS also result in a higher over-all yield.

## Only one commercial source

While many companies are doing research on SOS technology and have fabricated devices in the

Jules H. Gilder  
Associate Editor

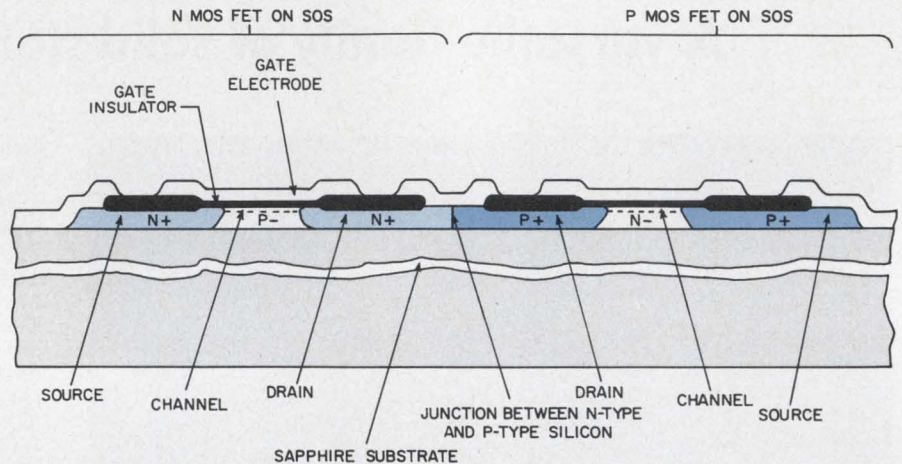

**CMOS/SOS devices** are fabricated by depositing 1 micron films of silicon on sapphire wafers. The silicon is selectively etched to form isolated islands and vertical junctions are made with diffusion techniques.

laboratory or on a custom basis, only one company, Inselek of Princeton, N.J., offers SOS devices on a commercial basis. Unlike most companies working on the technology, Inselek has decided to produce SOS equivalents of RCA's 4000 CMOS devices.

Ed Ross, vice president of Inselek, notes: "We have produced 26 of the 4000 series devices in SOS. In addition we have a number of proprietary devices, such as a 256-by-1 static CMOS/SOS RAM and a 4-by-4 crosspoint switch."

In comparing CMOS/SOS with standard CMOS, Ross notes that SOS results in a three to fivefold increase in speed for MSI functions. Bill Wagner, MOS marketing manager for RCA's Solid-State Div. in Somerville, N.J., reports that it is possible to get as much as a 10-to-1 increase in speed with SOS. He points out, however, that the speed advantages of SOS are only fully achieved on LSI devices.

In explaining why, he says that if standard parts—especially SSI or MSI—are used, the off-chip

capacitance of the package and printed-circuit board is just as great as ever. You really lose the benefit of the low capacitance of the SOS chips if you start to wire them together.

The high speed is particularly useful in watch circuits. Most watch circuits now use a 32-kHz crystal that costs \$3 to \$4. To use a less expensive crystal, it is necessary to go up in frequency. But when the frequency goes up, so does the power dissipation. With SOS, the power dissipation is the same and it is possible to raise the frequency to 4 MHz, where a less expensive crystal can be used.

## There are problems, too

Even though CMOS/SOS is closest to the ideal semiconductor technology, there are problems, as Ken Stevenson, manager of the Digital Applications Group at Harris Semiconductor, points out. The main one, he says, is high leakage.

At first glance, the high speed

# PULSED LASER MEASUREMENT RESULTS IN MINUTES!

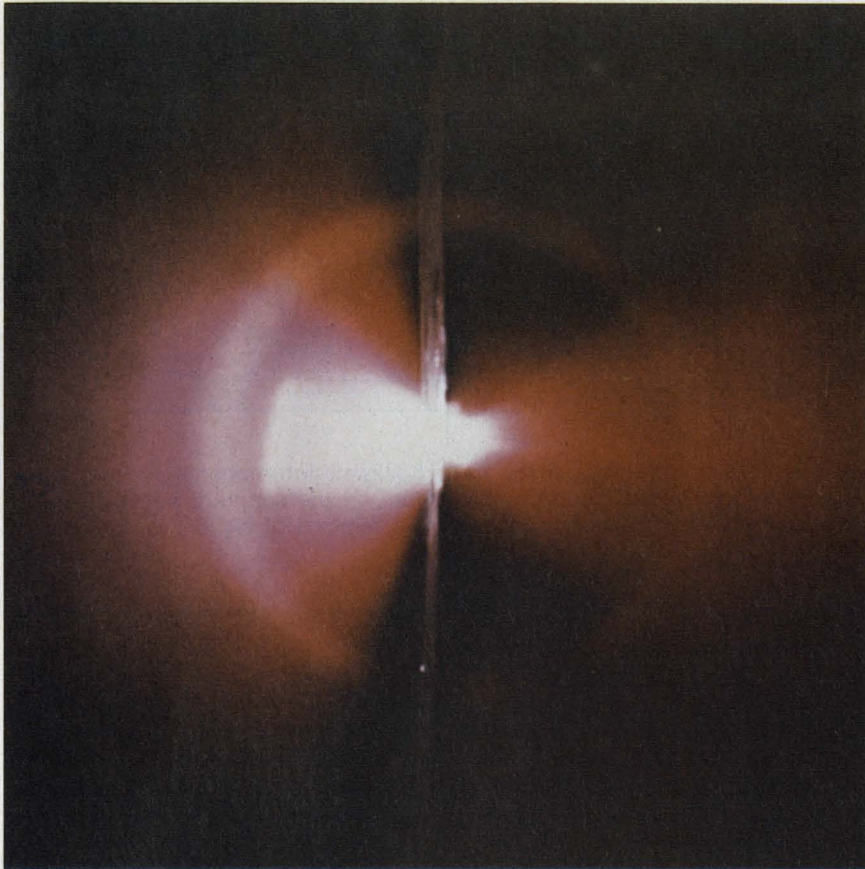

The R7912 offers you the following measurement capabilities:

**Analog Bandwidth:**

1 GHz at 4 V/DIV  
500 MHz at 10 mV/DIV

**Resolution:**

320 by 400 lines  
512 by 512 addressable points

**Writing Rate:**

8 DIV/N sec—Digital Mode  
30 DIV/N sec—TV Mode

**Sampling Rate (effective):**

10 psec (100 GHz) or slower

The TEKTRONIX R7912 Transient Digitizer represents orders of magnitude improvement in high speed transient measurements. It allows you to make your laser measurements quickly and easily—such measurements as checking switch-out effectiveness, looking for multi-modes, checking pumped amplifiers, and measuring effects on targets. One such target measurement is the study of particles generated from a plasma like that shown in the photo above.

Fast transient measurements can be viewed rapidly—with no need for photographs—whether your laser is running at a few pulses per second or single shot. The R7912 can be configured for direct viewing or for computer analysis. For repetitive signals (low or high rate), the TV mode offers large bright displays. For single transients, the digital display controller provides for viewing a refreshed display of the waveform on a monitor. For computer analysis, the PDP-11 interface allows waveform manipulation and measurement with Tektronix developed software.

Investigate the TEKTRONIX R7912 Transient Digitizer, it can make your pulse laser measurements easier and quicker. To obtain a copy of "New ways to see Fast Transients" and/or pertinent application notes, contact your Tektronix Field Engineer, use the reader service card, or write to Tektronix, Inc., P.O. Box 500A, Beaverton, Oregon 97005. Phone: 503/644-0161.

In Europe: Tektronix, Ltd., Guernsey, C.I., U.K.



  
**TEKTRONIX®**  
committed to  
technical excellence  
**SYSTEMS  
DIVISION**

INFORMATION RETRIEVAL NUMBER 15  
FOR DEMONSTRATION CIRCLE 236

and high leakage of SOS seem to be inconsistent with each other. Stevenson explains this by noting that while leakage is generally associated with an interface near the surface of the device, with SOS there is a second interface between the silicon and sapphire layers. It is this second interface, he notes, that induces the high leakage current. As a result, the leakage does not affect the speed of the device.

Another disadvantage of SOS, Stevenson reports, is that the substrate cannot be used as a voltage supply, as is the case with junction-isolated devices. With SOS, it is necessary to buss voltages on the surface of the chip via metal interconnections. This makes it more difficult to obtain high densities.

Gordon Hoffman, marketing manager for Mostek in Carrollton, Tex., points out other disadvantages of SOS. The sapphire substrate, he says, is not easy to cut. It can't be scribed like silicon substrate, but must be sawed. It might also be possible to use lasers to cut the sapphire.

Another problem with sapphire is that it cannot be die-mounted eutectically, but must be glued into place. And finally, Hoffman reports, sapphire has a higher thermal impedance than silicon, making it more difficult to dissipate the heat. That's why there is such a strong interest in CMOS/SOS.

### The market is big

Although very few SOS parts are available at present, the potential market is large. Inselek's Ross notes that of the existing CMOS market, 20 to 30% is available to the SOS manufacturer. This part of the market, says Ross, consists of designers with requirements for higher speed or greater complexity than is currently available. It also consists of buyers who must have a device that is free from the SCR latch-up found in bulk silicon.

Much business is also expected in areas where CMOS could not be considered before. These include very-high-speed microprocessors and 1-k CMOS RAMs that work over the full CMOS voltage range.

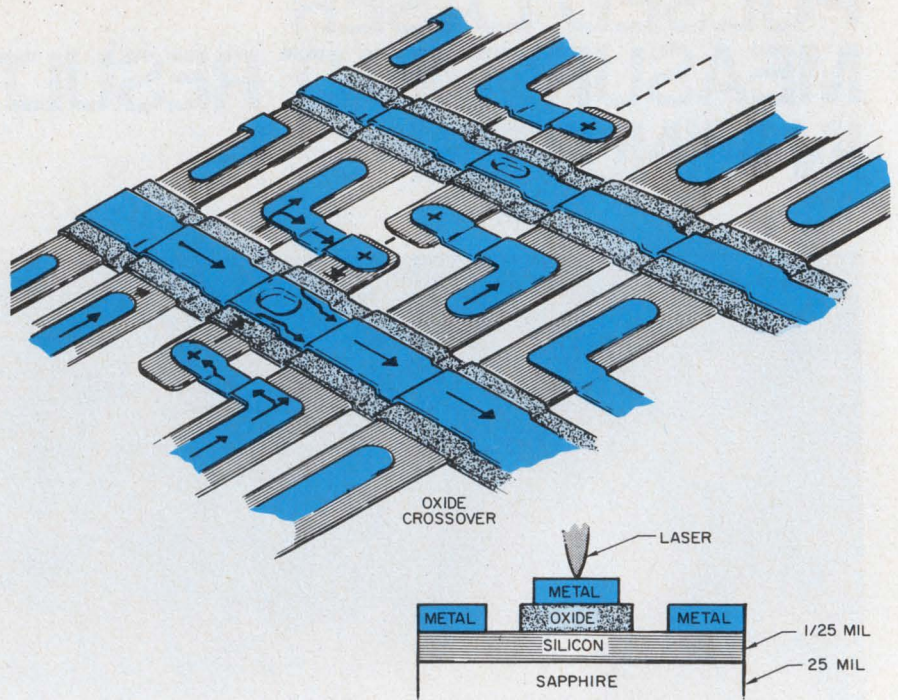

SOS programmable logic array from Rockwell International is composed of diodes and resistors. The thin silicon film on the sapphire substrate permits quick custom laser encoding via selective removal of silicon.

## All about SOS

Silicon-on-sapphire is a fabrication technique in which thin crystalline films of silicon are deposited on a single crystal alumina (sapphire) substrate.

According to Frank L. Chiaretta, director of process technology at Rockwell International, Anaheim, Calif., SOS films are usually poorer in quality than bulk silicon; their crystals are relatively disordered, particularly at the silicon/sapphire interface.

This characteristic, notes Chiaretta, tends to limit circuit fabrication to diode, resistor and MOSFET types of devices.

But for these devices SOS films as thin as 2  $\mu\text{m}$  can be produced. These thin films make it possible to reduce significantly, parasitic circuit capacitance and to achieve superior component isolation. With thicker films, like those achievable with bulk-silicon dielectric isolation approaches, dimensional control and the ability of the etchant mask to withstand the etch become major problems.

The thickness of SOS films is comparable with diffusion depths commonly used in MOS/LSI device fabrication. Consequently doping impurities penetrate completely through the silicon, so that the only component of the p-n junction is that normal to the surface. Since the principal area contributions to a p-n junction come from the underside and side walls of a diffusion well, the SOS vertical junction area—and hence capacitance—is reduced considerably.

In comparing the power dissipation of silicon-on-sapphire devices with bulk silicon, one can see that SOS is not especially advantageous in the standby mode because of its high  $I_{DSS}$  leakage. This is due primarily to the high lattice disorder of the crystal.

The power advantage of SOS can be seen, however, at operational speed, where power consumption is essentially a  $CV^2f$  term and where the SOS capacitance,  $C$ , is substantially less than the bulk-version value.





**Our gold  
spot  
could be  
your gold  
mine.**

*At today's prices, gold is just too expensive to use where it's not needed.*

*That's why Sylvania developed the technique of putting a circle of gold on lead frames (where it's needed) without coating the whole frame (where it's not needed).*

*Check gold prices in today's*

*paper. You'll see what real savings can be. And you'll see why our method offers the highest quality at a lower price.*

*You'll also see why people like us when we put them on the spot. GTE Sylvania, Parts Division, Warren, Pa. 16355.*

**GTE SYLVANIA**

Walter Kalin, CMOS marketing manager for Solid State Scientific, Inc., Montgomeryville, Pa., also sees a big market for CMOS/SOS microprocessors and RAMs, but not until 1976. The memories and processes will be available next year, he agrees, but he expects price and availability to be unfavorable. RAMs will probably cost about \$150 each, he says, and there's no mass market for that.

There won't be production capacity in the industry to support a mass market until 1976, Kalin predicts, and by that time the price of CMOS/SOS memory will be about 2 cents a bit. That's still a little high, he notes, but the advantages of the device will be enough to create a sizable market.

Beyond that? Kalin says that for the long haul, CMOS/SOS RAMs will cost about 0.2 to 0.3 cent a bit. But that won't be until at least 1978, he predicts.

#### Present supplies limited

What's available today? Not much. Most of the SOS ICs being produced are custom devices. An example is the n-channel SOS microprocessor developed by Rockwell International for General Automation. The microprocessor is

## SOS and bulk silicon memories compared

	1024 X 1	1024 X 1	512 X 1	1024 X 1	1024 X 1
	BULK SILICON N-MOS	BULK SILICON N-MOS	BULK SILICON CMOS	BULK SILICON BIPOLAR	SOS CMOS
	STATIC	STATIC	STATIC	STATIC	STATIC
TYP READ ACCESS TIME	500 NS	45 NS	200 NS	60 NS	60 NS
TYP POWER ACTIVE	150 MW	640 MW	7.5 MW	500 MW	100 MW
TYP POWER STBY	150 MW	60 MW	2 $\mu$ W	500 MW	100 $\mu$ W
COMMENTS	COMPLETELY TTL COMPATIBLE	NOT DIRECTLY TTL COMPATIBLE	NOT DIRECTLY TTL COMPATIBLE	COMPLETELY TTL COMPATIBLE	NOT DIRECTLY TTL COMPATIBLE

the first such SOS device to be fabricated. The processor can handle an 8-bit word and has an instruction execution time of 2.64  $\mu$ s.

CMOS/SOS processors are also being developed. One is a general-purpose unit being developed by RCA's Advanced Technology Laboratory for NASA. According to RCA's Feller, the SOS CPU will have the capability and complexity of an IBM 360/65. In addition, he says, it will have some features that the 360/65 doesn't have, such as considerable real-time capability.

Unlike the General Automation unit, which consists of only two chips, the unit being developed for NASA will consist of about 60 SOS chips of 13 different varie-

ties. That's a lot more than the General Automation unit has, but the NASA computer will be able to do more. It will, notes Feller, be capable of addressing a full 32-bit memory. The final system will contain 64,000 words of memory. Only the scratch-pad memory, which will contain 512 32-bit words, will be SOS; the rest will be NMOS. The SOS processor is to be capable of multiplying two 32-bit numbers in 9  $\mu$ s.

The CPU is to consume only 15 W of power, while the rest of the computer circuitry is designed to consume about 35 W. The entire computer will be housed in two 15-by-15-in. cards in a box slightly larger than one-half cubic foot in volume. ■■

## And now, magnetic bubbles for displays

Magnetic bubbles, traditionally thought of as a memory technology, are entering a new era of application—displays. The development that makes this possible is the discovery at IBM's Watson Research Center of liquid magnetic bubbles.

The IBM researchers at Yorktown Heights, N.Y., formed liquid magnetic bubbles by sandwiching between two plates of glass a ferrofluid—a liquid colloidal suspension of submicron magnetic particles—and a transparent immiscible host fluid of the same density. When they applied a magnetic field to this sandwich, small liquid magnetic bubbles formed.

The major difference between magnetic bubble domains and liquid magnetic bubbles is that the latter retains a constant volume and its propagation involves the actual transport of mass. Unlike magnetic domains, the liquid bubbles do not collapse, so that magnetic-field margins can be greatly relaxed.

The analogy between liquid magnetic bubbles and magnetic bubble domains is more than superficial, note the IBM researchers. Not only are the general properties—such as mutual repulsion, attraction to permalloy overlays and wall-motion coercivity—similar, but many of the numbers scale up as well. For example, devices fabricated with

liquid bubbles use the same T and I bar patterns that were used on magnetic-domain devices. The only difference is that they were scaled up about 20 times.

Since liquid-bubble propagation is limited by viscosity, interfacial tension and friction to the lower audio frequency range, its only practical application would appear to be for displays, the IBM researchers contend. In this it has several advantages, including these: a bubble size that can be varied between 50  $\mu$  and 1 mm; infinite contrast without the need for optics or polarizers, and extremely low cost of materials and fabrication. ■■

# Dialight sees a need:

(Need: Single source supply for all indicator lights.)

# See Dialight.

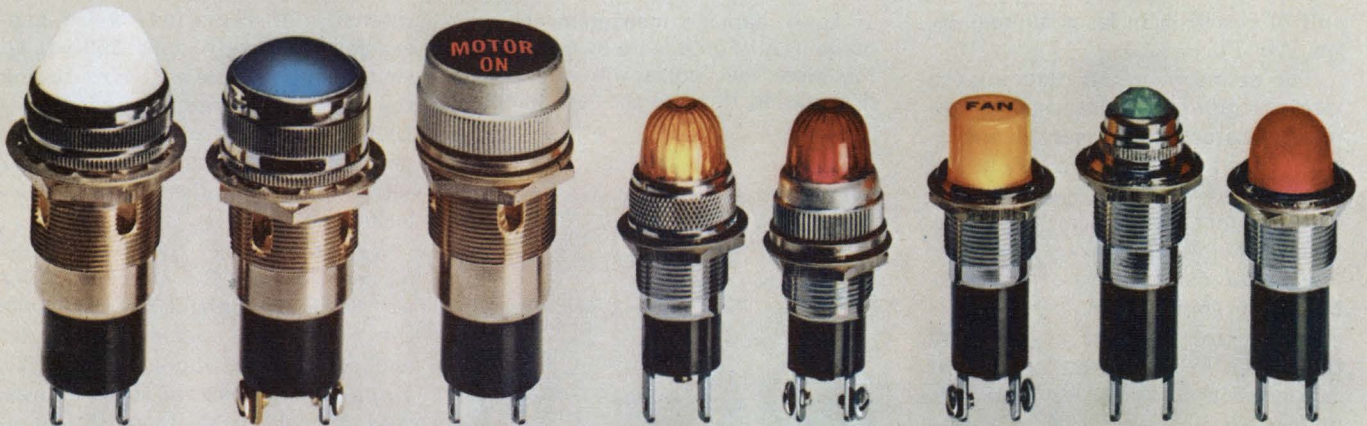

## INCANDESCENT OR NEON MINIATURE AND LARGE INDICATORS

Designed to accommodate either incandescent (2-250V) or neon (105-250V) lamps for panel mounting in 11/16" or 1" clearance holes. Units meet or exceed MIL-L-3661 requirements; all are listed in Underwriter's Recognized Components Index. Wide selection of lens shapes, colors,

finishes and terminations. Many lenses may be hot stamped, engraved or offered with film legend discs. Oil-tight units with unique "O" ring construction make them oil, water and dust tight on the face of the panel. Available off the shelf for prompt delivery.

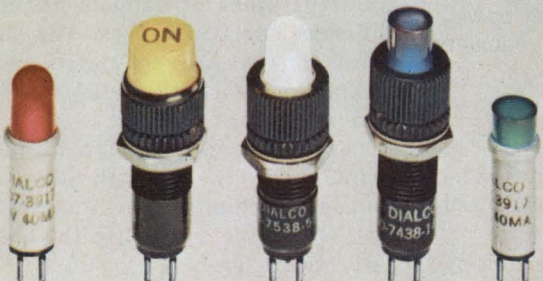

## LED, INCANDESCENT OR NEON ULTRA-MINIATURE DATALITES®

Meet or exceed MIL-L-3661. Replaceable plug-in cartridges for 1.35-125V operation. Indicators mount as close as 1/2" centers; available with red, green, amber, blue, white translucent, light yellow or colorless lenses in wide range of lens shapes, legends and finishes. Off-the-shelf.

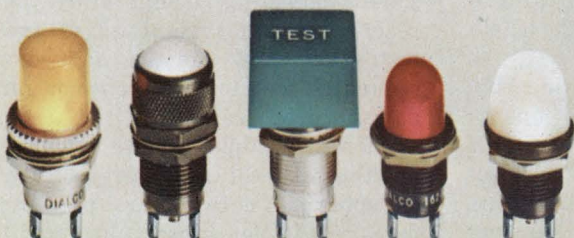

## INCANDESCENT OR NEON SUB-MINIATURE INDICATORS

Meet or exceed MIL-L-3661. Mounts in 15/32", 1/2" or 17/32" clearance holes. Incandescent for 1.35-28V; neon has patented built-in current limiting resistor. Choice of cylindrical, faceted, convex, flat, square and round lens shapes, colors, finishes, legends. Off-the-shelf.

## DIALIGHT

Dialight, A North American Philips Company  
203 Harrison Place, Brooklyn, N. Y. 11237 (212) 497-7600

SEND ME FREE INDICATOR LIGHT PRODUCT SELECTOR GUIDE.



# Study of internal laser damage may lead to smaller devices

High-power lasers—now made unduly large by oversized optical elements needed to withstand damage from the laser beam—may ultimately be trimmed in size and have their power output raised as a result of research in laser damage by the Air Force.

The prime factor in reducing the size of high-power lasers is eliminating damage to laser elements, says David Milam, physicist in the Laser Physics Branch at the Air Force Cambridge Research Laboratories, Bedford, Mass. Dielectric films used for reflectors and anti-reflection coatings on laser optical elements are damaged at one-third to one-tenth the power levels that can be withstood by high-quality, polished optical surfaces, he points out.

## Destructive causes identified

Until a year ago there was no firm identification of the cause of dielectric film damage, Milam explains. And only one mechanism for bulk material damage—avalanche breakdown—had been identified.

Now, researchers at the Air Force Laboratories have isolated three basic damage mechanisms responsible for the destruction of bulk material and of dielectric films. These mechanisms—bulk absorption of radiation, inclusion or defect absorption, and avalanche breakdown similar to that occurring in semiconductor devices—have been identified by a new technique that uses constant-intensity, square-wave laser pulses to produce damage in test specimens.

This is the first major step in finding solutions to the problem of

**Jim McDermott**  
Eastern Editor

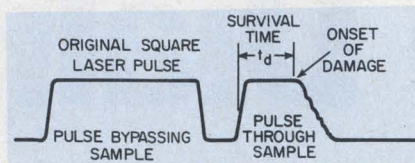

1. Laser damage measurements are made in Air Force tests by comparing the laser test pulse with the pulse transmitted through the test sample.

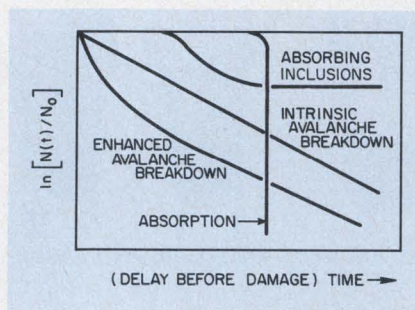

2. The laser-damage mechanism present can be identified by comparing test data with survival curves that are characteristic of damage types.

oversized lasers, Milam notes. The search for improved materials can now begin.

At present military use routinely requires larger lasers than desirable just to lower the power density of the beam, the physicist notes. And final laser amplifiers for fusion-energy experiments are huge, costly devices for the same reason.

Previous attempts to identify damage mechanisms were unsuccessful. They used the entire length of the round-topped laser pulse, Milam points out. But with these pulses, the damage mechanisms were superimposed on one another and impossible to separate, because of the inherent variation in laser-

beam intensity throughout the pulse.

“What we do now,” Milam says, “is to use a laser-triggered spark gap that drives a Pockels-cell shutter. To obtain a constant intensity of radiation, we’re generating relatively long 150-ns, Q-switched pulses. And we’re taking the center, high-intensity portion—10 to 50 ns—out of the long pulse with the shutter. This shutter selects a single pulse from a mode-locked pulse train.”

By comparing the pulse that passes through the element under test with the initial square wave, the researchers can see the start and progress of damage (Fig. 1). From a sequence of test firings, data are obtained, from the data, “survival curves” are generated.

These curves are a measure of how long a laser test element will survive until damage occurs. The different kinds of damage produce different survival curves. The survival curves are compared with computed theoretical functions for identification.

Interestingly enough, Milam points out, the identification of damage mechanisms by this method has nothing to do with the absolute power level.

If the sample under test is a completely uniform absorber, all of the areas that are irradiated with the same intensity survive until some damaging temperature is reached. At that point all of the test areas show damage, and consequently the curve for absorption damage drops rapidly.

At test samples where metallic or other absorbing inclusions, such as spherical defects, are present, damage will not appear until sufficient energy is applied by the laser pulse to increase the temperature of the most easily heated inclusion

# There's a little tiger in every Cherry switch

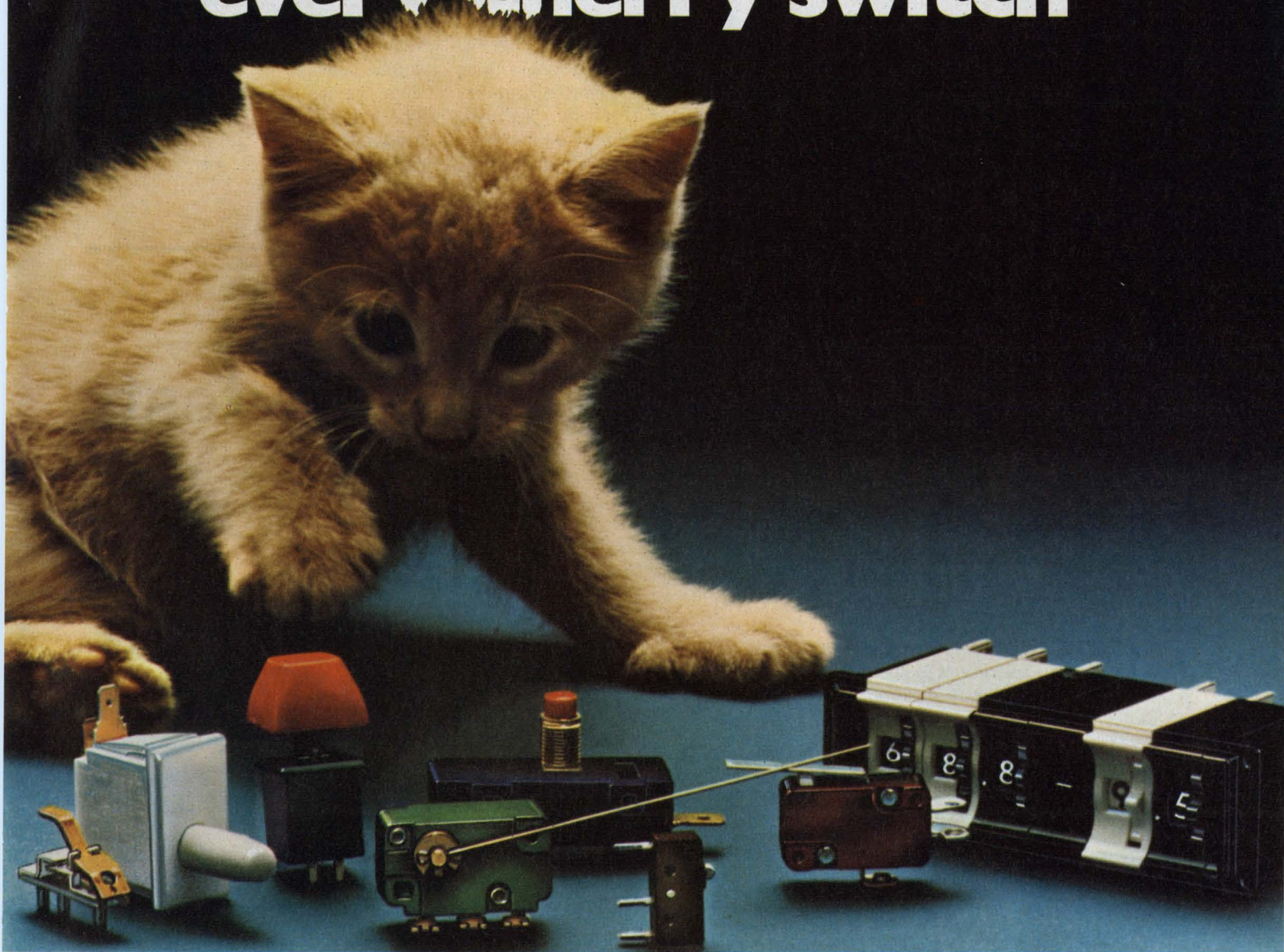

## ...but we're pussycats to do business with

Our products are tough, but our people aren't... and that's the beauty of dealing with Cherry.

You see, we can control the quality of our switches because we fabricate most of our own parts (moldings, stampings, springs, printed circuits, etc.) And we can keep the price down because we're loaded with automatic equipment to handle high volume.

But the real difference is in the *people* you work with at Cherry...from your first contact with a technically trained sales representative...through careful analysis and recommendations by engineers

who are really concerned about *your* problem... to production scheduling and customer service men who follow-up and expedite to make sure we keep our delivery promise to you.

Of course we're proud of our modern facilities and equipment...but what we're proudest of is our reputation for customer service. Try some.



Test a free sample "tiger" from the pussycats at Cherry.

Ask for our latest catalog which contains complete information on all our switches and keyboards, and we'll include a free sample switch. Just TWX 910-235-1572...or PHONE 312-689-7700... or circle the reader service number below.

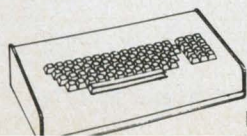

# CHERRY

CHERRY ELECTRICAL PRODUCTS CORP. • 3609 Sunset Avenue, Waukegan, Illinois 60085

ELECTRONIC DATA ENTRY KEYBOARDS • ELECTRONIC DESK TOP CALCULATORS

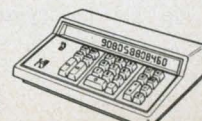

to the damaging point. At that point inclusion damage appears on the "absorbing inclusions" survival curve (Fig. 2). As the beam is moved around to different test sites on the same piece of material, damage does not occur for all tests, because all sites don't contain inclusions. As a result, the damage level stabilizes at a constant value that trails off to the right, terminating at the end of the experiment.

Avalanche breakdown also occurs with sufficiently high laser-beam power density. For example, when the laser beam is applied to a homogeneous, perfect dielectric material that is both nonabsorbing and transparent, an electric field oscillating at the laser frequency appears in the material. Where this field is sustained, it causes rupture damage. With intrinsic electron avalanche breakdown of the perfect material, the survival curve is

linear, with a fixed slope.

Where the material contains some defects, such as finishing scratches, the electric field at the defects is higher than the applied field, and what is termed enhanced avalanche breakdown occurs. Where defects are present, the avalanche curve is linear, but the slope varies for different defects. The superimposition of these lines produces the initial sag in the curve, as in Fig. 2. ■■

## Nuclear ILS for aircraft proves safe and sound in feasibility tests

A nuclear instrument-landing system for aircraft has been demonstrated as both safe and feasible in field and flight tests by the TRW Systems Group, Redondo Beach, Calif.

The system used beacons containing radioisotope sources, which emit controlled gamma radiation for guidance control. The development and test program, conducted by TRW for the Atomic Energy Administration and the Federal Aviation Administration, is reported to have demonstrated the following potential advantages:

- Use of gamma radiation makes the system immune to weather conditions.

- The nuclear system has no beam-reflection problems, as does the conventional instrument landing system (ILS). The radiation system could be used at sites where standard ILS would not work well.

- Because gamma radiation readily penetrates the aircraft structure, it does not require special openings or radomes in the plane.

- In conjunction with standard ILS, the nuclear system could provide an independent short-range guidance system during the final phases of descent and touchdown, particularly in zero-visibility weather.

- The nuclear system is relatively simple and low-cost and could be used at low-traffic-density fields



Experimental nuclear landing system beacon used for feasibility tests. The twin-engine aircraft (Piper Seneca) was used for flight system evaluation.

that could not support a standard ILS system.

### Similar to standard operation

The operating principles of the nuclear instrument landing system are similar to those of the standard radio-frequency instrument landing system, according to R. A. Kaminskis, TRW staff engineer and developer of the new system. Instead of radio antennas, four nuclear beacons are used, two for the localizer beam and two for the glide slope.

The gamma radiation is collimated in each beacon. In addition a mechanical shutter in each beacon modulates each of the beams at a

different frequency. The airborne equipment consists of a special radiation detector and receiver, the output of which is presented on an ILS localizer/glide-slope indicator.

Radiation safety was a major concern. The levels proved to be well below the safety standards of the Atomic Energy Commission, Kaminskis reports. The measured radiation rate at the runway ranged from 0.1 mrad for most of the runway, increasing to 0.3 mrad in the vicinity of the beacons.

The radiation dose received by a plane's occupants on landing was on the order of  $1.6 \times 10^{-3}$  mrad. On takeoff it diminished to  $10^{-3}$  mrad.

"When you get down to these

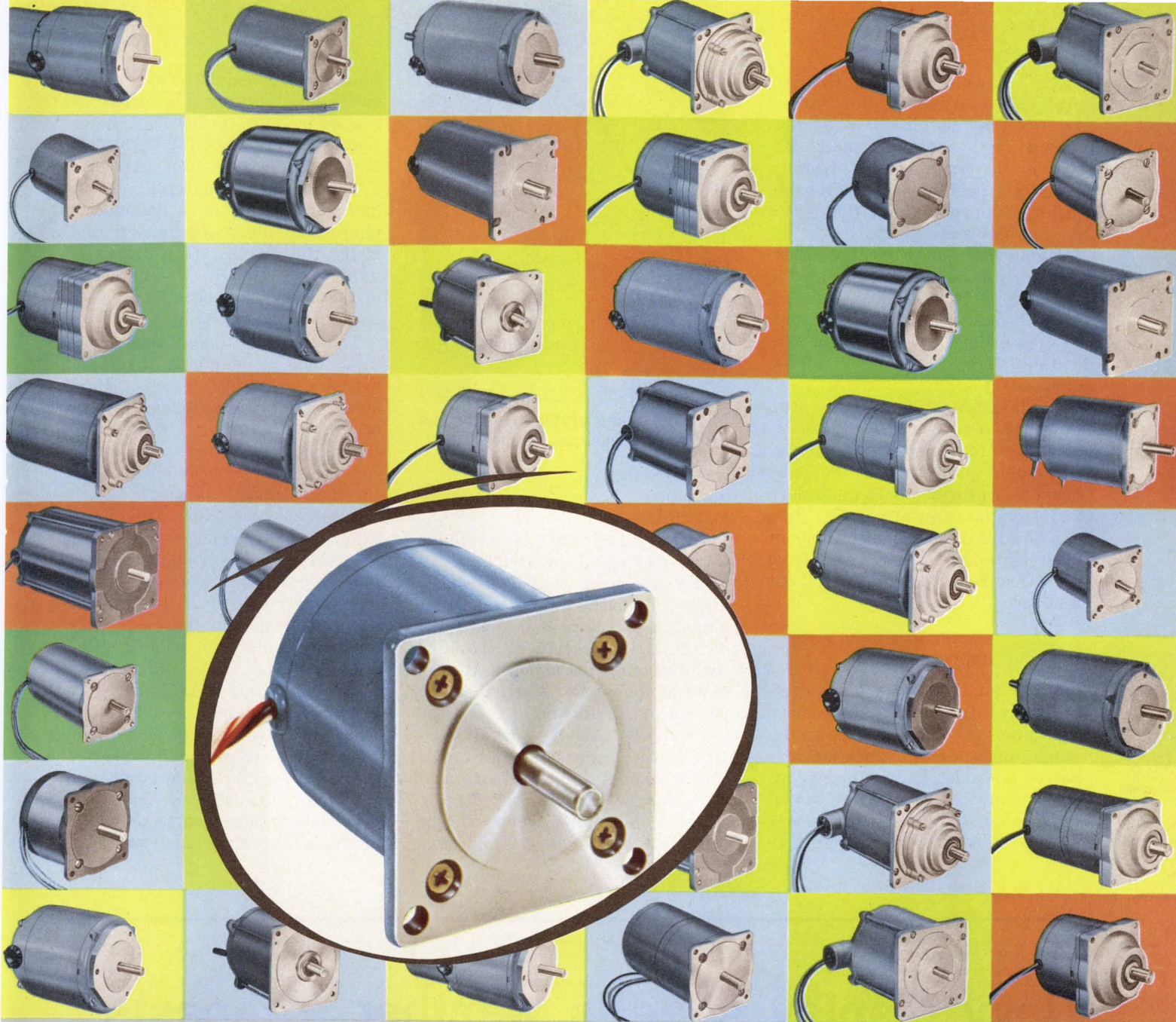

# Chances are 200 to 1 your next SLO-SYN<sup>®</sup> "Stepper" is in stock!

Because SLO-SYN sells more stepping motors and drives than anyone else, they have to make more and ship faster to their busy distributors.

Of course, there *are* more different standard, stock SLO-SYN motor sizes and torque ranges and more drive combinations available too.

This means SLO-SYN distributors have to carry the largest stock to satisfy the demand.

The next time you need a stepping motor or two or five hundred, call the SLO-SYN Distributor near you. Tell him the SLO-SYN ad said: "chances are 200 to

1" the custom solution to your incremental control of motion problem is on his shelf.

You can design peace-of-mind into a drive system when you specify from the wide-control-world of SLO-SYN motors and drives.

Send for the latest SLO-SYN Motor Catalog and Motor/Drive Selection Guide. Write, wire, The Superior Electric Company, Bristol, Connecticut 06010, or call Jack Wallace at 203/582-9561.



**SUPERIOR ELECTRIC**

INFORMATION RETRIEVAL NUMBER 22

levels," says Col. W. S. Holman, physical scientist at the Atomic Energy Commission's Div. of Biological and Environmental Research in Washington, "from a practical point, you're probably picking up more radiation from your wristwatch."

Kaminskas points out that an exclusion area is designed near the beacons, extending about 400 feet on both sides and 50 feet in front, to keep ground personnel at a safe distance from the most intense part of the beam.

As installed at a test site, two up-range beacons, located 500 to 1000 feet in front of the runway threshold, projected a combined beam that provided both glide slope and localizer information. Two down-range beacons, placed about 2500 feet down the runway from the threshold, provided roll-out guidance.

#### Dynamic approach used

While similar static nuclear instrument-landing systems have been proposed, TRW has used a dynamic approach, in which beacons on the left side of the runway emit overlapping beams that are modulated at 60 and 90 Hz. The beacons on the right of the runway produce

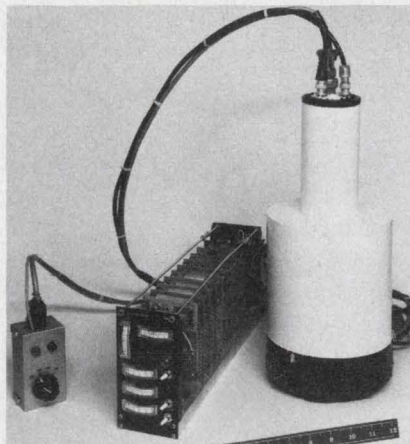

**Nuclear landing system detector and receiver are mounted in the aircraft.**

overlapping beams modulated at 24 and 36 Hz.

When the aircraft is on course it receives equal amplitudes of all four frequencies. If it is above the glide-slope path, the 60 and 24-Hz signals are greater than the 90 and 36 Hz. If the craft is on the glide path but off to the right, it receives more of the 24 and 36-Hz than the 90 and 36-Hz signals.

The position of the aircraft relative to the beam slope and center line is computed by comparison of the strengths of the four signals.

The radioisotope sources in the beacons—each beacon has two

sources—are modulated by rotating mechanical shutters. The beams are shaped so that the level of radiation at the center of the flight path and the runway remains constant.

The radiation detector consists of a scintillator and a photomultiplier tube. When the gamma rays strike the detector tiny flashes of light are produced. The intensity of the flashes is proportional to the energy of the radiation.

The photomultiplier detects the light flashes, amplifies them and produces electrical signals. These signals are processed and displayed on the ILS indicator. The output of the receiver is scaled to 0.5 ft/ $\mu$ A for the glide slope and 2.4 ft/ $\mu$ A for the localizer.

Although the gamma-ray emission consists of random pulses with an average rate of 5000 photons per second, the nuclear instrument-landing receiver is designed to respond only to the modulation frequencies of 24, 36, 60 and 90 Hz.

Ground and flight tests at Edwards Air Force Base, Calif., have demonstrated feasibility of the system, Kaminskas reports, but to obtain the desired system accuracy of  $\pm 1.5$  ft. for the glide slope and  $\pm 3$  ft. for the localizer, additional development is needed to refine the beam-shaping absorbers. ■■

## Navy display speeds weather forecasts

A communications and display system in prototype operation at the Navy's Fleet Numerical Weather Central in Monterey, Calif., is expected to improve and speed weather forecasts dramatically.

Developed by Genisco Technology Corp., Compton, Calif., the Naval Environmental Display Station (NEDS) provides full communications, remote processing, automatic graphic storage, retrieval and TV display capability up to 80 data bits. The system incorporates a special data-compression technique that permits the Naval Weather Service to use the existing Teletype network for transmitting weather and oceanographic data to the fleet.

Traditionally the service uses

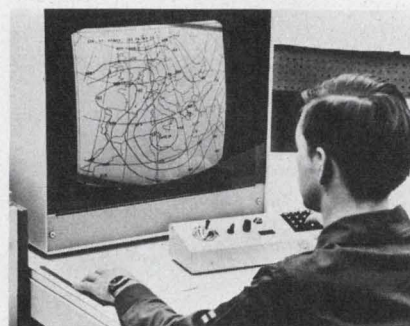

**Weather conditions are observed on a CRT display of the Naval Environmental Display Station now under test at Monterey, Calif.**

facsimile equipment to transmit graphic data over costly, wideband transmission lines. Weather and oceanographic maps received over the system often are of poor quality

and difficult to interpret. Correlation is done manually, and it involves the overlaying of maps by hand to make predictions.

The system being tested has two TV monitors and a keyboard that permits a forecaster to view alphanumeric and color graphic material, while a plotter/printer makes copies of any material of interest.

All data received, selected and stored are automatically logged into a computer index and become available, upon demand to the forecaster. He can call for a CRT display of the index, which lists the weather maps, messages and other data in the system's disc storage. He then calls for a display of the desired weather maps, via the keyboard, to do his forecast. ■■



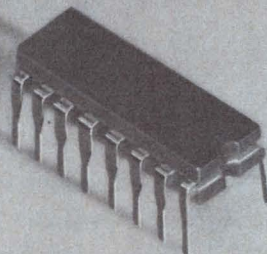
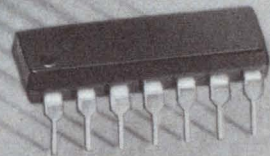
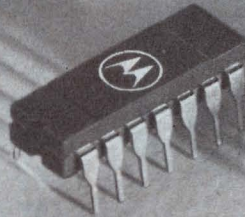
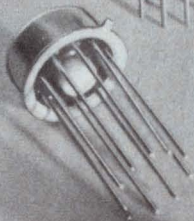
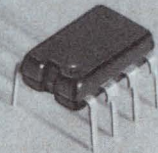
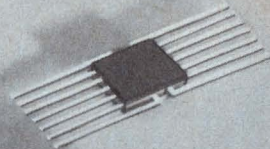
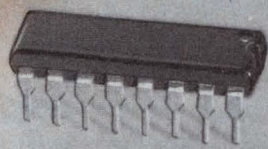

**One  
Good  
Interface  
Deserves  
Another...**

# And Another,



... ultimately generating a kaleidoscope of bilingual bonds between digital logic and associated circuitry. Like modem, memory, display and data bus interface. Peripheral, D/A and A/D and twisted pair interface. Industry firsts, innovative custom designs, and a lineup of popular second-source devices. Each a hue of the Motorola interface rainbow. A variegation that includes:

- the first quad versions of the MC75107-110 line drivers/receivers, the TTL compatible MC3450-53.
- the first quad high speed comparators (MC3430-33) with unique "input sensitivity" specing to refresh a stale op amp heritage.
- a major producer first in low-cost monolithic A/D, D/A converters, the MC1505, 6, 7 and 8.

And on and on. The choice is yours. Make it easy with the new 20-page "Pocket Guide to Linear Interface Functions" which includes function block diagrams, temperature ranges, and package descriptions and outlines. Read all about it. Just one thin request via coupon or reader service number.

# And Another,

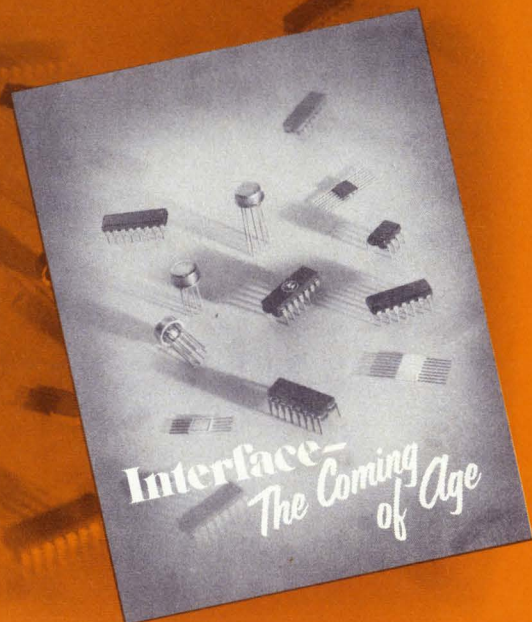

A new generation of interface for a new generation of design requirements. Interface shedding its linear genealogy and adopting digital technologies. Chips of LSI density.

Advanced MOS memory drivers and core-memory sense amplifiers, bus transceivers for minicomputer and microprocessor interface and high-voltage display drivers. High speed logic interface and instrument interface (G.P.I.B.) for measurement systems. More first generation monolithic A/D and D/A converters. Advanced refinements, like higher speed; and space saving strides, like quads, for existing device types.

Tomorrow's components sired by today's technologies. Preview their maturity in "Interface—The Coming of Age", a comprehensive report on the trends and developments in interface. Request it today and behold the benefits of allying your future with the future of Motorola interface.

# And...?

Interface. Big challenges today. Bigger challenges tomorrow.

Motorola. A myriad of solutions today. Solutions transcending tomorrow. Solutions with you in mind. After all, our success is riding on your success.

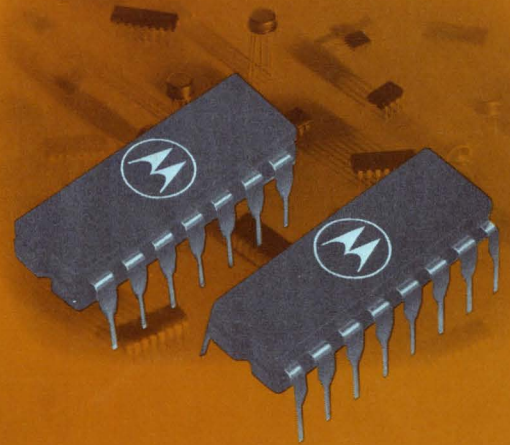

**MOTOROLA LINEAR**  
*Interface—The End Is Nowhere In Sight*

## MOTOROLA LINEAR INTERFACE FUNCTIONS

### MEMORY INTERFACE

- MC1540 Core Memory Sense Amplifier
- MC1541 Dual-Channel Gated Sense Amplifier
- MC1543 Dual MECL Core Memory Sense Amplifier
- MC7522 Dual High-Speed Sense Amplifier
- MC7524 Dual High-Speed Sense Amplifier
- MC7528 Dual High-Speed Sense Amplifier
- MC7534 Dual High-Speed Sense Amplifier
- MC7538 Dual High-Speed Sense Amplifier
- MMH0026 Dual MOS Clock Driver
- MC75325 Dual Memory Driver
- MC1544 AC-Coupled Four Channel Sense Amplifier

### MODEM INTERFACE

- MC1488 Quad MDTL Line Driver RS-232C
- MC1489 Quad MDTL Line Receiver RS-232C
- MC1489A Quad MDTL Line Receiver RS-232C

### DISPLAY INTERFACE

- MC75491 Multiple Light-Emitting Diode (LED) Driver
- MC75492 Multiple Light-Emitting Diode (LED) Driver

### PERIPHERAL INTERFACE

- MC75450 Dual Peripheral Positive "AND" Driver
- MC75451 Dual Peripheral Positive "AND" Driver
- MC75452 Dual Peripheral Positive "NAND" Driver
- MC75453 Dual Peripheral Positive "OR" Driver
- MC75454 Dual Peripheral Positive "NOR" Driver
- MC75461 High Voltage Dual "AND" Driver
- MC75462 High Voltage Dual "NAND" Driver
- MC75463 High Voltage Dual "OR" Driver
- MC75464 High Voltage Dual "NOR" Driver

### D/A AND A/D INTERFACE

- MC1506 Six Bit, Multiplying Digital-To-Analog Converter
- MC1508 Eight Bit, Multiplying Digital-To-Analog Converter
- MC1505 Analog-To-Digital Converter Subsystem
- MC1507 Analog-Digital Control Circuit

### COMPARATOR INTERFACE

- MC1710 Differential Comparator
- MC1711 Dual Differential Comparator
- MC1514 Dual Differential Comparator
- MLM111 High Performance Voltage Comparator
- MC3430 Quad High Speed Voltage Comparator
- MC3431 Quad High Speed Voltage Comparator
- MC3432 Quad High Speed Voltage Comparator
- MC3433 Quad High Speed Voltage Comparator

### TWISTED-PAIR INTERFACE

- MC3450 Quad Line Receivers with Common Three-State Strobe Input
- MC3452 Quad Line Receiver with Open-Collector Outputs
- MC3453 Quad Line Driver with Common Inhibit Input
- MC75107 Dual Line Receiver
- MC75108 Dual Line Receiver
- MC75109 Dual Line Driver
- MC75110 Dual Line Driver
- MC75140 Dual Line Receiver

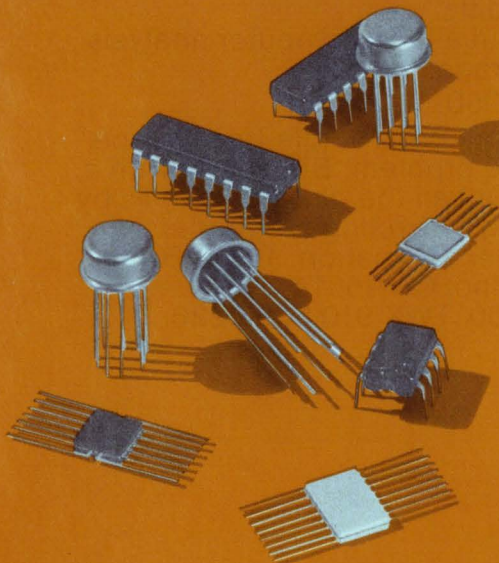

**For quick response, snip out and attach to company letterhead.**

*Turn me around to Motorola Interface*

Send:  Pocket Guide to Linear Interface Functions

Interface — The Coming of Age

Name \_\_\_\_\_

Title \_\_\_\_\_

Mail Drop \_\_\_\_\_

**Mail To:** MOTOROLA INTERFACE  
P. O. BOX 20912, PHOENIX, ARIZONA 85036

# the biomated scope

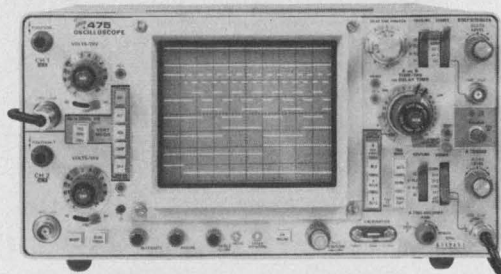

**your scope**

## 8 traces of digital logic!

If your world is digital, Biomation's 810-D Glitch Fixer can help you. Mate it to your scope and it captures and displays complex timing events on 8 channels at once. At speeds to 10MHz. *On your bench scope.*

Too many guys have had to sweat out a deglitching problem one line at a time. They asked us to help, and we answered with the 810-D. The unit contains 256 bits of memory per channel—producing a continuous 8-trace timing diagram display on your scope from just one logic stimulus combination of your device. The memory, in conjunction with a novel trigger delay and record control feature also gives you the ability to store a selected amount of the signals which occurred *prior* to the time of the detected trigger. Add to this the unit's 10ns glitchcatching mode and you will know why the 810-D has become a new basic diagnostic tool for designing and debugging digital circuits.

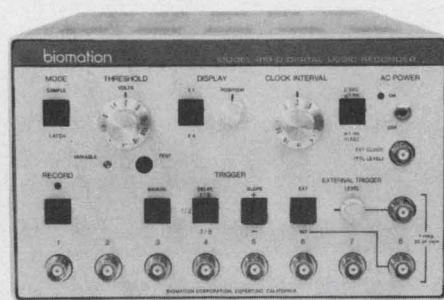

**our glitch fixer™**

## Features:

- Eight logic signal channels with 1M Ohm inputs.
- Presents 8 x 256 bits of recorded data on scope in easily-interpreted timing-diagram form.
- Input latch mode selection provides detection of random pulses—as narrow as 10ns.

- Selectable logic thresholds include TTL and EIA levels.
- Synchronous clock input to 10MHz.
- Or internal clock selection 20Hz to 10MHz.
- Saves selectable amount of *prior-trigger data*, provides pre-trigger lookback.
- Display expansion gives precise time analysis of data.
- Digital output allows computer analysis or mass storage.

Price: \$1950.

So if you've got a single trace scope and an 8-trace problem, Biomate it with a Glitch Fixer. Get all the glorious details by calling, writing or circling the reader service number. Biomation, 10411 Bubb Road, Cupertino, CA 95014. (408) 255-9500. TWX 910 338 0226.

# biomation

INFORMATION RETRIEVAL NUMBER 26

# POWER FOR YOUR IC'S OR OP AMPS

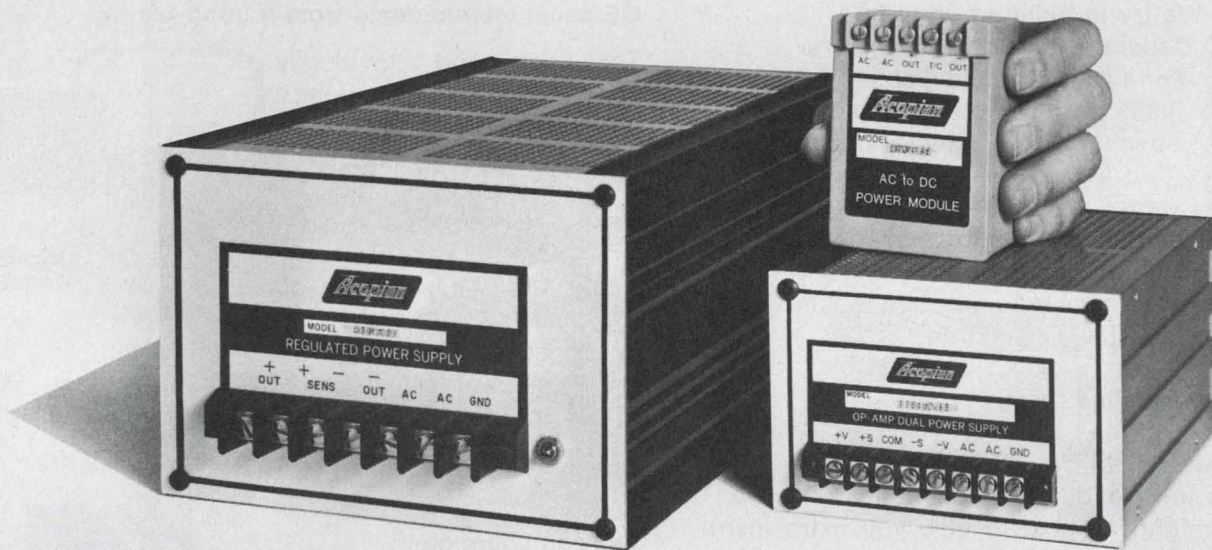

ALL MODELS U.L. RECOGNIZED

5 VOLTS				±15 VOLTS			
OUTPUT CURRENT AMPS	SIZE INCHES	PRICE	MODEL	OUTPUT CURRENT AMPS	SIZE INCHES	PRICE	MODEL
.5	3.5 x 2.5 x 1.4	\$55	5EB50	.1	3.5 x 2.5 x 1.4	\$55	DB15-10
1.0	3.5 x 2.5 x 1.6	75	5EB100	.15	3.5 x 2.5 x 1.4	65	DB15-15
2.0	3.5 x 2.5 x 2.4	115	5EB200	.2	3.5 x 2.5 x 1.4	75	DB15-20
2.5	3.5 x 2.5 x 2.4	130	5EB250	.4	3.4 x 5.1 x 5.1	85	TD15-40
5.1	3.4 x 5.1 x 6.6	150	A5MT510	1.0	3.4 x 5.1 x 5.1	125	TD15-100
9.0	3.4 x 5.1 x 9.3	180	A5MT900	1.6	3.4 x 5.1 x 6.6	150	TD15-160
12.0	3.4 x 5.1 x 13.3	200	A5MT1200	2.5	3.4 x 5.1 x 9.3	160	TD15-250
22.0	5.1 x 7.4 x 11.3	270	A5HT2200	4.5	3.4 x 5.1 x 13.3	225	TD15-450
32.0	5.1 x 7.4 x 16.0	320	A5HT3200	8.5	5.1 x 7.4 x 11.3	299	TD15-850

Line/Load Regulation:  $\pm 0.1\%$  or better; Ripple: 1.5 mv or less; Input: 105-125 VAC

Three day shipment guaranteed. Complete details on these plus a comprehensive line of other power supplies and systems are included in the Acopian 73-74 catalog. Request a copy.



Corp., Easton, Pa. 18042. Telephone: (215) 258-5441.

INFORMATION RETRIEVAL NUMBER 27

# All Panel Meters are not created equal.



## We try to build an edge into General Electric panel meters.

For instance, you won't see a GE panel meter turn yellow, because we use a special white paint that stays white. You won't get eyestrain either. GE panel meters come with extra-wide scales, big numerals, tapered pointers, and shadow-free cover plates for quick, sure readings. We're fussy about things like that.

## Once you've installed them, forget 'em.

GE's famous reliability just doesn't happen, we *build* it in! We designed-out a lot of extra parts that might fail, just to give you extra instrument reliability. To make sure, we added a 20% overload capability to our voltmeters and ammeters. Still not satisfied, we decided to measure instrument quality from parts to finished product in order to screen out anything marginal. Now, it's just too tough for a lemon to squeeze through.



## GE panel meters come from a good family.

They look good individually and they look good together. Choose the rounded **BIG LOOK®** design for unique style and wide-eyed readability. Or choose the clean **HORIZON LINE®** case for its behind-panel mounting flexibility (*without* the usual bezel), and its snap-off mask available in six colors. GE makes panel meters to suit you and to add snap to your application.

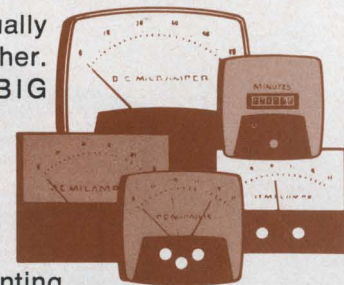

## You can count on General Electric panel meters.

They're built to help you do a better job. At GE, we're not interested in product equality. We want ours to be *better* than the rest.



For a complete catalog of competitively priced and readily available GE panel meters, see your nearby authorized GE distributor. Or write to General Electric Company, Section 592-43, One River Road, Schenectady, N. Y. 12345.

592-43

**Specify  
General Electric...  
just for good measure.**

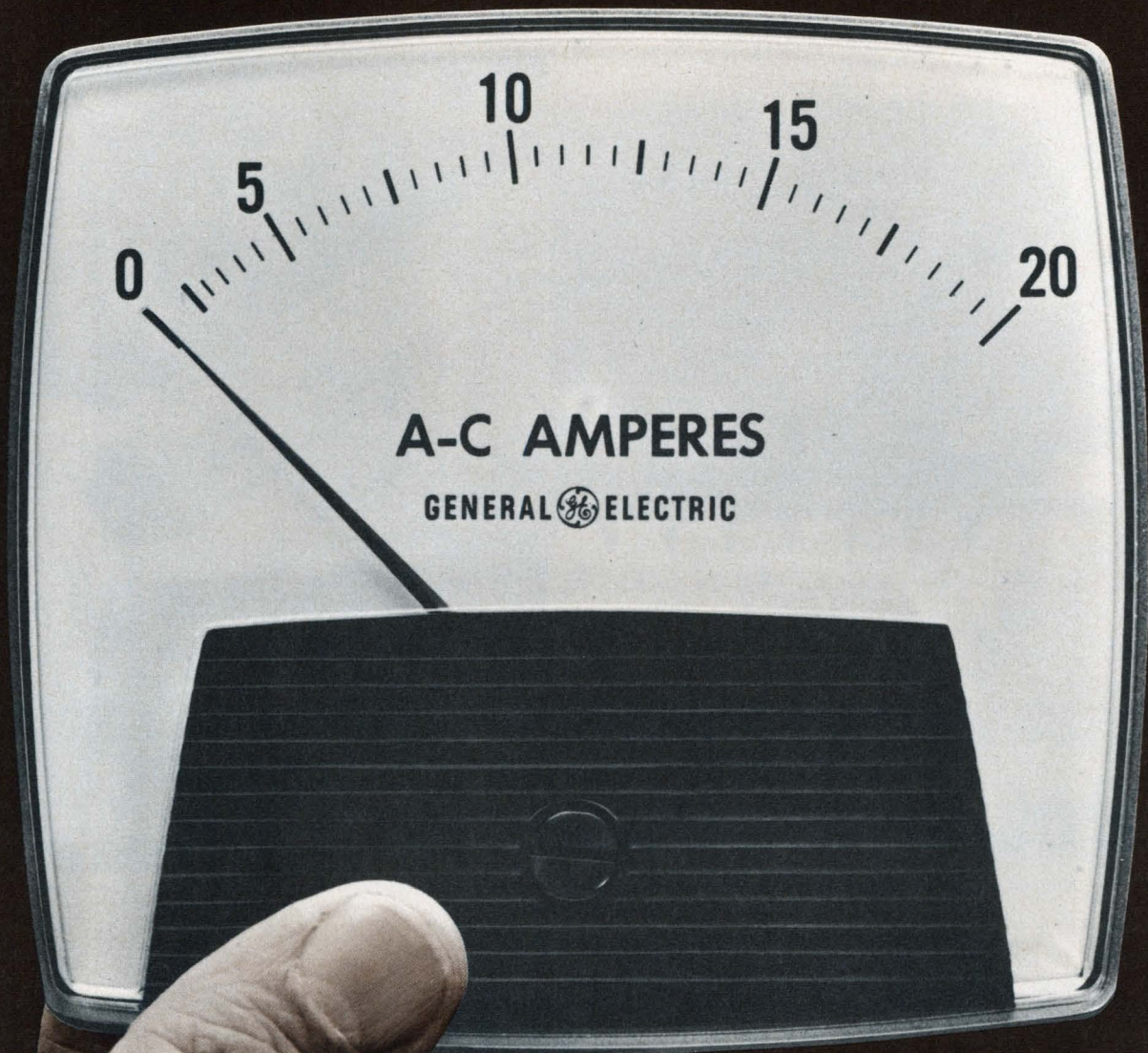

**A-C AMPERES**

GENERAL  ELECTRIC

GENERAL  ELECTRIC

# Digivue® - a better way to look at it.

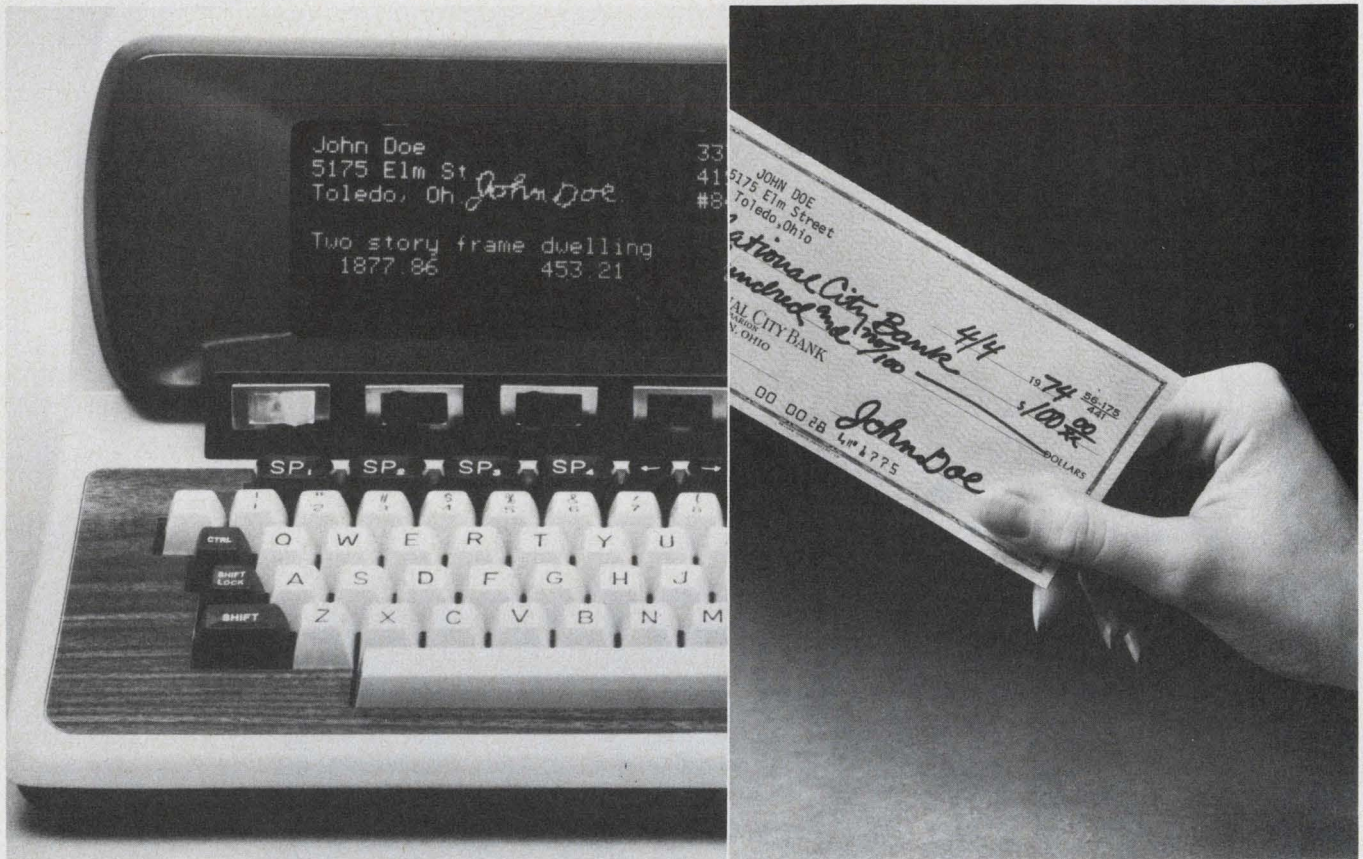

Digivue 80-33 in demonstration unit, showing high-contrast display for use in signature verification.

Because computer time is valuable to your customers, Digivue display/memory units offer an unforgettable advantage.

The advantage is inherent memory and it's an inherent part of every Digivue unit. This makes Digivue units especially useful for graphic presentations like signature verification since refresh is not required.

And Digivue units offer a high-contrast, flicker free display for precise readings with less chance of eye fatigue for people who spend long periods referring to data displays and computer terminals.

There's a lot more to Digivue, too. Our 512-60 models have hard copy and rear projection capabilities. And Digivue panels are flat and thin, allowing precise display and broad equipment design parameters.

As you may have guessed, Digivue display/memory units currently cost more than CRT's. But then, they offer a lot more. For a booklet that explains Digivue more fully, call (419) 242-6543, Ext. 66-415. Or write Electro/Optical Display Business Operations, Owens-Illinois, Inc., P.O. Box 1035, Toledo, Ohio 43666.

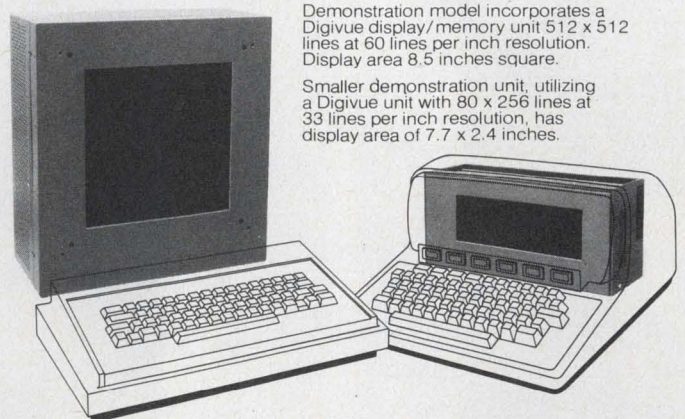

Demonstration model incorporates a Digivue display/memory unit 512 x 512 lines at 60 lines per inch resolution. Display area 8.5 inches square.

Smaller demonstration unit, utilizing a Digivue unit with 80 x 256 lines at 33 lines per inch resolution, has display area of 7.7 x 2.4 inches.

**OI**  
**OWENS-ILLINOIS**  
 Toledo, Ohio



# washington report

## **New science council is urged for White House**

The National Academy of Sciences has urged President Nixon and Congress to re-establish in the White House a panel to advise the President on matters involving science and technology. With the demise early last year of previous White House machinery for this purpose, there is currently no provision at the top level of the Government for sophisticated analyses of development programs in the energy field, transportation and other areas of national concern.

The recommendation by the academy calls for creation—preferably by legislation—of a Council for Science and Technology. It would work closely with other White House agencies, such as the Office of Management and Budget, in a “co-equal partnership.”

In previous advisory apparatus, a science adviser served as chairman of the President's Science Advisory Committee and head of the Office of Science and Technology within the Executive Office of the President. Unlike the previous committee, which consisted of 20 part-time specialists, the new council would be formed of only three individuals, with its chairman a personal adviser to the President. There would be a professional staff of 25 or 30, plus experts brought in to attack special problems. The old committee was concerned chiefly with defense matters; the new council would deal with both defense and civilian problems.

## **IBM enters domestic satellite competition**

Indicative of the increasing importance of communications to data processing, IBM plans to join forces with Comsat. The goal: to put a satellite communications system into operation. The computer corporation would become the first noncommunications entrant with any great financial strength in the domestic satellite communications field. But because of IBM's dominance in the computer field, its move into communications could be questioned by the Justice Dept. or attacked by competitors, who have already pressed restraint-of-trade lawsuits against the computer giant. In an apparent effort to avoid such attacks, a spokesman for the company notes that it intends to seek competitive bids for much of the computer equipment that will be used in the satellite network.

IBM and Comsat plan to buy out Lockheed Aircraft and MCI Communications, which, along with Comsat, own the CML Satellite Corp. The new company is to be renamed when the deal, which is subject to approval by the Federal Communications Commission, is completed. IBM would own 55% of the new venture and Comsat 45%. The IBM-Comsat

satellite system would compete with AT&T for data, facsimile and voice-transmission customers who want private-line service.

## Study use of computer techniques to predict earthquakes

A contract to use computer numerical simulation techniques to predict earthquakes has been awarded to S-Cubed Corp. of La Jolla, Calif., by the U.S. Geological Survey of the Dept. of the Interior. According to Dr. Sabodh K. Garg, principal investigator at S-Cubed, the velocity of sound through the earth changes in advance of an earthquake and then recovers to the normal velocity just prior to the quake. A buildup of underground stresses caused by a migration of water beneath the earth's surface may be responsible for the observed velocity variations, Garg suggests. This phenomenon will be further studied under the contract. Size of the award was not announced but the work is expected to take about 12 months.

## First Space Shuttle flight control units delivered

The first breadboard versions of five flight control systems for the Space Shuttle have been delivered to Rockwell International by Honeywell's Aerospace and Aeronautical Products Divisions. The systems will undergo system-level integration and testing by Rockwell—prime Shuttle orbiter contractor to NASA—at its Downey, Calif., Space Div. If the tests are successful, Honeywell will get the go-ahead to manufacture flight hardware to be used in the spaceplane's first flight tests scheduled for 1977. The flight controls will maintain the attitude and stability of the Space Shuttle through all phases of operations: liftoff from the launch pad, ascent into orbit, orbital operations, atmosphere reentry and landing.

**Capital Capsules:** Control Data Corp., under a contract with the Army's Electronics Command at Ft. Monmouth, N.J., **has built a desk-top optical character reader** designed to operate in tactical environments. The device will read documents from 5 to 8 1/2-in. wide and up to three feet long. Reading data is 240 characters per sec. . . . **A new digital radar processor for ground stations** is under development by the Air Force. Called Sapphire (synthetic aperture precision processor), the system is designed to simplify the radar interpreter's job, yet process the information faster than current analog displays. The program is a joint effort of the Aeronautical Systems Div. and the Air Force Avionics Laboratory at Wright-Patterson Air Force Base. . . . **Government outlays for command, control and communications systems** are expected to total \$9.4-billion for fiscal 1975-1979, according to Frost & Sullivan, the New York City-based market research organization. . . . **A military data-storage and retrieval system that contains one of the largest mass memories ever developed for use in a tactical environment** has been demonstrated by the Air Force and RCA. It is part of an information-processing and interpretation system that would support air and ground forces in combat. The system's disc-file memory has a 2.5-billion-bit capacity.

# 1000 cm/ $\mu$ sec stored writing speed, four storage modes, and more.

## 100 MHz oscilloscope

Tektronix 7633 oscilloscope gives you 100 MHz bandwidth and 1000 cm/ $\mu$ sec stored writing speed. So you can retain and view fast rise, low repetition rate, single shot or slow moving waveforms. All with one instrument. This allows you to solve problems in computer sciences, aerospace, ballistics, communications and various other applications.

## Multi-mode storage

The 7633 offers four operating modes: Non-store, normal and fast Variable Persistence and Bistable modes are available at the touch of a button. And, an 8 x 10 div. (.45 cm/div.) mode gives the instrument's top writing speed.

## Bright, burn-resistant CRT

No special operating safeguards are necessary with the 7633's rugged, burn resistant CRT. This makes it a dependable unit for design bench, hospital laboratory, service facility or classroom. The large 8 x 10 div. CRT is easy to read in both cabinet and rackmount configurations. An alphanumeric readout, exclusive on Tektronix instruments, makes quick on-screen reference and easy interpretation of photographic records. Or, the instrument may be ordered without the readout for \$400 less.

## Part of the 7000 Series

Select from thirty different 7000 Series plug-ins. You can custom tailor your instrument to meet your immediate need. And expand its capabilities later as the need arises. A 7633 mainframe costs \$3650. A typical configuration with dual trace vertical amplifier and delaying sweep timebase sells for \$5,550. For rackmount add \$100.

## Specifications

Vertical System—Accepts all 7000 Series vertical amplifiers. Bandwidth determined by mainframe plug-in unit up to 100 MHz. Left, Alternate, Add, Chop, Right display

modes. Chopped rate approximately 1 MHz. Horizontal System—Compatible with all 7000 Series plug-ins. Fastest calibrated sweep rate is 5 ns/div. Phase shift between vertical and horizontal is 2°, DC to 35 kHz for X-Y operation.

CRT and Display—Internal 8 x 10 div. (.9 cm/div) graticule with superimposed 8 x 10 div. (.45 cm/div) reduced scan area. Nonstore, variable persistence, and bistable in normal or fast and full or reduced scan storage modes push-button selected. Writing Speed and View Times—From .03 div/ $\mu$ sec until erased up to 2222 div/ $\mu$ sec at 30 sec view time. View time may be increased more than 30 times by using reduced intensity in the SAVE display mode.

## See for yourself

For a "hands-on" demonstration, contact your nearby Tektronix Field Engineer. Or write: Tektronix, Inc., P. O. Box 500, Beaverton, Oregon 97005. In Europe write: Tektronix Ltd., P. O. Box 36, St. Peter Port, Guernsey, C. I., U. K.



**TEKTRONIX®**  
committed to  
technical excellence

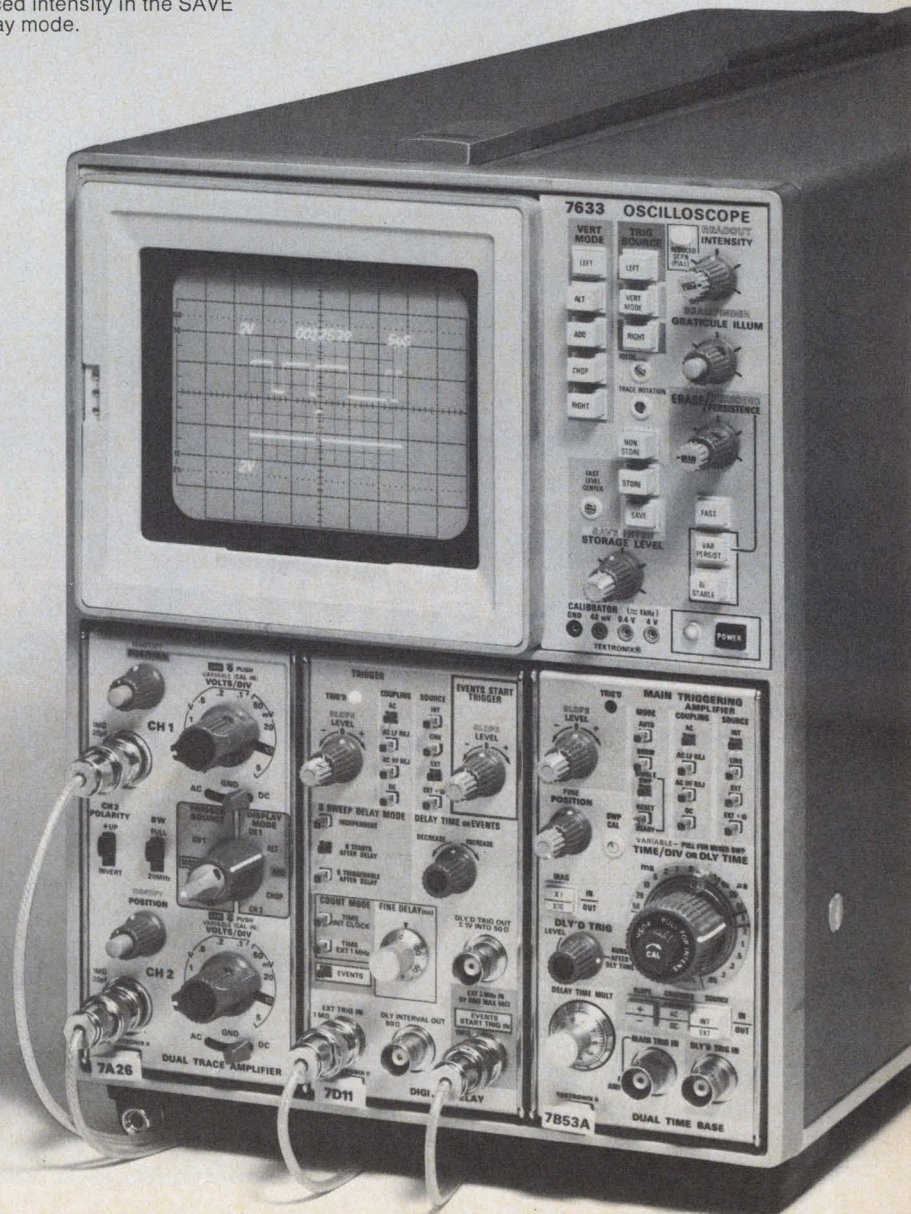



You don't have  
to give up  
carbon composition  
performance to  
save space.

If you're really  
serious about cost,  
be serious about quality.

Are you cramped for board space but not in power handling capabilities? Is reliable performance vital? Then use Allen-Bradley 1/8 watt carbon composition resistors. Get the pulse handling and overload capabilities that are superior to resistors manufactured by other technologies. Exclusive hot molded construction for a

dense resistance element which reduces noise, and results in a consistent performance. Most importantly, our 1/8 watt resistors have all of the quality and reliability common to our larger sizes. Quality that really can cut your fixed resistor costs. If you think resistors are identical, write for "7 Ways to Tell the Difference in

Fixed Resistors." Available from your Allen-Bradley Electronic Distributor, or: Allen-Bradley Electronics Division, 1201 South Second Street, Milwaukee, Wisconsin 53204. Export: Bloomfield, N.J. 07003. Canada: Allen-Bradley Canada Limited, Cambridge, Ontario. United Kingdom: Jarrow, Co. Durham NE32 3EN.

Actual size

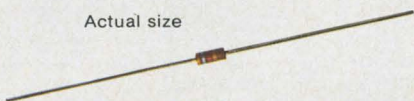

**Allen-Bradley**

Milwaukee, Wisconsin 53204

## The good boss

An old buddy of mine used to rave about what a great boss he had. Jack's boss never bothered him, never looked over his shoulder, never challenged anything he did, never tried to tell him how to do his job. And Jack was delighted. He developed some pretty fair products and they sold moderately well. So he couldn't wish for a better life—until the crunch came. His company folded and he found himself looking for another job. He had a tough time. He was stunned when he learned that he wasn't really up to date. He hadn't learned anything new in five years. He had become too complacent. He was too happy.

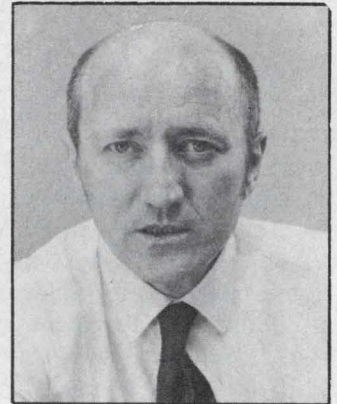

Another pal of mine had a boss who was always climbing on his back. Every week or two the boss would pop into Charlie's office, ask him about progress of his project, and question him about almost all of his decisions. His boss would want to know if a component was really suitable—if it offered the best performance or the best price, or the best performance for the price, or the best performance for the application. Charlie's boss wanted to know if he was designing for optimum production methods and if he had checked with enough vendors to see that different products in the design would be available in the quantities needed, when needed. He checked almost every circuit. He grilled Charlie about every piece of test equipment he bought. And though he was pleasant about it, Charlie's boss subjected him to some grueling half-hours every week or two. But my buddy finally outfoxed him.

Over a cool drink one night he told me he was finally getting his boss out of his hair. "I research the hell out of everything," he said. "I can justify every single resistor, every switch, every IC in my design. I know the cost of every line on every PC board. And let me tell you, my design may not be perfect, but none of my competitors comes within miles of it. Every time my boss challenges me, I drown him in solid facts. It has gotten so he doesn't come around much anymore."

After a few years Charlie was appointed vice president of engineering. He's really an easy-going guy and a wonderful fellow to swap war stories with. But every week or two he drops in on one of his engineers and asks one hell of a lot of incisive questions. The better engineers there are trying to figure how to get him out of their hair.

A handwritten signature in cursive script that reads "George Rostky".

GEORGE ROSTKY  
Editor-in-Chief

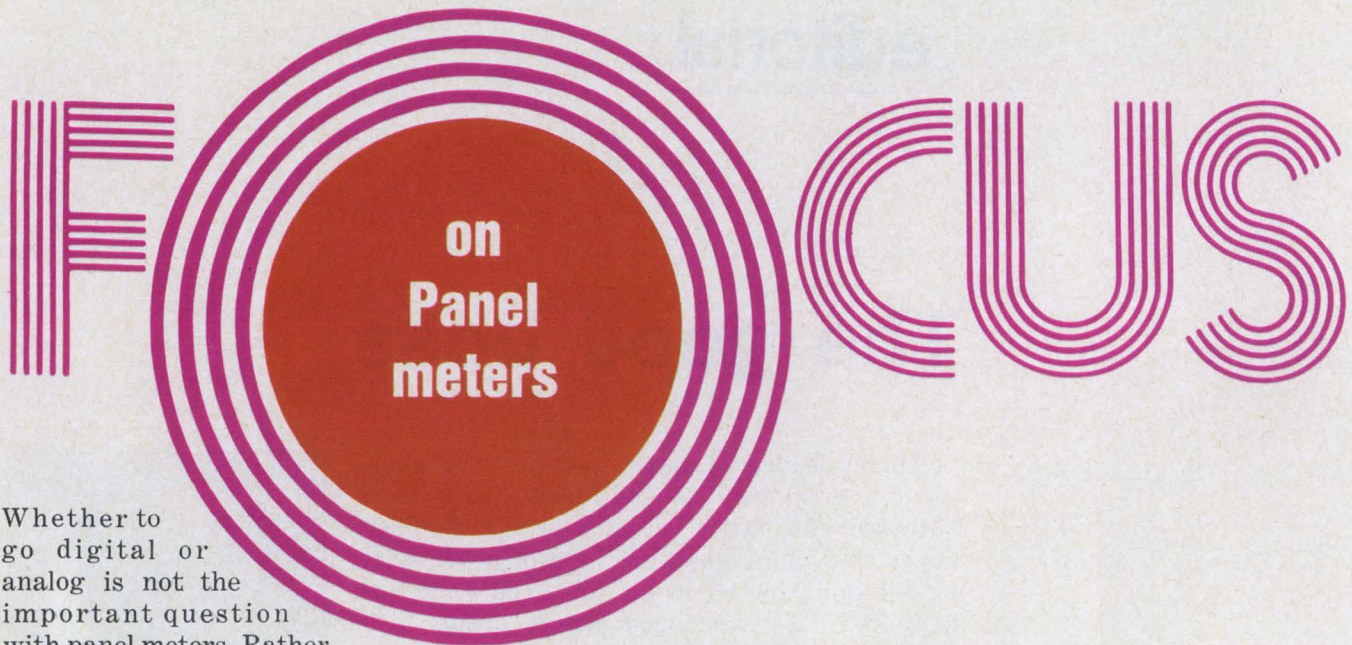

# FRONT PANEL METERS

Whether to go digital or analog is not the important question with panel meters. Rather, you should ask which DPM or which APM will best fill your needs. This question isn't so easily answered.

Behind the apparent simplicity of the venerable D'Arsonval meter lies a Pandora's box just waiting to be opened by an unsuspecting engineer. And though relatively new arrivals on the APM scene—like the taut band and the proprietary "parkermeter"—have solved some of the problems, they've done so at the expense of other characteristics.

By contrast, the DPM's far greater complexity should jolt the specifier into alertness. But he frequently ignores the warning, perhaps because the no-nonsense digital display lulls him into a false sense of security.

So, with both APMs and DPMs, you can expect problems—in selection and in use. To see what's in store, just look at any spec sheet.

## THE ANALOG PANEL METER

The D'Arsonval mechanism is about 80 years old and is used in approximately 90% of all dc APMs, so it's incredible that it still causes problems. But, like any instrument, it has limitations that are often overlooked by both vendor and specifier.

And with the industrial designer increasingly doing packaging, the APM may be selected more for looks than for performance. Thus, many data sheets are short on specs and long on styling.

Foremost among the missing are specs that tell how various influence factors affect APM accuracy and other important performance parameters. Most critical of the effects—which must be

added to a meter's basic inaccuracy—are those of temperature, shock, vibration and external magnetic fields. And these aren't all.

According to ANSI C39.1-1972—the industry standard for analog indicators—accuracy refers to the quality of closeness to a specified value under stated reference conditions. Intrinsic accuracy is the limit of an instrument's accuracy under the reference conditions, expressed as a percentage of a fiducial value, usually full scale.

Here's where the first of Pandora's little gremlins appear—in the form of spec sheets that list accuracy without stating the reference conditions. Or that confuse absolute accuracy with other terms, such as calibration accuracy, tracking accuracy, full-scale accuracy or repeatability accuracy. Each of these has a specific meaning, but none spells out the intrinsic accuracy.

Though analogs aren't known for accuracy—most list a 2% error and the best about 0.5%—you'd still like to know what accuracy you'll start with. And this depends on the type of APM, its design, how it's constructed and what materials are used. These also determine another critical meter characteristic: reliability.

## Friction can rub the wrong way

Analogs are generally classified into three broad categories: according to use, operating principle and the method of suspension of the moving element. The first category includes panel, switchboard and portable types, while the latter encompasses just two suspension methods: pivot and jewel (p & j) and taut band.

Operating principles include the permanent-magnet moving coil (which measures dc voltage and current), the moving iron (ac), the electro-

**Stanley Runyon**  
Associate Editor

dynamic (power), the thermocouple (true rms) and the rectifier (ac).

Regardless of use and regardless of principle, competing APM vendors generally battle it out on the basis of construction, with the major push concentrated on the suspension. And no wonder. The No. 1 enemy of all APMs is friction, and friction originates in the suspension: between the moving and stationary elements.

Thus vendors (and users) line up with p & j proponents on one side and taut-band enthusiasts on the other—depending, of course, on which suspension each vendor happens to make. Those few that make both types have a foot in each camp. Let's see how the two types stack up.

In the p & j, the moving elements are supported top and bottom by hardened, highly polished steel pivots, which fit into jewel bearings (usually sapphire). Current passing through the

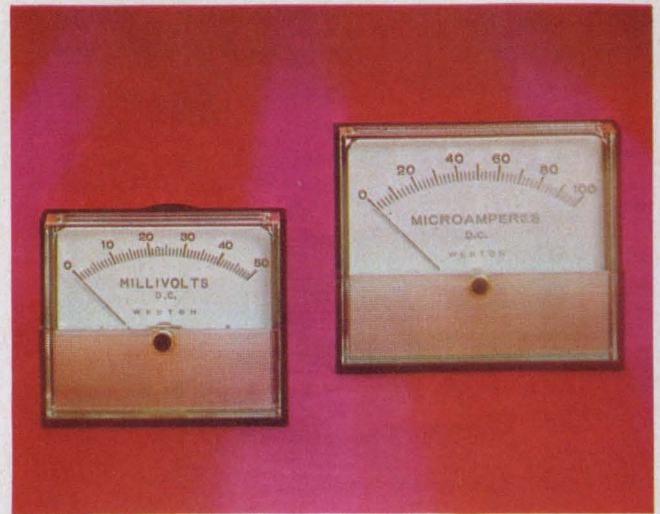

Meters in Weston's 1900 Series are standardized in appearance so all sizes match. The line includes both taut band and p & j's. Accuracy is 1% or 2%.

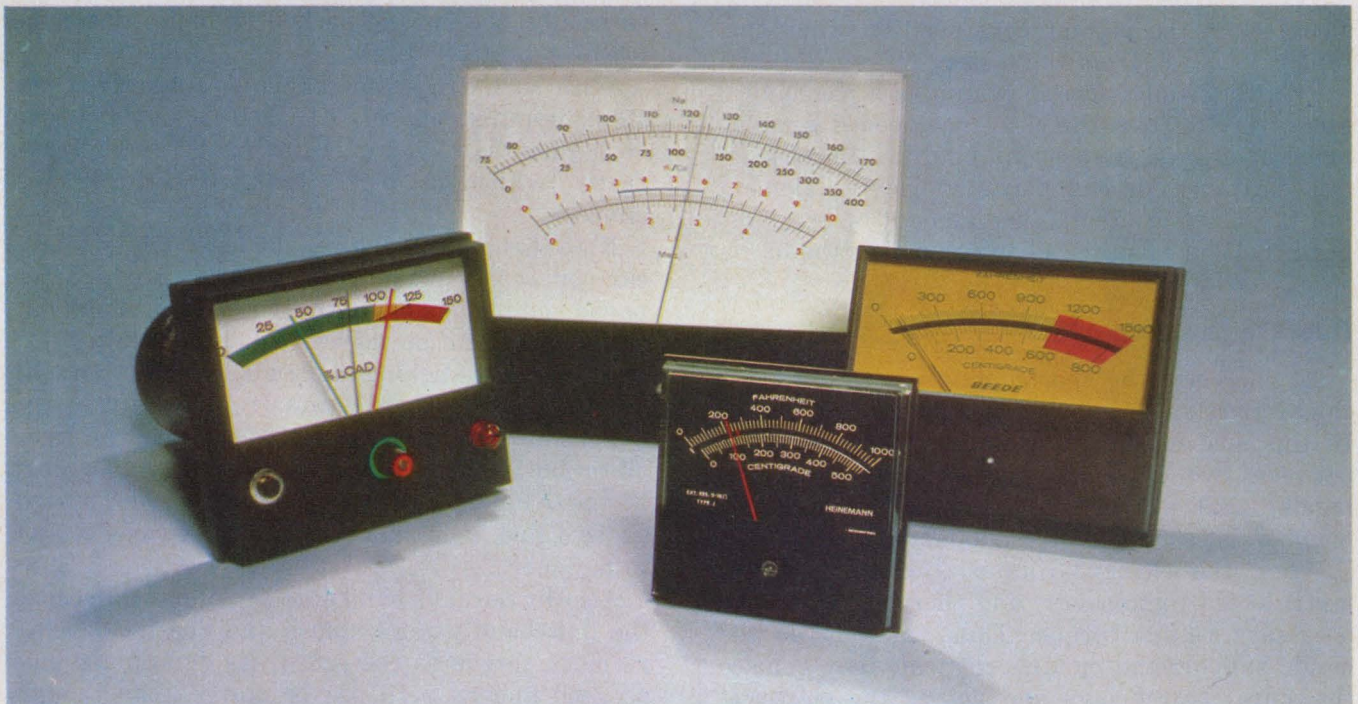

Beede's extensive line of panel instruments includes standard panel meters, edgewise indicators, control

meter relays, pyrometers and special meter movements, such as the 250° Super Torque.

APM causes rotation, and spiral hairsprings return the mechanism to the zero position when the current is removed.

When a measurement is made, the current must first overcome the static friction of the pivot in the jewel before motion occurs. Thus a dead zone results, and the APM can't show small current changes. Perhaps more important than the limited sensitivity is the accompanying deterioration in reading repeatability.

But repeatability is not just a function of friction, it also depends on the weight (mass) of the

moving system, on the restoring torque and on other factors. Thus repeatability—or lack of it—is not unique to the p & j.

However, in p & j's of high sensitivity and high internal resistance—10  $\mu$ A full scale and 5000  $\Omega$ , for example—input power and restoring torque are low. In this case, good repeatability is difficult to achieve; don't look for a 0.5% figure.

Two other sources of error can appear in the p & j suspension: that of spring set and fallover. The former is a time-related hysteresis or fatigue exhibited by the return springs, and shows up as

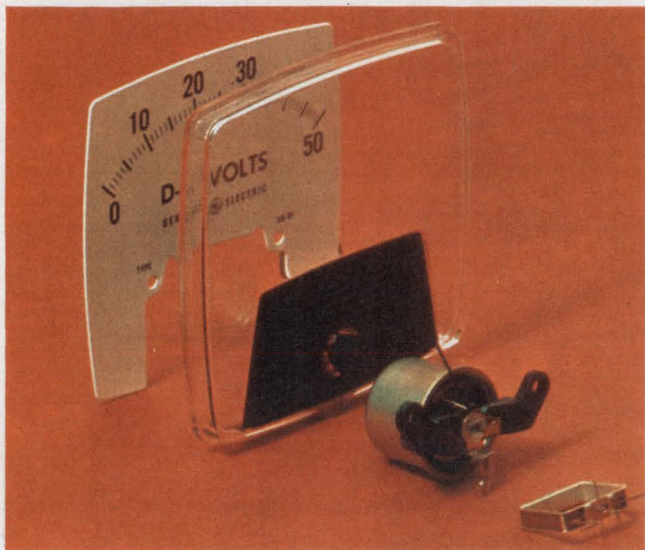

The Big Look is General Electric's contribution to the APM styling competition. Shown exploded is the dc voltmeter member of the family.

an offset in the pointer zero position when current is removed from the meter.

Fallover, which also shows up as a mechanical error, results from the clearance needed between pivot and jewel to prevent binding. Because of this clearance, or end play, the moving element can tilt, causing errors. The amount of error depends on how sloppy the vendor makes the fit.

### Enter the taut band

To overcome the shortcomings of the p & j—chiefly friction—vendors developed the taut band. In this suspension the moving element is hung between two extremely fine metal ribbons (or bands) that are kept under tension by elastic members at each end of the assembly.

When the element rotates, the bands twist, much like a torsion bar, and thereby supply the necessary return torque. Thus not only do the bands support the moving element, they replace the spiral hairsprings and act as the electrical connections to the moving part.

Since the taut band virtually eliminates friction, the torque needed to rotate the moving element—and hence the input power—is considerably reduced. Consequently highly sensitive meters—with good accuracy and very low repeatability errors—can be constructed with the taut-band approach. And since taut bands don't exhibit a gradual increase in friction with time—as the p & j can—they offer steady performance.

The fly in the ointment? (You knew there was one, didn't you?) On the debit side, taut bands generally cost about 20% more than comparable p & j's. And they are prone to unpredictable resonances when subjected to vibration—reso-

nances that can whip the pointer into a 50% error (when you can read it) and, in extreme cases, destroy the mechanism.

Though it's generally acknowledged that the taut band can't take vibration as well as the p & j, the situation isn't so definite when it comes to shock.

Some very large meter vendors advise engineers not to use the p & j in high-shock applications. Other vendors state that the p & j is the only type to use where high shock is encountered. Who is correct?

It's certainly true that the p & j—as well as any APM—is a delicate, precision device that can be damaged if dropped or abused. And because the contact area between the pivot and jewel is kept small, large stresses occur at the contact—stresses that can rocket to the damage level under shock.

To absorb shock, a p & j can be built with a cushion-backed or spring-loaded jewel. Of course, these cost more than the fixed-jewel APM—especially the spring-backed, which gives the greatest protection.

With such protection, the p & j can meet the shock requirements of MIL-M-10304, which can go higher than 2000 g. Taut bands, by contrast, rarely withstand more than 100 g without damage.

Note that failure of the taut band under vibration or shock is likely to be catastrophic: the bands simply snap. With the p & j, however, shock and vibration more frequently result in excessive wear, sticking and a significant loss of accuracy rather than a catastrophic failure.

Perhaps the best protection, where shock or vibration is likely, is to make MIL-M-10304 part of the APM spec. Or look into a vendor's ruggedized line, if he has one. In either case, expect to pay more.

Also in the taut-band's debit column: Because the taut band has less mass and doesn't develop as much torque as the p & j, its damping is not as good and its response is slower. And though friction has been eliminated, another specter rushes in to fill the void—hysteresis.

Hysteresis in the suspension system can affect a taut band's repeatability, just as friction does in the p & j. But you can eliminate the effects of friction in the p & j by a simple tap on the meter before you read it. With the taut band, tapping may relieve your nervousness—but not much else.

Both friction and hysteresis—as well as such errors as spring set and fallover—can be pinned down in a repeatability test, which gives the composite error. The procedure, as given in ANSI C39.1-1972, is performed without tapping.

Note that the effects of friction are sensitive to meter orientation—so make sure the vendor doesn't test his meters at some weird angle to



shrink the spec.

How serious are the problems from spring fatigue and fallover? It depends on how carefully a vendor controls his materials and manufacturing processes, as well as on the design. If he isn't careful these and other gremlins—sticking, for instance—are sure to surface.

### Don't get stuck with a sticker

If a manufacturer doesn't stop dirt, dust, lint or metallic material from getting into his APMs, he's sure to produce stickers: meters with pointers that decide to rest somewhere along the journey to the correct reading.

Clearances that are too small or changes in physical dimensions caused by temperature variations can also result in a sticker (or a "flopper"). So watch for cantilevered designs that can warp or shift under shock or temperature changes. High-quality meters usually use full-bridge construction, in which movements are anchored on both ends, and the mechanisms are thermally cycled to minimize shifting of parts.

Remember that most APMs are delicately balanced, so that anything that affects balance, such as internal shifts or changes in the position of the APM, can cause errors. In fact, errors of several percent can result if the APM is used in a position other than the one in which it was calibrated.

This must be especially considered in portable instruments, which often end up in precarious positions and also tend to get knocked about. But though meters can be balanced about two or more axes, don't expect such balancing unless you specify and pay for it. Even then, can any balance be perfect?

Some APMs are susceptible to external magnetic fields, which can suck the pointer into a false reading—or worse, permanently change the meter's calibration.

Particularly vulnerable is the practically obsolete external-magnet D'Arsonval. Here the moving coil is between two soft-iron pole pieces in the air gap of a horseshoe magnet. In fact, the external magnet is so sensitive to fields, its calibration will change if the unit is mounted on a ferrous panel.

Another point: If an APM's magnet hasn't been adequately stabilized, its strength—and hence meter calibration—can be changed by a stray field. Ask to see the vendor's demagnetization setup.

To get around the stray-field problem, many meters use an internal (core) magnet or bar-ring (annular) construction. These are self-shielding and consequently immune to large fields (50 Oe). When meters must be mounted close to one another, or close to transformers or wires with



In a machine-tool application, Simpson's Model 1327—a 3-1/2-in. Wide-Vue meter—displays spindle rpm, motor load and tool feed in inches per minute.

fairly large currents, self-shielded units are a must.

Various tradeoffs must be made with both the core and annular types. The relatively small magnet size of the core limits the available flux density—and consequently APM sensitivity—to about 0.5 mW. Deep cores can extend sensitivity, but at the price of increased meter depth and added cost.

Annulars—in which both magnet and moving coil are within a soft-iron ring—generally have longer magnets, and thus offer sensitivity comparable to that of the external-magnet meter.

Very low-cost meters—in the range of 50 cents to \$1.50—generally use moving-magnet construction, as opposed to moving coil. Moving magnets are limited in accuracy (5% at best), deflection angle (70°) and sensitivity (1 mA). They also exhibit poor damping and need more power than comparable D'Arsonvals. Main use of the moving magnet is in automobiles and other limited-performance applications, where price is the deciding factor.

### Low price, low performance

In most other applications it's dangerous to buy on price alone. Precision mechanisms can't be built inexpensively—even under high-volume, assembly-line conditions.

And even for a specific model (including quality designs) subtle differences from unit to unit in field strengths, spring torques and coil turns, among other things, can cause scaling errors—that is, the deflection for a fixed current

or voltage will vary from meter to meter by as much as two degrees.

Since less-expensive units generally use identical, mass-produced scales for all meters of a given type, you can predict the results: The pointer doesn't track the scale marks.

Pointers have been known to perform some other rather alarming tricks: Like creep up to the desired reading at an excruciating pace, or oscillate about the reading like a ball in a tennis match.

What a pointer does when the current changes suddenly is theoretically governed by what is sometimes called an instrument's ballistics—that is, the basic laws that characterize the motion of systems with mass (inertia), damping (friction) and stiffness (spring constant).

Thus to move a pointer and coil assembly through a given arc requires enough torque to overcome the inertia of the moving mass; frictional, magnetic and other damping, and the restoring moments of the springs.

The basic, second-order differential equation that relates the actuating torque to the three opposing torques is solved to obtain the angular deflection of the pointer as a function of time. Three solutions are possible, depending on how the APM designer has distributed the relative magnitudes of the moment of inertia, damping coefficient and spring constant:

1. In an underdamped meter, the pointer oscillates about its final target for awhile in ever decreasing values of overtravel before it comes to rest. How long "awhile" is and how much overtravel occurs are two things you'd like to know.

2. In an overdamped meter, the pointer takes an asymptotic approach to its final position. It starts out fast and slows as it closes in on the right scale mark. The closer the pointer gets, the slower it goes. When does it get there? Nobody knows.

3. Somewhere between "under" and "over" lies the critically damped case. In this meter the pointer moves promptly to the new position, zips past it by an amount limited to no more than half the APM's rated accuracy, then reverses and comes to rest at the new position. The small overshoot tells an observer that he's got his reading.

### How not to overshoot your budget

If you need critical damping, be prepared to pay for it. To get it, a vendor must control tightly many design parameters and tolerances—many of which are elusive, and some of which are mutually exclusive.

And remember that damping is also a function of the impedance external to the meter. If the circuit impedance is low—less than 10 times the meter resistance—you'd better tell the vendor, so

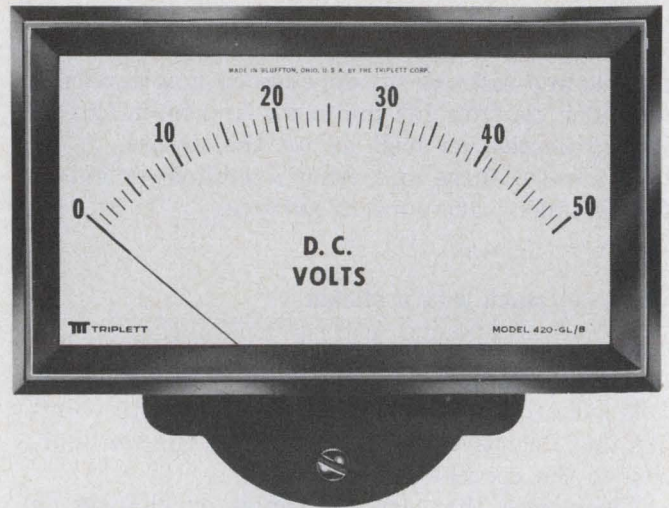

Triplet is one of the few companies that offer both APMs and DPMs. An integral bezel lets the 420-GL/B (top) mount behind the panel. Automatic polarity and low power mark the 4235-F DPM (bottom).

he can provide for it in the APM design. If you don't, you may end up with a creeper.

Damping is properly specified in terms of percentage overshoot, rather than damping factor, though the two are reciprocals.

Here's how ANSI C39.1-1972 defines overshoot: It's the ratio of the overtravel of the pointer beyond a new steady deflection to the change in steady deflection when a new constant value of the measured quantity is "suddenly" applied. Overtravel and deflection are given in angular units, and overshoot is given as a percentage.

Note the use of the subjective word "suddenly." Note also that overshoot may not be constant along the scale and, in some meters, depends on the magnitude of the deflection. If this is the case, make sure that a zero-to-end-scale deflection is used to determine overshoot.

APMs with overshoots that are allowed to range from 1% to 10% of full scale (damping factors between 10 and 100) generally cost half as much as critically damped units. Narrow overshoot limits also increase costs, so requirements should be specified realistically.

An APM's response time also influences its cost. This is the time required for the pointer to

come to apparent rest in a new position after an abrupt change in the measured quantity. Apparent rest means that the pointer enters—and remains—within a range of half the rated accuracy on either side of the final position.

A typical meter response time runs about 1-1/2 s. With small meters (short pointers), response gets faster; with large meters, it gets slower. As with overshoot, response time may depend on the deflection magnitude; so full-scale should be used when response is measured.

Ballistics are highly important in the recording and broadcasting industries, where overshoot and response times can be critical. Ballistics are also significant in aircraft and other vehicles that need sensitive, accurate meters. In other applications, pointer response may be completely unimportant.

But remember that pointer oscillations can set up a back emf at the APM terminals—something a sensitive source may not be too happy to see. And even if you don't care about ballistics, you can learn a lot about a meter from one simple figure of merit: the torque-to-weight ratio.

### Watch your weight

Though it's not found on any data sheet, torque-to-weight ratio is an important APM parameter, especially in meters with sensitivities below  $50 \mu\text{A}$ . (You know it's important because of its conspicuous absence, and because you get a lot of hemming and hawing when you ask vendors about it.)

What torque-to-weight tells you about a p & j is this: If the ratio is low, the effective friction is apt to be high and damping poor. The tendency for the pivot to ride up the side of the jewel in vertically positioned meters also increases with decreasing ratio.

High torque-to-weight ratio mechanisms considerably reduce these errors so that in the best p & j meter friction contributes about 0.1 to 0.2% to the total error. The ratio is also affected by one part of an APM that engineers seldom look at when they buy meters—the pointer.

A pointer does more than add good looks. It affects performance. If the pointer is too heavy, the torque-to-weight ratio goes down and takes performance along with it. If it isn't rigid enough for its length, a pointer can bend under a meter-zapping overload. And if the pointer is too wide for its scale, resolution and reading accuracy are poor.

To minimize scale-reading errors, the widths of both the pointer and the division marks should be about one-tenth of the interval between the marks. Of course, this may not be possible with small meters—where pointers tend to get wide in relation to the compressed scale. So don't



Five members of Analogic's extensive family of DPMs: Included are meters to measure voltage, current, ohms or ratio, and instruments for systems use, process monitoring and control.

buy more accuracy than you can read.

Don't forget, too, that reading errors zoom at the low end of a scale. For instance, on a 100-division scale, a reading error of one-tenth of a division gives four times the percentage error at quarter scale that it does at full scale.

Pointer shape and material can also be of significance. If the APM is to be read at a distance, check into the "spearhead" shape—the fat part enhances visibility. If nylon is the pointer material, watch for balance shifts caused by moisture absorption and for electrostatic pickup problems—especially at low humidities.

While you can learn much when you dig inside an APM, in the long run it's performance that counts. But what performance do you really need?

If you don't know, you can easily make the mistake of asking for high sensitivity coupled with high accuracy and repeatability—say, 1% for each. These just don't go together—at least not easily or inexpensively.

Or you might ask for tight tracking or linearity together with 1% full-scale accuracy—two specs that also don't mesh easily. For that matter, you might well ask: Just what do the terms accu-



In Newport's Model 257, full-scale range and function are selected by means of a 16-pin DIP plug-in module. Full scale can go down to 19.99 mV.



In a move away from red LEDs, Datel may soon offer DPMs with 0.33-in. amber and green displays—such as those offered by Monsanto.

racy, linearity, tracking and repeatability mean?

Unfortunately, and despite the standard definitions offered by ANSI, vendors still play the semantics game: They use shaded or nonstandard meanings to bamboozle and confuse. Two of the most abused terms are accuracy and tracking.

#### Accuracy by any other name isn't

To determine an APM's absolute accuracy across the entire scale, excitation is applied to bring the pointer first to the exact end-scale and then to at least five other equidistant scale marks, including zero. The difference between the excitation and scale-mark values at each mark, divided by the full-scale value and multiplied by 100, equals the percentage accuracy.

Note that the full-scale value is defined as the arithmetic sum of the two end-scale values. If zero isn't on the scale, then the full-scale value is the higher end-scale value. Thus in a zero-centered voltmeter—say, 50-0-50—full scale value is 100 V, not 50 V.

Full-scale accuracy is just that: how close the

end-scale value is to its corresponding excitation in a meter with the zero at one end. In other words, it's the accuracy at just one point—the end point. Watch out for a nonstandard accuracy term: calibration accuracy. When it's used, the term usually means the absolute accuracy at a single, arbitrary point on the scale, full scale or otherwise.

If you don't need absolute accuracy, you can save a bundle if you specify a low tracking error, say 1%, coupled with a modest full-scale accuracy—about 2% to 5%. But make sure the vendor's definition of tracking coincides with yours. Here's what tracking is all about.

Tracking is simply an APM's ability to indicate a scale mark when the meter is energized by the proportional value of actual end-scale excitation. Errors in indication are expressed as a percentage of a reference value—usually full scale. If the meter has an offset zero, the higher end-scale value forms the reference.

Thus on a 100-division scale, an APM with no tracking error will point exactly to the 50th division when half the actual full-scale signal is applied, and to the 10th division with a 10% signal. Note that the actual full-scale excitation doesn't necessarily correspond to the rated value. If it did, then the meter would not only track perfectly; it would be 100% accurate as well.

Obviously no meter has zero errors. The specifier must decide what maximum errors he can live with. But notice that good full-scale accuracy doesn't guarantee good tracking. At some point on the scale the maximum tracking error can be twice that of full scale.

The moral here is twofold: Don't expect a 1% unit to track tightly. Also try to avoid specifying tight tracking together with tight accuracy; you may not need both.

In many systems—especially those that are transducer-based—equipment and transducer errors can far exceed those of the readout. And such systems practically always have a built-in calibration adjustment to compensate for unavoidable variations, as well as to scale the system to read directly in engineering units (pH, rpm, etc.) rather than absolute electrical values. Consequently the absolute accuracy of the meter itself may be secondary; tracking may be the more important spec.

Whatever its accuracy, an APM won't hold it for long if you forget that temperature, humidity, dust and electrostatic effects can all drag APM performance down. Unfortunately data sheets often forget too.

#### What's the tempco?

Of all influence factors, temperature variations may be the worst. While dust and humidity can



Green LEDs are offered as an option on ERC's digital stop watch (top) and other DPMs. Also optional are large (0.77 in.) red LEDs (bottom).

be overcome with a hermetic seal, and electrostatics with chemical treatment (internal, not external), it isn't easy to compensate for temperature—especially over a wide range.

Temperature compensation is difficult because both springs and magnets—as well as the copper of the coil—are temperature-sensitive. Thus while an increase in temperature causes a drop in spring torque, it also decreases magnet flux. The former results in increased meter sensitivity, the latter in decreased sensitivity—but unfortunately the two don't cancel out.

To these must be added the tempo of the coil (and springs), which increases in resistance at a rate of 0.4%/°C. Unless coil resistance forms a negligible portion of the total network resistance, it must be compensated for.

This is readily done with internal shunts or multipliers that track coil tempo in an equal but opposite direction. But you've got to ask for—and pay for—compensation. While you're asking, inquire about the effects of another often-missing and seldom-mentioned spec: self-heating.

Other factors affect APM accuracy. In ac

meters, frequency and waveform influence performance. Terminal voltage to case or panel, if any, can move the pointer off zero. All these—and more—should be checked out.

High on any APM checklist should be the meter's overload characteristics. In general, an APM—whether a current or voltage meter—can withstand only a momentary overload before it goes poof. Just how much and how “momentary” are two things you'd like to know. So find out just what protection you can expect. Find out also what happens after the overload is removed. If you don't, you may end up with a 2% meter instead of the 0.5% unit you started with.

Here are some other pertinent questions to ask: What's the range of the zero adjustment? What symmetry error (the difference in readings when polarity is reversed) can I expect in an offset-zero meter? Can I readjust my full-scale calibration or does the magnet need to be replaced?

How about the mechanical aspects? What case material is best for my application? What are the tolerances of the mounting dimensions? Finally, ask how the scale length is measured. That 3-in. meter may turn out to be 2 in., after all.

In brief, perhaps the best advice for a meter specifier is this: Ignore listed MTBFs and glossy brochures. Get a copy of ANSI C39.1-1972 and study it. Visit the vendor and see how he builds meters. Check his reputation for reliability. And, finally, get a sample of the final product. Though an APM can outlast the man who buys it, don't depend on it unless you thoroughly check the meter in its intended job.

## THE DIGITAL PANEL METER

Compared with the problems of its analog cousin, those of the digital meter seem monumental. First, though it's still an infant, the DPM is far more complex than the APM. Second, DPM vendors come and go, like so many wind-borne dandelion puffs. Finally, since no standards exist, vendors can define terms and run tests to suit themselves.

Perhaps the greatest problems center on the specs you'd like to pin down the most: those that assault accuracy. Unfortunately there are far too many of these. Input bias current, stability, tempo and noise are just a few.

When you buy a DPM to measure voltage or current, you'd like to know how close its readings will be to the input values—in short, its accuracy. And most vendors will tell you. What they may not tell you, though, is how long the listed accuracy will last, and under what conditions.

Drift over a short or long period can clobber



Fluorescent displays mark LFE's line of DPMs to read voltage, pressure, temperature and other functions. The company also offers APMs.

accuracy. So can noise, temperature variations and line-voltage excursions. The effects of each of these should be clearly spelled out.

Some DPMs do specify both short and long-term accuracy. But what is "short" and what is "long"? Without standards, one man's "short" can be eight hours, another's 24. And "long" can mean one month, six months or a year. Since drift may not be linear, you can't compare units with different listed periods. Remember that poor long-term drift means frequent recalibration. High short-term drift means bad readings.

One thing many data sheets do shout about is a DPM's input impedance. True, high input impedance is a must to avoid loading of the source. But high input impedance alone is not enough. Input bias current can also nibble accuracy down. Where does the spec sheet tell you this? Usually there's nary a whisper.

Any current through the source impedance causes a voltage drop (or offset), and consequently an error. The higher the source impedance or the higher the bias, the higher the error. Of course, bias current can always be nulled out to eliminate the error. So what's really the problem? Simply this: Bias current varies with temperature. You can null it out at one temperature but not all. The vendor must therefore specify bias—and specify it across the entire operating temperature range. (Some units automatically buck out zero drift.)

In some applications bias error can't be zeroed out—even at constant temperature. This occurs when source impedance isn't fixed or isn't linear—for example, when you scan or switch the DPM's input among several sources. The way out? Pick a unit with sufficiently low bias current—one that stays low with time and temperature.

When you look into bias current, see if it is accompanied by other gremlins. Some DPMs can store charge in the input circuit and later kick back current into your source.

After you check out the tempo of bias, or offset, better move to the high end of the DPM's range. That's because temperature mounts a two-front war against the DPM and attacks the gain, or full-scale, reading as well.

Both tempcos must therefore be fully specified—that is, the listed figures should apply to the entire rated temperature range; not just to a narrow portion. How the tempcos are specified is another story.

### Which tempo do you mean?

There are eight or nine ways to spec tempo. A sampling: in parts per million (ppm), as a percentage of full scale, as a percentage of reading, or as a percentage of nothing. The latter is meaningless, of course. Or you might see any of these:  $\mu\text{V}/^\circ\text{C}$ ,  $\pm x$  counts,  $\pm x$  digits,  $\pm 1$  LSB,  $\pm 1$  bit.

This wouldn't be so bad if you could safely change any of the specification units to any other. But while the units may be theoretically equivalent, don't count on this in practice. (Expect to compare "apples and oranges" in accuracy specs, too.)

Don't relax after you've got the tempo; it doesn't tell the whole story. You can get burned—and badly—by heat rise within a DPM.

Heat kills more DPMs than any other factor. You've got to pin it down—and keep it down. If high internal temperature doesn't polish off the DPM, it can certainly decrease its life or make it erratic and unreliable.

How can you spot a unit that's going to run too hot? The tip-offs are high power consumption within a tiny, component-packed package, undersized transformers that run hot, a limited operating temperature range, and too long a warm-up time. Couple these characteristics to a high tempo and install the unit in an instrument that has its own temperature rise and . . . goodbye Charlie.

A DPM may hold its zero rock stable. It may have negligible full-scale error. But what happens between the bottom and the top? To find out, check the unit's linearity.

When you can find linearity on the spec sheet, it's usually given as a maximum deviation from a straight line. You're rarely, if ever, told where the point of maximum error occurs. You probably won't be told how linearity was calculated either: best straight-line fit, least squares or end-point fit. If you care about linearity, ask.

Tacked on to most DPM accuracy specs is the  $\pm 1$ -count error indigenous to all digital readouts.

(Some bury it in the percentage of full-scale term, or elsewhere). Which leads us into the gray world of counts, resolution, sensitivity and range.

### Be sensitive to resolution

To determine a DPM's percent resolution, you just take the lowest value of the last digit (0.1 mV, say) divide it by the full-scale reading and multiply by 100. Or you just invert the maximum count and multiply that by 100. Right?

Maybe.

While, say, a 200-mV, 3-1/2-digit DPM with 100% overrange can count to 1999—which means it can theoretically resolve 1 part in 2000, or 0.05%—it doesn't follow that the unit will track and display a 0.1-mV change in the input voltage.

First, the unit might have a dead band that's wider than its theoretical resolution. Next, internal or external noise can spin the last few digits around like so many wheels on a slot machine. And then errors in the a/d conversion process, such as nonmonotonicity or skipped codes, can also lop off the last digit.

What you really need to know is (1.) The smallest input change to which the meter accurately responds, and (2.) Whether this holds over the entire range.

Before you can find out the answers, you've got to know just what the range is. And this may not be obvious. Just because a DPM has 3-1/2 digits, you can't assume it will count to 1999. It will—if it has 100% overrange. But if it has 20%, 50% or some other oddball overrange figure, it won't. With a so-called 3/4 digit tacked on, instead of the 1/2, the situation gets worse. So ask the vendor, how many counts—not how many digits.

Another problem: When the vendor talks about full scale, does he include the overrange? With 100% overrange, he might do this to make his unit look twice as accurate as it really is. Or he may do it to hide the fact that accuracy derates in overrange. The data sheet won't tell you, so find out for yourself. While you're at it, clear up the noise specs, too.

For the purposes of specification, DPM vendors generally dump input noise into either of two bins: one labelled normal mode, the other common mode. Noise specs for each of these supposedly tell you how well the DPM rejects the noise. But things aren't so simple.

A straight number for normal-mode rejection (NMR) or common-mode rejection (CMR) doesn't tell the whole story. Since NMR or CMR depends on such items as noise waveform and frequencies, source impedances, grounding techniques, imbalance in the input circuit and other factors, these must be included.

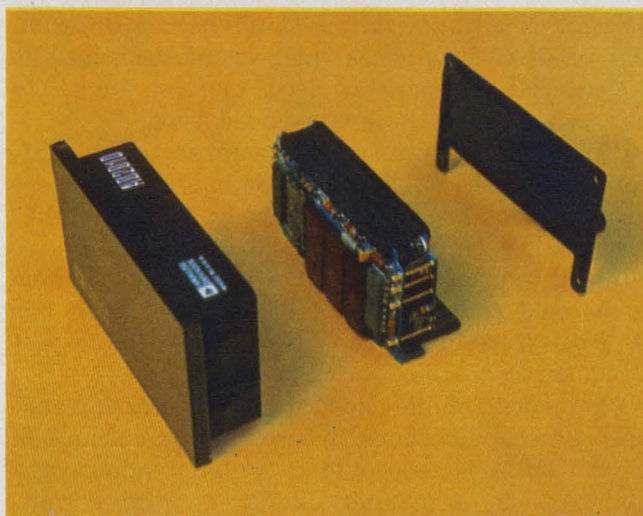

**The 5-V-power operation** of Analog Devices' AD2010 permits a package size of 3 × 1.8 in., with only 3/4 in. needed for depth. Input range is 199.9 mV.

Even if the vendor tells you under what conditions he measured the CMR & NMR, the odds are nil that your application will be an exact duplicate. To best pin down noise rejection, therefore, get a sample and see how it performs in the actual setup.

Normal-mode immunity can be boosted with an input filter. But filters need time to settle. So if the input changes too fast, the DPM can't respond. Since a slow response time doesn't look good on a data sheet, a vendor may simply list the response with the filter out. To get the noise spec, he flips it back in. You can easily catch him at this game: Just look for a high NMR coupled with a super-fast response. Response time is often confused with conversion time, reading rate, settling time, sampling rate, etc., so check the definitions.

Integrating DPMs inherently reject normal-mode noise, but they do this best only at multiples of a fixed noise frequency—usually that of the line. Thus the DPM's integration period should be set for your expected line frequency. Those designed for 60 Hz won't provide maximum rejection at 400 Hz, and vice versa.

In any case, frequency drift of commercial lines usually limits the maximum NMR of the integrating DPM to about 48 dB. For broadband or other noise, filtering is best.

The common-mode spec applies only to differential-input DPMs. But before you look into the CMR, first decide: Do I need a differential circuit? Those that make them, say yes. Those that don't, say no.

### Single ended or differential?

One important DPM vendor—who makes single-ended units only—claims that 80 to 90

percent of all applications don't need a differential input. And, argues this vendor, because the differential arrangement needs more op amps, it's not as stable as the single-ended type.

But another large vendor emphasizes the differential as the only type to use in systems where ground loops are likely to appear. Who is right? As usual, each tells half the story.

Since thousands of units of each type continue to be sold each year, it's obvious that each has its own place. The problem is to determine just what that place is.

In general, single-ended units are best for end-user type applications, where the main function of the DPM is to provide a visual readout of a quantity—in a manner similar to digital voltmeters. Where signals are already referenced to ground and noise is not a problem—in a battery-powered, portable instrument, for example—then the single-ended will probably do the job.

But in complex data gathering and processing systems—where the DPM is likely to be used more as an a/d converter with BCD outputs than as a visual-readout device—you'll probably opt for a balanced differential unit with isolated inputs and outputs.

Data-acquisition systems tend to be plagued with common-mode signals and multiple grounds (analog, digital, power, case). And since these systems can swell in size—with lots of transducers and DPMs—it can be a nightmare to keep digital signals and power noise off the low-level analog lines.

When you do look into a differential unit, remember that one man's true, floating differential input is not the same as another's. Remember, too, that the presence of a CMR spec—no matter how high—doesn't necessarily mean the unit has differential input circuitry. And remember to watch for contradictory CMR and common-mode voltage (CMV) specs.

When a CMR soars to 120 dB, but the maximum CMV is only 300 V, be suspicious. In a DPM that can handle a minimum difference signal of, say, 1 mV, it'll take a common-mode voltage of  $1 \text{ mV} \times 10^6 = 1000 \text{ V}$  to cut into the last digit. Does this mean the CMR is so good the vendor didn't really have to list it? Or does it mean the CMR figure can't be trusted? Or maybe the CMV?

Just as there's no clear winner in the single-ended-vs-differential battleground, no DPM comes out on top when it comes to 5-V vs line-power operation.

### Is 5 V better?

In general, a 5-V unit costs less, is smaller and consumes less power than an equivalent 115-V ac DPM. But not always.

Don't forget that if the low-voltage unit draws its voltage from a fairly inefficient 5-V power supply located within the same enclosure, the total power drawn by the system can zoom to three times the DPM's nominal.

And just because a DPM works from 5 V, it doesn't mean that your grounding problems are over. Unless the various analog, 5-V power and digital returns are isolated, ground loops are still possible.

But where battery operation is wanted, where excess 5-V logic power is available or where high voltages can't be tolerated, the 5-V DPM is the choice. Of course, the line-powered unit has its own set of applications, in which it excels. So match the DPM to the job.

One word of caution: Noise, spikes and



Typical of Schneider Electronics' plug-in, modular panel meters is the VT 2120, a 12,000-count unit that can operate from 12 V dc or 115 V ac.

transients are just as likely to show up on a system 5-V line as on a 115-V ac line. And if the 5-V unit uses an internal dc/dc converter to isolate or change the 5-V into internally needed levels, switching noise within the converter can work its way into the analog section. Moral: Filters may be needed at the 5-V input or elsewhere.

If you need BCD outputs, there are a host of digital specs to watch for. Isolation of the digital ground is one. Buffered outputs are another. You'll need buffering to drive lines that are longer than about ten feet and to avoid capacitive coupling between bundled lines.

To bus the outputs of several DPMs into one data line or to synchronize data, look into such items as gating and data storage. When you check into BCD, keep in mind that the meaning of "parallel" depends on who's talking: It can mean a full, parallel 12-line BCD or a four-line serial output.

Don't forget to check into a DPM's environ-



mental behavior in areas other than temperature—humidity can also spell trouble. Shock and vibration? An APM can be built to take the punishment. The question is, can the DPM?

The required cutout, size and readability of the display (LEDs and the Beckman gas discharge are now the most popular), second-source possibilities, and special features—both standard and optional—must all be checked out to fully characterize a unit. And these aren't all. Perhaps the most important piece of information about a DPM is also the hardest to pin down: reliability.

As with APMs, ignore the listed MTBF—it's probably meaningless. Units that brag a 50,000-h MTBF have been known to be dead on arrival. Units with socketed displays and ICs, instead of soldered, may be more reliable—but don't count on it. DPMs that use the dual-slope a/d conversion principle may be more stable than other conversion types—but not necessarily. In short, there's no short cut to reliability.

And while it's generally true that reliability increases with a decreasing number of components and connections, again, this is not a universal truth. Less components can mean short cuts were taken to lower the price—such as the use of cheap and dirty power supplies that give poor regulation, or front ends that aren't properly stabilized.

Get a sample and rip it apart (in some cases, you may literally have to do this). Watch for overstuffed PC boards, DIP packages used as hinges, components soldered together in mid air, flexible PCs twisted like pretzels, vertically mounted components with sharply bent leads—and the like. Any of these spell future shock.

Check the vendor's reputation. Visit him and ask embarrassing questions—like, what's your return rate? How do you ensure quality? Can I see your burn-in racks?

Empty promises of early delivery will be quickly uncovered by rows of equally empty burn-in racks. Of course, the DPM vendor may have shipped most of his units in time to close the books on the fiscal quarter. However, with some companies, the quarter seems to have just ended whenever you arrive—regardless of the calendar date.

### Who's who in panel meters

At least two dozen vendors offer APMs. About 20 make DPMs. And a few market both types. Each manufacturer usually offers a fairly wide line so there's something for everybody.

For analogs, check into Airpax Electronics' line of surface mounting, edge reading or control meters—all built around the company's proprietary "parkermeter", a mechanism whose

super-thin, etched-circuit coil makes the meter resistant to extreme shock and heavy, continuous overloads.

"Certrak" is Beede Electrical Instrument's name for APMs that certify tracking of better than  $\pm 1\%$  at no extra charge. The company's broad line includes both p & j's and taut band, 250-degree movements and VU meters. Beede's "Super-Torque" movement uses a signal power boost to develop 40 times more torque than conventional designs.

Both taut band and p & j's can be found among the hundreds of units marketed by General Electric, a company that's been making APMs for over 80 years. GE's 34 "modification" centers inventory standard units, customize semi-finished units to spec, and offer repair services.

Sizes from 1/2 to 8 in., in both commercial and ruggedized versions, are featured by Ideal Precision Meter Co. Recent developments at Ideal include bezel mounted and edgewise meters.

Specialists in edgewise displays are the International Instruments Division of Sigma Instruments. Included in the company's lineup are 19 sizes, five dual meters and scale lengths from 1 to 5-1/4 in.

And a complete line of stylized meters in taut band, p & j and repulsion-type iron-vane versions can be found at Jewell, formerly the Precision Meter Division of Honeywell. Jewell also offers hermetically sealed ruggedized units and custom-designed mechanisms for avionics.

High accuracy (0.5%) on a routine basis is the forté of LFE Corp., Process Control Division. The company designs many APMs with a computer for fast turnaround of specials, and to minimize errors. LFE is one of the few companies that make both analog and digital units.

Like many others, Phaostron Instrument and Electronics sees an industry trend toward edgewise units. So Phaostron, primarily a custom house, has recently added both commercial and ruggedized edgewise units to its line. Included in the line are iron vane, p & j's and taut bands in all sizes and shapes.

Simpson Electric is probably the largest producer of analog panel meters. And the company makes digitals, too. Newest addition to the broad Simpson family is the recently announced ANA/LED, a solid-state APM that displays signals with a linear "bar" of light that "moves" on a calibrated scale.

Another company that markets both APMs and DPMs is the Triplett Corp. Though the company stocks over 1300 standard APM styles, it offers practically any combination of customized dials, cases and performance; the latter includes accuracy, tracking, damping, resistance and custom ranges.

Standing out among the industry giants—in

both analogs and digitals—is Weston, a company that pioneered many of the advances in APMs. From optical indicators, to p & j's, to taut band; and from commercial to aerospace, you'll find it at Weston.

If it's a DPM you're looking for, chances are you'll also find it at Weston: The company kicked off the industry when it introduced the first DPM just seven years ago.

### Who's who in DPMs

Practically anything you want in a DPM, you can get. Analog Devices (the pioneer of 5-V DPMs), for example, offers units in a variety of digits, displays, sizes, features and options. Latest in the company's line is the 3-1/2-digit AD2006, a DPM that measures ratios.

You can choose from one of the broadest lines in the industry at Analogic Corp., one of the largest DPM vendors. The company offers over ten basic models, each with a host of features and options. For instance, you can transform the AN2533/AN2553 into any of a variety of precision measuring instruments: Just plug in your own circuitry to the unit's front or back ends. For example, you can mate a DPM to a load cell for weight measurements.

Unusual is Datascan's Model 820—the 3-1/2-digit unit, using CMOS circuitry, draws only 100 mW of power so you can operate it for over 600 h on four D cells.

Datel Systems' line includes the DM-2000 AR, the first DPM to autorange over three scales. Look for Datel to be one of the first to move to the newer amber and green LED displays for DPMs.

While Beckman planar gas discharge displays, LEDs, and RCA's incandescent Numitrons are the most popular displays at present, the older Burroughs Nixie tubes are still widely used. However, liquid crystals may be the wave of the future. Right now, only two companies—Digilin and Tekelec—offer them. Digilin claims a 50,000-h life for its liquid-crystal displays.

All of Digitec's DPMs use LEDs. The 4-1/2-digit 2780 is Digitec's newest, and forms part of the company's High Technology (HT) series.

Specializing in panel mount units for control systems and monitor-only applications, is Electronic Research Co. (ERC). Hot off the assembly line at ERC is the Series 3000B, a panel voltmeter with systems-control provisions.

Panel meters from Gralex are characterized by planar gas-discharge readouts and floating-differential, bipolar inputs on all models.

LFE Corp. is one of the few to use fluorescent displays in its DPMs. The company traces the high reliability—less than 3% returns—of its 4350 Series to the display.

Voltage, current, angular velocity, temperature, time and frequency are among the things you can measure with DPMs from Newport Laboratories. Over a dozen series offer one of the largest

## Need more information?

The products cited in this report don't represent the manufacturers' full lines. For additional details, circle the appropriate information retrieval number:

### Analog Meters

- Airpax Electronics, 6801 W. Sunrise Blvd., Fort Lauderdale, Fla. 33313. (305) 587-1100. (Herb Hedberg Jr.) **Circle No. 400**
- Ammon Instruments, Inc., 345 Kelley St., Manchester, N.H. 03105. (603) 669-1531. (C. W. Heath). **Circle No. 401**
- Beede Electrical Instruments Co., Inc., S. Main St., Penacook, N.H. 03301. (603) 753-6362. (Lou Issel). **Circle No. 402**
- Dixson Inc., P.O. Box 1449, Grand Junction, Colo. 81501. (303) 242-8863. (Kathy Rogers). **Circle No. 403**
- Electro-Mechanical Instrument Div., 8th & Chestnut St., Perkasio, Pa. 18944. (215) 257-6561 (R. Jones). **Circle No. 404**
- Faria Meter Corp., 19 Faria Lane, Uncasville, Conn. 06382. (203) 848-9271. **Circle No. 405**
- General Electric, Instrument Products Department, 40 Federal St., Lynn, Mass. 01910. (617) 594-0100. (John Pittman). **Circle No. 406**
- Hickok Electrical Instrument Co., 10514 Dupont Ave., Cleveland, Ohio 44108. (216) 541-8060. (Robert Kuederle). **Circle No. 407**
- Hoyt Electrical Instrument Works, 556 Trapelo Rd., Belmont, Mass. 02179. (617) 489-1520. (Richard Rearbon). **Circle No. 408**
- Ideal Precision Meter Co., 214 Franklin St., Brooklyn, N.Y. 11222. (212) 383-6904. (Robert Friedman). **Circle No. 409**
- International Instruments, 88 Marsh Hill Rd., Orange, Conn. 06477. (203) 795-4711. (John F. Connelly). **Circle No. 410**
- Jewell Electrical Instruments, Grenier Field, Manchester, N.H. 03105. (603) 669-6400. (D. A. Nelson). **Circle No. 411**

- Kratos, 403 S. Raymond Ave., Pasadena, Calif. 91105. (213) 449-3090. (R. Blehr). **Circle No. 412**
- LFE Corp., 1601 Trapelo Rd., Waltham, Mass. 02154. (617) 890-2000. (Roland Gubisch). **Circle No. 413**
- Larson Instruments Co., Inc., Greenbush Rd., Orangeburg, N.Y. 10962. (914) 359-3800. (A. D. Stephens). **Circle No. 414**
- Modutec Inc., 18 Marshall St., Norwalk, Conn. 06854. (203) 853-3636. (Mr. Deery). **Circle No. 415**
- Phoastron Instrument & Electronic Co., 151 Pasadena Ave., South Pasadena, Calif. 91030. (213) 255-1471. (J. Hoppert). **Circle No. 416**
- Simpson Electric Co., 5200 W. Kenzie St., Chicago, Ill. 60644. (312) 695-1121. (Mel Buehring). **Circle No. 417**
- Triplet Corp., 280 Harmon Rd., Bluffton, Ohio 45817. (419) 358-5015. (Richard Wagner). **Circle No. 418**
- Westinghouse Electric Corp., Relay Instrument Div., 95 Orange St., Newark, N.J. 07101. (201) 456-0222. (R. Lakin). **Circle No. 419**
- Weston Instruments Inc., 614 Frelinghuysen Ave., Newark, N.J. 07114. (201) 243-4700. (Bob Bilby). **Circle No. 420**
- Yewtec Corp., 1995 Palmer Ave., Larchmont, N.Y. 10538. (914) 834-3550. (Ralph Johnson). **Circle No. 421**

### Digital Meters

- Analog Devices, Route 1 Industrial Park, Norwood, Mass. 02062. (617) 329-4700. (Richard Goldberg). **Circle No. 422**
- Analogic, Audubon Rd., Wakefield, Mass. 01880. (617) 246-0300 (Bernard Gordon). **Circle No. 423**
- California Instruments Co., 5150 Convoy St., San Diego, Calif. 92111. (714) 279-8620. (William Barker). **Circle No. 424**
- Datascan Inc., 1111 Paulison Ave., Clifton, N.J. 07013. (201) 478-2800. (Gary J. Moore). **Circle No. 425**
- Data Technology Corp., 2700 S. Fairview Rd., Santa Ana, Calif. 92704. (714) 546-7160. (Diane Capeletti). **Circle No. 426**
- Datel Systems Inc., 1200 Turnpike St., Canton, Mass. 02021. (617) 828-6395. (Jack Gallagher). **Circle No. 427**
- Digilin Inc., 1007 Air Way, Glendale, Calif. 91209. (213) 846-1800. (E. B. Hibbs). **Circle No. 428**

selections anywhere. The new 250 Series offers both line and 5-V powered models.

One of the smallest DPMs is Non-Linear System's PM-4. Packed into a height of less than 1 in. are four digits and automatic zero and polarity. The PM-4 uses less than 0.5 W.

Schneider Electronics of Medford, Mass. offers two main series of DPMs; the VT 2000, a plug-in modular design in which user-selected options—from power to display to outputs—are PC mounted; and the IT 3000 Series, a standard design with no options. Schneider also offers panel-mounted digital thermometers.

Though both Simpson and Triplett are known chiefly for analog meters, both are also in the digital business—Simpson with its 3-1/2-digit 2830 and Triplett with five models, three of which use neon-glow displays; and the other two, fluorescents.

Field-effect liquid crystals are used exclusively in Tekelec's TA 300 Series, which includes 2-1/2, 3-1/2 and 4-1/2-digit models.

With a front-panel size of only 0.78 × 2.41 in., the Impac Series, by Velonex Division of Varian, is one of the tiniest of DPMs. With all characters illuminated, the Impac draws less than 1 W. Unusual, too, is the Impac's three-year warranty.

Weston ranks with the leaders in DPM shipments. Check into the company's 1220 Series, DPMs that feature plug-in LEDs, one-chip MOS LSI and battery operation at only 3/4 W. And no warm-up time is needed for full accuracy. ■■

DigiTec (United Systems Corp.), 918 Woodley Rd., Dayton, Ohio 45403. (513) 254-6251. (Jeff McDonald).

Circle No. 448

Doric Scientific Corp., 7601 Convoy St., San Diego, Calif. 92111. (714) 277-8421. (T. McColl).

Circle No. 429

Electronic Research Co., P.O. Box 913, Shawnee Mission, Kan. 66202. (913) 631-6700. (Eldon Hallblade).

Circle No. 430

Electro Numerics, 67 Evelyn Ave., Mountain View, Calif. 94040. (408) 738-1840. (Dennis Bethsneider).

Circle No. 431

Faratron Corp., 280 Green St., Hackensack, N.J. 07606. (201) 488-1440. (Edward Cappucci).

Circle No. 432

Gralex Industries, 155 Marine St., Farmingdale, N.Y. 11735. (516) 694-3607. (Harold Steinberg).

Circle No. 433

Instrument Displays, 225 Crescent St., Waltham, Mass. 02154. (617) 374-0311. (T. Chadurjian).

Circle No. 434

LFE Corp., 1601 Trapelo Rd., Waltham, Mass. 02154. (617) 890-2000. (Dave Cohen).

Circle No. 435

Meterex Corp., 646 Summer St., Brockton, Mass. 02402. (617) 588-8826. (Kenneth Sharples).

Circle No. 436

Nes Inc., 71662 Rte. 53, Itasca, Ill. 60143. (312) 773-0370. (R. Martin).

Circle No. 437

Newport Labs., 630 E. Young St., Santa Ana, Calif. 92705. (714) 540-4914. (Lyell Kinney).

Circle No. 438

Non-Linear Systems, Box N, Del Mar, Calif. 92014. (714) 755-1134. (Ben Fisher).

Circle No. 439

RDF Corp., 23 Elm Ave., Hudson, N.H. 03051. (603) 882-5159. (Albert L. Kadis).

Circle No. 440

Salford Electrical Instruments Ltd., Peel Works, Barton Lane, Eccles, Manchester M30 0HL, Great Britain. (David E. Hall).

Circle No. 441

Schneider Electronics, 11 Riverside Ave., Medford Mass. 02155. (617) 535-5620. (Francis Barroux).

Circle No. 442

Simpson Electric Co., 5200 W. Kenzie St., Chicago, Ill. 60644. (312) 695-1121. (Mel Buehring).

Circle No. 443

Tekelec Inc., 31829 W. La Tienda Dr., Westlake Village, Calif. 91361. (213) 889-2834. (Philip Wasserman).

Circle No. 444

Triplett Corp., 280 Harmon Rd., Bluffton, Ohio 45817. (419) 358-5015. (Walter Cerveny).

Circle No. 445

Velonex, Div. of Varian, 560 Robert Ave., Santa Clara, Calif. 95050. (408) 244-7370. (Robert Pecotich).

Circle No. 446

Weston Instruments Inc., 614 Frelinghuysen Ave., Newark, N.J. 07114. (201) 243-4700. (Bob Bilby).

Circle No. 447

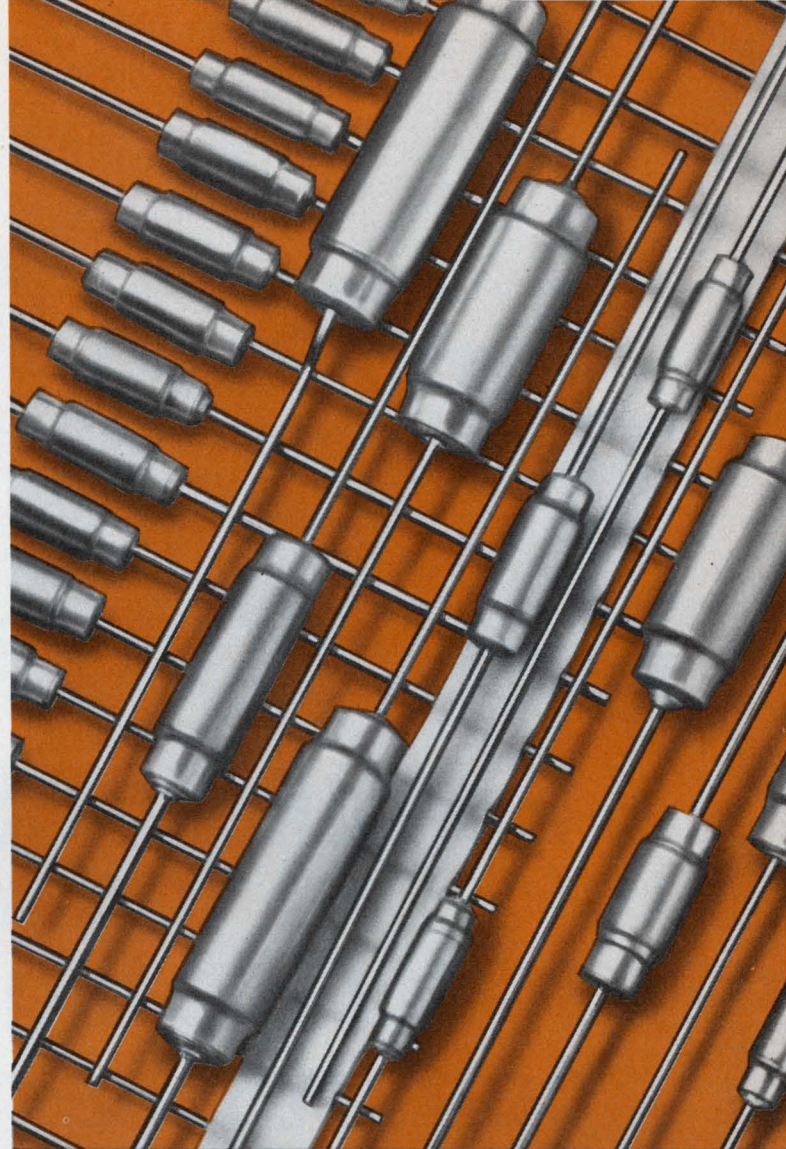

Last year these Paktron® film capacitors were revolutionary.

Now they are the standard.

And for good reasons. The Micromatic® capacitor, revolutionary for being wound on its own leads—and for its self-encased construction. Both polyester and polypropylene versions are widely accepted in industrial applications. Tape reeled for automatic insertion. Send for test samples and data.

PAKTRON, Division Illinois Tool Works Inc., 900 Follin Lane, S. E., Vienna, Virginia 22180. Phone (703) 281-2810. TWX 710-833-0682.



**itw** PAKTRON®  
innovators in film capacitors

The Innovative Electronic Group of ITW...  
PAKTRON • LICON • EMCON

© ILLINOIS TOOL WORKS INC. 1974

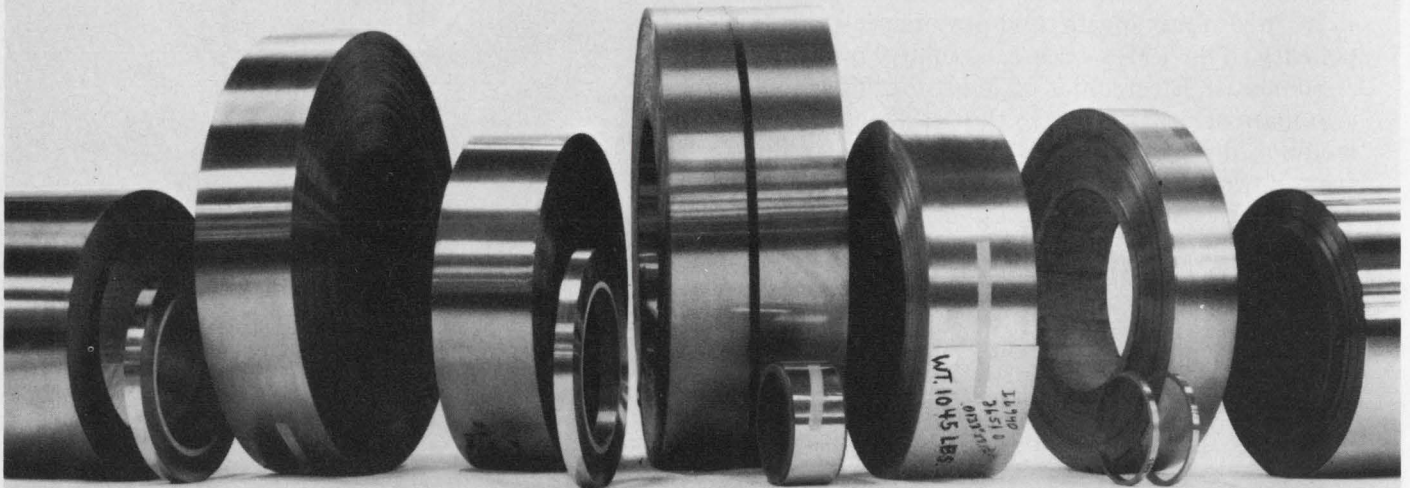

# For quick action on metals too special for the big or little mill, come to the mill that's both.

We take on what the big mills can't handle economically or promptly and the small mills haven't the equipment for.

Our specialties are: magnetic alloys, glass-to-metal sealing alloys, expansion alloys, temperature compensating alloys, shielding alloys and electronic alloys. In strip, foil, cut lengths or rod and wire. From several pounds to several tons.

We're geared to give fast service because we're totally integrated.

We're not slowed down by outside suppliers because we do all our own processing: vacuum and air melting, powder metallurgy production, hot and cold rolling, precision flattening, slitting and annealing.

So when you need specialty alloys, come to the mill whose total in-house capability includes quality control from start to finish. Come to Magnetics. Send for Bulletin MPB-1.



Butler PA 16001.

# Bigger and Better

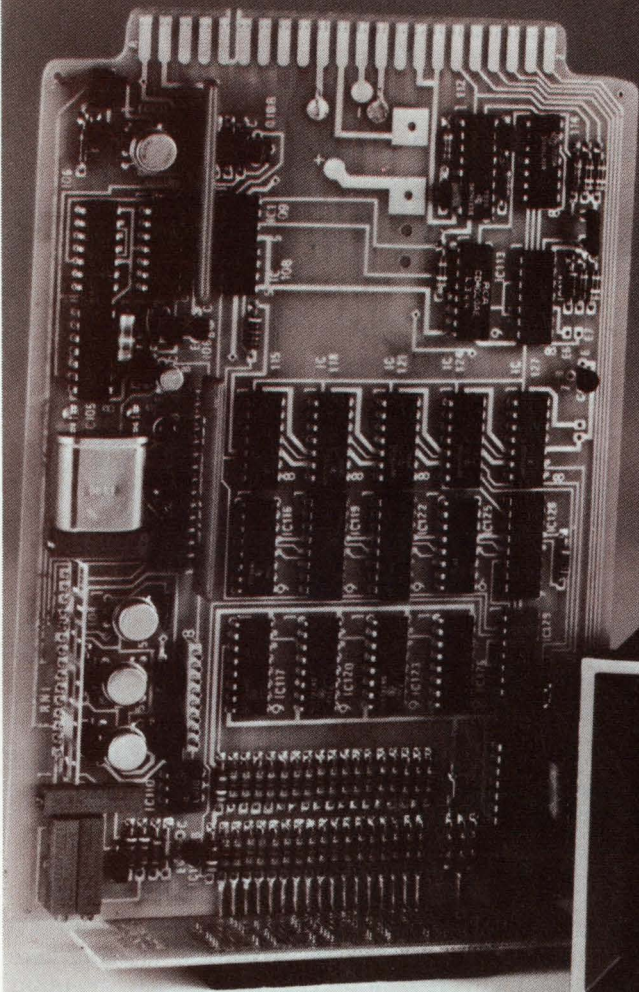

Series 3500

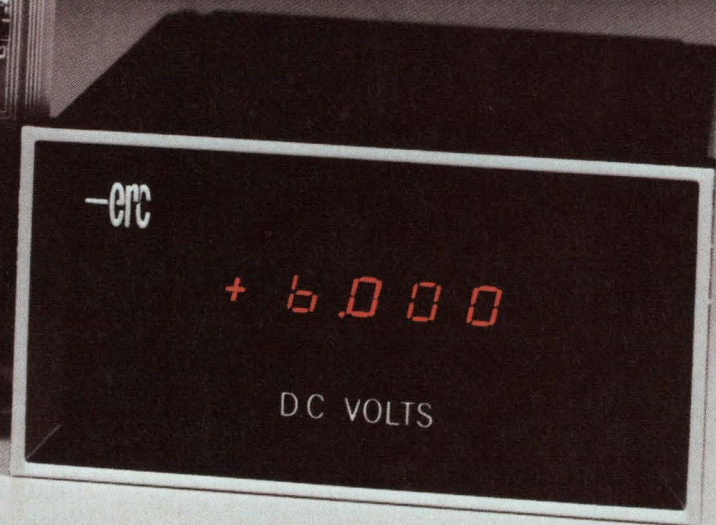

While most DPM manufacturers strive to compress their meters into a one inch cube, ERC has succeeded in making a producible and maintainable low-cost voltmeter with optically isolated parallel BCD outputs and 5999 count full-scale for reliability-conscious engineers in a package only 2.4" H x 5.06" W x 6.38" D, AND for only \$148 in quantities of 100...\$185 in single quantities. If the world's smallest DPM isn't your prime requirement but quality is, contact us for specs and delivery.

See *Electronic Design's Gold Book* for information on other ERC Digital Instruments

electronic research co. • a textron div.

7618 Wedd  
Overland Park•Kansas 66204  
Mail to: P.O. Box 913  
Shawnee Mission•Kansas 66201  
TWX: (910) 749-6477  
Telephone: (913) 631-6700

# ERC

## Which LCD is best?

With a choice among dynamic-scattering and field-effect types, operating in reflective or transmissive modes, the designer must know the tradeoffs.

With liquid-crystal displays (LCDs) growing in popularity as digital readouts for a variety of products, from wristwatches to instruments, more and more designers are asking: Should I use an LCD in my application? If so, which kind?

LCDs consist of two types: dynamic-scattering and field-effect (or twisted nematic). Each can be operated in a reflective or transmissive mode.

No matter which display you pick, it will consume very little power, permit direct MOS drive circuitry and be attractively priced. The key to selection, then, is tradeoffs. Let's examine them, with a look first at the theory of operation.

### LCDs operate in odd state

The nematic (with a thread-like molecular structure) material used in displays exists in an odd state called the anisotropic liquid phase. This state is midway between the solid and isotropic liquid conditions. The high degree of molecular orderliness inherent in the anisotropic state yields many of the optical properties of a crystal-like substance, even though the material appears physically to be a liquid—hence the name, *liquid crystals*.

The dynamic-scattering display—the first type commercially available—is used extensively for electronic calculators. The display's construction consists of a sandwich of two sheets of glass coated with a thin transparent conductor, such as tin oxide or indium oxide, etched in the shape of the segment of a numeral (Fig. 1). The space between conductors is filled with a lightly "doped" liquid-crystal material, and a seal surrounds the cavity to retain it.

The cell is normally transparent. However, a voltage applied between front and back electrodes causes an ionic current flow due to the dopant. These ions strike the liquid-crystal molecules and disrupt their orderly arrangement. A translucent region in the shape of a numeric or segment is thereby created. With a light source

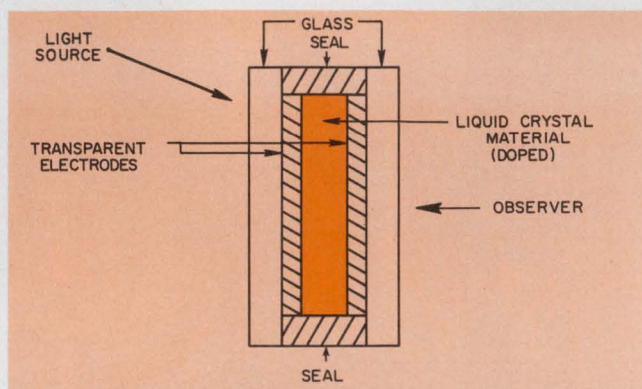

1. A dynamic-scattering display is transparent when not activated. Voltage applied to the electrodes causes the liquid crystal to become translucent.

located behind and above or below the display, the incident rays are scattered to the observer's eye. As an alternative, a reflective coating can be applied to the rear of the display and incident light is scattered by the translucent segment. Such a reflective display does not require an internal light source, but has proven to be of limited use because of annoying reflections from the background.

### Field effect type uses polarizers

A field-effect transmissive display is quite similar to the dynamic-scattering except for the addition of polarizers (Fig. 2). The operation, however, differs entirely. Internally the transparent electrodes are treated so the liquid-crystal molecules align themselves horizontally on the rear surface and vertically on the front. Thus there is a 90° "twist" of molecule alignment from back to front.

Light entering from the rear is first horizontally polarized. With no voltage on the display, the light follows the optical axis of the molecules, and experiences a 90° rotation of its plane of polarization in passing through the liquid-crystal layer. The second polarizer on the front stops this light and the display appears uniformly dark.

When a voltage is applied between the transparent electrodes, the molecules abandon their alignment with the surfaces and align themselves

Phillip Wasserman, President, Tekelec, Inc., 31829 Wila Tienda Dr., Westlake Village, Calif. 91361

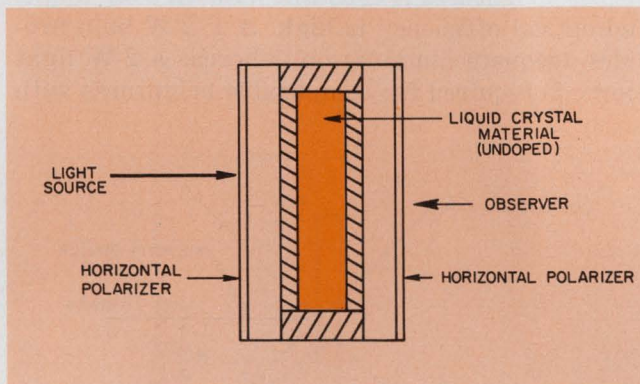

2. The field-effect transmissive display uses polarizers. Otherwise its construction, but not its operation, resembles that of the dynamic-scattering type.

with the electric field. The  $90^\circ$  twist is no longer applied and the display becomes transparent in the desired region, which is shaped to form a character or segment of a character. This "light-gating" action permits high contrast ratios with simple optical structures.

The front polarizer may also be vertically oriented and a reflective diffuser laminated to the rear surface. A reflective display is formed thereby (Fig. 3). With no voltage applied, incident light from the front is vertically polarized. The light passes through the liquid-crystal material acquiring a  $90^\circ$  rotation of its plane of polarization in the passage. The rotation allows the light to pass through the horizontal polarizer on the rear.

The light is then diffused and reflected forward where it is repolarized by the horizontal polarizer. Again its plane of polarization rotates  $90^\circ$  by the liquid-crystal material. The additional rotation allows the light to pass through the front vertical polarizer to the observer, who sees a uniformly illuminated surface.

When voltage is applied between the electrodes, the  $90^\circ$  twist from the liquid-crystal material is lost. Hence incident light polarizes vertically, passes through the liquid-crystal layer unchanged and becomes absorbed by the rear horizontal polarizer. To the observer, the regions covered by the activated electrodes appear dark against a bright background.

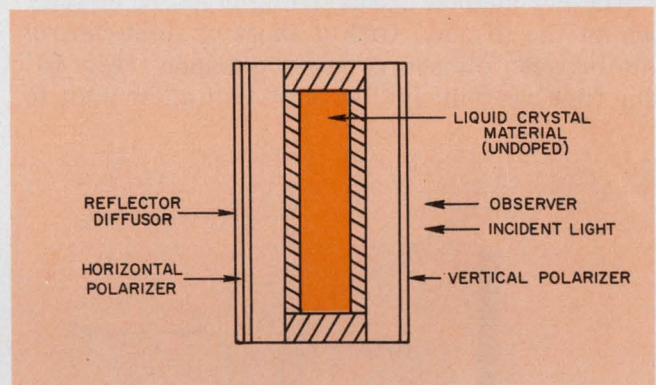

3. A reflective field-effect display uses a vertically oriented front polarizer, a horizontally oriented rear polarizer and a reflective diffuser at the rear.

For digital wristwatches, reflective operation must be employed, because of the prohibitive power that an internal light source would consume. Also, the field-effect display is the clear choice, because of undesirable background reflections present in a dynamic-scattering unit. For similar reasons, field-effect displays excel in nearly all low-power, battery-operated situations. Furthermore reflective field-effect displays get brighter in high ambient light, and thus are immune to washout in direct sunlight—a common problem with other displays.

In the case of line-operated equipment, the choice is not nearly as clear-cut. Often the decision hinges on the means of illumination.

### The problems of illumination

The transmissive dynamic-scattering display can be difficult to illuminate. Obviously the light source cannot be immediately behind the transparent display in the simple configuration; the observer would see the light rather than the display. One solution locates the light source above or below the display, with some optical system to direct the light down at a steep angle onto the display (Fig. 4). With a black background, the viewer sees only the light scattered by the translucent digit.

This system has a major limitation: The intensity of the scattered light varies as the cosine

of the angle between the incident ray and the observer, if the segment is an ideal diffuser. If it isn't, the situation gets worse (Fig. 5). If the light source is to be invisible, the angle of incidence  $\theta$  must be greater than the maximum viewing angle. This condition reduces the light scattered directly forward to the viewer. Moreover display brightness varies rapidly with viewing angle, so other optical techniques must be used to provide light from the bottom if brightness is to be relatively constant.

Another method places the light source directly behind the display, with a sheet of light-control film between the source and the display (Fig. 6). The film has built-in "louvers" that allow light to

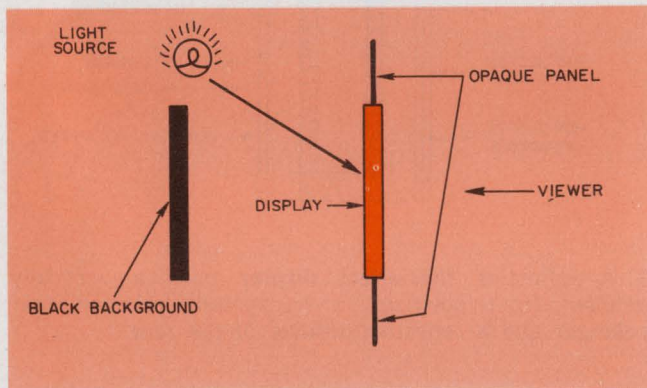

4. One illumination method for a transmissive dynamic-scattering unit has the light source above and behind.

pass through only at steep angles, an arrangement that results in optical inefficiency. Only those rays that arrive over a narrow range of angles reach the display, while the film absorbs the bulk of the light. Nevertheless an acceptable display results—although intensity varies dramatically with viewing angle (Fig. 5).

Both the elevated light source and the light-control film suffer from a common problem: If the viewer is sufficiently below the display, the light source becomes visible. In some equipment, the housing restricts viewing angle to avoid the problem. This approach is quite acceptable in applications that don't require wide angular visibility. In fact, the same technique can be used with a reflective dynamic-scattering display to eliminate sources of reflection. In at least one case, the carefully shrouded display provides an acceptable appearance over a narrow angle.

Other methods for illuminating transmissive dynamic-scattering displays achieve varying degrees of success. They include use of edge lighting, a prism to gather ambient light and "trans-reflective" displays with a partly transparent, reflective rear coating. Generally all methods show low optical efficiency, brightness variations with viewing angle and complex structures.

For widest angular visibility, the transmissive field-effect display is the best choice. Moreover its illumination system is extremely simple. For example, on Tekelec panel meters and multi-meters, a bulb provides light to a piece of lucite that is behind the display (Fig. 7). Internal reflections ensure uniform illumination of the rear surface, which is painted white. The "light valve" action of the display makes the energized segments transparent and the illuminated background visible. Since no scattering is involved, display brightness is constant with viewing angle, and optical efficiency is high. A 1/2-W bulb provides adequate illumination, whereas a 2-W light source is required for comparable brightness with

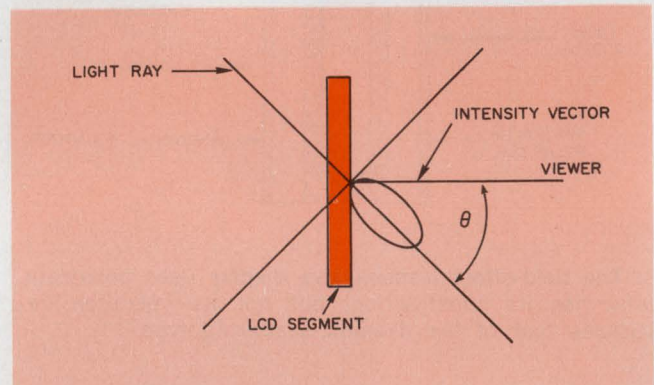

5. The illumination scheme suffers from a wide variation in light intensity with viewing angle.

a dynamic-scattering display.

Despite early problems, LCDs produced today should have virtually unlimited life when driven with the proper circuits. The liquid-crystal material is sensitive to contamination, a problem similar to that faced by the semiconductor industry. Extreme cleanliness in production, coupled with a good seal, are required.

#### Good seals extend display life

The seal has several stringent requirements: It must be impervious to contaminants; it must be matched in thermal expansion to the glass and to the liquid-crystal material; and it must not react with the liquid crystal. To date, there appear to be two successful approaches: glass-frit and plastic seals.

The glass-frit seal is, of course, quite nonreactive and impervious to diffusion of impurities. But it is difficult to match coefficients of thermal expansion, and usually it must have one or more open regions sealed with plastic. This is necessary because the liquid-crystal material cannot stand the sealing temperatures and must be introduced after sealing through "fill holes." These holes are then plugged, usually with some plastic ma-



terial. If this material is not carefully chosen and purified, discoloration can occur around the plug. Some promising laboratory work has been done on laser sealing and other methods to produce what manufacturers describe as a "true hermetic seal." However, such methods have not yet achieved commercial status.

The alternative is to use an effective plastic seal. Thermal expansion problems are eliminated, and sealing temperatures are low enough to allow prior introduction of the liquid-crystal material. Current plastic-sealed units survive extended high temperatures and pressures in a suitable test chamber. Although no good correlation exists between these tests and operating life

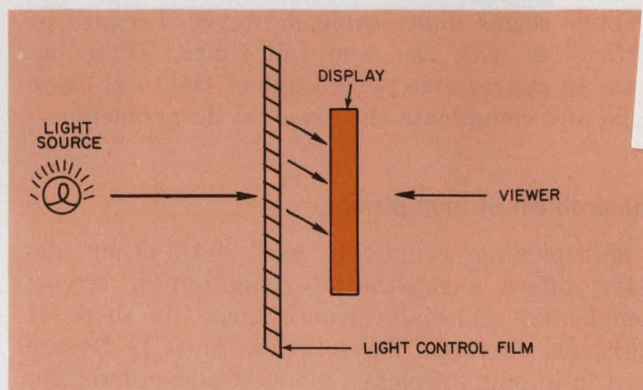

6. Use of light-control film allows placement of the light source directly behind the display.

in more benign environments, two things are certain: First, the newer plastic-sealed units are orders of magnitude more impervious to contamination than those they replace, and second, field history indicates a negligible incidence of degradation over a two-year period. Extrapolations suggest that lifetimes may well be 10 years or even longer, since no significant failure mechanisms are known.

Ideally the field-effect display is a perfect insulator. Any current flow results from internal impurities. By monitoring the current levels, an index of internal impurity concentration is obtained. Current levels are typically only a few nanoamps for an entire 4-1/2 digit display. By a monitoring of this current during environmental stress over a period of time, a sensitive index of seal integrity can be obtained. This monitoring ability is an important advantage over dynamic-scattering units, where impurities that are deliberately introduced mask the effect.

#### Avoid dc drive signals

Improper drive waveforms represent one major cause of display degradation. Direct-current operation is possible with field-effect dis-

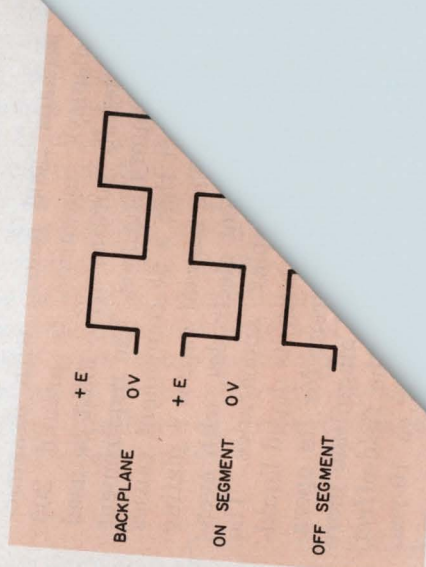

8. Typically LCDs. ON with each

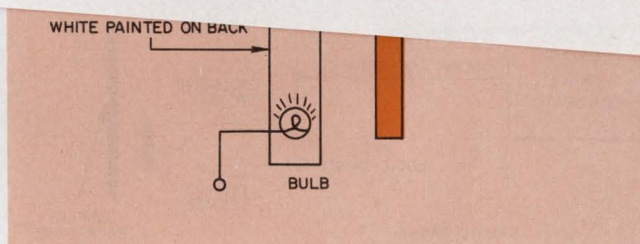

7. A simple illumination system for a transmissive field-effect display obtains the widest angular visibility.

Driving of the liquid-crystal display is both difficult and easy. The easy part results from the minute operating power of these units. A display segment's equivalent circuit consists of a capacitor of a few picofarads paralleled by a resistor of many megohms. Hence drivers need supply only microwatts to nanowatts per segment. Furthermore signal levels required vary from 5 to 30 V, or well within the range of standard transistors and ICs.

The difficulty is that the drive must be essentially pure ac. This places stringent requirements on the drive circuit and can result in complex circuitry.

The most common drive circuit uses a two-phase signal generated by logic circuitry (Fig. 8). The ON segments are driven by a signal that is 180° out-of-phase with the backplane signal and that produces a pk-pk ac signal of 2E between the transparent electrodes. The OFF segments are driven in phase with the backplane, and no net voltage appears across that portion of the display.

Fig. 9 shows the circuitry required to generate the required waveforms. A standard EXCLUSIVE-OR gate produces the required segment drive signal which is out-of-phase when the logic

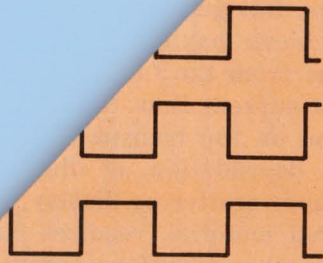

Two-phase drive signals are used to drive ON and OFF segments must be 180° out-of-phase with each other.

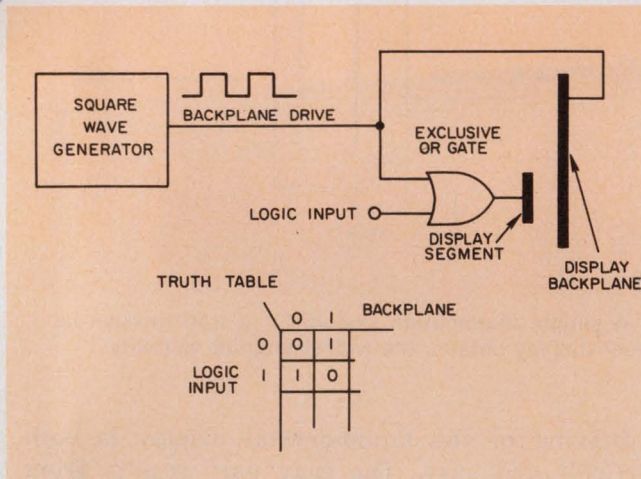

9. A standard EXCLUSIVE-OR gate produces the required segment drive signal. Any dc component must be held to less than approximately 0.05 V to avoid reduction in display lifetime.

input is at a zero level. Depending upon the voltage levels required, the gate might be TTL, CMOS or other standard logic.

With this drive method, great care must be exercised to avoid a dc component. Backplane and segment signals must be closely matched in both amplitude, as well as rise and fall times, since the dc component must be less than 0.05 V to maximize display life.

The liquid-crystal display interfaces directly with MOS circuitry—which is a major advantage. Light-emitting diodes and gas-discharge displays require external drivers because of the high power required of the former and the high voltage of the latter. These drivers have a high initial cost and lead to a more complicated and expensive unit.

Several custom MOS circuits, using both PMOS and CMOS versions, include the necessary drivers

for liquid-crystal displays in calculators, digital watches, digital panel meters and digital multimeters. At least two vendors offer standard products with this drive. However, a word of caution: Often the manufacturer doesn't specify residual dc that can result from circuit offset voltages or rise and fall-time differences.

The frequency of the drive should be carefully considered. Dynamic-scattering displays are sensitive to the frequency, and most manufacturers recommend a drive frequency of 60 Hz. This value is well above the "flicker frequency" of the human eye and well below the 300-to-400-Hz limit for most such displays.

Field-effect displays, on the other hand, can be successfully operated up to 10 kHz. This practice seems undesirable, however, because of difficulties with rise and fall times. These become an appreciable percentage of the total drive cycle and complicate the residual dc problem.

### The problem of multiplexing

Multiplexing, commonly used with other displays, offers a substantial reduction of circuit complexity—especially where large numbers of digits are involved. Nevertheless most LCDs are used in a nonmultiplexed mode because of the inherent difficulty in multiplexing. Fig. 10 shows the usual multiplexing arrangement applied to an LCD. Although dc drive is shown, the problem is essentially the same with the more common ac drive.

In the circuit of Fig. 10 voltage +E is applied to one backplane digit at a time. Meanwhile all like segments of a seven-segment display are tied together and connected to one of two voltages, depending upon whether the segment should be on or off. The problem is that if segment 1a is taken to a high potential to turn it off, segment 2a—and all like segments of other OFF digits—have this potential between the segment and backplane; consequently they turn on when they shouldn't. A LED display does not have this problem, because it is essentially a diode and does not glow when back-biased. In fact, insertion of diodes in each segment lead has been successfully used with LCDs. Cost and complexity make the diode approach unattractive, since a pullup resistor is also required for each segment to ensure that diode leakage does not turn on the segments.

The simple multiplexing circuit works without diodes in gas-discharge displays, even though they, like liquid crystals, are sensitive to voltages of both polarities. This is accomplished when the segment voltage is taken to some potential  $E_1$ , high enough to extinguish segment 1a but not high enough to reverse-fire segment 2a. Also,

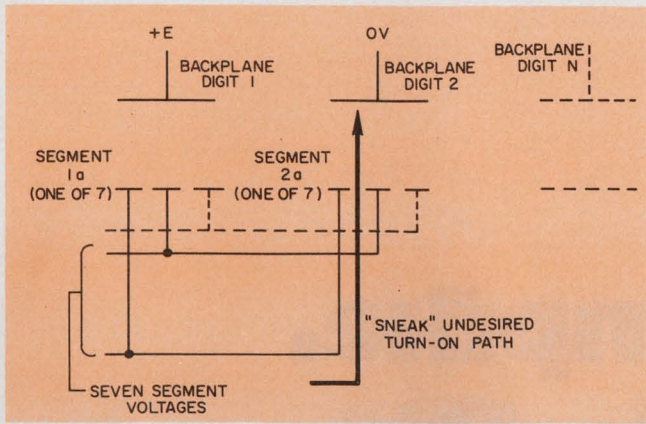

10. **LCDs don't multiplex easily.** Without the use of additional circuitry, LCD segments in multiplexed operation tend to turn on when they shouldn't.

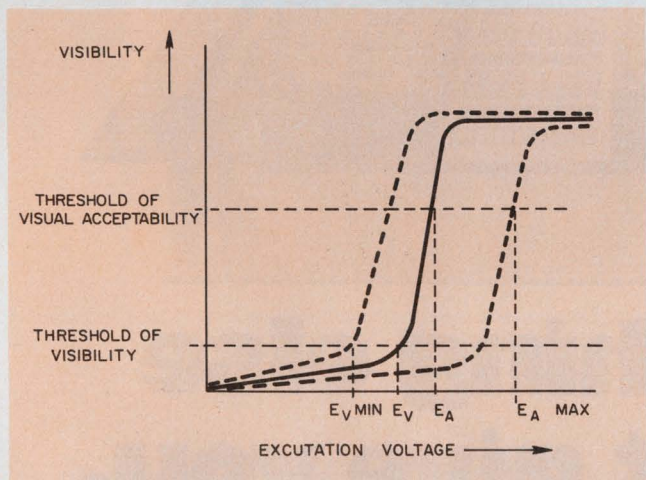

11. **Some field-effect displays exhibit an abrupt voltage characteristic** that is suitable for multiplexing. However, the operating point may not allow visibility, and it can change with temperature, time and material.

anodes are usually not taken to zero volt but rather to some other potential,  $E_2$ , which is inadequate to either fire or sustain a segment in an OFF digit.

A similar approach might be taken with a LCD. For example, if the ON backplane is taken to  $+E$ , the OFF backplanes to  $+E/3$ , the ON segments to zero volt and the OFF segments to  $2E/3$ , then a 3:1 ratio is established between the backplane-to-segment voltages for the ON vs OFF segments. However, for most dynamic-scattering LCDs, this is inadequate. These displays exhibit a more or less linear relationship between excitation voltage and visibility. A poor display results with OFF segments clearly visible.

Another multiplexing scheme makes use of the fact that certain field-effect displays exhibit a fairly abrupt "knee" in their response curves (Fig. 11). With any particular unit at any time,

it's possible to adjust  $+E$  to be greater than  $E_A$ —the voltage that produces an acceptable display. But then it's possible that  $E/3$  may be less than  $E_V$ —the voltage that produces the threshold of visibility.

Worse,  $E_V$  and  $E_A$  are functions of temperature, time and materials, as shown by the broken lines. Thus it is difficult to be certain that  $E > E_A$  max while  $E/3 < E_V$  min for a specified  $E$ . Moreover  $E_V$  and  $E_A$  are functions of the viewing angle.

An additional limitation of LCDs is that additional voltage beyond a certain level doesn't produce greater visibility. If you multiplex eight digits in a LED or gas-discharge display, eight times the average segment current flows to maintain the specified brightness. Of course, this approach cannot be used to multiplex LCDs (Fig. 11). As a result, visibility generally diminishes as the number of digits increases.

The effect is not as severe as might be expected. Some displays respond to the rms value of the applied voltage. Relatively more visibility is given thereby than would be anticipated from a simple time-averaging calculation. Also, it's often found that turn-on time is less than turn-off time. This can add to the visibility of a display operated with the short pulses encountered in multiplexing systems.

### LCDs can be slow

Other limitations of liquid-crystal displays include slow response times and limited temperature range. Also LCDs are prone to possible damage from ultraviolet light.

Turn-on and turn-off times of 100 to 150 ms are typical. Response time varies as the square of the thickness of the liquid-crystal layer. Since this layer is only 1/4 to 1/2-mil thick, maintenance of uniform response time in production is a formidable task. Response time also varies with viewing angle and must be carefully specified to be meaningful. As temperatures drop, response time becomes longer, and speed increases with temperature up to the "clearing point," where the liquid crystal enters the liquid phase.

Commercially available displays operate from 0 to 65 C and are not permanently damaged by exposure to temperatures from  $-55$  to  $+125$  C. Considerable variation in response time can be expected over this range.

Theoretically liquid-crystal materials can be damaged by ultraviolet light. In practice, the risk is nonexistent, since the glass used filters out ultraviolet to a high degree. The risk is comparable to that of getting burned by moonlight. ■■

# The Turnpike.

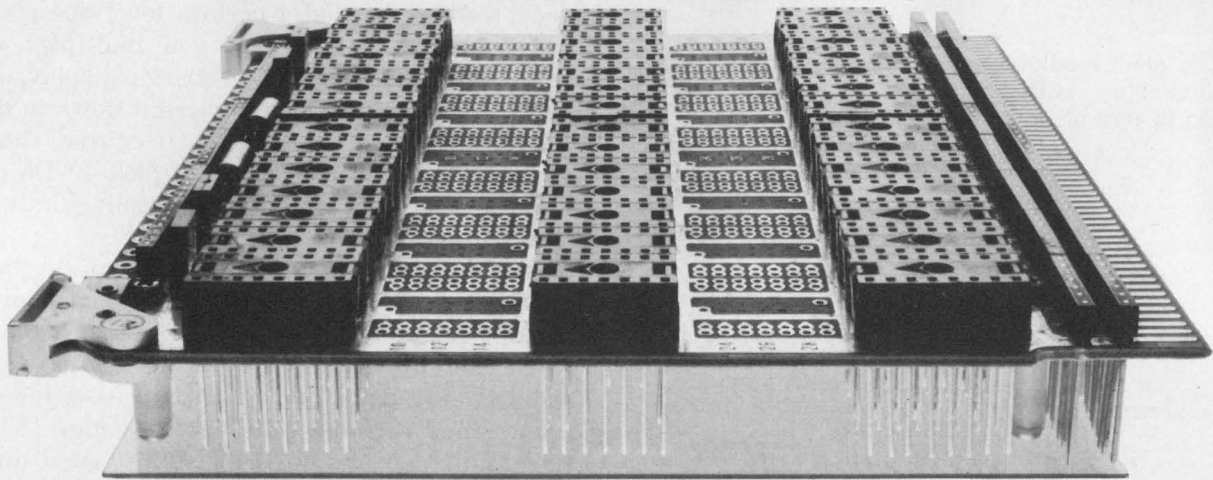

## It's something else Augat can't give you.

Those open lanes through the dual-in-line sockets are the Turnpike. On this turnpike you drop in whatever discrete components your design calls for. On the other side of the card you wire wrap those discretos into your circuitry. It's a low-profile feature you can find only on our 3-D Dual-in-Line Socket Cards. In addition you get built-in noise

protection, 22 built-in test points, and 120 connector contacts. Our standard configurations offer a wide choice of card layouts for two- and three-level wire wrapping.

This is why we say we give you more design freedom than Augat does.

**Try us. We'll see you through.**

## EECO

1441 East Chestnut Avenue  
Santa Ana, California 92701  
Phone 714/835-6000  
Also from G. S. Marshall Company nationwide.

FREE SOCKET BOARD AND PACKAGING  
HARDWARE CATALOG!  
We'll send it to you if you'll send us the  
information below.

Name \_\_\_\_\_  
Position \_\_\_\_\_  
Company \_\_\_\_\_  
Address \_\_\_\_\_

# Ferrite transformers cost less, increase reliability and eliminate scrap. Broad Band-Rated™ ferrites replace laminations to 16,000 perm.

## New design solutions

If you're using metal laminations to get high permeability transformers and inductors, take another look at ferrite technology. Our ferrite components now eliminate the high cost of lamination assembly in critical bandwidth applications from 100 Hz to above 250 MHz.

Increased reliability and guaranteed circuit performance of our components end design guesswork and production rework. You design with known circuit parameters and our pretesting program assures that our components will continue to meet your circuit requirements.

## Highest permeability available

Toroidal perm over 16,000 and

effective permeability over 5,000 allows you to use Broad Band-Rated ferrites in a wide variety of new applications. Our full range of shapes includes mated parts in pot core, RM6 and E core configurations to extend your design flexibility.

## Some help from your friends

We'd like to help you apply the latest ferrite technology to your broad band requirements. Our new design guide outlines the improved characteristics of our components and gives you guaranteed specs that make sense. Shunt resistance and reactance per turn squared, temperature coefficient, disaccommodation and hysteresis core constant.

The applications section covers

design of both high and low frequency transformers and shows you how our circuit specifications make your design task easier, more precise.

Circle the Bingo card for your copy of the design guide or call (201) 826-5100 and talk to the engineers who wrote it.

Either way, if you're still gluing laminations to get high permeability, talk to the ferrite experts.

That's us.

Indiana General  
Keasby, NJ 08832

*National distribution through Permagem in Atlanta, Boston, Chicago, Dallas, Detroit-Toledo, Los Angeles, New York and San Francisco.*

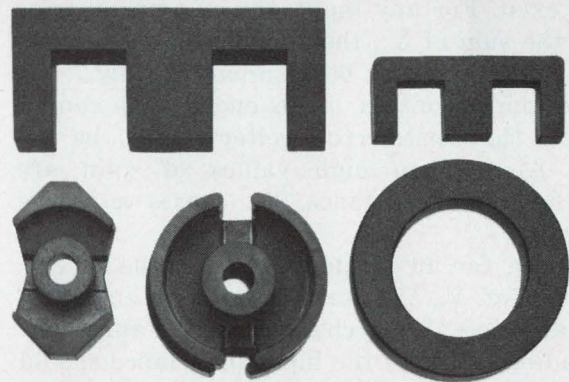
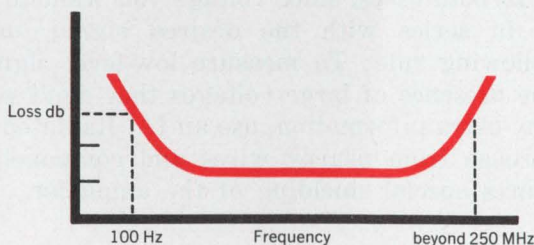

**indiana general**

a division of Electronic Memories & Magnetics Corporation

INFORMATION RETRIEVAL NUMBER 36

# For tough measurements, try IAs.

Instrumentation amplifiers offer three big advantages over simple, multiple op-amp instrumentation circuits.

Many difficult measurement problems can be solved with an instrumentation amplifier, and with three advantages that you won't get with simple op amps:

First, the instrumentation amplifier (IA) is a closed-loop differential circuit with externally programmable gain (gain adjustments don't affect input characteristics); it amplifies the difference between two ground-referenced signals. Second, this type of amplifier rejects ground-referenced, in-phase signals common to both inputs; this is called common-mode rejection (CMR). Finally, the IA input impedance is made extremely high and remains constant. Thus it minimizes input errors because it doesn't load the source impedance.

The generic term IA covers amplifiers that range from ultra-complex rack-mounting assemblies to simple monolithic arrays.

## An op amp has limitations

Let's see why a simple op-amp circuit can't do the same job as an IA. In Fig. 1, the input and output ground points of the op-amp circuit are separate. This permits a ground-loop voltage,  $V_{gl}$ , to exist. For any input, the op-amp inverter "sees" the sum of  $V_x$ , the signal to be measured, and  $V_{gl}$  and amplifies both signals equally.

Since the circuit is single-ended and cannot subtract, the series-error voltage can't be rejected. Also, when high values of gain are used, the input resistance,  $R_i$ , causes a source loading.

The need for an IA depends upon the acceptable ratio of  $V_x/V_{gl}$ , since the input signal-to-noise ratio doesn't get changed by the amplifier. The loading effect of the input impedance should also be considered.

The Wheatstone-bridge signal source of Fig. 2 precludes the use of a single-ended amplifier.

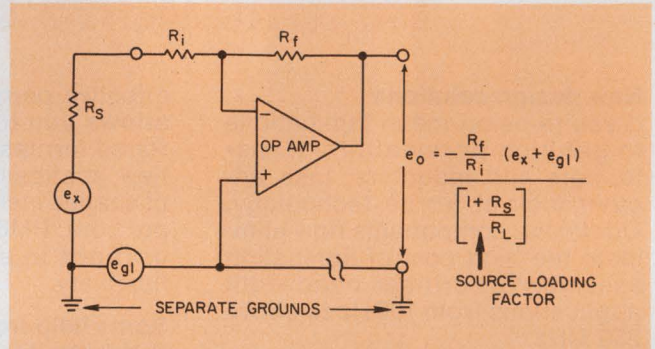

1. Single-ended inverter op amp just amplifies the ground-loop voltage along with the signal.

The large residual voltages at nodes  $e_1$  and  $e_2$  must be subtracted (rejected) to permit measurement of the small difference voltage between the nodes caused by a small change in  $R_x$ . Since the difference voltage is often 1000 times smaller than the residual, the amplifier must measure millivolts in the presence of volts. And you still have the problem of the resistance between nodes  $e_1$  and  $e_2$  with respect to ground.

Again, the need for voltage subtraction (or rejection) arises. Thus both the single-ended inverter and the double-ended bridge circuit present problems that an IA can solve.

In both cases, since voltage you want to reject is in series with the desired signal, use the following rule: To measure low-level signals in the presence of large voltages that don't provide any extra information, use an IA. Radiated interference from nearby wires and components requires special shielding of the amplifier.

## IA avoids interference problems

The op-amp subtractor circuit of Fig. 3 can simulate an IA in some ways because it has several identical features: It can measure two ground-referenced signals differentially and amplify the difference with predictable gain. Also the error voltage common to both input terminals,  $E_{cm}$ , produces a zero (ideal) addition to the output. Though the diagram looks simple, each

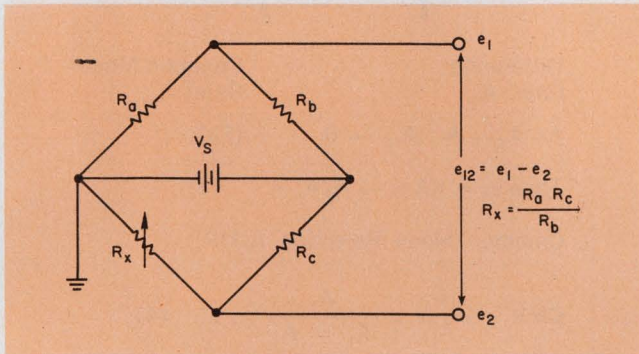

2. Wheatstone-bridge circuit provides a double-ended input, but it also masks the signal with high voltages.

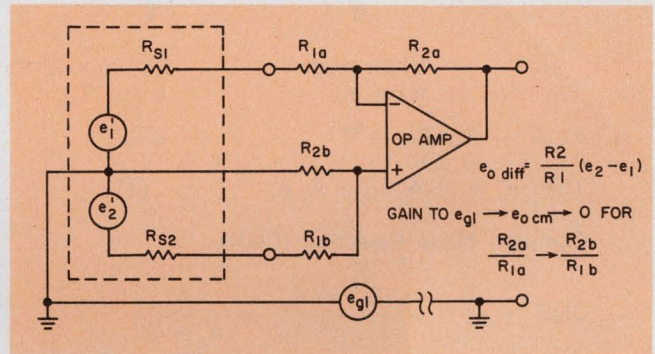

3. With a subtractor circuit, you can approximate the performance characteristics of an IA.

amplifier may be very complex and may require component matching, tracking and careful layout.

But the subtractor circuit has limited value; close resistor matching and amplifier CMR are crucial to the over-all circuit CMR. Stable matched resistors are costly, while op amps rarely have high CMRs that remain constant over a usable frequency range and provide the dc input characteristics usually required.

The practical ratios of  $R_2/R_1$  also restrict the gain and input impedance of the subtractor. Amplifier input bias current limits the subtractor input impedance. But too low a value loads the source; this, in turn, limits gain.

Changing the gain of the subtractor circuit is a major problem for this reason: Since ratio match must be maintained,  $R_{1a}$  and  $R_{1b}$  must track together. Input resistance also changes, decreasing for higher gains, and costly matched-resistor pairs or even more costly ganged potentiometers are needed.

If you analyze the elaborate multi-amplifier subtractor circuits, you will probably decide that a true IA (shown symbolically in Fig. 4) must be designed from scratch.

Fig. 5 shows the IA's basic structure. Internal circuit symmetry is of prime importance. For instance, if the gains are symmetrical, common-mode gain is eliminated. Eq. 2 in the table for the double ended source inputs shows that for  $A_1 = A_2$ , the common-mode voltage,  $E_{cm}$ , pro-

duces no output. The input impedances,  $R_{cm}$  and  $R_d$ , are dynamic and don't vary with the gain setting. And the gain-adjust resistor,  $R_o$ , permits simple wide-range gain adjustment.

### Select IAs carefully

Before you pick an instrumentation amplifier, check its many specifications. To start, note the differential gain. The equation for this usually takes the form

$$A_d = K [1 + R_a/R_o],$$

where  $R_a$  is given and  $R_o$  is the gain programming resistor. The constant,  $K$ , is the fixed, post-amplifier stage gain usually 10 or more.

The gain setting of the IA doesn't modify the input impedance, but it has a marked effect on the drift (referred to the output), CMR and dynamic response nonlinearity ( $e_{out}/e_a$ ). The nonlinearity, a function of loop gain, defines the deviation from a straight-line transfer characteristic. Make sure it is specified at the highest permissible gain level. Gain also varies with the temperature; be sure you know the tempo.

Consider also the input impedance of the IA. You should examine both the differential input impedance ( $R_d$ —the impedance between input terminals) and the common-mode input impedance (the impedance between each input terminal and ground). While the effects from each of these impedances overlap, each limits the

# Low-frequency IA performance equations

Double-ended source	Single-ended source
$e_o = K \left[ A_1 \frac{e_d}{2} + A_1 e_{cm} + A_2 \frac{e_d}{2} - A_2 e_{cm} \right] \dots (1)$	$e_o = K [A_1 (e_d + e_{cm}) - A_2 e_{cm}] \dots (1)$
$e_o = K \left[ e_d \frac{(A_1 + A_2)}{2} + e_{cm} (A_1 - A_2) \right] \dots (2)$	$e_o = K [A_1 e_d + e_{cm} (A_1 - A_2)] \dots (2)$
<p>Differential Gain: <math>A_d</math></p> <p>Common-Mode Gain: <math>A_{cm}</math></p> <p>As <math>A_2 \rightarrow A_1</math>; <math>A_{cm} \rightarrow 0 \dots \dots \dots (2a)</math></p> <p>Then <math>e_o = K A_1 e_d \rightarrow A_d e_d \dots \dots \dots (3)</math></p> <p>Common Mode Rejection (CMR):</p> $CMR = \frac{A_d}{A_{cm}} = \frac{A_1 + A_2}{2(A_1 - A_2)} = \frac{A_1}{A_1 - A_2} \Big _{A_2 \rightarrow A_1} \dots \dots \dots (4)$ <p>(With <math>R_s \ll R_{cm}</math>; <math>e_x = e_d</math>)</p>	<p>Differential Gain: <math>A_d</math></p> <p>Common-Mode Gain: <math>A_{cm}</math></p> <p>As <math>A_2 \rightarrow A_1</math>; <math>A_{cm} \rightarrow 0 \dots \dots \dots (2a)</math></p> <p>Then <math>e_d = K A_1 e_d \rightarrow A_d e_d \dots \dots \dots (3)</math></p> <p>Common Mode Rejection (CMR):</p> $CMR = \frac{A_d}{A_{cm}} = \frac{A_1}{A_1 - A_2} \dots \dots \dots (4)$

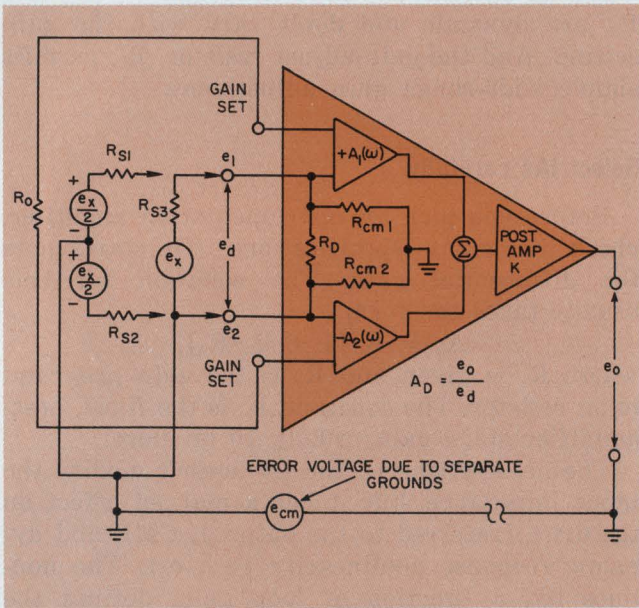

4. A true instrumentation amplifier offers variable gain along with very high common-mode rejection ratios and high input impedances.

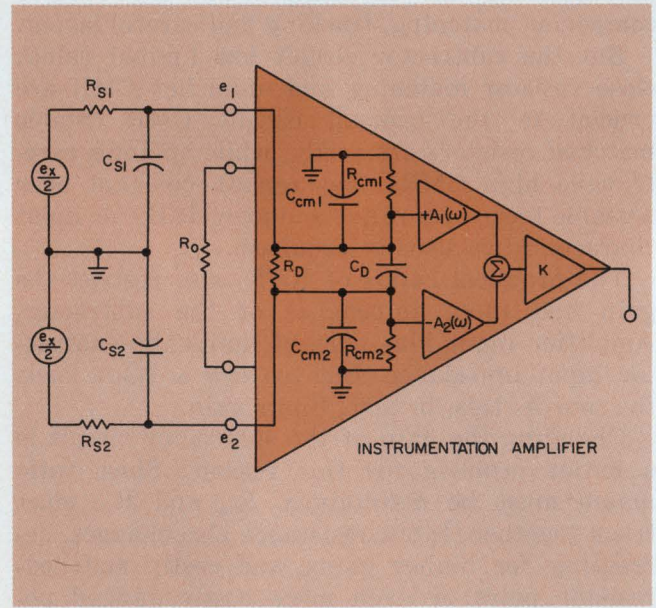

5. The internal input circuits of an IA avoid the measurement problems of simpler circuits. The IA includes features not found in other amplifier families.

permissible source characteristics in a different way.

Since  $R_d$  is across both input terminals, it doesn't produce an unbalance; but it does impose an upper limit on the source impedance. If  $R_d$  is too low, it will load the source and accentuate the effect that a source unbalance has on the com-

mon-mode error. Therefore the ratio of  $R_d/\bar{R}_s$  must be large enough to avoid source loading.

The common-mode input impedances,  $R_{cm1}$  and  $R_{cm2}$ , directly affect the input common-mode error. If  $R_d$  is removed from the circuit of Fig. 5, we are left with the voltage divider formed by  $R_s$  and  $R_{cm}$  at each input terminal. As  $R_{cm}$  ap-



proaches  $R_s$  in value, the equality of the voltage division at each terminal becomes increasingly critical. Since  $R_{cm}$  match is never specified, use the following rule of thumb: If the ratio of  $R_{cm}$  to  $R_s$  is much greater than the CMR of the IA, the IA alone determines the circuit CMR.

Though both impedances are reactive, only their resistive terms are specified. A high source impedance undergoes severe reactive loading with time-varying input signals.

#### Reminder: Check the CMR

The common-mode rejection of an IA is a function of gain. Usually the CMR is specified at a reference gain value. The CMR at a gain of 100 is higher than at a gain of 10, but direct proportionality cannot be assumed. Settling time usually increases with gain, while bandwidth decreases. To provide a measure of the IA's ability to interface with equipment, the CMR is usually specified with a 1-k $\Omega$  source unbalance. If it isn't, check your supplier or evaluate a unit.

The maximum safe level of common-mode voltage must be specified and observed. There are large transient spikes in many systems, and if they get onto the signal lines, they can zap an IA in microseconds.

CMR is a direct function of frequency and should be specified at a reference frequency, not necessarily the 3-dB break point. Ideally a family of curves—plots of CMR vs frequency—with gain as a parameter should be supplied by the manufacturer. Another problem to examine is the effect of gain on the input-offset voltage drift. The contribution of this drift to the output is found if you multiply the input offset by the gain selected. An additional, fixed-output drift component comes from the post amplifier and doesn't vary with gain. But you can refer the drift to the input by dividing it by the selected value of gain.

Most of the other IA specifications follow the same rules as the simple op amp. For example, you can use the input-offset current spec with a nearly balanced input bias current and the source spec with a grossly unbalanced source. Remember, however, that unbalance degrades the over-all CMR. With an unbalanced source, a resistor should be connected between the un-driven terminal and the common line to provide balance.

Problems arise when the IA is not fully understood. For instance, some IAs are advertised as being fully differential, but a floating signal source cannot just be connected across the input terminals. This type of amplifier would go right into saturation and stay there. These IAs, even though they are fully differential, require a common-mode ground return. ■■

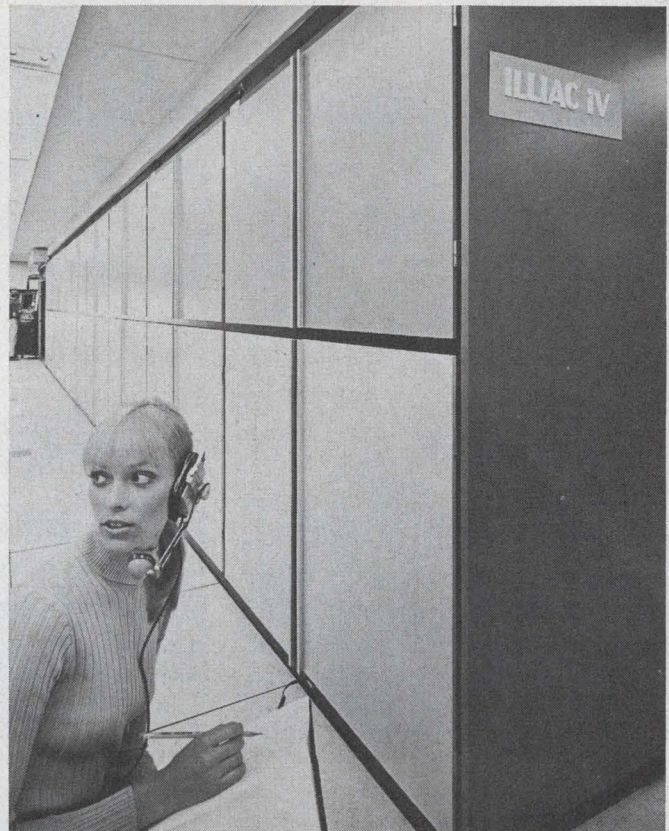

Photo courtesy Burroughs Corporation

## Now, that's sales appeal!

The ILLIAC IV, one of the world's largest computers, is another masterpiece of electronic engineering . . . and it looks it. Even sophisticated equipment such as this requires housing design that says beauty, purpose and durability. And nothing says it better than unique MET-L-WOOD® panels.

Met-L-Wood is a structural laminate combining the best qualities of wood and metal. It features high rigidity, strength, durability and lightweight. It has the solid feel and characteristics of steel plate without the weight, and a beautiful, smooth surface for immediate and lasting eye appeal.

First impressions often influence *final* decisions and acceptance. Met-L-Wood panels add more sales appeal than any other material you can use. Send for complete information today. Write: MET-L-WOOD CORPORATION, 6755 West 65th Street, Chicago, Illinois 60638.



**MET-L-WOOD Corporation**  
STRUCTURAL LAMINATES SINCE 1925

INFORMATION RETRIEVAL NUMBER 37

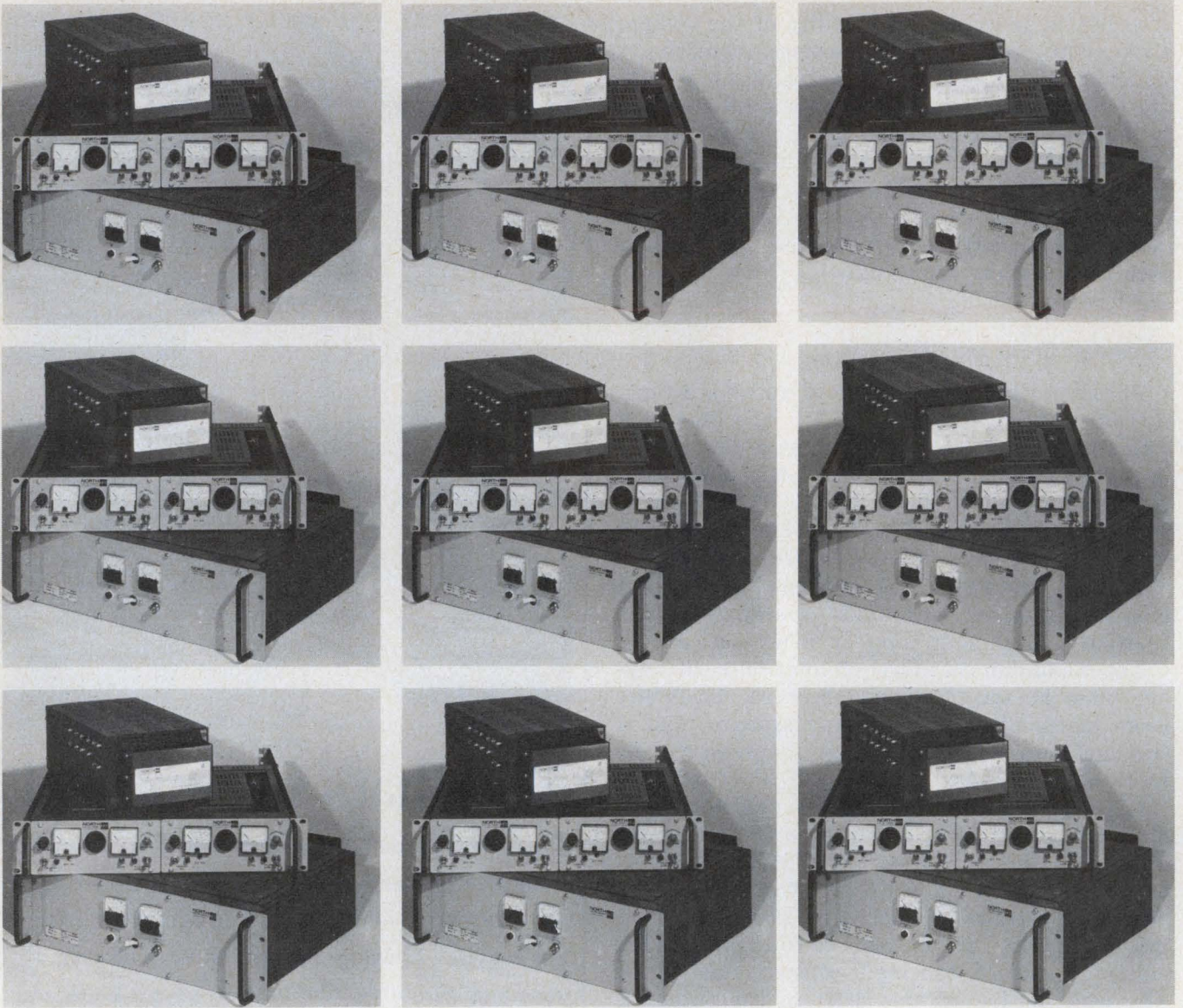

## Whether you buy one's, two's or multitudes North delivers power reliability!

The performance of your business machine products should never depend on anything less than reliable power supplies. It just doesn't make sense to risk the valuable reputation of a major piece of equipment over a minor component—especially, when the cost difference is so little.

Many O.E.M.'s are beginning to agree with this point of view, and if you're one of them, we'd like to quote your next power supply order. Whether you need one unit—or one hundred, North Electric has both the product selection and the production capacity to deliver more "reliability" for your power supply dollar.

And, to back it up, we offer the industry's finest technical specialists and more than 40 years experience as the leader in custom power supplies.

Send for a product catalog today, or for service information call your North Standard Product Manager at 419/468-8874.

MODEL	10000
VDC	AMPS
0-7.5	2.10
0-16	1.25
0-25	0.85
0-33	0.68

DUAL OUTPUT SUPPLIES	
MODEL	N03052
VDC	AMPS
±15-12	400MA
MODEL	N60052
VDC	AMPS
±15-12	1.0A

Listed here are the more popular models—many other voltages are available.

MODEL	11000	12000	13000	14000	15000	16000	17000	18000
VDC	AMPERES							
5.0	3.9	5.3	11.3	13.0	20.0	32.5	49.0	82.0
12.0	2.8	4.2	8.0	10.5	15.0	23.0	36.0	58.0
15.0	2.4	3.7	7.5	9.5	14.0	20.5	27.0	47.0
18.0	2.1	3.3	6.0	8.0	13.0	18.0	26.0	40.0
24.0	1.5	2.8	4.2	7.0	11.0	15.0	21.0	33.0
28.0	1.4	2.4	4.0	6.3	9.0	14.0	20.0	29.0
36.0	1.2	2.2	3.1	5.6	8.0	11.0	14.0	23.0
48.0	.95	1.8	2.6	4.2	6.0	8.0	10.0	18.0

**NORTH**   
ELECTRIC COMPANY

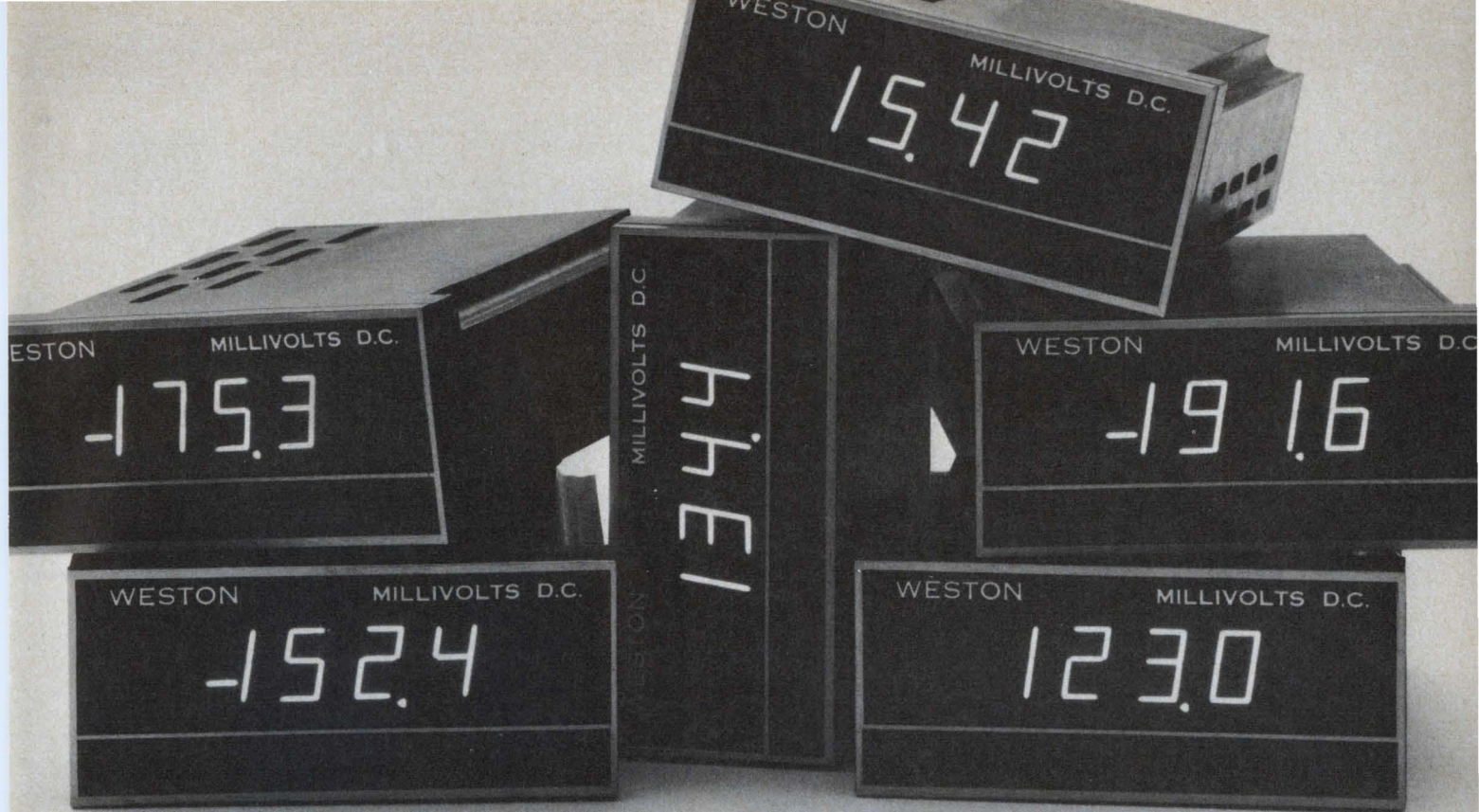

# The new WESTON Model 1230. More DPM at half the price.

Weston introduces the new Model 1230, a money-saving 3½-digit DPM with the best price/performance ratio of any meter on the market today.

Check these Model 1230 features. Full 3½-digit, plug-in, seven-segment Sperry display. All solid-state design with reliable TTL packages and advanced state-of-the-art CMOS circuits. Sturdy single PC board construction. Automatic zeroing. Bias current only 2nA maximum. 80 dB Common Mode noise rejection.

The Model 1230 also offers 0.1%, ± one digit accuracy—guaranteed, over a 0-50°C operating temperature range. Draws only 4.7 watts at standard line voltage. Uses only 7 sq. in. of panel space. Weighs only 13 oz. And, you get the Weston patented Dual Slope Conversion\* design for exceptional stability.

\*U.S. Pat. #3,051,939

Special OEM features in the Model 1230 include adjustable sampling rates, fixed or remote control of decimal point, external reference input, optional BCD output, synchronization to external equipment and easy slope adjustments.

But, the most amazing feature of the 1230 is the price. In OEM quantities the cost is less than \$90.00! And, you get the Weston dependable field service support at no extra cost.

So see the all-new Weston 1230 today. Ask your nearby distributor to show you how you can get more meter for your money.

Or, write direct to Weston Instruments, Inc., 614 Frelinghuysen Ave., Newark, N.J. 07114.

**We're either first or best. Or both.**

**WESTON**®

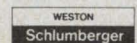

# Are your humidity readings valid?

Most test chambers are so poorly instrumented and serviced that major errors occur and engineers aren't aware of them.

Humidity tests are required by almost all electronic component and equipment specifications. But strong evidence shows that 90 to 95% of all humidity test chambers are "out of control."

In 80% of the cases the test operators are not even aware of the pitfalls they face in making these critical humidity measurements. And even if they suspect that a problem exists, often they're confused about how to restore control over the tests.

In an attempt to offset potential errors, some buyers insist on a more stringent spec from the supplier than they need. The supplier performs the humidity test at 90 to 98% relative humidity (RH), but the buyer runs the identical test at 80 to 90% RH. This is a poor solution to the problem of test errors.

Dale Electronics investigated a high-reliability component made by eight companies on the Military Qualified Products List. Four of the companies were selected at random and their product tested under controlled humidity. The components of three failed to meet the humidity requirements, and the fourth company was only borderline in complying with the spec. The companies are still listed as "qualified" military suppliers, however.

What are the problems? Here are some:

- A very popular method of recording wet and dry-bulb RH is the 24-hour circular chart. But it provides insufficient resolution to be useful for component humidity testing.

- Most methods use two pens for separate wet and dry-bulb temperatures. But there is an offset between the pens that makes it very difficult to correlate the two readings, especially when the temperatures are changing rapidly or make large excursions.

- The wet-bulb water is often impure, so that the wick becomes encrusted with deposits. As a result, the wet bulb gives inaccurate readings.

- There is insufficient air movement across the wick to achieve maximum evaporation rate.

- Calibration procedures are inadequate.

Humidity is measured and expressed by many methods besides RH: dew point, frost point, ppm of moisture by volume and ppm by weight. RH is the most widely used in testing and probably the easiest to implement. It makes use of the temperature-reduction effect caused by the evaporation of water. An RH chart then provides the percentage of relative humidity for a given dry-bulb temperatures vs temperature difference between dry and wet-bulb temperature readings (Fig. 1).

## The RH method is simple

But the simplicity of this method contains the seeds of the problems. Many RH systems use a 4-1/2-in.-radius, 24-hour circular chart (Fig. 2). The trace width on the chart is approximately 0.025 in. for each of two pens, and only 0.05 in. represents 2 F. At room temperature a 2-F change in the difference between the two readings represents 9% change in relative humidity.

MIL-STD 202, Method 106, requires that relative humidity be held between 90 and 98% during a component or system test (Fig. 3). It is quite obvious that the resolution of the widely used 24-hour circular recording is far from adequate. A recording chart that can resolve fractional-degree increments is necessary.

In addition, a two-pen system must have an offset to allow the pens to pass each other. This makes it hard to correlate corresponding readings. And equalizing the dynamic response between the pens also is difficult.

A way out of these problems is the use of a single-pen differential system (Fig. 4). Though not a new principle, its use has been extremely limited. In differential monitoring, the wet-bulb temperature is subtracted from the dry bulb and only the difference is recorded. This difference can then be magnified to cover the total chart. Resolution can be improved easily by 10 times. And there are no offset problems to deal with or response correlations to worry about. Fractional degree differences can be observed easily.

In spite of these advantages, a recent Dale

Wet Bulb depression in °F.		DRY BULB TEMPERATURE — °F.										Wet Bulb depression in °F.		
		77 to 81	82 to 87	88 to 95	96 to 103	104 to 113	114 to 127	128 to 141	142 to 149	150 to 161	162 to 171	172 to 200		
% RELATIVE HUMIDITY														
0.0	100.0	100.0	100.0	100.0	100.0	100.0	100.0	100.0	100.0	100.0	100.0	100.0	0.0	
.1	99.6	99.6	99.6	99.6	99.7	99.7	99.7	99.7	99.8	99.8	99.8	99.8	.1	
.2	99.2	99.2	99.2	99.2	99.4	99.4	99.4	99.4	99.6	99.6	99.6	99.6	.2	
.3	98.8	98.8	98.8	98.8	99.1	99.1	99.1	99.1	99.4	99.4	99.4	99.4	.3	
.4	98.4	98.4	98.4	98.4	98.8	98.8	98.8	98.8	98.8	99.2	99.2	99.2	.4	
.5	98.0	98.0	98.0	98.0	98.5	98.5	98.5	98.5	99.0	99.0	99.0	99.0	.5	
.6	97.6	97.6	97.6	97.6	98.2	98.2	98.2	98.2	98.8	98.8	98.8	98.8	.6	
.7	97.2	97.2	97.2	97.2	97.9	97.9	97.9	97.9	98.6	98.6	98.6	98.6	.7	
.8	96.8	96.8	96.8	96.8	97.6	97.6	97.6	97.6	98.4	98.4	98.4	98.4	.8	
.9	96.4	96.4	96.4	96.4	97.3	97.3	97.3	97.3	98.2	98.2	98.2	98.2	.9	
1.0	96.0	96.0	96.0	96.0	97.0	97.0	97.0	97.0	98.0	98.0	98.0	98.0	1.0	
.1	95.5	95.6	95.6	95.7	96.6	96.7	96.7	96.8	97.7	97.7	97.8	97.8	.1	
.2	95.0	95.2	95.2	95.4	96.2	96.4	96.4	96.6	97.4	97.4	97.6	97.6	.2	
.3	94.5	94.8	94.8	95.1	95.8	96.1	96.1	96.4	97.1	97.1	97.4	97.4	.3	
.4	94.0	94.4	94.4	94.8	95.4	95.8	95.8	96.2	96.8	96.8	97.2	97.2	.4	
.5	93.5	94.0	94.0	94.5	95.0	95.5	95.5	96.0	96.5	96.5	97.0	97.0	.5	
.6	93.0	93.6	93.6	94.2	94.6	95.2	95.2	95.8	96.2	96.2	96.8	96.8	.6	
.7	92.5	93.2	93.2	93.9	94.2	94.9	94.9	95.6	95.9	95.9	96.6	96.6	.7	
.8	92.0	92.8	92.8	93.6	93.6	94.6	94.6	95.4	95.6	95.6	96.4	96.4	.8	
.9	91.5	92.4	92.4	93.3	93.4	94.3	94.3	95.2	95.3	95.3	96.2	96.2	.9	
2.0	91.0	92.0	92.0	93.0	93.0	94.0	94.0	95.0	95.0	95.0	96.0	96.0	2.0	
.1	90.6	91.6	91.7	92.6	92.7	93.7	93.7	94.7	94.7	94.8	95.8	95.8	.1	
.2	90.2	91.2	91.4	92.2	92.4	93.4	93.4	94.4	94.4	94.6	95.6	95.6	.2	
.3	89.8	90.8	91.1	91.8	92.1	93.1	93.1	94.1	94.1	94.4	95.4	95.4	.3	
.4	89.4	90.4	90.8	91.4	91.8	92.8	92.8	93.8	93.8	94.2	95.2	95.2	.4	
.5	89.0	90.0	90.5	91.0	91.5	92.5	92.5	93.5	93.5	94.0	95.0	95.0	.5	
.6	88.6	89.6	90.2	90.6	91.2	92.2	92.2	93.2	93.2	93.8	94.8	94.8	.6	
.7	88.2	89.2	89.9	90.2	90.9	91.9	91.9	92.9	92.9	93.6	94.6	94.6	.7	
.8	87.8	88.8	89.6	89.8	90.6	91.6	91.6	92.6	92.6	93.4	94.4	94.4	.8	
.9	87.4	88.4	89.3	89.4	90.3	91.3	91.3	92.3	92.3	93.2	94.2	94.2	.9	
3.0	87.0	88.0	89.0	89.0	90.0	91.0	91.0	92.0	92.0	93.0	94.0	94.0	3.0	

1. The wet/dry-bulb method of measuring relative humidity is sensitive to the difference in temperature be-

tween the dry and the lower wet-bulb temperatures, but it is rather insensitive to the dry-bulb temperature.

Electronics survey of commercial testing laboratories found that only one of six used the differential-recording system.

### Wet-bulb water must be pure

Although RH testing has been around for some time, only in April, 1973, was a spec for the water used in humidity chambers added to the MIL-STD-202, Method 106: "Steam, or distilled and demineralized, or deionized water, having a PH value between 6.0 and 7.2 at 23 C, shall be used."

This is a step in the right direction, but it is not enough. A conductivity check also should be made. The minimum specific resistance of the water source should be 150,000/Ω cm.

Highly pure water aids in a humidity chamber's maintenance. And, as the water purity is improved, the test stress on parts exposed to its vapor increases. Stress on the parts is the whole

point of humidity testing. The very pure water behaves as an oxidizing agent and seeks electrons. As verification, note that test-chamber windows pit when high-purity water is used over a long time.

Another big problem area is the wet-bulb sock. Seemingly unimportant, it is one of the sneakiest obstacles to accuracy. The problem can be eliminated by the following steps:

- The material that covers the sensor should be muslin.
- Before installation, the sock should be washed in deionized water to eliminate contaminants.
- The material thickness should be thin enough so it doesn't mask rapid changes in evaporation, but heavy enough to hold a continuous film of water.
- The sock should be changed routinely. A monthly change is recommended. Mineral buildup on the sock prevents wicking of the water to

the sensor and slows evaporation.

Another source of trouble is the distance required for water to wick. If this distance is too great, the water will evaporate before it reaches the sensor. In general, the sensor should be within 2 in. of the water surface. However, if the wet-bulb sensor is too close to the water reservoir, the sensor will be affected by the reservoir's temperature.

### Air must move across the sensors

Many authorities on RH measurement recommend a minimum of 15-ft/s air velocity across the sensors. The best speed, however, depends on the size of the sensor and wick. Small sensors require less velocity to do the job; only enough to produce the lowest wet-bulb temperature is necessary.

When using a fan to create the air movement, note that many circular fans have a dead air space directly in the front-and-center region of the blades. It is also important to remember that wet and dry-bulb sensors should be placed as close to each other as possible to avoid temperature-gradient errors. The wet bulb should always be downstream from the dry bulb, with care taken not to block the air flow to the wet bulb. And the sensors should be in the working area of the chamber, not near the humidity-generation

port. Otherwise their readings will not be a representative sample of the chamber.

### Controlling humidity

To vary the humidity within a test chamber, you need a source of moisture. Three methods are used:

1. Steam humidity. It usually calls for a separate enclosure for the boiling water, and the steam is then injected in measured amounts into the chamber to maintain the required humidity level.

2. Atomizing. A pressure source is used to break water into a fine mist, which then is blown into the test chamber.

3. Evaporation. This calls for a large surface area of water, which is held near the evaporating point. A large volume of air moved over the water produces the required humidity.

Steam and evaporation are generally slow-responding in humidity-control systems. And when coupled with on/off dry-bulb temperature control, they are particularly undesirable. The cycling of the dry-bulb temperature about its set point is sufficient to affect the humidity. And the slow-responding steam or evaporation methods, in attempting to hold the humidity with an on/off control, can cause worse fluctuations.

To compound the problem, this overshooting of temperature and humidity, though very common, is masked by sluggish responding sensors. Thus the user is not even aware of the often violent fluctuations.

Atomizing humidity systems are better, because they employ a cool mist that does not upset the dry-bulb temperature when it humidifies. Also, atomizing in an on/off system can rapidly respond to a cutoff signal, thereby decreasing humidity overshoot.

But a proportional-time on/off controller would be better still. When "anticipation" is added to this controller and atomizing is used, an accurate, responsive humidity chamber can be obtained.

### The wet/dry-bulb method is primary

One important advantage of the wet/dry-bulb method is that it is a primary measuring system. With accurate temperature sensors and proper maintenance of the sock and water conditions, the RH is determined directly.

To keep the system accurate, the temperature sensors must be calibrated periodically. The sensors must be taken out of the chamber, the sock removed and all sensors tied together and checked for tracking throughout the temperature range.

But other secondary measuring systems, such

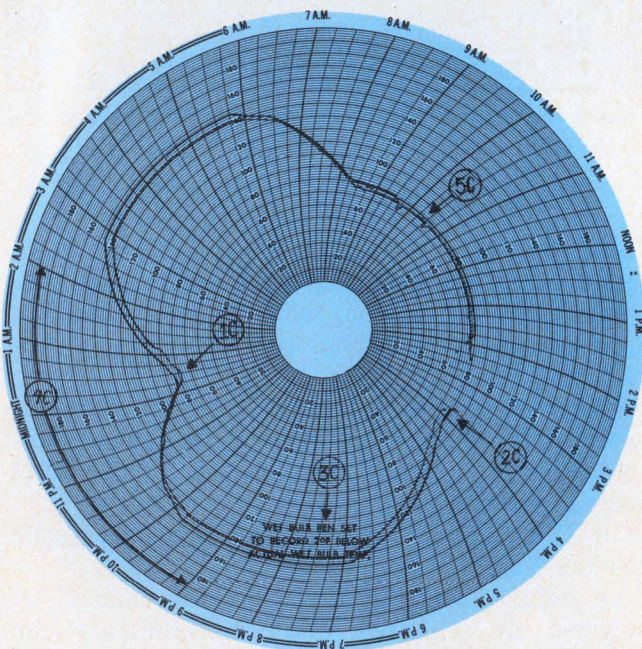

2. The popular 24-hour, two-pen circular chart provides less than one division, or 0.04 in., for the 90 to 98% RH range (1c). This small deflection, combined with a five-minute offset between the two pens (2c) and a temperature offset of 2 F (3c), makes the RH measurement very unreliable. A five-hour period (4c) is only 4.5-in. long and is not expandable on a circular chart. Limits for the 90 to 98% RH range are too close to draw (5c). The method of Fig. 4 is much better.

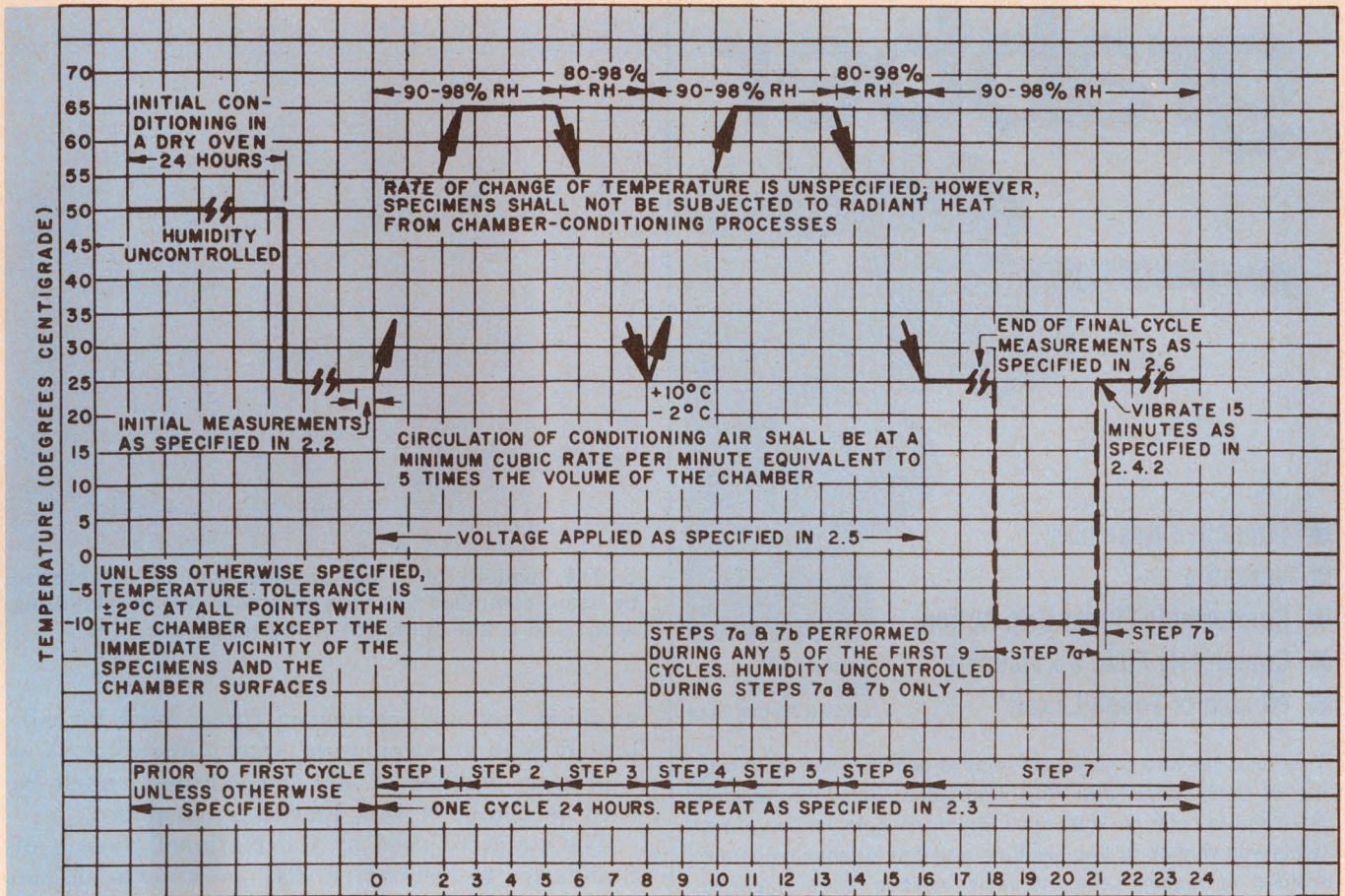

3. MIL-STD-202, Method 106, calls for maintenance of the relative humidity between 90 and 98% and 80 and

98% during alternate steps. Most chambers have insufficient definition to provide this reliably.

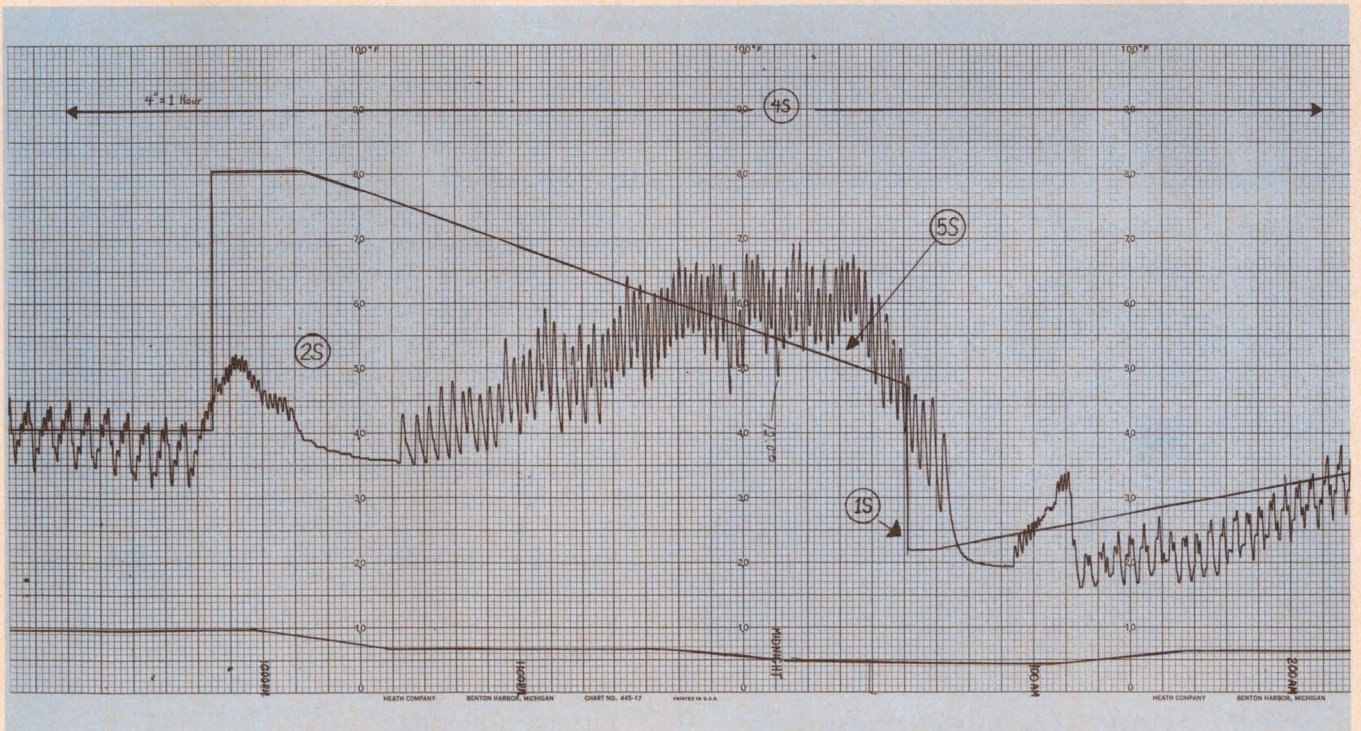

4. On a linear differential recording chart the 90 to 98% RH range is easily read as 1.7 in. (1s). No time-lag correction is required to read the single-pen trace

that directly records the wet/dry-bulb difference (2s). And five hours are stretched over 72 in. of chart (4s). Thus limits can be easily drawn (5s).

# DO-IT-YOURSELF grabber



- Simplified Assembly
- Versatile
- Comfortable Finger Grip Action
- Completely Field Serviceable
- Molded of Tough Lexan\*

Model 3925  
Mini Test Clip  
Shown Actual Size

This test clip with gold plated hook is excellent for rapid testing of components and Wire Wrap† pins. Clip is completely insulated to point of connection. Build any combination of test leads with wire up to .090 dia. Easy and comfortable to operate. Molded of rugged Lexan to resist melting when soldering. Write for literature and prices.



**MODEL 3925**  
hooks onto components or slips over square Wire-Wrap pins

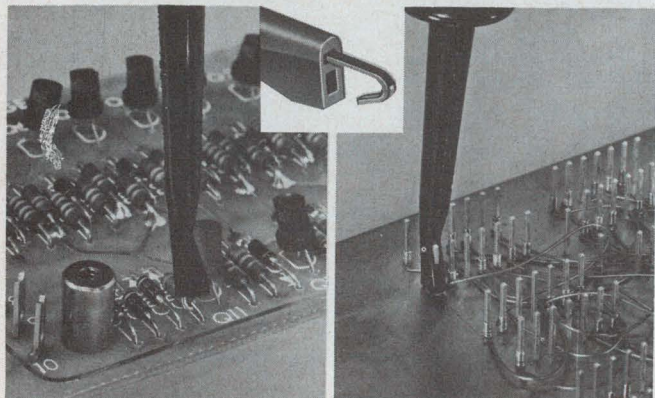

\*Lexan is a General Electric trade-mark. †Registered trade-mark of Gardner - Denver Co.



**POMONA ELECTRONICS**

A Division of ITT

1500 East Ninth St., Pomona, Calif. 91766  
Telephone (714) 623-3463

INFORMATION RETRIEVAL NUMBER 40

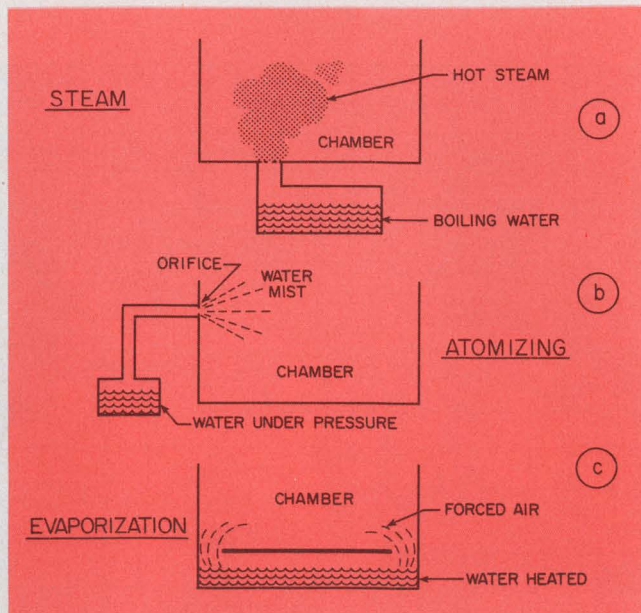

5. The humidity of a test chamber can be established by using controlled amounts of steam (a), by atomizing water into a fine spray (b) or by evaporation (c).

as those that use conducting films, must be calibrated in an atmosphere of known humidity. And a primary method of RH measurement must be used to establish this known atmosphere.

The standard used by the National Bureau of Standards to determine RH is known as the gravimetric method. The water vapor in a known volume of gas is exposed to a desiccant, usually phosphorous pentoxide. From the increase in weight of the desiccant, the relative humidity is calculated.

Though this test is very accurate, it is difficult to perform in commercial calibration. Commercial labs usually use the wet/dry-bulb psychrometer—a more refined and carefully maintained wet/dry-bulb system.

Commercial environmental testing labs also employ the equilibrium vapor pressure of saturated solutions of chemical salts in water to generate a known RH. A large surface area of such chemically treated water is introduced into a closed chamber and the air is circulated with a blower. Equilibrium is soon reached between the water solution and moisture in the air space.

The chemical solutions generally used and the relative humidities they produce at 25 C are:

Saturated Solution	RH Equilibrium
Potassium Nitrate	93%
Sodium Chloride	75
Magnesium Nitrate	52
Magnesium Chloride	33
Lithium Chloride	11

Other chemical solutions, derived from a water-sulphuric-acid solution and a water-glycerine mixture, also are used. ■■



# Remember the time you wanted something special in 3½ digits?

## Your time has come.

When we at Analog Devices introduced the 5-volt digital panel meter, we said there'd be more—a lot more. Look what we can offer you in 3½ digits alone.

Why so many? To give you a choice. So you won't have to order or build specials anymore. Because now we've made what you need a standard.

Let's say you need 3½ digit resolution. You can get it displayed in Numitron, LED, or even Sperry.

In Numitron, we can even give you a choice of green or red.

Now you have to power it. Most of our meters are 5 volts DC

because so much of what you're working on is in TTL logic. But if you need one that can run on 115 volts AC, you've got it. The AD2006 with Sperrys—in AC or DC. It's our latest DPM. But not our last.

You may even be designing something that will end up in another country. We can help you there too. With meters that will operate on voltages in Europe, the U.K., Japan, and just about anywhere else.

If you look closely, you'll see that one meter isn't a meter at all. It's a remote display. Sometimes you need that kind of thing.

But then giving you what you need is what it is all about. Like reliability. And extra features like card edge connectors. Ratiometric inputs. .05% accuracy. And low prices. Ours start at \$49 in hundreds for the remote display.

Now, would you like to see what we can do for you in 4½ digits—or 2½ digits? Give us a call. We'll see that you get a copy of the "Designer's Guide to Digital Panel Meters." And any other help you may need.

Analog Devices, Inc., Norwood, Mass. 02062. On the East Coast, call (617) 329-4700. In the Midwest, (312) 297-8710. And on the West Coast, (213) 595-1783.



**ANALOG  
DEVICES**

## Then it was special. Now its a standard.

# Get notch Qs in the hundreds

with a switched RC filter and a few op amps. One resistor varies Q without effect on center frequency.

With a modified commutative filter circuit, you can build notch filters whose center frequency is insensitive to component variations. The Q, which can easily be in the hundreds, is adjusted with a single resistor, and it does not affect the notch frequency.

A commutative filter, which provides bandpass operations, is cascaded with conventional pre-filters and postfilters. These filters are inserted into one signal path (Fig. 1). The narrow pass-band of the commutative filter is set solely by the clock's angular frequency,  $\omega_s$ . The pre-filters and postfilters are designed to add an over-all phase shift of  $180^\circ$  at frequency  $\omega_s$ . The resultant output of the filter system is the notch frequency component of the input signal with  $180^\circ$  phase shift.

The op amp sums the original signal and the commutative filter output. The bandpass signal components at  $\omega_s$  cancel those present in the original signal, to give the desired notch.

## Switched capacitors are used

The commutative filter has N identical capacitors labelled  $C_1$  to  $C_N$ , and resistor R (Fig. 2a). The switch alternately grounds and releases each capacitor, one-at-a-time, at a rate of  $Nf_s$ . If  $E_{in}(t)$  is periodic with radian frequency  $\omega_{in} = \omega_s$ , then each capacitor sees the same signal every time its electrode is grounded. The commutative filter output resembles the unattenuated version of the input, as modified by a sample-and-hold circuit (Fig. 2b). But if the signal period and sampling period differ, then each capacitor sees a different voltage each time the switch closes. And the capacitors tend to average out the difference between  $E_{in}(t)$  and the residual capacitor voltage. As a result the filter sharply attenuates all frequency components not in the vicinity of  $\omega_s$ .

An increase of R or C will increase the attenuation for frequencies  $\omega_i \neq \omega_s$  because of the larger time constant. Also an increase in N in-

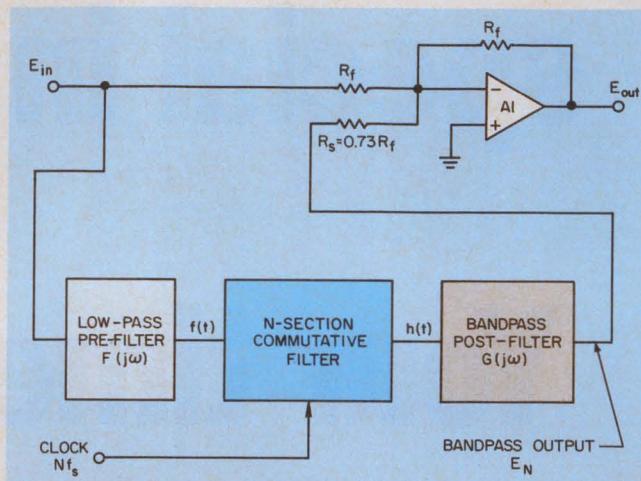

1. The notch filter reproduces the input except for sign inversion and the subtraction of a narrow notch of frequencies. The commutative bandpass section selects the narrow frequency notch and provides  $180^\circ$  phase shift. The summation of the original signal and the bandpass signal by op amp  $A_1$  produces the notch at  $f = f_s$ .

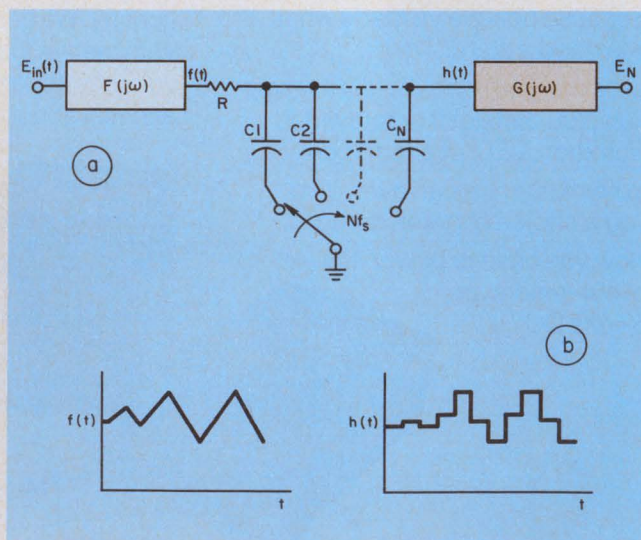

2. One resistor and N identical capacitors comprise the commutative filter (a). Each of the N contacts is closed periodically, one at a time. In effect,  $f(t)$  is sampled at the rate  $Nf_s$ . If the period of  $f(t)$  equals  $1/f_s$ , the output  $h(t)$  resembles  $f(t)$  but in a sample-and-hold form (b). But the filter sharply attenuates frequency components not in the vicinity of  $\omega_s$ .

**Mike Kaufman**, Member of the Technical Staff, Hughes Aircraft Co., Culver City, Calif. 90230.

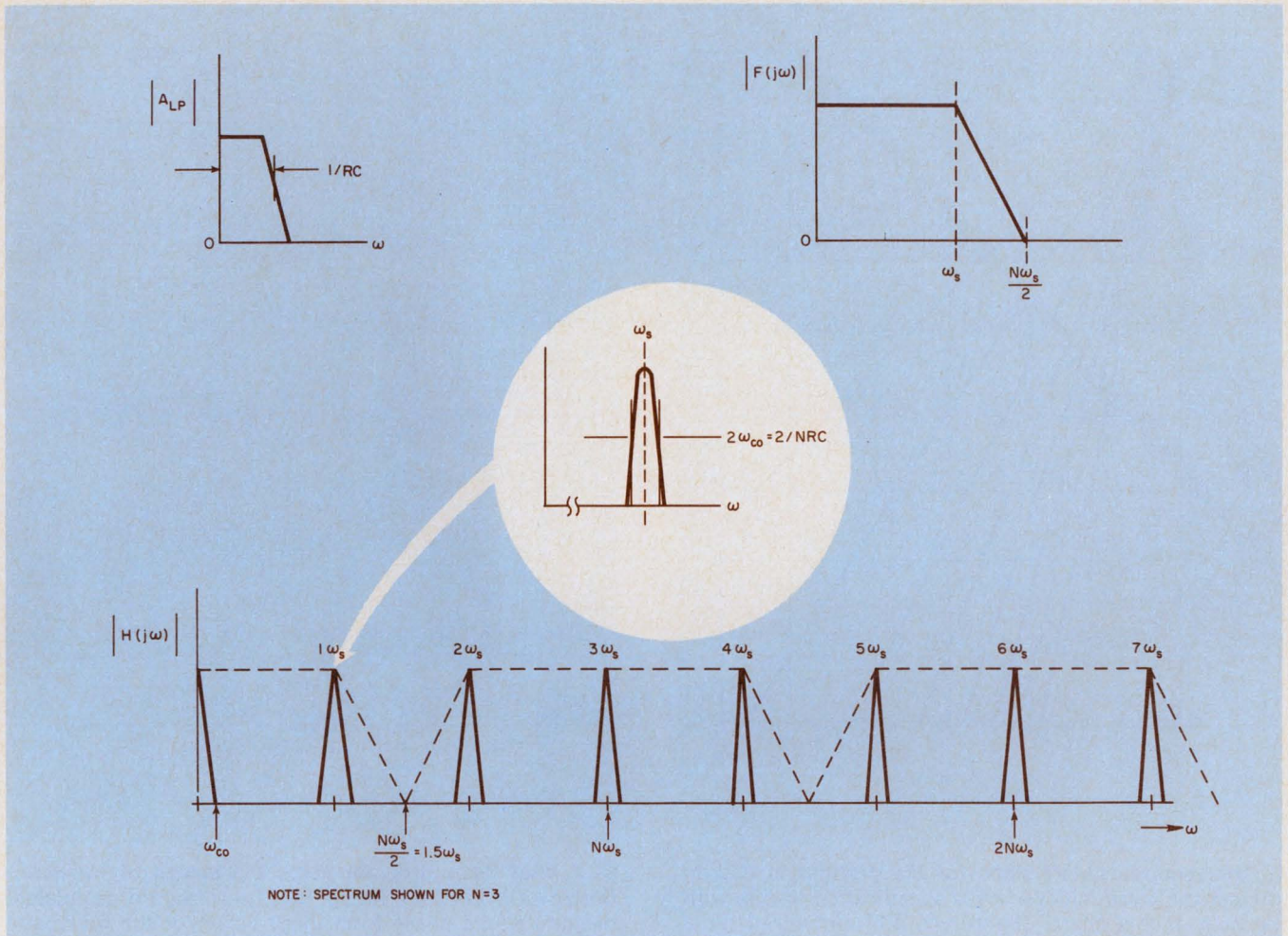

3. The frequency spectrum of the commutative-filter output is a composite of the prefilter and RC spectra. The RC spectrum  $A_{LP}$  appears at interval  $\omega_s$ , sharpened by a

factor  $N$ . The prefilter spectrum is the envelope that bounds the RC spectra and is centered at frequencies  $0, N\omega_s, 2N\omega_s$ , etc.

increases attenuation because each capacitor has less time in which to experience a change in voltage. In fact the width of the filter passband,  $2\omega_{co}$  is given by

$$2\omega_{co} = \frac{2}{NRC} \quad (1)$$

and is centered at  $\omega_s$ .

The commutative filter behaves as though the low-pass RC characteristic were sampled at the rate  $f_s$  or radian frequency  $\omega_s$ , and sharpened versions,  $A_{LP}(j\omega)$ , appear centered at all harmonics of radian frequency  $\omega_s = 2\pi f_s$  as shown in Fig. 3.

At the same time, the input to the commutative filter  $f(t)$  is sampled at an effective rate of  $Nf_s$  and the function  $F(j\omega)$  appears at all harmonics of  $N\omega_s$  in the form of an envelope that bounds  $A_{LP}(j\omega)$ .

The prefilter must obviously pass frequency  $\omega_s$  to produce the notch. And ideally for a sampling rate of  $Nf_s$ , the prefilter should roll off to zero for frequencies above  $(N\omega_s)/2$ . The lowest value of  $N$  that meets both conditions is three.

Otherwise the spectra overlap and cause a type of distortion called foldover (see box). But larger values of  $N$  permit use of shallower filter cutoff slopes. The bandpass spectra remain fixed while the envelope centers separate, of course, shallow slopes require simpler analog filter circuits.

While the above description is not completely rigorous, the results do provide straightforward analysis. The main deviation from classical sampling theory is the sharpened bandwidth of the notch.

A rigorous derivation for the waveform at the output of the commutative filter shows that

$$|H(j\omega)| = \sum_q \sum_m \left[ \left( \frac{\sin(\pi/N)}{(\pi/N)} \right)^2 \times \left| F(j\omega - jmN\omega_s) \right| \times \left| \frac{1}{NRC(j\omega - jq\omega_s) + 1} \right| \right]$$

The variables  $q$  and  $m$  are summation indices.

The constraints for the post-sampling filter are simple. You must suppress the first half-lobe of the RC filter at dc, and cut off all frequencies near the lobe centered at  $2\omega_s$  and above.

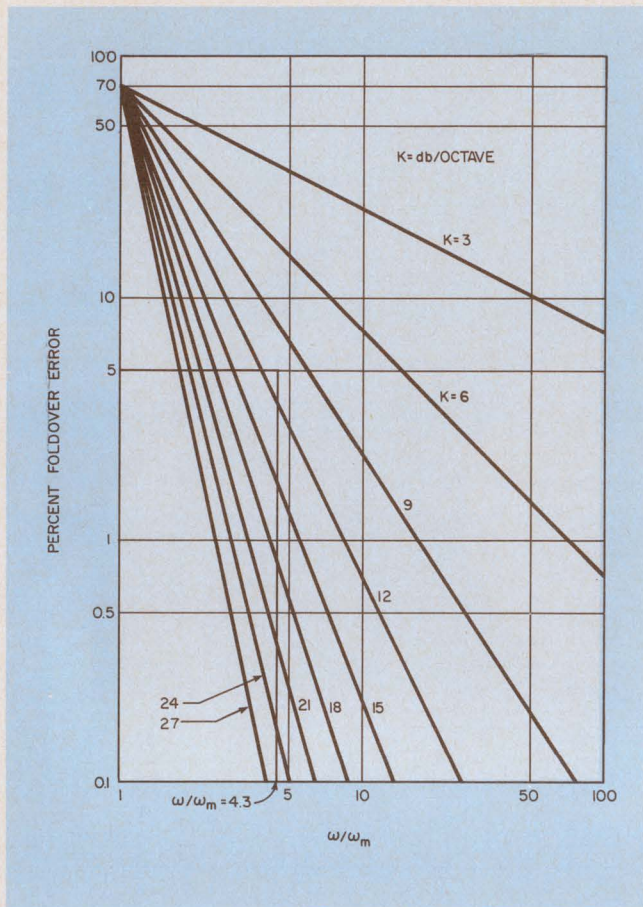

4. The required cutoff slope for the prefilter is chosen to meet the given foldover error specification of 5% with the help of this chart. The curves are normalized for a 3-dB response at  $\omega_m$ .

The constraint equations for the filter are  $G(j\omega) = 1$  for  $(1/NRC) \leq \omega \leq 2\omega_s - (1/NRC)$ ;  $G(j\omega) = 0$ , otherwise. (2)  
The  $Q$  of the over-all notch filter is computed from the definition

$$Q = \text{center frequency/bandwidth,} \\ \text{and for the notch filter} \\ Q = \omega_s / 2\omega_{co} = f_s (\pi NRC). \quad (3)$$

#### Let's design a notch filter

As an example, let's build a filter with a notch frequency of 165 Hz, a  $Q$  of 400 and a foldover error of less than 5%.

The notch frequency and  $Q$  help determine the number of capacitors, the clock rate and the RC time constants.

There must be more than three capacitors. For large  $f_s$ , large values of  $N$  also imply rapid switching—at the rate of  $Nf_s$ . Unless switching speed is a problem, a large value of  $N$  is preferred. A 3705 multiplexer has eight switches and is readily available, so  $N = 8$ .

The required clock frequency is therefore eight times  $f_s$  or 1320 Hz.

The low-pass filter's time constant is selected

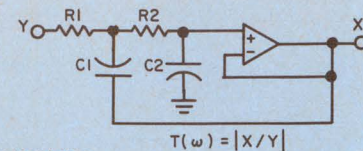

```

10 READ R1, R2, C1, C2
20 LET W1=1/(R1*C1)
30 LET W2=1/(R2*C2)
40 LET W3=SQR(W1*W2)
50 LET F3=W3/6.28
60 LET Z=1/(2*W3)*(W1+1/(R2*C1))
70 PRINT "R1="R1,"C1="C1,"FM="F3
80 PRINT "R2="R2,"C2="C2,"ZETA="Z
90 PRINT
100 PRINT "FREQ.,""T(W)","T(W) DB","DEG. PHASE"
110 FOR F=165 TO 660 STEP 165
120 LET W=6.28*F
130 LET T=W3+2/SQR((W3+2-W+2)+2 + W+2*(2*Z*W3)+2)
140 LET T1=(20/2.3)*LOG(T)
150 LET Q=W3*SQR(1-Z+2)
160 LET P=ATN((W+Q)/(Z*W3)) + ATN((W-Q)/(Z*W3))
170 LET P1=-57.3*P
180 PRINT F,T,T1,P1
185 NEXT F
190 GO TO 10
200 DATA 412E3, 412E3, 2.2E-9, 1.1E-9
210 END

```

R1= 412000 C1= 2.20000 E-9 FM= 248.448  
R2= 412000 C2= 1.10000 E-9 ZETA= .707107

FREQ.	T(W)	T(W)DB	DEG. PHASE
165	.914957	-.77285	-59.2468
330	.493112	-6.148	-112.147
495	.244286	-12.2558	-136.514
660	.140303	-17.0779	-148.201

5. A brief Basic program helps the design of two-pole, Butterworth low-pass filters (a). The program calculates magnitude and phase from input value for the four passive components (b).

to satisfy Eq. 3, rewritten as

$$RC \geq Q / (\pi N f_s)$$

or

$$RC \geq 400 / (165 \cdot 8 \cdot 3.14) = 0.096.$$

A large value of  $R$  is selected to nullify the effect of the 500- $\Omega$  ON resistance of the 3705. The values selected are as follows:

$$R = 1 \text{ M}\Omega$$

and

$$C = 0.1 \mu\text{F}.$$

Since a tight spec on  $Q$  is not called for, a 5% resistor and 20% capacitors will do.

Foldover error occurs because of the overlap of adjacent spectra. The most important pair are the baseband spectrum and the one centered at  $N\omega_s$  or  $8\omega_s$  in this instance. The error is a function of  $\omega/\omega_m$  and the steepness of the filter cutoff (Fig. 4). The lowest frequency of concern for foldover is  $\omega = 8\omega_s - \omega_m$ , and we set the 3-dB point of the filter,  $\omega_m$ , to be  $1.5\omega_s$ , so that

$$\omega/\omega_m = \frac{8\omega_s - 1.5\omega_s}{1.5\omega_s} = 4.3.$$

And from Fig. 4, we see that a 12-dB/octave filter satisfies the 5% requirement. In fact the foldover error is 3.6%.

A simple program written in Basic helps with

# Signal sampling and reconstruction errors

With classical sampling theory, a waveform  $f(t)$  is sampled with a train of impulses whose period is  $1/f_s$  and later reconstructed. Assume that the highest radian frequency component (signal or noise) in  $f(t)$  is  $\omega_m$ . Often  $f(t)$  is passed through a low-pass prefilter with  $\omega_{3db} = \omega_m$  to ensure that  $\omega_m$  is known.

Under these conditions, the sampled  $f(t)$  denoted  $f^*(t)$  is given by

$$f^*(t) = f(t)p(t) \quad (1)$$

in which  $p(t)$  is the impulse train. The Fourier series for  $p(t)$  is given by

$$p(t) = \sum_{-\infty}^{\infty} C_n \exp[-jn\omega_s t]$$

in which

$$C_n = \frac{1}{T} \int_{-T/2}^{T/2} p(t) \exp[jn\omega_s t] dt = \frac{1}{T}$$

Eq. 1 can therefore be written as

$$f^*(t) = f(t)p(t) = f(t) \left[ \frac{1}{T} \sum_{-\infty}^{\infty} \exp[-jn\omega_s t] \right] \quad (2)$$

The Fourier shifting theorem states that

$$f[f(t)e^{-jBt}] = F(j\omega - jB)$$

so that Eq. 2 can be written as

$$F^*(j\omega) = \frac{1}{T} \sum_{-\infty}^{\infty} F(j\omega - jn\omega_s) \quad (3)$$

The Fourier spectrum of  $f(t)$ ,  $F(j\omega)$ , is translated and repeated at all harmonics  $n\omega_s$  of the sample rate ( $a$ ). As the sample rate  $\omega_s$  relative to  $\omega_m$  increases, the adjacent  $F(j\omega)$  spectra separate from each other, and make it easier to reconstruct  $f(t)$  from  $f^*(t)$  with a post-sampler low-pass filter. Unless  $\omega_s \geq 2\omega_m$ , the  $F^*(j\omega)$  spectra overlap, and it becomes impossible to ever recover  $f(t)$  from  $f^*(t)$ . This last observation is essentially Nyquist's sampling theorem, which requires that  $\omega_s \geq 2\omega_m$ .

The overlapping of spectra produces a spectral distortion known as foldover error. The error is a function of the roll-off characteristics of the prefilter, and of the  $\omega_s/\omega_m$  ratio. Foldover error is defined by the following equation:

$$\text{Foldover error}(\%) = 100 \times |F(j\omega)| / |F(j\omega_m)| \quad (4)$$

When the sampler is not ideal and has a finite width, then aperture error occurs. The error can be represented as a  $\sin(x)/x$  envelope on  $F^*(j\omega)$  as shown in *b*. The width of the envelope is inversely proportional to the sampling width used in the time domain.

For a given sample interval  $a$ , the aperture error, in percent, is defined as

$$\text{Aperture error}(\%) = 100 [1 - \sin(\pi fa) / \pi fa] \quad (5)$$

The variable  $f$  represents the frequency of interest.

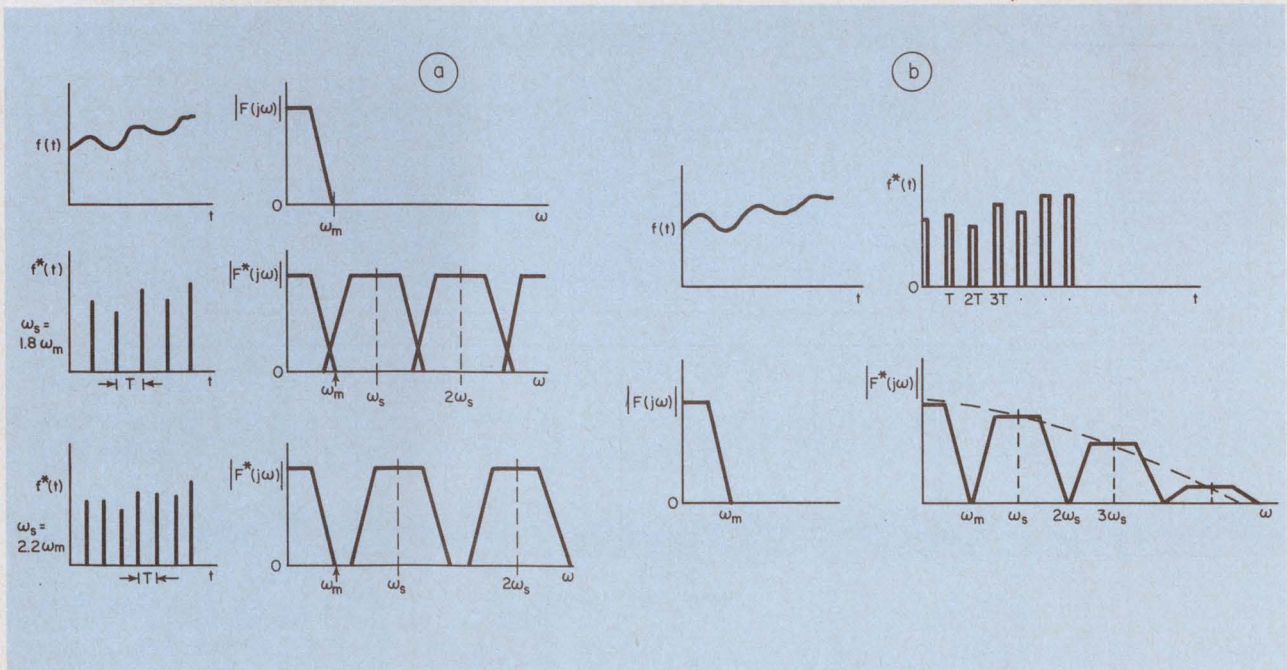

the filter design (Fig. 5a). The program analyzes two-pole Butterworth filters. The input is in the form of a data statement that supplies values for  $R_1$ ,  $R_2$ ,  $C_1$  and  $C_2$ . The Butterworth configuration is used as the best compromise between sharpness of rolloff and insensitivity of phase shift to filter-component changes.

The components selected for the first filter provide a 60-degree phase shift at  $f_s = 165$  Hz (Fig. 5b). The 3-dB frequency  $f_m$  turns out to be 248.4 Hz.

The requirements for the postfilter are given by Eq. 2. The filter must attenuate signals below 0.2 Hz, and attenuate signals above 329.8 Hz.

The filters used with the actual circuit consist of the low-pass design for the prefilter and a pair of the same design for the postfilter (Fig. 6). However, the attenuation below 0.2 Hz is supplied by  $R_9$  and  $C_{13}$ . Their 3-dB cutoff is 0.72 Hz, but they have negligible effect at 165 Hz. At 329.8 Hz, the pair of postfilters supplies about

12-dB attenuation. For the proper operation, the over-all phase shift between input signal and postfilter output must equal  $180^\circ$  at the notch frequency. This criterion is met, since the postfilter supplies  $120^\circ$  and the prefilter gives  $60^\circ$ —at 165 Hz. And with  $1\% \pm 25$  ppm filter components, the rms phase shift is less than  $\pm 3^\circ$  over a 100-C temperature change.

The summing resistor  $R_s$  is chosen to cancel  $E_{in}$  at 165 Hz. The transfer function of the entire commutative-filter section, including the post-filter is

$$\left| \frac{E_N}{E_{in}} \right| = \frac{\sin^2(\pi/N)}{(\pi/N)^2} \times \left| \frac{1}{NRC(j\omega - j\omega_s) + 1} \right| \times |F(j\omega) \cdot G(j\omega)|$$

At  $\omega = \omega_s$ , the magnitude of the transfer function equals

$$0.95 \times 0.915 \times 0.915 \times 0.915 = 0.728.$$

In the above calculation, 0.915 is the gain of a single low-pass filter at 165 Hz. On a normalized basis,  $R_s$  equals  $0.728 R_f$ , where  $R_f$  is the feed-

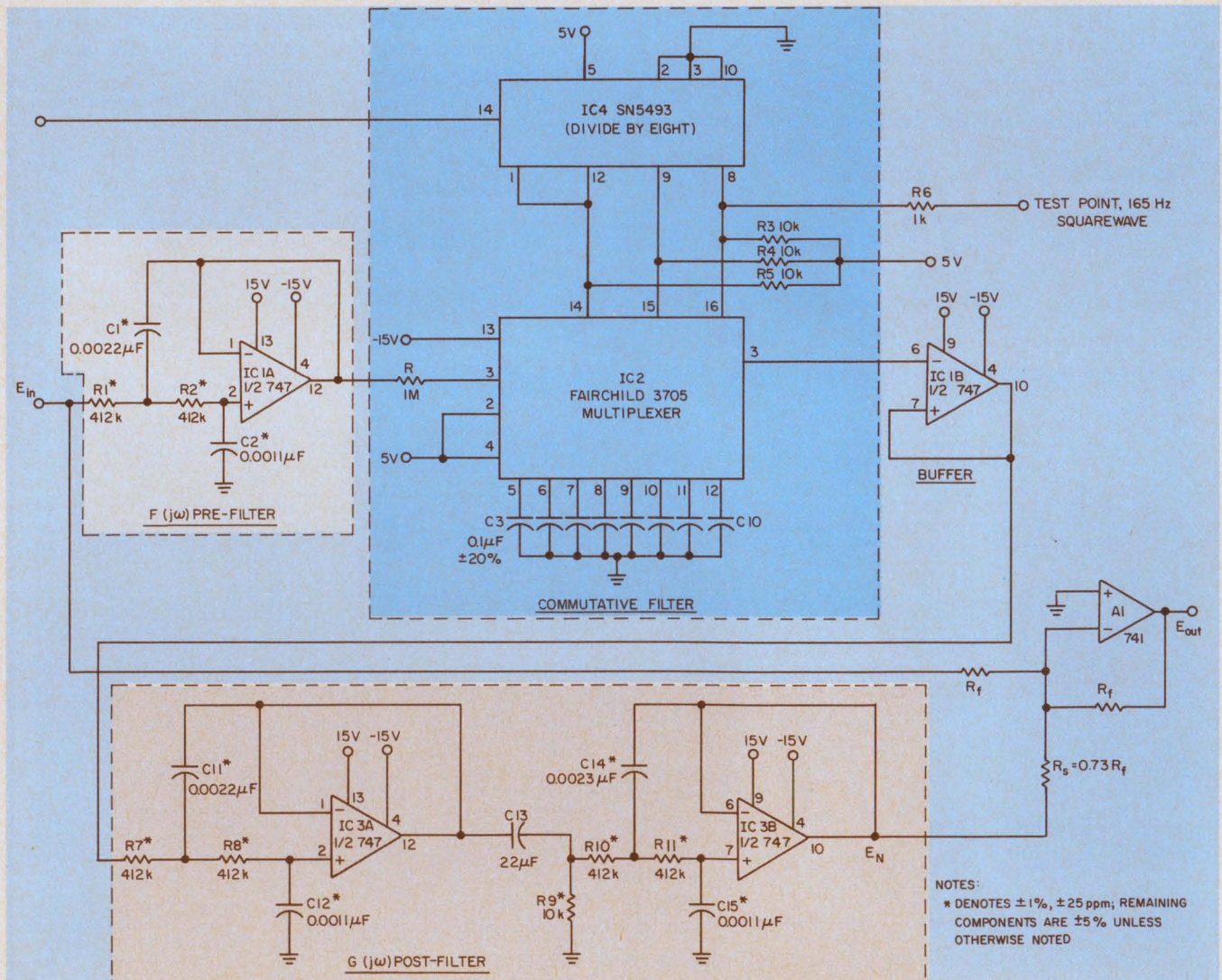

6. A 165 Hz notch filter uses an eight-leg commutative filter. Counter IC<sub>4</sub> causes the multiplexer to step the

capacitor connections at the rate of 1320 Hz. The over-all design has a frequency range of dc to 10 kHz.

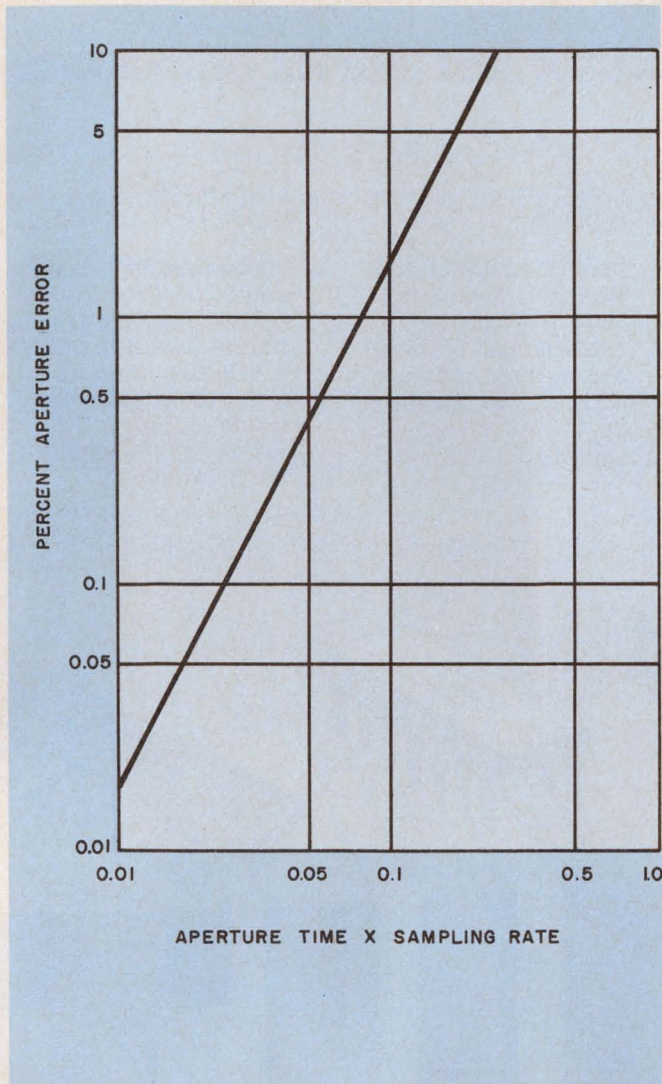

7. Finite sampling widths lead to aperture error, which is a function of aperture time  $\times$  sampling rate. The error is negligible with the design of Fig. 6;  $10^{-6} \times 1320 \text{ Hz} = 1.3 \times 10^{-3}$ .

back resistor of the summing amplifier (Fig. 6).

The commutative filter operates in a similar fashion to a sample-and-hold circuit, so aperture error is introduced. The 3705 has a  $1\text{-}\mu\text{s}$  transition time and  $nf_s = 1320 \text{ Hz}$ . The product of hold time and  $Nf_s$  is  $1.3 \times 10^{-3}$ , and the graph in Fig. 7 shows that the aperture error is nil.

The summing amplifier is chosen to pass the highest frequency components of  $E_{in}$ . For frequencies below 10 kHz, a 741 will suffice.

Test results bear out the viability of the design. A sine-wave input of 2-V rms at 165 Hz produces 1.42 V rms at the output of the commutative filter ( $IC_3$ , pin 10). This output represents a gain of 0.71. Compared with the theoretical gain of 0.728, the result is within 2.5%.

The 3-dB bandwidth (Fig. 8) is 0.36 Hz, which yields a Q of 460, as shown by

$$Q = 165 \text{ Hz} / 0.36 \text{ Hz} = 460.$$

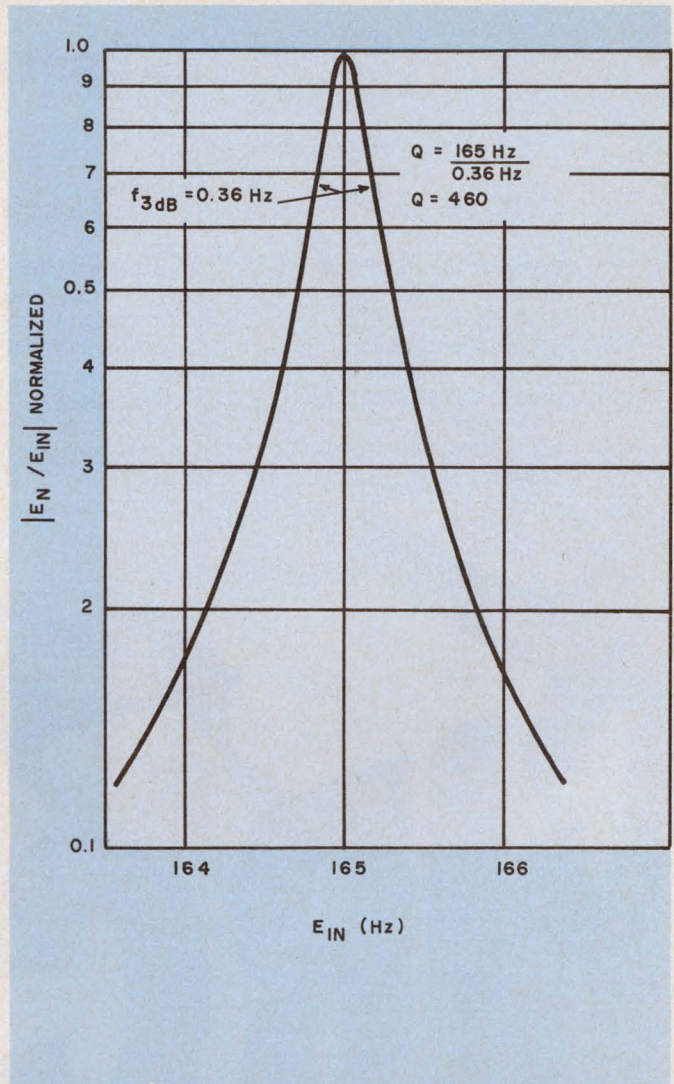

8. The 3-dB bandwidth of the actual circuit is 0.36 Hz, which equates to a Q of 460 at 165 Hz—well within the specified value of 400. The data are shown for a 2-V rms sine wave.

The value of Q is well within the spec of 400, especially with the tolerances used for R and  $C_3$  to  $C_{10}$ .

The test point shown in the circuit diagram furnishes a square-wave test signal for the commutative-filter section (Fig. 6). The square wave—whose frequency is  $f_s$ —is fed to the terminal for  $E_{in}$ . The output at pin 10 of  $IC_3$  should be a sine wave of frequency  $f_s$  that is  $180^\circ$  out of phase with the square wave. ■■

#### Bibliography

1. McDermott, J., "Unusual Filter Concept Promises High-Q, Low-Frequency IC Device," *Electronic Design*, No. 17, Aug. 16, 1973, pp. 22 and 24.
2. Kaufman, M.A., "Theory and Synthesis of the Digitalized Bandpass Filter," Master of Science Thesis, the University of California at Los Angeles, January, 1966.
3. Eggen, C. P., and McAllister, A. S., "Modern Low-Pass Filter Characteristics," *Electro-Technology*, August, 1966.
4. Jensen, O.W., "The Junction FET as a Switch," *EEE*, April, 1966.

## The best resistor networks come from

### LDP

Ceramic sandwich construction with epoxy coating. Suitable for automatic insertion. Available with 14, 16, 18 pins on .100" spacings. .125 watt max. per resistor. 1, 1/8, 1/4 watts per network.

### TKR-36

Double width DIP network designed for precision D/A conversion. Resistance: 1K, 5K, 10K, 20K. Accuracy:  $\pm 1/2$ , 1, 2 LSB. Tolerance:  $\pm 5\%$  typical.

### SDP

Ceramic sandwich construction. Suitable for automatic insertion. Available with 14, 16, 18 pins on .100" spacings. .125 watt max. per resistor. 1/8, 1/4, 1/2 watts per network.

### CSP

Flame retardant epoxy coated package with built-in standoffs (lead frame). Available with 4, 6, 8, 10 pins on .100" and .125" spacings. 1/8 watt max. per resistor. 1/2 through 1/4 watts per package.

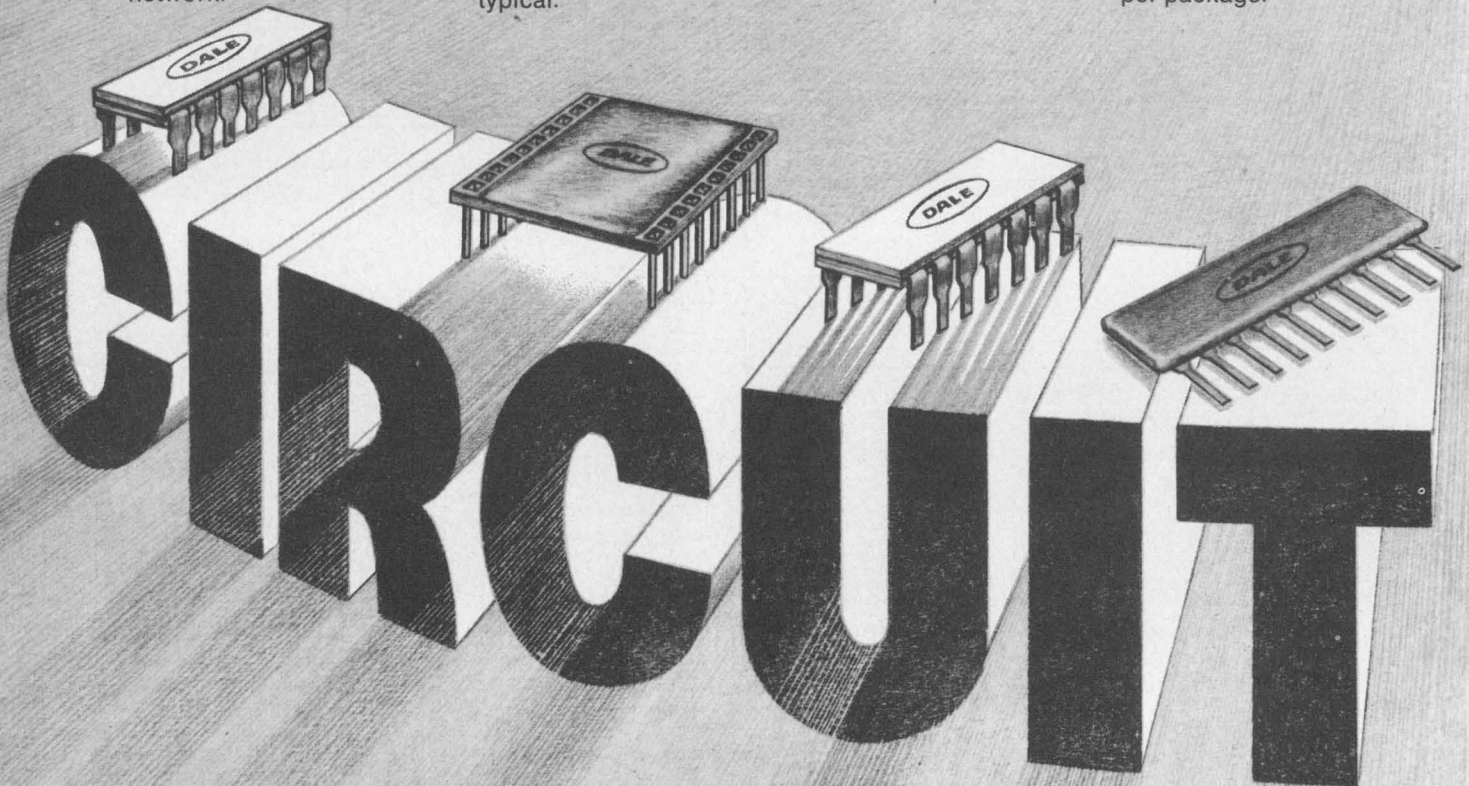

If you're going to depend on thick film networks to save space and money—depend on Dale. For the past five years, we have been quietly using our unmatched resistor know-how to build a strong, deep line of standard dual and single in-line packages. Our ability to produce quality can be measured by the fact that we were the first to be qualified to MIL-R-83401...and a look at our expanded laser trimming facilities will convince you that we're geared for volume. We can match your needs with one of the labor-saving packages above. Call today...402-371-0080.



**the people who really know resistors.**

## DFP

Ceramic flatpack.  
Resistance range:  
20 ohms to 1 Meg.  
Power: .2 watt or .1  
watt per resistor,  
depending on con-  
figuration. .65 watt  
max. per network at  
25°C.

## SIP

Solid block ceramic sin-  
gle in-line package with  
built in ceramic standoffs.  
Available with 4, 6, 8, 10  
pins on .100", .125" and  
.150" spacings. .125 watt  
max. per resistor. ¾  
through 2 watts per  
network.

## SDM

Meets requirements of  
MIL-R-83401. Ceramic  
sandwich construc-  
tion. Suitable for auto-  
matic insertion. Avail-  
able with 14, 16, 18  
pins on .100" spacings.  
.10 watt max. per res-  
istor. 1¼ watts max.  
per network.

## CDM

Ceramic sandwich con-  
struction with epoxy coat-  
ing. Suitable for automatic  
insertion. Available with 14, 16,  
18 pins on .100" spacings.  
.10 watt max. per resistor. 1¼  
watts max. per network.  
Designed to meet MIL-R-  
83401.

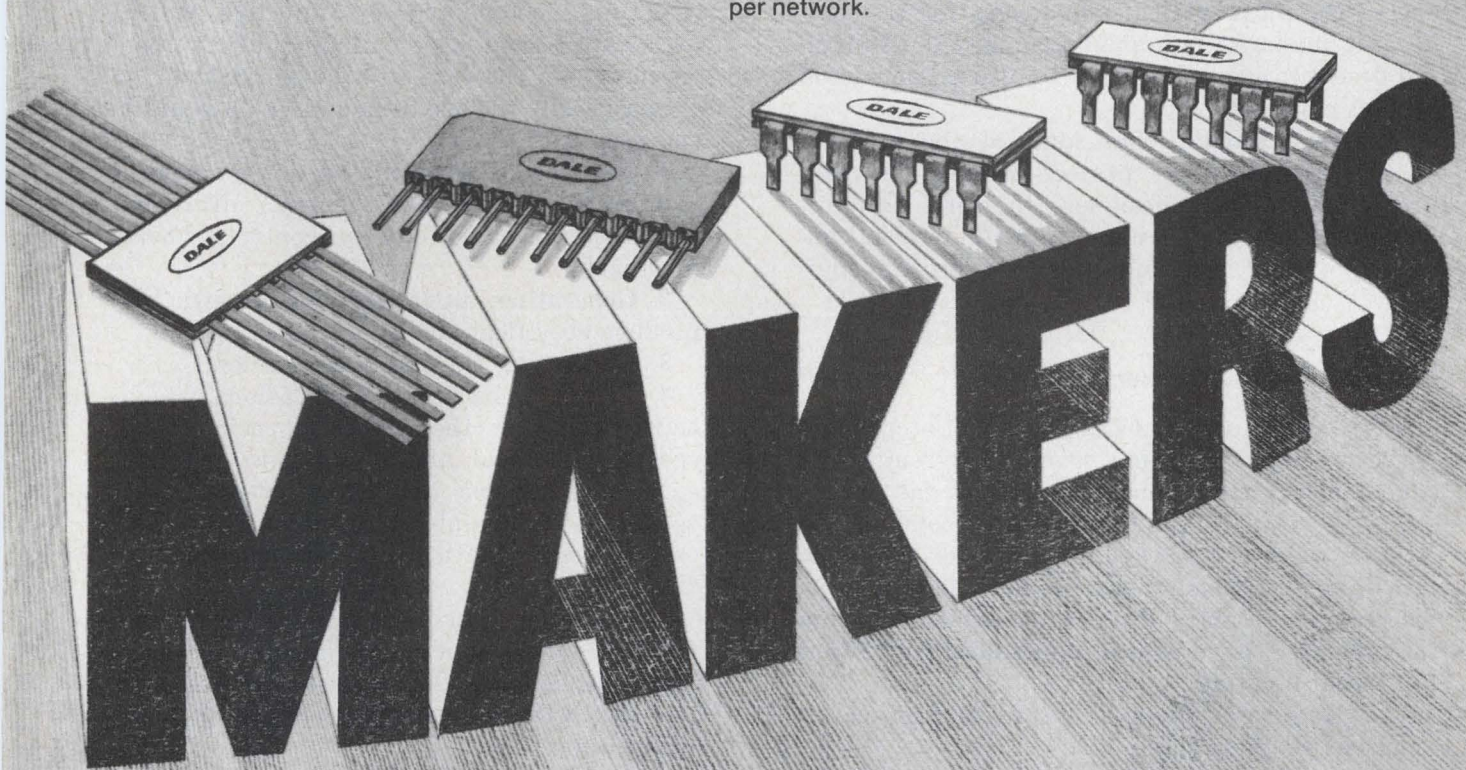

### BASIC NETWORK SPECIFICATIONS

Resistance Range: 10 ohms to 1 Meg.,  
depending on tolerance.

Tolerance:  $\pm 1\%$ , 2%, 5%, 10%, 20%

T.C.:  $\pm 300$  PPM/° C (lower available)

### THICK FILM CHIP RESISTORS

75, 100, 150, 300 mw sizes available  
in 100 ohms to 500K ohms range.

Tolerance as above. T.C.:  $\pm 200$  PPM.

DEPENDABLE  
**DALE**

**DALE ELECTRONICS, INC.** A subsidiary of The Lionel Corporation

P.O. Box 74, Norfolk, Nebraska 68701. In Canada: Dale Electronics Canada Ltd.

In Germany: Dale Electronics GMBH, 8 Munchen 60, Falkweg 51

**For the name of your nearest Dale representative, phone 800-645-9200**

## Learning to wear two hats on the job: the designer's and the project engineer's. Section manager tells why it's necessary in small companies.

Although most electronics companies need good designers and good project engineers, many smaller companies cannot afford to hire both. In fact, one of the most difficult challenges for an engineering manager in a small company is to instill the desire in good designers to also become good project engineers.

It seems, though, that some of the best designers are the least project-oriented. A main problem in getting designers to work like project engineers is the need to remind them constantly of the responsibilities of a project engineer.

### Designers respond to memo

What happens is that designers will occasionally revert to their small world of circuits and components, temporarily forgetting the larger "project world" around them. After some of our designers were becoming less project-oriented and unwilling to consider the broader aspects of a program, I recently distributed a memorandum that seems to have helped immeasurably. It went somewhat like this:

To: Engineers, Modular Products Section.  
From: S. Weisman  
Subject: Project engineering responsibilities.

Our engineering department has been structured into several project-oriented design sections, and each engineer in each section usually works as a project engineer. This is a good method that works well in other companies, and in general, it is working well here.

Every engineer here is a good one, and you are cranking out some fine designs. However, even though I've been pointing out some problems for over a year, engineers occasionally forget what some of the responsibilities of a project engineer are.

In our company a project engineer is re-

sponsible for the design of anything from a sub-module to a complete stand-alone system. All specifications are provided to him, as well as a time schedule and cost objective, which he is expected to meet with the aid of other engineers, in the case of a large project.

Specifically the requirements for a project engineer are:

1. Interfacing with the section manager, and with product management, drafting, manufacturing and quality control, where necessary.
2. Generating, updating and testing the product specification.
3. Generating the test specification.
4. Providing backup to publications, which means checking the product specification, operator's manual, and maintenance manual, as well as writing the theory of operation section of the maintenance manual.
5. Providing complete information to drafting whenever necessary.
6. Providing backup to manufacturing before and during pilot run, by answering their questions, helping define test fixtures and assisting with component problems such as substitution.

### Three categories of problems

As section manager, my job is to work closely with the project engineer. Fortunately, cooperation has generally been outstanding, and most projects are proceeding on schedule. The most difficult problems that have occurred can be generally broken down into these categories:

- Communication.
- Providing sufficient information to drafting.
- Interfacing with other departments.

Let's examine them.

*Communication:* I need the bad news as well as the good. If a problem comes up that affects design, specifications, schedules and deliveries I have to know about it. I also have to know when the problem is solved.

The layout of an engineering sketch of a schematic diagram should be done with the thought

## Sumner Weisman and B-D Electrodyne

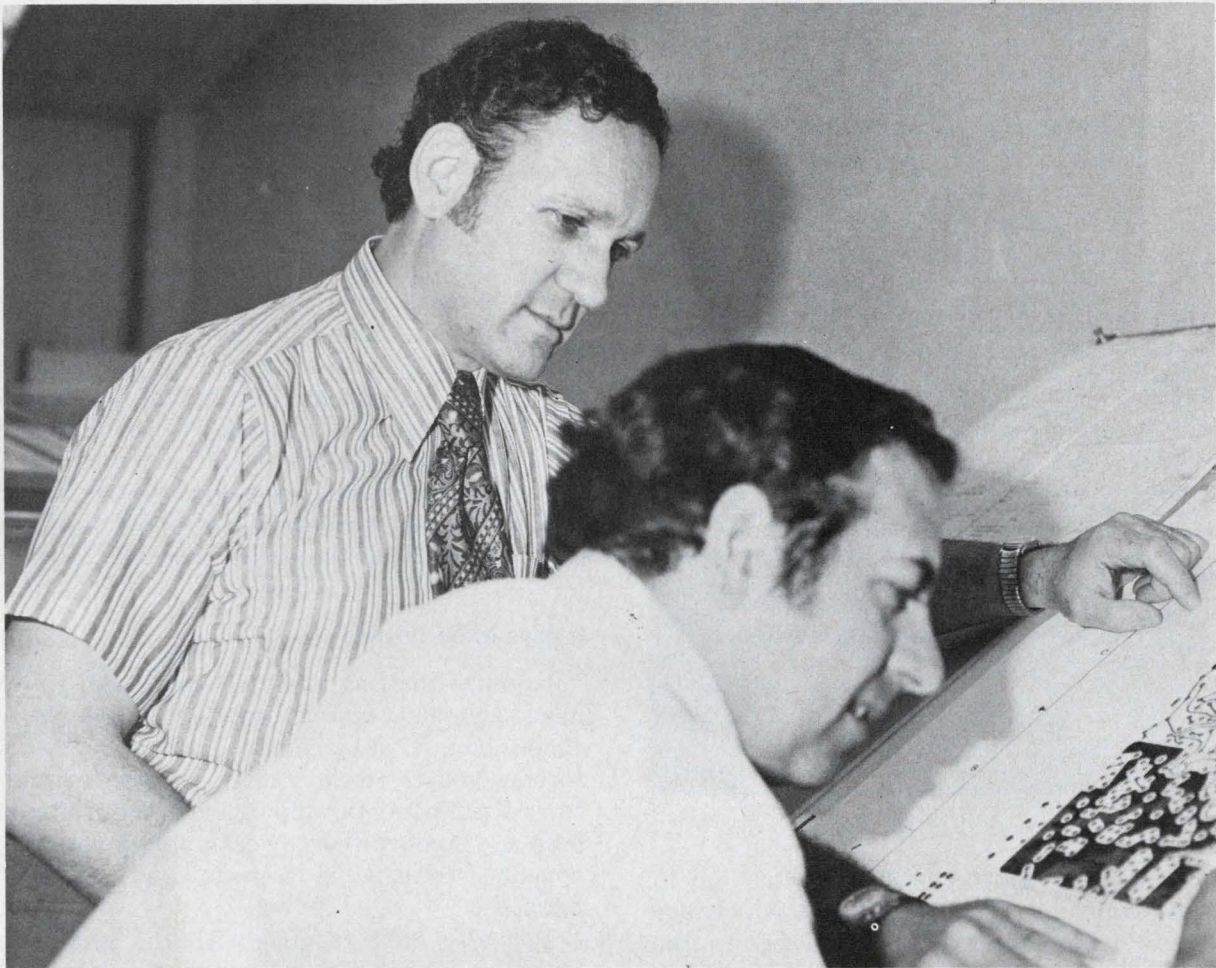

Before coming to B-D Electrodyne, Sumner Weisman had spent most of his engineering career in communications electronics. After earning his BSEE at the University of Florida, he worked as a communications technician in the U.S. Navy; a transmitter engineer in the radio broadcast industry; a research and development engineer at the Radar Meteorological Laboratory, University of Florida; and a senior engineer in the Data System Department, National Radio Company, Melrose, Mass.

He also worked as an electronic design engineer at Raytheon Co., Wayland, Mass., and as manager of the electronic engineering department at MKS, a small company that makes pressure vacuum instrumentation and transducers. He helped that company modernize its technology and capability from vacuum tube to the latest integrated circuit technology.

Weisman is a registered professional engineer in Massachusetts, and a member of the Association for the Advancement of Medical Instrumentation. He lives with his wife and three sons in Framingham, Mass.

At B-D Electrodyne, a division of Becton,

Dickinson and Company, Weisman is responsible for the design and development of medical monitors, defibrillators, isolated patient ECG amplifiers, and telemetry transmitters, receivers, and related equipment.

The company has been in the bio-medical monitoring field for 24 years. It was founded in 1950 and remained an independent company until its purchase by Becton, Dickinson and Company in January of 1965. In 1952 the company worked with Paul M. Zoll, M.D. and his associates at Beth Israel Hospital (Boston) and the Harvard School of Medicine, and developed apparatus that performed the first successful external treatment of cardiac standstill. The Electrodyne name for this instrument, the "Pacemaker," has literally become the most universally recognized generic term for this type of device. The term "pacemaker" is a registered trademark of Electrodyne.

The company now bases its activity in a new 65,000 square foot home office plant in Sharon, Massachusetts. There are 300 employees with 260 based in the home office and the balance located throughout the United States.



to communicate. It's not the draftsman's job to figure out which are the inputs and which are the outputs and where they should be on the paper; he has to be guided. Even though you understand your schematics, the layout must convey as much information as possible to other people. The value of a sketch layout is often underestimated.

*Providing sufficient information to drafting:* Giving a schematic to drafting is just like programming a computer—garbage in, garbage out—it should be a complete schematic, not a pile of sketches on little pieces of paper. For PC layout purposes, a parts list must be generated by the responsible engineer. It's his responsibility to select all components and to provide company numbers for every part possible.

Part numbers for new parts, pinouts and mounting dimensions must be provided by the project engineer to eliminate guessing or searching out by the PC layout man. The drafting department can't be expected to make correct guesses at whether the 0.01  $\mu$ F capacitor on your schematic, even if tolerance and voltage rating is given, is a polycarbonate, ceramic or polystyrene and then pick a part number from the computer runoff.

It's not drafting's job to figure out how various schematics interconnect or how the PC boards are

connected to each other or to panel components. It's up to the project engineer to provide a complete interconnection drawing.

*Interfacing cooperatively and cheerfully with other departments:* It's very easy, as well as traditional, to say "Manufacturing messed up" or "Marketing oversold" or "Q.C. is unreasonable." We all work for the same company and have the same goals. And everybody has problems. It's your job, as project engineer, to work willingly with people in other departments on tasks pertaining to your project. You may be surprised to discover that cooperation is contagious.

All of these items may sound trivial, and you may feel that I'm nitpicking. Well, the days are gone when an engineer could sit in a corner of the lab and design a circuit and not have anything else to worry about. In today's world, that man would be doing less than half his job. When an engineering project gets bogged down, schedules slip, products are released late and full of errors, sales are lost, and the entire company is affected.

#### **It pays to be flexible**

I realize that, as a project engineer, you don't have complete and absolute design freedom. You're hampered by component delivery problems forcing you to try to design only with multiple-source components, and by company standards, such as standardized power supply voltages, components, front-panel layouts and construction methods.

You also have to deal with the section manager's opinions of how certain functions should be accomplished. Though I may occasionally attempt to convince a project engineer to do it my way, I'll usually concede if he can suggest a better way. In like manner, the director of engineering occasionally influences the section manager in the way a project engineer should attack a problem. We all strive to be flexible, and a good bit of give and take goes on.

On the plus side, I try to get the project engineer involved with as much of the definition of the product specifications and scheduling as possible. He is usually invited to attend meetings with engineering management, marketing and product management on product definition and the drawing up of the time schedule. Invariably a person feels far more committed to a schedule that he helped to generate.

The project engineer is assigned the responsibility of maintaining the schedule and specifications and of notifying other people involved of any required changes. Thus he has quite a bit of effect on the parameters of the "black box" he has design responsibility for, and therefore feels much more involved and responsible than if they were merely provided for him. ■■

**For PBX, computer memory  
and instrument power  
supply applications**

# turn to CTS

**for cermet resistor networks**

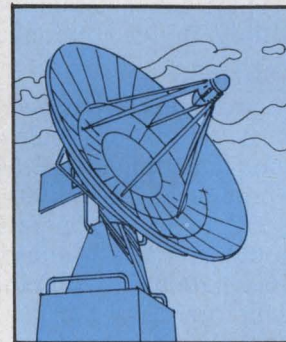
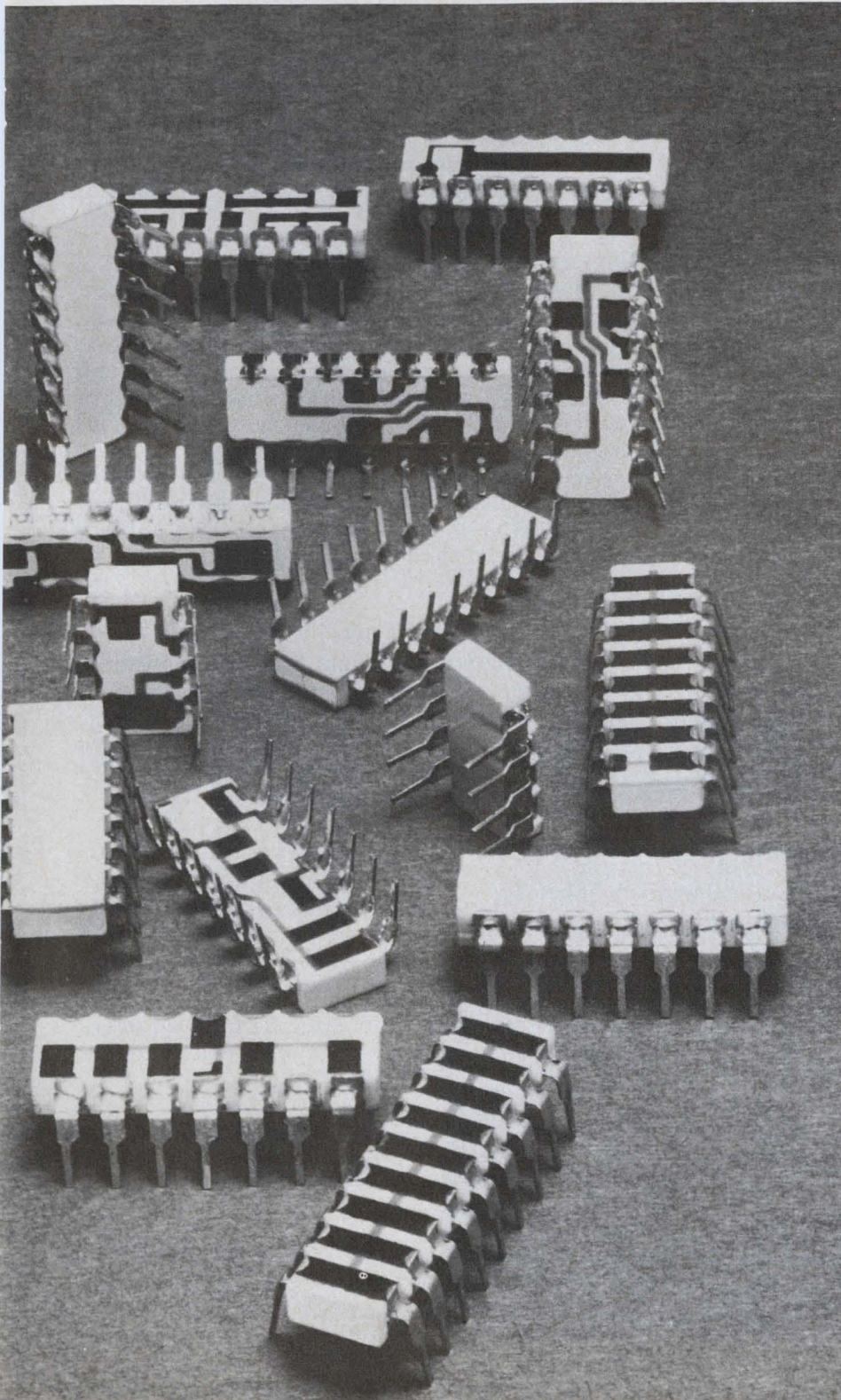

**Save Space. Money. Time.** It's easy with CTS Series 760 DIP Cermet Resistor Networks. Four popular packages . . . 8, -4, -16 and -18 lead styles . . . provide an infinite number of circuit combinations.

Compact, low profile design puts the squeeze on PCB space. Cost cutters, too. All designs eliminate lead forming and lead trimming for low cost automatic insertion along with IC's and other DIP components. Time saving? One 18-lead CTS 760 Series package can replace up to 32 separate components.

Available without organic cover coat, so you can trim for circuit balance. Precision .100" leads; rated up to 2 watts on 18 lead style; 5-lbs. pull strength on all leads.

Immediate delivery on standards. Custom designs to specifications. Be a saver. Turn to CTS of Berne, Inc., 406 Parr Road, Berne, Indiana 46711. Phone: (219) 589-3111.

**CTS CORPORATION**  
ELKHART, INDIANA



# Announcing your next cost under-run: Rolm's new ultra-rugged minicomputer at \$9,950.\*

The new ROLM 1603 computer is designed to meet both airborne and shipboard environmental specifications, comes with 8,000 words of memory, and costs less than \$10,000 in single unit quantities.

Yet even at this very low price, the performance of the ROLM 1603 equals or exceeds the performance of rugged computers costing a lot more. Consider these specifications:  1.2  $\mu$ sec cycle time  1.2  $\mu$ sec add time  769,000 words per second INPUT Direct Memory Access Rate  512,000 words per second OUTPUT Direct Memory Access Rate  7.7  $\mu$ sec Multiply/Divide (optional).

## ULTRA-RUGGEDNESS

The 1603 is suitable for rugged industrial applications; and it stands up against tough military specifications including MIL-E-5400 (airborne), MIL-E-16400 (shipboard), MIL-S-901 (shock) plus: Temperature:  $-55^{\circ}$  to  $+95^{\circ}$ C operational  $-65^{\circ}$  to  $+125^{\circ}$ C non-operational

Vibration: 10g, 5-2000 Hz with vibration isolators

2g, 5-2000 Hz, hard mounted

Shock: 15g, 11 msec

Humidity: 95% relative

EMI: MIL-STD-461A @ 400 Hz

Altitude: 80,000 ft.

Power: 115V, 47-440 Hz; MIL-STD-704A, Category B @ 400 Hz

## LOW PRICE

The 1603 is not a stripped down minicomputer. It includes the CPU, 8K memory, and power supply all packaged in a rugged ATR chassis. Each additional rugged 8K memory increment is only \$5,000. And

you receive at no charge, with each 1603 system, a reliability report, operation and service manuals, two man weeks of maintenance and software training . . . plus individual software manuals.

## EASE OF INTERFACING

Besides economical rugged computer power, the 1603 gives you over 30 general purpose interfaces, available off-the-shelf, for \$750 to \$2,000 each. Or your own special purpose interfaces can be placed right inside the 1603 chassis. You save money by not having to design a rugged chassis or rugged power supply.

## EASE OF PROGRAMMING

The 1603's software reduces the most expensive and longest lead time item in the systems task. It includes everything from a cross-assembler that lets you begin programming before delivery, to high level languages and operating systems which reduce your coding time, to debug packages that get your program finished sooner. The 1603 is software and I/O bus compatible with the Data General Nova series computers. The software delivered with your ROLM 1603 has been proven on over 10,000 military and commercial applications.

## DELIVERY

Delivery is fast. Typically 60-90 days.

If the 1603 sounds right for your application give us a call at 408-257-6440, TWX 910-338-0247, or write ROLM Corporation, 18922 Forge Drive, Cupertino, CA 95014. We'll get you all the facts that can help you achieve your next cost under-run.

**ROLM**  
CORPORATION

POWER SUPPLY AND REAL TIME CLOCK

4 CARD CENTRAL PROCESSING UNIT  
SEMICONDUCTOR MEMORY SLOT

## DIMENSIONS

7.62" H  $\times$  10.12" W  $\times$  19.56" D

## Domestic Sales Offices:

Los Angeles 213-784-8500  
Palo Alto 415-965-2224  
Cincinnati/Dayton 513-874-5406  
Washington D.C. 703-893-2696  
Boston 617-237-5752  
New York 914-297-9533  
Dallas 214-661-8905

## European Headquarters

Hanau, Germany (06181) 15011

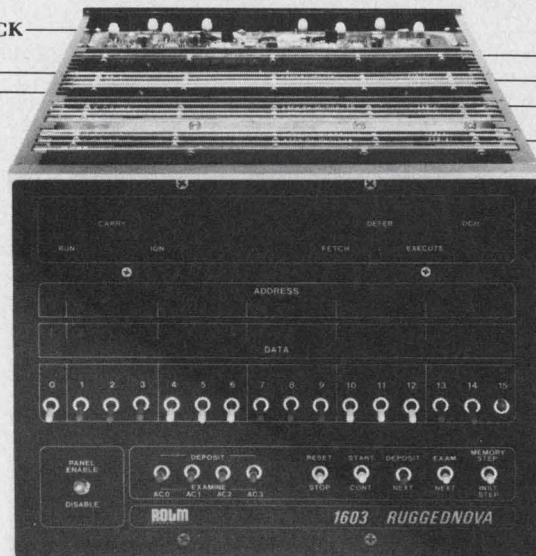

5 INTERFACING CARD SLOTS  
EXTENDED ARITHMETIC UNIT  
8K CORE MEMORY  
8K CORE MEMORY

CONTROL PANEL  
\*(not included in \$9,950 price)

## Domestic Representatives:

Denver 303-355-2521  
Kansas City 913-362-0919  
St. Louis 314-895-4100  
Seattle 206-624-9020

## International Representatives:

Ontario, Canada 416-742-8015  
Victoria, Australia (03) 729-5115  
Tel Aviv, Israel 53459  
Tokyo, Japan 343-4411

# CELCO makes "Above-Average" YOKES for "Above-Average" CRT Displays

Need a deflected CRT spot as small as 0.00065"?

The CELCO HDQ High-Resolution Deflectron for Satellite Photography Read-out was the choice of one of our customers for their "Above-Average" display requirements.

You can get performance like that with a CELCO YOKE optimized on your CRT for your "Above-Average" display. (measured with a CELCO CRT Spot Analyzer.)

Or YOUR "Above-Average" display may require fast Zero-approach settling time, as required in a Fingerprint Scanning job where CELCO HDN Deflectrons are specified to recover to 0.01% in 25 $\mu$ s.

Precision Linearity on the final film plane or work surface, in Integrated Circuit Mask-Generator Displays enables producers of LSI technology to make low-cost computers for all of us. CELCO Special Deflectrons and Linearity Correctors LC123 are being used by several equipment builders for their "Above-Average" displays.

For PEPR, a system for reading Bubble Chamber photographs, developed by a few individuals at MIT and refined and expanded by others at leading universities throughout the world, CELCO was asked to provide special Low Residual Yokes for their project. CELCO produced their HD Deflectron with special 0.003% residual, and GFJ irrational Focus Coils to help achieve the performance of these "Above-Average" displays. CELCO DAPP2N-7 Amplifiers drive the Dynamic Focus Coil; a CELCO DAPP2N-5 Amplifier was selected by another PEPR group to drive the CELCO B1700 Di-Quadrupole which produced the rotating high-resolution scanning line!

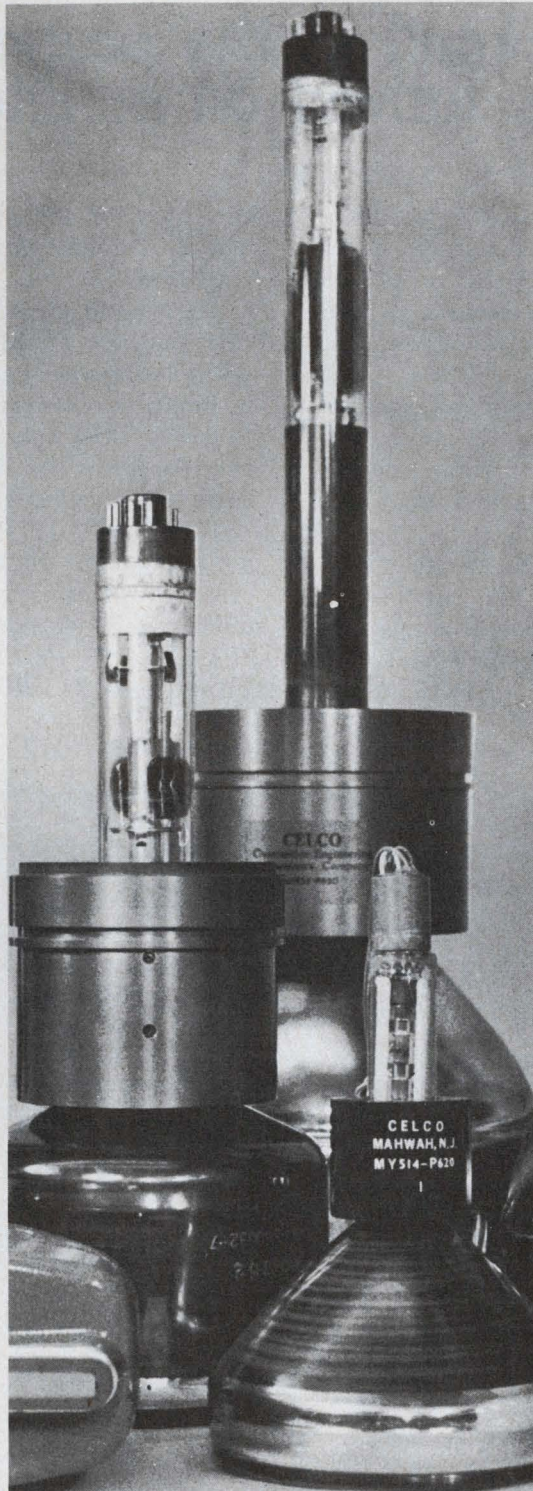

"Above-Average" Recording Storage Tube displays with 1 $\frac{1}{16}$ " neck scan converters and storage tubes need CELCO QY and QD Recording Storage Tube Yokes.

CELCO electronics and magnetics were integrated into a CELCO "DS" Special Display System for Oil Exploration and Data Reduction where "Above-Average" Linearity, Spot Growth, Zero-approach, Bandwidth, and Residual performances were required. Our customer decided to use CELCO's unique display experience to achieve his "Above-Average" display.

CELCO "Above-Average" deflection yokes, focus coils, beam-centering and aligners, astigmatic correctors, and pincushion correctors applied to your specific requirement will help you produce YOUR "Above-Average" Direct-View Display.

REMEMBER CELCO YOKES, whether you want to send a man to the moon, a probe to Jupiter or Mars, investigate chromosomes or trophoblast for cancer research, or build a large format scanner to generate type-setting masters, X-Ray enhancement, or data digitization.

- CELCO CRT Mounts, coil positioners, holders and magnetic shields will enable you to get everything together to achieve your "Above-Average" display.
- Write for CELCO YOKE BROCHURE and your FREE CELCO CRT Display Computer Slide Rule to compute the CELCO YOKE you need for your "Above-Average" CRT Display.

UPLAND CA 714-982-0215  
MAHWAH NJ 201-327-1123

(average is so . . . ho-hum to us.)

"Above-Average" YOKES for "Above-Average" CRT Displays.

CONSTANTINE ENGINEERING LABORATORIES COMPANY  
1150 E. Eighth Street, Upland, CA 91786

70 Constantine Drive, Mahwah, NJ 07430



INFORMATION RETRIEVAL NUMBER 46

# ideas for design

## Start a logic circuit in the proper mode when power is turned on or interrupted

Fast and clean transitions for starting a digital system in a desired mode can be generated automatically whenever a circuit is turned on or the power is interrupted. The two circuits in the figure can be used with any supply voltage,  $V_{cc}$ , from 4.5 to 18 V.

The location of capacitor C determines whether a positive or negative output pulse is generated. The diode ensures that even a momentary power loss will cause a pulse to be generated when the power comes on again.

With the capacitor connected to ground as in (a), a positive output pulse is generated with period  $T = 1.1 RC$ . When the power comes on, the capacitor holds the trigger input level LOW, and the output immediately goes HIGH. When

the capacitor charges to the 555's upper threshold, its internal flip-flop resets and the output goes LOW.

The second circuit (b) operates similarly, except that the capacitor is returned to  $V_{cc}$ . Now when the power is turned on, the upper threshold is immediately exceeded, and causes the output to reset LOW. As soon as the capacitor discharges below the 555's lower threshold level, the timer output goes HIGH after  $T = 1.1 RC$ .

The diode, a 1N4148, across resistor R assures quick capacitor discharge whenever there is a loss of power. If quick retriggering is not needed, the diode can be eliminated.

*Michael O. Paiva, McIntosh Laboratory Inc., 2 Chambers St., Binghamton, N.Y. 13903.*

CIRCLE No. 311

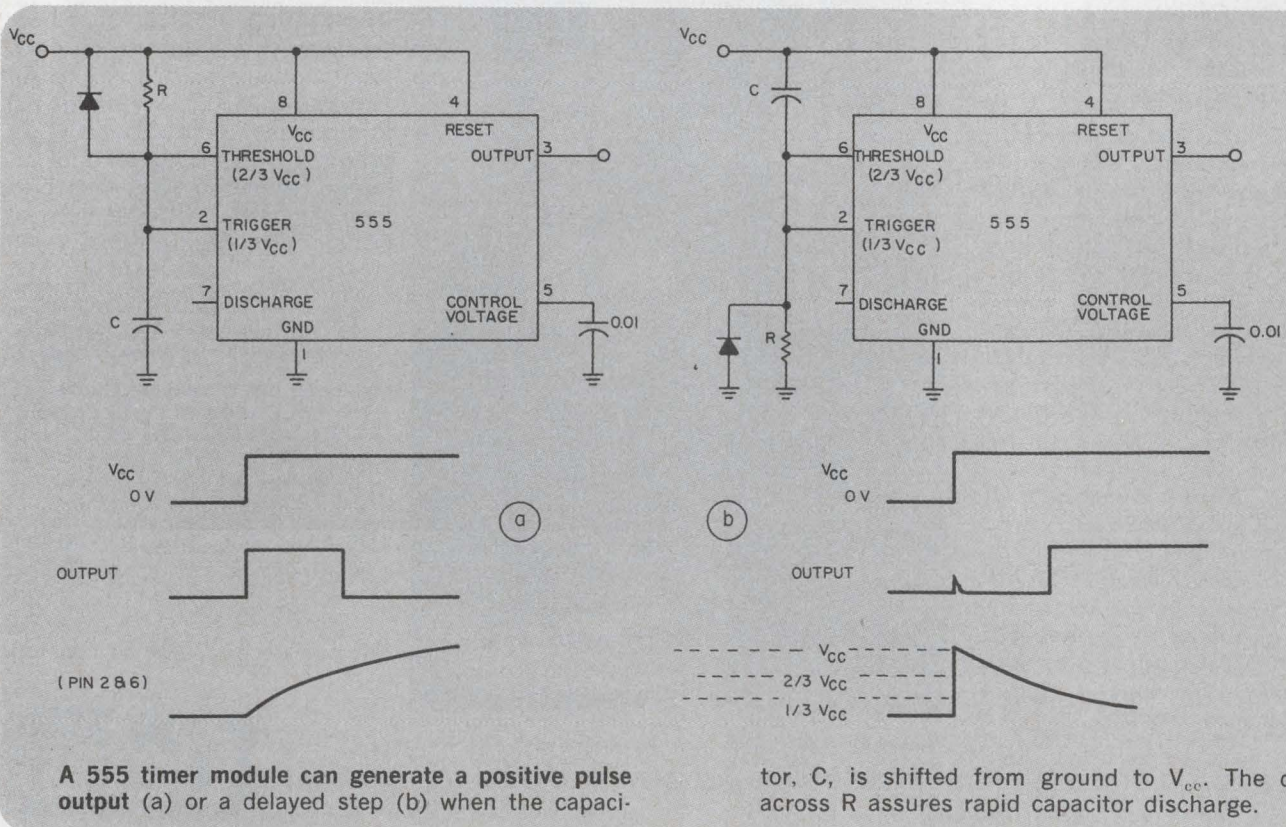



If you need  
**top-quality**  
**panel**  
**instruments**  
 with a clean,  
 modern look...

Buy  
**Triplett's**  
**Series GL**  
 or **GL/B**

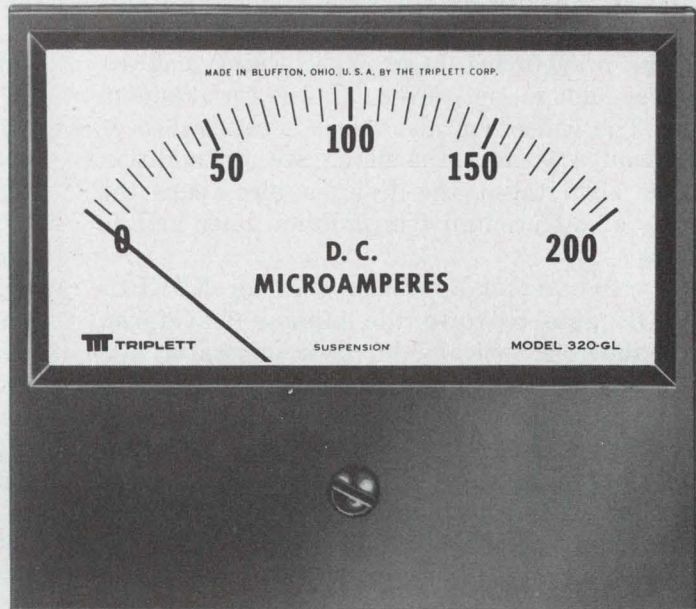

GL

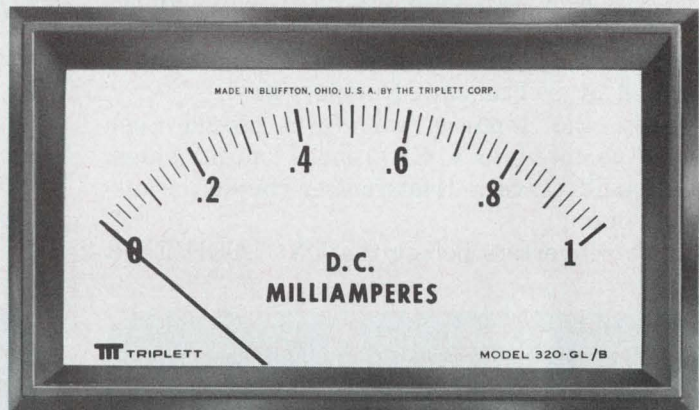

GL/B (mounted appearance)

Triplett's newest panel instruments, the Series GL and GL/B, feature glass windows, matte-finish phenolic cases and a dial design that can readily accommodate multiple scales. They are available in 3½", 4½" and 5½" sizes.

The GL Series features a standard 2-stud mount with 3- and 4-stud mounts available.

The feature of the GL/B Series is behind-the-panel mounting with a bezel which is an integral part of the case.

There's a choice of more than 275 stock sizes and ranges — in DC microammeters, milliammeters, ammeters, millivoltmeters and voltmeters; AC milliammeters, ammeters, and voltmeters; RF thermoammeters; dB meters and VU meters. For those who need special instruments . . . custom dials, pointers, scales, accuracy, tracking, resistance, response time or practically any combination of unusual specs can be put into these new cases. For quick, dependable delivery

of small quantities of these adaptable new instruments, contact your Triplett Sales/Service/Modification Center or distributor. For prototypes or production quantities, contact your Triplett representative. Triplett Corporation, Bluffton, Ohio 45817.

**TRIPLETT**  
 BLUFFTON, OHIO 45817  
 Manufacturers of the World's  
 most complete line of V-O-M's

INFORMATION RETRIEVAL NUMBER 47

# Biphase waveforms generated by shift-register circuits

Biphase waveforms for data communications can be generated easily by shift-register circuits. And the waveforms have self-clocking characteristics and a net-zero-dc level for random words. The waveform also needs a bandwidth of only about 1.5 times the data rate. In addition to these advantages, the designer also reaps the benefits of differential transmission lines and ac coupling.

One conventional approach uses an EXCLUSIVE-OR gate to form the biphase waveform. Fig. 1 shows a typical 8-bit code generator and its timing relationships. The EXCLUSIVE-OR gate inverts the clock signal for shift-register ONE outputs, and allows the passage of uninverted clock signals for ZERO outputs. Thus every time a bit of data changes from ZERO to ONE or vice versa, the output of the EXCLUSIVE-OR reverses phase.

The 8-bit shift register is loaded with the binary information to be transmitted. When the shift clock is active, data are shifted out of the register. The clock and shifted data are combined in the EXCLUSIVE-OR, and the final output is controlled by a Transmit-Enable signal.

Usually the biphase waveform would then become the input to a differential output stage, which would drive a transformer-coupled transmission line.

The two inverters before the EXCLUSIVE-OR

gate are intended to match the propagation delay of the shift register, to provide coincidence of the input wave fronts of the two EXCLUSIVE-ORs. At high clock rates, this alignment, as well as the differences between rise and fall times, becomes critical and the output waveshape is seriously altered by small time differences.

To overcome this high-frequency limitation, a biphase waveform may be constructed by use of a serial register of length  $2N$ , where  $N$  is the number of bits to be transmitted (Fig. 2). Each data bit is loaded into a shift register, both directly, and in the next higher adjacent stage, inverted. Thus the double-speed clocking generates an alternating logic-level signal for each data bit, and the signal's phase relations combine to form the biphase wave.

Since no compensation for propagation delay is required, the performance of this kind of waveform generator is limited only by the speed of the logic devices.

Note that where certain bits are predetermined, as in the sync field, the inverters associated with the adjacent inputs may be eliminated (Fig. 2). The inputs are then wired to ground or  $V_{cc}$  as required. The sync field is low for 1.5 bits and high for 1.5 bits. The data field is 5-bits long.

Jay L. Richman, Bendix Flight Systems Div., Teterboro, N.J. 07608.

CIRCLE No. 312

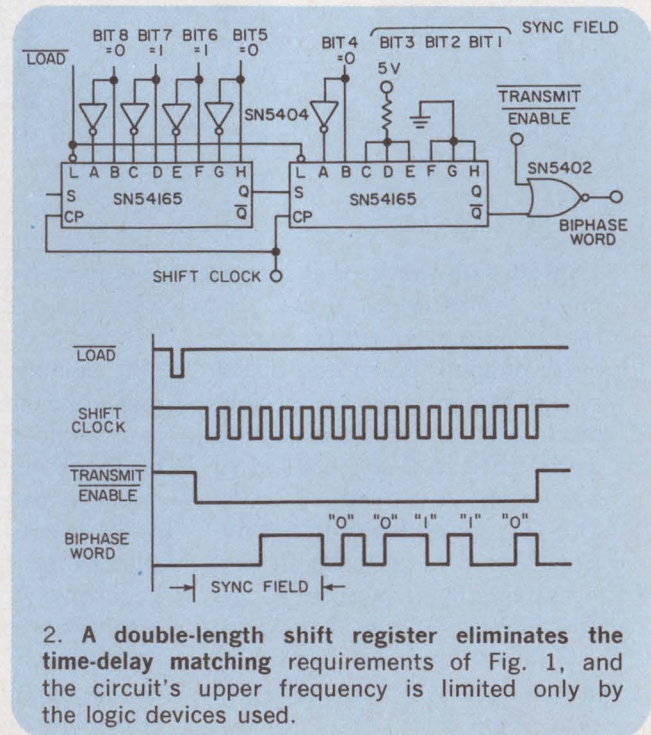
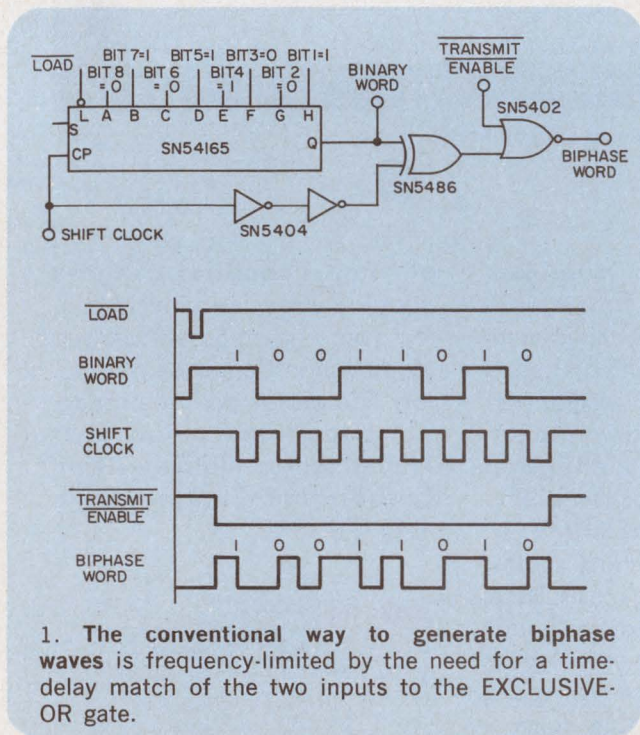



**I've got D.R.\***

**AND YOU CAN GET IT TOO!...  
in connectors with  
dielectric retention from Bendix**

#### **D.R. GIVES YOU**

- rear release crimp contacts—minimizes potential interfacial seal and contact damage during contact removal
- increased dielectric separation between contacts
- greater reliability plus weight savings—fewer components per connector
- hard-faced chamfered socket inserts assuring positive mating pin alignment
- improved temperature-life capability at 200°C
- optimum fuel and fluid resisting capabilities

\***dielectric retention** (re-ten'shun), n: an innovative method of retaining removable contacts in an electrical connector, incorporating a single dielectric wafer rather than individual metal contact retention clips

#### **D.R. CONNECTOR DESIGNS**

- are offered in MIL-C-26482, 38999 and 83723 types
- utilize common application tooling
- intermate and intermount with existing series
- are tooled in over 30 arrangements

#### **GETTING D.R. IS EASY.**

Just contact The Bendix Corporation, Electrical Components Division, Sidney, New York 13838, your nearest Bendix sales office or authorized Bendix distributor.



# Frequency doubler covers wide frequency range for unsymmetric square waves

Electronic systems frequently need a square-wave frequency doubler that covers a wide frequency range and is insensitive to supply voltage or asymmetry of the input signal. The circuit in Fig. 1 has a frequency range from 100 Hz to 4 kHz and can handle both time and voltage asymmetry (Fig. 2).

For a symmetrical wave (Fig. 2a), a high-gain comparator converts the input square wave to bipolar form. Then the signal enters a compensated integrator. The output of the integrator is a triangular wave that intersects the zero-voltage base line a  $T/4$ ,  $3T/4$ , etc., where  $T$  is the period of the input. The triangular wave is fed to a zero-crossing detector, whose output is a square wave with 90-degree phase lag. Then the input and the output of the zero-crossing detector enter an EXCLUSIVE-OR gate to produce the double-frequency output.

Without the feedback amplifier circuit to the integrator input, the voltage difference between the plus and minus power supplies ( $\pm V$ ) or unsymmetrical square-wave inputs could saturate the output of the integrator. Saturation distorts the triangular wave and shifts it either in the negative or positive direction, depending upon whether  $T_1$  is larger or smaller than  $T_2$  (Fig. 2b), or  $V_1$  is larger or smaller than  $V_2$  (Fig. 2c).

The feedback circuit automatically corrects for unsymmetrical supply voltages and input waves.

The output of the zero-crossing detector feeds a low-pass filter to obtain an average of the detector's output signal. This average voltage is amplified and fed back to the noninverting input of the integrator. In this way the integrator is kept from saturation by subtraction of the average value, and the integrator output can be symmetrical.

The values of  $R$  and  $C$  for the integrator are chosen to obtain the desired range of frequencies. For the lowest frequency that the doubler will handle, the peak amplitude of the triangular wave should be somewhat less than the magnitude of each supply voltage. The highest frequency is limited mainly by the offset of the operational amplifiers. The low-pass filter restricts the transient response of the doubler to frequency changes. And the feedback gain is chosen to keep the system stable.

Thus for a supply voltage of  $\pm 10$  V and a desired lowest frequency of 100 Hz, the integrator output must reach a 10-V peak in half the period of the input. Hence

$$RC = 1/2 \cdot \frac{1}{100} = 5 \text{ ms.}$$

If  $R = 10 \text{ k}\Omega$ , then  $C = 0.5 \mu\text{F}$ .

A low-leakage Mylar capacitor is recommended for  $C$ . For the zero-crossing detector to work correctly, the offset should produce less than 1% error. For the AD 108, an input voltage of 0.5 V

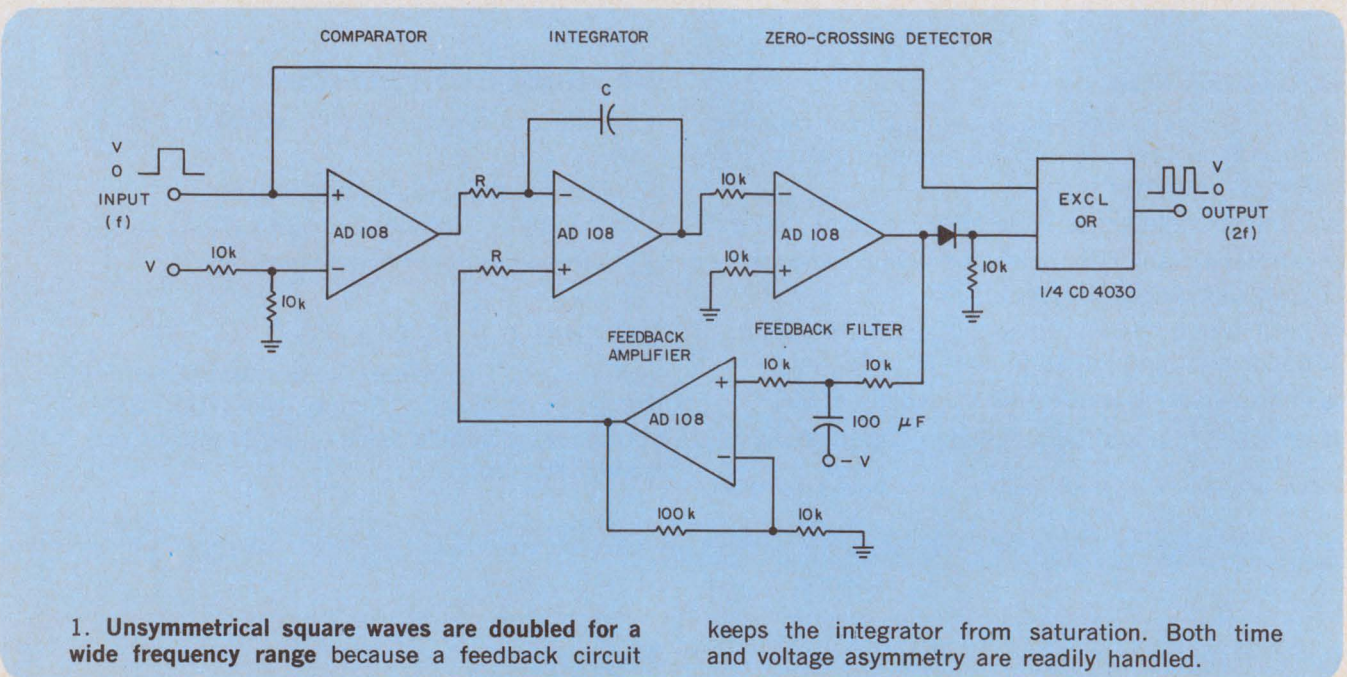

# SIEMENS

## Cost - Effective Solutions to Semiconductor Test Problems



### GENERAL PURPOSE IC TESTER COMPUTEST 716A

Low-cost parametric and functional tester for digital and linear circuits

### DIGITAL CIRCUIT TESTERS COMPUTEST 720 SERIES

Provides complete DC parametric and functional verification of digital IC's

### LINEAR CIRCUIT TESTER COMPUTEST 735

Tests operational amplifiers, regulators, comparators, sense amplifiers and custom linear circuits

### BENCH-TOP MEMORY TESTERS COMPUTEST 901 SERIES

Provides real-time verification of semiconductor memory performance from the device to the complete memory systems level

**FOR APPLICATIONS ASSISTANCE . . .  
CALL US!**

**FREE!**

Send for the Computest catalog of Semiconductor Test Equipment and our Semiconductor Program Library

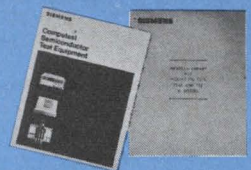

NAME \_\_\_\_\_

COMPANY \_\_\_\_\_

ADDRESS \_\_\_\_\_

CITY \_\_\_\_\_

STATE \_\_\_\_\_ ZIP \_\_\_\_\_

Siemens Corporation  
Electronic Systems Division  
Computest Products

3 Computer Drive, Cherry Hill, N.J. 08002 (609) 424-2400

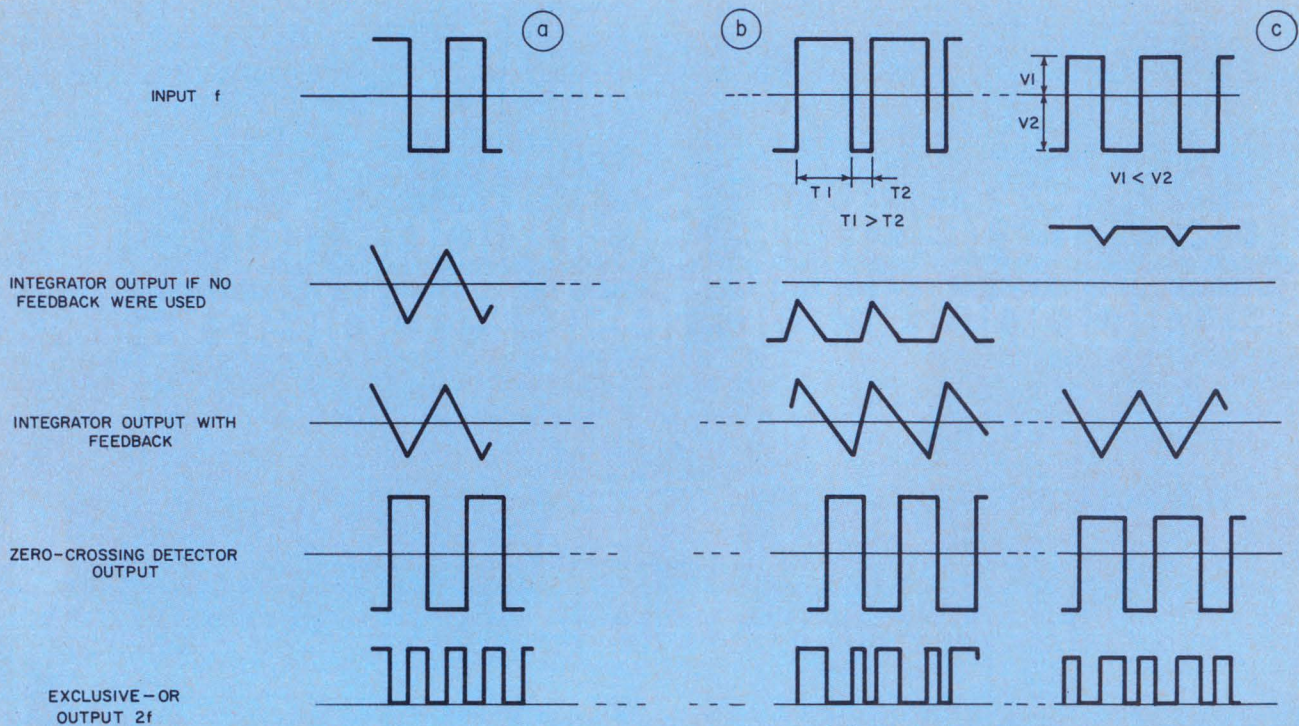

2. Both symmetrical signals (a) or unsymmetrical signals (b) and (c) are readily frequency-doubled.

pk-pk is required to attain this error. Since an integrator's output is inversely proportional to frequency, the offset error has the effect of determining the integrator's highest frequency. Therefore maximum frequency is

$$= \frac{\text{lowest frequency} \times \text{low-frequency pk-pk input}}{\text{minimum pk-pk input (high frequency)}}$$

$$= 100 \times 20/0.5$$

$$= 4 \text{ kHz}$$

A precision comparator like the 710 could pro-

vide a higher maximum frequency because it has a lower specified offset.

The feedback gain is set experimentally for stable operation. In Fig. 1 the gain is about 10, as determined by feedback resistors. The time constant of the feedback filter is about 1 s—more than adequate to filter the lowest frequency.

*T. K. Alex, Electronic Engineer, Indian Scientific Satellite Project, Bangalore, India.*

CIRCLE NO. 313

#### IFD Winner of April 1, 1974

**Robert J. Martin**, Staff Engineer, Martin Marietta Aerospace, P.O. Box 5837, Orlando, Fla. 32805. His idea "Multiple-feedback bandpass circuit allows use of standard capacitors in elliptic filter" has been voted the most valuable of Issue Award.

**Vote for the Best Idea in this issue** by circling the number for your selection on the Information Retrieval Card at the back of this issue.

**SEND US YOUR IDEAS FOR DESIGN.** You may win a grand total of \$1050 (cash)! Here's how. Submit your IFD describing a new or important circuit or design technique, the clever use of a new component or test equipment, packaging tips, cost-saving ideas to our Ideas for Design editor. Ideas can only be considered for publication if they are submitted exclusively to ELECTRONIC DESIGN. You will receive \$20 for each published idea, \$30 more if it is voted best of issue by our readers. The best-of-issue winners become eligible for the Idea of the Year award of \$1000.

ELECTRONIC DESIGN cannot assume responsibility for circuits shown nor represent freedom from patent infringement.

## RF Admittance Bridges 1MHz to 100MHz

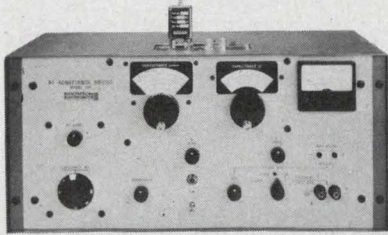

MODEL 33

Boonton Model 33 bridges measure two-terminal capacitance and conductance of high-Q diodes, varactors, and capacitors at 7 crystal-controlled frequencies from 1 to 100MHz, and provide accurate, high resolution balance at the low signal levels necessary for testing solid-state devices. Both internal and external DC bias facilities are standard. Contact: Boonton Electronics, Parsippany, N.J. 07054.

INFORMATION RETRIEVAL NUMBER 121

## Full Programmability is standard on RF Millivoltmeters 10kHz to 1.2GHz

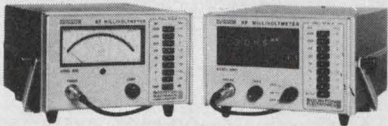

ANALOG 92B      DIGITAL 92BD

Boonton rf millivoltmeters offer state-of-the-art sensitivity, accuracy, and bandwidth with an unrivaled choice of features and options. Analog or digital versions, both with linear dc outputs. Digital version has ancillary analog dBm meter and BCD outputs, optional autoranging and dB display (0.01 dB resolution). Contact: Boonton Electronics, Parsippany, New Jersey 07054.

INFORMATION RETRIEVAL NUMBER 122

## Inductance Bridges measure nanohenries to henries

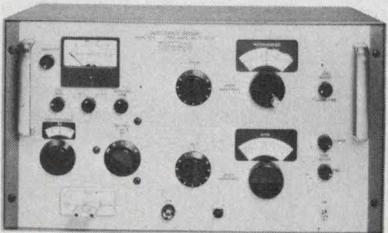

MODEL 63

Boonton Model 63 direct-reading inductance bridges have extremely wide useful ranges for both series L and R. Internal wide-range oscillator provides constant current, independent of balance condition. Three versions span 0.2nH to 11H, 0.4kHz to 500kHz. Contact: Boonton Electronics, Parsippany, N.J. 07054.

INFORMATION RETRIEVAL NUMBER 123

INFORMATION RETRIEVAL NUMBER 124 ▶

# Who said you can't beat the option game when buying a true-rms voltmeter?



## The one with the works

At \$1,200, our Model 93AD gives you the best price *and* the best performance. It's not just priced 20 to 32 percent under competition. It's complete

with *standard* performance and convenience features that the other manufacturer tags on as costly options . . . or can't give you at all.

Take remote programming and BCD outputs. They are a necessity for any kind of test automation. We don't ask you to pay an extra \$450 . . . we've made them standard.

If you're doing low-frequency work, spurious high-frequency signals are always a problem . . . but not with Boonton's selectable bandwidth. On the 100 kHz setting, you get immunity from spurious pickup; on the 20 MHz position, you get *twice* the full-performance bandwidth of the older designs at lower cost.

We've even removed the conflicting advantages of digital and analog readouts. We give you *both* — a 3½ digit LED display for absolute readings, and a special analog dB meter for easy peak/null adjustments . . . as standard.

Our dB option is not only \$100 less than the higher-priced spread but also gives you an ex-

tra digit for a constant  
0.01 dB resolution . . .  
available in your choice  
of 50 Ω, 75 Ω, 600 Ω, or  
1 V references.  
And we have a low-  
cost 10 MΩ, low-capac-  
itance probe for negligible circuit  
loading at high frequencies — not  
available from the competition.  
*What don't we do?*  
Well, our autoranging option  
costs \$25 more than the competi-  
tion and we don't go down to  
2 Hz or up to 100 MHz. But unlike  
some, we don't pretend to  
"cover" a frequency range be-  
yond our capability. Their adver-  
tised 100 MHz bandwidth is use-  
able on only the 0.1 and 1 volt  
ranges. On all other ranges, their  
upper frequency is 10 MHz or  
*less*. The 93AD has a 10 Hz to  
20 MHz bandwidth specified  
down to 300 μV with full cali-  
brated accuracy.  
But see for yourself. Before you  
pay more for less, write or call for  
the full specs or a demonstration:  
Boonton Electronics Corporation,  
Rt. 287 at Smith Road, Parsip-  
pany, New Jer-  
sey 07054;  
(201) 887-5110.

**DON'T  
NEED DIGITAL?  
OUR FULLY-PROGRAMMABLE  
ANALOG MODEL 93A GOES  
FOR A LOW  
\$600.**



# BOONTON

## 16-bit d/a converters don't need thermal matching of critical components

Until recently, few modular 16-bit d/a converters have maintained 0.00075% linearity (1/2 LSB). The design approach used at Hybrid Systems of Burlington, Mass., has achieved this performance, without relying on close thermal matching of resistors and switches. Some additional characteristics include: negligible warm-up time to stated accuracy and fast dynamic response to a digital input. The specifications of

the 16-bit converter are outlined in the table.

Circuit schemes like those shown in Figs. 1a and 1b were considered but both approaches were ruled out. The circuit of Fig. 1a is a conventional voltage switch and an R/2R ladder network. This configuration requires many parts, including 32 switches (usually expensive JFETs) and a precision R/2R network.

The current-switch circuit (Fig. 1b) has pa-

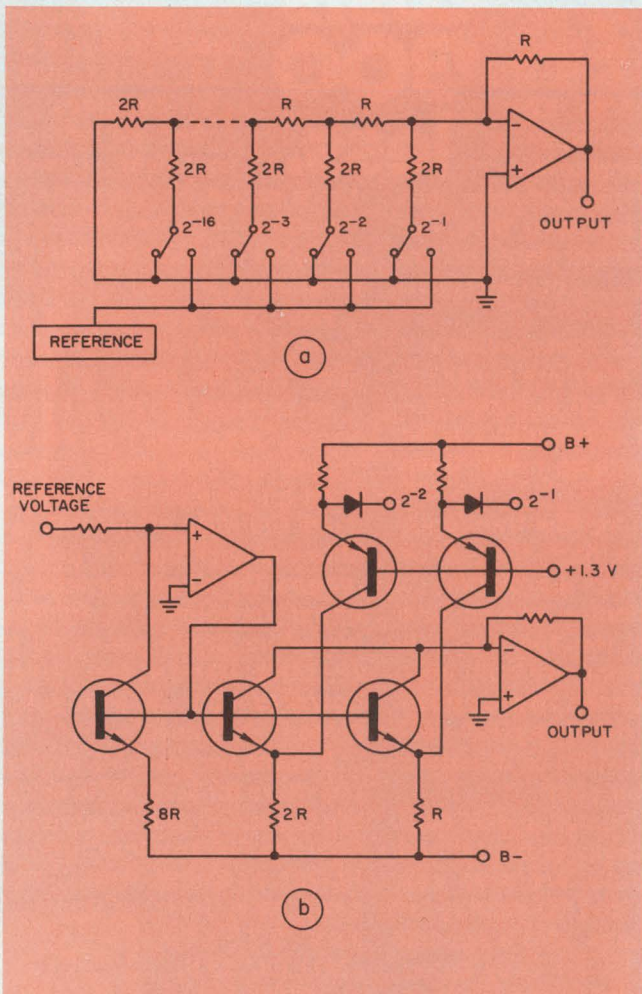

1. A conventional current switching DAC (a) requires a precision R/2R ladder network, while the transistor current switches of a more complex DAC (b) have thermal matching problems.

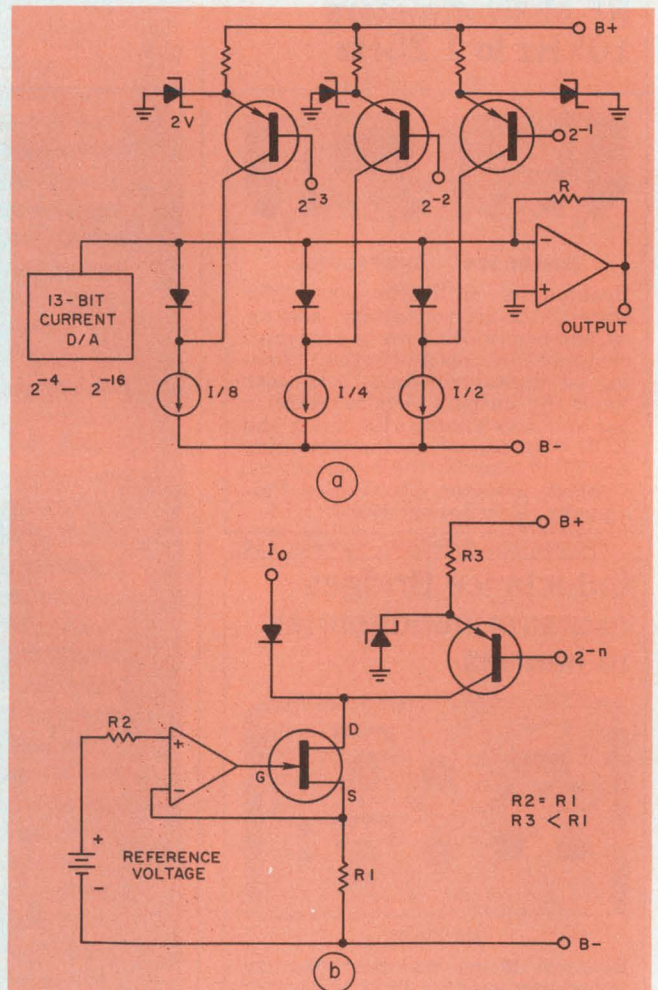

2. If current steering is used for constant-current sources (a) high precision DACs can be built. The reference (b) used by the Hybrid Systems DAC provides a stable current level.



rameters, such as base-to-emitter voltage and beta, that are extremely sensitive to thermal gradients. The critical transistors have fairly high dissipation, and, when the current-source transistor for each bit is switched, thermal gradients are generated that severely affect settling time at the 10- $\mu$ s level.

A simplified circuit configuration that met the design goals is shown in Fig. 2a. The three most-significant bits (MSBs) use constant-current sources, with switching accomplished by steering the current through either a diode or transistor. The 13 least-significant bits (LSBs) are a conventional current-output DAC.

The precision current source and its current steering network is shown in Fig. 2b. The reference voltage for the three MSBs is also used for the 13 LSBs. A low-drift op amp makes the voltage across the precision resistor,  $R_1$ , equal to the reference voltage. The amplifier was selected for low offset current, thereby making the source current of the FET equal to the reference voltage divided by  $R_1$ . Since the gate current of the FET is negligible,  $I_D = I_S$ . The voltage-to-current converter derives its stability from the op amp and  $R_1$ . Thus amplifier power dissipation is low and the FET unloads the amplifier output. Also, the power dissipated in the op amp and  $R_1$  is independent of input logic codes. This, coupled with current steering, keeps

## Selected 16-bit DAC specifications

Integral linearity	1 LSB (1/2 LSB Optional)
Differential linearity	1/2 LSB
Settling time to 0.01% (current output)	3 $\mu$ s
Small signal voltage	10 $\mu$ s
Slew rate	0.3 V/ $\mu$ s
Scale factor vs temp	5 ppm/ $^{\circ}$ C
Linearity vs temp	3 ppm/ $^{\circ}$ C
Offset vs temp (bipolar)	3 ppm/ $^{\circ}$ C
Long-term stability (less internal reference voltage)	10 ppm/yr

the DAC settling time low.

The current-steering switches, composed of diodes and transistors, don't require critical matching, and leakage current can be assumed to be negligible. Each op amp is independent, and thermal coupling is not required. Also, the precision resistors used have a maximum temperature coefficient of 1 ppm/ $^{\circ}$ C and, again, thermal matching is not critical. ■■

## Use Deltrol Controls' series D solenoids where **DEPENDABILITY** is a must

Deltrol Series D solenoids are intended for use in quality applications such as business machines, tape recorders and industrial control equipment and are available in the widest range of sizes in the industry. These linear-type units are available in 12 basic sizes with enough variations available to match almost any application. Deltrol "D" - frame solenoids have a high efficiency factor which provides for a maximum starting force and fast plunger operation. A molded nylon coil, standard on four units, improves heat dissipation while providing greater resistance to moisture, shock and rough handling. Available in a six to 240 volt, AC or DC coil voltage range, these moderately priced units are interchangeable with many competitive units. Options include push-mode units, spring returns and power surge units.

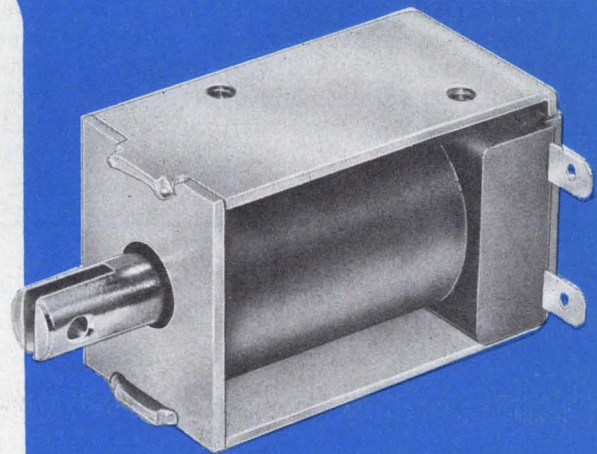

**DELTRON**  
*controls*

Division Of Deltrol Corp.

2745 South 19th Street, Milwaukee, Wisconsin  
53215, Phone (414) 671-6800, Telex 2-6871

1714-1

## Tuning control boosts spectrometer sensitivity

Using a new method to suppress system noise, Dutch researchers have greatly increased the sensitivity of electron-paramagnetic-resonance spectrometers that have a microwave signal source and cavity. An order of magnitude improvement is reported as a result of the work at the University of Delft.

The sensitivity of such an instrument is normally limited by the noise in its microwave generating and detecting systems. FM noise from instability in the microwave source predominates over the other noise at high-incident cavity power. The noise can be reduced over the entire spectrum of the instrument by direct cavity-stabilization techniques, but they are seldom used because cavity tuning is difficult.

In the Delft spectrometer, the stability of the microwave source—a reflex klystron—is improved

by use of an electronic control system for klystron tuning. The open-loop gain of the Delft control system, which is proportional to sensitivity, increases when microwave output decreases, thus increasing the incident cavity power.

When the power is increased, the rise in the open-loop gain is partly compensated for by a decrease in sensitivity. This compensation also increases the gain margin of the control system, which gives a larger open-loop gain and improved tuning stability.

In absorption-measurement tests that used the improved spectrometer, the electron-paramagnetic-resonance signal remained at a constant level, but the noise was suppressed. A sensitivity 10 times better than that of commercial, high-sensitivity E-line spectrometers was measured.

## YIG delay lines studied for mm-wave telephony

Yttrium-iron-garnet (YIG) magneto-static-wave delay lines, controlled by a magnetic bias, promise to solve a major problem in millimeter-wave telephone communications: the equalization of group delay between repeaters.

Currently available group-delay equalizers—such as folded-tape meanderlines, resonant-ring equalizers and bridge-T networks—have delay characteristics that are fixed in manufacturing. But researchers at the University of Edinburgh in Scotland who are developing the new YIG delay lines note that until the waveguide is strung across the terrain, the final

delay requirements are not known. The group delays also vary with frequency.

For example, the British Post Office is experimenting with trunk communication through overmoded circular waveguides with two transmission bands. Band 1 is from 32 to 50 GHz and has channels 500 MHz wide, while Band 2 extends from 52 to 80 GHz with channels 1 GHz wide. The repeater i-f values from Band 1 are 1.25 GHz, and for Band 2, 2.5 GHz.

Over a typical repeater-to-repeater cable length of 14.5 km; group delay variation over the two

bands is intolerable. The solution proposed is to equalize the group delay on the i-f signals before regeneration by use of an equalizer for each repeater channel.

The electronically variable YIG delay lines, which compensate for the various delay differences, are made with the liquid-phase epitaxy process. This process, say the university researchers, grows narrow-resonant line-width films that are compatible with planar microwave-IC technology.

The YIG films are operated in the surface-wave mode, and the delay imposed is generally inversely proportional to the film thickness. Preliminary measurements of temperature sensitivity have revealed no detectable change in the delay-vs-frequency characteristics over the range of 15 to 47 C.

## Monochromator contains holographic grating

A ghost-free monochromator that contains a holographic grating has been developed by Garching Instrumente of West Germany. The dispersive grating is claimed to have a scattered-light content of less than 0.2%. The holographic grating also guarantees a straight optical axis.

Ghosts in the spectra of conventional gratings are caused by mechanical faults in the ruling mechanism. Their elimination is a very costly part of the manufacturing process of ruled gratings.

CIRCLE NO. 319

## Reading machine model for blind demonstrated

The prototype of a reading machine for the blind has been demonstrated by researchers at Stuttgart University in West Germany. The machine works on the optical character-recognition principles used for computer input devices, and converts conventional characters into Braille.

The device will be ready for production within about two years, according to the researchers. The machine will be packaged in the size and weight of a portable typewriter. Reading speed will be about 15 characters/s.

**“When we were evaluating Augat panels, we had to be absolutely sure they would withstand the shock and vibration of a hard-working storage system.**

**“Now we’re sure.”**

Chuck Bates  
Senior Development Engineer  
Clark Equipment Company, Storage Systems

“Clark automated storage systems utilize a computer directed stacker crane. The heart of the system is a Clark-designed electronic logic package, built around Augat plug-in socket panels.

“When we were designing the system, we of course looked for density and design flexibility. And at the same time we found the cost of wire-wrapped panels attractive.

“What concerned us was if the socket panel concept could withstand shock and vibration with a high degree of reliability. Clark storage systems often work 24 hours a day. We found that Augat’s unique machined socket contact stood up very well in test

Testing control box featuring Augat panels.

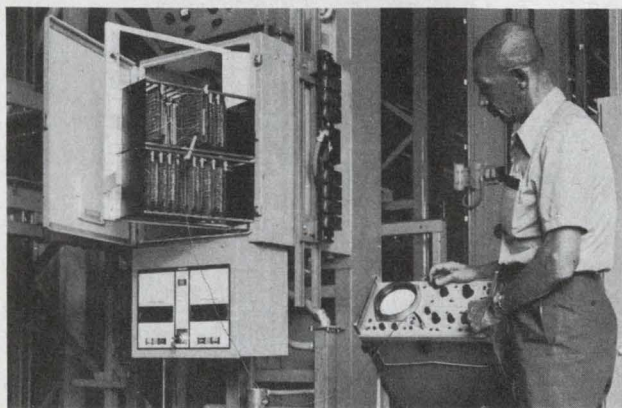

Chuck Bates

and in the field as well.

“Augat gave us an interconnection system which met our requirements from a cost, reliability and design standpoint.”

All of which just might tell you why Augat has become the world’s leading producer of wire-wrapped socket panels and other IC interconnection products. But Augat has more to offer than just hardware. Augat’s technical experience is ready to help you meet your interconnection requirements.

Call or write to us today. We’ll send you our free brochure and complete product information. Augat, Inc., 33 Perry Avenue, Attleboro, Massachusetts 02703. Represented and distributed internationally.

TYPE - 256 x 1 Static SOS/CMOS Ram

NUMBER - INS4200

READ CYCLE TIME - 180 nS

WRITE CYCLE TIME - 140 nS

QUIESCENT POWER DISSIPATION - 40  $\mu$ W @ 10 V

INPUT CAPACITANCE - 6.5 pF

SUPPLY VOLTAGES - 5 to 15 volts

OUTPUT - Three-state TTL compatible, full address  
decoding and bipolar compatible pin-outs.

PACKAGE - 16 pin dual-in-line

PRICE - Mil Range (100-999) \$38.00

Comm. Range (100-999) \$21.00

**256X1  
CMOS  
RAMS**

Only Inselek makes the lowest power, highest speed 256x1 Static SOS/CMOS RAM currently available. And the price is only \$38.00 in the military range and \$21.00 for the commercial version (100-999).

Excellent prices when you consider the added benefits you're getting with our proven SOS technology . . . exceptional reliability, high speed and low power. With an Inselek INS4200

Ram, a minimum number of additional components are required due to the 3 chip select inputs, especially when employed with large memory arrays. For the applications minded engineer or manager, you'll be glad to know that they're perfect for use in point-of-sale systems, mini & micro computers, computer peripherals, calculators & portable electronic systems. One more point. The Inselek INS4200 Ram is fully compatible with other CMOS and TTL devices. Check the specs above and then contact Bob Burlingame, your applications engineering specialist at

Inselek. Bob will be glad to discuss your specific requirements. Call Bob collect at (609) 452-2222, or write him at INSELEK, Inc., 743 Alexander Road, Princeton, New Jersey 08540.

**INSELEK**<sup>TM</sup>

SALES OFFICES IN:  
CONCORD, MASS. (617) 369-5298  
LOS ANGELES, CALIF. (213) 889-2788

DISTRIBUTORS

West Coast - WESTATES (213) 341-4411 • New England - GREEN SHAW (617) 969-8900 • Mid-Atlantic - WILSHIRE ELECTRONICS (609) 786-8990

## new products

# Autoranging 80-MHz counter is industry's least expensive

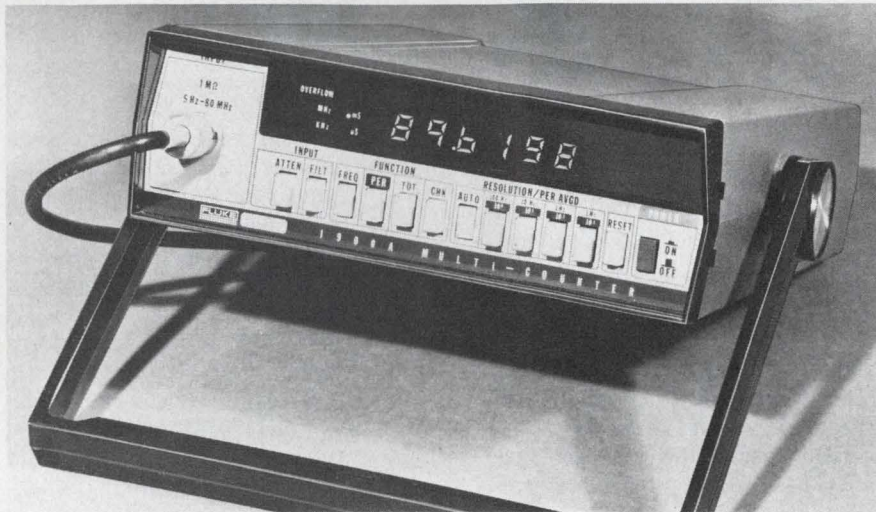

John Fluke Mfg. Co., Box 7428, Seattle, Wash. 98133. (206) 774-2214. \$349.

With a price of \$349, Fluke's 1900A multifunction counter is the least expensive autoranger.

And the price includes a combination of specs and features that will be hard to beat: specs such as an 80-MHz top frequency and 25-mV sensitivity; and features such as self-test, a switchable 1-MHz low-pass filter and a switchable  $\times 10$  attenuator.

But the 1900A doesn't stop there. Also included are leading-zero suppression of the 6-digit LED display and automatic annunciation of both units and overflow. Another feature is a unique autoreset on the pushbutton switches for gate time, function, filter and attenuator. This ensures that, whenever a switch setting is changed, the next displayed reading will be correct.

Besides frequency (from 5 Hz) and period (100-ns resolution), the Fluke unit also totalizes to 999999 and averages multiple periods (to 100-ps resolution). Though the unit autoranges in both frequency and period (but not through all ranges), you can select resolution manually with four pushbutton selected gate

times: 10 ms, 100 ms, 1 and 10 s.

The autorange feature of the 1900A works with a 20% hysteresis. That is, the unit downranges when the display tries to go higher than 999999, and upranges when it drops below 80000. This means your signal can contain up to 20% FM or PM.

Closest competitors of the 1900A appear to be autorangers from Hewlett Packard and Systron Donner—the 5302A and 6250, respectively. But both of these are universal counter-timers—they include A-B time-interval and ratio—whereas the Fluke 1900A doesn't.

HP's 5302A is a member of the company's snap-together 5300 system; so whereas the 50-MHz top frequency and \$670 price of the 5302A don't quite measure up to those of the 1900A, this must be weighed against the added versatility of the HP snap-on system.

Systron-Donner's 50-MHz 6250 also costs more than the Fluke unit—\$575—but the 6250 has 8 digits and an automatic gain control that sets all input adjustments. So, again, tradeoffs must be considered.

Fluke  
Hewlett-Packard  
Systron-Donner

CIRCLE NO. 253

CIRCLE NO. 254

CIRCLE NO. 255

## Small scope fits into modular test line

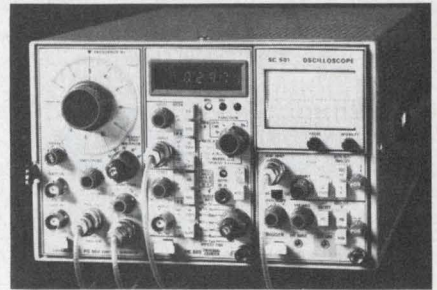

Tektronix, P.O. Box 500, Beaverton, Ore. 97005. (503) 644-0161. \$650.

The SC 501 is the first plug-in scope module for the company's TM 500 Series of multifunction test and measurement instruments. The unit weighs only 2-1/4 lb, has a bandwidth of 5 MHz and a calibrated vertical deflection range from 10 mV/div to 1 V/div, selectable in decade steps. A variable control extends this range to at least 10 V/div. A 2.5-in. CRT display signals at sweep rates from 1 s/div to 200 ns/div. An AUTO triggering mode and manual LEVEL/SLOPE selection is combined in a single control and is useful above 10 Hz.

CIRCLE NO. 256

## DMM needs only 50-pA input current



ITT-Metrix, Edinburg Way, Harlow, Essex, England. Harlow 26811.

MX 719A DMM features automatic range switching, a full three-digit LED display with automatic decimal point, automatic polarity and overrange indication. All ranges are protected and the zero calibration is automatic. Input current is less than 50 pA. Ranges include dc V from  $\pm 1$  mV to  $\pm 999$  V, ac V from 1 mV to 700 V rms, and resistance from 1  $\Omega$  to 15 M $\Omega$  approx. Accuracy is  $\pm 0.3\%$  of the reading  $\pm 1$  digit for dc V.

CIRCLE NO. 257

## Synthesizer offers 0.01-dB resolution



Exact Electronics, Box 160, Hillsboro, Ore. 97123. (503) 648-6661. \$2650.

Model 802 frequency synthesizer offers amplitude leveling and four-digit amplitude control. The unit provides coverage to 20 MHz in four synthesized digits plus two additional vernier digits. With the first four digits, frequency accuracy is  $\pm 0.001\%$ . With the vernier engaged, accuracy is  $\pm 1$  major vernier digit. Output of the 802 has 0.01-dB amplitude resolution from  $-69.99$  to  $+26.99$  dBm, with an output-level accuracy of 0.05 dBm and frequency response of 0.05 dB.

CIRCLE NO. 258

## Data-delay unit replaces endless-tape systems

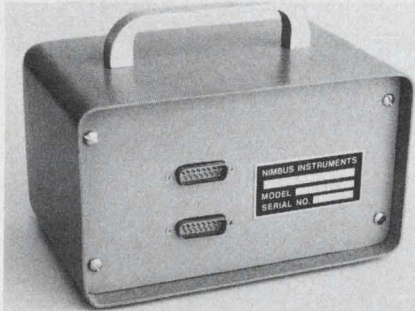

Nimbus Instruments, 2791 Del Monte St., West Sacramento, Calif. 95691. (916) 372-3800. \$650 and up; 6 wks.

DDD-1 digital data delay provides up to several seconds delay of up to eight analog signals. The instrument replaces endless-tape loop systems in the study of non-predictable transient signals. Analog signals are digitized, stored in a shift register, and then converted back to analog form for strip-chart or tape recording. Accuracy is  $1\% \pm 1$  LSB, resolution is 10 bits and sample rate is 250, 500, or 1000 per second.

CIRCLE NO. 259

## Triggered-sweep scope offered for \$425

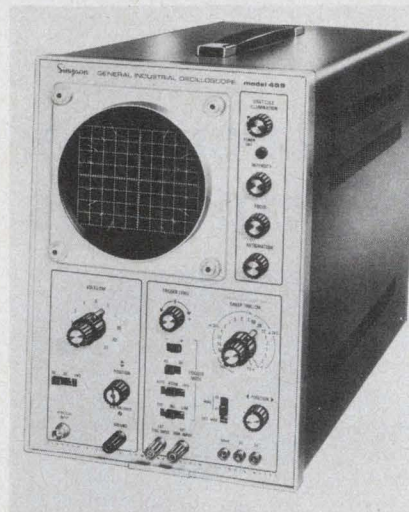

Simpson Electric, 853 Dundee Ave., Elgin, Ill. 60120. (312) 695-1121. \$425; stock.

This solid-state, dc-to-15-MHz scope, Model 459, has a 5-in. CRT, triggered sweep, and 10-mV/cm vertical sensitivity. Vertical sensitivity is continuously variable through 11 calibrated steps to 20 V/cm. Square-wave response gives less than 5% aberrations for a rise time of 25 ns. Input impedance is a constant 1 M $\Omega$ , 35 pF. Sweep speed is adjustable from 0.5 s/cm to 0.2  $\mu$ s/cm in 20 calibrated steps, plus special TV-H and TV-V settings. A 5 $\times$  magnifier extends sweep speed to 40 ns/cm.

CIRCLE NO. 260

## pROM station permits interactive development

Data Test Corp., 2450 Whitman Rd., Concord, Calif. 94518. (415) 326-2000. \$6645; 30 days.

Called the Datatester 8080, this pROM-development station permits interactive program development without auxiliary computer equipment or software. The unit can: simulate the pROM in the scratch-pad internal memory; develop and edit the internal memory contents from the keyboard; write a pROM; read a pROM; and read and write from external sources. Programs may be entered from previously programmed pROMs or ROMs, external sources or by keyboard entry. A personality board configures the inputs, power and clock durations required for particular pROMs.

CIRCLE NO. 261

## Capacitance meter works at 120 Hz

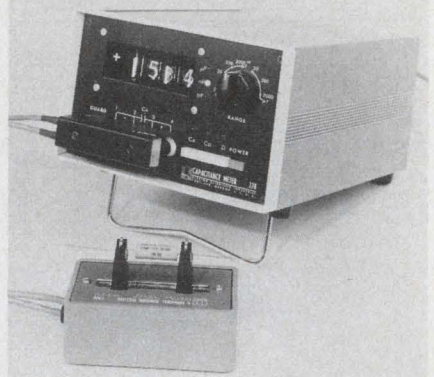

Electro Scientific Industries, 13900 N.W. Science Park Dr., Portland, Ore. 97229. (503) 646-4141. \$1425; stock to 90 days.

This digital capacitance meter, the Model 278, measures with a test voltage whose frequency is twice that of the line, a feature often required for testing tantalum and electrolytic capacitors. Model 278 has seven full-scale ranges, from 2000 pF to 2000  $\mu$ F, and gives 3-1/2-digit readings of  $C_s$ ,  $C_p$  or D with a typical accuracy of 0.1% plus a digit.

CIRCLE NO. 262

## Digital temperature unit linearizes setpoint



LFE Process Control Div., 1601 Trapelo Rd., Waltham, Mass. 02154. (617) 890-2000. \$220 to \$265 (prod. quantity; early fall).

Model 238 temperature controller has a digital setpoint that is electronically linearized to the actual temperature. The measured temperature is displayed on a  $\pm 50^\circ$  deviation indicator. The instrument has 1/4 DIN cutout and bezel dimensions and extends only 6 in. from the front of the panel. The unit is available in single or dual-output models and in bidirectional-output models.

CIRCLE NO. 263

# When RFI problems get sticky, try *stickn* fingers®

**Attaches faster, shields better than anything else!**

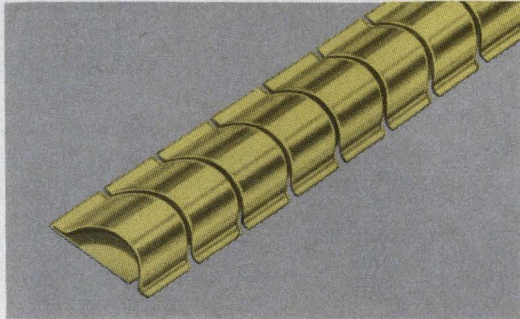

**SERIES 97-500** The original Sticky Fingers with superior shielding effectiveness.

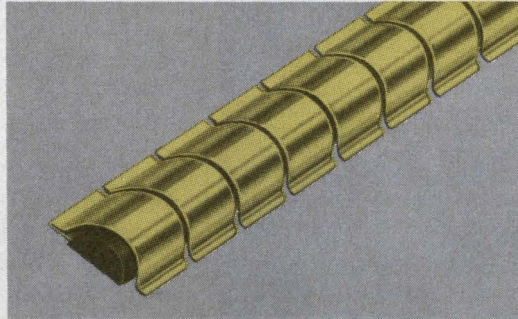

**SERIES 97-510** Provides even better magnetic shielding with Magnefil® insert strips.

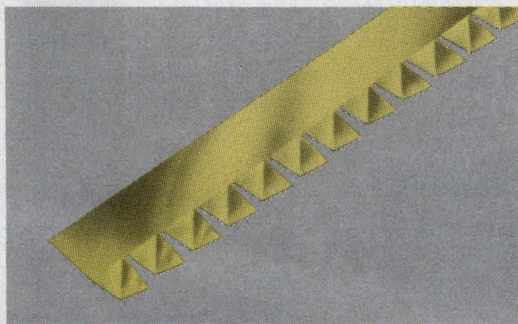

**SERIES 97-555** New Single-Twist Series for use when space is at a premium. Measures a scant  $\frac{3}{8}$ " wide.

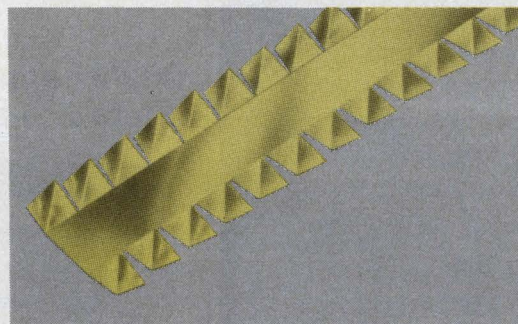

**SERIES 97-560** New  $\frac{1}{2}$ " wide Double-Twist Series, ideal for panel divider bar cabinets.

Now you can specify the exact type beryllium copper gasket that solves just about every RFI/EMI problem. Perfect for quick, simple installation; ideal for retro-fitting. Self-adhesive eliminates need for special tools or fasteners. Write for free samples and catalog.



**INSTRUMENT SPECIALTIES COMPANY**, Dept. ED-65

Little Falls, N.J. 07424

Phone—201-256-3500 • TWX—710-988-5732

# MORE POWER MORE BANDWIDTH

Our Model 503L is an ultra-wideband RF power amplifier whose wide range of frequency coverage and power output provides the user with the ultimate in flexibility and versatility in a laboratory instrument. Easily mated with any signal generator, this completely solid state unit amplifies AM, FM, SSB, TV, pulse and other complex modulations with minimum distortion.

Constant forward power is continuously available regardless of the output load impedance match, making the 503L ideal for driving highly reactive loads.

Unconditional stability and instantaneous failsafe provisions in the unit provide absolute protection from damage due to transients and overloads.

This low cost instrument, covers the frequency range of 1.6 to 540 MHz with a linear power output of 3 watts . . . and there's no tuning. Priced at \$995.\*

#### Applications include:

- Laboratory instrumentation
- Communication systems
- Laser modulation
- RFI/EMI testing
- Spectroscopy

\*USA and Canada



For further information or a demonstration contact

ENI, 3000 Winton Road South,  
Rochester, New York, 14623.  
Call 716-473-6900.  
Or TELEX 97-8283 ENI ROC.

# ENI

The world's leader  
in solid-state power amplifiers.

## INSTRUMENTATION

### Preset counter offers protected settings



Durgin & Browne, 80 Allen Rd.,  
South Burlington, Vt. 05401. (802)  
863-6873. Start at \$139; stock.

GARDIAN 4000 series solid-state counter/controller comes with two to five digits and counts at rates beyond 100 kHz. Front-panel switches, set by means of screw-driver slots, control all important functions. When the preset number is reached, an integral output relay performs a variety of functions. Manual reset, automatic reset for recycling, and adjustable output pulse and reset time delay are all standard.

CIRCLE NO. 264

### Dual-channel scope offers 2% accuracy

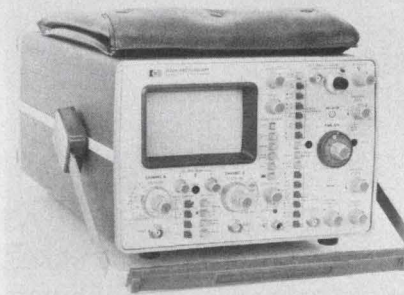

Hewlett-Packard, 1501 Page Mill Rd.,  
Palo Alto, Calif. 94304. (415)  
493-1501. \$3400; stock.

Model 1720A scope offers two channels with deflection factors to 10 mV/cm, sweep speeds to 1 ns/cm and frequency response of 275 MHz. Calibrated sweeps over the full 10-cm deflection are accurate to 3%, and 2% in the 50 ns/cm to 0.5 s/cm range. Vertical attenuator accuracy is 2% at all settings. Input impedance is selectable: 50  $\Omega$  or 1 M $\Omega$ , 11 pF. These performance characteristics are held over the full range of environmental specifications, including temperatures from 0 to 55 C.

CIRCLE NO. 265

### Unit reads and stores peak wave levels



Pioneer-Standard Electronics, 4800 E. 131 St.,  
Cleveland, Ohio 44015.  
(216) 587-3600. \$1190; 30 days.

Model 810 Peaklok voltmeter measures and stores peak voltages from dc to pulses of 1- $\mu$ s duration. It will measure the peaks of pulses, transients and waveforms of irregular or regular frequency and form. Length of storage is infinite. Five decade ranges extend from 100.0 mV fs to 1000 V, with a 3-digit display. Accuracy of the 810 for the digital readout and the recorder output is  $\pm(1\%$  full scale +0.5% input).

CIRCLE NO. 266

### Sweeper covers 200 Hz to 30 MHz in one band

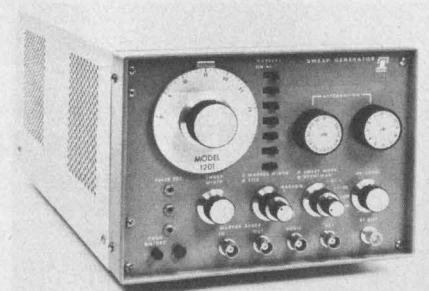

Telonic Altair, 21282 Laguna Canyon Rd.,  
Laguna Beach, Calif. 92652. (714) 494-9401. \$1895; 6 wks.

Model 1201 covers 200 Hz to 30 MHz in a single band. Attenuation of 50- $\Omega$  impedance is 110 dB in 1-dB steps, and 80 dB at 75  $\Omega$ . The unit combines a complete sweep-oscillator system with output attenuators, three variable voltage-referenced pulse markers, and up to seven crystal-controlled birdy markers, single or harmonic.

CIRCLE NO. 267





## If you're into control applications, We'll give you one-million good reasons to spend 19¢.

Here they are. MA47110s, MA47111s and MA47120s. Hermetically sealed glass packaged PIN diodes from Microwave Associates. 19¢ apiece in quantities of 1,000,000.

These rugged, application-oriented diodes are designed for use as switches and current controlled attenuators in constant impedance AGC circuits, such as those found in CATV and other communications systems. But the MA47111 gives you even lower intermodulation products than the MA47110.

The MA47120 is what you're looking for if you work with modulating circuits and matrix switching at frequencies as low as 1 MHz.

And all three of them give you uniformity and

repeatable performance. Even under extreme environmental conditions.

That means they're ideally suited for control applications. Like RF switching, limiting, duplexing, phase shifting, variable attenuation, modulation and pulse forming.

If you have a prototype to test, we'll be glad to send you some free samples. Because we're sure you'll be more than satisfied with what you can get for 19¢.

Microwave Associates, Inc., Northwest Industrial Park, Burlington, Mass. 01803, 617-272-3000; Dunstable Woodside Estate, Dunstable, Beds., United Kingdom, Tel: Dunstable 601441.



**MICROWAVE  
ASSOCIATES**

# NO-NONSENSE NUTS



If you are working with printed circuitry, cabinets, sheet metal, electro-mechanical devices, high frequency vibration, and high reliability calibration areas — and when your specs call for instrument mounting nuts, self-anchoring, captive, or flush mounted lock-nuts, or captive calibration devices — *Abbott Has the Solution — Right Off the Shelf!*

## CLINCH NUTS

Vibration proof, high reliability calibration devices, permitting high torque fastening and locking in thin material such as sheet, aluminum, steel, brass, plastic and PC boards. Available in Nylon insert and Allmetal configurations in steel, stainless steel, brass, aluminum and monel. Sizes include standard and miniature configurations.

## SPLINE NUTS

Same outstanding capabilities as our Clinch Nuts, but in larger diameters with higher clamp and torque factors. Available in low carbon and high strength alloys.

## MINIATURE HEX NUTS

Ideal for critical fail-safe applications in military and avionics work. Type 1660 is available in Allmetal and Nylon insert locking configurations, in vibration proof sizes from 0-80 to No. 5 diameters.

SPECIAL CONFIGURATIONS TO ORDER.  
ENGINEERING ASSISTANCE AVAILABLE.  
Call or Write for Engineering Catalog 190/74



**ABBOTT SCREW & MFG. CO.**

Dept. ED, 6525 N. Clark St.  
Chicago, Ill. 60626  
Telephone: (312) 761-8400

## INTEGRATED CIRCUITS

# Quad IC timers squeezed into a 16-pin plastic DIP

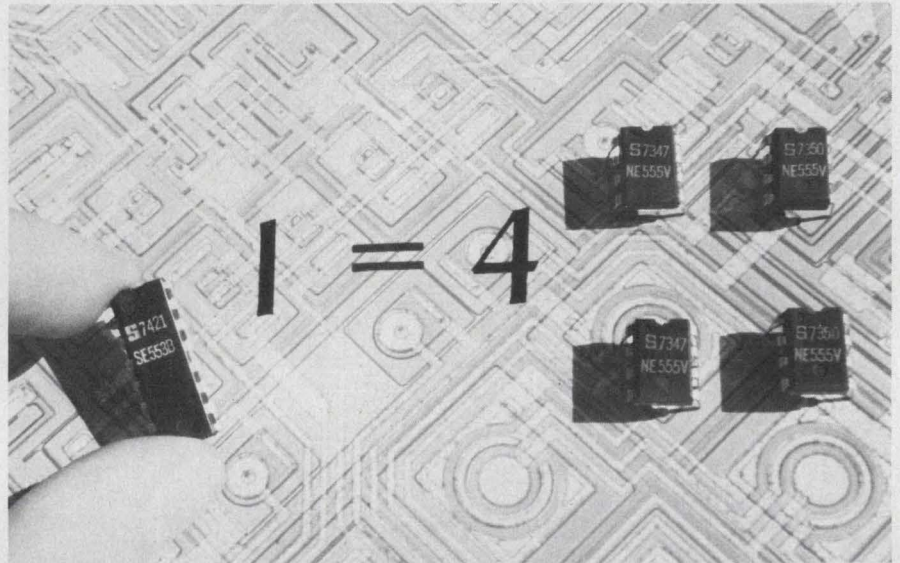

*Signetics, 811 E. Arques Ave., Sunnyvale, Calif. 94048. (408) 739-7700. P&A: See text.*

A single timer in an 8-pin DIP or a dual timer in a 14-pin DIP—sure. But a quad timer in a 16-pin DIP? Signetics has done it. The Models 553 and 554 provide four independent timer functions in a single package.

Compared with the well-known 555 single timer and the 556 dual, some design compromises had to be made. The 553 quad timer can sink 100 mA, while the 554 can source it. By contrast, the 555 and 556 timers do more: They can sink or source 200 mA.

Unlike the 555/556, the 553/554 timers have no reset control line. They are triggered on the negative edge of the control signal and are not level-sensitive. This level independence is extremely useful for sequential tandem timing applications, and it also eliminates the need for a coupling capacitor, as required by the 555/556.

The timer's supply voltage can vary from 4.5 to 16 V, with a maximum supply current of 25 mA for all four timers. The trigger current is 1  $\mu$ A, while the threshold is 0.25  $\mu$ A. At any input voltage, the timing accuracy stays

within 3% of the set value. And the timing drift is about 1%/V.

For many applications, the quad's disadvantages are offset by design innovations. For instance, the timing equations have been simplified from  $T_c = 1.1R_xC_x$  for the 555/556 to  $T_c = R_xC_x$  for the 553/554. This makes it easier to compute component values.

Both timers provide delays ranging from microseconds to hours. In the time-delay mode, one resistor and one capacitor determine the timing. Astable operation requires the use of two timer sections for an oscillator. The frequency and duty cycle of the resulting waveform are controlled by two resistors and one capacitor. This type of oscillator can also be frequency-modulated by a signal voltage applied to the common control-voltage lead.

The control-voltage pin, which is used to control the threshold point (and thus the duty cycle) of a timer circuit, is tied to all the timers in the 553/554. In the 555/556, each timer is independent.

Prices for the 553 or 554 quad timers are identical: \$1.86 for lots of 100. Delivery is from stock.

**INQUIRE DIRECT**

Our new Series-500 Logic-Circuit Testers say so. Loud and clear. They are: fully portable, fully automatic, with both random and programmable patterns, at quantity prices as low as \$5,950!

Correct. The whole bag. In a "suitcase."  
For tens of thousands of dollars less than previous production test systems.

There's more.  
Program compatibility with most other test systems. Superior fault-isolation techniques. Unusually high test rates and dynamic resolution.  
Low cost program preparation.

Questions? Fire away. Need literature? Just write. Trial sales? We have those too.  
It's a whole new way to look at logic circuit testing!

**From  
this moment on  
you will have  
to look at logic  
circuit testing in a  
totally different way.**

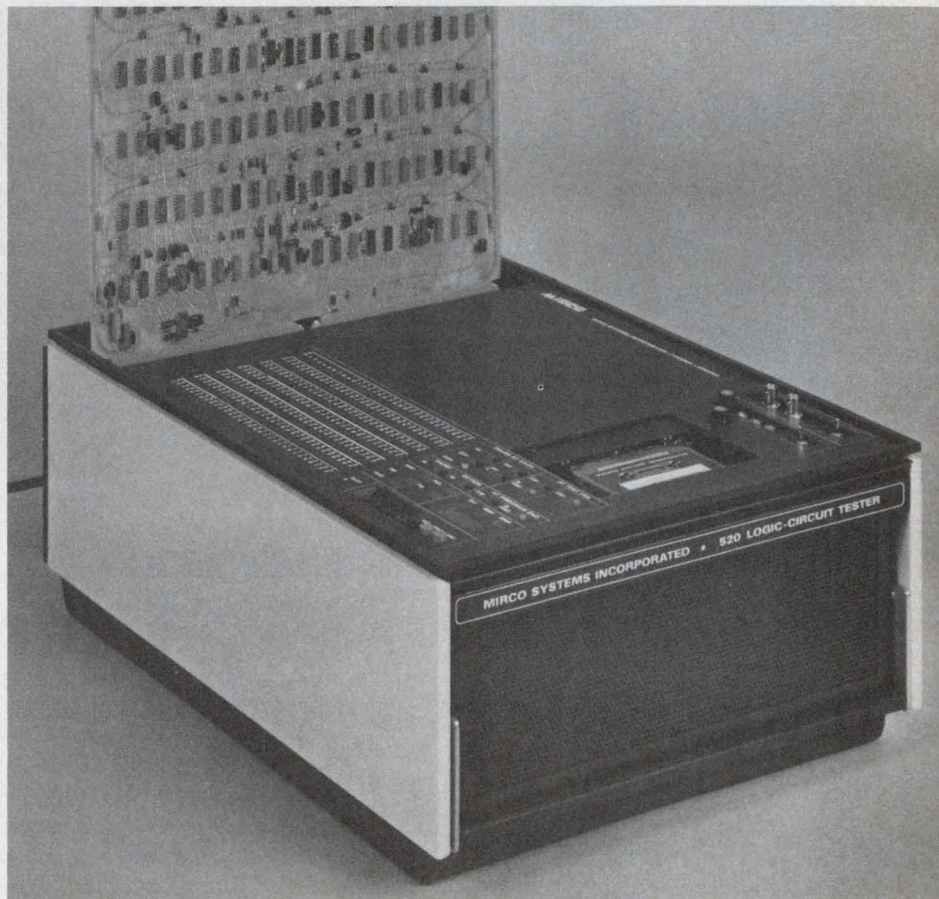

MIRCO 500-Series Portable Full-Capability Logic-Circuit Testers

**MIRCO**

**MIRCO SYSTEMS, INC.**  
2106 W. Peoria, Phoenix, Az. 85029 • Phone (602) 944-4691  
The only name you need to know in circuit testing

# 1% Tolerance SCHAUER 1-Watt ZENERS

AMERICAN MADE

## Immediate Shipment Low Prices

ANY voltage from 2.0 to 16.0

Quantity	Price each
1-99	\$1.07
100-499	.97
500-999	.91
1000-4999	.86
5000 up	.82

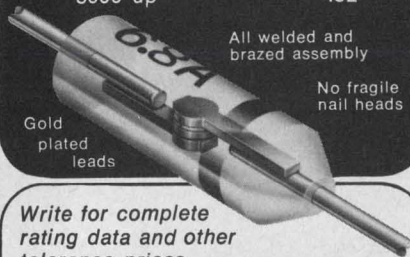

All welded and  
brazed assembly

No fragile  
lead heads

Gold  
plated  
leads

Write for complete  
rating data and other  
tolerance prices.

## Buy the kit- Save a lot



Kit contains a 51-piece assortment of SCHAUER 1% tolerance 1-watt zeners covering the voltage range of 2.7 to 16.0. Three diodes of each voltage packaged in reusable poly bags. Stored in a handy file box. Contact your distributor or order direct.

A \$54.57 value for  
**ONLY \$24<sup>50</sup>**

Semiconductor Division  
**SCHAUER**  
Manufacturing Corp.

4511 Alpine Ave. Cincinnati, Ohio 45242  
Telephone: 513/791-3030

## INTEGRATED CIRCUITS

### 3-digit CMOS IC counts to 999

Motorola, P.O. Box 20924, Phoenix, Ariz. 85036. (602) 244-3466. \$9.12 up (100-999); stock.

Counts up to 999 can be obtained with the MC14533, a three-digit decade CMOS counter. The new IC also provides an overflow for cascading devices and its TTL-compatible outputs transmit multiplexed BCD data. The circuit has a maximum clock frequency of 5 MHz, and it comes in a 16-pin ceramic DIP. Digit-select outputs provide display control.

CIRCLE NO. 268

### IC contains phone dialer

General Instrument Corp., Microelectronics, 600 W. John St., Hicksville, N.Y. 11802. (516) 733-3000. \$15 (100).

The AY-5-9100 MOS/LSI circuit provides all of the logic required for a low-cost pushbutton dialer. The IC converts a push-button switch closure to a series of pulses compatible with dial-telephone systems. Dialing rate, mark-to-space ratio, and interdigital pause are all pin-programmable to allow universal usage. In addition, it has the capability of remembering the last number dialed, allowing automatic re-dial of up to 20 digits. Dynamic circuitry reduces power requirements to less than 2 mW. The circuits come in an 18-lead package.

CIRCLE NO. 269

### 4-bit shifter IC makes debut

Advanced Micro Devices Inc., 901 Thompson Pl., Sunnyvale, Calif. 94086. (408) 732-2400. \$6.90 up (100 up).

The Am 25S10 4-bit shifter—reportedly a first for monolithic ICs—can shift data up to four places, either up or down. Built with Schottky-TTL techniques, the IC operates with a typical data propagation delay of 6.5 ns, and it features three-state outputs. As a high-speed combinatorial logic block, the Am 25S10 is the equivalent of four 4-input multiplexers.

CIRCLE NO. 270

### 1-k RAMs improve 1103 specs

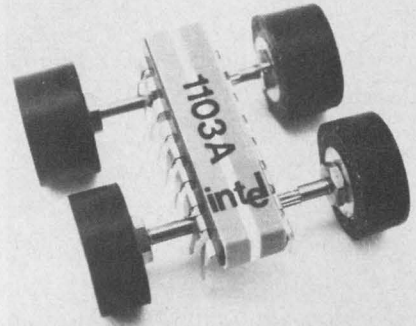

Intel Corp., 3065 Bowers Ave., Santa Clara, Calif. 95057. (408) 246-7501. \$7.80 to \$11.50 (100-999).

Improved versions of the company's 1103 memory, a 1024-bit PMOS dynamic RAM, come in three speed ratings. Unlike the original 1103, the new RAMs feature single-clock operation. They also operate with faster access times and dissipate less power than the 1103. Access times for the new RAMs range from 205 ns (1103A) to 145 ns (1103A-1 and 1103-2); cycle times are, respectively, 580 ns and 340 to 400 ns. The RAMs have a typical standby power of 2  $\mu$ W per bit. The 1103A version costs the same as the basic 1103 model.

CIRCLE NO. 271

### Quad op amp limits total drain to 0.8 mA

Silicon General, Inc., 2712 McGaw Ave., Irvine, Calif. 92705. (714) 556-1600. \$2.50 up (100); stock.

Four independent high-gain, internally compensated op amps are available in a single DIP. Called the SG124 Series, the new quad op amp operates from either a single supply of 3 to 30 V or from dual supplies of  $\pm 1.5$  to  $\pm 15$  V. The input common-mode voltage range includes ground, and the output voltage can also swing to ground, even when operated from a single supply. A low current drain—0.2 mA per amplifier or 0.8 mA per package—is independent of supply voltage. Other specs include a  $V_{10}$  of 2 mV,  $I_B$  of 45 nA and  $I_{10}$  of  $\pm 3$  nA. Large signal voltage gain is 100 dB. All versions in the series are direct replacements for National Semiconductor's LM124 series of quad op amps.

CIRCLE NO. 272

# A CHECK



## ON 3/4A AND 4A BRIDGE RECTIFIERS

	GENERAL INSTRUMENT	MOTOROLA	VARO	UNITRODE	SEMTECH	DIODES INC.
1—Who has a 4A rated bridge rectifier?.....	<input checked="" type="checkbox"/>	<input checked="" type="checkbox"/>	<input type="checkbox"/>	<input type="checkbox"/>	<input type="checkbox"/>	<input type="checkbox"/>
That does not require heatsinking?.....	<input checked="" type="checkbox"/>	<input type="checkbox"/>	<input type="checkbox"/>	<input type="checkbox"/>	<input type="checkbox"/>	<input type="checkbox"/>
At 85¢* each in 10K quantities?.....	<input checked="" type="checkbox"/>	<input type="checkbox"/>	<input type="checkbox"/>	<input type="checkbox"/>	<input type="checkbox"/>	<input type="checkbox"/>
2—Who has a 3/4A rated bridge rectifier?.....	<input checked="" type="checkbox"/>	<input type="checkbox"/>	<input checked="" type="checkbox"/>	<input type="checkbox"/>	<input type="checkbox"/>	<input type="checkbox"/>
Available in three case styles?.....	<input checked="" type="checkbox"/>	<input type="checkbox"/>	<input type="checkbox"/>	<input type="checkbox"/>	<input type="checkbox"/>	<input type="checkbox"/>
All at 20¢* each in 10K quantities?.....	<input checked="" type="checkbox"/>	<input type="checkbox"/>	<input type="checkbox"/>	<input type="checkbox"/>	<input type="checkbox"/>	<input type="checkbox"/>
3—Who has a bridge rectifier that can replace 4 rectifiers at no additional cost? .....	<input checked="" type="checkbox"/>	<input type="checkbox"/>	<input checked="" type="checkbox"/>	<input type="checkbox"/>	<input type="checkbox"/>	<input type="checkbox"/>
4—Which is the first and only company using flame-retarding materials (classified 94V-0) in the construction of its rectifiers and bridge rectifiers? .....	<input checked="" type="checkbox"/>	<input type="checkbox"/>	<input type="checkbox"/>	<input type="checkbox"/>	<input type="checkbox"/>	<input type="checkbox"/>
5—Which company should be checked for the lowest priced bridges, anywhere? .....	<input checked="" type="checkbox"/>	<input type="checkbox"/>	<input type="checkbox"/>	<input type="checkbox"/>	<input type="checkbox"/>	<input type="checkbox"/>

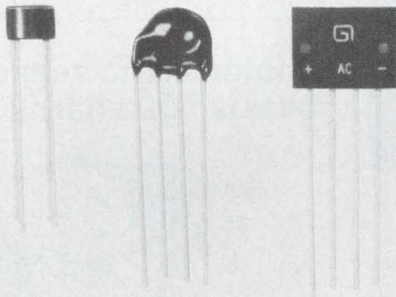

75WOM 75A 20¢\* 75KBD 75A 20¢\* 75KBP 75A 20¢\*  
 WOM 1.5A 25¢\* KBD 1.5A 25¢\* KBP 1.5A 25¢\*  
 KBL 4.0A 85¢\*

\*PRV @ 400V or lower, 10,000 units scheduled within 60 days.

# GI'S GOT IT!

For complete information on GI's bridge rectifiers, call toll-free 800-645-1247 (In New York State call 516-733-3235) or write, General Instrument Corporation, Semiconductor Components Division, 600 W. John St., Hicksville, N.Y. 11802.

**GENERAL INSTRUMENT CORPORATION  
 SEMICONDUCTOR COMPONENTS**



## 5-MHz bandwidth attained with CRT deflection system

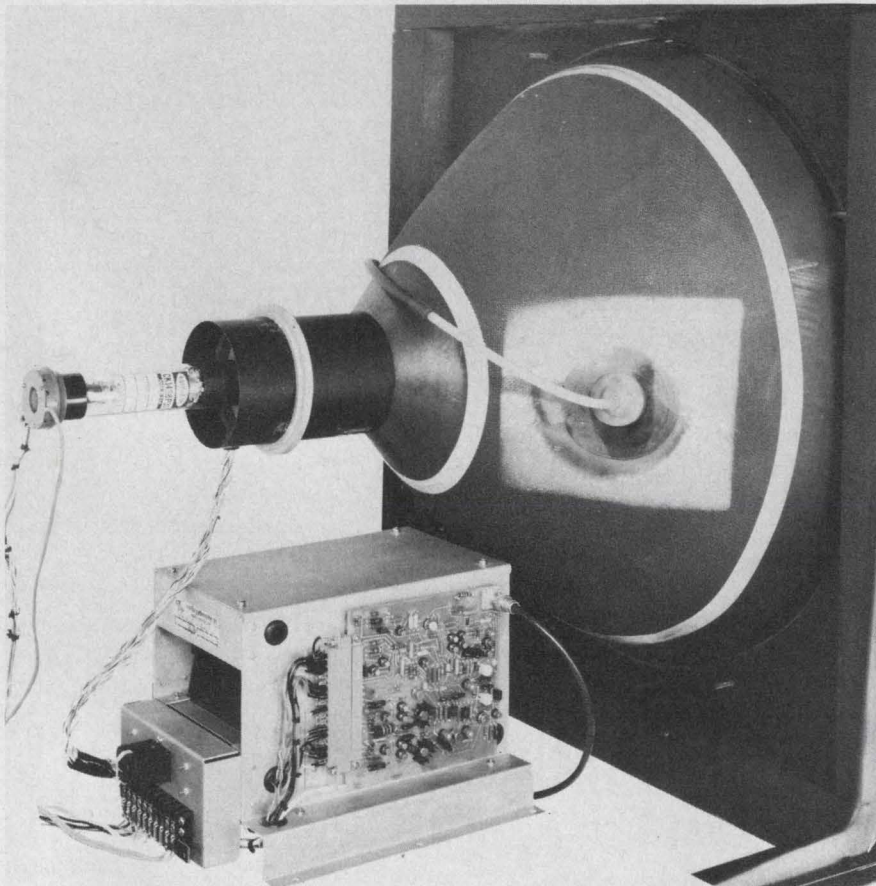

Display Components, Inc., Box 488, Littleton Common, Mass. 01460. (617) 486-3594. See text; stock to 4 wks.

To get lots of clear, detailed graphic material in a hurry, try the DA5000 amplifier/deflection coil combination made by Display Components, Inc.

Deflection is accomplished with a single 36- $\mu$ H coil. The system achieves its large 5-MHz bandwidth without large chunks of power—relatively small deflection currents are needed. The required input power is only 240 W per axis.

When the unit is used with a 22-in., 52° CRT at 20 kV, it affords 1% flatness from dc to 1 MHz with smooth rolloff to -3 dB at 5 MHz. You also get a full diameter jump-and-settle time of 16  $\mu$ s to 0.025%. And a spot size of 10 mils ensures that even the smallest details will

be rendered. In fact, resolution is the primary reason for use of magnetic systems. By contrast, most electrostatic systems have the speed but provide much lower resolution—about 25 to 30 mils.

The DA5000 accomplishes all the deflection requirements for a one major-axis system. Both high frequency, small-signal inputs—such as characters and symbols—are entered at the same amplifier input as are the large signals that define position, vectors, rasters and the like. There is no need to increase the amplifier voltage to slew the spot.

A similar deflection amplifier, the RDA-1260, is offered by Celco (70 Constantine Dr., Mahwah, N.J. 07430). When this amplifier is used with a 25- $\mu$ H yoke, you'll get the same 16- $\mu$ s slew as the DA5000 gives, but the small-signal band-

width only is 1.4 MHz. And power consumption—360 W per axis—is not as low.

The Display Components DA5000 also includes the following features: linearity of 0.25% of full diameter and a boost option that adds 945-line TV capability and reduces the full-diameter flyback time to 6  $\mu$ s with just a 10% increase in power.

The unit provides rated performance from 0 to 50 C. Signal amplitudes of  $\pm 4$  to  $\pm 7$  V give full-radius deflection. The maximum signal termination is 500  $\Omega$ , and the termination resistance is set to the customer's requirement.

The single-unit price of \$5000 includes the deflection yoke and focus coil. The unit price drops to \$4800 in lots of five.

Display Components **CIRCLE NO. 250**  
Celco **CIRCLE NO. 251**

## Photoelectric reader boasts 500-char/s rate

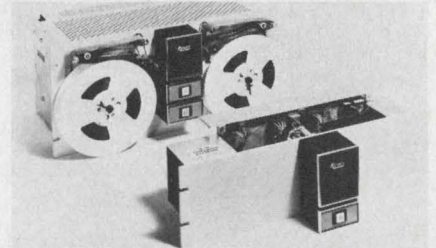

Remex, 1733 Alton St., Santa Ana, Calif. 92705. (714) 557-6860. See text; 90 days.

The Model RR 6500 photoelectric reader offers bidirectional operation at 300 char/s asynchronous and 500 char/s synchronous. The unit will read five to eight-level tapes with infrared transmissivities up to 57%. A minimum of moving parts and single PC-board construction are used to simplify maintenance. The RR 6500 costs \$895; the RRS 6500, a reader/spooler combination with 7.5-in. spool, costs \$1695.

**CIRCLE NO. 273**

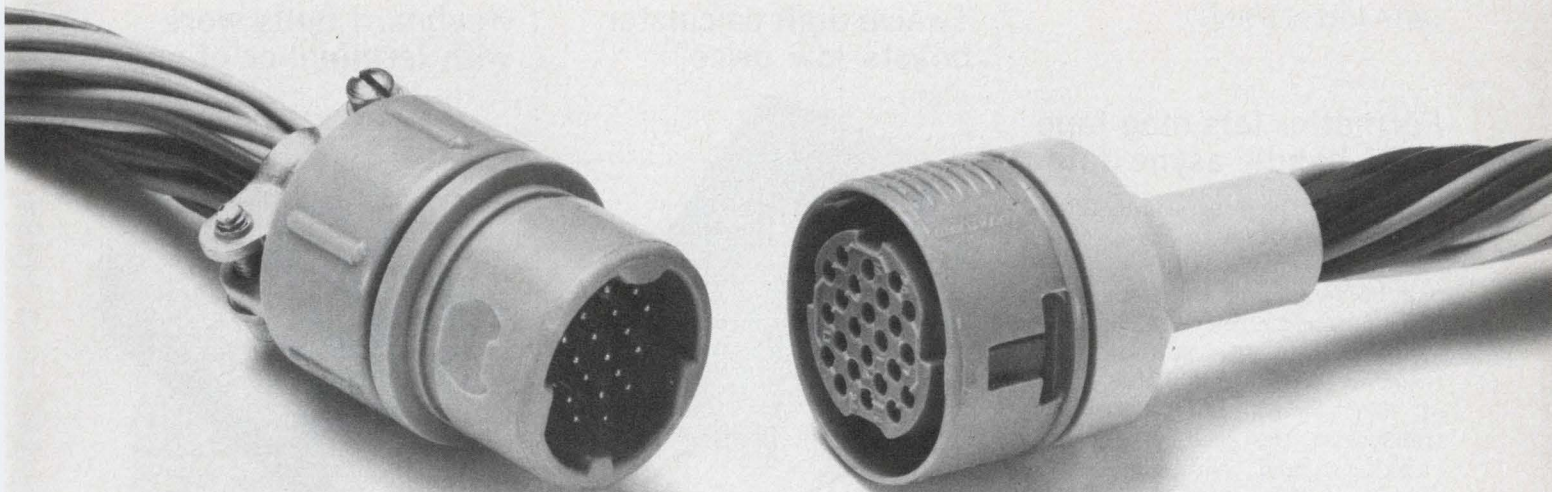

# You may remember these when they were made out of metal, and only a cost-plus contract could afford them.

Our miniature, Thorkom connectors are almost identical to the expensive, can't-possibly-fail version we developed and produced for critical, aerospace needs.

They have positive, vibration-proof locking with squeeze release (we also have a new variable friction release version for special needs). Contacts are gold plated and available in screw machined or die formed versions, and with crimp or solder pot types. Mounting to panels is quick and easy. And tolerances

throughout are just as close and exacting as before.

But there are two major changes:

1. Insulator, coupling ring and connector housing are molded into a single unit from high impact, UL approved polycarbonate, able to withstand 50 G's shock.

2. And the R&D costs are well behind us, so the cost to you is down where you want it.

Send for details. Or, if you're in a hurry, call Customer Service. (213) 341-4330.

**Ok. Send me:**  Details on low-cost Thorkom circular connectors.

My possible application: \_\_\_\_\_

Name \_\_\_\_\_ Title \_\_\_\_\_

Company \_\_\_\_\_ M/S \_\_\_\_\_

Address \_\_\_\_\_

City \_\_\_\_\_ State \_\_\_\_\_ Zip \_\_\_\_\_

 **Viking**  
**CONNECTORS**

Viking Industries, Inc./21001 Nordhoff St./Chatsworth, Calif. 91311

## Formatter lets mag tape units handle async data

*Pertec, 101 Continental Blvd., Suite 435, El Segundo, Calif. 90245. (213) 640-1540.*

A buffered formatter—that features automatic rewrite and reread—provides asynchronous data transfer to and from Pertec's line of synchronous magnetic tape transports. Designed to increase capacity and throughput, the formatter can make single block transfers into and out of the buffer at asynchronous rates of from zero through 1 MHz. Continuous data transfers with no data loss, at rates up to 80 kHz (phase-encoded) or 50 kHz (NRZI), are possible. Applications for the buffered formatter include asynchronous data acquisition, minicomputers, off-line tape oriented systems, and computer output microfilm systems. The buffer uses RAMs which provide storage capacities of 4096 characters or dual 2048 characters.

CIRCLE NO. 274

## Twelve-digit calculator boasts low price



*Sharp Electronics Corp., 10 Keystone Pl., Paramus, N.J. 07652. (201) 265-5600. \$44.95.*

The EL-122 calculator has a capacity of 12 digits. Numbers are displayed in two groups of six digits each on a soft green display. In addition to the four basic arithmetic calculations, the unit performs tax and discount calculations and has zero suppression. The EL-122 operates on three penlight batteries or ac.

CIRCLE NO. 275

## Keyboard units work with terminal or phone



*VMF Industries, 216 N. Fehr Way, Bay Shore, N.Y. 11706. (516) 242-3939. \$300; 2-3 wks.*

The KB-8 Series of numeric pads can be used as an auxiliary keyboard for a wide variety of terminals or will interface directly to a modem. The units can be set to encode in ASCII, EBCDIC or a code chosen by the user. In addition to the 10 digit keys, there are eight user-selectable function keys. Transmit speeds are available from 110 to 1200 baud.

CIRCLE NO. 276

## Introducing the expensive curve tracer that doesn't cost a lot.

The B&K Model 501A.

It hooks up to any scope, old or new. (Like our Model 1460 triggered-sweep scope.)

And it analyzes all semi-conductors including J-FET's, MOS-FET's, signal and power bipolar transistors, SCR's, UJT's and diodes. Fast and easy.

Constant current and voltage steps with 3% accuracy make the Model 501A an exceptional value. In fact, it performs like \$2,000 units. Yet you can afford one on each engineer's bench. And another for incoming quality control.

Call your B&K distributor. Or write Dynascan Corporation.

In stock at your parts distributor.



Product of Dynascan Corporation  
1801 West Belle Plaine Avenue, Chicago, Illinois 60613

**\$163<sup>00</sup>**

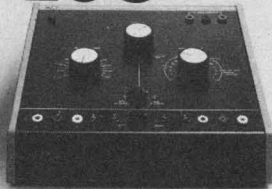

## You'd probably expect a portable oscilloscope as rugged and reliable as this one to cost a lot.

**You'd be wrong.**

Introducing the B&K Model 1403 3" Solid-state oscilloscope. It's so compact, reliable, and inexpensive that it's the perfect scope for most on-the-line monitoring applications. Look at its specs: DC to 2MHz bandwidth at 20mV/cm. Recurrent sweep speeds from 10Hz to 100k Hz. New wide-angle CRT to reduce case depth to a minimum. Direct-deflection terminals for waveforms up to 150 MHz. Weighs only 8½ pounds. And has a smoked acrylic graticule for trace sharpness and easy reading. All the reliability and accuracy you need in a monitor scope—at a surprisingly low price.

Contact your distributor, or write Dynascan Corporation.

**\$189<sup>00</sup>**

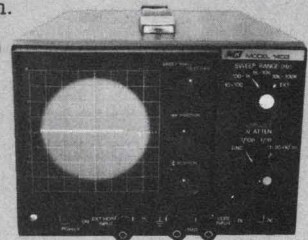

**B&K** Very good equipment at a very good price.

Dynascan Corporation.  
1801 West Belle Plaine Avenue, Chicago, Illinois 60613



# OEM Buyers take note: CONTROL DATA® Storage Module Drives Models 9760 and 9762.



40 and 80  
megabyte  
capacities.  
Removable  
media.

9760—now being  
delivered in  
production  
quantities.

#### Features:

- Offers substantial lower cost per megabyte than current competitive products of equivalent capacity.
- Basic unit consists of a spindle and associated drive motor; voice-coil head positioner and servo systems; read/write, fault, transmitter/receiver electronics; and air filtration system.
- Options available include:
  - 5 power supply options for versatility.
  - phase-lock oscillator data separator and NRZ to MFM data encoder simplify interface design.
  - daisy-chaining for system expandability.
  - rack-mount package.
  - base cabinet for stand-alone configuration.
  - hysteresis brake to reduce pack stop time to 18 sec.
  - variable sector length for flexibility.
- Specifications
  - Capacity - 40 MB - Model 9760/80 MB - Model 9762
  - Average Access Time — 30 MS
  - Bit Transfer Rate — 9.67 MHz @ 3600 RPM
  - (Optional) — 6.45 MHz @ 2400 RPM
  - Tracks per Inch — 192-9760/384-9762
  - Bits per Inch — 6038
  - Number of Disks — 5 (3 recording, 2 protective)
  - Usable Surfaces — 6 (5 read/write, 1 servo)
- Deck and logic chassis hinged for easy access to all components.
- Compact size — 10.5" H x 17.25" W x 30" D.
- Field test exerciser with head alignment feature is available.

40 and 80 MEGABYTE STORAGE MODULE DRIVES . . . add a whole new dimension to meeting medium to large capacity storage needs in a package less than half the size of other drives; use CDC® 9876 or 9877 removable disk packs; pack has 5 disks (3 for data and head positioning, 2 for data protection); rack-mount package or optional base cabinet; daisy-chain interface; average access time 30 ms.; data rate 9.67 MHz (6.45 MHz optional); MODELS 9760 AND 9762 RESPECTIVELY.

Control Data Corporation  
Ray Crowder, OEM Marketing Manager  
Normandale Operations,  
7801 Computer Ave. So.  
Dept. ED-84, Minneapolis, MN 55435

**CONTROL DATA**  
CORPORATION

Name \_\_\_\_\_

Title \_\_\_\_\_

Company \_\_\_\_\_

Address \_\_\_\_\_ Phone \_\_\_\_\_

City \_\_\_\_\_ State \_\_\_\_\_ Zip \_\_\_\_\_

I want to see a demonstration of the Control Data Models 9760 and 9762 Storage Module Drive. Have my Representative call.



flame  
out

Flame retardant, polyester TEMP-R-TAPE M67 passes U/L and ASTM requirements. This outstanding flame retardant safety feature, in combination with the excellent electrical and physical properties of polyester film backing provides you with a self-adhering tape for use in a wide variety of coil winding, coil holding, harness wrapping and other electrical/mechanical applications. It is especially valuable for radio and tv appliances to reduce fire and electrical shock hazards.

Find your nearest distributor in the "Yellow Pages" or in industrial directories. Or write The Connecticut Hard Rubber Company, New Haven, Connecticut 06509.

**CHR**

an ARMCO company

INFORMATION RETRIEVAL NUMBER 66

## DATA PROCESSING

### Computer features 57 Mbyte capacity



*Sperry Univac Corp., P.O. Box 500, Blue Bell, Pa. 19422. (215) 542-4213. See text.*

The 90/30 computer comes with a processor with 32 kbytes of storage, a video display console for operator interaction with the system, a 500-card-per-minute reader, a 500-line-per-minute printer, two 8416 disc drives with 57.8 Mbyte capacity and an optional card punch. Operating under microprogram control, the system's central processor uses 84 basic instructions, expandable to 148. Its semiconductor main storage operates at 600 ns for each two-byte word. The system can be expanded to 262 kbytes of main storage, up to eight 8416 disc drives with over 230 Mbytes storage, a 1000-card-per-minute reader and printers with speeds up to 2000 lpm. A larger capacity disc subsystem—providing up to 1600 Mbytes of disc storage—may be added. Prices for the 90/30 range from \$3750 to \$17,198 per month on a one-year rental plan. First deliveries are scheduled for Jan., 1975.

CIRCLE NO. 277

### Digital tape drive conserves panel space

*Quantex, 200 Terminal Dr., Plainview, N.Y. 11803. (516) 681-8350. Under \$300; see text.*

Digital data are recorded on up to four tracks with 3M data cartridges by the Model 600 tape drive. At 30 in/s, the data transfer rate is 48 kbit/s with a recording density of 1600 bit/in. The unit also has a 90 in/s high-speed search mode. Model 600 requires a 3.125 × 7-in panel space and may be mounted in any plane. Delivery is three to four weeks for evaluation units.

CIRCLE NO. 278

### Optical set transmits 35-MHz signals

*American Laser Systems, 106 James Fowler Rd., Santa Barbara Rd., Goleta, Calif. 93017. (805) 967-0423. Receiver: \$2550; transmitter: \$1800.*

The Model 732 Optical Transmission Set uses infrared light and a silicon avalanche detector to transmit wide bandwidth, fast rise-time analog signals over glass fiber waveguides. And the unit affords more than 8-MV isolation. The set is capable of transmitting 35-MHz signals with rise times of less than 10 ns over 100 ft. of conventional fiber optics with a signal-to-noise ratio of greater than 50 to 1. The transmitter is powered by a 12-V lead antimony battery while the receiver is either line or battery powered. Both units measure only 2.7 × 4.13 × 6.12 in.

CIRCLE NO. 279

### 40-column printer uses dot-matrix scan

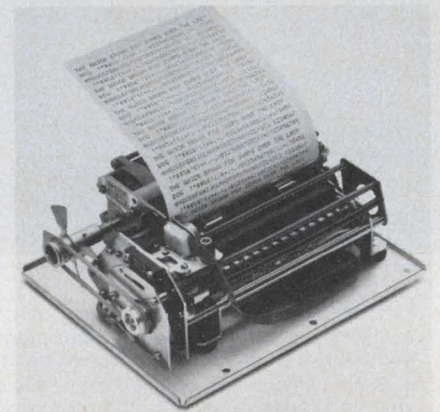

*Elec-Trol, 26477 N. Golden Valley Rd., Saugus, Calif. 91350. (805) 252-8330.*

The Model PR1004 column printer is a compact unit that prints 40 column lines at the rate of 2 lines/s. Electrosensitive paper is used and the scanning head generates dot matrix characters (9 rows by 5 columns). The unit is an ideal companion for 40-column CRT terminals, security systems or instrumentation. And the user can choose to print just about any character defined by the 45-element matrix. The manufacturer provides timing signals, but the user supplies the character-generation circuitry.

CIRCLE NO. 280

# FUJI

## FERRITES

FERRITE CORES, INDUCTORS, TRANSFORMERS, COILS  
.....are key components of electronics.

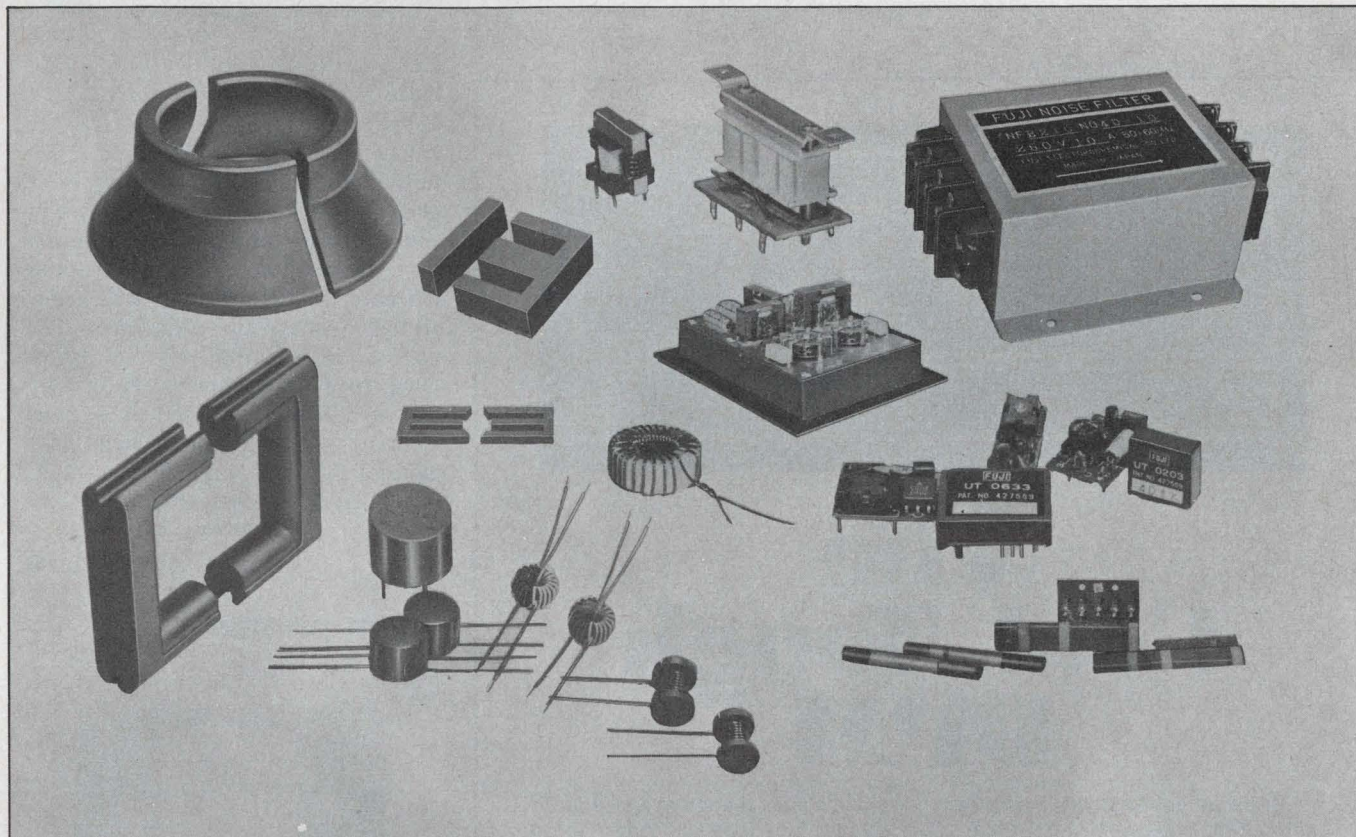

Excellent production techniques, modern facilities, and stringent quality control have made FUJI the world's second largest maker in volume, but the first in quality in the world.

FUJI produces a complete line of electronic components, not only ferrite cores, including deflection yokes, flyback transformers, pin cushion transformers, but also inductors and transformers for consumer electronics.

- A complete line of deflection yoke cores suited for all toroidal, saddle, and other winding shapes is characterized by its high resistance, high permeability, light weight and economical material.
- U-type flyback transformer cores in various dimensions from small to large are manufactured.

Especially H45 material operates stably at high efficiency in high temperature and high magnetic fields.

- Low-loss, low-distortion high fidelity is offered by network assembly of speakers used in audio systems, centering on an L element through our unique magnetic circuit design utilizing our material.
- A complete line of coil assemblies including DC-DC converters, AC-DC inverters, transformers, horizontal output transformers for TV receivers and antenna coils for radios are produced as our speciality.

FUJI also manufactures a wide variety of superior coil assemblies.

Excellent FUJI ferrite material and superior memory assembly design concepts are combined.

## FUJI ELECTROCHEMICAL CO.

Head Office: Hamagomu Bldg., 5-36-11, Shinbashi, Minato-ku, Tokyo, Japan TEL: 434-1271

Overseas Office: New York, TEL: (212) 532-5630  
Los Angeles, TEL: (213) 620-1640  
Düsseldorf, TEL: (211) 89031

TAD. ISHIZUKA  
SAM. YOSHINO  
TAD. KOMURO

INFORMATION RETRIEVAL NUMBER 68

## Floppy-disc system grows to 1-Mbyte

Tri-Data, 800 Maude Ave., Mountain View, Calif. 94040. (415) 969-3700. \$5200; stock.

The standard FlexiFile system includes two disc drives; a built-in controller with formatting electronics and a power supply. Its on-

line capacity is 524,288 bytes in a 16-sector, 64-track format with a data transfer rate of 31 kbytes. The unit accommodates an additional two-disc slave system, which increases the total capacity to one-million bytes. Access time is 10-ms track-to-track. Tri-Data plans to offer interfaces and cabling for most popular minicomputers. Immediately available are interfaces for DEC PDP-11 minicomputers.

CIRCLE NO. 281

## Free-cursor digitizers resolve to 0.001 in.

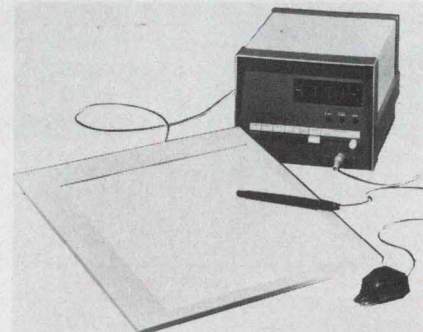

Electrak Corp., Suite 1513, 11200 Lockwood Dr., Silver Spring, Md. 20904. (301) 681-7500. See text.

The Trak 200 digitizers come with tablet sizes up to 3-by-4 ft. and have 0.001-in. resolution. The cursor is free and the unit operates by means of magnetostrictive ranging. A binary or BCD controller formats the coordinate data and permits input of additional data from a keyboard. Interfaces are available for use with most computers or off-line devices such as card punches and tape recorders. The price range, which includes software, is \$5000 to \$15,000.

CIRCLE NO. 282



# The Cool, Tough DPM

Priced under \$150, this new DPM gives you the most readable readout up front, but far fewer guts in back. For good reasons. Exclusive Unislope™ conversion circuitry reduces parts count 30% . . . giving you a cooler, tougher, more reliable DPM. And, because it uses discretes rather than LSI, you still get parallel BCD outputs free.

Unislope™ circuitry using easily serviced discrete components reduces worst case (127V, 50Hz) heat dissipation to about 3 W. (Other DPM's dissipate 7 to 15 W.) Sperry planar gas-discharge display is cooler, too. All circuitry except the display and decoder/driver fits snugly on one pc board. No flying components to shake loose. Three-wire input isolates power from logic to meet proposed international safety standards.

Compare these specs: Common mode rejection of 80 dB (with no filtering) at 50-60 Hz with 1kΩ in series. Accuracy is ±0.1% of reading, ±1 digit. Input resistance is 1000 MΩ for 200 mV and 2 V ranges. However Model 3312 withstands 200 V pk-pk continuously at any range. Includes free BCD drive for 5 TTL loads.

Write for complete data on this new Model 3312 3½-digit DPM.

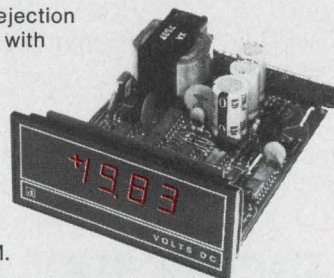

## the new data technology corp.

2700 S. Fairview Road, Santa Ana, Calif. 92704. (714) 546-7160



## Silent printer is easy to load

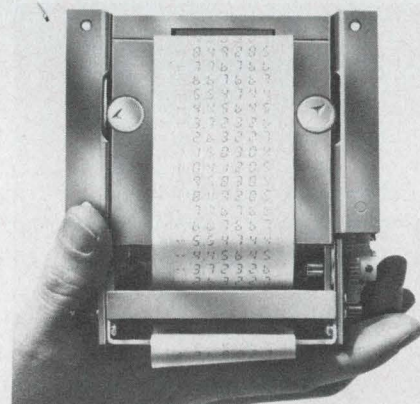

Gulton Industries, Measurement & Control Div., East Greenwich, R.I. 02818. (401) 884-6800.

The GP-606 thermal line printer prints six columns of seven-segment numeric characters at a 3 line/s rate. Important features include small size, floating decimal point, plus/minus sign, quiet operation and the absence of moving printing parts. Chart paper is loaded in seconds by swinging down the chart mechanism and dropping in a new roll.

CIRCLE NO. 283

# Frame them any old way

## Or any new way.

Then sit back and watch your Ise display electronics get your ideas across. Beautifully.

In an eye-easy fluorescent green glow.

At the same time, they're low on voltage and current drain.

High on stability.

Pick the readouts that offer more of everything, including variety, for a whole host of digital display ideas.

They're a difference you can see.

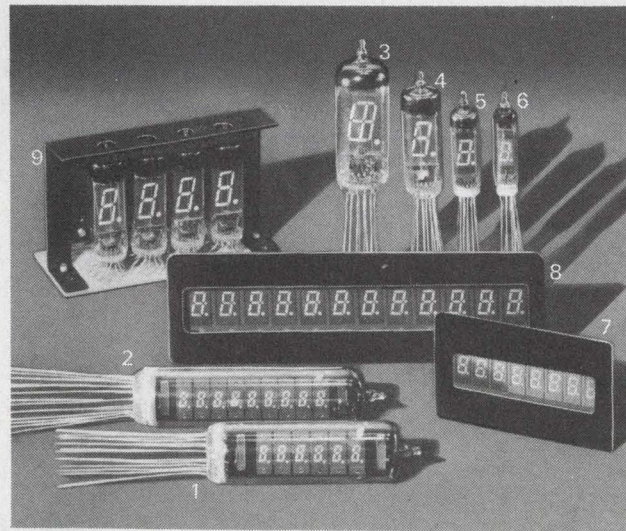
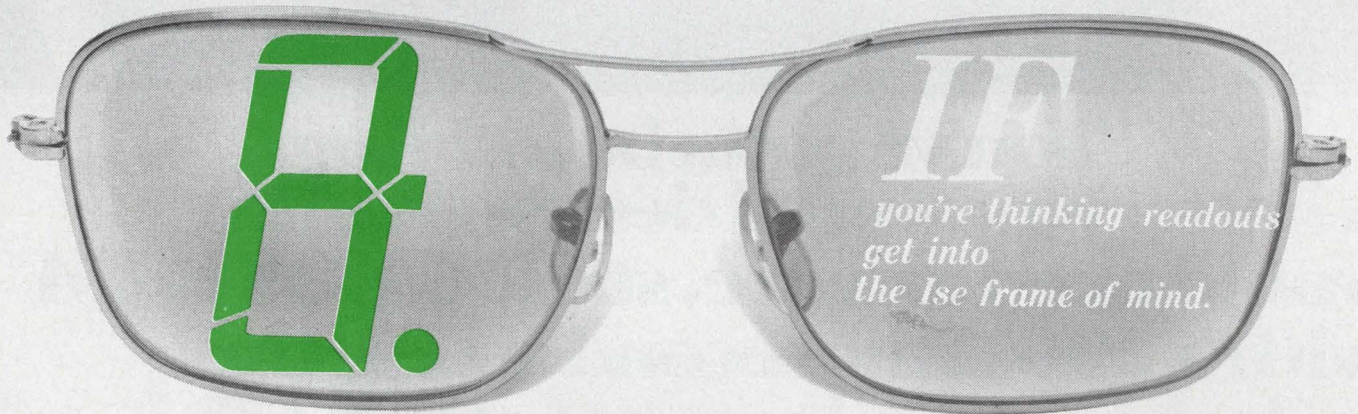

1. DP60A
2. DP90A
3. DG19E
4. DG12H
5. DG10F1
6. DG 8F
7. DP 89A
8. DP127F
9. DMCL12H (NEW)

**Display module w/counter & latch**

- Fluorescent green glow.
- 12-pin connector.
- Three performance perfect models.
- Custom ROM programming with other than BCD and seven-segment output.

The Brighter Side of Electronics



Creator of Fluorescent Digital Display:

**ISE ELECTRONICS CORP.** P.O. Box 46 Ise-city, Mie Pref., Japan  
Tel: (05963) 5-2121 Telex: 4969523

International Sales Div.:

**ISE INTERNATIONAL CORP.** 2-7-7, Higashi-Shinbashi, Minato-ku, Tokyo, Japan  
Tel: 433-6616~9 Telex: J26546 Cables: "ISEWORLDREP" TOKYO

Sales & Technical Office:

**ISE CORP. OF AMERICA** 1472 West 178th Street, Gardena, Calif., 90248 U.S.A.  
Tel: (213) 532-0470 Telex: 230674910

Representative: Paris, Munich, Amsterdam, Stockholm, Vienna, Milan, Bombay, Hong Kong, Taipei.

INFORMATION RETRIEVAL NUMBER 70



**“You’ve gotta be kidding.  
A battery-powered design like that  
would need a dense, static CMOS RAM  
with a 200 nanosecond access time  
and around 2 microwatt stand-by  
power.**

**“No way you’re going to find  
an outfit that can hack that.”**

**Give him  
the good news:**

Our new S2222 512x1 CMOS RAM does it all. It combines the highest density and performance with the lowest power requirements on the market — three more firsts from Number One. And at just \$41 apiece in 100-999 quantities, it also gives you the lowest cost per bit. For complete information, write AMI, 3800 Homestead Road, Santa Clara, CA 95051. Phone: (408) 246-0330.

Or call your distributor.

**AMI**  
AMERICAN MICROSYSTEMS, INC.

# Here's that dense, static CMOS RAM.

Our S2222 is a 512 word by one-bit RAM, constructed with silicon gate CMOS devices integrated on a monolithic array. Fully decoded on the chip, this memory uses DC stable (static) storage elements and needs no refresh to operate. The memory matrix is organized as 32 rows by 16 columns. High-speed operation and micropower supply requirements make our new RAM ideal for applications where you have to conserve electricity or use a battery.

You can't beat its performance, either. It has a 200 ns access time and 420 ns cycle time, with power dissipation of less than 5  $\mu$ w/bit and typical stand-by power of just 4 nw/bit. Since it is static, the data can be read without interruption. Maximum power dissipates only when the inputs change.

The unique circuit design lets the chip select precharge the internal nodes which minimize the power dissipation and maximize the performance. And for greater density, it is designed with five transistors per cell. All in all, it's the densest, lowest powered CMOS RAM ever produced.

## S2222 Specifications

- Access time: 200 ns at room temperature.  
300 ns at military temperature range.
- Cycle time: 420 ns
- Power dissipation: typically less than 5  $\mu$ w/bit.
- Stand-by power: 4 nw/bit.
- Power supply: single + 10 volt.
- Current sink output with "OR" tie capability.

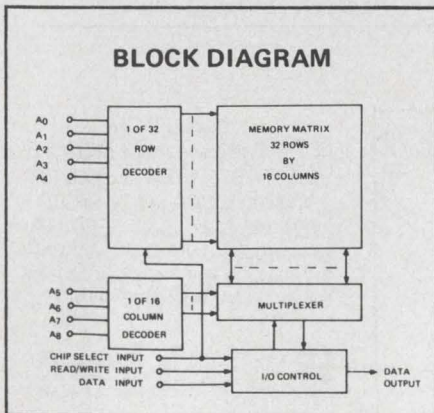

**AMI**

INFORMATION RETRIEVAL NUMBER 72

## MODULES & SUBASSEMBLIES

### Automatic call answering card uses Bell DAA

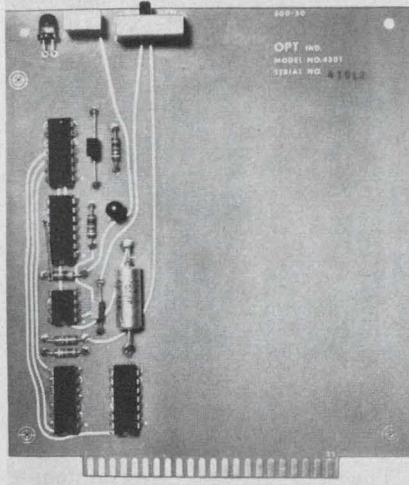

*OPT Industries, 300 Red School Lane, Phillipsburg, N.J. 08865. (201) 454-2600.*

The automatic answer card, Model 4301, is compatible with the Bell System data access arrangement (DAA) 1001A-CBS and with DTL/TTL circuitry on the users end. It indicates and controls the transmission circuit during incoming telephone calls. Electronics are mounted on a PC card 4.5 x 5.25 x 0.5 in. and uses a 22-pin card-edge connector. All controls—a slide switch that selects a predetermined or manual "off hook" time interval, a variable adjustment to set the time interval and a LED indicator to show line-in-use—are positioned on the outside edge of the card for easy adjustment.

CIRCLE NO. 284

### Solid-state relay can control 30-A loads

*Corona Engineering, 2497 Columbus Ave., Oceanside, N.Y. 11572. (516) 374-1154.*

The Model R30 Thyristat is a control system and electronic relay. It switches 50/60 Hz loads—heaters, refrigerators, machines, etc.—of up to 30 A in response to almost any kind of sensor—photo-cells, contacts, thermistors, etc. All this without requiring special matching circuitry. The unit includes a sensing circuit, power supply, amplifier, heat sink and finished cabinet.

CIRCLE NO. 285

### A/d and d/a converters have many features

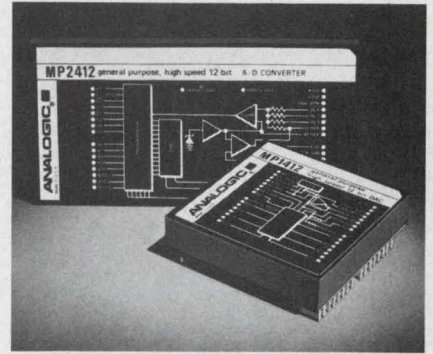

*Analogic, Audubon Rd., Wakefield, Mass. 01880. (617) 246-0300. 1412: \$39; 2412: \$75 (100-up prices); stock.*

The MP1412 12-bit d/a converter has a settling time of 5  $\mu$ s, 0.012% linearity, 500,000-hour MTBF and stability of 15 ppm/ $^{\circ}$ C. The MP2412 a/d converter has a max throughput rate of 25 kHz, 0.012% linearity, 250,000-hour MTBF and stability of 30 ppm/ $^{\circ}$ C. An accessible reference control permits ratiometric digitization.

CIRCLE NO. 286

### Noncontact proximity sensor highly sensitive

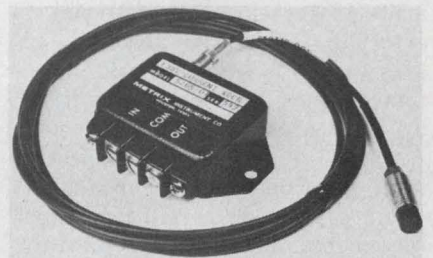

*Metrix Instrument, P.O. Box 36501, 5760 Rice Ave., Houston, Tex. 77036. (713) 668-2386.*

Model 5265 noncontact proximity sensor measures radial vibration or axial position of machinery shafts and other ferrous or nonferrous metallic objects. This system will sense a static change of position at frequencies up to 10 kHz. Motions as small as 40  $\mu$ m. and up to 0.05 in. can be measured. The system consists of a small probe, cable and solid state driver assembly powered by 12 V dc. The output signal sensitivity can be adjusted to 0.1 V/mil for any metallic target. Operating temperature range of the driver unit is -20 to 65 C and of the probe is -20 to 100 C.

CIRCLE NO. 287

### Motor driver handles units of up to 3 hp



Melstrom Manufacturing, 249 Westcott Dr., Rahway, N.J. 07065. (201) 382-8700.

The HP-1040 Series units are computer-interfaced motor control systems. Output power is rated from subfractional to 3 hp. These drives have control of velocity, acceleration and shaft position. The shafts of two or more motors can be made to remain in sync with each other within 2° of shaft angle, at all speeds up to 3500 rpm. In addition, the shafts can be made to increment in response to external pulses or absolute addresses. Sync can also be maintained when one shaft is rotated by hand at stand-still. A memory function lets the user select a total rotational angle for a shaft of up to 100,000 revolutions in 2° increments. These devices have dynamic current limiting, energy limited dynamic braking and continuous thermal protection.

CIRCLE NO. 288

### Programmable controller offers many options

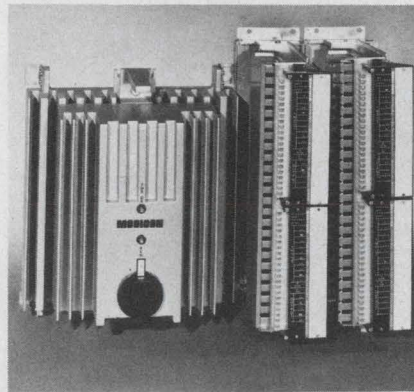

Modicon Corp., P.O. Box 83, Shawshen Village Station, Andover, Mass. 01810. (617) 475-4700.

The Model 284 programmable controller is available in three versions, each offering distinctive control configurations and cost advantages. The 283-40 has a built-in memory capacity for 40 lines of logic; the 284-80 and 284-120 have 80 and 120 lines, respectively. Each of the three offers expandable input and output capability, up to a maximum of 60 inputs and 30 outputs. Six individual modules that plug into compatible housings, two per housing, permit the user to buy only the capacity needed. Control functions of timing, counting, latching and sequencing as well as relay-type logic can be programmed in the 284. Dimensions of the basic 284, consisting of power supply mounted to the central processor, are 17-5/8 (with mounting feet) × 15 × 9-3/4 in. Each housing is 20 × 5 × 11-3/8 in.

CIRCLE NO. 289

### Electronic motor shaft synchronizer is precise



Control Systems Research, 632 Fort Duquesne Blvd., Pittsburgh, Pa. 15222. (412) 566-1200.

The ACC-U-LOK system can synchronize two or more shafts more accurately than with conventional gearing or mechanical coupling techniques. The system can electronically lock two or more shafts together and maintain a following accuracy of ±10 arc min. at positioning speeds in excess of 4000 rpm. In addition, one shaft can be precisely displaced or cycled relative to the other shaft upon command for cyclic operations. Two or more shafts can be remotely located by 300 ft. The ACC-U-LOK system is available with a broad range of servo controllers and drive motors ranging from 1/5 through 50 hp.

CIRCLE NO. 290



ANALOGY  
LET THE INTECH A403 EXORCISE YOUR SYSTEM. IT WILL DELIVER ±100V @ ±100mA AT A SPEED EVEN THE DEVIL CAN'T KEEP UP WITH. COMES IN A SMALL ECONOMY SIZE PACKAGE (1.6'x3'x1') AT A SMALL, ECONOMY SIZE PRICE.

**intech** INCORPORATED  
(408) 244-0500  
1220 COLEMAN, SANTA CLARA CA 95050



# if it's a meter or meter relay,

Stock or Special...

# Simpson

makes it.

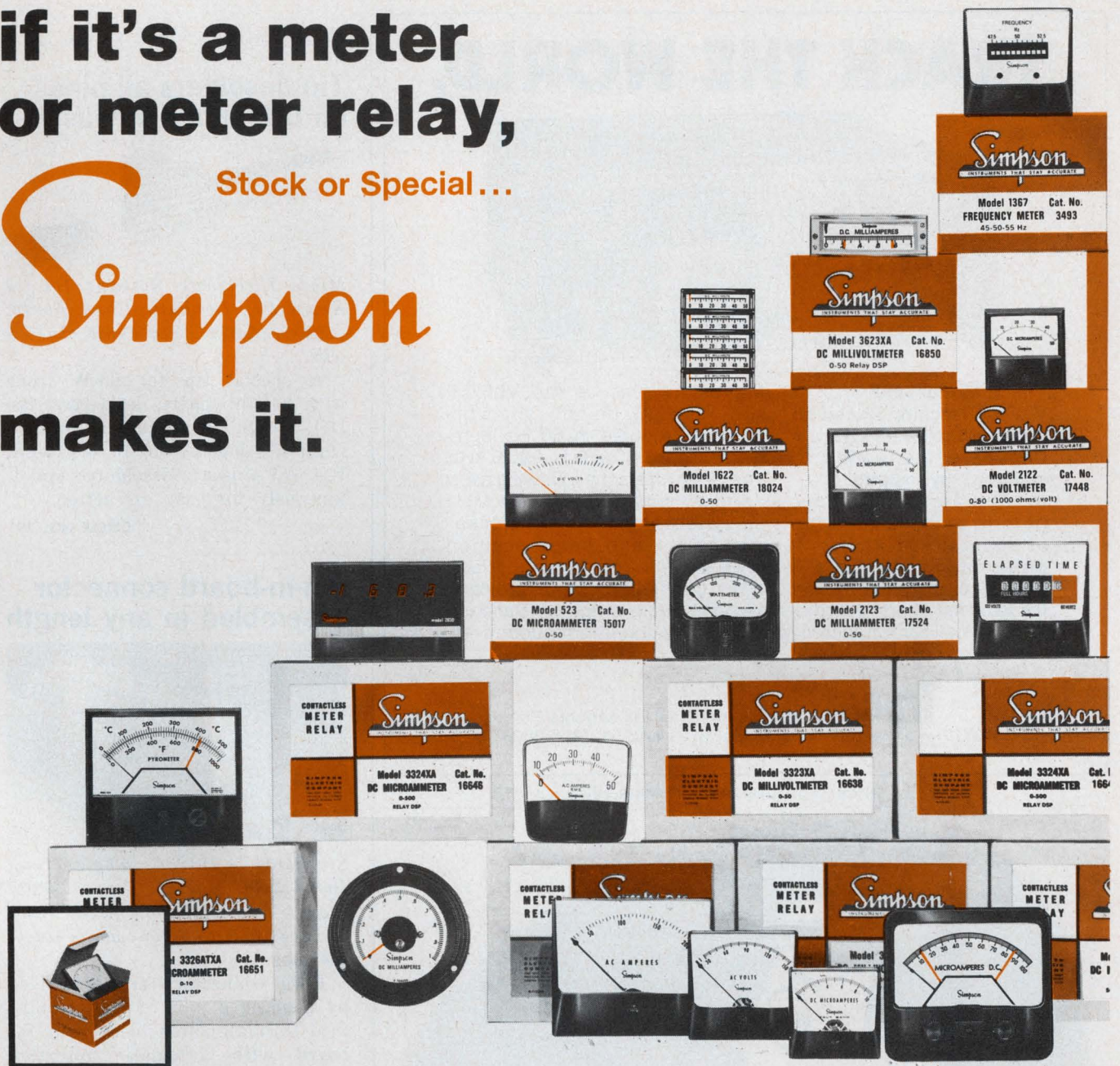

## Stock:

Simpson distributors nationwide stock over 1,500 types, ranges, styles and sizes of panel meters, relays and controllers. They're all listed in Catalog 4200. Write for your free copy.

## Special:

Need a special or unusual meter? Let Simpson help you custom design it. Send us your specs and we'll send you a quote. But check our catalog first—that "special" may be a standard Simpson stock item.

*Get off-the-shelf delivery from your local electronics distributor.*



### SIMPSON ELECTRIC COMPANY

853 Dundee Avenue, Elgin, Illinois 60120  
(312) 695-1121 • Cable: SIMELCO • Telex: 72-2416

IN CANADA: Bach-Simpson, Ltd., London, Ontario

IN ENGLAND: Bach-Simpson (U.K.) Limited, Wadebridge, Cornwall

IN INDIA: Ruttonsha-Simpson Private, Ltd., Vikhroli, Bombay

KATY INDUSTRIES



ELECTRICAL EQUIPMENT  
GROUP

INFORMATION RETRIEVAL NUMBER 74

# TRACK THE WORLD.



**Tracor Model 599K  
VLF/LF Tracking Receiver.**  
Tunable 3 to 99.95 kHz.  
Considered the "world's  
standard" by experts.

Makes full use of the VLF/LF stations now on the air. Continuously tunable in 50 Hz increments from 3.00 kHz to 99.95 kHz. The 599K offers the following uses: to calibrate any frequency standard with 100 kHz or 1 MHz output; to maintain long-term synchronization of "clocks" at separate locations; for navigation and other position determining purposes worldwide; and for investigations of VLF propagation. Rear chassis connector output provided for external chart recorder. Earphone audio output is standard. Write or call for full technical and application information.

**Tracor, Inc.** Industrial Instruments  
6500 Tracor Lane • Austin, Texas 78721 • AC 512/926-2800

INFORMATION RETRIEVAL NUMBER 76



**YOU'RE WHISTLING IN THE DARK...**

if you think that heart disease and stroke  
hit only the other fellow's family.

**GIVE ... so more will live  
HEART FUND**



## PACKAGING & MATERIALS

### Tip desolders all pins on DIP simultaneously

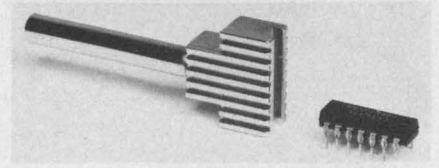

*Micro Electronic Systems Inc., 8  
Kevin Dr., Danbury, Conn. 06810.  
(203) 746-2525. \$16 (unit qty); 8  
wks.*

A special tip for 60-W irons with 1/4-in. shafts, designated the DIL-16-US, is machined for instant desoldering of 14 or 16-pin ICs. All pins are desoldered simultaneously for easy extraction.

CIRCLE NO. 291

### Pin-in-board connector assembled in any length

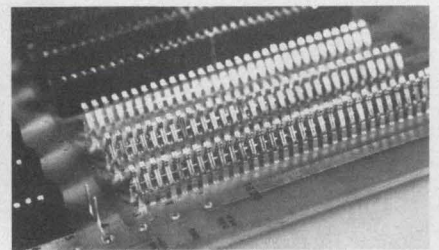

*Stanford Applied Engineering,  
Inc., 340 Martin Ave., Santa  
Clara, Calif. 95050. (408) 243-  
9200. \$0.045 to \$0.05 per contact;  
4-6 wks.*

PDQ connectors are assembled by pushing a pair of contact pins into through-plated holes in a PC board with automatic insertion equipment. The contact pins, made of gold-plated phosphor bronze, can be arranged on 0.100 × 0.125, 0.100 × 0.200, 0.125 × 0.125, and 0.125 × 0.250-in. centers. They form gas-tight connections, with contact resistance of less than 6 mΩ. Connectors can be spaced at 0.250-in. minimum and can be assembled to any length required. Available in dip-solder or wire-wrappable versions, the PDQ connector features: an extra-large throat opening for easier board entry; precise pin alignment with contact gaps maintained at 0.030 in. for a controlled insertion force; and connector tails that are perfectly aligned to simplify use of automatic wire-wrapping equipment.

CIRCLE NO. 292

## High-density connector has 165 pins

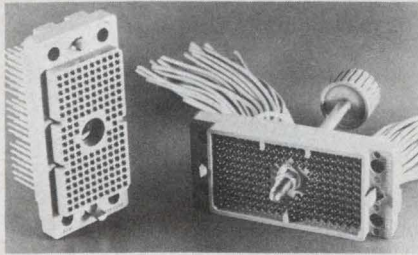

Elco Corp., Maryland Rd. & Computer Ave., Willow Grove, Pa. 19090. (215) 659-7000.

A new 165-contact Series 8026 high-density connector for rack-and-panel applications features an improved miniature Varicon contact with low insertion force and less-critical alignment requirements. The terminations are on a 0.100-in.-square grid and termination choices are 0.025-in.-square wire-wrappable tails or mini-Varilok wire-crimp contacts for 22-to-30 gauge wire. The connector's diallyl phthalate, glass-filled, flame-resistant body is keyed and shrouded to prevent mismatching and protect the contacts. Polarizing hardware permits 36 mating combinations per connector pair. The connectors also have a center jackscrew that easily locks mated connectors together and helps in blind mating situations. Optional cable clamps are available. Contacts are rated at 3 A and 5-mΩ maximum resistance, with a withdrawal force of 1 to 8 oz. per contact pair. All Series 8026 connectors meet the applicable portions of MIL-C-28731 and MIL-C-8384.

CIRCLE NO. 293

## Insulator film doesn't peel, chip or fracture

Thermalloy Inc., 2021 W. Valley View Ln., P.O. Box 34829, Dallas, Tex. 75234. (214) 243-4321. \$0.015 (1000 up); stock.

A new insulator, Thermafilm II, for use with TO-3, TO-5, TO-18, TO-66 and plastic packages is cost-competitive with mica, but it will not peel, chip or fracture. The material is 2-mils thick and its dielectric strength is 7000 V/mil. The insulator may be used for case temperatures to 125 C. Its bright green color makes it readily identifiable.

CIRCLE NO. 294

# If low cost and high performance are criteria... our new 82000 Series permanent magnet steppers are the answer.

Here's a new permanent magnet stepper motor line created to meet the design needs of analytical instrumentation and computer peripherals. Applications include tape drives, printer and chart drives and optical disc drives. Both 5 volt and 12 volt models are available.

All utilize 4-phase stators and permanent magnet rotors. Most

have 24-pole rotor construction. As a result, they offer excellent pull-in rates and good stepping accuracy. Another advantage is low temperature rise...over 50% lower than comparable variable reluctance stepper motors operating on a similar duty cycle. Gear boxes can be furnished to meet varying torque and speed requirements.

Write for information today!

Available pull-in torques from .750 oz-in. to 7.50 oz-in.  
Available stepping rates from 210 steps/sec to 440 steps/sec.

Our 4-page *Permanent Magnet Logic Stepper Motor* catalog provides all basic details including performance data and charts, dimensional drawings, as well as electronic drive information. Send for a copy.

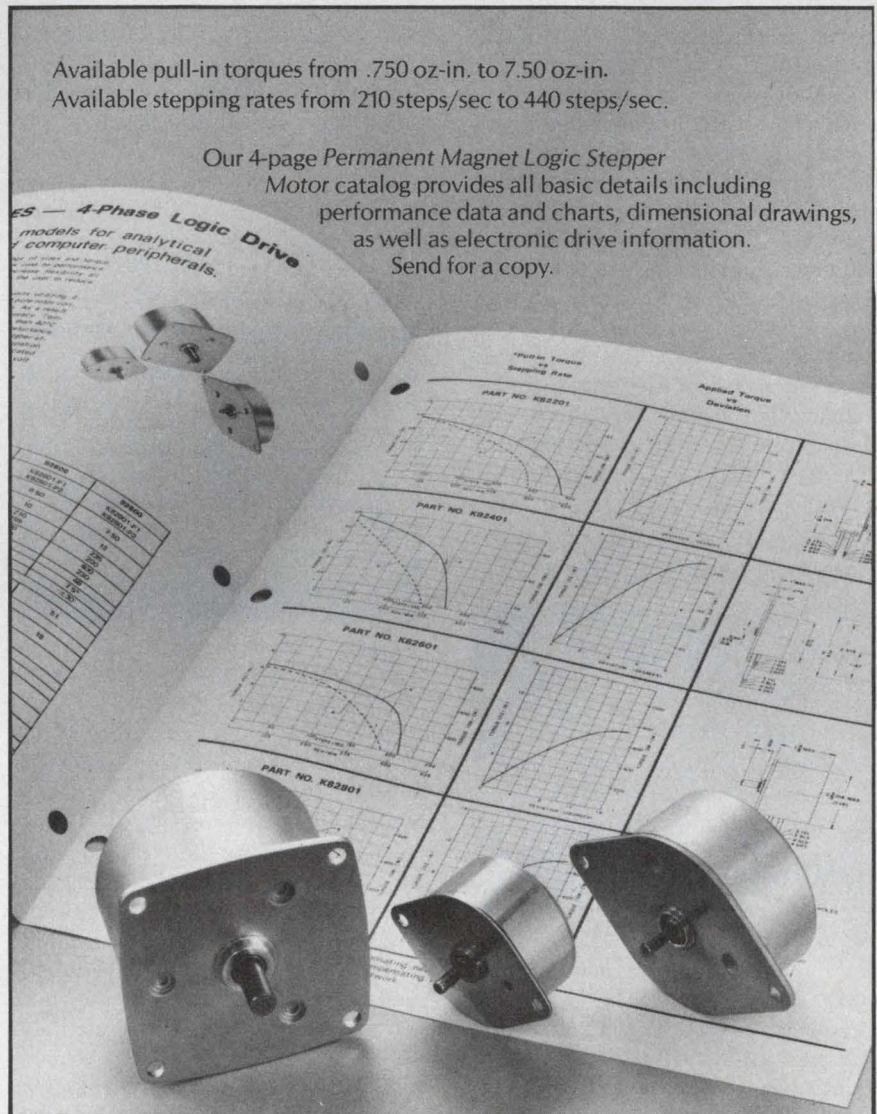

A. W. HAYDON CO. PRODUCTS

**NORTH AMERICAN PHILIPS CONTROLS CORP.**

Cheshire, Conn. 06410 • (203) 272-0301

INFORMATION RETRIEVAL NUMBER 77

### Heat-shrink material shields against RFI

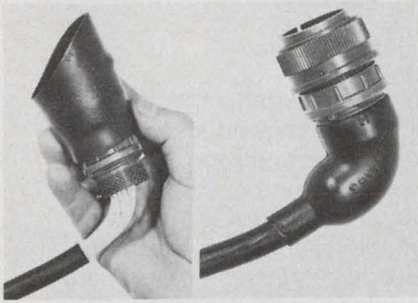

Emerson & Cuming, Inc., Canton, Mass. 02021. (617) 828-3300.

A new line of heat-shrink tubing and connector boots has RFI shielding capability. The new line is designated Eccoshield HS. The shielding effect is produced by the application of a highly conductive material to the inside surface of a Raychem tube or boot. The heat-shrink feature is not affected by this modification. Almost any product from Raychem's Rayclad Thermofit line can be modified by Emerson & Cuming in this way to produce an Eccoshield HS version. The boot provides an insertion loss within a few dB of an all-metal braid of the same dimensions. The boots fit almost all standard and miniature connectors.

CIRCLE NO. 295

### Antistatic polish cleans clear plastics

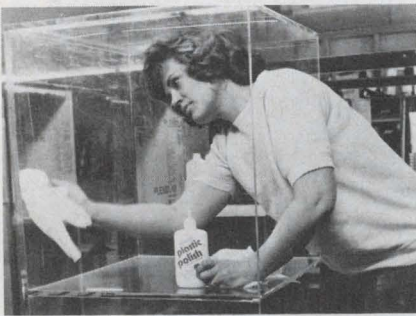

Novus Inc., 5301-B Edina Industrial Blvd., Minneapolis, Minn. 55435. (612) 831-2434. \$3.75 half gallon (6 per case); stock.

A new antistatic, dust-repellent polish, Novus Plastic Polish No. 1, cleans and glazes plastics in a single operation. Its concentrated formula polishes quickly to a high gloss, without streaking and leaves an antistatic glaze that resists finger marking, dust and smudging.

CIRCLE NO. 296

### Card pull handle mounts with single bolt

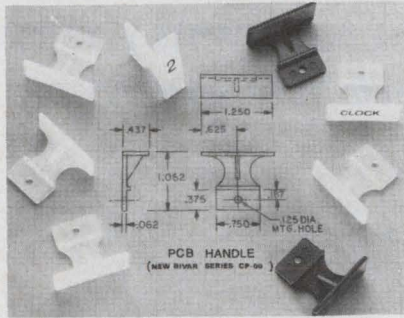

Bivar Inc., 1617 E. Edinger Ave., Santa Ana, Calif. 92705. (714) 547-5832. \$0.18 (1000 up); stock.

For use with PC boards of any thickness, Bivar's new Card-O-Pull handles feature a wide, flat area for marking or hot stamping and a shape that is specially designed for effective gripping. Installation is with a single eyelet, rivet or bolt and a molded-in ridge fits flush with the edge of the board to prevent rotation.

CIRCLE NO. 297

### IC test kit handles TO-5 cans and DIPs

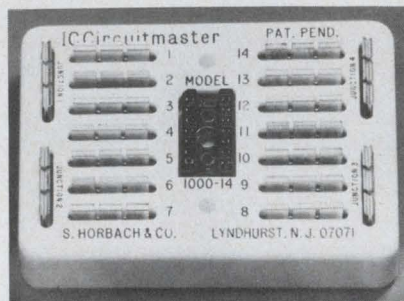

Stephen Horbach & Co., 275 Warren St., Lyndhurst, N.J. 07071. (201) 438-1900.

The new IC Circuitmaster Kit tests electronic components in circuits. A molded-plastic package houses a variety of spring-loaded, adjustable input/output contact clips that are connected internally by the PC board. Component values and circuit configurations under test can be changed quickly and repeatedly without the need for soldering. The kit is available in five sizes for ICs in TO-5 cans with 6, 8, 10 or 12 leads and in a 14-pin DIP package. Electrical specifications are: Current rating, 1 A; contact resistance, 6 mΩ; insulation resistance, 1 × 10<sup>6</sup> MΩ; dielectric breakdown voltage, 500 V ac; frequency range, to 40 MHz.

CIRCLE NO. 298

### Tool strips cables without damage



P. K. Neuses, Inc., Box 100, Arlington Heights, Ill. 60006. (312) 253-6555.

The N-2878 cable-sheath stripper can remove the jacket from all sizes of plastic and fabric covered cables. The phenolic handle is equipped with a razor blade and an L-shape, hardened-steel guide and blade guard. The operator can hold the stripper in one hand and guide the cable with the other to slit the cable jacket cleanly without damage to wire or insulation. Blades are reversible, and two-extra blades are enclosed in a slot in the handle. Blades are standard injector blades.

CIRCLE NO. 299

### Masking compound withstands 500 F

Techform Laboratories, 215 W. 131st St., Los Angeles, Calif. 90061. (213) 532-1254.

A flexible masking compound, called Flexible Mask, is specially formulated to protect and then be easily stripped from molds, lead wires, PC boards and potting forms. The quick drying compound doesn't corrode precious metals; can be applied by automatic dip, brush or flow methods; is nontoxic and nonflammable; prevents contamination during assembly operations; and can withstand temperatures up to 500 F. Once cured, Flexible Mask becomes a strippable seal that can be easily removed with a mild pulling action.

CIRCLE NO. 300

# OUR DAMN FAST BUFFER CAN BE USED AS A DIDDLE YOKE DRIVER

Presenting some really wild, far-out stuff from National Semiconductor.

For solving some really strange, unusual problems.

Like where you need a diddle yoke driver for your high resolution CRT displays... or something to continuously drive 50 ohm coaxial cables.

That'd be our LH0063 FET-input "Damn Fast Buffer" (that's its name, honest)... which is a whole order of magnitude faster than any other buffer on the market... slew rates up to 6000V/ $\mu$ s.

## Some other hot special function goodies.

The products we're talking about are hybrids. Special function analog and digital circuits that do things that can't be done with a monolithic chip.

A FET input op amp with very low offset voltage and 5 $\mu$ V/ $^{\circ}$ c max drift. LH0052.

A high speed sample and hold circuit capable of acquiring a 20V step signal in under 5.0  $\mu$ s. LH0053.

An ultra fast FET op amp with slew rates over 500 V/ $\mu$  sec. LH0032.

A high current op amp capable of delivering over one ampere of output current. LH0021.

Or just maybe you're looking for some kind of a thingamajig off the shelf that'll transmit sensor signals without line drops or voltage noise. (LH0045).

## Damn good reading.

We've rounded up all our way-out special function devices and put 'em in a catalog.

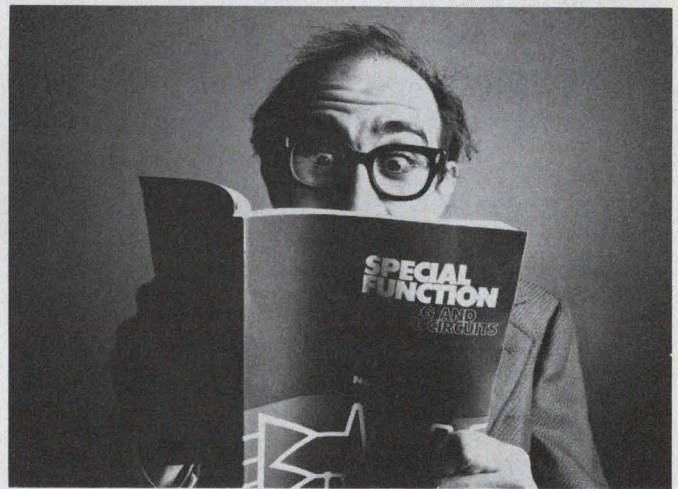

Which, happily, is yours for the asking. Call your friendly neighborhood National distributor, our office nearest you listed below, or use this coupon.

You need never again be without a diddle yoke driver.

Gentlemen,

I think your Damn Fast Buffer is a damn good idea. I'd like to receive your Special Function catalog... and be damn fast about it.

Name \_\_\_\_\_ Title \_\_\_\_\_

Company \_\_\_\_\_

Address \_\_\_\_\_

City \_\_\_\_\_ State \_\_\_\_\_ Zip \_\_\_\_\_

Mail to: National Semiconductor Corporation,  
2900 Semiconductor Drive, Santa Clara, California 95051.

# NATIONAL

National Semiconductor Corp., 2900 Semiconductor Drive, Santa Clara, Calif. 95051; Scottsdale, Ariz. (602) 945-8473; Mountain View, Calif. (415) 961-4740; Sherman Oaks, Calif. (213) 783-8272; Tustin, Calif. (714) 832-8113; Miami, Fla. (305) 446-8309; Chicago, Ill. (312) 693-2660; Indianapolis, Ind. (317) 255-5822; Lenexa, Kan. (816) 358-8102; Glen Burnie, Md. (301) 760-5220; Burlington, Mass. (617) 273-1350; Farmington, Mich. (313) 477-0400; Minneapolis, Minn. (612) 888-4666; Englewood Cliffs, N.J. (201) 871-4410; Syracuse, N.Y. (315) 455-5858; Dayton, Ohio (513) 434-0097; Dallas, Tex. (214) 233-6801.

# Mil spec converters and indicators: We can give you off-the-shelf delivery.

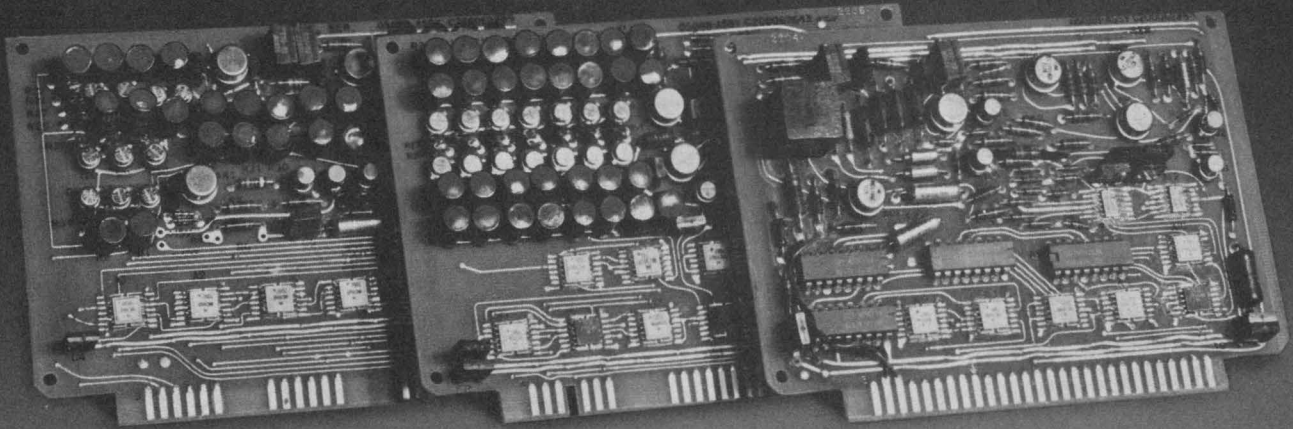

If you've got conversion problems, Kearfott production model converters and angle position indicators can help solve them. Here's how.

**TRIGAC I**—Single or multiplexed synchro or resolver/digital converters, accurate to 6 minutes (12 bit) 11.8 or 90 volt inputs, 60 to 400 Hz operation. Multiplex 4, 8 or multiples of 8 channels.

**TRIGAC III**—Synchro or resolver/digital tracking converter. 14 bit natural parallel output.

**TRIGAC IV**—Digital/synchro converter, 3 wire 11.8 or 90 volt output, accuracy to 4 minutes, 12 bit parallel input.

Also available:

- D.C. (sine-cosine) to synchro output. Power capability to 5VA.

- Digital resolver uses TRIGAC III circuitry. Unit equivalent to a control transformer, for digital command application.
- Synchro to D.C. converters for instrumentation applications.
- Solid state angle position indicators. TRIGAC circuitry. Available with 0-360° or ±180° outputs and LED readouts. D.C. outputs, BCD outputs also available as options with displays and special scale factors.

We can supply any of the above on cards or in mil-type corrosion-resistant enclosures. Write today for new catalog. The Singer Company, Kearfott Division, 1150 McBride Avenue, Little Falls, New Jersey 07424.

## SINGER

AEROSPACE & MARINE SYSTEMS

INFORMATION RETRIEVAL NUMBER 78

# Watch Out.

## The volts are out to ruin your computer, maybe your entire system!

Nobody needs to remind you that the erratic demand on electric power these days has created a potential "brownout" condition in just about every major industrial area. Protecting your computer or system from the crazy dips and surges in voltage is critical. A slight dip can cause a computer to drop a few digits, lose parity, distort information, or lose its memory entirely. A surge damages delicate components and ruins printed circuits.

Sola Electric's "brownout insurance" comes in the form of highly reliable constant voltage transformers and Solatron® Voltage Regulators

—in a wide range of specifications. Most are standard units and immediately available for off-the-shelf shipment. And our applications engineering people are ready to help right now —whether you're designing voltage regulation into your equipment or adding protection to an existing system.

Protect yourself. Contact your local Industrial Distributor or the AC Products Group at Sola Electric. Call (312) 439-2800 or write Sola Electric, 1717 Busse Rd., Elk Grove Village, Illinois 60007.

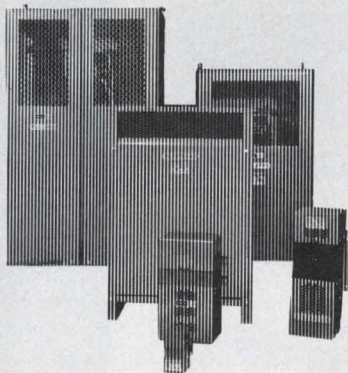

### Get brownout "insurance" from SOLA

**SOLA ELECTRIC**

**STB**  
SOLA BASIC

INFORMATION RETRIEVAL NUMBER 79

## Led panel lamps match incandescents at less current

Data Display Products, 5428 W. 104th St., Los Angeles, Calif. 90045. (213) 641-1232. Depending upon model, \$1.45 or \$1.60 (100-up); stock to 3 wk.

With the development of high-output LEDs, panel lights can be made to equal incandescents in brightness with lower current drain. Using LEDs manufactured by Hewlett-Packard (1501 Page Mill Rd., Palo Alto, Calif. 94304), Data Display Products has made a family of panel lights that are about four times brighter at the same current level than any other LED panel light.

The panel lamps come in red, amber and green. Typical light output runs 2.5 mcd at 10-mA drive for the red and amber, and 2 mcd at 20-mA drive for the green.

At 20-mA drive, the red appears

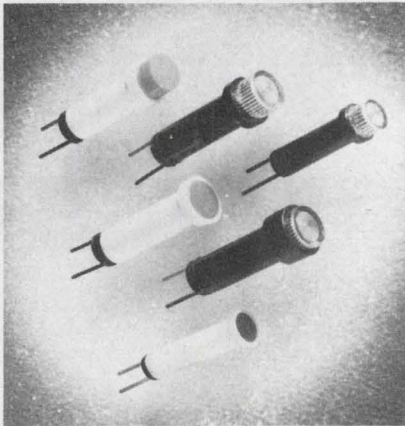

as bright as any 60-mA incandescent. The amber comes close to incandescents in brightness but must be used with a fresnel lens. The green is bright enough to be useful, but it is still far dimmer than the red or amber.

The LEDs are housed in plastic tubes with a lens on one end and gold-plated wrapped-wire pins on the other. Each assembly has a limiting resistor built in. For the red models, both fresnel and fully diffusing lenses are available in either squared-off, dome or low-profile, squared-off, shapes.

Yellow and green come only with fresnel lenses of the squared-off or low-profile, squared-off, shape. All colors can have either black or white outer casings.

Available lens diameters go from 0.205 to 0.284 in. Mounting diameters are 3/16, 1/4 or 0.284 in., depending on the desired package.

Models are available from 5 to 28 V. At several of the voltages, different intensities (different current drives) are also available.

CIRCLE NO. 252

## RF WIDE BAND TRANSFORMERS

- 0.1-500 MHz
- 50 ohm impedance
- 1:1 - 16:1 impedance ratio
- Micro-miniature case

**\$2.95**  
10 piece quantities  
Some models \$3.45



**ONE WEEK DELIVERY!**

Impedance ratios of standard models are 1:1, 2:1, 4:1, 9:1 and 16:1. MCL kit TK-1 includes 2 units of each type and sells for \$32.

We invite you to convince yourself. Place your order now and check our delivery, product performance and reliability.

**MCL Mini-Circuits Laboratory**

A Division Scientific Components Corp.

2913 Quentin Rd., Brooklyn, N.Y. 11229  
(212) 252-5252 Int'l Telex 620156

## The Brush recorder module. It gives your system the competitive edge.

OEM recorder modules give you design flexibility along with all the Brush exclusives.

Choose single or dual channel, low profile or vertical models. There's a wide range of chart speed options.

Plus Brush exclusives like pressurized ink writing and Metrisite® servo loop feedback system that assures 99.5% linearity.

Write Gould Inc., Instrument Systems Division, 3631 Perkins Avenue, Cleveland, Ohio 44114. Or Kouterveldstraat Z/N, B 1920 Diegem, Belgium.

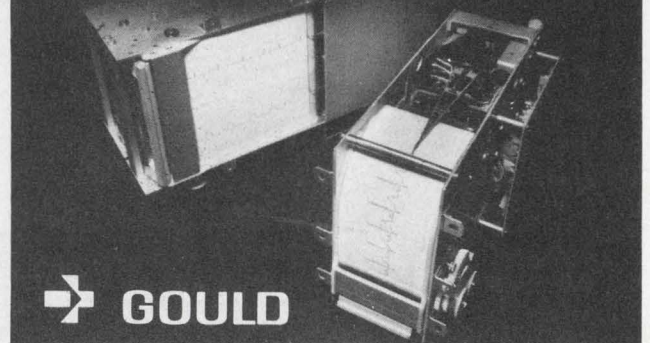

**GOULD**



# relays renewed

ISA-74 INTERNATIONAL SHOW Visit Booth 1423

## 2 HANDED DEADMAN'S THROTTLE

OSHA should be happy with this foolproof interlocked switching circuit that occupies both hands of a machine operator. The Run switch of Fig. 1 can't be simply taped closed, it must be cycled after each "Stop" of the "Forward-Stop-Reverse" Traverse switch.

Almost any combination of electromechanical or reed relays can be used since most contacts switch other control relays. However, with reed relay coils rated at 48 VDC maximum, the motor starter usually would require a separate power supply. Depending upon the size of motor starter MSF, control relays CRA and CRD could be S-D Frames 283, MRRN, or 314. For TCRB a modification of our Frame 236 would make an excellent choice.

Thanks to B.C.M., Nazareth, Pa. for this idea which he suggests for overhead cranes to insure that the operator keeps both hands inside the cab and on the controls.

Two interesting thought starters among the endless possibilities for relay-operated systems.

FIG. 1

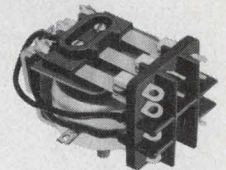
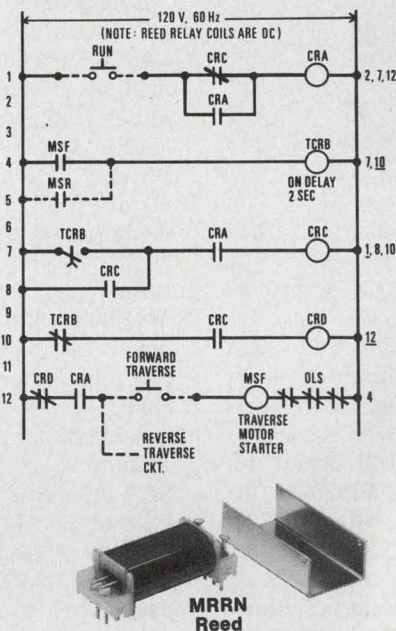

314 Frame

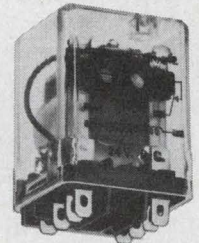

283 Frame Plug-in



MRRN Reed

## RELAY GUARDS SPRING-OPERATED MECHANISM

Here's a device that actually operates a conventional relay both electrically and mechanically. Its use of spring-stored energy may have other applications where a mechanical operation is needed without power or with only a local standby power source. Now used on stored energy operators of oil circuit breakers, this suggestion comes from F.L. of Foxboro, Ma.

The gear reduction motor of Fig. 2 charges a spring in one revolution of its output shaft. With the spring fully charged, a cam mechanically actuates the control relay into the energized position. As Fig. 3 shows, CR1 then stops the motor while CR2 readies a solenoid circuit that can detach the spring whenever required. When the spring discharges, the cam "unlatches" the relay and the motor starts recharging the spring. A failure elsewhere in the mechanism operates a contact that electrically energizes the control relay and stops the motor to prevent damage from repetitive spring discharges.

Relays such as S-D Frames 314, B1, 425, 219, are only a few of many types suited for such an arrangement. The choice depends largely on mounting requirements and number of poles required.

FIG. 2

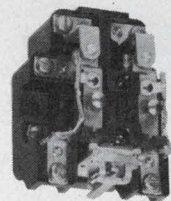
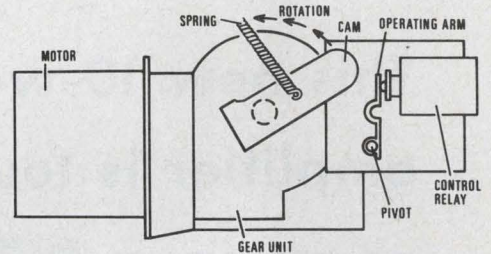

425 Frame

FIG. 3

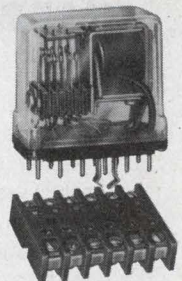
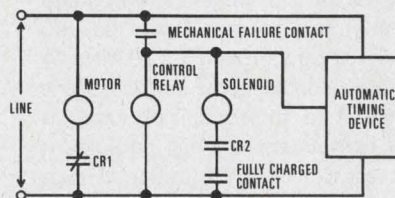

219 Frame & 12-Pin Socket

Struthers-Dunn Relays Are Stocked by Over 125 Distributors

1974 Catalog specs over 100 basic relays —EM, Reed, Hybrid, Solid State— plus solid state Programmable Controllers. Circle reader service card with number below for your copy.



**STRUTHERS-DUNN, INC.**

PITMAN, NEW JERSEY 08071

Canada: Struthers-Dunn Relay Div., Renfrew Electric Co., Ltd.



INFORMATION RETRIEVAL NUMBER 82

## Power transistors handle 5, 10 or 15 A in TO-3



Solitron Devices, Inc., 1177 Blue Heron Blvd., Riviera Beach, Fla. 33404. (305) 848-4311. From \$2 (100-up); stock to 3 wk.

A family of 5, 10 and 15-A switching npn Darlington power transistors is packaged in steel TO-3 cases. The 5-A series is identified as the SDM 20301-04; the 10-A series, SDM 20311-14; and the 15-A series, SDM 20321-24. All have  $V_{CE0}$  (sus) from 40 to 100 V,  $I_C$  (cont) = 10 A,  $I_C$  (peak) = 20 A, thermal resistance from 1.75 C/W and  $f_t$  = 20 MHz. The SDM 20301-24 has a  $h_{FE}$  (min) of 750 at 15 A.

CIRCLE NO. 301

## Medium power switching transistors handle 7 A

Power Physics Corp., Industrial Way West, Eatontown, N.J. 07724. (201) 542-1393. From \$0.85 (1 to 99); stock.

The 2N5490 through 2N5497 npn silicon diffused mesa plastic transistors are designed for use in medium power switching and amplifier applications. Two other types, the popular 2N6098 and 2N6099 ( $P_T$  = 75 W at  $T_C$  = 25 C) are also available. All units are designed to replace the TIP29 and TIP31 devices, and may be substituted for the 2N4921, 2N5191, MJE205, 520 and similar numbers. In many applications they are replacements for the D42C and D44C types as well. Electrical specifications of the 2N5490 series include  $V_{CE0}$ 's from 40 to 70 V,  $I_C$ 's of 7 A, gains from 20 to 100 and  $P_T$ 's of 50 W at  $T_C$  = 25 C. The 2N5490 series units are packaged in standard JEDEC 80-220 plastic cases with pin configurations supplied either as emitter, case and base; as base, case and emitter if desired.

CIRCLE NO. 302

## LED fault indicators come in green and yellow

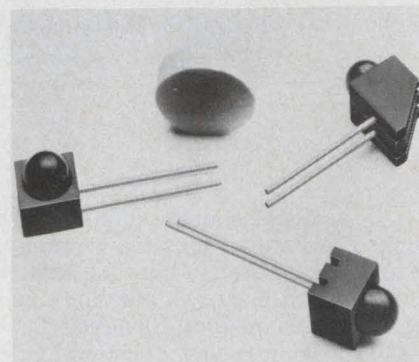

Dialight, 203 Harrison Pl., Brooklyn, N.Y. 11237. (212) 371-8800. Price: 1000-up \$0.39 (red), \$0.80 (green or yellow); stock.

The 550 series of LED fault indicators is available in green or yellow as well as red. The units are also designed for use as indicator lights, panel illuminators, logic-state indicators and for binary data displays. They are available with both axial and right angle leads. The fault indicator can be directly driven from DTL or TTL logic. Polarity of the device is clearly defined.

CIRCLE NO. 303

## This new 10-watt amplifier is tough -- even in a mismatch!



The Model 10LA is one broadband amplifier you don't have to treat with kid gloves. It will stand up under any mismatched load and provide you with 10 watts of swept power from 1-110 MHz. A directional wattmeter enables you to determine actual power delivered to the load. You can perform antenna and component testing, equipment calibration, NMR research -- any number of tests -- with complete confidence. It takes more than a mismatch to knock out our 10LA. Find out for yourself, write: Amplifier Research, 160 School House Road, Souderton, Pa. 18964. Phone: 215-723-8181

**AR** AMPLIFIER RESEARCH

INFORMATION RETRIEVAL NUMBER 83

## How welded contacts cut material costs up to 80%



- Improve physicals, performance and reliability
- Maintain original specified resistance

With welded contacts, only the exact amount of contact metal needed is applied to the base material. This eliminates indiscriminate use of precious metals compared with plating. You also save metal compared with riveted contacts. Welded contacts never increase in resistance as do riveted contacts. Heat conductivity and full strength of the base material are retained because there is no perforation. Let us quote on your contact sub-assemblies with welded contacts. Send for our FREE 20-page catalog. See our Ad in the Gold Book

RIVETED CONTACT



WELDED CONTACT



Riveted contact loses strength, Welded contact saves metal increases resistance loss

**braun**  
company inc.

4200 31st Street North St. Petersburg, Florida 33714  
813/526-9104

INFORMATION RETRIEVAL NUMBER 84

ELECTRONIC DESIGN 16, August 2, 1974

# Versatec does it again!

## Announcing 200-points-per-inch resolution

Versatec is making points like crazy.

While the rest of the electrostatic printer industry is plugging along at 80 points per inch . . . or 100 . . . we now introduce our tour de force . . .

The Matrix 1200A Printer/Plotter. Clearly the most impressive performer **ever** in electrostatic printers and plotters.

Consider. We can plot 3,600,000 points on a standard 8½ x 11 inch page!

In nine seconds.

Produced by 2,112 writing nibs in a **dual-array** configuration.

This staggering capability delivers overlapping dots and the kind of fine line resolution you expect from the best pen plotter . . . but 100 times faster.

And as for the printed page, the 1200A will print 132 16 x 16 dot matrix characters across the page at 500 LPM . . . in a typeface that is more handsome than that of any impact printer. You're looking at a sample of it right here.

You're probably thinking — "How come it's Versatec, Versatec, Versatec all the time who's making the breakthroughs?"

We are the only one with MEWT™, a true electrostatic writing technique. Years ago, we broke the price barriers with the least expensive electrostatic printers and plotters. And now we offer twice the resolution of anyone else.

With over 1,500 Matrix units in 20 countries

around the world, we're designing better products than anyone else.

But back to our Matrix 1200A. Write us today for more information, including a 200 points per inch print and plot sample that will knock your eyes out.

You have to see it to believe it.

Versatec, Inc.,  
10100 Bubb Road,  
Cupertino, California 95014.  
(408) 257-9900.



**VERSATEC**

**Specialists  
in hard copy  
information  
display**

"See us at WESCON 2527 and INFO '74 4447."

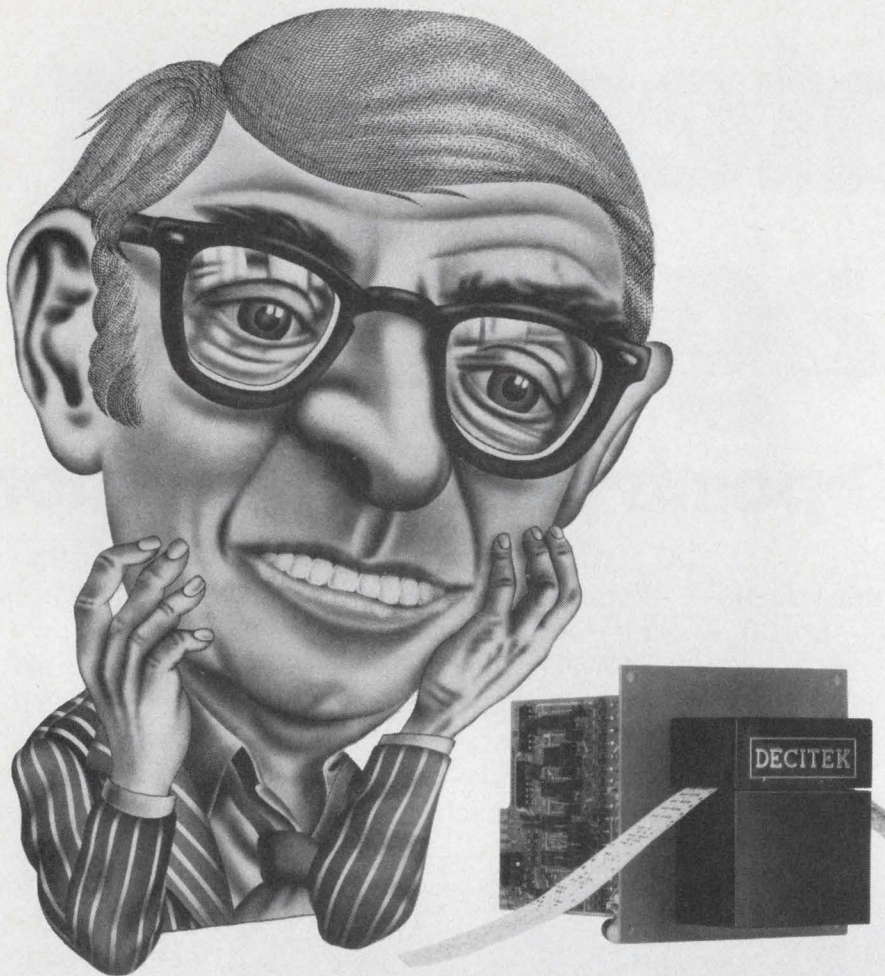

# PLAY IT AGAIN, SAM.

Sam is the name of Decitek's new low-cost 100 cps photoelectric tape reader. Sam? We could tell you that it's short for something like Superior Alignment Motion, which is precisely what our patented dual sprocket drive provides. But it isn't. We simply felt that Sam has a nice friendly ring to it and is easy to remember.

Sam offers good credentials.

This new reader incorporates the same unflappable tape transport that is the heart of Decitek's eye-blinking 600 cps reader. This drive doesn't need edge guides or keepers, there's no tape skew. Positive registration is assured—repeatedly through thousands of reruns with no measurable tape wear.

Fiber optic lighting from a single light source plus photo-transistor sensing are features that deliver dependable high-quality performance.

All this at a cost that compares favorably with mechanical readers!

For all the details on this new low-cost, highly reliable reader, just drop us a note or card with the words "Play it again, Sam."

When reading matters  
**DECITEK**

A DIVISION OF JAMESBURY CORPORATION  
250 CHANDLER STREET, WORCESTER, MASSACHUSETTS 01602, (617) 798-8731

INFORMATION RETRIEVAL NUMBER 86

## POWER SOURCES

### Dual-output modular units feature 25 models

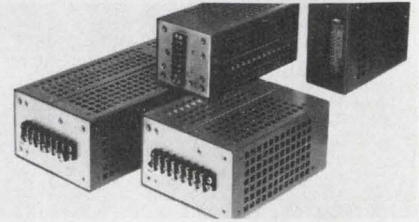

Power Pac Inc., 18 Marshall St., S. Norwalk, Conn. 06854. (203) 866-4484. \$60 to \$159.

Five new series of modular dc power supplies feature dual outputs. The five series (PPM2D through PPM5D), comprise 25 different models. Input for all models is 105 to 125 V ac, 47 to 440 Hz, with voltage outputs from  $\pm 2.5$  to  $\pm 24$  V dc, and current outputs ranging from 0.12 to 3.5 A. These convection-cooled modules have five wattage ranges. Line regulation of each series is  $\pm 0.01\%$ ; and load regulation is  $\pm 0.05\%$ . Ripple and noise is 0.5 mV rms, 2 mV pk-pk at 60 Hz.

CIRCLE NO. 304

### Converter boosts 15-V input to 1 kV



Sierra Systems, 650 Vaqueros, Sunnyvale, Calif. 94086. (408) 733-7040. \$97.50; stock.

Model 710-450 high-voltage dc/dc converter module is designed for PC-card mounting. Input and output voltages are 15 and 1000 V, respectively. The output voltage tracks the input voltage over a range from 750 to 1250 V. Rated power output is 6 W, and efficiency at 6 W is 65%. No-load to full-load regulation is 5% and ripple is 0.5% pk-pk at full load. The converter operates at a frequency greater than 20 kHz. Size is 1.25  $\times$  2.35  $\times$  3.35 in. and weight is 8 oz.

CIRCLE NO. 305

## Modular sources are programmable

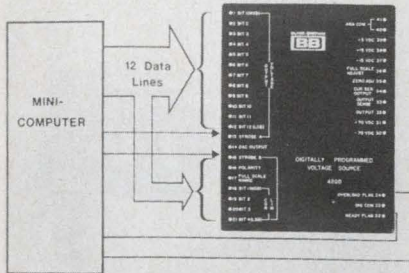

Burr-Brown Research Corp., International Airport Industrial Park, Tucson, Ariz. 85706. (602) 294-1431. \$650; stock to 4 wks.

Said to be the first modular, digitally programmed voltage sources (DPVS), these units are designed to be used in automatic computer-controlled test equipment and process-control systems. Models 4800 and 4801 can be interfaced with any minicomputer. The 4800 features 12-bit plus sign binary inputs while the 4801 features three BCD digits plus sign. These units have two digitally selectable output voltage ranges;  $\pm 10$  V dc and  $\pm 60$  V dc, both at 200 mA. Output settles to  $\pm 0.01\%$  in 100  $\mu$ s. Both units will drive capacitive loads to 1  $\mu$ F.

CIRCLE NO. 306

## Lithium battery comes in 1/2-AA size



Power Conversion Inc., 70 MacQuesten Pky S., Mount Vernon, N.Y. 10550. (914) 699-7333. \$1.68 (100 up); immed. delivery.

Model 400-5 "1/2-AA" cell size has been added to the company's line of Eternacell lithium primary batteries. Like all Eternacell batteries, the new cell exhibits a nominal voltage of 2.80 V, twice that of ordinary primary cells. Rated capacity is 0.6 A-h at 20 mA current drain and weight is 4.3 grams. Each cell is 0.56 in. dia. and 0.92 in. high. Shelf life is at least 5 years, and low-temperature operation goes down to  $-65$  F.

CIRCLE NO. 307

# Volts My Line?

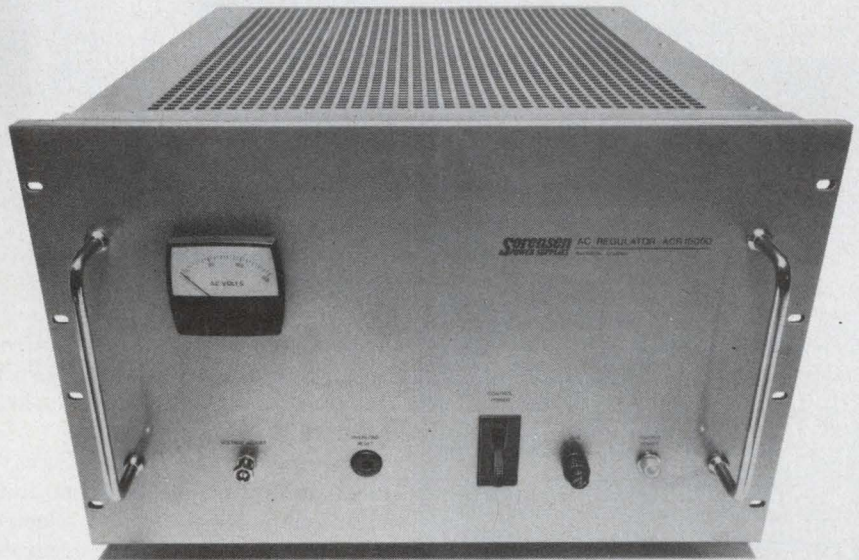

Holding that line-voltage. AC voltage regulation is efficient with the Sorensen ACR Series all solid-state regulators. Problems and damage caused by erratic line voltage are eliminated . . . performance is maximized with ACR features that include MTBF > 25,000 hours . . . remote sensing and remote programming capabilities . . . electronic current limiting . . . adjustable output voltage . . . power outputs to 15kVA—depending on model. Eight models in series. Three-phase systems available. For complete data, contact the Marketing Manager at Sorensen Company, a Unit of Raytheon Company, Manchester, N.H. (603) 668-4500.

### Representative Specifications — ACR

- Input Voltage: 95 to 130 Vac
- Total Regulation: 0.4% to 0.6%
- Efficiency: to 95%
- Price Range: \$380 to \$1775

## Sorensen POWER SUPPLIES

# SEMICONDUCTOR NOISE ANALYZERS

Noise testing of transistors is fast and efficient with Quan-Tech's Transistor Noise Test Sets.

From the compact, low cost (\$1495.), simple to operate Model 512B

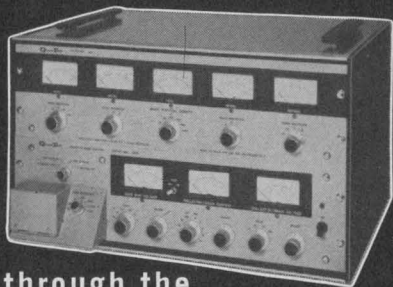
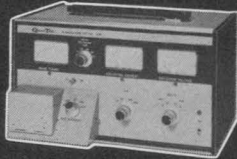

through the highly versatile Model 2173C-2181 transistor noise analyzer, 11 instruments are available to meet every laboratory or production line requirement. Measure field-effect and bipolar transistors, ICs, diodes, op-amps, and thick and thin film resistors.

Features available include:

- Direct measurement of popcorn, burst, flicker and broadband noise figures.
- Noise measurements at selected frequencies from 10 Hz through 100 KHz.
- Integral power sources.
- Automatic self calibration.
- Meets Standards for Industry and Government.

Call or write for a complete technical file on noise measurements or a demonstration.

## Quan-Tech<sup>®</sup> 41

Division of SCIENTIFIC-ATLANTA, Inc.  
Randolph Park West, Route #10, Randolph Township, N.J. 07801 • Tel: (201) 361-3100

## COMPONENTS

### Elapsed-time indicator is tamper proof

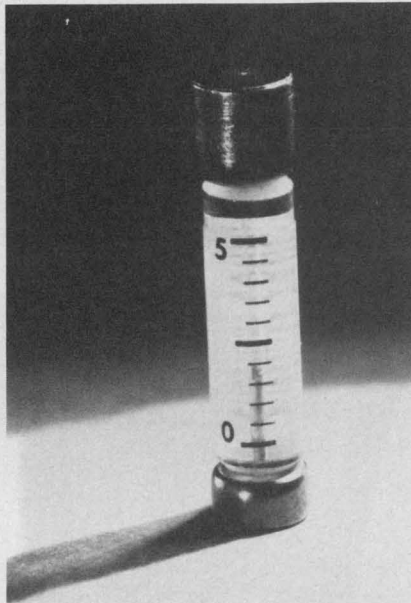

North American Philips Controls Corp., Cheshire Industrial Park, Cheshire, Conn. 06410. (203) 272-0301. \$2 (250).

The newly developed Series 49800 miniature elapsed-time indicator employs a simple electroplating process to provide accurate, nonreversible direct scale readouts of actual operating time. The device is approximately the size and configuration of a standard automobile fuse. In addition to compact size and low cost (\$1.00 in very large OEM quantities), the indicator is virtually tamper-proof. Models are available for 1000, 2000, 5000 and 10,000 h. The indicator operates on the coulometry principle. When a controlled dc current is applied across the indicator's terminals, there is a precise build-up of a copper column in the unit's calibrated glass tube. The mass of copper deposited is directly proportional to the length of time the current is applied. The tube, calibrated in hourly increments, affords direct readouts of equipment use time. Expected uses for the indicator include warranty validation, preventative maintenance and safety inspections of equipment and major components in a wide range of consumer, industrial and scientific equipment.

CIRCLE NO. 308

### PM gear motor provides synchronous operation

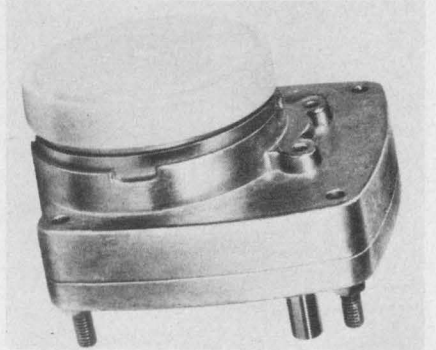

Molon Motor & Coil Corp., 3737 Industrial Ave., Rolling Meadows, Ill. 60008. (312) 259-3750. \$12 (5000 up).

A new PM gearmotor, identified as Model LHM, is 2-1/8-in. long and quiet in operation. The motor is reversible, splits the phase with a permanent capacitor and operates at 300-rpm synchronous speed with fast start/stop, braking and detent-torque characteristics. It's available in 6 to 240 V ac and 50 or 60 Hz. The motor's die-cast-zinc gearbox provides torques to 800 oz-in. at 1 rpm, in a standard version, and 1200 oz-in. at 1 rpm, in a heavy-duty version. A selection of gear trains provides output speeds from 1/60 to 60 rpm.

CIRCLE NO. 309

### Board-mounted switch provides 16-bit words

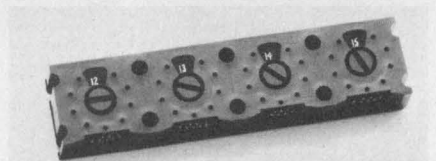

Electronic Engineering Company of California, 1441 E. Chestnut Ave., Santa Ana, Calif. 92701. (714) 835-6000. Under \$1.00 (OEM qty); 16 wks.

EECO's Stripswitch provides a small and inexpensive method for programming with 16-bit words. The switch is wave soldered directly on PC boards, vertically or horizontally, and on either side of the board. The units are one-piece molded with up to six switch stations per strip. The switches are also available in eight, 10 or 12 positions with decimal, BCD, BCD with complement and special binary codes in one and two-pole models.

CIRCLE NO. 310

# go portable

## Introducing THE Digital Panel Meter for Portable Instruments

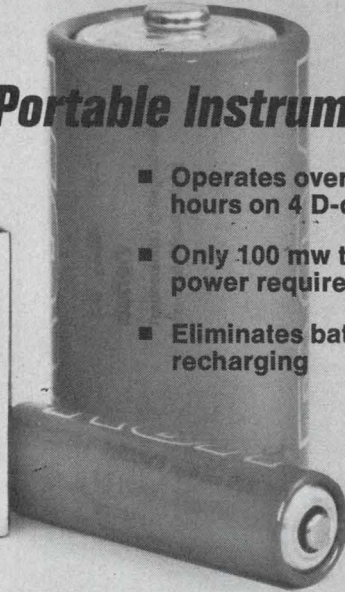

- Operates over 600 hours on 4 D-cells
- Only 100 mw total power required
- Eliminates battery recharging

NOW, make your portable instruments smaller, lighter, less expensive and more reliable. With the Datascan Model 820 battery powered DPM, you also get a bright, reliable and readable 3½ digit LED display, 0.1% (of reading) accuracy, battery input voltage from 4.8 to 8.0\* volts and an attractive miniaturized metal case that's only 3.5" deep x 2.5" wide x 1.3" high.

To get complete specs or to arrange for a demonstration, call or write. We're anxious to help you GO PORTABLE.

\*other ranges available.



Datascan  
Electronic  
Products

P.O. Box 785  
1111 Paulison Ave.  
Clifton, N.J. 07013  
Telephone: (201) 478-2800

### Datascan

INFORMATION RETRIEVAL NUMBER 89

## ATLAS positively guarantees...

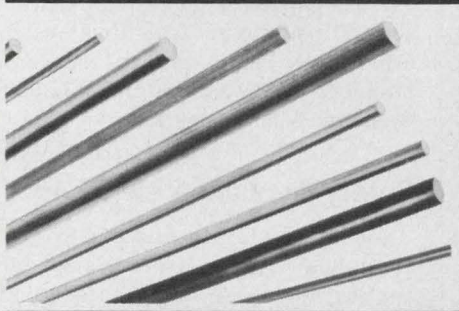

- ▼ fastest delivery
- ▼ unsurpassed accuracy
- ▼ lowest prices

on Turned and Precision-Ground

## PHENOLIC RODS

EPOXY

BAKELITE

Glass Supported TEFLON

- Stock sizes in any diameter from 3/32" to 1/2"
- Increments of .001 at no extra charge
- Most sizes available for immediate delivery
- Accuracy guaranteed to ± .001"

Plus . . . the largest inventory in the world!

SEND FOR  
COMPLETE  
PRICE LIST

### ATLAS FIBRE COMPANY

6980 N. Central Pk. Ave. Chicago, Ill. 60645  
(312) 465-1234

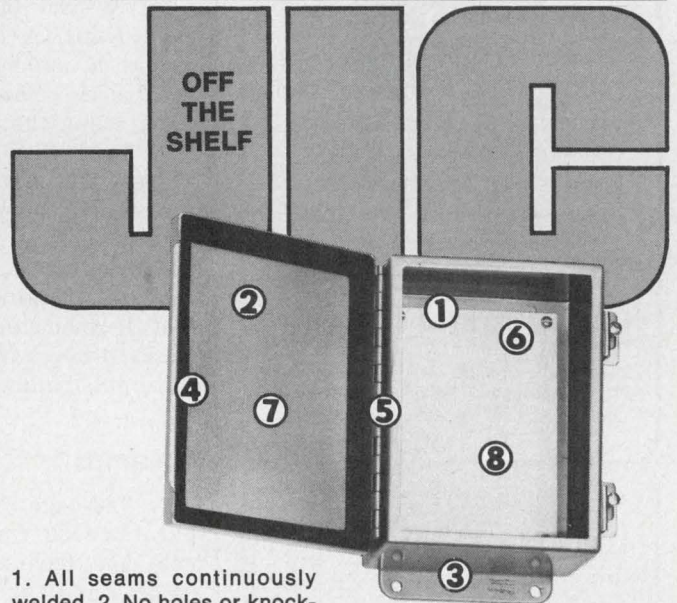

1. All seams continuously welded.
2. No holes or knock-outs.
3. External mounting feet.
4. Neoprene gasket with oil resistant adhesive.
5. Eight series for various applications: clamp and screw covers.
6. Most boxes have four weldnuts for optional panels and terminal kits.
7. From 4" x 4" x 3" to 16" x 14" x 6".
8. Choice of metals and finishes. For complete specifications write for Bulletins A-51 and A-53.

## Hoffman®

HOFFMAN ENGINEERING COMPANY  
Division of Federal Cartridge Corporation  
Anoka, Minnesota, Dept. ED 21

## ELECTRICAL ENCLOSURES

INFORMATION RETRIEVAL NUMBER 90

ELECTRONIC DESIGN 16, August 2, 1974

INFORMATION RETRIEVAL NUMBER 91

157

# AMPERITE

## Thermostatic RELAYS

- LONG DELAY -



240 & 300 Seconds

New! For applications requiring long delays. Hermetically sealed — not affected by altitude, moisture, or climate changes... SPST only — normally open or normally closed... Compensated for ambient

temperature changes from -55° to +80°C... Rugged, explosion-proof, long-lived... Standard radio octal base only.

Price, under \$6.00 ea.

Write for Bulletin No. LD-73.

DELAYS:  
2 to 180  
SECONDS\*

Same rugged construction, hermetic sealing and stability as the long Delay Relays described above... For standard radio octal and 9-pin miniatures.

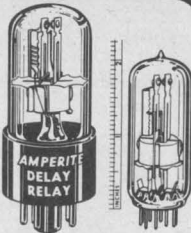

Price, standard or min., under \$4.00 ea.

\*Miniatures delays: 2 to 120 seconds.

PROBLEM? Send for Bulletin No. TR-81.

All Amperite Delay Relays are recognized under component program of Underwriters' Laboratories, Inc. for all voltages up to and including 115V.

## DIFFERENTIAL RELAYS

For automatic overload, over-voltage or under-voltage protection... Made only to specifications for 70V, 80V, 90V and 100V.

Price, under \$6.00 ea.

## AMPERITE BALLAST REGULATORS

Automatically keeps current and voltage at a definite value. For AC or DC... Hermetically sealed, rugged, vibration-resistant, compact, most inexpensive.

Price, under \$3.00 ea.

Write for 4-p. Bulletin No. AB-51.

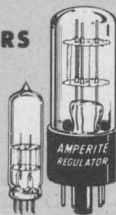

# AMPERITE

600 PALISADE AVE., UNION CITY, N.J. 07087

Telephone: 201 UNION 4-9503

In Canada: Atlas Electronics, Ltd.,  
50 Wingold Ave., Toronto 19

## application notes

### Voltage regulation

Details on the theory, design and operation of voltage regulators are presented in a 20-page brochure. Test data and conclusions are illustrated with tables, schematics, graphs and photos of oscilloscope tracings. A chart shows which types of regulators are appropriate for 39 widely used groups of business and industrial machinery, including process controls and computers. Sola Electric, Elk Grove Village, Ill.

CIRCLE NO. 320

### Control system problems

In a Calculator Application Summary, a software package that can analyze a control system up to the 10th order in just a few minutes is described. Hewlett-Packard, Palo Alto, Calif.

CIRCLE NO. 321

### A/d conversion methods

"Function and Application of 3-1/2-Digit A/D Converter Set" covers a number of methods of constructing a/d converter systems, using the company's LD110/LD111 IC chip set. Practical a/d circuits are offered, including auto-ranging digital voltmeters, isolated analog optical processors, ratio measurement, current-to-voltage converters, digital frequency meters and thermometers and a multiplexed BCD-to-parallel-BCD converter. Siliconix, Santa Clara, Calif.

CIRCLE NO. 322

### Op amps

A 136-page book contains applications on the company's products and technical discussions on op amp and function modules. The book has three indexes and is broken down into eight general product categories— op amps, a/d converters, logarithmic amplifiers, v/f converters, active filters, analog memories, measurement circuits and miscellaneous. The book costs \$5 or no charge with a \$50 purchase order for the company's products. Optical Electronics, P.O. Box 11140, Tucson, Ariz. 85706.

INQUIRE DIRECT

## evaluation samples

### Card handles

A PC card handle made of Diakon transparent acrylic MG/102/1 is available in three colors, clear, amber and red. The handle is a screw-on type and incorporates an identification strip. Vero Electronics.

CIRCLE NO. 323

### DIP connectors

A simple DIP connector allows users to make pin-to-pin connections in pluggable circuit boards. The 14 or 16-pin connectors eliminate the need for unnecessary wrapped-wire connections and simply plug into vacant IC receptacles. Garry Manufacturing.

CIRCLE NO. 324

### Plastic parts

A line of small nylon parts is available in flame-retardant Monsanto M-340-FR. This material carries the UL Type 1 rating in addition to the VE-O classification. Items available include transistor mounts, power transistor covers, capacitor mounts, machine screw insulators, finishing washers, plain and tapped spacers, bumpers, flat washers and shoulder washers. Micro Plastics.

CIRCLE NO. 325

### Rotary appliance switches

Models OAK 240 and 910 rotary appliance switches are designed for applications requiring long life and compactness. Power input ratings through 38 A, 2 hp, 12 to 240 V ac are available. Oak Industries.

CIRCLE NO. 326

### PC test jack

The PCJ-100 series test jacks can be used with 0.08-in. diameter test probes. The entrance holes will not permit entry of a probe larger than 0.085 in. diameter (as per MIL-C-39024). Contact material is beryllium copper per QQ-C-533 with a current rating of 5 A. Operating voltage is 1500 V<sub>RMS</sub> with a contact resistance of 5 mΩ max at rated current. JOLO Industries.

CIRCLE NO. 327



# A new autoranging multi-function counter using LSI/MOS from the "Counter House"

## \$349

Who else but FLUKE could bring you this new multi-counter at such an attractive price? A multi-counter that measures frequency or period—and totalizes too. Model 1900A from Fluke "The Counter House" has a dynamic range of 5 Hz to 80 MHz . . . advanced LSI/MOS circuitry . . . autoranging . . . and autoreset on all functions, gate times, filter and attenuator. And of course the 1900A incorporates all the traditional Fluke quality, and comes with a full 12-month guarantee plus a 15-day money-back policy.

Phone or write to-day for complete details on the \$349 multi-counter from Fluke — "The Counter House".

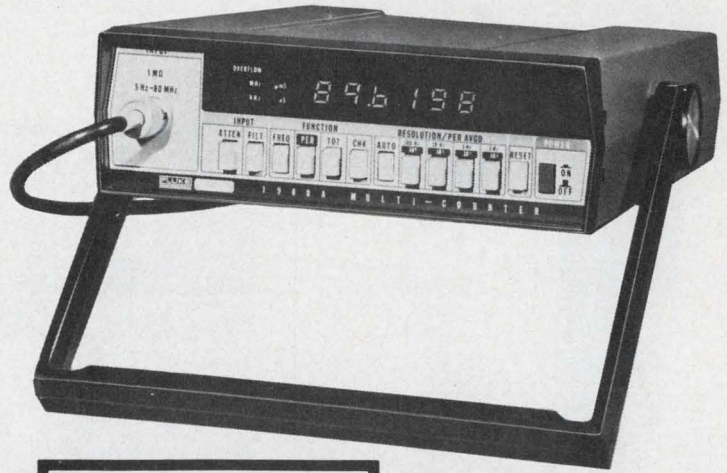

**FLUKE**  
COUNTER DIVISION

John Fluke Mfg. Co. Ltd., Counter Division,  
P.O. Box 1094, Station "D" Buffalo, N.Y., 14210.  
Phone (716) 842-0311. TWX 610-492-3214

INFORMATION RETRIEVAL NUMBER 93

**ALCOSWITCH** ©

Our subminiature TOGGLE SWITCHES are different . . . and better! This is because of the high degree of engineering expertise which went into their design. We offer many ALCO Exclusive Features at no hidden or additional costs.

MTA SERIES

Call us now to see what we mean. Our number is (617) 686-0126. Ask for a free sample, technical info and about cost savings!

ALCO ELECTRONIC PRODUCTS, INC.  
1551 Osgood St., No. Andover, Mass. 01845

**ALCOSWITCH** ©

INFORMATION RETRIEVAL NUMBER 94

**ALCOSWITCH** ©

Our PC mounted SLIDE switches have non-standard 3mm pin centers. That's how we manage to concentrate more poles in a limited space. Available in either silver or gold to meet your particular requirements.

MSS-PC SERIES

Don't hesitate to call (617) 686-0126 for additional information and samples on this full line of switches.

ALCO ELECTRONIC PRODUCTS, INC.  
1551 Osgood St., No. Andover, Mass. 01845

**ALCOSWITCH** ©

INFORMATION RETRIEVAL NUMBER 95

ELECTRONIC DESIGN 16, August 2, 1974

## automatic transfer standards

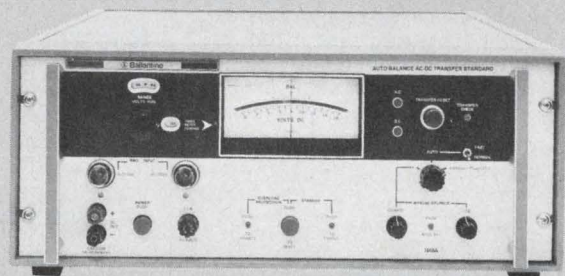

The 1600A Auto-Balance AC/DC Transfer Standard. Precise repeatable measurements every 30 seconds. Traceable to NBS. Takes tedium and guesswork out of 100 ppm transfer measurements in Lab, QA and production.

0.25 V to 1 kV rms, dc to > 100MHz: \$4500



**Ballantine Laboratories, Inc.**  
P.O. Box 97, Boonton, New Jersey 07005  
201-335-0900, TWX 710-987-8380

INFORMATION RETRIEVAL NUMBER 96

# Switch switches fast

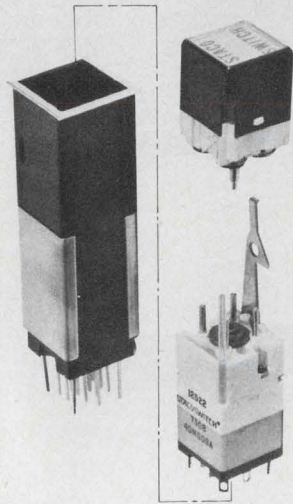

On those rare occasions when a switch malfunction shuts down equipment, STACO's Model 49 Illuminated Push-button Switch, with its plug-in switch module, can have things running again in less than 60 seconds. Simply flip a lever to remove the display pushbutton, and pull out the toilworn switch module. Slip in the plug-in replacement unit and reinsert the display pushbutton. It's that simple... and that fast!

No need to touch the behind-the-panel wiring. Once terminations are wired into the system, plug-in modules can be removed and replaced from front of panel. Choice of economical, dependable solder or wrap type terminations.

If your operation cannot tolerate downtime, then STACO's Model 49 can help keep the wheels turning. Its proven switch mechanism assures long service life and when at long last it needs replacing, a new module quickly plugs in. There's a choice of switch action and circuitry to meet your requirement.

When you think switch... think STACOSWITCH.

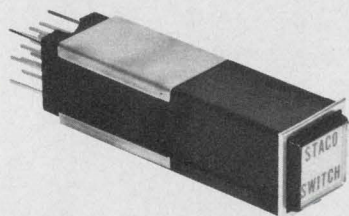

1139 BAKER STREET, COSTA MESA, CALIF. 92626  
(714) 549-3041 TWX 910 595 1507

Other STACO Company products: Fixed Ratio Transformers, STACO, INCORPORATED, Richmond, Indiana; Variable Transformers, STACO, INCORPORATED, Dayton, Ohio.

INFORMATION RETRIEVAL NUMBER 97

## new literature



### HV leads and connectors

Interconnecting leads and hermetic connectors for high-voltage applications are described in a 48-page catalog. Electrical and mechanical specifications along with application and dimensional data are included. AMP, Capatron Div., Elizabethtown, Penn.

CIRCLE NO. 328

### Integrated circuits

Integrated circuits for use in such applications as core memories, wire memories, peripheral equipment and tube drivers are covered in a 16-page catalog. Kyodo Electronic Laboratories, Kanagawa-ken, Japan.

CIRCLE NO. 329

### Recorders

An abbreviated catalog contains data on waveform and logic recorders. Biomation, Cupertino, Calif.

CIRCLE NO. 355

### Rf switches

Microwave coaxial switches—including high performance, Dynaform, bladed and CATV types—are described in a 28-page catalog. A functional selection chart divides criteria for selecting the proper switch into four basic categories—frequency range (GHz), function, size and general over-all characteristics—and provides product referencing page numbers. Amphenol RF Div., Danbury, Conn.

CIRCLE NO. 330

### Instruments

A 24-page catalog describes instrumentation and accessories for measurement of pressure, differential pressure, vacuum, flow and liquid levels throughout industry. Helpful selection charts include specifications of each product for quick comparison and application. Meriam Instrument, Cleveland, Ohio.

CIRCLE NO. 331

### Electrical penetrations

A 16-page brochure describes electrical penetrations designed for nuclear reactor containment vessels without disturbing the containment integrity under all conditions. Westinghouse, Electronic Tube Div., Elmira, N.Y.

CIRCLE NO. 332

### Mass memory subsystem

Series CL107MA high-speed militarized bulk-storage subsystem with NTDS controller, which interfaces many computer systems, is described in a data sheet. The Singer Co., Librascope Div., Glendale, Calif.

CIRCLE NO. 333

### Coaxial connectors

A 36-page catalog describes coaxial connectors. The four-color brochure contains specifications and outline drawings. Malco, Chicago, Ill.

CIRCLE NO. 334

### Active filters

"The State Variable Active Filter Configuration Handbook" is one of a series that deals with active filter design methods. The handbook offers the engineer or student a comprehensive compilation of over 200 state variable circuit configurations which includes diagrams, transfer functions, connection tables, dc analysis and a bibliography. The handbook is priced at \$5.95 (Calif. residents, add 6% tax). Estep Enterprises, 5217 Cangas Dr., Agoura, Calif. 91301.

INQUIRE DIRECT

**ABSOLUTELY**  
the world's most accurate rulings using vacuum deposit chrome, etch and fill or emulsion processes. They're produced on the world's largest 1 micro inch numerically controlled ruling engine with interferometric feedback controls. Need precision scales, grids, slits, reticles, Ronchis numbers, letters, circles, dots, or nickel mesh? We stock many items for immediate delivery. Send for brochure No. 38-36.

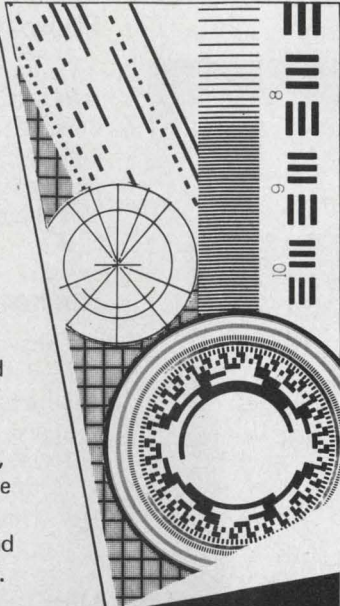

**SCALES RULINGS RETICLES  
& GRIDS FROM THE WORLDS  
LEADING SCALE MAKERS.**



JAMESTOWN, NY 14701 716/488-1958

INFORMATION RETRIEVAL NUMBER 98

## BLILEY CRYSTAL AND COMPONENT OVENS

- Oven Temperatures: 60° C, 70° C, 75° C, 85° C
- Stability:  $\pm 1^\circ$  C to  $\pm 0.1^\circ$  C over temp. range 0° C to +60° C
- Warmup Time @ -20° C: 20 min.  $\pm 1.0^\circ$  C  
30 min.  $\pm 0.1^\circ$  C
- Oven Voltages: 12 or 27 Vdc
- Internal Design Details:
  - Crystal Ovens: Sockets for MIL-types HC-32/U, HC-6/U, HC-36/U & HC-13/U
  - Component Ovens: Cavity sizes up to 2.7 cubic inches

Detail Specification Sheets Available On Request

*Bliley* if you buy quality

**BLILEY ELECTRIC COMPANY**  
2545 West Grandview Boulevard  
Erie, Pennsylvania 16512

INFORMATION RETRIEVAL NUMBER 99

for design  
engineers



**new  
fhp motor  
...and control  
catalog**

Just published! An expanded catalog covering more than 325 stock Bodine fractional horsepower motors, gearmotors, plus controls. Helps you select and match the right motor and control for your application.

Twenty pages, 75 illustrations, tables and drawings (all drawings decimalized). Includes 14 new gearmotors, adjustable speed/torque drive systems. Optional and accessory parts for motor controls fully tabulated. Also a performance chart on K-2 motors . . . covers normal slip, high slip and synchronous motors. Ask for Catalog S-5.

**BODINE**  
fractional/horsepower  
**MOTORS**

Bodine Electric Co., 2528 West Bradley Pl., Chicago, Ill. 60618

INFORMATION RETRIEVAL NUMBER 100

ELECTRONIC DESIGN 16, August 2, 1974

## HUNT: THE CASE PLACE

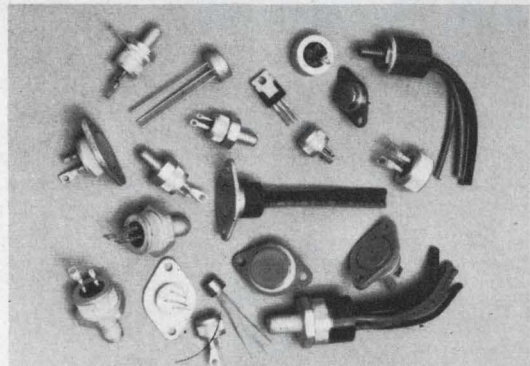

Need thyristors (triacs and SCR's) in a variety of cases? You can get 'em at the case place. Write Hunt for a brochure, or call toll-free 800-645-9200.



**HUNT ELECTRONICS**  
2639 Mañana, Dallas, Texas 75220  
(214) 350-5571

**oem**

INFORMATION RETRIEVAL NUMBER 101

# Keystone THERMISTOR TASK MINDERS

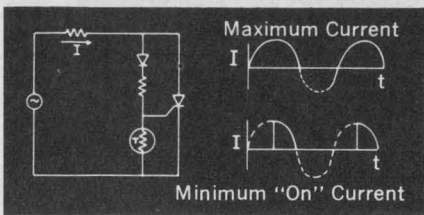
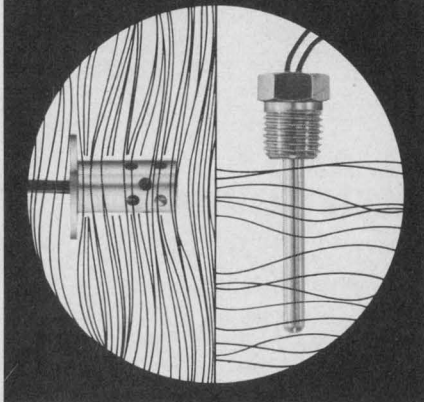

## LOW-COST TEMPERATURE CONTROL

As the resistance of the thermistor decreases, a larger voltage is required to fire the SCR. In this circuit, conduction angles from 90° to 180° can be achieved. Thus, the minimum "on" current will be 50% of the maximum "on" current.

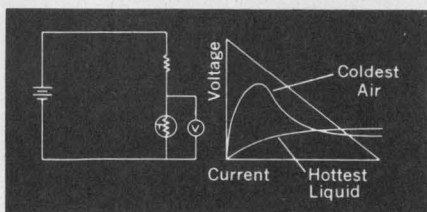

## LIQUID LEVEL DETECTION

Taking advantage of the difference in dissipation constant between a liquid and a gas enables thermistors to serve as liquid level sensors over a wide range of temperatures.

Send for 12-page thermistor probe catalog detailing 23 styles and 6 applications.

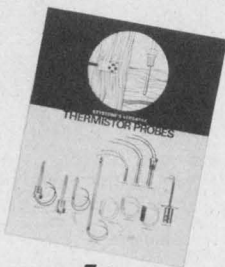

**Keystone**  
CARBON COMPANY  
Thermistor Division  
St. Marys, PA 15857  
814/781-1591 • Telex 91-4517

## NEW LITERATURE

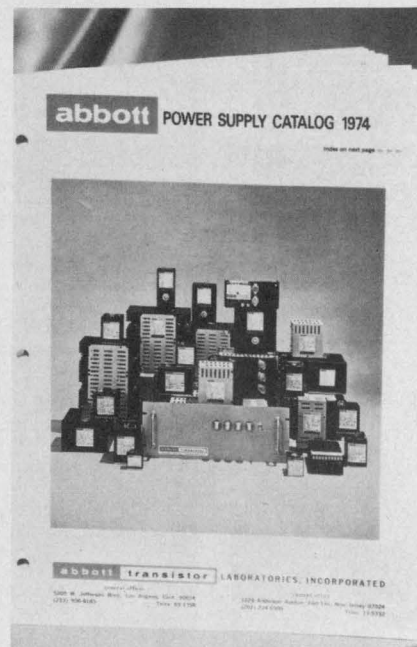

## Power supplies

Over 2616 power supplies are detailed with electrical specifications, operating parameters, dimensional charts and prices. A variety of options are presented. Abbott Transistor, Los Angeles, Calif.

CIRCLE NO. 335

## CATV/MATV cable

Physical and electrical characteristics of more than 50 standard CATV/MATV cables are presented in a 20-page illustrated booklet. The easy-to-read tabular format of the catalog divides the product line into RG-59/U type, RG-6/U type and special application classifications. Belden, Geneva, Ill.

CIRCLE NO. 336

## Subminiature lamps

A 44-page catalog contains technical information on T-3/4, T-7/8, T-1, T-1-1/4, T-1-3/4, and T-2 subminiature lamps. The catalog provides a numerical index. Oshino Electric Lamp Works, Tokyo, Japan.

CIRCLE NO. 337

## Ceramic capacitors

A four-page specification bulletin describes porcelain ceramic multilayer capacitors. Dimensional drawings, performance curves and ordering information are included. JFD Electronics Components Corp., Brooklyn, N.Y.

CIRCLE NO. 338

## Photocells

Cadmium-sulfide photoconductive cells, cadmium-selenide photoconductive cells and selenium photo-voltaic cells are described in a 24-page catalog. Moririca Electronics, Yokohama, Japan.

CIRCLE NO. 339

## Rocker switches

Snap-action rocker switches designed for test and measuring instruments, auto and recreational vehicles, appliances, computers, industrial controls are described in a four-page bulletin. Littelfuse, Des Plaines, Ill.

CIRCLE NO. 340

## High perm ferrites

Guaranteed electrical specifications for high permeability ferrites are covered in a 32-page broadband ferrite guide. They include shunt resistance and reactance per turn squared, temperature coefficient, disaccommodation and hysteresis core constant. Applications information and design examples are included for both high and low-frequency transformers. Indiana General, Keasbey, N.J.

CIRCLE NO. 341

## PC connectors

A 36-page catalog provides PC board connector dimensional specifications in millimeters as well as inches. Amphenol Industrial Div., Chicago, Ill.

CIRCLE NO. 342

## Formatters

A 52-page, 27-illustration technical booklet describes the design and implementation of the ANSI standard for 1600 bpi, phase-encoded recording using 0.25-in., 4-track, magnetic-tape cartridges. The brochure includes sections on the fundamentals of phase-encoding, system design considerations and a circuit description of the company's Model 337 Formatter which implements the standard. Kennedy, Altadena, Calif.

CIRCLE NO. 343

## Annunciators

A 16-page brochure describes the DMA-7700 series annunciators. Tec, Tucson, Ariz.

CIRCLE NO. 357



## The Digisec® Encoder keeps little bits from becoming big mistakes.

As some people have found out the hard way, all bits are not of equal length. And what may appear to be just a small error—say a fraction of an arc-second, can lead to a large accumulated error.

As the long recognized leader in encoders, Itek realizes the importance of maintaining accuracy commensurate with resolution. And Digisec Encoders have resolutions and accuracy up to 22 bits/revolution. But that's just part of the story.

Write for our free catalog. Read all about Digisec Encoders. They're more than a bit ahead of their time.

**Itek** Measurement Systems

A Division of Itek Corporation  
27 Christina Street, Newton, Mass. 02161

INFORMATION RETRIEVAL NUMBER 103

# FREE!

8-PAGE SECOND EDITION

## SCR POWER CONTROLLER APPLICATIONS GUIDE

The purpose of this guide is to assist the design engineer in selecting the proper SCR Power Controller for a specific application. It contains five pages of technical details including SCR firing, a comparison of on-off and proportional control modes, general design features, application consideration, performance options and a list of major parameters that must be considered when selecting a controller. Also included is an informative discussion on six-SCR versus three-SCR Hybrid models for three-phase systems. Vectrol power controllers are offered in 30 to 400 amp models.

SEND FOR YOUR FREE COPY TODAY



**VECTROL INC.**

1010 WESTMORE AVE., ROCKVILLE, MD. 20850, U.S.A. (301) 424-6900

INFORMATION RETRIEVAL NUMBER 104

ELECTRONIC DESIGN 16, August 2, 1974

# i'm free



**I'M A MAIL-LITE® SHIPPER**

**1 CASE of Mail-Lite FREE when you buy my \$50 table model heat sealer.**

**2 CASES of Mail-Lite FREE when you buy my \$100 floor model heat sealer.**



*Labor Savings: Can be heat sealed closed in 2 seconds*  
*Postal Savings • Waterproof • Pileproof • Lightweight • Clean*



WRITE TODAY FOR INFORMATION ON OUR MAIL-LITE SHIPPERS AND THE SPECIAL HEAT SEALER OFFER.

**Sealed Air Corporation**

19-01 State Highway 208, Fair Lawn, New Jersey 07410

INFORMATION RETRIEVAL NUMBER 105

## FOR THE UTMOST IN RELIABILITY

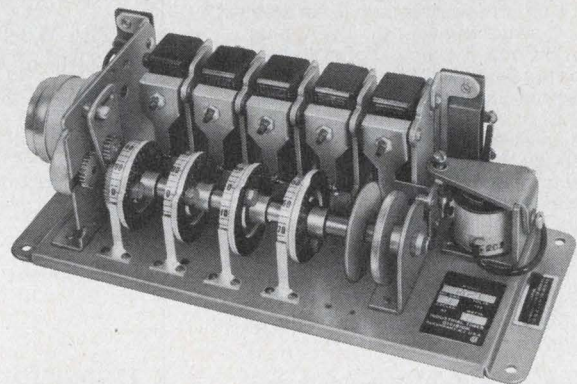

## RECYCLING TIMERS Series RC

This multi-cam timer is one of a family of very versatile recycling timers that are available in single or recycling types with up to 20 control circuits. Control cams are independently adjustable from 2% to 98% of the total time cycles enabling the timer to be used as a programming device. And with supplied interchangeable gear and rack assemblies you can select from 700 time cycles ranging from 2/3 second up to 72 hours. All our timers are made to give you service far beyond what you'd reason-

ably expect. Our line consists of 17 basic types, each available in various mountings, voltages, cycles, circuits and load ratings . . . and with whatever special wrinkles you may need. Bulletin #206 tells all about our line of reliable Recycling Timers. Write for it or a catalogue of our entire line. If you have an immediate timer requirement, send us your specifications. Or for fastest service, call (201) 887-2200.



**INDUSTRIAL TIMER**

A UNIT OF ESTERLINE CORPORATION

INFORMATION RETRIEVAL NUMBER 106

163

# Dual visual recognition switches with versatility and economy—that's yankee ingenuity.

Switchcraft's unique and highly versatile DVR Switches give you the advantage of advanced DUAL VISUAL RECOGNITION. When the pushbutton is "out," the black color band contrasts with the recognition cap; in the "in" position, only the colored recognition cap shows. It means we've made it easier to see the switch position, eliminating false indications.

This kind of advanced "human engineering"—plus its low cost—makes DVR ideal for applications in EDP, computer systems and peripheral equipment, sound and communications equipment, and telephone equipment. You get reliability and economy in one little package.

DVR Switches in either momentary or push-lock/push-release functions offer up to 4-C switching. Standard silver-plated, U-shaped bifurcated sliders are rated at 0.5 amp D.C., or 3 amps A.C., 125 V non-inductive load are ideal for dry circuit use. An 11 amp power module is offered with 1-C switching (depth: 1 1/32"), plus additional 1-C or 2-C of standard bifurcated switching (depth: 2 1/32"). Solder lug terminals are standard; P.C. or wire wrapping terminals are available. DVR switches mount in a single 1 1/32" hole and offer a variety of colors, styles, mounting hardware and legends.

Only Switchcraft—and a little Yankee Ingenuity—gives you all this for so little. Contact your Switchcraft Representative or Switchcraft, 5555 N. Elston Avenue, Chicago, Illinois 60630.

**SWITCHCRAFT®**

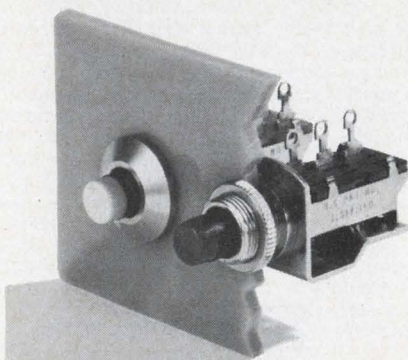

INFORMATION RETRIEVAL NUMBER 107

## NEW LITERATURE

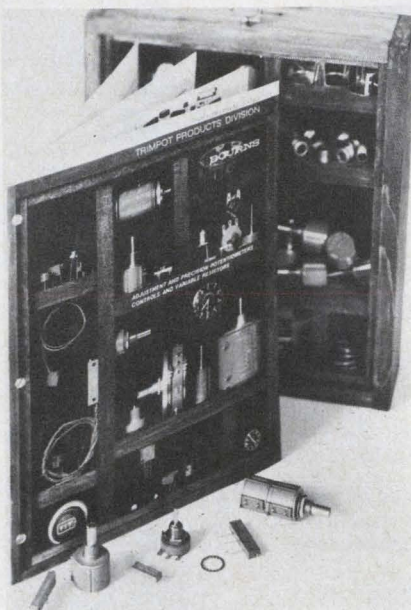

### Resistive components

Data on resistive components, including adjustment and precision potentiometers, controls and variable resistors, are presented in a 20-page catalog. A one-page index provides a ready reference. Technical data, specifications, selected cutaway views and pricing are presented. Bourns Trimpot Products Div., Riverside, Calif.

CIRCLE NO. 344

### Ham-radio equipment

The World of Amateur Radio is the title of a 20-page catalog which presents features, specifications and prices on the company's transceivers, linear amplifiers, fixed and mobile antennas and compatible accessories for the ham radio enthusiast. Swan Electronics, Ocean-side, Calif.

CIRCLE NO. 345

### Transistors and FETs

A 24-page guide to bipolar transistors and FETs lists 1162 industry part numbers in alphanumeric order, showing JEDEC-registered 2N and 3N numbers, followed by the house numbers of all major suppliers. For each part listed, there is a description and indication of its typical application. The guide lists the company's equivalent part numbers and package-type number. Intersil, Cupertino, Calif.

CIRCLE NO. 346

## ATTENUATORS

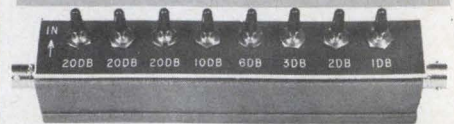

**MODEL AT-42** 1-9 QUANTITY \$70.00  
 • ATTENUATION RANGE 0-42 DB IN 1 DB STEPS  
 • IMPEDANCE 50 Ω OR 75 Ω  
 • FREQUENCY RANGE DC TO 300 MC

**MODEL AT-82** 1-9 QUANTITY \$85.00  
 • ATTENUATION RANGE 0-82 DB IN 1 DB STEPS  
 • IMPEDANCE 50 Ω OR 75 Ω  
 • FREQUENCY RANGE DC TO 300 MC

CHECK READER SERVICE #71

## CRYSTAL OSCILLATORS

**MODEL EXO-10**



FROM \$85.00

Stability 0.005%  
 Operating Temperature Range 0°C to +70°C  
 Power Out >10 Milliwatts into 50 Ω  
 Spurious & Harmonic Distortion >25 db down  
 Frequency Range 1-300 mc  
 Input Power -15 vdc

CHECK READER SERVICE #72

## HOPE ELECTRONICS

BOX 773, CLIFTON, N.J. 07013 (201) 777-3522

INFORMATION RETRIEVAL NUMBER 108

## High-Accuracy

# Phase Meters

0.5 Hz to 2 MHz

Digital or meter readouts

As low as \$1050



930 E. Meadow Dr. Palo Alto, Ca. 94303  
 (415) 321-7428

INFORMATION RETRIEVAL NUMBER 127

# bulletin board

Introduction of a 250-W Metalarc lamp to its line of high intensity discharge light sources for indoor and outdoor use has been announced by GTE Sylvania.

CIRCLE NO. 347

R.F. Power Labs has introduced rf signal processing components housed in 14-pin dual inline packages compatible with standard DIP devices used in logic and dc circuitry.

CIRCLE NO. 348

Bunker Ramo's Amphenol Cadre Div. will custom-produce any configuration of modem or data cable required by the computer and peripheral-equipment industry.

CIRCLE NO. 349

Four Hewlett-Packard optically coupled isolators have received component recognition by Underwriters' Laboratories, based upon test results for insulation voltage of 2500 V dc.

CIRCLE NO. 350

Bud Radio has introduced instrument enclosures designed to accommodate an accessory chassis or 1/16 in. thick PC boards. The chasis is reversible, therefore two configurations are possible with one unit.

CIRCLE NO. 351

## Price reductions

Texas Instruments SR-50 slide-rule calculator has been reduced from \$169.95 to \$149.95.

CIRCLE NO. 352

Motorola has reduced CMOS pricing on MSI functions by an average of 25% to as much as 50%.

CIRCLE NO. 353

Price cuts for all Darlington amplifiers averaging about 15% have been announced by TRW Semiconductors.

CIRCLE NO. 354

# TC CHIPS BY RMC

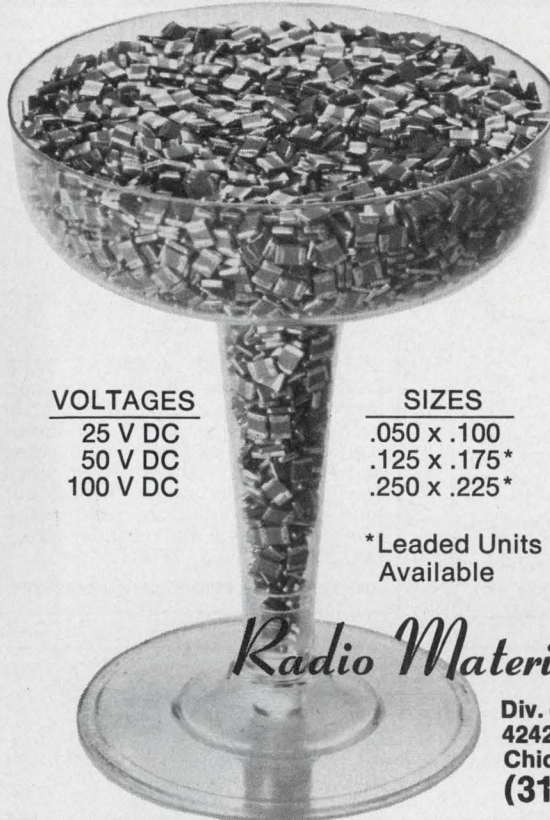

TEMPERATURE  
COMPENSATING  
MULTILAYER  
CAPACITORS

### VOLTAGES

25 V DC  
50 V DC  
100 V DC

### SIZES

.050 x .100  
.125 x .175\*  
.250 x .225\*

\*Leaded Units  
Available

### TCs

P100  
NPO  
N80  
N150  
N220  
N330  
N470  
N750

*Radio Materials Company*

Div. of P. R. Mallory & Co. Inc.  
4242 West Bryn Mawr Avenue  
Chicago, Illinois 60646  
(312) 478-3600

INFORMATION RETRIEVAL NUMBER 109

IT'S  
**CONCORD**  
FOR...

CONNECTORS/P.C.

**JACKS**

BERYLLIUM  
COPPER  
CAGES

**& PINS**

STANDARD & CUSTOM

**CONCORD ELECTRONICS CORPORATION**

37 GREAT JONES STREET • NEW YORK, N.Y. 10012  
(212) 777-6571 • TWX 710-581-4930

FREE CATALOG AVAILABLE.

INFORMATION RETRIEVAL NUMBER 110

# PULSE AMPS

C-COR

Fast Rise Time  
High Output  
PULSE AMPLIFIERS  
ARE the best.

Performance is why!

FOR EXAMPLE:

MODEL	3310	3370-P	3374-P
Risetime	0.95 ns	0.6 ns	1.1 ns
Gain	30dB	20dB	20dB
Z In/Out	50/50 ohms	50/50 ohms	1m/50 ohms
Output	± 9 Vp into 50 ohms	± 3 Vp into 50 ohms	± 3 Vp into 50 ohms

For a complete amplifier catalog  
call, write, or wire:

*C-COR*  
*Electronics, Inc.*

60 Decibel Road  
State College, PA 16801  
814-238-2461  
TWX 510-691-1933

INFORMATION RETRIEVAL NUMBER 111

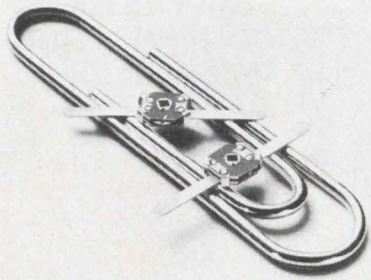

**Thin-Trim variable capacitors** provide a reliable means of adjusting capacitance without abrasive trimming or interchange of fixed capacitors. Series 9401 has high Q's and a range of capacitance values from 0.2-0.6 pf to 3.0-12.0 pf and 250 WVDC working voltage. Johanson Manufacturing Corporation, Boonton, New Jersey (201) 334-2676.

INFORMATION RETRIEVAL NUMBER 181

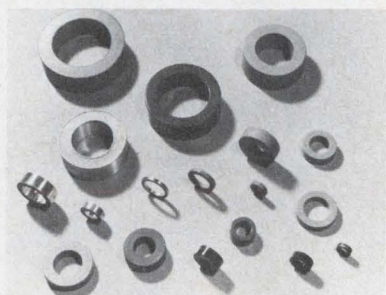

**3 THINGS MAKE A GREAT TAPE CORE:** The proper materials . . . correct engineering . . . Magnetics. Magnetics has been a leading supplier of high permeability tape wound cores and magnetic components since 1949. Our tape cores helped put men on the moon; are used exclusively for Viking Mars Lander. Magnetics, Butler, Pa. 16001.

INFORMATION RETRIEVAL NUMBER 184

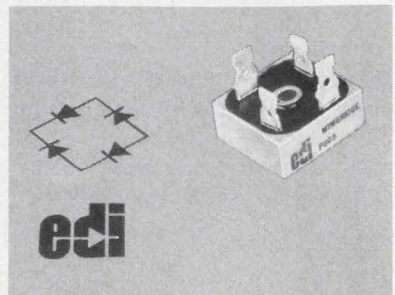

**30 Ampere silicon bridge rectifiers.** Features: 400 Amp surge capacity + new diffusion process + large junction area + lower forward voltage drop = lower power dissipation. Heat sink and chassis mounting. PRV 50 to 800 volts. Electronic Devices, Inc., 21 Gray Oaks Ave., Yonkers, N.Y. 10710, (914) 965-4400.

INFORMATION RETRIEVAL NUMBER 187

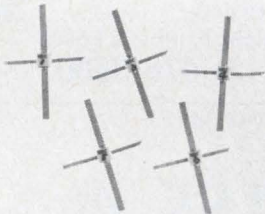

The **NEC V222 transistor** is a low noise amplifier with a minimum gain of 8 dB at 4 GHz. The V222 is available with three noise figure selections at 4 GHz: 3.5 dB, 4.0 dB and 4.5 dB. The package is the popular 100-mil square stripline. California Eastern Labs, Inc., One Edwards Court, Burlingame, Calif. (415) 342-7744.

INFORMATION RETRIEVAL NUMBER 182

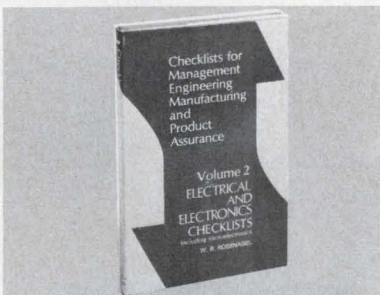

**Electrical/Electronics Checklists.** 22 detailed checklists to insure complete accuracy and efficiency for a broad array of designs. #9181, 190 pp., \$14.00. Circle the Info Retrieval No. to order 15-day exam copy. When billed, remit or return book with no obligation. Hayden Book Co. 50 Essex St., Rochelle Pk., N.J. 07660.

INFORMATION RETRIEVAL NUMBER 185

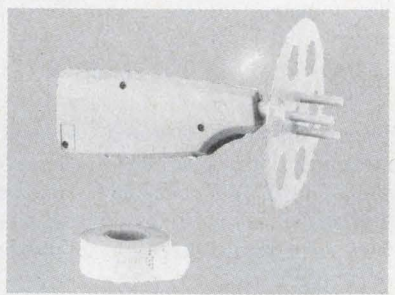

**Hi-Speed Cordless Paper Tape Winder** is light weight, portable and powered by its own internal battery pack. When not in use winder is attached to battery charging stand. Model 1000-1. \$50. A-B Supply Co., P.O. Box 5609, China Lake, Calif. 93555 (714) 375-7079

INFORMATION RETRIEVAL NUMBER 188



**Free catalog of 34,500 power supplies** from the worlds largest manufacturer of quality Power Supplies. New '74 catalog covers over 34,500 D.C. Power Supplies for every application. All units are UL approved, and meet most military and commercial specs for industrial and computer uses. Power Mate Corp. (201) 343-6294.

INFORMATION RETRIEVAL NUMBER 183

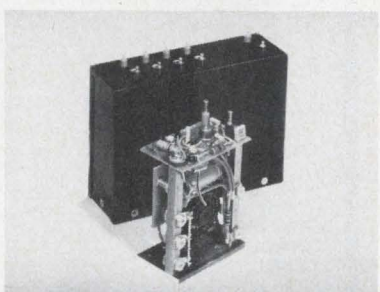

**Modular DC-DC power converters.** Designed to meet military/aerospace specs . . . priced for industrial applications. 12, 28, 48, 115 VDC inputs. 1-6 isolated, regulated (1% & 0.1%) outputs. 1-500 watts. Efficiencies to 85%. 1200 design-as-you-order configurations using standard modules. Arnold Magnetics, Culver City, Ca. (213) 870-7014.

INFORMATION RETRIEVAL NUMBER 186

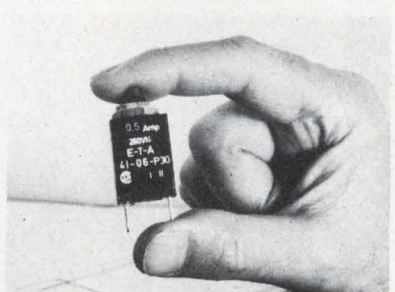

**Overcurrent Protector, manual reset** eliminates fuse replacement. Convenient panel mounting. 15 fractional ratings from 0.1 to 3 amp. Other models up to 400 amp. Trip-free and fool-proof, UL and CSA approved. High quality, low cost \$1.20 ea. in 1000 lots. E-T-A Products Co. of America, 7400 N. Croname Rd., Chicago, Ill. 60648. Tel: (312) 647-8303. Telex: 253780.

INFORMATION RETRIEVAL NUMBER 189



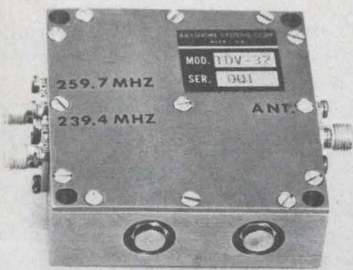

**Diplexers/Trip lexers**—A series of standard units have been developed to permit 2 transmitters to operate from one antenna on rockets, satellites and missiles. Available at VLF to S Band, 3 to 10% frequency separation, 20 to 50 dB isolation and up to 4000 G Shock and 150 G acceleration. Bayshore Systems Corporation Springfield, VA. (703) 321-9625.

INFORMATION RETRIEVAL NUMBER 190

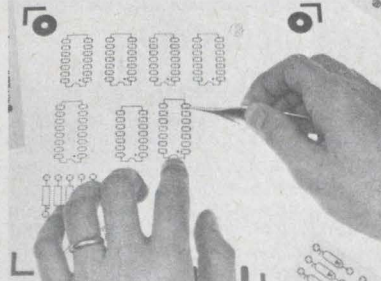

**Cut PC layout time 75%** with PUP-PETS™, Bishop's die-cut, transparent, reusable layout patterns in 2X or 4X scale that represent electronic components. Contain no adhesive yet adhere to any clear, non-matte drafting film. FREE Sample & technical bulletin. Bishop Graphics, Inc., 20450 Plummer Street, Chatsworth, CA 91311 (213) 993-1000.

INFORMATION RETRIEVAL NUMBER 193

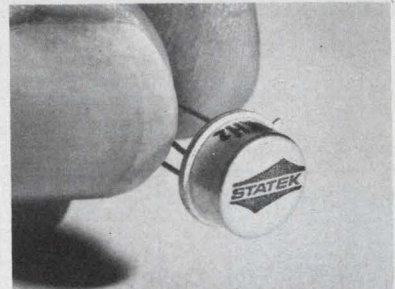

**10 KHz-250 KHz quartz crystals in TO-5's.** Use them for oscillators, filters, tone generators, timers. They're rugged \* accurate \* highly resistant to vibration & shock. Prices low as \$.95 in 100 k qty's. Send your written applications. We'll send a sample. Or, write for literature. Statek Corp., 1233 Alvarez Ave., Orange, Calif. 92668 (714) 639-7810

INFORMATION RETRIEVAL NUMBER 196

**FREE  
10 Ways  
To Use  
Conductive  
Paints**

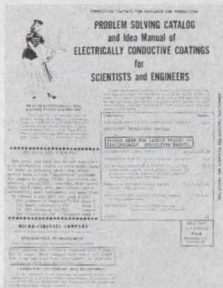

Our electrically conductive paints are solving "impossible" lab problems and reducing unit production costs. One customer saves a fortune each year PAINTING on four MILLION 1000 meg resistors. Think that over. Why not request "Ten Ways To Use Conductive Paints"? Micro Circuits Co., New Buffalo, Mich. 49117. (616) 469 2727.

INFORMATION RETRIEVAL NUMBER 191



**Introduction To Defense Radar Systems Engineering.** Excellent introduction and practical reference to radar systems design and applications. #9194, 260 pp., \$20.00. Circle the Info Retrieval No. to order 15-day exam copy. When billed, remit or return book with no obligation. Hayden Book Co. 50 Essex St. Rochelle Park, N.J. 07662

INFORMATION RETRIEVAL NUMBER 194

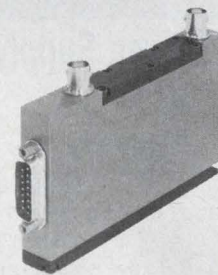

**Programmable Coaxial Attenuator**  
0 - 63.5 db Attenuation Range . . .  
.5 db Steps . . . DC thru 200 MHz  
. . . Seven Bit Binary Control . . .  
±2% Accuracy . . . Machined Aluminum Housing . . . MATRIX SYSTEMS CORPORATION . . . (213) 882-2008

INFORMATION RETRIEVAL NUMBER 197

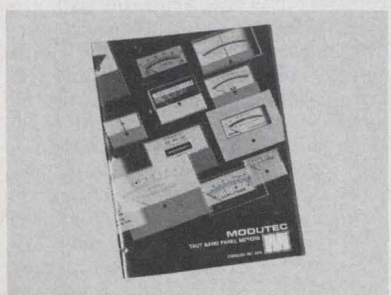

**Panel Meters shipped in One Week** (24 units or less) is Modutec's promise. Catalog 622 gives prices & specs on thousands of 1½" to 8" surface, bezel, and flush mount meters, includes new Multi-dial, Translit, and Thru-vue styles. Many options and modifications. Modutec, Inc., 18 Marshall St., Norwalk, Ct. 06854. (203) 853-3636 or TWX 710-468-2039.

INFORMATION RETRIEVAL NUMBER 192

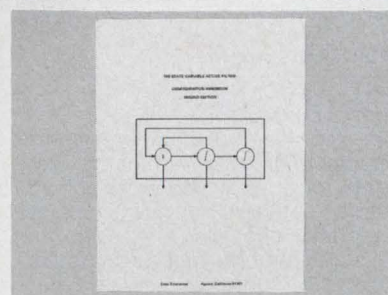

**Active Filter Handbook-Circuits, transfer functions and design data** for over 200 Active Filter realizations are included in this Handbook. Recognized as the most comprehensive practicum of 'universal' active filter design available anywhere. Estep Enterprises, 5217 Cangas Dr., Agoura, Ca. \$5.95 plus 85¢ postage. Cal. residents add 6% tax.

INFORMATION RETRIEVAL NUMBER 195

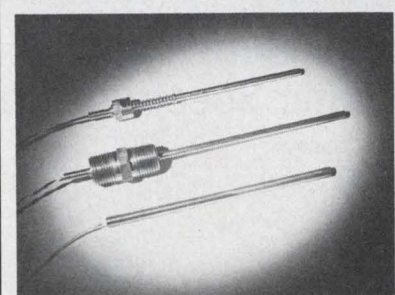

**Low Cost Temperature Sensors:** Platinum, Nickel-Iron, and Nickel temperature sensors for OEM Controller & sensing applications where linearity, and repeat-ability are required at low cost. Platinum sensors priced under \$15. in OEM quantities. Nickel-Iron under \$10. Call (collect) 617-891-8010 Thermalogic, 241 Crescent St., Waltham, Mass. 02154.

INFORMATION RETRIEVAL NUMBER 198

## The First Spectrum Analyzer-Calculator Simplifies Noise & Vibration Analysis in Real Time

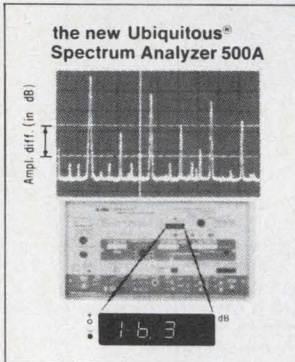

**New Ubiquitous® UA-500A** is world's first combination 500-line spectrum analyzer-averager that automatically **calculates** (computes): absolute frequency & amplitude in dB or % of full scale; relative amplitude above and below your calibration signal; frequency deviation from your chosen reference frequency; frequency in Hz and CPM (cycles/min.) for ease in reading RPM; which peaks are harmonically related by isolating them from others with harmonic markers or eliminating all else from the CRT display. Applications simplified include: machine diagnosis, rotating machine analysis, noise source identification, mechanical signatures, underwater acoustics, and noise reduction. Built-in dual memory averager allows comparison of past & present data. Small, portable, only 8¾" high. Highest speed: real-time 100% analysis to 10kHz. Thirteen ranges from 0-10Hz to 0-100kHz providing analysis bandwidths of .02Hz to 200Hz (also 0-5MHz direct input). Simplest to use.

**Nicolet Scientific Corp.** (formerly Federal Scientific Corp.)  
245 Livingston St., Northvale, New Jersey 07647  
(201) 767-7100. TWX: 710-991-9619

Immediate, circle No. 170  
Routine, circle No. 171

## New Kepco Power Supply Catalog and Handbook



Kepco, Inc. has published a new 1974 Power Supply Catalog and Handbook. In 130 pages, there are schematics and mechanical drawings of more than 30 power supply designs, encompassing several hundred separate models. The Kepco Catalog and Handbook includes applications material on high speed-fast programming models, digital control systems, measurements and power supply combinations. A comprehensive glossary is also included.

CIRCLE NO. 172

### KEPCO, INC.

131-38 Sanford Avenue, Flushing, N.Y. 11352  
(212) 461-7000

## Operator Can "Talk" Directly to Automatic Spectrum Processing System



Engineers without prior knowledge of computer operation "talk" directly to the SD1007D Automatic Spectrum Processing System after only brief indoctrination. Unusually flexible software allows complete operator/system interaction: changes in test procedures and data-processing input/output formats can be made as the test program requires. A single typed-in "DO" command in easily learned FOCAL language initiates an entire computer operation, complete to typed-out results. System includes a 500-line resolution Real Time Analyzer, large-screen oscilloscope, PDP 11-105 computer with 8K of core, and a Teletype for program loading, operator interaction and typing out results.

CIRCLE NO. 173

**Spectral Dynamics Corporation**  
P.O. Box 671, San Diego, Calif. 92112  
(714) 278-2501

ELECTRONIC DESIGN's function is:

- To aid progress in the electronics manufacturing industry by promoting good design.
- To give the electronic design engineer concepts and ideas that make his job easier and more productive.
- To provide a central source of timely electronics information.
- To promote communication among members of the electronics engineering community.

**Want a subscription?** ELECTRONIC DESIGN is sent free to qualified engineers and engineering managers doing design work, supervising design or setting standards in the United States and Western Europe. For a free subscription, use the application form bound in the magazine. If none is included, write to us direct for an application form.

If you do not qualify, you may take out a paid subscription for \$30 a year in the U.S.A., \$40 a year elsewhere. Single copies are \$1.50 each.

**If you change your address,** send us an old mailing label and your new address; there is generally a postcard for this bound in the magazine. You will have to requalify to continue receiving ELECTRONIC DESIGN free.

**The accuracy policy** of ELECTRONIC DESIGN is:

- To make diligent efforts to ensure the accuracy of editorial matter.
- To publish prompt corrections whenever inaccuracies are brought to our attention. Corrections appear in "Across the Desk."
- To encourage our readers as responsible members of our business community to report to us misleading or fraudulent advertising.
- To refuse any advertisement deemed to be misleading or fraudulent.

Microfilm copies are available of complete volumes of ELECTRONIC DESIGN at \$19 per volume, beginning with Volume 1, 1961 through Volume 20. Reprints of individual articles may be obtained for \$2.00 each, prepaid (\$1.50 for each additional copy of the same article) no matter how long the article. For further details and to place orders, contact the Customer Services Department, University Microfilms, 300 North Zeeb Road, Ann Arbor, Michigan 48106 telephone (313) 761-4700.

**Want to contact us?** If you have any comments or wish to submit a manuscript or article outline, address your correspondence to:

Editor  
ELECTRONIC DESIGN  
50 Essex Street  
Rochelle Park, N.J. 07662

recruitment  
and  
classified ads

**SAME DAY SHIPMENT**  
Minis & Peripherals  
**PRINTERS**

"**BRAND NEW**"  
**DATA PRODUCTS**  
2440- 700LPM  
2470-1250LPM  
**MDS 4320-300LPM**  
ALSO

**CENTRONICS, POTTER, CDC**  
**A. B. DICK, IBM, HIS, UNIVAC**  
617/261-1100

Send for Free Report  
"Maintenance of Computers"

**AMERICAN USED COMPUTER CORP.**

P.O. Box 68, Kenmore Sta., Boston MA 02215  
member COMPUTER DEALERS ASSOCIATION

CIRCLE NO. 242

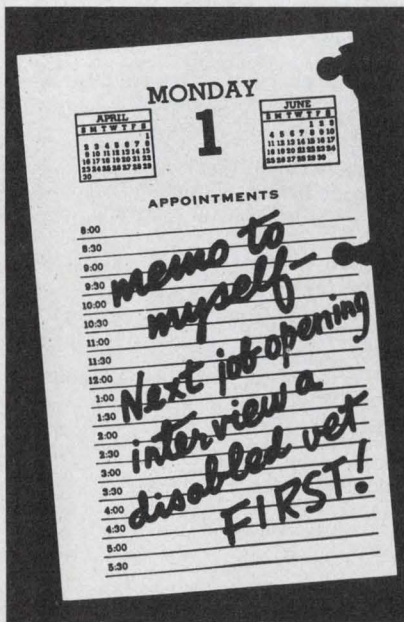

The President's Committee  
on Employment of the Handicapped  
Washington, D.C. 20210

# Electronic Design

## Advertising Sales Staff

Tom W. Carr  
Vice President &  
Sales Manager

## Rochelle Park, N.J. 07662

Robert W. Gascoigne  
Daniel J. Rowland  
(Recruitment, Quick Ads, Classified)  
50 Essex Street  
(201) 843-0550  
TWX: 710-990-5071

## Philadelphia

Thomas P. Barth  
50 Essex Street  
Rochelle Park, N.J. 07662  
(201) 843-0550

## Boston 02178

Gene Pritchard  
P.O. Box 379  
Belmont, Mass. 02178  
(617) 489-2340

## Chicago 60611

Thomas P. Kavooras  
Berry Conner, Jr.  
200 East Ontario  
(312) 337-0588

## Cleveland

Thomas P. Kavooras  
(Chicago)  
(312) 337-0588  
(call collect)

## Los Angeles 90303

Stanley I. Ehrenclou  
Burt Underwood  
2930 Imperial Highway  
Inglewood, Calif.  
(213) 757-0183

## San Francisco 94022

Jerry D. Latta  
P.O. Box 1248  
Los Altos, Calif.  
(415) 965-2636

## London

For United Kingdom and Europe  
John Ashcraft  
John Ashcraft & Co.  
12, Bear St.  
Leicester Square  
London WC2H 7AS England  
Phone: 01-930-0525  
W. J. M. Sanders  
John Ashcraft & Co.  
Herengracht 365  
Amsterdam C., Holland  
Phone: 020-24-09-08

## Tokyo

Haruki Hirayama  
Electronic Media Service  
5th Floor, Lila Bldg..  
4-9-8 Roppong  
Minato-ku  
Phone: 402-4556  
Cable: Electronicmedia, Tokyo



## PICTURE, PATTERN, OR PLOT



Alden recorder reproducing scanning electron microscope image of a 1 mil wire bond to an IC

Get sharp recordings displaying three dimensions and yielding greater detail and informational content than your present display with ALDEN COMPONENT FACSIMILE RECORDERS.

- Synchronizes easily with your scanning sensor or transducer
  - Available in print-out widths from 2" to 48"
  - Speeds range from 8 RPM to 3600 RPM
  - Presentations, linear or non-linear . . . simply
  - Used with a broad variety of systems such as ultrasonic/infrared flaw detectors, spectrum analyzers, computers, television, medical instrumentation and scanning radiometers, etc.
- Call or write for free descriptive catalog.

**ALDEN**

ELECTRONIC &  
IMPULSE RECORDING  
EQUIPMENT CO., INC.

Westboro, Mass. 01581 Tel.: (617) 366-8851

INFORMATION RETRIEVAL NUMBER 112

## THERMISTORS

BY

## THERMOMETRICS

**BEADS**

**PROBES**

**FLAKES**

**RODS**

**ASSEMBLIES**

obtain state-of-the-art performance at costs lower than your present commercial products

**SPECIAL CURVE MATCHES**

**HIGHEST STABILITY**

**0.05% TOLERANCES &  
INTERCHANGEABILITY**

**PRECISION CALIBRATION**

**FAST RESPONSE  
ASSEMBLIES (TO 3MS)**

**THERMOMETRICS INC.**

15 JEAN PLACE  
EDISON, N.J. 08817  
(201) 548-2299

INFORMATION RETRIEVAL NUMBER 113

# advertiser's index

Advertiser	Page	Advertiser	Page	Advertiser	Page
A-B Supply Co. ....	166	Fluke Counter Division .....	159	Owens-Illinois, Inc. ....	54
AMP, Incorporated .....	27, 28, 29, 30	Fuji Electrochemical Co. ....	137		
Abbott Screw & Mfg. Co. ....	128	Futaba Industries .....	20	Paktron, Division Illinois	
Acopian Corp. ....	51			Tool Works, Inc. ....	73
Alco Electronic Products, Inc. ....	159			*Philips Industries, Test and	
Alden Electronic & Impulse		GTE Sylvania .....	39	Measuring Instruments Dept. ....	150A
Recording Equipment Co., Inc. ....	169	General Electric Company .....	52, 53	Pico Electronics, Inc. ....	Cover II
Allen Bradley Co. ....	58	General Instrument Corporation .....	131	Pomona Electronics Co., Inc. ....	94
American Microsystems, Inc. ....	140, 141	Gould, Inc., Graphics Division .....	150	Power/Mate Corp. ....	166
Amperite Co., Inc. ....	158				
Amplifier Research Corporation .....	152			Quan-Tech, Division of	
Analog Devices Inc. ....	95			Scientific Atlanta, Inc. ....	156
Appleton Electric Company .....	25	Hayden Book Company, Inc. ....	166, 167		
Arnold Magnetics Corp. ....	166	Hewlett-Packard .....	9 thru 18	RCA Solid State Division .....	Cover IV
Atlas Fibre Co. ....	157	Hoffman Engineering Company .....	157	Radio Materials Company .....	165
Augat, Inc. ....	121	Hope Electronics .....	164	Reader Service Card .....	174A-174B
		Hoyt Electrical Instrument		Rolm Corporation .....	108
		Works, Inc. ....	171		
		Hunt Electronics .....	161	Schauer Manufacturing Corp. ....	130
				Sealed Air Corporation .....	163
Ballantine Laboratories, Inc. ....	159			Siemens Corporation .....	115
Bayshore Systems .....	167	ISE International Corporation .....	139	Signetics Corporation .....	30B
Belden Corporation .....	22, 23	Indiana General .....	83	Simpson Electric Company .....	143
Bell Industries, Electronic		Industrial Timer, A Unit of		Singer Company, Inc.,	
Components Division .....	171	Esterline Corporation .....	163	Kearfott Division .....	148
Bendix Corporation, The,		Information Handling Services .....	24	Sola Electric, Division of	
Electrical Components Division .....	113	Inselek, Inc. ....	122	Sola Basic Industries .....	149
Biomatron .....	50	Instruments for Industry, Inc. ....	125	Sorensen Company, A Unit of	
Bishop Graphics, Inc. ....	167	Intech, Incorporated .....	142	Raytheon Company .....	155
Bivar, Inc. ....	173	Intel Corporation .....	4, 5	Spectral Dynamics Corporation .....	168
Bliley Electric Co. ....	161	Itek Measurement Systems .....	163	Sprague Electric Company .....	26
Bodine Electric Company .....	161			Stacoswitch .....	160
Boonton Electronics Corporation .....	117	Johanson Manufacturing Corp. ....	7, 166	Stake Corp. ....	167
Bourns, Inc. Trimplot Products				Struthers-Dunn, Inc. ....	151
Division .....	30A	Keithley Instruments, Inc. ....	19	Superior Electric Company .....	45
Braun Co. ....	152	Kepeco, Inc. ....	168	Switchcraft, Inc. ....	164
		Keystone Carbon Company .....	162		
				TRW/IRC Resistors, an	
C-Cor Electronics, Inc. ....	165	Lemo USA .....	172	Electronic Components Division	
CTS Corporation .....	107			of TRW, Inc. ....	2
California Eastern Laboratories,		Magnecraft Electric		TRW Semiconductors, an	
Inc. ....	166	Company .....	Cover III	Electronic Components Division	
CELCO (Constantine Engineering		Magnetics .....	166	of TRW, Inc. ....	32
Laboratories, Inc.) .....	109	Magnetics, Division of		Tektronix, Inc. ....	37, 57
Cherry Electrical Products Corp. ....	43	Spang Industries, Inc. ....	74	Teledyne Relays .....	35
Chrono-Log Corp. ....	171	Matrix Systems .....	167	Thermologic .....	167
Concord Electronics Corporation .....	165	Met-L-Wood Corporation .....	87	ThermoMetrics .....	169
Connecticut Hard Rubber Co., The .....	136	Micro Circuits .....	167	Tracor, Inc. ....	144
Constantine Engineering		Micro-Line, Division of		Triplett Corporation .....	111
Laboratories, Inc. (CELCO) .....	109	Bausch & Lomb .....	161		
Control Data Corporation .....	135	Microswitch, A Division of		Vactec, Inc. ....	31
		Honeywell .....	21	Vectrol, Inc. ....	163
		Microwave Associates .....	127	Versatec, Inc. ....	153
Dale Electronics, Inc. ....	102, 103	Mini-Circuits Laboratory .....	150	Viking Industries, Inc. ....	133
Data Technology Corporation .....	138	Mirco Systems, Inc. ....	129		
Datascan Electronic Products .....	157	Modutec, Inc. ....	167	Wavetek .....	174
Decitek, A Division of		Motorola Semiconductor		Weston Instruments, Inc. ....	89
Jamesbury Corp. ....	154	Products, Inc. ....	47, 48, 49	Wiltron Company .....	164
Deltrol Controls .....	119			Woven Electronics .....	6
Dialight Corporation .....	41	National Semiconductor Corp. ....	147		
Dynascan Corporation .....	134	Nicolet Instrument Corp. ....	168		
		North American Philips			
EECO .....	82	Controls Corp. ....	145		
E-T-A Products Co. of America .....	166	North Electric Company .....	88		
Edmund Scientific Company .....	171				
*Electronic Design .....	150B				
Electronic Devices, Inc. ....	166				
Electronic Navigation Industries .....	126				
Electronic Research Corporation .....	75				
Estep Enterprises .....	167				
Exar Integrated Systems .....	1				

\*Advertisers in non-U.S. edition

**SCIENCE · OPTICS · ELECTRONICS**  
**ONOSOAC & HARD TO FIND BARGAINS**  
 NEW PRODUCTS · NEW MATERIALS · NEW METHODS

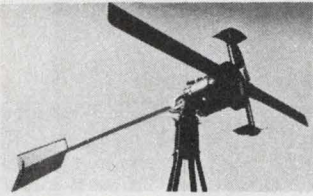

**12v WIND-POWERED GENERATOR**  
 Cheapest continuous source of electricity available! Attach to 12v truck batt. (not incl) and get free electricity from the wind. Needs only 7 mph wind—15 amps output in 23 mph wind; double the watt-hour output of ordinary radio chargers. Perfect remote area and alternate energy source. Big 6" propeller (Albers Air-Foil princ.) turns 200w generator; governor prevents overcharging/action. Price includes packing & shipping.  
 No. 19,189DA (10"-145 Lb.) ...\$425 Ppd.

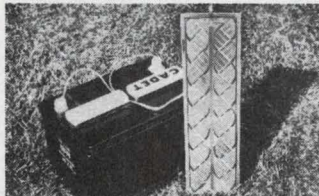

**GET A CHARGE FROM THE SUN!**  
 Our 12V Battery Charger allows direct conversion of light-to-electricity. Compact panel put on a boat can automatically charge its 12V battery over entire daylight period. Use anywhere for a trickle charge. Big value, it comprises 30 1/2V silicon solar cells in series w/ diode.  
 No. 71,971DA  
 (AB. 30 W-HRS./WK.) ...\$89.95 Ppd.  
 9x18" Hi Current Model (6W, 12V, 500mA) No. 72,010DA  
 (AB. 150 W-HRS./WK) ...\$420.00 Ppd.  
 6x6" Lo Voltage Model (1.5V, 38W, 250mA) No. 42,172DA .....\$49.95 Ppd.



**3" ASTRONOMICAL REFLECTOR!**  
 Terrific Buy! Top Quality! American Made! Famous Mt. Palomar type. Aluminized & overcoated 3" hi-speed f/10 mirror, 60X eyepiece & mounted 3X adi. Barlow give 120X & 180X (theoretical limit), 6X finder. Rack & pinion focusing. Metal fork mount, 36" hardwood tripod. Incl FREE: "HOW TO USE" Book; STAR FINDER, Instr. Stock No. 80,162DA .....\$66.00 Ppd.  
 #85,105DA .....\$115.00 F.O.B.  
 4 1/2" w/ CLOCK DRIVE .....\$149.95 F.O.B.  
 #85,107DA .....\$222.50 F.O.B.  
 #85,187DA .....\$259.50 F.O.B.  
 #85,086DA



**GIANT FREE CATALOG**  
 Brand New 1975 edition — 164 pages. Hundreds of unique new items! Hard-to-get surplus bargains. Ingenious scientific tools, 1000's of components: lenses, prisms, wedges, mirrors, mounts, all types of accessories. 100's of instruments, lasers, comparators, magnifiers, telescopes, projectors, microscopes, binoculars, photoattachments, black-light equipment and the world's largest selection of unique lighting equipment. Fully illustrated. Great buys! Write for Catalog "DA".

**EDMUND SCIENTIFIC CO.** PLEASE ORDER BY STOCK NO. · MONEY BACK GUARANTEE  
**300 EDCORP BLDG.**  
**BARRINGTON, NEW JERSEY 08007**  
 \$10.00 MIN. OPEN ACCOUNT TO WELL RATED FIRMS · PLEASE ADD 50¢ HANDLING · TELEPHONE: 609-547-3488

INFORMATION RETRIEVAL NUMBER 114

**HOYT**  
**COMPACT METERS**  
 Best for size, performance

No. 685 Moving Coil pancake edgewise meters, without barrel projection, may be mounted together for comparison reading applications. 30% larger dial area for better readability. Shielded high torque movement for all ranges 50 UA up to 750 volts, VU meters, and AC rectifier type volt-meters.

No. 2018 Custom 1 1/2" Panel Meter offers the same frictionless, self-shielded taut band movement as the 2 1/2" and 3 1/2" models. The #2018 is available in sensitivities from 100 Micro-amperes up to 5 Amperes, and as a DC Voltmeter up to 300 Volts DC, self-contained. #2018/B distinguishes panels with a die cast metal bezel for behind panel mounting. Colored fronts.

No. 685 Meter (without bezel)  
 2 1/4" x 7/8"

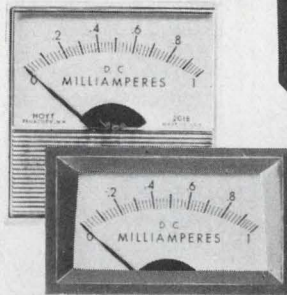

No. 2018, 1 3/4" square;  
 No. 2018/B (with bezel)

70<sup>th</sup>  
 OUR YEAR

**HOYT** HOYT ELECTRICAL INSTRUMENT WORKS, INC.  
 QUALITY INSTRUMENTS SINCE 1904. BURTON-ROGERS COMPANY / Sales Division  
 556 Trapelo Road, Belmont, Mass. 02179 (617) 489-1520

INFORMATION RETRIEVAL NUMBER 116

**New Low Cost**  
**TIME CODE**  
**GENERATOR/READER**

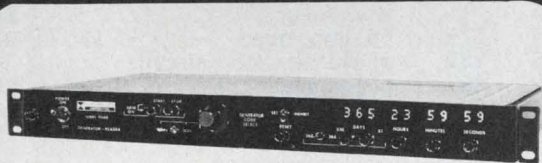

**Time Code Reader .....\$890.**  
**Generator/Reader .....\$1265.**

The new LOW COST Series 9000 Time Code Units generate and read serial IRIG Time Codes used in analog magnetic tape instrumentation, hard wire transmission and telemetry systems. In addition, they provide buffered parallel BCD outputs, TTL compatible, for digital storage devices and computer inputs. Options include Multi-code units, Day-of-Year Calendars and Millisecond BCD outputs.

Write or call Chrono-log Corporation, 2583 West Chester Pike, Broomall, Penna. 19008, 215-EL 6-6771



INFORMATION RETRIEVAL NUMBER 115

ELECTRONIC DESIGN 16, August 2, 1974

**Now Ceramic Chip Capacitors**  
 Available from 1 pf to 1 uf

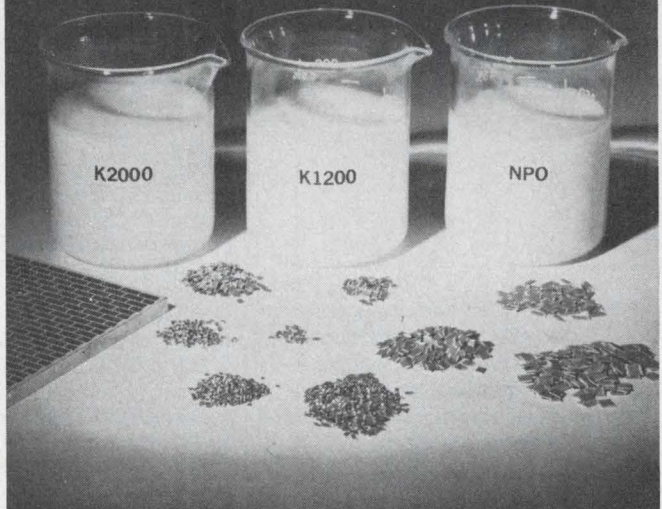

Many values off the shelf, other deliveries 6-8 weeks... K1200 (W5P) series from 100 pf through 1 uf... NPO series from 1 pf through .047 uf... 25, 50, 100, 200 WVDC.

Write for full line ceramic capacitor catalog.

**BELL INDUSTRIES / Electronic Components Division**  
 150 WEST CYPRESS AVE. · BURBANK, CALIFORNIA 91505  
 (213) 846-9302 · TWX 910-498-2207

INFORMATION RETRIEVAL NUMBER 117

# THE LEMO QUICK-LOK MULTICONTACT CONNECTOR.

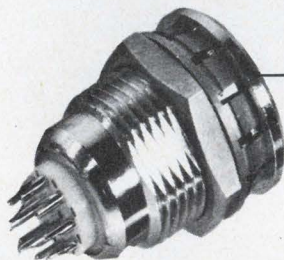

Easily engaged and disengaged  
Rugged, all metal machined shell  
Positive strain relief accepts  
cables from .070 to .410 O.D.

Polarized with hermaphroditic insert  
Easy to assemble

Miniature design saves panel space  
Quality appearance  
complements any front panel  
Available with 2 through 18 contacts



**LEMO U.S.A. INC.**  
2015 SECOND STREET • BERKELEY, CA 94710  
(415) 548-1966 • TELEX 335-393

## product index

**Information Retrieval Service.** New Products, Evaluation Samples (ES), Design Aids (DA), Application Notes (AN), and New Literature (NL) in this issue are listed here with page and Information Retrieval numbers. Reader requests will be promptly processed by computer and mailed to the manufacturer within three days.

Category	Page	IRN	Category	Page	IRN
<b>Components</b>			counter	126	264
attenuators	164	108	curve tracer	134	63
capacitors	7	7	DMM	123	257
capacitors	165	109	DMM, autoranging	19	7
capacitors	171	117	DPM	138	69
capacitors, ceramic	26	14	DPM	157	89
capacitors, film	73	32	data delay unit	124	259
elapsed-time indicator	156	308	facsimile recorders	169	112
indicators	20	8	function generator	174	120
indicators	41	20	generator/reader	171	115
motor, dc	21	9	logic-circuit testers	129	58
motor, synchronous	156	309	meter relays	143	74
motors, stepper	45	22	multifunction counter	159	93
motors, stepper	145	77	noise analyzer	156	88
readouts	139	70	oscilloscope	50	26
relays	151	82	oscilloscope	134	64
relays	158	92	pROM tester	124	261
relays, reed	III	244	panel instruments	111	47
resistor networks	107	44	panel meters	52	28
resistors	2	3	recorder modules	150	81
resistors	58	31	scales	161	98
solenoids	119	51	scope	124	260
switch, PC board	156	310	scope	126	265
switches	43	21	semi test equipment	115	49
switches	160	97	sweep generator	126	267
switches	164	107	synthesizer	124	258
switches, slide	159	94	temperature controller	124	263
switches, toggle	159	95	test clip	94	40
thermistors	162	102	tracking receiver	144	76
thermistors	169	113	voltmeter	75	34
timers	163	106	voltmeter	126	266
transformers	83	36			
transformers	II	243	<b>Integrated Circuits</b>		
yokes	109	46	CMOS RAMs	122	53
			counter, CMOS	130	268
<b>Data Processing</b>			ICs, linear	IV	245
calculator	134	275	op amp, quad	130	272
digitizer, tablet	138	282	phase lock loop circuits	1	2
disc, floppy	138	281	phone dialler	130	269
formatter	134	274	RAMs	130	271
keyboard	134	276	shifter	130	270
photoelectric tape reader	154	86			
printer, column	138	283	<b>Microwaves &amp; Lasers</b>		
printer, column	136	280	transformers, rf	150	80
reader, paper tape	132	273			
storage module drive	135	65	<b>Modules &amp; Subassemblies</b>		
system, computer	136	277	card, call answering	141	284
system, deflection	132	250	control, solid-state	141	285
tape drive, cartridge	136	278	controller, programmable	142	289
transmitter, optical	136	279	converters, d/a and a/d	141	286
			converters and		
<b>Discrete Semiconductors</b>			indicators	30B	132
diodes, p-i-n	127	56	driver, motor	142	288
indicators, fault	152	303	encoder	163	103
lamps, LED panel	150	252	power amplifiers	126	55
optoelectronics	31	18	pulse amps	165	111
power Darlington's	32	16	sensor, proximity	141	287
thyristors	161	101	synchronizer, shaft	142	290
transistors, power	152	301			
transistors, switching	152	302	<b>Packaging &amp; Materials</b>		
zeners	130	59	cable	6	5
			cable-sheath stripper	146	299
<b>Instrumentation</b>			card pull handles	146	297
ac/dc transfer standard	159	96	component ovens	161	99
capacitance meter	124	262	connector	145	293
counter	123	253	connector, PC	144	292

# DO COLLEGES HELP BUSINESS AS MUCH AS BUSINESS HELPS COLLEGES?

Yes, they do. But not in the same proportion.

Business contributes about 15% of the total voluntary support received by colleges.

But today, business gets half the college-trained people who are employed. Tomorrow, it will need even more.

As a result, businessmen should think seriously about increasing the level of corporate giving to education. Can you, as a businessman, think of a better investment?

For the latest national figures on corporate giving to higher education, write on your letterhead for "CFAE Survey of Corporation Support of Higher Education," and enclose \$2.00 to help cover costs. Mail to: Council for Financial Aid to Education, 6 East 45th Street, New York, N.Y. 10017.

Give to the college of your choice. Now.



Advertising contributed for the public good.

Category	Page	IRN
connectors	113	48
connectors	133	62
connectors, multicontact	172	118
contacts, welded	152	84
desolder tool	144	291
enclosures	157	91
ferrites	137	68
flexible-cable products	27	150
gold on lead frames	39	19
heat sealers	163	105
heat shrink RFI material	146	295
insulator	145	294
jacks and pins	165	110
masking compound	146	300
metals	74	33
nuts	128	57
panels	87	37
polish, antistatic	146	296
RFI shields	125	54
rods, phenolic	157	90
tape, polyester	136	66
test kit, IC	146	298
wire, cable and cord	23	234

Power Sources		
battery	155	307
battery charger	171	114
dc/dc converter	154	305
modular supply	154	304
power supplies	51	27
power supplies	88	38
programmable supply	155	306
voltage regulator	155	87
voltage transformers and regulators	30A	131

## new literature

CATV/MATV cable	162	336
catalog, motor	137	67
ceramic capacitors	162	338
coaxial connectors	160	334
electrical penetrations	160	332
formatters	162	343
HV leads and connectors	160	328
ham-radio equipment	164	345
high perm ferrites	162	341
ICs	160	329
instruments	160	331
mass memory subsystem	160	333
PC connectors	162	342
photocells	162	339
power supplies	162	335
rf switches	160	330
resistive components	164	344
rocker switches	162	340
SCR power controller guide	153	85
subminiature lamps	162	337
transistors and FETS	164	346

## application notes

a/d conversion methods	158	322
control system problems	158	321
voltage regulation	158	320

## evaluation samples

card handles	158	323
DIP converters	158	324
PC test jack	158	327
plastic parts	158	325
rotary appliance switches	158	326

The game of PCB insertion/extraction is a common one with headaches like stubborn connectors and damaging stresses and strains.

Card insertions and extractions are made safer and easier with simple, lever action CARD-O-PULLS™ that are designed for 1/16" and 3/32" thick PCBs and for most card support systems. No special tools are needed.

Nylon CARD-O-PULLS are available from stock in 8 styles, including locking versions to prevent accidental releases, and can be color coded and/or permanently marked for identification on a custom basis.

Details, pricing and specific samples on request.

BIVAR, Inc. 1500 South Lyon Street, Santa Ana, California 92705. Phone (714) 547-5832

*push,*  
**Pull &  
LOCK**

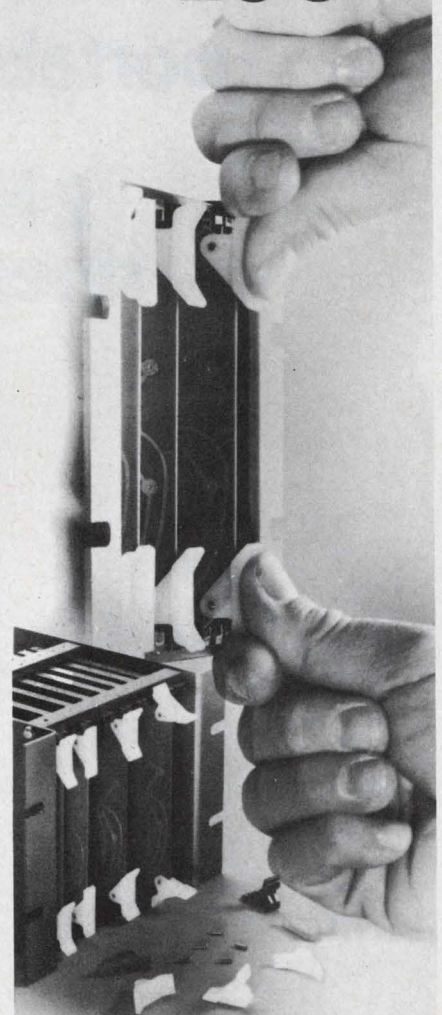

PACKAGING PROGRESS  
BY **Bivar**

INFORMATION RETRIEVAL NUMBER 119

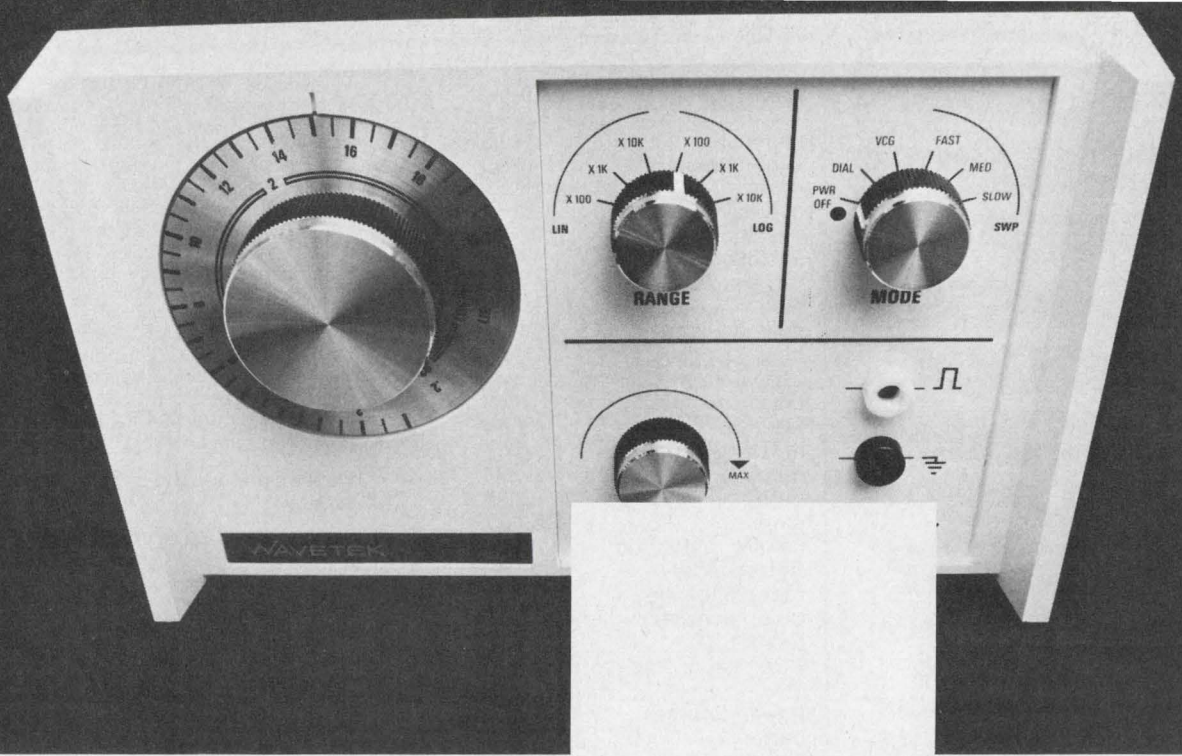

**This Model 30  
portable function generator  
goes from  
2 Hz to 200 kHz with  
sines, squares, triangles,  
and linear  
or log sweeps.**

**And it goes for  
\$149.<sup>95</sup>**



**WAVETEK®**

P.O. Box 651, San Diego, Calif. 92112  
TWX 910-335-2007, Tel. (714) 279-2200

INFORMATION RETRIEVAL NUMBER 120



Reed Relays in Stock with Long Life & Versatility

# READY REEDS

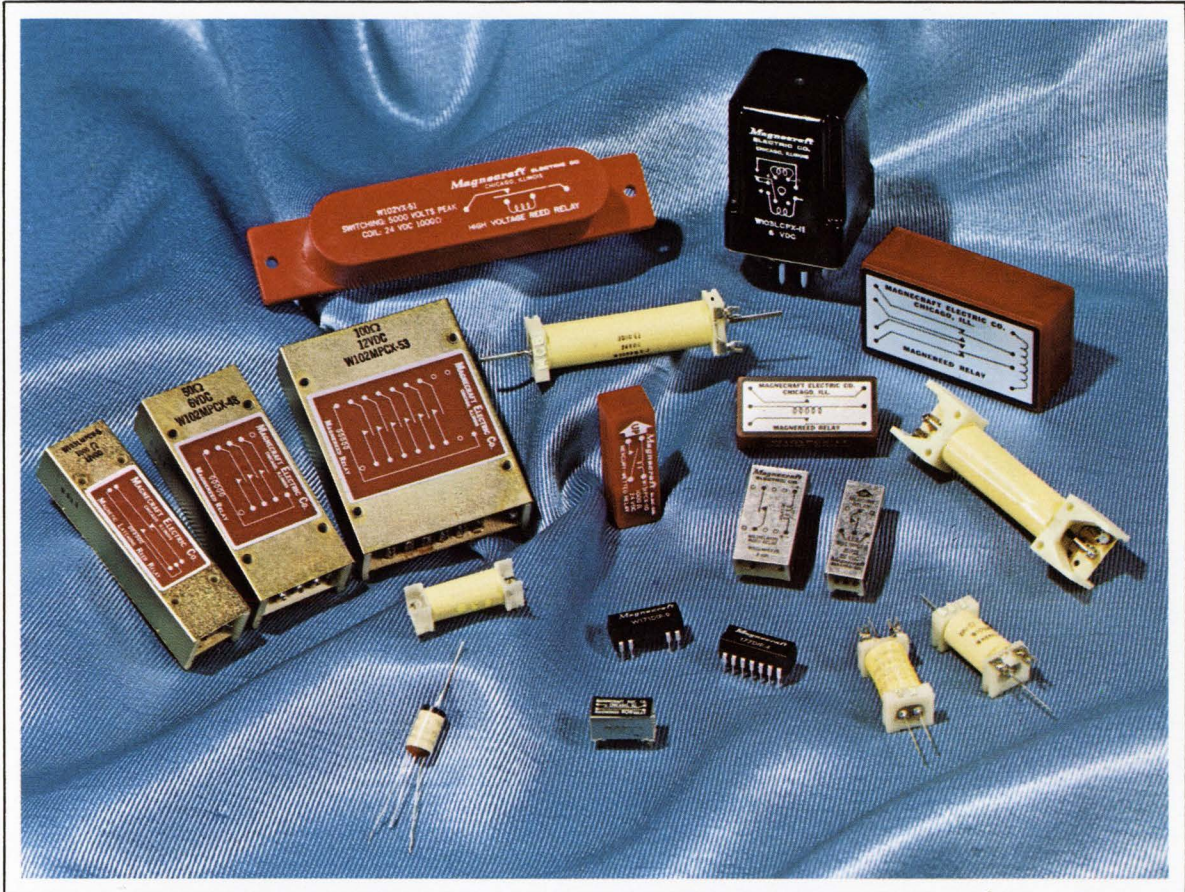

The Ready Reeds are ready for you! Over 290 high quality types of reed relays are in stock for immediate delivery. A wide variety of hermetically sealed contact combinations and packaging techniques are available. Versions offered include; dry, mercury-wetted, sensitive, latching, power, high voltage, time delay, electro-statically shielded, and dual-inline-package DIP's.

Magnecraft's reed relays can provide almost everything that a designer would want in order to accomplish a high speed switching function. The versatility of the relay is so great that it can be custom-fitted to almost any application at a lower cost in dollars and power and in a smaller space than almost any other device, conventional or solid state.

The photo above portrays the reed relay packaging characteristics available: epoxy encapsulated, axial leads, plug-in, eight and fourteen pin dual-inline-package, open styles, and standard, miniature, and micro miniature printed circuit packages.

Our nationwide network of distributors and Chicago plant stand ready to serve your applications. But, if you don't find what you need in stock we will make it for you!



**Free!**  
STOCK CATALOG

To help specify all your relay needs, ask for Magnecraft's new 1974 Stock Catalog with the most diversified line of over 1060 relays. A 68 page Designers Handbook and Catalog of Reed and Mercury Wetted Contact Relays with specific data drawings, and photos on all the various relays will accompany the Stock Catalog.

Find Magnecraft Relays in EEM sec. 4500.

**Magnecraft** ELECTRIC COMPANY

5575 NORTH LYNCH AVENUE • CHICAGO, ILLINOIS 60630 • 312 • 282-5500 • TWX-910-221-5221



## The solid-state janitor. If you want to design one tomorrow, we're ready with your linear IC's today.

Whatever you conjure up, we can help make a reality.

Maybe you're looking ahead to remote control using Digital to Analog Converters, to advanced mobile communications equipment, even to a completely automated factory. However advanced your design, we have a full house capability to help you get from the drawing board to the real world. We can supply the popular standard types, meet your

custom requirements and offer proprietary types.

We can help you with other products, too. We're a commodity supplier of power transistors; a recognized leader in CMOS; developers of liquid crystal displays; technology innovators of RF components; and a major supplier of thyristors.

In addition to comprehensive technical product data, RCA also gives you professional and exper-

rienced field engineering and applications support. As well as a commitment to excellence in everything from research to manufacturing.

So whatever you're into, and whatever you need, check with us first. Chances are one or more of our products anticipate your needs. A good place to start is to check our handy product-line guide. Write RCA Solid State, Section 57H2, Box 3200, Somerville, N. J. 08876.

**RCA** Solid State