

Electronic Design[®] 26

VOL. 22 NO.

FOR ENGINEERS AND ENGINEERING MANAGERS

DEC. 20, 1974

Choosing displays isn't easy. While certain applications dictate specific displays, many others do not. Spec sheets don't solve all selection problems either. Unlike

other devices, displays are often chosen for their looks and not their technical features. To learn how you can select them, and what's available, see page 52.

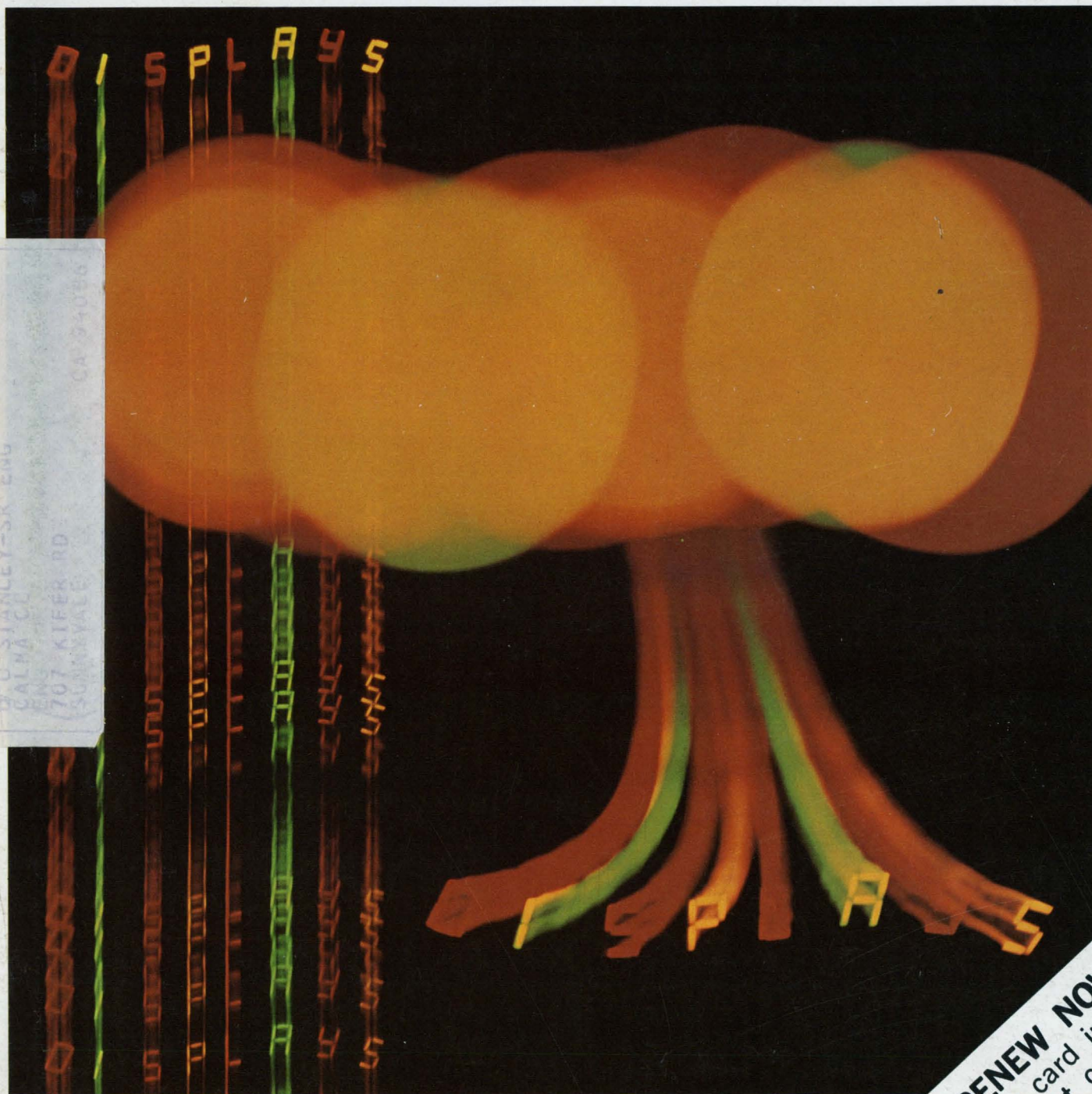

94066 CALCOUSTIAN 98 25/74 ED
BY G. STANLEY-SR. ENG
CALIF. CL
707 KIFER RD
SUNNYVALE CA 94086

RENEW NOW!
Use card inside
front cover.



Ultra reliability in ultra-miniature transformers...

...and they're off the shelf!

PICO Electronics' patented construction combines mass production with the utmost in reliability to produce the smallest possible transformer.

These little giants handle up to 600 milliwatts at 1 KHz and 1.5 watts at 10KHz. They cover the frequency range of 300Hz to 250KHz. Primary or Secondary impedances of 3.2 ohms to 250K ohms. Pulse applications .05 μ s to

100 μ s. Construction can be TO-5 plug-in, insulated flexible leads or flat pack ribbon style.

Size variations from 1/4" dia. x 1/4" ht. to 1 1/2" dia. x 1/2" ht. Special designs with 1/4" dia. and .180" ht.

Pico Electronics is a Q.P.L. source. All transformers are hermetically sealed in a metal case and in strict compliance with MIL-T-27 specifications. Every Pico device has the added reliability feature of being

guaranteed for 25 cycles of thermal shock (MIL-STD-202D, method 107C).

Industrial and Commercial designs are also available for maximum economy.

Over 600 standard transformers to choose from... Delivery—stock to one week... specials take a little longer—9 days.

Send for free 36 page catalog.

PICO Electronics, Inc.

50 South MacQuesten Pkwy., Mt. Vernon, New York 10551 • Telephone 914-699-5514

GENERAL ELECTRIC OPTOELECTRONIC COUPLER LINEUP

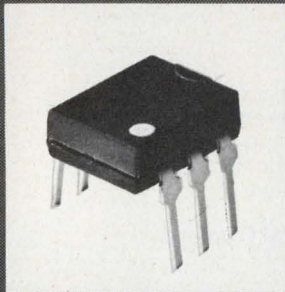

H11 SERIES COUPLERS

- 14 Different models — interchangeable with all popular industry types
- Transistor, Darlington and SCR outputs
- The Industry's first AC input coupler-H11AA and threshold coupler-H11A10
- GE's patented glass isolation yields the highest available CTR and isolation voltages-4N35 offers 100% CTR with 3500V isolation
- Covered under U.L. File E51868

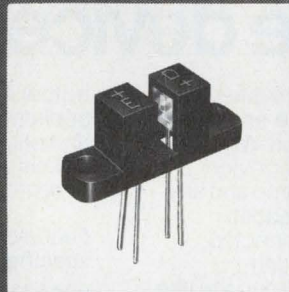

H13 SERIES INTERRUPTER MODULES

- 4 Models offer "no contact" switching
For use as:
 - shaft encoders
 - counters
 - position sensors
 - key boards
 - limit switches
 - electronic ignition systems

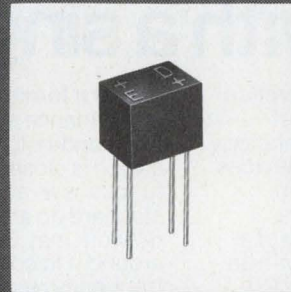

H15 SERIES COUPLERS

- 4000V isolation
- 4 low cost models for pulse transformer replacement, thyristor triggering, logic interfacing
- Transistor and Darlington outputs
- Solid state reliability at low cost
- Covered under U.L. File E51868

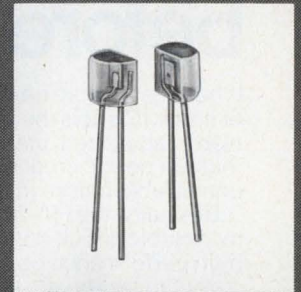

H17 SERIES MATCHED EMITTER DETECTOR PAIRS

- Industry's lowest cost matched pairs
- Transistor and Darlington outputs for general purpose detection applications and "no contact" switching
- Replacements for limit switches, small mechanical contacts and micro switches

**COMPETITIVELY PRICED AND AVAILABLE
NOW FROM YOUR GENERAL ELECTRIC DISTRIBUTOR
"THE BEST COST NO MORE"**

GENERAL  ELECTRIC

Sample and hold on a chip!

Harris' new HA-2420 gated op amp permits applications not possible before with a single device.

It heralds a whole new generation of linear IC's. It is the result of Harris' advanced linear technology that will permit creation of devices unavailable before in IC form.

Basically, the HA-2420 is a monolithic circuit consisting of a high performance op amp with its output in series with an ultra low leakage switch and a MOSFET input unity gain amplifier.

With an external holding capacitor connected to the switch

output it forms a versatile high performance sample-and-hold or track-and-hold circuit. When the switch is closed, the device functions as an op amp and any standard op amp feedback network may be connected around it to control gain, frequency response and the like. When the switch is opened, the output remains at its last level.

Without a holding capacitor the device serves as a versatile gated

output op amp for such applications as analog switches and peak holding circuits. For details see your Harris distributor or representative.

Features: (+25°C unless specified)

| | |
|--|--|
| Input Offset Voltage | 4mV (MAX) |
| Input Bias Current | 200nA (MAX) |
| Slew Rate (C_H = 1000pF) | 5V/μs (TYP) |
| Open Loop Gain | 50K (TYP) |
| Input Voltage Range | ±10V (MIN) |
| Output Voltage Swing | ±10V (MIN) |
| Output Impedance | 5ohms (TYP) |
| Drift Current on C_H (+125°C) | .5nA (TYP) |
| Acquisition time (C_H = 1000pF) | 4 μs (TYP) to 0.1% of final value |
| Control Input | TTL Compatible: [L sample [H hold |
| Aperture time | 50 ns (TYP) 100-999 units |

HA-2425
0°C to +75°C \$14.85

HA-2420
-55°C to +125°C \$29.70

Hermetic 14 pin DIP package

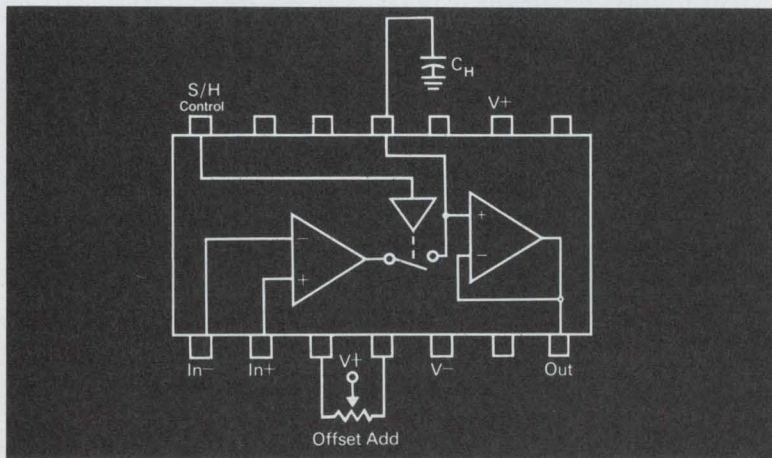

P.O. Box 883, Melbourne, Florida 32901 (305) 727-5430

WHERE TO BUY THEM: OEM SALES OFFICES: ARIZONA: Scottsdale, (602) 946-3556 **CALIFORNIA:** Long Beach, (213) 426-7687; Palo Alto, (415) 964-6443 **FLORIDA:** Melbourne, (305) 727-5826 **ILLINOIS:** Schaumburg, (312) 894-8824 **MASSACHUSETTS:** Wellesley Hills, (617) 237-5430 **MINNESOTA:** Burnsville, (612) 432-6111 **NEW YORK:** Endwell, (607) 754-5464; Melville, L.I., (516) 249-4500 **OHIO:** Dayton, (513) 226-0636 **PENNSYLVANIA:** Wayne, (215) 687-6680 **TEXAS:** Richardson, (214) 231-9031.

SALES REPRESENTATIVES: CALIFORNIA: San Diego, (714) 279-7961 **COLORADO:** Denver, (303) 771-4920 **KANSAS:** Olathe, (913) 782-1177 **MARYLAND:** Randallstown, (301) 922-1248 **NORTH CAROLINA:** Raleigh, (919) 828-0575 **NEW YORK:** Buffalo, (716) 633-7970 **OREGON:** Beaverton, (503) 643-1644 **TENNESSEE:** Shelbyville, (615) 684-4544 **VIRGINIA:** Falls Church, (703) 534-1673; Troutville, (703) 345-3283; Virginia Beach, (804) 481-7200 **WASHINGTON:** Bellevue, (206) 454-0300.

INFORMATION RETRIEVAL NUMBER 3

ELECTRONIC DESIGN 26, December 20, 1974

HIGH RELIABILITY



Get the **high reliability** that eliminates trouble. RN DIP sockets make contact with the wide, flat sides of your IC leads. This provides **100% greater surface contact** for positive electrical connection.

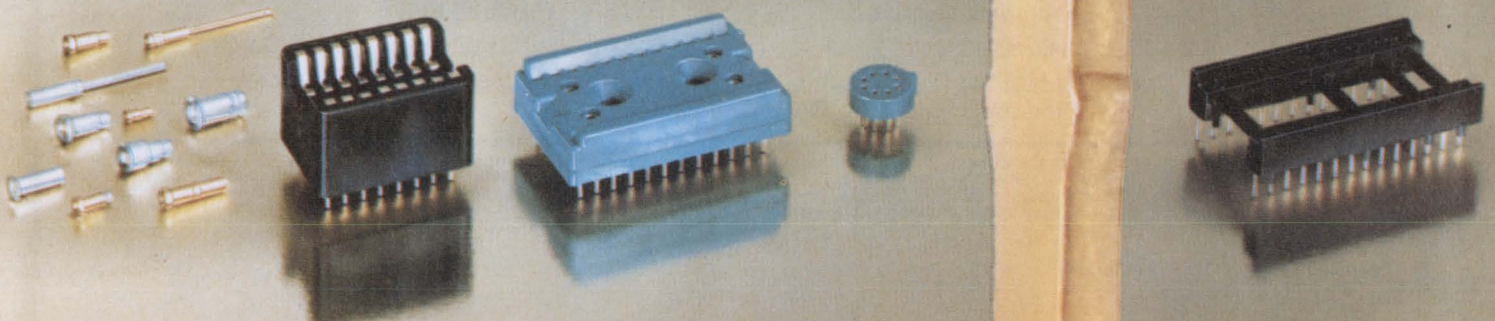

DIP SOCKETS **for the price you're paying for junk!**

Robinson Nugent "side-wipe" DIP sockets make 100% greater contact than any edge-bearing socket on the market.

This 100% greater contact with the wide, flat surface of your IC leads is your guarantee of unmatched reliability. This RN "side-wipe" contact provides constant low contact resistance. No edge-bearing contact can possibly deliver this long term dependability. This designed-in reliability of RN DIP sockets is your assurance of trouble-free IC interconnects—yet they cost no more than ordinary sockets.

Put an end to troublesome junk sockets! Write today for catalog and informative book "What to Look for in IC Interconnects." It's free from RN—the people who make more kinds of high reliability IC sockets than anyone.

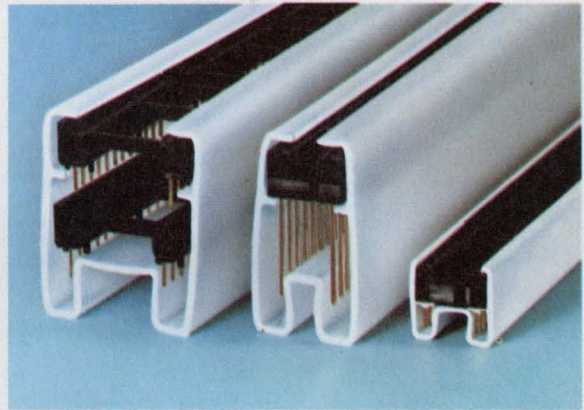

They're even packaged for high reliability.

"Protecto-pak"® packaging delivers consistently perfect RN sockets to your production line—for automated or manual assembly.

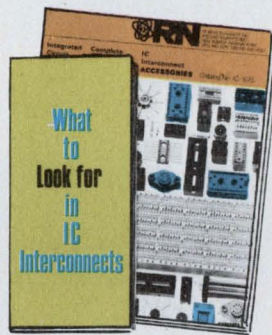

RN ROBINSON NUGENT, INC.

800 East Eighth Street • New Albany, Indiana 47150 • Phone: (812) 945-0211

INFORMATION RETRIEVAL NUMBER 4

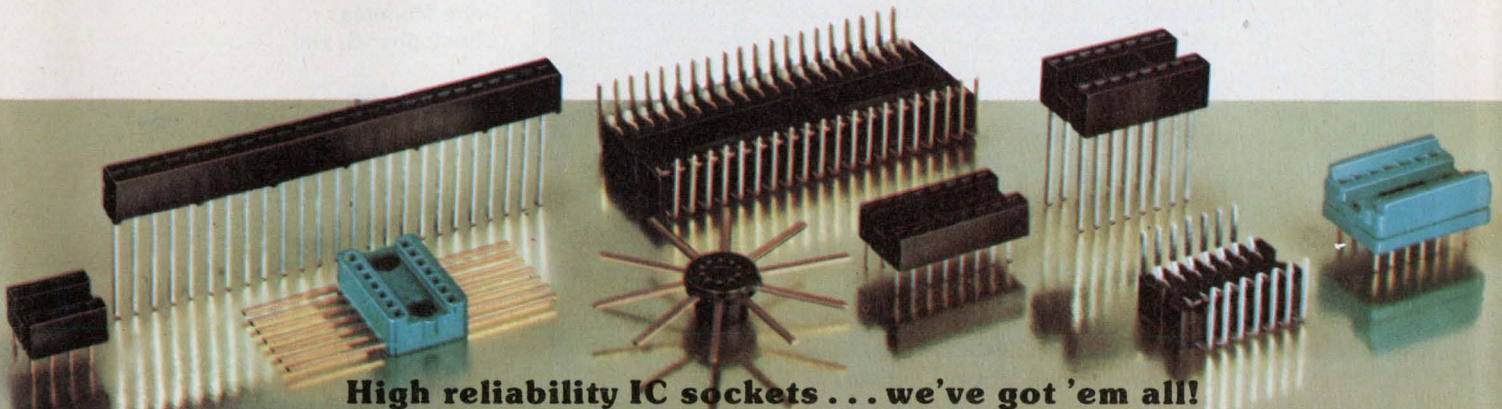

High reliability IC sockets . . . we've got 'em all!

CABLE-BILITY WOVEN'S FLAT GOT IT!

Ribbon Cable IC Interconnects Custom Harnesses

A total source for flat interconnect systems, Woven Electronics offers unlimited design capabilities combining signal/power transmission with specialized functions. Independently insulated conductors give tighter transmission control, more protection, allow easy lead exposure.

Specify sizes, color coding, insulations, custom break-outs without restrictions of other cable forms.

Cable and ability. Get the best of both from one source.

WOVEN ELECTRONICS

P.O. Box 189 Mauldin, South Carolina 29622
803/963-5131

Vice President, Publisher

Peter Coley

Editors

Editorial Offices
50 Essex St.
Rochelle Park, NJ 07662
(201) 843-0550
TWX: 710-990 5071
Cable: Haydenpubs Rochellepark

Editor-in-Chief George Rostky

Managing Editors:

Ralph Dobriner
Michael Elphick

Associate Editors:

Dave Bursky
Jules H. Gilder
Morris Grossman
Seymour T. Levine
John F. Mason
Stanley Runyon
Edward A. Torrero
Richard L. Turmail

Contributing Editors:

Peter N. Budzilovich
Alberto Socolovsky
Nathan Sussman

Editorial Field Offices .

East

Jim McDermott, Eastern Editor
P.O. Box 272
Easthampton, MA 01027
(413) 527-3632

West

David N. Kaye, Senior Western Editor
8939 S. Sepulveda Blvd.
Suite 510
Los Angeles, CA 90045
(213) 641-6544
Northe K. Osbrink, Western Editor
112 Coloma St.
Santa Cruz, CA 95060
(408) 426-3211

Editorial Production

Marjorie A. Duffy

Art

Art Director, William Kelly
Richard Luce
Anthony J. Fischetto

Production

Manager, Dollie S. Viebig
Helen De Polo
Anne Molfetas
Christopher G. Hill

Circulation

Manager, Evan Phoutrides

Information Retrieval

Peggy Long

Promotion

Manager, Walter G. Salm
Karen Kerrigan (Reprints)

across the desk

Acurex Corp. sets the record straight

We have received a number of inquiries as a result of the article "Sensors in 5 Areas Are Getting Tinier, Cheaper and More Precise Than Ever" (ED No. 15, July 19, 1974, pp. 30-38). However, I was disappointed to find that Acurex was listed incorrectly with respect to the type of transducer we manufacture. We manufacture a line of torque transducers that are similar in concept to the S. Himmelstein & Co. unit shown on p. 38 of the article.

Our approach is slightly different, in that we take an existing coupling in a rotating power train and convert that coupling to a torque transducer. We also have the capability of measuring horsepower directly. This modification to an existing coupling permits the user to use existing design hardware without modifications to its power train. The equipment is hermetically sealed to permit indefinite operation in very hostile industrial environments.

We do not manufacture displacement transducers. Please correct this mistake. Our equipment can operate in severe industrial environments up to 150 C and up to 30,000 g of static acceleration load. For high-speed rotating equipment, we know of no other reliable method of removing data from the rotating parts.

Edward L. Rossiter
Marketing Manager

Acurex Corp.
485 Clyde Ave.
Mountain View, CA 94042

Atom-waste disposal: An 'ejection' idea

In regard to the letter of Ralph S. Gobel ("He'd Give Atom Waste a Place in the Sun," ED No. 16, Aug. 2, 1974, p. 7), we would like to point out some serious problems in solar disposal of atomic waste. A short calculation shows that it is energetically cheaper to achieve escape velocity from the solar system than it is to place a payload in an orbit that intersects the sun.

To hit the sun, essentially all the orbital velocity of the earth (30 km/sec) must be subtracted from the payload, whereas only 41% of the earth's orbital velocity must be added to the payload to eject it from the solar system entirely. However, this is still not a very attractive solution, because even for relatively small payloads, achieving solar-escape velocity strains the limits of modern rocket technology.

One other technique requires slightly less energy than directly ejecting the waste from the solar system. This is to send the payload to Jupiter. Carefully guided close passages with Jupiter can be manipulated either to eject the payload from the solar system or to cancel its velocity entirely and send it falling into the sun. The latter technique requires enormously accurate guidance.

Thomas A Sargent
and

Thomas N. Gautier

University of Arizona
Steward Observatory
Tucson, AZ 85721

Electronic Design welcomes the opinions of its readers on the issues raised in the magazine's editorial columns. Address letters to Managing Editor, Electronic Design, 50 Essex St. Rochelle Park, N.J. 07662. Try to keep letters under 200 words. Letters must be signed. Names will be withheld on request.



AMERICAN MADE

Tolerance

SCHAUER

1-Watt

ZENERS

Immediate Shipment Low Prices

ANY voltage from 2.0 to 16.0

| Quantity | Price each |
|-----------|------------|
| 1-99 | \$1.07 |
| 100-499 | .97 |
| 500-999 | .91 |
| 1000-4999 | .86 |
| 5000 up | .82 |



Write for complete rating data and other tolerance prices.

Buy the kit- Save a lot



Kit contains a 51-piece assortment of SCHAUER 1% tolerance 1-watt zeners covering the voltage range of 2.7 to 16.0. Three diodes of each voltage packaged in reusable poly bags. Stored in a handy file box. Contact your distributor or order direct.

A \$54.57 value for
ONLY \$24⁵⁰

Semiconductor Division
SCHAUER
Manufacturing Corp.

4511 Alpine Ave. Cincinnati, Ohio 45242
Telephone: 513/791-3030

Now from Dale...a new generation of Low Profile Trimmers

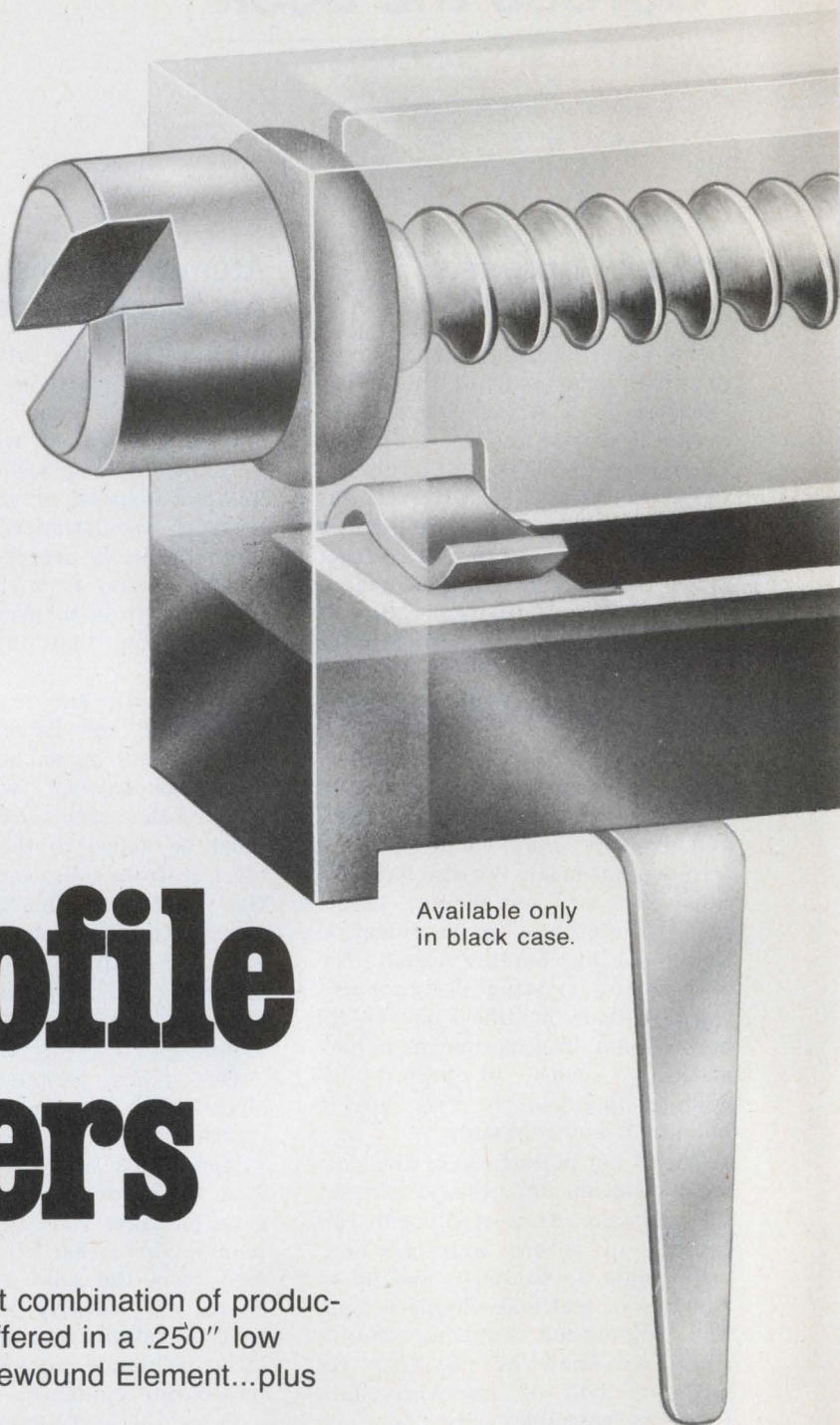

Available only
in black case.

Dale's new 700 Series gives you the best combination of production and performance advantages ever offered in a .250" low profile package. Choice of Cermet or Wirewound Element...plus good delivery and low price.

Better Adjustability: Cermet models provide output resistance of $\pm 0.10\%$ and output voltage ratio of $\pm 0.05\%$.

Higher Power: All models offer 1 watt power dissipation at 70°C.

Low T.C.: 100 PPM for all cermet models, 50 PPM for wirewound.

Low Noise: Cermet models with 3% contact resistance variation standard (1% available). Wirewound models have equivalent noise resistance of 100 ohms max.

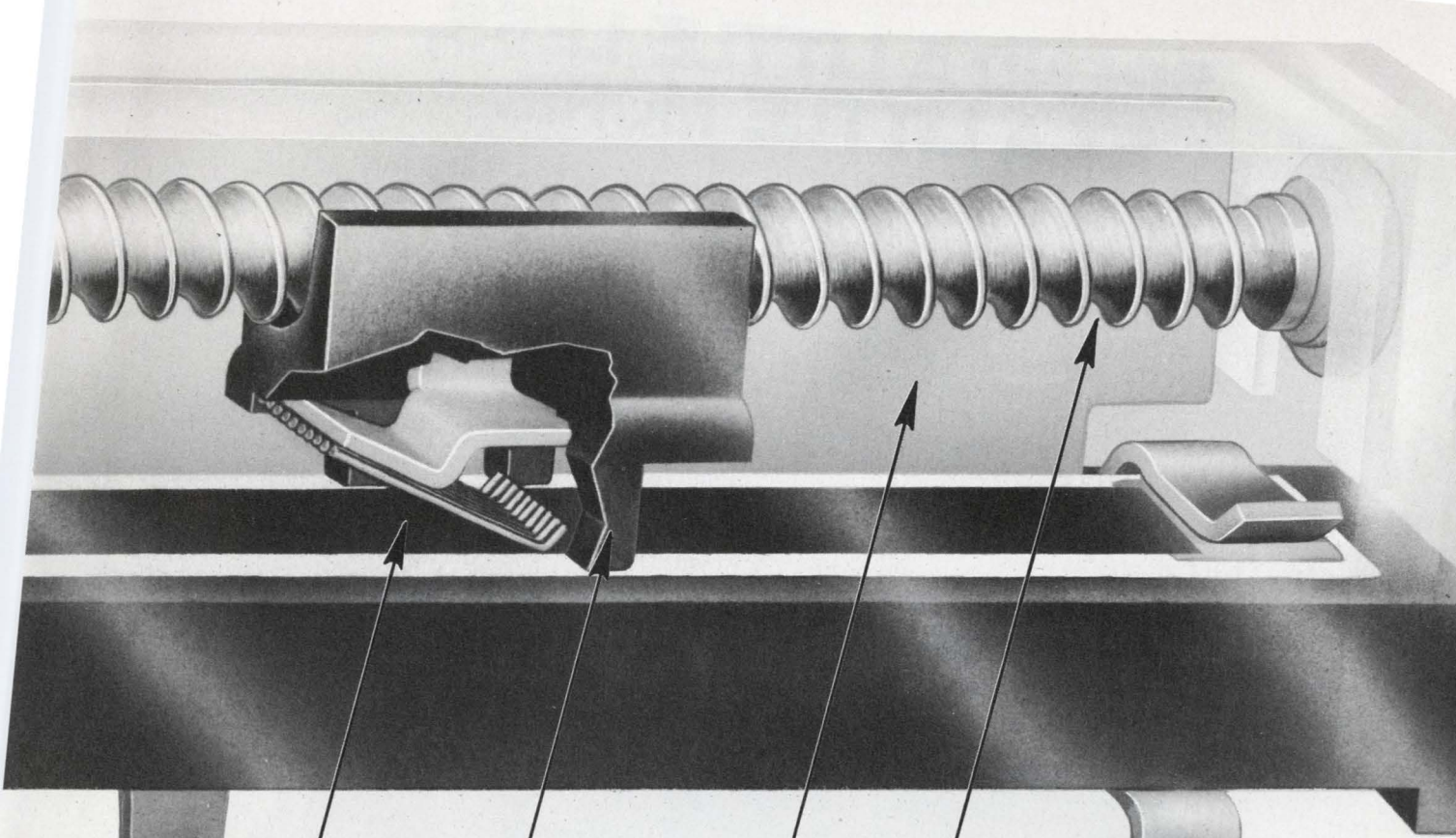

Largest Cermet Element
 covers nearly entire substrate. Enhances setability and CRV. Provides 1 watt at 70°C.

Solid Wiper Block
 with wire spring-finger contacts. Maintains optimum interface with resistance element. Provides low contact resistance variation and reduces backlash.

Patented Side Collector
 provides excellent setting stability by allowing use of broader element.

All Metal Screw.
 25-turn adjustment. One-piece clutch prevents overtravel damage.

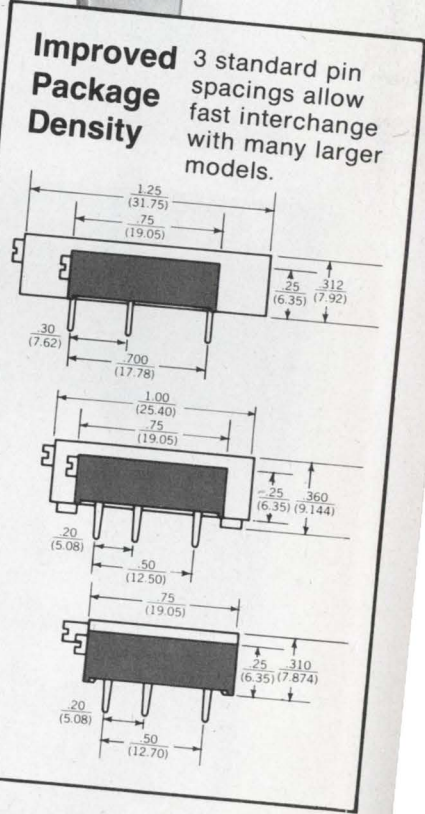

99 cents each in 1,000 quantity
 Samples available. Write today on company letterhead describing application...or call **402-564-3131**



DALE ELECTRONICS, INC.
 1300 28th Avenue, Columbus, Nebr. 68601
 In Canada: Dale Electronics Canada Ltd.
 In Europe: Dale Electronics GmbH
 8 Munchen 60, Falkweg 51, West Germany
 A subsidiary of The Lionel Corporation

Our complete product line can be found in *Electronic Design's GOLD BOOK*.
 ELECTRONIC DESIGN 26, December 20, 1974
 INFORMATION RETRIEVAL NUMBER 7

SPEND A LITTLE LESS, GET A LITTLE MORE.

Spend \$495, get a 9-column digital data printer. With buffered BCD outputs. DTL and T²L input compatibility. Externally controlled printing rate up to 3.7 lines/sec. And a single rotating print-drum designed for millions of cycles without readjustment.

Maintenance is easy because the ICs are socket-mounted. Replacement is even easier when you get our optional IC spares kit.

If you need a little more, spend a little more and get 18 columns for \$590.

Either way, the new Newport 810 digital printer offers

a lot of data input for a small dollar outlay. Options include universal breadboard card, input data storage, digital clock and events counter.

Get all the facts. Spend a second and circle the reader service number. Or spend a minute and write Newport Laboratories at 630 East Young Street, Santa Ana, California 92705. For immediate information, call collect. Dial (714) 540-4914. Ask for Lyell Kinney. Or TWX: 910-595-1787.

NEWPORT

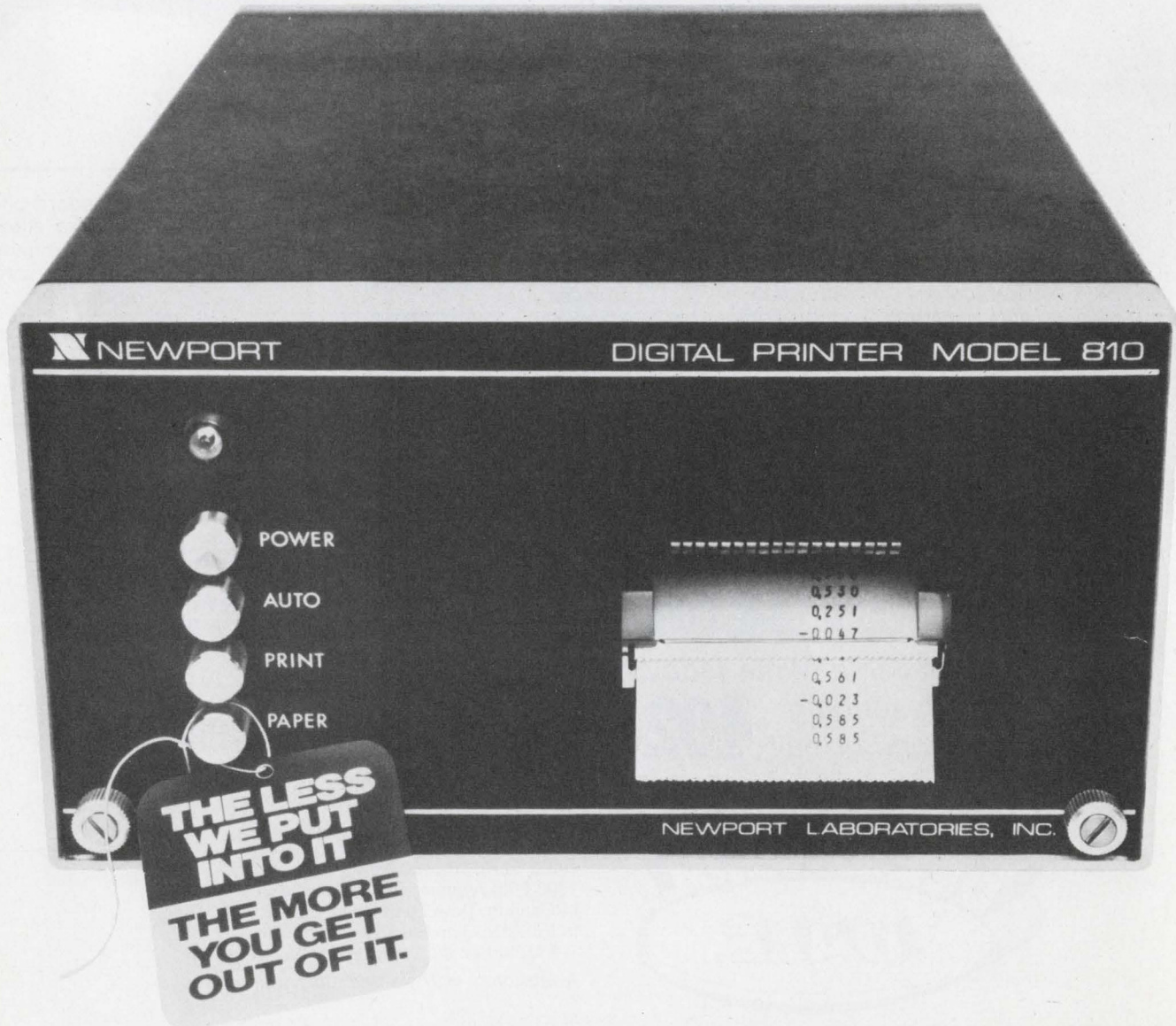

In Europe: Newport Laboratories B.V., P.O. Box 7759, Schiphol-0, Holland, Tel: 020-45-20-52
INFORMATION RETRIEVAL NUMBER 8

Centralab perspectives

FOR USERS OF ELECTRONIC COMPONENTS

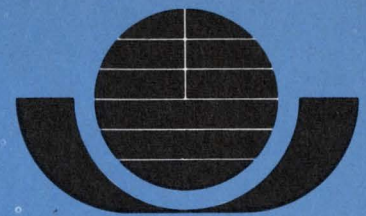

CENTRALAB

Electronics Division
GLOBE-UNION INC.

5757 NORTH GREEN BAY AVENUE
MILWAUKEE, WISCONSIN 53201

Here are three little ways to solve the big problem of switch selection when space is at a premium.

Slide, snap-action and rotary switches in the new line of Centralab micro-miniatures offer more than just size benefits. They're big in performance for a wide range of exacting applications.

The three new types of microminiature switches now available from Centralab, actually give you more than three ways to solve a switching problem. With the options available within each type, your selection is expanded to open a whole new world of design solutions for printed circuit board applications. If you're designing equipment or instrumentation that requires switch control for encoding, calibration, troubleshooting or a wide range of other functions, you'll find the perfect answer in this new Centralab line.



Actual Size

INTERDIL SLIDE SWITCHES

You'll really appreciate the modular flexibility of these switches. They're a DIP packaged, 2-pole switch that can be ganged to give you a pre-wired switch up to as many poles as required. There are three switching functions — SPST,

DPST and DPST Reversing, with each configuration coded in a different body color. All have color-dot status display to tell you when contact is made. Lead centers are standard .1" x .3". Rated 0.5 amps @ 12 VDC, 0.3 amps @ 24 VDC, they're a switch you can depend on for a guaranteed minimum life of 5000 operations.

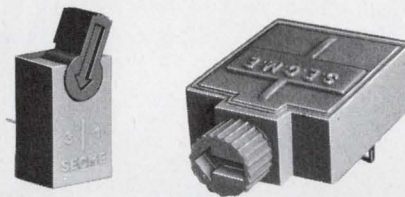

Actual Size

SNAP-ACTION SWITCHES

Here's a low-profile snap-action switch that has a power rating in both AC and DC. Depending on your particular application, you can select from ratings of 2.5 amps @ 110 VAC, 4.5 amps @ 12 VDC or 2.25 amps @ 24 VDC. You can specify either one or two pole versions with toggle or rotary actuation. You'll look far and wide to match the power-handling capability of these new little switches. But equally important is their size — they require a minimum of space for circuit board mounting — .35" high, .39" wide and .854" deep for one pole versions; .35" high, .74" wide and 1.126" deep for two pole types. You get silver contacts on enclosed switches, gold contacts on those with low current construction. And contact resistance is less than 10 milliohms. These, and many other features make them the perfect ones to switch to for snap action.

ROTARY SWITCHES

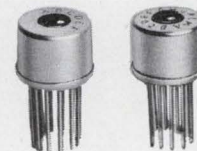

Actual Size

With the wide range of features offered in these microminiature rotary switches, you can meet the switching demands of almost any design. And their construction makes them so easy to work with. They're available as enclosed types with water sealed option, thus offering easy cleanup after flow soldering without risk of contamination.

To demonstrate their versatility, you can specify them in one, two or three pole versions, with 2 to 12 positions. They're rated 0.5 amps @ 12 VDC, 0.3 amps @ 24 VDC. Four types of actuation are available to best meet your needs — knob, lever, thumb-wheel or screw-driver adjust. Knob types are bushing mounted but all others are designed for board-mounting. Their size — less than 1/2" diameter — makes them ideal for circuit board or panel mounting when space is limited.



Actual Size

Now you have a new world of options in specifying the microminiature switch that's right for your design. The price and delivery are right too. Get all the details and specifications in Centralab's Catalog 1614S. Just circle the reader service number or call your Centralab representative.

Now Corning can meet precision metal film re

Request
For Quotation

Corning Glass Works
Electronic Products Div.
Corning, NY 14830

CORNING GLASS WORKS
ELECTRONIC PRODUCTS DIV.
CORNING, N.Y. 14830

Request
For Quotation

REQUEST
QUOTATION



CORNING GLASS WORKS
ELECTRONIC PRODUCTS DIVISION
CORNING, N.Y. 14830

REQUEST
FOR QUOTATION

Request
For Quotation



Request
For Quotation



Request

your complete resistor needs.

And you can quote us.

You can quote us on our new RN55, RN60, and RN65 "E" characteristic 25ppm precision metal film resistors in 0.1, 0.25, 0.5 and 1% tolerances, in addition to our full line of RL, RLR, and RN (C and D) characteristic resistors.

They're available now directly from us or through your Corning distributor.

Even before we put our new 25ppm precision metal film resistors on the market, Corning was manufacturing more metal film resistors than anyone else in the United States. There's a reason. Our multi-million dollar investment in high-speed automated equipment and improved techniques assures prompt delivery of volume orders. Our distribution supply center maintains a stock of Corning components in anticipation of future distributor needs.

The best distributor network in the country is ready to service your metal film resistor needs. Give them a call. For additional information, contact your nearest Corning Electronics sales office or Corning Glass Works, Electronic Products Division, HPA2, Corning, New York 14830, (607) 974-8652.

CORNING
ELECTRONICS

INFORMATION RETRIEVAL NUMBER 10

Request
For Quotation

Call your Corning distributor.

ALABAMA: Huntsville
Cramer/EW (205)539-5722

ARIZONA: Phoenix
Liberty Electronics (602)257-1272

CALIFORNIA: Gardena
Bell Industries Electronics (213)321-5802

CALIFORNIA: Los Angeles
Liberty Electronics (213)322-8100

CALIFORNIA: Mountainview
Elmar Electronics (415)961-3611

CALIFORNIA: San Diego
Liberty Electronics (714)565-9171

COLORADO: Commerce City
Elmar Electronics (303)287-9611

COLORADO: Denver
Cramer Electronics (303)758-2100

CONNECTICUT: North Haven
Cramer Electronics (203)239-5641

FLORIDA: Hollywood
Cramer/EW (305)923-8181
Hamilton/Avnet Electronics (305)925-5401

FLORIDA: Orlando
Cramer/EW (305)894-1511

ILLINOIS: Chicago
Bell Industries (312)282-5400
Schweber Electronics (312)593-2740

INDIANA: Indianapolis
Graham Electronics Supply (317)634-8202

MARYLAND: Baltimore
Radio Electric Service Co. (301)823-0070

MASSACHUSETTS: Watertown
Sterling Electronics (617)926-9720

MASSACHUSETTS: Newton Centre
Cramer Electronics (617)969-7700

MINNESOTA: St. Paul
Ragon Electronics (612)488-0201

NEW JERSEY: Cherry Hill
Cramer Electronics (609)424-5993

NEW JERSEY: Somerset
Schweber Electronics (201)469-6008

NEW MEXICO: Albuquerque
Cramer Electronics (505)265-5767

NEW YORK: Freeport
Milgray Electronics (516)546-6000

NEW YORK: Hauppauge
Cramer/Long Island (516)231-5600

NEW YORK: Rochester
Cramer/Rochester (716)275-0300

NEW YORK: Syracuse
Cramer/Eastern (315)437-6671

NEW YORK: Westbury
Schweber Electronics (516)334-7474

NEW YORK: Woodbury
Harvey Electronics (516)921-8700

NORTH CAROLINA: Raleigh
Radio Electric Service Co. (919)832-2077

NORTH CAROLINA: Winston-Salem
Cramer/EW (919)725-8711

OHIO: Cincinnati
Sheridan Sales Co. (513)761-5432

OHIO: Cleveland
Schweber Electronics (216)464-2970

OHIO: Columbus
Hughes-Peters (614)294-5351

PENNSYLVANIA: Philadelphia
Almo Electronics (215)676-6000

TEXAS: Dallas
Solid State Electronics (214)352-2601

TEXAS: Houston
Hamilton/Avnet Electronics (713)526-4661

UTAH: Salt Lake City
Cramer Electronics (801)487-4131

WASHINGTON, D.C.
Cramer/EW (301)948-0110
Milgray/Washington (301)864-1111

WASHINGTON: Seattle
Liberty Electronics/NW (206)763-8200

CANADA: Montreal
Cesco Electronics, Ltd. (514)735-5511

CANADA: Toronto
Cesco Electronics, Ltd. (416)661-0220

Digital introduces a pair of minis for the price of micros.

**8/A-400 with
8K core. \$1845.**

**8/A-200 with
4K MOS. \$1317.**

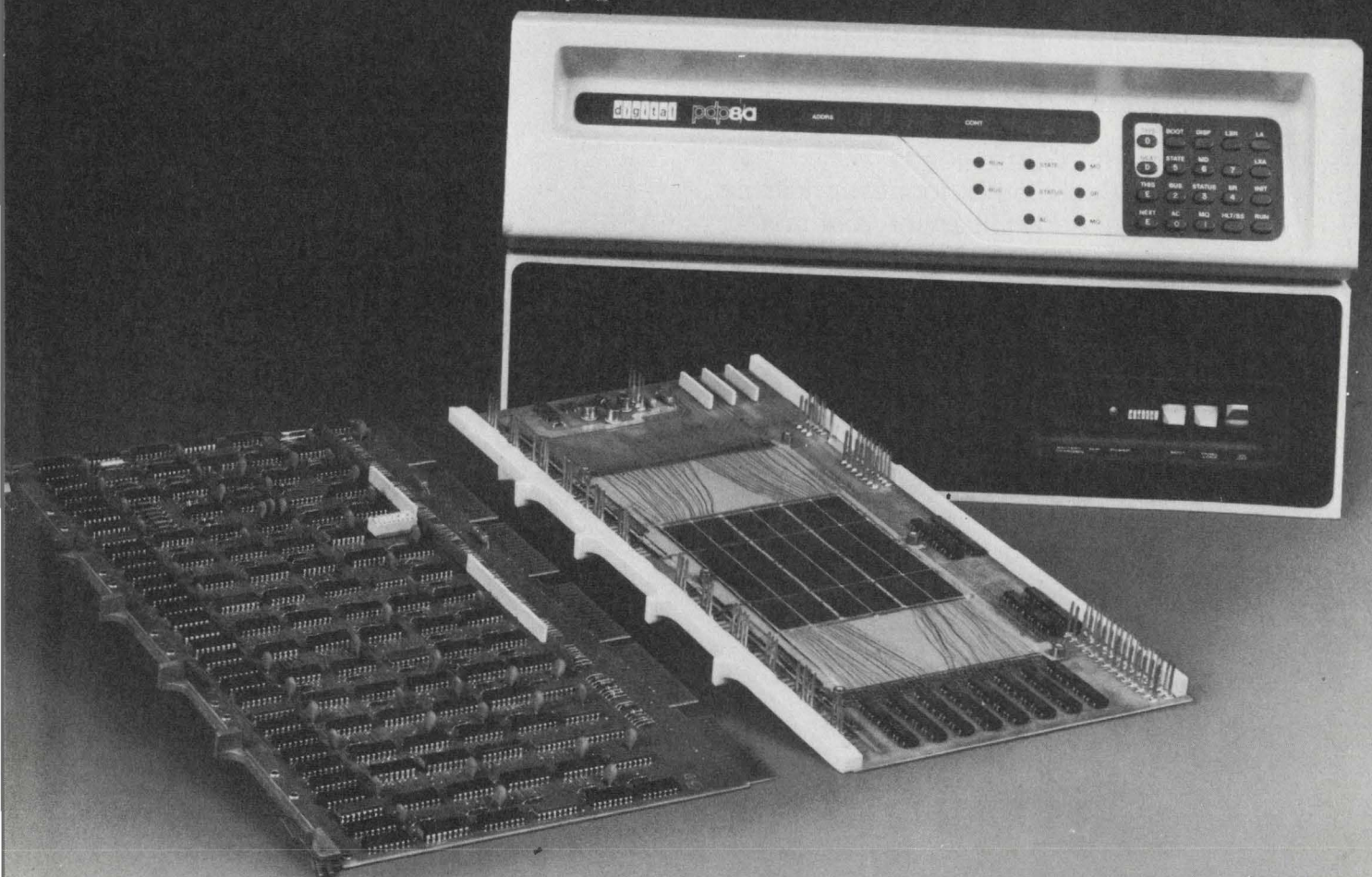

Two new small computers.
Two new bottom-busting prices.

The 8/A, with central processor, 4K of MOS (RAM) memory, chassis, power supply, operator's console, and battery backup. Just \$1317 in quantity 50.

The 8/A-400, with central processor, 8K of core memory, chassis, power supply, and operator's console. Only \$1845 in quantity 50.

Now take a look at the quantity prices in the table below. And while you're at it, take a close look at the competition's prices.

What you learn may surprise you.

But price is only half the story.

As part of the largest computer family in the world (over 25,000 PDP-8's installed), both these new computers are backed by 10 years of PDP-8 software development.

Dozens of PDP-8 peripherals. And a complete range of interfaces.

We've become the world's leading supplier of small computers by helping you make the most of computers.

Now prices are going to

keep us there.

For more information on these new computers, write Digital Equipment Corporation, Maynard, MA 01754. (617) 897-5111. European headquarters: 81 route de l'Aire, 1211 Geneva 26. Tel: 42 79 50. Digital Equipment of Canada, Ltd., P.O. Box 11500, Ottawa, Ontario K2H 8K8. (613) 592-5111.

digital

| | | CPU & 1K RAM Boards Only | CPU & 4K RAM Package | CPU & 8K CORE Package | CPU & 16K CORE Package |
|------------------------|-----------|-----------------------------------|-------------------------------|--------------------------------|---------------------------------|
| Digital Equipment | PDP-8/A | \$ 591 | \$1317 | \$1845 | \$2505 |
| Computer Automation | LSI 2/10 | \$1050 | \$2135 | \$2459 | \$3491 |
| Data General | Nova 2/4 | Not Available | \$2112 (CORE) | \$2432 | \$3456 |
| General Automation | LSI 12/16 | \$ 635 (Qty. 100) | \$2000 (Qty. 100) | \$2300 (Qty. 100) (RAM) | \$3100 (Qty. 100) (RAM) |
| National Semiconductor | IMP-16L | \$ 713 | \$2660 | \$3510 (RAM) | \$5210 (RAM) |

Based upon current published prices for discount level of 50 units.

Prices apply to U.S.A. and Canada only.

DIB*

DUAL IN-LINE BRIDGE

An integrated bridge rectifier in a dual in-line package

ACTUAL SIZE PACKAGE

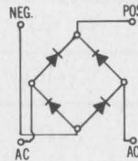
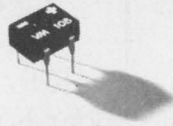

Another **FIRST** from Varo Semiconductor, Inc. An integrated bridge rectifier in a miniature, 4-pin, low-profile DIP.

The DIB, dual in-line bridge, is compatible with automated testing, handling and inserting equipment for production economy, handling ease and greatly reduced assembly errors. They are 100% surge tested at 25 AMPS and meet moisture resistance requirements of MIL-STD 202, method 106C. Higher component density, reduced labor and materials costs are among other advantages offered by the DIB.

For simplified board layout the four leads are on 0.10" (2,54mm) grid spacing. The bridge can be used with standard DIP sockets.

Typical applications include electronic calculators, small permanent magnet motors (such as used in shavers and hair dryers), solid state relays and similar applications where full-wave rectification and small size is required.

Two DIB series are available: 1/2 Amp I_o at 55°C, (T_A) with 25V, 50V, 100V and 200V (V_{RRM}), and a 1 AMP I_o at 40°C, (T_A) with 50V, 100V, 200V, 400V, 600V, 800V and 1000V (V_{RRM}).

You may never build another discrete diode bridge.

Write Dean Wolfe, Varo Semiconductor, Inc.

FOR FREE EVALUATION SAMPLE

Design us in . . . we'll stay there

VARO SEMICONDUCTOR, INC.

P.O. BOX 676, 1000 N. SHILOH, GARLAND, TEX. 75040 (214) 272-4551 TWX 910-860-5178

* TM-Varo Semiconductor, Inc.

Varo Sales Representatives

AL Buchanan & Abrams Assoc. 305-898-7444 • AZ W. W. Posey Co. 602-949-5873 • AR Whiteside Sales 214-231-9771 • CA (NO) W. W. Posey Co. 415-948-7771 • CA (SO) Corcoran Assoc. 213-823-4589 • CO Sage Sales 810-531-0531 • CT Comp Rep Assoc., Inc. 203-239-9762 • DE Tom Davis Marketers 302-998-0123 • FL Buchanan & Abrams Assoc. 305-898-7444 • GA Buchanan & Abrams Assoc. 305-898-7444 • IA Coombs Assoc. 312-298-4830 • IL (NO) Varo Semiconductor, Inc. 312-627-3802 • IL (SO) Beneke & McCaul 314-567-3399 • IN Technical Reps, Inc. 317-849-6454 • KS Beneke & McCaul 816-765-2998 • KY Technical Reps, Inc. 317-849-6454 • LA Whiteside Sales Co. 214-231-9771 • ME Comp Rep Assoc., Inc. 617-444-2484 • MD Tom Davis Marketers 703-591-7390 • MA Comp Rep Assoc., Inc. 617-444-2484 • MI Davis-Martensen Co. 313-474-8300 • MN Loren F. Green Assoc. 612-781-1611 • MS Buchanan & Abrams 305-898-7444 • MO Beneke & McCaul, Inc. 314-567-3399 • NB Beneke & McCaul 816-765-2998 • NJ (NO) Cooper-Simon & Co. 516-487-1142 • NJ (SO) Tom Davis Marketers 302-998-0123 • NM W. W. Posey Co. 602-949-5873 • NY (METRO) Cooper-Simon & Co. 516-487-1142 • NY (UPST) Bob Dean, Inc., 607-272-2187 • NC Buchanan & Abrams Assoc. 704-332-4974 • OH (NO) J. C. Hofstetter Co. 216-241-4880 & 216-725-4477 • OH (SO) J. C. Hofstetter Co. 513-296-1010 • OK Whiteside Sales Co. 214-231-9771 • OR C. K. Shanks & Assoc. 503-292-5656 • PA (E) Tom Davis Marketers 302-998-0123 • PA (W) J. C. Hofstetter Co. 412-561-5454 • RI Comp Rep Assoc., Inc. 617-444-2484 • SC Buchanan & Abrams Assoc. 704-332-4974 • TX Whiteside Sales Co. 214-231-9771 • UT Sage Sales 801-531-0531 • VA Tom Davis Marketers 703-591-7390 • WA C. K. Shanks & Assoc. 206-632-4290 • WI Varo Semiconductor, Inc. 414-782-7590 • CANADA • ONT Cantronics, Ltd. 416-661-2494 • QUE Cantronics, Inc. 514-341-5207

INFORMATION RETRIEVAL NUMBER 12

ELECTRONIC DESIGN 26, December 20, 1974

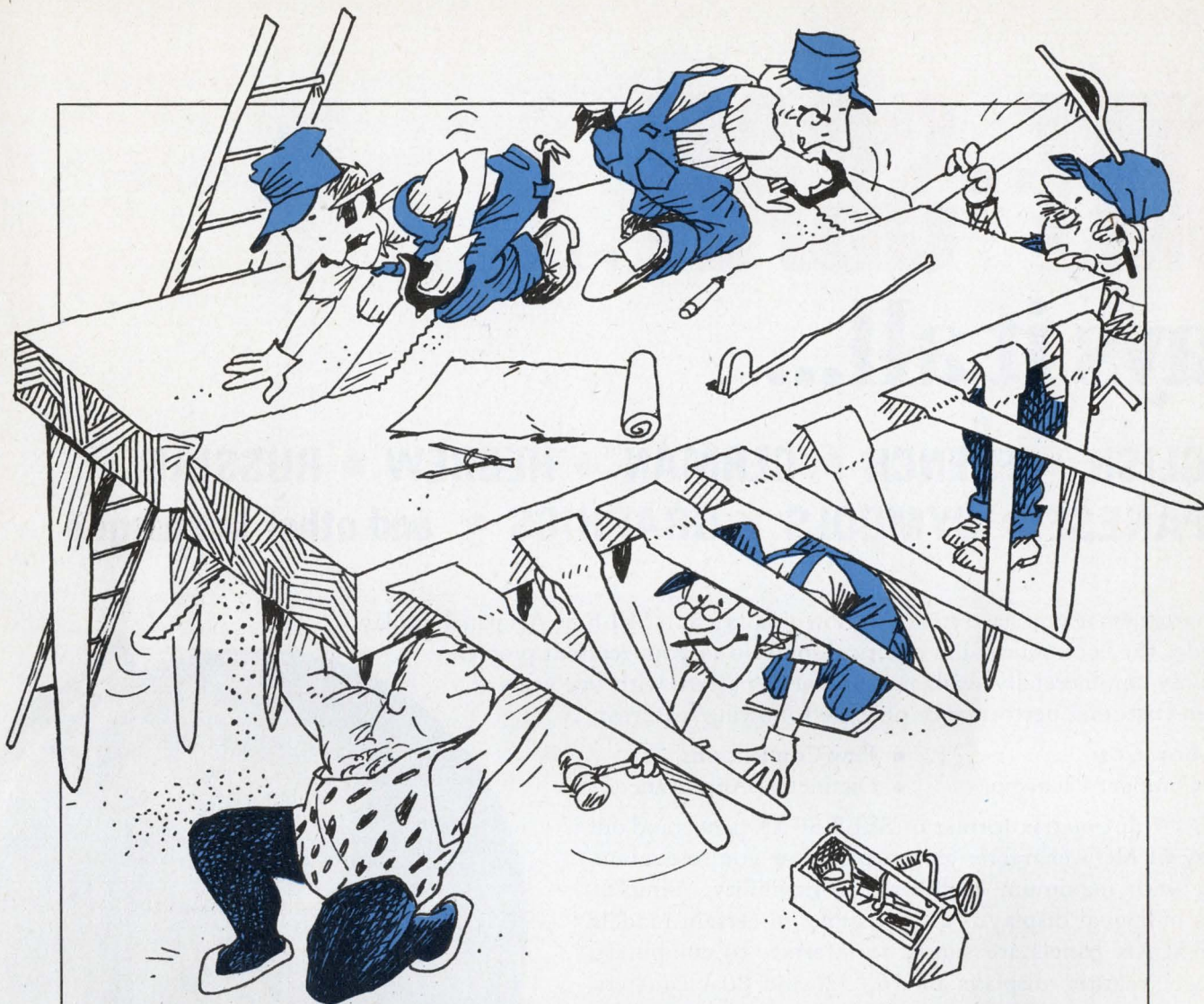

Our DIP crew makes great SIP resistor networks, too.

Leave it to our guys. They know you need a variety of space-stretchers to make your circuit-board packaging easier. And that's why these DIP experts also make Beckman RESNET™ standard SIP networks in 30 popular varieties.

These thick-film, cermet SIPs (.780" wide, .350" high, .090" thick) are standard 8-pin types, dimensionally uniform and ideal for automatic insertion techniques. Laser-tailoring assures precise resistance values, and every part is 100% tested.

Two convenient networks (see schematics)

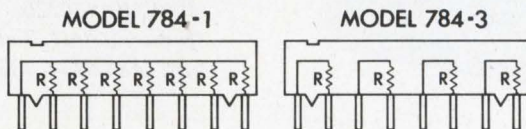

give you a 7-resistor model for applications like pull-up or pull-down networks, and a 4-resistor model for such typical uses as line termination and LED current limiting.

Resistance values available in both versions are 100, 150, 220, 330, 470, 680, 1K, 1.5K, 2.2K, 3.3K, 4.7K, 10K, 15K, and 22K.

And now for more good news. They're all stocked locally by your Beckman/Helipot distributor, ready for immediate delivery.

Cost? Truly competitive, actually giving you cermet quality at plastic prices.

Why wait? Let the new Beckman SIP line start making things a lot easier for you. For immediate literature or the phone number of your Beckman/Helipot representative, call toll-free (800) 437-4677. Right now.

Beckman®
HELIPOT DIVISION

a SELF-SCAN[®] PANEL

says it all...

**ENGLISH • FRENCH • GERMAN • HEBREW • RUSSIAN
JAPANESE • SYMBOLS • GRAPHICS • and other languages**

No matter what you have to say or how you say it, a SELF-SCAN panel display provides the economical and practical solution to your readout problem. The only commercially available dot matrix pattern with five years of proven customer performance plus the following features:

- Low Cost
- Compact Packaging
- Few Connections
- Distinctive Appearance

The 5 x 7 dot matrix format of SELF-SCAN panels and our variety of MOS character generators allow you to communicate with maximum legibility and flexibility. Simultaneous bi-lingual display is also possible on certain models. SELF-SCAN panels are simple to interface to computers.

Single register displays of 16, 32, and 80 characters, and multi-register displays of 256 (8 x 32) characters are available. 0.2", 0.3", 0.4" characters with soft neon-orange glow are visible up to 25 feet.

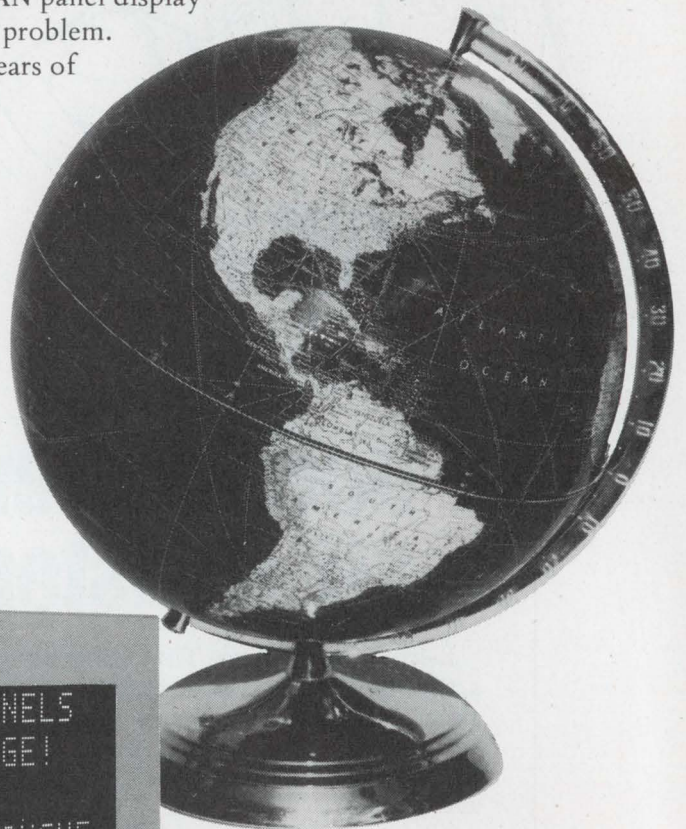

BURROUGHS' SELF-SCAN PANELS
CAN SPEAK YOUR LANGUAGE!
7+7) 3000"0 0+877
PEUVENT PARLER VOTRE LANGUE
ОНО ГОВОРИТ ПО-РУССКИ
SPRECHEN IHRE SPRACHE
AND MANY OTHERS TOO!
0123456789 OR 0123456789 CR ←

Call your Burroughs representative for a "briefcase" demonstration, or get in touch with Burroughs Corporation, Electronic Components Division, P.O. Box 1226, Plainfield, New Jersey 07061, Tel. (201) 757-3400 or (714) 835-7335.

You can see the difference

Burroughs



I²L turns up in wristwatch and a microprocessor chip

Commercially available integrated injection logic is about to make a big impact on the electronics industry.

The new circuit technique, which offers higher density than silicon-gate NMOS while promising lower cost and higher performance, has made its commercial debut in a new electronic watch produced jointly by Benrus and Texas Instruments.

A second shoe will drop on Jan. 23, when TI plans to unveil its long-rumored I²L microprocessor. According to Charles M. Clough, vice president and marketing manager for TI's Semiconductor Div., the watch chip and the microprocessor are only a start.

TI is planning a whole new product line of grand-scale integrated devices (GSI). The components in this family will be constructed with the I²L technology and contain a minimum of 1000 gates per chip. While early units, such as the watch chip, will be custom devices, Clough states that catalog items will be available by next year.

In describing the I²L watch chip, the TI vice president notes that it contains more than 2000 bipolar

transistors in a chip area that is 25% smaller than the CMOS circuits with which it is now competing.

A big advantage of the I²L approach is that it is possible to integrate the high-power digit and segment drivers, together with the time-keeping circuitry, on the same chip. With CMOS, additional driver chips are necessary. The new bipolar approach also reduces the component count from 23 for a typical CMOS watch module to five for I²L.

TI's injection-logic microprocessor, known as the SBP0400, is reported to be a 4-bit slice processor with an execution time of between 800 and 900 ns. The unit was developed for use in a new generation of high-speed computers, and the company is said to have given samples of the low-voltage micro to several of its customers. Versions that operate over the full MIL temperature range can be made, TI says.

The military version, the company says, can also be used under the hood of an automobile. Power dissipation is expected to be three to four times lower than that of an equivalent MOS unit.

Poof! And big reflector forms in ionosphere

The Defense Dept. has revealed that scientists have for several years been creating instantaneous giant reflectors in the ionosphere that bounce radio signals to far more distance points on the earth's surface than the normal ionosphere does. And the reflector will also handle much higher frequencies.

Normally signals in the 30-to-600 MHz band are transmitted and received in a line-of-sight mode

and have a range of between 50 and 100 miles. With the artificial reflector, however, signals can be propagated several thousand miles.

The "communications relay satellite" is an aurora that the scientists create by beaming rf energy from a ground-based transmitter straight up to the ionosphere. They can dissolve the aurora instantly by turning the transmitter off. No trace of the phenomenon is left—no ecological pollution of any kind.

What happens is that the high-powered energy heats up the elec-

trons in the ionosphere, creating scattering irregularities that are aligned with the geomagnetic field. The result is a reflector 100 miles in diameter and 10 miles thick. The enormous cloud can't be seen by the eye, but it can be photographed with an infrared camera.

The ground-based transmitter costs about \$2-million. It puts out 2 million W, which, with a high-gain antenna, has an effective radiated power of from 20 million to 30 million W. The transmitter station can be manned by three people.

Research has taken place at three sites, one, near Platteville, CO, is operated by the Institute for Telecommunications Sciences. Another is the 1000-foot dish at Arecibo, Puerto Rico, managed by Cornell University. A third is at Gorkie in the Soviet Union, about 400 km east of Moscow.

Studies on the feasibility of the system as a communications technique are being carried out by Stanford Research Institute, Menlo Park, CA.

The work was originally funded by the Defense Dept.'s Advanced Research Project Agency. The agency was trying to find a way to louse up an enemy's ionospheric scatter communications and accidentally discovered that it was a good way to enhance one's own communications.

Automatic interrogator doesn't need a computer

An automatic medical-history interrogator and recorder uses multiple-track tapes and simple logic to eliminate the need for a computer.

The system, which can be used either in a doctor's office or remotely by telephone, is called DataQuest I and was developed by the Westinghouse Health Systems Dept., Pittsburgh.

Audio tapes ask the questions. The patient responds by pushing buttons on a console or on a Touch-tone telephone. Language is no barrier, says the designer, John Waclo, since the system can be programmed to ask questions in one language and print the response in another.

Waclo explains that the history-taker contains three separate tapes.

The first contains all the questions. It has four tracks and can be read in the forward and reverse directions, which increases the storage capacity to eight tracks.

The multiple tracks make it easy for the system to branch in response to patient answers to questions, the tape also contains machine code for each question.

When a patient responds to a question, internal logic generates a code that controls a dictionary tape. This takes the patient's answer and converts it to an ASCII code, so it can be recorded further on a response tape or printed out directly on a printer. The response tape, which is a cassette, can hold information from 30 to 50 persons, each of whom gives about 300 responses. The response tape, Waclo says, makes it easy to batch-process the information and print out all the reports at once.

While the DataQuest I is not computerized, the project manager indicates that an interface is available to link the unit to any computer information system.

Touchtone converted to pulsed dialing

Increasing public demand for pushbutton telephone dialing has created a serious problem for many telephone companies: The tone signals for the Touchtone instrument will not directly operate the relays in central offices because they are designed for pulsed dialing. A recent solution permits push-button dialing with conventional central-office equipment.

The Sam/Bar Corp., Santa Ana, CA, a private telephone-equipment reconditioner, has introduced a printed circuit assembly that mounts under a conventional Touchtone pad and converts it to pulse dialing.

The converter, which contains about 95% of the circuitry, is made from an ion-implanted NMOS IC manufactured for Sam/Bar by the Nitron Div. of McDonnell Douglas Corp., Cupertino, CA. The chip uses a first-in/first-out shift-register memory to store numbers as they are punched. The chip simultaneously generates standard pulses. The remaining components on the PC board consist of a regu-

lator and switching transistors to open and close the telephone circuits.

According to Gene Watkins, project engineer with Sam/Bar: "MOS was an absolute necessity in devising a converter to install in telephone instruments, because it was important to derive all operating power from the existing telephone loop current. The phone companies are intent that external power be kept away from their lines. We use about 4 mA at 5 V from the standard 24-to-25-mA loop current."

Another feature of the converter is toll-call restriction. With a screwdriver adjustment, a phone can be prevented from dialing outside lines, outside operators or long-distance numbers.

Sam/Bar will either sell the boards or the complete touchpad converters for installation on any standard rotary dial phone. Or the company will modify phones as part of a reconditioning program.

Laser unit to monitor driving visibility

A gallium-arsenide semiconductor laser has been combined with an optical receiver to produce a new instrument for monitoring visibility along highways.

Known as the Model VS-1, by International Laser Systems Inc., Orlando, Fla, the unit will get its first tryout next month along a stretch of the New Jersey Turnpike.

The visibility sensor will detect fog, snow, smoke or blowing dust and transmit information on visibility by cable to the New Jersey Turnpike Authority headquarters. There someone monitoring the system can actual local warning signs to alert motorists of conditions ahead.

The instrument works by measurement of the transmittance of a laser beam through the atmosphere. The distance between the transmitter and the optical receiver can vary between 250 and 2000 ft. The minimum resolvable visibility is 40 ft.

The transmitter contains a built-in sighting telescope that allows an installer to align the transmitter with the receiver. Alterna-

tively the receiver can be aligned with the transmitter via an integral signal-strength indicator.

Heaters in both the transmitter and the receiver units keep the windows clear during fog or snow conditions.

Digital-image system reconstructs in color

A high-speed digital image reconstruction system that can produce full-color transparencies exposes over 28,000 picture elements per second—each 100 μm square—on a 10-by-10-inch film.

According to Glen Marcil, director of marketing for Optronics International, Chelmsford, MA, a principal factor in development of the Colorwrite C-3300 system was the use of a special white-light source—a glow crater tube. The tube can be modulated at high speed, yet it retains its white-light purity over an intensity-modulation range of 100:1.

The output of the glow tube is linear and is directly proportional to input current, Marcil points out. As a result, the current through the tube, which emits light in the 4000-to-7000- \AA band, is pulse-modulated. The level of each pulse, which controls the exposure for each picture element, is defined, by an 8-bit data word that is stored in a buffer memory.

The system, which was developed to reconstruct color data for the Earth Resources Technology Satellite can also be used in image enhancement and nondestructive testing, Marcil says. In the latter application, an X-ray is scanned and the various shades of gray in the X-ray are reproduced in color. With color it is easier to detect defects, Marcil says.

The system has a transparent rotating drum, and the film is clamped around it. The glow tube and its optical system move along the inside of the drum.

A wheel containing red, blue and green filters is used. One filter is inserted in front of the glow tube for each pass of the film. For full-color exposures, three separate passes are required, Marcil says. With a 100- μm picture element, about 30 min are required for three passes.

**JUST
HOW GOOD
IS THE
TELETYPE[®]
MODEL 40?**



La Salle National Bank

EXCHANGE NATIONAL BANK OF CHICAGO

Clock tower face

We think our data terminal system is so good nothing even comes close.

In fact, we believe the Teletype® model 40 system is so good it'll change the way business looks at data. We're that sure it's that good.

Here's why:

It's a complete, versatile, reliable terminal system delivering maximum efficiency in a wide range of applications. From message communications to computer input/output on switched network or private-line systems. Right now, the model 40 system is being used by airlines, news services, brokerage firms, manufacturers, law enforcement agencies and time-sharing services.

Significant features of the system are speed, ease of data preparation and editing, compactness and extremely low maintenance. And since the model 40 is completely modular, you can forget about obsolescence. It's designed to grow as your needs grow.

Data is presented with extreme clarity on the big, 13-inch screen. Characters are 35 percent larger than standard print size and are formed on a 7 x 9 dot matrix. Screen capacity is 24 lines of 80 characters each for a total of 1,920.

Teletype's exclusive solid-state design makes the model 40's fast (up to 2400 wpm), heavy-duty impact printer the most cost-effective unit on the market. Its simplicity of design makes it one of the most reliable printers we've ever made. And after more than 60 years experience building printers that set the standards for reliability, that's saying something.

It took a total corporate commitment to come up with something as good as the model 40. For example, we had to develop and manufacture our own MOS. It didn't come easy, but we think it's worth it. Because the solid-state components throughout the system deliver exceptionally high reliability.

And the self-diagnostic circuitry and design modularity significantly reduce downtime and maintenance costs.

Operator comfort and efficiency are increased by human-engineering efforts like a brightness control and screen tilt, plus a glare-reducing display tube and an easy to operate keyboard.

The Teletype model 40 data terminal system.

It's every bit as good as you've heard.

And probably even better.



The Teletype model 40 system.



Keyboard Display (KD)

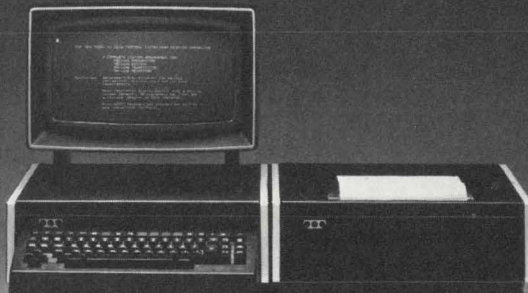

Keyboard Display Printer (KDP)

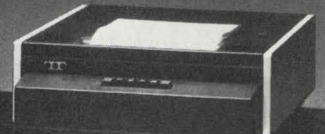

RO Printer

The Teletype model 40 is so good it's worth looking into.

Listed below are some of the general specifications of the model 40 system.

Display

5¼" x 11¼" viewing area on a 13" display tube.

High resolution 7 x 9 dot matrix character presentation.

127 characters of ASCII code displayed (all except backspace).

1,920 character screen capacity composed of 24 lines of 80 characters per line.

Anti-glare screen, brightness control plus tube tilt.

Constant image cursor—when cursor is positioned over a character, character becomes a negative image.

Refresh rate: 60 frames/second.

Operator Console

Standard keyboard generates 127 ASCII characters.

Six cursor positioning controls; Home, Return, Left, Right, Up and Down.

Five data editing controls; Clear, Character Insert, Character Delete, Line Insert and Line Delete.

Basic terminal controls; Send, Receive, Local.

Optional Page Printer

Impact printer provides hard copy of data stored in the display memory, or of data received directly from the communication line.

Printing speed is over 300 lines per minute (monospace), or 220 lines per minute (full upper and lower case).

Optional Features

Expanded memory, scrolling, protected format, highlight, tabulation, form send. Plus more.

Technical Information

Speed: serial interface; 105 or 120 cps. Code: 1968 USASCII.

Method: transmission is serial by bit and character with low order bit transmitted first.

Synchronization: asynchronous; 1 start bit, 7 information bits, 1 parity bit, 1 stop bit.

Communication line: switched network at 105 or 120 cps.

Bell System Data Sets 202C, 202R or equivalents. Other speeds optional.

Interface: serial—EIA RS-232C. Mode: half duplex.

Error control: optional vertical parity detection on received data (substitute character printed for errored characters). Keyboard generates even vertical parity.

Power requirements: 117V AC ± 10%; 50-60 Hz.

Operating environment: + 40° to 110° F, 2% to 95% humidity.

For complete technical data, please contact our Sales Headquarters at 5555 Touhy Avenue, Skokie, Illinois 60076. Or call TERMINAL CENTRAL at (312) 982-2000.

Teletype is a trademark registered in the United States Patent Office



Japan's electronics:

Fighting back

While Japan's economy is reeling from massive inflation and staggering under the impact of quadrupled oil prices, her electronics industry is fighting back.

In virtually every segment, from consumer electronics to sophisticated test equipment, her industry is offering new and better products—some of them dramatic. Many of these products could be seen at this year's Japan Electronics Show in Tokyo. They may have contributed to the success of this year's show in comparison with last year's, which was held in Osaka. But the products weren't the only factor.

The Tokyo show, which has taken place in even years since 1958 (originally as the TV and Radio Parts Show) has always drawn more engineers, and thus has always been bigger, than the Osaka Show, which takes place in odd years.

From an attendance viewpoint, this year's show may also have been helped by the People's Republic of China Exposition, which was held across the mall at the Harumi Exhibition Pier.

George Rostky
Editor-in-Chief

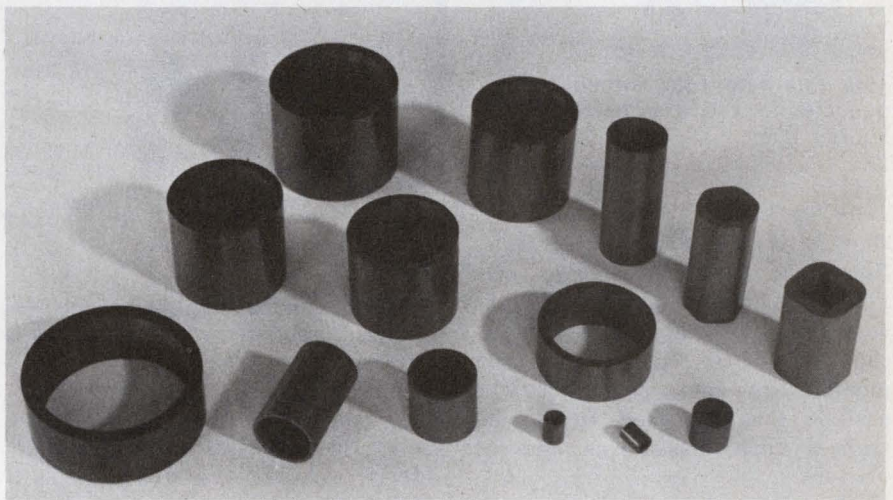

Baumkuchen magnets from Fuji Electrochemical use the thin spiral construction of a famed German cake—with thin ferrite sheets rather than dough. The magnets, with radial rather than longitudinal lines of force, are more powerful than others of the same size and weight.

While the Tokyo show usually draws 30% more visitors than the Osaka show, the show management this year predicted that attendance would top 350,000 or 450,000, compared with 250,000 for Osaka last year. These figures should not be compared too quickly with attendance figures of about 30,000 for the IEEE or Wescon shows, as the traditions in Japan are different.

The seven-day shows in Japan are open to the public. So a housewife, wandering through the exhib-

its of silks, furniture and oil-field models at the China Exposition, could walk across the mall to the Japan Electronics Show and see the latest color TVs, stereo receivers, scopes, power supplies, ICs and computers. If she leaves one exhibit hall and visits another, she is counted again—as she is if she walks out of any of the three exhibit pavilions and returns.

Further, while attendance figures at U.S. shows are normally drawn from registration data, the

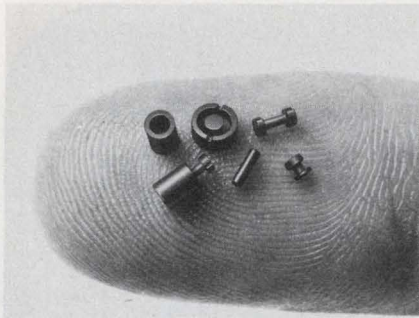

Some of the world's tiniest cores, from TDK Electronics, these are (clockwise from top left): sleeve, pot, bobbin, another bobbin, rod, and bobbin slipping into a sleeve.

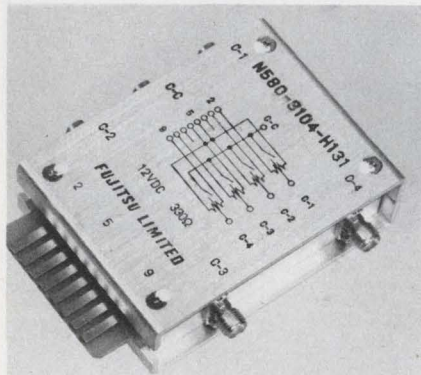

This four-pole coax switch for frequencies to 1 GHz is part of a new Fujitsu line.

counts at the Japan Electronics Show are based on figures provided by men stationed at the entrances with hand-held clicker-counters. These figures are later modified by show personnel, who assume that the men at the entrances have missed thousands of visitors.

Tour of the Crown Prince

But there was one visitor they didn't miss—Crown Prince Akihito, son of Emperor Hirohito. While the prince did not see all 1315 booth units of 432 exhibitors, he did see some of the most impressive products at the show.

He spent most of his time at 10 exhibits, where he saw a wide variety of products, including consumer-electronic equipment (San-
yo, Pioneer and Victor Co. of Japan), transformers for microwave ovens, (Tabuchi), closed-circuit color TV (Hitachi), a video facsimile storage system using slow-scan TV for transmission

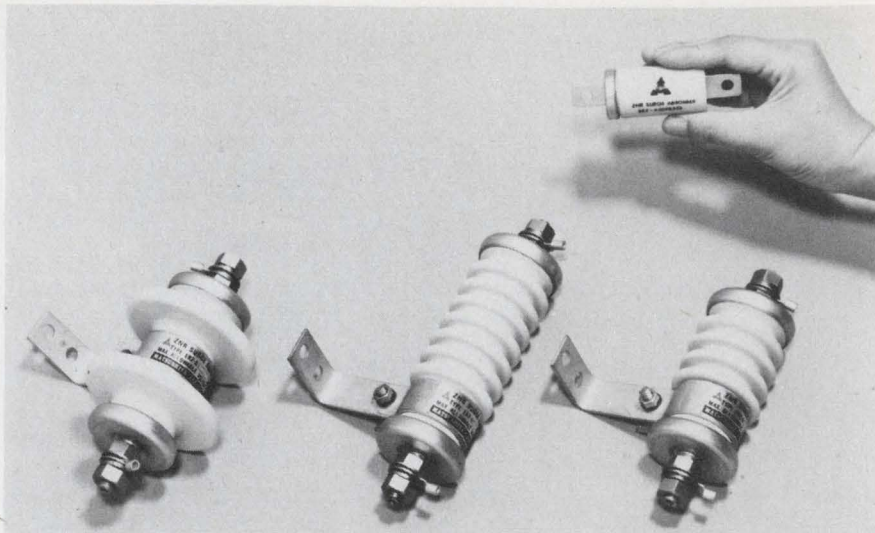

Zinc-oxide varistors from Matsushita now offer voltage ratings to 6.6 kV (center). They are used mainly as surge absorbers.

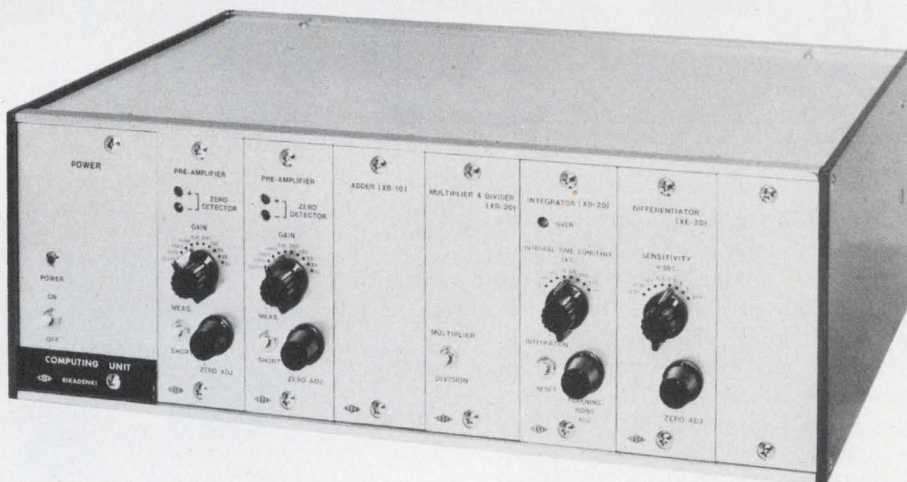

Signals can be amplified, added, subtracted, multiplied, divided, integrated and differentiated with Rikadenki's Computing Unit—a powerful accessory for graphic recorders.

over telephone lines (Nippon Electric), liquid-crystal displays (Sharp), test equipment (Yokogawa), a microcomputer (Toshiba) and advanced semiconductors (Matsushita).

Broadly, these products reflected much of the advanced work in Japanese electronics. The major efforts appear in several areas.

Consumer electronics for the ear

An omnidirectional loudspeaker from Pioneer Electronics uses a piezoelectric polymer film as the vibrating element. Since the film has extremely low mass compared with that of the usual loudspeaker cone, and since its impedance is almost entirely capacitive, the speaker requires very little power and

provides an unusually linear, distortion-free response in all directions (though it can be shaped to provide any directional pattern).

Its characteristics are similar to those of an electrostatic speaker, without requiring an additional high-voltage power supply.

The loudspeaker is now in development along with an extremely low-mass, high-compliance phonograph cartridge and a low-mass microphone. Stereo headphones using the film are already commercially available.

For the system between microphone and loudspeaker, the Victor Co. of Japan demonstrated quadraphonic stereo using the CD-4 system. There was more activity, though, in TV. Hitachi's main feature was a closed circuit color-

ERIE RESPONDS. that's why WE'RE NO. 1 WORLDWIDE in Ceramic Capacitors



Forty years ago, ERIE foresaw a need and introduced the first ceramic capacitor to U.S. markets. Today, more than 7000 people—working in a million-plus square feet of plant space—in seven nations . . . are still dedicated to fulfilling customer needs. Our state-of-the-art ceramic technology continues to lead the way in the development of smaller, more efficient ceramic capacitors, both fixed and variable. And ERIE's line of high quality components is as broad as the markets we serve. So when knowledgeable people think ceramic capacitors, increasingly, they think ERIE. To remain number one in our competitive industry, we have to be responsive to your needs. We think we are. Try us.

ERIE TECHNOLOGICAL PRODUCTS, INC.
Erie, Pennsylvania 16512

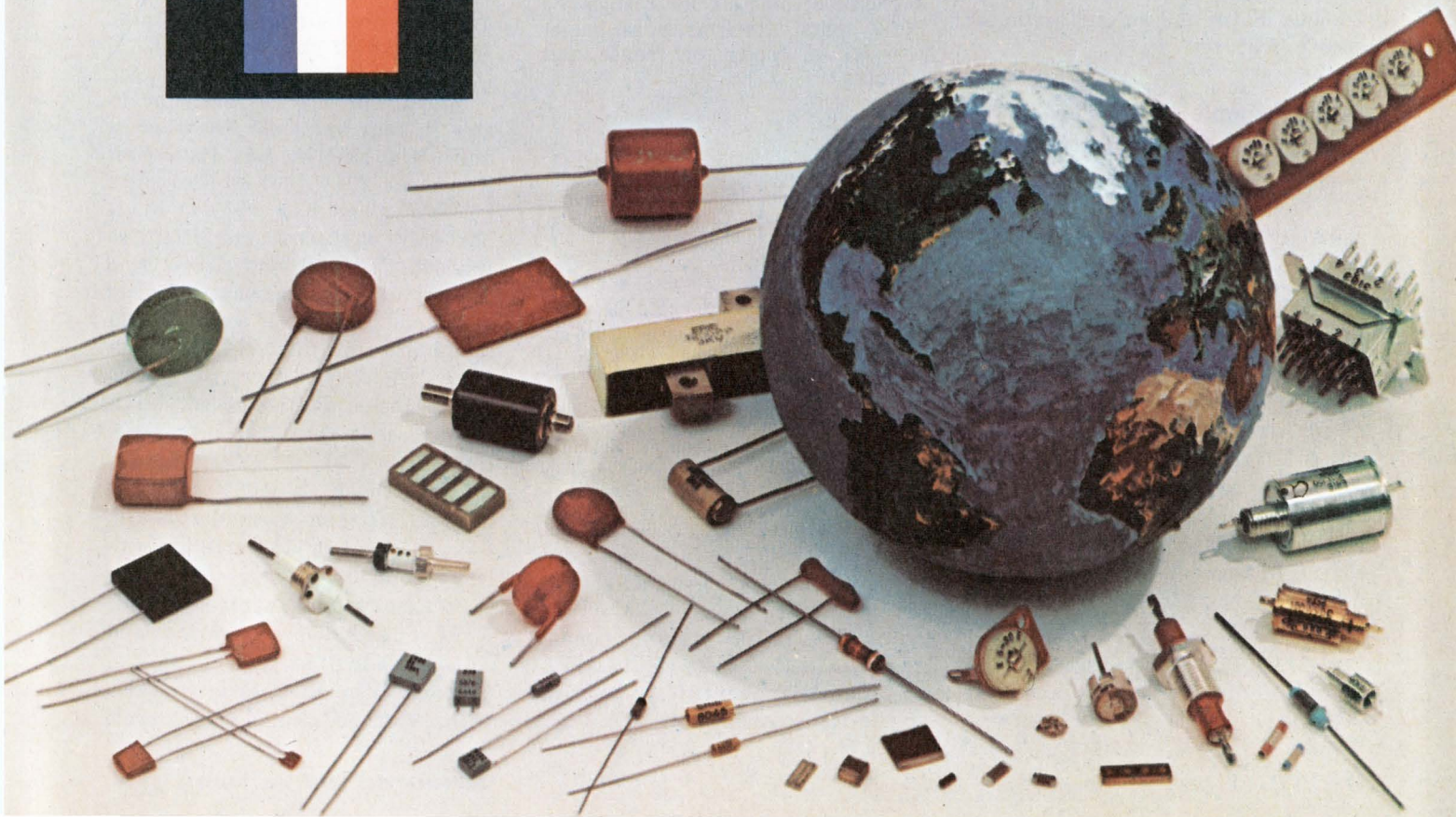

TV system. And Sanyo showed a small video color cassette recorder using half-inch tape.

A quick switch

Perhaps less colorful than color TV, a new line of switches from Fujitsu can prove useful to engineers who must switch high-speed signals. The basic configuration is a Form A coax switch, suitable for signals from dc to 1 GHz. But units can be combined in a single package to provide other arrangements. A 5 Form A combination costs about 50,000 yen, which, at a recent exchange rate of 300 yen per dollar, works out to about \$170 in small quantities.

Another manufacturer, Ise Electronics, a leader in fluorescent displays, is making a different kind of switch in expanding its traditional line of fluorescent displays for calculators and test equipment to include displays for digital clocks. The first versions are four-digit fluorescent displays, about 0.43-inch high. Later versions will be smaller and larger and will come with a colon and am/pm indicator.

Switching from its concentration on bare displays for the first time, Ise introduced a basic digital clock that uses its displays. The clock, the "Comet 12," is available on an OEM basis and includes a 24-hour alarm and an eight-minute snooze feature.

Semis—simple to complex

While most of the effort of semiconductor manufacturers is aimed at LSI developments, there's occasional but significant progress in discrete, small-signal devices. An important example is the "lambda" diode, so-called by Matsushita because of the shape of an important segment of its EI characteristic curve. This diode is intended mainly for use as an oscillator in the 2-to-3-MHz range. But it's also useful in low-voltage warning circuits, overvoltage protection circuits and a host of other applications. In sample quantities, it's now available for 500 yen (about \$1.70).

Matsushita Electronics has moved another step ahead in discretes by boosting the surge-

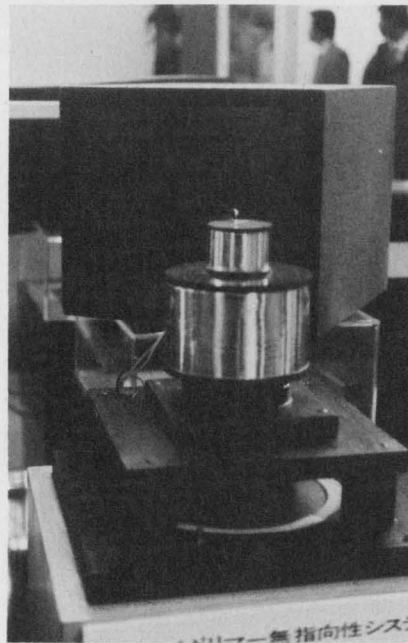

A low-mass piezoelectric film is the vibrating element in Pioneer Electronic's developmental omnidirectional loudspeaker.



A choice of plug-ins for Yokogawa's 2504 digital, true-rms power meter provides a choice of ranges and features.

voltage ratings available in its zinc-oxide varistors—used mainly as surge absorbers—from 3.3 kV to 6.6 kV.

But the company hasn't restricted its efforts to discrete devices. One of its more dramatic developments is a new 2×512 -bit bucket-brigade device that is just going into production. A silicon-gate PMOS device, it uses a tetrode configuration to improve charge transfer.

The BBD works with clock rates from 10 to 800 kHz and consumes no more than 4 mW, including the dissipation in a source-follower resistor. The initial price in sample quantities is 5000 yen (about \$17). In production quantities, the price should dip to about 3000 yen.

Equally impressive are memory developments from Fujitsu. The company is now working on a prototype 8-k, n-channel RAM with 120-ns access time. In production are 1-k p-channel RAMs as well as 1-k, 2-k and 4-k n-channel RAMs.

LSI developments, of course, are not restricted to memories. Toshiba, for example, demonstrated its TLCS-12 microcomputer, which uses 12 microprocessor chips. The computer uses a 1.2-MHz timing-generator chip and a controlled microprogram offering one micro-step in 800 ns and one full instruction in 10 microsteps, or 8 μ s. The machine includes 18 basic instructions.

Mag memories alive and well

While there are some who feel that semiconductor memories will take over the world, others believe that magnetic memories will have a place for many years to come. Toko, for one, is offering a line of small-capacity, woven, plated-wire memories. As one might expect, Toko emphasizes nonvolatility. But the company also stresses flexibility; its Mini-ROMs, with minor modification (in one case by the flick of a switch), can be used as ROMs, electrically alterable ROMs, RAMs, or partial ROMs, in which the basic 1024-word \times 8-bit or 9-bit system is divided into four 256-word units, each of which can serve as RAM or ROM.

Mini-ROMs are currently available in four versions. The slowest unit, Mini-ROM-A, has 1024 8-bit words (or 2048 4-bit words) on a board of about $8 \times 10 \times 1$ in. It has only one sense amplifier, so readout is serial and access and cycle times are somewhat leisurely at 2.4 and 3 μ s. RAM and EAROM capability are provided by an add-on $3\text{-}3/8 \times 3\text{-}3/4$ -in. piggyback board. Including the board, Mini-ROM-A sells for \$260 in quantities of 1 to 10.

Mini-ROM-B, a 1024 \times 9-bit memory, fits on a smaller board, $8 \times 8 \times 3/4$ in. and offers parallel readout, 0.5- μ s access and 1- μ s cycle time. It has switch-selectable RAM or EAROM operation and costs \$380 in 1 to 10.

Toko's Mini-ROM-C is quicker, with 300-ns access and 600-ns cycle

The Schottky sandwich.



The Augat Schottky board is something you can really sink your teeth into.

On the outside there are two ground planes, top and bottom, instead of just one.

On the inside there's a special voltage plane that's made of a generous slice of copper.

Laminated together, it makes a very neat sandwich that goes perfectly with Schottky TTL design.

For example, it increases distributed capacitance by as much as 400 percent. And at the same time, it greatly reduces high frequency noise.

It has ground embraced socket and I.O. connections that enhance isolation of signal interconnections.

Individual DIP decoupling capacitor zones and electrolytic-type decouplers at every power entry point.

And voltage and ground socket pins that are soldered directly to their planes to drastically lower impedance.

All in all, the Augat Schottky board can save you up to 90 percent in breadboarding and prototyping time. Tens of thousands of dollars in start-up costs. And many expensive hours in field maintenance.

The Augat Schottky boards are standard catalog items available right now in any quantity and in any multiple of patterns, from 30 up to 180.

If you'd like a taste of what it's all about, contact any of our world-wide distributors or Augat, Inc.,
33 Perry Avenue, Attleboro, Mass. 02703.
Tel. 617-222-2202. TWX 710-391-0644.

AUGAT[®]

time. It's available as a 1-k × 9-bit memory or as a memory with two 512-word sections, each to serve as RAM or ROM. It fits on a 6-1/4 × 8-3/4 × 1-in. board.

Sub Mini-ROM, the last of the series, is smaller and slower, with 512 4-bit words, 4- μ s access and 5- μ s cycle. It fits on a 6-1/4 × 7-7/8 × 5/8-in. board.

Ferrites for old and new

Toko is not alone in nonsemiconductor memories. Many manufacturers are heavily promoting core. Fuji Electrochemical, a major supplier, is making a particular drive for its small-capacity, nonvolatile core RAMs. These include on-board hybrid and monolithic drive, sense and decode circuits. Memories range from 128 × 4-bit RAMs that cost about 3 cents a bit to 4096 × 9-bit units that cost 1.2 to 1.5 cents a bit.

But Fuji doesn't restrict its ferrite efforts to core memories. The company has developed a "Baumkuchen" magnet, which derives its name from the shape, but not the flavor or texture, of a delectable German cake. The magnet is made by rolling, then pressing, thin 0.1-mm sheets of ferrite tape up to 2 m wide into cylinders, then slicing off desired widths.

The unique spiral construction provides radial lines of force with a remarkably high-energy product of 2.5 to 3 × 10⁶, as against a BH of 1 to 1.2 × 10⁶ for conven-

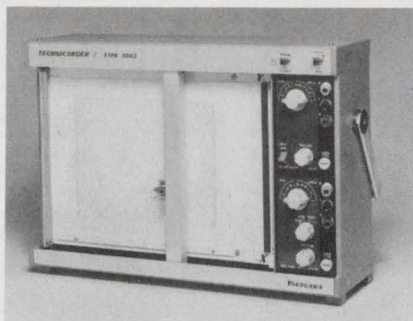

This plug-in X-Y recorder from Yokogawa can also serve as a strip-chart recorder.

tional, unoriented magnets. The Baumkuchen has about triple the performance of conventional magnets at, initially, about a 70% price premium.

The new magnet has a residual flux density of 3500 to 4000 gs and a coercive force of 2500 to 3000 Oe. It's aimed mainly at applications in stepping motors, brushless dc motors and automotive generators.

Equally unusual are some ferrite products from TDK Electronics, which is known throughout the world for its magnetic tape. The new products include some of the world's smallest cores. Bobbin cores, for example, are available with 1.5-mm over-all length and outer diameter. Sleeve cores have lengths and ODs of 2.79 and 2.16 mm, respectively; rod cores, 2.79 and 0.787 mm; pot cores, 2.6 and 3.3 mm; and poroids have IDs down to 2 mm.

TDK has also developed a ferrite electrode with enormous corrosion resistance. At normal temperatures, the electrode is practically undissolvable in aqueous solutions of hydrochloric acid or caustic soda. It has 10 times the corrosion resistance of magnetite, 100 times that of graphite. Aimed at applications like desalinization, water treatment and chlorine production, the electrode can be made with the resistivity from 0.01 to 0.5 Ω -cm.

Another example of TDK's work in ferrites is a doppler radar transmit-receive module using a calcium zirconium garnet substrate for the circulator, crystal mixer and filter, and directional coupler. The circulator is formed by printing a gold pattern on both sides of the magnetic garnet, rather than by mounting a YIG circulator on an alumina substrate or in a hole in the substrate.

The calcium zirconium offers much lower porosity and higher density than alumina does. The precise pattern printing made possible by the technique allows substantial cost savings. Initially, in quantities of 10, the new module costs about 150,000 yen (\$500), while traditional YIG modules cost about 200,000 yen.

To round out its new ferrite products, TDK introduced two materials—the super-low-loss H68-H3 and super-high- μ H5E. The former has a loss factor less than 1.2 × 10⁻⁶ at 100 kHz and initial permeability (μ) of 1300. The latter has a μ of 10,000 and a loss factor of less than 15 × 10⁻⁶ at 10 kHz.

Advances in materials technology—in a different direction—come from Fujitsu, which is working with single crystals of lithium tantalate, lithium niobate and lead molybdenite. Depending on composition and cutting orientation, these lend themselves to a wide variety of applications because they offer higher time and temperature stability than competing material.

Applications for the lithium tantalate include optical modulators and shutters, acoustic transducers, surface-wave delay lines and filters and piezoelectric devices.

The lithium niobate is intended mainly for ultrasonic transducers,

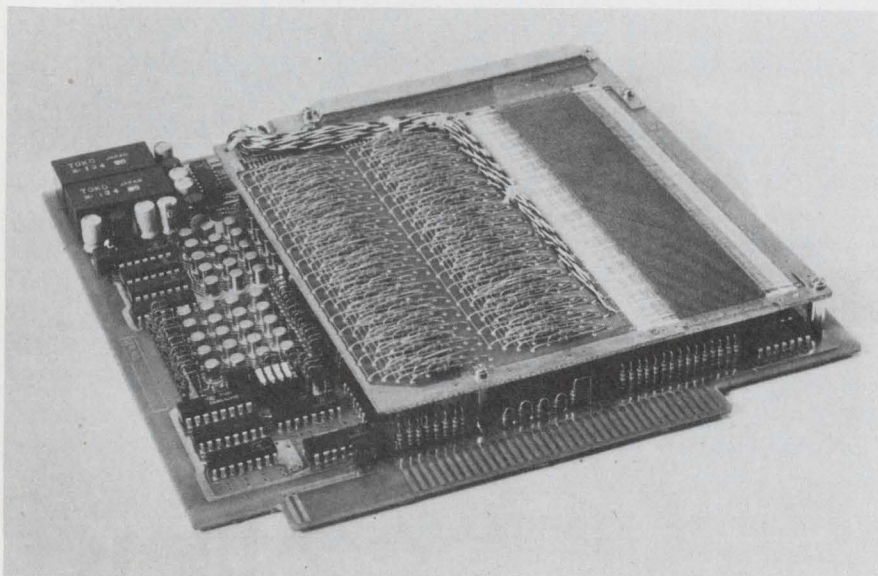

Switches can select ROM, RAM or EAROM operation in Toko's Mini-ROM-B, a 1024 × 9-bit woven, plated-wire memory.

There's nothing new about a 2N3055 but there's a **powerful** difference in this one.

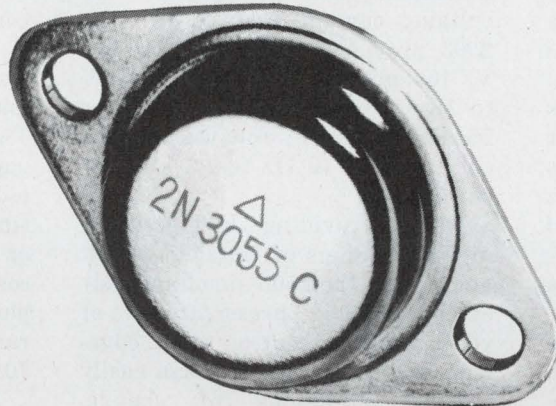

**That's why we call ours the 2N3055C*
*“C” designates it as the Cadillac of power transistors.**

Compare the specs below and see at a glance why Sensitron's upgraded version of the workhorse 2N3055 . . . the 2N3055C . . . is your best bet for a wide range of power transistor applications.

| Parameter | Conventional 2N3055 | RSM Sensitron “Cadillac” 2N3055C |
|-----------------------|--------------------------|--|
| Chip size | 140-175 mil ² | 210 mil ² |
| P _D | 115 W @ 25°C case temp. | 150 W @ 25°C case temp. |
| I _{Cmax} | 15 A | 30 A |
| BV _{EBO} | 7V | 10V |
| BV _{CEO} | 60 V | 120 V |
| BV _{CER} | 70 V | 130 V |
| I _{CEX} | @ 100 V < 5 mA | @ 120 V < 1 mA |
| h _{FE} | 20 @ 4 A | 25 @ 4 A |
| h _{FE} | 5 @ 10 A | 10 @ 8 A |
| V _{CE} (sat) | 1.1 V @ 4 A | 0.75 V @ 4 A |
| V _{CE} (sat) | 8.0 V @ 10 A | 3.0 V @ 10 A |
| SOAR | 60 V @ 1.9 A | 70 V @ 2.15 A |

Write or call for more information or applications assistance on the 2N3055C and other RSM Sensitron single diffused power transistors.



Sensitron Semiconductor

A DIVISION OF RSM ELECTRON POWER, INC.
221 West Industry Court • Deer Park, N.Y. 11729
Telephone 516-586-7600 • Telex 96-7737

INFORMATION RETRIEVAL NUMBER 17

surface-wave devices, light switches and frequency doublers. The lead molybdenite is particularly useful for acousto-optic light-deflectors for high-capacity holographs.

The good test

Two basic types of test equipment have tended to monopolize recent advances—digital meters and graphic recorders. The advances in these instruments come mainly from three vendors: Takeda Riken, Yokogawa Electric Works (YEW) and Rikadenki.

The most impressive DVM comes from Takeda Riken, which, four years ago, developed the world's fastest pulse generator, a 1-GHz unit with 300-ps rise time and which will soon introduce a super-speed LSI-memory tester with a 50-MHz clock.

The company's 6501, to be shown at the IEEE show in April, displays up to 11999999 for measurements of voltage, resistance, V or R ratio and temperature. At the most sensitive of its six voltage ranges—100 mV +20% overrange—it offers resolution of 10-nV. On the lowest of five resistance ranges—1 Ω + 20% overrange—it can resolve 100 n Ω . With a suitable transducer, it can resolve temperature to 0.001 C.

At about \$20,000, the 6501 is fully programmable and provides automatic zero and full-scale calibration with each reading—once a second for voltage measurement, once every two seconds for resist-

ance and ratio measurements.

Further, the instrument uses microprogramming to provide average readings and standard deviations or to linearize transducers for temperature measurements.

Though lacking the astounding resolution of the Takeda Riken meter, two instruments from Yokogawa are equally impressive in their own way. YEW's 2503 and 2504 are true-rms meters with maximum readings to 11900 for voltage, current and power. The 2503 provides ranges of 3 to 600 V, 100 mA to 30 A and 300 mW to 18 kW at frequencies of dc or 25 Hz to 2 kHz for voltage and current, and 40 Hz to 1.2 kHz for power.

While providing high-accuracy digital readings of voltage, current and power, the 2503 simultaneously offers analog presentations of voltage and current on small, edge-wise meters so the user can easily observe directions of change. Available in single or three-phase versions—with BCD output and remote control as standard features and analog output as an option—the 2503 recently received an award for excellence from Premier Kakuei Tanaka.

Its sister instrument, the 2504, uses plug-ins to provide a choice of features. A single-input plug-in provides ranges of 100 V, 5 A and 500 W, while a multirange module offers five ranges from 30 to 300 V (with resolution to 10 mV), five ranges from 500 mA to 10 A (with resolution to 100 μ A)

and, effectively, 25 ranges from 15 W to 3 kW. The 2504 offers specified accuracy (which varies with frequency to a worst case of 0.5% of range from 25 to 50 Hz and 60 Hz to 1 kHz) at voltage crest factors to 4 and current crest factors to 2. Depending on plug-ins selected, the price of the 2504 ranges from 400,000 to 700,000 yen (\$1330 to \$2330).

Yokogawa has extended the plug-in concept to its line of X-Y recorders, in which the 3083 offers a selection of eight plug-ins, including a dc-voltage unit with maximum sensitivity of 5 μ V/cm. The instrument accepts roll-chart paper or sheets, and it records on a 250 \times 8-mm area with a felt-tipped pen, ballpoint pen, pencil or ink-fed pen. The mainframe costs 250,000 yen (\$830), while plug-ins, depending on number of ranges and sensitivity, 14,000 to 70,000 yen (\$47 to \$235).

More unusual is Rikadenki's Computing Unit, a powerful accessory for single-pen or multiple-pen graphic recorders. The unit is a mainframe with a built-in power supply and one or more plug-in signal conditioners. These include a preamp with adjustable gain from 10 to 10,000, an adder, a multiplier and divider, an integrator and a differentiator.

Using the Computing Unit with a three-pen recorder, for example, one can record voltage with one pen, current with another and, with the multiplier/divider plug-in, power with the third pen. ■■

Want more information?

Readers interested in further information on the developments discussed in this report may wish to write to the manufacturers. They are listed here (with their U.S. headquarters, where available). Or, simpler yet, circle the Information Retrieval Number.

Fuji Electromechanical Co., Ltd., 36-11, 5-chome, Shinbashi, Minato-ku, Tokyo. (U.S.: 680 Fifth Ave., New York, NY 10019) **Circle 585**

Fujitsu Ltd., 6-1 Marunouchi, 2-chome, Chiyoda-ku, Tokyo. (U.S.: 680 Fifth Ave., New York, NY 10019) **Circle 586**

Hitachi, Ltd., 6-2, 2-chome, Ohtemachi, Chiyoda-ku, Tokyo 100. (U.S.: 437 Madison Ave., New York, NY 10022) **Circle 587**

Ise International Corp., 2-7-7 Higashishinbashi, Minato-ku, Tokyo. (U.S.: 1472 W. 178 St., Gardena, CA 90249) **Circle 588**

Matsushita Electric Industrial Co., Ltd., 1006 Kadoma, Osaka 571. (U.S.: 200 Park Ave., New York, NY 10017) **Circle 589**

Pioneer Electronics Corp., 4-1, 1-chome, Meguro, Meguro-ku, Tokyo. (U.S.: 75 Oxford Dr., Moonachie, NJ 07074) **Circle 590**

Rikadenki Kogyo Co., Ltd., 9-1 Chuo-Cho, 1-chome Meguro-ku, Tokyo. (U.S.: Soltec Corp., 1074 Chandler Blvd., North Hollywood, CA 91601) **Circle 591**

Sanyo Electric Co., Ltd., 18 Keihan-Hondori 2-chome, Moriguchi City, Osaka. (U.S.: 1200 W. Artesia Blvd., Compton, CA 90220) **Circle 592**

Sharp Corp., 22-22 Nagaike-cho, Abeno-ku, Osaka. (U.S.: 10 Keystone Pl., Paramus, NJ 07652) **Circle 593**

Takeda Riken Industry Co., Ltd., 1-32-1 Asahi-cho, Nerima-ku, Tokyo 176. (U.S.: T.R.I. Corp., 505 W. Olive Ave., Sunnyvale, CA 94086) **Circle 594**

TDK Electronics Co., Ltd., 14-6, 2-chome, Uchikanda, Chiyoda-ku, Tokyo 101. (U.S.: 23-73 48th St., Long Island City, NY 11103) **Circle 595**

Toko, Inc., 1-17, Higashi-Yukigaya 2-chome, Ohta-ku, Tokyo. (U.S.: 350 Fifth Ave., New York, NY 10001) **Circle 596**

Toshiba (Tokyo Shibaura Electric Co.), 2-1 Ginza 5-chome, Chuo-ku, Tokyo. (U.S.: 280 Park Ave., New York, NY 10017) **Circle 597**

Yokogawa Electric Works, Ltd., 2-9 Nakacho, Musashino-shi, Tokyo 180. (U.S.: Yewtec Corp., 1995 Palmer Ave., Larchmont, NY 10538) **Circle 598**

Victor Company of Japan, Ltd., 1 Nihonbashi-Honcho 4-chome, Chuo-ku, Tokyo **Circle 599**

IF WE CAN'T MAKE YOUR MINICOMPUTER SYSTEM DO MORE WORK FOR LESS MONEY, NOBODY CAN.

When we introduced the SPC-16, we promised it would be the world's most powerful, versatile, cost-effective family of minicomputers.

It was. It still is.

The SPC-16 isn't the lowest priced hardware you can buy. But it will give you the lowest cost solution.

Through advanced systems architecture, simplified interfacing and a powerful instruction repertoire, the SPC-16 allows you to minimize programming, interfacing and memory costs no matter what size your system is.

Six mighty minis.

The SPC-16 family consists of six minicomputers offering a choice of three memory cycle times (800ns, 960ns and 1440ns), memory expansion to 128K using efficient 16K boards, and two different packaging configurations.

If you build a system around the SPC-16, it will do more work for less money than any other system you could build.

And that translates into more profits.

We know it for a fact. In the past few years, we helped a lot of OEMs get the edge on their competition by designing our product into their products. We helped a lot of end users solve a lot of tough, tight-budget applications. And, we produced some cost-effective systems of our own.

Two hard working systems.

Take RTOS II for example. It's a multi-programming system offering real-time event driven foreground processing concurrent with background job development and computation.

You couldn't buy a better price/performance solution for applications such as process control, data acquisition, laboratory research, material handling, communications or overall manufacturing automation.

We also built a powerful disk-based general purpose system around the SPC-16. DBOS II lets you do more computation with less memory, in far less time, at a lower price than any system on the market. It offers both scientific and commercial languages and a combination of interactive and batch operation.

This system is perfect for service centers, research and development groups and system house dedicated applications.

That's the short form.

To really appreciate how much power we can deliver for your money, write for our book

"The Value of Power." It will give you the facts to back up our claim: If General Automation can't make your system do more work for less money, nobody can.

Write General Automation, 1055 South East Street, Anaheim, California 92803. Or call (714) 778-4800. In Europe, write General Automation, S.A., 24 rue du Sergent Bauchat, 75012 Paris, France. Telephone (1) 346/7973. In Canada, write G.A. Computer Ltd., 880 Lady Ellen Place, Ottawa K1Z5L9, Ontario. Telephone (613) 725-3626.

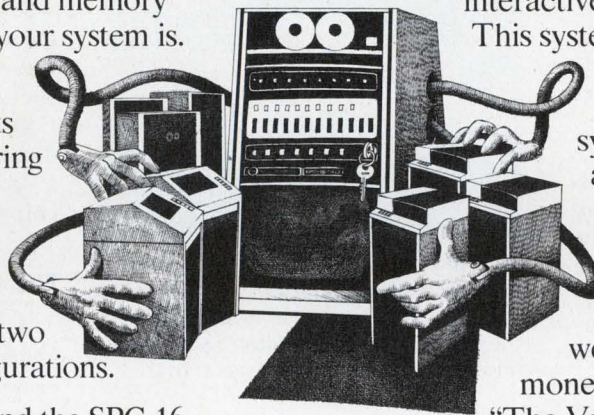

POWERFUL MINICOMPUTERS BY GENERAL AUTOMATION

HIGHLIGHTS FROM THE ELECTRON DEVICES MEETING

Laser technique promises repair of ICs from 'spares' on the chip

Repair of integrated circuits on the chip or wafer level is now possible with a new laser technique that uses nanosecond-wide pulses to form connections between the aluminum and diffused silicon layers of a conventional MOS structure. The approach is attractive for read-only memories and programmable logic arrays.

Developed at IBM's Thomas J. Watson Research Center, Yorktown Heights, NY, the new technique was described at the International Electron Devices Meeting in Washington, DC, earlier this month. Other advances in technology discussed at the meeting included non-volatile charge-coupled-device memories, Josephson-tunneling logic and electron-beam addressed storage systems.

In describing the laser-connection technique, Stanley E. Schuster, one of the researchers on the project noted that dye laser pulses from 2 to 6 ns wide were used. The shortness of the pulses, he explained, minimizes thermal diffusion normally caused by a laser beam and prevents damage to structures surrounding the contact site.

3 major steps involved

The connection is formed in three steps and involves a number of pulses, he reported. First, a hole is opened in the aluminum layer, with material removed primarily by vaporization. Then the silicon-dioxide insulating layer is removed by a controlled microexplosion, caused by thermal stress, or vaporization, of material at the silicon-dioxide/silicon interface.

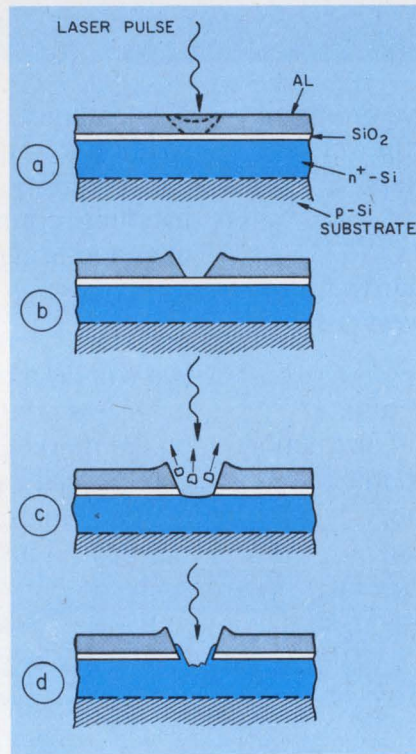

To make laser connections in a semiconductor the aluminum (a) is vaporized (b) the oxide removed (c) and the semiconductor melted so it flows and connects the two layers (d).

Finally, Schuster explained, a conducting path is formed when the molten silicon flows into contact with the aluminum.

According to Schuster, aluminum-to-silicon contact resistance for 5- μm diameter connections is dominated by "spreading" resistance and corresponds roughly to that of conventional contacts. Thermal and electrical stress tests on the laser contacts indicate a reliable process, the researcher reported. Connections have undergone over 2000 hours of testing without any failures.

Schuster sees the primary application of this technique in pro-

grammable devices that are needed in small quantities—not enough to justify a special set of masks.

The laser approach has several advantages over the "blasting" techniques currently used to program devices, Schuster said. The major one is that it is possible to connect selectively only the good parts of a circuit. This is easier than disconnecting the bad parts of a blast-programmable device, because it is often difficult to determine exactly where these units failed.

As for repairing defective chips, Schuster noted that this technique would be most appropriate for bus-oriented devices that have several functions connected to one bus on the same chip. If a particular function element is defective, it can be disconnected with a laser pulse and a spare—contained on the same chip—can be used to replace it.

The NOVCAM memory

A new charge-coupled device known as a nonvolatile charge-addressed memory (NOVCAM) was described by Marvin H. White, a CCD researcher from the Advanced Technology Laboratory of Westinghouse Defense and Electronic Systems, Baltimore. The CCD memory is made nonvolatile, White explained, by combining it with an MNOS (metal nitride oxide semiconductor) device.

In initial attempts to combine these two structures, he reported, the MNOS storage site was placed inside a stepped dielectric, two-phase, CCD shift register. This structure, however, had problems. Inadequate charge-handling capability resulted in poor write characteristics, spurious pulses from high-voltage clocks made the write/inhibit operation ineffective,

The first name in counters is not the counter you name first.

We aren't as well known for our counters as we are for our digital multimeters. But we should be. Because we make some of the best counters available for the money.

The nine models in our 8000B/8100 series feature measurements such as frequency, period, multiple period, time interval, time interval average and totalize modes.

A standard 8-digit display provides high resolution measurements. Models feature 10 nanosecond resolution for single shot time events along with 150 picosecond resolution for repetitive events.

ATE. For more accurate waveform parameter testing, the counters feature digitally programmed trigger-level resolution of .05 volts and trigger-level hysteresis compensation.

Communications. For low-level, high-frequency measurements, sensitivity as high as one millivolt at 500 MC is featured. Counters also employ a 150 MC direct count capability.

Yet prices start at \$1,390.

So before you talk to the biggest name in counters, talk to the best. Contact your Dana sales representative by calling toll-free 800-645-9200. In New York, phone 516-294-0990. In Europe, call 02-241-4550.



DANA
Others measure by us.

and a large access time to the first bit made for a poor read operation.

To overcome these problems, the NOVCAM structure was developed. In this configuration the memory cell is composed of a CCD shift register and a thin-oxide MNOS memory structure in parallel with it. This provides separate locations for signal address and storage.

In describing the operation of the new memory cell, White noted that it is addressed like any other CCD structure. Then voltage is applied to a transfer gate, and charge from the CCD is transferred to the MNOS device. This transfer of charge results in a collapse of the surface potential beneath the MNOS device. Once the surface potential is collapsed, the oxide electric field increases, and the tun-

neling of signal charge from the surface channel to deep traps near the oxide/nitride interface begins. It is the trapping of charge at this interface that makes the device nonvolatile.

According to White, the write voltage is the same as the CCD clock voltage—20 V. Pulse width is about 10 μ s. The reading out of data is nondestructive and typically takes 1 to 2 μ s, which is the CCD transfer time. The read voltage required is only 2 V. These read and write voltages are lower than those required for MNOS memories that use conventional transistor structures.

To date, only a 64-bit four-phase shift register has been produced. Work is proceeding, however, on a high-density device, White indi-

cates, and masks will be ready soon. The next step in this project is to produce a demonstration chip that would have 8-k bits of memory. The cell size for such a device would be 15 by 40 μ , for a total of 0.9 sq. mils. Included in the cell is the CCD for transporting the data to the memory site and a parallel stabilized charge injector for high-speed readout.

Beyond the 8-k chip is a 32-k device. The memory, including clock drivers, signal reconstruction circuitry and other supporting circuits, can be put on a chip that measures 200 mils on a side.

Both the 8-k and the proposed 32-k memory chips will use a three-phase clock instead of the four-phase used on the 64-bit device. This switch to a three-phase clock makes it possible to save up to 25% in chip area.

Josephson shift register made

The Josephson shift-register element discussed at the Electron Devices Meeting was covered in a paper by Y. L. Yao and D. J. Herrell of IBM's Thomas J. Watson Research Center, Yorktown Heights, NY. The authors described an experimental 8-bit static shift register that operates with all data patterns at a maximum shift rate of 160 MHz, and with limited patterns at 200 MHz. The average power dissipation was given as only 20 μ W per bit.

Josephson-tunneling logic devices are based on the phenomenon of superconductive tunneling between two closely spaced superconductors at a temperature of 4.2 K. Until now, the authors indicated, only Josephson logic gates have been investigated experimentally.

The basic shift register is formed when two three-input gates Q_1 and Q_2 (see illustration) are cascaded in series and operated in a master-slave mode from externally clocked current supplies, I_1 and I_2 . Data are transferred from Q_1 to Q_2 and then from Q_2 to Q_3 under the control of two strobe pulses, IC_2 and IC_1 . The current level of the strobe signals is $2i$ to ensure that a data ONE condition of i , together with the strobe signal, will exceed the $3i$ threshold of the Josephson gate.

Shift registers ranging from 3 to 8 bits long have been fabricated

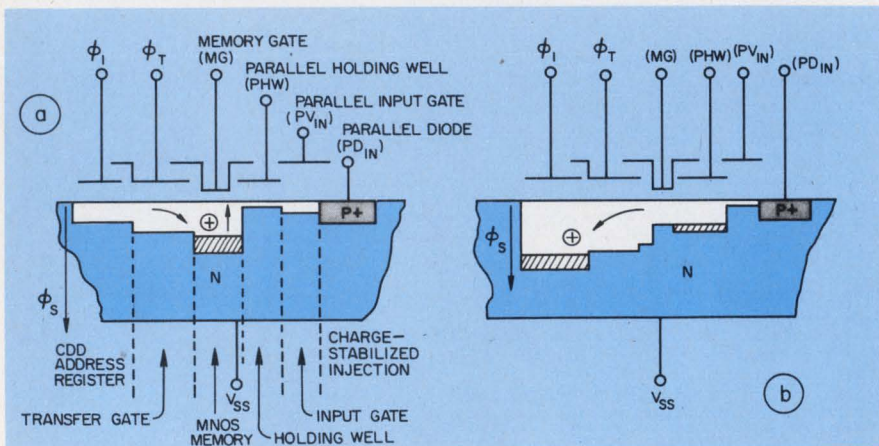
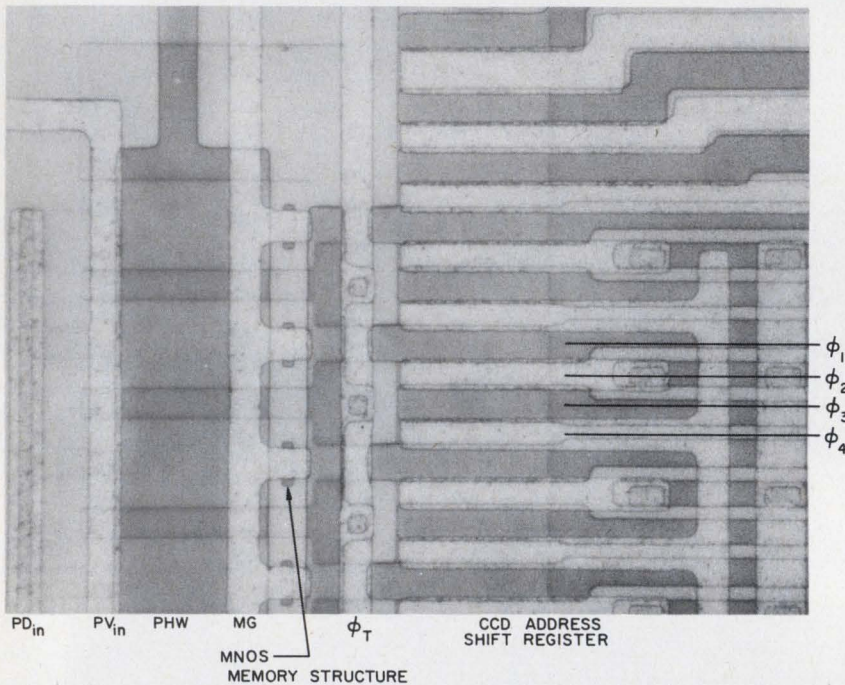

MNOS and CCD technology combine to form a nonvolatile charge-addressed memory. When ϕ_T is activated, charge from the CCD register is transferred to the MNOS memory site, where it is trapped near the oxide/nitride interface.

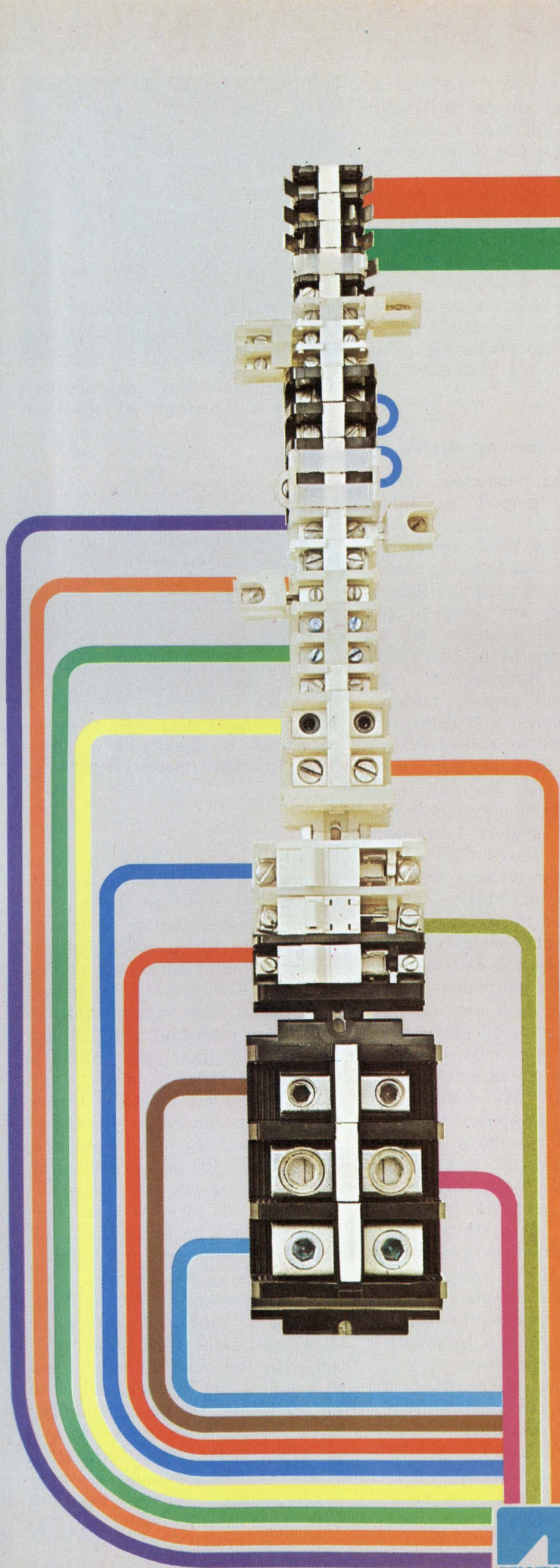

Put it all together with Buchanan[®] Terminal Blocks!

10 ways we can help you solve your design problems:

- 1. Eliminate lugging!**
Just insert wire and tighten the screw.
UL and CSA listed.
- 2. Save space!**
Terminate up to 48 circuits per foot; wires from
#30 thru 600 mcm.
- 3. Work at high temperatures!**
Up to 302 F with Buchanan phenolic blocks; also
resist moisture, solvents, shock, radiation.
- 4. Choose your mounting method!**
Flat base blocks for direct mounting; dovetail bases
if you want a channel; combination bases for either
way.
- 5. Assemble quickly!**
Snap off sections from pre-assembled lengths of 6 to
25 . . . or order the exact number you want!
- 6. For aluminum wire, too!**
Al-Cu contacts are UL listed for aluminum or
copper wire, #18 thru #4/0.
- 7. Identify circuits quickly!**
Four marking methods: Directly on block; on painted
area; removable vinyl strip; or pressure-sensitive
tape.
- 8. Meet non-tracking requirements!**
Nylon or polypropylene blocks meet automotive
non-tracking requirements—yet provide close
spacing for tight layouts.
- 9. Get dead-front safety!**
See-thru covers snap over contacts—permit viewing
with protection.
- 10. Bridge other components!**
Steel and pre-punched aluminum channels are
available for dovetail or combination base blocks.

Want to cut design time? Our literature can really help you. Ask for a catalog and "What You Should Know About Terminal Blocks." Phone (201) 964-4400 or write us at Dept. ED-3.



**CONTROL PRODUCTS
DIVISION**

Amerace Corporation
Control Products Division
2330 Vauxhall Road
Union, New Jersey 07083

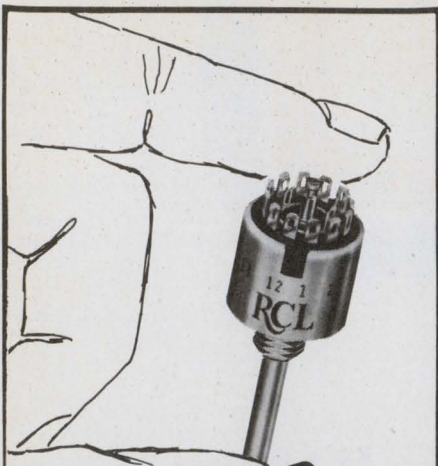

AT YOUR FINGERTIPS

Industry's Best Delivery On Every

MINIATURE ROTARY SWITCH

In Our Catalog

PROTOTYPES: 1 WEEK
PRODUCTION QUANTITIES:
START 2 - 3 WEEKS

Commercial Versions Competitively Priced With Open Deck Wafer Switches

Call our hotline for prompt service and delivery.
(201) 374-3311

RCL
ELECTRONICS, Inc.

General Sales Office:
700 So. 21st Street
Irvington, N. J. 07111

with a minimum line width of 1 mil. While a maximum shift rate of only 200 MHz was attainable with the four-phase device, computer simulations indicate that with an improved internal power distribution scheme, that limit can be raised to 360 MHz.

The power dissipation per bit for an all ONE data pattern was $40 \mu\text{W}$ with a 70% duty cycle for I_1 and I_2 . Since the ZERO state does not dissipate power, the average dissipation for the device is $20 \mu\text{W}$.

Electron-beam memory arrives

Electron-beam memories, which promise high density at high speeds, have been in development for several years. Now, according to John Kelly, a researcher at Stanford Research Institute, Menlo Park, CA, they are ready to go into commercial systems. In a paper on electron-beam addressed memory tubes, Kelly pointed out that a 65,536-bit memory module had been developed and delivered to the Air Force Avionics Laboratory at Wright-Patterson Air Force Base, Dayton, OH. The unit consists of a single-tube system operating from a memory exerciser, which acts as a source of data and addresses for the memory testing.

Although the bit capacity of the tube is small and the delivered system consists of only one tube, Kelly noted that progress to date verifies that tubes of approximately 4 megabits can be made now.

The time is ripe to produce a commercial memory with 18 such tubes, for a system capacity of 64 megabits, Kelly said. Electron-beam addressed memories, he added, promise to become a leading contender for low-cost, large-memory systems, with fast access times, high reliability and data rates.

Referring to the system he developed, Kelly noted that two items were the keys to a successful device: the nature of the storage target and the means by which stored information can be repeatedly located or addressed.

The target used in the Stanford system is an electro-static storage target. It is of metal-oxide-silicon construction with holes etched into the oxide. Two external connections are made—one to a metal gate and the other to the low-

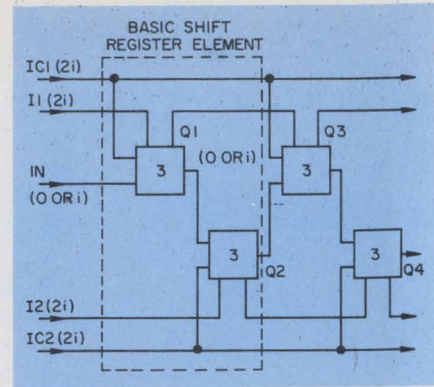

Each element of this Josephson shift register is made from two three-input logic gates.

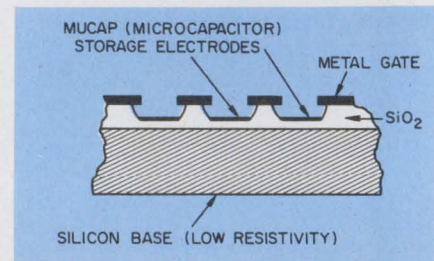

Data are stored as charges on microcapacitors in Stanford's electron-beam addressed memory system.

resistivity silicon base. A third electrode is deposited in the bottom of the dielectric holes, providing a microcapacitor, or mucap, electrode on which charge can be stored. A major advantage of this structure, Kelly pointed out, is that the electron beam approaching the target sees essentially only the potential of the metal gate, which is normally held at ground.

When data are stored, a binary ONE is represented by storage of a -40-V charge on the mucaps, whereas a ZERO is represented by 2 V. In actual use, more than one mucap is used to store data. This is because it is desirable that a bit location be determined by the point of incidence of the electron beam on the target, and not by the structure of the target. Therefore the structure is made fine in comparison with the beam diameter, and as many as nine mucaps are used for each bit. Occasional missing mucaps do not impede operation. In addition data may be written along a curved path and raster distortion, "within reason," does not affect performance. ■■

FUJI Ferrites

LEADING MAKER OF FERRITE CORES FOR TELECOMMUNICATION

POT CORES (ROUND)



BOBBINS AND COILFORMERS

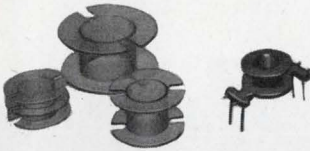

INDUCTANCE ADJUSTORS



POT CORES (SQUARE AND SPECIALITIES)

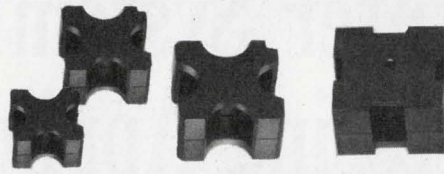

MOUNTING PARTS



COIL ASSEMBLIES

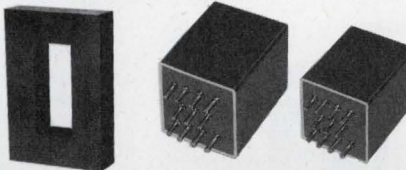

In the 20 years since our founding we have grown to become the world's second largest manufacturer of ferrite in production volume.

In quality, we are the world's first and manufacture ferrite cores for communications equipment, having superb characteristics.

Our pot cores are primarily used in filter coils, loading coils, coupling transformers, oscillation transformers and other similar devices and have been widely acclaimed by users.

Cores are produced conforming to IEC Standards, but square cores originally developed by us are also available.

A complete stock of standard type cores and accessories assures quick delivery.

Complete coil assemblies can also be manufactured to your specifications.

FUJI ELECTROCHEMICAL CO.

Head Office: Hamagomu Bldg., 5-36-11, Shinbashi, Minato-ku, Tokyo, Japan TEL: 434-1271
 Overseas Office: New York TEL: (212) 532-5630 JOHN TSUKIKAWA
 Los Angeles TEL: (213) 620-1640 SAM YOSHINO
 Düsseldorf TEL: (211) 89031 TAD KOMURO

INFORMATION RETRIEVAL NUMBER 22

NUMERICS LARGE



AND SMALL

- LOW INSTALLED COST
- READY TO PANEL MOUNT
- FRONT SERVICED W/O TOOLS

WE HAVE THEM ALL & WITH A CUSTOM LOOK!

Characters of .7", 1", 2", 3", & 5 1/2" for viewing to 150 ft. Supplied complete with bezel, anti-glare "Black-Out" front panel & color filter • Message module, ± sign, etc. integrated into package • Standard, long life T 1 3/4 lamp light source (2" & higher redundantly lamped) • Wear parts (lamps and drive logic) socket mounted. NEMA dust/water tight mounting hardware available.

212 - 476-1287

"LINKS BETWEEN MAN AND MACHINE"

INFO-LITE CORPORATION

46-10 104th STREET • CORONA, N. Y. 11368

INFORMATION RETRIEVAL NUMBER 23

ELECTRONIC DESIGN 26, December 20, 1974

RF WIDE BAND TRANSFORMERS

- 0.1-500 MHz
- 50 ohm impedance
- 1:1-16:1 impedance ratio
- Micro-miniature case

\$2.95
10 piece quantities
Some models \$3.45

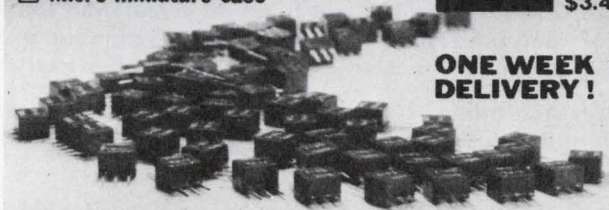

ONE WEEK DELIVERY!

Impedance ratios of standard models are 1:1, 2:1, 4:1, 9:1 and 16:1. MCL kit TK-1 includes 2 units of each type and sells for \$32.

We invite you to convince yourself. Place your order now and check our delivery, product performance and reliability.

MCL
Mini-Circuits Laboratory
A Division Scientific Components Corp.

837-843 Utica Avenue, Brooklyn, N.Y. 11203
(212) 342-2500

INFORMATION RETRIEVAL NUMBER 24

CELCO can make an "Above-Average" Scanner & Printer System for your Image Processing Application.

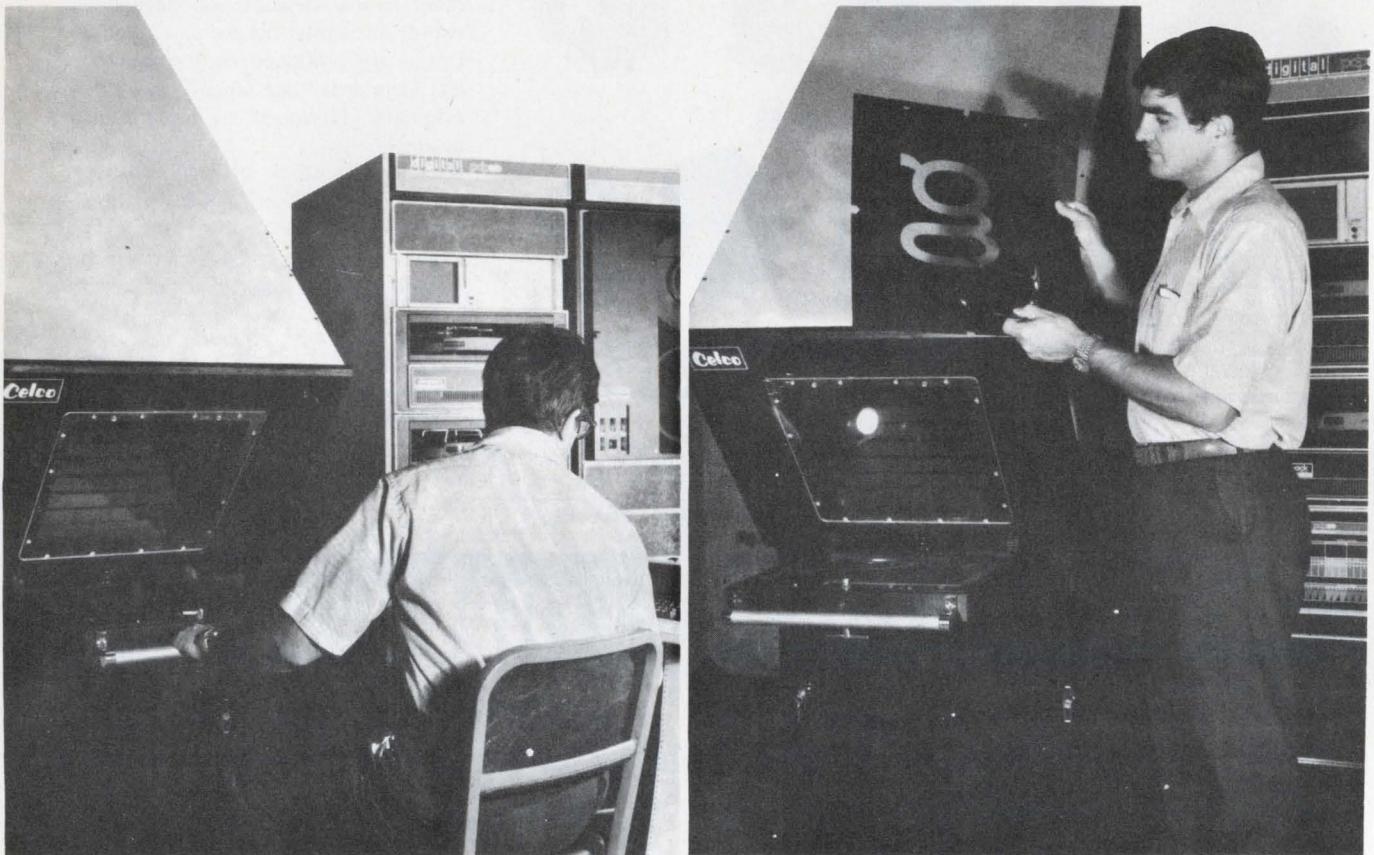

CELCO's Large-Format Scanner is a unique solution for automating the production of master fonts for a manufacturer of computer typesetting equipment. Scanning a 16-million point area, this system calibrates itself and reduces an artwork master 14 inches x 14 inches to a digital record in 16 seconds.

Our Precision Printer is designed to automatically access the digital records created by the Scanner, and reproduce high-resolution photo-reductions on a master plate.

CELCO has led the field in producing High-Resolution CRT Scanning Systems for applications in Satellite Image Recording, Nuclear and Astronomical Research, Pattern Recognition, Medical Research, high-speed Map-Making, Automatic Inspection Systems, and other "Above-Average" requirements.

This "Above-Average" Scanner and Printer System represents a combination of CELCO's unique in-house

capabilities. From long experience in analog electronics and display engineering, to a broad achievement in both digital hardware and software systems, CELCO can offer a "state-of-the-art" approach to your most unusual problems.

If you have an image processing application, look to CELCO for the "Above-Average" solution.

CONSTANTINE ENGINEERING LABORATORIES COMPANY
1150 E. Eighth Street, Upland, CA 91786

70 Constantine Drive, Mahwah, N J 07430



Introducing the new generation: 900 MHz power transistors with Tuned Q.

Outside, they look like standards. But inside, they're a whole new type of high-performance transistor. Tuned Q. The result of a synergistic combination of three of our special capabilities.

First, automatic wire bonding. Which maintains precise positioning of the bonding wire in the internal LC matching network.

Second, reproducible devices through advanced wafer technology and internal lot control documentation.

Third, unique package designs. We've tooled internal structures to control lead inductances and yet remain mechanically compatible with standard sockets.

What's it all mean? Well, you can use our new 1-, 5-, 15-, 25-, and 40-watt Tuned Q transistors in power chains that go from 0.1 watt drive to a single-transistor 40 watts out.

Remember, these are all original, proprietary designs . . . not second source copies.

The 1, 5, and 15 are available in common-emitter or common-base configurations; the 25 and 40 in common-base only. All five come in either the 380 flange or 380 SOE package, which are mechanically compatible with standard sockets.

All five are also available in our unique MCC (Miniature Chip Carrier) package which features exceptionally low parasitics and can be soldered or epoxy bonded directly to the substrate.

Whatever their package they're electrically superior. Specs? Samples? Technical Information? Call. Write.



SOLID STATE SCIENTIFIC INC.
Montgomeryville, Pa. 18936 / (215) 855-8400 / TWX 510-661-7267

The RF specialists.

**For
time code
instruments
and systems,
see a
specialist.**

**The customer's
always right.**

Systron-Donner's time code instrumentation ranks No. 1 when it comes to quality, ruggedness and ability to meet specs. How do we know? Because our *customers* say so, based on their tests.

Today S-D offers the most complete line of time code generation, reading and tape search equipment . . . computer compatible for systems applications. All this is backed by a factory team of specialists and a

national service organization. Send for S-D's authoritative 121-page Handbook, "Precision Timekeeping and Tape Search."

Price \$3.50. Or you may request our free Time Code Instruments Catalog.

In the U.S. give your local Scientific-Devices office a call. Abroad, contact Systron-Donner GmbH, Munich; Systron-Donner Ltd., Leamington Spa, U.K.; Systron-Donner S.A., Paris (Le Port Marly); Systron-Donner Pty. Ltd., Melbourne.

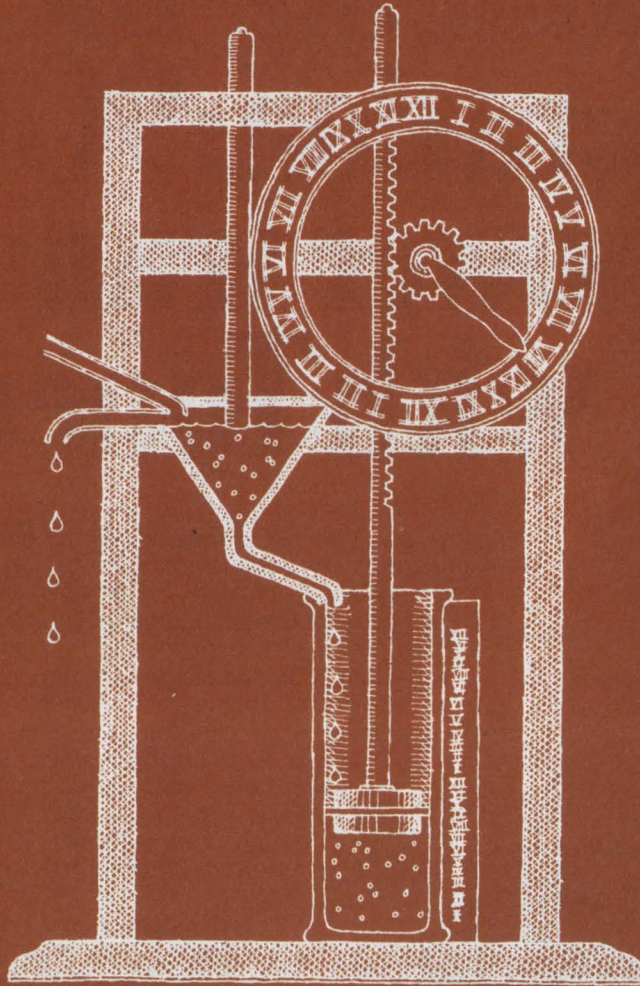

This Egyptian Clepsydra (water clock) was the standard of its day—just as S-D's precision timing instruments are today's standards.



SYSTRON  DONNER

1 Systron Drive, Concord, CA 94518. Phone (415) 676-5000
INFORMATION RETRIEVAL NUMBER 27

washington report

Senator Glenn viewed as R&D proponent

Research and development stands to gain a banner carrier in the election victory of former astronaut John Glenn in the Ohio senatorial race. The retired Marine Corps colonel would seem a natural for a spot on the Armed Services Committee and the Aeronautical and Space Sciences Committee, but being at the bottom of the pole in seniority he will have to be content with what comes his way.

Glenn has left the strong impression that he is more interested in technology than defense, and informants say he wouldn't be unhappy to take two committee seats now occupied by the Ohio incumbent—Aeronautical and Space Sciences, and Interior. The Interior Committee will oversee the Energy Research and Development Administration, which is slated to take over all R&D of that nature on Jan. 1. This will amount to some \$2-billion annually, a hefty bit of which could be in electronics.

Navstar: A navigation system for the 1980s

The Navy has served warning that while no firm decision has been made yet on the future of Navstar satellite navigation system, now under development, users of Transit, or those considering future use, should look toward the 1982-1984 period. If a go decision is made on schedule the Navy says it will be able to start the phaseout of Transit at that time. The Defense Dept. says it's unlikely it will maintain both systems. Transit, if it remains, will need support from some other Government agency.

Gen. Samuel C. Phillips, commander of the Air Force Systems Command, recently told an Air Force audience that the Navstar global-positioning system would provide worldwide navigation aid after 1985. The system is to consist of 24 satellites—three groups of eight satellites operating in separate orbits. Position errors are expected to be no greater than 30 feet 90 per cent of the time.

Musical chairs altering U.S. defense setup

Recently announced closings of military bases and realignment of functions by the Defense Dept. will have an impact on the electronics industry, but mostly in transfers of activities rather than cuts in funding. The major changes will affect the Air Force's Rome Air Development Center in New York State and the Air Force Communications Service at Richards Gebaur Air Force Base in Kansas.

The electronic warfare function at Rome will shift to Wright-Patterson AFB, Ohio, to become a part of the new Wright Technology Center, which will consist of four laboratories: propulsion, avionics, flight dynamics and materials. The Aerospace Research Laboratory there will be deactivated. Rome's command, control and communication function will move to the Electronic Systems Command complex at Hanscom Field in

Massachusetts.

The environmental research activities of the Cambridge Research Laboratory at Hanscom will move to Kirtland AFB in New Mexico, where the Air Force Special Weapons Center is being deactivated; however, the Air Force Weapons Laboratory will remain active at Kirtland. The Air Force Communication Service will move to the Military Airlift Command at Scott AFB in Illinois.

Other major changes planned by the Defense Dept. include the closing of both the Frankford Arsenal at Philadelphia and Ellington AFB, Houston, TX.

Rises in engineer salaries forecast

While the economic picture at the moment isn't bright, a new report issued by the Washington-based National Planning Association forecasts better days for engineers. The report, "Technical Change and American Enterprise," by J. Herbert Hollomon, director of the Center for Policy Alternatives, at the Massachusetts Institute of Technology, says that in 1975 salaries of engineers should increase dramatically, because "we will have one-half the annual growth of engineers we had five years ago, and industry will have increased its ability to pay for them and its general need for them."

According to the forecast, another five to 10 years will be needed to raise the supply of engineers to meet demand and still another five years after that to create a balance of supply and demand. The supply system went out of kilter between 1968 and 1972, when the ratio of engineers to total college students dropped from 23 to 9 per cent. About one million engineers are currently in the nation's inventory, and the Institute of Electrical and Electronics Engineers estimates that today the average number of annual openings for engineers is around 73,500.

Capital Capsules: NASA has announced the development of a solid-state data recorder that has no moving parts. The agency says the new device may replace magnetic tape recorders aboard spacecraft in the 1980s. The technology is based on magnetic bubbles in specially prepared garnet chips. NASA, which is shooting for a unit with 100-million-bit capacity by 1978, notes that the potential commercial applications are many—such as electronic control systems in mass transit. . . . The Air Force is seeking ways to improve the bandwidth efficiency of digital microwave communications systems. State-of-the-art modulation techniques require excessive amounts of rf bandwidth; the Air Force wants a contractor to investigate cross-polarization techniques. With these, the bandwidth efficiency can be doubled; however, the effects produced can render the performance unacceptable. Developing algorithms is seen as a solution. . . . NASA is in the market for 43 and 85-GHz coupled-cavity traveling-wave tubes for space use. Wanted are designs of 100 and 200-W TWTs with operating frequency ranges of 41 to 43 GHz and 84 to 86 GHz. . . . Two new standards for television monitors have been developed by the Electronic Industries Association. They are "Electrical Performance Standards for Direct-View Monochrome Closed-Circuit Television Monitors 525/60 Interlaced 2:1" and "Electrical Performance Standards for Direct-View, High-Resolution Monochrome Closed-Circuit Television Monitors."

ENCODERS



Many configurations
from 1 to 20,000 counts.
English/Metric available.

Designed for
Disc Memory
Files.

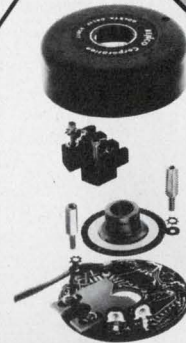

For velocity, feedback
or positioning
applications.

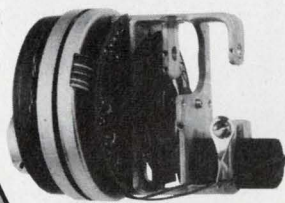

Will design to fit
your Altimeter.

Up to 13 bits—
NB or Gray... and
9999 BCD.

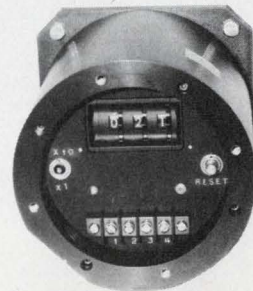

Will design to
meet your
applications.



RENCO CORPORATION

Santa Barbara Research Park
26 Coromar Drive • P.O. Box 246
Goleta, California 93017
Phone (805) 968-1525 TWX 910-334-1180

Digivue® - a better way to look at it.

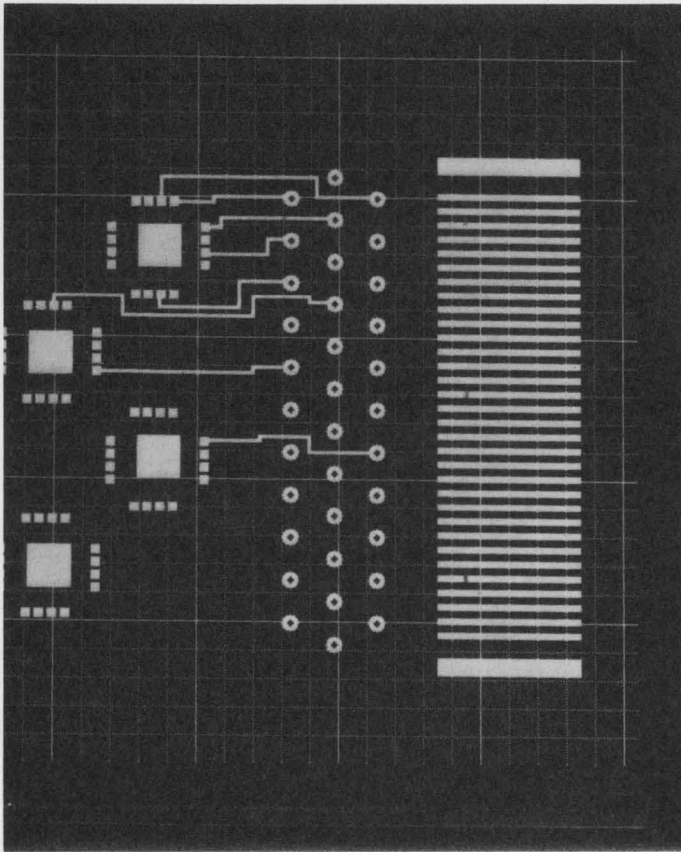

Unretouched time exposure of data displayed on a Digivue unit. Note high contrast picture, precise graphics.

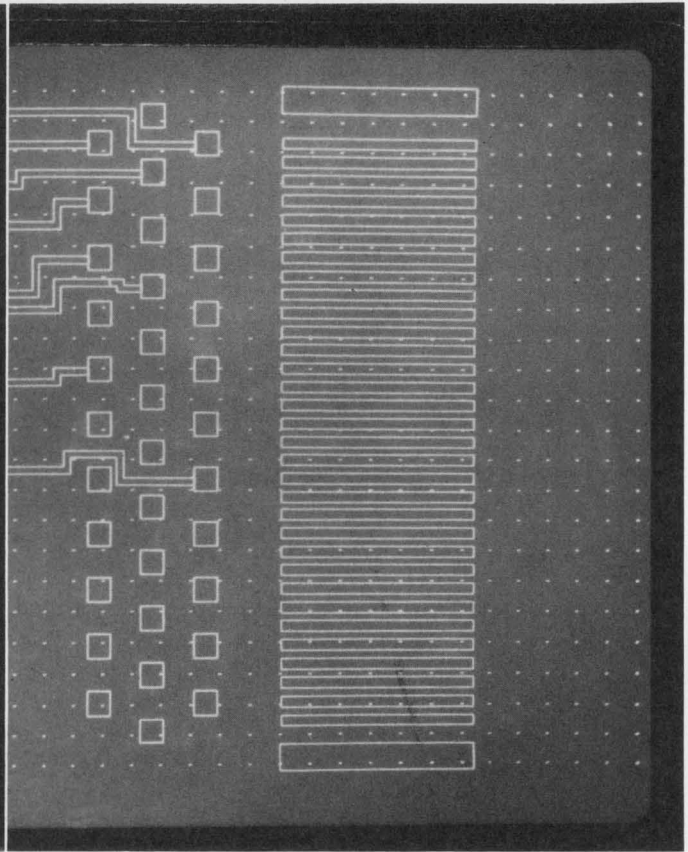

Unretouched time exposure of same data displayed on a CRT. Note lack of contrast in CRT image.

When your customers spend a lot of time looking at data displays and computer terminals, the advantages of Digivue plasma display units over CRT's become clear.

Very simply, Digivue display/memory units are better to look at. Digivue units present a flicker-free high contrast display for more precise readings and reduced chance of eye fatigue.

And Digivue units make it easier to use what's on the screen. Inherent memory is a feature of every unit. Digivue images appear on a thin, flat panel — which allows you to design compact components. The 512-60 models offer hard copy and rear projection capabilities, too. All of which gives you a product with more features to sell.

Sure, Digivue display/memory units currently cost more than CRT's. But they're worth a lot more to your customer, because they do a lot more.

For an informative booklet about Digivue display/memory units call (419) 242-6543, Ext. 66-415, or write Electro/Optical Display Business Operations, Owens-Illinois, Inc., P.O. Box 1035, Toledo, Ohio 43666.

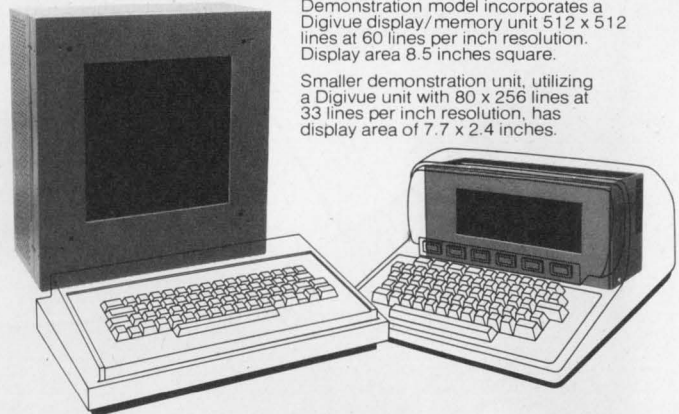

Demonstration model incorporates a Digivue display/memory unit 512 x 512 lines at 60 lines per inch resolution. Display area 8.5 inches square.

Smaller demonstration unit, utilizing a Digivue unit with 80 x 256 lines at 33 lines per inch resolution, has display area of 7.7 x 2.4 inches.

OWENS-ILLINOIS

Toledo, Ohio

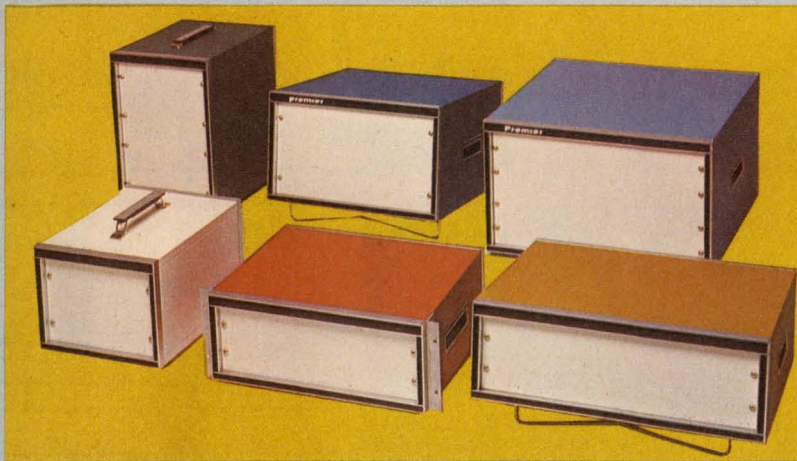

CONSOLES • CABINETS • CASES

by **PREMIER**

THE TRIMLINE SERIES
backed by over 28 years
of service to the industry

- Tasteful Designs • Optional Trims & Finishes • Modular for Console Configuration • Rugged Mechanical Strength***
- Variety of Shapes & Sizes • Full Line of Accessories***
- Moderately Priced.***

An ideal choice for systems in varied environmental locations from factory floor to well appointed offices.

Modifications are readily accommodated through our systems of staging stock parts ready for any additional fabrication and completion on short interval scheduling.

Send for our complete catalog of over 1300 products in the category of cabinets, consoles, racks, cases, blowers, fans, slides, chassis, boxes, hardware and other accessory items used for electronic system housing.

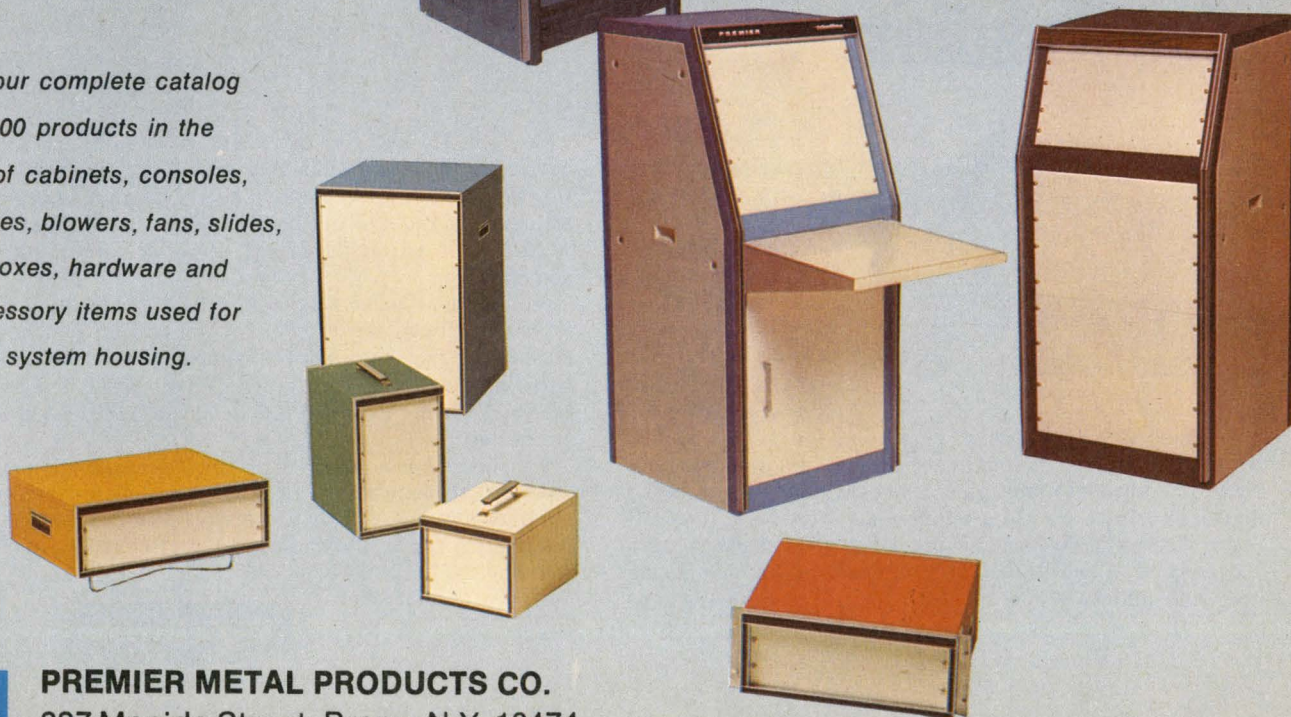

PREMIER METAL PRODUCTS CO.

337 Manida Street, Bronx, N.Y. 10474

Phone: (212) 991-6600

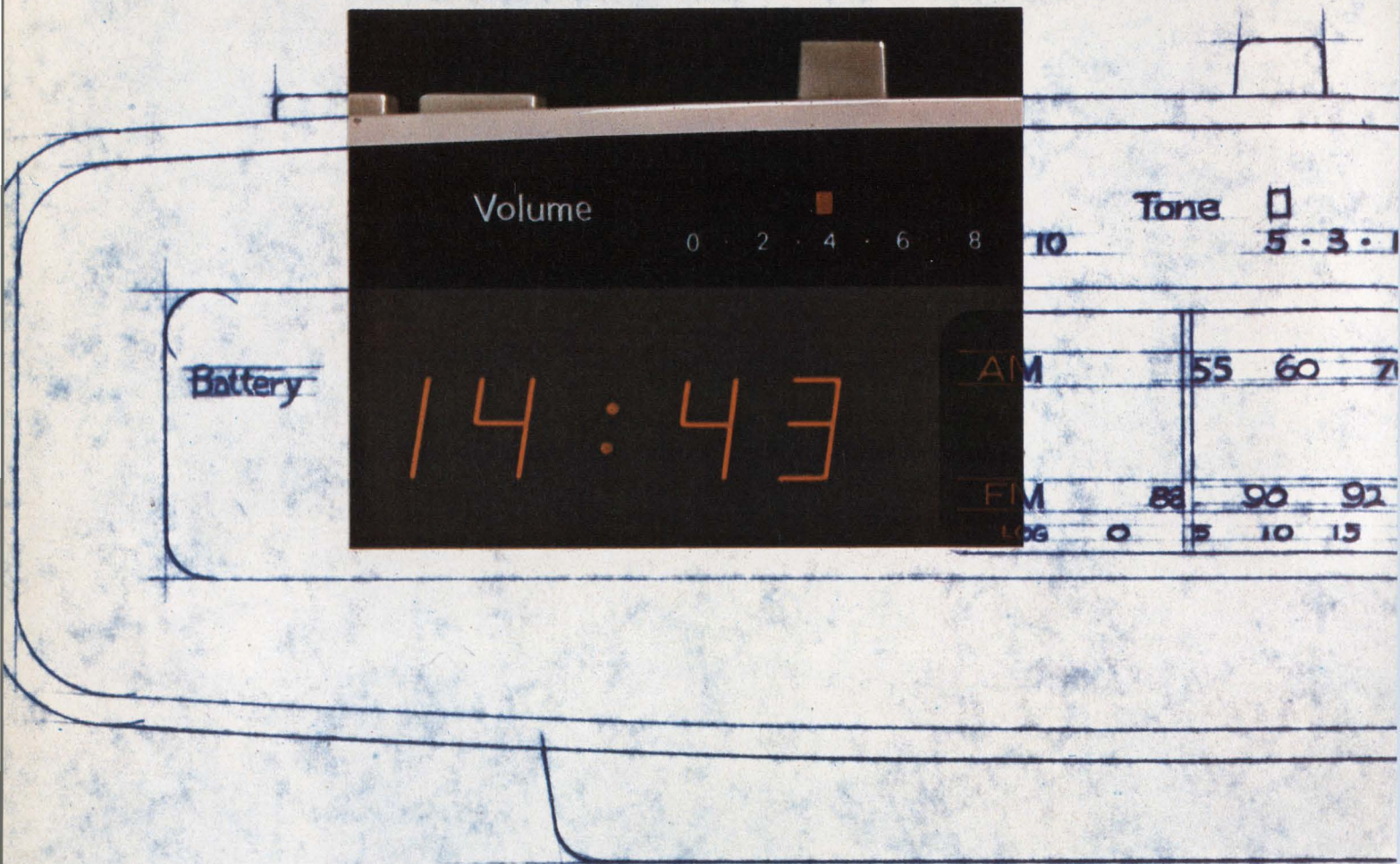

Better looking Beckman Displays are a natural for clocks and clock-radios



There are several big reasons why Beckman Displays are being used in more and more electronic clocks and clock radios. First, there are special 12 and 24-hour clock modules which help make application and production assembly easier. Secondly, the better looking Beckman Displays help attract buyers, help build sales. Next, in addition to multiplex mode, the displays can be DC driven to reduce RFI to a minimum.

For electronic clocks and clock radios you can choose from a variety of 1/2" clock display combinations from Beckman: hour and minute readouts; hour, minute, second displays;

even with AM and PM indicators. Beckman Displays produce crisp, clear, unbroken numerals that add "buy appeal" to any product. They have a pleasing neon orange color (filterable to red) and are bright enough (210 foot lamberts) to be read in all ambient light conditions including direct sunlight.

Add to this the low cost (as low as \$.70 per digit in large OEM quantities), the proven reliability, and you have the ideal display for today's new designs. See for yourself. Compare Beckman Displays side-by-side with LEDs or any other readout. You'll choose Beckman because they look better, are better.

For the telephone number of your Beckman/Helipot sales office, or the name of your Beckman stocking distributor, call toll free (800) 437-4677. Or write, Beckman Instruments Inc., Information Displays Operations, P. O. Box 3579, Scottsdale, Arizona 85257.

Beckman
INFORMATION DISPLAYS OPERATIONS

There's more eye appeal in Beckman Displays!

Making it tough for European engineers

Associate Editor John Mason, home from a month in Europe, brought back a grim picture. John visited scores of engineers in dozens of plants in 14 cities in eight European countries. Though his main mission was to gather impressions about Electronic Design and Electronic Design's GOLD BOOK, he learned a lot about European attitudes toward American companies. In sum, many Europeans are miffed.

We should understand that no European goes out of his way to buy American. For convenience, if for no other reason, the French engineer would rather buy in France, the British engineer in Britain and the German engineer in Germany. But often these engineers need to buy from the United States because the U.S. product offers some advantages. And that's where American manufacturers make it tough.

The engineer learns about a product in Electronic Design or the GOLD BOOK (which now has more than 11,300 users in Europe), then gets in touch with the local representative. But the rep doesn't know anything about the product. So the engineer writes to the manufacturer's home office in the United States and, if he gets a reply at all, he is referred back to the rep—where he started. Distributors are worse.

"If you can believe it," said one engineer, "distributors don't even know what lines they're carrying. They handle one line today and another tomorrow. And they're not technical, so you can't ask them any questions."

When he places an order, the European engineer runs into further trouble. In one case, an engineer wanted to place an order for some samples worth \$100. The local man didn't have the product and knew nothing about it. The home office in the U.S. returned his purchase order; it would not accept an order for less than \$1000, though the engineer's company was a giant. If the European works for a company that isn't known to the American, he has an even rougher time—even if his company is vast.

There are exceptions, of course, notably Hewlett-Packard, Tektronix, Motorola and Texas Instruments, whose reputations in Europe are superb. But many U.S. companies sell to Europe in spite of themselves. Some have fine reputations for customer service in the U.S.—but not in Europe.

In general, American engineers design for engineers throughout the world. Too often, unfortunately, their products can be purchased only by those engineers with enough tenacity to overcome the purchasing barriers erected by American companies. Most American manufacturers raise all sorts of hell when they learn of trade barriers erected by other countries. They needn't bother; they are creating their own.

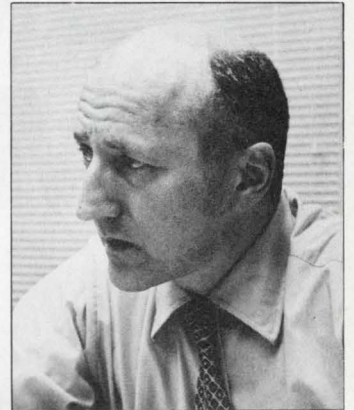

GEORGE ROSTKY
Editor-in-Chief

Gralex can deliver almost anything you want in DPMs.

From the broadest line in the industry, with 17 models offering a choice of:

Resolution.... $2\frac{1}{2}$, $2\frac{3}{4}$, $3\frac{1}{2}$, $3\frac{3}{4}$ or $4\frac{1}{2}$ -digit
Display Beckman, LED or Nixie
Power AC or 5VDC



The Designer's Choice.

That's our new low cost Series 37. It includes 14 different models, *any of which can be interchangeably plugged into the same panel cutout and connector.* Now you can offer your product with a full choice of DPM resolution, display and power options at little or no extra cost! Shown here, in actual size, is a $3\frac{3}{4}$ -digit model with Beckman display.

GRALEX INDUSTRIES

DIVISION OF GENERAL MICROWAVE CORP.
155 Marine St., Farmingdale, N.Y. • 516-694-3607

INFORMATION RETRIEVAL NUMBER 32

**From instrumentation
to computers,
demanding OEMs**

turn to CTS

for the best cermet trimmer values

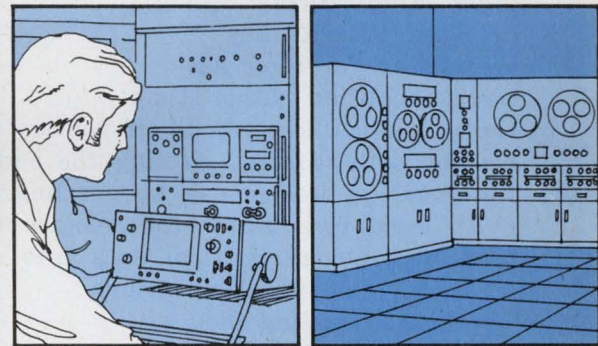
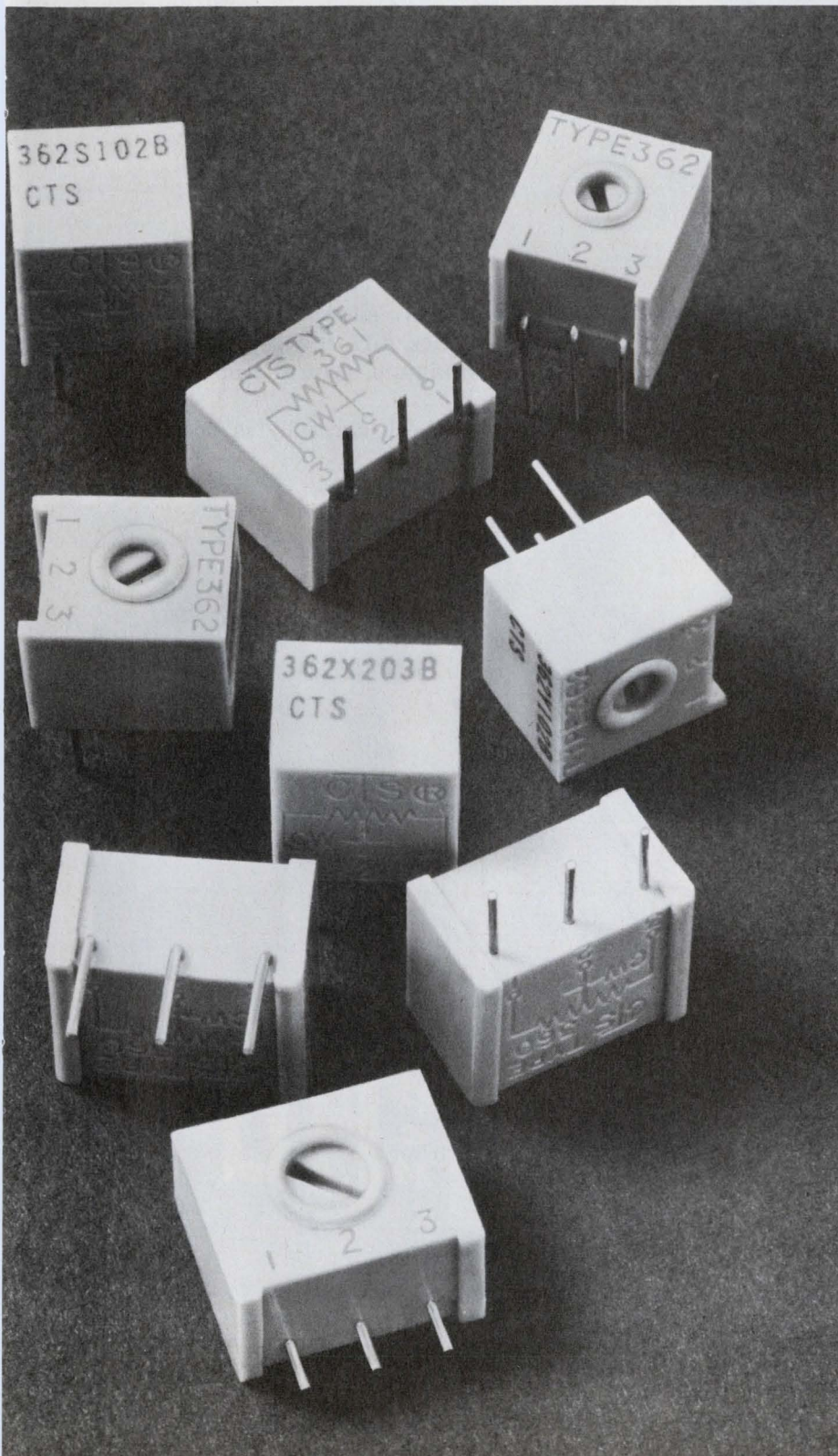

CTS is the "engineer's choice" for quality cermet trimmers. CTS delivers proven performance, uniformity and reliability . . . at economical prices. The best known calculators and all types of fine tolerance instruments incorporate CTS trimmers. Our industrial 360 Series satisfies a wide range of critical OEM applications.

Nine popular styles give you the pin spacing you need. Choose from top and side adjust .100", .125", .150" and TO-5. Plus top adjust .200" grid, too. Units are flux sealed, and feature a low TC cermet element. Settability: 0.03%.

- 1 watt power @ 25° C., ½ watt @ 85° C
- 1.5% average ENR noise resistance
- 0.5% average CRV

Available off-the-shelf from CTS Industrial Distributors. CTS of Berne, Inc., 406 Parr Road, Berne, Indiana 46711. Phone: (219) 589-3111.

CTS CORPORATION
ELKHART, INDIANA



Focus on Displays

Displays are unlike most other electronic devices. Often they are chosen for their aesthetic qualities rather than their technical superiority. If you try to get the best of both worlds, selecting the right display for your application can be puzzling.

At least five major technologies are being used to convert electrical data into some sort of digital readout. They include:

- Light emitting diodes.
- Gas-discharge devices.
- Incandescent displays.
- Liquid-crystal readouts.
- Fluorescent tubes.

Deciding among these technologies requires proper interpretation of spec-sheet data and a thorough understanding of the tradeoffs involved.

Since all displays must ultimately be read by people, the first thing to ask yourself is whether the display is pleasing to the eye. Next, determine if it will be used in high ambient light.

Another factor to consider is the contrast ratio of the display. Also: What is the viewing angle? Is the digit big enough to be seen from the normal operating distance? Is ruggedness a key requirement? What color should the display be? Is full alphanumeric capability required? How much data will be displayed at one time? Will the display be operated in the parallel mode or multiplexed? What voltage does the display require? How much power will it consume? How much does it cost?

Watch those specs

As with many other electronic devices, beware of specsmanship. Frequently data are not given

over the full operating range but only at the point where the display shows up best. Because display characteristics differ with temperature, be sure you get minimum, typical and maximum values.

Another spec to check carefully is power dis-

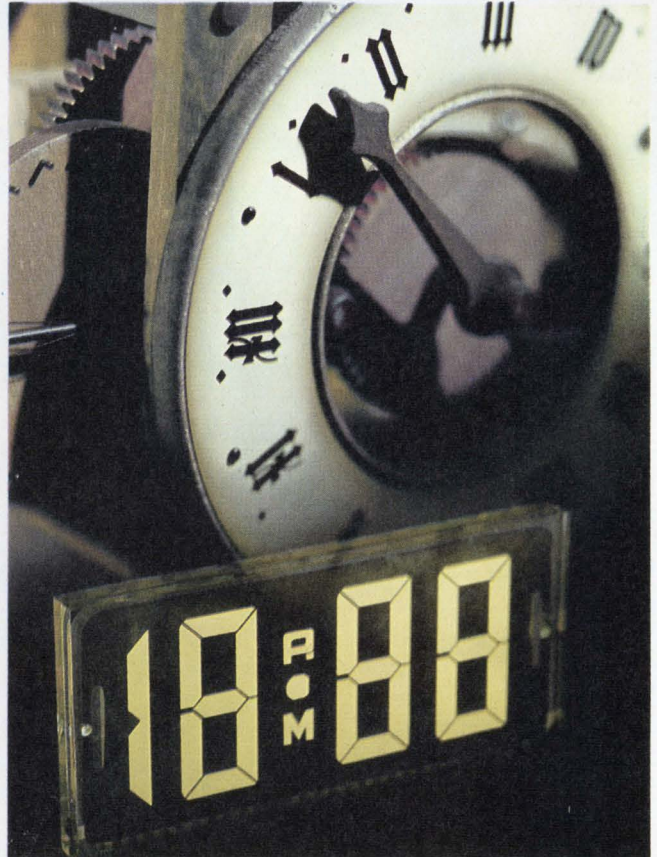

Liquid-crystal clock displays, such as this 3-1/2-digit unit from Hamlin, are available in either reflective or transmissive models.

Jules H. Gilder
Associate Editor

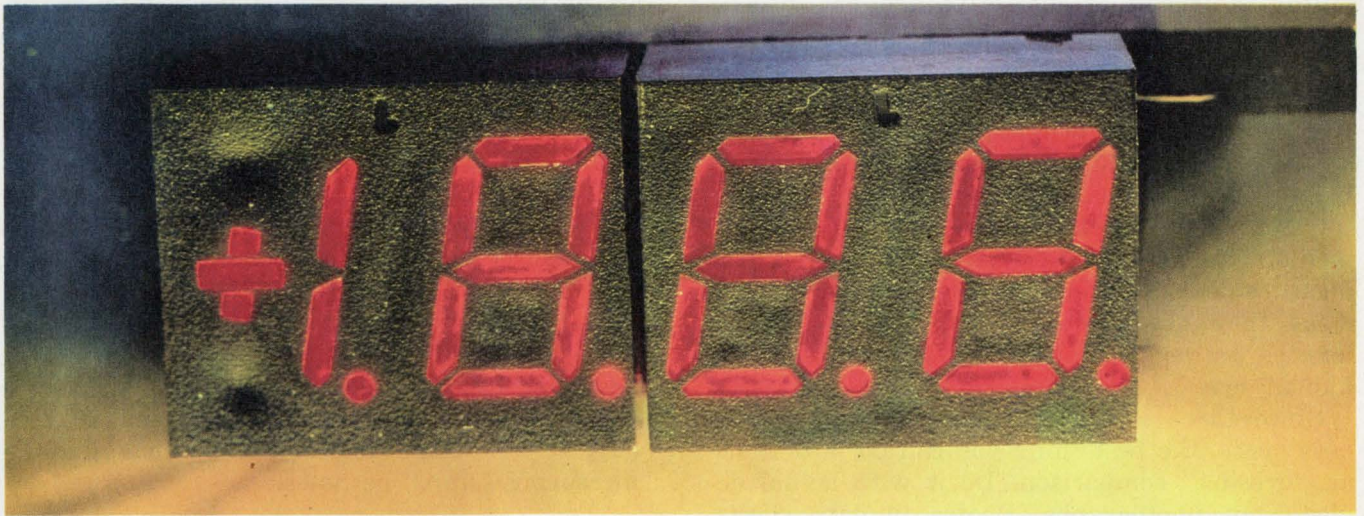

A new trend in large LED displays is to package them as multiple-digit units. The DL 721 and DL 727 from

Litronix each contain two 0.5-in. characters, and can be used to form 3-1/2, 4, 5-1/2 or 6-digit displays.

sipation. Sometimes values are given at minimum current or with only five segments of the display lighted. This makes the dissipation look better than it really is. For nominal performance levels, dissipation should be specified at typical current and with all segments lighted.

Here's another thing that causes problems: You're looking at the power-dissipation spec, but what you're really interested in is power consumption. There is a difference. Dissipation refers to the power drop across the display itself, while consumption refers to the power drop across both the display and any associated dropping resistor.

Even if you take care to differentiate between dissipation and consumption and are careful to use typical rather than minimum power specs, you may still have a problem. Your application may require a display of a specific brightness or readability. To fulfil this requirement, it may be necessary to drive the display harder than the typical spec requires. This increases power consumption and may make an alternate technology more desirable.

How bright is bright?

When a spec sheet says that a display is rated at a specific brightness, what does it mean? Not much. The reason is no one really knows what is the best way to specify it. Some manufacturers specify brightness in terms of source intensity—candlepower. This measurement is not related to surface area; it indicates the amount of light—the lumen level—available for viewing by an observer.

Other manufacturers specify brightness in terms of surface illuminance—in foot-candles or

lumens per square foot. This measures the amount of light per unit area falling on a surface. Still other manufacturers specify brightness in terms of surface luminance, or foot-lamberts. This is a complex function describing surface-reflected light, and it includes solid-

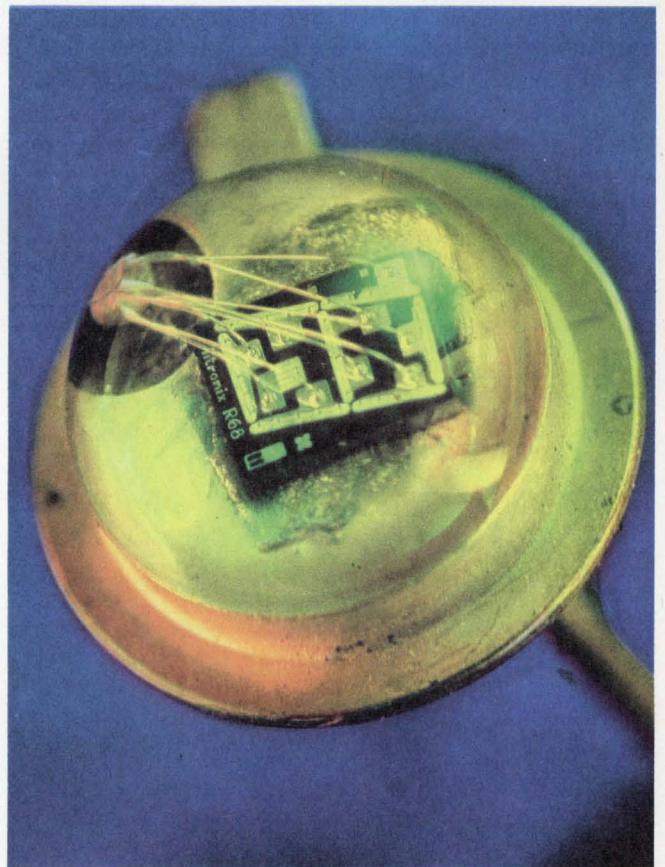

Cross-talk between segments is eliminated by using GaAsP on opaque GaAs substrates in monolithic yellow displays. Early units used GaP substrates.

angle and area factors.

But brightness is subjective and not directly measurable. It is a response of the human eye to visible electromagnetic radiation. And the eye-ball tends to see surfaces—not points or spots, which yield better brightness data.

There is no industry standard for measuring brightness. Most manufacturers use either a photometer or a spectrophotometer for measurements. Taken with a spectrophotometer, the measurements can be of questionable worth, since they are made at peak emitting wavelengths rather than at the wavelength of the human eye.

Since there is so much confusion in brightness specs, the best thing you can do is to make an "eyes-on" comparison. Do it with actual devices, not photographs. Photos in data sheets, catalogs and magazine articles are often flattering and sometimes deceptive. Some displays simply do not photograph well; they may look better to the eye than to film. Often manufacturers feel the camera has "lied," so they "help" the picture with an artist's airbrush and imagination.

When comparing different displays, do it under conditions that closely approximate the actual application. Such examinations should include the optical filtering that will be used to increase contrast and reduce reflections from ambient light. No matter what the spec sheet says, the only true test of display brightness is one involving actual viewing.

Get several samples of each device to be evaluated. One sample can disclose much, but several can tell a lot more. It's possible, for example, to see the spread in brightness and color from character to character. And uniformity of character shape and size can also be seen.

Several sets of eyes are also better than one. Ask co-workers to view the displays.



Large dynamic-scattering liquid-crystal displays that vary in height from 4 to 8 in. are available from Transparent Conductors Inc.

The readability of a display does not depend on brightness alone. A high-contrast ratio between the lighted portion of the display and the background is also necessary. Reflection of ambient light from the display background reduces the contrast ratio. Therefore to get the best readability, use either a black, matte-finish background material as an ambient-light absorber or a colored or polarized filter in front of the display. If the filter route is chosen, remember it will decrease brightness a bit.

As for liquid crystals, "forget the data sheet," advises John D. Dunn, product manager for Beckman Instrument's information displays. "I can measure a contrast ratio of from 20:1 to 60:1 for the same device just by changing the measuring setup," he notes.

How long will a display last?

The life expectancy of displays varies from 10,000 hours for liquid-crystal and incandescent units to 100,000 hours for gas-discharge, fluorescent and light-emitting diode displays.

But don't depend on life-expectancy numbers too much. Poorly stated specs can often mislead. For example, a life-expectancy claim for a readout may be based on laboratory life testing on a per-segment basis. In many applications, however, multidigit displays are used, and they may contain several dozen segments. The statistical life expectancy of such a display is significantly lower than that of the individual segment.

Even if the life-expectancy spec is not deceptively stated, you can't always tell how long a display will last—unless you consider the way it will be driven. Certain driving schemes are tougher on displays than others. For many LED applications, the display array is multiplexed and segments are turned on and off at rates exceeding 40 Hz. This switching subjects the LEDs to degrading effects similar to thermal fatigue. Multiplexing is detrimental to gas-discharge displays as well. The high peak currents caused by the multiplexing circuitry can greatly reduce life expectancy.

Viewing angle must be considered

The viewing angle of a display is another spec that must be approached with caution. There is no good definition for it, and therefore it can be misleading. Different manufacturers specify viewing angles in different ways. And even the same manufacturer may use different techniques to specify the viewing angle on different product lines.

Frequently viewing angle is defined as the half-power point—the point at which the lumi-

nous intensity of the display is one-half that of the display when it is viewed straight-on. Sometimes the angle defined by the half-power point is used, and sometimes it is doubled, to get what can be called the total included angle. There is nothing mystical about the half-power point; it is simply a carryover from microwave specs that deal with 3-dB, or half-power, points. In fact, many industry spokesmen feel that the viewing angle should tell the engineer something about when the full display is no longer visible.

This has given rise to another way of specifying viewing angle, a way used primarily for magnified displays, such as those used in handheld calculators. In this definition, viewing angle is the point at which one or more segments of the digit cannot be seen.

There are several points worth noting about magnified digits. First, the viewing angle of the digits changes faster in the horizontal direction than it does for the vertical. Thus while the digit might be visible 40 degrees off the vertical axis, it may not be 40 degrees off the horizontal axis.

Another point to remember: The greater the magnification, the narrower the angle of view. In general, magnified digits have a viewing angle that is limited to between 20 and 35 degrees.

The best way to specify viewing angle—the one that limits the specsmanship of manufacturers—is to use a polar plot of constant luminous intensity. This presents information in an unambiguous way and allows you to determine the best viewing angle. Polar plots are now being used on some of the newer LED displays and on liquid-crystal displays.

An important point to remember about liquid crystals is that the viewing angle depends on the display's contrast ratio, because it is not a

light emitter. And since the contrast ratio varies with driving voltage, so does the viewing angle.

You better believe

According to most display manufacturers, the biggest mistake engineers make is not getting in touch with the display manufacturer's application department. This initial mistake may often lead to more serious ones.

A common problem encountered with LEDs is that users simply don't want to believe the manufacturer when he says the LEDs must be driven from a current source. Many engineers try to use voltage drivers on LEDs, and they wind up with problems. They fail to realize that if there is a slight difference in voltage from one segment to the next, the lower-voltage diode will draw more current, causing a brightness mismatch. Remember: LEDs require a constant current source.

Another major problem is that environmental conditions are ignored. Customers expect the displays to work under humidity ranges and temperature cycles that the manufacturer does not recommend. Temperature-derating information is sometimes ignored, as are recommendations on soldering and lead length. The problem is particularly acute for LEDs, because they are packaged in clear epoxy.

In the packages used with ICs, opaque fillers in the epoxy give the ICs superior heat characteristics. But fillers can't be used with clear epoxy. If the package heats up too much, the plastic melts. And this relaxes the pressure on the leads, and some of the thermocompression bonds fly open. Most of these failures are catastrophic.

A common mistake made by designers who use liquid-crystal devices is that they try to use the display for its low power advantage and then put in a backlight to obtain adequate visibility. This results in a display whose power consumption is higher than that of LEDs or gas-discharge types.

Other factors often neglected with liquid crystals are the limited temperature range of operation—sometimes a heater is required—the need for an ac drive signal and the cost of special connectors to make the display replaceable.

A common mistake with gas-discharge displays occurs in power supply and interface design. A good example of this is in multiplexed circuits. A typical circuit has high voltage anode and cathode transistors. The engineer generally over-designs his circuits for high voltage. This can be avoided by use of a voltage-divider network to bias the transistor to a predetermined voltage level. The transistor will not have to swing the full power-supply voltage and cheaper,



An experimental 2-in.-high, 3-1/2 digit dynamic scattering liquid-crystal readout, designed for digital-clock applications, has been fabricated by RCA.

50-V transistors can be used instead of the more expensive 200-V.

Designers don't always understand the features that are built into displays. For instance, some manufacturers use a "keep-alive" cathode that provides an internal ion source. This aids multiplexing, operation in the dark or at low temperatures and applications requiring suppression of zeros.

Another oft-forgotten fact is that since brightness is directly proportional to the average segment current, pulsed power can be used to increase or reduce display brightness.

If you are using a multipackage array of gas-discharge devices, it's essential that you allow for different striking voltages; otherwise one digit might not ignite. In other words, don't base your design on the minimum voltage specified for the display.

Two more points worth remembering: Gas-discharge displays cannot be flow-soldered, because the temperature shock may damage the hermetic glass seal. And current-limiting resistors are necessary.

Users of fluorescent displays sometimes forget, when they are considering the power consumption of the unit, to take into account the current requirements of the permanent filament. Also, since fluorescent units are subject to differential fading of segment brightness, simple field replacement is a must.

Tradeoffs depend on application

Since it's highly unlikely that a single display technology will always do everything you want, tradeoffs can be critical. Certain applications will make the decisions easier. They may have a few key specs that virtually dictate which display to use. The digital wristwatch is a good example. It requires a display whose power consumption, size and driving voltage are all low. This eliminates all but light-emitting diodes and liquid crystals.

Other applications don't make the choice so easy. Digital bench-top instruments, for example, don't have a critical power requirement; nor are size or driving-voltage magnitude generally problems. Thus as many as five different technologies can be used. Let's look at each type of display in a little more detail.

Light-emitting diodes are 'in'

The most popular display used today is the light-emitting diode. LEDs got their start in 1968 when Monsanto introduced devices priced at \$495 and \$165. This year, at about a dollar a digit, LEDs will probably account for more digits than any other technology.

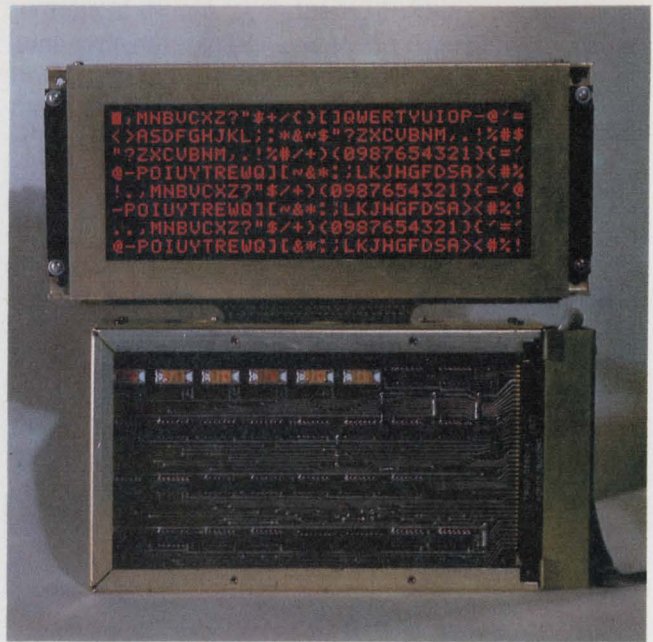

As many as 256 alphanumeric characters can be displayed on Burroughs' Self-Scan gas discharge panel. The panel includes all decode, drive and scan circuitry.

There are several reasons why LEDs are popular, the most important probably being that they are solid state. This means that they are inherently more reliable and have a long life expectancy. Another key factor is their low cost. In the last two years prices have plummeted, and they now range from 50 cents to \$2 a digit, depending on size.

Basically, LEDs are made by fabricating a p-n junction in gallium-based semiconducting materials. Red, orange and yellow displays are generally fabricated from various combinations of gallium arsenide and phosphorous, while green displays are produced from gallium phosphide.

The types of LED displays available today can be classified into two groups that use three fabrication techniques. The first group consists of small monolithic displays whose character height ranges from 0.1 to 0.2 in. The second group consists of larger digits that use hybrid and light-pipe construction.

The small digits are used primarily for hand-held equipment, such as calculators and digital watches, although some are now starting to appear in bench-top instruments, such as the new Hewlett-Packard 1722A microprocessor scope.

Monolithic LEDs are not widely available as single-digit displays; multiple-digit versions, containing between four and nine digits, have proved more popular. They offer the advantage of consistent segment alignment, since all of the segments are etched into the emitting material in a simple, one-step process. Another plus is that like segments on each digit are connected in parallel, making multiplexed operation easy.



Incandescent displays that use directly viewed filaments, such as RCA's Numitron, can be filtered to produce a wide variety of colors.

LEDs are a natural for multiplexing, where each digit is driven at N times its usual drive level for $1/N$ of the time. The reason is that as the current increases, so does the luminous intensity. Above a certain level of luminous intensity, the eye saturates and cannot recognize digit-to-digit or segment-to-segment differences. The result is a high apparent display brightness with low power consumption.

Another plus for multiplexing of GaAsP LEDs is that as the drive levels go up, the devices become more efficient, so that the same brightness can be obtained for less power than with a dc-driven display. This increase in efficiency is so effective that often displays used in non-multiplexed applications are driven from a pulsed source to reduce power dissipation.

Monolithic LEDs are almost always packaged with a magnifying lens placed over the die. Magnification of the digit size can vary from about 1.5 to 2.5 times normal size. In addition to enlarging the digit, the lens concentrates the light emitted into a narrow cone in the forward direction. Normally this decreasing of the viewing angle would be a distinct disadvantage, but for hand-held equipment it's not that critical.

LEDs are getting bigger and prettier

Among the new developments in LED technology is a trend toward bigger and better-looking displays. The 0.25 and 0.3-in. devices have given way to the 0.4 and 0.6-in., and the multi-chip per segment hybrid approach has yielded to the reflecting-cavity, light-pipe approach.

Until recently, the most commonly used technique for fabricating large LED displays was the hybrid one in which monolithic LED chips were placed on a ceramic substrate and connected to form a numeric. Often displays, such as Monsanto's MAN 10, use two chips per segment. The hybrid approach has several advantages over the monolithic, including a reduction in the amount of LED material needed and the ability to salvage defective digits by replacement of individual segments.

An improvement on the hybrid approach—one that uses even less LED material and results in a better looking display—is the reflective light-pipe technique.

In light-pipe construction a single, small LED chip is placed in a reflecting cavity, which deflects the emitted light onto a preformed plastic segment bar in the cap of the display. This makes it possible to construct digits that have wider, more evenly lighted segment bars. It also makes it easier and less expensive to produce large digits—such as the FND 500 from Fairchild Semiconductor, a 0.5-in. device.

Another new development is an apparent effort by LED manufacturers to take over many of the applications now being filled by gas-discharge displays. Monsanto has just introduced a new series of 0.4-in. LED displays that feature what the company calls a high readability font. The font looks a lot like the one used on Burrough's gas-discharge Panaplex II, and it uses beveled segment corners to eliminate much of the gappy appearance of other seven-segment displays. Designated the MAN 4000 series, the Monsanto displays are available in neon orange, red, yellow and green. Like other recent entries, the 4000 series uses light-pipe technology.

In another apparent attack on gas-discharge technology, Litronix is extending its multidigit packaging capability to large digits. The first large multiple-digit devices to appear are the DL-721 and DL-727. The DL-721 consists of an overflow function and a seven-segment digit in the same DIP package, while the DL-727 contains two digits. Both units have 0.5-in. characters and are designed to be used together to form 3-1/2, 4, 5-1/2 or 6-digit readouts.

If you want to use LEDs to present alphanumeric information, you can use either 16-bar-segment or dot-matrix devices. The 16-segment display is generally easier to drive, but its characters are slightly distorted. For multiple-character applications, American Electronic Laboratories offers the 5010 series of devices. These consist of 8, 16, 24 and 32-character displays that have self-contained data storage, drive and refresh circuitry.

If you want to use a dot matrix to get better-formed characters and at the same time want the



Attractive gas-discharge displays, like this one from Beckman, can be viewed even in direct sunlight. They use high voltage, but need little power.

flexibility of using as many characters as you want, consider the HP 5082-7100 devices. These feature three, four or five characters per package. The 5-by-7 matrix of LEDs is X-Y addressable and is capable of displaying all the ASCII characters.

Gas discharge displays still being used

Twenty years after Burroughs introduced the first commercial gas-discharge display, the Nixie, that technology is still going strong. But the Nixie is not being designed into much new equipment these days; it's being sold mainly as a replacement part. Today's gas-discharge displays have replaced the individual numeric cathodes of the Nixie with segmented numbers.

The gas-discharge that seems to be the darling of the industry is Beckman's (formerly Sperry's) unit. It comes in 1-1/2, 2, 2-1/2, 3 and 3-1/2 digits and consists of 0.33 or 0.5-in. seven-segment numerics. The segments that make up the number are extended to eliminate side and corner gaps, thereby producing a pleasing display.

Beckman's displays draw between 200 and 500 μA per segment, depending on digit size. The tradeoff is the requirement for 160 V. This high-voltage requirement is not really significant, especially for equipment that is powered by 117 V ac. But for engineers who think the world runs on 5 V, Beckman offers an economical dc-to-dc converter to operate the displays.

If more digits are required, the Panaplex II displays from Burroughs might be the thing. They are available with as few as four digits or as many as 12. Panaplex II consists of a sandwich of two pieces of glass, on which the seven-segment cathode elements of the numerics and interconnections are silk-screened. The sandwich is then vacuum-sealed with a neon-mercury gas mixture. The big advantage of the display is

that it eliminates a lot of external connections.

For example, a 12-digit discrete LED display would require 132 connections, while a 12-digit Panaplex II unit requires only 19 connections. Like the Beckman display, the Panaplex requires high driving voltage.

Another source for plasma displays is Cherry Electrical Products Corp. Its unit, the Plasma-Lux, is interchangeable with the Panaplex. National Electronics also makes gas-discharge displays, its Plasmac panel coming in sizes ranging from 1×3 to 8×15 in. Plasmac can display unlimited combinations of fixed messages, numeric and alphanumeric characters on a single panel.

Plasma panels bridge the gap

Plasma panels—devices that are capable of displaying large amounts of alphanumeric data via a series of 5-by-7 dot matrices—are aimed at bridging the gap between applications that require single-character readouts and those calling for a CRT that can display hundreds of thousands of characters. The Self-Scan panel from Burroughs is good for applications that require between 10 and 600 characters, while the Digivue from Owens-Illinois can hold up to 4000 characters.

In the Burroughs unit, a glass plate with an array of holes is sandwiched between top-wire anodes above the glass, cathode strips and bottom-wire anodes below it. The holes form cells for the neon gas. There is one cathode strip for each seven-dot column. The strips are scanned, and the gas in the cell becomes visible when the cathode is switched from 100 V to ground, while the top anode is switched from 130 to 250 V and the bottom anode remains at 250 V.

Whereas the Self-Scan panel is a dc unit, the Digivue is ac. In operation, a sustaining voltage—not enough to trigger the display—is applied to all elements. To make the gas become visible, a voltage pulse is added to the sustaining voltage to raise it to the breakdown potential of the gas.

Plasma panels are also available from Industrial Electronic Engineers, Inc. Unlike the Burroughs or Owens-Illinois devices, however, the Industrial Electronic Argus dot-matrix panels use a phosphor coating inside the display to achieve a soft green color instead of the conventional orange. But orange is available if desired. Green plasma panels are also available from Okidata, along with red ones.

The latest addition to the plasma scene is a bar-graph display from Burroughs. This device combines the thick-film technology of Panaplex displays with the internal scanning technique of Self-Scan panels to produce a display that can

present analog data with digital accuracy. The display uses what is known as the glow-transfer principle, in which a glow is established at the reset cathode and then transferred up the bars. The height of the bar is regulated by the amount of time that the front anode is on for each bar. When the anode is turned off, the glow stops.

For low power, it's liquid crystals

Eight years ago liquid crystals were a laboratory curiosity with no important commercial future. Today, because of their low power requirements, they have emerged as one of the strong contenders in the display field.

Liquid-crystal displays are constructed from two glass plates that have been coated with an electrically conductive film. For transmissive devices, the films on both plates are transparent; for reflective dynamic-scattering displays, one film is a highly reflective material, such as gold. The films are selectively patterned to produce seven-segment characters, and a layer of liquid-crystal solution is hermetically sealed between the plates.

With dynamic-scattering liquid-crystal devices, application of an electric field causes domains of crystals to form. The domains reflect light at the boundaries and scatter the incident beam. Inactive areas remain transparent.

With field-effect (twisted-nematic) liquid crystals, application of an electric field causes the material to rotate the plane of light polarization that passes through the display. The orientation of polarizing filters determines whether the display is transmissive or reflective.

A new type of liquid-crystal display is starting to appear. It's called a transflective display and is being pushed primarily for watch applications, where people want to be able to tell time

in the dark, too. The display has a diffused metallic background. In daylight it's reflective, and in the dark it's transmissive when backlit by a small bulb.

Liquid-crystal displays generally don't tolerate dc driving voltages; the voltages destroy the display by electrolysis. But American Microsystems, Inc., has fabricated a dynamic-scattering liquid-crystal material that allows as much as 20 V dc to be applied without damage. The same concern also makes field-effect liquid-crystal displays, but right now they're mainly for digital watches.

Beckman Instruments is another supplier of field-effect liquid-crystal displays, but don't look for any literature until at least next month. While the company has been in production with liquid crystals for over a year, the work has been primarily custom.

RCA, however, is not limited to custom applications. It has several dynamic-scattering and field-effect displays in 3-1/2, 4 and 8-1/2-digit configurations. These are small devices intended for use in watches and calculators. But a bigger 2-in. display has been fabricated, and units are now being shown to prospective customers.

If you want really big displays, though, you're probably better off with the 8 × 10-in. dynamic-scattering displays from Transparent Conductors Inc. Too big? The company has 4-in. units as well. Both the 4 and 8-in. devices are available as 7 or 16-bar readouts.

Incandescents find limited use

Incandescent displays are the oldest of electrical displays. Their primary advantage is that they produce a very bright display with a broad frequency spectrum. This means they won't wash out easily in direct sunlight, and they can be

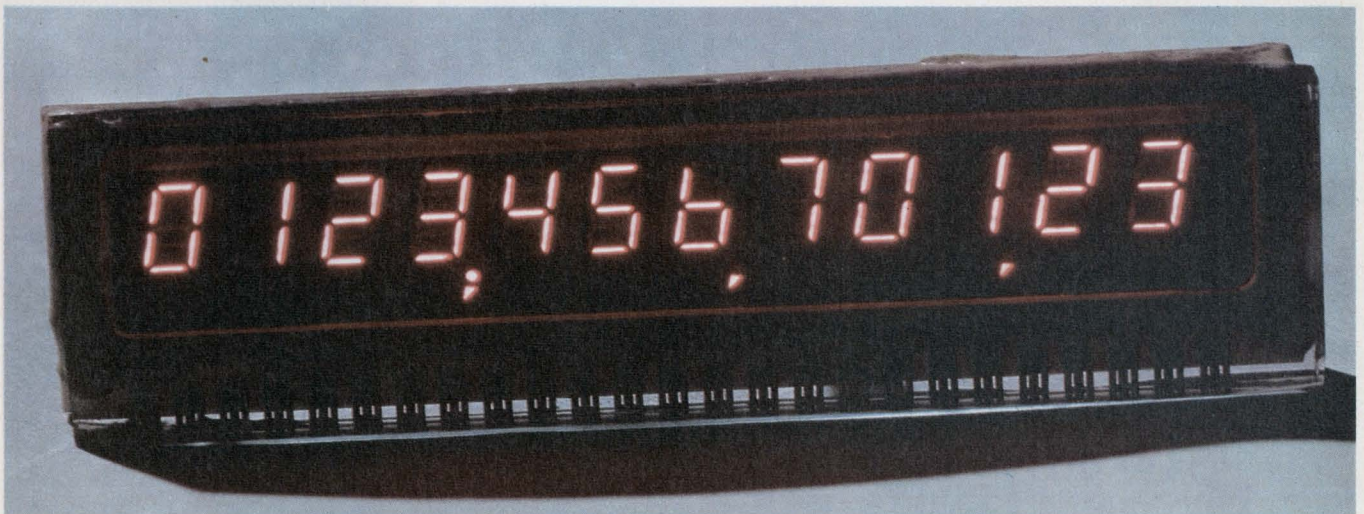

For applications requiring multiple digits, the Panaplex II from Burroughs is attractive. Like segments of all digits

are connected together so the unit must be operated in a multiplexed mode.

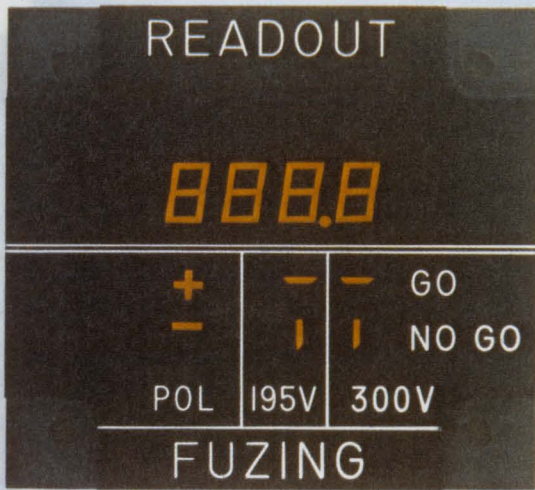

Illuminated incandescent displays from Wagner Electric use individual bulbs and light pipes to produce either 7 or 16-segment characters.

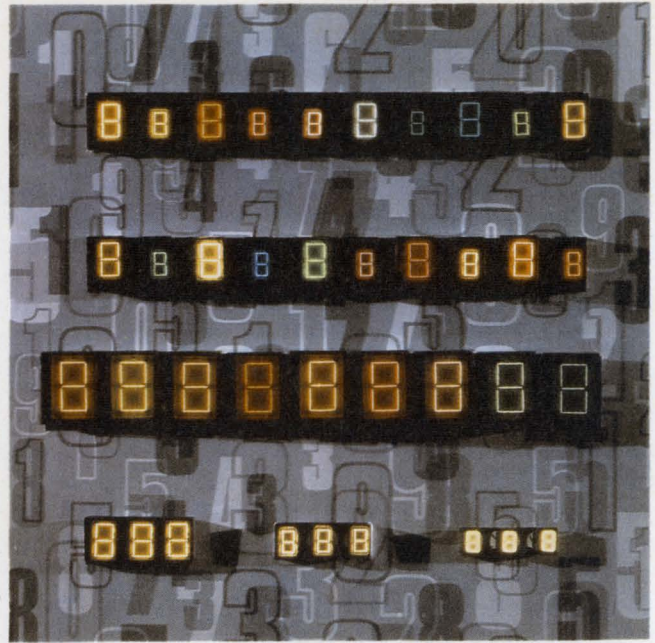

Fragility is not a problem with these incandescent readouts from Pinlites because the filament is operated at lower temperatures than those in ordinary lamps.

Comparison of digital display technologies

| | LED | Nixie | Gas Discharge | Fluorescent | Incandescent | Dynamic Scattering LCD | Field Effect LCD |
|---|---|-----------------------|-----------------------------|---------------------------------|------------------------------------|-------------------------|-------------------------|
| Power/digit | 10 to 140 mW, depending on color | 350 mW | 30 to 100 mW | 100 mW | 250 mW to 1 W | 100 μ W | 1 to 10 μ W |
| Voltage | 5 V | 175 V | 180 V | 15 to 25 V | 5 V | 18 V | 3 to 7 V |
| Temperature range ($^{\circ}$ C) | -55 to 125 | 0 to 70 | 0 to 55 | -55 to 100 | -55 to 100 | 0 to 80 | 0 to 70 |
| Switching speed | 1 μ s | 150 μ s | 1 ms | 1 ms | 150 μ s | 300 ms | 100 to 300 ms |
| Life in hours | 100,000+ | 200,000 | 30,000 | 100,000 | 10,000 to 100,000 | 10,000 | 10,000 |
| Colors | red, orange, yellow, green | neon orange | orange, others with filters | blue-green; others with filters | all with filters | depends on illumination | depends on illumination |
| Brightness | good to excellent | excellent | good | good | excellent | not applicable | not applicable |
| Contrast ratio | 10:1 | 8:1 | 20:1 | 10:1 | 20:1 | 20:1 | 20:1 |
| Appearance | good to excellent | fair | excellent | excellent | excellent | good | good to excellent |
| Viewing angle | 150 $^{\circ}$ | 100 $^{\circ}$ | 120 $^{\circ}$ | 150 $^{\circ}$ | 150 $^{\circ}$ | 90 to 150 $^{\circ}$ | 90 to 120 $^{\circ}$ |
| Font | 7 and 16 segment, 5 \times 7 dot matrix | individual characters | 7 segment | 7 segment | 7 and 16 segment shaped characters | 7 and 16 segment | 7 and 16 segment |
| Vertical size | 0.1 to 0.6 in. | 0.3 to 2 in. | 0.2 to 0.7 in. | 0.5 to 0.75 in. | up to 1 in. | 0.2 to 8 in. | 0.2 to 2 in. |
| MOS compatibility | small yes; large no | no | yes | yes | no | yes | yes |
| Cost per digit (0.3 to 0.6 in.) 10 k pieces | \$1.50 | \$2.35 | 60¢ | \$1 | \$1 to \$2 | \$1 | \$1.50 |
| Ruggedness | excellent | poor | fair | poor | fair | good | good |
| Ease of mounting | excellent | good | fair | good | good | poor | poor |

Prepared by Symon Chang of AMI.

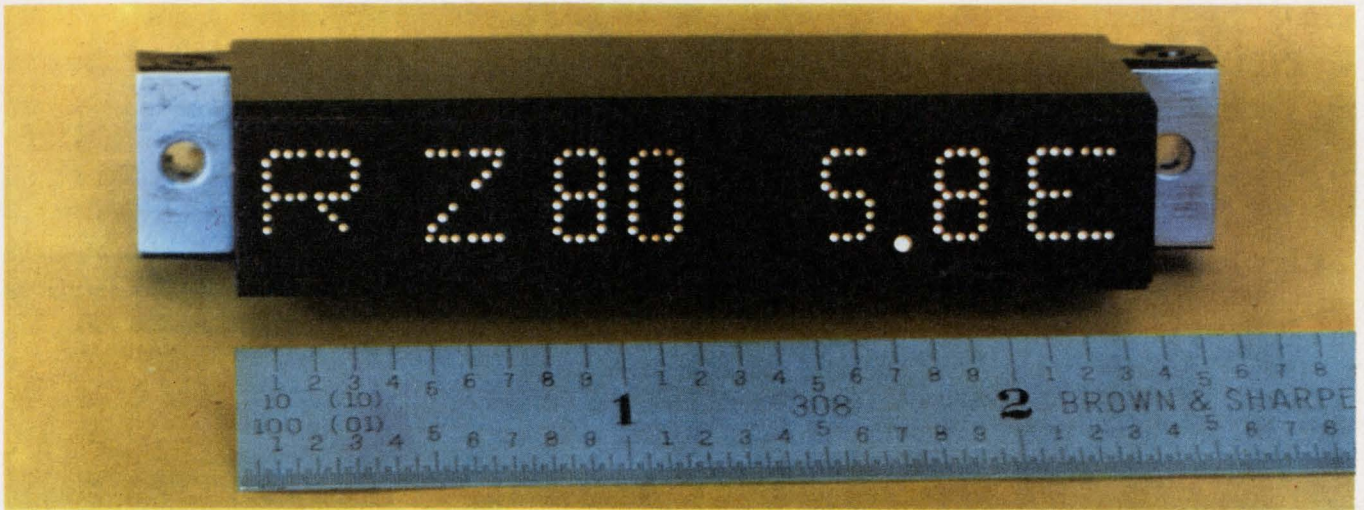

Optical fibers are used to transmit light from individual bulbs to a viewing screen. The fibers form a 7 or 16-

segment character. LEDs or incandescents are used. Standard modules contain from one to six digits.

filtered to produce a display of virtually any color.

Incandescents have some problems in certain applications. They consume a lot of power—anywhere from 250 mW to 1 W per digit. And it's difficult to multiplex them, because isolation diodes must be added.

But incandescent units operate over a very broad temperature range, and they can be run from 5-V logic levels. The expected lifetime of these displays ranges from 10,000 to 100,000 hours. Life, however, is greatly affected by the temperature of the filament, which is a function of the voltage. The lower the voltage, the greater the life.

There are several types of incandescent displays: direct-viewed filament devices, lamp-illuminated and fiber-optic.

Direct-viewed filament displays include RCA's Numitron, the CM 5 Series from Chicago Miniature Lamp Works, the Series 5 from Readouts, Inc., and incandescent units from Pinlites.

Numeric and alphanumeric displays that use individual bulbs and a light pipe are made by the Tungsol Div. of Wagner Electric. Another light-bulb display is a transilluminated device from Industrial Electronic Engineers. Fiber-optic displays, which form a seven-segment read-out by attaching several fibers to each bulb that represents a digit segment, are available from Master Specialties and IEE.

Fluorescents look good

One of the better-looking displays is the vacuum-fluorescent, which produces digits with a blue-green color. They still aren't being used too much in the U.S., however. They are available from Wagner Electric, ISE Electronics Corp. and Futaba Electric Industries.

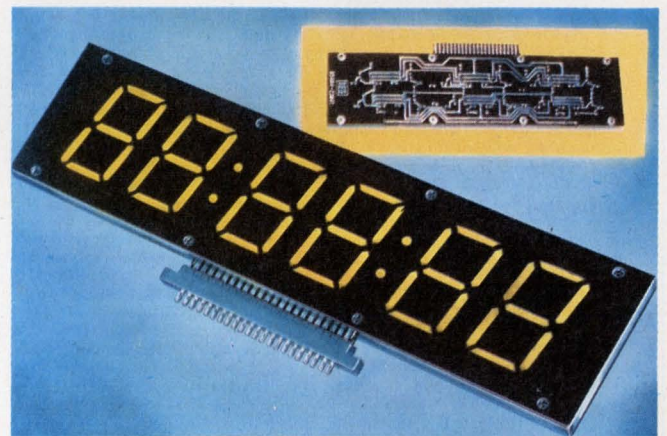

Transilluminated displays are good for saving space. This one from Industrial Electronic Engineers is only one-half inch thick. It uses replaceable lamps.

Fluorescent displays contain seven anodes, each coated with a phosphor and a filament. The filament is placed between the viewer and the anodes, which are arranged in the seven-segment configuration.

In operation, the filament is heated to just below incandescence. When an additional 12 to 25 V is applied to the anodes, they glow. A big plus for the fluorescent display is its wide operating temperature range—from -55 C to 100 C.

Another advantage of fluorescents is that since the light they emit has a broad spectrum, they can be filtered to produce displays of various colors. But there are also problems. The devices are packaged in glass and thus susceptible to damage from shock. They require continuous power drain for the filament. Filament breakage can make it necessary to discard a multidigit display, but some manufacturers—like Wagner Electric—minimize this possibility by including two filaments in each tube. ■■

(continued on page 62)

Need more information?

The products cited in this report don't represent the manufacturer's full lines. For additional details circle the appropriate information retrieval numbers. For data sheets and more vendors, consult ELECTRONIC DESIGN'S GOLD BOOK.

- Actron Ind Inc., 700 Royal Oak Dr., Monrovia, CA 91016. (213) 359-8216. (R. H. Carpenter). **Circle No. 500**
- AEL, PO Box 552, Lansdale, PA 19446. (215) 822-2929. (Adolph Rosset). **Circle No. 501**
- Aircraft Instrument Co., Commerce Dr., Montgomeryville, PA 18936. (215) 368-0175. (J. C. Rychlak). **Circle No. 502**
- Alco Electronic Products Inc., 1551 Osgood St., Dept A, North Andover, MA 01845. (617) 685-4371. (Tom Clark). **Circle No. 503**
- Ametek, Straza Div., 790 Greenfield Dr., El Cajon, CA 92021. (714) 442-3451. (S. A. Walker). **Circle No. 504**
- Amperex Electronic Corp., Providence Pike, Slatersville, RI 02876. (401) 762-9000. (Ed Feinberg). **Circle No. 505**
- Anacom General Corp., Med-Tek Div., 8560 B Roland St., Buena Park, CA 90621. (714) 521-0577. (W. K. Haines). **Circle No. 506**
- Antex Industry Inc., 455 E. Middlefield Rd., Mountain View, CA 94043. (415) 961-1111. (D. A. Holst). **Circle No. 507**
- Aspect Electronic, Inc., 711 Stierlin Rd., Mountain View, CA 94043. (415) 965-4144. (M. Hyman). **Circle No. 508**
- Automation Displays Inc., 3833 N. White Ave., Eau Claire, WI 54701. (715) 834-9595. (J. E. Carpentier). **Circle No. 509**
- Aydin Corp., 401 Commerce Dr., Fort Washington, PA 19034. (215) 643-7500. (R. Ashcroft). **Circle No. 510**
- Beckman Instruments, 2500 Harbor Blvd., Fullerton, CA 92634. (714) 871-4848. (R. E. Schmidt). **Circle No. 511**
- Bowmar Instrument Corp., 8000 Bluffton Rd., Fort Wayne, IN 46807. (219) 747-3121. **Circle No. 512**
- Burrughs Corp., Elec Components Div., P. O. Box 1226, Plainfield, NJ 07061. (201) 757-3400. (S. Kuchinsky). **Circle No. 513**
- Cherry Electrical Products Corp., 3600 Sunset, Waukegan, IL 60085. (312) 689-7600. (J. U. Dernehl). **Circle No. 514**
- Chicago Miniature Lamp Works, 4433 N. Ravenswood Ave., Chicago, IL 60640. (312) 784-1020. (D. Wallach). **Circle No. 515**
- Dale Electronics, 1376 28 Ave., Columbus, NE 68601. (402) 564-3131. (C. Novicki). **Circle No. 516**
- Dialight Corp., 203 Harrison Pl., Brooklyn, NY 11237. (212) 497-7600. (R. Laken). **Circle No. 517**
- Digilite Corp., 91 Rome St., Farmingdale, NY 11735. (516) 694-6545. (George A. Franco). **Circle No. 518**
- Display Devices Inc., 130 W. East St., Encinitas, CA 92024. (714) 753-0113. (R. C. Ross Jr). **Circle No. 518**
- Dyma Engineering Inc., Rt 1/Box 51, Taos, NM 87571. (505) 758-2686. (C. G. Cunningham). **Circle No. 519**
- Econolite, A Div. of Altec Corp., P. O. Box 6150, Anaheim, CA 92806. (714) 630-3700. (J. T. Gillis). **Circle No. 520**
- Electrodata Concepts, 69 Connecticut Ave., Norwalk, CT 06854. (203) 853-2792. (R. J. Borstelmann). **Circle No. 521**
- Elec Research Co., Div. Textron P. O. Box 913, Shawnee Mission, KS 66201. (913) 631-6700. (J. Mutrux). **Circle No. 522**
- ES Enterprises, 10418 La Cienega, Inglewood, CA 90304. (213) 674-3021. (R. M. Mayers). **Circle No. 523**
- Fairchild Semiconductor, 464 Ellis Ct., Mountain View, CA 94042. (415) 962-5011. (John Duffy). **Circle No. 524**
- Ferranti Electric Inc., E. Bethpage Rd., Plainview, NY 11803. (516) 293-8383. (V. M. Pastore). **Circle No. 525**
- Ferranti-Packard Ltd., Elecs Div., 121 Industry St., Toronto, Ont., Canada. (416) 762-3661. **Circle No. 526**
- Fujitsu Ltd., 2-chome, 6-1 Chiyoda-ku, Tokyo, Japan 100 03 21 63211. (H. Seimiya). **Circle No. 527**
- Futaba Electronic Industries Ltd., Super Bldg., 1-11-5 Sotokanda Chiyoda-ku, Tokyo, Japan. 03-25 5-5881. (T. Etoh). **Circle No. 528**
- General Electric Co., Electronic Components, 1 River Rd., Schenectady, NY 12345. **Circle No. 529**
- General Instrument Corp., Electronic Systems Div., 600 W. John St., Hicksville, NY 11802. (516) 733-3000. (J. S. Adams). **Circle No. 530**
- Genisco Technology Corp., 18435 Susana Rd., Compton, CA 90221. (213) 537-4750. (W. R. Esser). **Circle No. 531**
- Goerz-Inland System Div., 301 Alpha Dr., Pittsburgh, PA 15238. (412) 782-3516. (G. Economou). **Circle No. 532**
- Hamlin Inc., Lake & Grove Sts., Lake Mills, WI 53551. (414) 648-2361. (R. T. Armantrout). **Circle No. 533**
- Hewlett-Packard, 1501 Page Mill Rd., Palo Alto, CA 94304. (415) 493-1501. (R. Boniface). **Circle No. 534**
- Hughes Aircraft Co., Centinela & Teale St., Culver City, CA 90230. (213) 391-0711. (J. L. Winkel). **Circle No. 535**
- IEE Inc., 7740 Lemona Ave., Van Nuys, CA 91405. (213) 787-0311. (Art Westburg). **Circle No. 536**
- Info-Lite Corp., 46-10 104 St., Corona, NY 11368. (212) 476-1287. (Joseph M. Cartelli). **Circle No. 537**

- Information Displays, 333 N. Bedford Rd., Mount Kisco, NY 10549. (914) 241-1000. (C. Machover). **Circle No. 538**
- Integrated Microsystems, 1215 Terra Bella Ave., Mountain View, CA 94040. (415) 965-3900. (P. R. Kemp Jr). **Circle No. 539**
- Interface Technology Inc., 10500 Kahlmeyer, St. Louis, MO 63132. (314) 426-6880. (A. H. Koester). **Circle No. 540**
- Inter-Market Inc., 1920 Waukegan Rd., Glenview, IL 60025. (312) 729-5330. (R. Scott). **Circle No. 541**
- ISE Elecs Corp., P. O. Box 46, Ise City, Japan 516-1 (039) 635-2121. (K. Aoyagi). **Circle No. 542**
- Kalart Victor Corp., Hultenius St., Plainville, CT 06062. (203) 747-1663. (M. Goldberg). **Circle No. 543**
- Keltron Corp., 223-225 Crescent St., Waltham, MA 02154. (617) 894-0525. (T. Chadurjian). **Circle No. 544**
- Leeds & Northrup Co., Summeytown Pike, North Wales, PA 19454. (215) 643-2000. (W. S. Mahle). **Circle No. 545**
- Litronix Inc., 19001 Homestead Rd., Cupertino, CA 95014. (408) 257-7910. (I. Cooper). **Circle No. 546**
- LVC Industries Inc., 135-25 37 Ave., Flushing, NY 11354. (212) 939-9777. (N. Marino). **Circle No. 547**
- Master Specialties, 1640 Monrovia Ave., Costa Mesa, CA 92627. (714) 642-2427. (B. Maguire). **Circle No. 548**
- Monsanto, Electronic Special Products, 3400 Hillview Ave., Palo Alto, CA 94304. (415) 493-3300. (R. Clark). **Circle No. 549**
- Motorola Inc., Quartz Timepiece, 3102 N. 56 St., Phoenix, AZ 85018. (602) 244-4406. (C. T. Johnson). **Circle No. 550**
- National Elecs Inc., P. O. Box 269, Geneva, IL 60134. (312) 232-4300. (W. D. Ball). **Circle No. 551**
- National Semiconductor Corp., 2900 Semiconductor Dr., Santa Clara, CA 95051. (408) 732-5000. (F. Kvamme). **Inquire Direct**
- Nationwide Electronic Systems Inc., 1536 Brandy Pkwy., Streamwood, IL 60103. (312) 289-8820. (R. Lounsbury). **Circle No. 552**
- Novelite Corp., 226 N. 6 St., Brooklyn, NY 11211. (212) 388-4833. (R. Sanchez). **Circle No. 553**
- Okidata Corp., 111 Gaither Dr., Moorestown, NJ 08057. (609) 235-2600. (J. R. Powell). **Circle No. 554**
- OKI Electronics Of America Inc., 4031 N. E. 12 Ter., Fort Lauderdale, FL 33307. (305) 563-6234. (T. J. Tsevdos). **Circle No. 555**
- Opcoa Inc., 330 Talmadge Rd., Edison, NJ 08817. (201) 287-0355. **Circle No. 581**
- Oppenheimer Precision Products, 2475 Wyandotte Rd., Willow Grove, PA 19090. (215) 659-6000. (T. Kirk). **Circle No. 556**
- Owens-Illinois Inc., P.O. Box 1035, Toledo, OH 43666. (419) 242-6543. (J. Schepman). **Circle No. 557**
- Panel Tech Inc., P.O. Box 587, Lewistown, PA 17044. (717) 242-1411. (W. T. O'Donnell). **Circle No. 558**
- Pinlites Div., Refac, P.O. Box 453, Caldwell, NJ 07006. (201) 575-8820. (Dan Rovine). **Circle No. 559**
- RCA Electronic Components, 415 S. Fifth St., Harrison, NJ 07029. (201) 485-3900. (R. B. Means). **Circle No. 560**
- RCA Solid State Div., Box 3200, Somerville, NJ 08876. (201) 722-3200. (D. P. DelFrate). **Circle No. 561**
- Readouts Inc., P.O. Box 149, Del Mar, CA 92014. (714) 755-2641. (C. Fortin). **Circle No. 562**
- Sakata International Inc., 651 Bonnie Ln., Elk Grove Village, IL 60007. (312) 593-3211. (G. Lundt). **Circle No. 563**
- Shelly Assoc., 1562 Reynolds, Santa Ana, CA 92705. (714) 540-9330. (A. F. Werner). **Circle No. 564**
- Shigoto Industries Ltd., 350 5 Ave., New York, NY 10001. (212) 695-0200. (M. Rubin). **Circle No. 565**
- Shindengen Electric Mfg. Co Ltd., New-Ohtemachi Bldg., 2-1 2-Chome Ohtemachi Chiyoda-Ku, Tokyo, Japan 03 27 94431. (H. Akihama). **Circle No. 566**
- Siemens Corp., 186 Wood Ave., South Iselin, NJ 08830. (201) 494-1000. (B. Mayer). **Circle No. 567**
- Signalite, Div. General Instruments, 1933 Heckt Ave., Neptune, NJ 07753. (201) 775-2490. (R. C. Kolts) **Circle No. 568**
- Technology Inc., 1115 Talbott Tower, Dayton, OH 45402. (513) 224-9066. (J. Pugh). **Circle No. 569**
- TEC Inc., 9802 N. Oracle Rd., Tucson, AZ 85704. (602) 297-1111. (B. M. Hamilton). **Circle No. 570**
- Telectro System Corp., 96-18 43 Ave., Corona, NY 11368. (212) 651-8900. (J. R. Sussman). **Circle No. 571**
- Teledyne Brown Engrg., Cummings Research Pk., Huntsville, AL 35807. (205) 532-1208. (L. W. Owen). **Circle No. 572**
- Texas Instruments Inc., P.O. Box 5012, Mail Station 84, Dallas, TX 75222. (214) 238-2011. (C. Clough). **Circle No. 573**
- Transparent Conductors Inc., P.O. Box 549, Goleta, CA 93017. (805) 968-3561. (B. Feldman). **Circle No. 574**
- Vari-Light Corp., 9770 Conklin Rd., Cincinnati, OH 45242. (513) 791-6330. (J. L. Schenz). **Circle No. 575**
- Vemaline Products Co., 455 W. Main St., Wyckoff, NJ 07481. (201) 891-3200. (C. J. Dawkins). **Circle No. 576**
- Wagner Electronic Corp., Tung Sol, 630 W. Mount Pleasant Ave., Livingston, NJ 07039. (201) 992-1100. (J. L. Emaus). **Circle No. 577**
- Xciton Corp., 5 Hemlock St., Latham, NY 12110. (518) 783-7726. (A. Ligorner). **Circle No. 578**
- Xtel Inc., 2421 W. Hillcrest Dr., Newbury Park, CA 91320. (805) 498-6601. (M. K. Kilcoyne). **Circle No. 579**

The image shows a lead frame, a component used in microelectronics. It consists of a central square area with a gold spot, from which numerous thin, parallel lines radiate outwards to form a grid-like structure. The lines are arranged in a pattern that resembles a stylized sunburst or a series of parallel paths. The central gold spot is a small, square area with a white background, containing the text "Our gold spot could be your gold mine." The rest of the frame is a dark, metallic color with a grid of rectangular openings.

Our gold spot could be your gold mine.

At today's prices, gold is just too expensive to use where it's not needed.

That's why Sylvania developed the technique of putting a circle of gold on lead frames (where it's needed) without coating the whole frame (where it's not needed).

Check gold prices in today's

paper. You'll see what real savings can be. And you'll see why our method offers the highest quality at a lower price.

You'll also see why people like us when we put them on the spot. GTE Sylvania, Parts Division, Warren, Pa. 16365.

GTE SYLVANIA

DC Volts and Current

COMPLETE TEST PANEL INSTRUMENTATION



SERIES 200AS

For resolution of 0.05%, counts to ± 1999 in four voltage and six current ranges. Up to 60 readings/second. Low-cost. Sperry display. From \$159.



SERIES 200BS

Single polarity low cost OEM meter with BCD outputs. 1.999 volts full scale; 0.05% resolution. Up to 60 readings/second. Sperry display. From \$139.



SERIES 253

Small, 5 VDC powered ± 1999 counts with $10\mu\text{V}$ basic sensitivity. 12 voltage and current ranges selected by plug-in range change module. LED display. From \$120.



SERIES 257

Small size. Line powered. ± 1999 counts with $10\mu\text{V}$ basic sensitivity. 12 voltage and current ranges selected by plug-in range module. Sperry display. From \$145.



SERIES 400AS

Low-cost unit counts to ± 3999 in four voltage and five current ranges. Gated and buffered BCD outputs provide easy multiplexing. High common-mode rejection. Sperry display. ± 4999 counts optional. From \$189.



SERIES 2000AS

Top performer counts to ± 39999 for high resolution. Externally controlled storage for BCD data, overload, and polarity bits. 3-pole active input filter. Easily interfaces into data systems. Sperry display. From \$385.



SERIES 2000BS

Versatile low-cost $4\frac{1}{2}$ digit DPM covers four voltage and four current ranges. Resolution to 0.005%. Priced for OEMs. Compact size. Sperry display. ± 39999 counts optional. From \$280.



MODEL 2400AS

High-performance microvoltmeter has $\pm 39,999$ mv range, $1\mu\text{V}/\text{digit}$ sensitivity. Stabilized input and multipole active filter. Optional DC excitation supply drives strain gage transducers. Sperry display. From \$585.

Temperature Measurements

Time and Event Measurement



SERIES 260

Measure and display temperature in standard NBS thermocouple ranges. Four digits (to ± 3999 counts) give 1° resolution. Excellent conformity. Reading rates to 60/second. 0.1° resolution for RTD models. From \$500.



SERIES 2600

Best available conformity and accuracy. Five digits (to ± 38000 counts) for 0.1° resolution. Accuracy limited only by thermocouple itself. Fast response. Easy-to-integrate data system interface. From \$750.



MODEL 6110

Industrial tachometer-counter, for accurate indications of RPM and other industrial frequency and rotational measurements. Optically-coupled, isolated input. To 999,999 counts. Sperry display. Liberal O.E.M. discounts all models. From \$250.



MODEL 6210

Industrial accumulator with exceptional radiated and conducted noise immunity. Optically-coupled, isolated input with 50 mV sensitivity. Sperry display, to 999,999 counts. Buffered, isolated and gated BCD data outputs. From \$210.

Compatible Accessories



MODEL 810

The 810 is a basic 9 column printer expandable to 18 columns. It records in two colors at rates to 3.7 lines per second. New formats can be quickly made by rearranging the internal format patchboard. From \$495.



SERIES 270

Used with any digital panel instrument with BCD output, digital comparators provide instant alarm or control outputs whenever an input digital number exceeds a preset limit. From \$135.



MODEL 6151

Remote Storage and Display receives parallel digital data, octal or BCD. Up to six digits are stored and displayed while source instrument is encoding a new reading. From \$175.



MODEL 6700S

Digital clock displays days, hours, minutes or hours, minutes, and seconds, and provides gated and buffered BCD time-of-day output. Optional internal oscillator gives accuracy of up to $3 \times 10^{-7}/\text{mo}$. Sperry display. From \$275.

Newport Digital Panel Instruments

NEWPORT LABORATORIES, INC. 630 EAST YOUNG STREET ■ SANTA ANA, CALIFORNIA 92705 ■ 714/540-4914



We feel a little flag-waving is called for

After all, it's not every day a Spanish company opens a manufacturing plant in the USA. Especially in the highly competitive world of electronics.

But that's just what we've done. Bearded the electronic giants in their own dens.

Our new American den is in Boston. Right now we're manufacturing carbon film resistors – with other component lines to follow – on our own specially designed machines, drawing on the identical advanced technology and production techniques that have taken us to the top in Europe.

And we know this little bit of flag-waving will catch the eye of our European customers. They'll appreciate how the extra production from our US plant will ease their own deliveries in Europe. We will no longer have to divert so much of our European capacity across the

Atlantic. So everybody benefits.

To our American friends we say, "Happy to be in the USA". We know *all* our customers are going to be happy we are.

Find out more about Piher. A leader in component technology.

PIHER International Corp., (Sales Office)
1239 Rand Road, Des Plaines, Illinois 60016.
Tel: 312-297 1560 Telex: 282514

PIHER Corp., (Manufacturing Plant)
399 Washington Street, Woburn, Mass. 01801
Tel: 617-935 8750 Telex: 94-9382



When we say Brand-Rex Vylink™ wires



Vylink is the Brand-Rex trade name for its tough irradiated PVC insulated wire and cable. A thermosetting material, it has superior heat resistance, is unaffected when accidentally touched by a solder iron and has outstanding cut-through, abrasion and chemical resistance – all in addition to vinyl's inherent non-flammability (it meets UL's FR-1 requirements), high dielectric strength and insulation resistance.

Five important processing and operating characteristics of Vylink and conventional PVC insulated wires are compared in the following panels. Test procedures and Vylink's properties are detailed in Brand-Rex specification BR-790. Write for your copy to Brand-Rex Company, Willimantic, Conn. 06226. Tel. (203) 423-7771.

Heat Resistance

After 96 hours at 350°F, Vylink is unaffected, conventional PVC flows. Vylink wire provides far greater protection against current overloads and high temperature environments. It is recommended for shrink-tubing and wave solder cable terminations where wires are exposed to heat guns or solder baths – an excellent low-cost substitute for the premium-priced "high temperature" wires usually used in this application.

Solder Resistance

When a weighted solder iron (1½ lbs. force) is applied to the wire surface, conventional PVC insulation melts almost instantly; Vylink, though it may exhibit slight surface discoloration, shows no substantial change – even after several minutes. Regardless of method – hand gun, solder dip, wave soldering – Vylink insulation will neither shrink back nor melt. Shorts due to soldering are avoided. Circuit integrity is assured.

and cables are tough, we prove it.

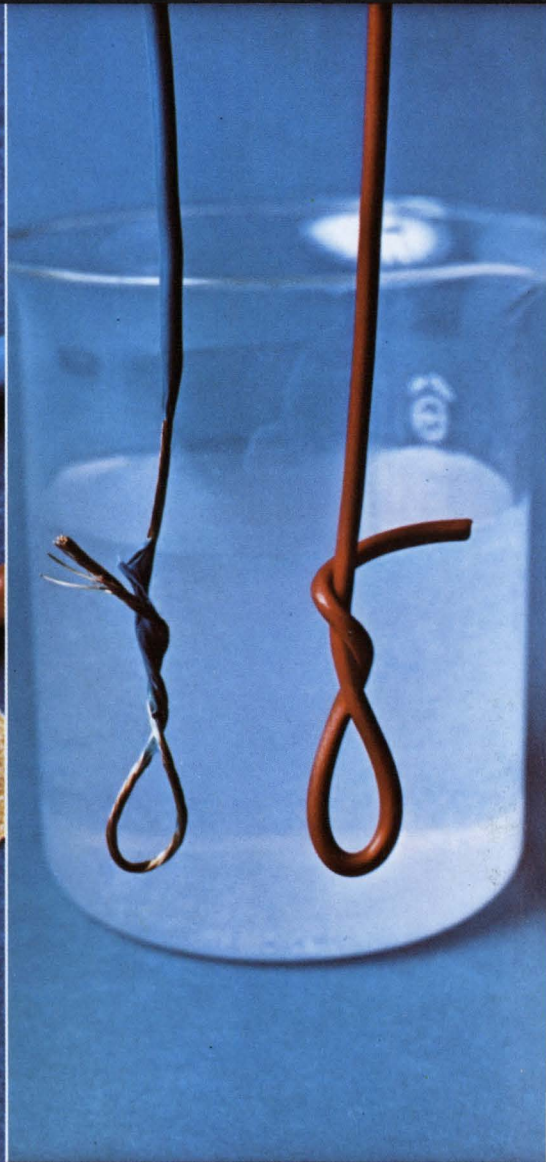
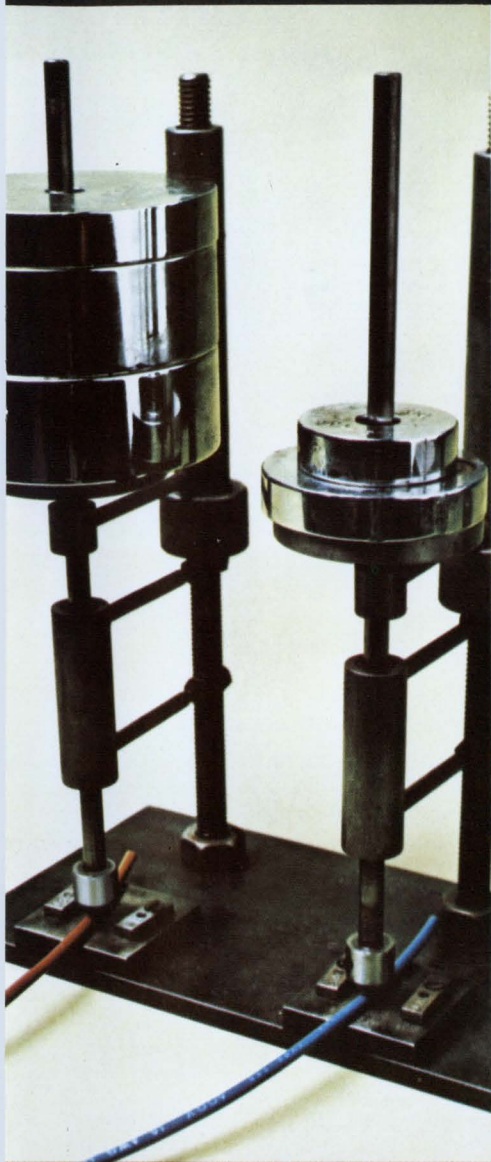

Cut-through Resistance

The relative resistance of *Vylink* and conventional PVC insulated wires to penetration may be demonstrated by applying a 90° V cutting edge attached to a weighted plunger perpendicularly to samples of each. To have the specimens cut through in the same length of time, *Vylink* wire must be subjected to at least 5 times the weight. This extra toughness makes thinner insulation walls possible without compromising physical properties. The result – lighter weight, smaller diameter, but equally reliable, cable.

Abrasion Resistance

In this test, a predetermined weight presses a conventional PVC wire sample against a moving 400 grit, aluminum oxide abrasive tape until the insulation has been worn away and conductor exposed. By comparison, more than half the insulation remains when the same amount of tape abrades *Vylink* insulated wire under identical conditions. This toughness permits the use of thinner insulation which UL recognizes by rating 6½ mil wall *Vylink* wire at 125 volts (UL Style 1472).

Chemical Resistance

Electronic bombardment of the specially formulated *Vylink* compound causes a change in the molecular structure and transforms this PVC material from a thermoplastic to a thermosetting plastic. *Vylink*, like all thermosets is generally inert to chemicals and solvents. When *Vylink* and conventional PVC are boiled for two hours in MEK (methyl ethyl ketone), a good solvent for vinyls, *Vylink* is virtually unaffected; conventional PVC is completely dissolved.

Tests were conducted on 16 (26/30) AWG with 1/32" insulation.

INFORMATION RETRIEVAL NUMBER 215

BRAND-REX
4,000 solutions in search of a problem.

BRAND-REX CO., A PART OF AKZONA INCORPORATED

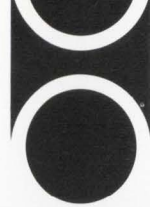

u.s.precision lens

THE OPTIC COMPANY THAT SPECIALIZES IN PLASTICS

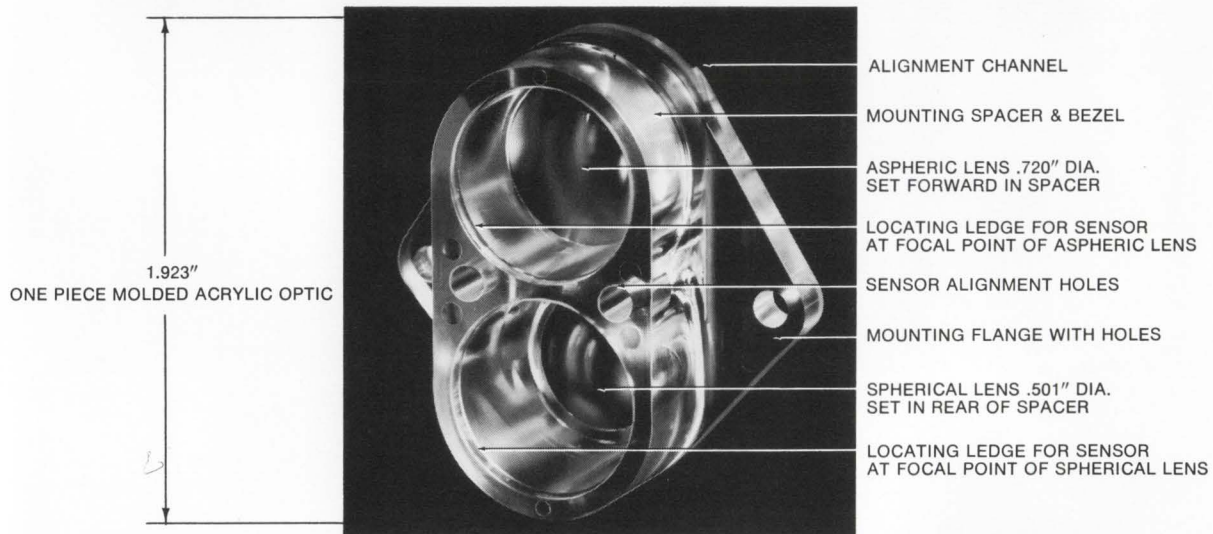

molded plastic optics for economy and design flexibility

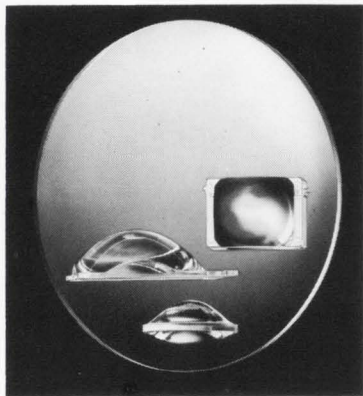

ASPHERICS & SCHMIDT CORRECTOR

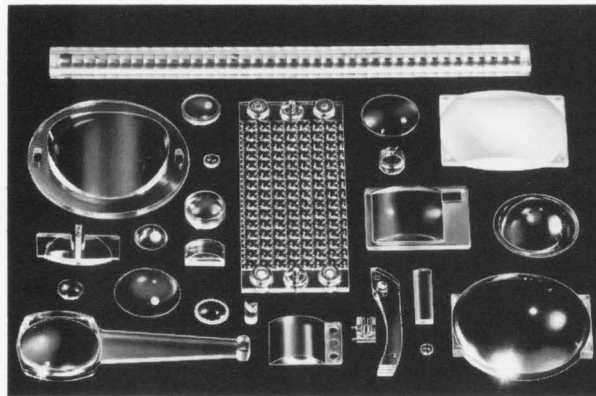

SIMPLE & SPECIAL CONFIGURATION LENSES & LENS ARRAYS

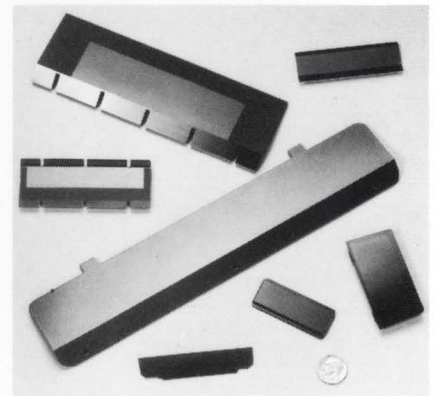

INSTRUMENT WINDOWS WITH HL ANTIGLARE SURFACE

u.s.precision lens

3997 McMANN ROAD · CINCINNATI, OHIO 45245 · (513) 752-7000
INFORMATION RETRIEVAL NUMBER 216

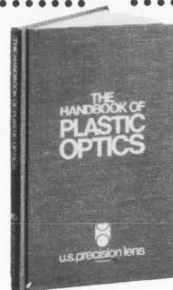

HANDBOOK OF PLASTIC OPTICS (HARD BOUND)

COVERS ADVANTAGES, LIMITATIONS, CONFIGURATION OPPORTUNITIES, DESIGN AND TOOLING.

\$5.00 U.S.A. & CANADA . . . \$10.00 ELSEWHERE

ENCLOSED IS \$..... FOR..... COPIES.

NAME TITLE.....

COMPANY

ADDRESS

CITY..... STATE..... ZIP.....

U.S. PRECISION LENS, INC. • 3997 McMANN RD. • CINCINNATI, OHIO 45245

The case for Liquid Crystal Displays

Dynamic Scattering or Field Effect

Liquid Crystal Displays; light emitting diodes; incandescent and fluorescent displays and "Nixie" tubes are becoming solidly established in circuit design as the trend to digital readout continues. The design engineer faces an unusually formidable task in determining the type of display most suitable and practical for his product. We make liquid crystal displays — dynamic scattering and field effect.

The display of the future? Our displays are as sandwiches of two glass plates, spaced typically about .0005" apart with a nematic liquid crystal solution between them and hermetically sealed at the perimeters.

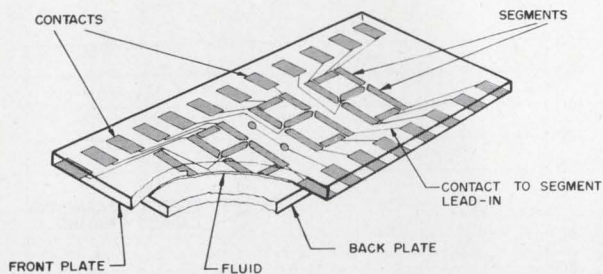

How they work. When the liquid is not electrically excited, its long cigar-shaped molecules are parallel to one another in a position perpendicular to the plates. The liquid appears transparent. When an electric current is applied, ion activity of the molecules leads to turbulence causing the liquid to scatter incident light. Depending on the type of nematic liquid used, either a dynamic scattering or field effect display results.

Dynamic scattering. We use a nematic liquid crystal solution in our dynamic scattering displays. This nematic liquid crystal is conductive, has negative dielectric anisotropy, and is oriented in either a homeotropic or homogeneous alignment. In either case the liquid is clear in the absence of an electric field. When an electric field is induced, the molecules scatter, giving the visual effect of a frosted piece of glass.

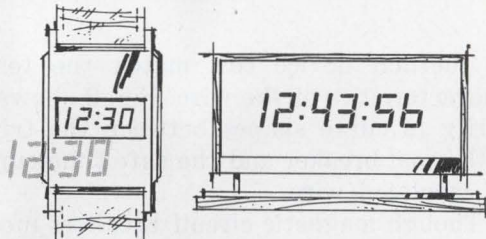

Field effect. These displays also utilize a nematic liquid crystal but with a different molecular orientation. The molecules are arranged in a helical stack, like a spiral staircase. The liquid is also sandwiched between two polarizers which are at right angles with each other. When current is applied the molecules rotate 90° so that they become perpendicular to the front polarizer. Light that passes through them is not rotated and therefore is absorbed by the rear polarizer. The result is a dark image on a light background. The image also can be reversed — light on dark.

Producing an image — digital or other — simply requires a conductive surface the shape of the desired image on the front glass plate. Current flowing from the conductive image through the liquid crystal to the common ground back plate causes the liquid to change from clear to a frosted appearance in the current-carrying areas.

The images almost always are in the form of seven segments formed on the front glass with transparent oxide and each with its own electrical lead. Energizing the proper segments produces the desired numerals. Lead-ins connect the segments to external contacts on the sandwich (display).

Consider the advantages. Liquid crystal displays have a number of distinct advantages. Simplicity is the reason for several of these. The elements are few and passive — very little can go wrong with an LCD and this means reliability and long life. Simplicity means low cost too — lower than that of most similar displays. Packaging costs are low because LCD's can be driven directly by MOS and C/MOS circuits. Very narrow character widths are possible and still provide a good viewing angle — 60 degrees in many cases.

Low power consumption makes LCD's a logical choice where power limitations rule other displays out. They do not generate light as do other displays so use no power for that purpose. Watch type field effect LCD's use only 3.μW. for example with all segments energized at 7 Volts.

LCD's offer the greatest flexibility of any display type. Several standard displays, dynamic scattering or field effect, are immediately available from Hamlin's stock. Special displays with virtually any type of image can be produced with surprisingly low preparation or "tooling" cost. Because of the LCD's simplicity, lead time on specials is only a matter of weeks.

DYNAMIC SCATTERING

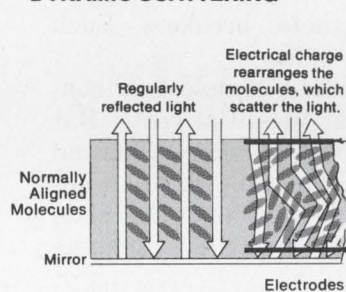

FIELD EFFECT

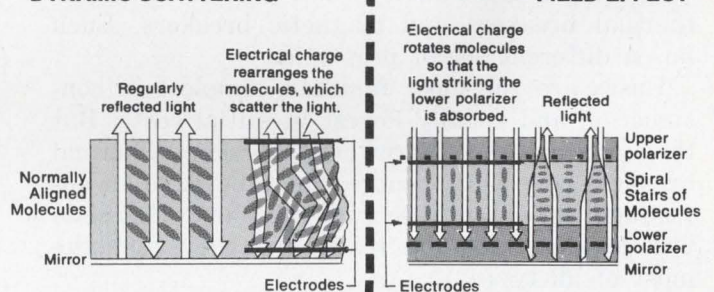

A few limitations. LCD's have limitations too. Operating temperature range is one. Liquid crystals slow down and may even cease to function at temperatures below 0°C. Above 50-60°C, crystals go into solution and will not function properly. But extremes do not damage LCD's. Once the temperature returns to normal, operation is automatically resumed.

LCD's are somewhat difficult to read under low ambient light conditions. (Side or back lighting can remedy this.) Visibility under medium to high ambient light conditions is excellent.

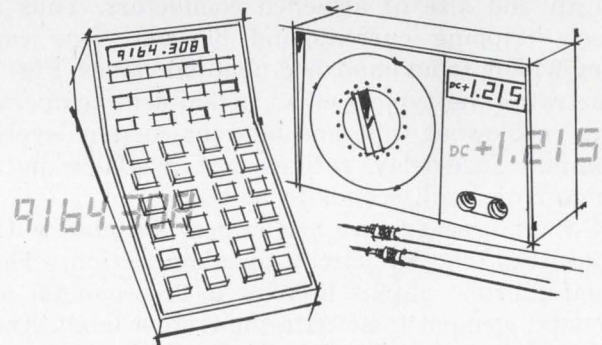

Conclusion. In the majority of display applications, MOS and C/MOS compatibility, reliability, flexibility and low power requirements are important considerations. No other display can match the liquid crystal display on these jobs. They could be the display of the future.

And that's the case for the LCD. For specifications, and application data, write Hamlin, Inc., Lake Mills, WI 53551 • 414/648-2361. Or dial toll-free 800-645-9200 for name of nearest representative. (Evaluation samples are available at moderate cost.)

HAMLIN

INCORPORATED

INFORMATION RETRIEVAL NUMBER 36

Fuses or circuit breakers?

They have distinctly different characteristics. What's advantageous in one application can lead to damage in another.

The design calls for a circuit protective device and someone says offhand: "Let's use a 10-A fuse." Slow down. Such flippancy can result in a wide range of problems—from merely annoying blackouts to disastrous damage. The choice of device depends on the application, and it should not be made lightly.

There are three basic circuit protectors: fuses, thermal breakers and magnetic breakers. Each has a different set of properties.

Fuses are the most familiar, simplest in construction and usually lowest in initial costs. But they are one-shot, throwaway devices. Thermal breakers cost a little more, but they have an advantage over the fuse: resettability. Magnetic breakers can also be reset, but they cost the most of all types.

Magnetic vs thermal protectors

A fuse is blown by the I^2R heat generated in its resistance, with the precise current at which this occurs depending on the ambient temperature, the fuse-clip size and mounting, and the length and size of attached conductors. Thus a fuse's tripping current and blowout time can vary widely from published nominal values. Fig. 1 illustrates the typical effect of ambient temperature on blowout time and blowout current levels. Nominal fuse-delay ratings are available in a range from milliseconds to hours.

Circuit breakers are mechanical switches with mousetrap-trigger, circuit-opening action. The usual thermal circuit breaker uses a bimetal or trimetal element to actuate the trigger latch. And like fuses, most thermal breakers are affected by ambient temperature. However, thermal breakers can be ambient-temperature compensated by the addition of a complementary bimetal element; fuses generally can't be.

Thermal devices, both breakers and fuses, are better suited for the protection of long runs of wire and wire insulation than magnetic breakers.

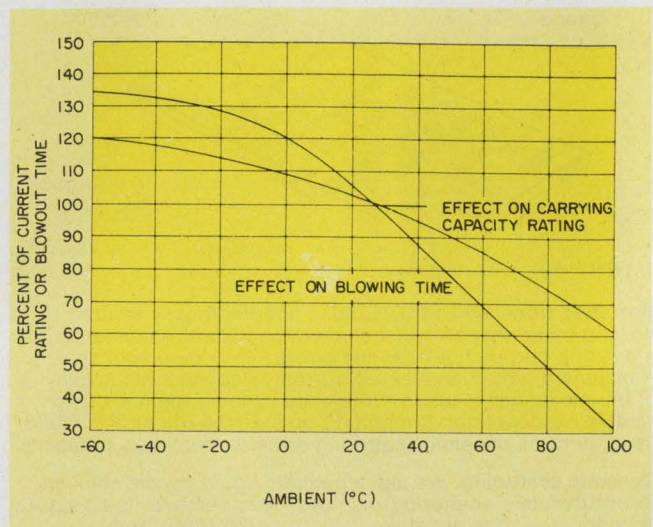

1. The ambient temperature strongly affects both the blowout point and delay time of fuses.

A thermal device can match the temperature characteristics of the wire. Fig. 2 shows the similarity in curve shapes between the trip time of a thermal breaker and the safe time-current limit of insulated wire.

Though magnetic circuit breakers mechanically trip a circuit open in roughly the same way that thermal breakers do, they operate on ampere-turns of the current rather than heating. This difference allows the use of magnetic breakers in applications that require full operating current without danger of accidental tripping when the ambient temperature rises. Magnetic breakers easily handle a temperature range of -40 to 85 C.

The current-sensing element of the magnetic breaker is an electromagnetic solenoid. Time delay is achieved usually by use of an iron core that moves in a hydraulic dash-pot arrangement (Fig. 3). The speed of core movement, and thus the time to trip, depends upon the amount of overcurrent and the viscosity of the dash-pot oil, usually a silicone. Current ratings and trip curves can be easily adapted by the manufacturer for close correlation with the needs of mixed loads. These ratings can be matched to wiring, PC board, motors, transformers, lights and other

Lyal N. Merriken, Senior Design Engineer, Airpax Electronics, Woods Rd., Cambridge, MD 21613.

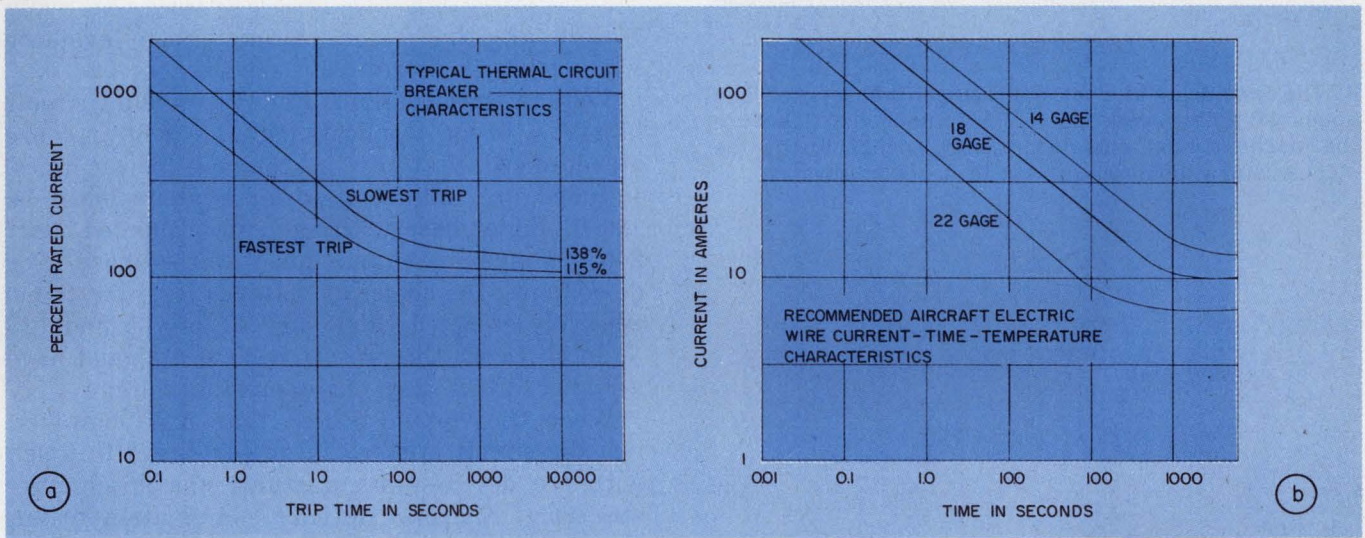

2. Thermal breaker trip-delay characteristics (a), match the safe-operating time of insulated electrical wire (b)

and are thus suitable for the protection of wiring networks as in aircraft power systems.

components. Magnetic breakers can have secondary applications, too—as in sequencing and remote control.

Breakers with extra advantages

An important advantage of the magnetic breaker over other protective devices is its ability to perform functions in addition to protection. This versatility stems from its electrically isolated electromagnetic actuating coil, as in a relay. Thus a magnetic breaker can be supplied with extra independent contacts. And several coils can be combined to make a multipole magnetic breaker, in which a fault current in any one coil will automatically trip all circuits.

In this way a magnetic breaker can provide, in addition to overcurrent protection, the remote indication of a circuit's condition and allow remote, manual or automatic circuit interruption. With two-pole interrupting contacts, both sides of the line are controlled and the unit can be used as an on-off power switch. Though such an assembly costs more than a simple protective device, much can be saved on relays, solenoids and switches that would be needed to accomplish the

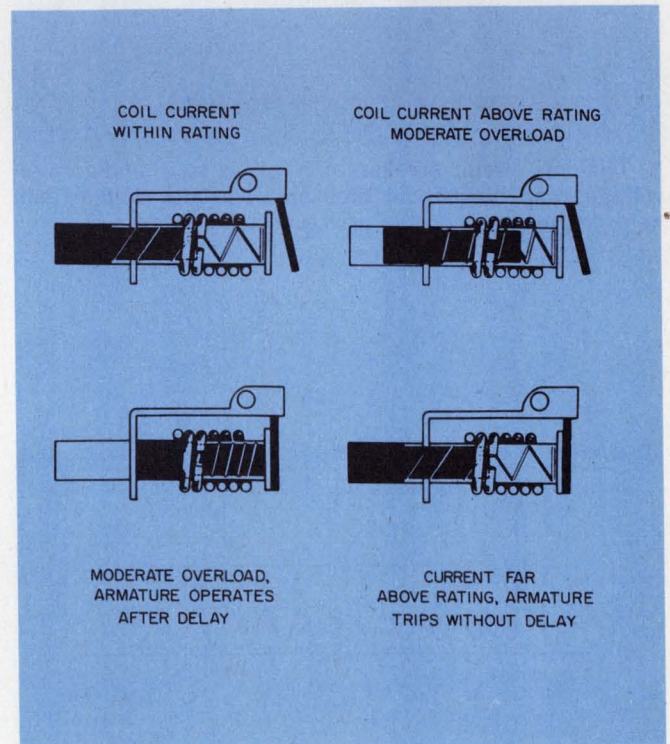

3. In electromechanical breakers, controlled time delay is obtained by means of a moving iron core in a hydraulic fluid.

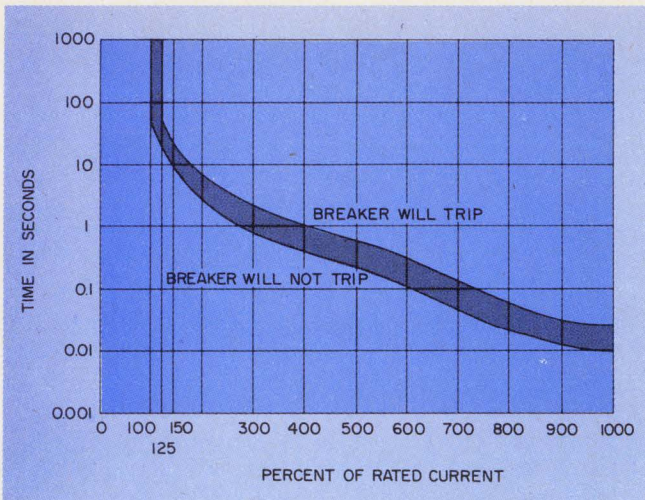

4. The time-delay in electromechanical breakers, beyond about 10-times overload, is "instantaneous," because the magnetic flux generated is large enough to trip the mechanism without waiting for the core to advance.

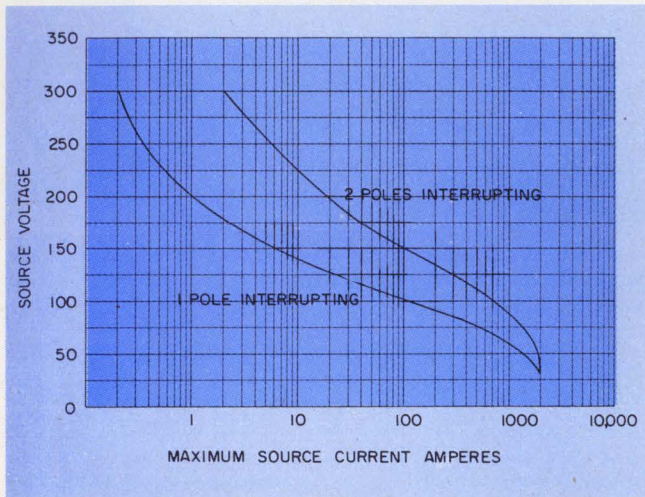

5. Two-pole circuit breakers can, of course, handle more voltage than single-pole breakers, and the double gap helps rapidly quench the arc, especially on dc.

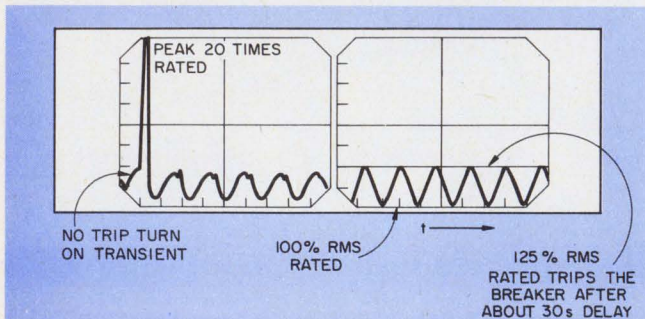

6. Circuit breakers with high pulse tolerances are needed for inductive loads like transformers and motors.

same functions.

While the initial cost of the fuse is low, the cost of its replacement when it is blown—and of equipment downtime while a fuse replacement is being sought—can easily offset this advantage. In addition there can be damage to equipment if the replacement fuse is rated at a higher current than the original; a common mistake.

If over-all cost is considered, magnetic breakers can be cheap—especially when you take into account their extra capabilities.

Selection parameters

Here are the major parameters to evaluate when you pick a protective device:

Voltage specification. For fuses and circuit breakers in ac applications, the voltages are standardized to those in common power lines. Included are units for power systems such as 120-V single-phase with one side grounded, 120/240-V single-phase and 208-V three-phase. For dc voltages, the choice of voltages is wider. Some generally accepted values are 32, 50, 65 and 125 V. In all cases, the protective device should have a higher rating than the operating voltage.

When the voltage is less than 5 V, however, and the circuit is rated in amperes, get in touch with the device's manufacturer for specific restrictions; this is a difficult combination to implement properly. And milliamperes-rated devices should be checked for minimum allowable operating voltage, because the protective unit may introduce a substantial voltage drop.

Of course, dc is more difficult to switch than ac, because dc doesn't go through zero and extinguish its arc, as ac does. With dc voltages, use a two-pole breaker to break both sides of the line. This provides a longer, more easily extinguished arc gap (Fig. 5).

Tripping current rating. The current ratings of fuses or breakers should be selected approximately 20% higher than the full-load current of the protected device. This allows leeway for manufacturing tolerances and voltage fluctuations of the power mains.

Maximum short-circuit current-carrying rating. It's important that the circuit protector be capable of safely interrupting the maximum-available fault current. "Available" fault current is a theoretical value that generally neglects current-limiting factors, such as source and transformer impedances, terminal resistances and the fault resistance. For example, if a 120-V line that normally supplies 30 A has a 0.02- Ω line resistance, the available fault current is taken as 600 A at the end of the line. Thus a short-circuit breaker rating of 1000 A would be adequate for use at the end of the line.

Power frequency. Fuses and thermal breakers

are not affected by the frequency of the current. But magnetic protectors are sensitive to frequency. The protector's design is usually different for dc, 60 or 400-Hz operation. In some applications, though, multifrequency operation is allowed with a single magnetic protector, provided the trip points and other parameters

specification tolerances are broadened. For such special multifrequency operation, consult the manufacturer.

Trip delay. This should be matched to the application. The delay should be long enough to allow nonharmful transients of current to pass without nuisance tripping, yet fast enough to open the circuit to protect the system. Trip delays come in four categories:

1. Instantaneous—trip in milliseconds, usually under 100 ms, with most at approximately 15 ms.
2. Fast delay—trip in less than 10 s.
3. Slow delay—trip in 10 to 100 s.
4. Very slow delay—trip in more than 100 s.

Instantaneous delay is used for very sensitive circuits, where low overloads of short duration could be harmful. It's also used as a limiter, when a specific high current should not pass.

Fast delay is used for circuits where temporary overloads of over 200% cannot be tolerated for more than a few seconds. Most dc and electronic applications are in this category.

Slow delay is natural for most large transformer-coupled loads, where an overload of several seconds' duration can be tolerated without damage. The slow delay also allows the turn-on transient to pass without false tripping.

Very long delays are used mostly to protect wiring. A limited overload will usually not cause damage. Some motor loads have normal starting-current surges that can last for a second or more and draw 600% of the nameplate running-current rating.

In all protective devices, the time delay becomes less as the overload increases. At very high fault currents, the mechanical inertia of the mechanism and the arc-quenching properties of the protective device are the only limits to the circuit-interrupting speed. The practical limit for magnetic breakers varies from about 4 to 10 ms. Fuse and thermal-breaker delays vs trip current approximate a logarithmic curve (Fig. 2a) and magnetic breakers combine a logarithmic curve with a step function (Fig. 4). In magnetic breakers, beyond 10-times overload, the logarithmic curve is replaced by the step, where the breaker operates in the so-called "instantaneous" mode.

Tolerance to pulses. This is the ability to withstand a short-duration pulse of high amplitude without tripping. For example, a protector with a pulse tolerance of 20 should be able to withstand half of a 60-Hz sine wave pulse with a peak amplitude that is 20 times the trip-current rating (Fig. 6).

Transformers or other highly inductive loads can generate such high turn-on transients. Peak

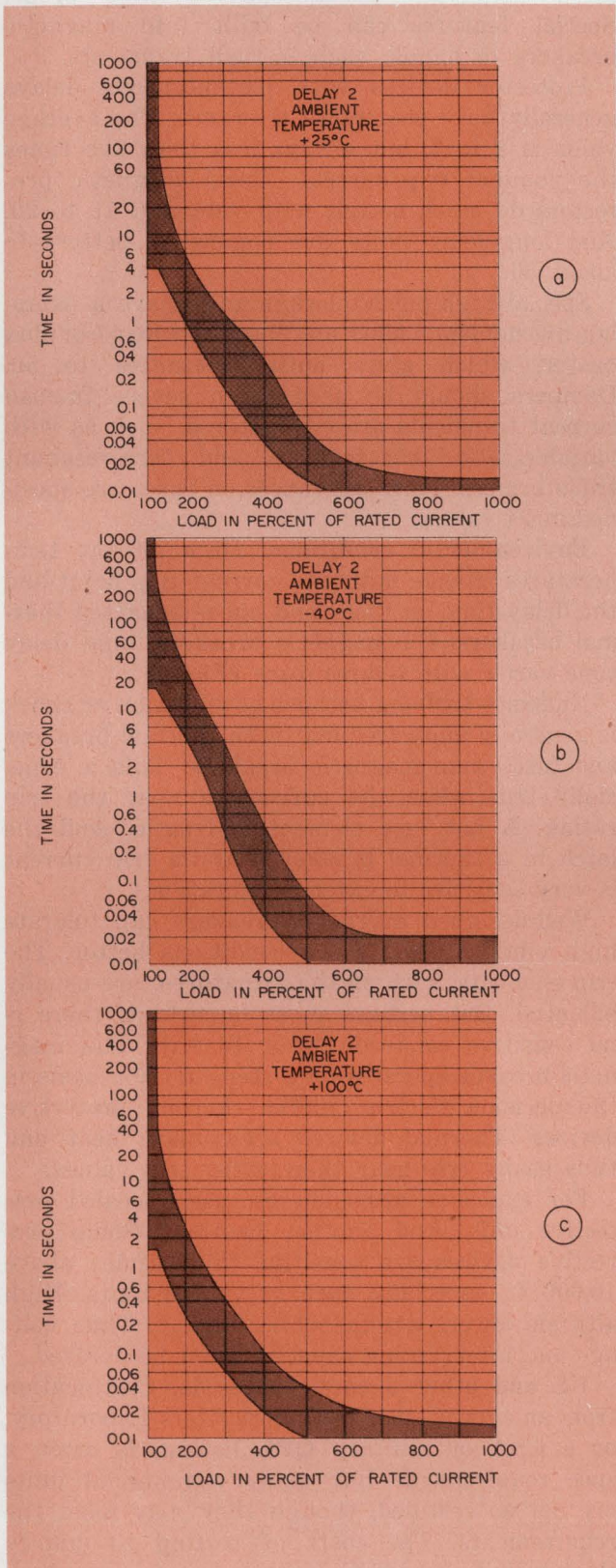

7. Magnetic breakers are relatively insensitive to changes in temperature. Only delay time varies substantially with temperature.

BERG Minisert™

... Low-Profile P.C. Socket provides repeated pluggability for IC's, DIP's, etc.

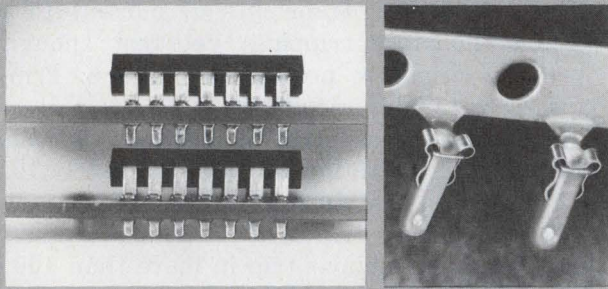

For use where space is restricted; extends just .030" above and .088" below board, allows .400" board-to-board spacing. One size MINISERT® socket fits wide range of hole sizes—.050" to .058" in diameter. RTV diaphragm seals foreign matter out of the socket. MINISERT socket accepts round or flat leads of DIP's, LED's and LSI's. Free-standing design can be used in any socket pattern. Semi-automatic machine inserts at rates up to 2000 per hour. Write for Bulletin 120, or call:



BERG
ELECTRONICS
Division, E. I. du Pont de Nemours & Co. (Inc.)

New Cumberland, Pa. 17070 Phone: (717) 938-6711

*Terminals sell for \$20 to \$30 per thousand in volume quantities.

INFORMATION RETRIEVAL NUMBER 37

QUICKIE* CONNECTOR...

FOR THE RAPID, RELIABLE TERMINATION OF FLAT FLEXIBLE CABLE.

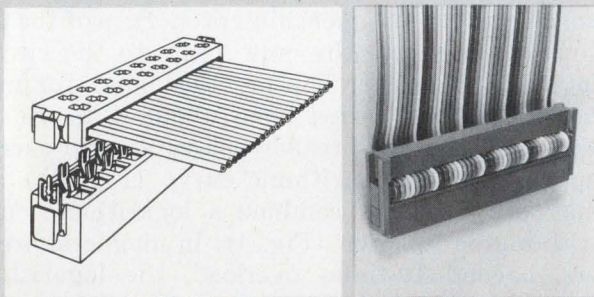

The Berg QUICKIE, a female connector, simultaneously terminates multi-lead flexible round cable *without* pre-stripping. The askewed tines of the contact effect a stripping action which terminates virtually any brand of cable, regardless of insulation material, in about 10 seconds. Design assures redundant electrical contact, and allows for visual inspection *before* assembly. QUICKIE can be used to interface cable on .050" centers to .025" square wire-wrapping posts on .100" sq. grid. Write for Catalog 125 or call:

*Berg Electronics Trademark



BERG
ELECTRONICS
Division, E. I. du Pont de Nemours & Co. (INCORPORATED)

New Cumberland, Pa. 17070 Phone: (717) 938-6711

INFORMATION RETRIEVAL NUMBER 38

values of 30 times rated current, which can last for one-half cycle, are not unusual. And this is a common source of nuisance tripping. Further, it is difficult to observe or measure these transients. Current probes for oscilloscopes often saturate and give an erroneous picture. One of the best ways to examine such transients is across a metering shunt in series with the line and monitored with the oscilloscope's voltage probe. Special features can be built into magnetic breakers to handle such in-rush transients.

Protector devices with instantaneous delays generally have poor pulse tolerance. The average value is 2 to 3, but always less than five times the nominal trip current. Delay magnetic protectors do much better, with values of 10 to 20. And long-delay units are somewhat better—to about 30.

Special high-pulse-tolerant units have a damping mechanism, called an "inertial wheel" or flux buster, which gives pulse tolerances to 50. Dampers should be used when severe in-rush current transients are encountered, such as with variable-ratio transformers and ferroresonant transformers. Pulse tolerances on fuses are specified in I^2t values.

Environmental conditions. High or low temperatures change both the current trip point and the delay time on fuses and uncompensated thermal breakers. On magnetic breakers, only delay time varies with temperature (Fig. 7).

Nuisance tripping because of vibration or shock is generally more frequent with thermal breakers and fuses than magnetic breakers. This is especially true when the current is near the trip rating. A hot fuse element is fragile. And the latch in a thermal breaker near its trip current is very sensitive to external vibration.

Well-designed magnetic breakers can tolerate high vibration and shock conditions better. The trip elements, such as the armatures, are usually balanced. But perhaps most important, there is no sensitive condition prior to trip. The magnetic breaker operates on a step-function basis in the decision to trip, unlike thermal protective devices. Thermal devices accumulate heat and thus easily trip near their rated trip values.

For explosive atmospheres, use a sealed protective unit. And another caution: Some protective devices are sensitive to altitudes above 10,000 ft, especially open or vented units. High altitude lowers arc-quenching ability. Thus voltage and interrupting capacity must be derated.

UL and other agency approvals. Certification from an agency such as Underwriters Laboratory, or a CSA or military QPL listing, is often a spec requirement. But many commercial units are not so certified, though they may meet the requirements. The costs of testing to qualify them may be prohibitive. ■■

Another FIRST from DDC...

The smallest glitchless DAC is also the fastest! . . . 13 bit resolution, settling time 50 ns per bit . . . in the first hybrid glitchless DAC. From DDC, of course. DDC, the leader in data conversion, has done it again! This time with the first hybrid deglitched digital-to-analog converter. So you could have the benefits of high speed plus compact size for critical CRT displays and precise testing applications.

The new Model DDAC hybrid features a 13 bit monotonic output, with programmable output of $\pm 2.5V$, $\pm 5V$, or $\pm 10V$ and 300mA coax drive capability. Other features include internal or external reference, 150 mV•ns glitch, and short circuit protected output. It's available as a complete two channel P.C. card assembly, a set of 3 hybrid modules or individual DAC, deglitcher, and coax driver.

And it's from DDC. The data conversion people who have made a habit of being first.

For product or technical applications information, write or call Steve Muth or Jim Sheahan. They're engineers, so they talk your language.

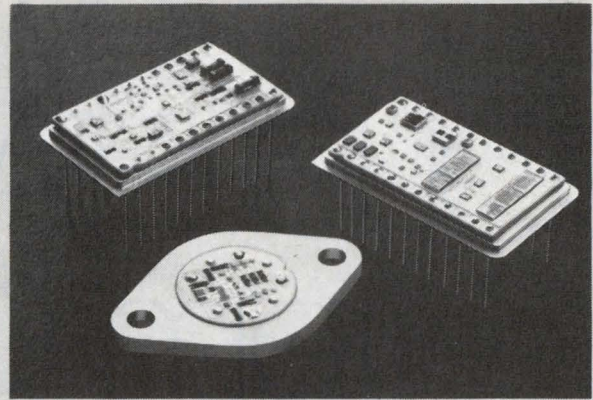

DDC

ILC DATA DEVICE CORPORATION

A Wholly Owned Subsidiary of ILC Industries, Inc.
AIRPORT INTERNATIONAL PLAZA
BOHEMIA, LONG ISLAND, N. Y. 11716 (516) 567-5600
Shaping the future of data conversion.

APPLICATION CENTERS

| | | |
|--------------------------------------|-------------------------------------|---------------------------|
| Long Beach, Calif. (213) 597-5744 | Washington, D. C. (703) 536-2212 | Europe (Tel. 62.01.59) |
|--------------------------------------|-------------------------------------|---------------------------|

Shaping the future of Display DACs

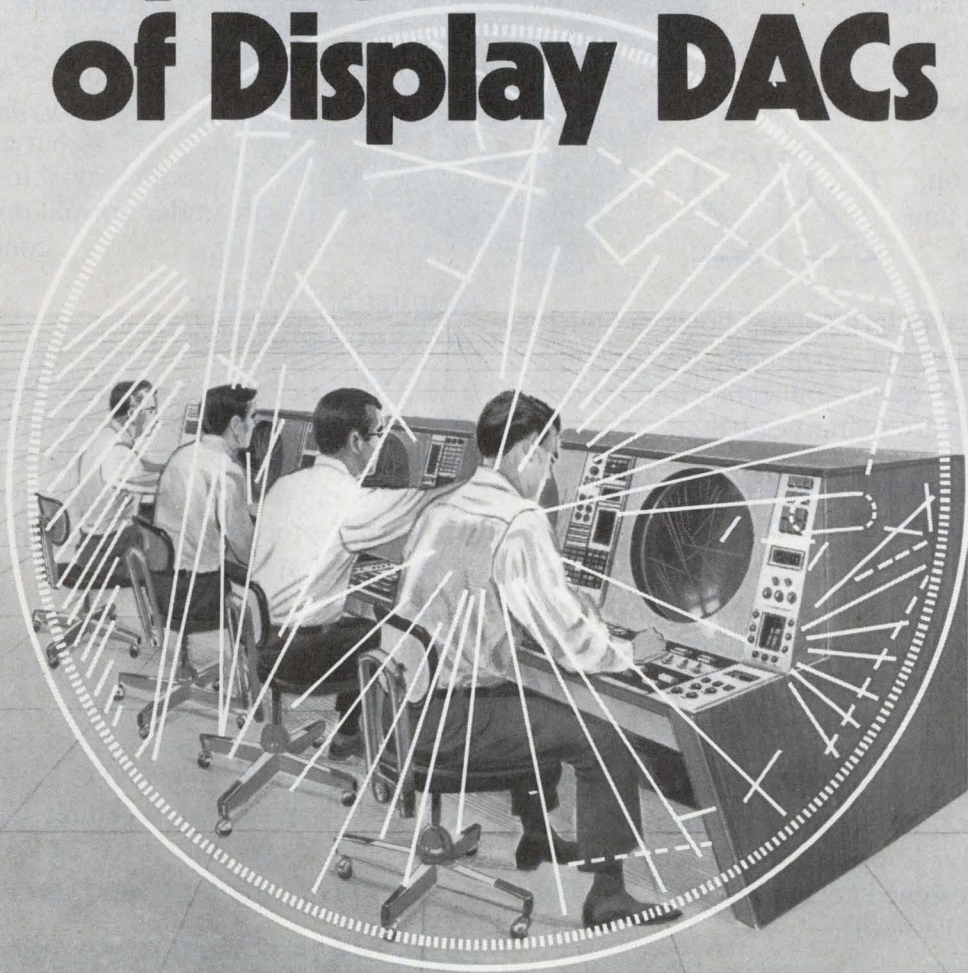

New AC SOLID STATE RELAY from CLARE

A solid state relay for fast, economical assembly

Clare's new 212 Series AC Solid State Relay gives you all needed relay functions at an affordable price. No printed circuit assembly or electromechanical device can match the 212 Series Relay for assembly speed and convenience on your production line. Two screws through the molded-in, standard-spaced holes mount it. The combination terminals accept lugs, bare wires or quick-connects without additional hardware being needed.

A highly sensitive yet extremely versatile solid state relay

Clare's new 212 Series Relay features zero-crossing synchronous switching, and has heavy duty switching capabilities, with a choice of 10 or 25 amp ratings at 140 or 250 Vac. The opto-isolator provides total input/output isolation, and the sensitive input is fully compatible with DTL/TTL inputs. The 212 Series relay also provides transient dv/dt protection for the output, and it is designed to handle both resistive and inductive loads.

212



Long life and safety are integral design features

This tough, dependable relay has a one-cycle surge current rating of 1,000%. Recessed terminals and molded-in dividers eliminate externally caused short circuits. Its arc-free switching makes it safe for use in explosive atmospheres. Operating temperature range is from -40°C . to $+80^{\circ}\text{C}$. With no moving parts, the 212 Series Relay has an almost indefinite life under normal operating conditions.

Applicable for use in many industries

The 212 Series AC Solid State Relay will reliably, conveniently and economically fill switching needs for lamps, motor starters and solenoids. It is ideal for computer peripheral, process control system and inductive load applications.

Available now!

For full technical data, contact your nearest Clare sales office or distributor. For more comprehensive application information, contact George Neeno, C.P. Clare & Company, 3101 W. Pratt Avenue, Chicago, Illinois 60645. Or Phone (312) 262-7700.

QUALITY, SERVICE, RELIABILITY

C. P. CLARE & COMPANY a subsidiary of
GENERAL INSTRUMENT CORPORATION



Don't stick your neck out. Get the clear picture from Hughes.

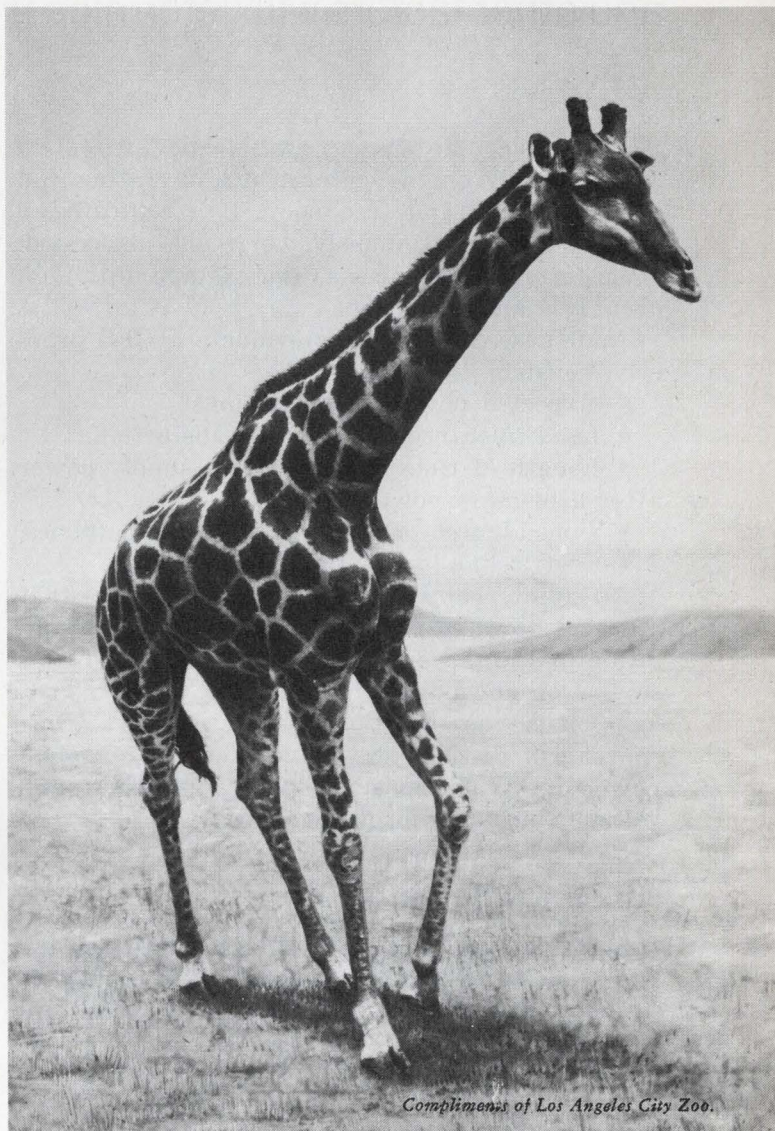
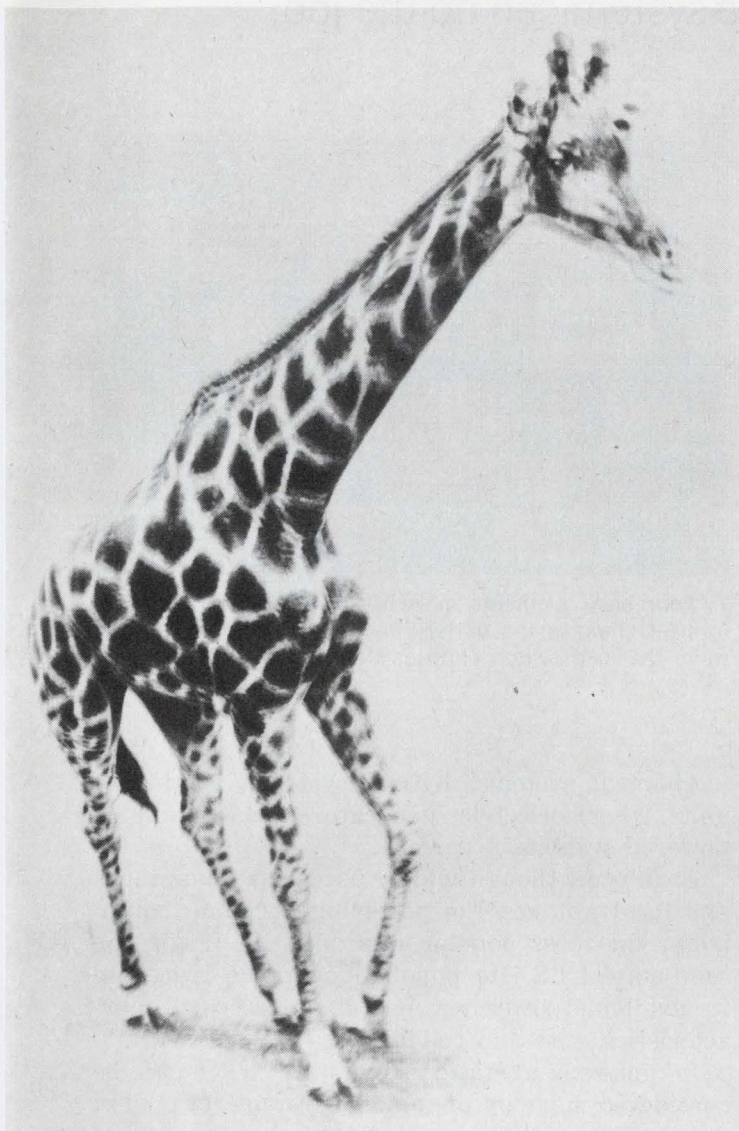

Compliments of Los Angeles City Zoo.

Hughes image storage equipment gives you more detail per dollar than any other image storage technology.

Pictures come out clear, clean and bright. In ten different shades of gray.

Hughes memories will store slow-scan pictures, graphics, and random vectors then replay the complete assemblies. Scan rates can be changed and storage time selected.

Whatever your application, you

don't have to pay for more storage than you need. Model 639 with optional 3000 TV lines limiting resolution (diagonal measure) and standard Model 639

(2100 TV lines limiting) are both compatible with TV displays of any scan line format from 525 to 1229.

Model MSC-1 is a natural for 525 scan line systems.

And for TV "frame grabbing," Model TVS-1 is unequalled for simple, silent, reliable television storage.

Like what you see? Pull your neck in and write: 6855 El Camino Real, Carlsbad, CA 92008. Or call (714) 729-9191.



HUGHES

HUGHES AIRCRAFT COMPANY
INDUSTRIAL PRODUCTS DIVISION
IMAGE DEVICES

Creative Image Processing.

INFORMATION RETRIEVAL NUMBER 41

Consider more than power when you select an uninterruptible power system. Internal connections and other factors will determine if the system can do the job.

Don't select an uninterruptible power system (UPS) solely on the criteria of kVA rating and output voltage and frequency. If a critical load must function continuously, worry also about such short-term disturbances as line-voltage dips, sub-cycle loss and transients.

And these aren't all. To evaluate a UPS properly, consider these areas, too:

- Expected power-line conditions.
- Load tolerance to waveform distortion.
- Length of time the UPS must supply power after a primary-power failure.
- Time allowed to recharge the UPS batteries.
- Cost, reliability and maintenance.

An uninterruptible power system ensures that a load is powered properly, regardless of the condition of the power line. In addition it performs several other valuable functions: It protects critical loads, as mentioned previously, against short-term disturbances. And it guards against power-line variations in both frequency and voltage, including brownouts.

Standby or UPS units?

Systems that produce electrical power at the site of some critical load are often classified as standby. The choice between standby and uninterruptible systems generally is dictated by the length of time the load can be without power.

Standby systems are typically activated only in emergencies and for maintenance checks. By contrast, a UPS must operate at all times and must include a supply of stored energy that is accessible instantaneously. Some flywheel/alternator systems are in use for this purpose, but the majority of applications today are served by storage batteries and power inverters of various types.

A number of UPS schemes are in use today. Included are on-line rotating equipment, electro-

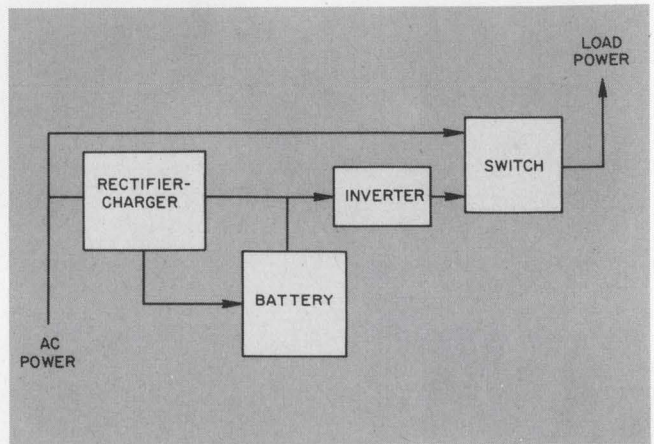

1. **Four basic elements** make up a solid-state UPS. The inverter changes the battery energy to the desired form while the load switch chooses line or UPS power.

mechanical systems, hybrid systems, solid-state units, thermoelectric generators and sunlight-powered systems.

Each type, though widely used, has advantages and disadvantages. For powering electronic equipment, the most popular approach by far is the solid-state UPS. Its popularity can be traced to its available power ratings, size, electrical characteristics, cost and reliability.

In general, a static, solid-state UPS can be considered made up of four subsystems (Fig. 1):

1. An energy storage system (a battery).
2. An arrangement to put energy into the storage system (a rectifier-charger).
3. A system to convert the stored energy into a usable form (an inverter).
4. A circuit to connect and disconnect the UPS from the line and/or load (a switch).

Let's look at the more important characteristics of each.

A choice of batteries

Four types of batteries are commonly used: the lead-antimony, lead-calcium, gel electrolyte and nickel-cadmium. In the lead antimony, the

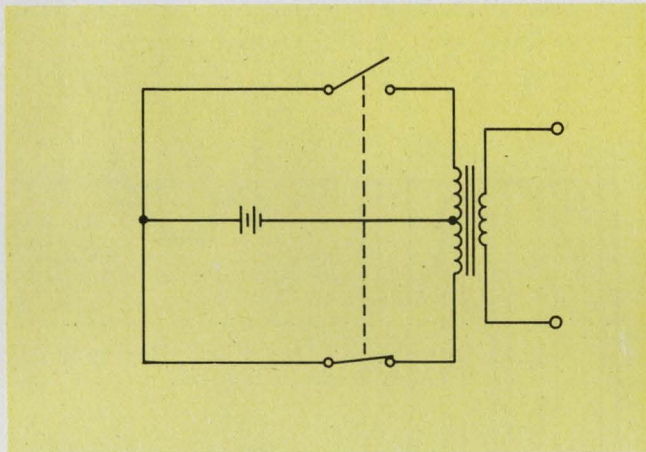

2. The most important part of a UPS is its inverter. In simplified form, the unit can be broken down to its switching elements, control logic and waveform filters.

grids are constructed of an alloy of lead and antimony and surrounded by an electrolyte of sulphuric acid. With this construction, cell voltages must be equalized during charge cycles. By contrast, the lead-calcium battery uses calcium alloyed with lead to allow charging without equalizing; it requires very little maintenance.

Of the remaining batteries, the gel electrolyte-lead acid is generally more expensive than liquid electrolyte batteries, but it is usually sealed and maintenance-free. The nickel-cadmium offers high storage capacity in small size. However, it is more expensive than lead acid and needs to be equalized.

While the requirements of an individual application may dictate the battery type, the size of the battery bank will be a function of the current to be supplied and the length of time the load must be supported. These two requirements determine the ampere-hour rating of the battery.

Conductor sizes, and the currents to be handled by the switching semiconductors in the inverter stage, determine the battery bank's voltage. In general, very small systems use low voltages, while large systems use battery banks of several hundred volts. The banks are generally mounted

in nearby racks. For the smaller systems, the batteries are often mounted in adjacent compartments or within the UPS in one small enclosure.

When the power line is present, the rectifier circuit supplies all of the power used by the inverter and maintains the battery at full charge. The ratings of the rectifier circuit are determined by the requirements of the inverter and the current to recharge the battery after line power is restored.

Systems that need a very long charging time require a rectifier-charger circuit that is only slightly larger than that of the inverter. In systems where a short recharge time is needed, the rectifier-charger becomes much larger. Expandable systems, which later may assume a greater inverter load or require more batteries, should have rectifier-charger circuits with excess capacity.

The heart of a UPS: Its inverter

In a typical UPS, the inverter accounts for more than half the cost. Inverters generally use three basic kinds of circuitry: the switching elements, the logic circuitry (which controls the switching elements) and a filter to improve the waveform of the output power.

Typically the dc power available from the rectifier-charger is converted to ac by switches that turn on and off in a way that causes a transformer core to magnetize first in one direction and then in the opposite (Fig. 2). Ac power is then drawn from another winding on the same core.

The switching elements in small, low-voltage inverters are generally transistors, while silicon-controlled rectifiers (SCRs) are usually used in higher-powered, higher-voltage systems. Very large systems use banks of parallel SCRs, each operating at well over 100 A. The switching elements are connected and controlled to deliver one of four types of waveforms (Fig. 3):

1. *Square wave*: The simplest of inverter outputs, it results from alternate opening and closing of two switches at a constant rate. A square

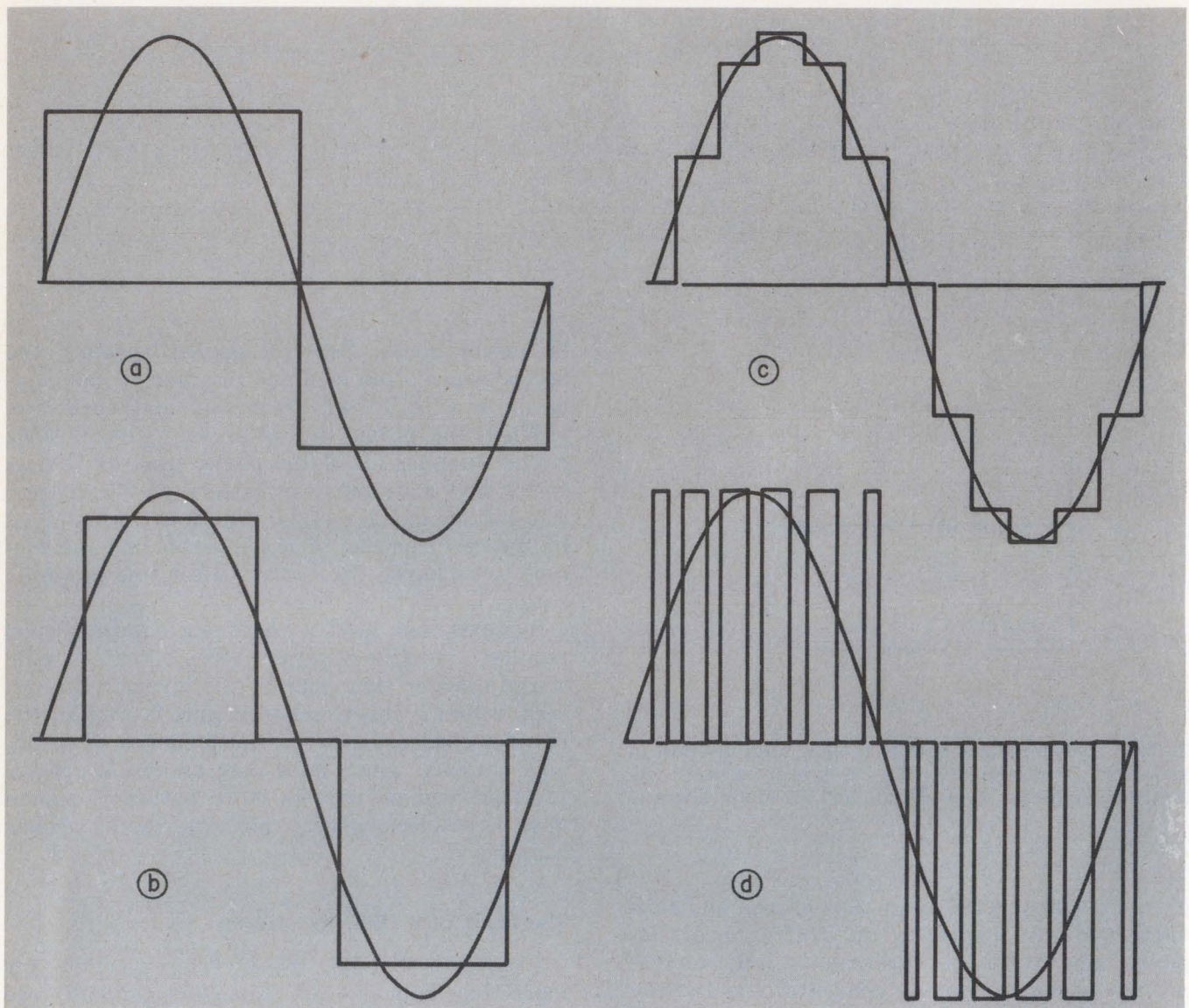

3. An inverter's switching elements can be designed to deliver several types of waveforms. Square waves are satisfactory for many loads (a), but the quasi-square

wave is closer to a sinusoid (b). Stepped (c) or pulse-modulated (d) waveforms give further improvement. The closer to a sine, of course, the easier it is to filter.

wave with an amplitude of about 140 V is adequate to power many small loads, such as cathode-ray-tube monitors, intermittent-duty printers and many kinds of test equipment. Loads containing both peak-charging filters and averaging filters may not operate satisfactorily from square-wave power. Many computers and data-processing machines use both kinds of filters.

2. *Quasi-square wave:* Similar to a square wave, except that there is a dead time between alternate half cycles to more nearly approximate a sine wave. The relationships between rms, peak and average voltages are considerably improved over the 1:1:1 ratios of the square wave, while the circuitry involved is still relatively simple. Voltage is regulated by control of the duty cycle—longer on time results in higher output voltage.

3. *Stepped waveform:* A further improvement in waveshape is accomplished with inverters whose on and off times are controlled, and whose outputs add together. When none of the switches is on, the output voltage is zero. With all of the switches on, the voltage is maximized. And with some on, there is an intermediate voltage at the output. When the various switches are sequenced on and off, the output waveform can be given a stairstep pattern that follows the general shape of a sine wave. More levels of voltage can be obtained with additional inverter sections to give a closer approximation of a sine wave.

Voltage regulation in the step approach is generally obtained by generation of two out-of-phase stepped waveforms and the summation of their outputs. When the two waveforms are near-

ly in phase, the output voltage is high; greater displacement produces a lower voltage. The extreme case illustrates the principle: Two equal waveforms displaced 180 degrees produce no output.

4. *Modulated waveform*: In this method, a single set of switches is turned on and off at high frequency in a pulse-width-modulated pattern. This produces a maximum voltage at the peak of a sinusoid at large conduction angles, and minimum voltage near zero-crossing at small conduction angles.

A wide variety of control circuitry is used with the different inverters. While the basic function of the controller is to turn the switches on and off, the control circuitry also may be responsible for the following:

- Frequency stability.
- Voltage regulation.
- Current sensing and current limiting.
- Synchronization of output to power frequency.
- Phase displacement on three-phase systems.
- Soft start capabilities.
- Paralleling capabilities.
- Sufficient drive for load surge conditions.

Which filter?

All high-efficiency inverters produce non-sinusoidal waveforms. The primary function of the filter is to shape the waveform by elimination of harmonics. The load generally looks directly into the filter section of the UPS, so filter design may be important to the user's system. Some of the more commonly used filters are:

- Ferroresonant transformer—one of the simplest and most effective of all output filters. When used as the output section of a square-wave inverter, it provides primary-to-secondary isolation, a high degree of noise isolation, inherent current limiting and very good waveform shaping and voltage regulation. Its disadvantages are its bulk, low efficiency and slow response time.
- Harmonic-suppressing transformer—an output transformer tuned to resonance at the inverter's operating frequency. Like the ferroresonant transformer, it performs the functions of isolation and harmonic suppression, but it is considerably lighter and smaller. The heat developed in the harmonic-suppressing transformer limits its usefulness to relatively small systems.
- LC filters—various combinations of chokes and capacitors configured to pass the fundamental frequencies and to shunt or trap high-frequency components. LC filters can be used to smooth square, quasi-square, stepped or modulated waveforms. They tend to become smaller and more

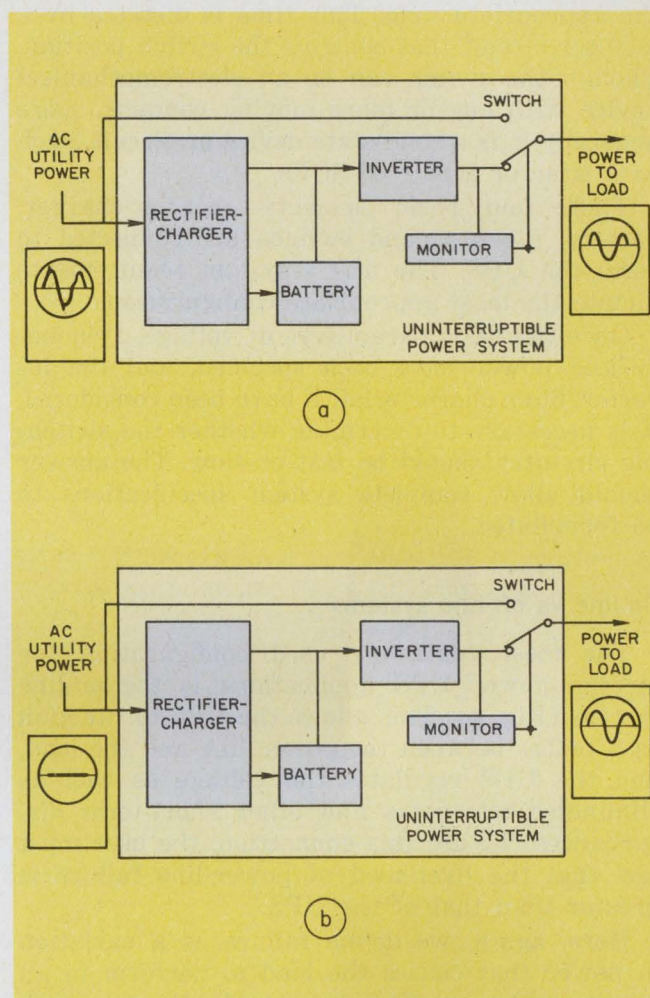

4. In the on-line system (a), the UPS acts as a buffer between the load and primary power. Thus the load sees a clean sinusoid. When power fails, the battery serves as the prime source to keep the load alive (b).

efficient when the input waveform approaches the output waveform. Large filters tend to affect the response time of closed-loop systems adversely.

Commonly used combinations of inverters and filters include a square-wave inverter with a ferroresonant transformer, a quasi-square-wave inverter with harmonic-suppressing transformers, and stepped-waveform and pulse-width-modulated inverters with LC filters.

To the UPS user, the important inverter considerations are output waveform characteristics and the ability of the inverter to synchronize with the power line and support the load under start-up and other high-surge conditions.

The switch that connects the load to either the inverter or to the power line is the fourth major component of a UPS. Normally the load can be connected to either source; the switch's primary function is to break that connection and to con-

nect the load to the alternate source of power at the appropriate time. This time is dictated by a monitor circuit that controls the switch position. Though the switch can be an electromechanical device with one or more moving contacts, more generally it is a solid-state device or circuit, such as a triac or a pair of SCRs.

These four basic elements—rectifier-charger, battery, inverter, and switch—are connected to form the UPS. The user's system requirements dictate the most appropriate configuration.

Once the basic parameters of voltage, frequency and power have been specified, and the inverter/filter characteristics have been considered, it is necessary to determine whether the switching circuitry should be fast or slow. The answer should allow complete system specifications to be formulated.

On-line vs off-line systems

The most commonly used configuration for medium-power UPS applications is the on-line system (Fig. 4). This allows the UPS to function as a buffer between the power line and the load, and the UPS regulates the voltage as well as eliminates transients and other short-term disturbances. To use this connection, the user must feel that the likelihood of power-line failure is greater than that of the UPS.

Here, again, we define failure as a variation in power that causes the load to perform in an unacceptable way. This is generally the case with data-processing and communications equipment in urban areas, where the more common utility failures consist of transients, noise and brown-outs, and complete power outages are relatively rare.

Many computer installations are much better equipped to deal with power outages than with noise or power flickers. Outage causes data to be reloaded and alerts operators to take appropriate precautions: to verify data, monitor processes and the like. A subtle noise-induced error in the data-processing system may escape detection and have later consequences.

The best total system protection is provided by the on-line UPS. The system is generally configured so the ac utility power is applied to a rectifier-charger that converts ac to dc at a voltage level that maintains a proper charge on the battery. The rectifier-charger also powers the dc/ac inverter, which, in turn, powers the load.

The battery is continuously available to supply power to the inverter in the event of utility power outage or brownout. The battery floats, fully charged, across the inverter input and acts like a huge capacitor that absorbs line surges, provides immunity to line dips and absorbs mis-

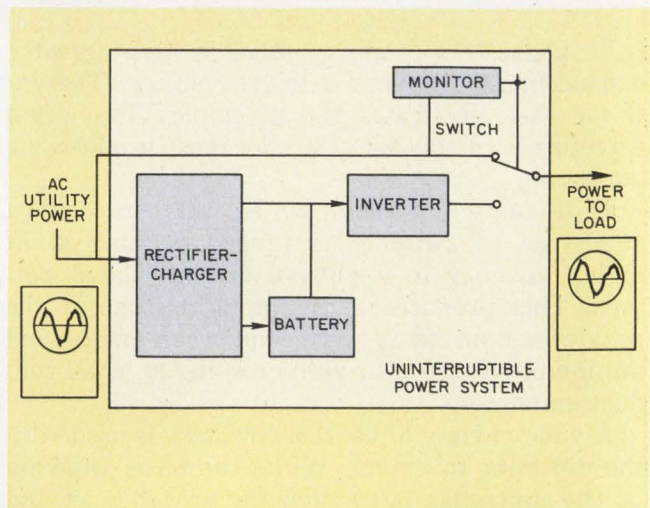

5. The off-line UPS system delivers primary power to the load until an outage occurs. The monitor then connects the load to the output of the inverter.

cellaneous power-circuit disturbances.

In the event of a failure within the inverter, the monitor circuit detects the output change and commands the switch to connect the load to the primary power line.

On-line systems are generally used for computerized data-acquisition, process-control and other real-time operations, as well as for communications systems and medical applications. Usually the on-line unit is used in installations that are characterized by utility lines of doubtful quality and by equipment that responds rapidly to changes in power.

Connecting to reliable power

If the critical load is placed at a spot where the probability of utility power failure is extremely low—say, a communications system at a hydroelectric-generating station that has delivered clean, continuous power for 40 years—it would be reasonable to assume that the mean-time-between-failure of the UPS will be considerably less than that of the primary power. In such a case, the load normally is connected directly to the primary power, with the UPS hooked up as shown in Fig. 5.

The switch is connected so that the inverter stands by in an unloaded condition as long as the primary power is present. When a primary-power outage occurs, the monitor circuit detects the condition and tells the switch to connect the load to the inverter output. Many systems are configured so that, after restoration of normal power, the monitor circuit causes the switch to be reset.

The UPS connection in Fig. 5 satisfies many standby-power applications in which switching speed is not critical. In some, a person performs

the monitor and switch functions by noting that the primary power is out, pulling the critical load's power cord out of the wall socket and plugging it into the inverter. When the power comes on again, the human monitor plugs the load back into the wall socket.

Many systems of this type contain a manually operated switch that allows the inverter to remain off until the load is connected to the output. While this manually switched arrangement is an extreme example of slow monitoring and slow switching, it differs from more sophisticated systems only in speed of response.

A very simple system, which operates in one or two cycles of the line frequency, consists of a switch that is nothing more than a relay or contactor whose coil is powered by the utility line. When the line power is not present, the contacts switch the load from the line to the inverter.

A faster system uses a rapidly responding monitor circuit and a solid-state switch to provide switching time on the order of several milliseconds—fast enough for most data-processing and process-control equipment.

Off-line system is limited

Though the off-line unit has advantages over the on-line system, in terms of efficiency and rectifier-charger cost, it has the inherent disadvantage of being able to protect only against power outages. It offers no buffering against transients and other short-term disturbances, and normally it does not function as a voltage regulator or brownout eliminator. However, these capabilities can be incorporated by design of the monitor so that the switch connects the load to the line only while the line is within certain tolerable voltage limits. At other times the load is connected to the inverter.

Extremely fast monitors and switches are available today that make the off-line UPS ideal for such loads as printers, copying machines, voice-communication systems and remote monitoring apparatus.

For many systems powered by relatively dependable—but noisy—utility lines, an off-line UPS can overcome power outage and brownout problems. An ultra-isolation transformer can be connected between the load and the switch to provide bidirectional common-mode noise attenuation on the order of 1,000,000 to 1—many times more effective than a typical UPS.

In many applications, the power-failure mode is almost entirely noise-related, as distinguished from power-related. The most effective solution in this case may not be a UPS but noise-isolation equipment, installed either at the critical load or at the source of the noise. ■■

BOURNS™

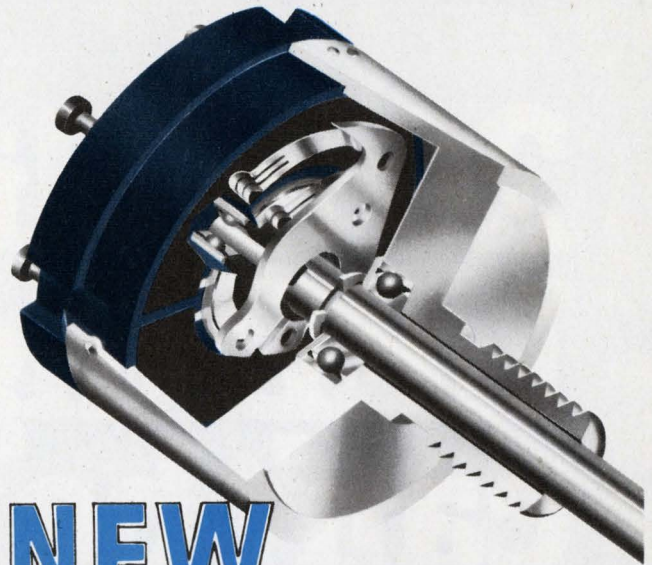

NEW

single-turn precision potentiometer features ball-bearing supported shaft, long-life, economy price.

Here is high quality that you can depend on . . . BOURNS® Models 6538 and 6638 conductive plastic potentiometers. Both models feature full front-and-rear ball bearing supported shaft and rugged, reliable molded-in terminals. Value priced at well under \$15.00 in 100-pc. quantity.



High quality replacement for the NEI ECONOPOT and the SPECTROL 158

SIGNIFICANT FEATURES:

Infinite resolution element • standard linearity of $\pm 1.0\%$, with specials available • extended temperature range of -65°C to $+125^{\circ}\text{C}$ • standard output smoothness of 0.1% • Servo and Bushing mount • wide range of options, plus custom designs available • resistance range — 1K to 100K ohms • rotational life — 20 million revolutions.

SAMPLES AVAILABLE

Call PRC at (714) 684-1700, ext. 326, and tell us about your application. Or contact your local Bourns representative.



TRIMPOT PRODUCTS DIVISION

1200 COLUMBIA AVENUE, RIVERSIDE, CALIFORNIA 92507
PHONE 714 684-1700, TWX 910 332-6103, CABLE BOURNSINC.

INFORMATION RETRIEVAL NUMBER 42

20 million LED digits can't be wrong.

Litronix DL-707 0.3" high digit has same superior features as DL-747 below.

Litronix DL-747 has 0.6" high digits 44% larger in area than digits from any other major supplier.

Mitered corners increase eye appeal.

Light pipe spreads illumination evenly.

Mounted on DIP with standard pin spacing.

DL-747 with cap in place over light pipes.

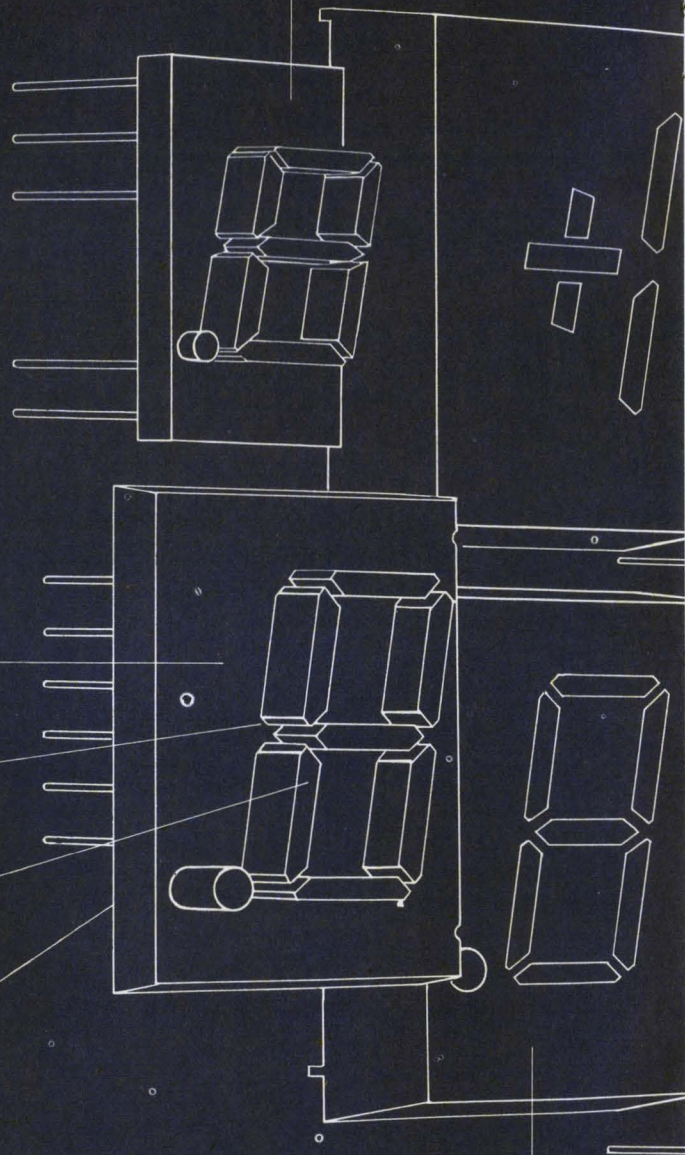

Analyze various mixtures without fuss.
The new digital display will detect major detection
Scanned electronically by the chemical composition

You'll find major advantages in dealing with the world's largest supplier of LEDs—the one that's shipped over 20 million LED digits to date and will deliver many millions more in 1974.

For openers, the Litronix product line is so broad that you can get exactly what you need. Sizes from 0.1" to 0.6". Colors like red and orange today, with yellow and green in volume production soon. Common anode or common cathode. And polarity overflow digits in many sizes.

Perhaps even more important, you're assured of a consistent, reliable product. Litronix doesn't buy any high-technology parts from others. We make everything in-house—starting with the basic GaAsP materials. The result is that we have better overall control: high brightness, proven reliability and assured delivery.

Litronix has two plants in the U.S. and three more overseas to keep the LEDs flowing. Because our volume is large, our prices are very, very competitive.

The drawing at left of our big 0.6"-high DL-747 shows some of the superior characteristics of the popular Litronix 700 Series displays.

Contact us right now for LED displays, LED lamps, opto-isolators, or phototransistors. We know we can meet your needs. Like we say, over 20 million LED digits can't be wrong.

Litronix, Inc., 19000 Homestead Road, Cupertino, CA 95014. Phone (408) 257-7910. TWX 910-338-0022.

**No wonder
we're No.1
in LEDs**

litronix

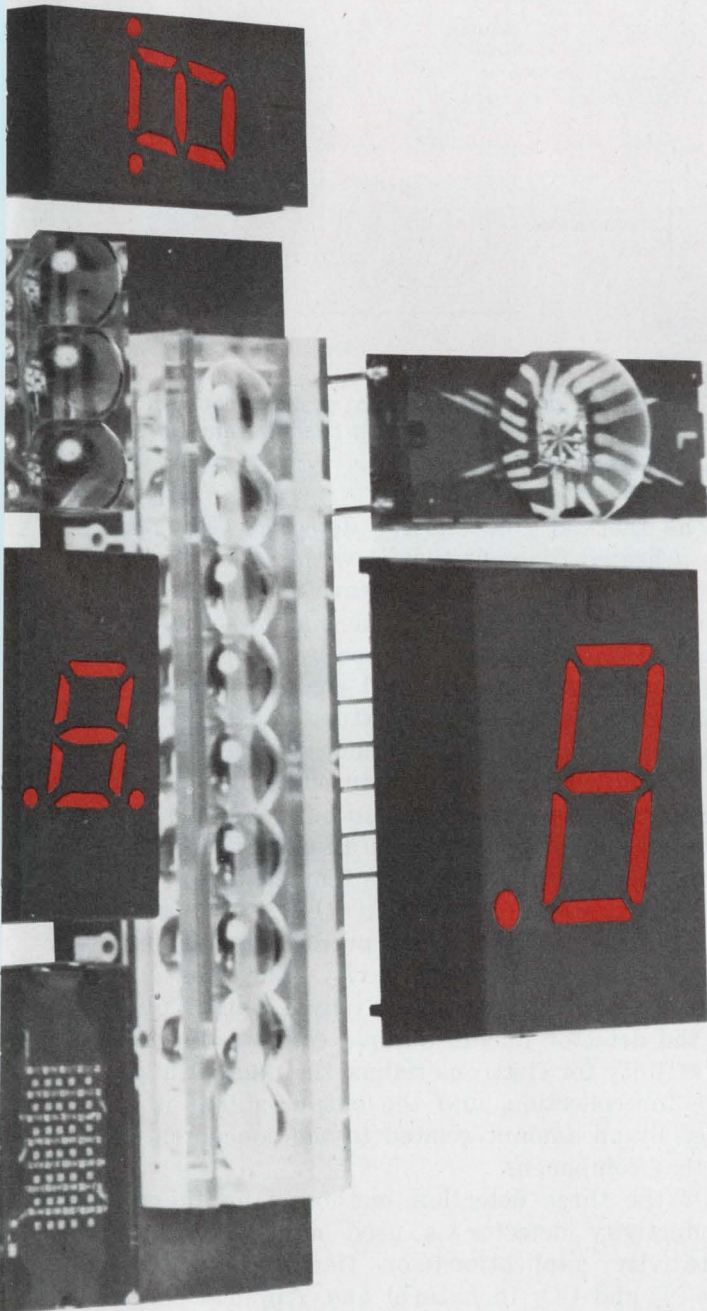

Analyze gaseous mixtures without fuss.

The gas chromatograph, with one of three major detection schemes, electronically analyzes chemical composition.

Three of the most common detectors used in gas chromatography are the flame ionization type, which measures ionic current generated by a burning sample; the thermal conductivity type, which measures temperature changes, and the electron capture detector, which measures the electric current generated by a radioactive source.

If you understand the various types of gas chromatographs, you can put their gas-analysis capability to full use. These instruments perform a chemical-to-electrical conversion to help analyze unknown substances introduced into a known gaseous carrier.

In a gas chromatograph, a stream of a carrier (neutral) gas moves an unknown sample gas through the analysis system (Fig. 1). The unknown is usually introduced into the system through an injection port and then swept into a separation column by the carrier.

The column is filled with an inert support material such as diatomaceous earth (a porous fossilized skeleton of a coral-like material coated with a thin oil film) or porous glass beads with a thin film (liquid phase). Differences in the attraction between the sample gases and the thin film coating cause the various gas components to slow down by different amounts. Thus they enter the detection chamber at different times. Then a detector produces a separate electrical output that corresponds to each of the gas components. The sequence in which the peaks appear tells you which component it is, and the size of the peak tells you how much of it there is (Fig. 2).

Three basic detector types

Flame ionization detection methods (Fig. 3a) burn a sample in a hydrogen/air flame to create ions. A potential applied to the ion detector section collects the ions, and the current generated by the ions is measured by an electrometer-amplifier.

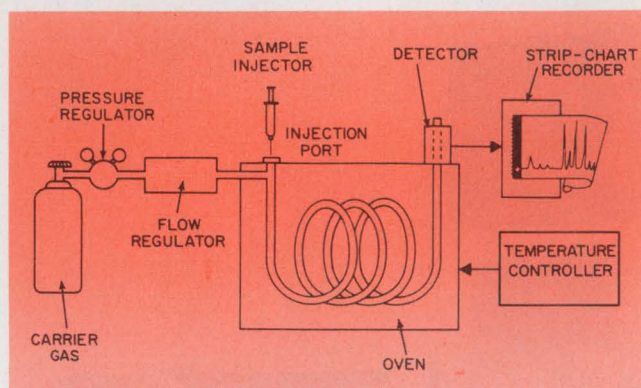

1. The basic gas-chromatograph system consists of a carrier gas, an oven, a detection chamber and an output recording system.

The thermal conductivity detector (Fig. 3b) has a heated filament that is within the carrier/sample stream. The temperature of the powered filament is related to the thermal losses of the detector wall as the gas passes by. When a sample component enters the test chamber, the thermal conductivity of the mixture causes a temperature change in the filament. If the filament is part of an electronic balanced-bridge circuit, the change in temperature can be translated into a resistance change and thus an electrical output proportional to the change in temperature.

Electron capture detection (Fig. 3c) uses a radioactive beta source to produce low energy electrons in the detector cavity. The free electrons are collected periodically by a voltage pulse on the detector anode. Sample components with an affinity for electrons reduce the number available for collection, and the output signal is altered by an amount related to the concentration of that component.

Of the three detection methods, the thermal conductivity detector is used mostly for low-sensitivity applications or fixed-gas analysis, like N_2 and CO_2 in natural gas. Applications of the flame ionization detector are, of course, limited to burnable samples, like organic compounds. For such samples, this detector can be 100 times more sensitive than the thermal conductivity detector. The flame method is also used in trace analysis, in drug screening and in testing for

Ernest Zerenner, Design Engineer, Hewlett-Packard, Route 41, Avondale, PA 19311.

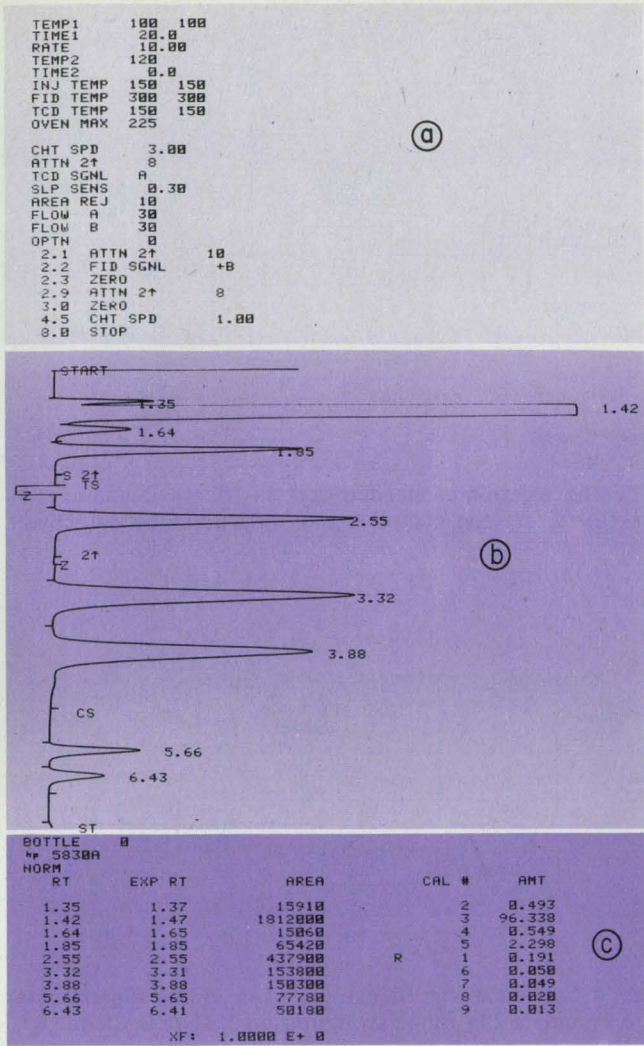

2. A gas-chromatograph output shows the program (a), the peaks and valleys corresponding to gas concentrations with their retention times (b) and the analysis (c).

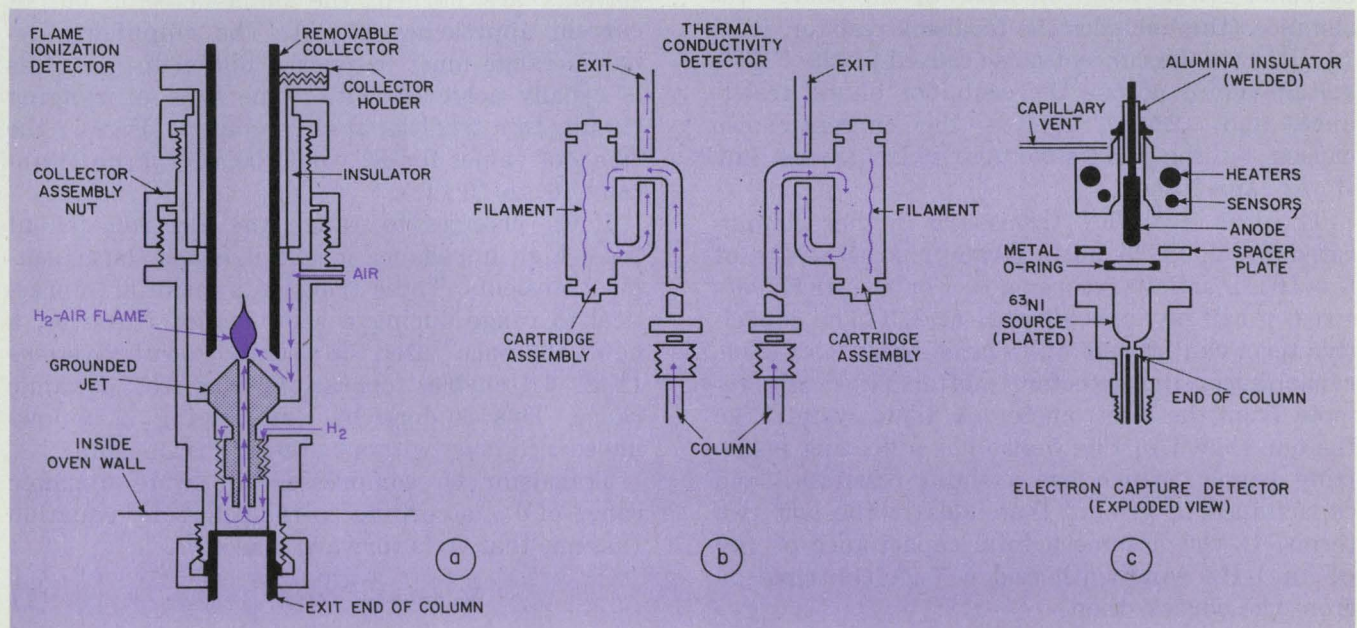

3. The three most common gas chromatograph detectors use schemes that operate from flame ionization (a), thermal conductivity (b), and electron capture (c). The

hydrocarbons as part of pollution in the air. In some cases the electron capture detector is 20 times more sensitive than the flame ionization detector. But it tends to be selective for halogens. Its primary area of application is in pesticide residue detection.

With the increase in availability of microprocessors to aid analysis, many chromatographs are being redesigned to interface and operate in processor-controlled data-collection systems. Some of the newer instruments include such items as keyboards for functional control and read-only memories for storage of programs and algorithms needed during operation. If the detector is considered as the signal source, you can design the circuitry to enhance the usually weak signal.

Analyze the electrical conditions

Let's start the electrical analysis of chromatograph systems by looking at the flame ionization detector technique. A detector background current of between 10 to 20 pA exists. This current is generated mainly by the thin film coating that evaporates from the porous support material and releases electrons.

The current generated has a shot-noise component that can be described by

$$I_n = (2qI \cdot NBW)^{1/2} \text{ A rms.}$$

In this equation q is the electron charge, 1.6×10^{-19} coulomb; I_n is the background current in amperes and NBW is the noise bandwidth in hertz, usually 1 Hz.

Fig. 4 describes the detector noise as a function of background current. The noise bandwidth

electrical output provided, by these detectors can be conditioned by electronic circuits for analysis of the chemical compounds in the gas.

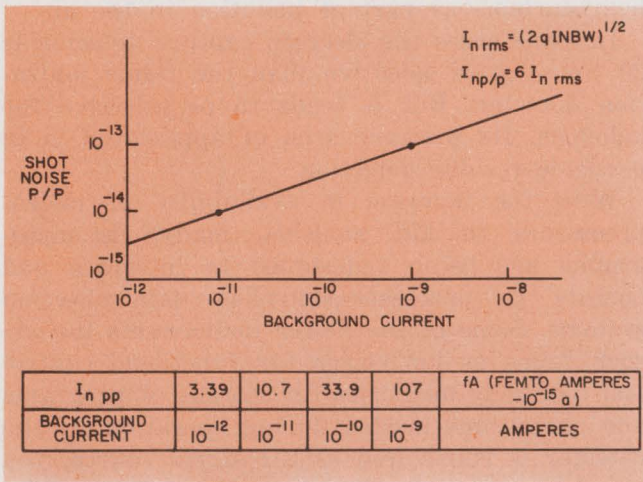

4. Shot noise compared with background noise of the flame-ionization detector increases proportionally.

of 1 Hz is common in gas chromatograph work and will be used in the rest of the discussions.

Note that peak-to-peak background noise is plotted, since this shows most closely what is seen by a recording device. Since a low background current would be about 10 pA, the electrometer-amplifiers must have a total current noise under about 7.3 fA to contribute less than 20% to the peak-to-peak noise.

Small geometry JFETs with low leakage (I_{gss} less than 1 pA) can easily meet this requirement. Care must be taken, however, with other aspects of the design, since noise is not only generated here.

The total noise in a system can be approximated as

$I_{n\text{ rms}}^2 = I_{n\text{ FET}}^2 + I_{n\text{ th}}^2 + (e_n/R_{\text{sh}})^2 + (2\pi f e_n C_{\text{in sh}})^2$
 where $I_{n\text{ FET}}$ is shot noise due to FET leakage current; $I_{n\text{ th}}$ is Johnson noise of the source resistance (this includes the feedback resistor, R_n); $(e_n/R_{\text{sh}})^2$ is the current noise caused by the FET's voltage noise across the amplifier shunt resistance, and $(2\pi f e_n C_{\text{in sh}})^2$ is the current noise caused by the FET's voltage noise across any shunt capacitance.

The last two FET terms are further complicated by the $1/f^n$ noise power characteristic of the JFET at low frequencies. For the JFET desired, n can be approximated as 2/3. The capacitive term can become quite large because of cable capacitance; the detector is often physically remote from the electrometer. A flame system like the one shown in Fig. 5 also has a floating polarizing supply, which has a shunt resistance and capacitance to ground that adds to the last two terms. If you assume a total capacitance of 100 pF, a 1-Hz bandwidth and a 7-fA contribution from the source, then

$$e_{n\text{ pp}} = \frac{I_n}{2\pi f C}$$

$$e_{n\text{ pp}} = 7.95 \mu\text{V}$$

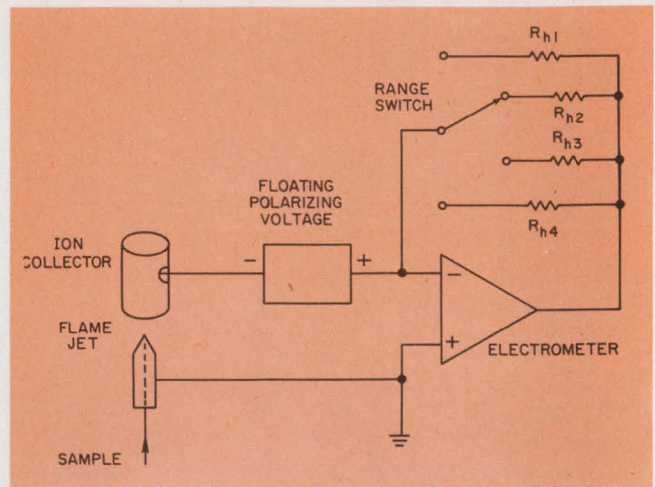

5. The electronics needed for the flame ionization detector aren't too complex, but they must be sensitive.

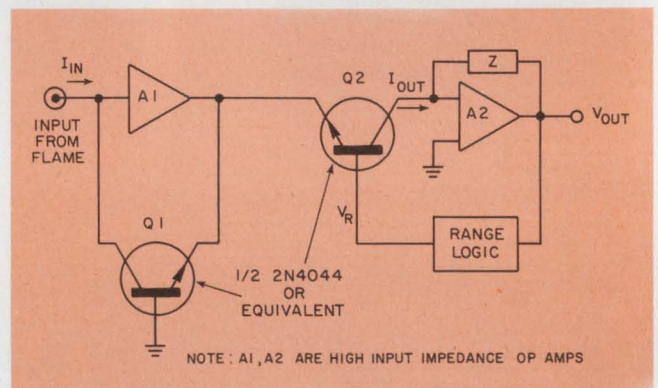

6. A log/linear circuit can be used in the electrometer to eliminate the range-switching on the input node.

A noise voltage this low is difficult to obtain and often requires a JFET rather than a MOSFET.

When large samples (10% concentration) or solvents are burned, the flame-detector output current approaches 10 μA . The amplifier's dynamic range must be over a billion to one; this is usually achieved with some type of ranging circuit. In a traditional electrometer (Fig. 5) the range of values for R_n would be very large (typically 10⁶ to 10¹² Ω).

If R_n changes to range the electrometer at these high impedance levels, it causes large output transients. These transients make it impractical to range during a sample run. However, a new approach used in some recent systems (Fig. 6) enables operation over 10⁹ dynamic range. This is done by autoranging at a low-impedance node without creating transients.¹

Transistor Q_1 compresses the wide dynamic range of I_{in} , according to the following equation (assume that Q_1 is forward biased):

$$V_1 = \frac{-nKT}{q} \ln \frac{I_{\text{in}}}{I_{s1}} \quad (1)$$

In this equation I_{s1} is the saturation current of Q_1 ; q is the charge of an electron; T is absolute temperature in degrees Kelvin; n is a device

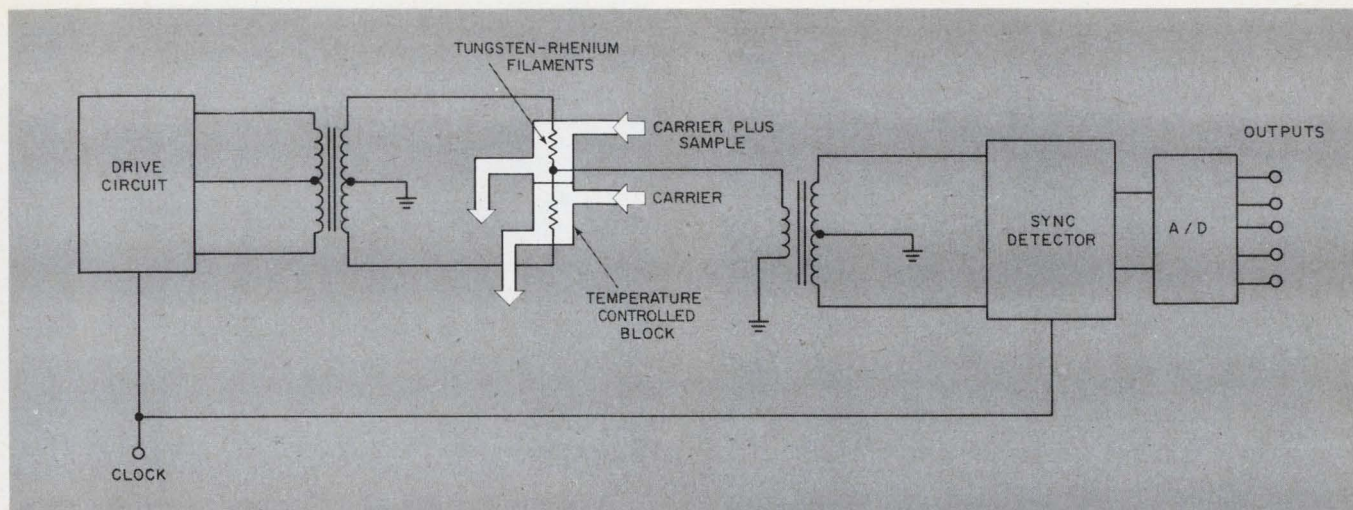

7. Thermal conductivity detectors use tungsten-rhenium heater elements modulated by a high-frequency drive.

constant (near unity); and K is the Boltzman constant, 1.38×10^{-23} .

The exponential amplifier ranges if you add a range voltage, V_r , to V_1 . This yields

$$V_{out} = Z I_{out} \quad (2)$$

$$= Z I_{s2} e^{\frac{q(V_1 - V_r)}{nKT}}$$

If you substitute Eq. 1 into Eq. 2 for V_1 , you get

$$V_{out} = Z I_{in} \left[\frac{I_{s2}}{I_{s1}} \right] e^{\frac{qV_r}{nKT}}$$

Since Q_1 and Q_2 are a temperature-controlled matched pair, the factors q/nKT and I_{s2}/I_{s1} can be considered constants.² This results in

$$V_{out} = K_1 I_{in} e^{K_2 V_r}$$

If V_r is changed in 79 mV steps (at 55 C), hexadecimal ranging results for I_{in} . Since changes in V_r occur at a low impedance node, range switching transients are small. Elimination of the range switch also removes a leakage source on the high-impedance input. The amplifier, A, in Fig. 6 is an integrating analog-to-digital converter that digitizes the input current for transmission to a processor.

About half of all chromatographs use the flame ionization detector. Although a number of compounds produce little response when burned, the flame ionization detector is a popular choice for organic mixture analysis. A flame ionization detector that has a sensitivity of about 15 microcoulomb/gram carbon and a background noise of about 20 fA can detect a level of 4 picogram carbon/s of sample (signal/noise = 2).

Heat-sensitive detectors

The thermal conductivity detector (Fig. 7) is not limited to burnable samples, as in the flame ionization. Therefore it is widely used for gas or air analysis when many of the constituents (ni-

trogen, sulfur dioxide, carbon dioxide, etc.) are not detectable in a flame-ionization system.

Tungsten-rhenium filaments used in the thermal detector are heated in a short-circuit current bridge by an ac drive. The ac bridge operation avoids thermocouple effects. The heat balance equation for each filament shows³ that

$$\frac{I^2 R}{J} = G \lambda (T_2 - T_1) + S.$$

In this equation $I^2 R$ is the electrical power input (about 1 to 2 W); J is Joule's constant; G , a constant that describes the geometry of the cell; λ , the thermal conductivity of column effluent; T_2 , the temperature of the hot element; T_1 , the temperature of the detector block; and S , the other sources of heat loss not dependent on λ (end effects, radiation, etc.).

With a constant power input and constant block temperature, T_1 , you can prove that

$$\frac{\partial T_2}{\partial \lambda} = - \frac{I^2 R}{JG \lambda^2} \quad (3)$$

The temperature of the hot element is measured as if it were a resistance thermometer. Generally one column is used as a reference, and the other is used for samples. This enables the instrument to treat changes in flow rate and temperature of the block as a common-mode signal that substantially reduces the noise and drift. The noise-limiting factor is not Johnson noise from the source impedance (50 Ω), but the thermal limitations of the block temperature and flow changes.⁴ From Eq. 3 you can show, for example, that the thermal stability required for a minimum detectable propane sample concentration of 1 ng/ml (one nanogram of sample in a milliliter of carrier gas) is about 10^{-6} C.

The ac signal from the bridge is impedance-matched to a synchronous detector. And an analog-to-digital converter transforms the output of the synchronous detector into a digital signal for transmission to the processor. The converter is

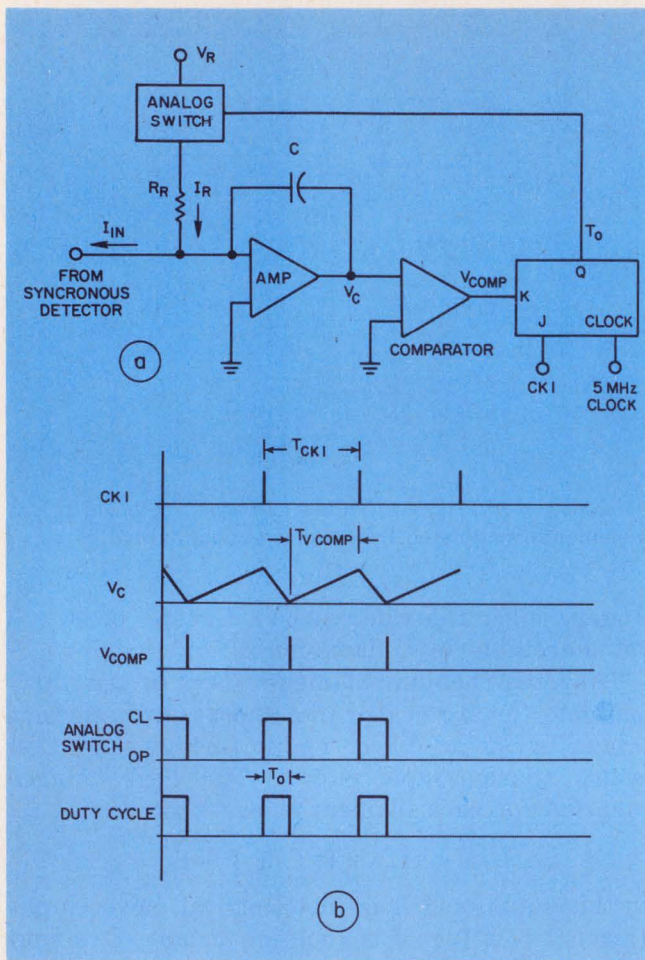

8. An analog-to-duty cycle converter takes the output of the synchronous detector and changes it into a digitally compatible signal.

similar to one used in the flame ionization detector and is an integrating analog-to-duty cycle unit (Fig. 8). Since this method conserves charge, it follows that

$$I_{in} = I_r \frac{(T_{ck1} - T_{vcomp})}{T_{ck1}} = I_r T_o$$

The system clock measures the duty-cycle interval, T_o (Fig. 9). At periodic intervals the counters are loaded into the parallel-in/serial-out shift register for transmission to the processor. Since the registers are not unloaded for every interval of T_o , they integrate and store the value in the counter until requested by the processor. This feature is important, since it allows the processor to spend less time in the input/output mode.

Radiation measures gas concentrations

The electron capture detector uses a radioactive beta source (frequently Ni63 because of its long half life and high-temperature capability) as a generator of high-energy free electrons. Repeated collisions of these electrons with the carrier gas produce about 100 times as many

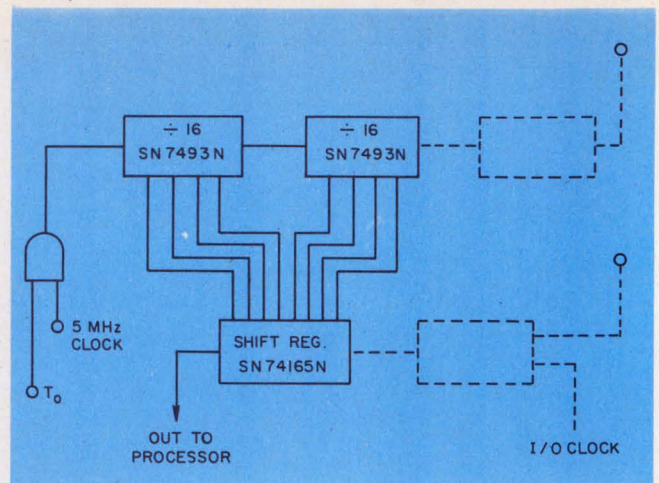

9. Some counters and shift registers convert the duty-cycle output into digital words to be processed.

secondary electrons, which, because of additional collisions, reach thermal energy levels. With no sample (no capture), these electrons are collected and produce a standing current of 9 nA for a 15 millicurie beta source.

Several techniques are used to measure the collected current:

- Dc potential.
- Pulsed (constant frequency).
- Constant current (variable frequency).

The first technique applies a dc potential across the cell to collect the electrons generated. When a sample enters the cell, some electrons are captured, and the negative ions that result recombine with positive ions faster than they can be collected.

However, the higher-mobility electrons that have not been captured are collected. The net result is a decrease in current when an electron-capturing gas sample is fed into the detector. This mode of operation has problems with space-charge effects, contact potentials and an exponential relationship of output to concentration (Fig. 10a).

But if a 60-V potential is applied for several microseconds the space-charge and contact-potential problems of the dc mode of operation can be avoided. Sensitivity remains at least as good and usually better, since the electron density in the detector continues to rise during the intervals (5 to 150 μ s) between pulses. However, this mode also has a basic nonlinearity in its output,⁵ as shown in the following equation:

$$I = \frac{I_s}{1 + (b/f) + C(a/f)}$$

where I is the collected current; I_s , the standing current (about 9 nA) and b , the cell constants (usually sample dependent); f , the frequency of the pulser and C , the concentration of the sample.

At constant frequencies the output current is inversely proportional to concentration plus a

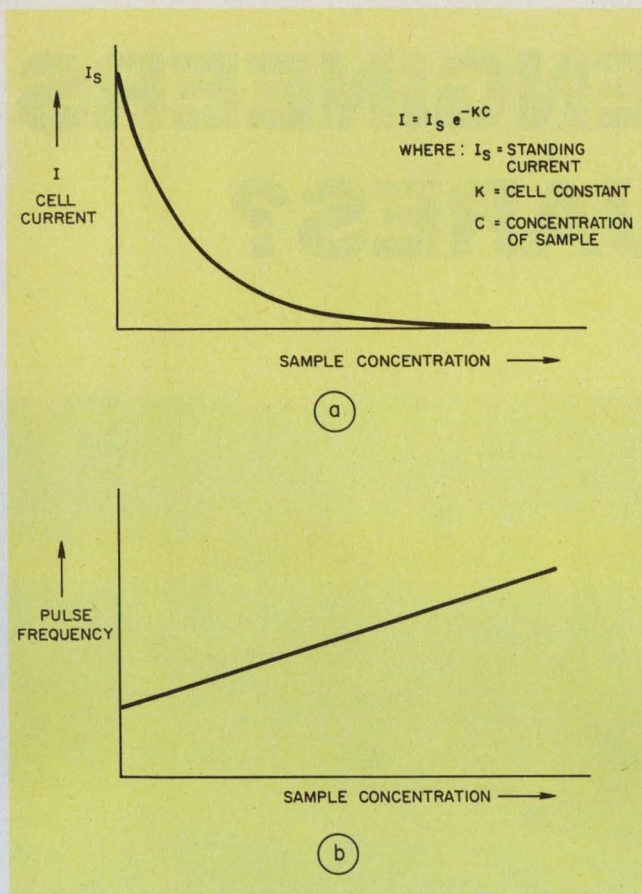

10. In the electron capture detector, cell current decreases exponentially (dc operating mode) as sample concentration increases (a). Pulse output frequency increases linearly as the sample concentration increases (b) when the detector operates in the constant-current mode.

constant. If this equation is rearranged and solved for frequency then

$$f = \frac{I}{I_s - I} (aC + b).$$

With the cell current I held constant, the output frequency is linear in sample concentration (Fig. 10b). Since a and b are not entirely independent of concentration or sample type, the linear range is limited to about 10,000. This is a considerable improvement over the 100-to-1 linear range in the dc and constant-frequency modes of operation.

Fig. 11 is a block diagram of a constant-current, electron capture detection system. This consists of a servo loop, which varies the pulser frequency to maintain I_{cell} equal to a reference level, I_R . The pulser generates 300-ns pulses at the servoed frequency with an amplitude of 70 V. These pulses are applied to the cell to collect the uncaptured electrons and maintain the time average of zero current into the input node. The comparator converts the integrated error signal from the amplifier into a frequency that is linear in concentration.

A 15-millicurie source yields 5.55×10^8 disin-

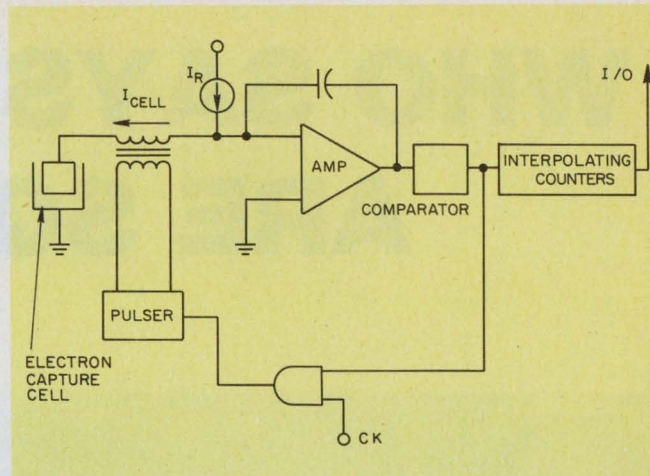

11. The constant-current mode, electron-capture detector uses a current-to-frequency converter to gather data generated by a radioactive source.

tegrations per second. Since this is a random process, the signal-to-noise ratio is

$$\begin{aligned} S/N \text{ pk-pk} &= (KT)^{1/2}/6 \\ &= 2.78 \times 10^3, \end{aligned}$$

where K is the disintegration rate and T is the time of observation (0.5 s for a 1 Hz NBW).

To translate this into electronic terms: If the collected current (equal to I_R) used is 1.5 nA, the noise current is 0.54 pA pk-pk for a 1-Hz NBW. Therefore a FET front end is required, but the leakage requirements are several orders of magnitude easier to meet than for the flame ionization detector. Since the base frequency can be as low as 300 Hz, a resolution of 0.1 Hz is needed to make full use of the signal-to-noise ratio. An interpolating counter increases the resolution of the output counts and stores the results for transmission to the specialized processor.

The electron capture detector is one of the most sensitive detectors available today. It can detect as little as 2 picograms of compounds like carbon tetrachloride or other electron-capturing species. For 1-microliter-size injections, this corresponds to less than two-parts-per-billion concentration. ■■

References

1. Smith, Douglas H., Bump, Robert B., Zerener, Ernest H., "A New High Dynamic Range Electrometer for Gas Chromatography," Paper #17, Pittsburgh Conference on Analytical Chemistry and Applied Spectroscopy, March, 1972.
2. Smith, Douglas H., "High-Performance Flame Ionization Detector System for Gas Chromatography," *Hewlett-Packard Journal*, March, 1973.
3. Little, A. B., "Gas Chromatography," Academic Press, 1970, Chapter 10.
4. Goedert, M. and Guiochon, G., "A Study of Sources of Error in Quantities GC: Reproducibility of the Response of a Catharometer," *Journal of Chromatographic Science*, Vol. 7, June, 1969, pp. 323-39.
5. Sullivan, J. J., and Smith, D. H., "A New Linear Electron Capture Detector with Extended Dynamic Range," Paper #49, Pittsburgh Conference on Analytical Chemistry and Applied Spectroscopy, March, 1972.

WHO SAYS ENGINEERS ARE SQUARES?



WIN A FREE CARIBBEAN WINDJAMMER CRUISE PLUS \$1,000 CASH

Once again, by reader demand, a week's Windjammer Cruise for two in the fabulous blue Caribbean is waiting for the lucky winner of *Electronic Design's* TOP TEN CONTEST. And that's not all! The first prize winner gets \$1,000 in cash, round-trip air transportation for two, plus a free ad re-run worth thousands of dollars for his company.

Think of it . . . warm sun . . . bright blue water . . . easy carefree days cruising among the Bahama Out-Islands, the Virgin Islands, or the exotic Windward/Leewards. Visit foreign ports. Swim . . . snorkel, or just relax.

IT'S EASY TO ENTER. Nothing to write, nothing to buy, no slogans, no gimmicks. All you have to do is select the TOP TEN ads in the January 4 issue, as measured by *Reader Recall* (*Electronic Design's* method of gaging readership). It's a

*Free reruns awarded only if the company has an advertisement in the January 4 issue.

once-a-year chance to test your skill as well as win valuable prizes for yourself and for your company.

100 PRIZES IN ALL. Portable color TV; Bulova electronic timepieces and technical books broaden your chance to win, make it even more worthwhile to enter.

SEPARATE CONTEST FOR ADVERTISERS

Advertisers, marketing men and advertising agencies can enter too. Duplicate awards are given to the top three winners (Windjammer Cruise, cash, air transportation, free ad re-run; Color TV; Bulova timepiece).

Remind your advertising people that it's the issue of the year for readership . . . the issue of the year for prizes. Put your hard-earned degrees or just plain common sense to work. This year you can be the winner!

THIS YEAR TRY YOUR LUCK!

(Who says engineers are squares?)

**WAKE UP AND JOIN THE
FUN AND EXCITEMENT!**

100 VALUABLE PRIZES!

**ENTER Electronic Design's
1975 TOP TEN CONTEST**



"We enjoyed every minute we were there," writes Paul R. Saunders, winner of last year's Top Ten Contest. "The islands, the people of those islands and the cruise are wonderful . . . the hardest part of the whole trip was returning to reality." Paul and his wife are shown, left, at the end of their trip at English Harbour, Antigua. Paul also won \$1,000 cash and round-trip air tickets for two to the Windjammer Cruise home port. At the time of the contest Paul was associated with Varisystems Corporation, Long Island, N.Y.

**WATCH FOR COMPLETE RULES AND ENTRY BLANKS IN
ELECTRONIC DESIGN'S JANUARY 4, 1975 ISSUE**

Build counters with calculator chips.

For low counting rates and display of totals, these ICs simplify designs. Use them to replace mechanical counters.

If your application requires counting at relatively low rates and display of the accumulated totals, you probably can simplify the design and cut costs by using calculator chips.

Already designers have found a wide range of counter uses for these LSI circuits—from timers and stopwatches to bin counters, DPMs and table-coordinate counters. Nearly any application that now employs mechanical counters could be upgraded with a calculator IC.

Actually counting is a simple function for these circuits. Repeated additions of a constant to an accumulated total—which can be continuously displayed—represent the basic operation. In its simplest form, a complete counter can be built with only two ICs and a display.

Some of the benefits

Here are the advantages that calculator chips bring to counting applications:

- *Display driving capability.* Most calculator chips have multiplexed outputs that can drive a display directly, or in conjunction with segment and digit drivers. The internal circuitry simplifies drive requirements and reduces the number of external components needed.

- *Switch debounce logic.* Many calculator chips have built-in switch debounce logic that overcomes the most common problem in count-switch or relay-closure applications, especially when the only switches employed are single-pole, single-throw types.

- *Multiple decades of counting in one package.* Even the simplest calculator chips usually have six digits or so and can be used for six-decade counting. Chips with eight to 10 digits are also readily available. Hence a great deal of counting capability is available in a single IC.

- *Counting by various radices.* Since counting is obtained by repeated addition of a constant to an accumulated total, it is possible to count by

any desired radix simply by changing the constant. Consequently it is just as easy to build a counter that counts by 2's or 9's as it is to build one that counts by 1's. With a slight increase in complexity, even counts by unusual numbers—like 972 or 11,576—can be obtained.

- *Low package count and cost.* The low parts count offered by a calculator chip can rarely be equaled by medium-scale-integrated components, especially when three or more decades are needed. For example, a six-digit counter that drives a LED display and counts at a maximum rate of about 60 Hz can be built with only two ICs—a calculator chip and a digit driver. Increased counting rates, simplified control and heightened versatility in the display drive can be obtained with the addition of a few components.

- *Low power consumption.* Many MOS calculator chips operate from battery supplies, and they draw very little current. The bulk of supply current is consumed by the display rather than the calculator chip. If CMOS elements are used to control the calculator chip, very little additional supply current is needed.

Tradeoffs in chip selection

The many available calculator chips tend to make selection of the right one difficult. However, the process can be simplified by examination of the major characteristics needed for a good counter. For a particular calculator chip, the key points to check are these:

- Autosummation.
- "Constant" operation.
- Speed of count.
- Wasted capabilities.
- Interface ease.
- Display-drive capabilities.

Does the chip allow autosumming?

A calculator chip has the autosumming feature if, after initial depression, subsequent depressions of the add key result in repeated addition of the first entry to the accumulated total. Chips based on algebraic notation generally *do not* have

Michael E. Watts, Digital Systems Application Engineer, National Semiconductor, 2900 Semiconductor Dr., Santa Clara, CA 95051.

this feature, while chips based on so-called Polish notation *do*.

Autosumming offers the best way to make a calculator chip count, since it involves the fewest different types of entries—just 1 and the plus symbol (Table 1). After entry of the first 1, counting takes place each time the plus entry is activated.

Does it have 'constant' operation?

Some calculators have a "constant" function that can be used to make repeated additions and so make the calculator count. However, some constant functions work only for "multiply" and "divide" and not for "plus." Some others work only with numbers stored in memory and not with the working registers.

In addition operation of the constant function might be significantly slower than desired, and more initialization becomes required. Table 2 illustrates how to set up a chip with algebraic notation—National Semiconductor's MM5738—for constant operation, so the chip will count. This method isn't as desirable as the autosumming approach, because more initialization steps are required, necessitating increased external logic and heightened system costs.

How fast does it count?

Maximum counting speed is a prime consideration in almost any counting application. Most calculators are relatively slow, as counters go.

Table 1. Autosumming saves entries

| Key Sequence | Display |
|--------------|---------|
| C | 0 |
| 1 | 1 |
| + | 1 |
| + | 2 |
| + | 3 |
| + | 4 |

Table 2. 'Constant' counting

| Key | Display | Action |
|-----|---------|-------------------------------|
| C | 0 | Clears chip |
| 1 | 1 | Enters a 1 |
| × | 1 | Stores "×" function |
| = | 1 | Stores 1 in constant register |
| + | 1 | Changes mode to add |
| K | 2 | Repeats add |
| K | 3 | Repeats add |

Speeds in excess of several hundred hertz are usually beyond reach, so that chips can't be used as frequency counters, for example. But all slow counting and display applications are prime targets. These involve man-to-machine interactions, which are limited by human response times.

Consequently most calculator chips are loosely spec'd with regard to execution times. This allows the semiconductor manufacturer a wide range of process variation, which reduces costs. Reference to calculator-chip data sheets reveals an unusually wide range between the minimum and maximum execution speeds that are guaranteed. These speeds may be a long way from either the mean or the median. But a designer must either live with these speeds or ask the manufacturer to perform special sorting to separate the faster chips.

The time required for each count involves both that for the actual addition and the time to enter the function that causes each addition—either "plus" or "constant." Usually the time required for entry consists of both a key-depression debounce time and a key-release debounce time. Also to be determined is whether the addition time overlaps one or both debounce times. This sort of information is not always available from an ordinary data sheet and may have to be obtained from the manufacturer's applications department.

National Semiconductor's MM5736 calculator chip, for example, has a debounce time-out for key depression and key release of eight word times each. The data sheet indicates that a word time—

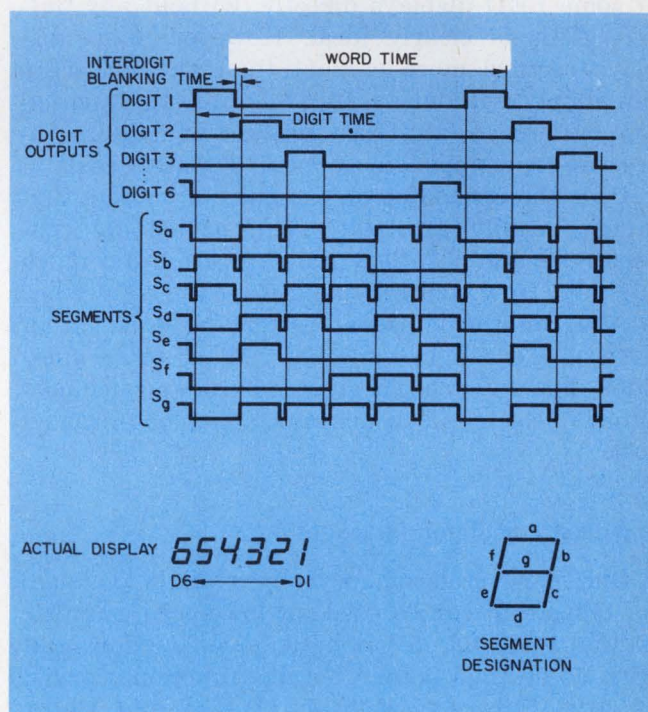

1. LED-display timing relationships for the MM5736, a six-digit calculator chip. The word time represents a basic system cycle.

a basic cycle—varies from 420 μ s to 1.60 ms. Thus the time taken to enter any key depression and get ready for the next one runs from 6.7 to 25.6 ms. The time to execute the addition overlaps the key-release debounce time-out, so that the maximum speed varies from about 40 to 150 Hz. However, the MM5736 has a feature that allows these speeds to be doubled.

Choose the simplest chip

Obviously the more capability left unused when a calculator is used as a counter, the less economical the solution becomes. Don't use a 12-digit, floating-point calculator with memory and constant if you only need a six-digit counter. Choose the simplest calculator chip that satisfies the counting requirement. In general, look for a fixed-point unit with the necessary digits and with Polish notation. Such a chip should yield an economical solution, provided you don't have to count too fast.

The calculator should interface with other logic elements without additional components, if the total component count is to be kept low. If the calculator chip runs off a single supply of less than 15 V, CMOS logic elements can control the calculator. CMOS circuits usually drive the calculator directly, and vice versa. If the calculator requires a voltage higher than 15 V, additional interface elements have to be built, and this requirement can rapidly erode the economic advantages of a calculator chip.

Some calculator chips drive the segment inputs of some LED displays directly, without any buffers. This is clearly ideal. However, some displays require more current than an MOS chip can supply without emitter followers or Darling-ton buffers. Again, the addition of buffers increases the component count and system costs.

Does the calculator chip require a voltage that is not readily available? Will a dc-to-dc converter be needed? Does the chip draw too much current? How well regulated must the supply be? If the counter is to be battery-powered, what battery life can be expected? All of these questions should also be considered before a calculator chip is selected. The answers affect end-product cost.

A typical calculator for counting

One of several commercially available calculator chips that can be used for low-speed counting is the MM5736, a six-digit, five-function unit with no decimal point. The five functions consist of Add, Subtract, Multiply, Divide and Clear. Three inputs— K_1 , K_2 and K_3 —are designed to be used with a keyboard matrix and the chip's digit outputs.

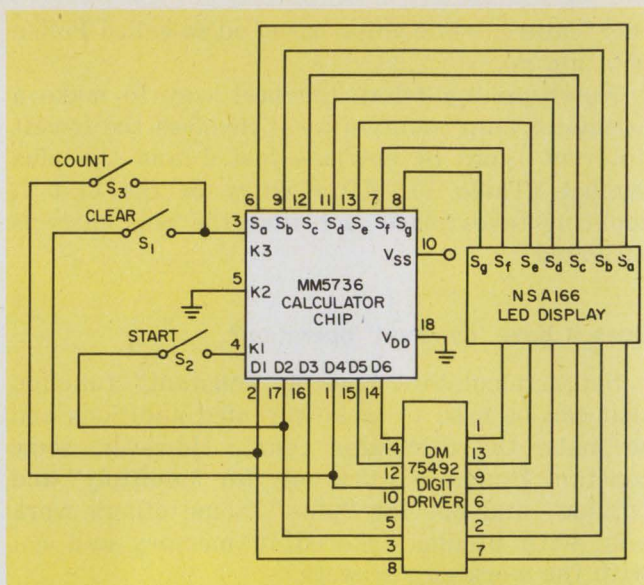

2. Only two ICs are needed to build this six-decade counter. Accumulated totals appear on the six-digit LED display, and the counting rate is typically 60 Hz.

Table 3. Entries and chip inputs

| Digit # | INPUTS | | |
|---------|--------|-------|-------|
| | K_1 | K_2 | K_3 |
| 1 | 0 | | CLR |
| 2 | 1 | 6 | |
| 3 | 2 | 7 | - |
| 4 | 3 | 8 | + |
| 5 | 4 | 9 | × |
| 6 | 5 | | ÷ |

Note: Blanks are illegal connections.

The chip has six digit and seven segment outputs. The segment outputs provide a positive true, seven-segment code that represents the information in the calculator's display register. Multiplexing of these outputs provides the seven-segment code for digit 1 during the first digit time. The code for digit 2 appears during the second digit time, and so on, as shown in Fig. 1.

Also the outputs can drive a LED readout in a digit-multiplexed way by a strobe of the LED characters with the digit outputs. The digit outputs cannot drive the LED display directly and must be buffered with a digit driver. However, the segment outputs can drive some LED displays directly, but you must choose the display carefully to avoid the use of segment drivers.

Numbers enter the calculator by connection of the appropriate digit output to either the K_1 or the K_2 input (Table 3). Arithmetic and Clear operations are initiated by connection of the appropriate digit output to the K_3 input.

Switch debounce requires that a digit output be connected to the proper input for at least

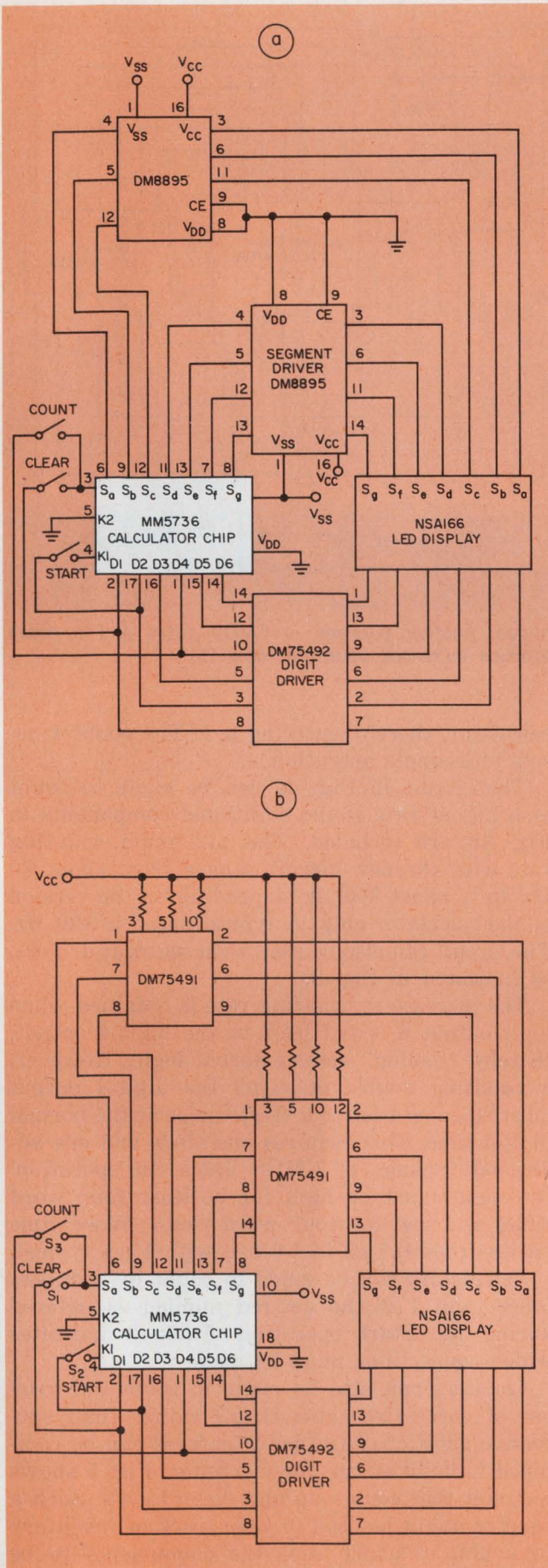

3. Extension of the two-chip circuit in Fig. 2 incorporate segment drivers: Mask programmable types (a) or drivers that use current-limiting resistors (b).

eight consecutive word times. Before another entry can be made, at least eight word times must elapse, during which none of the digits' outputs are applied to the K inputs. This requirement limits the speed of the calculator, but it is needed to provide an adequate debounce time-out.

The MM5736 operates from a single voltage in the range of 6.5 to 9.5 V, which allows battery supplies. The calculator chip itself draws about 6 mA. If a LED display is driven directly, without segment drivers, the current that drives the display must come through the calculator, so the total power supply current can be as high as 110 mA; typically it's about 50 mA.

The power-supply voltage must come up to an operational level fairly quickly, since a slow ramp doesn't always initialize the calculator properly. If the chip is used with a heavily filtered power supply, some provision should be made to allow the V_{SS} terminal of the calculator to rise abruptly. After power up, the calculator should be cleared twice to ensure that all registers are reset to zero. The first Clear operation affects only the display register, while the second Clear affects all other registers.

The calculator chip is directly compatible with standard CMOS circuits. The maximum CMOS load that the calculator can drive depends on capacitive loading. Loads of 200 pF or less should present no problem to the digit outputs, but the segment outputs should not be loaded with more than about 50 pF. As a result, fanout should be limited to about 10 on the digit outputs and four on the segment outputs.

Two ICs make a counter

A six-decade counter that drives a display and requires a minimum of components appears in Fig. 2. The circuit uses two ICs and has a maximum counting rate that is typically 60 Hz. Some chips may run as slow as 40 Hz, while others count as fast as 150 Hz. This is because of inherent variations in the internal oscillator from one IC to another.

The counter in Fig. 2 requires manual reset, which consists of two steps: Clear the calculator and enter a "1" into it again. (Only one Clear operation is needed after an arithmetic operation.) The two steps are accomplished by depression of S₁ and S₂.

Two variations of this counter are shown in Fig. 3. The circuits indicate how to build the same counter but with segment drivers. The driver in the circuit of Fig. 3a must be mask-programmed to source a specific value of current. Generally available currents range from 5 mA up to about 17 mA per segment. Hence fairly large displays can be handled.

Different segment drivers are employed in

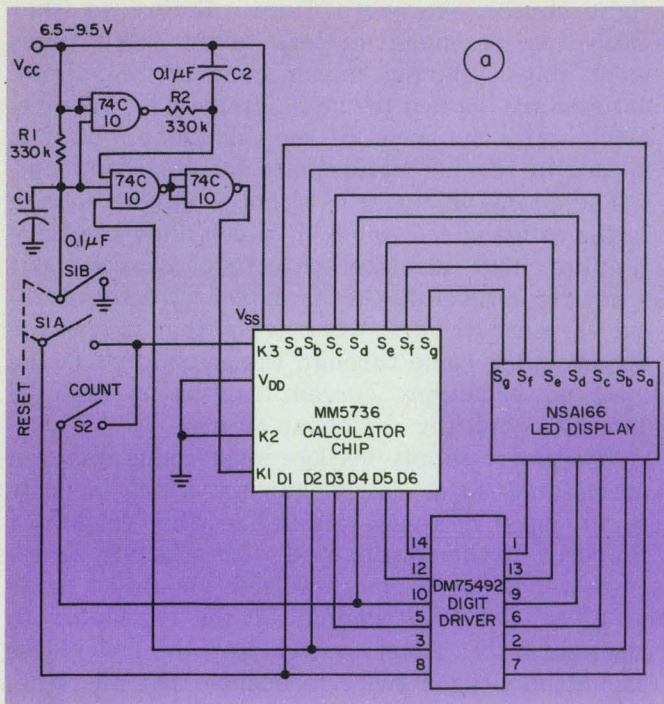

4. Additional components yield further improvements. With CMOS gates, a self-starting counter (a) is ob-

Fig. 3b. External current-limiting resistors determine the current drive to the LED.

With the addition of only one package of CMOS gates, a self-starting counter can be built (Fig. 4a). The counter does not require a separate start operation to enter an initial 1 into the calculator chip. When the Reset switch is returned to its normal position after the calculator has been cleared, the additional components generate a delayed pulse that gates digit output 2 into the

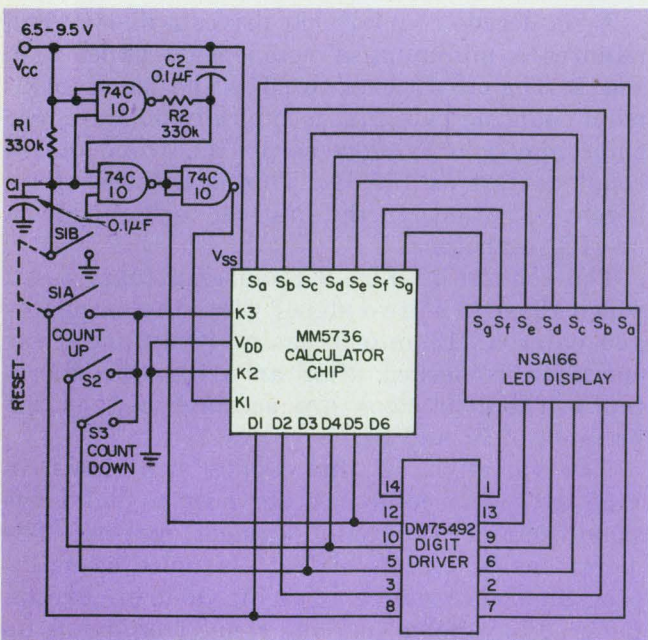

5. Up and down counts of 4 are tracked by this circuit. Counts by numbers other than one are achieved by the connections indicated in Table 3.

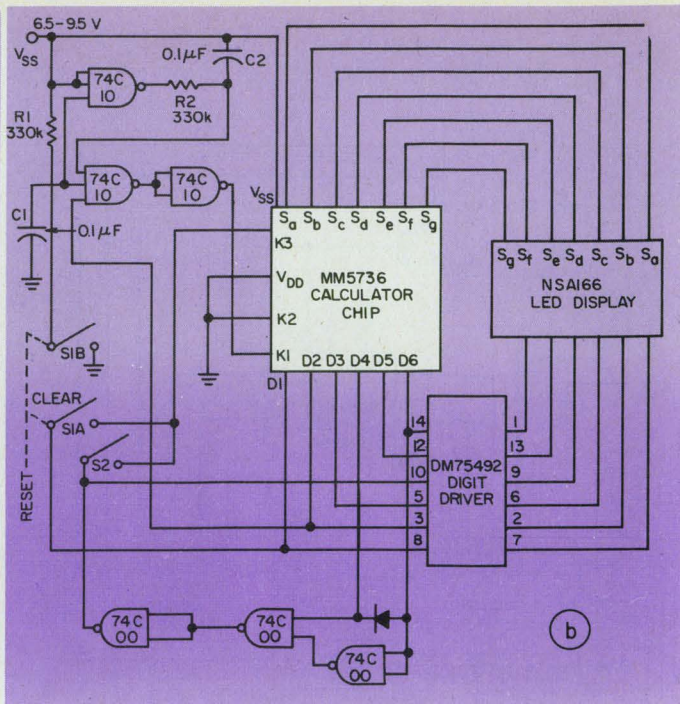

tained. Another package of CMOS gates and a diode produce increased counting rates (b).

calculator, thereby entering a 1. The counter resets in a single operation.

The circuit in Fig. 4a can be made to count at a higher rate if the additional components in Fig. 4b are included. The maximum counting rate with the new circuit ranges from about 80 Hz up to about 300 Hz, depending on the version of the calculator chip. A typical speed is 120 Hz. The circuit can also be used with segment drivers, as indicated in Fig. 3.

The increase in counting rate is obtained when digit output 6 is fed back to the digit-4 output, thereby "fooling" some internal logic. However, a resulting double pulse on the digit-4 output must be gated back to a single pulse at the normal digit-4 time. This requires one diode and one additional package of CMOS gates. In operation, the input must be high for at least four word times and low for four word times. Word time varies from 420 µs to 1.6 ms, with 1 ms typical.

Calculators can be made to count by numbers other than 1 if the desired number is entered during the Start operation. Table 3 indicates which connections must be made.

Counters can also be made to count down by use of successive subtractions rather than successive additions. And both features can be combined to build an up/down counter. Fig. 5 shows a circuit that counts up and down by 4's. Such a counter might be used to keep track of inventory in a bin, in which case the components to be inventoried must be packaged in groups of 4's. When a package is put into the bin, switch S₂ is activated and the counter adds 4 to the accumu-

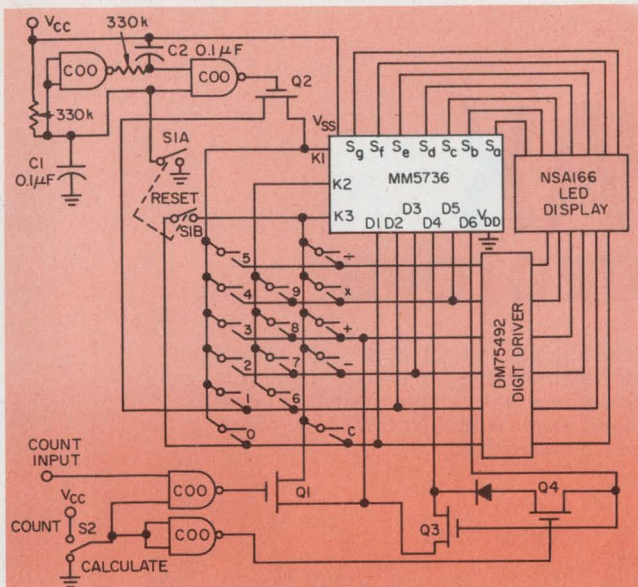

6. A calculator or a counter? Use of external MOS transistors for isolation from the keyboard permits the circuit to operate in either mode. Hence the full capabilities of the calculator chip can be retained.

lated total. When a package is taken out of the bin, switch S_3 is activated and the counter subtracts 4.

Retaining full use of the calculator

Counters also can be built to retain full use of the calculator. This requires that the usual keyboard arrangement of the calculator be undisturbed by the counting logic. Fig. 6 illustrates a circuit that uses MOS transistors to achieve this. The usual calculator operation is retained when S_2 is in the calculate position, since all four MOS transistors— Q_1 through Q_4 —are off (gates are at V_{CC}). With the Reset switch activated, D_1 connects to K_3 and the calculator clears. Capacitors C_1 and C_2 discharge, while S_1 activates. But as soon as S_1 is released, C_1 and C_2 charge to generate a delayed pulse (negative going) on the gate of Q_2 . Then D_2 gates into K_1 and causes a 1 to be entered into the calculator. The delay caused by C_1 allows the Clear function to be debounced.

Maximum counting rate doubles through a reduction of the internal debounce time-out. With S_2 in the Count mode, Q_4 turns on and D_6 ties to D_4 . The count input is now enabled, and an input pulse turns Q_1 on. Then D_4 gates into the K_3 input and causes the calculator to perform an addition. Each subsequent input pulse causes 1 to be added to the sum. When S_2 is returned to the calculate position, the count input disables and Q_4 turns off—an action that returns the keyboard logic to its normal state.

The circuit of Fig. 6 also can be built with NOR gates instead of NAND gates. Then the MOS transistors can be replaced with a CMOS switch. ■■

OSCILLATORS



ANALOG ENGINEERS — We haven't forgotten you. Accutronics has not devoted all its engineering talents to digital devices which are compatible with TTL, ECL, MECL and COS/MOS logic. In our standard product line we carry a complete line of SINE WAVE oscillators from 1 Hz to 250 MHz. Take for example our Series 110 which is neatly packaged in a 1.5 x 1.5 x 1.5 hermetically sealed can and available from 10 MHz to 250 MHz with +10dbm out into 50Ω. GREAT for your analog application.

INTERESTING? Call Gerry DeWar (312) 232-2600, and he will be glad to fill you in on all the details and send you our new catalog.



Series 110

FREQUENCY: 10 MHz to 250 MHz
 FREQUENCY TOLERANCE: $\pm 0.001\%$ from
 0°C to 60°C

SUPPLY VOLTAGE: +12V DC
 OUTPUT VOLTAGE: +10dbm $\pm 3\text{db}$ into 50Ω
 SPURIOUS RESPONSE: >70db down
 HARMONICS: >20 db down
 SIZE: 1.5 x 1.5 x 1.5" typical with OSM
 connector

See Gold Book, Vol. 2 pg. 936-937

Please write or
 call for

NEW 1975 CATALOG

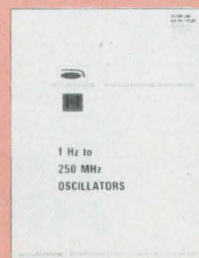

Our new catalog covers various types of oscillators: VCXO, LCVCO, RCVCO, high stability, computer clocks, high output power, Navy standard hardware modules and low current drain oscillators from 1 Hz to 250 MHz. We'll even send you three neat conversion charts (3) to hang on your wall and impress your friends.

accutronics

A HAMMOND CORPORATION COMPANY

628 NORTH STREET • GENEVA, ILLINOIS 60134

INFORMATION RETRIEVAL NUMBER 46

AIRPAX™

CIRCUIT PROTECTORS

Airpax magnetic protectors provide reliable, low cost circuit protection for industrial applications and ground support military equipment. Handle action is trip-free, making it impossible to hold the circuit

closed against a fault. Multi-pole assemblies can be furnished with a mix of ratings, delays, and internal circuit configurations. All Airpax circuit protectors shown here are UL Recognized.

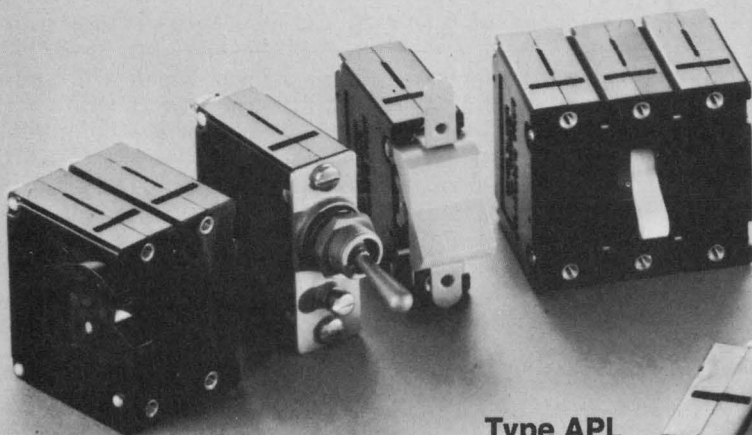

Type APG

Type APG protectors offer a choice of actuators: toggle, thumbwheel, rocker arm, and panel seal. Two and three pole assemblies have single actuators, a unique feature which simplifies mounting. A SPDT auxiliary switch for remote signaling or alarm, rated at 5 amps, can be supplied with series trip types. Current range is 0.02 to 50 amperes. Ask for Bulletin 2003.

Type APL

Type APL protectors have a higher interrupting capacity than any other comparable protector on the market. They are available with extended delay times to accommodate high inrush or motor starting currents without tripping. The APL-RS has a single-pole, double-throw snap switch, rated 5 amps, that is independent of breaker contact. Operates ONLY on electrical overload, does NOT operate when breaker is switched by hand. Full load current ratings from 0.02 to 100 amperes. Ask for Bulletin 2002.

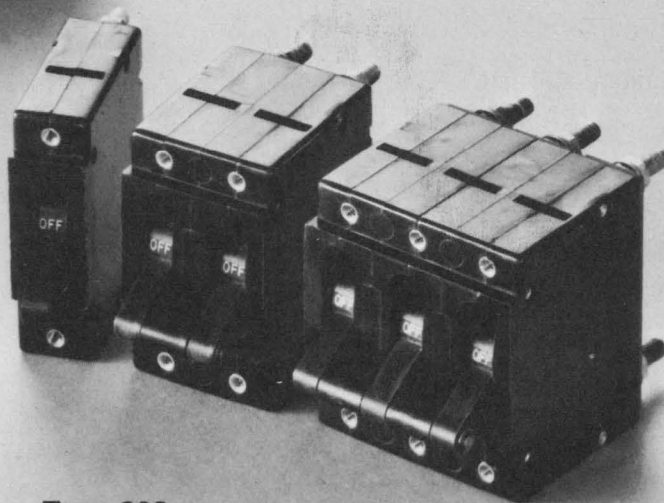

Type 203

Type 203 protectors combine positive over-current protection, ON-OFF switch function, snap-in front panel mounting or optional flush mounting, and plain or illuminated single-rocker actuator. Choice of case, rocker arm, and illumination color combinations. Accurate current ratings from 0.02 to 20 amperes. Ask for Bulletin 2009.



AIRPAX™

ELECTRONICS

Cambridge Division, Cambridge, Maryland 21613
Phone (301) 228-4600

Singer is here to Servo you.

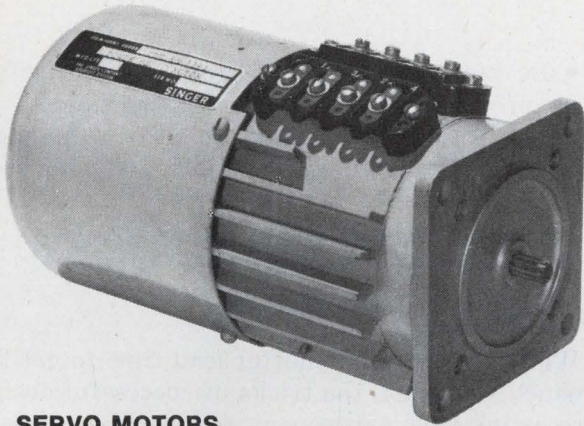

SERVO MOTORS.

Kearfott offers you a complete line to fit just about any application. From a $\frac{3}{4}$ " diameter motor with an acceleration of $150,300 \text{ rad/sec}^2$ to units such as the 7" diameter 1 HP Servo Motor shown above.

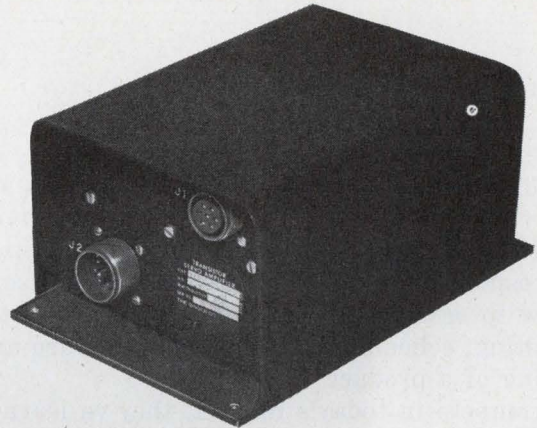

SERVO AMPLIFIERS.

Choose from 1.4 watt output amplifiers to the new 2200 watt unit above. Only 10" long and weighing just 7 lbs., the XA-2200 is a highly-efficient solid-state amplifier that furnishes output required by 1 HP motors.

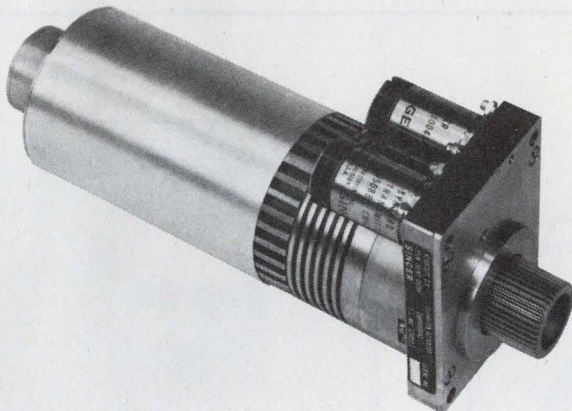

PRECISION POWER SERVO DRIVES.

Our broad line of Servo Motors (to 1 HP) are the primary drive source for our Power Servo Drives. Typical units give you: accurate positional feedback information; low backlash; highest performance/pound.

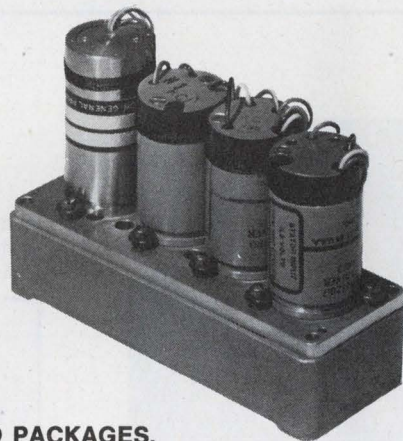

SERVO PACKAGES.

We can give you the "tightest" job, the lowest price and meet your delivery dates. How? We make thousands of Servo components, from motors to clutches. We design and build all associated electronics, from Servo amplifiers to switching networks.

We can meet almost any Servo requirement you may have from a single source—Singer's Kearfott Division.

For nearly 30 years Kearfott has been a pacesetter in the development of small motors and their associated electronics. Today we can offer you a wider variety of Servo components than any other single supplier.

All components are built to the highest order of precision, both in concept and construction. In

addition, we'll design and produce units to your special requirements.

To learn more about Kearfott Servos and capabilities, mail the coupon now, for our information-packed 24-page brochure "Servo Motors". We'll rush it to you. The Singer Company, Kearfott Division, 1150 McBride Avenue, Little Falls, New Jersey 07424.

SINGER
AEROSPACE & MARINE SYSTEMS

The Singer Company, Kearfott Division
1150 McBride Avenue
Little Falls, New Jersey 07424 ED-12

Gentlemen:

Please send me your 24-page booklet on Servo Motors.

Name _____

Title _____

Company _____

Address _____

City _____ State _____ Zip _____

Project success: the main concern in '74.

Eight interviewees tell how they forecast, schedule, design, manufacture and service a product in this year-end roundup.

Richard L. Turmail, Associate Editor

Eight of the 20 engineering managers we interviewed this year for *ELECTRONIC DESIGN* told us how to manage a project better. Shortages, inflation, recession and keener competition were responsible for their overwhelming concern on how to save time and money through better forecasting, scheduling, design, manufacture and servicing of a product.

To compete in today's market, they've learned that they must:

- Be more cognizant of what the customer needs rather than what he wants.
- Be more attentive than ever to design detail.

- Be more aware of the total project effort from product forecast to product servicing.

Here's a roundup of ideas on project management from the engineering managers who were interviewed in 1974 for the series "Challenges to the Engineer Who Manages."

Tightening the loop on forecasts

With a shorter and shorter lead time to get the product to market, the tricks of successful design forecasting and subsequent follow-through take on greater importance for both top management and the designer.

To improve the forecasting ability of Airpax

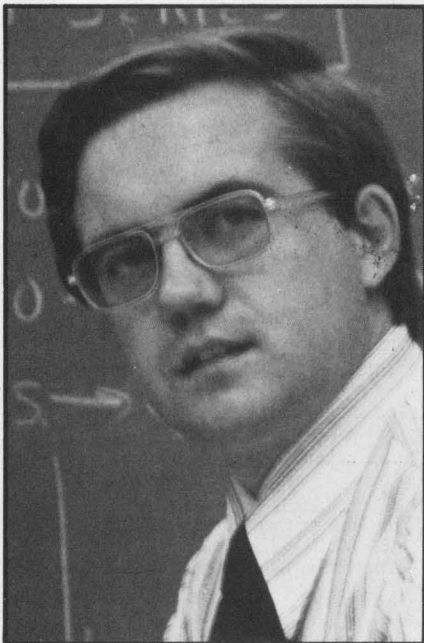

Bernard Schmidt, Manager CMOS Production and Design, Motorola, Phoenix, AZ.

Harold Goldberg, President, Data Precision, Wakefield, MA.

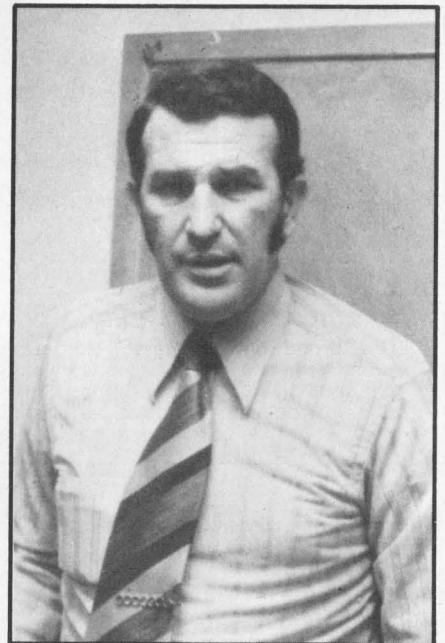

L. J. Seiden, Manager, Engineering, T-Bar, Inc., Wilton, CT.

of Fort Lauderdale, FL, Herb Cook, president, uses the computer models of the U.S. economy.

"I've found these models to be quite accurate and a lot more bullish on America than the stock market has been," Cook says.

Cook also believes in sending his engineers back to school. He's found that it helps to sit at the feet of an experienced physicist, someone who can help the designer take a very long-range look at the state of the art he's in. Such an expert can answer questions like: Is there anything fundamental in the art that's going to change? Is a product line going to become obsolete? If so, why?

Cook says, "An engineer also has to be willing to do some of the dirty work." He has to be able to do the layout for a draftsman and have the draftsman clean it up. That's the trick today—to translate a problem into a commercial reality.

But according to Cook, there aren't enough engineers today who can do printed-circuit-board layouts. An experienced engineer can lay one out in about 35 hours. It would take a technical draftsman maybe 400 hours to do the same thing. It takes personal discipline on the part of the engineer because it's a laborious task. Cook says that it pays off.

But discipline alone, of course, is not enough.

The times also call for the engineer to be shrewder and more informed. The specific reasons for this, says Harold Goldberg, president of Data Precision, Wakefield, MA, is that the ground rules for design have changed in the last few years in the following ways:

- Because of the vagaries of the component market today's designer must be more concerned than ever about their price and availability.

- Unlimited design changes and improvements are a thing of the past; unlike the old aerospace market, in the commercial area it's still a question of price and field service.

- Customers don't want versatility any more. They are looking for small, inexpensive dedicated instruments, and complex ICs are fulfilling the need here.

- Engineers must learn to interface with all departments to be better informed about customer problems.

- Engineers must keep up with current events, particularly where they relate to overseas technology and competition.

"The older engineers resist change," Goldberg says. "The newer designers don't resist as much because they think that computer technology is a panacea, and that's not realistic either."

Goldberg says that engineers should accom-

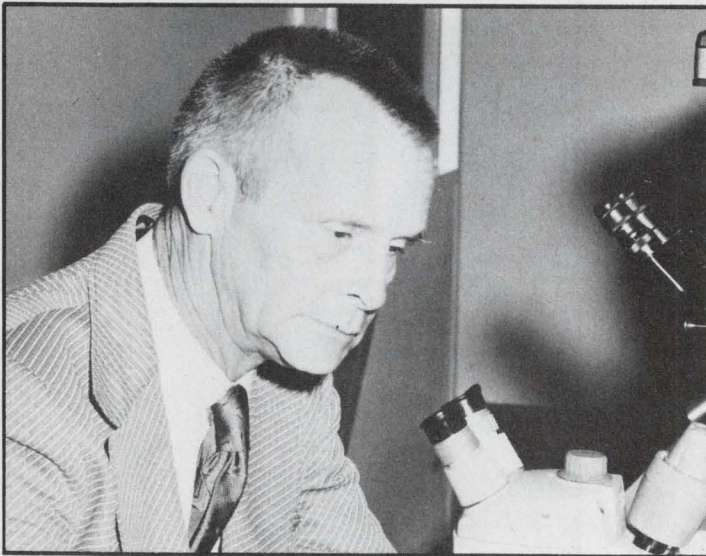

Herb Cook, President, Airpax, Ft. Lauderdale, FL.

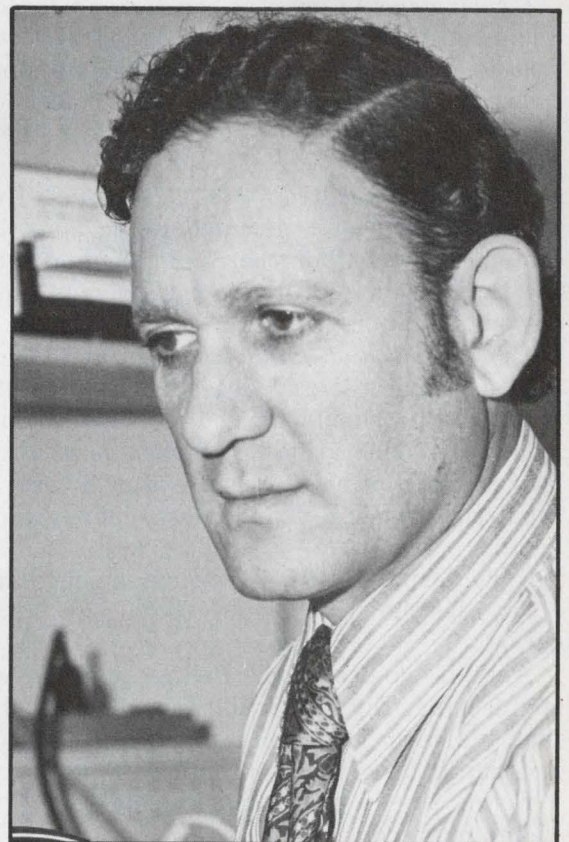

Sumner Weisman, Section Manager, Modular Products, Electrodyne, Sharon, MA.

pany his firm's salesmen on their field trips to hear first hand the user's complaints. He also believes that engineers can no longer afford to ignore the parts salesman or rely on only one vendor or one technology to see them through a project.

Staying loose on design

"And remember," Peter G. Bartlett, president, Automation Systems, Inc., Eldridge, IA, says, "the designs that sell require compromise."

According to Bartlett, when a designer visits a customer to talk about a new product concept, he's often so concerned about losing a prospective sale that he tells the customer he'll give him anything he wants.

"That's a mistake," Bartlett says, "because the customer may be wrong. What the designer should do is analyze the customer's requirements and understand them well enough to know what he needs, instead of what he wants. When the designer is finished, he should know the product better than the customer does."

To reach that point, Bartlett says that a designer must show his ignorance, which he's usually afraid to do. He should realize that he's there to learn what his prospective customer's business is. The customer will most probably be impressed by his candidness.

Three of the traps of compromise that Bartlett says designers should consider are:

Experimenting on the customer's product—Should the designer use an integrated circuit that is higher priced than the old standbys because he wants to use the newer technology? Bartlett advises not to use it unless there's a definite need for it.

The "not invented here" syndrome—Even if the designer hasn't invented it, he must let the customer know when there's an item on the market that's very similar to the product that the customer wants.

Upgrading and downgrading the customer's specs—Maybe the guy doesn't need gold-plating, or maybe he should have it because of environmental considerations. Maybe paper circuit boards can't be used because they'd have to be repaired frequently, and glass epoxy would be better.

"The designer must use common sense and not always let the specs dictate the design," Bartlett says.

And if you're Tom Beling, vice president, engineering, Sigma, Braintree, MA, you believe that it's most important to review that design constantly to test how practical it is.

Beling says: "The market changes and the designer must constantly review his product to determine if it's worth developing further."

Beling knows that charts and reports and planning methods are valuable to keep track of what's going on. But he feels that the danger in using established methods exclusively is that people use them to meet milestones directly and to develop the product indirectly.

To keep his design as current as possible, Beling does two things: He sticks to his initial design approach most of the time and solves the most difficult technical design problem first.

To start or not to start a new design approach is a difficult question.

"It's hard to see the problems in a new approach as opposed to the problems you already know about in the old approach," Beling says.

"My experience tells me: I had a plan and I expected troubles . . . now what's really wrong with that plan? Sometimes that really sober me up. But 70% of the time I'm better off sticking to my first approach."

Beling never bases his decision on how much money has been spent; he feels there's no way he's going to get it back. He has tried both ways often enough and most of the time he has found that if he tries the second approach, the first approach starts to look pretty good again.

Two of the managers we talked to had interest-

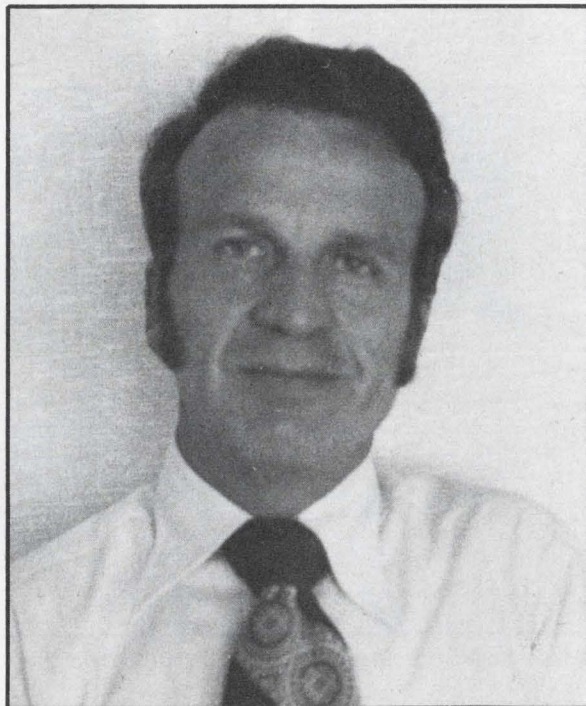

Tom Beling, VP Engineering, Sigma, Braintree, MA.

ing ways of completing their projects on time.

Bernard Schmidt, manager, CMOS Production and Design, Motorola, Phoenix, AZ, says that by cross-fertilizing his staff, hiring support personnel before the designers and giving engineers freedom to invent, he was able to finish a large project fast.

Beating the project clock

Schmidt believes that a common problem of many project managers is to try to pick up experienced talent in the particular field of the project design.

"That's a mistake," he says, "because the engineers you pick tend to be narrow-minded, which leaves little chance for cross-fertilization within the group. Quite often these people just don't have the broad perspective that's needed to generate new ideas."

So Schmidt cross-fertilized ideas in the IC design game. He hired a systems man, a bipolar IC design man, an engineer who was experienced in the PC-board business, a military designer and an R&D engineer.

"That's quite a hodgepodge," he says, "but it was a very creative group."

Schmidt also puts a lot more emphasis than is normal on selection of the leaders of the support personnel—the leader of the drafting group and the leader of the technicians—and trains them before he completes the hiring of the engineering staff.

Delays in time mount against a project while the manager tries to find that one key engineer who's going to make his project successful.

Schmidt says that it's better to look for people with basic engineering ability and count on the training function and experience on the job to make them productive. The manager can afford to do this if he has experienced support personnel.

Schmidt also believes that the manager must constantly reinforce the creative urge of his engineers:

"When there's a creative challenge," he says, "I've found that you can manage the project better by asking your staff to come up with a number of patentable ideas."

Another supervisor, L. J. Seiden, manager, engineering, T-Bar, Inc., Wilton, CT, completes his projects by designing and manufacturing parts for the same project simultaneously. The idea is to send a design drawing to the manufacturing department rather than to make a prototype. This means that he can package a job about as fast as it can be conceived. It also means that the designer has to think fast and make few mistakes.

Most companies, when faced with production of a product in a hurry, design, build, test, then render production drawings of it. But Seiden's approach is to render a set of production drawings first and then test the concept. He's committed to design and development, not research and development. He's not looking for new principles; he's looking to apply known principles—and as rapidly as possible. To do that, he has to get all the needed information on the drawings on the first go-around.

"I remember reading somewhere that no one is more liable to mistakes than he who acts only on second thoughts," Seiden says. "I think of that whenever I use the principle of concurrent design and manufacture to help me manage my projects, because with it, the engineers' first thoughts are the ones that count."

With the concurrent approach, Seiden designs the entire unit at the start as best he can, based on his experience. Less rework is required. They end up with some minor bugs, but they don't end up scrapping the product. They've thought out the problems in advance and made a lot of generalized ground rules that they've decided to live with.

"They may not always be the best rules," Seiden says, "but they're adequate, and we get



Peter G. Bartlett, President, Automation Systems, Inc., Eldridge, IA.

IEE-ELECTRA™

SUBMINIATURE INCANDESCENT LAMPS

- All standard sizes, T ¼ through T 1 ¼, including NEW T1, 28V
- Choice of wire terminal, screw base, bi-pin, midget flange, sub-midget flange special midget flange, and midget groove base configurations
- Broad electrical range: 4 to 28 volts; .014 to .6 MSCP
- Special lamps available to customer specifications
- Hand-crafted for accurate filament location and superior mechanical characteristics
- Seamless and tipless, glass envelope for absolute clarity
- Controlled aging (24 to 36 hours) at rated voltages for filament stabilization and elimination of random failures. **NOW AVAILABLE AT NEW "INFLATION-FIGHTING" PRICES,** Effective Nov. 1st.

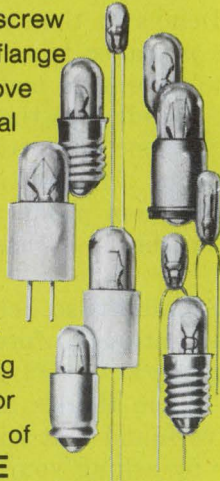

INFORMATION RETRIEVAL NUMBER 291

IEE

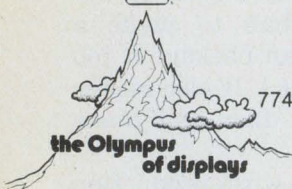

Industrial Electronic Engineers, Inc.

7740 Lemona Ave., Van Nuys, Calif. 91405
Phone: (213) 787-0311

European Office: 6707 Schifferstadt, Eichendorff-Allee 19, Germany.

IEE-HELIOS™

HIGH INTENSITY FIBREOPTIC DISPLAYS



- Extremely high density packaging—.1 cu. in./ .1 oz. per digit & .2 cu. in./ .15 oz. per A/N.—modular assemblies
- ¼" high characters—

7 segment numeric or 16 segment alphanumeric • Ideally suited for avionics & cockpit usage — easily readable in direct sunlight at 40,000' altitude • Variable brightness for night vision — full range of colors • Designed to meet MIL-E-5400 • Low power — 20mA per segment at 5VDC



INFORMATION RETRIEVAL NUMBER 292

DIAL-A-SOURCE: Call toll-free 800-645-9200

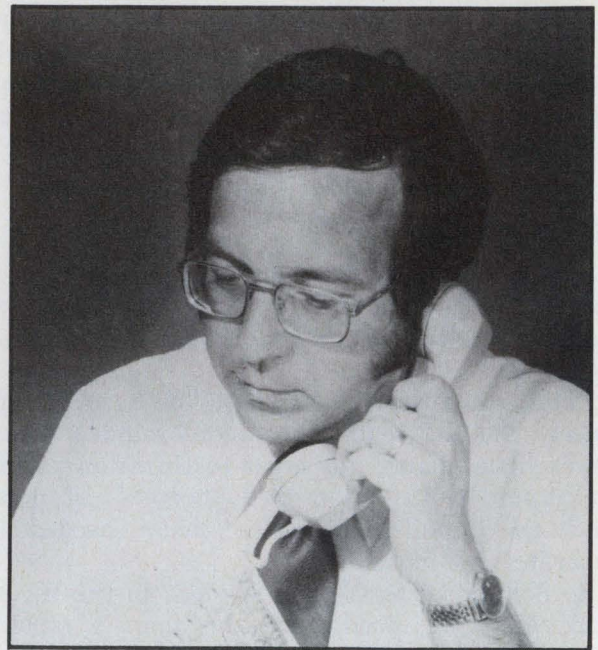

Jack Alford, Director of Product Planning, ILC Data Devices Corp., Bohemia, NY.

the job out in a hurry."

But no matter what management method is used, small companies often have trouble completing projects simply because they cannot always afford to hire both good designers and good project engineers.

Sumner Weisman, section manager, Modular Products, Electrodyne, Sharon, MA, says that learning to wear two hats on the job is one of the most important responsibilities of an engineer in a small company.

"You must remind them constantly of that responsibility," Weisman says.

What happens, according to Weisman, is that designers will occasionally revert to their small world of circuits and components, temporarily forgetting the larger "project world" around them. After some of his designers were becoming less project-oriented and unwilling to consider the broader aspects of a program, he recently distributed a memorandum specifying the requirements for a project engineer as follows:

1. Interface with the section manager and with project management, drafting, manufacturing and quality control, where necessary.

2. Generate, update and test the product specification.

3. Generate the test specification.

4. Provide backup to publications, which means checking the product specification, operator's manual and maintenance manual, as well as writing the theory of operation section of the

maintenance manual.

5. Provide complete information to drafting whenever necessary.

6. Provide backup to manufacturing before and during pilot run, by answering their questions, helping define test fixtures and assisting with component problems such as substitution.

Minimizing later customer problems

Most project managers in companies large and small realize that if their company is going to service its product, they must provide a design capability that minimizes later problems with the customer.

Such is the charter of Jack Alford, director of product planning, ILC Data Devices Corp., Bohemia, NY.

Alford says, "As a company whose goal is to do complete servicing for every product we design, we're acutely aware of a problem that nearly all electronics manufacturers face: How to design products that won't give trouble to the end user—or, if they do, that can be serviced easily."

His engineering staff aims to do it by meeting the following challenges:

- Providing full product characterization.
- Using long-life components.
- Realizing that compromise designs are possible.
- Providing complete documentation.

Any company that is going to service its own product must determine the full characterization of the products, according to Alford. It must find out everything its products can do—not just the minimum and maximum specs, but everything. That will also provide a complete list of applications for potential customers.

After growing from a small company to a larger one, Alford says that they initiated a unilateral engineering review of all new-product designs. As they progressed, they found that the best method was a joint review of design among management, design and manufacturing personnel. This helped to uncover some more of the difficulties that come up in any normal design, and it eliminated the bulk of them.

"Engineering must always realize," says Alford, "that its job isn't done until manufacturing is capable of producing the design with minimum assistance from engineering."

And a company might as well stay away from the ballpark altogether if its engineers are hooked on designing only products that are technological milestones.

"Engineering managers should make it clear to their staffs," says Alford, "that the idea for new products is only as good as the market will accept." ■■

IEE-HERCULES™

LIGHT EMITTING DIODE DISPLAYS

- Red, yellow or green display selection; optional neutral or matching screens for enhanced color
- Choice of .3" (7.62mm) or .6" (16mm) high, seven segment and 5x7 dot matrix A/N characters
- IC, code & logic compatible (with self-contained logic options)
- ReflectORIZED, high contrast design easily readable over 75°-80° angles
- Slim profile, single plane, standard 14-pin, DIP packaging
- Simply installed with IEE-ATLAS Universal Display Mounting Hardware

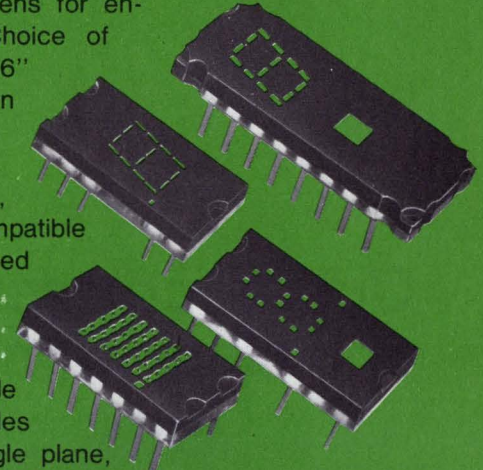

INFORMATION RETRIEVAL NUMBER 293

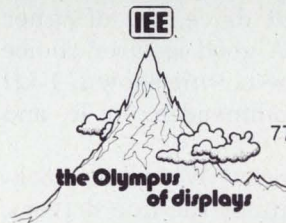

Industrial Electronic Engineers, Inc.

7740 Lemona Ave., Van Nuys, Calif. 91405
Phone: (213) 787-0311

European Office: 6707 Schifferstadt, Eichendorff-Allee 19, Germany.

IEE-ATLAS™

UNIVERSAL DISPLAY MOUNTING HARDWARE

- Provides automatically self-aligning, unitized, "SLIP-IN" installation
- Offers optional two through eight digit flexibility
- Accommodates all standard 14/16 pin, DIP-packaged LED and planar displays
- Simplifies interconnection through wirewrap terminations
- Facilitates wide-angle, optional color, polarized viewing
- Forever puts an end to "do-it-yourself" installation problems

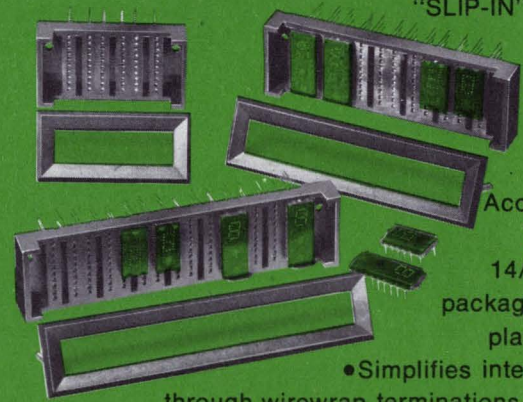

INFORMATION RETRIEVAL NUMBER 294

DIAL-A-SOURCE: Call toll-free 800-645-9200

Optical coupler helps transmit data and clock signals on single wire pair

Both data and clock signals can be transmitted on a single pair of conductors through the use of optically coupled isolators. The circuit concept can be used on party lines.

Selection of the optically coupled isolators depends on the application. When the isolators, OC₃ and OC₄, have sufficient drive, the designer can eliminate inverters G₇. A good isolator choice is the HP 5082-4370. For the circuit shown, 1-k Ω and 330- Ω resistors are recommended for R₁ and R₂, respectively.

Here's how the system works: When the clock-in signal is LOW, the outputs of the line drivers, G₁, are both HIGH, the output transistors from the optically coupled isolators, G₃ and G₄, are both OFF and the clock-out signal is LOW. When the clock-in signal goes HIGH, one of the line

driver outputs goes LOW and the other remains HIGH. If the data-in line is HIGH when the clock-in line goes HIGH, the output transistor of G₁ turns ON, the output transistor of G₃ remains OFF, the clock-out line goes HIGH and the data-out line goes HIGH.

The clock-out line always follows the clock-in line. The data-out line follows the data-in-line when a HIGH clock-in signal is present. When the clock-in signal goes LOW, the data-out line remains in the state prior to the last clock transition. The data-out signals can be fed into a serial-in shift register, which shifts data in on the trailing edge of the clock-out signal.

Richard Gunderson, Senior Project Engineer, ADC Products, 4900 W. 78th St., Minneapolis, MN 55435.

CIRCLE NO. 311

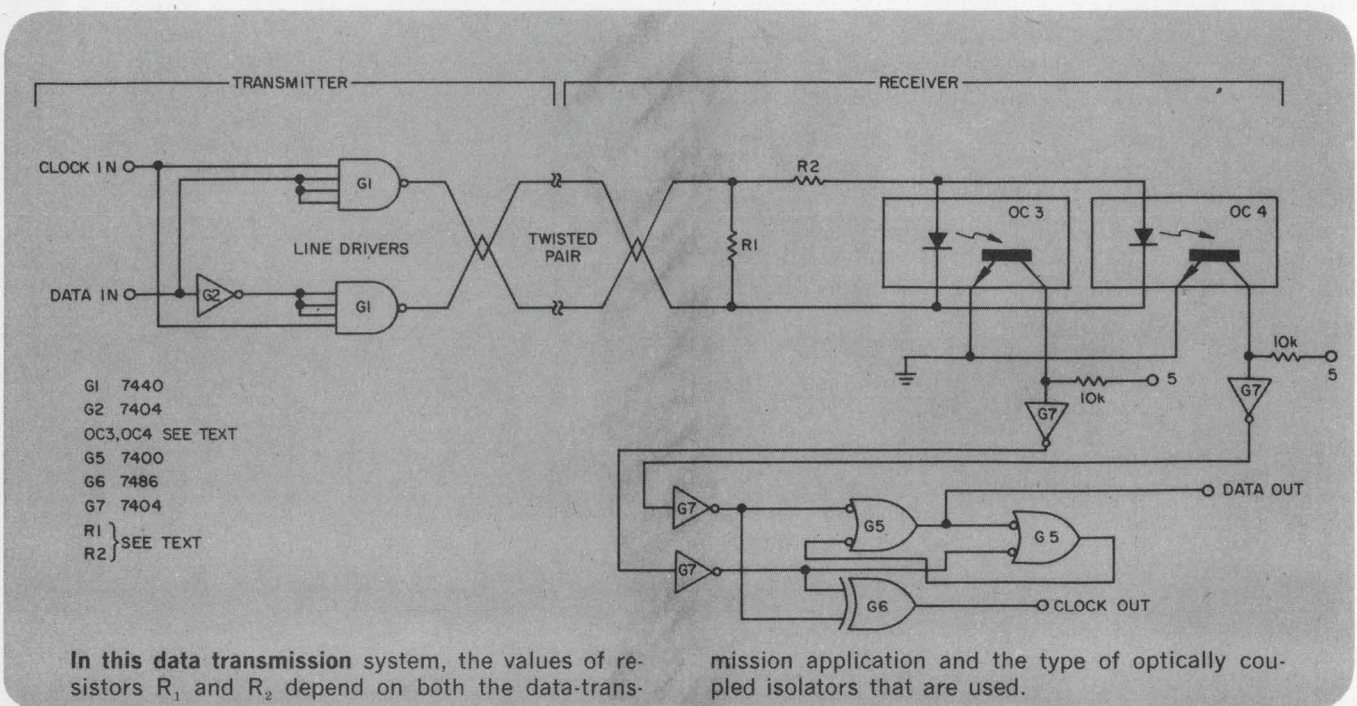

If you need
a tester
with **special**
scales, ranges,
accessories
or any
combination...

Buy a
Triplett tester
custom-designed
for you

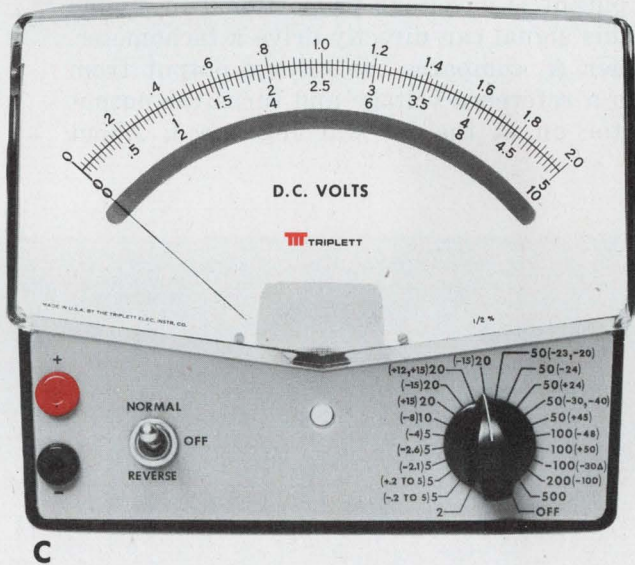
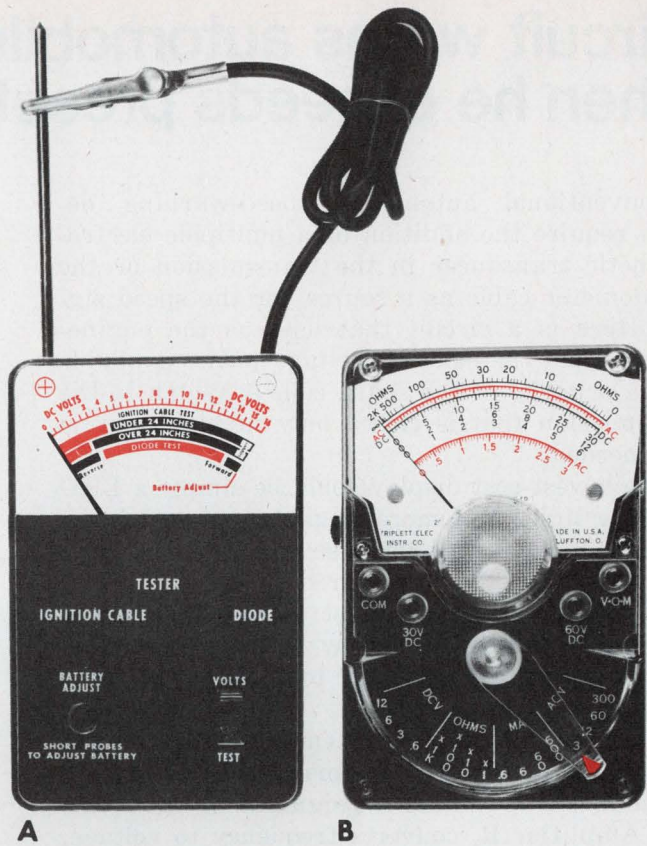

Triplett, manufacturer of the World's most complete line of V-O-M's, is ready, willing and able to design and manufacture special testers of virtually any size, style or type to meet your specifications.

Tester A (above) was designed to give auto mechanics a simple, rugged tester for "go/no go" tests that would otherwise be measured in electrical units unfamiliar to them.

Tester B is a modification of a

standard Triplett tester incorporating only the specific ranges needed by the field service engineers for whom it was designed.

Tester C has special ranges and special input connectors and cables to permit a single-point connection for trouble-shooting and servicing all the circuits of a complex business machine.

Several other buyers of standard Triplett test equipment request their company name on the dial to personalize their testers.

If you think a custom tester may solve some problems for you, contact your Triplett representative. He'll put you in touch with the Tester Designers and Engineers at Triplett who'll help you analyze the problem and suggest the optimum cost/result solution. Triplett Corporation, Bluffton, Ohio 45817

TRIPLETT
BLUFFTON, OHIO 45817

Manufacturers of the World's
most complete line of V-O-M's

INFORMATION RETRIEVAL NUMBER 49

ASK FOR THE NEW

ACOPIAN



POWER SUPPLY CATALOG 1974 1975

...and when it arrives, take special note of pages 42 and 43. They contain a factual—and useful—discussion of Acopian's long-standing 3-day-shipment policy.

You'll find that "3 days" is not just an advertising slogan. It is a firm commitment that we have *never* failed to meet. You'll learn that, in an emergency, we may be able to do

better than 3 days. We've also commented on the "stock delivery" claims of other power supply manufacturers, and what happens to delivery when the units ordered are out of stock.

The remaining pages provide complete specifications and prices for a comprehensive line of power modules and systems. Included are mini

modules for powering IC's and op amps, as well as other supplies with ratings to 60 Amps and regulation to $\pm 0.005\%$. The Acopian catalog also lists redundant output power systems, narrow profile and plug-in modules, and unregulated supplies.

Ask for the new Acopian 1974-1975 power supply catalog.



Corp., Easton, Pa. 18042. Telephone: (215) 258-5441.

INFORMATION RETRIEVAL NUMBER 50

Circuit provides slow auto-wiper cycling, with one to 20 seconds between sweeps

An all-solid-state automobile wiper-control circuit allows the windshield wiper to sweep at selected frequencies from once a second to once every 20 seconds. The circuit uses one IC, two silicon transistors and seven discrete components.

Circuit timing is determined by a 555-timer IC and its external parts, R_A , R_B and C . Transistor Q_1 is switched on when V_1 goes LOW, and npn transistor Q_2 also turns on. The mechanical park switch takes over and conducts the motor current until one cycle of wiper motion is complete. At wiper park, the park switch opens and stops the wiper.

Transistors Q_1 and Q_2 conduct for only about 0.5 s. They do not conduct again until the next timer pulse. The delay between pulses is adjusted with the 500-k Ω delay resistor.

Resistor R_1 limits the current into Q_1 and the base of Q_2 . The peak collector current into Q_2 is about 3 A. Since the duty cycle is normally very low, little heating occurs.

This circuit is in use on a GM-Delco rectangular-motor wiper system.

Paul Galluzzi, Electrical Engineer, P.O. Box 352, Beverly, MA 01915.

CIRCLE No. 313

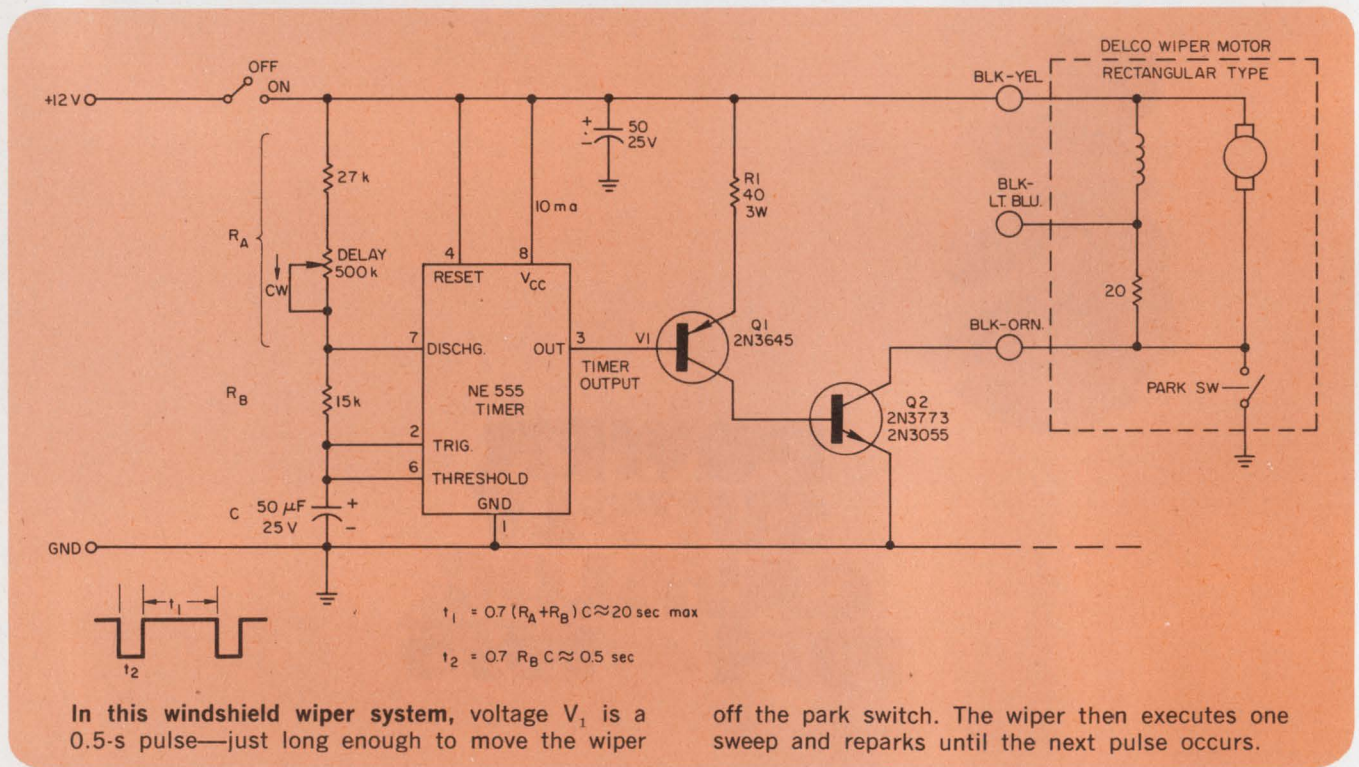

IFD Winner of August 16, 1974

Donn Soderquist, Application Engineer, and Jerry Zis, Mktg. Mgr., Precision Monolithics, 1500 Space Park Dr., Santa Clara, CA 95050. His idea "Successive Approximation A/D Converter Uses Three ICs and Costs Under \$25" has been voted the Most Valuable of Issue Award.

Vote for the Best Idea in this issue by circling the number for your selection on the Information Retrieval Card at the back of this issue.

SEND US YOUR IDEAS FOR DESIGN. You may win a grand total of \$1050 (cash)! Here's how. Submit your IFD describing a new or important circuit or design technique, the clever use of a new component or test equipment, packaging tips, cost-saving ideas to our Ideas for Design editor. Ideas can only be considered for publication if they are submitted exclusively to ELECTRONIC DESIGN. You will receive \$20 for each published idea, \$30 more if it is voted best of issue by our readers. The best-of-issue winners become eligible for the Idea of the Year award of \$1000.

ELECTRONIC DESIGN cannot assume responsibility for circuits shown nor represent freedom from patent infringement.



STRIKE

GOLD

**...every time you
actuate a
Cherry
Keyboard Switch**

Cherry's unique gold "crosspoint" contacts eliminate the two main causes of contact failure—(1) formation of insulating chemical film on contact surfaces, (2) mechanical interference of foreign particles on contacts.

This proven design concept (gold prisms at right angles to each other) provides high force per unit of contact area to enhance reliability. Tested to 50,000,000 operations and beyond, the gold crosspoint contact keyboard switch is available individually, with or without two-shot molded keycaps, or as part of a fully encoded electronic data entry keyboard.

FOR A FREE SAMPLE SWITCH and all the facts on Cherry keyboard switches, plus standard and custom keyboards, PHONE 312-689-7700 . . . or circle reader service number below.

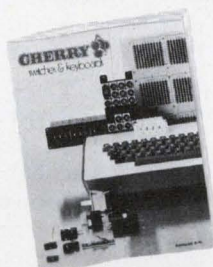

Model B70-54AA Keyboard
53-Key Special Quad Mode

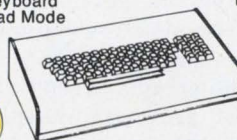

Model B65-1712 Keyboard
12-Key Numeric



Electronic Desk Top
Calculators

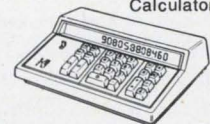

CHERRY



CHERRY ELECTRICAL PRODUCTS CORP.
3609 Sunset Avenue, Waukegan, Illinois 60085

Cherry Worldwide: (Subsidiaries) Hirose Cherry Precision Co., Ltd., Tokyo • Cherry Mikroschalter GmbH, Bayreuth, Germany
• Cherry Electrical Products (U.K.) Ltd., St. Albans, Herts • (Licensee) G.W. Engineering Pty. Ltd., Sydney



INFORMATION RETRIEVAL NUMBER 51

Radar chain to cover Netherlands waterway

A radar chain covering the entire Westerschelde estuary, a Dutch waterway that also serves ports in Belgium, is being constructed by Philips Telecommunicatie Industrie in the Netherlands.

The chain on the eastern part of the Westerschelde will have two unmanned radar towers and a central station using two 3-cm radars. Telecommunication channels will be provided for command and return signals. One tower, the Saaftinge, is to be built on an artificial island

in the estuary.

The 3-cm radar has high resolving power, and the antenna rotates at 20 rpm. Except for the magnetron, the equipment is solid-state. The pulse-repetition frequency is 3000 Hz and the peak power 30 kW.

A time-division-multiplex circuit combines the video signal, the synchronizing signals and the antenna-angle data into a signal with a bandwidth of about 13 MHz. This combined signal is passed to either

of two transistorized radio-relay transmitters operating in the 7 GHz band.

One of these two transmitters is always connected to the antenna, while the output power of the other is dissipated in an artificial load. The antenna has a parabolic reflector of 2.4 m and a gain of about 42 dB. On each tower the antenna is pointed at two identical antennas of the radar center.

Each of these antennas is connected to two 7-GHz wide-band receivers, the output signals of which are continuously compared on the space-diversity principle. The strongest signal is selected automatically.

The time-multiplex signal selected is passed on to a circuit in which it is demultiplexed into a radar video signal, a synchronizing signal and an antenna angle-data signal. These signals are passed on to the display units.

The complete radar chain will have eight or nine unmanned towers.

Strain gauge senses pressures inside body

An electronic system has been designed for the measurement of multiple parameters inside the body, such as the intestinal tract, the circulatory system or the cervical tract. Developed at the Dept. of Biophysics of the Bulgarian Academy of Sciences in Sofia, Bulgaria, the system monitors biomedical pressure waves.

A special silicon strain gauge known as a "rosette" was developed. Twenty-one of these gauges each $1 \times 1 \times 0.05$ mm, are mounted at 3-mm intervals on a probe with a 70-mm-long active section and a diameter of 3.5 mm.

The gauges sense pressure variations, and the outputs from the matrix of gauges show the speed of biomedical waves. Temperature compensation is provided by a non-active strain resistor in a bridge circuit which uses 21 active gauges. Multichannel tensiometric equipment records the outputs of the gauges in parallel or in series,

depending on the propagation speed of the phenomena being examined. Patterns of normal biomedical waves can be obtained, so the system can distinguish abnormal circumstances.

The apparatus is useful for clinical and research applications and can also be a helpful adjunct to surgery.

Contact resistances too low to measure

Metal-to-semiconductor contacts that have resistances too low to be measured have been obtained at the University of Newcastle-upon-Tyne in England. Even when subjected to liquid-nitrogen temperatures, these contacts show no indication of the energy barrier that is typical of grown liquid-epitaxy types.

Usually a thick, high-conductance layer must be grown by costly and complex processes. If strict control is not maintained on the thickness of such a layer, it has excessively high thermal resistance

and, at a certain stage, electrical-contact resistance reappears.

The difficulty in growing a layer of GaAs or InP lies in the volatility of the As and P components. The thin, high-conductance layers are formed by one of the metals acting as an ionizable shallow impurity. At low alloying temperatures, this can be achieved only by regrowth of the semiconducting material after it has been dissolved by metal-layer saturation. The loss of the volatile As and P components results in a regrown layer that is substantially thinner than the dissolved layer. This leads to unwanted contact resistance and an energy barrier.

To avoid out-diffusion of the volatile component, a certain amount of the volatile material is introduced into the alloying chamber, so that its vapor pressure can be carefully controlled. By use of an "overpressure" of As in the growth of contacts on GaAs, a very slow alloying cycle is achieved, and full control is maintained of the growth of the layer thickness.

SEARCHING FOR . . .
RELIABILITY AND PERFORMANCE
IN TINY WIDEBAND TRANSFORMERS?

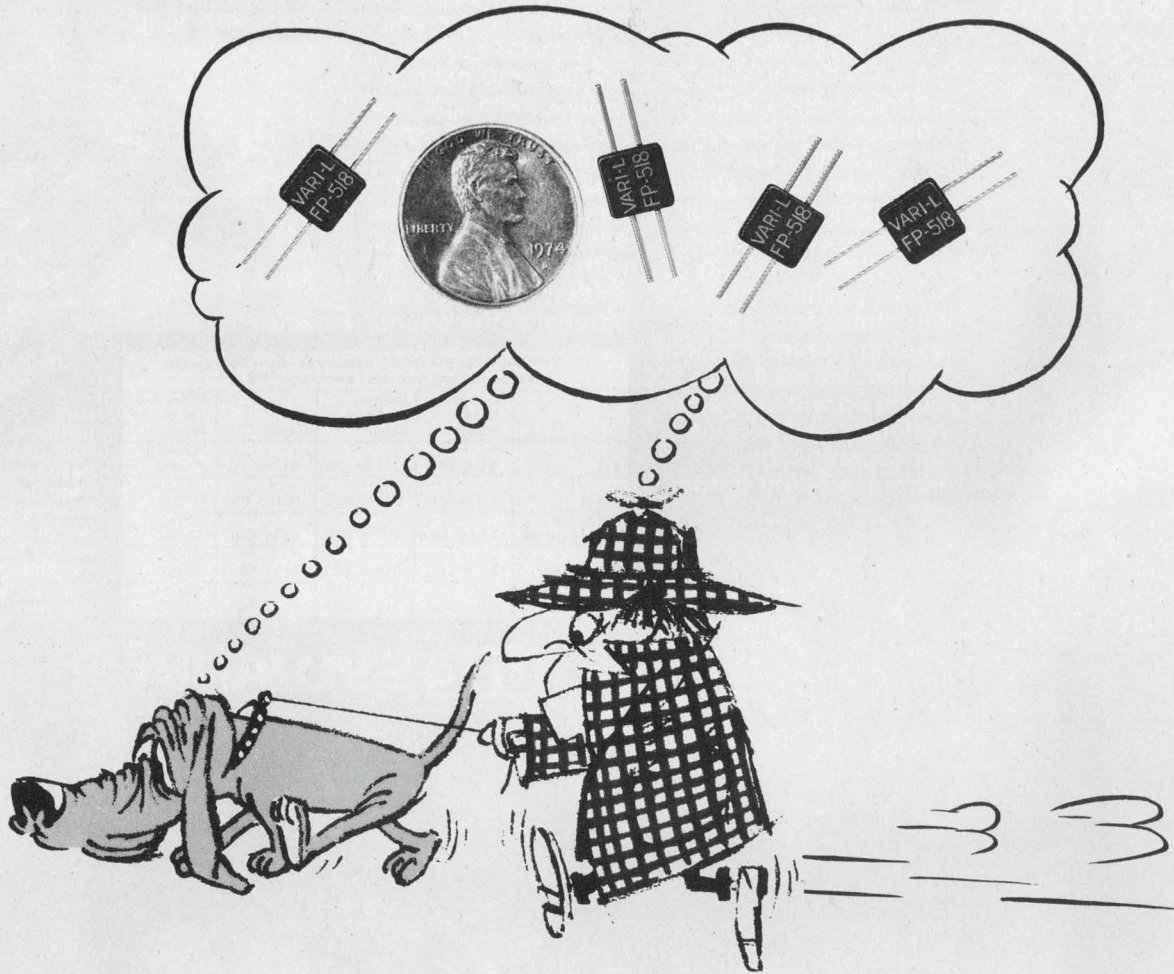

Discover Vari-L's new substrate compatible flatpack wideband transformers.

- Subminiature size — $\frac{1}{4}$ " x $\frac{1}{4}$ " x $\frac{1}{8}$ "
- 0.5 Db Insertion loss
- Ribbon leads
- 12.5 to 600 ohm impedance range
- Up to 1 GHz bandwidth
- MIC Substrate compatible
- Balanced & unbalanced configurations

Their small size, easily solderable or weldable planar ribbon leads, and high performance/high reliability design makes them ideal for MIC substrate and conventional printed circuit applications.

CALL OR WRITE FOR COMPLETE INFORMATION



VARI-L COMPANY, Inc.

3883 Monaco Parkway ■ Denver, Colorado 80207 ■ Phone: (303) 321-1511 ■ TWX: 910-931-0590

Only Sylvania gives you so many ways to beat the real estate squeeze in PC-board indicator lamp arrays.

When you're laying out an indicator lamp array in tight spacing, you need solutions to a wide range of applications problems . . . not just lots of sizes. That's why we've packed so much versatility into our line of PC-board compatible bi-pin lamps.

For example, our new T-2 Tu Pin line offers a wide range of voltages and currents in flat-top bulbs designed for maximum end light output—all engineered with the legendary reliability we've perfected for the telephone industry over the years. For that matter, we've even come up with a special reflectorized version for dramatically increased light output.

But that's just the start. Add our T-1 3/4 and T-1 Bi Pin lamps to the breadth of the T-2 line and you've got lamps with ratings of from 3 to 48 volts, in sizes to meet all needs.

For still more design freedom, our Pin Socket Lamps (another Sylvania first) come with sockets installed on the lamp pins. Solder them into your PC-board, and presto—the lamp is field-replaceable without desoldering. You can even order the lamps with leads bent to 90° so that the lamp lies parallel to the board.

Any way you look at it—if you want versatility in PC-board compatibility, what you want is what we've got. Write or call: Sylvania Miniature Lighting Products Inc., a subsidiary of GTE Sylvania, 526 Elm St., Kearny, N. J. 07032; (201) 997-1850.

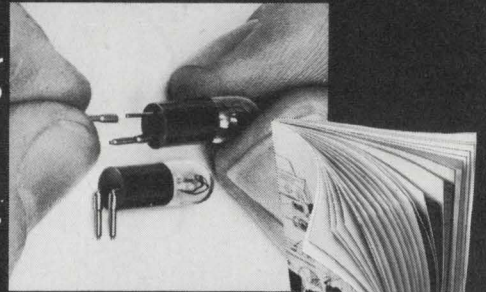

TYPICAL APPLICATIONS: keyboards • busy field arrays • switches • circuit resistors • electronic POS

| | Design Volts Range | Design Amperes Range | MSCP Range | Rated Avg. Life Hours Range |
|--------------------------|--------------------|----------------------|--------------|-----------------------------|
| T-1 | 5.0 to 28.0 | .021 to .115 | .030 to .15 | 10,000 to 60,000 |
| T-1 3/4 | 3.0 to 28.0 | .014 to .350 | .004 to .650 | 1,000 to 60,000 |
| T-1 3/4 Pin Socket Lamps | 1.35 to 28.0 | .014 to .350 | .01 to .650 | 600 to 50,000 |
| T-2 Tu-Pins | 4.0 to 14.0 | .010 to .080 | .01 to .50 | 5,000 to 50,000 |
| T-2 Tu-Pin Reflectors | 4.0 to 48.0 | .010 to .200 | .01 to .50 | 5,000 to 50,000 |

ONE SOURCE, ONE CATALOG
Send for the 56-page Design Data Handbook and full-line Catalog written specifically for the practicing engineer and designer

GTE SYLVANIA

Pack 'em in.

new products

8-bit a/d converter module cuts size and price in half

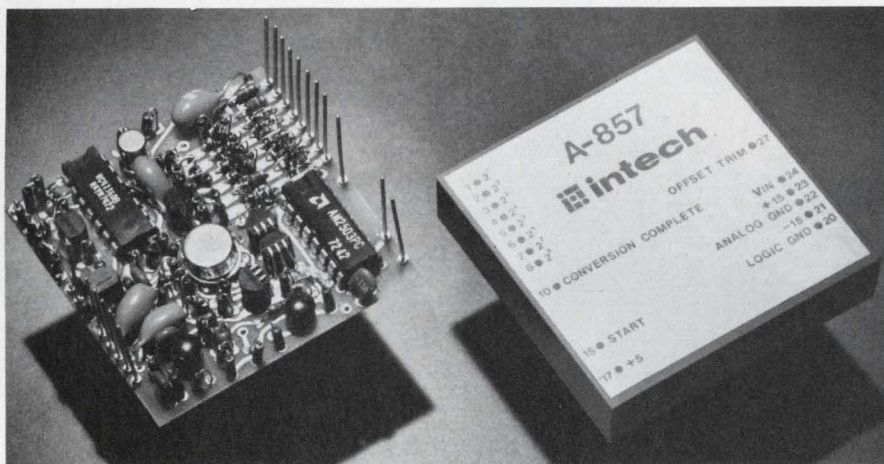

Intech, 1220 Coleman Ave., Santa Clara, CA 95050. (408) 244-0550. \$199 (1 to 24); stock.

Priced at less than \$200 and offering an 800-ns max conversion time in a package only 2 × 2 × 0.4 in., the Intech A-857 analog-to-digital converter shrinks both size and price, compared with its closest competition, the ADC-G8B from Datel Systems (Canton, MA).

The \$385 Datel module, packaged in a 2 × 4 × 0.4 in. case, is almost twice the price and twice the length of the Intech A-857—with about the same conversion time (but for more bits).

Both modules are linear to within ±0.5 LSB, offer at least 8-bit resolution (the Datel unit provides 10 bits) and have an accuracy of about ±0.1% ±0.5 LSB. The modules also share the same successive-approximation conversion technique—the source of their high conversion speed.

Power-supply requirements for both modules are +15, -15 and +5 V dc, but the A-857 needs only +35, -35 and +75 mA, respectively, while the ADC-G8B needs 50, 30 and 380 mA. Supply regulation is less critical for the A-857, since it has internal regulators.

The Intech unit also has an edge on operating and storage temperature ranges: -25 to +80 C and -55 to +125 C, respectively, compared with 0 to 70 and -55 to +85 C for Datel's unit.

The noise immunity, input impedances (2 to 2.5 kΩ), temperature coefficients (50 to 100 ppm/°C) and long-term stabilities (about ±0.1%/6 months) of both modules are comparable.

In a space formerly occupied by an 800-ns a/d converter, a pair of A-857s can provide 400-ns conversion time. This can be done if the converters are multiplexed and allowed to sample input voltages. These voltages are then converted and outputted alternately. The relatively low price of the converter makes this an attractive option.

The Intech A-857 is available with a ±10-V input range, ±15-V overload and complementary binary offset output.

The ADC-G8B from Datel, though, can be ordered with a choice of 0 to -5, 0 to -10, ±5 or ±10-V input ranges, all with ±15-V overload capability, and also with unipolar binary, offset binary or 2's-complement outputs. For Intech **CIRCLE NO. 304**
For Datel **CIRCLE NO. 305**

D/a converters designed for low power drain

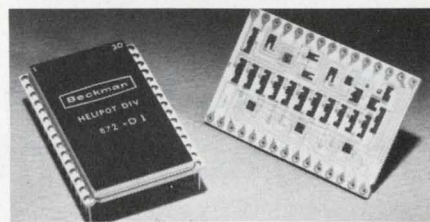

Beckman, 2500 Harbor Blvd., Fullerton, CA 92634. (714) 871-4848. D1: \$88, D2: \$66 (1 to 9 pcs).

The series 872 d/a converter is designed for low-power applications. Features include CMOS switching, an R-2R binary ladder network, a micro-power type 4250 output buffer amplifier and an internal ±10 V precision reference. Typical power dissipation levels are 4.5 mW for the DAC portion of the hybrid, and 40 mW for the precision reference section, which can be operated separately or disconnected. Two models are available, which differentiate between levels of linearity and precision reference specifications. Model 872-D1 accuracy code guarantees ±1/2 LSB in 10 bits over a temperature range of -55 to +125 C. Model 872-D2 guarantees ±1/2 LSB in 9 bits, over the same temperature range. Both units have a typical offset specification of ±1 mV and can be connected for 0 to +10, or -10-V-scale range by external connections.

CIRCLE NO. 309

Retroreflective control has range of 60 ft

MEKontrol, 56 Hudson St., Northboro, MA 01532. (617) 393-2451. From \$180 (single qty.); stock.

The MEK-55-RD81-AAF LED reflective control has a 60 ft. operating range when used with a 3 in. diameter reflector. Ambient light does not affect the unit's operation, whether bright sun or total darkness. The LED light source and alignment indicator have an expected life greater than 100,000 hr. Plug-in relays, reed relays, logic, solid-state ac and dc outputs and five plug-in timing functions are available to provide maximum design flexibility. The unit is available in an "O" ring gasketed NEMA 3, 4, 5 and 12 die cast housing.

CIRCLE NO. 310

DIP-housed multipliers give accuracies within 0.25%

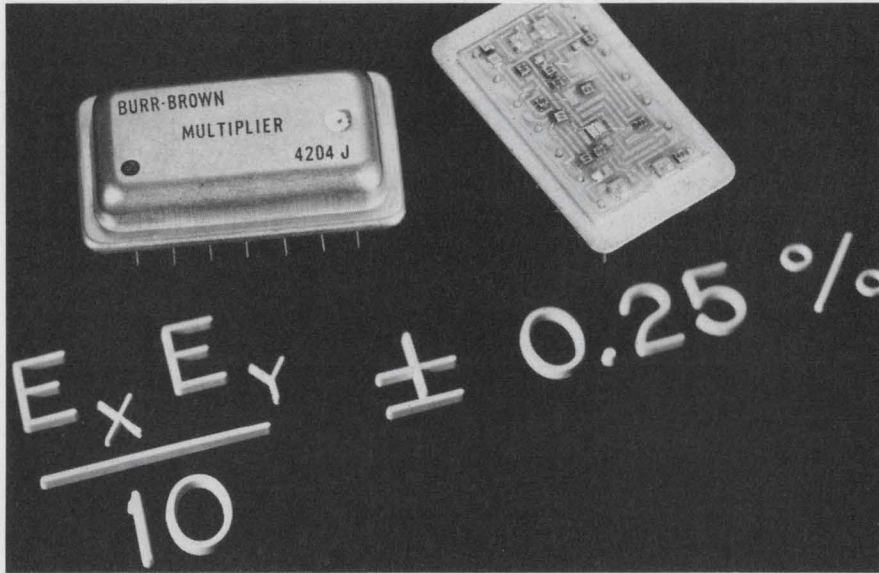

Burr-Brown, International Airport Industrial Park, Tucson, AZ 85734. (602) 294-1431. P&A: See text.

Tighter specs, lower cost and a smaller package are combined in the Burr-Brown 4204J and 4204K hybrid analog multipliers. These units housed in 14-pin hermetically sealed DIPs can deliver pretrimmed 0.5-to-0.25% accuracies at a maximum cost of \$69.

Both multipliers are laser-trimmed for four-quadrant operation. No external components or amplifiers are needed for operation. Output accuracy drifts only 0.019%/°C vs temperature, while

vs voltage, it drifts 0.02%/°.

When connected to standard ±15-V supplies, the multipliers have a 1 V/μs slew rate, a 250-kHz, small-signal bandwidth and a 20-kHz, full-power response. Output noise over a dc to 10 kHz bandwidth (with zero input) is a low 300 μV rms. Signal feed-through at 50 Hz is 10 mV, pk-pk, for the 4204J and 5 mV, pk-pk, for the 4204K.

The internal output amplifier in either model can deliver ±10-V output swings at up to ±5 mA. Output impedance is a low 1 Ω.

Burr-Brown says these units are

the most accurate DIP-sized multipliers available. The closest competitor in package size is Analog Devices, Norwood, MA, with its \$26 Model 532, which has 1% accuracy. Modular units, though, are available from: Function Modules, Irvine, CA; Intronics, Newton, MA; Teledyne Philbrick, Dedham, MA, and Analog Devices, to name a few.

The Function Modules 551 has an accuracy of 0.25% and temperature drift of ±0.015%/°C. It measures 1.5 × 1.5 × 0.4 in. and costs \$98—double the cost of the Burr-Brown 4204J and more than double the size. The M611 from Intronics has about the same specs but costs even more—\$125. The Teledyne Philbrick 4455 is comparable to the Intronics unit—at least for the specs mentioned.

The 435K multiplier from Analog Devices costs \$98, is internally trimmed to an accuracy of 0.1%, has a tempco of 0.002%/°C and is in a 1.4 × 1.4 × 0.65-in. case.

The Burr-Brown multipliers, the 4204J and 4204K, have accuracies of 0.5% and 0.25%, and cost \$49 and \$69, respectively. Delivery is from stock.

| | |
|--------------------|----------------|
| Burr-Brown | CIRCLE NO. 320 |
| Analog Devices | CIRCLE NO. 321 |
| Function Modules | CIRCLE NO. 322 |
| Intronics | CIRCLE NO. 323 |
| Teledyne Philbrick | CIRCLE NO. 324 |



ANALOGY

INTECH'S 3020 TRIPLE LED/LAMP FLASHER IC TO THE RESCUE. THREE INDEPENDENT LAMP DRIVERS, EACH WITH 100 mA CAPABILITY. EACH DRIVER HAS TWO TTL-COMPATIBLE INPUTS. VARIABLE FLASHING AND DUTY CYCLE 5 TO 15V SUPPLY AND LOW STANDBY.

intech INCORPORATED
(408) 244-0500
1220 COLEMAN, SANTA CLARA CA 95050

SIEMENS

High Power Zeners with tested reliability.

Siemens high voltage regulating (Zener) diodes are tested to the extreme to assure you of reliability you can count on, batch after batch, year after year. Here are some of the more significant test procedures that each and every Zener goes through before it leaves our Arizona manufacturing facility:

1. 12 hours storage at 200°C prior to final weld.
2. -55°C to +150°C liquid thermal shock prior to test.
3. All electrical parameters are tested including VZ, ZZT, ZZK, IR and VF.
4. Process norm IR.
5. Process norm VF.

When you need high power and high quality, ask for Siemens. Units are available from stock. For the phone number of your nearest Siemens Components Group sales office, PHONE TOLL FREE (800) 645-9200 (call collect in New York (516) 294-0990).

SIEMENS HIGH POWER ZENERS

| 10 Watt | 50 Watt | 50 Watt |
|-------------|-------------|--------------|
| DO-4 Stud | DO-5 Stud | TO-3 Diamond |
| IN3993-4000 | IN4549-4556 | IN4557-4564 |
| IN2970-3015 | IN3305-3350 | IN2804-2846 |

JAN, JANTX and JANTXV units are also available.

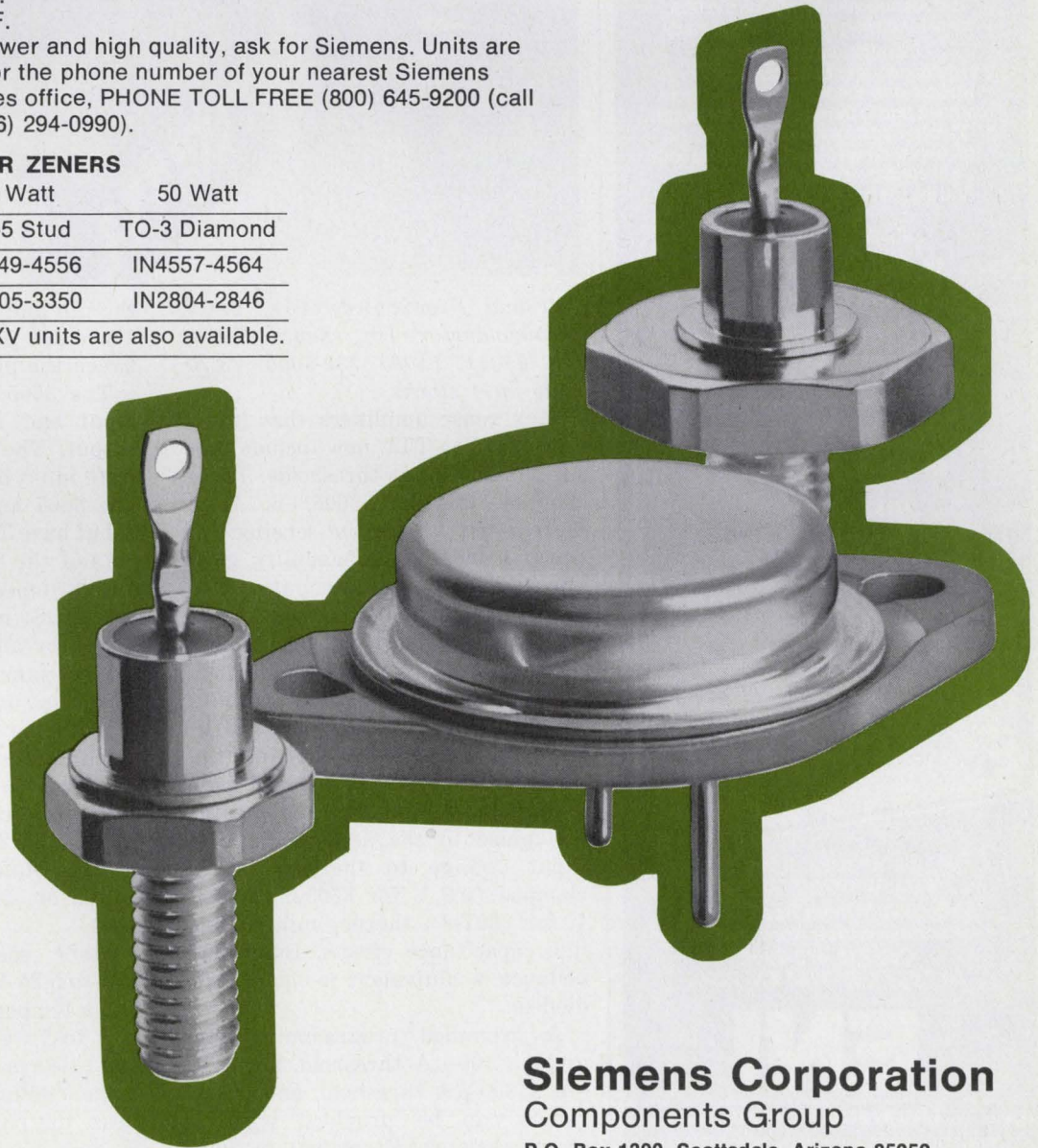

Siemens Corporation
Components Group

P.O. Box 1390, Scottsdale, Arizona 85252
(602) 947-2231 TWX 910-950-1292 Telex 667-406

INFORMATION RETRIEVAL NUMBER 55

MORE POWER MORE BANDWIDTH

Our Model 503L is an ultra-wideband RF power amplifier whose wide range of frequency coverage and power output provides the user with the ultimate in flexibility and versatility in a laboratory instrument. Easily mated with any signal generator, this completely solid state unit amplifies AM, FM, SSB, TV, pulse and other complex modulations with minimum distortion.

Constant forward power is continuously available regardless of the output load impedance match, making the 503L ideal for driving highly reactive loads.

Unconditional stability and instantaneous failsafe provisions in the unit provide absolute protection from damage due to transients and overloads.

This low cost instrument, covers the frequency range of 1.6 to 540 MHz with a linear power output of 3 watts ... and there's no tuning. Priced at \$995.*

Applications include:

- Laboratory instrumentation
- Communication systems
- Laser modulation
- RFI/EMI testing
- Spectroscopy

*USA and Canada



For further information or a demonstration contact

ENI, 3000 Winton Road South,
Rochester, New York, 14623.
Call 716-473-6900.
Or TELEX 97-8283 ENI ROC.

ENI

The world's leader
in solid-state power amplifiers.

INTEGRATED CIRCUITS

Hex MOS/TTL sense amps have programmed levels

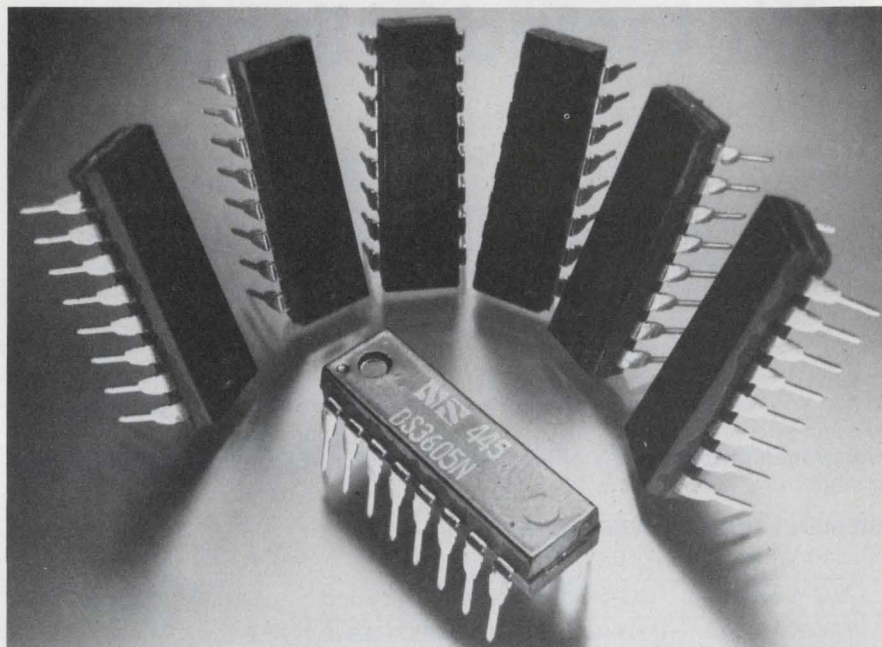

National Semiconductor, 2900 Semiconductor Dr., Santa Clara, CA 95051. (408) 732-5000. \$3.70 (100-up); stock.

Hex sense amplifiers that interface MOS to TTL now include programmable input thresholds. These devices—the DS 3605, 6, 7, 8 series—use a current-sensing input to provide wide flexibility, good speed and noise immunity. The four types available include inverting and noninverting outputs and bi-state and Tri-State inputs.

Input current sensing permits greater output speed for MOS memory systems by allowing the designer to pick the earliest possible point for detection of the input pulse to the sense amp. The input voltage to the circuits is clamped (0.8 V for 3605-6 and 1.6 V for 3607-8), thereby minimizing line capacitance effects. Input impedance is equivalent to one or two diodes.

A grounded programming pin gives a 100- μ A threshold, an open pin a 300- μ A threshold, and other values can be provided with a single resistor. From 100 to 300- μ A, a resistor is connected between

the pin and ground, and for values above 300 μ A the connection is between the pin and V_{cc} .

The 3605 version has a bi-state input and noninverting Tri-State output. The 3606 also has the bi-state input but an inverting output. The 3607 and 3608 follow similarly but have Tri-State inputs. The inputs of the 3607-8 can be forced to a high impedance state, permitting the MOS memory output to be sensed by another MOS device tied to the same line. A bipolar bus driver can interface with the MOS memory via the same line, with the sense inputs presenting no load.

The circuits can sink a maximum of 50 mA at 0.4 V and source 5.2 mA at 2.4 V. In the high-impedance state, the outputs will not source or sink more than 40 μ A, max.

Other specifications include a 4.75-to-5.25-V operating range for V_{cc} , a temperature operating range of 0 to 70 C and typical propagation delays in the 16-to-28-ns range. Being current-sensing devices, the parts do not require the resistor in each input, as used for

(continued on p. 118)

6 ways you can get design flexibility with Panasonic miniature aluminum electrolytics.



1. Panasonic L Series gives you a complete range of standard miniature electrolytics for commercial, industrial and entertainment use. Wide range, from .47µfd to 10,000µfd. 6.3 through 100 volts. Available in axial and radial design, with temperature range of -40°C to +85°C. Panasonic L series mini's can be ordered in standard capacitor tolerances of ±10%; ±20%; or -10%, +75%.

2. Panasonic MS Series can be used to replace larger, more costly mylar capacitors. Their small size reduces space and weight on your PC boards. And because of their extremely low leakage and ESR ratings the MS series can be used to replace dipped tantalums at considerable cost savings. Panasonic MS electrolytics have a capacitance range of .1µfd through 100µfd, 6.3 to 100 WVDC.

3. Panasonic 2H Series gives you top performance under wide temperature conditions. Temperature characteristics from -55°C to +105°C. They have long product life and are available in radial and axial types. These electrolytics can be ordered in a choice of tolerances; ±10% and ±20%.

4. Panasonic 3H Series incorporates very wide temperature range (-55°C to +125°C) and attractive low temperature stability characteristics. The 3H Series can also meet most stringent environmental conditions. Available in axial and radial lead configurations with a choice of tolerances; ±10%, ±20%.

5. Panasonic Z Series are designed specifically for high stability over a temperature range of -40°C to

+85°C. These miniature electrolytics have exceptionally smooth performance curves for temperature vs. capacitance, temperature vs. impedance and D.F. vs. temperature. Both in radial and axial type.

6. Panasonic High Voltage Electrolytics rated up to 500 volts (axial type) and up to 350 volts (radial type). Temperature range from -25°C to +85°C. Panasonic High Voltage Electrolytics are available in capacitance tolerances from -10%, +100%; -10%, +75% or ±20%.

Panasonic miniature electrolytics can meet most tough design specifications that call for very close tolerances, demanding ESR and leakage specs. We invite your special requirements. Panasonic's wide range of miniature electrolytics may be the answer to that special application problem you are trying to solve.

Matsushita Electric Corp. of America
Industrial Division
200 Park Avenue, New York, N.Y. 10017

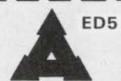

- Have a representative call.
- Send more information on aluminum electrolytics.

Name _____

Title _____

Company _____

Address _____

Phone _____

Panasonic Electronic Components

our technology is all around you

New and improved General Electric lamps provide for increased design flexibility.

Two new sub-miniature halogen cycle lamps ideal for miniaturization.

These new T-2, 6.3V, 2.1 amps, 75 hour GE halogen cycle lamps are the smallest of their type (.265") and set industry standards for size and light output (16-20 candlepower). They are perfect for miniaturization of equipment such as reflectors, housings and optical systems. They also save on overall cost of equipment and are less than half the cost of the #1973 quartz lamp they replace.

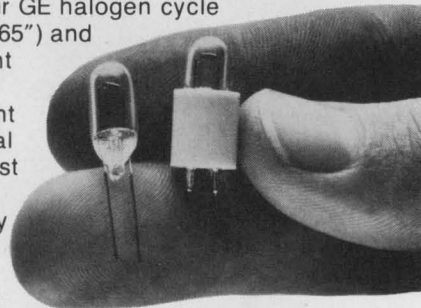

Two terminal configurations are available. #3026 (20 candlepower) has wire terminals. #3027 (16 candlepower) has a new two pin, ceramic base that plugs in to make installation and removal a snap. Samples of the #3027 lamp are available in limited quantities now; production quantities will be available in the first quarter of 1975. These lamps have an iodine additive that creates a regenerative cycle that practically eliminates normal bulb blackening. They will produce approximately 95% light output at 75% of rated life.

An expanded line of Wedge Base Lamps for simple, low-cost circuitry.

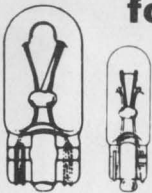

Now you can have greater design freedom than ever before with wedge base lamps. GE now offers six large lamps in its line of T-1 3/4 (.230" max.) all-glass, sub-miniature wedge base lamps. In addition to our three 14V lamps (#37, #73 and #74), we now also offer two 6.3V lamps (#84 and #86) and a 28V lamp (#85).

These lamps are ideal for applications where space is at a premium. Their wedge-based construction allows you to design for low-cost sockets and virtually ends corrosion problems because they won't freeze in the sockets. And the filament, which is always positioned in the same relation to the base, offers more uniform brightness.

Green Glow Lamp has been improved over previous lamp.



Actual Size

Now our G2B Green Glow Lamp, the only domestic green lamp on the market today, gives a more uniform, purer green light than our previous model. It's bright enough for your circuit component applications. With appropriate current limiting resistors, it can be used for 120/240 volt green indicator service. Or used together with our high-brightness C2A red/orange/yellow glow lamps to emphasize multiple functions with color.

All GE glow lamps give the benefits of small size, rugged construction and low cost — 12¢ each for the G2B, 4.4¢ each for the C2A in 100,000 quantities.

Send today for newest literature.

For the most up-to-date technical information on any or all of these lamps, write: General Electric, Miniature Lamp Products Department, # 7412L, Nela Park, Cleveland, Ohio 44112.

GENERAL  ELECTRIC

INFORMATION RETRIEVAL NUMBER 58

INTEGRATED CIRCUITS

(continued from p. 116)

such units as the 3208A and 75108.

The series can be used with a wide variety of MOS RAMs—including most 1-k and 2-k memories, such as the 1103, 1101, 5262 and 6003—and can interface CMOS to TTL. Even with some 4-k RAMs equipped with TTL outputs, the circuits can increase the over-all memory speed.

All versions are packaged in 16-pin DIPs, and a military series is available (DS 1605-8) in ceramic packaging for \$8 in quantities of 100 and up.

INQUIRE DIRECT

Gates, inverters extend low-power S-TTL line

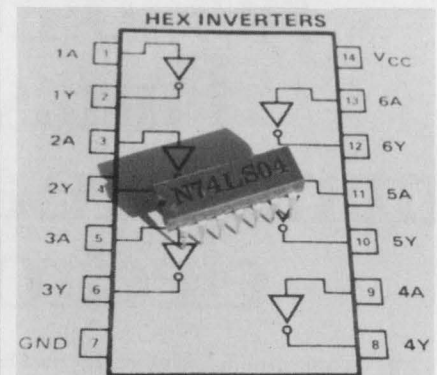

Signetics, 811 E. Arques Ave., Sunnyvale, CA 94086. (408) 739-7700. 50¢ to \$2.42 (100).

Eight positive NAND gates and two inverters form part of the company's low-power Schottky-TTL series. Key features of the circuits include a typical propagation time of 25 ns when driving a load of 15-pF capacitance, and a typical power dissipation of 2 mW per gate when operating at a duty cycle of 50%. The inverters are the S54LS04 and N74LS04, each of which contains six inverters on a chip. The NAND gates include the following ICs; the quadruple two-input S54LS00 and N74LS00, the triple three-input S54LS10 and N74LS10, the dual four-input S54LS20 and N74LS20, and the eight-input S54LS30 and N74LS30. The prefix S54 represents the military temperature range of -55 C to +125 C, and the N74 prefix indicates the 0-to-70-C commercial range.

INQUIRE DIRECT

Scientific calculator comes on single chip

MOS Technology, Valley Forge Corporate Center, 950 Rittenhouse Rd., Norristown, PA 19401. (215) 666-7950. \$17.50 (250,000 up).

A single-chip calculator array (MPS2529) combines algebraic problem entry with parenthesis together with a full range of advanced scientific functions. Initially the array will be offered in three versions for operation with keyboards having 40, 35 or 20 keys. Besides the parenthesis capability, which permits two-level nesting, all versions also have these features: full-range scientific rotation for entry and result data, 12-digit display (8-digit mantissa); improved accuracy using 10-digit internal precision; memory with store, recall and accumulate keys, and full-chain calculation with any function sequence. In addition all versions handle basic arithmetic, exponential, and logarithmic and anti-log functions. Also, included are trigonometric, inverse trig and several convenience functions. Each array comes in a 28-lead DIP, and each contains internal clock generators on the chip.

CIRCLE NO. 325

256 and 128-bit RAMs use ECL 10,000

Motorola Semiconductors, P.O. Box 20924, Phoenix, AZ 85036. (602) 244-3466. \$35 to \$40 (100-999).

Two ECL-10,000 RAMs, the MCM10144L/AL and MCM10147L, are available in 256 × 1 and 128 × 1 formats, respectively. Address-input-to-memory-output access time, for the MC10144, is typically 18 ns, with a maximum of 30 ns. Address-to-output access time for the MCM10147 is typically 10 ns with a maximum of 12 ns. Maximum chip-enable-to-memory-output access times are 10 ns and 8 ns, respectively, for the MCM10144 and MCM10147. Both devices have open-emitter outputs, allowing wire-ORed connection to data busses. Chip Enable inputs permit memory expansion without additional decoding. Operating over a temperature range of -30 to +85 C, the memories are housed in 16-pin ceramic DIPs.

CIRCLE NO. 326

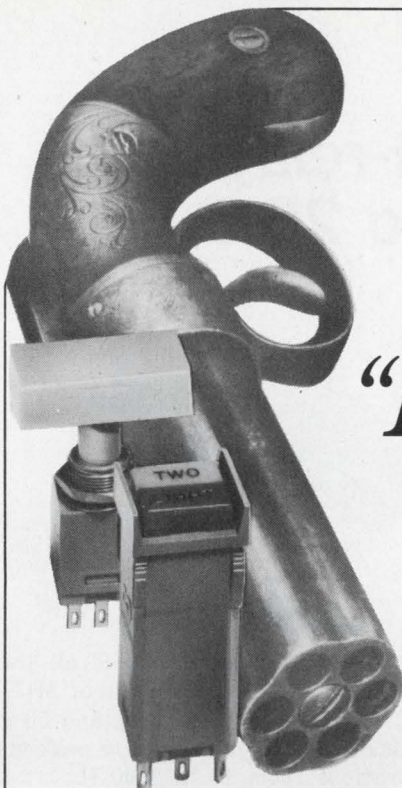

Before you order switchlights, we challenge you to compare our low cost

"Persuader Line"

feature for feature with other leading brands

We're the kind of firm that believes in more than one gun barrel and plenty of ammunition. So when you add our familiar S410* series to our new S190* series, you'll find we have a very convincing line of general purpose switchlights indeed. It's "The Persuader" —the line we invite you to compare for low cost, quality and versatility with that of any other manufacturer. Just check the list below, then get in touch with your local distributor for exact specifications. And we're easy to find . . . located in major cities world wide.

| Standard Features | Clare-Pendar "Persuader" | Micro | Dialight | Other |
|--------------------------|--------------------------|-------|----------|-------|
| 1. Low Cost | YES | | | |
| 2. Distributor Stock | YES | | | |
| 3. U.L. Listed | YES | | | |
| 4. 2 Form C | YES | | | |
| 5. Wiping Contacts | YES | | | |
| 6. Snap Action Contacts | YES | | | |
| 7. 10 amp Rated | YES | | | |
| 8. 2 amp Rated | YES | | | |
| 9. 100,000 Cycle Life | YES | | | |
| 10. 6 Lens Shapes | YES | | | |
| 11. Split Lens Displays | YES | | | |
| 12. Solid/Proj. Displays | YES | | | |
| 13. 5 Adapter Shapes | YES | | | |
| 14. Barrier Adapters | YES | | | |
| 15. Snap-In Mount | YES | | | |
| 16. Rear Panel Mount | YES | | | |
| 17. Gang Frame Mount | YES | | | |
| 18. Quick Connect Trmls. | YES | | | |
| 19. Engraved Legends | YES | | | |
| 20. Alt. Remain-In | YES | | | |
| 21. Mom./Alt./Indicator | YES | | | |

*S190 \$1.62 in quantities of 1000

*S410 \$2.53 in quantities of 1000

See distributor listing Vol 1/568

SEE
Electronic Design's
GOLD BOOK
FOR COMPLETE
PURCHASING
INFORMATION

CLARE-PENDAR



CLARE-PENDAR
a GENERAL INSTRUMENT CO.
Box 785, Post Falls, Idaho 83854
(208) 773-4541

Low profile mini-relays can handle up to 26.5 W

WABCO, Aerospace Dept., Swissvale P.O., Pittsburgh, PA 15218. (412) 242-5000. P&A: See text.

The 911 series of hermetically sealed low profile relays is designed to fit on densely packed printed circuit boards. The flat packaged, rotary armature type relays measure only 0.25 in. high and have rigid, 0.25 in. long, 0.025 in. diameter, terminal mounting pins.

Relay contacts are arranged as double-pole, double-throw (dpdt) to give two independent circuit switching actions.

The relays are available in coil voltages of 6, 12, 26.5, 48 and 76 V dc. Other coil voltages are available on special order. The series

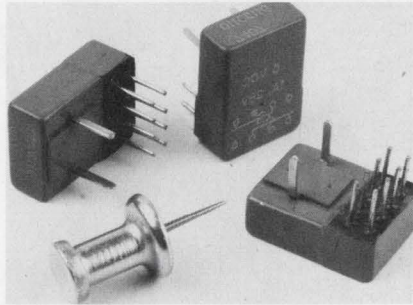

911 relays meet or exceed all the performance requirements of MIL-R-5757D. They can withstand 50 g shocks for 11 ms and 20 g peak vibrations from 10 to 2000 Hz.

The low height of the relay permits closer board spacing, while the plug-in, solder dip terminals

simplify self-mounting. The terminals also eliminate the need to fish free leads through PC board holes or use mounting brackets with screws or rivets. Contacts are rated for low-level dry circuit loads of up to 1 A at 26.5 V dc, resistive (maximum). The contact life expectancy is specified for more than 100,000 operations at full rated power to the load.

The operating temperature range for the relays spans -65 to $+125$ C.

Prices for the 911 series relays start at \$7 to \$8 when ordered in 1000 piece lots. Delivery for the relays is from 8 to 10 weeks.

CIRCLE NO. 302

10MHz 5" scope with easier calibration and voltage measurement

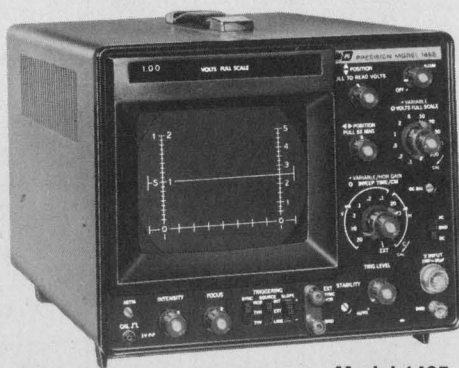

Model 1465 \$400

Here are some B&K extra touches. Besides DC-to-10MHz bandwidth, triggered sweep, automatic sync, 16.6mV/cm vertical sensitivity, DC-coupled amplifier and front-panel Vectorscope capability, Model 1465 also has 5X magnification to increase sweep speed to 0.2usec/cm for complex waveform analysis. And Cali-Brain®, which collapses horizontal sweep to let you measure instantaneous peak-to-peak voltage easily while simultaneously displaying the full-scale voltage range. Now in stock at your local distributor or write Dynascan.

B&K PRODUCTS OF
DYNASCAN
1801 W. Belle Plaine Ave.
Chicago, IL 60613 • (312) 327-7270

Your quality work deserves digital convenience



Model 282 Multimeter, \$200

Model 282's DC accuracy of reading of $0.5\% \pm 1$ least significant digit makes it 6 to 13 times more accurate than the industry's most popular bench-type VOM. And it's much easier to read Model 282's bright digital display. Also features automatic polarity, clear out-of-range indication, automatically positioned decimal point, full overload protection, 100% overrange capability, 10 megohm input and isolation probe. Now in stock at your local distributor or write Dynascan.

B&K PRODUCTS OF
DYNASCAN
1801 W. Belle Plaine Ave.
Chicago, IL 60613 • Phone (312) 327-7270

Precision potentiometer features low cost



Beckman Instrument, 2500 Harbor Blvd., Fullerton, CA 92634. \$5.50 (1-9); stock.

Model 7286 precision potentiometer is a high-performance, low-cost unit. Some features of the 10-turn, 7/8-in.-dia, bushing-mounted resistance element are: 2-W power rating at 70 C, independent linearity within 0.25% and ambient temperature range from -55 to 125 C. A separate contact position guide decreases coil wear. Several other features available on order are: center tap, linearity tap, flatted shaft, slotted shaft and shaft lock.

CIRCLE NO. 327

Pushbutton switches assemble to 50 stations

Sys-Tec, Inc., 877 Third St. S.W., New Brighton, MN 77112. (612) 636-6373.

The simple basic design of CG-7700 pushbutton switches allows many variations. It is possible to have a continuous bank of up to 50 stations, lighted or unlighted. Contacts are either leaf-type springs with cross-bar contacts, open snap-action contacts or enclosed snap-action contacts. Contacts can be stacked in assemblies from 4PDT to 12PST. Standard construction allows interlatching and lock-out actions between all stations on a single bank assembly of up to 50 stations.

CIRCLE NO. 328



Introducing Shelly's TRANS-EYE

the microminiature front-relampable indicator light with a built-in solid state amplifier.

Built-in Hybrid Drive Amplifier

Another good reason why Shelly sells more T1 incandescent indicators than anyone. It's our Trans-Eye with built-in hybrid amplifier. Configurations (NPN or PNP) include internal base current limiting resistor, pull-up resistor, diode in series with base to increase noise immunity,

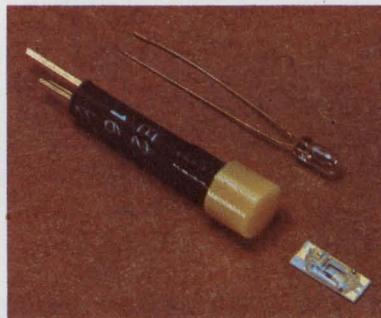

and a unit which is compatible with positive inverted logic. We've put the drive circuitry into the lamp so you don't have to mess around with it on your boards.

Just Snap Into Panel

Trans-Eyes are easiest to use too. Just insert into .191" hole and press into position. Front panel relamping is also a cinch.



No tools needed. Just remove snap-on cap, remove lamp, insert new one, replace cap. Takes just seconds. Trans-Eyes are just right for contemporary panels where space is at a premium. Mounting on .225 centers, they offer clean design and high illumination. The modern look.

Standards Or Specials

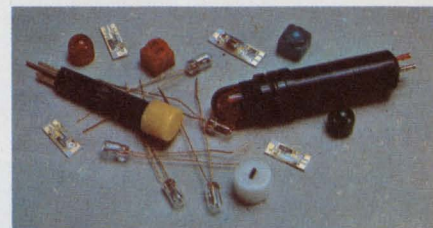

Choose from a wide variety of standards. 7 cap styles. Translucent or transparent caps in red, green, amber, yellow, blue, white and clear. Eight different base/circuit configurations. Or specify Trans-Eyes to your own special requirements. Tell us what you need. We'll take it from there.

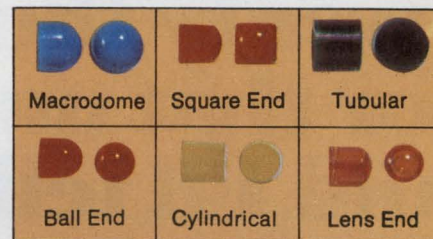

Digi-Caps Too

Imagine. One or two letters, numerals or symbols imprinted on a tiny Trans-Eye indicator. A great way to give added dimension to your display.



Send for our free "How To Order" brochure or phone 800-645-9200 EEM Dial-A-Source.

shelly associates

A Subsidiary of Datatron, Inc.

1562 REYNOLDS AVENUE, SANTA ANA, CALIFORNIA 92705
PHONE (714) 540-9330 • TWX 910-595-1859
MAILING ADDRESS: P.O. BOX 11427, SANTA ANA, CALIFORNIA 92711
INDICATORS • MULTI MESSAGE DISPLAYS • FIBER OPTICS • ANNUNCIATORS

INFORMATION RETRIEVAL NUMBER 62



**“Okay, okay.
You tell me where we can find
twenty thousand RAMs a week
for that much less than the 2102
and I’ll tell you where to find
the Easter bunny.”**

*New low price —
\$3 each!
(quantities over 1000)*

Give him the good news:

You can find all the 1K RAMs you need right now—right here at AMI. We have 4006, 4008 and 4008-9 RAMs ready for immediate delivery. They’re pin-for-pin with Mostek’s. But you can get more of ours—faster. (Stands to reason that when you have larger production facilities you can produce more.) The price is right, too. For example, the 4008-9 is yours for just \$3.50 in quantities over 1000. You get the advantages of a 2102 system, while saving a bundle with our 4006 family. You can get an application note on how to do it, and a free sample, by writing to

Frank Rittiman, AMI, 3800 Homestead Road, Santa Clara,
CA 95051. Phone: (408) 255-3651. Or ask your distributor.

AMI
AMERICAN MICROSYSTEMS, INC.

Low-cost disc drives offer 6.2 Mbit capacity

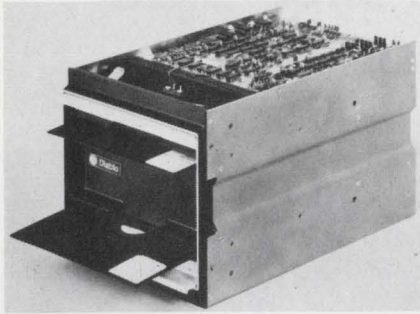

Diablo Systems, 24500 Industrial Blvd., Hayward, CA 94545. (415) 783-3910. See text; stock.

Features of the Series 10, Model 12 flexible disc drives include copy capability, 612 Mbit capacity, IBM 3740 compatibility and ceramic/ferrite heads for longer diskette life. These units are said to provide two drives in about the same size package as most single units. Price for single units is \$1100, which drops to under \$600 for large quantities.

CIRCLE NO. 329

Adapter mates mini to maxi as a peripheral

Austron, Inc., 1915 Kramer Lane, Austin, TX 78758. (512) 836-3523. See text.

The Model 8001 is a buffered adapter that performs all interfacing between the IBM 360/370 multiplexer channel and a bidirectional 16-bit minicomputer I/O channel. Either single byte or multibyte transfers are accomplished (four-byte maximum). A sequence buffer relieves the mini of channel response requirements. Transfer speed depends on mini cycle time. A 1- μ s mini can achieve 42 kbyte/s; for minis with 750 ns or less, the rate goes to 50 kbyte/s. The adapter plugs into the channel cable and conforms with the interface standard for IBM peripherals. Software is free, and the mini can appear as a card reader, line printer to the maxi. Price varies with quantity from \$8500 (for a single unit) to \$4000 for large purchases.

CIRCLE NO. 330

TTY-compatible terminal has 132 print positions



Sperry Univac, P.O. Box 500, Blue Bell, PA 19422. (215) 542-4213. \$2592; stock.

A communications terminal named the DCT 475 includes a data entry keyboard and an incremental printer for operation at 10 char/s. The TTY-compatible unit prints the full 63 ASCII characters and provides up to 132 print positions. Communications can be full or half-duplex.

CIRCLE NO. 331

THE MAXI KEYBOARD FAMILY

Shopping for keyboards? Don't buy more — or less — than you need. Maxi can supply keyboards to your mechanical and electronic requirements, in standard or custom configurations.

Economy? Our 3100 Series encoded keyboard with mechanical contacts is priced as low as the \$50.00 range in quantity. Dual bifurcated gold contacts have a life of over 10^7 operations under load.

Need the option of glass reed switching? The Maxi 2700 Series keyboard combines low cost and high reliability. All reeds are pre-tested before assembly, and switch modules are machine-adjusted for accurate operating point.

Special key actions? The Maxi 1800 Series keyboard offers more action options than any other keyboard on the market. Interlatch and lockout, accumulative latch, solenoid hold and release to name a few. Even illuminated buttons if you need them. Its metal frame construction makes the 1800 Series the strongest keyboard of the market.

The Maxi keyboard line includes double-shot and engraved buttons in a variety of sizes and colors. Encoding is another flexible Maxi option. Specify USASCII, EBCDIC or special codes in up to nine bits. The Maxi keyboard family has a member exactly suited to your needs. Call or send your specs for a firm quote on cost and delivery.



THE

(See Maxi in EEM)

Maxi-SWITCH CO.

9697 East River Road • Minneapolis, Minnesota 55433 • (612) 755-7660



Our advanced hi-speed CRT's now available with color.

- high sensitivity, short length, electrostatic deflection.
 - up to 15" diagonal and 16" diameter tubes.
 - up to 850 MHz bandwidth.
 - ruggedized types available.
- for oscilloscope, radar and data display.



THOMSON-CSF

MARKETED IN NORTH AMERICA BY DUMONT ELECTRON TUBES & DEVICES / 750 BLOOMFIELD AV. / CLIFTON N.J. / TEL (201) 773-2000
FRANCE - THOMSON-CSF GROUPEMENT TUBES ELECTRONIQUES / 8, RUE CHASSELOUP-LAUBAT / 75737 PARIS CEDEX 15 / Tél. (1) 566 70 04
Germany - THOMSON-CSF Elektronenröhren GmbH / Am Leonhardsbrunn 10 / 6 FRANKFURT/MAIN / Tel. (0611) 70 20 99
Italy - THOMSON-CSF Tubi Elettronici SRL / Viale degli Ammiragli 71 / ROMA / Tel. (6) 38 14 58
Japan - THOMSON-CSF Japan K.K. / Kyosho Building / 1-9-3, Hirakawa-cho / Chiyoda-ku / TOKYO 〒102 / Tel. (03) 264 6341
Sweden - THOMSON-CSF Elektronrör AB / Box 27080 / S 10251 STOCKHOLM 27 / Tel. (08) 22 58 15
United Kingdom - THOMSON-CSF Electronic Tubes Ltd / Bilton House / Uxbridge Road / Ealing / LONDON W 5 2TT / Tel. (01) 579 55 11 / Telex 26 659

2111

INFORMATION RETRIEVAL NUMBER 66

ALL AMERICAN LINE

PUSHBUTTON

As low as **19c** per station.

Order 1 to 15 stations with 1 to 6 poles and multiple actuations. U.L. listed 3 or 6 amps, 125v.

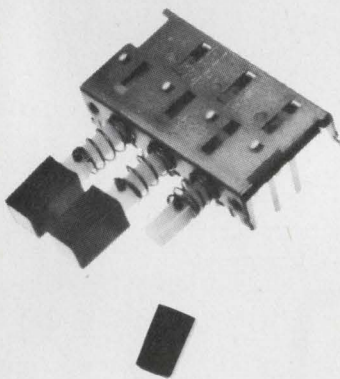

NEW metal shaft industrial pushbutton, 4 and 6 poles.

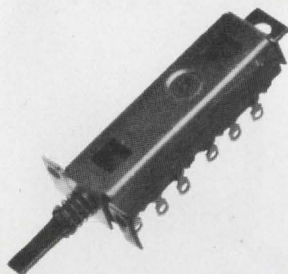

AMF
UID Electronics

UID Electronics Division
AMF Incorporated
4105 Pembroke Rd.
Hollywood, Florida 33021
Phone (305) 981-1211
TWX 510-954-9810

DATA PROCESSING

Sealed disc made for OEMs is rugged and inexpensive

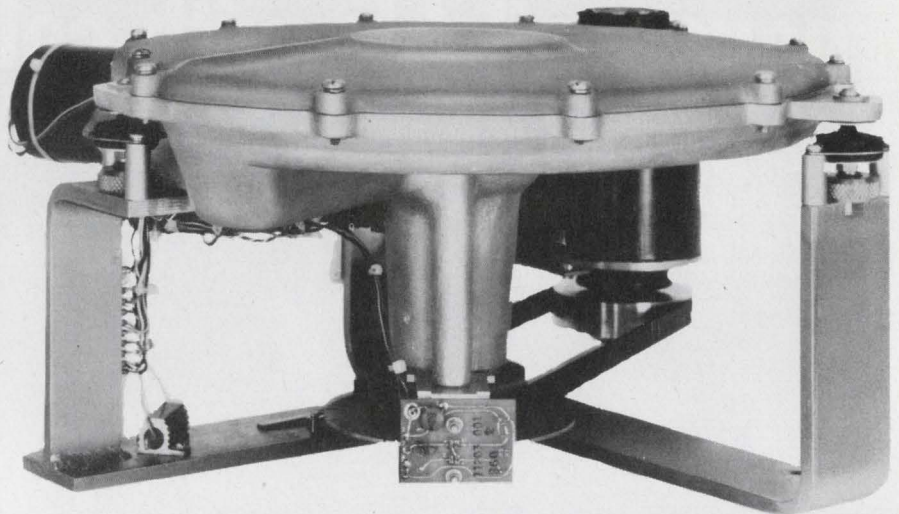

Tri-Data, 800 Maude Ave., Mountain View, CA 94043. (415) 969-3700. \$1325 (unit quantity); 60 day.

A sealed, fixed-disc subsystem from Tri-Data, the Model 100, is designed to operate for up to five years with no maintenance. The subsystem is sealed against dust and can withstand a 10-g shock (11 ms, 1/2 sine wave) while operating, or up to 15 g during transport.

The unformatted data capacity of the disc is 2.9 million bits, with 2400 bits for each of 16 sectors. Access time is 10 ms, track-to-track, with a 10-ms settling time and 16.7-ms average latency. The unit has a recording density of 1600 bpi (inner track), 64 tracks per head (total 128), and the number of sectors is variable from 1 to 16.

The hard-read error rate is one for every 10^9 bits read, with one seek error in 10^6 seeks. The drive-and-disc assembly is in a 20-lb casting that is 6.5 in. high and has a diameter of 13 in. The power requirements are 75 W at 105 to 125 V ac, 50 to 60 Hz. Since the system is designed for the OEM, it is difficult to determine precisely what the electronics would cost to support the memory, but costs are estimated at about \$750 to \$1500.

Although not intended to compete with floppy discs, the Model 100 does compare in many ways with such units as the SA 900 diskette storage drive from Shugart Associates, Sunnyvale, CA. The SA 900 has an unformatted capacity of 3.1 megabits, data-transfer rate of 250 kilobits per sec and access and settling times the same as the Model 100, with an 83-ms latency.

The diskette uses an IBM-compatible recording format that permits data to be transferred from machine to machine—which, of course, a sealed disc cannot do. A diskette drive does require periodic maintenance, ranging from every few weeks to a few times a year, depending on use. And the diskette is designed to last over a year under most conditions, over five years when treated more carefully.

The SA 900 from Shugart Associates will not operate properly with a 10-g applied force, but it can operate with about 2 g's. It has no dust filter but will work in most offices or light-industrial environments.

The disc in the Tri-Data Model 100 is a 9-in. nickel-cobalt medium with a protective overcoating. It rotates at 1800 rpm and is sealed in an airtight housing

(continued on p. 128)

**This
Green
Light
Says,**

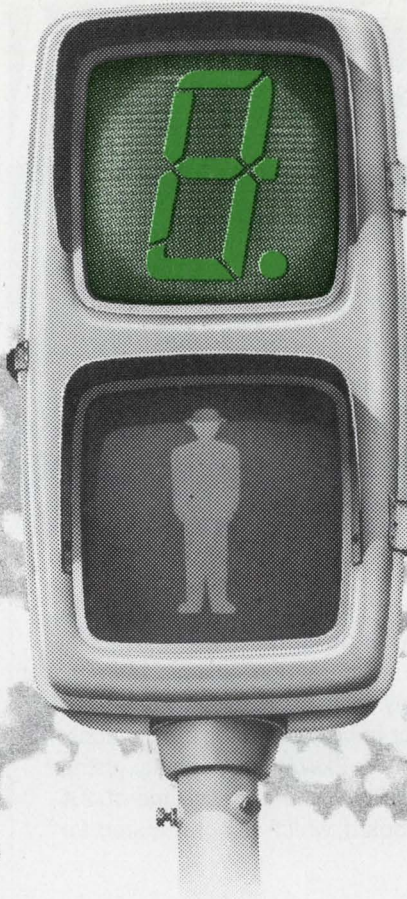

**“Go ahead
with
slim trim
display
equipment
ideas.”**

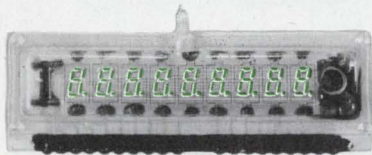

Multi-Digit Display with nine, eleven or thirteen digits. Or the FG type Multi-Digit Display with nine or twelve digits.

Go ahead because Ise lights your way to smaller, snappier equipment with a new wafer-thin multi-digit display. Then in addition to lighting the way, gives you a choice of two displays to work with. The DP-AS

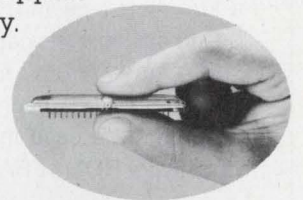

Digits on <FG> models measure a mini 5mm high to help you be as small in your thinking as you want. Both new displays are glass-enclosed all around. And have easy-mounting pin connectors. But mounting isn't the only thing that comes easy with these trimmed-down displays. Reading the indication they give comes easy, also. Because Ise keeps with the past. Gives these new multi-displays the same eye-easy green glow and planer construction that make their forerunners so popular. In addition, they also give you low-voltage advantages for direct LSI drive.

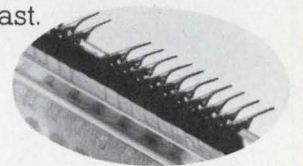

If you've been holding back on a headful of ideas simply because the right multi-digit display wasn't available, it's time to stop.

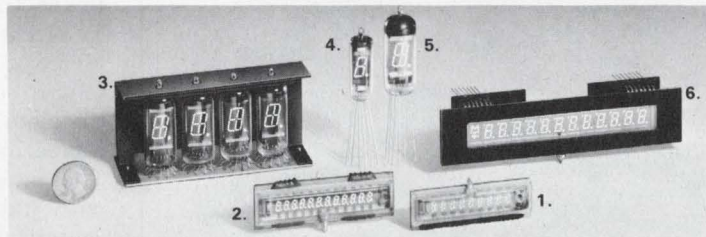

- 1. FG95A (NEW)
- 2. FG125A2 (NEW)
- 3. DMCL19E1
- 4. DG12H1
- 5. DG19E1
- 6. DP128AS (NEW)

The Brighter Side of Electronics



Creator of Fluorescent Digital Display:

ISE ELECTRONICS CORP. P.O. Box 46 Ise-city, Mie Pref., Japan
Tel: (05963) 5-2121 Telex: 4969523

Sales & Technical Office:

ISE CORP. OF AMERICA 1472 West 178th Street, Gardena, Calif., 90248 U.S.A.
Tel: (213) 532-0470 Telex: 230674910

Representative: Paris, Munich, Amsterdam, Stockholm, Vienna, Milan, Bombay, Hong Kong, Taipei.

INFORMATION RETRIEVAL NUMBER 68

MINI-ROM

The New Toko Plated Wire Memory System: Electrically Alterable Read Only Memory (EAROM)

Unique versatility from a non-destructive read-out memory, (NDRO), thanks to special TOKO woven plated wire design.

This system is ideally suited for use as a random-access memory (RAM), an electrically alterable read-only memory (EAROM) or a fixed read-only memory. EAROM is suitable for micro-computer applications.

The MINI-ROM A has either 1kW/8-bit or 2kW/4-bit capacity, using only a single board, with a cycle time of 3 μ s and access time of 2.4 μ s. Mounted on small removable RAM board, which is not required for read-only (ROM) functions.

MINI-ROM B has a 1kW/9-bit capacity, with a 1 μ s cycle time and 500 ns access time. Its capacity comes from four 256W/9-bit units, each of which can be used individually for ROM or RAM.

Specifications

| | MINI-ROM A | MINI-ROM B |
|----------------|--------------------------------------|--------------------------------|
| Capacity | 1kW-8 bit (2kW-4 bit) | 1kW-9 bit |
| Access Time | 2.4 μ s (1.2 μ s) | 0.5 μ s |
| Cycle Time | 3.0 μ s (1.5 μ s) | 1.0 μ s |
| Power | +5V -9V 10.5W(ROM), 11.5W(RAM) | +5V 12.5W(ROM), 15W(RAM) |
| Dimensions | 200D x 250W x 29mmH | 200D x 200W x 24mmH |
| Interface | TTL Negative Logic | TTL Negative Logic |
| Memory Element | NDRO type Plated Wire | NDRO type Plated Wire |

MINI-ROM B
NEW PRODUCT

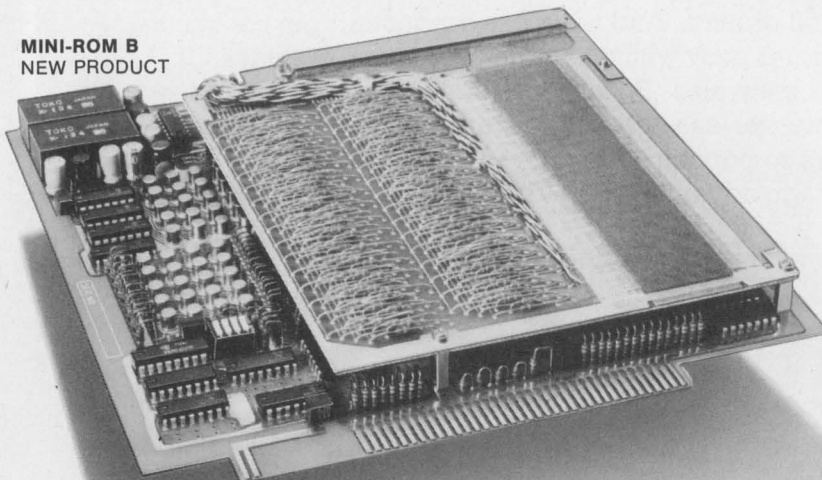

TOKO AMERICA INC.

350 Fifth Avenue, New York, N.Y. 10001 Tel: 212-736-0245~8
Technological Communication Division
4901 Main St., Downers Grove, Ill. 60515 Tel: 312-971-2265

DATA PROCESSING
(continued from p. 126)

with a 10- μ (absolute) filter to eliminate particles up to 2 μ , thus minimizing head and disc wear. Air movement is controlled within the housing to assure that all contained air circulates through the filter. In addition the two read/write heads are mounted on a wear-compensating carriage to help assure head to disc alignment throughout the five year period.

Tri-Data CIRCLE NO. 306
Shugart Associates CIRCLE NO. 307

Eight 2.5-Mbyte discs added to PDP-11

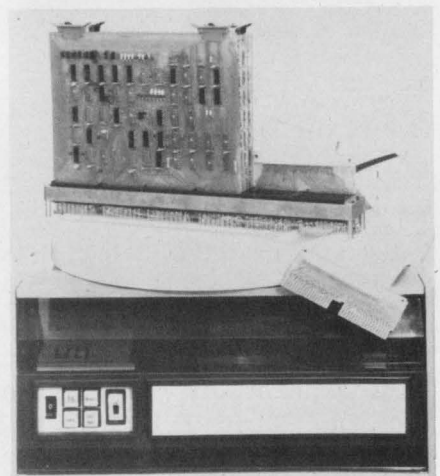

Computer Labs, 1109 S. Chapman St., Greensboro, NC 27403. (919) 292-6427. \$8950 (two discs); 30 to 45 days.

The Series M3000 disc memory consists of a moving head, rotating mass memory, controller, and all necessary cables for connection to the UNIBUS of the DEC PDP-11 computer family. This disc Memory System—at what is said to be substantial savings—offers complete software and hardware compatibility with the PDP-11. The single platter is changeable with the DEC RK05. The self-contained controller can access up to eight 2.5 Mbyte discs. Models are available in single (removable) platter, dual (fixed and removable) platter, front and top-loading systems. All have 35 ms (average) positioning time for random moves and 9 ms for track-to-track positioning.

CIRCLE NO. 332

Rf transformers operate up to 600 MHz

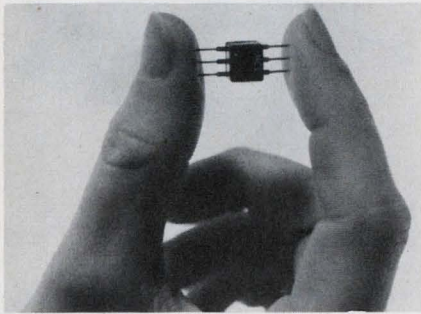

Mini-Circuits Laboratory, 2913 Quentin Rd., Brooklyn, NY 11229. (212) 252-5252. \$2.95 to \$3.45 (10-49); stock.

The company's T-Series compact rf transformers cover the 0.015-to-600-MHz frequency range. The new units operate with impedance levels of 12.5 to 800 Ω , and they feature typical insertion losses of less than 0.5 dB. A typical unit—the Model T4-1, for 4:1 impedance ratio based on 50 Ω —list a maximum insertion loss of 1 dB over the 2-to-100-MHz band. From 5 to 100 MHz, it has a maximum unbalance of 0.1 dB in amplitude and 1° in phase.

CIRCLE NO. 333

Sources generate L-to-X band signals

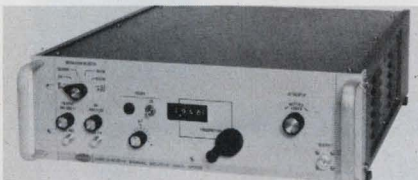

Polarad Electronic Instruments, 5 Delaware Dr., Lake Success, NY 11040. (516) 328-1100.

Four modular signal sources—the 1205 through 1208—cover L through X bands in overlapping ranges from 800 MHz to 11 GHz. The 5-1/4-in-high units contain modulation capabilities for FM and square wave. For widely adjustable pulse modulation, the company offers the Model 1020 modulator. The four new sources have minimum output power ratings of 35 to 80 mW. Stability and freedom from harmonics are reportedly provided by the sources' lightly loaded cavity-tuned oscillators. The company offers a one-year warranty without component exclusions.

CIRCLE NO. 334

A year ago we introduced 7 new JCM miniature RF coaxial connectors that "do the job for a fraction of SMA prices."

Here, by popular demand, are 8 more.

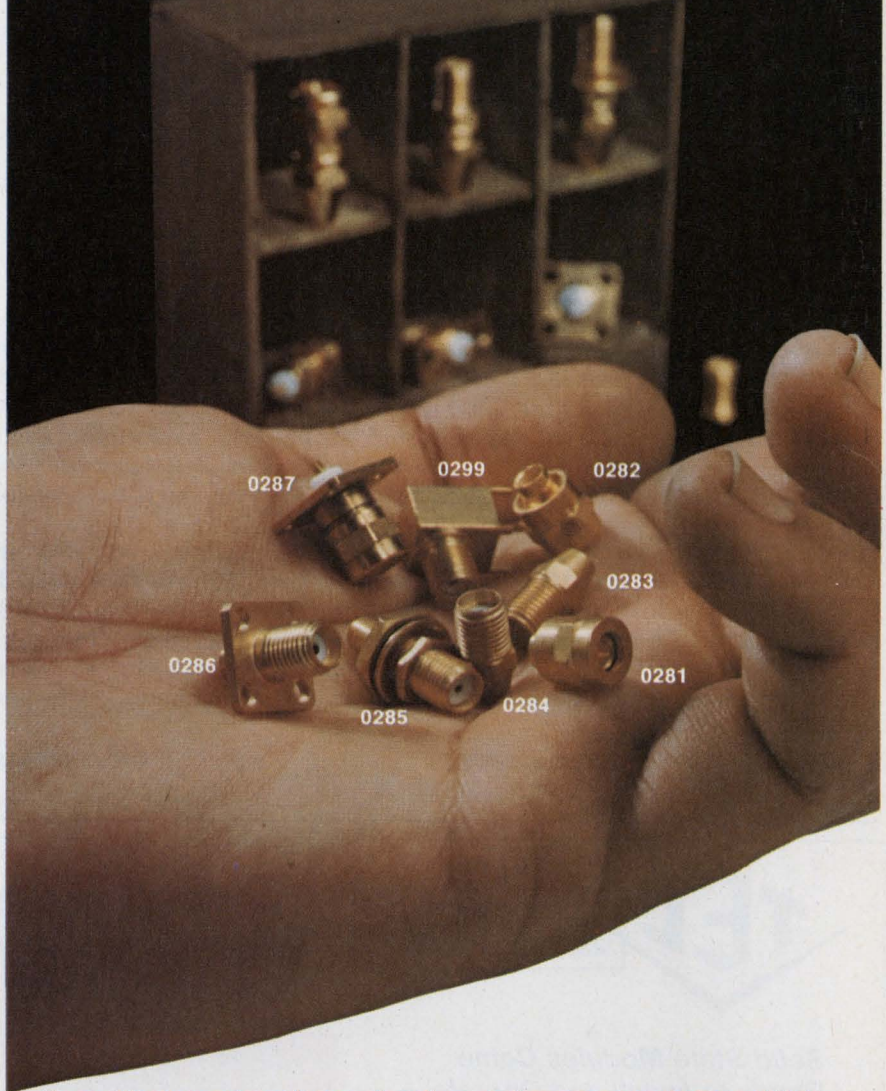

If you don't require all the electrical performance built into SMA type connectors, why pay for it? Up to 3 GHz for flexible cable assembly and even beyond 6 GHz for semi-rigid assembly, our new JCM series gives you the same electrical performance as the far more expensive SMA types. The series includes connectors for both panel and PC mounting. All are interchangeable and intermateable with the standard, expensive SMA connectors. So you can use them without making any changes . . . and without compromising required performance. There are JCM connectors to accept virtually any miniature size cable, so you don't have to stock a big variety. It's worth looking into, isn't it? All it costs is a stamp.

E. F. JOHNSON COMPANY / Waseca, Minnesota 56093

Dept. ED 12

Please check for technical information or test samples of our new low-cost series 142-0200-001 JCM connectors.

- Please send technical information.
- I desire test samples. Please call me at _____

NAME _____
 FIRM _____ TITLE _____
 ADDRESS _____
 CITY _____ STATE _____ ZIP _____



E. F. JOHNSON COMPANY

INFORMATION RETRIEVAL NUMBER 70

Harmonic rejection filters work to 12 GHz



Cir-Q-Tel Inc., 10504 Wheatley St., Kensington, MD 20795. (301) 946-1800.

A broad line of low-pass harmonic rejection filters spans a cut-off frequency range of 250 MHz to 12.4 GHz. The new units have a rejection ratio of at least 60 dB at 1.4 times the passband high frequency. They are tubular in shape and available in 13 standard models. Frequencies from 250 to 1000 MHz are covered by Models 1L, with a diameter of 1/2 in. and power capacity exceeding 15 W cw. Higher frequencies from 1500 MHz to 12.4 GHz are covered by 2L Models that are 1/4 in. in diameter, with power handling capacity exceeding 2 W cw.

CIRCLE NO. 335

Cascadable amps have 35-dB NF

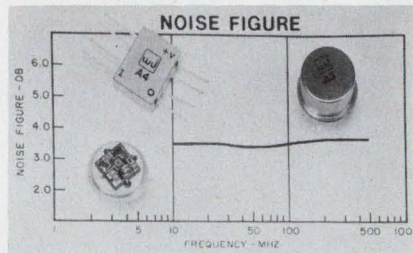

Watkins-Johnson, 3333 Hillview Ave., Palo Alto, CA 94304. (415) 493-4141. \$109 (1-9); stock.

Two low-noise cascadable amplifiers—the WJ-A3 and A4—offer gains of typically 15.5 dB and VSWRs of less than 1.3:1 across a 5-to-500-MHz bandwidth. Each can be used in 50-Ω microstrip rf and i-f systems, and each model has a noise figure of 3.5 dB typical. The new units are intended for use as first stages for reduced system noise figure. The WJ-A3 comes in a hermetic, four-pin, TO-8 package, while the WJ-A4 is housed in a hermetic, eight-pin flatpack.

CIRCLE NO. 336

Optical gate selects pulse

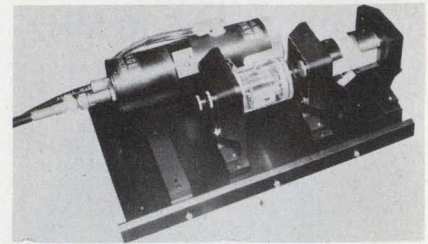

Hadron, Inc., 2520 Colorado Ave., Santa Monica, CA 90404. (213) 829-3377. \$9200 to \$9800.

The Model KQS4 optical gate can be used at the output of either ruby or Nd:Glass Q-switched laser oscillators, operating in either the normal giant pulse mode or in a mode-locked configuration. When used with normal giant pulse oscillators, the KQS4 can gate out pulse widths as narrow as 3 ns. When used with mode-locked oscillators, the KQS4 is capable of gating out a single sub-nanosecond pulse from a train of pulses. The KQS4 contains the electronics for powering the unit, and the optics assembly.

CIRCLE NO. 337

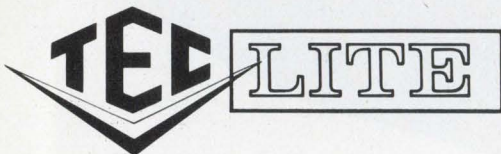

Solid State Modules Come Ready to Install and Operate — Include Decoder/Driver and all Circuitry Needed to Hook up to Your System

- Standard 0-9 plus overflow, with character height of 0.27"
- Accept BCD input code
- Compatible with TTL logic
- Optional bezel with choice of 3 filters

And Immediate Delivery!

DISTRIBUTORS:

Audio Electronics, Inc., Canada (416) 495-0720
 Bordewick Sales Co., New England (617) 659-4915
 Century Aero Corp., So. California (213) 772-1166
 Peerless Radio Corp., Florida (305) 566-5966
 Ratel Electronics, No. California (415) 965-2010



9800 NORTH ORACLE ROAD • TUCSON, ARIZONA USA 85704 • (602) 297-1111 • TWX 910-952-1377

LOW-COST, LED DIGITAL READOUT MODULES IN RED, YELLOW OR GREEN



Only
\$7.95
 in 100 qty's.

LARGEST LINE OF

SOLDERLESS WIRE-WRAPPED TERMINATION PRINTED CIRCUIT CONNECTORS

**.025" and .045"
Square Contact Terminations
for Wire-Wrapping**

Various sizes from 12 to 100
terminals with a choice of
.100", .125", .156" or .200"
contact centers. Accept
.054"-.071" printed circuit
board (1/16").

**WRITE OR PHONE
FOR COMPLETE
PRINTED CIRCUIT
CATALOGS:
(212) 899-4422**



For the Sales Representative Nearest You, See Our Listings in EEM and GOLD BOOK Directories.

CONTINENTAL CONNECTORS

CONTINENTAL CONNECTOR CORPORATION ■ WOODSIDE, NEW YORK 11377

INFORMATION RETRIEVAL NUMBER 73

from SPECTRUM.... for emi CONTROL. The 1 MF. FEED-THRU CAPACITOR.



SHOWN
ACTUAL
SIZE

The combined technologies of SPECTRUM CONTROL, INC. and ALLEN-BRADLEY CO. have produced this exciting line of multi-layer feed-thru capacitors. Their tubular design and coaxial construction gives low inductance with capacitance values to 1 MF. The operating temperature range is -55°C to +125°C at 10 amps and 50 VDC. They are ideally suited for bypassing, filtering and coupling applications. Write today for our complete catalog.

| Part No. (Threaded) Part No. (Solder-In) | 54-785-005 54-785-006 | 54-786-013 54-786-015 | 54-786-021 54-786-019 | 54-786-014 54-786-016 |
|--|--------------------------|--------------------------|--------------------------|--------------------------|
| DC Working Voltage | 100 | 50 | 50 | 50 |
| Capacitance, MF. at 0.1 VRMS, 25°C, 1 KHz | 0.05 GMV | 0.3 GMV | 0.5 GMV | 1.0±20% |
| Insertion Loss (db) | | | | |
| 1 Mhz | 16 | 32 | 35 | 40 |
| 1 Ghz | 50 | 70 | 70 | 80 |
| Thread Size - Bolt | 8-32 | 10-32 | 10-32 | 10-32 |
| Mounting Hole Size (Solder-In) | .140 ±.015 | .171 ±.015 | .171 ±.015 | .171 ±.015 |

Available now from these authorized distributors:

| | |
|-----------------------|--------------|
| HALL-MARK ELECTRONICS | 215-355-7300 |
| METUCHEN CAPACITOR | 201-442-0500 |
| MIRCO ELECTRONICS | 602-944-2281 |
| ROSE ELECTRONICS | 415-697-0224 |

SPECTRUM CONTROL INC.

152 EAST MAIN ST. • FAIRVIEW, PENNSYLVANIA 16415
PH. 814-474-5593 TWX 510-699-6848



INFORMATION RETRIEVAL NUMBER 74

POWER SOURCES

Isolator/regulator gives 100 MΩ/250-pF I/O

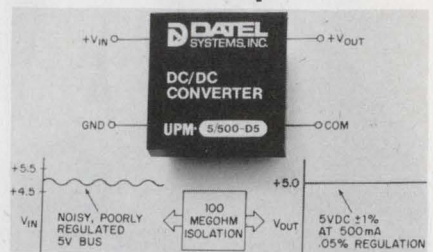

Datel Systems, 1020 Turnpike St.,
Canton, MA 02021. (617) 828-8000.
\$79.

The UPM-5/500-D5 is a dc/dc converter with 100-MΩ isolation and only 250-pF capacitive coupling from input to output. It is designed for local circuit board transformation of a 4.5-to-5.5-V noisy or unregulated logic power into regulated and isolated 5 V. The unit can also be used to develop negative 5-V power from a positive 5-V power bus. The output voltage has a 200 ppm/°C tempco and is short-circuit protected with fold-back current limiting. Output ripple voltage is less than 1 mV rms. Other specs include 500-mA output and 0.05% regulation. Size is 2 × 2 × 0.432 in.

CIRCLE NO. 338

Dc/dc converter works under high CMVs

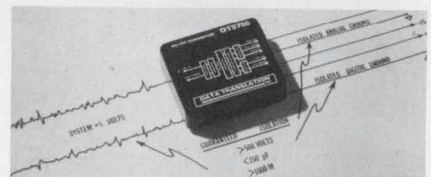

Data Translation, 109 Concord St.,
Framingham, MA 01701. (617)
879-3595. \$149; stock to 2 wks.

Model DT5750 dc/dc converter is designed for use where high common-mode voltages are prevalent. This completely floating module converts ±5 V to ±15 V and +5-V power despite voltage differences of 500 V between input and output. The converter supplies 165 mA from each side of the 15 V and 750 mA from the 5-V output. All outputs are floating and isolated, multiple input/output isolation is less than 150 pF and greater than 1000 MΩ, and breakdown voltage between input and any output is greater than 500 V.

CIRCLE NO. 339

Vector PRESENTS KLIP-BLOKS

FOR BREADBOARDING

- NO SOLDERING
...Just Push In
- DIPS, transistors,
components
patch with
ordinary wire
- Buy only
sockets needed
and — save money!
- Exclusive thru-holes open
top and bottom give greater
component density. 4 connected
contacts per strip with 1 to 24 strips
per block -- all on .1" grid. FAST! EASY!

Available From Vector Distributors or Factory

12460 E. Gladstone Ave.
Sylmar, Calif. 91342
(213) 365 9661 TWX (910) 496 1539

INFORMATION RETRIEVAL NUMBER 75



We challenge
any leading
switchlight
manufacturer
to match our
*"Persuader
Line"*

Make your own comparison
from our 21 point check
list. See page 119 then call your
local distributor or
Clare-Pendar, Box 785, Post Falls,
Idaho 83854 (208) 773-4541

CLARE-PENDAR



INFORMATION RETRIEVAL NUMBER 76

TRANSFORMERS AUDIO POWER



NEW!

PLUG-IN
PC POWER

TELEPHONE
COUPLING

DC-DC
CONVERTER

STUDIO
BROADCAST

← REQUEST NEW
CATALOG # 741

COMMERCIAL / MIL

COMPLETE LINE OF STOCK TRANSFORMERS
IMMEDIATE DELIVERY FROM DISTRIBUTORS



MICROTRAN

COMPANY, INC.

145 E. Mineola Ave., Valley Stream, N.Y. 11582

INFORMATION RETRIEVAL NUMBER 77

ELECTRONIC DESIGN 26, December 20, 1974

GIVE YOUR CIRCUIT
"A SHOT IN THE ARM"

WITH ATC
CAPACITORS

- HIGH Q THRU MICROWAVES
- 0.1 pF TO 1000 pF STANDARD
- HIGH RF CURRENT CAPABILITY
- RUGGED TERMINATIONS
- HERMETIC CONSTRUCTION
- HIGH RELIABILITY

NEED TECHNICAL
ASSISTANCE ?

The ATC Engineering Group is available to assist in solving your capacitor application problem. Our staff includes specialists in the areas of RF design, process engineering, measurement techniques, and reliability engineering. This cooperative group is interested in hearing your problem and in providing practical solutions. Just call the number below and ask for applications assistance. For your copy of "To you it's a capacitor... but what does the circuit see?", circle the reader's service number.

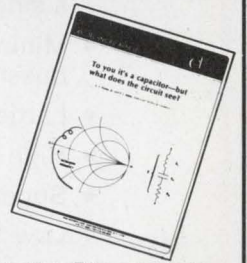

tomorrow's capacitors today

ONE NORDEN LANE, HUNTINGTON STATION, NEW YORK 11746
516/271-9600 • TWX 510-226-6993

INFORMATION RETRIEVAL NUMBER 78

Op-amp supply delivers ± 100 mA

Optical Electronics, P. O. Box 11140 Tucson, AZ 85706. (602) 624-8358. \$66; stock.

Model 8430 dual ± 15 -V power

supply can deliver continuous current of ± 100 mA. The unit is protected against overload currents, short-circuits, and high ambient temperatures. The 8430 is also protected against reverse currents driven into the power supply from the load. The unit can operate at line-voltage frequencies of 50 to 400 Hz and line voltages from 125 V ac down to 90 V ac. Size is 3.5 \times 2.5 \times 1.25 in.

CIRCLE NO. 340

Voltage standard is accurate to 0.005%



Zi-Tech Div., Aikenwood Co., 223 Forest Ave., Box 26, Palo Alto, CA 94302. (415) 326-2151. \$1200.

Model TE2004 dc voltage standard provides four full-scale operating ranges from 11 mV to 11 V with better than 1-ppm resolution. The precision output voltages within each range are set by six digiswitches. Two portable models with specified setting accuracies of 0.01% or 0.005% are available. No standardization is required because a high-stability reference is included in the unit. Other built-in features are a sensitive microvolt null-balance potentiometer and an output-polarity reversing switch. The battery/line power unit makes possible field operation independent of line power.

CIRCLE NO. 341

20-W dc/dc converter delivers triple outputs



CellMate Div., 1405 Civic Center Dr., Santa Clara, CA 95050. (408) 249-8400. \$149; 60 days.

Claimed to be the first triple-output dc/dc converter to deliver 20 W, the Model 100 offers practically universal output voltage selection. One output is 5 V. The other two outputs are of opposite polarity, and each is individually adjustable from 0 to 15 V. The unit operates from any voltage source within the range of 10 to 32 V and features a unique inward-folded case design which provides over 100 square inches of heat-dissipating surface. Size is 4-1/2 \times 4 \times 1-5/8 in. and weight is 15 ounces.

CIRCLE NO. 342

PLASMAC™

A *New* DISPLAY OPPORTUNITY



Custom Design Capability Allows Significant Cost Reductions

- Unlimited combinations of fixed messages, numeric and alphanumeric characters in a single panel.
- Minimized drive requirements with internal bussing and multiplexing.
- Large panels with Large Characters.
- High Brightness with Uniformity.
- Superior Readability.
- Low Power Consumption.

Call or write for full details



NATIONAL ELECTRONICS

a varian division
geneva, illinois 60134 (312) 232-4300

TO-5's WE CAN COOL 'em



5.0¢*

1134-U Press on
Typical R_{θ} , 59° C/W



5.1¢*

2226-U Press-on
Clears adjacent compo-
nents
Typical R_{θ} , 59° C/W

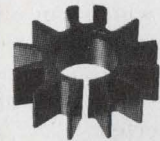

8.2¢*

2230-B5, 3/4" Press-on
gear type, screw mount
Typical R_{θ} , 51° C/W



8.5¢*

2257-R 1/2" Press-on
gear type
Typical R_{θ} , 68° C/W

Popular, easy-to-use economy coolers for PC board components. Thermalloy offers the most complete line of heat sinks in the industry: over 100 designs for cooling all types of packages including DIP's, plastics, TO-3's, TO-66's, and power transistors.

*Prices for 5000 quantity
 R_{θ} values for natural convection @ 1 W

**Free Samples
and Catalog
Write Today**



Thermalloy Inc.

NUMBER ONE IN SEMICONDUCTOR ACCESSORIES
P.O. BOX 34829
2021 W. VALLEY VIEW LANE, DALLAS, TEXAS 75234
PHONE 214-243-4321/TWX 910-860-5542

Logic supply reads ONEs and ZEROs



Grumil Corp., 4626 Idlewilde Lane SE, Albuquerque, NM 87108 (505) 265-2320. \$84; \$105 with option.

This 5-V, 1-A laboratory supply features a seven-segment direct-readout logic-probe option. Standard specs include: output fully protected against overload, floating output (± 300 V dc) load regulation of 0.01% NL-FL, line regulation of 0.01% NL-FL, ripple and noise of 1 mV pk-pk and tempco of 0.02%/°C. The logic probe option provides direct readout of ONE, ZERO and "H" for high-impedance or open-collector three-state logic, and flashing display to indicate a fast pulse.

CIRCLE NO. 343

Compact hv unit can be programmed



Sierra Systems, 650 Vaqueros, Sunnyvale, CA 94086. (408) 733-1040. \$100; stock to 2 wks.

Series 774 high-voltage module is encapsulated for full environmental protection. Input voltage is 28 V dc; ripple and regulation is 0.1% pk-pk and 0.5%, respectively. Output voltages for the nine variations of the Series 774 range from 500 to 18,000 V. The unit is solid-state and resistance and voltage programmable.

CIRCLE NO. 344

Simple answer to a pressing problem

"UNISWITCH." It lets you do those bright but simple switching jobs without expensive, complicated lighting devices. This low-cost, momentary pushbutton illuminated switch has a 1-A circuit in only 11/16" square panel space.

If you want to look expensive (but stay low-cost and un-complicated) the illuminated "Uniswitch" is available in color. Lots of it. Red, white, blue, green and yellow are standard. You get brilliant front and side lighting, clearly visible in either high or low ambient environment. Light is evenly diffused throughout visible button surfaces. Lighting is constant and independent of switching action. Front of panel relamping.

And installation is low-cost. Just snap "Uniswitch" in, no tools needed. The low-silhouette bezel serves as an escutcheon plate. Terminals are screw and/or solder. Silver plated contacts rated at 250 ma., 30 watts, A.C. non inductive load.

Don't over-design your next panel. Get your free Engineering Specification File on illuminated and non-illuminated (for very low-cost application) "Uniswitch" Switches. Contact your local Switchcraft representative, or write Switchcraft, Inc., 5555 N. Elston Avenue, Chicago, Illinois 60630.

SWITCHCRAFT
INC.

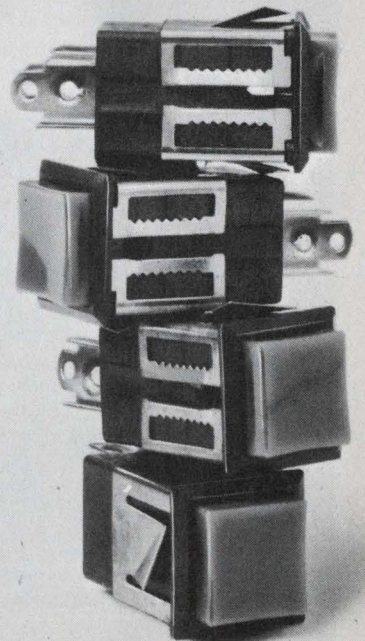

Everything in precision voltage sources from A to B.



A
6-digit Model M106 A. Accuracy $\pm 0.002\%$. Range ± 1 microvolt to $\pm 1,000$ VDC in 4 ranges. Solid-state voltage selections and digital display. **Isolated remote BCD programming optional.** A proven, versatile performer for bench, production or computer-controlled test systems... with a low basic price of \$2,615.

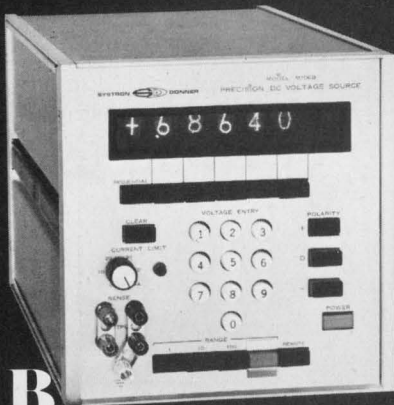

B
5-digit Model M106 B. Same as A version except: Accuracy $\pm 0.008\%$, range ± 10 μ V to ± 100 VDC in 3 ranges. (± 1000 VDC ranges optional). No need to pay for super-precision if you don't need it: basic price is only \$1,975.

For further details on both A and B. Contact your Scientific Devices office or Systron-Donner at 10 Systron Drive, Concord, CA 94518. For immediate details, call our Quick Reaction line (415) 682-6471 collect.



SYSTRON-DONNER

INFORMATION RETRIEVAL NUMBER 82

INSTRUMENTATION

Modules manipulate & send test data at 150 Mbits/s

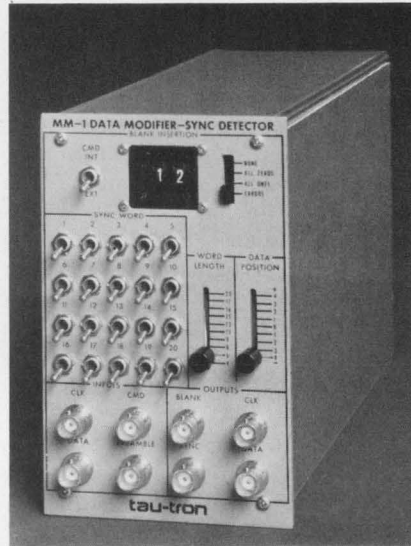

Tau-Tron, 11 Esquire Rd., North Billerica, MA 01824. (617) 667-3874. ME-1: \$1200, MM-1: \$1800; stock to 6 wks.

Engineers who use Tau-Tron equipment to make error-rate measurements can now do so at 150 Mbit/s and with increased data-manipulation capability. Two additions to the company's modular TMI instrument line make this possible.

The ME-1, called a bit-rate extender, serves as a companion to the year-old pseudorandom generator and error detector, or receiver, that form the foundation of the test line. With the ME-1, data can be zipped through the system under test at twice the original rate of 75 MHz.

The second module, the MM-1, takes the pseudorandom stream, searches for a particular sequence in the stream up to 20 bits long and then, upon detection of the sequence (or upon external command), modifies a number of successive bits up to 99. Modification can involve injection of errors logic complements) or the forcing of a byte to ZERO or ONE.

The first bit of the modified sequence can be selected anywhere from four bits before detection to four bits after. Front-panel toggle

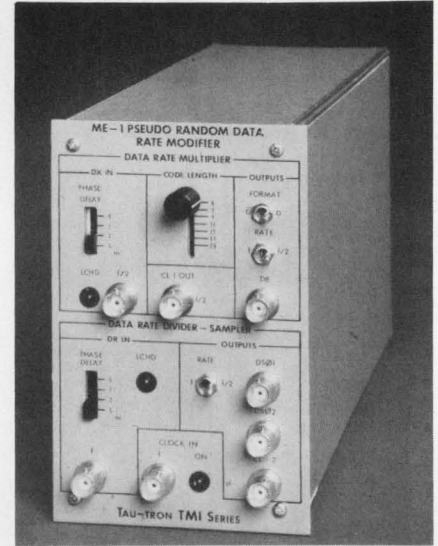

switches plus a two-digit thumb-wheel select the desired sequence and the number of bits to be manipulated.

Thus the MM-1, which can operate to 75 MHz, makes the pseudorandom sequence less random as special test codes—or a preamble, if desired—are inserted.

Preambles up to 99 bits can be inserted when the sync pulse—generated upon detection of the unique incoming sequence—is used to trigger an external, fixed-word generator. The output of the generator is connected to the MM-1's preamble input jack, and the fixed word appears in a selected, blanked (all ZEROs) portion of the pseudorandom sequence.

Since the modules in the Tau-Tron transmission/detection system operate synchronously with a system clock, provision is made in the ME-1 rate extender to prevent races and allow alignment between the data and the clock. Adjustments are made with indicators and slide switches that can be set for various phase delays from 0 to 5 ns. The indicators tell when the data input is properly latched and when the data and clock have proper phase.

Delivery is stock to six weeks.

CIRCLE NO. 303

JAN & JANTX 2N4150 SWITCHING TRANSISTORS

are now
available for your
MILITARY SYSTEMS.

GENERAL SEMICONDUCTOR INDUSTRIES
Manufactures Over 200 Types of
HIGH SPEED, HIGH POWER
NPN Switching Transistors
Ranging From 1 To 60 AMPS.



GENERAL SEMICONDUCTOR INDUSTRIES, INC.

2001 West 10th Place, Tempe, Arizona 85281 • (602) 968-3101 • Mailing Address: Post Office Box 3078

INFORMATION RETRIEVAL NUMBER 83

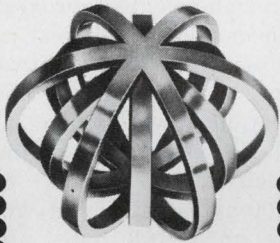

57077 visitors
from 88 countries
in 1974

Salon international des
**composants
électroniques 75**

Paris
2-8 April

For you, this year again,
Paris is a must

French Trade Shows
1350 Av. of the Americas
New York N.Y. 10019
☎ (212) 582.49.60

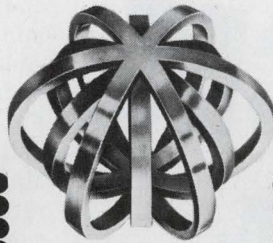

1138 exhibitors
from 24 countries
in 1974.

Salon international des
**composants
électroniques 75**

Paris
2-8 April

For you, this year again,
Paris is a must

French Trade Shows
1350 Av. of the Americas
New York N.Y. 10019
☎ (212) 582.49.60

INFORMATION RETRIEVAL NUMBER 84

ELECTRONIC DESIGN 26, December 20, 1974

ALCOSWITCH®

Our new multi-pole switch in a DUAL-IN-LINE package now available in 7, 8 or 10 positions, with more to come later. Most dependable switch of this type on today's market. Contacts and terminals gold plated for dry circuits and easy soldering. Wiping action, too. Call (617) 686-0126 today for complete information, samples and competitive pricing.

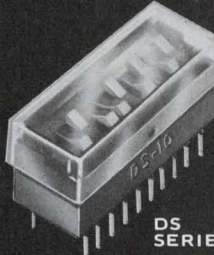

DS
SERIES

ALCO ELECTRONIC PRODUCTS, INC.
1551 Osgood St., No. Andover, Mass. 01845

ALCOSWITCH®

INFORMATION RETRIEVAL NUMBER 211

ALCOSWITCH®

New ROTARY SWITCHES feature adjustable stops up to 10 positions. Molded-in terminals prevent contamination. PC or hand wired use. 1 thru 4 poles with 36° detent. Waterproof models also available. 10,000 operations @ .5 amps, 125 VAC. One pole, 10 position switch priced at \$6.65 in single lots.

MRC
SERIES



ALCO ELECTRONIC PRODUCTS, INC.
1551 Osgood St., No. Andover, Mass. 01845

ALCOSWITCH®

INFORMATION RETRIEVAL NUMBER 212

The Only Full Feature Scientific For \$99.95!

The Commodore 1400 Advanced Slide Rule Computer

- RECHARGEABLE (Batteries and AC adapter/Charger incl.)
- 14 Character Display (10 Digit Mantissa)
- Full Memory Storage
- Automatic Floating Decimal
- Overflow/Underflow Indicators
- Low Battery Signal
- Zero Suppression
- Clear Error Key
- Brightly-Lit Readout
- Fully Depressed Keyboard
- 1 YEAR FREE REPLACEMENT WARRANTY
- Special PARENTHESIS KEYS—(2 Level)
- Radial/Degree Mode Selection Key and Lamp Indicator
- Exponent Key
- Change Sign Key
- Reciprocal Key
- Square Root Key
- π Key
- Sine Key
- Cosine Key
- Tangent Key
- ARC Key
- X^2 Key
- Y^x Key
- X-Y Key (enables factor reversal)
- Common Log Key
- Natural Log Key
- Common Antilog Function
- Natural Antilog Function
- Non-Scientific Notation
- Compact Size: 3 1/4" x 6" x 1 3/4".

The exciting new "1400" instantly computes natural and common logs and antilogs as well. It calculates sines, cosines, and tangents, and their respective inverses. It expertly handles quantities as small as 1.0×10^{-99} up to $9.999999999 \times 10^{99}$. It features special parenthesis keys, prefers non-scientific notation, and has a 14 character display. The "1400" is quite comparable to units selling for \$150-\$225. Order now for immediate delivery. Compact Size: 3 1/4" x 6" x 1 3/4".



Please send me _____ Commodore 1400 Scientific Electronic Calculator(s) at \$99.95 (plus \$3.95 shipping, handling, and insurance) each. If not completely satisfied, I can return it within 2 weeks for an Immediate Refund.

Check or Money Order Enclosed (Ill. res. add 5% tax)

Charge to my credit card below

American Express BankAmericard Master Charge Diners Club Card Carte Blanche

Credit Card # _____

Expiration Date _____

Master Charge Code # _____ (4 digits)

Name _____

Address _____

City _____ State _____ Zip _____

Signature _____ 50-12/20

Send Coupon to: Contemporary Marketing Inc. 607 A Country Club Dr. Bensenville, IL 60106 Phone: (312) 595-0461

INFORMATION RETRIEVAL NUMBER 85

INSTRUMENTATION

Card tester handles up to 160 I/O lines

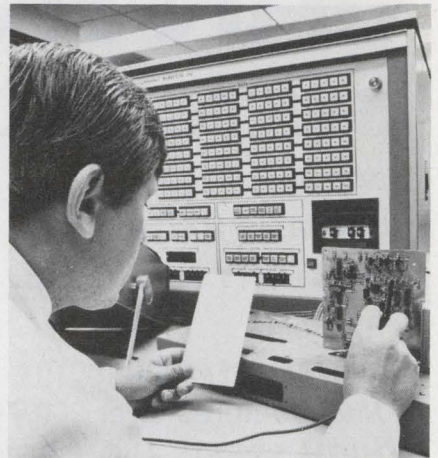

Technology Marketing, 3170 Red Hill Ave., Costa Mesa, CA 92626. (714) 979-1100. \$20,000 to \$29,000; 60 days.

Model 2160 computer-controlled system simultaneously tests logic states and timing for up to 160 I/O lines. The system is designed for high volume production tests of circuit cards and other electronic devices and assemblies. No languages are required. Operator oriented front-panel controls and technician-oriented programming methods allow the lowest possible level of skills. Costly software maintenance expenses are avoided. Fault isolation down to node and individual ICs are easily attained. Major specifications include: test rate of 6400 bytes/sec.; read/write memory of up to 16K bytes.

CIRCLE NO. 345

IC tester draws battery power

Fut-heuristic Devices, Box 1117, Reseda, CA 91335. (213) 348-9188. \$300; stock.

The Evaluator is a portable digital IC tester that measures $8 \times 11 \times 4\frac{1}{2}$ in. and weighs about 4 lb. The unit will test approximately 10,000 ICs on a fully charged set of NiCd batteries. An inexperienced operator can easily test 500 ICs per hour, including 100% testing of all TTL, DTL, CMOS and many other ICs. This includes the popular 7400 series, 74, 74L, 74H, 74S, 74LS, etc. It can test these ICs under load if desired.

CIRCLE NO. 346

IMMEDIATE DELIVERY! IN STOCK

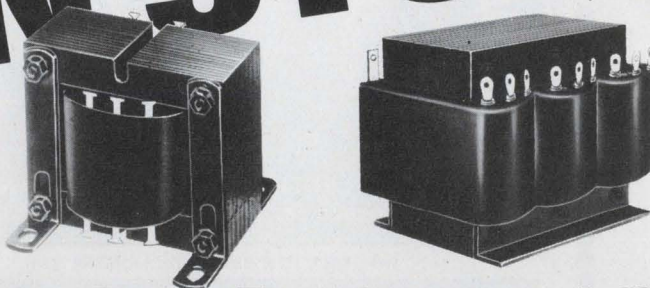

Rectifier Power Transformers and Chokes

SIGNAL HAS THE LARGEST SELECTION OF OUTPUT RATINGS AVAILABLE.

- Most Economical—No Minimum order Requirement.
- Ideal for Single or Dual DC Supplies.
- Wide Diversity of Ratings —5 to 300V, 0.1A to 200 Amp.
- Very High Current Units Up to 1000 Amps, Single and 3 Phase.

See EEM Vol.3-1273-1285

Signal transformer co. inc.

1 Junius St., Brooklyn, N.Y. 11212
Telephone (212) 498-5111

Send for Free Catalog also listing extensive lines of Printed Circuit Plug-In Transformers, Flat Plug-Ins and Constant Voltage Transformers.

INFORMATION RETRIEVAL NUMBER 86

6-digit DPM counts to 1 GHz

Amtex Research, P. O. Box 1714, Rockville, MD 20850. (301) 424-6112. \$799; stock to 8 wks.

LPM 1000 is said to be the smallest 1000-MHz frequency counter. The unit is a six-digit panel meter. Sensitivity is 50 mV rms. The logic panel meter is completely self-contained and includes a high-stability crystal oscillator, time base, counter, decoder and LED display in a 3 × 1.4 × 2.45-in. case. Weight is 3.5 oz. Other frequency versions are available at 10, 120 and 600 MHz. The LPM 1000 is fully programmable for time-base expansion, frequency multiplication or division, internally programmable three-decade offset and BCD outputs available.

CIRCLE NO. 347

Thermocouple meters come in 40 models



Omega Engineering Inc., Box 4047, Stamford, CT 06907. (203) 359-1660. \$200 to \$450; stock.

Over 40 different portable thermocouple readout meters having built-in, high-gain amplifiers are available in a choice of three accuracy categories. Class I meters come in both battery-powered portable units and 115-V-ac units with an accuracy of 1 C throughout the entire range of -120 to 1800 C in 12 to 18 steps. For greater accuracy, Class II units can measure temperatures below -100 up to 1800 C. Class III meters work to an accuracy of 0.1 C from levels as low as -200, up to 1300 C.

CIRCLE NO. 348

GET ON BOARD...

with TANTALEX[®] Low-Cost Solid Tantalum Capacitors

Sprague Gives You a Choice for Flexibility in Your Printed Board Designs.

DIPPED ...

SPRAGUE TYPE 196D

Small size economical capacitors that utilize high-quality tantalum pellet construction. Conformal epoxy resin coating is highly resistant to moisture and mechanical damage. This capacitor has found wide usage in consumer and commercial electronic equipment. Operating temperature range, -55 C to +85 C. Available in all popular 10% decade values from 0.1 μ F to 330 μ F. Voltage range, 4 to 50 VDC. Standard lead spacing, 0.125" and 0.250". For complete data, write for Engineering Bulletin 3545B.

INFORMATION RETRIEVAL NUMBER 298

Call your nearest Sprague district office or sales representative, or write for the bulletins mentioned above to Sprague Electric Company, 347 Marshall Street, North Adams, Mass. 01247.

MOLDED ...

SPRAGUE TYPE 198D

Economically priced, molded-case Econoline[™] capacitors. Standard lead spacing, 0.100", 0.200", and 0.250". Tough, flame-retardant, crack resistant case has flattened section and polarity indicator for easy-to-read marking and error-free insertion. Fixed external dimensions allow increased productivity during assembly of PC boards. Designed for severe vibration and shock environment, where lead support alone is not adequate. Operating temperature range, -55 C to +85 C. Capacitance values from 0.1 to 100 μ F. Voltage range, 4 to 50 VDC. For complete data, write for Bulletin 3546.

INFORMATION RETRIEVAL NUMBER 299

THE BROAD-LINE PRODUCER OF ELECTRONIC PARTS



... King; 94107; (415)986-
 ... SUPPLY CO ; (415)431-6300
 ... SIS ; (415)391-8776
 ... MARKING EQPT CO 533 Mission St; (415)397-
 ... ELECS 1444G Market St; 94102; (415)626-1444;VN
 Zachariah president

SAN JOSE
 AMFAC ELEC SUPPLY CO ; (408)298-5800
 ASTRONICS 560G Hyde Pk Dr; 95136; (408)578-6223;M
 Hecht president
 Dr; CALVERT ELECS INTL PO Box 5066; 95150; (408)247-
 4700
 (714) CB SLS F CALIFORNIA 1275 Bryan Av; 95118; (408)266-
 6096
 6-4162 CONSOLIDATED PARTS INC ; (408)294-2302
 278-3040; DUNLAP ELECS, DEPT G, 970 S Bascom Av; 95128;(408)
 287-2627;B Hill br mgr
 5-9171 WW GRAINGER INC, DEPT G, 1260 N 13 St; 95112;(408)
 288-9160
 GRAYBAR ELECTRIC CO, DEPT G, 1376 N 10 St; 95103;
 (408)292-9090
 heon Rd; ITT JENNINGS 970 Mc Laughlin; 95116; (408)292-4025
 92123; JAMES ELEC TOOL CO ; (408)272-1818
 MILLERS ELEC SUPPLY 522 S Bascom Av; 95128; (408)
 295-6818
 2121; PENINSULA LEC SUPPLY INC 980 S 1 St; 95110; (408)
 294-3594
 4) QUEMENT ELECS, DEPT G, 1000 S Bascom Av; 95128;
 (408)998-5900;B Quement president
 WALSH ELEC 1419 A Foyworthy Ave; 95118; (408)265-
 0340

SAN LEANDRO
 ASSOC ; (415)483-9616
 CON INC 14302 Wicks Blv; 94577; (415)351-2716
 SUPPLY CO ; (415)357-2211
 ENGRG 2081 Edison Ave; (415)635-3831

SANTA CRUZ
 BELL ELECTRIC
 BROWNELL ELEC INC
 CALVERT ELECS INC 290
 4700
 COMPUMECH 2938G Scott Blv; 95
 Richards president
 FISHER SWITCHES INC ; (408)244-6182
 MOLTRONICS 337 Mathews St; (910)338-0030
 NOVA TRONIX ; (408)243-9530
 SOLID STATE TECHNOLOGY 3650 Charles; 9505
 247-8620
 STRUCTURAL TECHNOLOGY 2550 Scott Blvd; 95
 (408)241-5102

SANTA CRUZ
 SANTA CRUZ ELECS INC 718 Frederick; 95060; (408)423
 1140

SANTA FE SPRINGS
 DYNAMICS ELEC PRODS INC ; (213)945-2493
 HY CAL ENGRG 12105 Los Nietos; 90670; (213)698-7785
 MCMASTER CARR SUPPLY ; (213)945-1311

SANTA MARIA
 VALLEY ELECTRIC CO 901 S Blosser Rd; 93454; (805)
 Wa5-9585

SANTA MONICA
 AIR SUPPLY CO ; (213)829-1781
 ALVARADIO IND INC 2105 Colorado St; 90404; (213)828-
 0385
 DISTRIBUTOR SPECIALISTS ; (213)829-5401
 IFR AVIONICS 2701 Airport Av; 90405; (213)390-3409
 MASTER DISTRIBUTORS, DEPT G, 1553 17 St; 90
 (213)395-2637;K Nizam president
 SHELLEY FRANK ELEC ; (213)392-3913
 TEXAS INSTRUMENTS SUP CO 1651 10Th; 90
 393-6731
 TRANS TEL IND LTD 2180 Colorado Av
 828-6808

SANTA ROSA
 F PLANTE ELEC INC 423 45

SAUSALITO
 RH BAL

LOOKING FOR A DISTRIBUTOR NEAR YOU?

Distributors are listed 3 ways in *Electronic Design's GOLD BOOK*:

1. IF YOU KNOW THE MANUFACTURER, you will find his U.S. distributors included under his listing in the MANUFACTURERS DIRECTORY. Name, city, and phone numbers are provided.
2. IF YOU KNOW THE DISTRIBUTOR'S NAME, you can find his complete address, zip, and phone number in the *alphabetic section* of the DISTRIBUTORS DIRECTORY. In most cases annual sales volume or net worth, year established, and names of key officials are included.
3. IF YOU WANT TO FIND OUT WHICH DISTRIBUTORS ARE LOCATED NEAR YOU, check the *geographical section* of the DISTRIBUTORS DIRECTORY. You enter the section by state, then find your city — or one nearby — and the distributors located in that city. You can then go back to the *alphabetic section* to learn more about them.

Electronic Design's GOLD BOOK

BIGGEST AND BEST ELECTRONICS MASTER CATALOG
 & DIRECTORY IN THE WORLD

We can deliver add-on memories to every PDP-11 user in the next 10 days.

Wherever you are.

We've stocked up on PDP-11 add-on memories, because we know you don't want to wait a month — or longer — when you need more memory. They're thoroughly tested. Operational. Ready for delivery. That's why we can guarantee that you'll receive your memory 10 days after we receive your order. Prices? You might pay less for somebody else's. And you can pay a lot more. We're competitive. But we deliver. Call the daring young men in our Memory Products department today, place a verbal order, confirm it with a written P.O. and 10

days after we receive your order, you'll receive your memory. Call (305) 974-1700. Ask for Gen Fortin. Or write Harris Corporation, Computer Systems Division, 1200 Gateway Drive, Fort Lauderdale, Florida 33309.

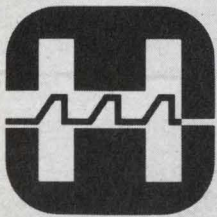

HARRIS

COMMUNICATIONS AND
INFORMATION HANDLING

INFORMATION RETRIEVAL NUMBER 88



Make the big change-over to the new DMM from T.R.I.

High performance, low cost (\$279) and compact size, 10 μ V Resolution.

10 μ V resolution, \$279
Model 6355 is a portable DMM having a 10 μ V (DC voltage) resolution. It is comparable to DMM's for laboratory use, priced at an economical \$279, and sets a new standard of performance for portable DMM's.

Fully automatic
Operation is as simple as selecting the function and signal connection. The measured value is displayed

through the automatic selection of 5 functional modes: range selection, unit display, polarity, over-range indication and overload protection.

True portability
It measures 4-3/8" (W) x 2-7/8" (H) x 6" (D) and is a light-weight 1.8 lbs for complete portability. The shock-resistant design even protects the unit against accidental drop damage.

Rechargeable battery (Option)
Besides the AC power supply, the standard composition includes an alkaline battery. Optionally available is a rechargeable battery. Standard accessories include a battery charger.



T.R.I. Corporation
505 West Olive Avenue
Sunnyvale, CA 94086
(408) 733-9080

New

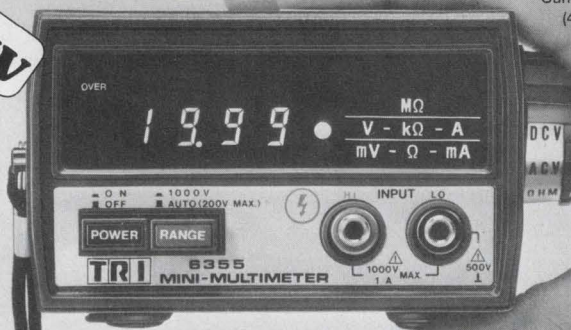

Model: 6355 Mini-multimeter \$279

INFORMATION RETRIEVAL NUMBER 89

SUBMINIATURE LAMP SPECIALISTS

Complete line of PC board Bi-Pin lamps and sockets
INCANDESCENT—SOLID STATE

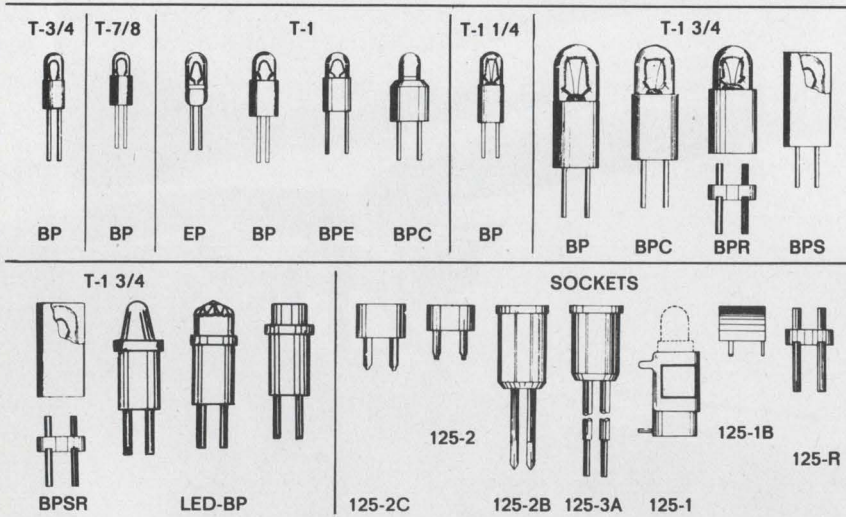

15 sizes, hundreds of electrical specifications.

• Ask informations to:
WAMCO Technical Sales, Inc.
705 W. 16th Street, Costa Mesa, California 92627
TEL: (714) 642-5100 TELEX: 678459

Mid West 12 states only
CIMCO International, Inc.
201 North Wells St. (Rm. 1920) Chicago, Illinois 60606
TEL: (312) 782-5621 TELEX: 724426

OSHINO ELECTRIC LAMP WORKS, LTD. TOKYO, JAPAN

INFORMATION RETRIEVAL NUMBER 90

DISCRETE SEMICONDUCTORS

LED indicators come in red, yellow or green

Dialight, 203 Harrison Pl., Brooklyn, NY 11237. (212) 371-8800. From \$0.39 (1000-up); stock.

Several new green, yellow and red LED logic state/fault indicators can be stacked so that multiple functions can be displayed. The indicators are available with both axial and right angle leads, thus making it possible to view the LED from any angle. Devices can be purchased with or without an internal dropping resistor. Axial LED indicators include: 550-0204, green; 0304, yellow; 0404, red; and 0504, red with resistor for 5-V operation. Right-angle LED indicators include: 550-0205 and 0206, green; 0305 and 0306, yellow; 0405 and 0406, red; and 0505 and 0506, red with resistor for 5-V operation.

CIRCLE NO. 349

Rf power transistors handle up to 25 W

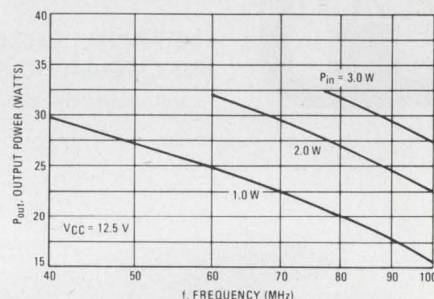

MRF234 - OUTPUT POWER versus FREQUENCY

Motorola, P.O. Box 20924, Phoenix, AZ 85036. (602) 244-6900. From \$1.75 (100-up); stock.

Five rf power transistors are designed for the 40 to 110 MHz mid-band international radio market. The MRF230 through MRF234 series of drivers and final amplifiers are rated at 1.5, 3.5, 7.5, 15 and 25 W of output power, respectively. To maintain stable operation over the entire frequency range, the gains of the devices are kept within the 10-dB range. Operation at VSWRs of up to 30:1, at any phase angle, can be tolerated. Characterization also includes series and parallel-equivalent impedance parameters over the frequency range for ease of design.

CIRCLE NO. 350

OEM Power Supplies

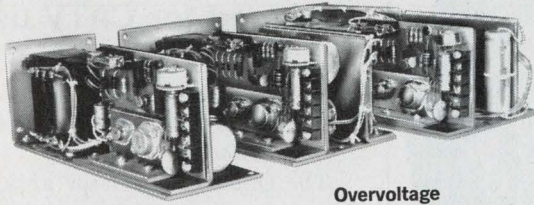

Overvoltage
Protection Standard

| Single Output 3 3/8 x 3 1/4 x 8 7/8 \$59.00 | | | Dual Output 3 3/8 x 4 5/8 x 8 7/8 \$99.00 | | | Triple Output 3 3/8 x 5 x 10 1/2 \$129.00 | | |
|---|------|-----|---|------|-----|---|--------|-----|
| MOD | VOLT | AMP | MOD | VOLT | AMP | MOD | VOLT | AMP |
| 86-301 | 3.6 | 4 | 86-307 | ±5 | 2.0 | 86-310 | +5 | 4 |
| 86-302 | 5 | 4 | 86-308 | ±12 | 1.2 | | ±12-15 | 0.3 |
| 86-303 | 12 | 2.5 | 86-309 | ±15 | 1.2 | | | |
| 86-304 | 15 | 2.5 | | | | | | |
| 86-305 | 24 | 1.5 | | | | | | |
| 86-306 | 28 | 1.2 | | | | | | |

Full rated, economical, power modules designed to meet a large segment of the OEM market. Overvoltage crowbar protection is standard along with foldback current limiting. Remote sensing is another desirable feature.

REQUEST BULLETIN PS-301
115 Marine St., Farmingdale, N.Y. 11735 • (516) CH 9-2336

VOLTEX

INFORMATION RETRIEVAL NUMBER 91

NEED DEPENDABLE PUSHBUTTONS? SWITCH TO CONTROL SWITCH

- High contact pressure for low contact resistance
- Fast make and break to reduce arcing and extend contact life

WIDE RANGE OF STYLES AVAILABLE

UNIFORM PANEL APPEARANCE



- Same external appearance even with different ratings, circuits and other characteristics.
- Building block approach . . . wide variety of mechanisms, adapters, and buttons.

HEAVY DUTY PUSHBUTTON SWITCHES

. . . ratings to 35A



SUBMINIATURE PUSHBUTTON SWITCHES

. . . space saving design



SEND FOR PORTFOLIO OF TECHNICAL BULLETINS

CONTROL SWITCH

A CUTLER-HAMMER COMPANY

1420 DELMAR DRIVE, FOLCROFT, PA. 19032



INFORMATION RETRIEVAL NUMBER 92

ELECTRONIC DESIGN 26, December 20, 1974

EFFECTIVE!

Heat DISSIPATORS

Low-Cost!



KOOLER-KROWN

FOR TO-5, TO-8, TO-66
Power Transistors

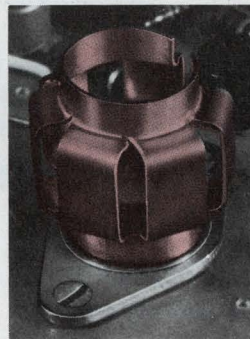

Extend the life and useful power range of transistors with low-cost Kooler-Krown Heat Dissipators. The engineered design combines a large heat dissipation area with good natural air flow. Heat is effectively transferred by circumferential, intimate fit of heat dissipator to transistor case. Heavy gauge formed metal gives sufficient mass for heat dissipation, and acts as a firm spring to hold the Kooler-Krown onto the case. Ease of assembly, exceptional performance characteristics and low cost (only 24¢ each in quantity) are provided by Kooler-Krown heat dissipators. Best of all, get a sample and try it!

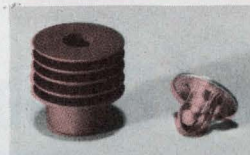

TRIAC-KOOLER

For Triac Packages

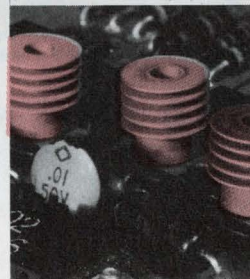

The Triac-Kooler is a low cost (only 17¢ each in quantity) heat dissipator that effectively levels excessive heat rise in triacs, affording greatly prolonged usefulness to the triac. A push-in rivet firmly assembles the Triac-Kooler to the base of the triac. The multiple finned area disperses the heat. The small size of the Triac-Kooler permits dense packaging. The attaching push-in rivet is supplied with each Triac-Kooler. Nothing else is needed. No tools. Send for your sample . . . try it.

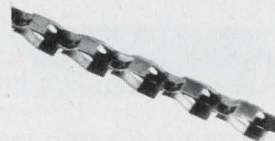

Another Heat Dissipator!
The well known metal UNITRACK card guide affords heat dissipation or grounding for your "hot" boards right into the chassis.

UNITRACK®

UNITRACK Division Calabro Plastics, Inc.
8738 West Chester Pike, Upper Darby, Pa. 19082
Telephone (215) 789-3820

INFORMATION RETRIEVAL NUMBER 93

NEW NEW NEW

IMC introduces fan for cooling sandwiched areas

IMC's new, high performance FULMAR fan features maximum efficiency for cooling high power density enclosures and rows of printed circuit board arrays. Unique design of this fan allows for convenience of "Side by Side" mountings for maximum airflow distribution and stable motor performance under low voltage (brown out conditions). Fulmar's low noise level is a natural for computer room use.



4-3/4" diameter by 5-29/32"

FEATURES

- A compact 2" in depth
- Meets U.L. recognition requirements
- Automatic reset overload protector is standard
- Capacitor supplied with unit

50/60 HZ AIRMOVER



Circle the "Bingo" for details! For immediate service please call Fred Taylor, Sales Manager at (603) 332-5300 or write:

IMC MAGNETICS CORP.

NEW HAMPSHIRE DIVISION

ROUTE 16B, ROCHESTER, NEW HAMPSHIRE 03867

INFORMATION RETRIEVAL NUMBER 94

Card Edge and Edgeboard Connectors from **Eby**™

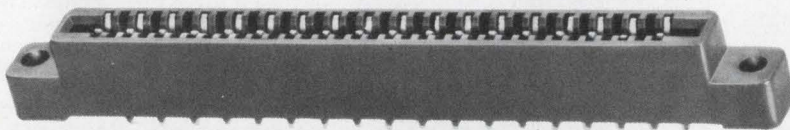

CARD EDGE CONNECTORS (9775-95)

* 156 CENTERS * DIP SOLDER TERMINATIONS

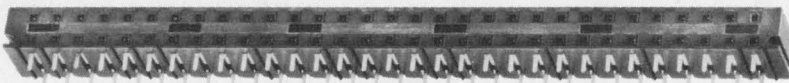

FEMALE EDGEBOARD CONNECTORS (9775-102)

* FOR .025" SQUARE POST ON .150 GRID

Consult us for other Connector Packaging Items—and for information on our Custom Manufacturing Service.



HUGH H. EBY CO.

4701 GERMANTOWN AVENUE, PHILADELPHIA, PA. 19144
(215) 842-3000 a division of REDM Corp.

E-102

INFORMATION RETRIEVAL NUMBER 95

DISCRETE SEMICONDUCTORS

Quad power transistors designed for CATV use

Communications Transistor, 301 Industrial Way, San Carlos, CA 94070. (415) 591-8921. \$33.50 (1 to 99); stock.

The Quad 1 transistor array has four rf power transistors in one package. Quad 1 offers high gain over the 40-to-300-MHz CATV band. Other performance features include return loss input to output, more than 18 dB; cross-modulation +50 dBmV, 12 ch flat = -65 dB; second IM distortion, +50 dBmV, -80 dB (typical); and triple beat distortion, +50

CIRCLE NO. 351

LED lamps in four colors include limiting resistor

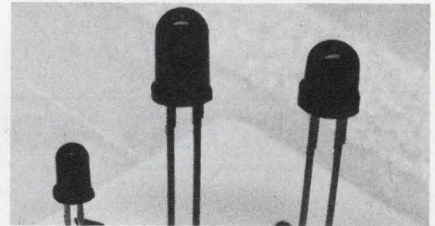

Xciton Corp., Shaker Park, 5 Hemlock St., Latham, NY 12110. (518) 783-7726. From \$0.50 (1000 up); stock.

A series of resistor-LED lamps is available in three different plastic lens styles and in four colors—red, green, yellow and orange—rated for either 5 or 12-V-dc operation. Each of the 24 LED lamps is in popular epoxy-molded, radial-lead cases. Each lamp is rated for luminous intensity at a forward current of 16 mA. Basic specifications for the resistor-LED styles are: XC209 lamps have viewing angles of 75°. Lamp lenses have diameters of 0.125 in. and heights of 0.21 in. Luminous intensity is 0.6 mcd minimum and 2 mcd typical. XC5053 lamps are wide angle indicators with viewing angles of 80°. Lamp lenses have diameters of 0.2 in. and heights of 0.34 in. Luminous intensity is 0.5 mcd minimum, and 1.5 mcd typical. XC22 lamps also have viewing angles of 80°, diameters of 0.2 in. and heights of 0.24 in. Luminous intensity is 0.5 mcd, minimum, and 1.5 mcd, typical.

CIRCLE NO. 352

PICTURE, PATTERN, OR PLOT



Alden recorder reproducing scanning electron microscope image of a 1 mil wire bond to an IC

Get sharp recordings displaying three dimensions and yielding greater detail and informational content than your present display with ALDEN COMPONENT FACSIMILE RECORDERS.

- Synchronizes easily with your scanning sensor or transducer
- Available in print-out widths from 2" to 48"
- Speeds range from 8 RPM to 3600 RPM
- Presentations, linear or non-linear . . . simply
- Used with a broad variety of systems such as ultrasonic/infrared flaw detectors, spectrum analyzers, computers, television, medical instrumentation and scanning radiometers, etc.

Call or write for free descriptive catalog.

ALDEN ELECTRONIC & IMPULSE RECORDING EQUIPMENT CO., INC.

Westboro, Mass. 01581 Tel.: (617) 366-8851

INFORMATION RETRIEVAL NUMBER 96

Compact, High-Quality LiNbO₃, LiTaO₃ Light Modulator

We have now added a high performance LiTaO₃ light modulator which utilizes the features of LiTaO₃ to our conventional large LiNbO₃ light modulators. This new light modulator has a wide range of applications in light communications, light memories, laser displays, laser strobo, measurement, facsimile and a broad range of other fields.

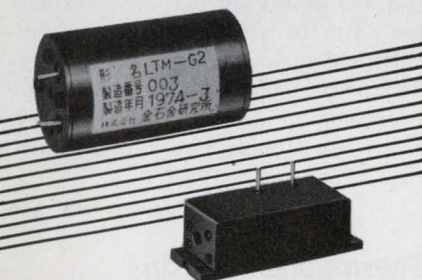

Specifications

| Type | LNM | LTM-G1 | LTM-G2 |
|---------------------------|-------------------------|--------------------|------------------------|
| Crystal | LiNbO ₃ | LiTaO ₃ | LiTaO ₃ |
| Dimensions | 63 [±] × 279mm | 14 × 13 × 46mm | 26 [±] × 45mm |
| Extinction ratio | 50:1 | 70:1 | 70:1 |
| Capacitance | 10pF (50MHz) | 32pF (1KHz) | 32pF (1KHz) |
| Half-wave voltages | 100 Volts | 32 Volts | 32 Volts |
| Piezoelectrical resonance | 4.0MHz | 9.0MHz | 9.0MHz |
| Operating temp. | 175°C | R.T. | R.T. |

(Measured values are for He-Ne laser 6328Å light.)
We also sell and fabricate as grown single crystals.



House of Crystal...

Kinsekisha Laboratory Ltd.

• Head Office & Plant: 23-17, 2-chome Miyasaka, Setagaya-ku, Tokyo, Japan. Tel: 429-2111
• Mail Address: Central P.O. Box 350, Tokyo, Japan. • Cable Address: CRYSTAL TOKYO

INFORMATION RETRIEVAL NUMBER 97

ELECTRONIC DESIGN 26, December 20, 1974

LED panel lamps have large lens diameter

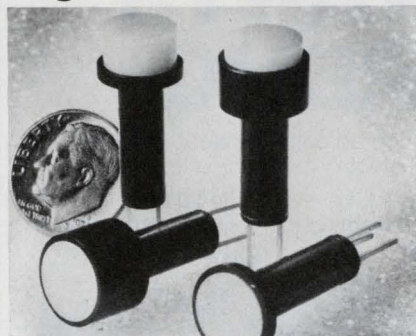

Data Display Products, 5428 W. 104 St., Los Angeles, CA 90045. (213) 641-1232. \$1.45 (100-up); stock to 3 wk.

The 460 series LED displays use high-brightness LEDs to provide large (0.39 in.) diameter lighted areas. The lamps are available with green, yellow, amber or red LEDs, with lenses tinted clear or translucent in any of the four colors, or water clear. All lenses have an internal freznel pattern for optimum light diffusion even in clear. The lense style is cylindrical with either standard projection or low-profile (1/16 in.) freznel panel projection. Lamps mount in 0.25 in. diameter holes and can be positioned on 0.5 in. centers. They may be mounted directly in the panel with supplied hardware (neoprene washer and retaining clip) or they may be ordered as a cartridge type for front panel replaceability. All lights have wrapped-wire type gold-plated terminals, and are available with voltage ratings of 2 to 28 V at currents from 9 to 35 mA.

CIRCLE NO. 353

Darlington transistors handle up to 100 W

RCA, Route 202, Somerville, NJ 08876. (201) 722-3200. 1000-up prices: 1B07 (\$1.30); 1B08 (\$1.60); stock.

Two complementary npn and pnp Darlington transistors, types RCA-1B07 and RCA1B08, are designed for audio-amplifier applications. The transistors have a sustaining voltage ($V_{CEO(sus)}$) of 80 or -80 V and a gain (h_{FE}) of 1000 to 15,000, with a dissipation rating (P_T) of 100 W. The RCA1B07 and RCA-1B08 are supplied in the JEDEC TO-3 hermetic package.

CIRCLE NO. 354

AVAILABLE NOW!

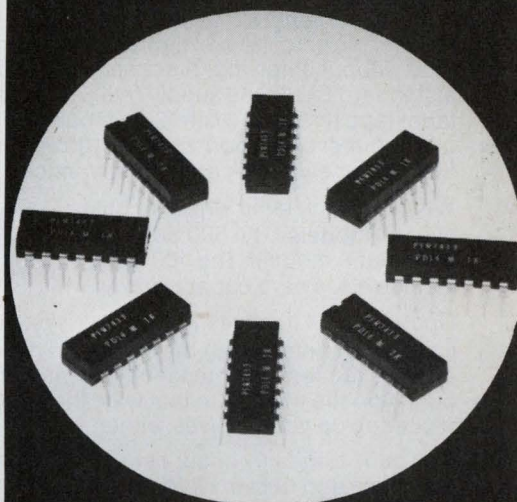

NEW PYROFILM THICK FILM DIPs

Standard Circuits
Custom Circuits

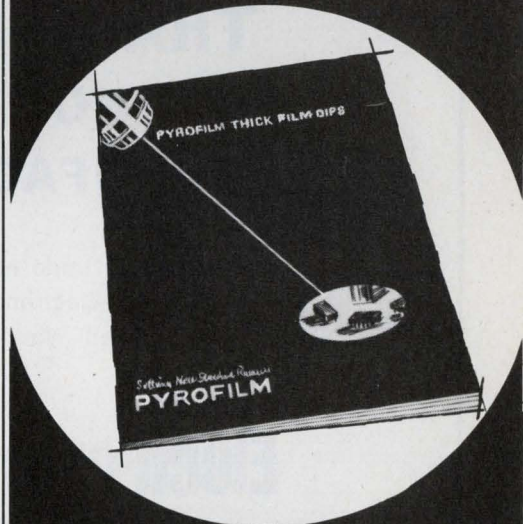

AVAILABLE SOON!

Complete Full Line Catalog

Circle Information Retrieval
Number 248

Setting New Standards in Reliability

PYROFILM

60 S. Jefferson Road • Whippany, N. J. 07981
(201) 887-8100

NOBODY WANTS A CLUTTERBUG

We had your end-user in mind when we engineered our compact, self-contained, no fuss, no muss, 50/60 cps, electro-mechanical punches.

With conveniences that show at the installation. Like bi-directional feed. An over-sized chad box that can contain chad from up to 1000 feet of punched tape without emptying. A drawer which holds a standard 8½" tape supply reel. An out of tape/tape tension switch. Side mounted take-up reel Operation "cool" at 100°F. Long life Extremely low operator intervention.

We had you in mind when we built over 60 models. The 500 Series are paper tape models. The 400 Series include edge card capabilities as well.

Once you sell them (as part of your system installation or terminal) they'll stay sold and require less maintenance than any other punch on the market. In that way, they won't be cluttering up your shelves, either.

You can "bug" any of our field representatives for prices and delivery information.

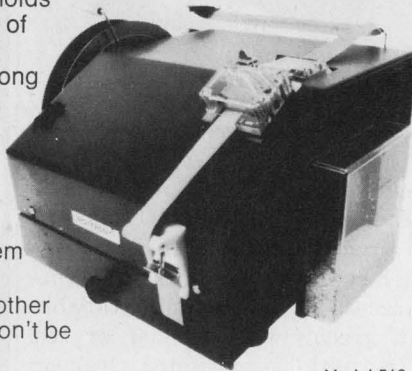

Model 518
Paper Tape Punch Station



OEM PRODUCTS DIVISION

LITTON ABS

Automated Business Systems

34 Maple Avenue, Pine Brook, N.J. 07058/(201) 575-8100

IN U.K. — LBS, 27 Goswell Road, E.C.1, London

IN FRANCE — LITTON ABS/OEM, 9/15 Avenue Paul Doumer, 92504 Rueil-Malmaison

INFORMATION RETRIEVAL NUMBER 98

KNOW THE TRADE NAME BUT NOT THE MANUFACTURER?

Almost 5,000 trade names are identified for you in Electronic Design's GOLD BOOK. When you need information FAST . . .

Electronic Design's GOLD BOOK IS THE PLACE TO LOOK

application notes

Nitrogen lasers

"Nitrogen Laser Requirements for Successful Dye Laser Pumping" discusses nitrogen laser parameters. The note stresses the importance of pulse width, power and beam characteristics and compares spark gap vs thyatron switching of the laser. Moletron, Sunnyvale, CA

CIRCLE NO. 355

FET input op amps

An 18-page note discusses the advantages of FET input stages over the bipolar transistor stage, pointing out that low input and offset current characteristics of matched FET pairs are three-to-five orders of magnitude lower than those of bipolar-driven op amps. Siliconix, Santa Clara, CA

CIRCLE NO. 356

Flat ribbon cable

A series of six "How To" data sheets illustrates the techniques of terminating bonded and laminated round-conductor flat ribbon cable. Spectra-Strip, Garden Grove, CA

CIRCLE NO. 357

Temperature measurement

An application note describes the use of highly matched transistor pairs to perform accurate temperature measurement without requiring expensive reference junctions or linearizing circuitry. Precision Monolithics, Santa Clara, CA

CIRCLE NO. 358

Thermoplastic resins

Design, fabrication and performance data of thermoplastic resins are covered in a 56-page manual. A fold-out section provides easy reference for formula symbols and notations. Detailed illustrations of techniques, design equations, application data and performance characteristics are included. General Electric Plastics Dept., Selkirk, NY

CIRCLE NO. 359

IC POWER SUPPLY 5 volts at 1 amp

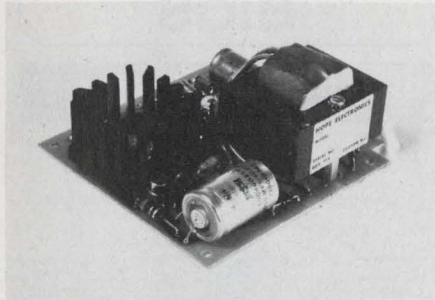

DELIVERY FROM STOCK

1-9 QUANTITY **\$3300**

- Input 117 V $\pm 10\%$ — 60 to 400 CPS
- Output Adjustable $\pm 10\%$ at 1 amp
- Line Regulation 0.1%
- Load Regulation 0.5%
- Ripple and Noise <1 MV peak to peak
- Short Circuit Proof
- Over Voltage Protection

HOPE ELECTRONICS

Box 773, Clifton, New Jersey 07013
Phone (201) 777-3522

Contact us for Your Custom Requirements

Oscillators • Amplifiers • Modulators
Attenuators • Sweep Generators • Filters

INFORMATION RETRIEVAL NUMBER 100

Circuit Savers

DC **95¢** 1000 pcs.
TRANSIENT SUPPRESSOR

The TSD-1.5 Series are ideal for protection of long signal lines from damage from induced lightning etc. Reaction time is in nanoseconds.

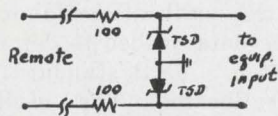

2 units (back to back) will protect sensitive components from a 5KV, 1ms duration transient. Clamp voltages from 5V to 200V. Call Mike Coyle for applications assistance. Full line of protection modules for every hi-lo voltage/current requirement. Write or call for Catalog 749.

279 Skidmore Road
Deer Park, New York 11729
Telephone: 516 - 586-5125

MCG Electronics

INFORMATION RETRIEVAL NUMBER 101
ELECTRONIC DESIGN 26, December 20, 1974

evaluation samples

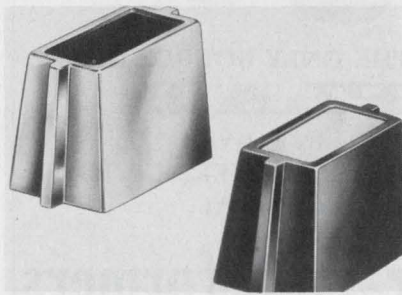

Knobs for linear controls

Plastic knobs that are designed for linear controls with manual slide actions are molded of ABS thermoplastic material. They come in 18 standard colors and chrome-plated finish. Available for various shaft configurations, the knobs are press-fit in place. Rogan, 3455 Woodhead Dr., Northbrook, IL 60062

INQUIRE DIRECT

PC card ejector set

A PC card ejector set, featuring self-lubricating nylon material, consists of two ejectors and mounting pins. Scanbe Manufacturing.

CIRCLE NO. 360

Mini temp recorders

Self-adhesive miniature three and four-increment temperature recorders indicate overheating of electronic circuit board components. The recorders are accurate to $\pm 1\%$ over the 37-to-260-C temperature range in increments of 5 C. When exposed to the rated critical temperature, the indicators turn in sequence from silver to black for a direct readout, which is both permanent and irreversible. William Wahl, Temp-Plate Div.

CIRCLE NO. 361

Ferrite cores

A small kit offers power-circuit designers a simple way to discover the advantages of ferrite cores in a converter circuit. The kit includes a ferrite core and a diagram for a converter circuit that can be built in a few minutes. The circuit converts 12 V dc to 150 V dc at an efficiency of over 80%. Ferro-cube.

CIRCLE NO. 362

AVAILABLE NOW!

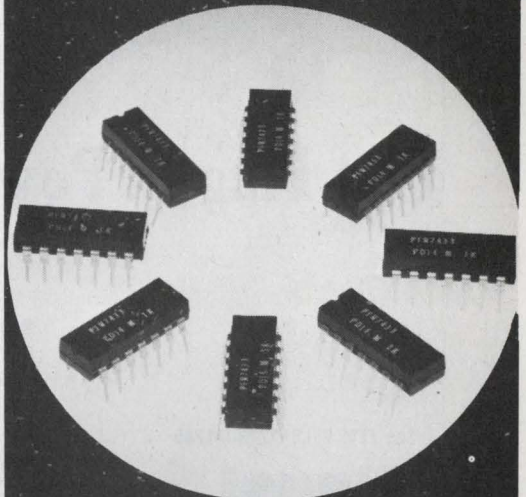

NEW PYROFILM THICK FILM DIPs

Standard Circuits
Custom Circuits

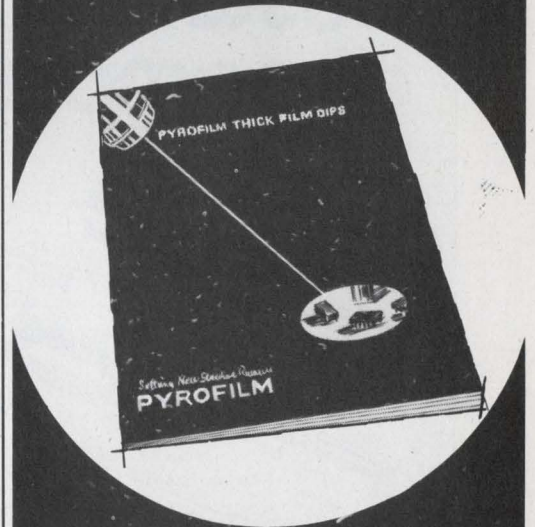

AVAILABLE SOON!

Complete Full Line Catalog
Circle Information Retrieval
Number 248

Setting New Standards in Reliability
PYROFILM

60 S. Jefferson Road • Whippany, N. J. 07981
(201) 887-8100

IMMEDIATE DELIVERY!
IN STOCK

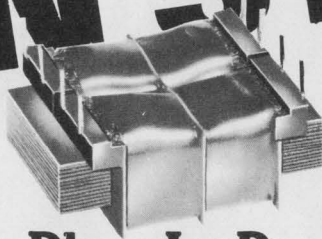

THE ONLY SOURCE OF
FLAT
PLUG-IN POWER
TRANSFORMERS UP TO
6VA IS SIGNAL

Flat Plug-In Power Transformers

- Maximum Height of 0.850 Inches Allows Stacking PC Boards on 1 Inch Centers.
- 6VA Rating at 50/60 Hz.
- HUM—Bucking Construction—Reduces Magnetic Field-Balanced Windings.
- Dual Primaries 115/230 V, 50/60 Hz.
- Ratings from 5 to 230 Volts.

Send for Free Catalog also listing extensive lines of PC Plug-In to 24VA, Rectifier Power Transformers and Chokes, and Constant Voltage Transformers.

See EEM Vol.3•1273—1285

**Signal
transformer co. inc.**

1 Junius St., Brooklyn, N.Y. 11212
Telephone (212) 498-5111

INFORMATION RETRIEVAL NUMBER 102

custom options at compact prices

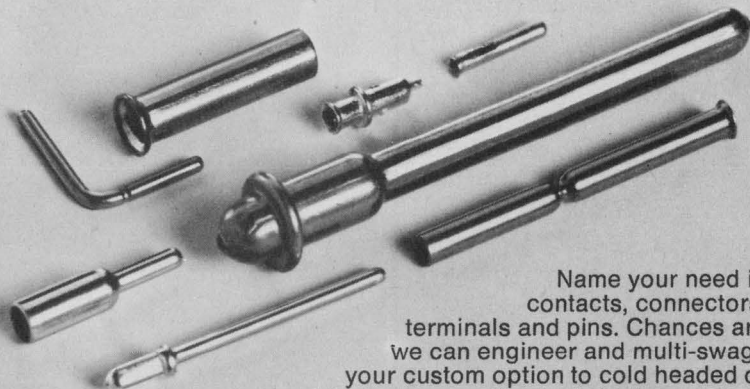

Name your need in contacts, connectors, terminals and pins. Chances are we can engineer and multi-surge your custom option to cold headed or machine screw quality. And slash your costs 40% or more. Delivery is when you want it, too. Get all the details in our new catalog. Write or call.



bead electronics

A Division of Bead Chain Manufacturing Co.
58 Mountain Grove St., Bridgeport, Conn. 06605
Phone: (203) 334-4124

INFORMATION RETRIEVAL NUMBER 103

design aids

KEMET

**UNION
CARBIDE**

UNION CARBIDE CORPORATION

TECHNICAL DATA

ADDRESS: COMPONENTS DEPARTMENT, P. O. BOX 1928, GREENVILLE, S. C. • TEL: (803) 963-6300

Established Reliability Solid Tantalum Capacitor Conversion Chart

From MIL-C-39003C to MIL-C-39003D



DASH NUMBER REFERENCE TO CSR99, CSR13, CSR23, CSR33, CSR91, and CSR99 CAPACITORS WITH CROSS REFERENCE TO EQUIVALENT KEMET PART NUMBERS.

TABLE OF CONTENTS

| | |
|--------------------------------------|--------------|
| Introduction | Page 2 |
| Specification Requirements | Pages 2 & 3 |
| Part Numbering Systems | Page 4 |
| Capacitor Outline Drawings | Page 15 |
| Cross Reference | |
| CSR13: MIL-C-39003/1E, 1D, 1C, 1A, 1 | Page 5-12 |
| and MIL-C-39003/20, CS12 & CS13 | Page 13 |
| CSR09: MIL-C-39003/2B & 2A | Page 13 & 14 |
| CSR23: MIL-C-39003/3B | Page 14 & 15 |
| CSR33: MIL-C-39003/3E | Page 16 & 17 |
| CSR91: MIL-C-39003/4B | Page 5-12 |
| CSR99: MIL-C-39003/5 | |

NEW IN THIS ISSUE
MIL-C-39003D & CSR33 INFORMATION

Capacitor chart

An 18-page Established Reliability Tantalum Capacitor Conversion Chart compares the electrical, acceptance inspection tests and marking requirements between MIL-C-39003D and MIL-C-39003C. Union Carbide.

CIRCLE NO. 363

Minicomputer template

A computer-programming aid is offered to users of the company's D-116 and the Data General NOVA 1200 series minicomputers. The paper data lamp decoder template affixes to the front panel and provides the system programmer with an easily read interpretation of the computer's data lamp instructions. Digital Computer Controls.

CIRCLE NO. 364

Calibration chart

A stability/calibration chart gives the calibration laboratory man the data needed to determine how often a local standard must be recalibrated. The oscillator drift rate or stability is used as the determining factor. True Time Instrument.

CIRCLE NO. 365

Aluminum standards

"Aluminum Standards & Data" is a basic reference to mechanical, physical and other properties of aluminum. The Aluminum Association.

CIRCLE NO. 366

USC GR/RGR HIGH DENSITY WRAP/CRIMP CONNECTORS

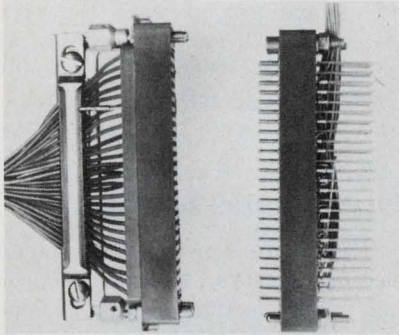

1 of over 20,000 types
of Connectors. Send today
for GR/RGR Series Catalog.

U. S. COMPONENTS, INC.

Leader in advanced engineering & design

1320 Zerega Avenue, Bronx, N. Y. 10462
(212) 824-1600 TWX: 710-593-2141
Telex: 1-2411 Cable: COMPONENTS, N. Y. K.

INFORMATION RETRIEVAL NUMBER 104

PIEZOELECTRIC TUNING FORK

LOW PRICE
HIGH RELIABILITY

TYPE: TFR 697.5Hz~1492.5Hz

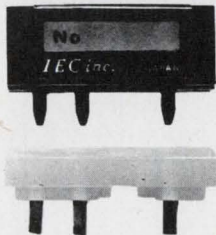

22^L × 9.0^H × 7.5^W mm

PRICE \$ 1.20 F.O.B TOKYO
(OVER 1,000PCS.)



**IWATA ELECTRIC
CO., LTD**

Mansei Bldg. Rm. 36 1-16, 1-Chome
Soto-Kanda, Chiyoda-ku, Tokyo 101, Japan

new literature

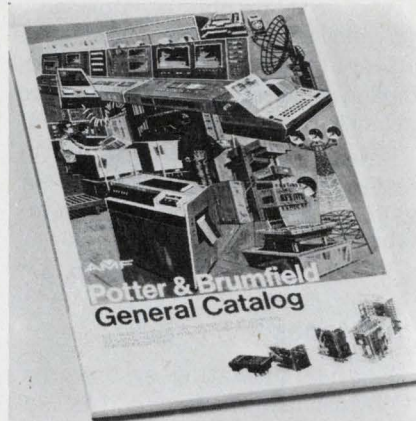

General relays

Electromechanical, dry reed and mercury-wetted relays, time delay and interval timer relays, hybrid and solid-state relays, precision snap-action switches and custom control assemblies are shown in a catalog. The catalog contains electrical specifications, mechanical requirements and wiring diagrams for each model. For PC board models there are suggested PC layouts. Potter & Brumfield, Princeton, IN

CIRCLE NO. 367

Custom ICs

A 16-page publication describes the company's unique custom IC concept. The key to the concept are three standard bipolar chips that contain a large number of standardized IC components. Interdesign, Sunnyvale, CA

CIRCLE NO. 368

Laboratory products

Descriptions, applications information, prices and illustrations of equipment used in scientific, industrial and research laboratories are presented in a 32-page catalog. Science Essentials Operations, Anaheim, CA

CIRCLE NO. 369

Capacitors

A revised guide to MIL-style CSR09, CSR13 and CSR23 capacitors abstracts all important data from MIL-C-39003 established reliability "D" revision in an easy-to-use format. Sprague, North Adams, MA

CIRCLE NO. 370

AVAILABLE NOW!

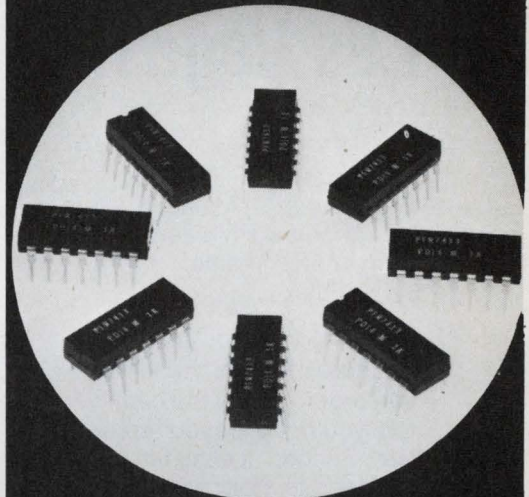

NEW PYROFILM THICK FILM DIPs

Standard Circuits
Custom Circuits

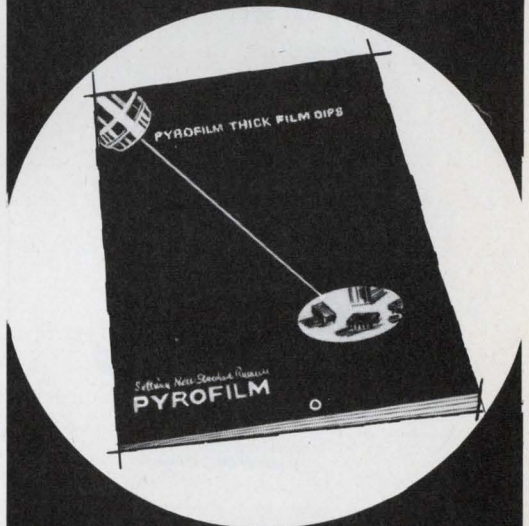

AVAILABLE SOON!

Complete Full Line Catalog
Circle Information Retrieval
Number 248

Setting New Standards in Reliability
PYROFILM

60 S. Jefferson Road • Whippany, N. J. 07981
(201) 887-8100

Our System Works In Las Vegas.

It also works in Miami, Boston, Los Angeles, Philadelphia, Denver and Seattle.

The Wesco system is a three-way sure thing for your capacitor requirements. First, it lets you order exactly the capacitors you need for your application. Second, it eliminates the need to order and test 100 ten percenters for every 10 two percenters you want. And third, the Wesco system frees you from an inventory of hundreds of "extras" that you can't use.

It's even money that when you use the Wesco system, you'll never order from another capacitor company again.

The Wesco system.
It's your roll.

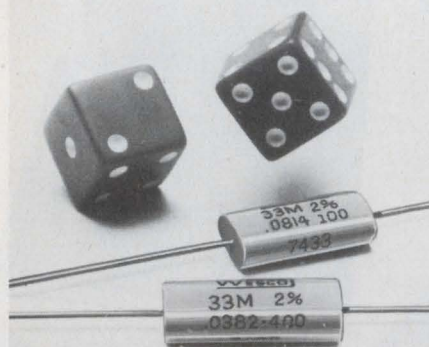

WESCO
WESCO ELECTRICAL COMPANY
201 MUNSON STREET
GREENFIELD, MASSACHUSETTS 01301
TELEPHONE: 413-774-4358

NEW LITERATURE

Film resistors

A four-color film resistor catalog showcases metal, cermet or carbon-film resistors. Easily understood descriptions of the standard packaging offered are included as well as a special section aimed at easing the job of ordering the components. Mepco/Electra, Morristown, NJ

CIRCLE NO. 371

Vinyl tapes

A guide to plating systems for PC board manufacturing lists and describes vinyl tapes for use during solder stripping and gold-plating procedures. It also describes polyester and polyethylene protective tapes. A chart lists properties for each tape—total caliper, adhesion to steel, available colors and elongation. 3M, St. Paul, MN

CIRCLE NO. 372

Gas regulating equipment

"How to Safely Operate Gas Regulating Equipment" explains how to select, install and operate gas regulators for specialty gases, including flammable, oxidant, corrosive, inert, toxic and high pressure gases. Air Products and Chemicals, Specialty Gas Dept., Allentown, PA

CIRCLE NO. 373

Environmental equipment

A 40-page catalog illustrates and describes environmental simulation equipment designed to perform under the most rigorous government and commercial specifications. Technical configurations and drawings are included. Associated Environmental Systems, Lawrence, MA

CIRCLE NO. 374

3-D displays

Three-dimensional display system comprised of building-block modules is described in an eight-page catalog. The catalog photographically illustrates the various capabilities of the 3-D system. Specifications and prices are provided. Optical Electronics, Tucson, AZ

CIRCLE NO. 375

Microwave instruments

An 84-page illustrated catalog describes features and specifications of sweep oscillators and instruments for the measurement of microwave parameters. Details on over 80 instruments are given. Twenty-three pages contain applications, techniques and theory on microwave sweepers, attenuation measurements and rf power measurements. Weinschel Engineering, Gaithersburg, MD

CIRCLE NO. 376

Photoelectric scanners

Completely self-contained photoelectric sensors, two-part sensors and photoelectric system components are detailed in a 24-page catalog. Block diagrams and wiring diagrams for sensor units, timing diagrams for time-delay modules, schematic diagrams of output switching devices and dimensional drawings are included. Warner Electric Brake & Clutch, Beloit, WI

CIRCLE NO. 377

SUBSCRIBER SERVICE For prompt service include the addressed label when writing about your subscription.

CHANGE OF ADDRESS

| | | | | | | | |
|-------------|------|---------|---------------------|-----------------|------|-------|-----|
| NEW ADDRESS | name | company | division/department | company address | city | state | zip |
| | | | | | | | |
| | | | | | | | |
| | | | | | | | |
| | | | | | | | |

If you're moving, please let us know six weeks before changing your address. If you have a question, place your magazine address label here and clip this form to your letter.

MAIL TO: ELECTRONIC DESIGN Circulation Dept. Hayden Publishing Co., Inc., 50 Essex Street, Rochelle Park, NJ 07662

Holographic laser systems

Pulsed holographic lasers operating at $0.532 \mu\text{m}$ are described in a two-color, four-page brochure. Included with the brochure is a data sheet entitled, "What's Coherence Length," which defines this often misunderstood parameter. Also presented is a discussion of how to measure coherence length. International Laser Systems, Orlando, FL

CIRCLE NO. 378

Plastics guide

An updated edition of "Standard Tests on Plastics" is illustrated with photos, drawings, tables and charts. The brochure describes test procedures in six categories: mechanical, thermal, optical, permanence, analytical and electrical. In each specific test, the specimen, procedure and significance are discussed. Celanese Plastics, Newark, NJ

CIRCLE NO. 379

Transistors, Darlingtons

Power transistors and Darlingtons using glass passivation techniques for improved performance are described in a series of nine data sheets. Each data sheet contains curves, specifications and ratings and applications information. Dimensional drawings and a photograph of each device are provided. International Rectifier, Semiconductor Div., El Segundo, CA

CIRCLE NO. 380

Printer/plotters

Status electrostatic printer/plotters are covered in a 10-page catalog. The catalog shows maps, charts and graphs generated on Status units. Varian Data Machines, Irvine, CA

CIRCLE NO. 381

CB radio accessories

CB and amateur radio replacement parts, accessories and "step-up" items are illustrated in a catalog. The eight-page catalog features such items as power base and mobile unit microphones, dual power SWR meters, noise filters and suppressors and microphone and antenna plugs and connectors. GC Electronics, Rockford, IL

CIRCLE NO. 382

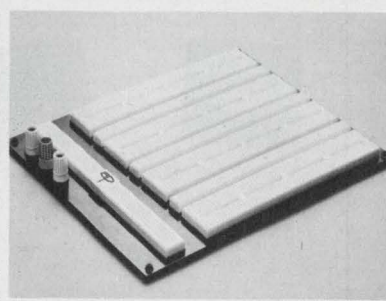

A P Breadboard II. Completely assembled; 2696 solderless plug-in tie points; no special patch cords required. Accept DIPs, TO-5's or discrete components with leads to .032". Has low impedance distribution with integral ground plane. Unparalleled high-speed circuit performance. A P Products Inc., Box 110, Painesville, Ohio 44077.

INFORMATION RETRIEVAL NUMBER 601

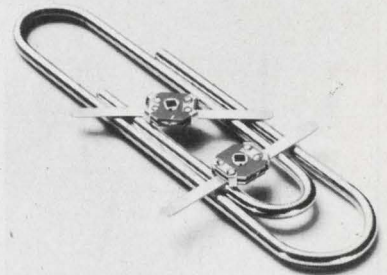

Thin-Trim variable capacitors provide a reliable means of adjusting capacitance without abrasive trimming or interchange of fixed capacitors. Series 9401 has high Q's and a range of capacitance values from 0.2-0.6 pf to 3.0-12.0 pf and 250 WVDC working voltage. Johanson Manufacturing Corporation, Boonton, New Jersey (201) 334-2676.

INFORMATION RETRIEVAL NUMBER 604



Free catalog of 34,500 power supplies from the worlds largest manufacturer of quality Power Supplies. New '74 catalog covers over 34,500 D.C. Power Supplies for every application. All units are UL approved, and meet most military and commercial specs for industrial and computer uses. Power Mate Corp. (201) 343-6294.

INFORMATION RETRIEVAL NUMBER 602

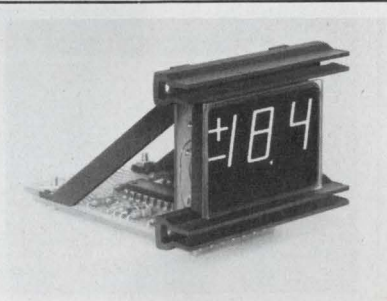

Low-Profile gas discharge readout assemblies packaged on horizontal p.c. boards for applications with limited top/bottom mounting space. Includes decoder/driver and optional power supply for 5 VDC input. Master Specialties, 1640 Monrovia, Costa Mesa, Calif. 92627. (714) 642-2427.

INFORMATION RETRIEVAL NUMBER 605

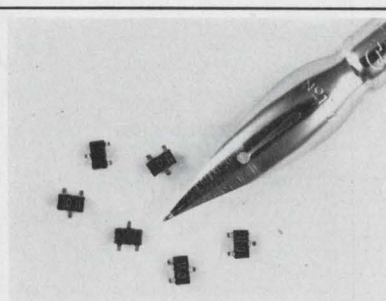

The NEC V734M is a high frequency transistor in a very small package, $1.5 \times 2.8 \text{ mm}$. With an f_c of 2 GHz and a noise figure of 3 db at 500 MHz this inexpensive transistor is suitable for many applications in amplifiers and oscillators. California Eastern Labs, Inc. One Edwards Court, Burlingame, Calif. (415) 342-7744.

INFORMATION RETRIEVAL NUMBER 603

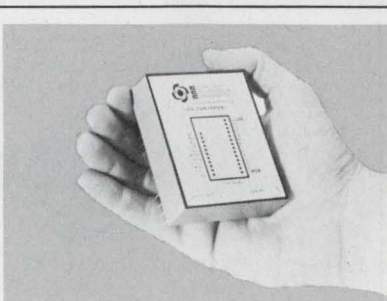

"Synchro to digital converters - 10, 12, or 14 bit output, errorless tracking up to 4 r.p.s., accuracy $\pm 4 \text{ min.}$ of arc $\pm .9 \text{ LSB}$, resolution - 1.3 minutes, 60 or 400 Hz input, Module $2.6 \times 3.1 \times .82 \text{ H}$, Price From \$350 in qty. Computer Conversions Corp., East Northport, N.Y. 11731 (516) 261-3300."

INFORMATION RETRIEVAL NUMBER 606

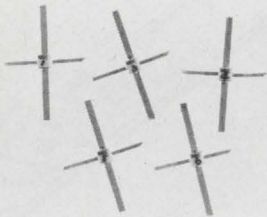

The NEC V222 transistor is a low noise amplifier with a minimum gain of 8 dB at 4 GHz. The V222 is available with three noise figure selections at 4 GHz: 3.5 dB, 4.0 dB and 4.5 dB. The package is the popular 100-mil square stripline. California Eastern Labs, Inc., One Edwards Court, Burlingame, Calif. (415) 342-7744.

INFORMATION RETRIEVAL NUMBER 607

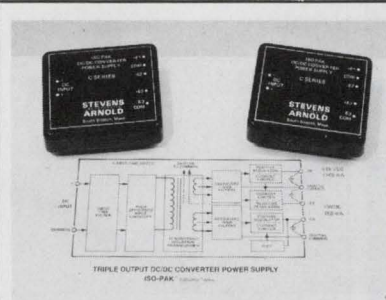

9 watt triple output dc/dc supply is completely shielded and isolated. Outputs $\pm 15\text{VDC}$, $\pm 165\text{mA}$ and $+5\text{VDC}$, 750mA . Transformer-Isolated with Analog & Digital Grounds. Regulation $\pm 0.02\%$. Package Shielded 6 sides. Survives 8 hour short at $+71^\circ\text{C}$. Order Series C at \$99 (1-9). Stevens-Arnold, South Boston, Mass. (617) 268-1170.

INFORMATION RETRIEVAL NUMBER 610

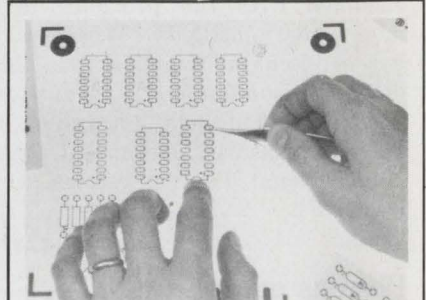

Cut PC layout time 75% with PUPETS™, Bishop's die-cut, transparent, reusable layout patterns in 2X or 4X scale that represent electronic components. Contain no adhesive yet adhere to any clear, non-matte drafting film. FREE Sample & technical bulletin. Bishop Graphics, Inc., 20450 Plummer Street, Chatsworth, CA 91311 (213) 993-1000.

INFORMATION RETRIEVAL NUMBER 613

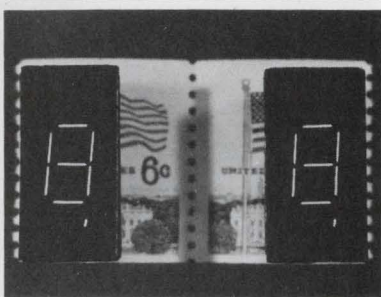

The Proven Incandescent Readout Standard 16 Pin DIP Flat Pack. All units 5 Volt 100,000 hrs. plus
3015F-BM 08ma/seg 700 ft/lam
3015F-BM10 10ma/seg 1700 ft/lam
3015F-BM15 15ma/seg 4500 ft/lam
Field tested over 4 years in many applications. READOUTS, INC. P.O. Box 149, Del Mar, Ca. 92014 Tel. 714-755-2641 Telex 69-7992.

INFORMATION RETRIEVAL NUMBER 608

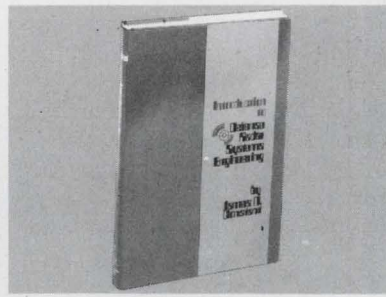

Introduction To Defense Radar Systems Engineering. Excellent introduction and practical reference to radar systems design and applications. #9194, 260 pp., \$20.00. Circle the Info Retrieval No. to order 15-day exam copy. When billed, remit or return book with no obligation. Hayden Book Co. 50 Essex St. Rochelle Park, N.J. 07662

INFORMATION RETRIEVAL NUMBER 611

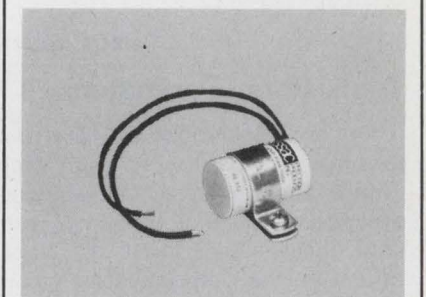

Lowest cost approach to solid state timing: NEW PS Series. Uses your relay/contacter to provide end output of delay, thus eliminating extra costs. Operating voltages: 12 to 230 VAC or DC. Delays from 100 ms. to 300 secs. 10 amp switch rating. \$2.80 ea. in quantity. SSAC PRECISION PRODUCTS, INC. P.O. Box 395, Liverpool, NY 13088 (315) 457-9610.

INFORMATION RETRIEVAL NUMBER 614

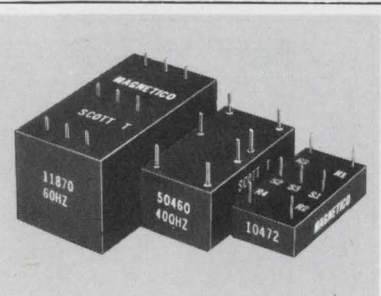

Scott T Transformer. 11870: 60HZ, 90v, L-L in. 1.1x2.1x1.1. 50460: 400HZ, 90v, L-L in. 7/8x1-5/8 x11/16. 50642: 400HZ, 11.8v, L-L in. 7/8x1-5/8-11/16. 10472: 400-HZ, 11.8v, L-L in. 3/4x1-1/2x3/8. All with 6v RMS sine & cosine output. MAGNETICO, INC., 182 Morris Ave, Holtsville, N.Y. 11742 516-654-1166.

INFORMATION RETRIEVAL NUMBER 609

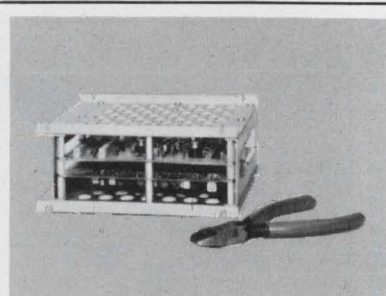

Model MOD-815 A/D Converter. Digital data with 8-bit resolution at any random or periodic word rate from DC through 15 MHz. Only 100 cu. in. Power dissipation approx. 20 watts. Computer Labs, 1109 S. Chapman St., Greensboro, N.C. 27403.

INFORMATION RETRIEVAL NUMBER 612

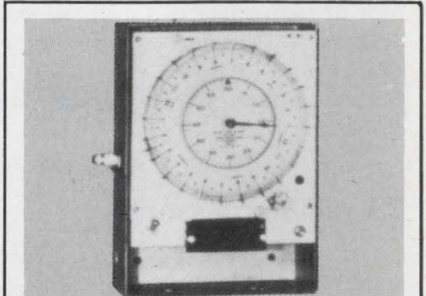

Model LPC program clock. Designed to operate for short periods-5 to 60 seconds. Models are available to operate two different signals at different times. Dimension: 12" x 8" x 4". LUMENITE ELECTRONIC CO., Engineers Designers Manufacturers, 2331 North 17th Avenue, Franklin Park, Ill. 60131. Phone (312) 455-1450.

INFORMATION RETRIEVAL NUMBER 615

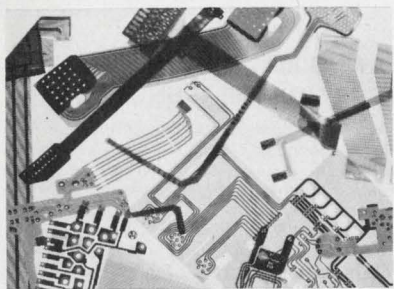

FLEXIBLE CIRCUITS BY ROGERS. We have the people, experience, plant, equipment—and know-how! Write for information—or call Herman Gordon for action. ROGERS CORPORATION, P.O. Box 700, Chandler, Arizona 85224, Phone (602) 963-4584.

INFORMATION RETRIEVAL NUMBER 616

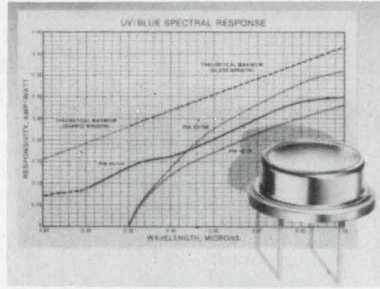

UV Blue Response Photodiode: United Detector Technology now offers blue, super blue, and UV enhanced silicon photodiodes with near theoretical responsivity in the range from 200 to 550 nanometers. Available in both the Pin-5 .5 cm² and the Pin-10 1 cm² configuration. United Detector Technology, 2644 30th St., Santa Monica, Ca. 213 396-3175.

INFORMATION RETRIEVAL NUMBER 619

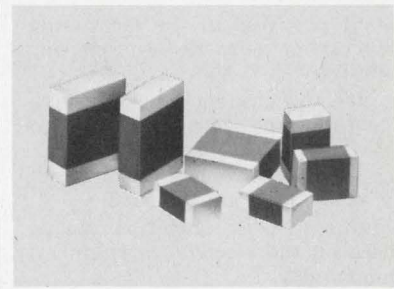

HIGH Q MULTILAYER CAPACITORS feature very high quality factors at microwave frequencies. Offered in three standard sizes: .050 x .040, .080 x .050, .125 x .095. Capacitance values from 0.1 pf to 1000 pf with close tolerance and voltages to 1000 VDCW. Johanson/Monolithic Dielectrics Div., Box 6456, Burbank, Ca. 91510, (213) 848-4465.

INFORMATION RETRIEVAL NUMBER 622

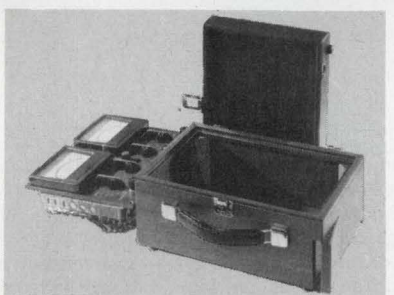

Custom made cases, cabinets and enclosures. Exceptionally rugged construction, laminated Formica-wood-Formica. Internally reinforced corners. Attractive wood grain or solid color exteriors. Superb workmanship, competitive prices, small or quantity lots. W. A. Miller Co., Inc., 306 Mingo Loop, Oquossoc, Maine 04964. Telephone: 207/864-3344.

INFORMATION RETRIEVAL NUMBER 617

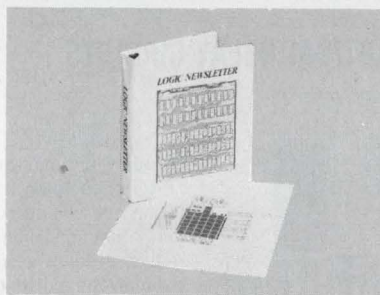

THE LOGIC NEWSLETTER—Free sample copy of low cost publication that emphasizes logic, Minicomputers, Microcomputers and microprocessors. A special offer is included for all of those who failed to keep-up with microprocessors in 1974. THE LOGIC PRESS, 260 GODWIN AVENUE, WYCKOFF, N. J. 07481.

INFORMATION RETRIEVAL NUMBER 620

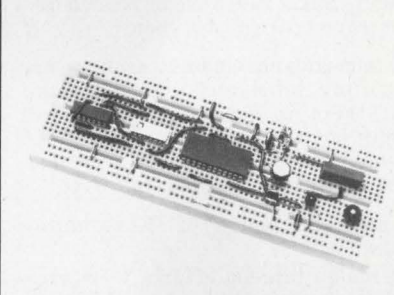

A P Super-Strip. Universal breadboarding with 840 solderless, plug-in tie points, incorporates eight distribution buses. Specifically designed for LSI packages and components with lead diameters up to .032". Accommodates up to eight 14 pin DIPs. No special patch cords required. A P Products Inc., Box 110, Painesville, Ohio 44077.

INFORMATION RETRIEVAL NUMBER 623



Basic Engineering Sciences & Structural Engineering for E-I-T Exams. Sampling for test problems makes the best preparation yet for exams. #5712-1, 424 pp., \$14.95. Circle the Info Retrieval No. to order 15-day exam copy. When billed, remit or return book with no obligation. Hayden Book Co., 50 Essex St., Rochelle Pk., N.J. 07662

INFORMATION RETRIEVAL NUMBER 618

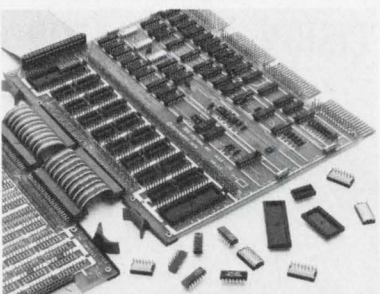

PDP-11 General Purpose Interface. The MDB-11C provides all features of a DEC DR11C plus additional 16 bit register, 4 selectable interrupt control levels, 16 decoded device addresses, takes only one quad slot, has maximum Unibus load of 1. Also, 20 wirewrap positions are provided. \$390. MDB Systems, Inc., 981 N. Main Street, Orange, CA 92667.

INFORMATION RETRIEVAL NUMBER 621

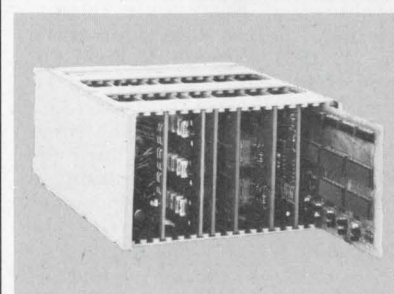

Solid-State Voice Systems for audio readout of numbers and words. Whole-words are stored in ROMs with natural sounding voice reproduction. Standard models offer 10 numeric words (0 - 9). Master Specialties, 1640 Monrovia, Costa Mesa, Calif. 92627. (714) 642-2427.

INFORMATION RETRIEVAL NUMBER 624

ELECTRONIC DESIGN's function is:

- To aid progress in the electronics manufacturing industry by promoting good design.
- To give the electronic design engineer concepts and ideas that make his job easier and more productive.
- To provide a central source of timely electronics information.
- To promote communication among members of the electronics engineering community.

Want a subscription? ELECTRONIC DESIGN is sent free to qualified engineers and engineering managers doing design work, supervising design or setting standards in the United States and Western Europe. For a free subscription, use the application form bound in the magazine. If none is included, write to us direct for an application form.

If you do not qualify, you may take out a paid subscription for \$30 a year in the U.S.A., \$40 a year elsewhere. Single copies are \$1.50 each.

If you change your address, send us an old mailing label and your new address; there is generally a postcard for this bound in the magazine. You will have to requalify to continue receiving ELECTRONIC DESIGN free.

The accuracy policy of ELECTRONIC DESIGN is:

- To make diligent efforts to ensure the accuracy of editorial matter.
- To publish prompt corrections whenever inaccuracies are brought to our attention. Corrections appear in "Across the Desk."
- To encourage our readers as responsible members of our business community to report to us misleading or fraudulent advertising.
- To refuse any advertisement deemed to be misleading or fraudulent.

Microfilm copies are available of complete volumes of ELECTRONIC DESIGN at \$19 per volume, beginning with Volume 1, 1961 through Volume 20. Reprints of individual articles may be obtained for \$2.00 each, prepaid (\$.50 for each additional copy of the same article) no matter how long the article. For further details and to place orders, contact the Customer Services Department, University Microfilms, 300 North Zeeb Road, Ann Arbor, Michigan 48106 telephone (313) 761-4700.

Want to contact us? If you have any comments or wish to submit a manuscript or article outline, address your correspondence to:

Editor
ELECTRONIC DESIGN
50 Essex Street
Rochelle Park, N.J. 07662

Design Data from

REAL-TIME ANALYZER FOR ROTATING MACHINERY NOISE/VIBRATION MEASUREMENTS

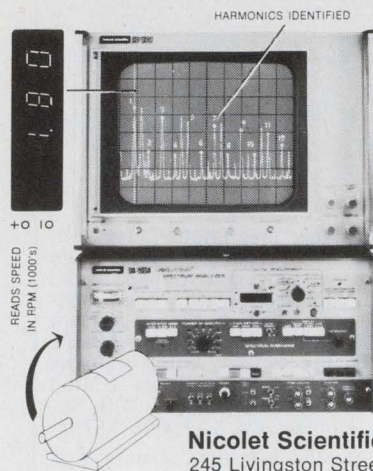

To simplify frequency analysis of noise/vibration in rotating machinery, new Ubiquitous® UA-500A-1 real-time spectrum analyzer with built-in calculator provides: digital measurement of not only absolute frequency, but also *difference from a selected reference frequency* to read variations from a nominal rotational speed directly; digital measurement of amplitudes in %-full scale (linear scale), dB-below-full-scale (log scales), or *difference in dB above & below a selected ref level*, so that amplitude of freq peaks (in 3 spectra stored in 3 memories) can be compared; *readout of freq in CPM* for direct measurement of RPM, (and in Hz or cycles/sec); *identification of all spectrum peaks harmonically related to a selected fundamental*, such as main shaft rotation, to easily separate them from other signal sources. Built-in dual-memory averager combined with main processing memory of Analyzer provides *storage of 3 separate spectra* for comparison of standard machine signatures with new ones as they are analyzed.

Demo, circle 170
Lit., circle 171

Nicolet Scientific Corp. (formerly Federal Scientific Corp.)
245 Livingston Street, Northvale, New Jersey 07647
(201) 767-7100. TWX: 710-991-9619

PRACTICAL RELAY CIRCUITS

By Frank J. Oliver

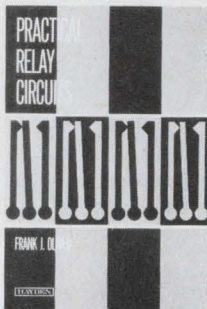

Uniquely groups various relay circuits according to the functions they perform, enabling the systems designer to quickly select the best circuit for his specific purposes. Includes arc and RFI suppression systems; time delay function; audio tone control and resonant-reed relays; sequential relays; protective functions of relays against overload overvoltage, and overcurrent, pulse generation and detection; logic circuits; and more. Particularly important is coverage of pulse-operated relay systems now extensively used with automated control systems. Illustrated with many circuit diagrams using the latest American National Standard graphical symbols. 363 pp., 6 x 9 1/4, illus., cloth, \$17.20 **Circle the reader-service number to order a 15-day examination copy.**

CIRCLE NO. 172



HAYDEN BOOK COMPANY, INC., 50 Essex St., Rochelle Park, N.J. 07662

PRECISION CORRELATOR AND SQUARE LAW DETECTOR



Princeton Applied Research Corporation announces a new, self-contained multiplier/divider, the Model 193. The Model 193 provides pushbutton selection of the functions $A \times B$, A^2 , \sqrt{A} , or A/B . It can be used as a precision square law detector to measure such quantities as true average power, noise power, noise figure, noise temperature, and detectivity (D^*). In addition to square-root and ratio modes, the Model 193 also functions as a high-quality linear modulator or voltage-controlled variable gain amplifier in its $A \times B$ mode, and it can be used as a correlation detector for any signal for which a replica is available. For more information send for Bulletin T-337 from Princeton Applied Research Corporation.

CIRCLE NO. 173

PRINCETON APPLIED RESEARCH CORPORATION
P.O. Box 2565
Princeton, New Jersey 08540

Manufacturers

Advertisements of booklets, brochures, catalogs and data sheets. To order use Reader-Service Card (Advertisement)

New Kepco Power Supply Catalog and Handbook



Kepco, Inc. has published a new 1974 Power Supply Catalog and Handbook. In 130 pages, there are schematics and mechanical drawings of more than 30 power supply designs, encompassing several hundred separate models. The Kepco Catalog and Handbook includes applications material on high speed-fast programming models, digital control systems, measurements and power supply combinations. A comprehensive glossary is also included.

KEPCO, INC.

131-38 Sanford Avenue, Flushing, N.Y. 11352
(212) 461-7000

CIRCLE NO. 174

ENGINEERING PRODUCT HANDBOOK A/D and D/A Converters

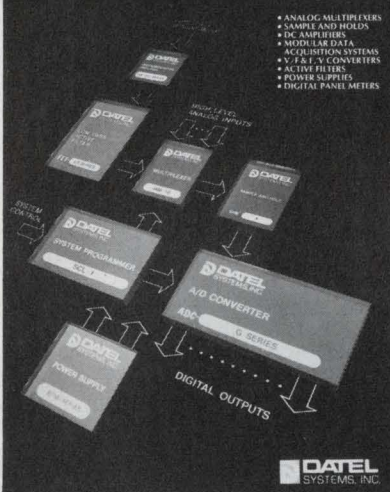

70 page A/D-D/A Engineering Product Handbook

A new 70 page product handbook contains detailed electrical and mechanical information on A/D—D/A Converters, Sample/Hold Amplifiers, Wide Band DC Amplifiers, Instrumentation Amplifiers, Analog Multiplexers, DC-DC Converters and Data Acquisition Systems. Also included are typical applications for Data Conversion Devices.

D **DATEL**
SYSTEMS, INC.

CIRCLE NO. 175

1020 Turnpike St., Canton, Mass. 02021/(617) 828-8000

MATERIALS FOR MAGNETIC FUNCTIONS

by Fennimore N. Bradley

This valuable reference provides a thorough background as well as practical design techniques for the materials needed for magnetic functions. Included in its exhaustive coverage is detailed treatment of key parameters of about 30 classes of ferrite materials relating processing to costs and design trade-offs . . . and equally thorough coverage of about 40 classes of both conventional and exotic magnetic metals and processes. The book focuses on design problems encountered in a wide range of permanent-magnet applications . . . pinpoints design problems in nearly 30 categories of electromagnetic devices . . . and concludes with coverage of environmental influences such as corrosion, magnetic field, temperature, stress, etc. 360 pp., 6 x 9, illus., cloth, \$17.20. Circle the reader-service number to order a 15-day examination copy.

CIRCLE NO. 176



HAYDEN BOOK COMPANY, INC., 50 Essex St., Rochelle Park, N.J. 07662

Electronic Design

Advertising Sales Staff

Tom W. Carr, Sales Director

Rochelle Park, N.J. 07662

Robert W. Gascoigne

Daniel J. Rowland

(Recruitment, Quick Ads, Classified)

50 Essex Street

(201) 843-0550

TWX: 710-990-5071

Philadelphia

Thomas P. Barth

50 Essex Street

Rochelle Park, N.J. 07662

(201) 843-0550

Boston 02178

Gene Pritchard

P.O. Box 379

Belmont, Mass. 02178

(617) 489-2340

Chicago 60611

Thomas P. Kavooras

Berry Conner, Jr.

200 East Ontario

(312) 337-0588

Cleveland

Thomas P. Kavooras

(Chicago)

(312) 337-0588

Los Angeles 90045

Stanley I. Ehrenclou

Burt Underwood

8939 S. Sepulveda Boulevard
Suite 510

Los Angeles, Calif.

(213) 641-6544

San Francisco 94022

Jerry D. Latta

P.O. Box 1248

Los Altos, Calif.

(415) 965-2636

London, Amsterdam, Tokyo, Seoul

John Ashcraft

12, Bear St.

Leicester Square

London WC2H 7AS England

Phone: 01-930-0525

W. J. M. Sanders

John Ashcraft & Co.

Herengracht 365

Amsterdam C., Holland

Phone: 020-24-09-08

Haruki Hirayama

Electronic Media Service

5th Floor, Lila Bldg.,

4-9-8 Roppongi

Minato-ku, Tokyo, Japan

Phone: 402-4556

Cable: Electronicmedia, Tokyo

Mr. O-kyn Park, President

Dongbo International

Corporation

1.P. O. Box 4010

Seoul, Korea

Phone: 28-1911

Cable: Dongbo Seoul



advertiser's index

| Advertiser | Page | Advertiser | Page | Advertiser | Page |
|--|----------|--|--------------------|---|----------------|
| A P Products, Inc. | 151, 153 | General Electric Company, Semiconductor Products Department | 1 | *Philips Industries, Test and Measuring Instruments Dept. | 11 |
| Accutronics, Inc. | 95 | General Semiconductor Industries, Inc. | 137 | Pico Electronics, Inc. | Cover II |
| Acopian Corp. | 107 | Gold Book, The | 137, 140, 146 | Piher International Corp. | 64A |
| Airpax Electronics, Cambridge Division | 96 | Gralex Industries, Division of General Microwave Corp. | 50 | Pomona Electronics Co., Inc. | 159 |
| Alco Electronic Products, Inc. | 137 | Hamlin, Inc. | 65 | Power/Mate Corp. | 151 |
| Alden Electronic & Impulse Recording Equipment Co., Inc. | 145 | Harris Corporation, Computer Systems Division | 141 | Power Monolithics Inc. | 32 A-F |
| Amerace Corporation | 37 | Harris Semiconductor, A Division of Harris Intertype Corporation | 2 | Premier Metal Products Company | 47 |
| American Microsystems, Inc. | 122, 123 | Hayden Book Company, Inc. | 152, 153, 154, 155 | Princeton Applied Research Corp. | 154 |
| American Technical Ceramics | 133 | Hoffman Engineering Company | 160 | Pyrofilm Corporation | 145, 147, 149 |
| Arrow-M Corp. | 160 | Hope Electronics | 147 | RCA Solid State | Cover IV |
| Astrodyne Inc. | 159 | Hughes Aircraft Company, Industrial Products Division | 73 | RCL Electronics, Inc. | 38 |
| Augat, Inc. | 29 | ILC Data Devices, Inc. | 71 | RSM Sensitron Semiconductor | 31 |
| Bead Electronics | 148 | IMC Magnetics Corporation | 144 | Reader Service Card | 160A, 160B |
| Beckman Instruments, Inc. Helipot Division | 17 | Industrial Electronic Engineers, Inc. | 102, 103 | Readouts, Inc. | 152 |
| Beckman Instruments, Inc., Information Displays Operations | 48 | Infolite | 39 | Renco Corporation | 45 |
| Berg Electronics, Inc. | 70 | Intech Incorporated | 114 | Robinson Nugent, Incorporated | 4, 5 |
| Bishop Graphics, Inc. | 152 | Interface | 160 | Rogers Corporation | 153 |
| Bourns, Inc. Trimpot Products Division | 79 | Ise Electronics Corp. | 127 | SSAC Precision Products, Inc. | 152 |
| Brand-Rex Company | 64B, 64C | Iwata Electric Co., Ltd. | 149 | Schauer Manufacturing Corp. | 7 |
| Burroughs Corporation | 18 | Johanson Manufacturing Corp. | 151 | Shelley-Datatron | 121 |
| CTS Corporation | 51 | Johanson Monolithic Dielectrics Div. | 153, 159 | Shigoto Industries, Ltd. | 160 |
| California Eastern Laboratories, Inc. | 151, 152 | Johnson Company, E. F. | 129 | Siemens Corporation | 115 |
| CELCO (Constantine Engineering Laboratories, Inc.) | 40 | Kepeco, Inc. | 155 | Signal Transformer Co., Inc. | 138, 148 |
| Centralab, The Electronics Division of Globe-Union, Inc. | 11 | Kinsekisha Laboratory Ltd. | 145 | Singer Company, Inc., Kearfott Division | 97 |
| Cherry Electrical Products Corp. | 109 | Litronix, Inc. | 80, 81 | Solid State Scientific, Inc. | 41 |
| Clare & Co., C. P. | 72 | Litton OEM Products | 146 | Spectrum Control, Inc. | 132 |
| Clare-Pendar | 119, 133 | Logic Press | 153 | Sprague Electric Company | 139 |
| Computer Conversions Corp. | 151 | Lumenite Electronics | 152 | Stevens-Arnold | 152 |
| Computer Labs, Inc. | 152 | MCG Electronics | 147 | Switchcraft, Inc. | 135 |
| Conner-Winfield Corp. | 158 | MDB Systems | 153 | Sylvania Miniature Lighting Products, Inc. A subsidiary of GTE Sylvania | 112 |
| Constantine Engineering Laboratories, Inc. (CELCO) | 40 | Magnecraft Electric Company | Cover III | Systron-Donner | 42, 136 |
| Contemporary Marketing | 138 | Magnetic, Inc. | 152 | TEC, Incorporated | 130 |
| Continental Connector Corporation | 131 | *Marconi Instruments Limited | 12 | T. R. I. Corporation | 142 |
| Control Switch, Inc. | 143 | Master Specialties | 151, 153 | Teletype Corporation | 21, 22, 23, 24 |
| Corning Glass Works, Electronic Products Division | 12, 13 | Maxi-Switch Co. | 124 | Thermalloy Company | 135 |
| Dale Electronics, Inc. | 8, 9 | Microtran Company Inc. | 133 | Thomson CSF | 125 |
| Dana Laboratories, Inc. | 35 | Miller, W. A. | 153 | Toko America, Inc. | 128 |
| Datel Systems, Inc. | 155 | Mini-Circuits Laboratory | 39 | Triplet Corporation | 105 |
| Digital Equipment Corporation | 14, 15 | National Electronics, A Varian Division | 134 | U. S. Components, Inc. | 149 |
| Dynascan Corporation | 120 | Newport Laboratories, Inc. | 10, 64 | UID Electronics | 126 |
| Eby Co., Hugh H. | 144 | Nicolet Scientific Corp. | 154 | U. S. Precision Lens | 64D |
| Electronic Design | 88, 89 | Oshino Electric Lamp Works, Ltd. | 142 | Unitrack Division, Calabro Plastics, Inc. | 143 |
| *Electronic Design | 114B | Owens-Illinois, Inc. | 46 | United Detector Technology, Inc. | 153 |
| Electronic Navigation Industries | 116 | Panasonic Matsushita Electric | 119 | Vari-L, Inc. | 111 |
| Erie Technological Products, Inc. | 27 | *Philips Industries Electronic Components and Materials Division | 13, 17, 144A | Varo Semiconductor, Inc. | 16 |
| French Trade Shows | 137 | | | Vector Electronic Co., Inc. | 132 |
| Fuji Electrochemical Co. | 39 | | | Voltex | 143 |
| GTE Sylvania, Parts Division | 63 | | | Wesco Electrical Company | 150 |
| General Automation, Inc. | 33 | | | Woven Electronics | 6 |
| General Electric Company, Miniature Lamp Products Department | 118 | | | | |

* Advertisers in non-U.S. edition.

recruitment
and
classified ads

SAME DAY SHIPMENT
Minis & Peripherals
PRINTERS
Some "BRAND NEW"
DATA PRODUCTS
2440—700 LPM
2470—1250 LPM \$9500
MOHAWK DATA SCIENCES
4320—300 LPM
4330—380 LPM
CONTROL DATA CORP.
9322—200 LPM \$2500
9352—600 LPM
ALSO CENTRONICS, POTTER,
A. B. DICK, IBM, HIS, UNIVAC
617-261-1100

Send for Free Report
"Maintenance of Computers"

AMERICAN USED
COMPUTER CORP.
P. O. Box 68, Kenmore Sta.,
Boston, MA 02215
member
COMPUTER DEALERS ASSOCIATION

CIRCLE NO. 201

EMITRONICS, INC.

FIELD ENGINEERS

The success of the EMI-Scanner, a new computerized X-ray system has opened up exceptional opportunities for Field Engineers in the local area.

Immediate vacancies exist for Technical Service Engineers. Experience in analog and digital systems, electro-mechanical systems, mini-computers and X-ray systems preferred.

Liberal company benefits for all employees.

Send resume, including salary requirements and availability to:

DEPT. CM

EMITRONICS is an equal opportunity employer.

CIRCLE NO. 202

FREE ALARM CATALOG

Full line of professional burglar and fire alarm systems and supplies. 96 pages, 450 items. Off the shelf delivery, quantity prices.



mountain west alarm
4215 n. 16th st., phoenix, az. 85016

CIRCLE NO. 203

HERMETIC SEALING

Connectors • Headers • Relay Bases
Terminals • Custom Seals • Testing
Glass/Ceramic To Metal • Since 1959

DETORONICS CORPORATION

10660 E. Rush • S. El Monte, CA 91733
(213) 579-7130 • TWX 910-587-3436

CIRCLE NO. 204

PERSONNEL
RECRUITMENT
ADVERTISING
IN
Electronic Design
REACHES THE
RIGHT PEOPLE
AT A LOWER COST
PER THOUSAND

Call the
HOTLINE
today
for complete
information:
(201) 843-0550
extension 246

CONNOR-WINFIELD'S

NEW

LOW PROFILE

DIP CRYSTAL OSCILLATOR



Actual Size

MODEL S14R-1

FREQUENCY TOLERANCE:

±.01% from -25°C to +75°C

FREQUENCY RANGE: Available

4 MHz to 20 MHz

OUTPUT WAVEFORM: TTL

Logic 0 ≤ 0.4V

Logic 1 ≥ 2.4V

Risetime and Falltime ≤ 50ns

Duty Cycle 30/70 or better

Fanout of 10

SUPPLY CURRENT: 1 ma to 5 ma

TERMINATION: 14 pin DIP socket
pin diameter .02"

SUPPLY VOLTAGE: 5Vdc ±20%

DIMENSIONS:

0.3" H x 0.5" W x 0.8" L

* **SMALL SIZE**

* **LOW COST**

* **HIGH FREQUENCY**

CONNOR-WINFIELD CORP.



West Chicago,
Illinois 60185
Phone: (312) 231-5270

INFORMATION RETRIEVAL NUMBER 114

product index

Information Retrieval Service. New Products, Evaluation Samples (ES), Design Aids (DA), Application Notes (AN), and New Literature (NL) in this issue are listed here with page and Information Retrieval numbers. Reader requests will be promptly processed by computer and mailed to the manufacturer within three days.

| Category | Page | IRN | Category | Page | IRN |
|----------------------------|------|-----|------------------------------------|------|-----|
| Components | | | Discrete Semiconductors | | |
| breadboards | 132 | 75 | LEDs | 81 | 43 |
| CRTs | 125 | 66 | power amplifier, rf | 116 | 56 |
| capacitors | 139 | 298 | power transistors | 41 | 26 |
| capacitors | 139 | 299 | switching transistors | 137 | 83 |
| capacitors | 150 | 106 | transistors, Darlington | 145 | 354 |
| capacitors, ceramic | 27 | 15 | transistors, rf power | 142 | 350 |
| capacitors, chip | 159 | 107 | zeners | 7 | 6 |
| capacitors, feedthrough | 132 | 74 | zeners | 115 | 55 |
| circuit protectors | 95 | 46 | | | |
| display mounting hardware | 103 | 294 | Instrumentation | | |
| displays | 48 | 31 | DMM | 142 | 89 |
| displays | 127 | 68 | error-rate tester | 136 | 303 |
| displays | 134 | 79 | IC tester | 138 | 346 |
| ferrite cores | 39 | 22 | multimeter | 120 | 61 |
| fiber-optic display | 102 | 292 | oscilloscope | 120 | 60 |
| incandescent lamps | 102 | 291 | testers | 105 | 49 |
| indicator lamp array | 112 | 53 | | | |
| indicator lights | 121 | 62 | Integrated Circuits | | |
| keyboard switches | 109 | 51 | calculator chip | 119 | 325 |
| keyboards | 124 | 65 | LED/lamp flasher IC | 114 | 54 |
| LED displays | 103 | 293 | MOS RAM | 122 | 63 |
| lamps and sockets | 142 | 90 | mini-ROM | 128 | 69 |
| lamps, subminiature | 118 | 58 | op amp | 2 | 3 |
| liquid-crystal displays | 65 | 36 | op amps | IV | 245 |
| load cells | 160 | 113 | | | |
| motors, servo | 96 | 47 | Microwaves & Lasers | | |
| numerics | 39 | 23 | dual in-line bridge | 16 | 12 |
| potentiometer | 121 | 327 | light modulator | 145 | 97 |
| potentiometers | 79 | 42 | oscillators | 95 | 46 |
| readouts | 130 | 72 | relays, solid-state | 72 | 40 |
| relays | III | 244 | transformer, rf | 129 | 333 |
| resistor networks | 17 | 13 | transformers | 39 | 24 |
| resistors | 13 | 296 | | | |
| switches | 11 | 9 | Modules & Subassemblies | | |
| switches | 135 | 81 | converters, d/a | 113 | 309 |
| switches | 143 | 92 | multiplier | 114 | 320 |
| switches, multipole | 137 | 211 | | | |
| switches, pushbutton | 126 | 67 | Packaging & Materials | | |
| switches, rotary | 38 | 21 | cable | 6 | 5 |
| switches, rotary | 137 | 212 | cable and cord sets | 160 | 111 |
| switchlights | 119 | 59 | circuit board | 29 | 16 |
| switchlights | 133 | 76 | connectors | 70 | 38 |
| transformers | 133 | 77 | connectors | 149 | 104 |
| transformers | II | 243 | connectors | 144 | 95 |
| transformers, wideband | 111 | 52 | connectors, PC | 131 | 73 |
| transient suppressor | 147 | 101 | connectors, coaxial | 129 | 70 |
| trimmers | 9 | 7 | DIP sockets | 5 | 4 |
| trimmers | 51 | 33 | enclosures | 47 | 30 |
| tuning fork | 149 | 105 | enclosures | 160 | 112 |
| | | | fans | 144 | 94 |
| | | | gold on lead frames | 63 | 34 |
| Data Processing | | | heat dissipators | 143 | 93 |
| controller, remote | 123 | 308 | heat pipes | 159 | 108 |
| image storage equipment | 73 | 41 | pins | 148 | 103 |
| keyboard display printer | 24 | 230 | sockets | 70 | 37 |
| memory, disc | 126 | 306 | terminal blocks | 37 | 20 |
| minicomputer | 33 | 18 | test clip | 159 | 109 |
| minicomputers | 15 | 11 | | | |
| paper tape punch | 146 | 98 | Power Sources | | |
| recorders | 145 | 96 | power supplies | 107 | 50 |
| scanner and printer system | 40 | 25 | power supplies | 143 | 91 |
| terminal, data | 124 | 331 | power supply, OEM | 147 | 100 |
| | | | precision voltage sources | 138 | 86 |

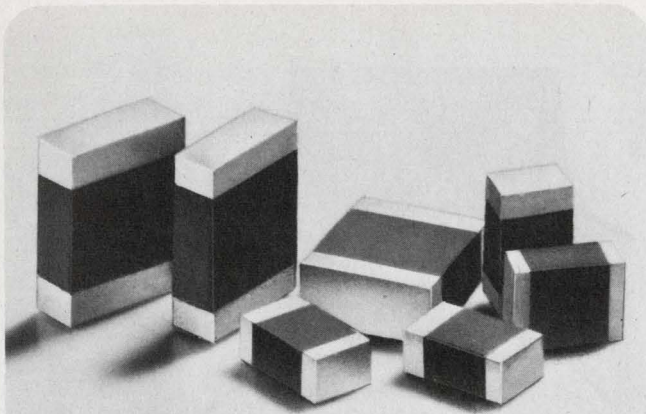

HIGH Q CHIP CAPACITORS

High Q multilayer capacitors feature very high quality factors at microwave frequencies. Superior dielectric properties and structure permit operation at high voltage and high current at microwave frequencies through the full temperature range with minimum dielectric loss. Offered in 4 standard sizes from .040" x .030" to .125" x .095". Applications include UHF-microwave hybrids and MIC's.

Johanson

Monolithic Dielectrics

Box 6456 / Burbank, California 91505
(213) 848-4465 / TWX 910-498-2735

INFORMATION RETRIEVAL NUMBER 107

HEAT PIPE

'Break-through' by astrodyne

Major fabrication "break-through" by **astrodyne** makes HEAT PIPES available at prices that permit serious consideration of these remarkable heat transfer devices. HEAT PIPES are ideally suited to transfer heat from 'black boxes,' compact assemblies and similar restricted areas to remote heat sinks.

astrodyne has the capability and "know-how" to fabricate complete transfer systems — from heat source to heat sink — to meet your application.

Demonstration kits, available from Astrodyne at \$8.00, compare the fast heat transfer of HEAT PIPES with a solid copper conductor.

Contact your Astrodyne representative for further information or assistance with your application.



astrodyne, inc.

SUBSIDIARY OF ROANWELL CORPORATION
353 MIDDLESEX AVENUE / WILMINGTON, MASSACHUSETTS 01887
(617) 272-3850 TWX 710-347-0704

INFORMATION RETRIEVAL NUMBER 108

ELECTRONIC DESIGN 26, December 20, 1974

DO-IT-YOURSELF grabber

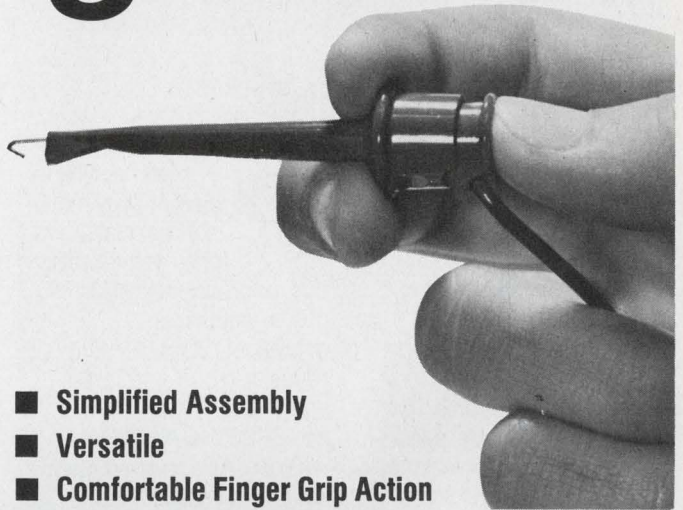

- Simplified Assembly
- Versatile
- Comfortable Finger Grip Action
- Completely Field Serviceable
- Molded of Tough Lexan*

Model 3925
Mini Test Clip
Shown Actual Size

This test clip with gold plated hook is excellent for rapid testing of components and Wire Wrap† pins. Clip is completely insulated to point of connection. Build any combination of test leads with wire up to .090 dia. Easy and comfortable to operate. Molded of rugged Lexan to resist melting when soldering. Write for literature and prices.

SIMPLIFIED ASSEMBLY

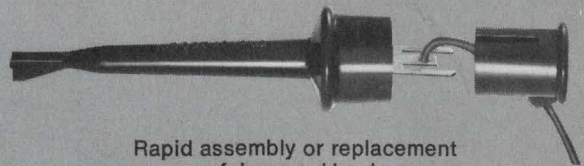

Rapid assembly or replacement of damaged lead.

MODEL 3925

hooks onto components or slips over square Wire-Wrap pins

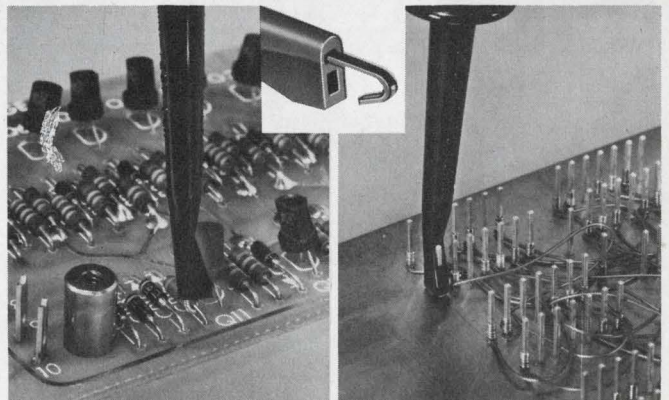

*Lexan is a General Electric trade-mark. †Registered trade-mark of Gardner - Denver Co.



POMONA ELECTRONICS

A Division of ITT

1500 East Ninth St., Pomona, Calif. 91766
Telephone (714) 623-3463

INFORMATION RETRIEVAL NUMBER 109

THE ONLY 4PDT, 5 A RELAY IN ITS CLASS OK'D BY UL, CSA, & VDE.

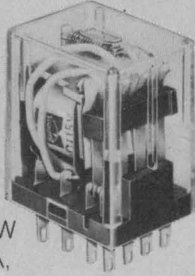

You can go only to Arrow-M for a 4PDT relay of this small size: 1.079" L x .827" W x 1.280" H with a 5 A, 240 VAC resistive rating approved by UL, CSA, and VDE for unqualified industrial use. Check these great design features: arc barriers, debris wells, one-piece molded contact blocks, gold-flashed AgCdO

contacts, and hermetic sealing in plastic. They make for the quality and long-lived reliability that approval demands (10^8 mechanical operations). This HC relay series also contains DPDT and 3PDT (7 A, 240 VAC) and SPDT (10 A, 240 VAC) versions. All approved. Send for your full specs.

Relays for advanced technology.



Arrow-M Corp. 250 Sheffield St., Mountainside, N.J. 07092 U.S.A.
Telephone: 201-232-4260

INFORMATION RETRIEVAL NUMBER 110

shigoto cables and cord sets

... we go to any lengths.
... we go to any ends.

That's why Shigoto can help make your ends meet. From hundreds of standard combinations to unusual characteristics that meet your own requirements. Even U.L. and C.S.A. approved. Our volume production for O.E.M.'s in electronics, communications, automotive, appliances, and practically every other industry, takes all the variables out of price-performance differences. Shigoto's ability to consistently produce top quality assemblies, when combined with large quantities, always brings in the prices you need. Unmatched quality has become our standard, our reliability and delivery schedules will become yours. Call, write, or wire your specs. At Shigoto, you'll find we'll go to any ends, to any lengths, to satisfy you.

Shigoto Industries Ltd.

350 Fifth Ave., N.Y., N.Y. 10001/(212) 695-0200/Telex 224219
One of the World's Largest Manufacturing Importers

INFORMATION RETRIEVAL NUMBER 111

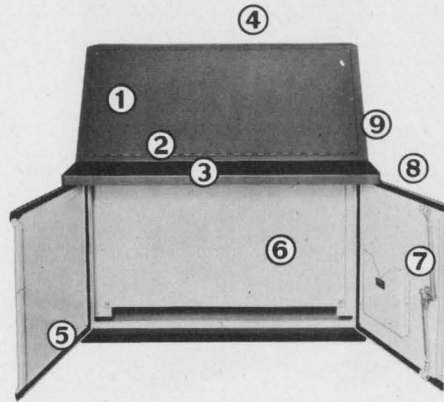

1. 24", 36", 48", or 60" width. 2. Hinged sloping control panel. 3. Optional writing desk. 4. Instrument panel top available. 5. Neoprene gaskets for complete oil tightness. 6. Accessory subpanel. 7. Three-point latches and key-locking handles. 8. Doors on both front and back. 9. All seams continuously welded. 10. NEMA-12 construction. 11. Many modifications available. Write for Bulletin C-14.

Hoffman **ELECTRICAL ENCLOSURES**

HOFFMAN ENGINEERING COMPANY
Division of Federal Cartridge Corporation
Anoka, Minnesota, Dept. ED55

INFORMATION RETRIEVAL NUMBER 112

HERE'S A LOW COST LOAD CELL THAT'S NOT AFRAID OF WATER

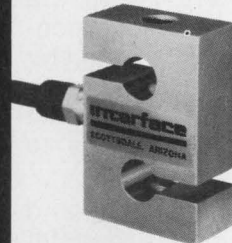

■ In the past, low cost load cells could only be used in closely controlled environments. That meant no water splashes, no steam, and no condensation. Times have changed. With the new Sealed Super-Mini Load Cell from Interface, you don't have to worry about outdoor environmental conditions, and you don't have to worry about a high price either.

■ The rugged Sealed Super-Mini is designed to replace all those costly load cells you've been using and provide you with guaranteed performance of $\pm 0.05\%$ non-linearity, $\pm 0.03\%$ hysteresis, $\pm 0.01\%$ non-repeatability, $\pm 0.03\%$ creep, and a list price of just \$295. Standard ranges are 0 to ± 500 , and 0 to ± 1000 pounds and they can be provided with either a rugged electrical connector or an integral cable.

■ For complete information on these load cells and others in ranges from 5 pounds to 100 tons, call or write Ted Johnson at Interface, today.

interface

7401 East Butherus Drive / Scottsdale, Arizona 85260
Telephone (602) 948-5555

INFORMATION RETRIEVAL NUMBER 113

ELECTRONIC DESIGN 26, December 20, 1974

BIG TIMERS

Relays That Can Solve Your Time Delay Problems

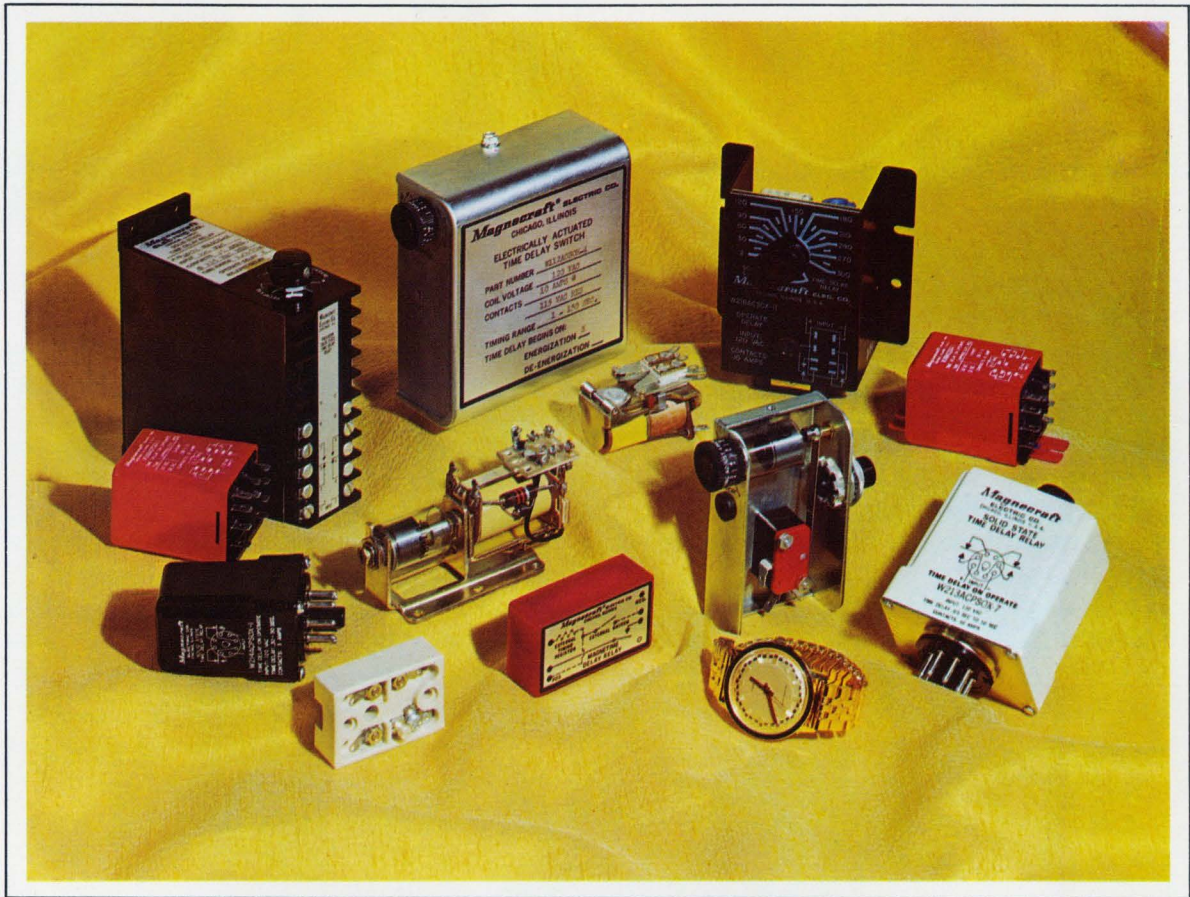

Magnecraft's BIG TIMERS come in all shapes, sizes, and timing ranges for your applications. Time delay relays with slow operate or slow release and time repeat accuracy $\pm 1\%$. Each relay is designed to function with absolute reliability, for long life at lowest cost. Versions offered include: solid state hybrid, copper slug, thermal, air dashpot, telephone type, mercury displacement, and solid state-static output. The photo portrays just some of the endless features, mountings and packaging characteristics available with Magnecraft built-in quality and integrity.

Over 100 different stock time delay relays are available through our nationwide network of distributors. But, if you don't find what you need in stock we will custom build it for you!

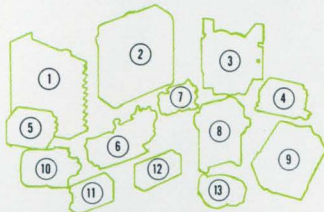

1) Air Dashpot Class 112M 2) Air Dashpot Class 112C 3) Solid State (Hybrid) Class 218 4) Solid State (Hybrid) Class 388 Flange Mount 5) Solid State (Hybrid) Class 388 Plug-In 6) Air Dashpot Class 110 7) Copper Slug Class 66S 8) Air Dashpot Class 113C 9) Solid State (Hybrid) Class 211CP 10) Solid State (Hybrid) Class 214CP 11) Thermal Class 150 12) Printed Circuit Class 502 13) Our Advertising Manager's Watch



Free!
TIME DELAY
RELAY CATALOG

To help specify your time delay relay needs, ask for Magnecraft's Seventh Edition of the Time Delay Relay Catalog. It offers suggestions on how to specify, testing procedures, comparisons of the types available, principles of operation and a glossary of terms. This super, 52 page catalog is yours for the asking.

Find Magnecraft Relays in EEM sec. 4500
and the Gold Book sec. 1600.

Magnecraft ELECTRIC COMPANY

5575 NORTH LYNCH AVENUE • CHICAGO, ILLINOIS 60630 • 312 • 282-5500 • TWX 910 221 5221

INFORMATION RETRIEVAL NUMBER 244

A surprise offer from RCA...

Try a package of our op amps.

We've put together an assortment of 20 different devices that cover most of the things you want to do with op amps. With this package at your elbow you will be able to reduce your idea-to-breadboard time from days, or even weeks, to minutes.

Here are some of the reasons we think it will be useful to you:

First, it contains the CA3130, our new device that combines MOS/FET, bipolar and CMOS on the same chip and gives you a lot of performance for a low price.

Second, you will have a number of RCA versions of industry standard types that will let you evaluate and compare them with what you are now using.

Third, you can get first-hand experience with some of the new devices that could soon become industry standards— they're the types we've developed over the past 12 months to help you design for improved performance and lower cost.

In addition to general-purpose, precision and high current types you will get wideband and operational transconductance amplifiers, as well as RCA micropower programmable op amps. And we've wrapped up this neat little package with both a data book and applications manual.

For specific information about the Op Amp Selector, contact your local RCA Solid State distributor or write RCA Solid State, Box 3200, Somerville, N.J. 08876. Phone (201) 722-3200, Ext. 3142.

RCA Solid State
A full house in Linear ICs.

