

Suddenly it's easier to switch. Switching power supplies can be designed with 20 to 50 fewer discrete components than before. A single IC performs all of the

control functions required for a push-pull output design. The IC is called a regulating pulse-width modulator. To see if you would rather switch, turn to page 125.

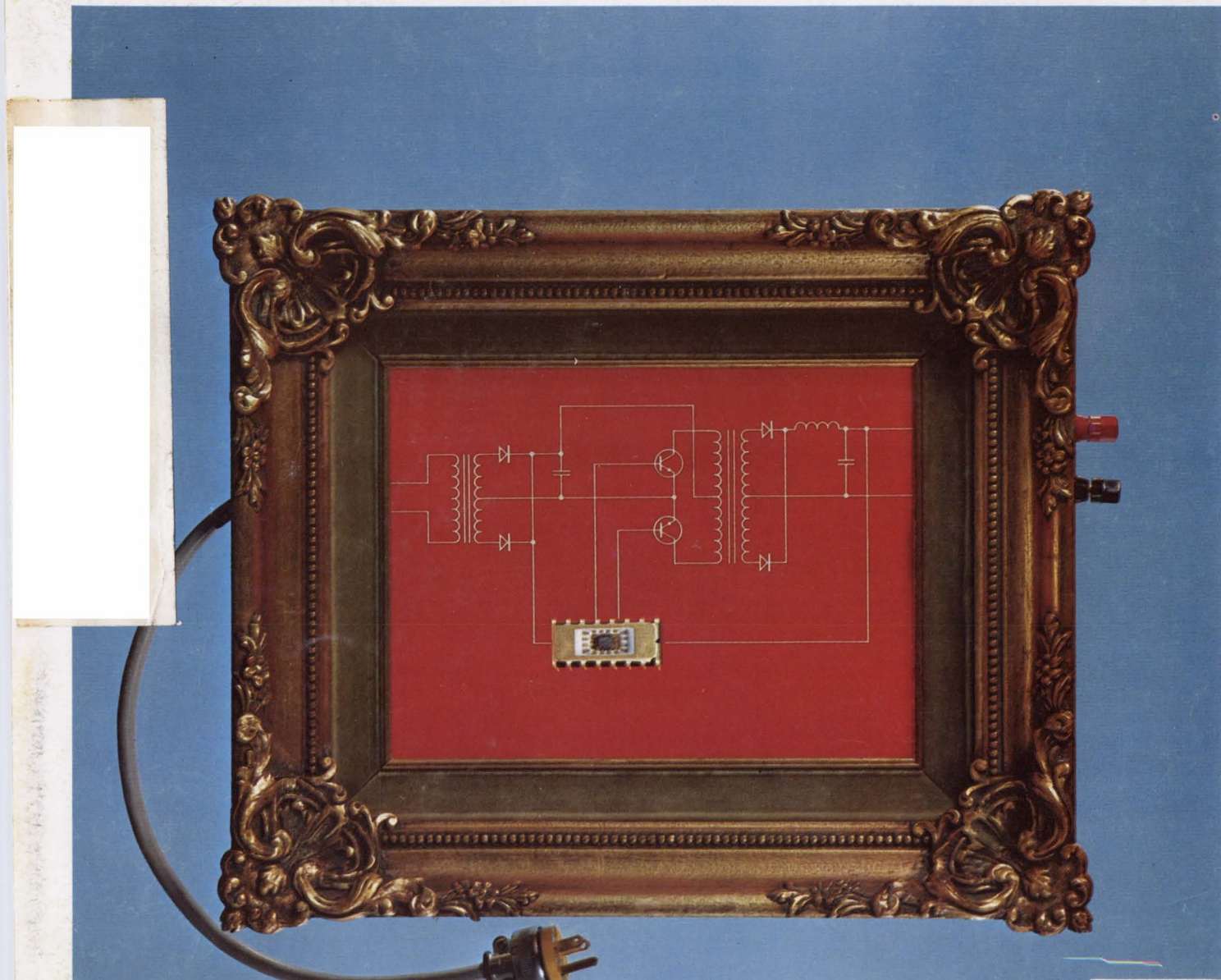

So good... you can actually feel the difference!

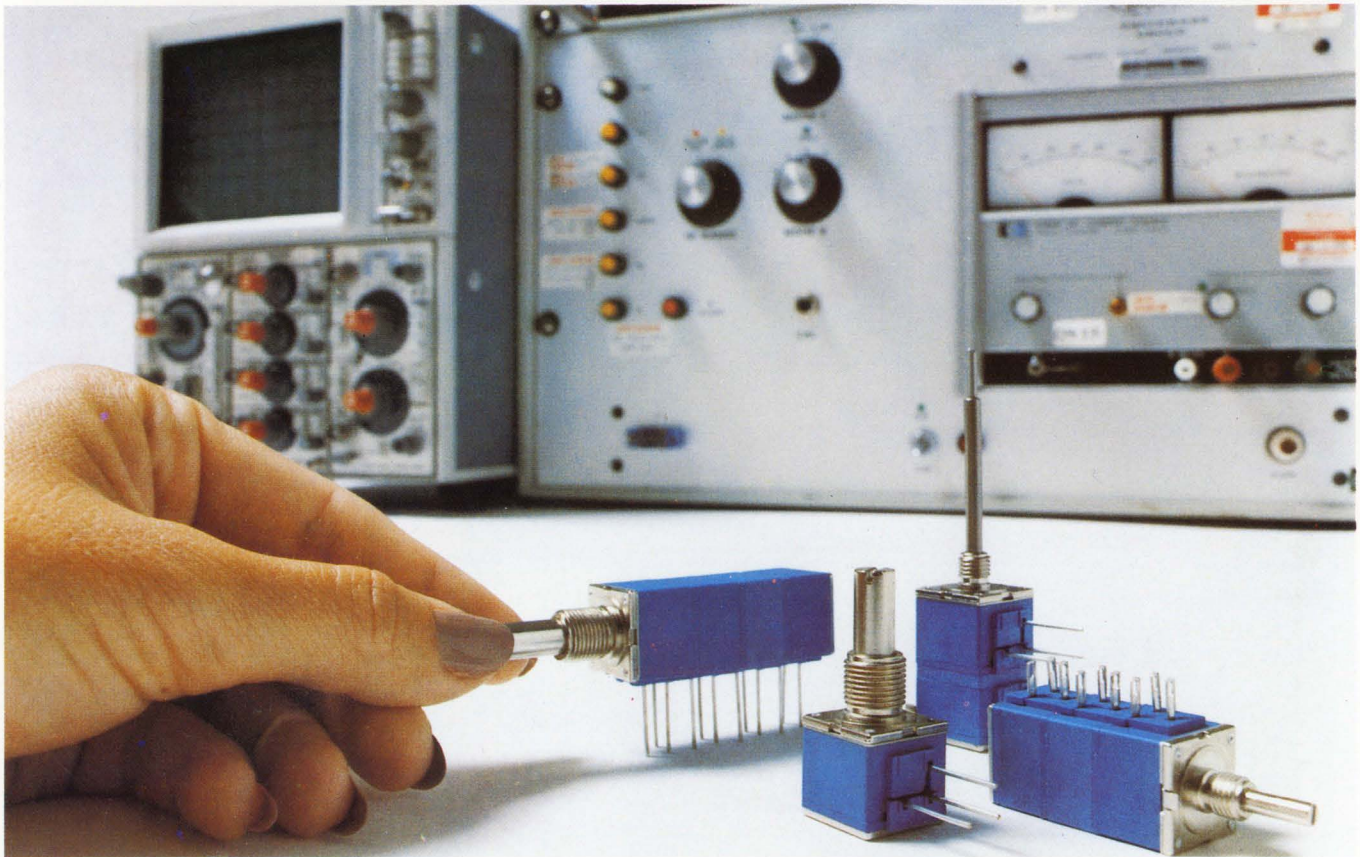

BOURNS announces an ADVANCED building-block potentiometer...

... with a velvety smooth control feel that will enhance the quality image of your equipment. It's BOURNS® new Model 80 Building-Block potentiometer.

The Model 80 incorporates a unique new shaft torque control device which enables us to produce an advanced modular potentiometer with a smooth, consistent high quality "feel" ... regardless of the number of modules ganged on a single shaft (shaft torque only .3 to 2.0 oz.-in.).

MODULAR VERSATILITY, FACTORY ASSEMBLY

Bourns modular concept combines the design versatility of advanced building-

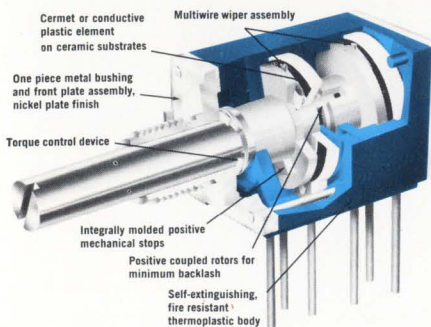

block construction ... with factory assembled reliability and quality control. All Model 80 potentiometers are built to your "prescription" by full-time production personnel, under the supervision and control of the industry's most respected quality assurance organization. High-volume assembly techniques, plus mass-produced modular components stock means fast delivery ... at competitive prices.

CERMET OR CONDUCTIVE PLASTIC

Bourns Model 80 is available with either cermet or conductive plastic elements in virtually all linear and non-linear tapers. Element types may be mixed in multiple section units. **INDEPENDENT LINEARITY IS $\pm 5\%$** ... offering more precise phasing of potentiometer output to panel calibration.

SUPER SETABILITY

A multifinger wiper and precise resistive ink formulations provide tight 1% CRV in both cermet and conductive plastic elements. This — combined with a smooth, no backlash feel — makes for easy, accurate operator settings

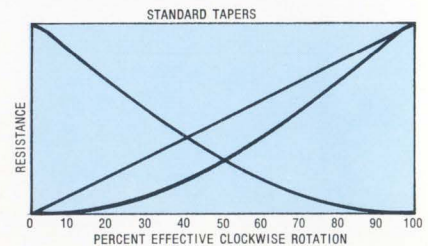

NO SHARP KNEE ON TAPERS

Model 80 audio tapers provide a smooth "knee", which allows improved setability within the crossover area on both cermet and conductive plastic.



FREE SAMPLES

Write on your company letterhead and tell us about your application. We'll send you the Model 80 that best suits your needs.



TRIMPOT PRODUCTS DIVISION

1200 COLUMBIA AVENUE, RIVERSIDE, CALIFORNIA 92507
PHONE 714 781-5122, TWX 910 332-1252, CABLE BOURNSINC

SURPRISE!



High Reliability Optoelectronic Products!

Hermetic lamps, displays and isolators from Hewlett-Packard. That's our family of high-reliability optoelectronic products. These devices are ideal for ground, airborne and shipboard equipment, medical instrumentation, fire-control and space flight systems.

Lamps are available in high-efficiency red, yellow and green.

Our isolators offer high speed.

And displays come with a built-in decoder, driver and memory.

In the U.S., contact Hall-Mark, Schweber, Wilshire or the Wyle Distribution Group (Liberty/Elmer) for immediate delivery.

In Canada, contact Bowtek Electronics Co., Ltd., Schweber Electronics or Zentronics, Ltd.

HEWLETT  PACKARD

Sales and service from 172 offices in 65 countries.
1507 Page Mill Road, Palo Alto, California 94304

Microprocessors take control with Teledyne I/O converters

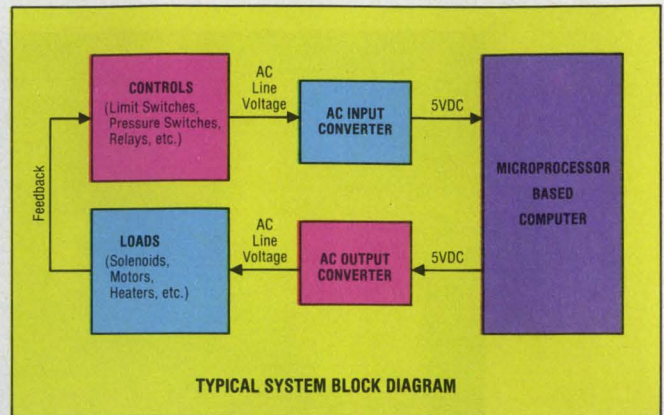

Modular packaging of input/output interface circuitry. That's what Teledyne I/O Converter Modules provide microprocessor based industrial controls for maximum I/O flexibility and expandability. This single circuit modular concept features all-solid-state circuitry, 1500V optical isolation, and high noise immunity. Our 671 Series modules plug directly into a low cost custom-designed mounting panel, which physically isolates

service wiring from logic connections. For pc boards, we offer the same circuitry in our 675 Series low profile package. Both series include ac and dc input/output converters.

So for the best in I/O interface circuitry for microprocessor based industrial controls, contact the people who know the "ins and outs" of this business — Teledyne Relays.

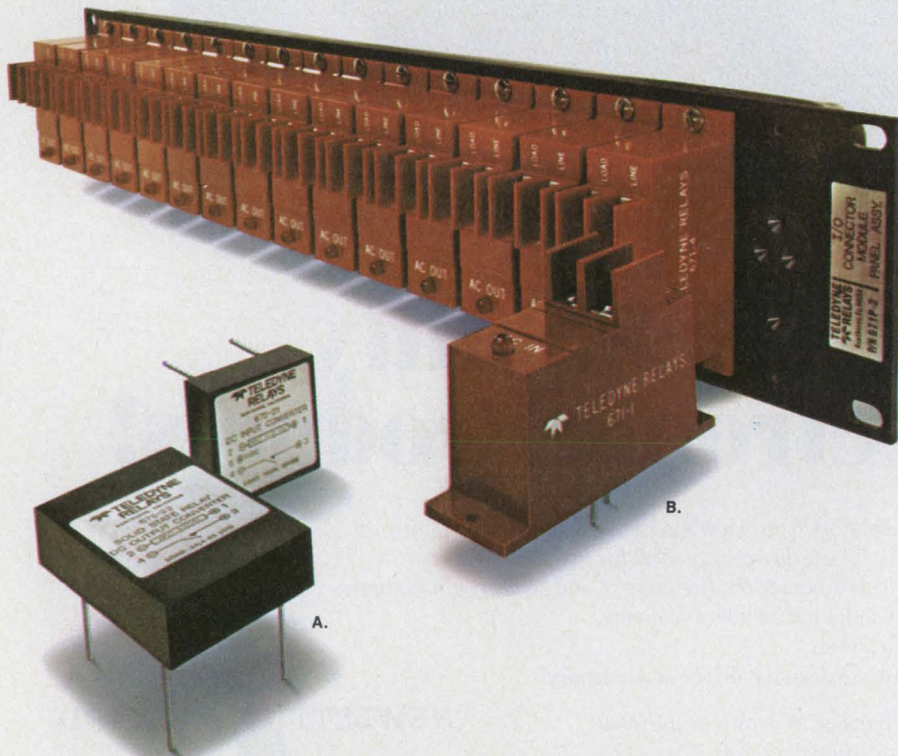

C.

- A. 675 Series — Low profile I/O converter modules for pc board mounting
- B. 671 Series — Panel mounted I/O converter modules (with integral LED status indicators)
- C. 671P Series — Custom-designed mounting panel

TELEDYNE RELAYS

3155 West El Segundo Boulevard, Hawthorne, California 90250
Telephone (213) 973-4545

CIRCLE NUMBER 3

NEWS

- 23 **News Scope**
- 28 **Designers are taking a close look at the new generation of monolithic DACs and ADCs**—An Electronic Design special report.
- 38 **Acoustic holography** gets sharper pictures of organs in human body.
- 51 **Washington Report**

TECHNOLOGY

- 55 **MICROPROCESSOR DESIGN**
- 68 **FOCUS on high-voltage power supplies:** Unique to high-voltage supplies are problems such as corona and arcing that can cause premature failure. Also user safety must be considered when specifying a supply.
- 78 **Keep modular supplies going** by limiting heat build-up. Just a modest temperature rise can drastically shorten lifetime.
- 86 **Insulate with plastics and elastomers.** Today's smart designer must know the characteristics of thermosets and thermoplastics to remain competitive.
- 98 **Select more-reliable switches** by testing them yourself. Here is a simple test system that can evaluate keyswitches and rotary switches.
- 104 **Use defensive interfacing** for remote control of your digital system. Follow these five rules and save many tedious hours of troubleshooting.
- 110 **Prevent emitter-follower oscillation** by understanding its causes. You can minimize problems by adding an inexpensive resistor or ferrite bead.
- 116 **Ideas for Design:**
CMOS frequency-to-voltage converter is linear over wide frequency range. Improve conventional ignition systems with a transistor-assisted approach. Self-adjusting trigger level featured in monostable photocell circuit.
- 122 **International Technology**

PRODUCTS

- 125 **Integrated Circuits:** Control a switching power supply with a single LSI circuit.
- 148 **Modules & Subassemblies:** Wideband rms-to-dc module offers high accuracy at low cost.
- 132 Discrete Semiconductors
- 138 Instrumentation
- 157 Power Sources
- 160 Data Processing
- 167 Packaging & Materials
- 171 Components

DEPARTMENTS

- 63 **Editorial:** My crime
- 7 Across the Desk
- 180 Vendors Report
- 181 Application Notes
- 183 New Literature
- 190 Advertisers' Index
- 192 Product Index
- 192 Information Retrieval Card

Cover: Photo by Don Lauritzen, courtesy of Silicon General Inc.

Switchmode Power.

It brings you into the design cycle instead of keeping you out

Take Your Pick.
Which would you design into your switcher?

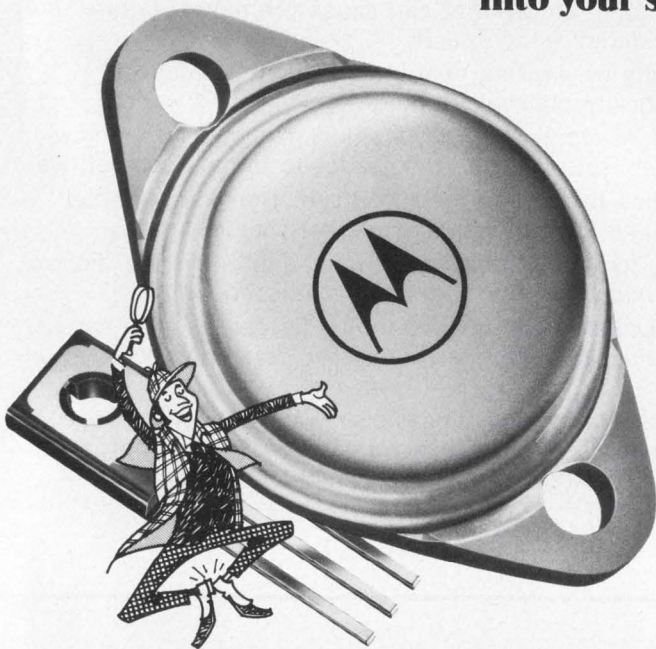

THE SPEC:

1. Active region SOA
2. $V_{CEO(sus)}$, $I_C(max)$, h_{FE} , f_T
3. RBSOA under clamped inductive conditions at 100°C
4. 100°C specs for V_{CEV} , I_{CEV} , $V_{CE(sat)}$, $V_{BE(sat)}$
5. Inductive switching data, 100°C
 - t_{sv} = voltage storage time, 90% I_{B1} to 10% V_{CE}
 - t_{rv} = voltage rise time, 10-90% V_{CE}
 - t_{fi} = current fall time, 90-10% I_C
 - t_{ti} = current tail (coll. current decay) 10-2% I_C
 - t_c = commutation time, 10% V_{CE} to 10% I_C

THE ADVANTAGE:

Specified limits for turn-on energy.
Complete information on basic requirements.
Turn-off energy capability aids in reliable design.
No dependence on "typical" or room temperature specs; efficiency with lower P_D .
Accurate determination of switching losses under actual operating conditions.



THE SPEC:

1. Active region SOA
2. $V_{CEO(sus)}$, $I_C(max)$, h_{FE} , f_T
3. Unspecified
4. Unspecified
5. Unspecified

THE ADVANTAGE:

Typically, "typical."
Complete information on basic requirements.
None.
None.
None.



MOTOROLA

Switchmode devices are SPECIFICALLY designed and characterized for switchers

All the way. Every way.

1. When you're looking for definition of reverse or OFF-biased Safe Operating Area (RBSOA) . . . you've got it.
2. When you need high-temperature, inductive load switching specs . . . you've got 'em.
3. When you want to know switching times as functions of collector current and temperature with inductive loads . . . you've got 'em.
4. When you must know precise information regarding secondary breakdown . . . you've got it.
5. When you require OFF and ON characteristics at 100°C . . . you've got 'em.

No other manufacturer has taken the time and effort to completely define all necessary performance data of this state-of-the-power-art. These unique, first-time specs are presented with important applications info to aid you in device selection and use under actual operation conditions.

No unknowns, empiricals, vague or non-existent device specs, but solid, practical data from a pragmatic source — the *Designers Data Sheet*.

Truly, we've taken the "typical" out of switching design.

The big switch is to switchers and the best switchers will be designed with Switchmode® silicon power!

Switchmode - ideal for the 20 kHz regulator revolution

...plus high-frequency, high-voltage applications like

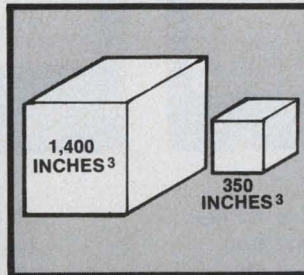
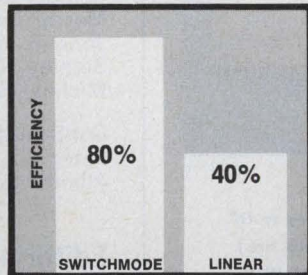
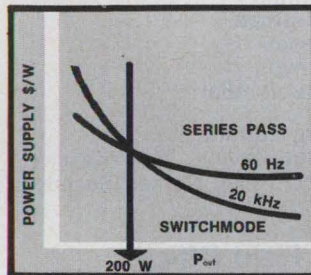

- inverters and converters
- solenoid and relay drivers
- motor controls
- deflection circuits
- induction heating
- ultrasonic cleaning and welding
- fluorescent lamp ballast

... TO SAVE MONEY

As frequency and power go up, costs go down. A high-wattage 20 kHz switching regulator can cost significantly less than a series pass.

... TO SAVE POWER

Efficiency ratings of 80% or even more are obtainable in switchers compared to 40% or less for linear supplies. For a 500 watt supply this means only 125 watts of wasted power instead of 750 wasted watts — a saving of 625 watts!

... TO SAVE SPACE

The total weight and size of switchers is much less than series pass. Heat sinks, magnetics and capacitors are all greatly reduced in size. Most suppliers are able to shrink the dimensions by 2/3 and some greater than 3/4.



...and provides unique tools to optimize your design now!

THE ONLY SWITCHMODE DARLINGTONS

MJ10000, MJ10001, MJ10002, MJ10003
\$3.95 to \$7.75

350 V RBSOA
@ 5 and 10 A,
100°C

3 V sat @
20 A, Forced
Gain 20

300 and 500 ns
inductive tr
@ 10/15 A,
100°C

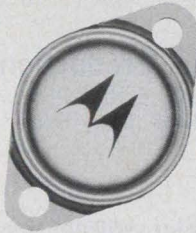

THE MOST SWITCHMODE DISCRETES

2N6306-08 \$3.12 to \$4.30
2N6542-46 \$2.25 to \$6.50
MJ13010 \$7.50

450 V RBSOA
@ 2.5, 4.5
and 8A

Sat voltages
low as 0.8
V @ 3 A

Inductive tr
as low as 800
ns max @
10 A, 100°C



THE FIRST PLASTIC SWITCHMODE

MJE13002/03 75¢ and 95¢

Glassivated
Construction,
Industry's
Most
Reliable
Package,
TO-126

700 V RBSOA
@ 500 mA

200 ns
inductive tr
@ 1.5 A,
100°C

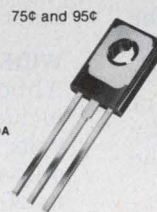

THE BEST SWITCHMODE MIL QUALS

2N6308JAN \$7.85
2N6308JANTX \$10.95

Thirteen, HV,
High-Speed
Switcher
Units on QPL

150 ns
inductive tr
@ 3 A, 25°C

1.5 V sat
@ 4 A



Unique Designers Data Sheets Switch to Switchmode

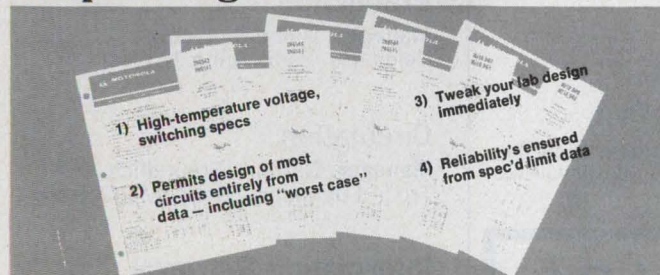

Get into the Switchmode design cycle fast! Send for this free literature file with Designers Data Sheets, application notes, and selector guides. Write Box 20912, Phoenix, AZ 85251, or contact your authorized Motorola distributor or sales office, or your in-plant VSMF center.



*Trademark of Motorola Inc.

All Prices to 999

Semiconductors

SUPERPOWER
unlimited

CIRCLE NUMBER 4

When You Buy a Power Supply, Why Not Get the Best?



28 VDC to DC
(55,463 Hrs.)
Model C95D

28 VDC to 400 A
(61,387 Hrs.)
Model S3D

400 A to DC
(56,148 Hrs.)
Model W5D

Abbott's New Hi-Performance Modules

are designed to operate in the stringent environment required by aerospace systems — MIL-STD-810B and MIL-STD-461A for electromagnetic interference.

RELIABILITY — MTBF (mean time between failures) as calculated in the MIL-HDBK-217 handbook can be expected in excess of 50,000 hours at 100°C for all of these power modules. The hours listed under the photos above are the MTBF figures for each of the models shown. Additional information on typical MTBF's for our other models can be obtained by phoning or writing to us at the address below.

QUALITY CONTROL — High reliability can only be obtained through high quality control. Only the highest quality components are used in the construction of the Abbott power module. Each unit is tested no less than **41 times** as it passes through our factory during fabrication — tests which include the scru-

tinizing of the power module and all of its component parts by our experienced inspectors.

NEW CATALOG—Useful data is contained in the new Abbott Catalog. It includes a discussion of thermal considerations using heat sinks and air convection, a description of optional features, a discussion of environmental testing, electromagnetic interference and operating hints.

WIDE RANGE OF OUTPUTS — The Abbott line of power modules includes output voltages from 5.0 volts DC to 740 volts DC with output currents from 2 milliamperes to 20 amperes. Over 3000 models are listed **with prices** in the new Abbott Catalog with various inputs:

60A to DC
400A to DC
28 VDC to DC
28 VDC to 400A
12-28 VDC to 60 A

Please see pages 1037-1056 Volume 1 of your 1975-76 EEM (ELECTRONIC ENGINEERS MASTER Catalog) or pages 612-620 Volume 2 of your 1975-76 GOLD BOOK for complete information on Abbott Modules.

Send for our new 60 page FREE catalog.

abbott transistor

LABORATORIES, INCORPORATED
general offices eastern office

5200 W. Jefferson Blvd./Los Angeles 90016
(213) 936-8185 Telex: 69-1398

1224 Anderson Ave./Fort Lee, N.J. 07024
(201) 224-6900 Telex: 13-5332

CIRCLE NUMBER 5

Sr. Vice President, Publisher
Peter Coley

Editors

Editorial Offices
50 Essex St.
Rochelle Park, NJ 07662
(201) 843-0550
TWX: 710-990-5071
Cable: Haydenpubs Rochellepark

Editor-in-Chief George Rostky

Managing Editors:

Ralph Dobriner
Michael Elphick

Associate Editors:

Dave Bursky
Samuel Derman
Morris Grossman
John F. Mason
Stanley Runyon
Michael Shunfenthal

Contributing Editors:

Peter N. Budzilovich, John Kessler
Alberto Socolovsky, Nathan Sussman

Editorial Field Offices

East

Jim McDermott, Eastern Editor
P.O. Box 272
Easthampton, MA 01027
(413) 527-3632

West

David N. Kaye, Senior Western Editor
8939 S. Sepulveda Blvd., Suite 510
Los Angeles, CA 90045
(213) 641-6544
TWX: 1-910-328-7240

Jim Gold, Western Editor
1537 Shasta Ave.
San Jose, CA 95128
(408) 279-8588

Editorial Production

Marjorie A. Duffy, Production Editor
Tom Collins, Copy Editor

Art

Art Director, William Kelly
Richard Luce, Anthony J. Fischetto

Production

Manager, Dollie S. Viebig
Helen De Polo, Anne Molfetas

Circulation

Manager, Barbara Freundlich
Trish Edelmann, Gene M. Corrado

Information Retrieval

Peggy Long

Advertising Promotion

Paul K. Hogue

Across the Desk

The Czardine and the bilby

This is a reply to Robert Bilby's letter "A Matter of Fact" (ED No. 7, March 29, 1976, p. 8).

The progeny of the Czar and the Czarina, so vacuously referred to as Czardines, are correctly identified as czarevitek (male) and czarevna (female).

One should keep in mind that sardines have greatly contributed to mankind because they are used as food by many—a statement that may not be as applicable to a nocturnal burrowing rat kangaroo (i.e., a bilby).

Alexander Kocheigis
Electronic Engineer

Lockheed Missiles
P.O. Box 504
Sunnyvale, CA

Patent objections are voiced

I was most disappointed with your report, "Patent System May Be Overhauled" (ED No. 7, Mar. 29, 1976, p. 43). In this respect, I feel the following points are relevant:

(1) Inventors without considerable means wouldn't have any hope for patent protection if Senate Bill 2255 passes in its present form. The present philosophy of this bill is to limit greatly the availability of the Patent Office to the public, thereby cutting down the number of patent applications filed and granted each year.

(2) Costs for "private inventors and small business" will not be lowered to the inventor, will not be less to maintain, and certainly will not be less susceptible to challenge,

because the severe requirements for getting a patent will never be met, and, therefore, the patent will always be subject to challenge.

(3) Your article speaks of an "organized patent bar." Do you honestly think that any organized lobby with any ability would have been caught "flatfooted" when a bill of the consequences of the Patent Bill went through the Senate on the Summary Docket?

I found this news report misleading. Obviously, the news was picked up from a source favorable to the bill who still subscribes to the old adage "tell a lie often enough and loud enough. . . ."

David M. Ostfeld
Attorney at Law

4802 Imogene
Houston, TX 77035

Misplaced Caption Dept.



If those chips get any smaller, I'm getting out of this business.

Sorry. That's Edgar Degas' "Awaiting the Cue," which hangs in a private collection in New York.

Army's fast counter not the first

I have enjoyed your "200 Years of Progress" issue. However, there

(continued on page 10)

Electronic Design welcomes the opinions of its readers on the issues raised in the magazine's editorial columns. Address letters to Managing Editor, Electronic Design, 50 Essex St. Rochelle Park, N.J. 07662. Try to keep letters under 200 words. Letters must be signed. Names will be withheld on request.

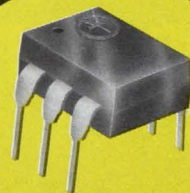

5 kV ISOLATION
"DIP"
Isolators

OPTRON OPTICALLY COUPLED ISOLATORS

NEW HIGH ISOLATION VOLTAGE
"DIP" SERIES OFFERS
HIGH TRANSFER RATIO

Now, Optron provides a 5 kV isolation voltage capability for its standard six pin plastic dual-in-line isolators. A new, unique internal design allows high voltage isolation while still maintaining a high current transfer ratio. The 5 kV DC or 3750 rms AC feature is available for all devices in Optron's popular OPI 2100 and OPI 3100 series.

Optron's extended "DIP" series includes JEDEC types 4N25 through 4N38A, features complete interchangeability with popular industry types and provides an inexpensive coupler for every application. Devices are available with isolation voltages of 1500, 2500 or 5000 volts with minimum current transfer ratios ranging from 2.0 to 500%.

Optron's "DIP" and a full line of other isolator packages with isolation voltages to 50 kV provide the versatility required for maximum electrical and mechanical design flexibility.

1.5 kV isolation with 60% current transfer ratio. Phototransistor base lead available. Hermetic TO-5 package.



OPI 102

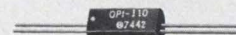

OPI 110

10 kV isolation and 40% current transfer ratio. 4 μ sec switching time in low cost miniature plastic package.

Detailed technical information on "DIP" and other isolators as well as all Optron optoelectronic products . . . chips, discrete components, assemblies, and PC board arrays . . . is available from your nearest Optron sales representative or the factory direct.



OPTRON, INC.

1201 Tappan Circle
Carrollton, Texas 75006, U.S.A.
214/242-6571 • TELEEX-73-0701
TWX-910-860-5958

When you can buy all this for a total of \$701*

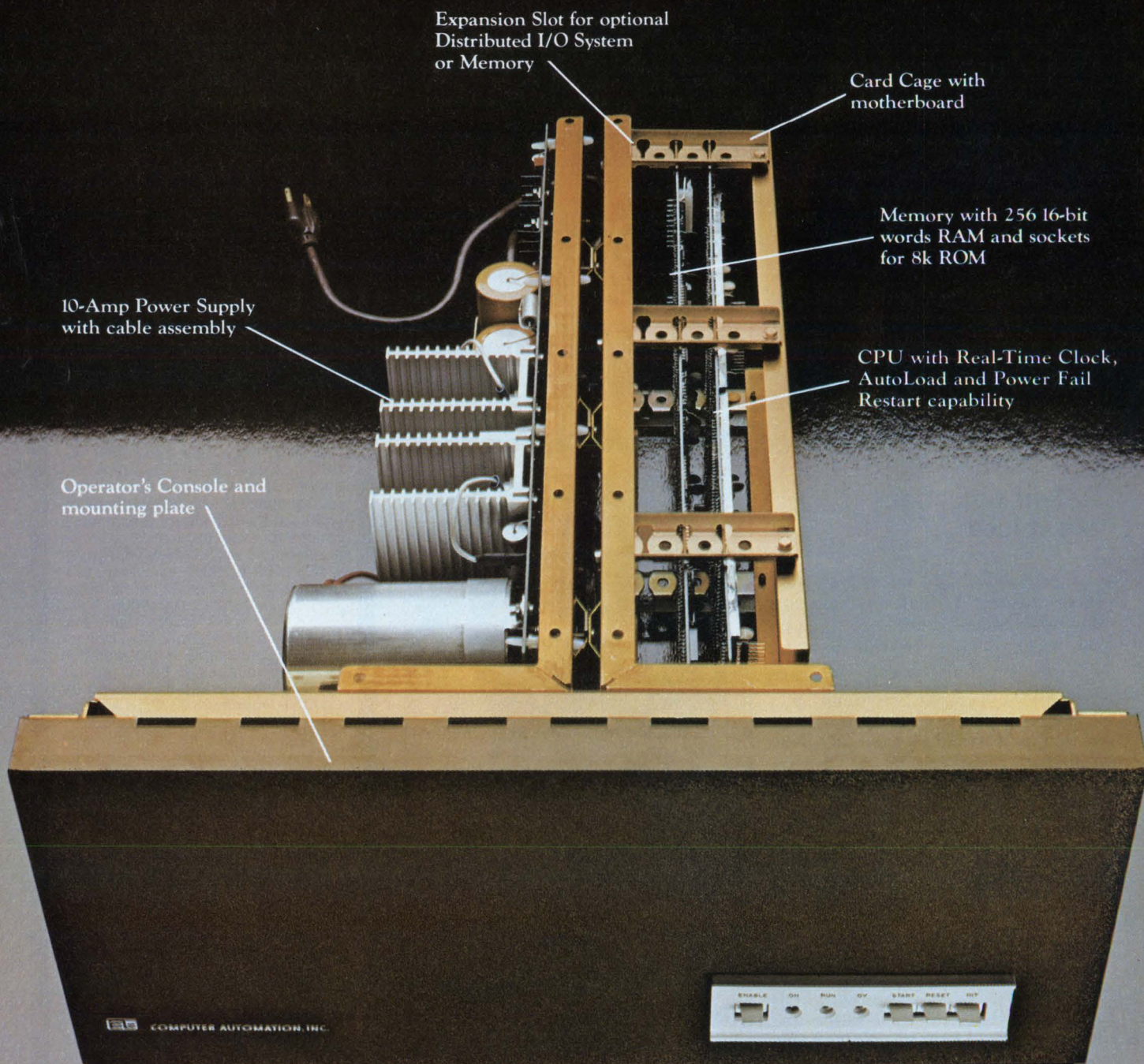

The ALPHA™ LSI-3/05 Millicomputer.
The lowest priced, 16-bit, full-scale, packaged computer in the world.

...building your own just doesn't add up.

Sum and substance. An unbeatable combination even for our competition, so you needn't feel too badly.

Especially when you consider everything we've got going for us.

Specialization, of course. OEM computers — *low-cost* OEM computers — are our only business. The NAKED MINI® people, remember? And when you do only one thing, you do it better.

Experience, too. Over 10,000 up-and-running, field-proven computers successfully integrated into all kinds of sophisticated OEM products.

Also, some things Henry Ford would have appreciated. Buying in volumes most OEM's can't manage. Building the same way.

Where all that gets you is on the down-hill side of the learning curve... where we get our pay-off and you get the lowest-priced, most reliable computers around.

That explains why we can, but not necessarily why you can't. Here's the rest of the rationale:

The chip shot: a hit or a myth?

The fallacy of the micro-processor is that a chip set isn't a computer. Even if you got your chip sets *free* you still couldn't build a computer equivalent to our ALPHA LSI-3/05 for \$701.

Price out the subassemblies shown in the picture and see what we mean. CPU, memory, card cage, power supply and console. All of that design and development time. Amortized over maybe a few hundred systems?

Heart of the ALPHA LSI-3/05 shown at left is this NAKED™ MILLI central processor and memory for \$395*

ComputerAutomation will build thousands of ALPHA LSI-3/05 systems.

Then there's the packaging and fabrication. Cable assemblies, too.

Just think about the procurement activity alone. The lead time. Getting our picture?

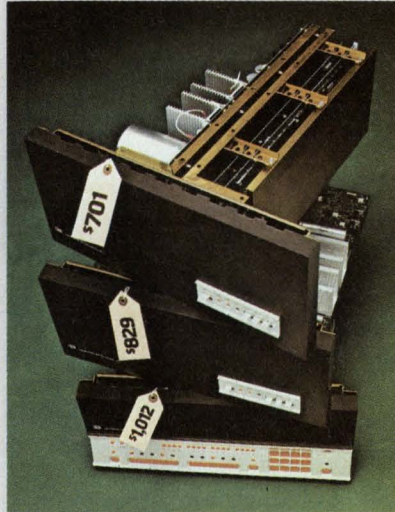

The ALPHA LSI-3/05 is offered in three series featuring a choice of card cages, consoles, memories and power supplies.

Computers vs. computerization

How do you talk to a computer?

Mostly with money, it turns out. Interface money. And mostly a lot of it.

Interfacing a computer to one or two peripheral devices can easily cost as much or more than the computer itself.

Which is why we invented the Distributed I/O System. An optional interfacing system that simultaneously interfaces up to 32 peripherals and special devices, serial or parallel in any combination, for less than \$200* per interface.

What you see is not exactly what you get

Here's what else you get when you buy an ALPHA LSI-3/05 millicomputer:

- 95 powerful instructions
 - Individually vectored interrupts
 - Direct Memory Access
 - Memory expansion to 32K
 - Maxi-Bus interchangeability for easy upward expansion to our full line of compatible minicomputers
- Plus full-fledged mini-computer software.

From the people who brought you the NAKED MINI

The people with the largest line of compatible computers in the world.



Maxi-Bus compatible ALPHA LSI-3/05 achieves unprecedented cost-effectiveness with ComputerAutomation's new Distributed I/O System.

The people with the lowest-priced computers in the world.

The people with the first and only Distributed I/O System in the world.

The people who've been simplifying OEM build versus buy decisions for years.

ComputerAutomation
NAKED MINI Division

U.S.A. 18651 Von Karman, Irvine, CA 92715
(714) 833-8830
EUROPE Hertford House, Denham Way, Maple Cross, Rickmansworth WD3 2XD, Hertfordshire, England; Telephone: Rickmansworth 71211

*All prices shown are for lots of 100 (U.S.A. only)
Patent Pending

FOR FURTHER INFORMATION CIRCLE #281

(continued from page 7)

are two things I would like to point out if I may.

Twice I have seen in print the statement "Engineers at Berkeley Scientific devised an instrument that could count at rates up to 40,000 per second." This may be true, but Berkeley Scientific was far behind the times.

I was an enlisted man at the instrument center of the Aberdeen Proving Grounds in Maryland in 1944-45. There the need for accurate measurement of muzzle velocity of artillery and small arms, on which all firing tables are based, lead to the development of counter and timing circuits using the Eccles-Jordan flip-flop as the basis.

Under the guidance of our civilian building head, Nathan A. Moerman, several G.I.'s—including Ernest Seewald, a graduate of Northwestern University—developed the units to the point where they could accurately determine the flight time of shells.

The projectile was magnetized and fired through two coils to gate the counter on and off. The crystal-controlled oscillator ran at 100 kHz. The readout was in decades using the classical 8421 output through neon lights.

These units were built in their final form by Potter Instrument Co. One unit was portable for use and the field, and groups attached to our instrument section traveled to the front-line artillery battalions during early '45 checking muzzle velocity and gun wear so that proper firing tables could be employed for maximum accuracy. Mr. Moerman became Chief Engineer of Potter Instrument Co. Before 1948 Potter had high speed counters out working in industrial environments.

In our Instrument Building we also had one of IBM's first relay computers hooked to an electric typewriter. It would calculate the muzzle velocity from the flight time and the coil separation distance and type out the result on a form prepared by a typist (see p. 191, paragraph 10-2-4 of "High Speed Computing Devices," Mc-

(continued on page 16)

Our Micro-J[®] capacitors exceeded even our own expectations.

Not long after we introduced our sub-miniature ceramic disc trimmers, some customers began calling our attention to an error we made. It seems our Micro-J Capacitors actually perform better than we said they would.

The Quality Factor is typically greater than 1000 at 1 MHz. And the temperature coefficient of capacitance is typically better than ± 150 PPM/ $^{\circ}$ C over the entire

operating range from -55° to 125° C. This has prompted a number of people to call our Micro-J the best ceramic disc trimmer available at any price. And one customer even suggested that we could probably start charging more for it.

We must admit we were tempted. But we decided to continue selling Micro-J's at the original price.

We don't think you'll mind.

E. F. Johnson Company / Dept. E.D., Waseca, MN 56093

I'd like more information about your Micro-J's.

Please send me your specifications.

I desire test samples. Please call me at _____.

Name _____

Title _____

Firm _____

Address _____

City _____

State _____ Zip _____



JOHNSON

For fast service, contact your local Johnson Distributor.

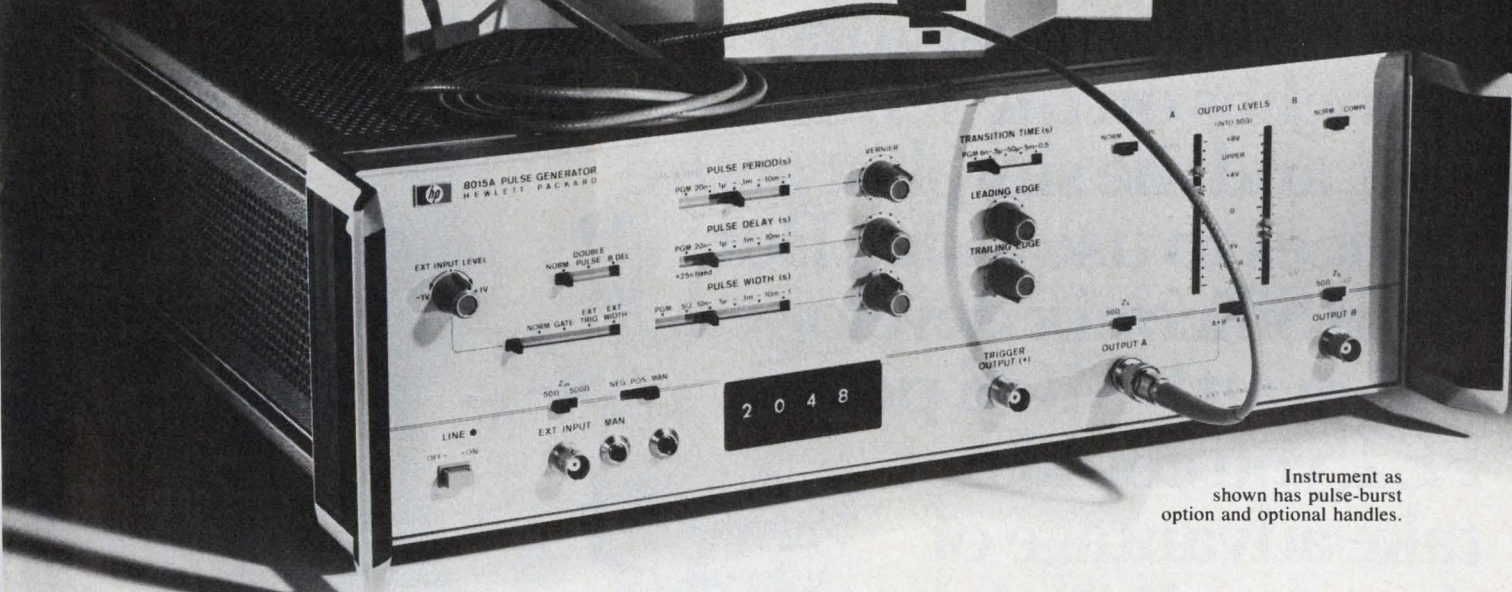
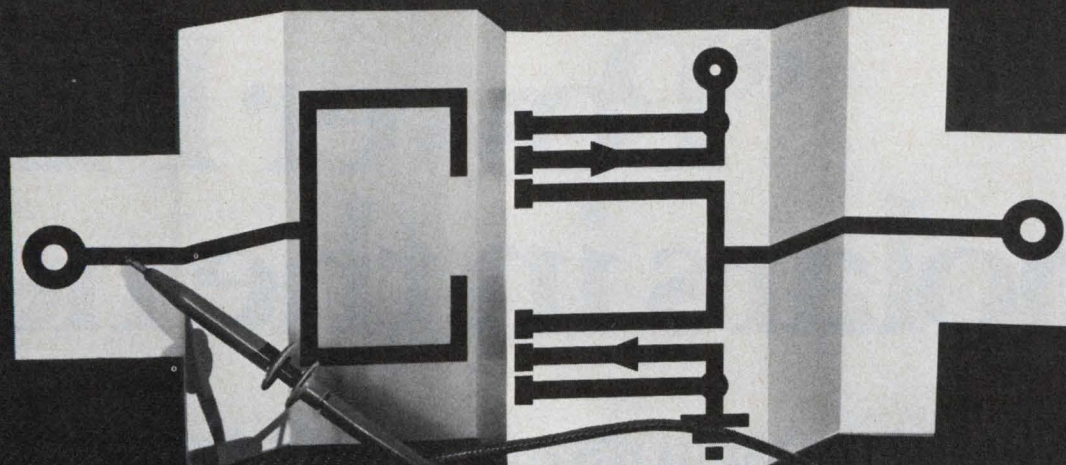

Instrument as shown has pulse-burst option and optional handles.

CMOS parametric testing makes special demands...

Meet them with HP's 8015A Pulse Generator.

This pulse generator has standard features and options that make it ideal for MOS and CMOS parametric testing. For example:

You get dual-channel outputs, each variable to 16V. Or, they combine into a single 30V channel adjustable within a $\pm 16V$ window. That versatility makes the 8015A compatible with CMOS, and most MOS devices. You can delay channel B with respect to A for generating 2-phase nonoverlapping clocks. And combine the adjustable B delay with A + B to generate three-level signals.

Selectable source impedance on both channels lets you choose the best output termination configuration for your application. Of course you can vary the width (10ns to 1s), transition time (6ns to 0.5s), and rate (1Hz to 50 MHz). High-speed capability lets you work with advanced TTL and HTL logic as well as MOS. And low rep. rates or manual operation let you slowly step through logic states.

The 8015A options makes CMOS testing even easier. Pulse Burst (option 002) eliminates conventional gating problems. Just set the exact number of pulses you want (from 1 to 9,999) on thumb-wheel switches. That's exactly the number you get...independent of pulse-rate settings.

Upper Output Level Tracking (option 006) automatically keeps clock and data-pulse amplitudes at the proper level relative to the supply voltage. This prevents CMOS circuit damage due to overvoltage on the inputs, even if the power supply is turned off.

Direct Output Amplifier Access (option 004) lets you convert word generator outputs, or TTL signals, to MOS/CMOS levels, or amplify low-level analog control signals to MOS/CMOS levels.

With Remote Control (option 003), you can build the 8015A into a test system and control all pulse parameter ranges with digital signals. Verniers are controlled by

current or voltage inputs.

And TTL Output (option 005) gives you a separate TTL compatible, 50-ohm output that tracks channel A output with fixed TTL levels.

The 8015A, starting at \$2,250*, gives you parametric testing flexibility and saves valuable setup time.

Or, if your need is for functional CMOS testing, consider HP's 8011A. Priced at just \$525*, it gives you high amplitude (to 16V) pulses at rates from 0.1 Hz to 20 MHz, and offers the Pulse-Burst Option.

Contact your local HP field engineer for all the details. Or, write for the 8015A and 8011A data sheets and our Application Note 195 — "Pulse Generator Techniques in CMOS Applications."

* Domestic U.S.A. prices only.

086/9

HEWLETT  **PACKARD**

Sales and service from 172 offices in 65 countries.
1507 Page Mill Road, Palo Alto, California 94304

"Power FETs bipolars in the next

"Field-effect transistors are one of the oldest branches on the semiconductor family tree, and the simplest active devices to use today. But until Siliconix developed a 25-watt VMOS power FET, you could not take advantage of that simplicity in digital drive, power supplies, servos, motor control and most other high current switching and linear circuits."

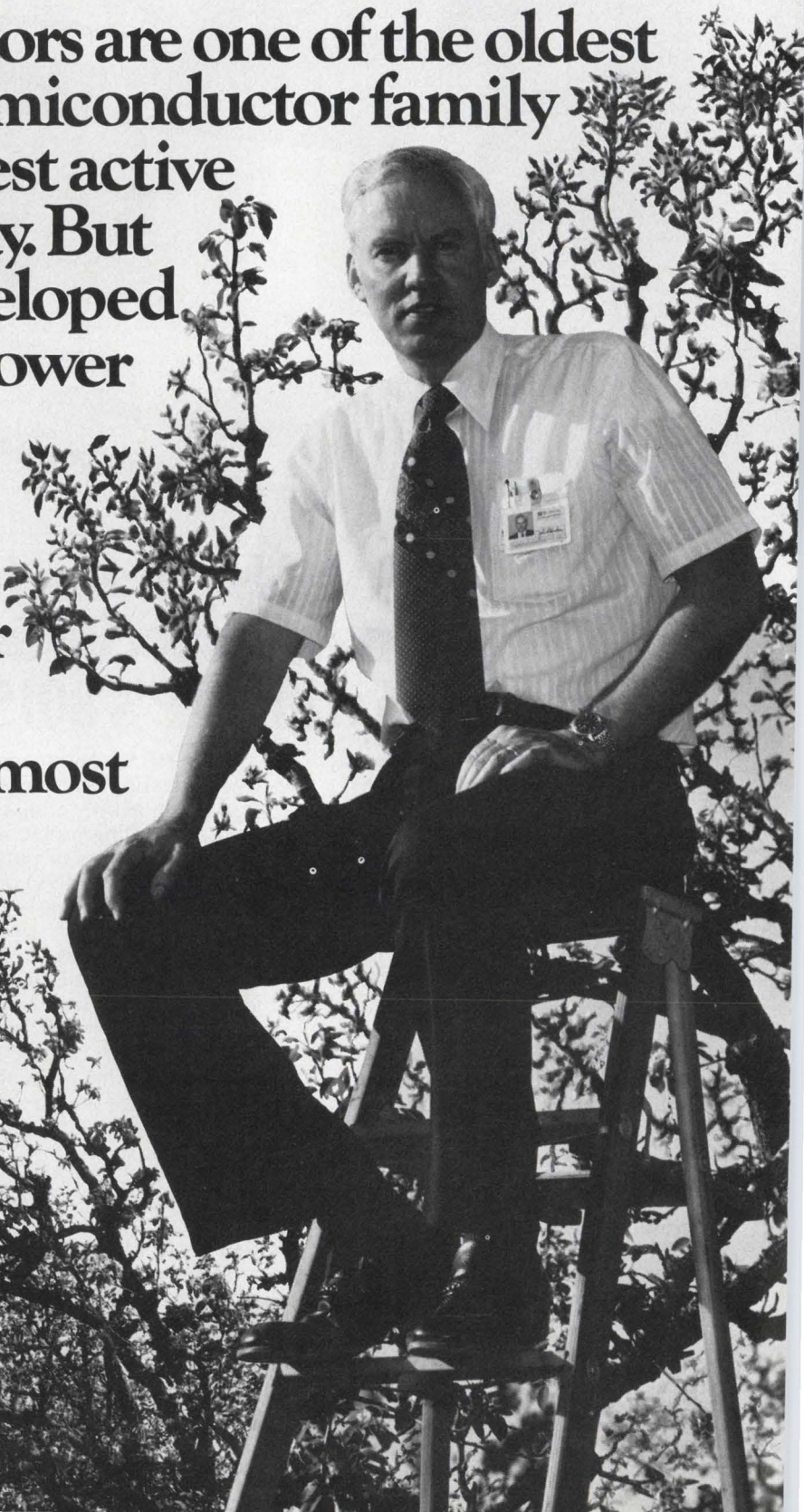

just may eliminate five years."

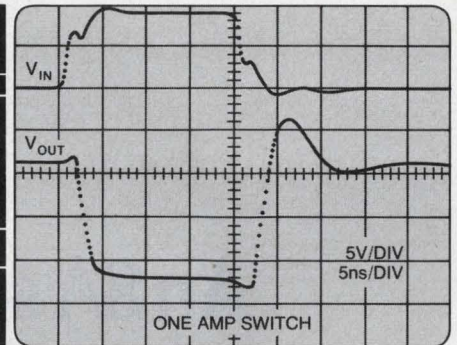
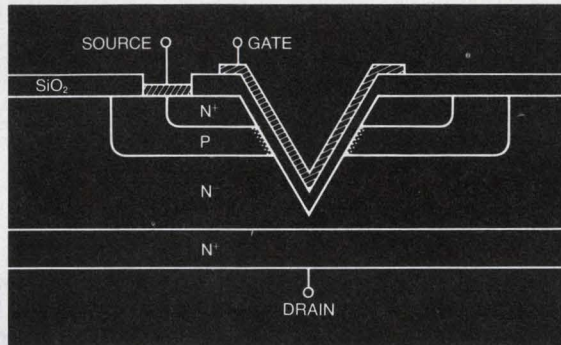

"Historically, designers have had to use Darlington bipolar devices to control high currents. But FETs have the advantage in other respects. They operate with near zero input current, are easier to bias, and are not susceptible to secondary breakdown, thermal runaway, or current hogging, and exhibit no minority carrier storage time.

"With Siliconix' new vertical MOS (VMOS) technology, the current control problem is solved. Our new VMP 1 MOSPOWER™ FET switches 1 ampere in 4 nanoseconds and performs excellently at 2 amps.

"In a VMOS transistor, current flows vertically from a source region at the top of the chip to a substrate drain. This construction multiplies current density through the channel and enhances high speed switching performance.

"Digital designers will find the VMP series as easy to use as a gate. It requires no interface circuit design, can switch faster than TTL and, because FETs are voltage-controlled, it requires negligible input current. For example, CMOS can easily control an ampere of drive current with a single VMP. When multiple devices are used in parallel, they share current instead of hogging it.

"In switching supply regulators, since the VMP series has effectively no minority carrier storage time, switching speeds can be greatly increased offering drastically improved efficiencies.

"Analog control designers can avoid thermal runaway, eliminate preamplifier stages and achieve highly linear control. A high input impedance and low leakage (typically 200 nanoamps or less) gives the current gain equivalent of

nearly infinite bipolar beta. Transfer characteristics are linear from 200 milliamps to over 2 amps.

"In any application that requires drive power, VMOS means economy, simplicity and reliability."

PART NUMBER	BREAKDOWN VOLTAGE	R _{DS} MAX. AT 1 AMP
25 Watts, TO-3 Package		
VMP 11	35 Volts	1.8 Ohms
VMP 1	60	3.0
VMP 12	90	4.0
4 Watts, TO-39 Package		
VMP 21	35 Volts	2.0 Ohms
VMP 2	60	3.0
VMP 22	90	4.5

To order the VMP series, contact our franchised distributors: Components Plus, Cramer, Elmar, Hamilton/Avnet, Pioneer, Quality Components or R.A.E. For more details, call or write Siliconix, 2201 Laurelwood Road, Santa Clara, CA 95054, (408) 246-8000.

Siliconix incorporated

The first GTO SCRs you can actually use.

An 8A series with gate turn-off gains up to 1000—even at 125°C.

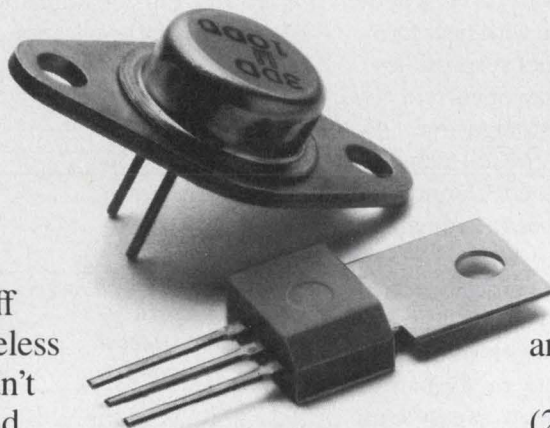

Up till now, gate turn-off SCRs have been pretty useless products. They simply didn't have high enough gains and low enough turn-off voltages to be practical for real-world applications.

But now there's Unitrode's new 8A GTO SCR.

Unlike other GTO SCRs, which need 1A or more to turn off 4 or 5A, ours can turn off 4A with just a few milliamps—for a gain of nearly a thousand.

Unlike other GTO SCRs,

our turn-off gains are virtually flat right up to 125°C.

Unlike other GTO SCRs, which need -30 to -70V for turn-off at the gate, ours need less than -5V.

Of course, our GTO SCRs will also give you the basic GTO benefit of simplified circuit design. Making them perfect for applications like ignition systems, DC circuit

breakers, multivibrators, and inverters.

Unitrode fast switching (200ns) GTO SCRs are available from 50 to 400V in either TO-66 hermetic or TO-202 plastic packages and start at the lowest price in the business.

And that's the most practical part of all.

For fast action, call 617-926-0404, or drop us a line on your corporate letterhead. Unitrode Corporation, 580 Pleasant Street, Watertown, MA 02172.



UNITRODE

CIRCLE NUMBER 11

CAUTION: 50,000 VOLTS



LET ERIE DESIGN and BUILD YOUR HIGH VOLTAGE POWER SUPPLIES and VOLTAGE MULTIPLIERS

When you talk about designing and packaging miniature, low current High Voltage Power Supplies and Voltage Multipliers, the name ERIE should come to mind first. Why? *No other manufacturer of these sophisticated devices has its own capacitor and rectifier technology in-house.* Only ERIE does it all. Our many years experience in producing State of the Art high voltage capacitors and high voltage silicon rectifiers — plus an unsurpassed technology in circuit designing, packaging and encapsulation, makes ERIE an ideal source for your high voltage component needs. From very low input voltages, ERIE can produce output voltages up to 50,000 volts. Application for these compact, high reliability devices includes night-vision image intensification systems. Apollo TV cameras. CRT displays. Avionics systems exposed to rugged environments. Industrial, commercial and military equipments . . . an almost infinite variety of applications. So bring ERIE in early. Let us design and build *your* High Voltage Power Supplies and Voltage Multipliers. We're equipped to handle large or small volume orders . . . in-house.

Write for our 32-page catalog . . .
High Voltage Components and
Devices . . . or for technical
assistance, call
613/392-2581

ERIE TECHNOLOGICAL PRODUCTS, INC.
Erie, Pennsylvania 16512

ERIE

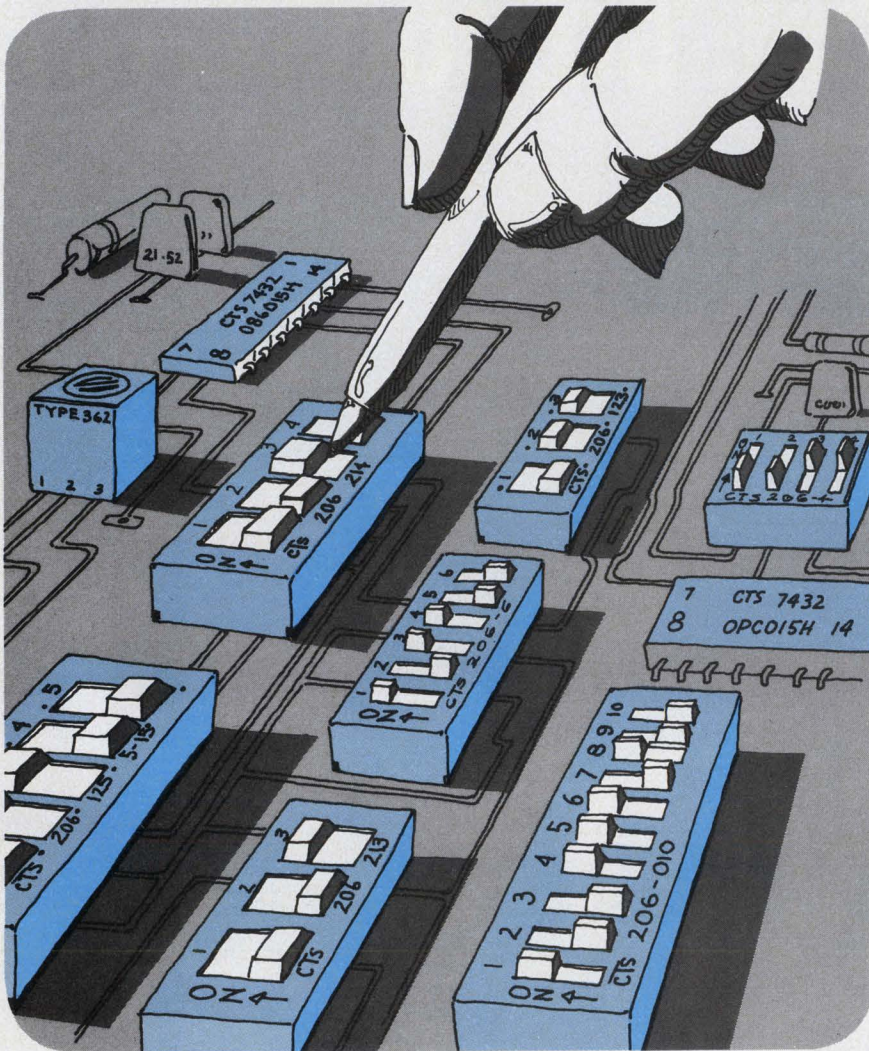

Take your pick... DPST, SPDT or SPST programmable DIP switches

CTS offers them all... with the addition of NEW 2, 3, 4 and 5 section SPDT and DPST switch styles.

A total of 15 Series 206 DIP switch packages are now available from CTS ... 7 with SPST actuation, 4 with SPDT actuation and 4 with DPST actuation. All have .100" by .300" centers for PCB or standard DIP socket insertion. Gold plated contacts with nickel barrier assure lowest contact resistance throughout life.

All provide crisp slide actuation and reliable, positive contact wiping

action. Program up to 10 different logic functions with one compact SPST package or up to 5 SPDT or DPST functions with the identical size package.

Use the quality, reliable CTS Series 206 for your next computer, computer peripheral, communication or test equipment switch application. Available from the factory or off the shelf from CTS Distributors. For complete information, write **CTS KEENE, INC.**, 3230 Riverside Avenue, Paso Robles, CA 93446. Phone: (805) 238-0350.

CTS CORPORATION
ELKHART, INDIANA
A world leader in cermet technology



CIRCLE NUMBER 13

ACROSS THE DESK

(continued from page 10)
Graw-Hill—1950).

Also, I wonder why Bill Gutzwiller of GE is not given proper credit for his part in the SCR development of GE. One can say he came by this honestly as his father brought to Allis-Chalmers the mercury arc rectifier, a related device.

William D. Hibbard
Manager R&D

Crawford Technical Services Corp.
10855 W. Potter Rd.
Wauwatosa, WI 53226

Editor's note: Credit is often given to the company that makes and markets the first commercial device.

PC boards—a plea for information

The article on PC artwork was of great interest ("Improve Your PC Artwork Techniques," ED No. 25, Dec. 6, 1975, p. 72). One important point, however, was not dealt with.

PC boards often serve as heat sinks for power devices. In particular, integrated circuits often have fins that are directly soldered to the PC board. I have been unable to find any information on the thermal impedance of PC boards and wonder if you could supply a source of additional information.

H. Guntner

Siemens AG, Vertrieb Bauelemente
Integrierte Schaltungen 1
D-8000 Munchen 80
Postfach 801709, West Germany

Ed. note: Can any of our readers help?

Stable, yes, but . . .

In the story "Crystal Oscillator Comes with Proportional Oven" on page 92 of the March 1 issue, we wrote that the Model TCO-612 from Toyo Communications had a stability of 1×10^{-8} ppm. Reader R. Brandon of E-H Research caught our goof. The figure we stated, he pointed out, equals 1×10^{-14} , which approaches the stability of an atomic frequency standard—which the TCO-612 is not.

Sorry. We goofed. The stability is 1×10^{-8} —not 1×10^{-8} ppm.

Who provides the industry's broadest line of electronic packaging hardware ... including Logic Panels?

SAE does! And we offer several types of panels to choose from. Our standard 8186 Series accommodates up to 180 device patterns and accepts a variety of I/O connectors. The plug-in version is compatible with other industry-supplied modules, and contains 122 contacts in the I/O connector section.

Features include machined socket terminals with closed entry contacts; a double-sided board with power and ground planes, and pin spacing for almost any IC configuration.

Our EX700 Series supports dual-in-line ICs, discrete components, etc. in a modular, high-density configuration (a third greater than conventional panels). It comes in almost any IC pattern for extra design flexibility, and a plug-in version with an 80-pin I/O connector is also available.

A total ground plane concept provides a much lower ground impedance characteristic, resulting in excellent noise immunity. Power distribution is through bus-bar interconnection, and/or through direct power and ground input terminals.

And if we haven't described one you like, we'll be pleased to quote a custom panel to your specifications including ECL and Schottky logic. Our new 128 page packaging handbook gives complete details. It also describes our other family of logic panels and our entire line of electronic packaging and interconnection hardware.

For an immediate reply, call the following toll-free "ZIP QUOTE" number at the factory ... 800-538-6843.

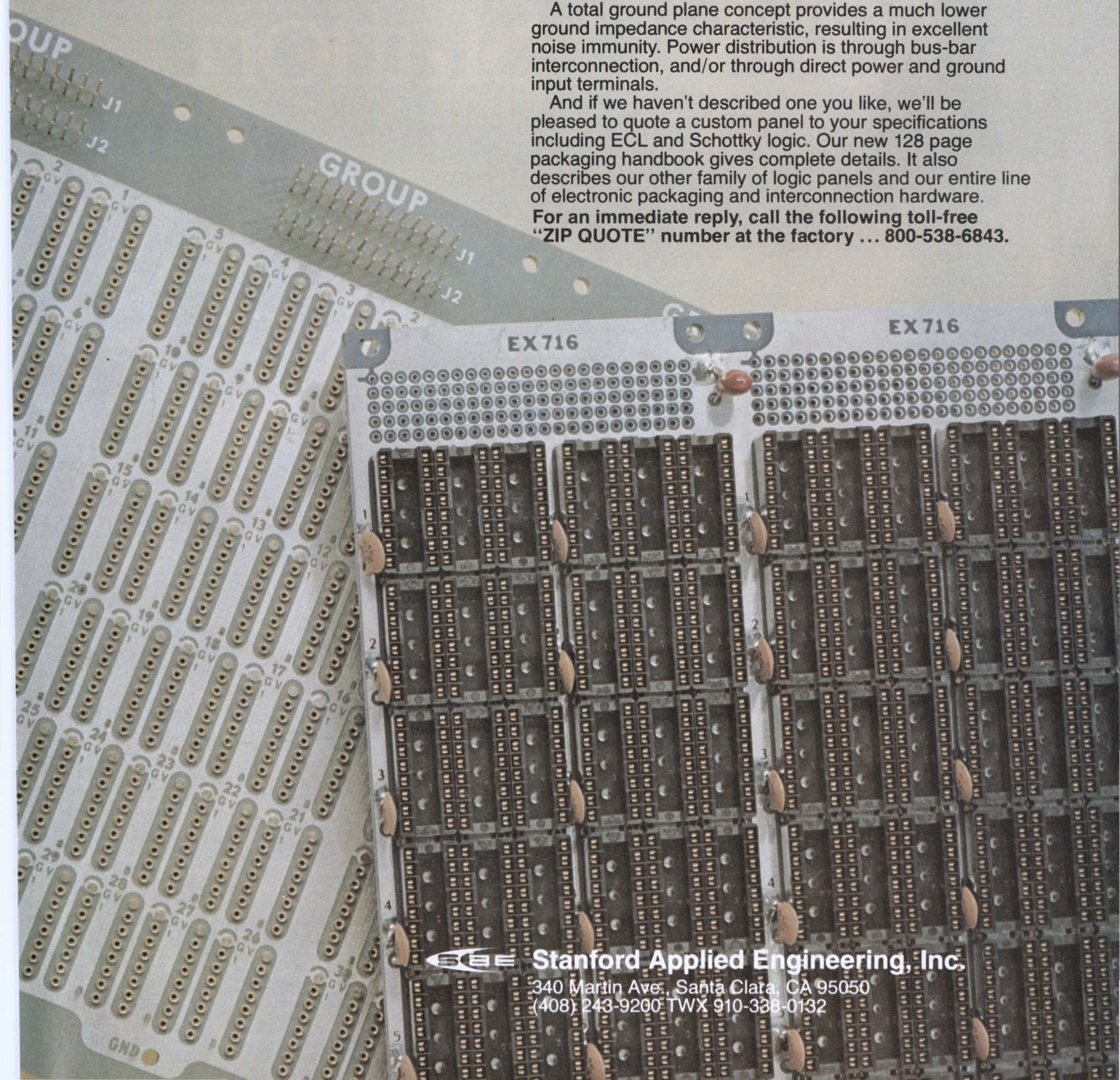

Stanford Applied Engineering, Inc.

340 Martin Ave., Santa Clara, CA 95050
(408) 243-9200 TWX 910-338-0132

Announcing MOSTEK's F8 AID Station

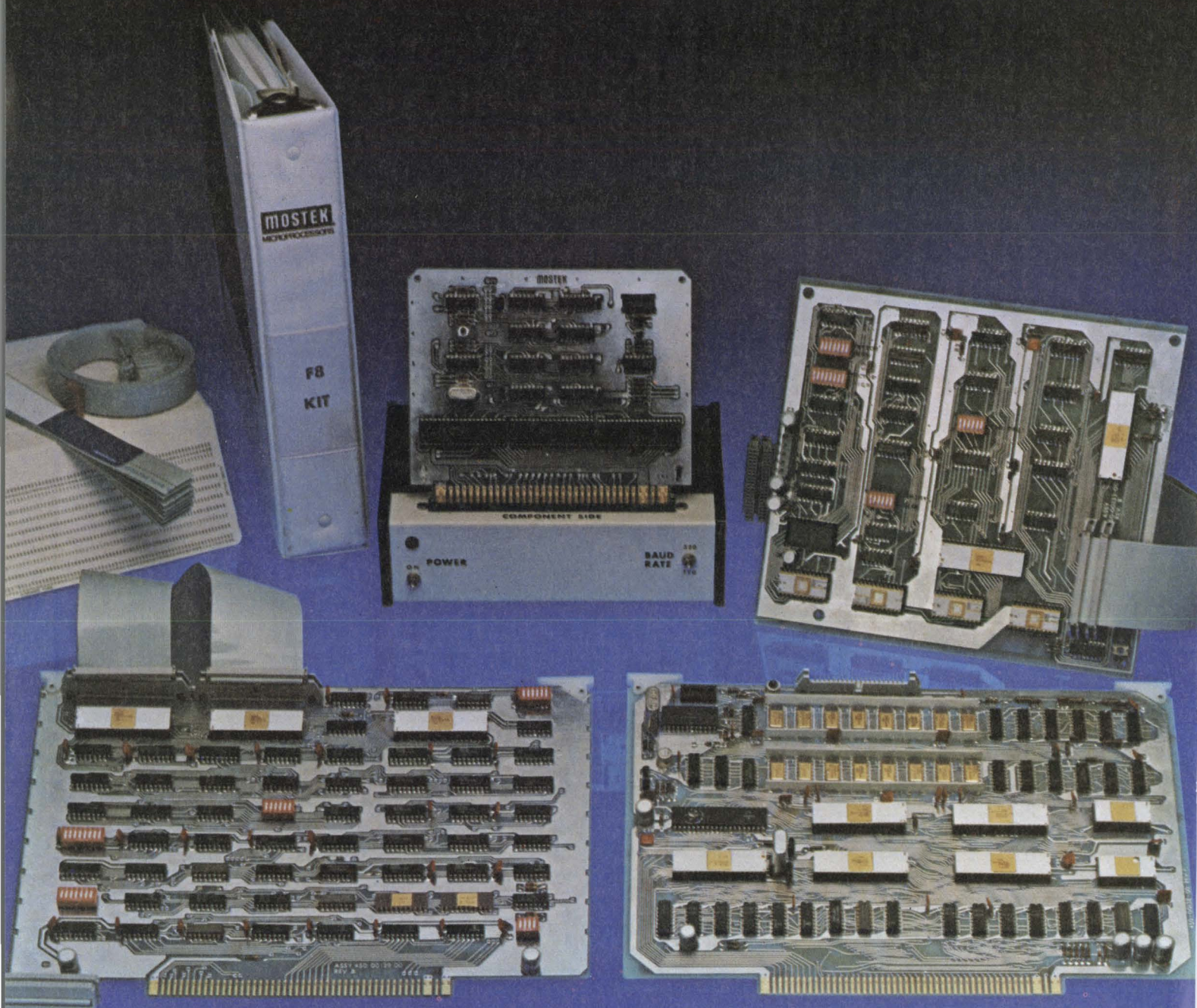

Develop F8 applications from concept to working production systems. Fast!

With MOSTEK's F8 AID (Aid In Development) Station you choose the configuration that works best for your application. It's a streamlined approach for maximum cost-effectiveness. And it allows you to completely debug software and hardware providing a fast confirmation of your actual application before you commit to expensive, time-consuming custom ROM patterns. The big advantage is that you determine the complexity and expense of the development system required for your application. You can use one or all of the development tools, depending on your requirements.

Example:

Start with the F8 Survival Kit as a low-cost training aid and evaluation system. Next...develop and debug ROM or PROM firmware in your final system configuration (target) using SDB/AIM:

F8 AID Station

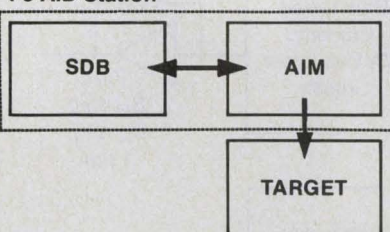

For PSU-based systems, the PSU Emulator is available for verifying or field testing ROM programming prior to ordering custom PSU's.

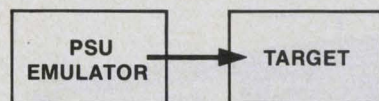

The Mostek Survival Kit—\$185.00

This high performance kit is a ready-to-go microcomputer for evaluation of the F8 instruction set, hardware features and performance. It includes a user operating system, (DDT-1), 1K of RAM, four 8-bit I/O ports, TTY interface, timer, interrupt and Fortran IV F8 Cross Assembler. MOSTEK's Survival Kit can be used for the complete development of many F8 control applications. Unassembled kit price is \$147.00.

The Software Development Board (SDB)—\$1295

With the SDB you can also execute and debug software for your F8 applications. In addition, the SDB offers the capability to create and edit "source" listings (using the F8 resident text editor) and assemble them into corresponding "object" code (using the F8 resident assembler).

The 2Kx8 user operating system (DDT-2) offers 10 basic commands:

- .M s display and update memory at s
- .M s,f tabulate memory block s,f
- .P s display and update port s
- .P s,f tabulate port block s,f
- .E s execute program at s
- .B s set breakpoint to exit program at s
- .S s single step execution at s in program
- .L load tape into memory
- .D s,f dump tape from memory block s,f
- .C s,f,d copy memory block s,f to d

Mostek's SDB also provides 8Kx8 of RAM, four 8-bit I/O ports, serial

ASCII interface (110-9600 baud) and a parallel interface for high speed reader/punch.

The Application Interface Module (AIM)—\$750

With SDB/AIM you can debug F8 applications in the actual hardware and software configuration of your final system (Target). AIM allows you to actually emulate the target ROM, or PROM with RAM. The RAM, which appears as ROM to the application, can be loaded, debugged and modified using peripherals independent of the target. All of the peripheral and debugging capabilities of the SDB can be applied directly to the final system configuration of any F8 application.

The Emulator—\$435

This development aid is ideal for designing and field testing F8 μ Computer systems which use one or more MK 3851 Program Storage Unit (PSU) circuits. It's electrically equivalent to the PSU but is field programmable rather than mask programmable allowing final hardware verification of all PSU programming prior to ordering custom PSU circuits.

Get started with the F8 Development Aid Station now. It's available at MOSTEK distributors complete with thorough documentation. Or call your MOSTEK sales representative.

MOSTEK

In Europe, Contact:
 MOSTEK GmbH
 TALSTR. 172
 7024 Bernhausen
 West Germany
 Telephone: (0711) 701096

1215 West Crosby Road
 Carrollton, TX 75006

Unmatched Performance and Selection in High Speed Data Acquisition

Ultra-high speed ADC's and DAC's, sample-holds, multiplexers, and super-fast op amps. Individually, they're outstanding — many without peer. Collectively, they are carefully matched to provide the fastest data acquisition systems available. Anywhere.

Ultra-High Speed ADC's	Resolution	Conv Time	Gtd Throughput Rate with 4855S/H*	Time per Channel	Add a 4550 Multiplexer Throughput
4130	8-bits	0.75 μ s	1.25 MHz	1.10 μ s	909 kHz
4131	10-bits	1.00 μ s	940 kHz	2.12 μ s	471 kHz
4133	12-bits	2.50 μ s	377 kHz	3.30 μ s	303 kHz

*Model 4855 features 250 nsec acquisition time to 0.01% and an aperture time of 2 nsec max.

For high speed MIL-applications, our 4058, a true 12-bit microcircuit DAC, features ultra-fast, ultra-stable operation from -55°C to $+125^{\circ}\text{C}$ with 100% screening available to MIL-STD-883.

Settling at 200 nsec to 0.01% max and providing 10 V @ 50mA output, our 1430 IC op amp is still the performance leader. Combine it with 4058: without question the fastest 12-bit hybrid voltage DAC. Anywhere.

The industry's fastest MDAC's — that's our 4070 series. 8, 10, or 12-bit resolution, 500 nsec settling to 0.1%, and inputs up to 7 MHz.

High Speed Current DAC's — our 4060 series give you a competitive and compatible selection, with a guaranteed settling of 85 nsec to $\pm 0.1\%$.

Radar pulse digitizing, video digitizing, FFT, simultaneous sample-hold systems, CRT displays, and waveform synthesis — applications where only Teledyne Philbrick can give you the complete high speed solution. And, a new series of Application Bulletins will facilitate your high speed design. Just write for them.

Teledyne Philbrick, Allied Drive, Dedham, MA 02026 — Telephone (617) 329-1600. In Europe, Telephone 673.99.88, Telex 25881, or write 181 Chaussee De La Hulpe, 1170 Brussels.

TELEDYNE PHILBRICK

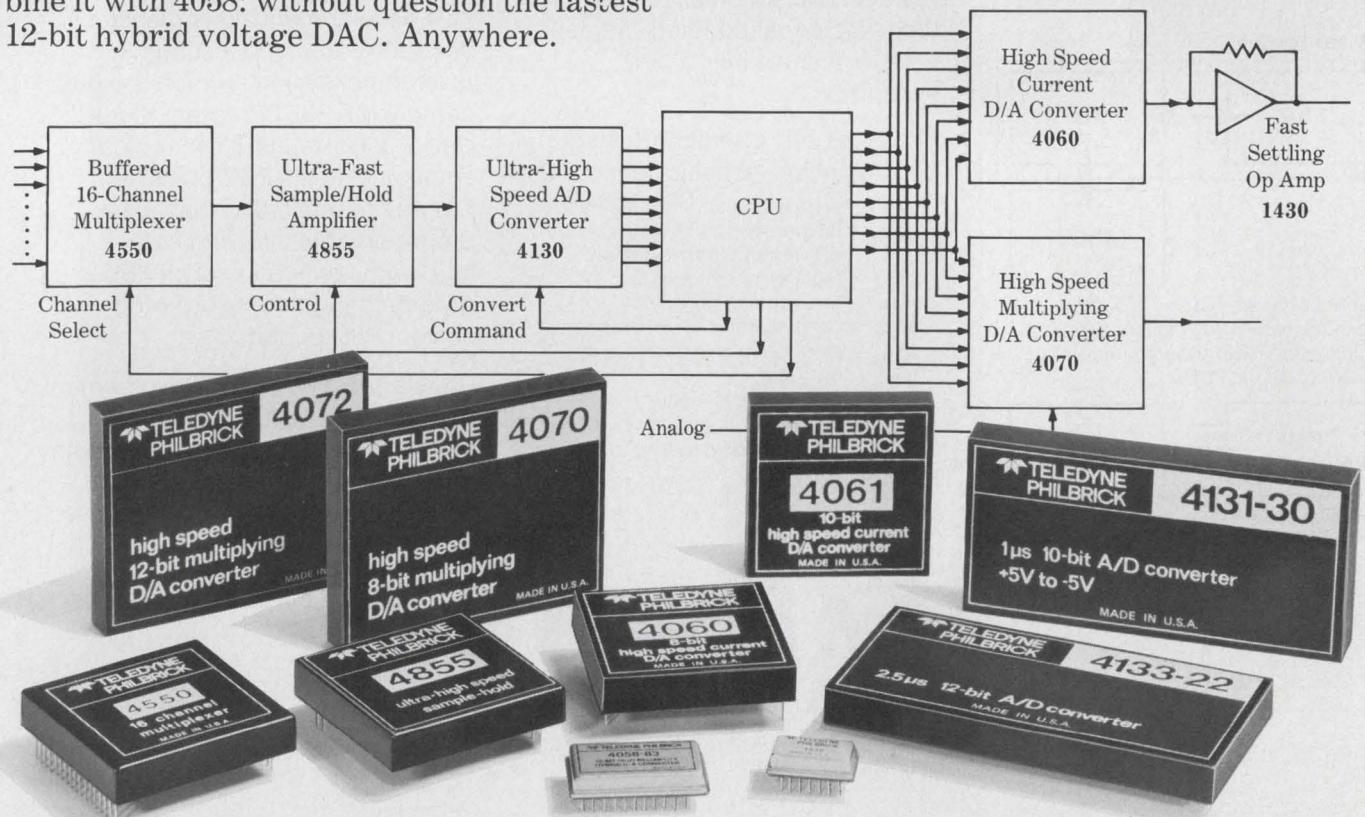



Select from this family of aluminum electrolytic capacitors designed for output filtering in switching power supplies



TYPE 672D

- Suitable for parallel stacking
- Plug-in PWB mounting
- Low to medium ripple current capability



TYPE 604D

- True 4-terminal isolation
- Low profile PWB mounting
- Medium ripple current capability



TYPE 622D

- Symmetrical ESR and capacitance tolerance
- Conventional stud mounting
- High ripple current capability



TYPE 432D

- Lowest available ESR and impedance
- Bus-bar mounting
- Maximum ripple current capability

Construction	Rolled-Section		Rolled-Section		Rolled-Section		Stacked-foil	
Terminal Configuration	2 terminals, wire pins		4 terminals, wire leads		2 terminals, low or high female threaded		2 terminals, strip-line, female threaded	
Case Size Range (D. x L.)	.326" x .505" to 1.000" x 1.625"		.750" x 1.625" to 1.000" x 3.625"		1.375" x 2.125" to 1.375" x 5.625"		1.375" x 2.125" to 3.000" x 5.625"	
Operating Temperature Range	-55°C to +105°C		-55°C to +105°C		-55°C to +85°C		-40°C to +85°C	
WVDC Range	6.3 to 100		5 to 200		5 to 55		6 to 50	
Capacitance (Range (μF))	4.7 to 6800		50 to 16,000		2,800 to 67,000		470 to 100,000	
Capacitance Tolerance	-10, +100%		thru 50 V: -10, +75% over 50 V: -10, +50%		±20%		-0, +100%	
Max. Inductance (@ 1 MHz & within .125" of capacitor)	20 nH		2 nH		20 nH		2 nH	
Max. ESR (@ 25°C and 120 Hz)	1200 μF @ 6.3 WVDC	.11 ohm	16,000 μF @ 5 WVDC	.022 ohm	67,000 μF @ 5 WVDC	.004 ohm	100,000 μF @ 6 WVDC	.0015 ohm
RMS Ripple Current (@ 85°C)		2.61 A @ 100 kHz		7.00 A @ 10 kHz		19.5 A @ 20 kHz		54.6 A @ 1 kHz
Max. Impedance (@ 25°C)		.06Ω @ 100 kHz		.017Ω @ 10 kHz		.010Ω @ 10-40 kHz		.001Ω @ 10 kHz
Engineering Bulletin	3452		3458A		3459		3443A	
	Check 261 on Reader Service Card		Check 262 on Reader Service Card		Check 263 on Reader Service Card		Check 264 on Reader Service Card	

For complete technical data, write for Engineering Bulletin(s) (see table for bulletin numbers) on the capacitor(s) in which you are interested to: Technical Literature Service, Sprague Electric Company, 347 Marshall St., North Adams, Mass. 01247.



THE BROAD-LINE PRODUCER OF ELECTRONIC PARTS

**You can buy
this Spectrum Analyzer
and take a big chunk
out of your budget.**

**You can rent
this Spectrum Analyzer
and get more
equipment out of
your budget.**

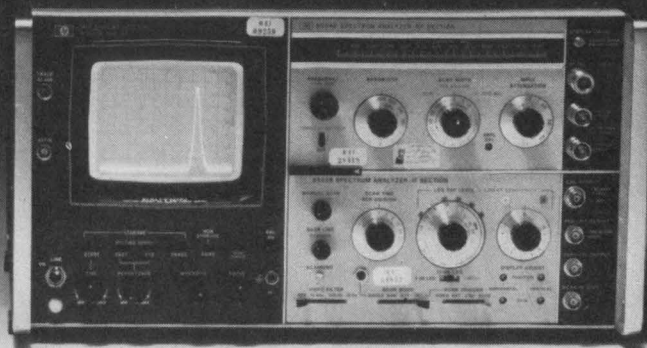

Even the best equipment budget can only go so far. And at the price you pay for electronic test equipment nowadays, that's not very far at all.

Unless you rent your equipment from REI.

When you rent from us, there's no large cash outlay. You pay only for the time you have your instruments, and you return them when you're through. So you never have to spend your money on idle equipment.

Getting more for your money is just one reason for renting from REI. Immediate delivery is another. We have over \$10 million in inventory in fully stocked centers around the country. And, when you have short-term needs, you can rent equipment for just as long as you need it, and make it pay for itself.

REI stocks over 8,000 fully checked-out test instruments, and they're ready whenever you are. For the full story on renting, as well as our low prices, send in the coupon for prompt delivery of our free illustrated catalog... or call us now for your immediate requirements.

Rental Electronics, Inc.
99 Hartwell Avenue, Lexington, Mass. 02173
Please send me your free instrument rental catalog:

Name _____ Title _____

Company _____

Address _____

City _____ State _____ Zip _____

Tel. Number _____

Rental Electronics, Inc. 

A DEPSICO LEASING COMPANY

Burlington, MA (617) 273-2770 • Gaithersburg, MD (301) 948-0620 • Oakland, NJ (201) 337-3757 • Ft. Lauderdale, FL (305) 771-3500
• Des Plaines, IL (312) 827-6670 • Dallas, TX (214) 661-8082 • Mountain View, CA (415) 968-8845 • Anaheim, CA (714) 879-0561
• Rexdale, Ontario (PLC Leasing Ltd.) (416) 677-7513

JUNE 21, 1976

Time-shared network will aid research on nuclear fusion

A nationwide, time-shared computer network has been set up to accelerate research on nuclear-fusion power. Network headquarters is at Lawrence Livermore Laboratory of the University of California.

The center will perform numerical simulations of the complex plasma interactions that occur during controlled thermonuclear experiments. The results of these simulations will be used in the design of experimental reactors and as the basis for further calculations in fusion plasma physics.

Commercially available power generated by controlled fusion is at least 20 years away, according to Dr. John Killeen, head of the national controlled thermonuclear research computing (CTR) center. An experimental fusion-power reactor is expected to generate about 100 megawatts of power by 1985.

Both Russia and Japan are aggressively pushing fusion programs and both may very well have their experimental reactors operating some time before that of the United States, Killeen says.

Equations describing the behavior of plasma in CTR devices are so complex that they can only be solved approximately by analytical techniques presently available, say Energy Research and Development Administration scientists at Livermore. Therefore, computer models must be used extensively to understand and predict plasma behavior.

A Control Data Cyber 76 computer provides the main computing power and a Cyber 73 system handles the communications load, acts as a file transport between remote sites, and manages the large, centralized data base. At present, four remote user service centers are operational, and there are plans for the creation of more.

The four operational cities are

the Oak Ridge National Laboratory, TN; Los Alamos Scientific Laboratory, NM; Plasma Physics Laboratory, Princeton University, NJ; and Gulf General Atomic, La Jolla, CA.

Each of the remote user-service centers uses a PDP-10 to provide local computation support and to communicate over 50-kilobit lines with the Livermore center through a PDP-11 computer and a complement of input-output devices.

Terminals at the remote-user sites and the host laboratory include a mix of 30-character-per-second electrostatic printers, interactive CRTs with alphanumeric keyboard, and graphic-alphanumeric displays operating at 9600 baud. The network is designed so that when a small, remote computer cannot complete a calculation, it automatically calls upon the Cyber at Livermore.

Files, stored under a Livermore-developed program called FILEM, are user-created. These files are managed by the CDC Cyber 73 and are retained on disc, then transferred to tape after a predetermined period. The Cyber 73 computer maintains an index, and a request for a purged file brings the data back on to CDC 844 discs. A mass memory, planned for later this year, will replace the tapes to some extent, but tapes will remain as back-up.

The data-communications portion of the network is controlled by a PDP-11 used as a concentrator. File transport and terminal traffic flows site-to-site through this network. Communication with the Cyber 76 computer can also be handled by direct dial to a concentrator at Livermore.

A growing number of universities are receiving funding by ERDA for fusion research, and private contractors are expected to

enter the program as feasibility becomes further established. These new participants, as well as a number of university laboratories presently in the program, will be served by the CTR computer network.

μ P in radio scanner finds 12,000 frequencies

The first radio scanner to use a microprocessor can search for and locate some 12,000 vhf and uhf frequencies in the police, fire, weather, marine, rescue and business bands. Up to 16 discrete channel frequencies can be stored in the μ P memory and recalled through a calculator keyboard on the front panel of the receiver.

Another key feature, a crystal-controlled phase-locked loop, eliminates the individual crystals required for each channel and for all competitive receivers.

The scanner, called the Memory-scan MCP-1, developed by Tenelec Inc., Oak Ridge, TN, also has a LED display on which 6-digit frequencies are displayed alternately with assigned channel numbers.

A Rockwell PPS-4/2 μ P provides several automatic control functions. Upon front panel command the processor automatically searches over a 10 MHz bandwidth within the following bands: 31.180 to 51.655 MHz, 151.180 to 171.655 MHz and 451.180 to 471.655.

Because the individual frequencies can be directly accessed through the front panel keyboard, the frequency directory code book required with other scanners is not needed.

The μ P controls several key functions. It drives a frequency synthesizer that produces the local oscillator signal for the receiver. When a command is entered into the keyboard the keys are interrogated by software built into the μ P system. The keys are strobed to find out which ones are depressed and key debounce action is also taken care of by software.

At the same time, the strobes that interrogated the keyboard also strobe the 6-digit LED display that shows a desired frequency. When a function key like "enter frequency" is pushed, the μ P reads

the frequency in the display and correlates it with the band selected.

The processor then makes an error check to be sure that the frequency selected is within the band capability of the receiver. The validated frequency is then stored in memory and the receiver circuits are tuned to it.

As a final check, the μ P again looks at the frequency stored in memory. The processor recomputes the band and the frequency within the band. The action verifies that the displayed frequency is the one stored in the memory.

Up to 16 frequency channels can be stored. To change a stored frequency the channel-select button is depressed and the unit searches upwards in frequency through 256 channels in increments of 5 kHz. The channels are scanned at the rate of 10 per second. The display continuously and alternately displays the readout of the frequency and channel number selected.

The receiver is matched for optimum response with an 18-in.-width antenna.

CCD technology invades the digital domain

Charge-coupled-devices are now being applied to digital equipment. For the first time CCDs are appearing in multipliers, adders, and Fast Fourier Transform (FFT) analyzers. This work, much of it still developmental, is being performed at TRW Inc., Redondo Beach, CA, under contract to the United States Navy.

Until now, most applications of CCDs have been devoted to analog signal processing, imaging, and memory implementation, situations where the high circuit density possible with these devices offers many advantages over conventional technology.

Application of CCDs to digital signal processing is expected to lead to the development of a complete FFT-analyzer computer by early 1977, a TRW spokesman reports. Such analyzers perform spectral analysis of signals for use in a wide variety of signal-processing applications.

One use, for example, is for enhancing signal-to-noise-ratio.

The FFT can determine the frequency spectrum of undesired noise components. Then the appropriate filters can be built to remove the unwanted noise. FFTs also are used for target identification in military applications.

A CCD-based bulk memory, capable of storing several megabits of digital data on a single IC chip, is also under development at TRW. One use for such a large-scale serial memory is to replace the video disc that are currently used.

Memory arrays capable of storing more than 100,000 bits are expected late this year, the spokesman adds.

Small dictation machine has electronic controls

A cassette dictation transcription system that may be the forerunner of a new generation of desk-top dictation devices has been introduced by Dictaphone Corp., Rye, NY.

The recorder, called "Thought Master," has solid-state touch control instead of the more cumbersome mechanical switches and dials on traditional dictation machines.

Other features include the use of light-emitting diodes for the unit's index display system. The electronic indexer also allows the user to record subsonic signals on the tape, to indicate the number and length of dictated documents. Special instructions can be included and located by use of the tone.

The system also provides a sensor, called Auto Scan, to facilitate rapid dictation review. When the user presses either the rewind or the fast-forward control, the Auto Scan sensor automatically stops the recorder at the beginning of each dictated document.

An optional phone adaptor gives the unit the ability to answer and record up to 30 minutes of dictation from any telephone.

Navy radar antenna does two jobs

A tracking radar that transmits both Ka and X-band frequencies through a single dish antenna has been developed at the Naval Research Laboratory (NRL), Wash-

ington, DC. The procedure is said to be unique for tracking radars.

By combining the antennas used in two earlier experimental tracking radars into a single unit, NRL engineers have produced a compact, low-inertia system that results in improved performance of the antenna's tracking servo.

This dual system (called TRAKX) is achieved by using a dichroic material, a substance that reflects Ka-band signals but is transparent to signals at X-band. The antenna dish operates as a simple reflector for X-band, but through the use of the dichroic material, which is mounted as a sub-reflector, it becomes a cassegrain type at Ka-band.

NRL engineers report successful skin tracking of an aircraft at altitudes as low as 100 ft at a range of 15-nautical miles, using the Ka-band portion of the tracker with its narrow beam width (0.25°).

The X-band tracker, with its wider beam width, 1°, serves primarily for initial target acquisition and for long-range tracking.

Your 'common' fuse has been redesigned

The traditional round glass cartridge fuse may be replaced by a flat plastic package with metal contacts. The plug-in unit is the first major redesign of American automotive fuses in 60 years.

The Autofuse, developed by Liltelfuse Inc., Des Plaines, IL, consists of the fuse element and flat terminals protected by a tough plastic housing. The glass fuse, in contrast, has six components, less reliability, and a shorter life.

Compared to glass fuses, the Autofuse has demonstrated an order-of-magnitude increase in the number of test current cycles that it can withstand before becoming inoperative. (Cycles vary from 0 to 70% of full load.) Also, the new-fuse life has been increased to 100 times longer than the life of glass fuses, according to a Liltelfuse spokesman.

Another advantage of the Autofuse is a form factor that gives a 30 to 40% smaller fuse block than is required for glass-fuse units.

The Autofuses are produced in 32-V ratings from 3 to 30 A.

Intro- ducing the amaz- ing EECO

machine: in one end you put your raw, un-annotated logic diagram, and out of the other comes your fully wire wrapped socket board/frame/drawer/system—your choice. Together with a *Final Exception Report*, a *Final String List*,

an IC Location List, *lists for IC Type and Socket Size*, *a Wire Loop List*, *a Pin Assignment List*, *an Unused Circuit Elements and Pins List*, *a Pin by Pin Wire List*, and your diagram back, fully annotated.

This machine uses a computer, and people, and hardware all under the same roof, and gives you a chance to correct or change your circuitry before we go to hardware. We deliver in as little as two weeks, including time for you to review. We've been doing this for more than five years, almost in secret. Now we're telling you and the world because it's about time. Write or phone the keeper of the EECO machine, Dick Hunter.



EEECO
PACKAGING/SWITCHES/READERS

1441 East Chestnut Avenue, Santa Ana, California 92701
Phone 714/835-6000

CIRCLE NUMBER 19

Our 8,257
brand-new
voltage
regulators:

The LM-117.

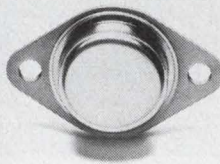

We proudly announce the world's first and only 3-terminal adjustable regulator.

Our ubiquitous LM-117.

With this one product, you can eliminate a whole mitful of fixed-regulator problems. The designing-in, the multiple specs, the overwhelming inventory. Because this one product can be any regulator you want it to be.

But it's not just a substitute for fixed regulators. It'll give you 5 times the performance. It'll supply in excess of 1.5A over a 1.2V to 37V output voltage range (or up to infinity, using

precautions) with ripple rejection of 80dB.

For the QA guys, it features 100% electrical burn-in. There's full overload, safe area, and thermal protection.

And for the dazzlement of everyone, you can use it as a programmable output regulator, or an adjustable switching regulator, or as a precision current regulator, or a high-voltage regulator, or whatever.

Mail the coupon for our free booklet on the LM-117. And see for yourself what it — er, they — can do.

National Semiconductor ED621
2900 Semiconductor Drive, Santa Clara, CA 95051

Gentlemen:
Send me your LM-117 book.

NAME _____ TITLE _____
COMPANY _____
ADDRESS _____
CITY _____ STATE _____ ZIP _____

National Semiconductor 

Designers are looking closely at new monolithic DACs and ADCs

A new generation of monolithic digital-to-analog and analog-to-digital converters is arriving on the scene. These complex, special-purpose chips assist the designer in solving specific system problems more cheaply than with conventional hybrid and potted-module DACs and ADCs.

Examples of monolithic devices that have appeared in the last year include companding DACs for communications, digitally buffered DACs and ADCs for μ P-based systems, and multiplexed sampling ADCs for process control.

Digital-to-analog converters (DACs) can be distinguished by output type. Voltage-output devices produce an analog-voltage output that is proportional to their digital input and scaled by a reference input. Similarly, current-output units produce an analog-current output rather than a voltage.

All monolithic DACs on the market today internally generate currents that are proportional to integer powers of two. These currents, scaled by a reference input, are individually directed into a common signal line by switches controlled by the DAC's digital inputs. Thus the current in the common signal line is an analog representation of the digital data on the inputs.

This current may itself be used as an output from the DAC, or it may be fed into the summing node of an on-chip op-amp to produce a voltage output. Although in most applications the voltage output is easier for the design engineer to deal with, the current-output DAC is generally faster in operation be-

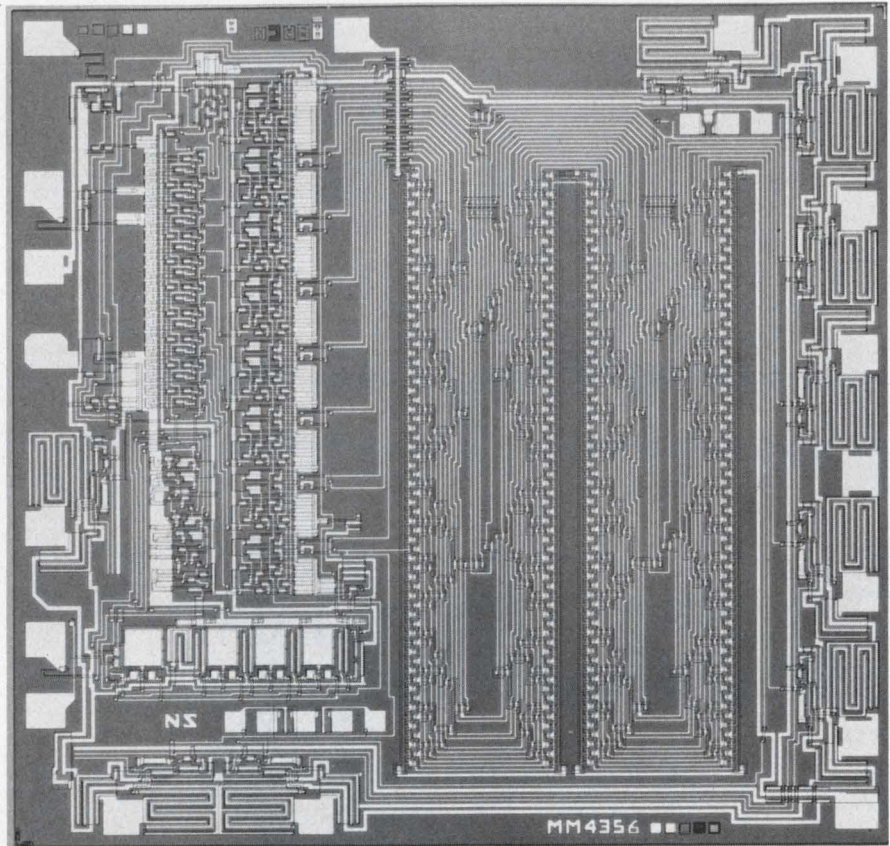

Eight-bit ADC from National Semiconductor uses 256 resistors to successively approximate analog input. It uses the same number of PMOS switches.

cause propagation delays in the output op-amp are eliminated.

Voltage-output DACs

Precision Monolithics, Santa Clara, CA, produces a range of voltage-output DACs. PMI's initial entry into the field was the DAC-01, a 6-bit device with 3μ s settling time and output ranges of 0 to +10 V, ± 5 V, and ± 10 V, driving a 2-k Ω load. The DAC-01 also incorporates an internal reference supply.

The 10-bit DAC-03 and DAC-04

units followed. They offered a choice of straight-binary coding and two's-complement binary coding respectively, and had an improved settling time of 1.5μ s. The DAC-03 offers a choice of output ranges, either 0 to +5 V, or 0 to +10 V; the DAC-04 only offers a range of 0 to +10 V.

The DAC-02 is a bipolar version of the DAC-03, with identical specifications except that an additional sign bit determines the polarity of the output, producing in effect an 11-bit device.

The DAC-02, -03, and -04 have

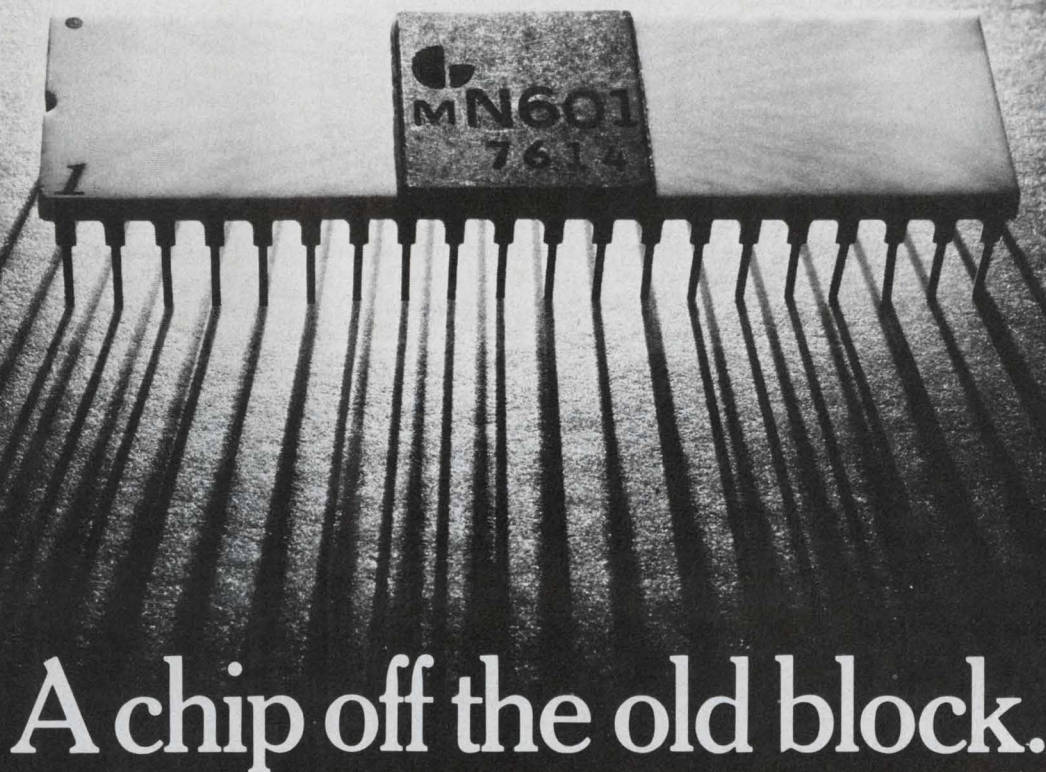

A chip off the old block.

As you can see, this chip is housed in ceramic and mounted in a forty pin, dual in-line package.

As you can't see, it's a NOVA[®] computer.

Inside that packaging sits a full 16-bit, silicon gate, NMOS microNOVA CPU. The mN601.

The mN601 is the first microprocessor designed and manufactured by a minicomputer company. And it's the highest performance NMOS microprocessor on the market. With our 160 nanosecond RAM, it has a memory cycle time of 960 nanoseconds and the fastest instruction times going. Like an Add of 2.4 microseconds. And a Load of 2.9 microseconds.

The mN601 has the 16-bit NOVA instruction set including hardware stack for easy programming. And 16-bit data for efficient memory use.

It also has hardware multiply/divide for fast program execution. Integral data channel logic for easy interfacing to high performance peripherals. Control and timing for high density RAM memories. Integral hidden refresh logic that overlaps instruction execution timing. Plus a unique I/O encoding scheme for efficient easy interface design. Even the real-time clock is included. All of which reduces the chip count.

And all that computer is in a single chip.

And because the mN601 is a NOVA, it uses the most mature, field-proven software you can get with any micro. So you can cut back on development time and cost by using compatible software like our diskette-based Disc Operating System and our Real-Time Operating System.

Also, the mN601 comes with the full documentation support you'd expect from a minicomputer company like Data General.

If you want more than a chip, you can get it. There's a whole chip set, a 4K computer-on-a-board and a fully-packaged 9-slot microNOVA MOS mini. And there's more.

Don't stop here.

Sign up for a technical seminar on the microNOVA. They'll be held in major cities around the country from New York to Los Angeles. They'll last a half-day. And they're free.

For more information call our toll free number, 800-225-9497 (Unless you're in Massachusetts. In which case, call 1-617-485-9100 Ext. 2509.)

microNOVA:

A giant reduction in the NOVA line.

DataGeneral

• Data General, Route 9, Southboro, Mass. 01772 (617) 485-9100. Data General (Canada) Ltd., Ontario. Data General Europe, 15 Rue Le Sueur, Paris 75116, France. Data General Australia, Melbourne (03) 82-1361
NOVA is a registered trademark of Data General Corp.

NEWS

internal references that may be bypassed if system considerations require. Full-mil versions are available for all members of the DAC-01 through -04 series.

PMI also has a 12-bit DAC in development that is to be available around the end of the year.

Current-output DACs

Motorola Semiconductor, Phoenix, AZ, entered the current-output-DAC market with the 6-bit MC1406, a 150 ns device which requires an external reference. The required reference may be varied over a ratio of 64 to 1. The ratio is scaled by the digital input, producing a single-quadrant multiplying function. Typical full-scale output from the MC1406 is 2 mA, with an output voltage compliance of +0.1 V to -0.3 V. The MC1506 is a full-mil version of the MC1406.

The Motorola MC1408, and full-mil MC1508, are 8-bit DACs patterned after the MC1406. At 300 ns the MC1408 is slower, but it has a higher output-voltage compliance of +0.5 V to -0.6 V.

The MC1408 is the first monolithic DAC to be second sourced. The Analog Devices AD559 produced in Norwood, MA, is a direct second source for the MC1408/1508. The PMI SSS1408A/1508A has a slightly superior speed of 250 ns. Signetics and Advanced Micro Devices, both of Sunnyvale, CA, expect to have MC1408 samples at the end of the third quarter this year, and National Semiconductor, Santa Clara, CA, is also developing an MC1408 second source.

Precision Monolithics also makes an 8-bit current-output DAC of its own design, the DAC-08. This 85-ns unit has two complementary outputs that have compliance voltages of +18 V to -10 V. The DAC-08 has a typical full-scale output of 2 mA, and may be used to multiply its external reference. The large output-voltage compliance may be used to advantage when a voltage-output-DAC function is required, by merely driving a resistor with the DAC current output. A full-mil version is available.

Signetics, National, and Advanced Micro Devices each expect to

introduce DAC-08 second-source parts at the end of the third quarter this year. Signetics is also working on a proprietary I²L 8-bit DAC for sampling by 1977.

Motorola expects to have a 20-ns, 8-bit DAC, the MC10318, available for sampling at the end of this summer, according to Steve Faulkner, its product planner for interface circuits. The MC10318 will be an adjunct to the MECL-10K logic series.

Analog Devices of Santa Clara,

The laser severs the aluminum links connecting parallel resistors in the ladder, but does not change the value of any individual diffused resistor. The MC3410 settles in 250 ns, and has a full-scale output of 4 mA, with an output voltage compliance of +0.2 V to -2.5 V.

The Analog Devices AD7520/7530 is supplemented by the 12-bit AD7521. This device, which has the same 10-bit linearity specification as the AD7520, has 12-bit

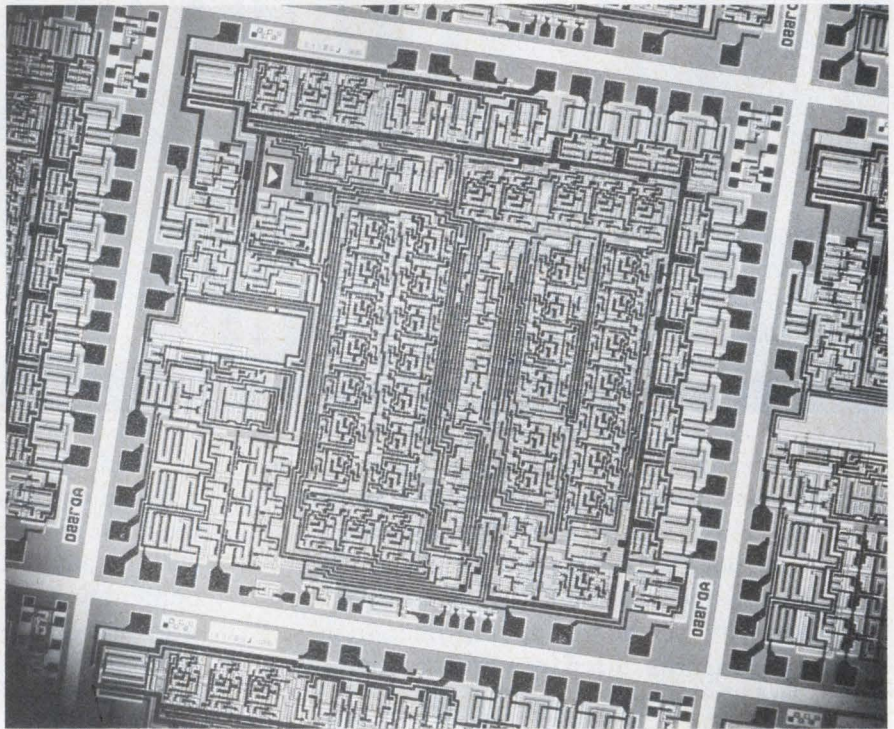

Analog Devices' 13-bit CMOS ADC uses a quad-slope conversion technique.

CA, is using a CMOS process to produce a 10-bit DAC that allows use of a reference of either polarity. The AD7520, and the more loosely specified AD7530, settle in 500 ns and have a full-scale output of ± 2.5 mA. The two converters can thus serve as two-quadrant multiplying DACs, but their output must work into a virtual ground, which generally means that an external op-amp must be used. The AD7520 is available in a full-mil version.

The Motorola MC3410 and the full-mil MC3510 are 10-bit DACs in the MC1406/1408 series. The accuracy increment from the 8-bit MC1408 to the 10-bit MC3410 is achieved by trimming the MC3410's current-ratio resistance ladder with a laser.

resolution, and is available in a full-mil version.

Motorola is working on a 12-bit DAC using thin-film resistors, but the device is about a year away from volume production.

New directions in DAC design

Two new directions are appearing in DAC design. PMI has inaugurated a DAC with nonlinear scaling, aimed at the communications market, and Analog Devices is providing digital input latches on a DAC for easy system interface.

PMI's DAC-76, introduced in the April 26, 1976 issue of ELECTRONIC DESIGN, is a companding 4-bit DAC, followed by a 3-bit digitally-controlled variable-gain amplifier

PRECISION.

The mark of a Pro. Like P&B.
Time delay relays with up to $\pm .05\%$ repeatability.
And delay times to a year or more.

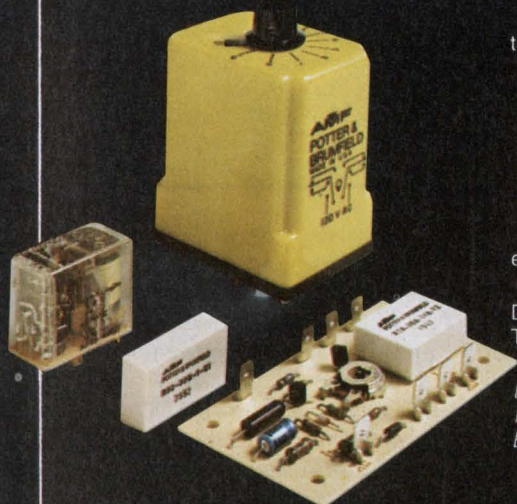
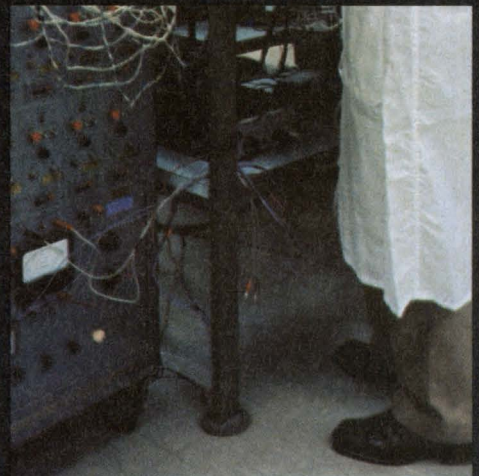
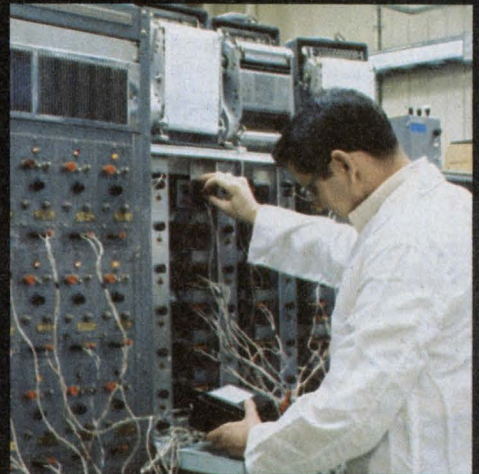

That's the kind of precision you get with Potter & Brumfield **CG Series** relays. And there are many more P&B time delay relays to meet virtually any requirement. Including . . .

R12, R13, R14, R15 Series. Sophisticated circuitry usually found in more expensive relays. Repeatabilities to $\pm 3\%$; time delays to 600 sec.

Low cost R16 Series. Easily mounted p.c. board module. Delay on operate ranges: 0.2 to 2, 2.0 to 30, 5.0 to 100 sec. Potentiometer or resistor adjustable.

R52 modules. Inexpensive way to make all but a few 6, 12 or 24 VDC P&B relays into time delays. Resistor adjustable timing ranges from 0.2 to 100 sec.

Also low profile, solid state hybrid, adjustable and non-adjustable—even dry reed. With every type of termination, too!

Design for precision. Specify P&B. See your P&B sales representative, or P&B Pro Shop Distributor. Or, contact Potter & Brumfield Division AMF Incorporated, Princeton, IN 47671. Telephone: 812-386-1000.

European address: Electrical Products Group, AMF International Limited, AMF House, Whitby Road, Bristol BS4 4AZ, England. Telephone: (0272) 778383, Telex: 449481, AMMAFOCO, BRSTL.

Go with the Pros and you can't go wrong.

AMF
Potter & Brumfield

Auto-zero techniques remove errors

An auto-zero cycle added to an integrating ADC requires added switching to save a value corresponding to errors of the ADC in a second storage element. These errors include offset voltages and currents (in both the ADC's integrator and comparator), propagation delays, scaling errors between positive and negative references, and analog-switch variations in offset and resistance.

Various modifications to the integration approach have been developed to improve accuracy, and to avoid infringing on the basic dual-slope patent held by Weston Instruments of Newark, NJ. Two of these methods are described below.

Quad slope explained

Quad-slope is the auto-calibrating ADC technique developed by Analog Devices. The company predicts a 16-bit theoretical resolution limit for the procedure.

Basically, quad-slope has two cycles of dual-slope integration ramps. The first is used to accumulate system-error information, which is fed back into the second dual-slope measurement cycle by varying the time for which the unknown analog input is integrated.

In the quad-slope calibration cycle, half of the reference voltage is integrated up for a fixed time, t_1 , and then the second half of the reference is integrated down for enough time to reach zero charge.

Two things happen at this time. First, the total time elapsed since the start of the calibration cycle is stored digitally for future use as an error

signal. Second, the measurement cycle begins with the unknown analog input and half of the reference input integrated up, until a fixed time from the start of the calibration cycle.

Next, the remaining half of the reference is again integrated down until the integrator reaches zero charge. A counter registers this last slope's time.

Finally, this last slope's count, minus the digitally-stored error signal from the calibration cycle, is used as a digital output from the converter.

The process of splitting the reference input in half allows input signals of either polarity to be measured. Quad-slope also has the advantage of resetting the ADC before the initial calibration cycle by providing a ramp down towards zero. This guarantees that the zero-sensing comparator always acts on a falling slope, minimizing comparator offset and propagation delay.

Quantized charge balancing

Quantized charge balancing is an auto-zero integrating-ADC technique developed by Siliconix.

In the quantized charge-balancing ADC, an on-chip sample-and-hold circuit, using a standard capacitor-and-op-amp approach, creates a voltage that biases the ADC's integrating op-amp and comparator. The applied bias compensates for offsets and nonmatching of components, and also displaces the measurement system's zero point to half of the externally applied reference input.

The zero-displacement function is performed by clocking the reference into the sample-and-hold, through the integra-

tor, at a 50% duty cycle, with the measured input disconnected. An advantage of the zero displacement is to allow inputs of either voltage polarity to be handled simply by what is otherwise a unipolar ADC.

After the integrator and comparator have been offset by the auto-zero cycle to approximately half the external reference, the external reference and ground may be treated as separate references of opposing polarities. The reference will cause the integrator's output to ramp down. Ground will cause the integrator to ramp up at essentially the same rate.

During the measurement cycle, the analog input is constantly applied to the integrator input. The reference and ground are also connected such that, on average, the unknown input is balanced. When taken over a unit time the algebraic difference of the time the reference is applied to the integrator, and the time the ground is applied to the integrator, is the digital representation of the analog input signal. The subtraction function is performed by an internal up-down counter.

The specific technique used to connect the reference and ground signals to the integrator guarantees their alternation at least once every eight clock pulses.

The alternation allows the comparator to be strobed every eighth clock pulse, always while the integrator is ramping down. The strobing removes hysteresis and propagation-delay. The specific ramp-up/ramp-down duty cycles chosen by Siliconix are 1/8 and 7/8.

that drives an output selected by a sign bit and an encode/decode switch, and defines an 8-segment piecewise-linear approximation of an exponential input-output transfer function.

The function has 16 discrete steps per segment, and is symmetrical about zero. The exact exponential relationship chosen by PMI was specified by the Bell Tele-

phone System for pulse-code-modulation transmission.

The exponential nature of the DAC-76 transfer function allows the small-signal output accuracy of at ± 12 -bit DAC to be coded in a ± 7 -bit format. This is particularly useful for encoding and decoding physical phenomena that have exponential characteristics.

The DAC-76 uses an external

reference input, and thus can be used to multiply an analog input. Its full-scale output current is 4.2 mA, and its output voltage compliance is +18 V to -5 V. The settling time for the DAC-76 is 500 ns, and the device is available over the full-mil range.

Analog Devices is directing its DAC efforts to systems applications. The AD7522 is a 10-bit DAC

New! Bi-polarity Silicon Transient Suppressors!

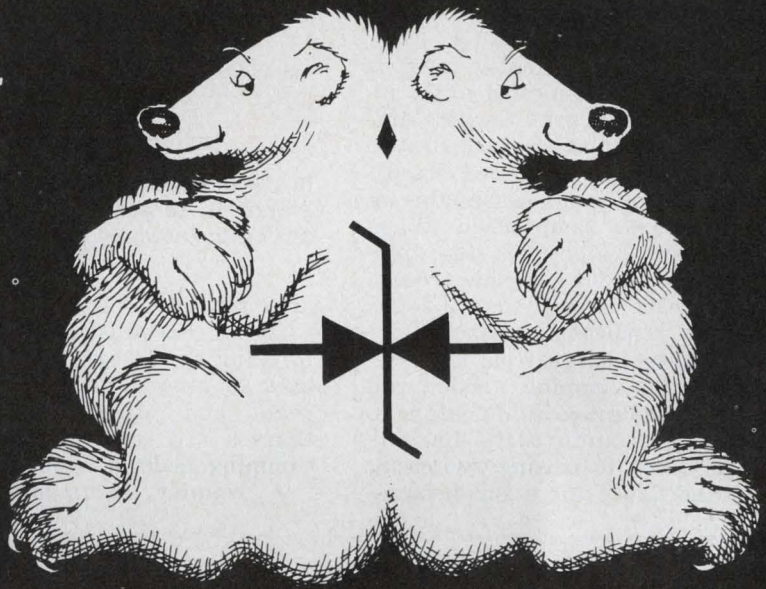
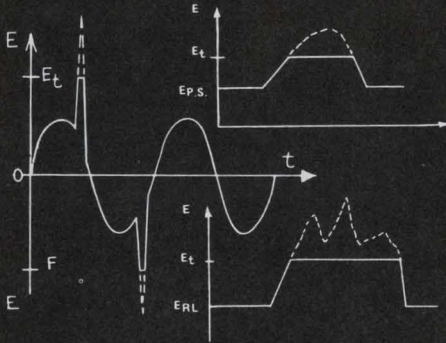

LOWEST DYNAMIC IMPEDANCE!

**Can be supplied as JAN, JANTX or JANTXV
to MIL-S-19500/516 (EL)**

This new series of silicon bi-polarity transient suppressors is unique in that a single device will provide voltage transient protection symmetrically (i.e., provide protection for A.C. signals in addition to D.C.). This new series of devices has peak pulse power ratings of 500 to 1500 watts for 1 millisecond and its response time is effectively instantaneous (less than 1×10^{-12} sec.). Therefore, these versatile devices have many protection applications where large voltage transients can permanently damage voltage-sensitive components. The devices are encased in Semtech's Metoxilite, fused directly to the high temperature metallurgically bonded assembly. For use in commercial, industrial, military and space programs.

500 Watt

Peak Pulse Power

Types: IN6102 through IN6137

Break down Voltage V(BR):

From 6.8 to 200Vdc $\pm 10\%$

Peak Surge Voltage (Vsm): 11.0 to 286.0V

Peak Surge Current (Ism): 45.4 to 1.7A

Temperature Coefficient of (VBR): .05 to .11%/°C

Case Size (Max.): .140" D x .165" L

1500 Watt

Peak Pulse Power

Types: 1N6138 through 1N6173

Breakdown Voltage V(BR):

From 6.8 to 200Vdc $\pm 10\%$

Peak Surge Voltage (Vsm): 11.0 to 286.0V

Peak Surge Current (Ism): 136.4 to 5.2A

Temperature Coefficient of V(BR): .05 to .11%/°C

Case Size (Max.): .180" D x .165" L

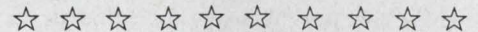

4-LAYER DIODE IN METOXILITE!

Reduce circuit costs and increase reliability!

Semtech's 4 Layer Diode (PNPN) is a silicon switch that is controlled by the amount of voltage applied. The application of this diode to a circuit often reduces the number of associated components which in turn, leads to cost reduction and increased reliability. Now available in Semtech's proven Metoxilite construction as two terminal, fast-switching devices specifically designed for low voltage applications such as logic circuits, pulse generators, memory and relay drivers, relay replacements, alarm circuits, multivibrators, ring counters, and telephone switching circuits.

Types: 1N5779 thru 93, 1N5158 thru 60

Switching Voltage: 10 to 15V

Switching Speeds: t(on) = 75ns, t(off) = 250ns.

Junction Capacitance: 150pF

Case Size (Max.): .070" D x .165" L

1975 NATIONAL SBA SUBCONTRACTOR OF THE YEAR



652 Mitchell Road, Newbury Park, California 91320
(805) 498-2111 • (213) 628-5392 • TWX 910 336 1264

CHICAGO (312) 352 3227 • DALLAS (214) 387 3551

FLORIDA (305) 644 5404 • MARYLAND (301) 424 6663

NEW JERSEY (201) 654 4884 • SAN FRANCISCO (415) 494 0113

EUROPEAN SALES: Bourns AG Zug, Switzerland (042) 232 242

Incremental charge balancing: how it works

Incremental charge balancing is the technique developed by Teledyne Semiconductor for use in its integrating ADCs.

The unknown analog input is continuously connected to the input of an integrator whose output goes into a comparator. (S_2 in the figure is fixed closed.) The analog input causes the integrator to ramp down. When the comparator sees the integrator's output go below ground, it signals on-chip control logic, which removes a measured incremental charge from the integrator's summing node and causes the integrator's output to rise incrementally. This is equivalent to closing switch S_1 in the figure for a small, meas-

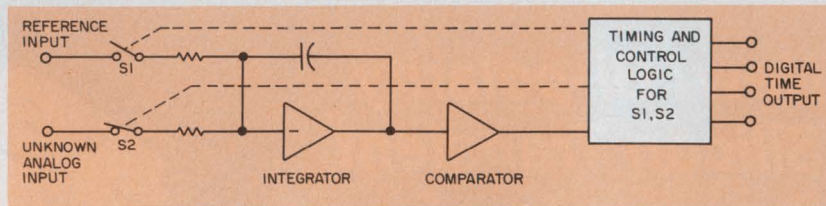

In the integrating ADC, a balance between the analog input and the reference is sensed by the comparator. The time ratio of reference to analog unknown is the digital result.

ured time interval.

If the charge is not sufficient to bring the integrator's output back to ground, the process repeats and other incremental charges are removed from the summing node as required.

A counter accumulates the

number of charge increments required per unit time to balance the analog input on average. The total in the counter at the end of the timed interval is latched as the digital output. The method is implemented in a unipolar fashion.

with two stages of digital latches on each of its 10 input lines. The latches are configured so that one value may be transmitted to the DAC either serially or in parallel while the previous analog value is maintained on the output of the DAC.

Eight-bit microprocessor compatibility was enhanced by breaking up the 10-bit data-input latch into 2-bit and 8-bit latches that may be loaded either by a μP simultaneously, or sequentially from parallel data lines. These latches may also be loaded serially with data clocked in through a serial port, because they are internally configured as a 10-bit shift register.

Once the 10 bits are loaded into the data-input latch, they can be dumped into the second 10-bit register which actually controls the DAC by holding its output fixed, until its contents are replaced by subsequent data.

The DAC used in the AD7522 is essentially the same as the AD7520 but with a minor difference: the end of the resistor ladder is available. Because it does not go to ground internally on the chip, the outputs are allowed to depart from virtual ground if the outputs are kept stable with respect to the reference return.

Like the AD7520, the AD7522 can use either polarity of reference input, and can perform a two-quadrant multiplying function. A full-mil version is available.

Two types of ADCs available

Two types of monolithic analog-to-digital converters (ADCs) are on the market; sequential approximation ADCs, and integrating ADCs.

The monolithic, sequential-approximation ADC uses a DAC, a level comparator and appropriate control circuitry, to make best-choice approximations of the analog input. By using these approximations in a sequence optimized for rapid conversion, conversions are achieved at the rate of one approximation per bit of resolution.

The integrating ADC accumulates charge on a capacitor proportional to the analog input. The charge is removed in metered amounts by the ADC. The resulting zero-charge balance between unknown analog input and digitally-controlled metered charge determines when the digital value is a correct representation of the analog input.

TRW Systems, Redondo Beach, CA, is manufacturing an 8-bit sequential approximation ADC with

a conversion time of 140 ns. It has an input of 0 to -2 V , and emitter-coupled-logic (ECL) outputs. The ADC was initially produced for internal use by TRW Systems, and will be available later this year for small-scale use by Department of Defense contractors.

National Semiconductor's 8-bit ADC, the MM5357, has a conversion time of $40\ \mu\text{s}$ and will drive a standard transistor-transistor-logic-load with its Tri-State outputs. The unit has a unique way of approximating an unknown input. Instead of using the common ladder-network DAC, there are 256 series resistors and an equivalent number of PMOS switches. The device is also available in a full-mil version, the MM4357, and an open-collector output version, the MM-4356.

Precision Monolithics is also expected to have a monolithic, 8-bit, sequential-approximation ADC by the end of the year.

Monolithic ADCs on the way

The Analog Devices AD7570 10-bit sequential-approximation CMOS ADC is not strictly monolithic—it lacks the necessary comparator function on-chip. Even so, the unit points the way for succeeding monolithic ADCs. This converter

Announcing Hewlett-Packard's Real-Time HP-IB Minicomputer.

Your powerful connection to easier automated testing.

The Real-Time HP-IB Minicomputer is the best thing to happen to automated testing since the Hewlett-Packard Interface Bus (HP-IB*), which brought order and simplicity to the world of programmable instruments. Now you can apply the power of an HP 21MX minicomputer to your bus for do-it-yourself automated testing.



With an HP-IB/21MX Minicomputer your multi-programming system can run multiple instrument clusters concurrently. And your system also can be generating new programs in Real-Time BASIC, FORTRAN IV or HP Assembler; organizing and analyzing data; and producing timely management reports. All at the same time.

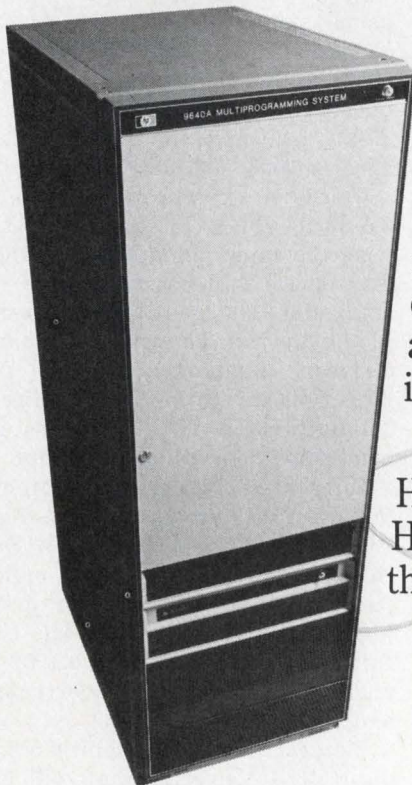
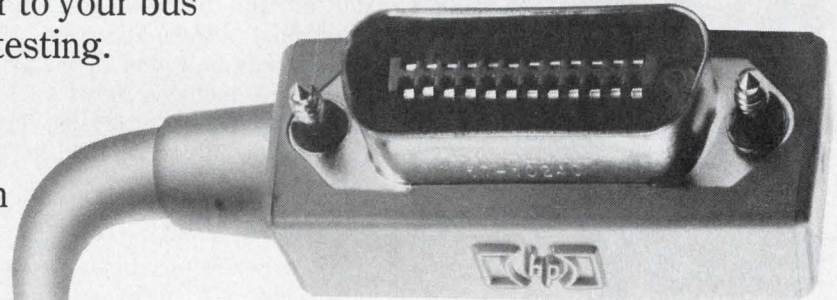

21MX minicomputers can even be easily linked together to form plant-wide networks. And upwards to a central HP 3000 or IBM 360/370.

Real-Time HP-IB Minicomputers. They give you the simplicity of HP-IB interfacing, and the minicomputer power to gain real management control of your automated testing. Prices, with disc and bus interface included, start at about \$33,000 in the U.S.

For more on what Hewlett-Packard's Real-Time HP-IB Minicomputers can do for you, call your nearest HP field sales office. There are 172 of them around the world.

*Hewlett-Packard's implementation of IEEE Standard 488-1975, "Digital Interface for Programmable Instrumentation."

HEWLETT  PACKARD

Sales and Service from 172 offices in 65 countries.
1507 Page Mill Road, Palo Alto, California 94304
CIRCLE NUMBER 24



Blind coaxial mating made easy.

Blind coaxial mating used to pose a real problem. Now, standard connectors in Omni Spectra's OMQ[®] miniature and OSQ[®] subminiature series make it easy. Units in both series allow you to construct a virtually endless variety of multiple coupling configurations.

And electrical performance is outstanding. Pulse rise times of 30 picoseconds are passed without discernible degradation. Typical VSWR is 1.15 at 5 GHz.

OMQ and OSQ series also offer units for optional access to bulkhead connectors via flexible or semi-rigid cable. This includes quick connect/disconnect units that can be used with or without positive locking.

Send for complete catalog.

Omni

Spectra, Inc. OSM DIVISION

21 Continental Boulevard, Merrimack, N.H. 03054
Tel. (603) 424-4111, TWX 710-366-0674

was designed as a conversion subsystem, with 8-bit microprocessors in mind. Two forms of three-state standard TTL or CMOS outputs are available: parallel with low-order 8 bits and high-order 2 bits, independently strobed; and serial, with all 10 bits multiplexed on one line. The DAC used internally is functionally the same as in the AD7520. Conversion time is 20 μ s.

TRW Systems is also producing 10-bit and 12-bit devices in its ECL sequential-approximation ADC line, with conversion times of 200 ns and 500 ns, respectively. Additional information on these devices may be found in the article "Fastest Monolithic 10-bit A/D Device Has 200-ns Conversion Time" (ED No. 5, March 1, 1976, p. 20).

Integrating ADCs

Teledyne Semiconductor, Mountain View, CA, produces an 8-bit integrating ADC. The 8700 uses Teledyne's incremental charge-balancing technique for a conversion that takes 1.8 ms. The 8700's outputs will drive a low-power TTL load, and its analog input is the summing-node of an internal CMOS op-amp requiring 10 μ A for full-scale digital output.

Teledyne produces a 10-bit ADC that also uses the incremental charge-balancing technique, the 8701. It converts in 6 ms, and otherwise has specifications identical to the 8700's.

Micro Power Systems is producing a custom CMOS ADC in Santa Clara, CA. This 10-bit, dual slope unit is unavailable except to its contract customer. It points the way toward system uses of integrating ADCs. Included on the same chip as the 10-bit ADC are an 8-input analog multiplexer and a sample-and-hold circuit.

Micro Power Systems also has plans to become a second source for Analog Devices' CMOS DACs and ADCs once Analog Devices is established in its new CMOS facility in Ireland next year.

RCA, Somerville, NJ, has produced a CMOS 11-bit integrating ADC configured for sign-plus-ten-

bit output. A modified dual-slope conversion technique is used.

The Teledyne 8702, a 12-bit ADC in the 8700 series, uses incremental charge-balancing. Conversion time is 24 ms, with other parameters unchanged. Teledyne will shortly announce additions to the 8700 series that incorporate three-state outputs.

Analog Devices is manufacturing the AD7550, a 13-bit integrating ADC that uses the firm's patented quad-slope conversion technique. The conversion is performed in 40 ms. Its analog-voltage input has a 1 M Ω input impedance, and the three-state digital outputs will drive a standard TTL load. As in the AD7570, the lower-8 output bits may be gated out independently of the upper-5 output bits.

Siliconix, Santa Clara, CA, is producing an ADC with BCD outputs that uses a quantized feedback technique and has an output resolution of ± 3 digits. The CMOS LD130 has multiplexed outputs, each capable of driving a standard TTL load, for use with digital-panel meter displays. Overrange and underrange outputs are available, and the conversion takes place in 100 ms. The input range is ± 999 mV, and the input impedance is 1000 M Ω .

Teledyne expects to produce a 3.5-digit BCD integrating ADC with the same pinouts as its 8702. The device will use the firm's incremental charge-balancing technique, and will be available around midyear. Similarly, Analog Devices will shortly be introducing a 3.5-digit BCD ADC that uses its quad-slope conversion technique.

Integrated Photomatrix, Mountainside, NJ, produces a 3.5-digit BCD integrating ADC. The MC904 converts in 300 ms, and has multiplexed outputs designed to drive MOS loads. The converter has two full-scale input ranges: ± 0.1999 V and ± 1.999 V, and has overrange and underrange outputs.

Motorola is also developing a 3.5-digit BCD converter that will use a modified dual-slope with auto-zero conversion technique. ■■

AMP has high powered solutions to high current problems.

When you specify AMP high current connectors you get the problem-solving support a professional engineer deserves. On the production line, in quality control, in sampling for prototyping and by working with you on future improvements.

Product solutions too—like the Power Lock Connectors which feature hermaphroditic contacts rated at 30A or 75A, and snap together housing designs that reduce inventory and provide unlimited variations. Our economical *rectangular* High Current Commercial Connectors incorporate a positive locking feature. With silo construction housings, they are suitable for both free hanging and panel mounted applications. And are recognized under the U.L. component program for 35A, 125 V circuit breaking.

Widely accepted in many industries, the *Circular Plastic Connector* series features two designs rated up to 35A, and includes the recently introduced, sealed 7-way version for highway equipment.

Need a solution for a p.c. board power problem? The *Hi-current Edge Connector* is an economical one, available in 2 through 12 positions and rated to 30A.

Write today for information on AMP High Current Connectors. Learn why we have an international reputation for innovation. AMP Incorporated, Harrisburg, PA 17105. (717) 564-0100.

CIRCLE NUMBER 26

AMP is a trademark of AMP Incorporated.



AMP
INCORPORATED

Acoustic holography gets sharper pictures of organs in human body

Acoustic holography, a technique for looking at the soft tissues within the human body, is undergoing dramatic improvement in terms of image quality and resolution.

Early systems produced a real-time, motion picture-like image of the tissues, but with poor resolution (several millimeters). Newer techniques produce a high-resolution (1.5 mm or better) single-frame image that allows such things as tendons and blood vessels and tumors to be studied in great detail (see "Acoustic Holography Picks Up Where Medical X-rays Leave Off," *ELECTRONIC DESIGN* No. 15, July 22, 1971, p. 24).

A form of ultrasonic imaging

Acoustic holography is a form of ultrasonic imaging. The subject of interest is submerged in water and ultrasonic energy is bounced off it. Sensors are used at the surface of the water to detect the pressure waves that result. Information from these sensors is used to construct the desired image.

Many different kinds of sensors have been used in the past. Even lasers have been used to bounce light off the ripple pattern at the surface of the water. Unfortunately, the detection sensitivity of the various schemes used so far has been no better than 10^{-4} to 10^{-6} W/cm².

Piezoelectric sensors and a computer have been used by Gordon Stewart and Wayne Fenner of Aerospace Corp., El Segundo, CA, to achieve a detection sensitivity of about 10^{-12} W/cm². In addition, they can use the computer to construct the image at any viewing

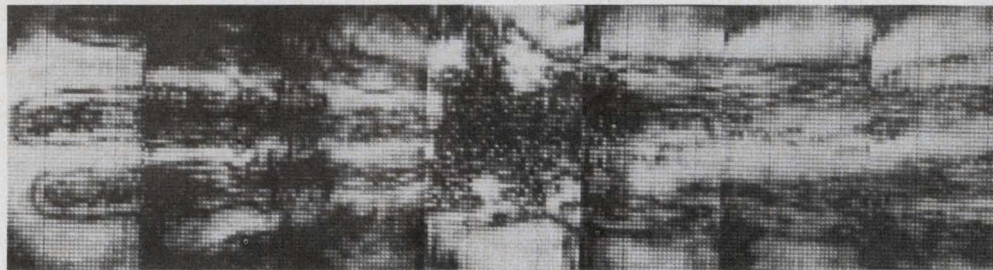

A human hand and forearm are viewed by Aerospace Corp.'s acoustic holography technique. Not only can bones be seen, as in an X-ray, but also soft tissues such as blood vessels and tendons.

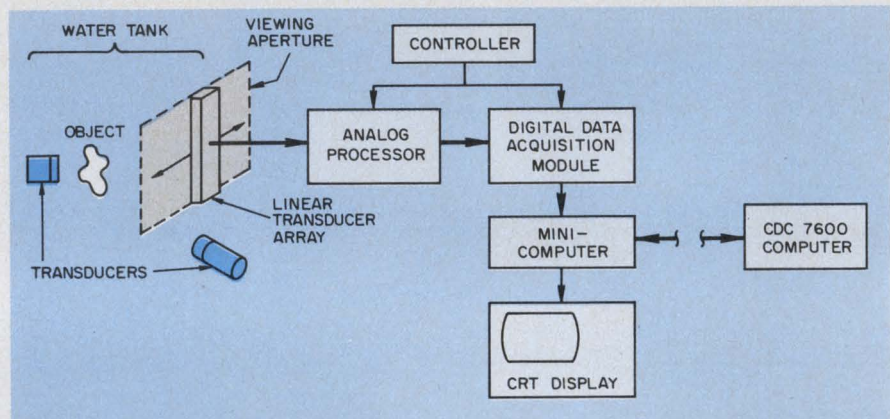

An aperture of 10 cm × 10 cm is mechanically scanned by a 64-transducer array at an ultrasonic frequency of 1 MHz. A digital computer does a Fast-Fourier transform and additional processing to create an image on the CRT.

plane desired.

In the new technique, the object under view is submerged in a tank of water and illuminated by 1-MHz ultrasound from an array of transducers. An array of 64 PZT-5 piezoelectric detectors is mechanically scanned across a viewing aperture at one side of the water tank. The aperture is 10 cm × 10 cm.

The outputs of the sensors are amplified and split, then mixed with the output of quadrature-phase local oscillators. The output

signals from the mixers are integrated and fed through an analog multiplexer to an analog-to-digital converter. The digital output is stored in memory.

An entire frame constitutes 8000 data points. Using a Control Data CDC 7600 computer, the data in memory are Fast-Fourier-transformed. Each point represents a plane wave at the aperture plane. The computer, multiplying by a phase factor, propagates the plane waves backward to the image plane. An inverse Fourier transform is

David N. Kaye
Senior Western Editor

NOW— A FAIL-SAFE SOLID-STATE RELAY

With most solid-state relays, if the triac fails to fire they may just roast to death and become the unfortunate cause of catastrophic system failures.

Not ours.

A unique combination of dv/dt snubber, fusible-link protection, and an oversized triac makes the new optically-coupled Heinemann SSRs fail-safe. Now, the worst thing that can happen to your system is the simple need to replace the relay. That's a lot better than having to reprogram your entire control sequence, isn't it?

We make our new SSRs for either zero-voltage or non-zero-voltage switching, and both types are rated for maximum ac load currents of 5A or 10A. Any control voltage from 3Vdc to 32Vdc; all models compatible with TTL, DTL, and CMOS logic.

And you have a choice of solder-pin, quick-on, and screw terminals.

Talk with Bob Kusek (609-882-4800) or write for further information. Heinemann Electric Company, Brunswick Pike, Trenton, NJ 08602.

HEINEMANN

We keep you out of trouble.

then done to get the pressure distribution at the object plane. This distribution is squared to get the reconstructed image, which is displayed on a CRT monitor.

"If you repeat the process using different phase factors," says Stewart, "you can reconstruct the image at different planes so that variable depth information can be retrieved." In addition, the data can be preprocessed to correct for nonuniformity of the sensors or for any other known errors in the system. Even image enhancement could be done to bring out more detail.

Increasing the resolution

Although the present system has 1.5-mm resolution, increasing the frequency to 2 to 3 MHz will not only improve the resolution by a factor of 2 or 3, Fenner says, but will be ideal for abdominal imaging. Earlier tests indicate that 2 to 3 MHz is the ideal frequency for viewing the details of the abdomen. Fenner notes that the practical upper limit for medical applications is about 5 MHz.

A 256-detector array (instead of the 64-detector array presently used) is also being studied. In addition, a two-axis array with electronic scanning is under consideration to eliminate the stepping motor that mechanically scans the linear array across the viewing aperture.

Fenner also says that, "we're looking at doing broadband imaging. We would like to use a frequency band of about an octave, but the number of discrete frequencies necessary has not yet been determined. The technique would allow us to see the relative absorption characteristics at different frequencies and would remove much of the diffraction and speckle that occurs in imaging." ■■

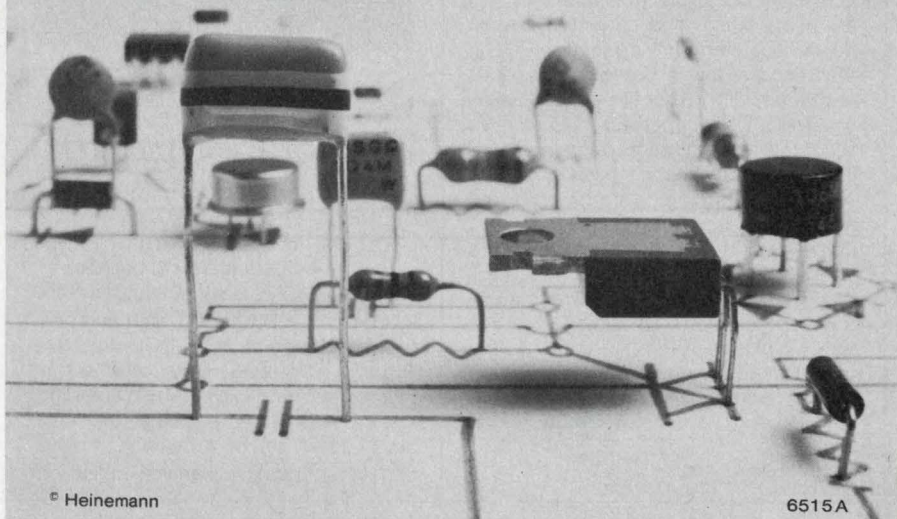
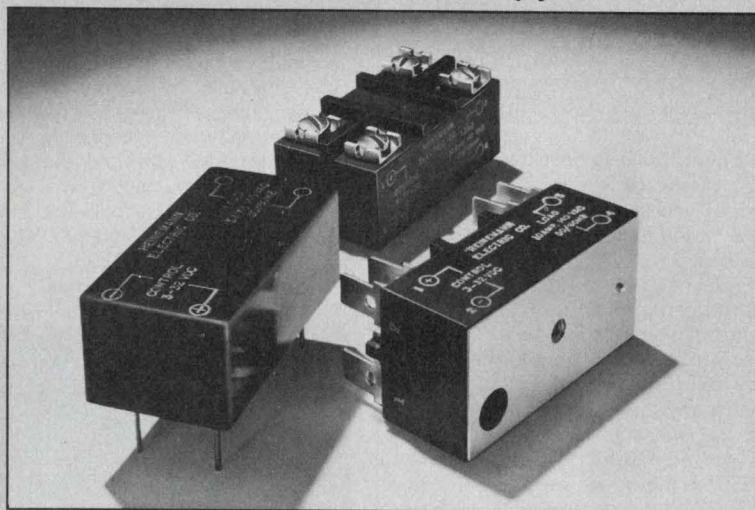

© Heinemann

6515A

MOTOROLA Semi

The 25A TO-220 SCR

Today's Technology.

Today's Performance. Today's Price.

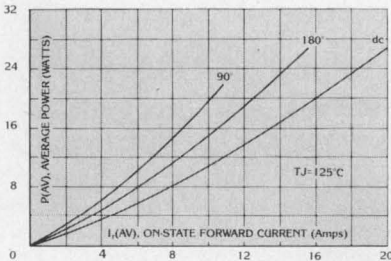
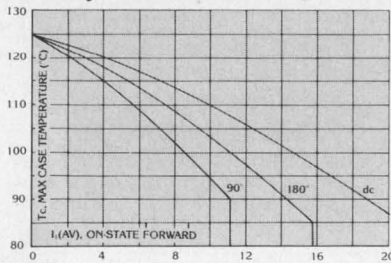

That's right, it's finally been done — a 25A (RMS) plastic SCR with 300 A surge at prices you can't pass up. How about a 30% saving in any quantity over metal equivalents!

The new 2N6504-09 series is a natural-born replacement for those goodie-but-oldie 2N681-series sockets where you're operating up to max limits set by '681 data sheet ratings. That could be most anywhere: motor and heating controls, power supplies, battery chargers, crowbars, ad infinitum.

Unlike the power-wasting '681 stud, the TO-220 has super-low 1.8 V max V_F at 50 A peak. That translates to just 26 W P_D at full-rated current...you can heat sink it to an allowable 85°C case and that means lower thermal excursions and potentially longer life.

Reliability's super, too, because it's rooted in improvements like glassivated junctions, gate-cathode passivation, improved copper piece parts, void-free encapsulant, in-process and outgoing QC and reliability verification (see story in New Literature).

Try the 2N6504 series where up-to-25 A metal parts are now used. See how far plastic SCRs have come to give you what you need in today's optimized designs.

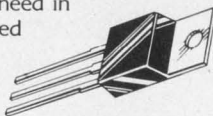

DUOWATTS DRIVE

DOUBLE-FISTED DESIGN ADVANTAGE

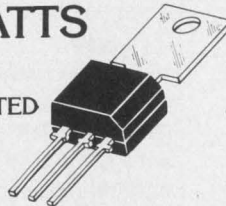

Two-fisted stuff for you! 250 V power tabs for just 60¢!

Duowatts* do the job between TO-92 and TO-220. They're the only devices in their class with an honest-to-gosh, conservatively-rated-in-free-air 2 watts capability. Not 1.67. Not 1.75. TWO watts.

And 250 V fits line-operated drives for dc motor controls, relays and solenoids. HV linear amps and linear and switching amps are possible for less than you pay for an over-spec'd TO-220.

You can push 'em to higher power levels because of second-generation epoxy molding with lower heat resistance, high thermal cycling capability, heavy-duty 2-mil gold wire and the lowest Θ_{JC} in the industry: 62.5°C/W.

Enough technical brilliance. Here's the 100-ups for 150, 200 and 250 V types: 58¢...60¢...63¢. 2N6591-93.

It's the only 2N series around.

*TRADEMARK MOTOROLA INC.

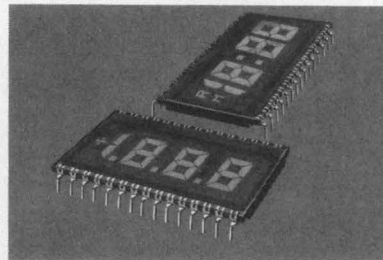

Drop LCDS into Your PC Boards

Off the drawing board and into digital clocks and instruments are LCDS with integral connector pins you plug right into **standard PC boards**.

The MLC201 clock LCD and MLC250 instrument LCD offer 1/2" high numbers. One has a.m./p.m. designation, the other + and - prefixing. Both offer super-reliable hermetic glass frit plate sealing, advanced LCD compounds, sharp character definition, dc **excluding** passivation, (dc in the drive signal, if unblocked,

can cause failure) and 3 V operation.

Or, you can have 0.38" high characters in 3 1/2 digit with the MLC400, a popular "straight-up" for instruments.

Customs, too—plus MLC400T for backlighting with less current drain than LEDs. Good Show, what?

MC3408 —

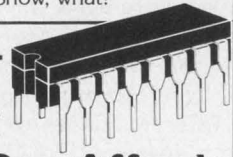

The DAC Anyone Can Afford

For just \$2.95 one of the most accurate DACs in the industry is yours... the MC3408 with relative +0.5% error max and 300 ns typ settling time.

It consists of a ref current amplifier, R-2R ladder and eight high-speed current switches. For many applications only a resistor and reference voltage need be added. It may be used in multiplying mode with good accuracy when V_{ref} is varied over a 256:1 range.

Now you can plug an accurate DAC into those super low-cost applications like successive approximation . . . waveform synthesis . . . programmable gain & attenuation . . . CRT character generation . . . programmable power supplies . . . ad infinitum.

Suffice to say, it's a bargain and a good one. Other features include noninverting TTL/CMOS-compatible digital inputs, +0.4 to -5.0 V swing and 4 mA/ μ s slew rate.

It's a DAC you can afford today.

Small Signal Transistor Costs Take Whopping Cuts

Big news here is **ECONOMY**.

If you don't need metal cans' hermeticity, you can reduce small-signal transistor costs sensationally just by specifying our plastic MPS-types instead of 2N-metal and plastic units...and get the same performance!

For instance, the metal 2N929/A family is industry listed all over the map...some high as \$1.35. Our plastic

conductor Report

MPS929 is 26¢, 100-up. Same specs, mind you, just plastic packaging.

Or take our MPS2222. For only 20¢. Average 2N2222 list runs 35-40¢. Or the 27¢ Motorola MPS2907A vs. the 40¢ metal type.

We even replace low-cost plastic with still lower-cost plastic: the popular MPS-3903-06 PNP/NPN switch/amplifiers can be had for lists of 18¢-23¢... far less than the average 30¢-35¢ price for plastic 2N's. The only spec difference is relaxed switching speeds.

Contact factory or distributor.

ALL PRICES 100-999.

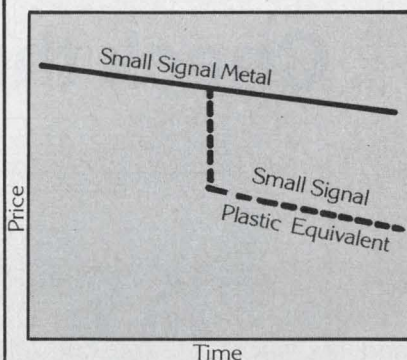

New Literature Dept.

**CHIPS
DATA
BOOK
TELLS
ALL
TO
HYBRID DESIGNER**

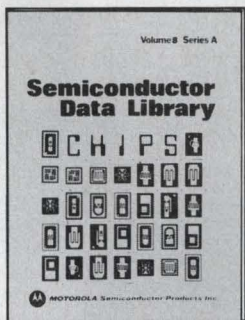

Available Mid-August

Look! — hundreds of see-all, tell-all pages on Motorola's complete line of chips... unencapsulated semiconductor to the word-conscious.

All here — no parts left out. Linear, digital, discrete, beam-lead, flip-chip defined according to stock, standard and special.

See geometries laid bare. Metallizations described. Dimensions listed. Electrical and handling info for more than 2,000 of Motorola's popular devices on all lines examined. "Must" reading for the mature hybrid designer.

Also included are passive component passages and an appendix bursting with definitions and other do it yourself criteria.

Order this sensational exposé through authorized distributor or factory bookstore. Even the pictures look good.

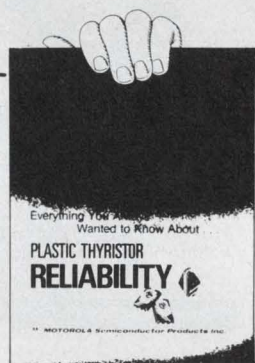

Plastic Thyristor RELIABILITY FIRST-TIME DOCUMENTED

In the dumps about power control climate?

Read how to beat it—or at least ignore it—with reliable Motorola plastic thyristors who, despite all odds, rise above every obstacle to a better, long-lasting life.

They can take almost anything you can throw at them.

Like worst-case, full-on, full-off power cycling with junction temps reaching the breaking point. Our units survived 43 MILLION cycles at ΔT_j of 30° to 125°C with just 15 failures. An MTTF of 3 million cycles.

Or full-reverse rated voltage at 90° to 100° ambient, gate open or 1 k Ω R_{GK} shunt. Our units combined 459,000 hours with just one failure.

Or 200 days at Mil-S-750 conditions — 92% to 98% relative humidity (practically underwater) with units alternately drenched, then dried, during 24-hour cycles. Again, just one failure.

Raise your SCR and Triac standard of living. Start with this new brochure. The best always beats being better.



Semiconductor Report Card

For complete data, fill out and send this to:
Motorola Semiconductors
Box 20912, Phoenix, AZ 85036

Please have salesman call

Phone: _____

Name _____

Company _____

Title _____

Address _____

City _____

State _____ Zip _____

Check Your Choice:

- 2N6504 series SCR
- MC3408 DAC
- MLC201/250 LCD
- 2N6591-93 Duowatt
- 2N3903-06 Transistors
- Chips Data Book

(Send check or money order for \$2.50 to Motorola, Attn: W.W. Wallace, Box 20912)

Thyristor Reliability brochure

- AN756 — Crystal Switching Methods for MC12060/MC12061 Oscillators
- AN757 — A/D Conversion Techniques With M6800 MPU
- AN758 — A 2-State 1 KW Solid-State Linear Amplifier
- AN759 — A CMOS Keyboard Data Entry System For Bus-Oriented Memories
- AN760 — Applications of MC3416 Crosspoint Switch
- AN762 — 1.6-30 MHz Linear Amplifier For Mobile Operation
- AN763 — Fully Programmable dc Modulator
- EB62 — Plastic Encapsulated Transistor Reliability

Who's the performance winner in 16k and 32k memory systems?

Check the specs.

Fabri-Tek has packed more speed and total performance into single-board 16K and 32K memory systems than anybody else in the business. Compare our 696 and 698 systems against the competition, and you'll see what we mean. We'll not only beat them in specifications — we're the only company that offers you total upward compatibility to 32K. At competitive prices, too. It's what you'd expect from a company with years of leadership in the memory business. Go with the winner — call us today for the best in both off-the-shelf and custom memory systems.

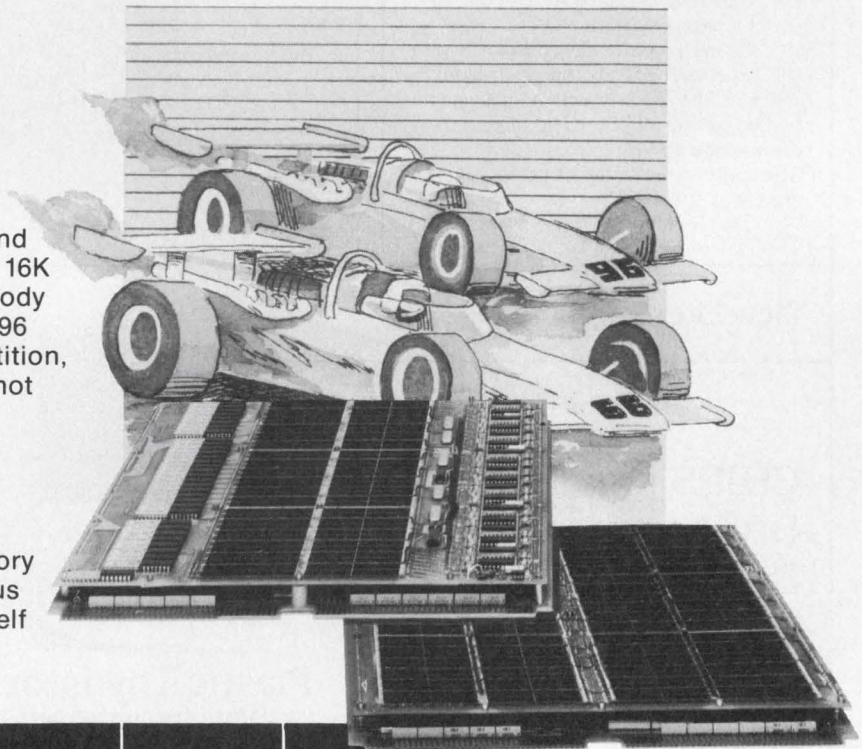

	FABRI-TEK		EMM		DATA PRODUCTS		DATARAM	
	696	698	Micro 3000 D.D.	Micro 3000 Q.D.	Store 1680		DR-103	DR-103
MODEL	696	698	Micro 3000 D.D.	Micro 3000 Q.D.	Store 1680		DR-103	DR-103
MEMORY SIZE	16K	32K	16K	32K	16K	32K	16K	32K
CYCLE TIME	650	650	650	850	650		650	750
ACCESS TIME	250	250	270	300	280		265	300
PHYSICAL SIZE	11.75x15.4 x1.0	11.75x15.4 x1.0	11.75x15.4 x1.0	11.75x15.4 x1.0	11.75x15.4 x1.0		11.5x13.7 x1.0	11.5x13.7 x1.0
COMPATIBILITY 16K TO 32K	YES		NO		NO		NO	



FABRI-TEK INC.
COMPUTER SYSTEMS

5901 South County Road 18 • Minneapolis, MN 55436 • (612) 935-8811

SALES OFFICES:

Boston
(617) 969-5077
Tom Fitzgerald

Chicago
(312) 437-4116
Bruce Richardson

Dallas
(214) 661-3155
Al Yarnell

Hawthorne, Calif.
(213) 973-0484
Wally Harrison
Don deVries

San Jose, Calif.
(408) 246-8391
John French

Minneapolis
(612) 935-8811
Jack Graham

CIRCLE NUMBER 29

FORGET EVERYTHING YOU EVER KNEW ABOUT IMAGE PROCESSING AND DISPLAY

"You want to process electronic information.
You need an image display.
You're thinking of using digital scan converters,
direct view storage displays,
or computer memories . . ."

"Don't."

A revolutionary new instrument will help you solve virtually all of the problems associated with processing electronic information for image displays. From ultrasound scanners. Computers. Nuclear gamma cameras. Telephone lines. X-ray sources. Or outer space.

After eight years. Making thousands of earlier versions of this new instrument. For hundreds of different applications. Princeton Electronic Products introduces the **PEP 500 Lithocon® Solid State Image Memory**.

Pull it out of the carton. Plug it in. Knock it around. Heat it. This is a field-tested workhorse. Not a laboratory device.

It's the first beam-addressed, solid-state image memory and scan converter that has been designed for industrial and commercial use. In the field. Under extreme operating environments. In tropical heat. In sub-zero temperatures. Anywhere. Everywhere. A new dimension in electronic imaging. It's a revolution.

For about \$4,000. Call: 201-297-4448. Write:

 **PRINCETON ELECTRONIC PRODUCTS, Inc.**
Box 101, North Brunswick, New Jersey 08902

CIRCLE NUMBER 30

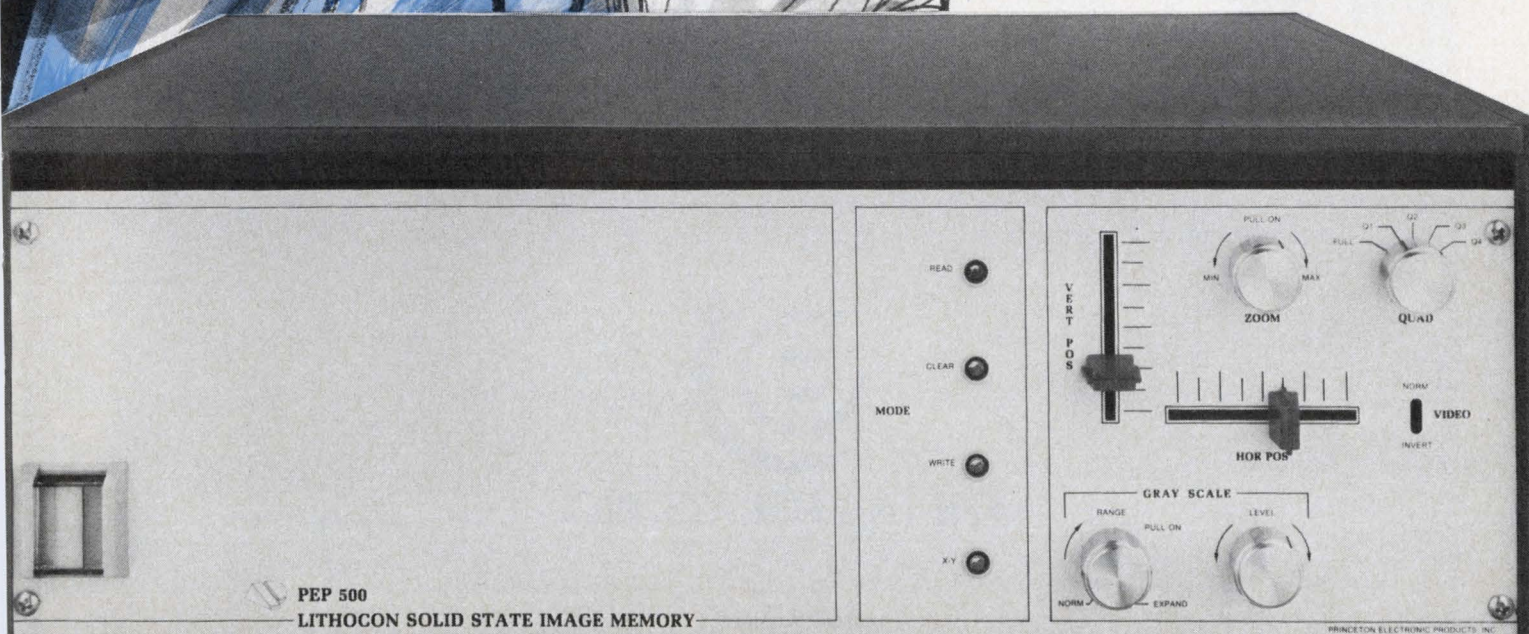

PEP 500
LITHOCON SOLID STATE IMAGE MEMORY

THE ONLY 10 AMP ZERO-CROSSING SOLID-STATE RELAY

**THAT
SELLS
FOR
UNDER
\$5.00***

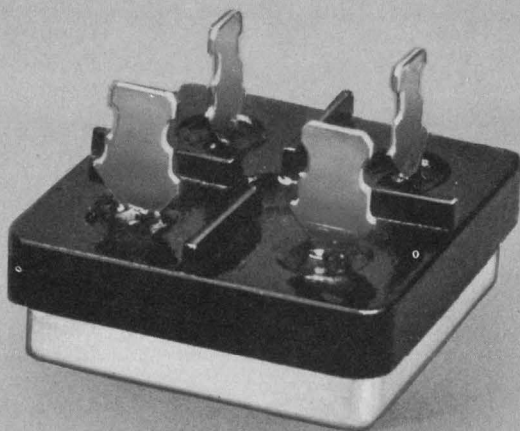

**AND
OCCUPIES
LESS THAN
A CUBIC
INCH**

THE REVOLUTIONARY THETA-J J-PAK™ SERIES†

Catalog Number	Control Voltage	Output Voltage
MA-1210Z MA-2410Z	4 - 8 4 - 8	90 - 140 180 - 280
MB-1210Z MB-2410Z	9 - 15 9 - 15	90 - 140 180 - 280
MC-1210Z MC-2410Z	16 - 32 16 - 32	90 - 140 180 - 280
MD-1210Z MD-2410Z	120 120	90 - 140 180 - 280

- Less than 10% Off-State Leakage Current of other makes
- TTL Compatible - less than 5 mA Control Current
- Mounting on Standard TO-3 hole centers
- CMOS Option Available to operate on less than 1 milliamp

†Patent Pending
*5,000 lot price (non zero-crossing types about 10% less)

For immediate delivery call, write or TWX:
2 Linden Street • Reading, MA 01867 • (617) 942-0390 • TWX 710 393-6560 (LITTLECO)



THETA-J RELAYS, INC.

Dialight sees a need:

(Need: A switch for all reasons.)

Reason 1: Dialight offers three switch configurations to meet all your needs—*snap-action switches with silver contacts* for moderate-level applications, *snap-action switches with gold contacts* for intermediate-level applications, and *wiping-action switches with gold contacts* for low-level applications. Each of these ranges is served by two switching actions—momentary (life: 600,000 operations) and alternate (life: 250,000 operations).

Reason 2: Dialight's snap-action and wiping-action switches come in a new modular design concept . . . a common switch body for either high or low current operation. All 554 series switches and matching indicators have the same rear-panel projection dimensions.

The snap-action switching mechanism guarantees a fast closing and opening rate. This insures that contact force and contact resistance

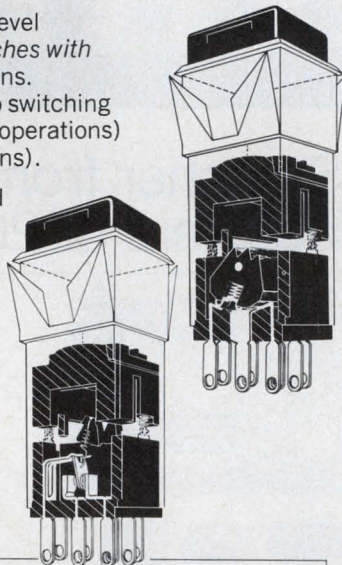
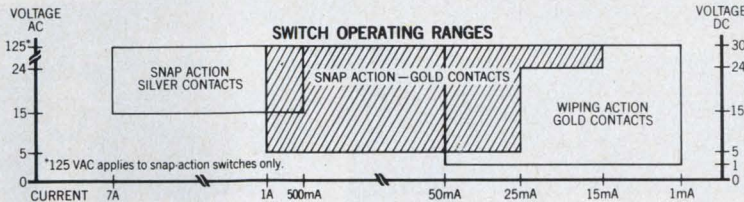

types. There are over 240 switch variations to choose from.

The 554 illuminated switch, designed for front of panel lamp replacement, gives you a choice of five different bezel sizes . . . 3/4" x 1", 5/8" x 3/4", 3/4" square, 5/8" square, and 1/2" square. The first four sizes are also available with barriers. You also get a choice of six cap colors . . . white, blue, amber, red, green, and light yellow . . . four different underlying filter colors . . . red, green, amber, and blue and a variety of engraved or hot-stamped legends . . . over 300 cap styles . . . over 100,000 combinations.

There is also a variety of terminal connections . . . solder blade, quick connect, and for PC board insertions.

Reason 4: Dialight's 554 series is designed as a low cost switch with computer-grade quality.

Reason 3: Dialight offers a wide variety of panel and snap-in bezel mounting switches with momentary and alternate action configurations in SPDT and DPDT

PRODUCT SELECTOR GUIDE						
SWITCHING ACTIONS	Snap-Silver contacts		Snap-Gold contacts		Wiping-Gold contacts	
	SPDT	DPDT	SPDT	DPDT	SPDT	DPDT
MOMENTARY	○	○	○	○	○	○
ALTERNATE	○	○	○	○	○	○
OPTIONS						
	PUSH BUTTON CAP SIZES					
	1/2" Sq.	5/8" Sq.	5/8" x 3/4"	3/4" Sq.	3/4" x 1"	
BEZEL MOUNTING TO ACCOMMODATE	○	○	○	○	○	
BEZEL MOUNTING WITH BARRIERS TO ACCOMMODATE		○	○	○	○	
PANEL MOUNTING TO ACCOMMODATE	○	○	○	○	○	
MATCHING INDICATORS	○	○	○	○	○	

are independent of the switch's actuation speed.

In the wiping-action switch, the contacts are under constant pressure (A unique Dialight design). This insures long life with a minimum build-up of contact resistance.

Both switch types are tease-proof.

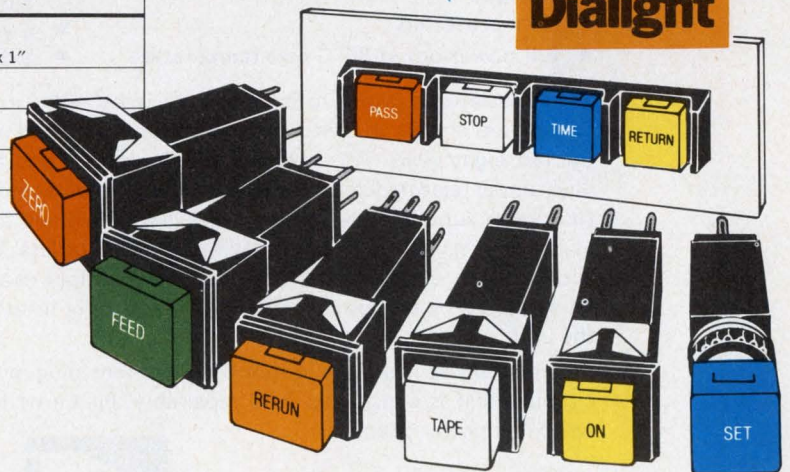

DIALIGHT

A North American Philips Company
203 Harrison Place, Brooklyn, N.Y. 11237
(212) 497-7600

5V @ 25 AMPS

only 1.68" high

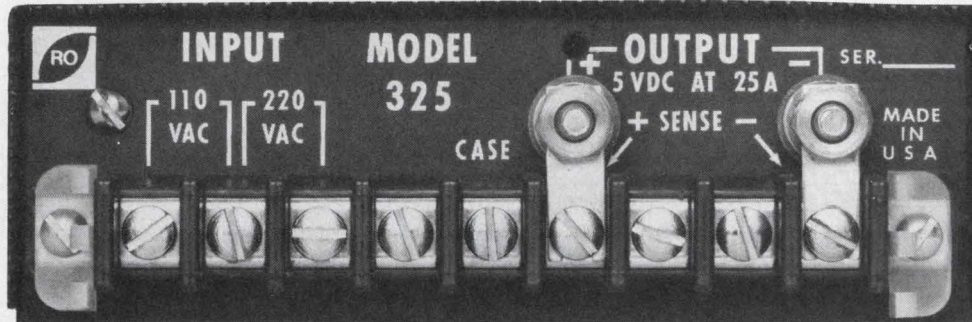

ACTUAL SIZE

The Newest Switcher from the Oldest Manufacturers of 20Khz

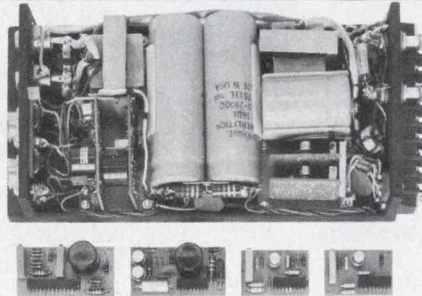

FEATURES

- 70% minimum efficiency
- low profile 1.7 inches
- 1.3W per cubic inch
- 115/230 VAC input without any strapping changes
- fully protected
- full power out at 80°C case temperature
- brownout protection to below 95 or 190 VAC in
- self-recovering overvoltage protection which does not turn off TTL loads
- paralleable by simply strapping the outputs together
- 5 year warranty
- \$299 in 100 piece quantity

RO Associates is proud to introduce its latest entry in the 20 kHz high efficiency switchers. We are the leaders in switching power supplies based on the number of units shipped within the last eight years. All units are fully burned in and thermally cycled over a period of four days under elevated temperatures which eliminates infant mortality failures. Like all other RO power supplies, a heatsink surface is supplied and the full output can be obtained as long as the case temperature is maintained at 80°C or less. The low profile of less than 1.7 inches allows use in spaces where no other power supply can be placed. All magnetics are vacuum impregnated or encapsulated in epoxy, and only teflon wire and sleeving is used throughout the unit.

This new series is unique in that there are four plug-in boards which contain all the low level circuitry and is considered field repairable. Please write for a complete catalog of all of our switching power supplies.



RO ASSOCIATES, Incorporated/3705 Haven Ave./Menlo Park, California 94025/[415] 322-5321/TWX 910-378-5929

CIRCLE NUMBER 33

Join with us in marking Ray Simpson's 70th Year as pioneer and leader in electrical and electronic instrumentation.



RAY SIMPSON
ORIGINATOR OF THE
WORLD-FAMOUS 260®

Ray Simpson Invites You to
**NAME THESE
TWO NEW
Simpson® DIGITALS**
and Suggest New Or Unusual
Applications for Them



**The
360-2
Digital
VOM**



**The 464
Digital Multimeter**

4 Ways to Win A Famous

Pulsar®

For Best Names and Applications



And 4 Runner-up
Prizes
for best
applications

EASY TO ENTER! EASY TO WIN! No purchase necessary.

**SEE YOUR LOCAL ELECTRONICS DISTRIBUTOR
FOR OFFICIAL ENTRY BLANKS!**

While you're there, see these new Simpson digitals. Ask for a demonstration.

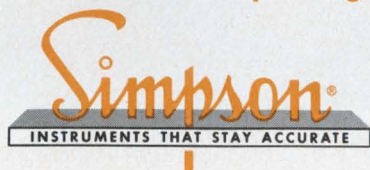

SIMPSON ELECTRIC COMPANY

853 Dundee Ave., Elgin, IL 60120 U.S.A.

(312) 697-2260 • Telex: 74-2416 • Cable SIMELCO

KATY INDUSTRIES



INDUSTRIAL
EQUIPMENT
GROUP

TERADYNE'S J401: THE FULL CAPABILITY IC TEST SYSTEM EVERY ENGINEER CAN USE.

Until now, the complexities of test programming have kept all but a few specialists from using IC test systems. Everyone else had to queue up at the programmer's desk or do without the kind of information that was really needed.

Now there's a J401. A fully programmable test system for T²L ICs with up to 24 pins, complete with built-in CRT, printer, and mag tape unit, that any engineer can learn to use in minutes.

For IC producers this means immediate access to vital process control information. For IC users it means the data necessary to choose components and vendors intelligently. And the ability to extract from field returns the information needed to improve product quality and yield.

The performance and flexibility of a large, computer-operated test system.

The J401 delivers the flexibility ordinarily associated only with larger, more expensive systems. It can datalog any forced or measured function and it can generate an x-y plot of any two parameters. The system also operates as a high throughput go/no-go tester for the production line or incoming inspection.

Product data fast. Higher product yield.

For the semiconductor manufacturer, the easy-to-use J401 allows errors to be spotted before they can begin to multiply. QC engineers can use it to evaluate devices, determine test margins, and check device lots.

The electronic equipment manufacturer will find the J401 useful in monitoring vendor-to-vendor and lot-to-lot variations.

It enables him to spot device characteristics that could be contributing to problems. And QC personnel can use the system to analyze failures and reduce service costs.

A system for meeting the real objectives of incoming inspection.

The J401 gives you fast go/no-go testing with an important difference. It gives control over the *way* devices are tested. By pushing a few keys you can change test conditions, bin out top-quality ICs, or have datalogging to support returns. All in seconds. This is incoming inspection as it should be.

It's a Teradyne.

Each J401 is built for hard use on the factory floor. Each is supported by Teradyne's ten-year circuit module warranty, a 24-hour telephone troubleshooting service, and a worldwide field service backed up by local parts stocking centers.

For complete information on the J401, write:
Teradyne, 183 Essex Street,
Boston, Massachusetts. In Europe:
Teradyne, Ltd., Clive House,
Weybridge, Surrey, England.

WE SELL PRODUCTIVITY.

TERADYNE



CHICAGO (312) 298-8610/DALLAS (214) 231-5384/NEW ENGLAND (617) 458-1256/NEW YORK (201) 334-9770
SUNNYVALE (408) 732-8770/LONDON (0932) 51431/PARIS 073 16 98/ROME 59 47 62/MUNICH (089) 33 50 61/TOKYO (03) 406-4021

CIRCLE NUMBER 35

Let's talk about YOUR ENGINEERING DOLLAR and HP Logic State Analyzers.

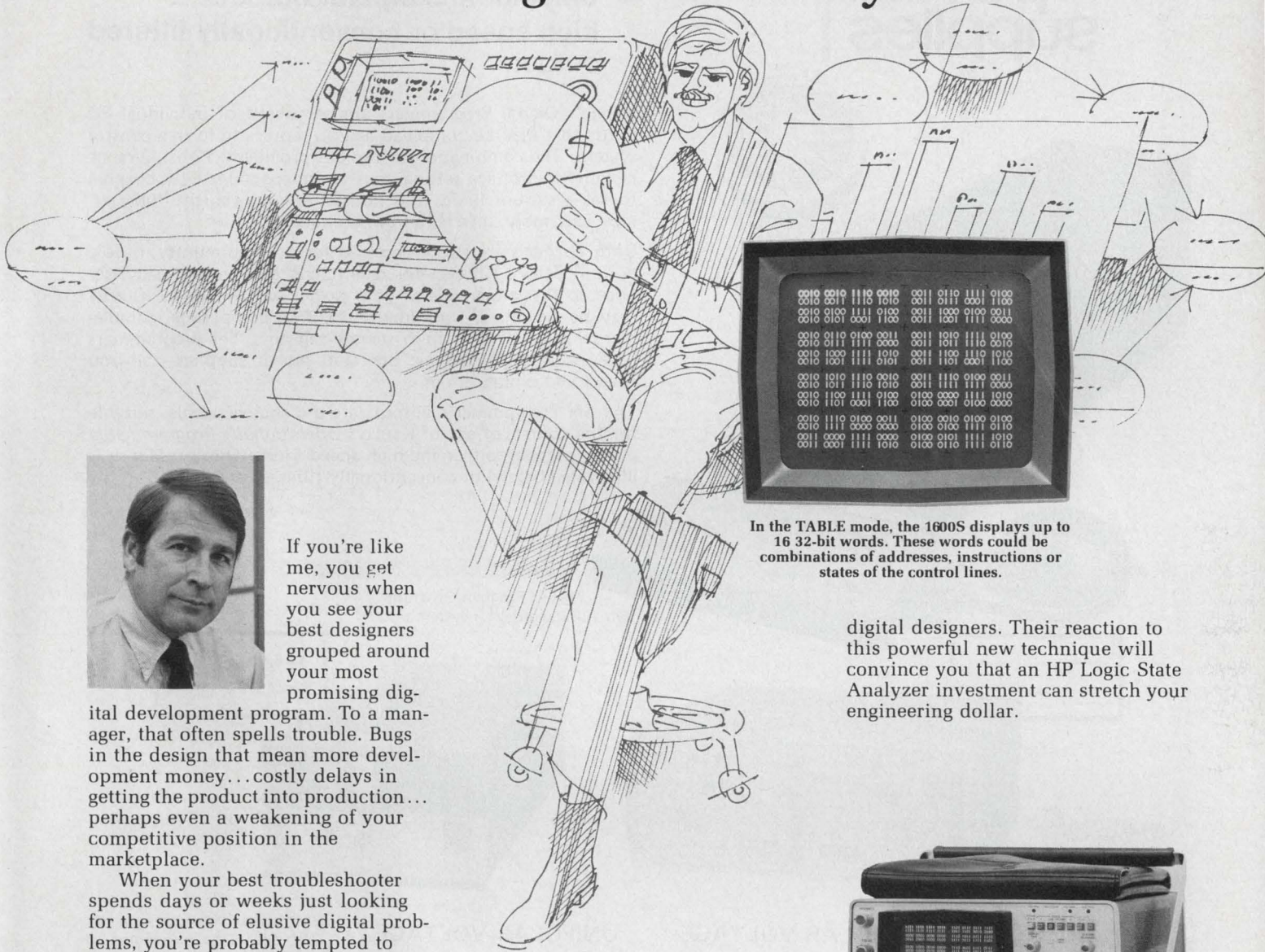

If you're like me, you get nervous when you see your best designers grouped around your most promising digi-

tal development program. To a manager, that often spells trouble. Bugs in the design that mean more development money... costly delays in getting the product into production... perhaps even a weakening of your competitive position in the marketplace.

When your best troubleshooter spends days or weeks just looking for the source of elusive digital problems, you're probably tempted to jump right in and start troubleshooting yourself.

Actually, there's a better solution. And it beats waiting, twiddling your thumbs, and hassling your designers. Give them the equipment they need to find the problem source quickly. I mean HP Logic State Analyzers—the latest and most effective tool I know of for digital design and troubleshooting.

They give your designers an operational view of program flow. Thirty-two channels let them see combinations of address, data and control, capturing 16 successive clock periods at one time. And for intermittent problems they can store and look back in time (negative time) to see what took place before a problem occurred. That's the kind of capability you probably wished your test

equipment had when you were tackling similar types of digital problems.

Time and again, our customers have told us that HP Logic State Analyzers have saved hours, days, and even months of difficult digital troubleshooting.

Save yourself some anxious hours and unpleasant budget sessions. Find out how HP Logic State Analyzers can help your designers pinpoint problems quickly and help get your designs into production on time.

Send for our new 8-page brochure on Logic State Analyzers, and for information on data-domain application notes. Contact your local HP field engineer too, and ask him about HP's Logic State Analyzer application seminars. Then send your top

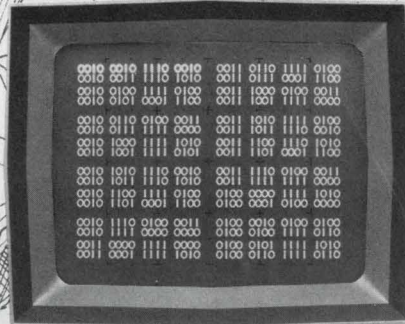

In the TABLE mode, the 1600S displays up to 16 32-bit words. These words could be combinations of addresses, instructions or states of the control lines.

digital designers. Their reaction to this powerful new technique will convince you that an HP Logic State Analyzer investment can stretch your engineering dollar.



086/10

HEWLETT  PACKARD

Sales and service from 172 offices in 65 countries.
1507 Page Mill Road, Palo Alto, California 94304

CIRCLE NUMBER 36

KEPCO

digital power supplies

your
choice
of:

- resolution: 2 or 3- digit BCD; 8-, 10- or 12-bit binary.
- grounding: fully isolated optically.
- volts and amperes: to 1000V, to 90A.
- unipolar and bipolar outputs.
- high speed or conventionally filtered output.

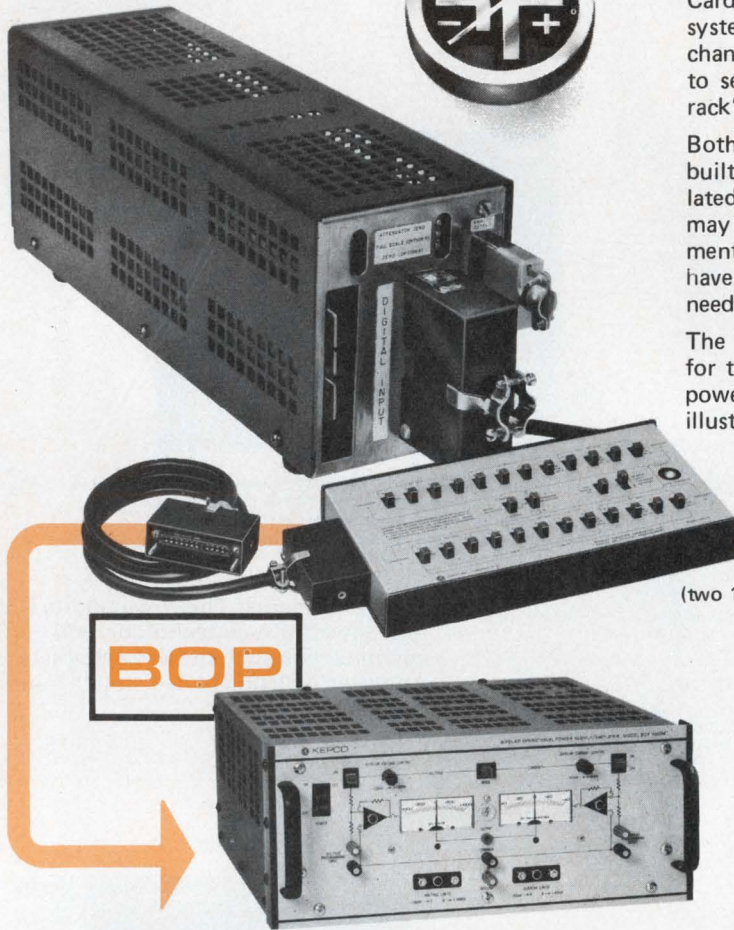

Manual Program Generator
(two 12-bit words) for system test.

BOP

OPS

Response character of the BOP 1000M, programmed from -250V to +250V, showing strobe and delay.

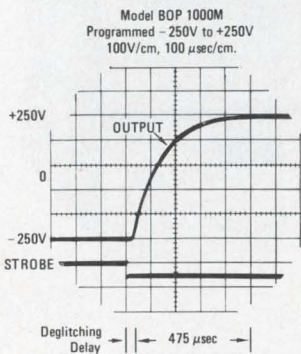

BIPOLAR VOLTAGE

The SN Programmer mates perfectly with one of the new Kepeco high voltage, bipolar units, Model BOP 1000M with an SN-12R (12-bit) Card controlling voltage, and an SN-8R (8-bit) card controlling current. Your *Bipolar* output is:

RANGE	RESOLUTION
-1000V to +1000V	244 mV
-100V to +100V	24.4 mV
-40 mA to +40 mA	0.16 mA

For complete specifications and applications notes on our full line of voltage and current regulators and digital programming interfaces, write Department FJ-05

UNIPOLAR VOLTAGE

The SN Programmer also mates beautifully with Kepeco's many high speed unipolar power supplies, for example, a Model OPS 55-5M. With the SN-12R Card for voltage control and the SN-8R Card for current control, you get a *Unipolar* output of:

RANGE	RESOLUTION
0-55V	13.2 mV
0-5.5V	1.3 mV
0-5 A	20 mA

KEPCO®

Response character of the OPS 55-5M, programmed from 40V down to 5V, showing strobe and delay.

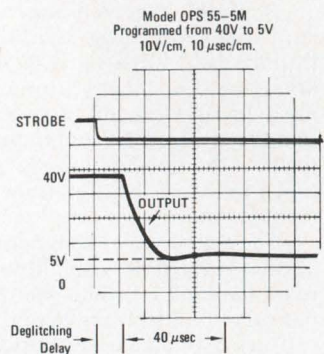

KEPCO, INC. • 131-38 SANFORD AVENUE • FLUSHING, N.Y. 11352 U.S.A.
(212) 461-7000 • TWX #710-582-2631 • Cable: KEPCOPOWER NEWYORK

CIRCLE NUMBER 37

Washington Report

ERDA looking at industrial application of solar energy

The Energy Research and Development Administration is attempting to aid industry by coming up with solar heating systems that require water temperatures of 350 F or less. Heating water to these temperatures is within the capability of present solar techniques, ERDA says, and would satisfy 16% of the nation's total energy needs.

Battelle Institute and Inter Technology Corp. are seeking to identify the processes that could most efficiently use solar energy. Honeywell, working with Battelle, is designing solar-powered systems to be used with the selected processes.

Out of 43 proposals submitted, ERDA selected four for detailed design and analysis. When that phase is completed, in about nine months, two or more will be selected for construction and operational testing. The four companies that shared some \$730 million in funding, and their applications, are AAI, Baltimore, curing concrete blocks; Acurex, Mountain View, CA, washing cans in a canning factory, GE, Valley Forge, PA, textile dyeing; and Jacobs Engineering, Pasadena, CA, commercial laundries.

NSF predicts drop in science, engineering PhDs

A continued decline in advanced science and engineering degrees is projected by the National Science Foundation. The physical and mathematical sciences and engineering will be hardest hit when doctoral degrees in 1985 drop to 60% of the 1974 level. Total doctoral awards that year are expected to be 17,000, about the same as at present, but the difference will be made up by degrees in the social sciences.

This shift to the social sciences will be even more pronounced in four-year degrees. They are expected to increase from 280,000 in 1972 to 340,000 in 1985, chiefly because of increases anticipated in the social sciences, according to the NSF.

Enrollment for advanced degrees in science and engineering, which reached a peak of 250,000 in 1970, is projected to remain stable until the late 1970s, when the decline is expected. Science and engineering enrollment in 1985 is projected to be 13% below the level of 1972.

ARPA chief warns of 'technological surprise'

The United States should prepare itself for "technological surprises" from an energetic and well-financed Soviet effort in R&D, according to Dr. George Heilmeyer, director of the Pentagon's Advanced Research Projects Agency. Heilmeyer detailed his warning in recent discussions he has held with industrial leaders throughout the United States.

Areas in which the Soviets are outspending the United States, according to the research chief, include high-pressure physics, ocean-wave theory, MHD power production, inductive storage and switching systems for pulsed-power control and satellite-borne radar.

Areas in which he thinks the United States should take the initiative include high-energy chemical lasers for space-based operation; monolithic infrared ICs to perform sensing and signal-processing functions on a single chip, for passive air defense and multipurpose warning; adaptive optics that can compensate for atmospheric turbulence in real time; artificial intelligence, coupled with LSI circuitry, for "ultra-smart" weapons; and what he called "a technology that can make the sea amenable to the same kind of signal-processing sophistication that made ballistic-missile-launch detection, trajectory prediction and target discrimination possible."

The agency is asking Congress for \$246.4 million in the next fiscal year, up from this year's \$214 million, and is projecting a request of \$285.3 million for fiscal 1978.

Navy seeking new memory to fill airborne gap

The Naval Air Systems Command plans a new development program in fiscal year 1977 to design an airborne memory to fill the gap between slow, high-density, low-cost bulk storage memories and those that fall in the random-access class.

The new structure, called a Crosstie memory, is fabricated from a thin (300 to 400 Å) permalloy film. The array permits random data access at rates of more than 20 bits per second. This is in contrast to the faster (between 2 and 5 ms) bubble memories, which are serially-accessed. For the Crosstie array bit packing densities of 1-million bits per sq. in. are attainable.

Capital Capsules: The Electronic Industries Association is **working on a revised standard for vehicular antennas used in land-mobile communications in the 132 to 1000 MHz range**, and expects the effort to reach the standard-proposal stage this year. The revision is to include development of both a "transfer standard" antenna and antenna-mounting hardware. The association has completed a standard, RS-329-A, for land-mobile antennas operating at 25 MHz to 1 GHz to cover the newly opened 900-MHz spectrum. The new standard will be a revision to RS-329-1. . . . The Air Force's Space and Missile Systems Organization is **looking for a new surface-acoustic-wave oscillator with at least an order of magnitude improvement over current quartz oscillators, which have a vibrational sensitivity of 1 part in 10⁹ per gram**. Suggested approaches include delay-line and resonator elements. Application is for the Navstar Global Positioning Satellite. . . . NASA's Space Technology Laboratories **successfully demonstrated sending medical data (including electrocardiograms) from a moving ambulance to a hospital via satellite**. The ambulance was near the STL at Bay St. Louis, MS, and communications were received as far away as New Mexico over the GOES-3 satellite. . . . **The Air Force will hold a classified briefing on its Advanced Ballistic Reentry System (ABRES) July 14 and 15 at the Air Force Academy, Colorado Springs, CO**. The briefing will cover the next 10 years of ICBM requirements. ARBES is considered a prime candidate to be the warhead on the proposed M-X missile system.

Designing switching regulators?



Here comes help

NEW FERRITE COMPONENTS are designed, specified and tested for storage inductor applications in switching regulators. They're easier to use, smaller, more economical and will improve your regulator performance significantly.

NEW DESIGN DATA makes it easy to use the full range of SWITCHING REGULATOR-RATED™ ferrites. Nomographs relate guaranteed energy storage, temperature rise and inductance for each component to help you select the smallest inductor that meets your design requirements.

DESIGN ASSISTANCE is available to help you apply this new ferrite technology to your products. Please call Application Engineering — (201) 826-5100 or write Indiana General, Keasbey, New Jersey 08832.

EMM indiana general
a division of Electronic Memories & Magnetics Corp.
Keasbey, N.J. 08832 • (201) 826-5100

Inherently rugged, these triple-diffused devices permit circuit operation directly from rectified 117V or 220V line — eliminating transformers. Ideally suited for inverters, converters, switching regulators, motor controls and wherever there's hi-rel applications. The exploded view demonstrates our single chip design and packaging

concept which makes high-voltage, high-current transistors off-the-shelf availability possible. Pre-rating and pre-testing techniques of chip allows choice of solid copper packages. For further information

TYPE #	(pk.) I _C	V _{CE}	h _{FE} @ I _C	Switching Speed (Typ.)
PT-3512	70A	325	10 @ 30A	t _r = .5 μs
PT-3513	70A	400	10 @ 30A	t _s = 1.2 μs
PT-3522	90A	325	10 @ 50A	t _r = .5 μs
PT-3523	90A	400	10 @ 50A	
350 Watt Power Rating		Guaranteed SOAR		

and application assistance, call Sales Engineering, PowerTech, Inc., 9 Baker Court, Clifton, N.J. 07011. (201) 478-6205.

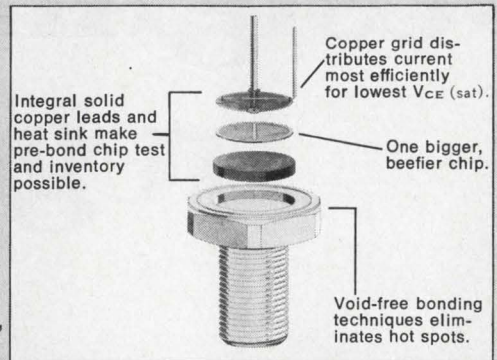

PowerTech, Inc.

"BIG IDEAS IN
BIG POWER"

400V90 AMP



NPN Silicon
Power Transistor
Switch — Highest KVA
at lower cost,
weight & space.

Microprocessor Design

Carefully select analog interfaces to reduce expensive external circuitry

Roger Van Aken, marketing manager of Analog Devices Microsystems, Norwood, MA, presents his views here for ELECTRONIC DESIGN readers.

Microprocessor-based systems very often must interface to the analog world. Analog input variables must be manipulated digitally, and the result of such manipulation might in turn be converted back to analog to drive a recording device.

Converters, both analog to digital (a/d) and digital to analog (d/a), must be specified carefully to minimize external circuitry and interface problems between analog and digital circuits.

To connect efficiently with microprocessor-based systems, converters should include these features:

- Compatible parallel outputs. Since most microprocessors have data-word lengths of 8 or 16 bits, converters must handle digital

(continued on page 56)

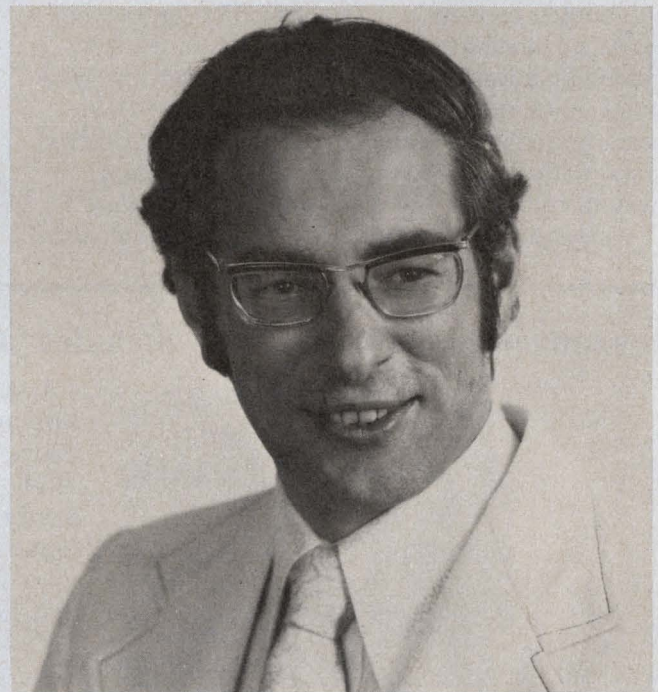

Microcomputer system includes hardware debugging program



The Model 4060 computer system—complete with debugging program—is now available in either a half or full-sized Cambion bin with swingout front panel. Based on the 4040 μ P, the computer comes with 1 kilobyte of RAM and 1 kilobyte of PROM.

Included in the system is the CPU board with a fully decoded I/O structure that is TTL compatible. The system also has an RS-232 interface, a 20-mA current-loop TTY interface and a front-panel driver board.

The 4060, made by International Microsystems (122 Hutton St., Gaithersburg, MD 20760. 301-840-1078)

comes ready to use and has a heavy-duty power supply, prewired backplane and front panel, terminal I/O connectors and an extender card.

A hardware-debugging software package is included in a preprogrammed PROM, as is the system-monitor program. The base system costs \$1195 and delivery is in 15 days.

CIRCLE NO. 389

MICROPROCESSOR DESIGN

(continued from page 55)

busses in 8-bit bytes. For example, a 13-bit a/d should output the least significant 8 bits and then the most significant 5 bits.

- Three-state drivers. Because several a/d converters will be used in a typical system all the converter digital outputs should be tied in parallel. Enable only one output at a time, and keep the unused devices in a high-impedance state; that is only possible when three-state drivers are used as digital outputs.

- Double latches. Use an a/d converter having two digital latches, one latch to capture data from the digital bus, and a separate latch to drive the analog conversion circuitry. The converter holds an analog output while simultaneously reading another word from the digital bus. The word read into the digital bus latch is then transferred to the analog output at any desired time without requiring the microprocessor system to update the converter at that time.

- System-compatible clock speeds. When the

a/d converter serially transfers data to a μ P system, the converter clock should be synchronized to the digital system's clock.

There is no need to generate a reference voltage inside an a/d converter. Very often, a bridge input circuit generates the analog signal and uses a reference that is also fed to the converter. Thus, the digital output is simply a ratio between the analog signal and its reference, rather than an absolute representation of the analog value. An internal reference would not only increase the complexity and cost of the converter, it would impose additional stability requirements on the reference used in the bridge.

A/d converters are not required to generate a two's complement or other sign-indicating digital code, because that can be done more cheaply and easily within the microprocessor, saving on analog system adjustments and complexity.

There is also no requirement for standardization of supply voltages, which is a secondary consideration for companies using analog interfaces.

Inexpensive microcomputer includes all panel controls

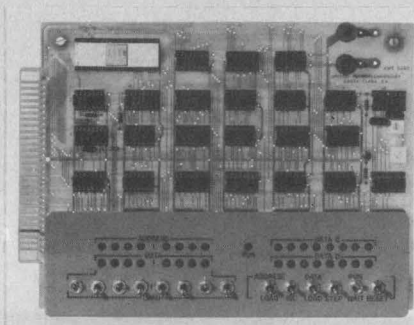

Looking for a low-cost μ P-based microcomputer? Applied Microtechnology (100 N. Winchester, Santa Clara, CA 95050. 408-244-8695) has developed the AMT 2650—a self-contained microcomputer based on the Signetics 2650 μ P. The system includes a panel that contains data/address displays, data-port LEDs and control switches. The panel is mounted on the circuit card that holds the μ C.

The AMT 2650 computer contains 256 bytes of RAM but additional RAM, ROM and PROM—up to 32-k bytes—can be directly interfaced via a 62-pin card-edge connector.

The card measures 7 × 10 in. and has rubber feet so that it can be used on top of a bench. A 5-V, 2-A dc power supply can support the system. Two 8-bit output ports that are fully buffered are also available on the card, as is an adjustable clock.

Price of the AMT 2650 is \$195 completely assembled and tested. An optional 5-V, 3-A power supply is available for an additional \$39.95. Delivery is within 30 days.

CIRCLE NO. 390

Development system works with 4 and 8-bit units

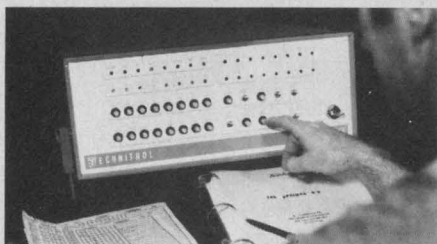

Both 4 and 8-bit microprocessors now have a software-supported system for learning and development. The system, called the μ Primer 4/8, serves as a learning aid to help master microprocessors and basic programming.

Included in the μ Primer 4/8 is a μ P-based processor, memory circuits for program and data storage and front panel controls. Indicators address and display the memory contents, and the condition of the CPU and all necessary

power supplies. The system permits: (1) direct entry of memory address and instructions in machine language; (2) display of memory address and data by front-panel LEDs; (3)

(continued on page 58)

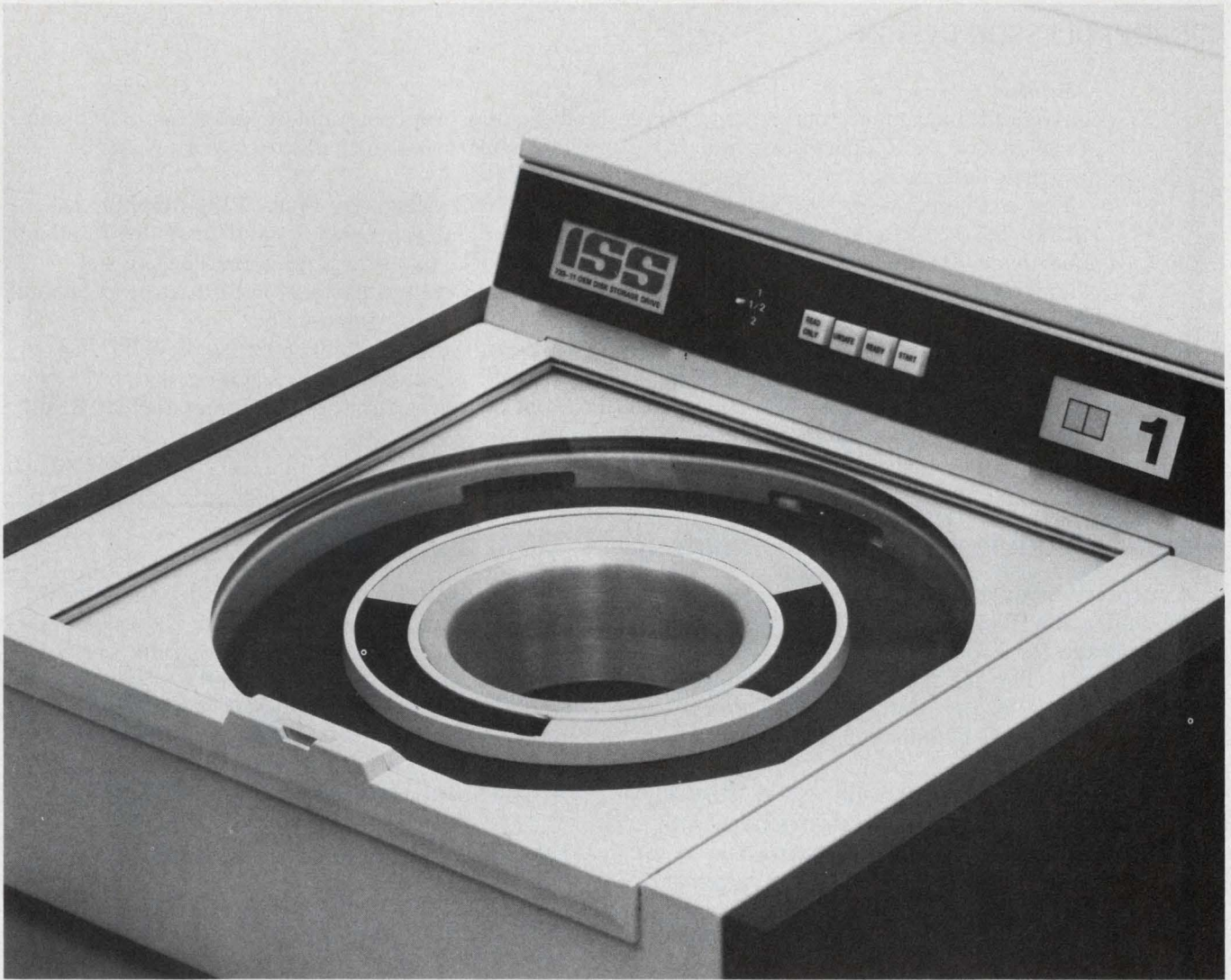

They're here. The industry's most advanced 100/200 megabyte OEM disk drives.

The new ISS 733-10/11 disk drives are the most advanced random access storage devices ever designed for the OEM market. With features that benefit you *and* your customers.

For example, exceptional speed in head positioning and start/stop times. Compactness. Quietness. Easy waist-high pack loading.

The big news, however, is their field-upgrade capabilities. The 100-megabyte 733-10 can be easily field-upgraded to 200 megabytes. Or you can have 200 megabytes immediately with ISS 733-11. And both can be ordered with, or field-upgraded to, dual port.

Advanced interface design

Our interface permits functional compatibility between ISS 733-10/11 and most current 40, 80, 100, 150, 200, and 300-megabyte drives. This means minimal controller modifications, if any.

Performance features

Integral power supply. Tolerates wide power variations, reduces susceptibility to cycle sags and brown-outs.

Module select plug. Permits flexibility in disk address assignments in multi-drive systems.

Data separation and write data

precompensation. All data encoding/decoding is performed in the drive.

Absolute cylinder addressing. Disk addressing done in the drive, not the controller. Simplifies programming.

Industry standard media. 3336 and 3336-11 or equivalent disk packs.

Programmable sector mark. Allows user to select sector size to fit his application.

Important options

Dual port. ISS 733-10/11 can be upgraded from single to dual port in the field. Or dual port can be installed prior to delivery.

Sector counter. Signals the system which data sector is approaching the read/write heads.

Rotational position sensing. Signals the system when the desired sector is approaching the read/write heads. Increases system throughput.

Address mark format. Permits variable record lengths.

Daisy chaining. Greatly reduces cabling.

Round-the-clock ISS support

ISS maintains a complete support facility. Not just spares, but also technical assistance is available round-the-clock. Just call.

We'll be glad to send more information about the ISS 733-10/11. Write or call ISS Marketing, 10435 N. Tantau Ave., Cupertino, CA 95014, (408) 257-6220. ISS is an operating unit of Sperry Univac.



ISS

Technological leadership
for the generations ahead.

Sperry Univac is a division of Sperry Rand Corporation

CIRCLE NUMBER 40

MICROPROCESSOR DESIGN

(continued from page 56)

convenient increment, decrement, forced-loading, and program memory address; (4) display of results of CPU operation; and (5) single-step operation to facilitate learning and program debugging.

The μ Primer 4/8, available from Technitrol (1952 Allegheny Ave., Philadelphia, PA 19134. 215-426-9125), works with most 4 and 8-bit microprocessors and provides hands-on experience. It can execute all instructions in the CPU manufacturer's instruction set. These instructions include arithmetic operations, logic manipulations, accumulator rotations, register-to-register transfers, conditional and unconditional jumps, etc.

Available options include conversion kits to permit use of 4040, 8080, and 6800 microprocessors; hexadecimal keyboard and display, expanded program memory to 1 kilobyte and additional TTL-compatible I/O ports. Prices for the μ Primer start at \$1400 and delivery time is 3 weeks.

CIRCLE NO. 391

Memory module for Exorciser holds RAM, ROM and PROM

A memory module that includes an erasable ROM and a RAM expands the range of design aids available for the development of M6800-based systems. The MEX68RR plugs directly into the card slot of any Motorola (P.O. Box 20912, Phoenix, AZ 85036. 602-244-6900) Exorciser.

Various combinations of RAM, ROM, PROM or EROM can be arranged in the twenty 24-pin DIP sockets on the MEX68RR board. The maximum capacity of the board is 512 bytes of RAM and 16-k bytes of ROM or PROM. Four sockets on the board are reserved for MCM6810 RAMs (128 \times 8) and the remaining sockets can hold MCM68708 alterable ROMs or other ROMs with 512 \times 8 or 1024 \times 8 organizations.

The RAMs are connected to the address bus

in such a way that they will occupy the lowest 512 bytes of address space in the Exorciser. The ROM section is divided into four arrays, and each array can be assigned to various locations within the user portion of the address space by base-memory address switches. Also, each ROM socket is connected to a read/disable switch. In the read mode each socket is allocated 1-k byte of address space; when the control line is disabled, the memory space can be used by other devices.

The MEX68RR has an operating temperature range of 0 to 70 C and a power requirement of ± 5 , ± 12 V dc at 1 A, maximum, for each. The module costs \$395 (less memory circuits) and is available from stock.

CIRCLE NO. 392

\$99 kit forms control system based on SC/MP

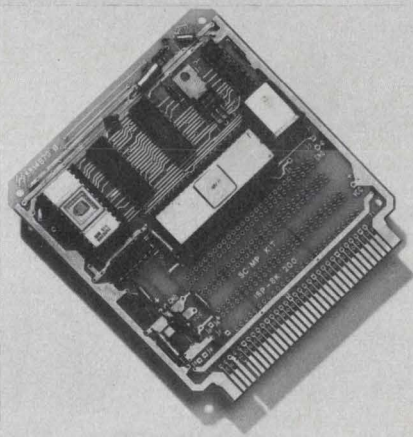

All the components needed to build a simple control system based on SC/MP—National Semiconductor's latest 8-bit single-chip CPU—are contained in the ISP-8K/200 kit. The kit's PC board provides all component interconnections, thereby simplifying assembly and reducing the possibility of assembly errors. Offered by National Semiconductor (2900 Semiconductor Dr., Santa Clara, CA 95051. 408-732-5000), the new kit costs only \$99.

The kit interfaces directly to a teletypewriter. A PROM containing the Kitbug monitor allows programs written on a TTY to be entered into the kit's memory. Kitbug then lets a designer execute the program and examine the contents of memory and the SC/MP registers to monitor performance.

Besides SC/MP and monitor PROM, the ISP-8K/200 contains a voltage regulator, 256 bytes of RAM, 8-bit data buffer and a 1-MHz timing crystal. Available board space can be used to mount additional components. The board has a standard 72-pin edge connector.

Delivery is from stock.

CIRCLE NO. 393

eliminate assembly problems & save 60¢ per connector*



*labor savings
attained with the Molex
Dualcon™ crimp/snap-in
28 position connector

The facts ... A study conducted at a major west coast peripheral manufacturer clearly shows the labor and cost savings between the Molex 4338 crimp/snap-in connector versus a solder eyelet P.C. Connector. The evaluation was made on a fully loaded 28 position dual connector.

OPERATION	SOLDERING METHOD	MOLEX 4338 CRIMP/STYLE
STRIP INSULATION	5:37	5:37
SHRINK TUBING ON WIRE	4:40	N/A
SELECT TERMINAL AND ATTACH WIRE	10:17	N/A
SOLDER WIRE TO TERMINAL	3:44	N/A
POSITION SHRINK TUBING	1:53	N/A
HEAT SHRINK TUBING ON FIRST SIDE	1:00	N/A
HEAT SHRINK TUBING ON SECOND SIDE	0:16	N/A
CRIMP WIRE TO TERMINAL*	N/A	2:12
SELECTIVELY LOAD TERMINAL	N/A	7:27
TOTAL OPERATION TIME	27:27	15:16
Using a \$3.00 per hour labor rate ... it costs \$1.38 per connector using the soldering method, versus 78¢ per connector, using the Molex crimp/style snap-in. A savings of 60¢ per connector ... or a 44% SAVINGS.		

*Based on 1200 crimps per hour

The designer and manufacturing engineers answer to eliminating assembly operations, saving time and lowering cost ... **The Molex Dualcon.**

The 4338 Series Dualcon is a new .156 crimp/snap-in dual readout edge connector for .062 P.C. cards. The snap-in type contact allows greater production flexibility and at the same time reduced labor/assembly man-hours **because you use only the contacts you need.**

Literature and Information — How much can you save on your present or future application? Ask your Molex Sales Engineer. For more information on the 4338 call or write MOLEX INCORPORATED, 2222 Wellington Court, Lisle, IL 60532. (Phone: 312/969-4550)

Options: The 5 Amp rated terminals are available with pre-tin gold over nickel, or selective gold plating and will accommodate 18–24, and 24–30 AWG. Solder loop and split eyelet type terminals are available. Inter-contact and on-contact polarizing keys are optional.

The connector housing is available with or without mounting flanges in 6, 8, 10, 12, 15, 18, 22, 24, 25, and 28 dual row positions.

Application tooling is available for hand termination, semi-automatic bench machines (available on lease or purchase terms) and fully automatic units for extremely high speed production.

molex ... Affordable Technology

CIRCLE NUMBER 41

**Micro-
processing
becomes
a buyer's
market.**

If you're a MOS microprocessor customer, the last few years haven't been a whole lot of laughs.

One supplier had all the good stuff, made all the rules, told you what you could buy. And when. And for how much.

But something happened to change all that: Advanced Micro Devices.

We make the best microprocessor in the world, the Am9080A, and we make all the support circuits you need. They're yours now, off the shelf, at competitive prices. That's right. Competitive.

But we make more than microprocessor products. We make you a promise:

We'll sell you any part, in any quantity, bundled or unbundled. You're the customer.

So, if you suddenly find yourself having an easier time buying microprocessors, just remember why. And who.

If you're shy, and you're just not sure how to say thank you, an order would be really nice.

Write or phone Advanced Micro Devices, The Buyer's Market.

Ours and Theirs.

(The 9080A)

Specification	AMD	Intel
Minimum Instruction Cycle Time	1 microsecond	1.3 microseconds
Maximum Power Dissipation (at 1.3 microsec. 0-70°)	829 milliwatts	1307 milliwatts
Output Drive	3.2mA @ .4V	1.9mA @ .45V
Minimum Input High Voltage	3.0V	3.3V
MIL-STD-883	Standard	Special
Price per 100	\$21.00 (Am9080A)	\$40.00 (C8080A)

Ours and Ours.

(Am9080A System Circuits)

AMD Part Number	Description	Availability
CPU		
Am9080A/-2/-1/-4	Speeds to 250 nsec. 0 to 70°C	In Dist. Stock
Am 9080A/-2	Speeds to 380 nsec. -55 to +125°C	In Dist. Stock
Static Read/Write Random Access Memories		
Am9101A/B/C/D	256x4. 22 Pin Speeds to 250 nsec.	In Dist. Stock
Am91L01A/B/C	256x4. 22 Pin Speeds to 300 nsec.	In Dist. Stock
Am9102A/B/C/D	1K x1. 16 Pin Speeds to 250 nsec.	In Dist. Stock
Am91L02A/B/C	1K x1. 16 Pin Speeds to 300 nsec.	In Dist. Stock
Am9111A/B/C/D	256x4. 18 Pin Speeds to 250 nsec.	In Dist. Stock
Am91L11A/B/C	256x4. 18 Pin Speeds to 300 nsec.	In Dist. Stock
Am9112A/B/C/D	256x4. 16 Pin Speeds to 250 nsec.	In Dist. Stock
Am91L12A/B/C	256x4. 16 Pin Speeds to 300 nsec.	In Dist. Stock
Am9130A/B/C/D/E	1024x4. 22 Pin Speeds to 200 nsec.	In Dist. Stock
Am9140A/B/C/D/E	4096x1. 22 Pin Speeds to 200 nsec.	In Dist. Stock
Dynamic Read/Write Random Access Memories		
Am9050C/D/E	4K x1. 22 Pin Speeds to 200 nsec.	In Dist. Stock
Am9060C/D/E	4K x1. 18 Pin Speeds to 200 nsec.	In Dist. Stock

AMD Part Number	Description	Availability
Mask Programmable Read-Only Memories		
Am9208/B/C/D	1Kx8 Speeds to 250 nsec.	Available Now
Am9214	512x8. 500 nsec.	Available Now
Am9216B/C	2Kx8. 300 nsec.	Available Now
Erasable Read-Only Memories		
Am1702A	256x8. 1.0 μsec.	In Dist. Stock
Am2708	1024x8. 450 μsec.	3rd Q. 1976
Processor System Support Circuits		
Am8212	8-bit I/O Port	In Dist. Stock
Am8216	Non-Inverting Bus Transceiver	3rd Q. 1976
Am8224	Clock Generator	In Dist. Stock
Am8226	Inverting Bus Transceiver	3rd Q. 1976
Am8228	System Controller	In Dist. Stock
Am9557	Direct Memory Access Controller	1st Q. 1977
Am9559	Priority Interrupt Controller	1st Q. 1977
Am25LS138	1-of-8 Decoder	In Dist. Stock
Am25LS139	Dual 1-of-4 Decoder	In Dist. Stock
*Am25LS240	8-bit Inverting Bus Transceiver	3rd Q. 1976
*Am25LS241	8-bit Non-Inverting Bus Transceiver	3rd Q. 1976
*Am25LS273	8-bit Common Clear Latch	3rd Q. 1976
*Am25LS374	8-bit 3-state Latch	3rd Q. 1976
*Am25LS377	8-bit Common Enable Latch	3rd Q. 1976

*All combine high performance and low power in space saving 20-pin package

CPU: 9080A = 480 nsec. -2 = 380 nsec. -1 = 320 nsec. -4 = 250 nsec. MEM: A = 500 nsec. B = 400 nsec. C = 300 nsec. D = 250 nsec. E = 200 nsec.

Advanced MOS/LSI

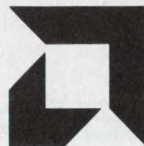

Advanced Micro Devices • 901 Thompson Place, Sunnyvale, California 94086 • Telephone (408) 732-2400 • Distributed nationally by Hamilton/Avnet, Cramer and Schweber Electronics.

CIRCLE NUMBER 42

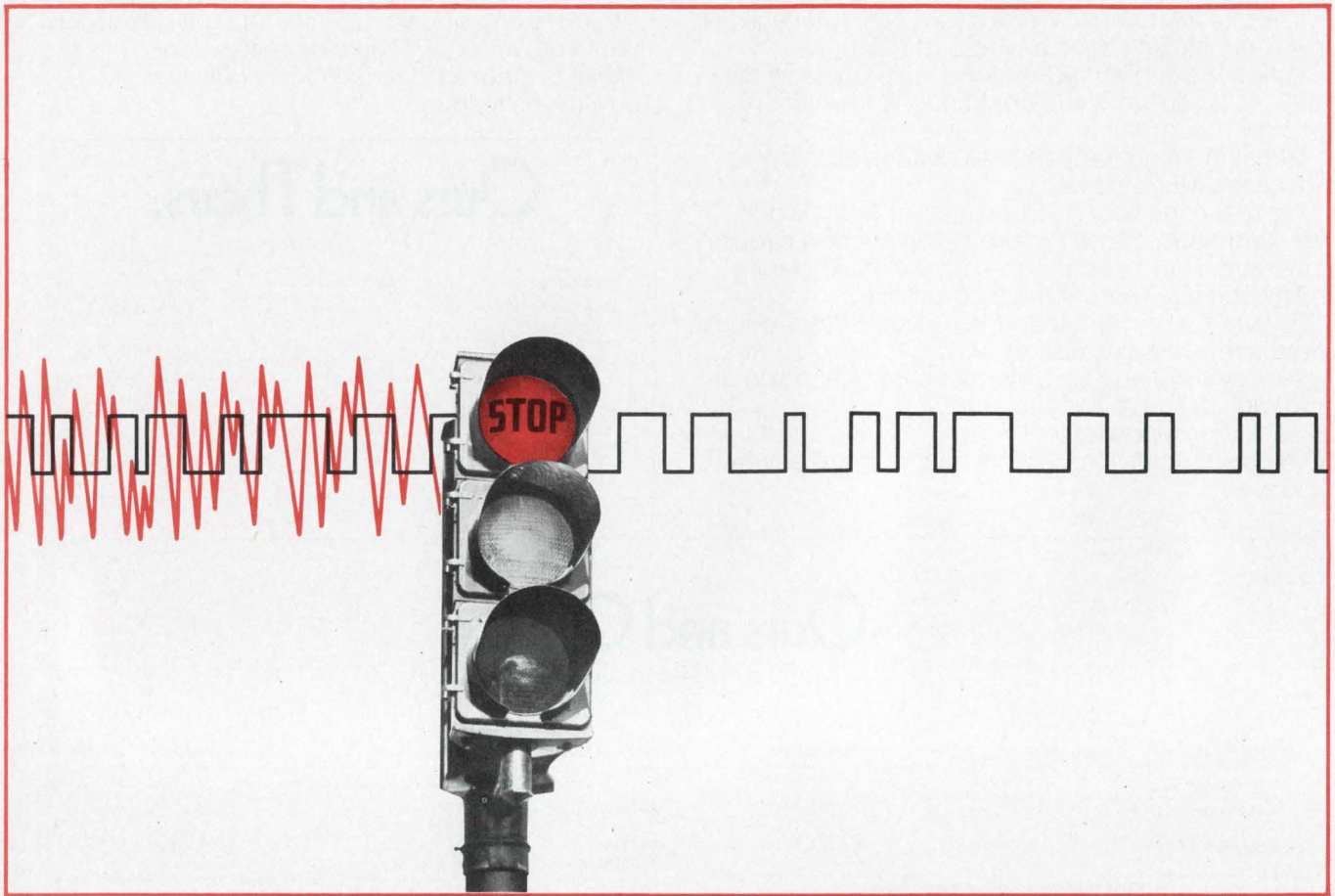

Stop noise problems. HiNIL gives you the best protection available. Bar none.

Noisy environments simply cease to be a problem when you design with High Noise Immunity Logic from Teledyne. HiNIL provides high immunity to any and all types of electrical noise, without the cost and inconvenience of special filtering or shielding.

Use HiNIL in place of your conventional I/O logic. It interfaces easily with TTL, DTL, MOS and CMOS. It will protect your CMOS inputs against static charge damage and SCR latchup. And it gives you a guaranteed dc noise margin of 3.5 V (as compared to 1.0 V for CMOS

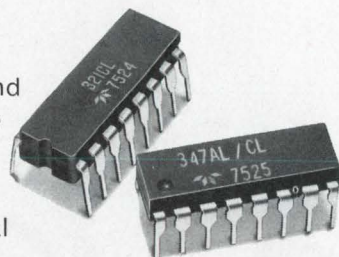

and 0.4 V for TTL) without added filter circuits or tight supply regulation.

Or design entirely with HiNIL. You will get even better noise protection and a simpler design, and you can use a low cost, loosely regulated power supply. The complete HiNIL family includes more than 40 devices, with more being added all the time. They're available in ceramic or molded plastic DIPs.

Get complete details on the full family of HiNIL logic circuits from your local Teledyne Rep or Distributor. Or contact us at the address below.

TELEDYNE SEMICONDUCTOR

1300 Terra Bella Avenue, Mountain View, California 94043 Tel: (415) 968-9241 TWX: 910-379-6494 Telex: 34-8416

SALES OFFICES:

DOMESTIC: Salem, N.H. (603) 893-9551; Stony Brook, N.Y. (516) 751-5640; Des Plaines, IL (312) 299-6196; Los Angeles, CA (213) 826-6639; Mountain View, CA (415) 968-9241 • INTERNATIONAL: Hounslow, Middlesex, England (44) 01-897-2503; Tiengen, West Germany 7741-5066; Kowloon, Hong Kong 3-240122; Tokyo, Japan 03-405-5738.

CIRCLE NUMBER 43

My crime

I broke the law. Seeing a long stretch of clear highway ahead, I pushed a bit on the gas pedal and reached a speed that the local gendarmes felt was excessive. On a highway built for safe travel at 100 miles per hour, in a car that was hardly trying, I exceeded the legal, 55-mph limit.

I'm normally a law-abiding citizen. I don't spit on the sidewalk; I don't covet my neighbor's wife (who's ugly anyway); and I don't steal or murder. But I drove too fast. On a typical American highway that's better than those in most nations, I exceeded a speed limit that most nations would consider slow—and joined the ranks of law-breakers.

I confess it now. I didn't feel terribly guilty about that. After all, there are laws made to be broken. Through fines, lawbreaking is a good source of income for state authorities and it helps create jobs. So it's surely a worthy and even commendable activity.

Most of us honorable and moral people are skilled at sensing which laws we can freely break (being careful not to be caught, of course) and which we must obey. We drive too fast, for example. But we never steal. Well, hardly ever.

After all, it isn't really stealing if we goof off and deprive our employers of some of our effort that they pay for. What they don't know doesn't hurt them and, after all, everybody does it. It's quite acceptable socially.

And for that matter, it's not really stealing if we try to squeeze a bit more out of our employees than they expected. That's just smart business and smart business is always ethical.

Further, many laws are written by politicians seeking to curry favor with somebody or seeking to shift a financial burden from one group to another. So those laws aren't very important. They can certainly be broken without straining anybody's conscience.

If we lie a little now and then; and if in our business dealings, we bend the truth even to the point of breaking its back; that can surely be understood in terms of higher morality. As I see it, that morality is one that pays no heed to your concept of what's right and wrong and pays strict attention to mine.



RECOGNIZED BY
AMERICAN REVOLUTION
BICENTENNIAL
ADMINISTRATION

ELECTRONIC DESIGN is deeply honored to have received official recognition as a participant in the American Revolution Bicentennial Celebration, with authority to display the Bicentennial Symbol.

A handwritten signature in cursive script that reads "George Rostky".

GEORGE ROSTKY
Editor-in-Chief

Announcing...the *new* Electronic Design®

Book Club

(The new NO OBLIGATION book club*!)

*As an *Electronic Design* subscriber, you're already a member.

**NO OBLIGATION TO BUY... UP TO 25% DISCOUNT
ON ALL BOOKS... GREAT BUYS ON THE BEST BOOKS
FOR ENGINEERS FROM LEADING PUBLISHERS.**

Membership in a book club usually means you're obligated to buy a certain number of books a year. Not with us. As a subscriber to *Electronic Design*, you're already a member in good standing of the "Electronic Design Book Club." And, you're entitled to all club discounts.

Because you subscribe to *Electronic Design*, we know you belong to a select group of professionals who are always on the lookout for new publications to keep up on the latest developments in the field.

Why should we pressure you with rules and regulations? So, rest easy. Here, there are no membership forms to obligate you. *Only great buys on the best and most popular books for engineers from leading publishers!*

Sound like a good deal? It is. Just watch the pages of *Electronic Design* for all club announcements and take advantage of great discounts—on every single book we list.

Now you can brainstorm
with the best of them!

400 Ideas for Design, Volume 3

Electronic Design

A priceless collection of the best contributions to *Electronic Design's* "Ideas for Design" section. These practical design ideas will save you hours of work—lead you to valuable new work habits. A pacesetter handbook for the creative engineer, the book covers complex to very simple approaches in different design areas. Hayden list price: \$13.95

Subscriber's club price: \$11.85
Order #S119

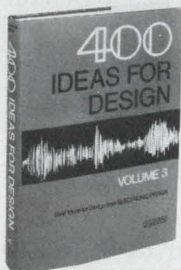

A complete handbook
on the design of power
circuits for all types
of converters . . .

Power Semiconductor Circuits

S. B. Dewan & A. Straughen

A fully illustrated guide to the design of converter power circuits, including the specification of the required thyristors and diodes, and protective and commutating circuit elements. Treats design of various kinds of converter chapter by chapter. All methods have been successfully applied to the design of industrial equipment. Wiley list price: \$26.50

Subscriber's club price: \$19.95
Order #S122



The Psychology of Computer Programming

Gerald M. Weinberg

"The best book about programming yet to be published..."—*Datamation*. This fascinating book reveals the *human factor* in programming. Explores the behavior and thought processes of programmers in their daily work. Here is must reading for every computer professional. Van Nostrand list price: \$9.50.

Subscriber's club price: \$8.50
Order #S102

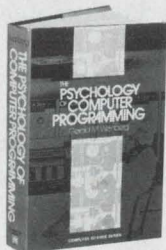

Crime By Computer

Donn B. Parker

Fascinating case histories reveal startling new kinds of million-dollar fraud, theft, larceny and embezzlement. Who's doing it, why, how, and how to stop them. "Must reading for those involved in electronic data processing, and especially business managers . . ."—*Publisher's Weekly*. Scribner's list price: \$10.95

Subscriber's club price: \$9.30
Order #S117

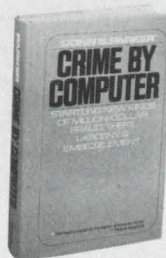

Assembly Level Programming for Small Computers

Walter J. Weller

Gradually builds your skills in every aspect of assembly level programming applicable to a wide range of minicomputers. Improves your problem-solving abilities with practical problems in real time control, monitoring, and data acquisition. Lexington Books list price: \$14.95

Subscriber's club price: \$12.70
Order #S101

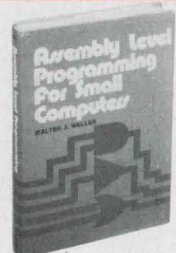

Modern Data Communication: Concepts, Language, and Media

William P. Davenport

An on-the-job handbook mapping out the latest techniques, systems, and services for the most efficient data transmission. Includes simplified coding techniques; ways of dealing with distortion, distraction, interference; efficiency and control techniques; modulating and multiplexing methods; and good advice on system costs. Hayden list price: \$10.30

Subscriber's club price: \$9.25
Order #S111



Game Playing with Computers, Second Edition

Donald D. Spencer

Now you can match your wits against a digital computer! Here are over 70 games, puzzles, and mathematical recreations, along with more than 25 complete programs in FORTRAN or BASIC. Binary games, casino and board games, unusual gambling games and many others. Hayden list price: \$14.95

Subscriber's club price: \$12.70
Order #S112



Microprocessors: New Directions for Designers

Edward Torrero

Here's two years of a wealth of information on microprocessors from *Electronic Design*. It's packed with data and advice on selecting micros, and operating and improving them to your best advantage. It's the "last word" in micros. Hayden list price: \$8.95

Subscriber's club price: \$7.95
Order #S100



Fundamentals and Applications of Digital Logic Circuits

Sol Libes

Includes everything from basic theory to the most advanced applications—circuitry of calculators, voltmeters, frequency counters, and the latest computer applications. Explores the applications of RTL, DTL, TTL, and other gating circuits. Hayden list price: \$8.98

Subscriber's club price: \$7.20
Order #S121



"... well-organized, extremely well written ... highly recommended for practicing engineers ..."
—*IEEE Transactions*

Digital Signal Analysis

Samuel D. Stearns

Including a Foreword by Richard Hamming, this ideal master handbook on signal processing contains recent advances, new design material, and a comparison between continual and digital systems extremely helpful to newcomers to the field. Includes special sections on analog and digital filter design. Hayden list price: \$18.95

Subscriber's club price: \$15.20
Order #S120

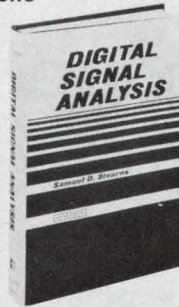

Basic Electronic Switching for Telephone Systems

David Talley

Probably the most practical, complete coverage of today's telephone systems, particularly the operations of central offices and their switching networks. Discusses Bell's No. 1 and No. 2 ESS central offices, and the No. 1 EAX System from GTE labs. Great for engineers, technicians, and executives alike. Hayden list price: \$6.95

Subscriber's club price: \$5.90
Order #S115



Assembler Language Programming: The IBM/360 and 370 Second Edition

George W. Struble

This guide offers a double value, enabling you to gain command of the structure and operation of the System/360 and 370, as you master the system's versatile assembler language. This new edition contains additional problems and examples to strengthen your working knowledge. Addison-Wesley list price: \$14.95

Subscriber's club price: \$12.70
Order #S103



Mathematical Foundations of Systems Analysis

R. H. Kupperman and Harvey Smith

A high-powered refresher course for analysts who want to bolster their mathematical abilities and handle all their system work with more expertise. Filled with problems and examples to improve your problem-solving skills—particularly in the areas of optimization. Addison-Wesley list price: \$13.95

Subscriber's club price: \$10.50
Order #S110



ELECTRONIC DESIGN BOOK CLUB

50 Essex Street
Rochelle Park, New Jersey 07662

Order Form

Your new NO OBLIGATION book club is a great idea! Please send the following book(s) on 10-day examination. At the end of that time, I will send payment plus postage and handling (and state sales tax where applicable) or return the book(s) and owe nothing.

As a subscriber to *Electronic Design*, I understand that I am under no obligation to buy a specific number of books to continue to take advantage of your discounts.

FILL IN BOOK ORDER NO. AND TITLE BELOW:

Order #	Title	PRICE
_____	_____	_____
_____	_____	_____
_____	_____	_____
_____	_____	_____
_____	_____	_____
_____	_____	_____
_____	_____	_____
_____	_____	_____
_____	_____	_____
_____	_____	_____

Sales tax: N.J.—5%, Ca.—6%, Fla.—4%

Sales Tax _____

SHIP TO:

Name _____

Firm/Institution _____

Address _____

City/State _____ Zip _____

To take advantage of our subscriber's club price, you must fill in your *Electronic Design* subscription number (the long number over your name at the top of your address label on the front of this issue).

(Yes... We need all 29 numbers and letters)

CREDIT CARDS ACCEPTED—Customer pays postage and handling

CHECK ONE: Master Charge BankAmericard

Acct. No. _____

Expiration Date _____

InterBank No. _____ (Master Charge ONLY)

Signature _____

Payment (check or money order) enclosed.

We've doubled our high voltage Power Transistor line.

Read what's in it for you.

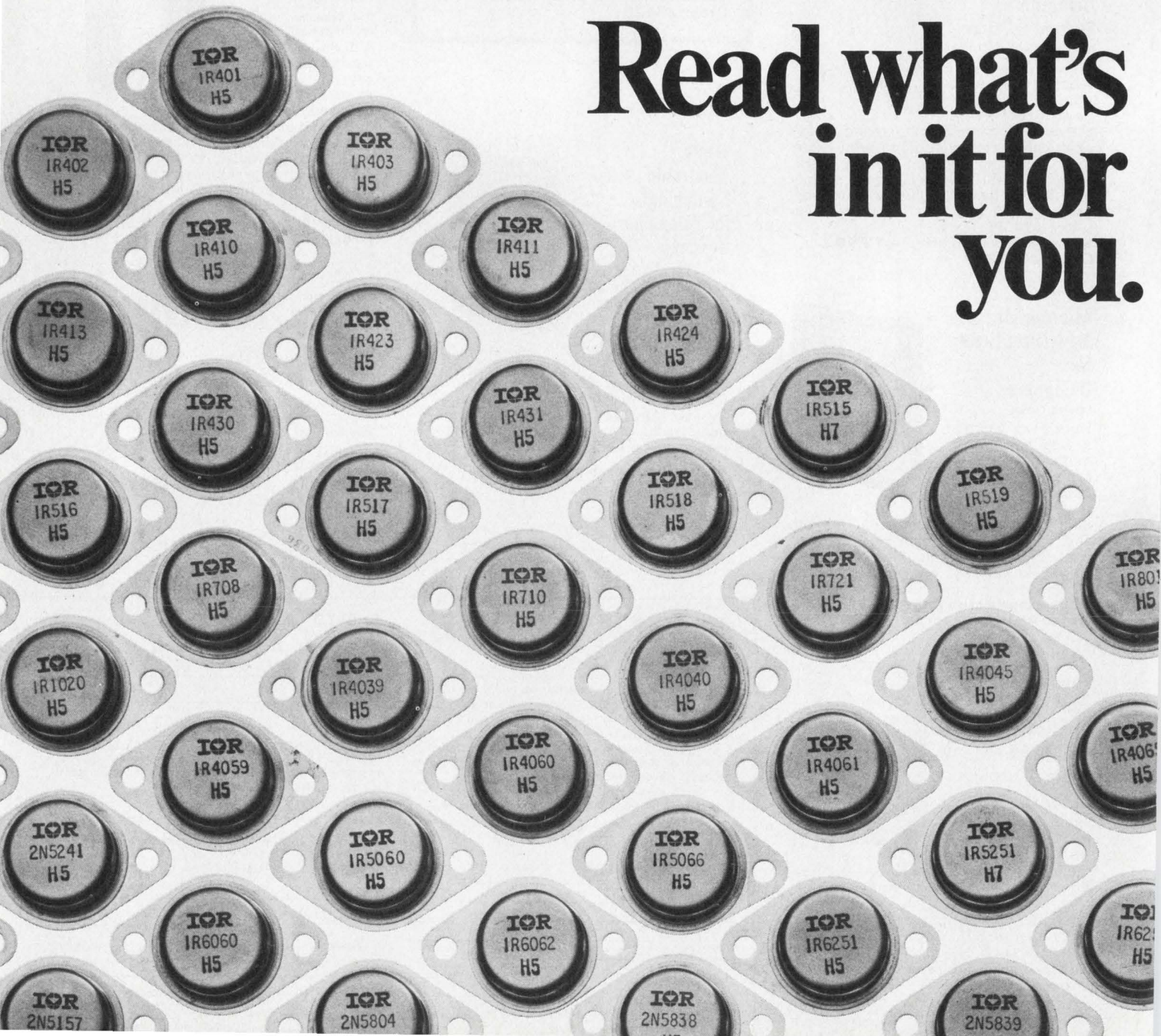

Our new, expanded line offers a lot more types than we could show here. But that isn't important to you. What is important is that now you can probably get a better device than you are now using, for these reasons.

All of the top power transistor companies make pretty good high voltage devices with low sats, broad operating areas, low switching losses. IR gives you that, and more.

For example, we use hard-glass passivation for our chips. That gives our devices longer life than those using organic passivating materials. It also gives a high-temperature stability that you can see in Figure 1, but may never see for other devices. It costs us more to apply. But it is far better for you in the long run.

We build and rate our devices to operate reliably and continuously at maximum rated junction temperatures. Other brands which come up short in high-temperature stability may require temperature derating. Check the performance of the ones you use.

Because we've specialized in "power" semiconductors for more than 28 years, we know the

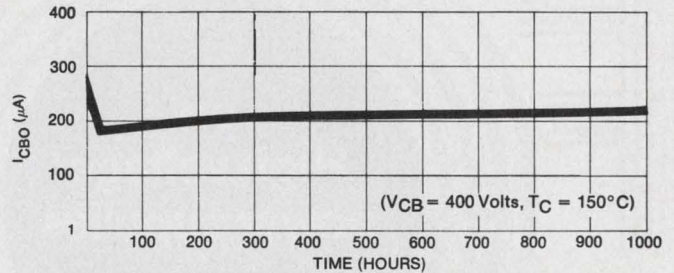

FIGURE 1 Typical High Temperature Reverse Bias Characteristics Vs. Time

importance of reliability testing. In addition to testing the 11 basic parameters of every device, we perform 100% tests on a curve tracer to make sure each part has a sharp high-voltage characteristic.

And there are other demands on power devices we've learned to handle over the years. Like mounting chips to the substrate so they stay there through years of temperature cycling. And making connections between the chip and case that last. Little things? No. They loom large when things go wrong on other devices.

In the case of chips to package yourself, you'll get a completely finished, fully protected and tested transistor for more flexibility in design and higher yields in your end product.

We offer the most popular types for the applications listed, so get our "Power Transistor Application Guide". Check it for our equivalents to the types you're using now. When you find them, you've found the way to add more stability and longer life to your product without adding to your costs.

That's what's in it for you!

Contact your local IR salesman, rep or distributor, or write to: International Rectifier, 233 Kansas Street, El Segundo, CA 90245. Call (213) 322-3331.

Our "Power Transistor Application Guide" gives the part numbers of types available for these applications. Get yours today.

- Switching Power Supplies 64 Types
- High Voltage Linear Regulators 30 Types
- Auto Ignition Systems 22 Types
- Ultrasonic Power Generators 13 Types
- Vertical Deflection 17 Types
- Horizontal Deflection 23 Types
- Motor Drives 32 Types
- High Frequency Lighting 11 Types

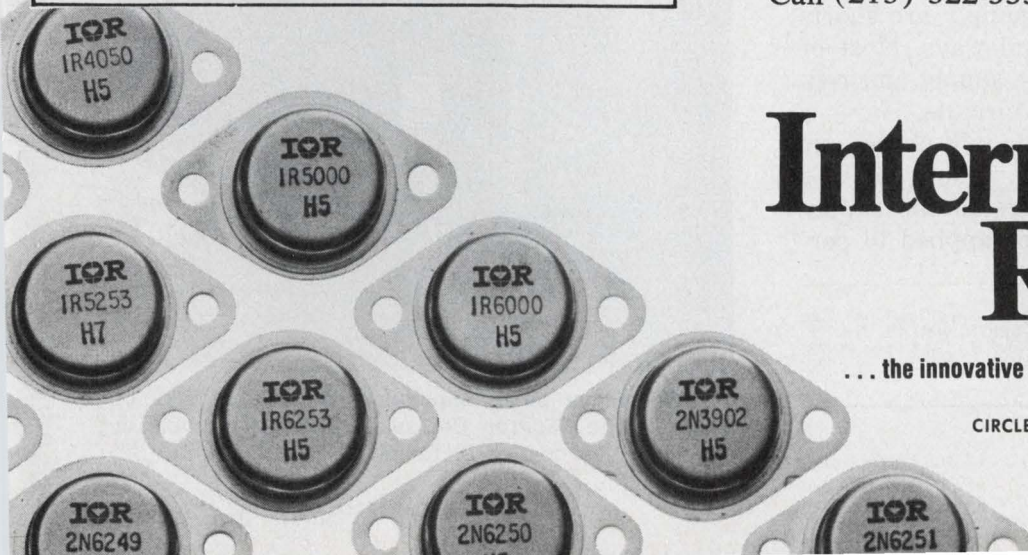

International Rectifier

... the innovative semiconductor people



CIRCLE NUMBER 47

Focus on High voltage power supplies

The problems of specifying a high-voltage dc supply include all those you'll run into with low-voltage units—and then some.* The “then some” comes from the unique problems and specifications of supplies that must deliver 500 V or more.

At high-voltages, problems such as arcing, corona and decay time add to the already muddled selection dilemma. And more familiar power-supply specs, such as ripple, regulation, temperature drift and response time may take on a different significance. Let's take a closer look at some of the problems of specifying high-voltage supplies.

They are usually bulkier than most lower-voltage supplies. Conductor spacing and component placement are more critical because of the dangerous voltages. Material selection can be critical as can the processes used to manufacture, assemble and package the different components. Don't hesitate to ask the manufacturer for a peek inside the unit to check out the construction methods and the components used.

Selected shorts and the protection racket

Arcing problems in a power supply are shorts that can be dealt with in several ways. Most of the time arcs are external to the supply and represent current surges or short circuits.

Arcs, corona and decay time all share one common binding point—safety. Many of the methods used to prevent damage in the supply or to a sensitive load can also be applied to per-

*For additional information on power-supply specifications, see the following back issues of ELECTRONIC DESIGN: Vol. 21, No. 25, Dec. 6, 1973, pp. 58-71; Vol. 22, No. 23, Nov. 8, 1974, pp. 70-78; Vol. 23, No. 10, May 10, 1975, pp. 100-108; and Vol. 23, No. 20, Sept. 27, 1975, pp. 52-61.

Dave Bursky
Associate Editor



A wide range of high-voltage supplies is available from CPS. This unit, the 100P, has a 0-to-30-kV output range at a maximum current of 5 mA.



Small, modular power supplies, such as this 6-kV unit made by the Capiton Div. of Amp, offer multiple outputs that can operate at temperatures of 100 C.

sonnel safety, as we'll see when we look at protection methods.

Manufacturers offer several protection schemes that are built into the supply to prevent it from being damaged by a short in the output circuit.

However, there are three basic protection methods that the manufacturer offers you, so you should not choose a supply simply because it has short-circuit protection. Know the type of short circuit protection.

Is the protection for momentary short circuits or for continuous short circuits? In many cases—with power supplies that drive tubes, for example—the supply must be able to withstand several momentary arcing shorts before the load current will stabilize. The simplest approach is a self-oscillating high-voltage circuit that stops oscillating when the load current is too high. The components used in such a supply are not rated for continuous operation at heavy currents, and will burn out rapidly if arcs persist.

Another protection method is current-foldback to roll back the current to a preset value, during a momentary or continuous short circuit. However, this circuit can be dangerous to anyone not entirely familiar with its characteristics. If a short is removed from such a circuit the voltage returns to full strength.

More complex power supplies use yet another method to prevent damage. A circuit is set to count a predetermined number of momentary shorts before it shuts off the supply. If the shorts stop before the preset number is reached, the supply feeds the required power to the load.

The nature of the short circuit or arc is another important factor to consider before you specify any type of protection circuitry. Have the manufacturer define the kind of arc the supply can withstand. Arcs that occur in high vacuums are more dangerous than arcs in air because the vacuum discharge occurs in a matter of microseconds and causes a high rate of current change. In turn, the di/dt causes cable ringing and large voltage transients.

Arcing when you try to separate live connections, which can be live even with power off because of capacitive storage, can cause large voltage transients in both the load and supply, and in the ground circuit. Transients can reach values of several kilovolts if ground returns are incorrectly laid out.

Corona losses cause problems

When the power supply is turned on, do you hear any hissing or crackling? If you do, you have corona, possibly some major corona losses, and unwanted rfi. Have the manufacturer specify the amount of corona you can expect. Small round balls covering all pointed terminals can

reduce the possibility of corona and the intermittent rf noise it generates.

Make sure the manufacturer doesn't skimp on insulation or conductor spacing. At high altitudes conductor spacing set up at sea level can cause arcing or corona discharge. As a general rule, make sure the vendor allows 1 in. between conductors for every 10 kV of output voltage.

If corona can't be completely eliminated, have the manufacturer specify the amount of radiated electrical noise the supply will produce.

Have him pin down the amount of audible supply noise caused by corona. And don't forget to include this noise in addition to the audible noise generated by the supply conversion circuits.

High-voltage supplies, of course, present some tricky safety problems. When you shut off the supply the voltage may take several seconds to decay to a safe level, especially if the power supply has a large capacitance on the output.

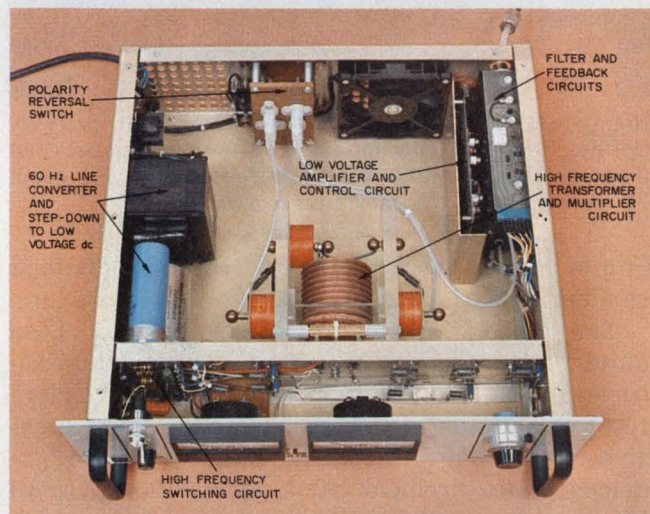

Rack-mounting power supplies, such as this unit made by Spellman High Voltage, permit large distances between conductors to prevent any internal shorts.

Switching and rf supplies don't have as much of a problem as do the series-pass units. The decay time should be specified, together with the value to which the voltage decays.

Built-in safety features help get around the danger of high voltages. Interlocks such as micro-switches can sense when the cable is connected and control the high-voltage output. By mounting a switch inside the cable receptacle, the manufacturer has an almost foolproof way to prevent accidental shocks or unwanted arcing when the cable is unplugged.

Ripple and noise can be a severe problem with high-voltage supplies; they can have amplitudes of several volts or more. The National Electrical Manufacturers Association has developed a specification that combines both the ripple and noise

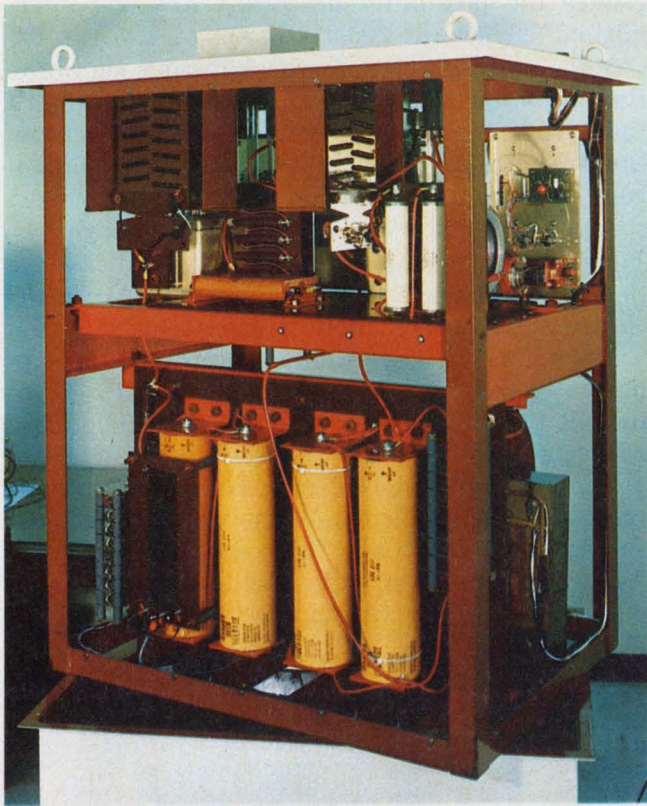

High-power supplies such as this Scan-X unit made by Del Electronics usually require 208 or 220 V inputs but they can deliver 4000 W of power—in this case about 75 kV with a 40 mA maximum current.

into a single spec called PARD (periodic and random deviations).¹

The NEMA spec (PY1-1972) has not been universally accepted by power supply manufacturers. It calls out some tests that many vendors feel are unrealistic and, in some cases, too expensive to run. For its PARD spec, NEMA recommends a measurement bandwidth of 20 Hz to 10 MHz, while many power-supply vendors prefer a much narrower span.

In high voltage units, ripple is commonly specified in volts rms, which, of course, provides a lower number than would a peak-to-peak spec. This isn't too misleading, however; if the ripple is pretty sinusoidal, you can convert rms to peak-to-peak just by multiplying it by 2.828. With other unwanted outputs such as short-duration spikes, noise and other hash rms values are totally useless. Manufacturers can easily hide peak values of short spikes in rms figures. Calculated peak-to-peak values could be off by a factor of ten or more.

Make sure the manufacturer defines the bandwidth over which the noise was measured—the narrower the bandwidth, the lower the noise figure. Damaging spikes that occur at high rep rates can be "legally" eliminated just by narrowing the bandwidth.

Watch out for voltage feedthrough. Both the ripple and noise can feed into lower voltage



Laboratory power supplies such as these offer you adjustable outputs that can be set either by thumbwheel switches, as in Models 6516A and 6525A, or by a potentiometer control as in the Model 6515A. These units are from Hewlett-Packard.

control circuits that are coupled to the high voltage section by capacitors. Make sure the circuits are rated for operation at the peak ripple or noise levels the supply will produce.

Don't forget to turn the power supply around and check how much ripple or noise is fed back to the input line by any of the possible coupling paths. Whatever is fed back may not affect your supply, but it may affect others in the system. The reflected PARD should be specified as peak-to-peak to eliminate any possible confusion.

Rock-solid outputs are only imaginary

Power-supply regulation (called stabilization by NEMA) may not be the most critical factor when you select a supply. Check your application carefully before you demand unnecessarily tight regulation, which can end up costing a bundle. Applications like CRT displays, where the load current doesn't change much, may not require tight load regulation.

When you do specify stabilization, make sure it includes the actual line and load change and the worst combination of the two. Many vendors supply only the load or line regulation and almost never the worst-case combination.

To trim the supply cost, some manufacturers suggest that you specify the regulation over the actual load change rather than over the more common "zero-to-full-load" range. Check your application very carefully before doing so. Photomultipliers and image intensifiers demand tight stabilization, though other applications may let you shave costs.

For your dynamic-regulation requirements, determine the peak pulse currents needed by the load, and their duration. Then define the peak output-voltage change that the load can tolerate under pulsed-current load conditions.

High-voltage supply regulation can range from

none at all to 0.001% and tighter for load or line changes. There are many factors that can affect the output of the power supply. Temperature and time are two of the most prominent.

We're just drifting along

Once a power supply is turned on, its output voltage will drift. The drift can be broken into three different categories: warm-up drift, temperature drift and time stability. Check your data sheets to make sure the manufacturer specifies all three.

Warm-up times differ from vendor to vendor. A supply can require several minutes to many hours to warm up enough to meet the manufacturer's specs. If you work in a lab, try not to get stuck with a supply that must be left on overnight just so it can meet spec during morning use. And, of course, supplies intended for portable instruments should have short warm ups.

As the surrounding temperature changes, so does the output voltage of the supply. Don't let the manufacturer get away without specifying the tempo of the output voltage.

Have him also tell you if the tempo becomes nonlinear over a portion of the output range. You might, for example, find that a 20 ppm/°C change at 25 C turns into a 45 ppm/°C shift at one of the temperature extremes.

Tempcos can be expressed as either ppm/°C or a voltage change/°C. In most cases the voltage change over temperature is the clearest, but many manufacturers don't like to show large numbers. More commonly you'll find the tempo specified in ppm/°C.

Often, a manufacturer can "improve" his tempo spec by just specifying it over a portion of the actual operating temperature range. Another trick he uses is to put some footnotes down at the bottom of the data sheet that may call out some restrictions on the supply operation when the tempo was measured. Look carefully for any such notations. Changing line and load conditions can affect the rating because thermal transients and voltage changes can affect the heat rise inside the supply and thus affect the tempo.

The last drift factor is time. With use, many power-supply components will age, and change their value, which causes the supply output to change.

While we're looking at the power supply's output, let's see how different vendors specify dynamic response to load changes. Most companies call this response time; others call it recovery time. NEMA prefers the term recovery time to refer to power-supply reactions to load changes. Response time is used by many companies to indicate the supply reaction to an input control change.



The 205A-30 laboratory power supply produced by Bertan Associates offers a 0 to 30-kV output and has a ripple voltage of only 600 mV peak-to-peak.

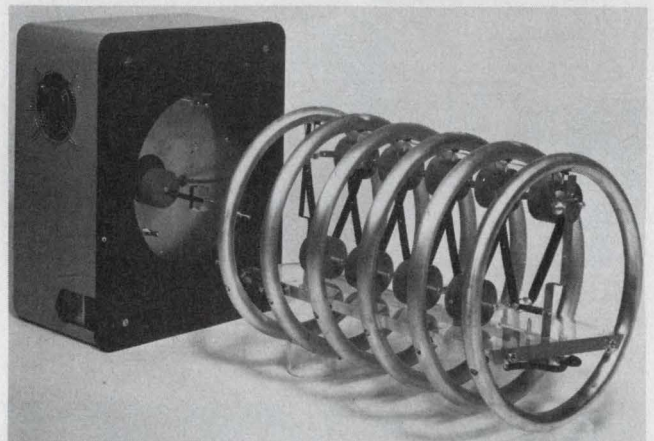

This 150 kV at 2.5-mA supply designed by Deltaray was developed for the semiconductor industry. It is used for ion-implantation accelerators.

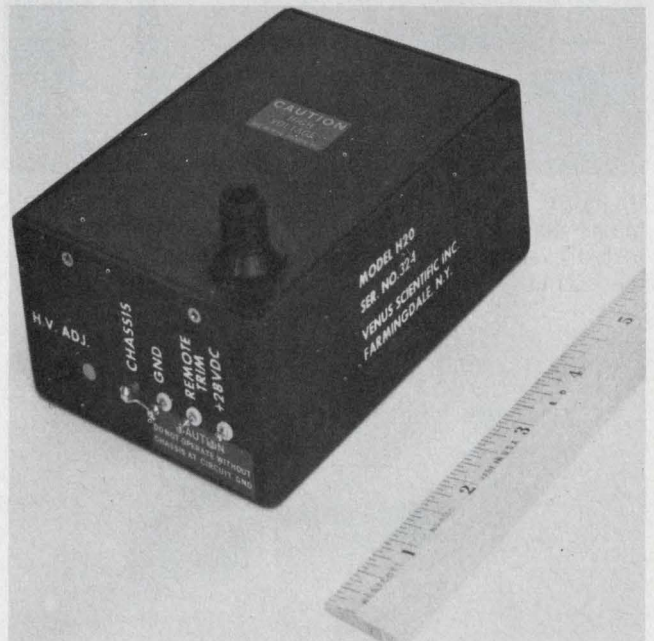

Providing 0 to 20 kV at a current of 500 μ A, this Model H-20 power supply developed by Venus Scientific has a remote trim control and a ripple of only 0.05% peak-to-peak at full load.



This Model 21500 power supply delivers up to 1.5 MV at 30 μ A to test insulation. It is only part of the line of power supplies available from Hipotronics.



Up to 30 kV at 500 μ A is available from Brandenburg's Model 827 high-voltage supply. The unit can be adjusted over 0 to 30 kV and has dual meters to monitor the output.

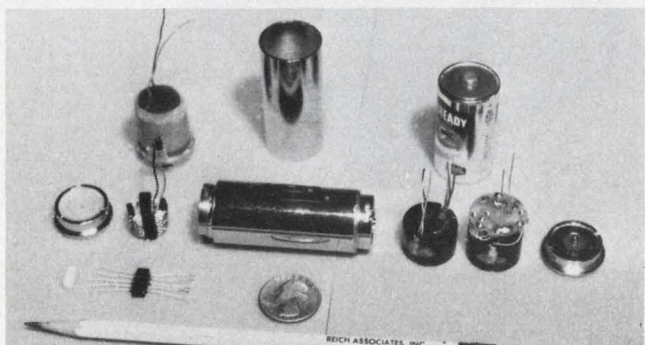

Highly compact dc-to-dc power supplies, such as this 16 kV at 1 μ A unit produced by Reich Associates, can operate from a 1.5-V source.

How long does it take the power-supply output to settle within its regulation band for a new load current? Make sure the manufacturer includes all the ringing and delay time that output capacitance can cause, as well as the type of load the spec applies for. Resistive loads will let the supply recover faster than inductive or capacitive.

High-voltage supplies usually require milliseconds and sometimes seconds to settle to a new value, so don't just consider the recovery-time spec alone. Ask the vendor how he defines the term. What happens during those few milliseconds? Does the voltage undershoot or overshoot? How much ringing takes place on the output?

For step-load and line changes many supplies use large-value capacitors to store charge, and these capacitors usually take a long time to charge or discharge. The stored energy in the capacitance can also cause safety hazards to operating or service personnel.

Don't get zapped by high voltage

High-voltage power supplies can be quite lethal if you don't pay them the proper respect in handling. Special connectors for the line outputs should be used to prevent connecting the high-voltage line before the ground wire. Also, the connectors should not be interchangeable with other cable connectors. For instance, some companies use a back-filled BNC connector that will mate with any other BNC. A safer unit is the extended BNC, which has a depth from the ground shield of almost half an inch to prevent accidental contact with high voltage.

Check to see how the supply's output voltage is adjusted. Is the adjustment done in the low-voltage section, or do the controls directly adjust the high voltage? If the latter, make sure the controls are adequately insulated against accidental shorts.

Sometimes you may find it necessary to "stack" the power supplies to get an even higher voltage; find out how far you can go. Most companies have units that can be floated up to several thousand volts above ground, but check the data sheets to make sure.

Heat—the giant killer

High-voltage power supplies are probably more sensitive to damage from heat than are other types. Capacitor leakage currents can easily become excessive because heat adds to the stress on the dielectric materials. Insulation may start to break down and resistances will change. To avoid reliability problems, most vendors recommend that engineers shouldn't leave the supply selection till last. The widespread stick-it-in-any-spot attitude often causes a high failure rate

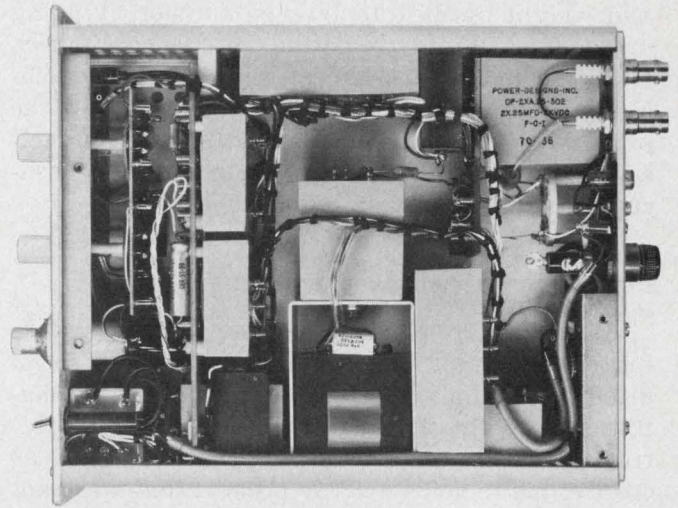
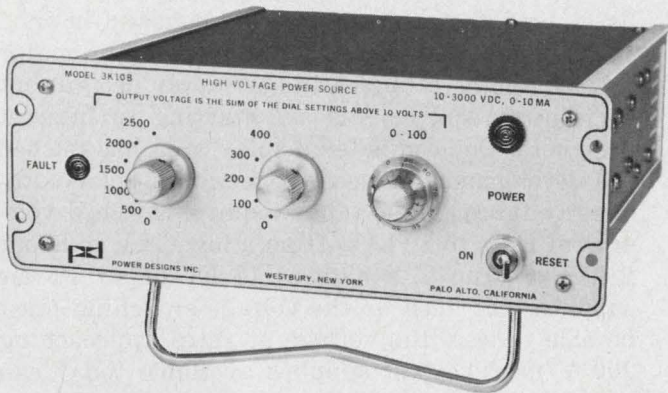

Get adjustable outputs of 10 to 3000 V at currents from 0 to 10 mA from Power Designs' Model 3K10B. Both the front (right) and top (left) views are shown.

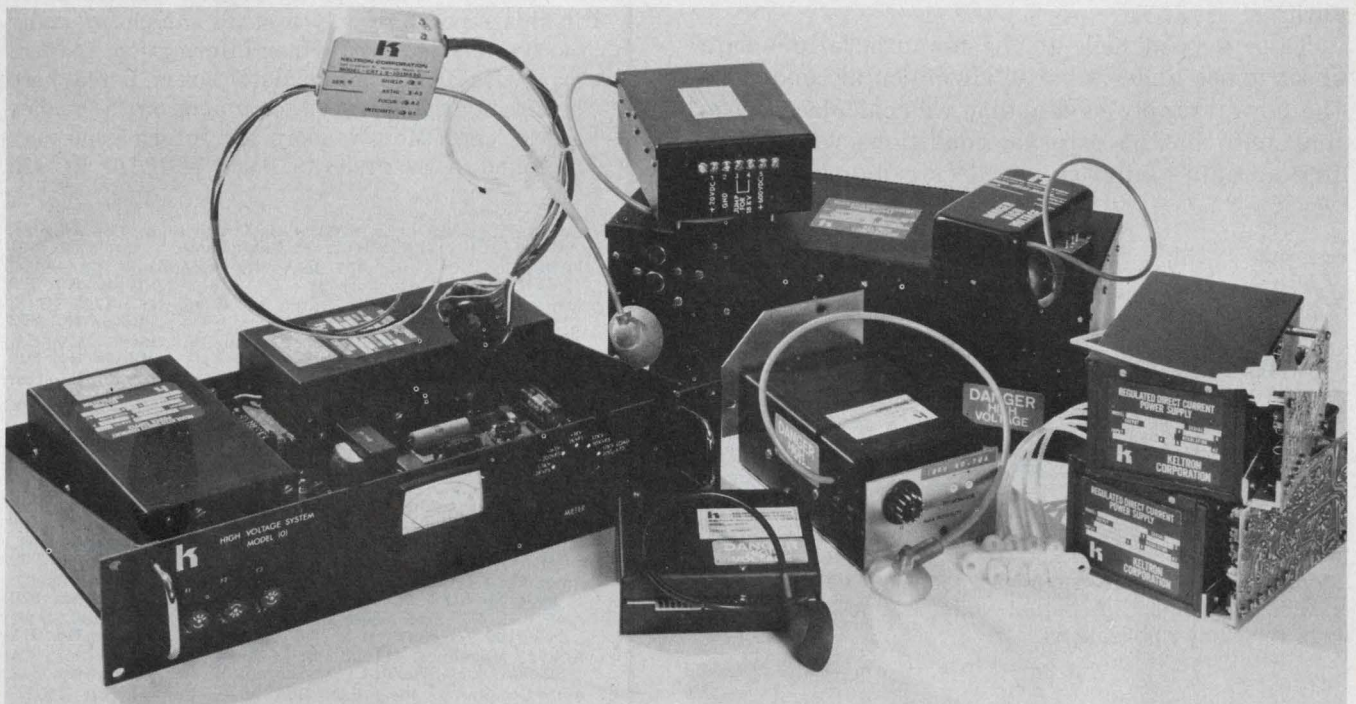

Many different sizes and ratings are available in Kelltron's line of high-voltage supplies. The units shown

here range from a 2 x 2 in. module to large, 19-in.-wide rack-mounted units.

until the supply is redesigned or moved to a different place in the equipment.

Heat build-up due to poor ventilation, or placement near a heat source, can cause early component failure. Internal sources of heat from the supply must also have an outlet—but be careful. If the supply is going into an open environment, make sure you dustproof the box or can perform routine maintenance to prevent dust buildup from causing internal leakage or shorting.

Manufacturers are currently using three major methods to generate high voltages, each of which offers several different advantages and disadvantages. The familiar series-pass supply is still around, but is slowly giving way to dc-to-dc switching units and to even higher frequency dc-

to-rf-to-dc converters.

The series pass offers the quietest operation available for situations where noise and other unwanted components on the output can't be tolerated. However, these supplies are bulky and require quite a bit of input power. The dc-to-dc supplies cut the cost of the magnetics and the size and weight of the package considerably, since they operate at frequencies of up to about 20 kHz. However, they cannot match the performance of the series-pass supply for low ripple and noise. Switching-supply efficiency can be 10 to 30% better than the series-pass units, which are typically 50 to 60% efficient.

Top efficiency goes to the so-called "rf" high-voltage power supply. These units cut the size

and weight of the supply even further by going up to 50 or 100 kHz to do the dc-to-dc conversion. Bulky inductors are almost eliminated, and efficiency approaches 90%. However, you pay the price with some problems—radiated and conducted emi and rfi that can find their way into adjacent circuits and cause interference.

Problems only compound problems

After they are put together many of the switching power supplies are totally encapsulated in an attempt to eliminate many of the failure mechanisms open circuits are prone to. However, potting can also create its own problems—such as corona due to voids and air pockets that were not eliminated; material breakdown due to heat and humidity; and voltage stress or mechanical fatigue.

Take a good look at the manufacturer's data sheet to see under what environmental conditions the power supply's reliability was calculated. You may find that no external conditions were taken into account and after you derate the parameters



Modular high-voltage supplies made by Velonex offer a wide assortment of output voltages and current ratings for many applications.



For photomultiplier applications try Keithley's Model-244 variable-output, 0 to 2.2-kV supply. It can deliver currents of up to 10 mA.

the 20,000 hour reliability figure given on the data sheet drops to only a few thousand hours.

In the last few years there have been no major breakthroughs in high-voltage supply design, but some new requirements are starting to interest designers. The computer display area has pushed the development of beam-penetration color cathode-ray tubes. These tubes require switched voltages of close to 10 kV—from a low 6 kV in about 2 kV steps up to a high of 18 kV or so. Power supplies that must do the voltage switching must be able to slew the voltage at rates approaching 200 V/ μ s. The best supplies available today can

Need more information?

The high-voltage power supply vendors listed in this report are only a small sample of many more available. For further information, readers may wish to consult manufacturers listed here by circling the appropriate number on the reader service card. More vendors and information may be found in ELECTRONIC DESIGN's GOLD BOOK.

- Abbott Transistor Labs, 5200 W. Jefferson Blvd., Los Angeles, CA 90016. (213) 936-8185. (R. Baldarrama) **Circle No. 501**
- ACDC Elecs. Co., Inc., 401 Jones Rd., Oceanside, CA 92054. (714) 757-1880. (D. Purkey) **Circle No. 502**
- Acme Electric Corp., 205 Water St., Cuba, NY 14727. (716) 968-2400. (D. Guilford) **Circle No. 503**
- Acopian Corp., 131 Loomis St., Easton, PA 18042. (215) 258-5441. (T. Skopal) **Circle No. 504**
- Advanced High Voltage Co., Inc., 14532 Arminta St., Van Nuys, CA 91402. (213) 997-7222. (M. Alexander) **Circle No. 505**
- Advanced Kinetics Inc., 1231 Victoria, Costa Mesa, CA 92627. (714) 646-7165. (R. Gradishar) **Circle No. 506**
- AEL, P.O. Box 552, Lansdale, PA 19446. (215) 822-2929. (B. Bernard) **Circle No. 507**
- Almond Instrument Co., Inc., 1223 E. Edna Pl., Covina, CA 91724. (213) 967-4151. (G. Almond) **Circle No. 508**
- American Design Components, 39 Lisperard St., New York, NY 10013. (212) 966-5650. (A. Berkun) **Circle No. 509**
- American Elec. Controls, 25 Clark Dr., Barrington, NJ 08007. (609) 546-5792. (E. Gerber) **Circle No. 510**
- AMP Inc., 449 Eisenhower Blvd., Harrisburg, PA 17105. (717) 564-0100. (J. Pletcher) **Circle No. 511**
- Arnold Magnetics, 11520 W. Jefferson, Culver City, CA 90230. (213) 870-7014. (A. Schramm) **Circle No. 512**
- Astro-Geo-Marine Inc., P.O. Box 5526, Oxnard, CA 93031. (805) 485-3128. (J. Fenole) **Circle No. 513**
- Bertan Assoc., Inc., 180 Miller Pl., Hicksville, NY 11801. (516) 433-3110. (R. Becker) **Circle No. 514**
- Bikor Corp., 1228 253 St., Harbor City, CA 90710. (213) 325-2820. (R. Pizer) **Circle No. 515**
- Brandenberg Ltd., 939 London Rd., Thornton Heath, Surrey CR4 6JE, England. (P. Walters) **Circle No. 516**
- CPS Inc., 722 E. Evelyn Ave., Sunnyvale, CA 94086. (408) 738-0530. (J. Fontenot) **Circle No. 517**
- Christie Electric Corp., 3410 W. 67 St., Los Angeles, CA 90043. (213) 750-1151. (F. Benjamin) **Circle No. 518**
- Cober Elecs., Inc., 7 Gleason Ave., Stamford, CT 06902. (203) 327-0003. (B. Krieger) **Circle No. 519**
- Cyberex Inc., 7171 Industrial Park Blvd., Mentor, OH 44060. (216) 946-1783. (D.C. Griffith) **Circle No. 521**
- Del Elecs. Corp., 250 E. Sandford, Mount Vernon, NY 10550. (914) 699-2000. (B. Michalak) **Circle No. 522**
- Deltaray Corp., South Bedford St., Burlington, MA 01803. (617) 273-1513. (W. Bygrave) **Circle No. 520**
- Deltron Inc., Wissahickon Ave. N., Wales, PA 19454. (215) 699-9261. (J. Phillips) **Circle No. 523**
- Dynage Inc., 1331 Blue Hills Ave., Bloomfield, CT 06002. (203) 243-0315. (R.W. Egglestone) **Circle No. 524**
- Elasco Div., Buchbinder Corp., 6 Northwood Rd., Bloomfield, CT 06002. (203) 242-0708. **Circle No. 525**
- ELDEC Corp., 16700 13 Ave. W., P.O. Box 100, Lynnwood, WA 98036. (206) 743-1313. (D. Soward) **Circle No. 526**
- Elec. Measurements Inc., 405 Essex Rd., Neptune, NJ 07753. (201) 922-9300. (C. Applegate) **Circle No. 527**
- Elma Engineering, 1066 E. Meadow Cir., Palo Alto, CA 94303. (415) 321-5220. (J.E. Frederick) **Circle No. 529**
- EMCO High Voltage, 2444 Old Middlefield Way, Mountain View, CA 94043. (415) 969-3056. **Circle No. 528**

just about meet that requirement, although several companies have working prototypes of units that can go the full distance. (The beam-penetration CRT has two phosphor coatings and the anode voltage determines the coating depth to which the electron beam sinks, and thus determines the color of the display.)

Switching regulators are gaining popularity as many of their original design problems have been ironed out and better oscillator circuits are developed to generate cleaner signals and less rfi.

Regulation specs are heading in both directions simultaneously—for microscopes they must be

tighter, and for CRTs and some other devices they can be almost nonexistent. Stabilities are getting better; many manufacturers now claim they can provide units with 10 or 30 minute stabilities as low as 1 ppm (under ideal laboratory conditions, of course.). Better semiconductor devices are providing the designers with the components they need to remove the last few tubes still in use. ■■

Reference

Specification PY1-1972, National Electrical Manufacturer's Association, 155 E. 44 St., New York, NY 10017.

Emerson Electric Co., Rantec Div., 24003 Ventura Blvd., Calabasas, CA 91302. (213) 347-5446. (L.E. Roby)
Circle No. 530

EMI GENCOM Inc., 80 Express St., Plainview, NY 11803. (516) 433-5900. (F. Belasco)
Circle No. 531

Endicott Coil Co., 24 Charlotte St., Binghamton, NY 13905. (607) 797-1263.
Circle No. 532

ERA Trans Pac Corp., 311A E. Park St., Dept. 1201, Moonachie, NJ 07074. (201) 641-3650. (P. Greco)
Circle No. 533

Erie Tech Products, 5 Fraser Ave., Trenton, Ontario K8V 5S1, Canada (613) 392-2581.
Circle No. 534

Faratron Corp., 280 Green St., South Hackensack, NJ 07606. (201) 488-1440. (E.M. Cappucci)
Circle No. 535

Ferrotran Elecs. Co., 683 Broadway, New York, NY 10012. (212) 254-5810.
Circle No. 536

Firing Circuits Inc., Muller Ave., Norwalk, CT 06852. (203) 846-1633. (C.G. Sims)
Circle No. 537

Gates Elec. Co., Inc., 526 Van Nest Ave., Bronx, NY 10460. (212) 881-5900. (Ms. Regenbogen)
Circle No. 538

Georator Corp., 9016 Prince William St., Manassas, VA 22110. (703) 368-2101. (C.E. Trefzger)
Circle No. 539

Gulton Ind. Inc., Trans-Rex Div., 2001 W. Artesia Blvd., Torrance, CA 90504. (213) 327-9224. (M. Anderson)
Circle No. 540

Hewlett-Packard, 1501 Page Mill Rd., Palo Alto, CA 94304. (415) 493-1501. (M. Fornell)
Circle No. 541

Hipotronics Inc., Route 22, P.O. Box A, Brewster, NY 10509. (914) 279-8091. (R. Reid)
Circle No. 542

Hisonic Inc., 249 N. Troost St., Olathe, KS 66061. (913) 782-0012. (D. Hersh)
Circle No. 543

Intronics Inc., 57 Chapel St., Newton, MA 02158. (617) 332-7350. (A.G. Pfalzer)
Circle No. 544

Keithley Instruments Inc., 28775 Aurora Rd., Cleveland, OH 44139. (216) 248-0400. (D. Bartos)
Circle No. 545

Keltec Florida Div. Aiken Ind., Inc., P.O. Box 1348, Fort Walton Beach, FL 32548. (904) 651-1210. (A. Coronis)
Circle No. 546

Keltron Corp., 223-225 Crescent St., Waltham, MA 02154. (617) 894-0525. (T. Chadurjian)
Circle No. 547

Kepeco Inc., 131-38 Sanford Ave., Flushing, NY 11352. (212) 461-7000. (P. Birman)
Circle No. 548

Kilovolt Corp., 238 High St., Hackensack, NJ 07602. (201) 488-7373. (S. Rothman)
Circle No. 549

Laser Diode Labs Inc., 205 Forrest St., Metuchen, NJ 08840. (201) 549-7700. (G. Swan)
Circle No. 550

Leader Instruments Corp., 151 Dupont St., Plainview, NY 11803. (516) 822-9300. (S. Nihei)
Circle No. 551

Litton, Electron Tube Div., 960 Industrial Rd., San Carlos, CA 94070. (415) 591-8411. (E. Taylor)
Circle No. 552

McKee-Pedersen Instruments, Box 322, Danville, CA 94526. (415) 937-3630. (R. McKee)
Circle No. 553

Megavolt Inc., 211 W. 61 St., New York, NY 10023. (212) 245-2727. (H. Tekel)
Circle No. 554

MIL Elecs. Inc., 176 Walker St., Lowell, MA 01854. (617) 453-4142. (B.W. Eldridge)
Circle No. 555

James Millen Mfg. Co., Inc., 150 Exchange St., Malden, MA 02148. (617) 324-4108. (J. Millen)
Circle No. 556

NCR, Scott Electronics Div., P.O. Box 898, Lake Mary, FL 32746. (305) 323-9250. (A. Egan)
Circle No. 559

NH Research Inc., 1510 S. Lyon St., Santa Ana, CA 92705. (714) 835-1616. (N. Paik)
Circle No. 557

NJE, P.O. Box 50, Dayton, NJ 08810. (201) 329-4611. (D. Bruni)
Circle No. 558

North Electric Co., Elecs. Div., P.O. Box 688, Galion, OH 44833. (419) 468-8100. (J.D. Neff)
Circle No. 559

North Hills Elecs. Inc., Alexander Pl., Glen Cove, NY 11542. (516) 671-5700.
Circle No. 560

OECO Corp., 712 S. E. Hawthorne Blvd., Portland, OR 97214. (503) 238-2440. (D. Fuller)
Circle No. 575

Peschel Instruments Inc., 1412 Viscaya Pkwy., Cape Coral, FL 33904. (813) 542-3164. (W. Strobel)
Circle No. 561

Powercube Corp., 214 A Calvary St., Waltham, MA 02154. (617) 891-1830. (C. Schuler)
Circle No. 562

Power Designs Inc., 1700 Shames Dr., Westbury, NY 11590. (516) 333-6200. (R. Roth)
Circle No. 563

Power-One Inc., 531 Dawson Dr., Camarillo, CA 93010. (805) 484-2806. (L. Wallace)
Circle No. 564

Powertec Inc., 9168 Desoto Ave., Chatsworth, CA 91311. (213) 882-0004. (J. Poturny)
Circle No. 565

Power Technology Inc., 7925 Mabelvale Cutoff, Little Rock, AR 72204. (501) 568-1995.
Circle No. 566

PRD Elecs. Inc., Sub Harris Corp., 1200 Prospect Ave., Westbury, NY 11590. (516) 334-7810. (R.R. Uhrich)
Circle No. 567

PTK Corp., 825 Capitolio Way, San Luis Obispo, CA 93401. (805) 544-7948. (M. Stephens)
Circle No. 591

Reich Associates Inc., Box 73, Plano, TX 75074. (214) 424-7904. (E. Reich)
Circle No. 568

Semiconductor Circuits Inc., 306 River St., Haverhill, MA 01830. (617) 373-9104. (P. LaBrie)
Circle No. 570

Shindengem Electric Mfg. Co. Ltd., New-Ohtemachi Bldg., 2-1 2-Chome Ohtemachi, Chiyoda-ku, Tokyo (03)794431. (T. Shimamura)
Circle No. 571

Sola Electric Div., 1717 Busse Rd., Elk Grove Village, IL 60007. (312) 439-2800. (I. Roane)
Circle No. 572

Sorensen Co., 676 Island Pond Rd., Manchester, NJ 03103. (603) 668-4500. (R.J. McCue)
Circle No. 573

Spellman High Voltage Elecs., 1930 Adeo, Bronx, NY 10469. (212) 671-0300. (M. Civic)
Circle No. 574

TDK Elecs. Co., 14-6 2-Chome, Chichikanda, Chiyoda-ku, Tokyo.
Circle No. 576

Technipower Sub. Benrus, Benrus Center, Ridgefield, CT 06877. (203) 431-1300. (A. Saenz)
Circle No. 577

Tectetics Inc., 1625 Range St., Boulder, CO 80302. (303) 442-3837. (V. Garrison)
Circle No. 578

Teledyne Brown Engineering, Cummings Research Park, Huntsville, AL 35807. (205) 532-1208.
Circle No. 579

Teledyne MEC, 3165 Porter Dr., Palo Alto, CA 94304. (415) 493-1770. (F. May)
Circle No. 580

Todd Products Corp., 123 Milbar Blvd., Farmingdale, NY 11735. (516) 293-3440. (B. Savold)
Circle No. 581

Transistor Devices Inc., 85 Horsehill Rd., Cedar Knolls, NJ 07297. (201) 267-1900. (J.A. Gilson)
Circle No. 582

Transrex Div. Gulton Inds. Inc., 2001 W. Artesia, Torrance, CA 90504. (213) 327-9224. (M. Anderson)
Circle No. 583

Triad-Utrad Div., Litton Systems Inc., 305 N. Briant St., Huntington, IN 46750. (219) 356-7100. (J.A. Tracy)
Circle No. 584

Tucker Elecs. Co., P.O. Box 1050, Garland, TX 75040. (214) 348-8800. (J.K. Schrenghost)
Circle No. 585

Universal Voltronics, 27 Radio Cir. Dr., Mount Kisco, NY 10549. (914) 241-1300. (B. Ressler)
Circle No. 586

Vectrol Inc., 1010 Westmore Ave., Rockville, MD 20853. (301) 424-6900. (R. Mitchell)
Circle No. 587

Velonex Div. Varian, 560 Robert Ave., Santa Clara, CA 95050. (408) 244-7370. (G. Obinger)
Circle No. 588

Venus Scientific Inc., 399 Smith St., Farmingdale, NY 11735. (516) 293-4100. (T. Krilovich)
Circle No. 589

Viking Elecs. Inc., 406 2 St., Hudson, WI 54016. (715) 386-5188.
Circle No. 590

Voltex Co., Inc., 115 Marine St., Farmingdale, NY 11735. (516) 249-2336. (N. Rothenberg)
Circle No. 592

VTA Inc., 2125 Pearl St., Boulder, CO 80302. (303) 449-5484.
Circle No. 593

Wall Industries, 175 Middlesex Tpke., Bedford, MA 01730. (617) 275-0708.
Circle No. 597

Weinschel Engineering, 1 Weinschel Lane, Gaithersburg, MD 20760. (301) 948-3434. (W. Ronis)
Circle No. 594

Wilmore Electronics Co., Inc., P.O. Box 2973, West Durham Station, Durham, NC 27705. (919) 489-3318. (T.G. Wilson)
Circle No. 595

Zi-Tech Div., Aikenwood Co., 223 Forest Ave., Palo Alto, CA 94301. (415) 326-2151. (J. Lincoln)
Circle No. 596

THE BIG SWITCH

(and Powertec)

Why Switchers?

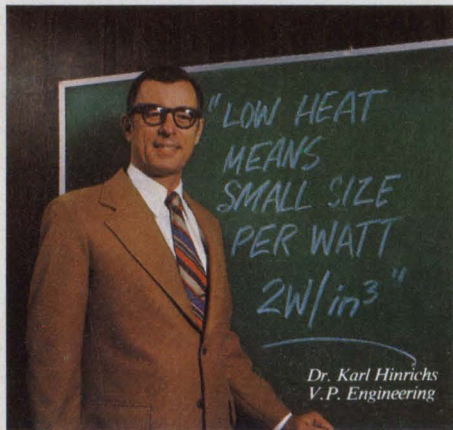

Dr. Karl Hinrichs
V.P. Engineering

1. Twice the efficiency for a more economical, reliable system

Efficiency ratings of 80% are common in switching-regulated power supplies, compared to 40% or less for linear-regulated supplies. For the same output power level, then, the switched supply throws away only 1/9 the heat.

requires less space for sinks and fans. For the user, it means a smaller system . . . or more capability in the same package.

3. Fewer high-temperature, high-power components for improved reliability

Switching technology can replace the 22 hot (120°C Rise) power transistors of a 600-watt linear supply with 4 cool (20°C Rise) transistors. Also, the power-sharing resistors are eliminated, and both storage and filter capacitors are greatly reduced in size. The parts count of a switching regulator is higher, but the additional components operate at very low stress levels and do not add appreciably to the failure rate.



energy storage is performed "off-line" at high voltage (energy storage improves with the square of the voltage, while electrolytic capacitor volume is proportional to voltage). A switching-regulated supply can readily keep output voltages within regulation limits for 30 msec following loss of AC input power.

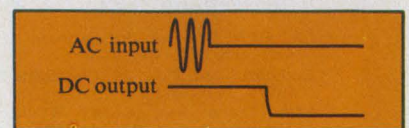

This represents a substantial improvement over the normal 2 msec achieved by linear power supplies where the cost and size of comparable storage are excessive.

6. Not completely a bed of roses

While advantages of switching regulators far exceed disadvantages, there are certain characteristics which require close consideration before final selection.



Switching generally produces an order-of-magnitude more EMI, both conducted and radiated, so that shielding and filtering must be integral to the design. Also, an order-of-magnitude difference in response time between switching and linear regulators dictates that a switcher be designed with adequate output capacity.

Below 300 watts, control circuitry cannot be appreciably reduced, so that low-power switchers are more expensive than the series equivalents. Above 300 watts, however, the inherent power-saving advantages of switching technology dominate, yielding lower costs at higher power.

Can you afford to waste 1750 watts?

AC INPUT POWER 2500 WATTS
(For 750 Watts DC output)

Conventional Series Regulated Design.
Efficiency = 30%



DC OUTPUT POWER 750 WATTS

DISSIPATED POWER 1750 WATTS
(Wasted)

937 WATTS

Powertec's New Super Switcher
Efficiency = 80%
(Model 9N15-50)



750 WATTS

only 187 WATTS

This reduction in wasted power and heat-removal burden results in lower operating costs. Lower temperatures mean longer life for both supply and system.

2. One-fourth the size and weight reduces the size of your system

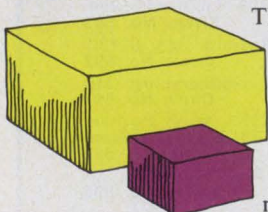

The same output power is available in less than 1/4 the size and weight of conventional supplies. High-frequency magnetics are small,

and less capacity is required to smooth high-frequency ripple. The low heat loss

4. Operation under brown-out conditions

Switcher operation over a +10/-20% line is available. A linear-regulated supply operating over a +10/-10% line would have to increase dissipation by 30% to meet a +10/-20% line requirement. A switching regulator's efficiency is nearly independent of input voltage range.

5. A 30-msec UPS for reduced down time

Energy storage time (carryover) is greatly improved over linear designs because

SOME PRIME APPLICATIONS

- Add-on memory systems
- Computer main frames
- Telephone systems
- Display consoles
- Desktop instruments
- Data acquisition systems

IS TO SWITCHERS

leads the way)

Why Powertec?

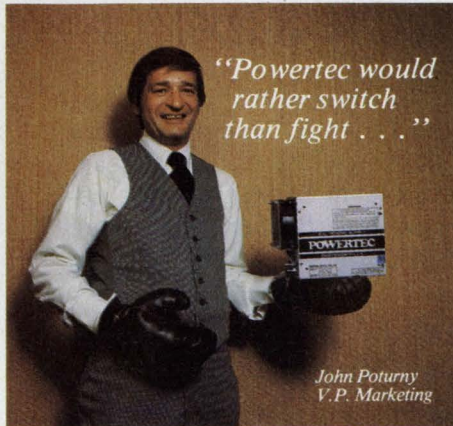

It isn't that we're not fighters. Over the years we fought our way to the top in open frame and sub-module power supplies. We fought hard for our position of leadership by developing new, innovative techniques . . . and by producing the highest quality power supplies at competitive prices.

This determination to "lead the way" is why we have placed such heavy emphasis on switching technology during the past five years. It's why Powertec's line of SS Series Super Switchers is already considered the industry standard . . . and why, today, there are over 4100 SS units in use throughout the world.

Good reasons for choosing Powertec switchers

Efficient, Small and Light

The SS Series case is a compact 10 x 7 $\frac{3}{4}$ x 5 inches. It weighs a remarkably light 12 pounds. Yet efficiencies of up to 80% are attained! This combination of efficiency and small size results in the highest watts/in³ available today.

Modularized by Function

Each Super Switcher uses functionalized modular P.C. boards to eliminate most wire harnessing, reduce potential high pot

failures, and increase reliability through design simplification.

Cyclic Testing and Burn-in

Each SS undergoes a 24-hour burn-in with cyclic testing where, at elevated temperature, AC input is turned on and off, the load step changed from N.L. to F.L. to N.L., and output terminals short circuited on and off during switching. Dependable long-life performance is assured, with minimum danger of "infant" failures.

Master/slave Capability

Up to four units can be paralleled on an *equal load sharing* basis . . . without power supply modification.

Advanced Features

Slow turn-on circuitry protects against high line current surges. Energy storage time (carryover) assures output voltage within regulation limits for at least 30 msec. Overload and overvoltage protection, logic inhibit function, remote sensing, and remote voltage programming are standard features.

Broad Model Range

The SS line offers ten standard models, with outputs from 2V, 200A to 28V, 28A and an exceptionally wide range of inputs. Each model is programmable.

Highest Quality Components

Premium-grade low ESR capacitors are designed into output filter circuitry. A long-life fan and large internal heatsinks provide efficient cooling in any mounting plane.

Model Number	DC Output			
	Voltage Nominal	Current @ +40°C	Efficiency (Typical)	Price
9N2-200	2.0V	200A	55%	\$695
9N5-150	5.0V	150A	80%	\$695
9N5-120	5.0V	120A	65%	\$625
9N6-100	6.0V	100A	65%	\$625
9N12-50	12.0V	50A	75%	\$625
9N15-50	15.0V	50A	80%	\$625
9N17-42	17.0V	42A	80%	\$625
9N20-40	20.0V	40A	80%	\$625
9N24-33	24.0V	33A	80%	\$625
9N28-28	28.0V	28A	80%	\$625

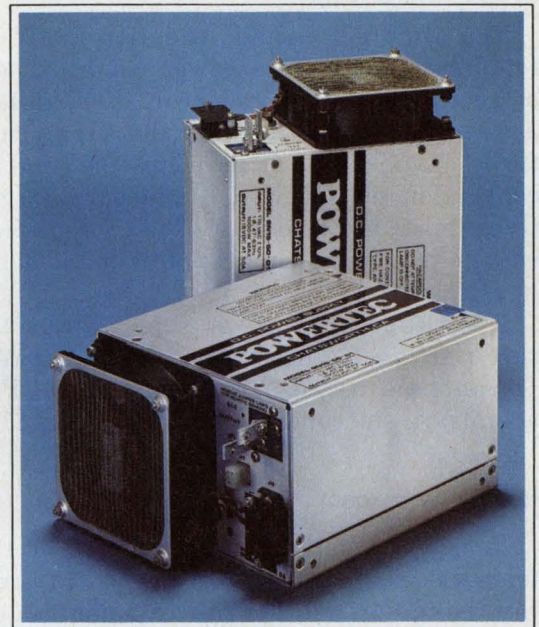

Summing it up

Any relatively new technology demands close evaluation of a company's reputation and past record. Powertec invites just such an evaluation . . . by you, personally. We're confident that our SS Series is unrivaled in quality, craftsmanship, and design. We're also confident that we can answer any questions or help solve any design problems you may have.

Just give us a call, or send us your specs and a statement of your requirements.

Free Instructive Booklets

1. Switcher Evaluation Guide
2. How to Spec a Switcher

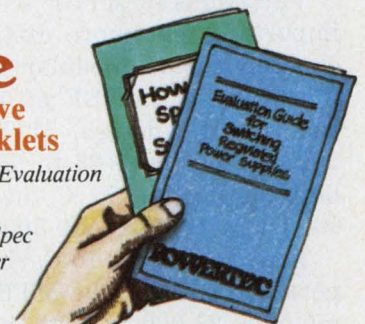

9168 DeSoto Avenue, Chatsworth, California 91311 • (213) 882-0004 • TWX 910-494-2092

POWERTEC

Keep modular supplies going by limiting heat build-up. Just a modest temperature rise can drastically shorten lifetime.

Too often not enough attention is given to the temperature rise of a power supply. The results of such neglect are premature field failures and a tarnished reputation for the supply manufacturer. To avoid such problems, use the supply's conversion efficiency (η) and surface geometry to estimate the heat rise. The computation is an easy-to-perform, semigraphical method based on physical laws.

Knowledge of a power supply's case-temperature rise gives a measure of long-term reliability (mean time between failures, or MTBF) under actual system conditions.

Reliability is cool

Consider reliability as a function of time and temperature. System or component reliability can be described by the exponential equation $R(t) = e^{-\alpha t}$, where α , the average failure rate, equals $1/\text{MTBF}$, and t is the desired operating time. (Fig. 1).

The curve shows that after a supply has survived the infant-mortality stage, about a 15% failure rate is statistically probable if a system or component has operated for 20% of its effective MTBF. But 85% of the units remain operational, which is the bright side of the coin. At the end of about 3-1/2 years, a power supply with a 150,000-h MTBF may, statistically, exhibit a 15% failure rate.

Variations in MTBF with temperature are also important, but more difficult to pin down. For example, some modular series-pass power supplies have an MTBF of 150,000 h at 25 C. For this specific design, MTBF decreases by about 2500 h/°C in the 25 to 55-C temperature range; between 55 and 71 C the MTBF decreases at a steeper rate of about 3000 h/°C.

Thus a modest 10-C rise in the ambient temperature reduces the MTBF of this design by as much as 25 000 h. Note, however, even with that loss the MTBF earns high marks for reliability

in the field of economy-priced encapsulated supplies.

Figure 1 shows that the loss of 30,000 h can be more serious than first appears. Many engineers mistakenly believe that an MTBF rating of, say, 150,000 h means that equipment will operate reliably for that period of time. Rather, this rating predicts that at the end of 150,000 h it is probable that two out of three units will have failed.

Watch for misleading MTBFs

All the definitions in the world won't help prevent thermal stress and reliability problems if specsmanship is applied to a supply's MTBF rating. To get the correct MTBF requires the measurement of both the electrical and thermal stress of each component under actual operating, worst-case conditions: at high line and full load.

The MTBF of each component is then calculated and all the values properly combined to provide an average figure. These measurements are usually made at 25 C; other operating points can be used to generate a curve of MTBF vs temperature.

Unfortunately, no general statement can be made about power-supply reliability as a function of temperature. The specific design determines whether the unit must be derated at elevated temperatures and how reliability varies with temperature. Each design must be evaluated separately.

It's important to remember that power supplies usually operate in enclosures along with other components that generate or are sensitive to heat. Under such conditions, proper thermal management is mandatory to achieve a reliable system.

Getting a handle on heat

A 100%-efficient supply converts all of its input into useful output, so that only the load generates heat. A more realistic supply—one with losses—is modeled in Fig. 2. The power loss within the supply (P_d) must be singled out as both an energy waster and the primary cause of heat rise. Inefficient power transformers, regulators

Paul LaBrie, Executive Vice President, and William D. Miller, Consultant, Semiconductor Circuits, Inc., 306 River St., Haverhill, MA 01830.

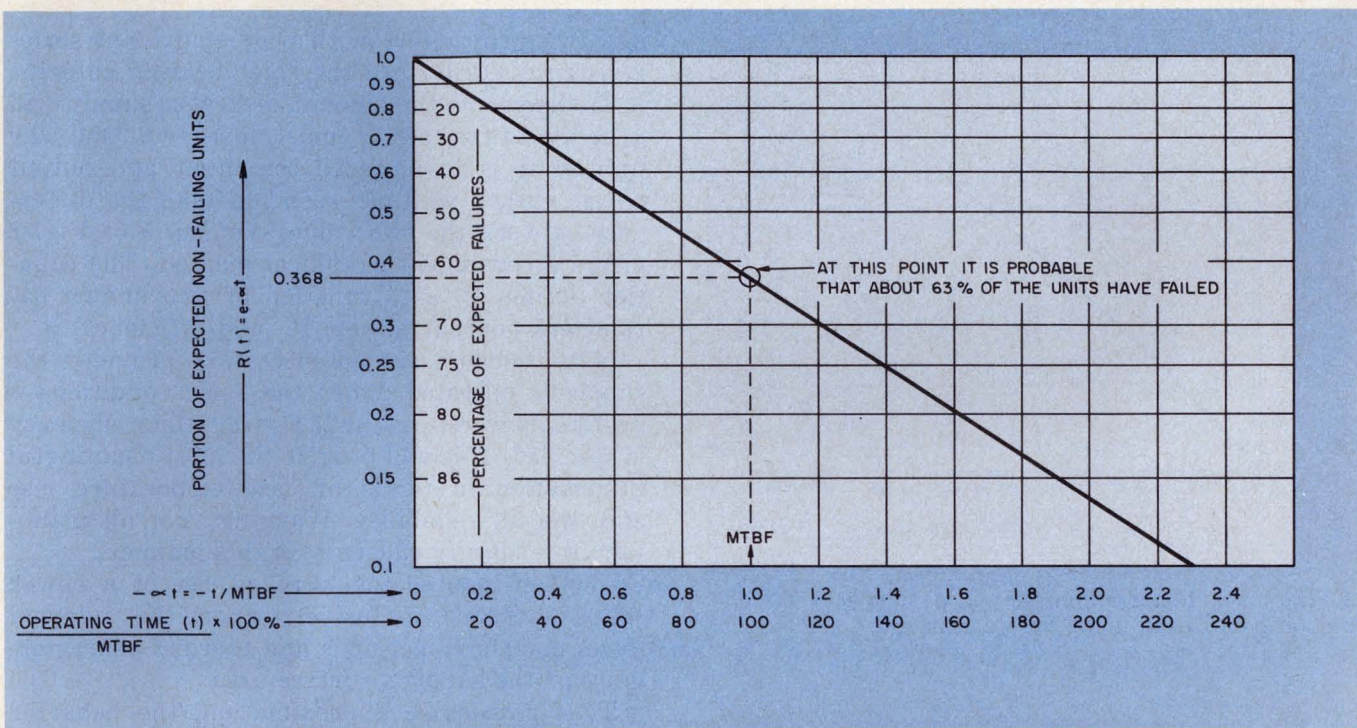

1. When a product's failure rate is described by an exponential equation, the mean-time-between-failures

(MTBF) indicates the probability of failure—not how long the product goes before failing.

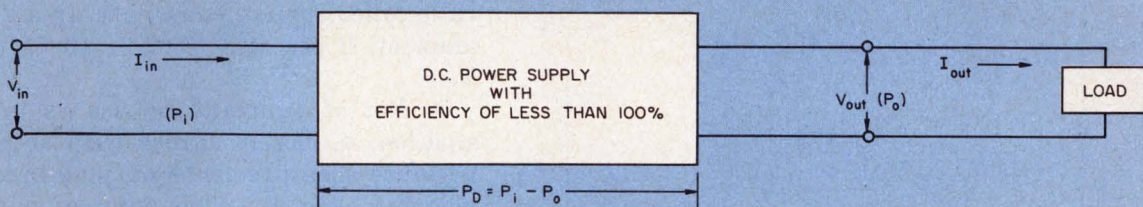

Definitions of terms

- a) P_i is the input power in watts.
- b) P_o is the output power in watts.
- c) P_D is the power lost or dissipated in the supply and produces the case temperature rise of the supply.

Working equations

- 1) Efficiency, $\eta \Delta (P_o/P_i) \times 100\%$
- 2) $P_D = P_i - P_o$
- 3a) From 1: $P_i = P_o/\eta$
- 3b) From 2: $P_i = P_o + P_D$
- 4. Combining the results of 3: $\eta = \frac{P_o}{P_D + P_o}$
- 5. Solving 4 for P_D : $P_D = P_o \frac{(1 - \eta)}{\eta}$

2. Practical power supplies have losses. To calculate the power dissipated (P_d) within a supply requires a

knowledge of both the input and output power. The chief energy wasters are the transformers and regulators.

The greater the inefficiency, the greater the heat

Model	A	B	Brand X
Efficiency	75%	40%	35%
Output power	5 W	*	*
Dimensions	2.5 × 3.5 × 1.25 in.	*	*
Surface area	32.5 sq. in.	*	*
Case temperature rise	8 C	28 C	35 C

* Same as first column values

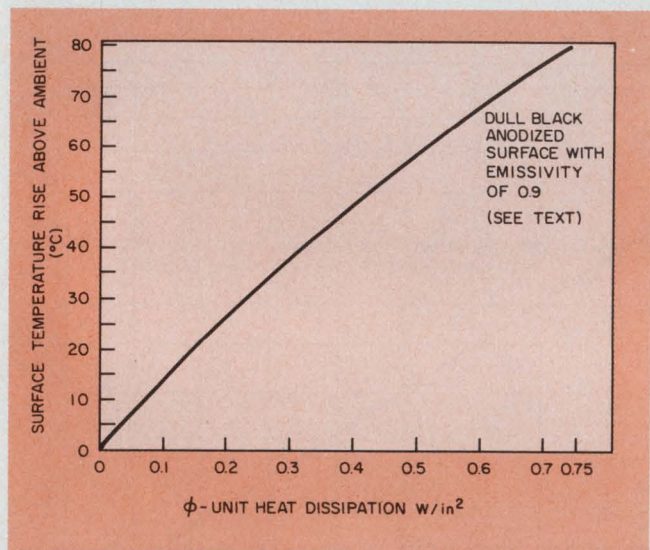

3. The case temperature rise of a supply is directly proportional to the unit's heat dissipation.

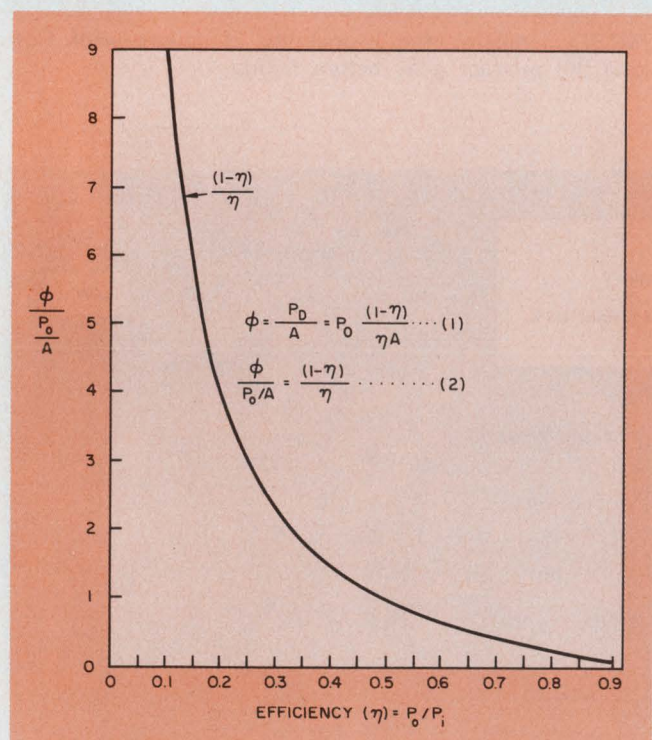

4. How efficiency (η) affects heat dissipation: The greater the η , the cooler the supply.

and filter capacitors with poor equivalent series resistance (ESR) are the chief heating culprits.

To determine the amount of heat a supply will generate in free air, P_d must be known. One way to find it is to measure the input and output power with a wattmeter and to take the difference between the two values. Or Eq. 5 of Fig. 2 offers a convenient graphical method. The equation defines P_d as a function of two known parameters—output power, P_o , and efficiency, η .

Measurements are not necessary provided the supply is operated under the same conditions—preferably worst-case at 25 C—for which efficiency is specified. This will provide the most meaningful information in terms of case-temperature rise and over-all reliability. Warning: not all manufacturers specify efficiency in this manner..

The self-induced temperature rise of a power supply depends exclusively upon the internal losses and the dimensions and thermal characteristics of the supply's surface area.

To a reasonable approximation, the behavior follows Stefan's Law, $R = E_T \sigma (T_2^4 - T_1^4)$, where R is the power supply's radiated energy loss in W/in^2 and σ is a constant. T_2 is the power-supply temperature and T_1 is the ambient temperature—both in degrees Kelvin. The factor E_T diminishes at higher temperatures and is a dimensionless ratio called surface emissivity. In a 27-C (300 K) ambient, R becomes $(3.67 \times 10^{-11}) (E_T) (T_2^4 - T_1^4)$.

A plot of temperature rise vs unit heat dissipation, ϕ , closely agrees with actual case-temperature measurements of plug-in encapsulated modules (Fig. 3). This kind of supply is used extensively because of its compactness and convenient geometry, but since the small size makes it susceptible to thermal problems it will be quite useful to analyze the free-air thermal behavior of the encapsulated supply.

When both P_d and the surface area of the supply are known, the resulting temperature rise is found easily from Fig. 3. For example, the figure shows that a supply dissipating $0.2 W/in^2$ will experience an average temperature rise of about 25 C above ambient. Thus a modular power supply, with dimensions $L \times W \times H$ in., that dissi-

pates P_d watts into free space will have a ϕ of

$$\frac{P_d}{2(LW+HW+HL)} = \frac{P_d}{\text{Surface area}}$$

A graph of ϕ vs efficiency clearly demonstrates that the more efficient a power supply is, the less heat is generated (Fig. 4). The main value of such a graph is that it quickly provides a value for ϕ as a function of operating efficiency. The derived value of ϕ can then be applied to Fig. 3 to find the average case-temperature rise.

Figs. 3 and 4 can provide the operating efficiency when the average case-temperature rise and module dimensions are known. For example:

Suppose you want to find the average case-temperature rise of a number of power supplies. Model A is 75% efficient, Model B is 40% efficient, and a competing unit, brand X has an efficiency of less than 35%.

Each power supply produces a full-rated output of 5 V dc at 1 A, and each is packaged in a case that is $2.5 \times 3.5 \times 1.25$ in.

The solution for all models follows:

$$P_o = V_o \times I_o = 5 \text{ V} \times 1 \text{ A} = 5 \text{ W} \quad (1)$$

$$\text{Surface area } A = 2 [LW+HW+HL] = 2 [(2.5 \times 3.5) + (1.25 \times 2.5) + (1.25 \times 3.5)] \quad (2)$$

$$\frac{P_o}{A} = \frac{5}{32.5} = 0.154 \text{ W/in}^2 \quad (3)$$

For each model, Fig. 4 gives the value of $\phi/(P_o/A)$. The values are 0.3, 1.5 and 1.8 for Models A, B and X, respectively. The value of ϕ for each supply is found by equating $\phi/0.154$ to the graph values. Thus $\phi = 0.046$, 0.230 and 0.277 W/in.², respectively. Entering each value of ϕ into Fig. 3 gives the average case-temperature rise (Δt) of each supply. The approximate Δt for Model A is 8 C; for Model B, it's 28 C and for X, the Δt is 35 C.

Efficiency quenches heat

Table 1 summarizes the power-supply characteristics and illustrates the effect of efficiency upon temperature. Using the previous approximations for the rate of change of MTBF over various temperature ranges—2500 h/°C between 25 C and 55 C and 3000 h/°C between 55 C and 71 C—the reduction in MTBF can be calculated for Models A and B.

Alternately, you can determine efficiency once the average case temperature rise is known. Assume the brand A supply has been redesigned so that its case-temperature rise is now only 20 C. If the case size and the power-output rating remain as before how efficient is the supply?

From the previous example, $P_o/A = 0.154$ W/in.². From Fig. 3, the value of ϕ that corresponds to a 20-C rise is 0.15 W/in.². Then

$$\phi/(P_o/A) = 0.15/0.154 = 0.974.$$

From Fig. 4, the efficiency is therefore about 50%. Remember that in most cases the operating efficiency of a supply varies widely with line and load; even so, η can be pinned down by the method outlined.

When you put it in a box

So far, the examples have assumed that the supply operates in a free-air environment. More likely, however, the supply and its load will be in an enclosure that restricts ventilation, and will be surrounded by a warm environment. That is the harsh world a power supply must survive.

Again, the efficiency, surface area and output power of the confined supply will determine the supply's average temperature rise above that of its enclosure (Fig. 5). Remember: the supply, its load and all other power-dissipating components—all contribute heat.

If the enclosure's surface area is too small, or if its radiation properties are inadequate, the cumulative heat inputs will surely reduce the MTBF, or worse, cause short-term failures of the internal components.

Consequently, the enclosure must dissipate all the heat, not just P_d . Total input power of the supply is expressed as P_o/η and can exceed P_d by a significant amount: 100% for a 50% efficient supply, for example.

Fig. 6 provides a convenient way to estimate the average temperature rise at the outer surface of an enclosure. Results must be fitted to each case because no rule covers all the possible variations in load and enclosure geometries. An example follows.

Assume that Model B, which is 40% efficient, is placed with its 5-W load into a sealed enclosure having a 325-in.² surface area and an emissivity of 0.9. The load is a resistor with a negligible surface area. What is the average temperature rise of the enclosure's surface?

The total ϕ is given by $P_o/\eta S_A = 5/(0.4)(325) = 0.038$ K/in.². From Fig. 6, the enclosure's average surface temperature rise, Δt , is approximately 13 C.

Both Fig. 6 and the equation for ϕ_{total} clearly show that a more efficient power supply or a larger surface area for the enclosure results in less heat per unit area being pumped to the outside world. But the equation tells nothing about the temperature rise of the supply—which could well be starting to melt.

The simplest way to determine the average case-temperature rise of the supply itself is to remove the load circuitry from the enclosure, and then determine the enclosure's surface temperature rise. With P_d the sole source of heat, Figs. 3 and 4 provide the needed information:

- ϕ_A = The unit dissipation of the enclosure in W/in.²
- A = Average surface area of enclosure
- ΔT_A = Average change of temperature of the enclosure surfaces
- B = Average surface area of power supply
- ΔT_B = Average change of temperature of power supply surfaces
- ϕ_B = The unit dissipation of the power supply in W/in.²

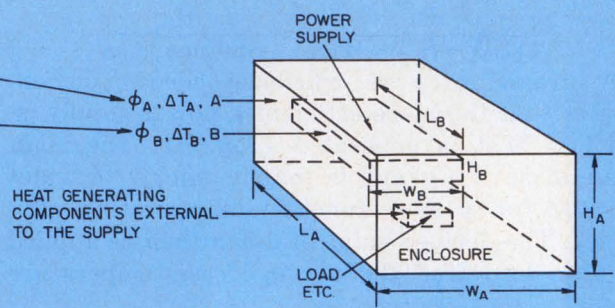

NOTES:

- (1) Surface area of enclosure $S_A = 2(H_A L_A + H_A W_A + L_A W_A)$
- (2) Surface area of power supply $S_B = 2(H_B L_B + H_B W_B + L_B W_B)$
- (3) $\phi_A = \frac{P_{in}}{S_A} \left(\frac{W}{in.^2} \right)$ is the enclosure unit heat dissipation.
- (4) $\phi_B = \frac{P_{in}}{S_B} \left(\frac{W}{in.^2} \right)$ is the power-supply unit heat dissipation.

5. **Things change rapidly** when an enclosure surrounds a power supply. The restriction or reduction in ventila-

tion can cut into MTBF or cause component failure. The solution: get rid of heat.

Suppose the 40% efficient supply remains in the sealed 325-in.² enclosure, but now the supply drives an external 5-W load. If the enclosure has an average surface-temperature rise of 3.8 C, what is the average case-temperature rise of the internal power supply?

Fig. 3 shows that a 3.8-C surface temperature rise for the enclosure corresponds to an enclosure ϕ of about 0.023/in.². Because the enclosure's surface area is 10 times that of the supply, the unit heat dissipation of the supply is 10 times greater than that of the enclosure. Therefore, $\phi_{supply} = 10 \phi_{enclosure} = 10 \times 0.023 = 0.23 \text{ W/in.}^2$. Fig. 3 gives the supply's case-temperature rise, Δt , as about 28 C.

Notice that the ϕ s of both the enclosure and the supply are in inverse proportion to the respective surface areas, a valid relationship when the power supply is considered to be the sole source of heat.

But notice, too, that the 10:1 surface-area ratio produces only an approximate 7:1 temperature-rise ratio. This occurs because the temperature rise of each surface area is determined from the nonlinear curve of Fig. 3. To repeat: an enclosure that is cool to the touch can contain circuitry that is a great deal warmer.

Why average values?

The average-surface-temperature approach is valuable because it best fits the nature of the problem (though it can lull one into a false sense of security). Generally, both the power supply and the load contain hot spots from which larger amounts of heat (per unit area) radiate.

The components that make up the load, for example, rarely dissipate equal amounts of heat

because each usually serves a different circuit function. Undefined load-circuit geometry—that is the random location of components on a PC board—further strengthens the case for average heat values.

Major heat sources in an encapsulated series-pass supply include the power transformer, the rectifier diodes and the series-pass transistors. Lesser amounts of heat are generated by the reference diode, the filter capacitors and the reference circuitry. Because these components operate at different temperatures, and are distributed throughout the module, temperature gradients will always exist to some degree.

Alleviating the situation, though, is the epoxy encapsulant, which conducts heat away from the supply components about six times more effectively than air. This promotes more even heat distribution over the module's surface area—in effect, a form of averaging.

Averaging won't eliminate the problems that arise when careless circuit-board layout places the power supply too close to another component or restricts the flow of convective air currents. If a hot spot on any component faces a neighboring component, averaging may not be helpful.

Two crucial links in the chain of reliability, then, are a thermally effective enclosure and a board layout that minimizes heat coupling between components while sustaining convective air flow. Remember, peak temperatures can combine to destroy components despite the use of an amply proportional enclosure.

Using average temperature rise

The average internal temperature can be estimated with reasonable accuracy, assuming that

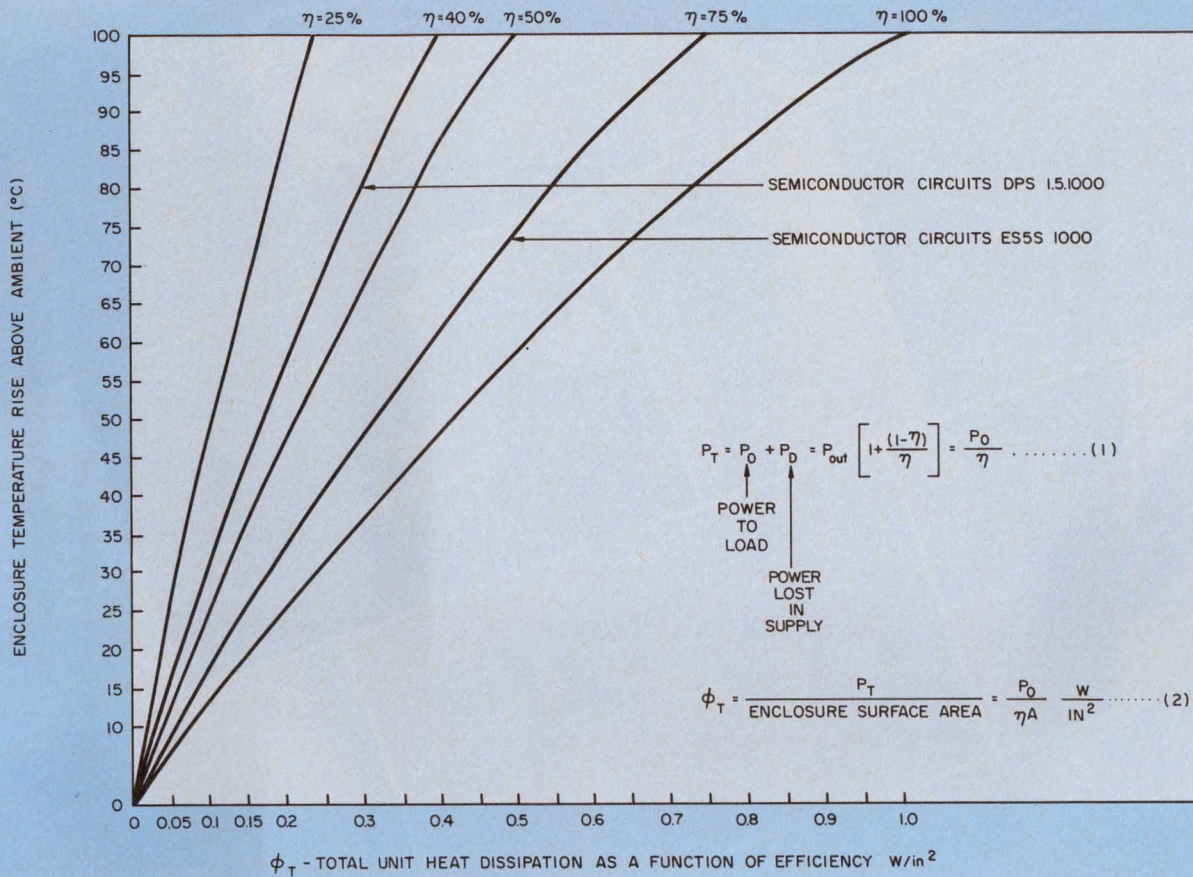

6. Curves can help in estimating the average rise in temperature at the outer surface of an enclosure. Be-

cause of load and case-geometry variations, each supply should be analyzed individually.

the power supply and its distributed load are secured to a common PC board and that the board is somewhat centrally located within a sealed enclosure.

A form of averaging results from the latter condition and, for purposes of calculation, leads to the postulate that half of the internal heat-generating components are contained within a scaled down imaginary enclosure with half the area, but of the same shape, as the actual enclosure.

From the geometry, each linear dimension of the imaginary enclosure is $1/\sqrt{2} \approx 0.707$ the size of the real dimensions. Assume that the ϕ s of the actual and imaginary enclosures are linearly proportioned based on the respective surface areas; the temperature rise of each enclosure is again determined from Fig. 3.

To illustrate, use Model B, this time with its distributed 5-W load mounted on a common circuit board and placed in a sealed enclosure 11 × 8 × 4 in. With an average temperature rise of, say, 13 C at the enclosure's surface, the "half-area" method determines the average internal-temperature rise:

The enclosure's surface area $S_A = 2 (LW + LH + WH) = 2 [(11 \times 8) + (11 \times 4) + (8 \times 4)] =$

328 in². The imaginary enclosure's surface area (A_1) is $1/2 S_A = 1/2 \times 328 = 164$ in². Thus:

$$\phi_{total} = \frac{P_o}{7 A_1} = \frac{5 \text{ W}}{(0.4) (164) \text{ in}^2} \approx 0.076 \frac{\text{W}}{\text{in}^2}$$

From Fig. 6, the average internal temperature rise Δt for 40% efficiency is approximately +25 C. The power supply and its load consequently operate at a temperature of about 27 + 25 = 52 C.

Although this is an approximation, it shows close agreement with the previous example. Both ϕ_{total} and temperature have nearly doubled, showing that as the surface area of the heat source approaches that of the enclosure, the heat-rise ratio approaches the surface-area ratio.

Now consider the MTBF. If the board-mounted supply and load have individual MTBF's of 150,000 h, and if both use similar components, the combined MTBF is cut in half to 75,000 h.

The MTBF is further slashed by the 25-C internal temperature rise—by a staggering 2500 h/°C × 25 C = 62,500 h.

The final MTBF—a mere 12,500 h—almost guarantees that failures will occur 12 times earlier than the individual MTBF's imply. The low MTBF results from a modest 25-C temperature rise. ■■

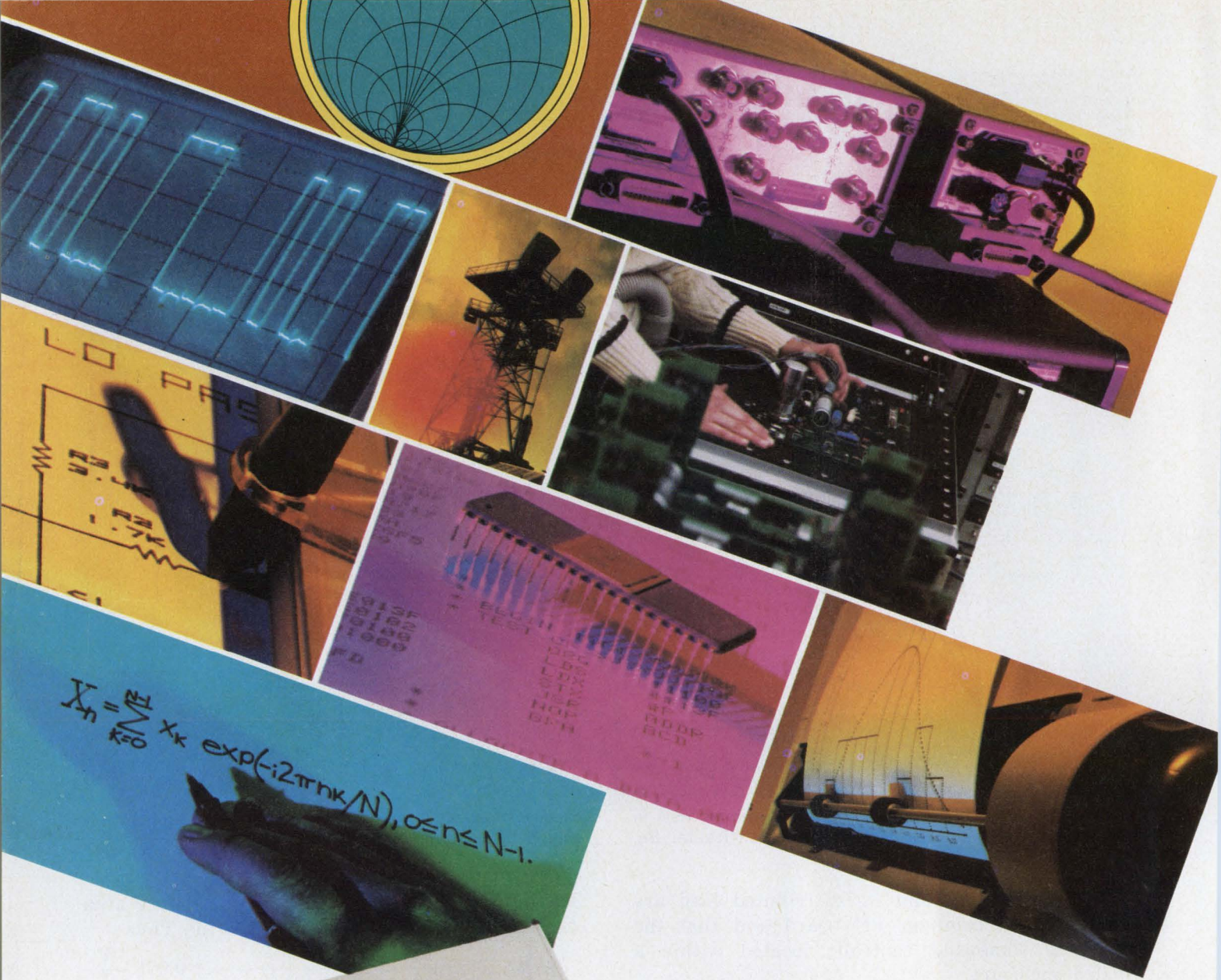

$$X_n = \sum_{k=0}^{N-1} x_k \exp(-i2\pi nk/N), \quad 0 \leq n \leq N-1.$$



Sharpen your competitive edge. Use an HP computing calculator for design, analysis, control, and test.

In the highly competitive, high technology electronics business, everything counts: keeping costs in line, exploring promising design alternatives, shortening lead-times, testing products and prototypes, and increasing productivity. That's where HP computing calculators, software, peripherals, and interfacing capabilities come in. They can help you get and maintain a competitive edge.

Three computing calculators and plenty of peripherals: It's your choice. We offer a range of computing power and I/O options so you can configure a system just right for you.

Choose the low-cost HP 9815 for programmed problem-solving, small interfacing applications, and quick keystroke calculations. It's easy to use and easy to justify.

The HP 9825 with interrupt, direct memory access, live keyboard, and a state-of-the-art NMOS processor has minicomputer

capabilities for systems control jobs and for raw number-crunching capability.

The HP 9830, programmed in BASIC, is an all-purpose system. With an extensive software library and a large choice of peripherals (including 4.8 million bytes of mass memory and data communications capability), it may be all the computing power a small company or a large department requires.

HP peripherals include card readers, paper tape readers/punches, printers, storage devices, a CRT, and a digitizer. And, the X-Y plotter is just the thing for analysis of circuit designs.

Software, specialized and generalized, helps you look at more alternatives.

HP engineers developed software to optimize designs and analyze engineering problems quickly. There's a State Variables package for control system analysis. There's CNAP for circuit design and analysis, BAMP for microwave design and analysis, and Digital Simulation for state and timing analysis.

You can add other programs, too—commonly needed math routines and statistical programs to name but two. Programs are also available for accounting applications, report generation, and financial analysis.

Automate your instruments. We make the connection friendly. From simple data logging to complex system integration, our programming commands and interface cards make instrument interfacing easy. Whether your instruments require BCD, bit-parallel, RS 232-C, or HP-IB (HP's implementation of IEEE Standard 488-1975), you plug the correct interface into the calculator and connect the cable to your instrument. It's the friendly connection.

HP computing calculators: from initial design to final test. Whether you're in research, design, production, or test—or all four—we can provide the computing power and programs to help you increase productivity and sharpen your competitive edge. We have a new brochure for electronic engineers that will show you how. Get a copy from your HP representative, or circle our reader service number in this magazine.

HP computing calculators put the power where the problems are.



Sales and service from 172 offices in 65 countries.

P.O. Box 301, Loveland, Colorado 80537

For assistance call: Washington (301) 948-6370, Chicago (312) 677-0400,
Atlanta (404) 434-4000, Los Angeles (213) 877-1282, Toronto (416) 678-9430

40614

Insulate with plastics and elastomers.

Today's smart designer must know the characteristics of thermosets and thermoplastics to remain competitive.

Plastics designed for electronics applications have come a long way during the past decade. The upper temperature limit, for example, has climbed to well beyond 500 F. Chemical advances have produced hundreds of high-performance plastics for such applications as potting, casting, encapsulating, insulating, packaging of assemblies, wire jacketing, and gasketing. Many of the benefits are made possible by adding fillers to each plastic.

But to make the right choice, you've got to know the difference between a thermoset and a thermoplastic. And you need to understand the major characteristics of each basic material within these two classes.

A third class of polymer is the broad range of rubber-like materials known as elastomers. There are currently a dozen recognized types of elastomers. But they are generally used only for cushioning materials, gasketing, wire jacketing, sealing or similar applications where rubber-like properties, coupled with some selected combination of mechanical, electrical, or fluid-retardant properties, are required. Some key characteristics of representative elastomers are listed in Table 4.

Nearly all plastics can be placed in one of two major classifications: thermosetting materials (thermosets) and thermoplastic materials. There are different processing techniques for each, with different applications and economic considerations. Since most thermosets are hard or brittle, fillers are usually added to them to influence product properties. Basically, thermoplastics are remeltable and thermosets are not.

Thermoplastics tend to be softer and more flexible than thermosets, with actual softness and flexibility varying over a fairly broad range. Although it is generally not necessary to add fillers

to thermoplastic materials, the use of filled (especially glass fiber) or reinforced thermoplastics has grown dramatically in recent years owing to the many improvements in strength that fillers make possible.

Thermosets include epoxies and silicones

A summary of the basic electrical data for thermosets is given in Table 1. The most important considerations in using thermosetting plastics as electrical insulation are as follows.

Development of alkyds, which have long been used in the electrical industry, has led to electronic-grade compounds of high performance. Comparisons of dielectric constant and dissipation factor for general-purpose and electronic-grade alkyd compounds are shown in Fig. 1.

The greatest limitations of alkyds are in extremes of temperature and humidity. Silicones and diallyl phthalates (DAPs) are superior here, especially with respect to humidity. The electrical-insulation resistance of alkyds decreases considerably in high, continuous-humidity conditions, as shown in Fig. 2.

Amino molding compounds are primarily of two types, melamines and ureas, and can be fabricated by economical molding methods. They are durable, hard, abrasion-resistant, and have high resistance to deformation under load. Melamines have good arc resistance and are widely used for connectors, although diallyl phthalate connectors are generally more electrically stable in high-humidity environments.

Diallyl phthalates rank among the thermosetting plastics that have highest insulation resistance and lowest electrical losses. Excellent properties are maintained up to 400 F or higher, and in the presence of high humidity. Also, diallyl-phthalate resins are easily molded and fabricated, and have excellent stability in nearly all mechanical and electrical properties.

The effect of frequency and temperature on dielectric constant is shown in Fig. 3; the loss characteristics of DAP as a function of temperature are shown in Fig. 4. Diallyl isophthalate,

Charles A. Harper, Systems Development Div., Westinghouse Electric Corp., Baltimore, MD 21203.

(This article includes material from the "Handbook of Electronic Packaging" and the "Handbook of Plastics and Elastomers," edited by Charles A. Harper and published by McGraw-Hill Book Co.)

Table 1. Electrical properties of thermosetting plastics

Material	Property				
	Volume resistivity (Ω -cm)	Dielectric constant at 60 Hz	Dielectric strength at 60 Hz	Dissipation factor ($\times 10^{-3}$) at 60 Hz	Arc resistance (sec)
Alkyd (mineral filled)	10^{13} - 10^{18}	5.1-7.5	350-450	9-60	75-190
Alkyd (glass filled)	10^{18}	5.7	350	10	180
Diallyl phthalate (mineral filled)	$>10^{13}$	5.2	395-420	30-60	140-190
Diallyl phthalate (glass filled)	10^{13} - 10^{18}	4.3	395-450	10-50	125-180
Epoxy (mineral filled)	$>10^{14}$	3.5-5.0	300-400	10	150-190
Epoxy (glass filled)	$>10^{14}$	3.5-5.0	300-400	10	120-180
Melamine (cellulose filled)	—	6.2-7.8	350-400	19-33	95-135
Melamine (glass filled)	2×10^{11}	9.7-11.1	170-300	14-23	180
Phenolic (wood-flour filled)	10^9 - 10^{13}	5.0-13.0	200-400	50-300	(tracks)
Phenolic (glass filled)	7×10^{12}	7.1	140-400	50	to 190
Polyester (glass filled)	10^{12} - 10^{16}	5.3-7.3	345-420	11-41	120-240
Silicone (mineral filled)	10^{14}	3.5-3.6	200-400	4-5	250-420
Silicone (glass filled)	10^{10} - 10^{14}	3.3-5.2	200-400	4-30	150-250
Urea (cellulose filled)	10^{12} - 10^{13}	7.0-9.5	300-400	35-43	80-150

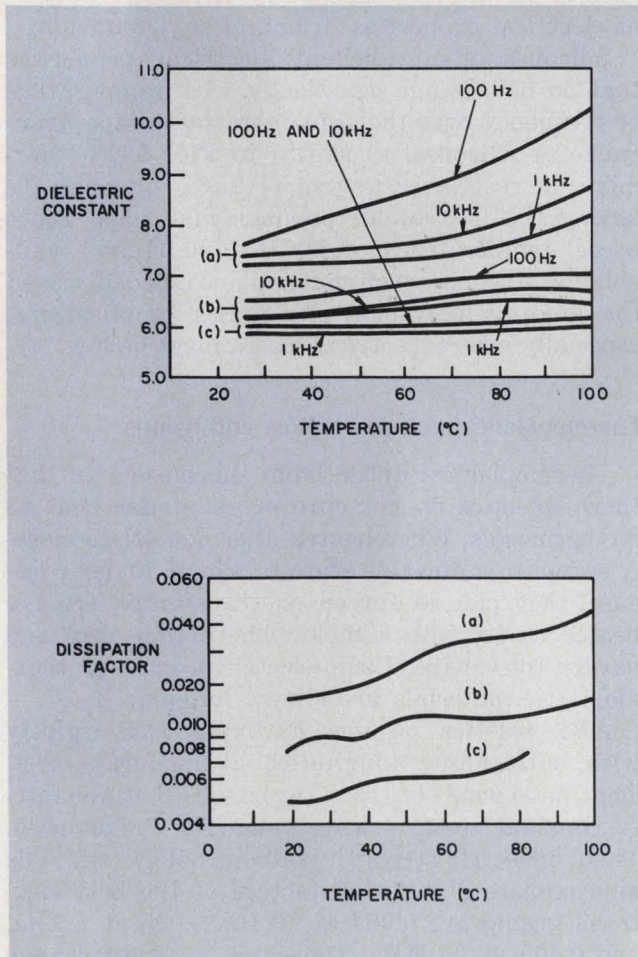

1. Dielectric-constant and dissipation-factor comparisons are shown for (a) general-purpose alkyds, (b) general-purpose electronic-grade alkyds, and (c) high-performance electronic-grade alkyds.

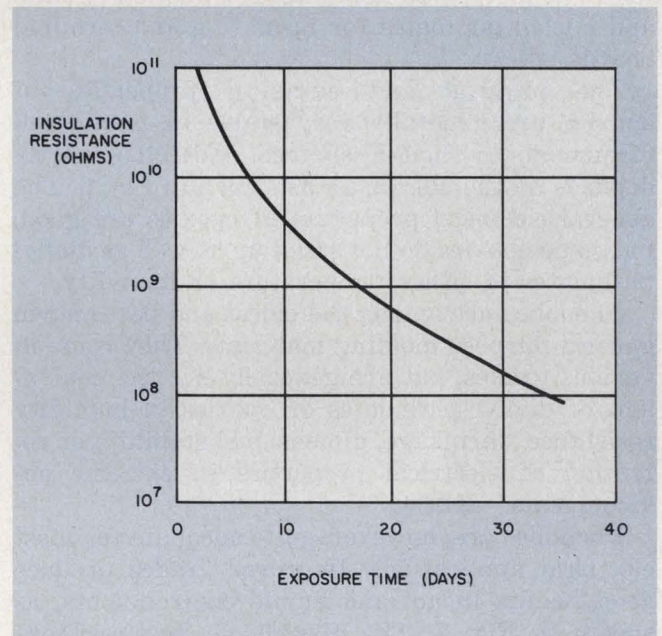

2. The insulation resistance of alkyds decreases considerably in high, continuous-humidity conditions.

DAIP, is also especially good in retention of dielectric strength, as indicated in Fig. 5. Among plastics, it rates high in resistivity levels.

Epoxyes are versatile

Epoxyes are among the most versatile and most widely used plastics in the electronics field, primarily because of the wide variety of formulations possible. They can easily be compounded and

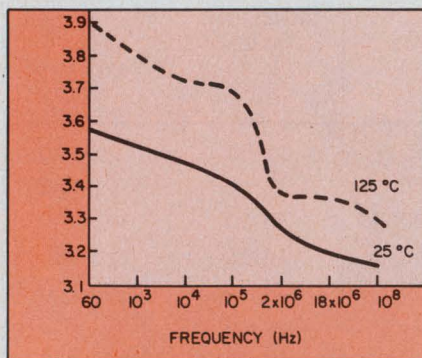

3. The dielectric constant of diallyl phthalate drops markedly as operating frequency increases.

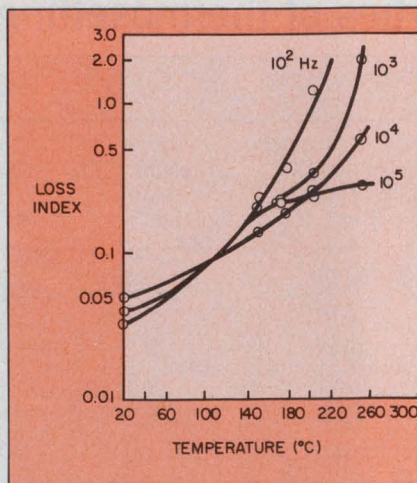

4. Loss index vs temperature and frequency is shown for glass-filled diallyl phthalate (DAP).

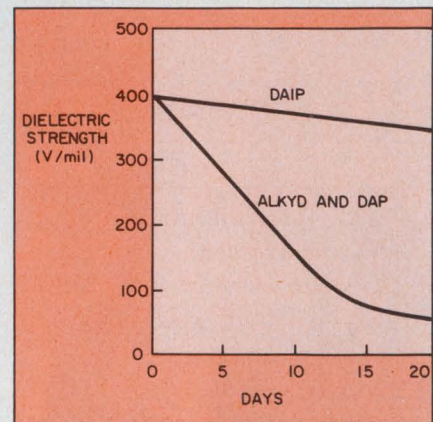

5. Diallyl isophthalate (DAIP) offers better retention of dielectric strength than alkyd and DAP materials.

used with minimal equipment requirements.

The broadest applications of epoxies in electronics are in embedding applications (potting, casting, encapsulating and impregnating) and in molded products. They are also used in such forms as metal-clad laminates for printed circuits and unclad laminates for insulating and terminal boards.

The physical and electrical properties of epoxies are generally very stable in humid environments, although surface resistivity partly depends on the filler used, as shown in Fig. 6. The general electrical properties of epoxies are good, but some epoxies do not stand up as well as diallyl phthalates to either temperature or humidity.

Phenolics are among the oldest and best known general-purpose molding materials. They come in various grades, but are generally not the equivalent of diallyl phthalates or epoxies in humidity resistance, shrinkage, dimensional stability, or retention of electrical properties in extreme environments.

Phenolics are, however, quite adequate for most electrical applications. Improved grades produce good results in hot and humid environments, as shown in Fig. 7. The glass-filled, heat-resistant grades have outstanding thermal stability up to 400 F or more.

Polybutadienes are a versatile family of thermosetting plastic materials that have excellent properties and that are stable at high frequencies and elevated temperatures. Further, these materials offer low moisture absorption, excellent chemical resistance, and excellent thermal stability. They are fast curing, and can be molded, laminated or used as casting and potting materials.

Polyesters are versatile resins. The liquids are used, as epoxies are, for embedding applications and laminated products. The pastes are used for molding applications.

Their major advantages over epoxies are lower cost and the appreciably lower electrical losses. Some comparative disadvantages are lower adhesion to most substrates, higher polymerization shrinkage, a greater tendency to crack during cure or in thermal shock, and a greater change of electrical properties in humid environments.

Silicones offer excellent electrical properties that do not change drastically with temperature or frequency over the safe-operating-temperature range of silicones, as shown in Fig. 8. Furthermore, in resistance to temperature, silicones are among the best of all polymer materials. Since useful temperatures of 500 to 700 F are available for silicones, such materials are broadly used for high-temperature electronics applications, especially where electrical losses must be low.

Thermoplastics include acrylics and nylons

Thermoplastics differ from thermosets in that thermoplastics do not cure or set under heat as do thermosets. When heated, thermoplastics merely soften to a flowable state in which, under pressure, they can be forced or transferred from a heated cavity into a mold, where they cool and harden into shape. Basic electrical data for thermoplastic materials are shown in Table 2.

ABS plastics possess hardness and rigidity with outstanding toughness, at moderate cost. They have good electrical properties that are fairly constant over a wide range of frequencies. Their dielectric strength is about 350 V/mil. The approximate dissipation factors of the best electrical grades are 0.004 at 60 Hz, 0.005 at 1 kHz, and 0.009 at 11 MHz. Dielectric constants range from 2.4 to 5.0, volume resistivities from 1.0 to $5.0 \times 10^{16} \Omega\text{-cm}$, and arc resistance from 50 to 90 seconds.

Acetal plastics are tough, high-performance in-

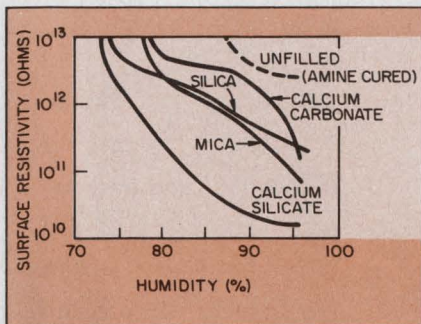

6. The resistance properties of epoxies exposed to humidity are affected by the fillers used.

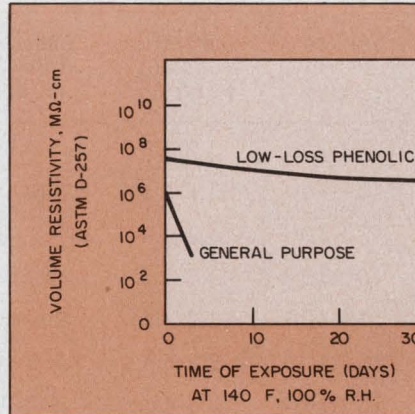

7. The humidity effects on volume resistivity are compared for general-purpose and low-loss phenolics.

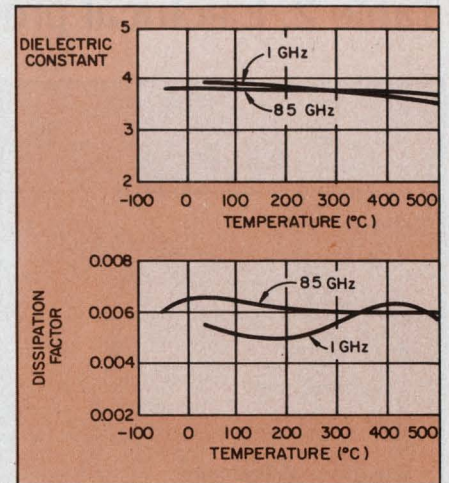

8. Silicones display only slight changes in electrical properties over a wide temperature range.

insulating materials that have relatively low dissipation factors and dielectric constants. The electrical properties (Table 2) of acetals are largely retained for water immersion or high humidity, and at temperatures of 200 F or higher.

Acrylics have exceptional optical clarity and good weather resistance, strength, electrical properties and chemical resistance. Their high arc resistance and excellent tracking characteristics make them a good choice for such high-voltage applications as circuit breakers. Their dielectric strength is 450 to 500 V/mil. While not having the low loss properties of some competing materials, acrylics exhibit an essentially linear decrease in dielectric constant and dissipation factor as frequency increases.

Cellulosics are among the toughest of plastics and are generally low in cost. They make good insulating materials but are temperature-limited and not as resistant to extreme environments as many other thermoplastics. None of their electrical properties is outstanding, as Table 2 shows. They are formulated with a wide range of plasticizers to obtain specific flexibilities, but the plasticizers sometimes impair other characteristics.

Fluorocarbons offer top electrical properties

Fluorocarbons are very useful materials because their excellent electrical properties are relatively unaffected by most environments and operating conditions. The most widely used fluorocarbon, perhaps, is polytetrafluoroethylene (TFE fluorocarbon).

Fluorocarbons have excellent electrical properties. TFE and FEP (fluorinated ethylene propylene) fluorocarbons, in particular, have low dielectric constants, and dissipation factors that change little with temperature or frequency.

The dielectric strength of TFE and FEP plas-

tics is high and does not vary with temperature or thermal aging. Initial dielectric strength is very high. As with most dielectric materials, the value drops as specimen thickness increases; further, the dielectric strength is a function of frequency.

Life at high dielectric stresses depends on corona discharge (see Fig. 9). The absence of corona, as in special wire constructions, permits very high voltage stress without damage to either TFE or FEP resins. Changes in relative humidity or in the physical stress imposed upon the material do not diminish life at these voltage stresses.

Surface arc resistance of TFE and FEP plastics is high, and is not affected by heat aging. When these plastics are subjected to a surface arc in air, they do not crack or form a carbonized conducting path. When tested per ASTM D 495, performance exceeds a maximum time of 200 seconds.

Volume resistivity (10^{18} Ω -cm) and surface resistivity (10^{16} Ω /sq) for both FEP and TFE plastics are at the top of the measurable range. Neither resistivity is affected by heat aging or by temperatures up to recommended service limits.

Ionomers offer outstanding toughness, transparency and solvent resistance. Their limitations include poor stiffness, susceptibility to creep, low distortion temperature and ultraviolet deterioration unless stabilizers are added.

Most ionomers have good dielectric characteristics over a broad frequency range. The combination of these electrical properties with high melt strength and good abrasion resistance qualifies these materials primarily for the insulation and jacketing of wire and cable.

Nylons, also known as polyamides, are strong, tough thermoplastics having good impact, tensile and flexural strengths over a temperature range

Table 2. Electrical properties of thermoplastics

Material	Volume resistivity (Ω -cm)	Dielectric constant at 60 Hz	Dielectric strength* (V/mil)	Dissipation factor at 60 Hz	Arc resistance (sec)
Acetal	$1 \cdot 10^{14}$	3.7-3.8	500	0.004-0.005	129
ABS	10^{15} - 10^{17}	2.6-3.5	300-450	0.003-0.007	45-90
Acrylic	$>10^{14}$	3.3-3.9	400	0.04-0.05	(no tracking)
Acrylic, high-impact	10^{16} - 10^{17}	3.5-3.7	450-480	0.04-0.05	(no tracking)
Cellulose acetate	10^{10} - 10^{12}	3.2-7.5	290-600	0.01-0.10	50-130
Cellulose acetate butyrate	10^{10} - 10^{12}	3.2-6.4	250-400	0.01-0.04	50-150
Cellulose propionate	10^{12} - 10^{16}	3.3-4.2	300-450	0.01-0.05	170-190
Ethyl vinyl acetate	1.5×10^8	3.16	525	0.003	50-150
Chlorotrifluoroethylene	10^{18}	2.65	450	0.015	>360
Fluorinated ethylene propylene (FEP)	$>10^{18}$	2.1	500	0.0002	>165
Polytetrafluoroethylene (TFE)	$>10^{18}$	2.1	400	<0.0001	(no tracking)
Nylon 6	10^{14} - 10^{15}	6.1	300-400	0.4-0.6	140
Nylon 6/6	10^{14} - 10^{15}	3.6-4.0	300-400	0.014	140
Nylon 6/10	10^{14} - 10^{15}	4.0-7.6	300-400	0.04-0.05	140
Polyallomer	$>10^{16}$	2.3	500-1000	0.0001-0.0005	
Polycarbonate	6.1×10^{15}	2.97	410	0.0001-0.0005	10-120
Polyethylene, low-density	10^{15} - 10^{18}	2.28	450-1000	0.006	100-200
Polyethylene, medium-density	10^{15} - 10^{18}	2.3	450-1000	0.0001-0.0005	100-200
Polyethylene, high-density	6×10^{15} - 10^{18}	2.3	450-1000	0.003-0.002	100-200
Polyethylene, high-molecular-weight	$>10^{16}$	2.3-2.6	500-710	0.0003	100-200
Polyimide	10^{16} - 10^{17}	3.5	400	0.002-0.003	230
Polypropylene	10^{15} - 10^{17}	2.1-2.7	450-650	0.0007-0.005	36-136
Polystyrene	10^{17} - 10^{21}	2.5-2.65	500-700	0.0001-0.0005	60-100
Polystyrene, high-impact	10^{10} - 10^{17}	2.5-3.5	500	0.003-0.005	60-90
Polyurethane	2×10^{11}	6-8	850-1000	0.276	100-150
Polyvinyl chloride (flexible)	10^{11} - 10^{15}	5-9	300-1000	0.08-0.15	50-100
Polyvinyl chloride (rigid)	10^{12} - 10^{16}	3.4	425-1040	0.01-0.02	50-100
Polyvinyl dichloride (rigid)	10^{15}	3.08	1200-1550	0.018-0.0208	50-100
Styrene acrylonitrile (SAN)	10^{15}	2.8-3	400-500	0.006-0.008	100-150
Ionomer	$>10^{16}$	2.4-2.5	1000	0.001	100
Polymethylpentene	$>10^{16}$	2.12	700	0.001	100-200
Polyaryl sulfone	3.2×10^{16}	3.94	350-400	0.003	67
Thermoplastic polyester	4×10^{16}	3.3	590	0.002	190
Polyphenylene sulfide	10^{16}	3.1	595	0.0004	75-150
Polyphenylene oxide	10^{17}	2.58	400-500	0.00035	75
Polysulfone	5×10^{16}	2.82	425	0.008-0.0056	122
Polyethersulfone	10^{17} - 10^{18}	3.5	400	0.001	100-200

*Short-time, for 1/8-in. thickness

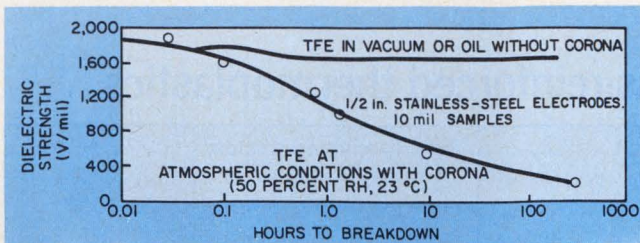

9. The life of TFE and FEP fluorocarbons depends on corona discharge.

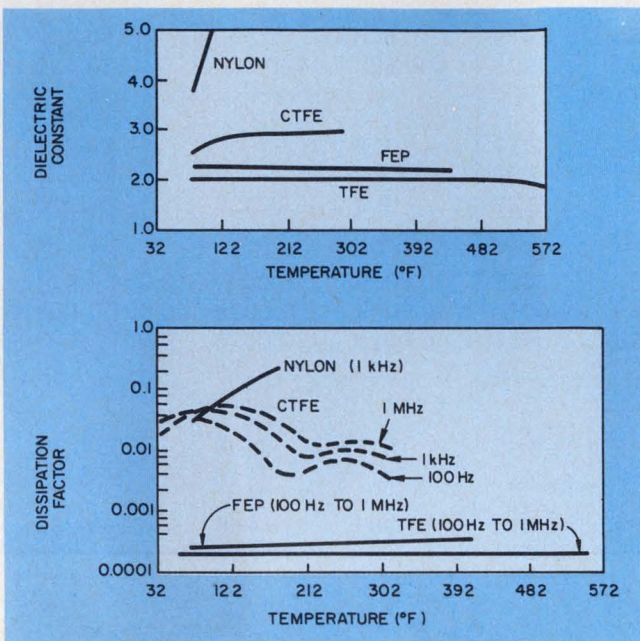

10. The effect of temperature on the dielectric constant and on the dissipation factor of fluorocarbon and nylon is shown in these curves.

from freezing up to 300 F. They have excellent resistivities and low-friction properties. All nylons absorb some moisture from environmental humidity, which affects their electrical characteristics. Volume resistivity, dielectric strength, dielectric constant, and dissipation factor vary with the nylon's moisture content and temperature as well as with the specific kind of nylon.

The effect of temperature on dielectric constant and dissipation factor is presented in Fig. 10. Nylons do not compare favorably in these areas with the good electrical thermoplastics such as fluorocarbons or polystyrene, but they are good general-purpose electrical materials. Resistivity decreases rapidly with moisture content, dropping as low as 10^{12} Ω -cm at 4% moisture, and as low as 10^9 Ω -cm at 8% moisture.

High-temperature nylons have recently been reclassified as aramids. Aramids retain about 60% of their strength at temperatures of 475 to 500 F, which would melt conventional nylons, and have good dielectric strength, which is constant to 400 F and 95% relative humidity. Fabricated

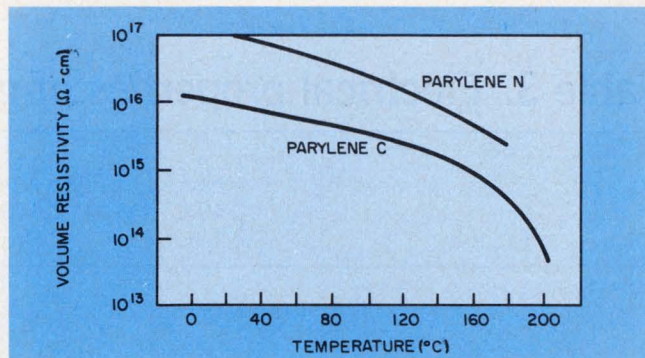

11. The volume resistivity of Parylene N and Parylene C decreases as temperature is raised.

primarily in sheet, fiber and paper form, this material is being used in such wrapped-insulation constructions as transformer coils and motor stators.

Parylene is the generic name for members of a thermoplastic polymer series developed by Union Carbide. The series is unique among plastics in that it is produced as a thin film by vapor-phase polymerization. Parylenes are good dielectric materials; Parylene N has a consistent dielectric constant of 2.65 and a dissipation factor that increases from 0.0002 to 0.0006, over the range of 60 Hz to 1 MHz, at room temperature.

In the same frequency range, Parylene C offers lower permeability to moisture and gases, with a dielectric constant of 2.9 to 3.1 and a dissipation factor of 0.012 to 0.020. Volume resistivity values approximate 10^{17} Ω -cm at room temperature; short-time dielectric-strength values are 5600 V/mil for Parylene C, and 7000 V/mil for Parylene N, in 1-mil test samples. Dielectric strength values decrease with increasing thickness, of course. The effect of temperature on volume resistivity is shown in Fig. 11.

Polyolefins—a broad class

Polyallomers, polyethylenes, and polypropylenes all belong to the broad chemical classification known as polyolefins. Broadly speaking, the similarities are appearance, electrical properties and general chemical characteristics. The main differences are in the properties of physical and thermal stability. All three groups exhibit decreases in physical strength at somewhat lower temperatures than for the higher performance thermoplastics, and all have nearly identical dissipation factors and dielectric constants. Both these factors have low values and are relatively independent of frequency and temperature.

Polyaryl sulfone is another high-thermal-stability thermoplastic that offers useful properties up to 500 F. Polyaryl sulfone has been successfully used for electrical connector bodies that are

Table 3. Electrical properties of glass-reinforced thermoplastics

Property	Nylon 20-40% filled	Polycarbonate, 20-40% filled	Poly- propylene, 20-40% filled	Polyphrenylene oxides, 30% filled		Polystyrene, 20-30% filled
				PPO	Noryl	
Volume resistivity at 50% RH, (Ω -cm)	$1.53-5.5 \times 10^{16}$	$1.4-1.52 \times 10^{16}$	1.7×10^{16}	2.5×10^{17}	2.1×10^{17}	$3.2-37 \times 10^{16}$
Dielectric strength, 1/8 in., (V/mil):						
Short-time	408-503	475	475	500	550	350-425
Step-by-step	375-450	475	375	400-500	400-500	350-430
Dielectric constant:						
60 Hz	4.0-4.6	3.7	2.37	2.9	2.9	2.8-3.1
1 kHz	3.9-4.4	3.7	2.36	2.9	2.9	2.8-3.0
1 MHz	3.4-3.9	3.2-3.5	2.38	2.9	2.9	2.8-3.0
Dissipation factor:						
60 Hz	0.018-0.025	0.003-0.005	0.0022	0.0009	0.0009	0.004-0.014
1 kHz	0.020-0.025	0.002-0.004	0.0017	0.0009	0.0009	0.001-0.004
1 MHz	0.017-0.022	0.009	0.0035	0.0016	0.0015	0.001-0.003
Arc resistance, (sec)	92-148	5-120	74	120	75	25-40
Water absorption, 1/8 in., after 24 h, (%)	0.2-2.0	0.07-0.10	0.01-0.05	0.07	0.06	0.05-0.10
Max continuous use temp, ($^{\circ}$ F)	300-400	278-300	300-320	315-365	225-250	180-200

required to meet severe structural and environmental stresses, and for parts in other critical electromechanical devices. Volume resistivity at room temperature is $3.2 \times 10^{16} \Omega$ -cm, and the short-time dielectric strength is 350 V/mil for a 1/16-in.-thick sample. Arc resistance is 67 seconds.

Polycarbonates have a dissipation factor that varies widely as a function of frequency (Fig. 12), but neither their dissipation factor nor dielectric constant exhibit major changes up to about 150 C. Both begin to increase beyond the 150 to 175 C range, however. The dielectric constant remains at about three up to at least 100 MHz, although the power (loss) factor does increase somewhat in that frequency range. Electrical properties remain relatively stable in high humidity environments.

Thermoplastic polyesters are used extensively in the production of such films as Du-Pont's Mylar. In the past few years a new class of molding and extrusion grades of thermoplastic polyesters has been made available.

The unreinforced plastic is hard, strong and extremely tough, has high abrasion resistance and a low coefficient of friction. Besides their low moisture absorption, polyesters are resistant to cold flow, chemicals and stress; their electrical properties and surface appearance are good.

The electrical properties of these thermoplastics are relatively stable up to the rated temperature limits of about 300 F. Because of these electrical and mechanical properties and the low finished-part cost, reinforced thermoplastic polyesters are replacing phenolics, alkyds, DAP and glass-reinforced thermoplastics in selected applications.

Polyimides stable beyond 500 F

Polyimides offer same outstanding properties for electronic applications. This is due to their combination of high-temperature stability through 500 F and good electrical and mechanical properties that are relatively stable across a wide range of temperatures. This is also true for a related class of plastics known as polyamide-imides.

The combination of very good electrical properties and high strength with excellent thermal and radiation resistance makes polyimide parts outstanding candidates for electrical applications in most severe environments. The dielectric constant decreases gradually from 3.5 at room temperature to 3.0 at 500 F. At a given temperature, dielectric constant is essentially unchanged for frequency variations over the range of 100 Hz to 100 kHz.

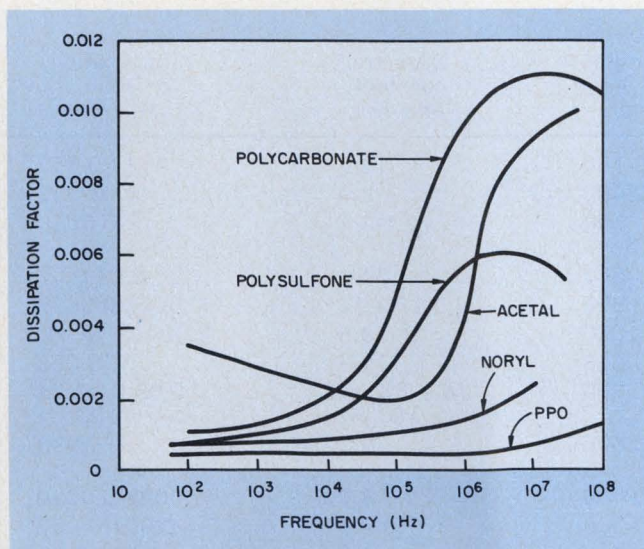

12. The dissipation factor of the polycarbonates varies widely as frequency increases.

Dissipation factor is influenced by both temperature and frequency. Up to about 212 F, dissipation factor increases with increasing frequency. From 212 to 400 F, frequency has essentially no effect. Above 400 F, dissipation factor decreases with increasing frequency.

Both the dielectric constant and dissipation factor of polyimides increase with increasing moisture content. For example, at 1 kHz and room temperature the dielectric constant of a dry test bar of unfilled polyimide is 3.1 and the dissipation factor is 0.0001. With a moisture content of 2.4% (obtained after a 30-hour immersion in water at room temperature), these values are 4.0 and 0.0002, respectively. Drying will restore the original values.

The volume resistivity of samples molded from unfilled polyimide is 10^{17} Ω -cm at room temperature; this value decreases linearly to 10^{11} Ω -cm at 572 F. Surface resistivity is 10^{16} Ω /sq at room temperature and decreases linearly to 5×10^{10} at 572 F.

Polyimide parts, as fabricated from unfilled resin, have a very high arc resistance of 230 seconds, but a carbon track is formed when they are exposed to arcing. The corona resistance is superior to that attainable with fluorocarbons. For example, at 200 V/mil (60 Hz and room temperature), corona life is 2200 hours. The effect of temperature on dielectric strength in air is shown in Fig. 13.

Polyphenylene oxides are characterized by outstanding dimensional stability at elevated temperatures, a broad temperature-use range, outstanding hydrolytic stability, and excellent dielectric properties over a wide range of frequencies and temperatures. Polyphenylene oxides have excel-

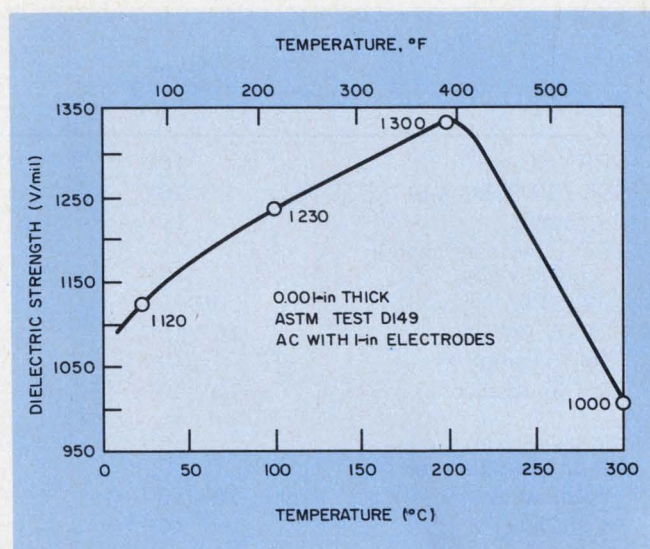

13. The dielectric strength of unfilled polyimides drops rapidly beyond 200 C.

lent electrical properties that remain relatively constant with frequency and temperature.

The effect of frequency on dissipation factor is given in Fig. 12. The dielectric constant is low and relatively stable up to the 200 to 225-F range. Dielectric strength is 500 to 550 V/mil in 1/8-in. sections. Electrical properties are relatively unaffected by temperature and humidity.

Polystyrenes have low losses

Polystyrenes represent an important class of thermoplastic materials in the electronics industry because of very low electrical losses. Mechanical properties are adequate but polystyrenes are, in general, useful only up to 200 F. The dielectric constant and dissipation factors of some polystyrenes increase rapidly above about 1 GHz, so the specific material and application should be checked in that frequency area.

The low dissipation factor, coupled with the relative rigidity of polystyrene compared to polyethylene and TFE, gives polystyrene advantages in many electronics applications requiring material hardness and extremely low electrical losses—particularly at high frequencies. Crosslinked polystyrenes with thermal stability up to 250 to 275 F are available and are especially useful for electronic design.

The dielectric strength of polystyrenes is excellent, and the resistivity properties are outstanding. These materials are most useful in high-frequency applications.

Polysulfones are another very useful class of engineering thermoplastics for electronic design. They have excellent strength, good electrical properties and outstanding strength retention over

Table 4. Electrical properties of various elastomers

Elastomer	Resistivity (Ω -cm)	Dielectric strength (short time) (V/mil)	Dielectric constant, at 1 kHz	Dissipation factor, at 1 kHz
NBR (nitrile)	10^{10}	200-400	13.0	0.055
SBR (GR-S, buna-S)	10^{15}	200-400	2.9	0.0032
IIR (butyl)	10^{17}	600	2.1-2.4	0.0030
CSM (chlorosulfonated polyethylene)	10^{14}	500	7-10	0.03-0.07
EPR (EPM)	10^{15} - 10^{17}	900	3.17-3.34	0.0066-0.0079
EPT (EPDM)	10^{15} - 10^{17}	900-1050	3.0-3.5	0.004, at 60 Hz
FPM (hexafluor)	10^{14}	613	5.9	0.053
FSI (fluorosilicone)	10^{13} - 10^{14}	340-350	6.9-7.4, at 100 Hz	0.03-0.07, at 100 Hz
CR (neoprene)	10^{11}	150-600	9.0	0.030
NR or IR (natural or synthetic)	10^{15} - 10^{17}	200-400	2.3-3.0	0.0023-0.0030
Polysulfide	10^{12}	250-600	7.0-9.5	0.001-0.005
Urethane	10^{11} - 10^{14}	350-525	5-8	0.015-0.09
SI (silicone)	10^{11} - 10^{17}	100-655	3.0-3.5	0.001-0.010

long periods of aging at temperatures of 300 F or more.

The dielectric constant of polysulfones is approximately 3.1 up to 1 MHz, and decreases slightly at 10 MHz. The other important electrical properties of polysulfones are also good, and satisfactory for most electronics applications. The electrical properties of polysulfones are maintained to approximately 90% of their initial values after one year or more of exposure at 300 F. Also, the basic electrical properties are generally stable up to about 350 F, and under exposure to water or high humidity.

Vinyls useful for sleeving and tubing

Vinyls are good general-purpose electrical insulating materials, but are not outstanding in electronics. The wide range of basic formulations and modifications makes necessary a detailed study of specific materials for any given use. Perhaps their wider application in electronics is as jacketing, sleeving and tubing for wire and cable.

Polyvinyl chloride (PVC) is perhaps the most widely used and highest-volume member of the vinyl family. PVC and polyvinyl chloride-acetate are the most commonly used vinyls for electronics and electrical applications.

Basically, thermoplastic molding materials are unfilled and can be used without fillers being incorporated into the compound. However, many thermoplastics do suffer from creep and dimensional stability problems, especially under increased temperature and load conditions.

Glass-fiber-reinforced thermoplastics help to simplify these problems. For instance, 40%-glass-fiber-reinforced nylon outperforms its unrein-

forced version by exhibiting 2.5 times greater tensile and impact strength, four times greater flexural modulus, and only 0.2 times the tensile creep.

One significant property for engineers is temperature resistance. Glass-reinforced nylons, for example, have a deflection temperature of up to 500 F, compared to 250 F for the same material in unreinforced form. This allows use of these materials in places where heat might accumulate—such as solder junctions. The electrical properties of several glass-reinforced thermoplastics are shown in Table 3. ■■

References

1. Harper, C. A., *Handbook of Plastics and Elastomers*, McGraw-Hill Book Co., New York, NY, 1975.
2. Harper, C. A., *Handbook of Electronic Packaging*, McGraw-Hill Book Co., New York, NY, 1971.
3. Harper, C. A., *Handbook of Wiring, Cabling and Interconnection for Electronics*, McGraw-Hill Book Co., New York, NY, 1972.
4. Harper, C. A., *Handbook of Materials and Processes for Electronics*, McGraw-Hill Book Co., New York, NY, 1972.
5. Carpenter, R. E., "Insulating and Structural Properties of Alkyd Molding Compounds," *Electro-Technology*, June, 1965.
6. Parry, H. L., et al., "High Humidity Insulation Resistance of Resin Systems," *Soc. Plast. Eng. J.*, October, 1957.
7. Jessup, J. N., and Beacham, H. H., "Effects of Temperature and Humidity on Electrical Properties of Thermosets," *Modern Plastics*, December, 1968.
8. Chapman, J. J., and Frisco, L. J., *A Practical Interpretation of Dielectric Measurements up to 100 Mc*, Dielectrics Laboratory Report, Johns Hopkins University, Baltimore, MD, December, 1963.
9. Keegan, James F., *Durez Electrical Insulation Materials*, Hooker Chemical Corp., North Tonawanda, NY, 1973.
10. Buchoff, L. S., "Effect of Humidity on Surface Resistance of Filled Epoxy Resins," *Soc. Plast. Eng. Ann. Nat. Tech. Conf.*, Chicago, IL, January, 1960.

12 reasons why *only* Buchanan® Terminal Blocks provide **Lowest Total Applied Cost!**

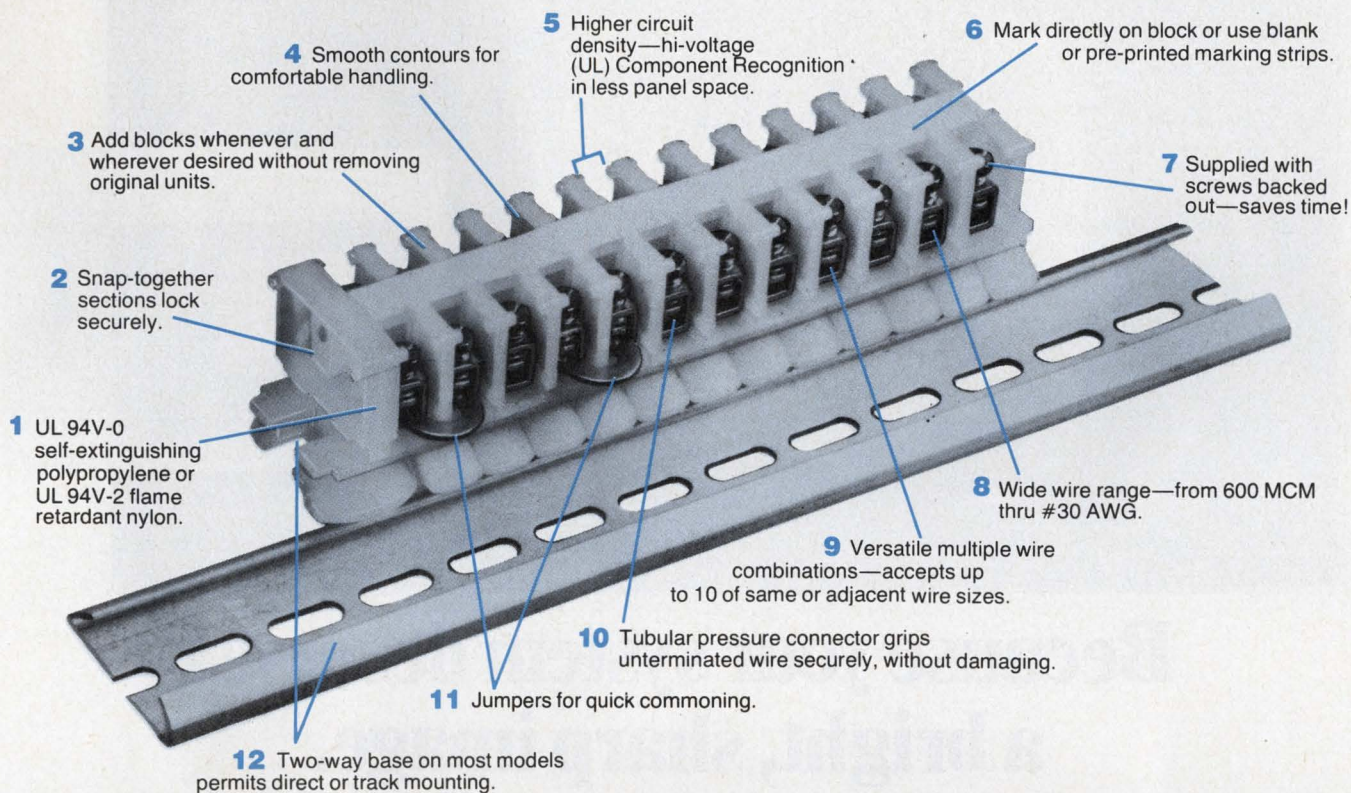

AND—you can get 'em when you need 'em!

No matter how many advantages offered by a specific terminal block, you can't get the advantages if you can't get the block!

Which is why we make sure Buchanan blocks are stocked in ample quantities throughout the country. Buchanan has anywhere from twice to eight times as many stocking distributors as other manufacturers—so you can get the blocks you need *when* you need them.

And only Buchanan distributors can give you *all* the advantages shown above.

Copper tubular contacts that really grip . . . higher circuit density . . . ease of assembly and add-on . . . everything that works together to provide Lowest Total Applied Cost!

Next time you order terminal blocks, specify Buchanan and be sure of *all* the advantages, *plus* prompt delivery. In the meantime, send for our handy Selector Chart and Catalog. Use the Reader Service Card. (If you have a special application, call one of our Regional Offices shown below.)



**CONTROL PRODUCTS
DIVISION**

Amerace Corporation
Control Products Division
2330 Vauxhall Road
Union, N. J. 07083, U.S.A.
Telex 138-978

16

Atlanta—(404) 261-1224 • Cleveland—(216) 333-8540 • Chicago—(312) 437-8354 • New York Metro.—(201) 355-7770 • Los Angeles—(213) 863-5753

CIRCLE NUMBER 52

HP displays.

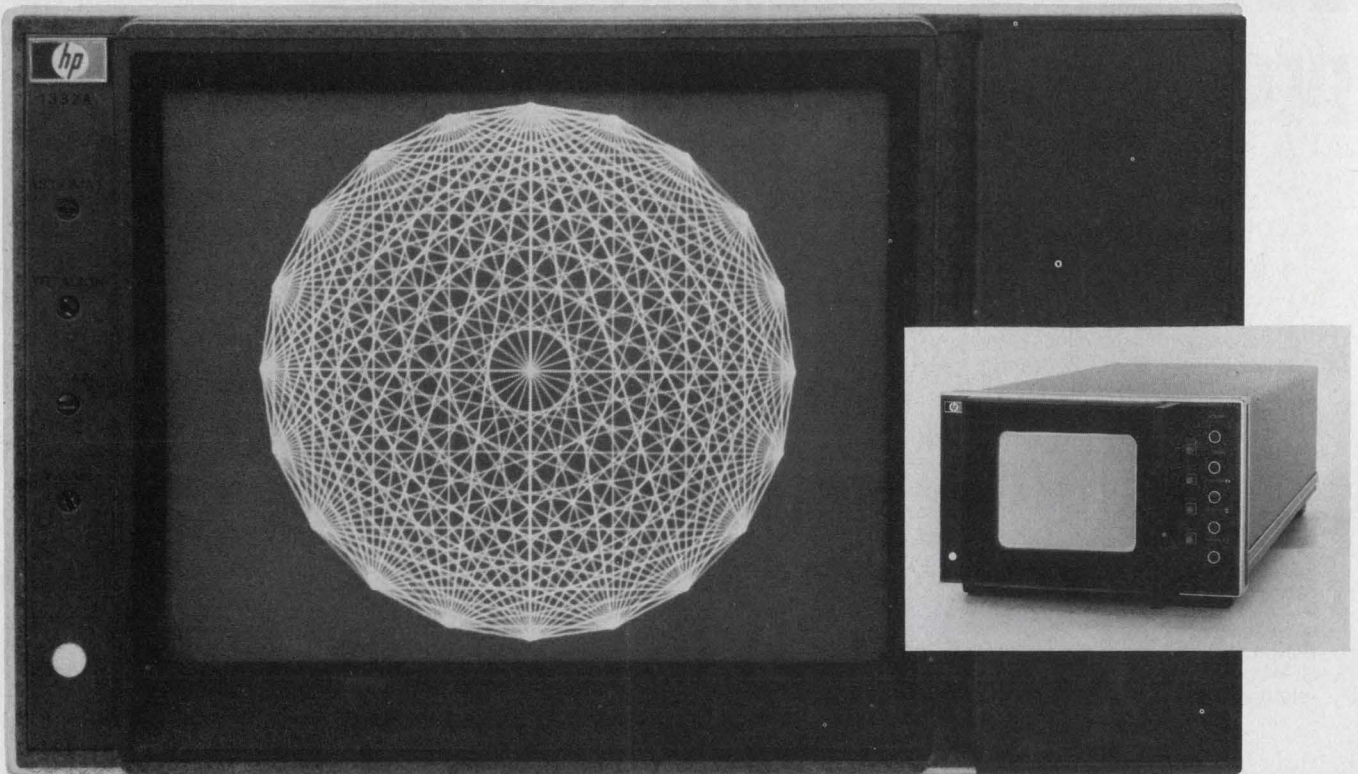

Because your system deserves a bright, sharp image.

You put a lot into each OEM system: good circuit design, quality components, careful testing. But end users will judge it by the information they get from the display. They expect bright, sharp images. That's why HP's 1332A, 1333A, and 1335A CRT displays make excellent choices for all types of systems—from spectrum, network, and chemical analyzers, to automatic test systems.

Each display has a very small spot size that focuses uniformly over the complete viewing area, regardless of writing speeds or intensity level. This eliminates the need to refocus at each intensity setting and assures crisp images, even around the outer edges of the screen. Fine image detail with excellent contrast and uniformity make them particularly well suited for applications involving complex graphics, especially those with alphanumeric data.

The 1335A, a variable-persistence, storage, and non-storage display, introduces a totally new CRT design optimized exclusively for information display. It offers exceptionally good resolution over the entire 8 x 10 cm screen. And the 1335A is versatile too. Any operating mode—erase, store, write, conventional, or variable persistence—can be selected with manual front-panel controls, remote program inputs, or a combination of both. Manual controls can be inhibited entirely during remote operations. The 1335A is a welcome

addition to medical and instrumentation systems.

OEMs who need a larger viewing area and a brighter image at faster scan rates like the 1332A. They appreciate its 9.6 x 11.9 cm viewing area, its superior performance, and the ease with which the 1332A, like the others, integrates into a variety of racks and cabinets.

For photographic recording of displayed data, the new 1333A offers new performance levels. Its extremely small spot size of 0.20 mm (0.008 in.) provides the exceptional quality necessary for easy and accurate photo evaluation. And its 8 x 10 cm screen allows reproduction on Polaroid film with very little optic reduction. For convenience, all frequently used controls on all of these displays have been placed on the front panel for maximum accessibility.

Which display best fits your requirements? Let your local HP field engineer help you decide. Or write for specific details. We'll help you pick a display that makes your system look as good as it actually is.

08519 A

HEWLETT  PACKARD

Sales and service from 172 offices in 65 countries.
1507 Page Mill Road, Palo Alto, California 94304

FAST SWITCHING, HIGH VOLTAGE POWER TRANSISTORS FROM SOLITRON!

If you're looking for NPN Silicon Power transistors with fast switching characteristics, look no further. Solitron has them! They're packaged with design and performance features to save space, reduce weight and cut costs. Plus these devices are available in quantity and competitively priced.

SOLITRON FAST SWITCHING HIGH VOLTAGE POWER TRANSISTORS

SERIES NO.	CASE*	V _{CEO} (sus)	V _{EBO}	I _C (max)	h _{FE} (min)	f _t (typ)	SWITCHING TIMES (typ)
2N6560	TO-3	450V	5V	15A	10 @ 5A,5V	25MHz	3.6 μs
2N6561	TO-3	300V	5V	20A	10 @ 10A,2V	25MHz	2.3 μs
SDT12301	TO-3	200V	5V	20A	10 @ 10A,5V	25MHz	1.6 μs
SDT12302	TO-3	250V	5V	20A	10 @ 10A,5V	25MHz	1.6 μs
SDT12303	TO-3	300V	5V	20A	10 @ 10A,5V	25MHz	1.6 μs
SDT13301	TO-3	300V	5V	20A	10 @ 5A,5V	25MHz	2.2 μs
SDT13302	TO-3	350V	5V	20A	10 @ 5A,5V	25MHz	2.2 μs
SDT13303	TO-3	400V	5V	20A	10 @ 5A,5V	25MHz	2.2 μs
SDT13304	TO-3	450V	5V	20A	10 @ 5A,5V	25MHz	2.2 μs
SDT13305	TO-3	500V	5V	20A	10 @ 5A,5V	25MHz	2.2 μs

*TO-61 isolated versions also available.

SCHOTTKY POWER DIODES FROM SOLITRON!

Look over Solitron's Schottky Diode Product Guide. You'll quickly see that a wide line of hermetic Schottky Diodes is available now from Solitron — from small signal to the highest rated power types. These Schottky Diodes combine low thermal generation with the high efficiency power dissipation of standard rectifier packages for energy savings.

SOLITRON SCHOTTKY DIODE PRODUCT GUIDE

SERIES NO.	PACKAGE	I _F RATING	V _{BR} RANGE	V _F @I _F	I surge*
MS 8000	DO-35	to 100 mA	5-70	0.4 @ 1mA	—
MS 9000	DO-7	to 500 mA	5-70	0.5 @ 100mA	—
SSP 200	DO-29	2.0A	5-70	0.6 @ 2.0A	75A
SSP 300	DO-4	3.0A	5-70	0.6 @ 3.0A	100A
SSP 800	DO-4	8.0A	5-70	0.56 @ 8.0A	450A
SSP 2000	DO-4	20A	5-70	0.56 @ 20A	650A
SSP 3000	DO-5	30A	5-70	0.56 @ 30A	800A
SSP 6000	DO-5	60A	5-50	0.56 @ 60A	1200A
SSP 12500	DO-5	125A	5-50	0.56 @ 125A	2000A

*8.3 msec sine wave pulse under simulated load conditions

For complete information on Solitron's Schottky Diodes or High Voltage Power Transistors, call toll-free 800-327-8462.

Solitron
DEVICES, INC.

1177 Blue Heron Boulevard
Riviera Beach, Florida 33404
Tel: (305) 848-4311
TWX: (510) 952-7610

PLANTS IN: CALIFORNIA • FLORIDA • NEW YORK • ENGLAND • HONG KONG • MEXICO

CIRCLE NUMBER 54

Select more-reliable switches by testing them yourself. Here is a simple combination of mechanical and electronic components that can evaluate keyswitches and rotary switches.

Minimize the human error in testing momentary-keyswitches or rotary switches by using an electromechanical switch test set. The equipment needed uses common ICs, a small motor and mechanical levers and gears to actually push buttons or turn shafts. You can minimize field failures by doing your own reliability testing under simulated operating conditions before selection.

Since procedures for mechanically actuating keyswitches are radically different than for rotary units, let's start by looking at the method for testing keyswitches. The heart of the test set is a crystal oscillator in a circuit that can detect errors (Fig. 1). If you want to test a group of switches, as you might do to compare several different types, the circuit must be repeated for each switch.

The error-detection circuit monitors each mechanical operation and can display an error for leading-edge bounce, trailing-edge bounce, continuity (closure), or all three simultaneously.

Synchronize the switch test

To make sure the error-detection circuits detect errors only after the switch is activated, the motor-driven cam arrangement (Fig. 2) must be the controlling element of the entire circuit. By placing a small magnet on the cam pulley you can trigger a magnetic switch (preferably solid-state for fast response) on the test bed. The switch, in turn, sends a pulse that advances the cycle counter (upper-right corner of Fig. 3).

The voltage used to stress the switch contacts has an open-circuit potential of 5 V dc and when the switch contacts close, they carry a current of about 2.6 mA. However, if your application is for logic levels other than TTL, the voltage and current can be adjusted accordingly by redesign of the error detector circuit.

At Stackpole, the closing of switch contacts is defined as "any closure such that a drop of 3.6

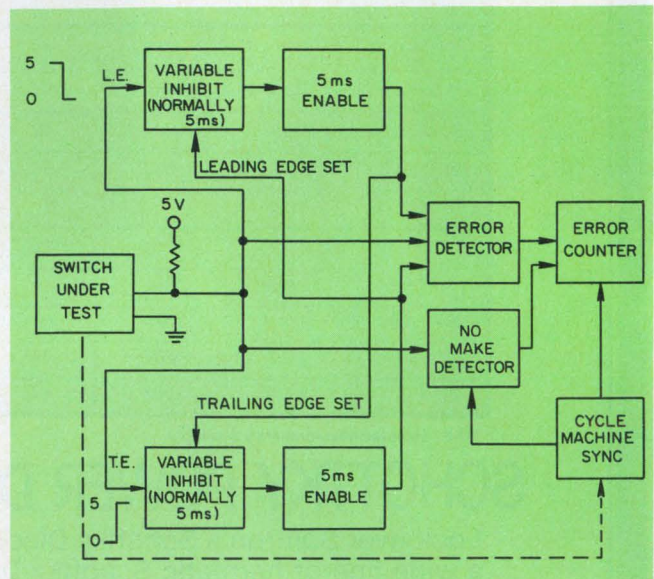

1. This block diagram of a momentary-keyswitch test set shows the complexity of the circuitry needed. The leading-edge switch signal is first inhibited to eliminate bounce, then enabled to detect continuity or any errors being generated. The same process must be repeated for the trailing edge.

V, nominal, or more occurs, for a minimum of 13 ns, in the pull-down resistor." The error-detection circuit sees a transition from logic ONE to ZERO upon closure and from ZERO to ONE when contacts open.

When a switch is closed, an inhibit circuit triggers and screens out the contact bounce as set by the delay time. The inhibit interval is made variable so that it can be set for different durations, depending upon the application of the switch. A typical range is 0.5 to 5 ms, or 1 to 10 ms. At the end of the inhibit time an enabling circuit is activated for 5 ms. During this time period the switch contacts must remain closed; any opening will be counted as an error in leading-edge bounce or continuity.

After the leading-edge enable time expires, and no error has occurred, the circuit is ready to examine the trailing edge as the contacts open. A timing sequence identical to that for the leading edge is initiated. During the 5-ms enable period, though, the switch contacts must stay

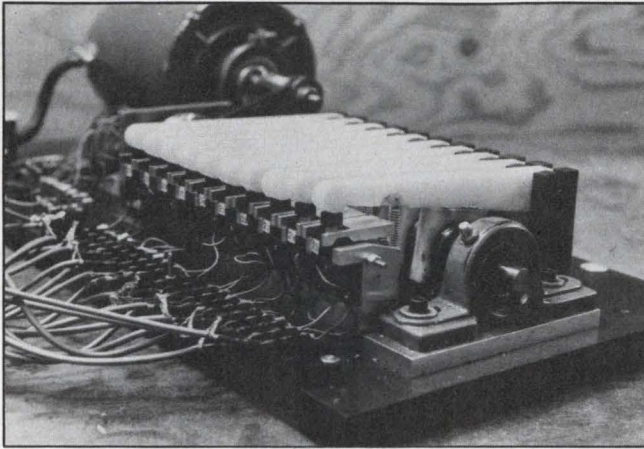

2. The cam and lever-arm assembly needed for switches can be fabricated in most prototype shops. Cycling speeds of close to 900 cycles per minute are not considered unrealistic.

open. Once the enable period expires, the magnet should be in position to reset the circuit for the next mechanical cycle.

The actual circuits that are needed to do this detection and counting are shown in Fig. 4. Except for the oscillator and reset circuits, you must duplicate the circuitry for each switch you're testing.

Carefully consider the mechanical mounting

The biggest problem in designing the test set is probably the mechanical design of the key-pushing mechanism. No matter what type of key-switch is selected, you will have to build a custom rack-and-cam assembly. The arrangement used in the test set of Fig. 2 holds the switches by the upper part of their housings and leaves the switch bases unsupported. This also permits the housing-to-base seals to be strength tested during cycling.

Switch terminals usually have to be hand soldered to leads that go to a terminal block on the test stand. Shielded cables are used to connect the terminal block to the error-detector circuitry.

During actual operation, keyswitches "see" slightly different strokes, depending upon the

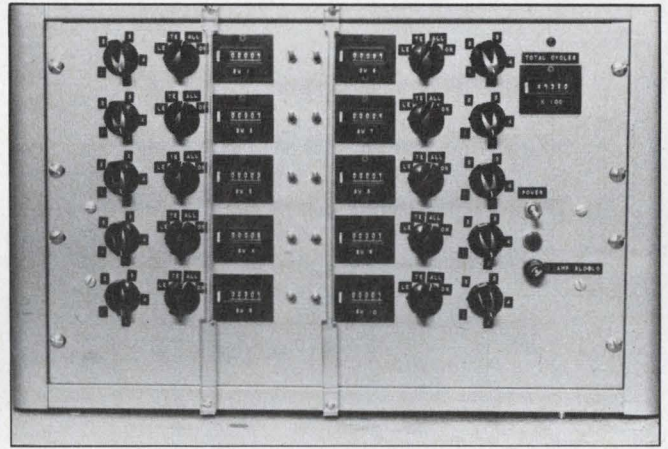

3. The main control panel of the momentary-switch test set contains an error counter for each switch, a total-cycle counter and several switches to select the desired test and delay-time allowance.

operator. These strokes are not always directly downward, but include side forces that create different wear patterns on mechanical parts and contacts. Where applicable, special switch caps that have a 5° top-surface slope can simulate side loading and create maximum wear. To vary the wear patterns, the caps are rotated 90° at any selected number of cycles during a test.

The switches being tested are pushed by spring force and released by cam lever arms. These arms should be spring loaded so that for most switch types, the switch bottoming force is about 2 lb. To get the force needed, the approach velocity of the cam is about 10 to 20 in./s at the switch-travel starting point.

The necessary cam speed needed to give the arm the velocity is about 860 rpm—which is faster than human operation. This "cycle" time gives most momentary switches an on time of about 25 ms \pm 5 ms, which varies with the plunger travel. Various gear ratios can, of course, change the cycle time.

Rotary switches: test them similarly

Similar mechanical arrangements and test sets can be built for rotary switches, but rotational

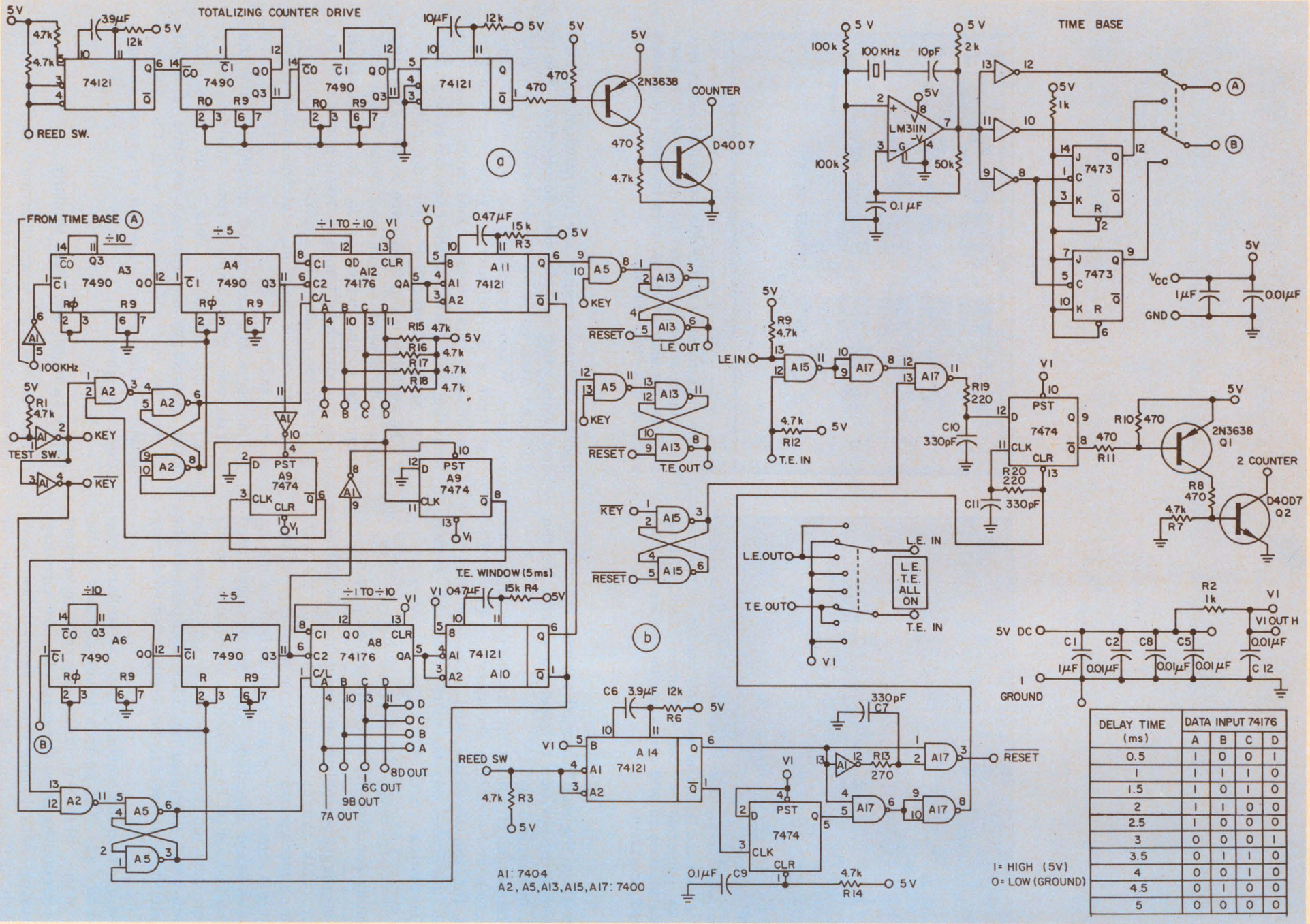

4. The entire circuit for the test set can be broken down into two parts. One part (a) consists of the time base, a totalizing counter that keeps track of the cycles, and

the individual error counters. The second part (b) consists of the leading and trailing-edge detectors, the enable circuits, the error detector and the reset circuits.

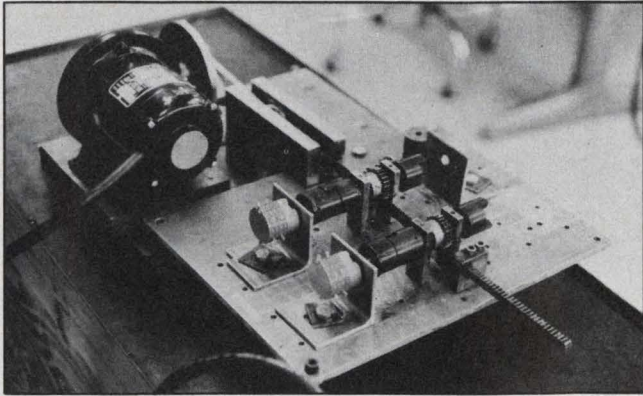

5. The electromechanical test bed for rotary-switch testing uses rack-and-pinion mechanical connections to step the rotary switches through their many contact positions.

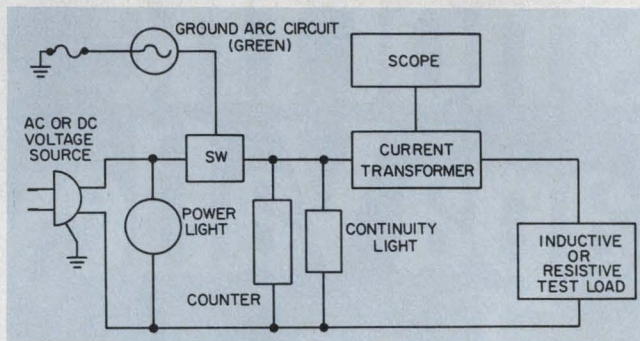

6. A simple test set can supply pertinent information required to test the rotary switches. The difference in counts between mechanical and electronic counters determines the error rate.

motion, instead of up-down movement, must occur (Fig. 5). Tests performed on rotary switches also differ from momentary-switch testing since different parameters are measured (Fig. 6). The block diagram of the switch test set shows that only continuity and waveform observations are made.

Most mechanical components must be custom made for the switches to be tested. The switches are turned by rack-and-pinion arrangements that permit variable-cycle arcs. The fixture built by Stackpole uses a motor that cycles 10 times a minute. Since the rotational direction reverses each half cycle, the cycle rate of the switch contacts is double that of the drive wheel.

The power supply's primary side can provide a reasonable inductive load for most switch contacts. Simple light bulbs or electric counters can serve as visible monitors. Every 5000 cycles the switch contacts are checked for contact-resistance wear and detent-torque changes. Contact wiping action can be observed on an oscilloscope.

Error rates are determined by comparing the cycles registered on the mechanical and electrical counters. The error rate is the difference between the mechanical count and the electrical count divided by the mechanical count. ■■

If we haven't made the mechanical filter you need yet, we can.

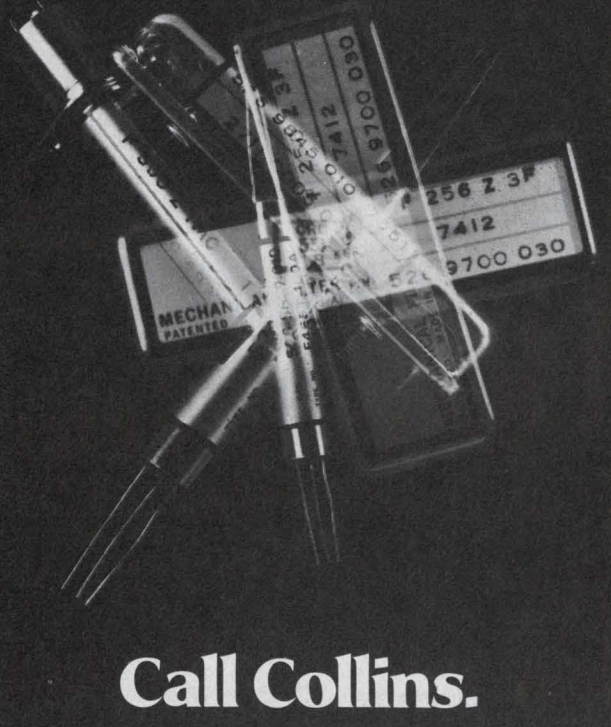

Call Collins.

The worldwide reputation of Collins' standard mechanical filters is the same today as it has been for the past two decades: high quality and reliability. Their excellent rejection of unwanted signals has been demonstrated in applications ranging from CB transceivers to missile guidance systems.

Today, as a direct result of our years of experience in these diverse applications, we have a cost-effective solution to your filtering problems readily available.

Moreover, we have the engineering know-how to create an original design concept for your custom requirements.

For information call or write: Mechanical Filters Marketing, Collins Radio Group, Rockwell International, 4311 Jamboree Road, Newport Beach, California 92663. Phone: 714/833-4632.



Rockwell International

...where science gets down to business

CIRCLE NUMBER 55

No.
**Galileo is not the
little old Napa Valley
winemaker.**

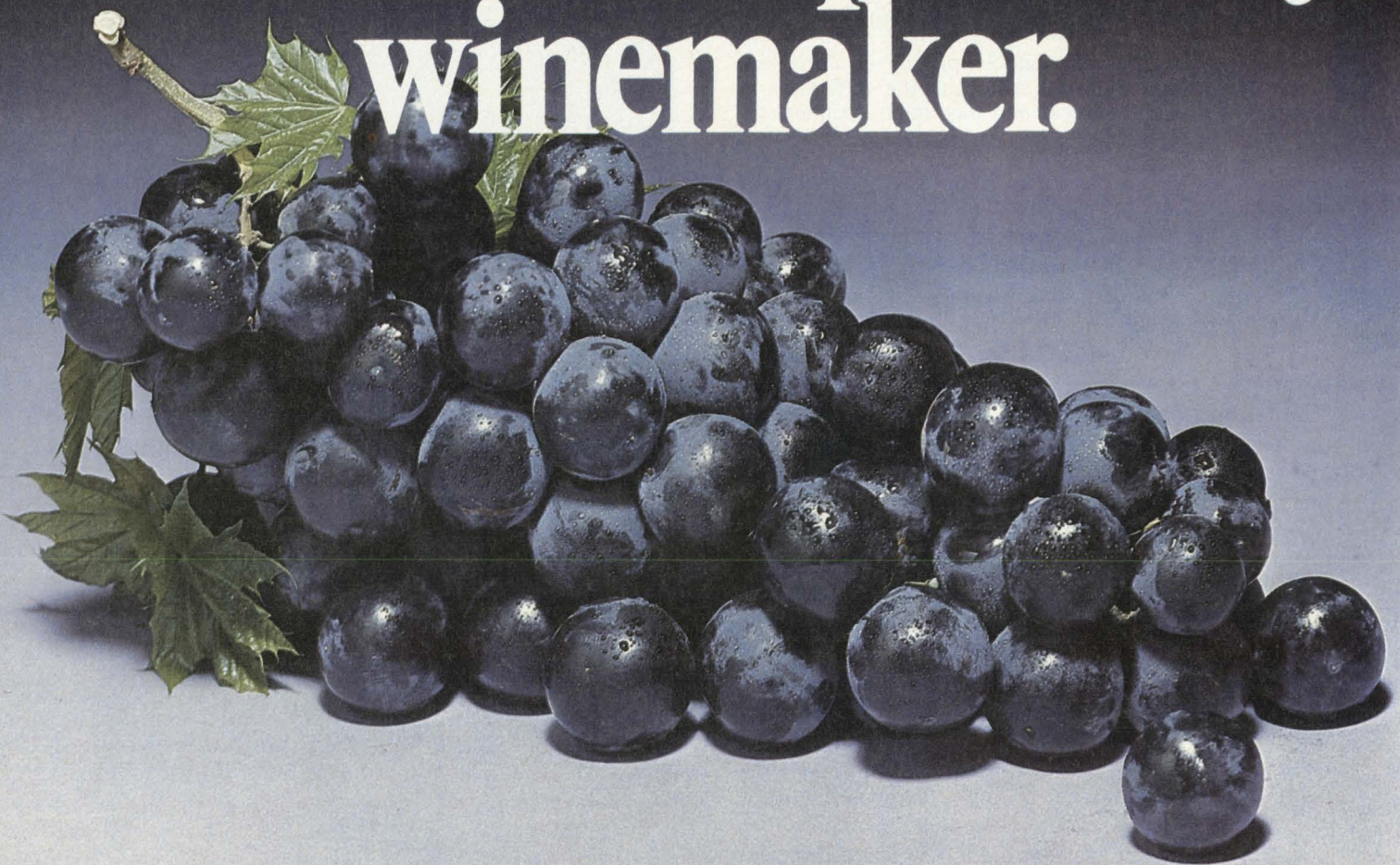

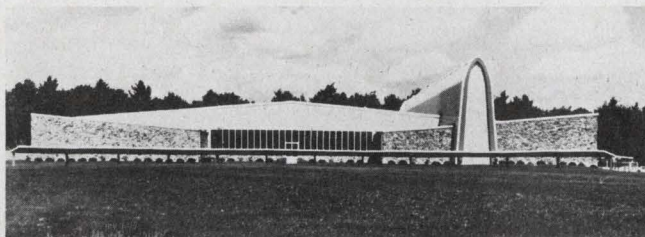

Galileo Electro-Optics Corporation isn't little nor relatively old. We're located about 3,102 miles this side of Napa Valley. (That's Sturbridge, Mass. to be exact.) And no, we don't make wine either.

Galileo is simply the world's largest producer of fiber optics. We realize that fiber optic technology may sound new, but we've already produced trillions of feet of optical glass fibers for technical use in the last fifteen years!

One of the uses of our fiber is for optical communications. You see, Galileo's communication fibers offer distinct advantages over copper wire and eliminate most of copper's limitations. Extremely pure, very strong glass fibers combine the wide bandwidth of waveguide systems with the small size and great flexibility of wire at a substantial weight savings. And because light waves are being transmitted, there's no spark or fire hazard.

You'll also realize other benefits over coaxial and twisted pair cable. Fiber optic cables have high information carrying capacity, and are immune to electromagnetic interference (EMI/RFI). All virtually eliminate cross talk between communication channels. These advantages are particularly important for use in computers, ships, aircraft and high rise buildings.

As an innovative leader in optical communication cables, Galileo operates a completely integrated fiber manufacturing facility, from glass melting to cable jacketing. This means we carefully control quality at each critical manufacturing step. And because we utilize five completely different glass making processes, plus possess the largest production capacity of any optical communication cable facility, you can obtain the broadest range of cables anywhere. Promptly. From current stock. And at the best price.

Our new family of Galite™ optical communication cables is a most significant break-

through in the ability to supply the optimum cable for your specific application. Galite 1000, 2000, 3000, 4000, and 5000 span the widest spectrum of communication cables available from one manufacturer. And with more to come. The Galite family's numerical apertures range from 0.2 to 0.66 with attenuation levels that permit increasingly longer communication systems. Examples of current applications are inter-and-intracomputer data transfer, secure phone and video lines, military communication centers, medical monitoring, industrial controls, and many, many more.

Galileo also manufactures a broad range of fiber optic components, Channeltron® electron

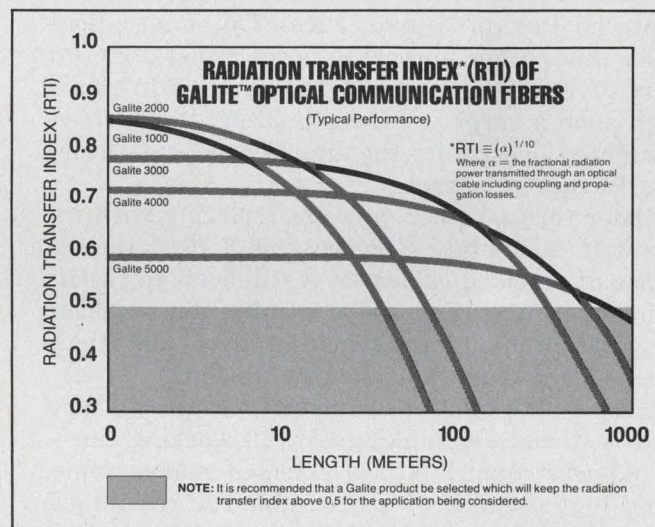

Radiation Transfer Index (RTI) is a simple, easily-remembered measure of fiber optic cable performance. Write for "Tech Memo 201" for detailed explanation.

multipliers and microchannel plate multiplier arrays, miniature high voltage power supplies, and silicon diodes and rectifiers.

So no matter if you're faced with a supply problem requiring large production quantities for immediate delivery at very economical prices. Or a design problem demanding a truly unique solution, Galileo can help you right now with both. And on a non-

disclosure basis. For more information, write: Galileo Electro-Optics Corporation, Galileo Park, Sturbridge, Mass. 01518. Or call us at (617) 347-9191. You'll soon discover all our products are of the finest vintage.

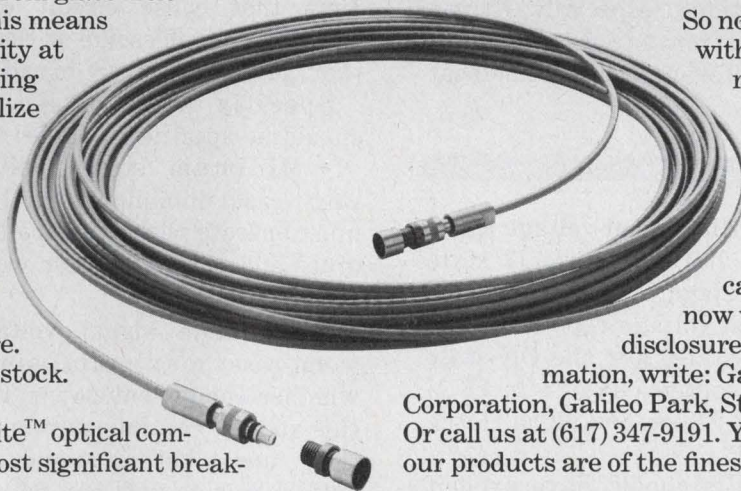

Imagine what we could be doing for you right now.

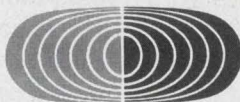

Galileo Electro-Optics Corp. Galileo Park, Sturbridge, Massachusetts 01518, (617) 347-9191

Use defensive interfacing for remote control of your digital system. Follow these five rules and save many tedious hours of troubleshooting.

If you never worked with industrial controls before, you probably never dreamed that so much noise could be picked up in the cables of remote controls. But, of course, wires for motors, solenoids and other powerful noise generators are part of the cable assembly, so it shouldn't have been such a surprise. Unfortunately, the garbage generated doesn't fit the simple clean-cut theory you learned in school.

Older relay systems you are replacing with the latest in solid-state circuitry didn't need the expense of shielded cables, so it's difficult to justify using shielding. You spend a miserable weekend desperately hanging capacitors here and there and somehow get your system working.

Just as the unpleasant memory begins to fade, and systems are cranking out, all working fine—it happens again! A new solenoid makes somewhat bigger spikes or a new cable run rearranges

the noise: another lost weekend.

You know in your heart that you're pure and blameless, because the real circuit works; it's the fault of those other guys. Not working is not working, so you don't get much sympathy, but you do have plenty of company: variations of this scenario have been played out by generations of engineers.

Take heart! There is a better way. Defensive interfacing for remote controls can ensure endless benefits and uninterrupted weekends. The secret: Recognize control-signal interfacing as a design discipline in its own right. Many engineers become so preoccupied with the primary design that interfaces get scant thought, even though interface design can be just as challenging. The environment is difficult to control, but the following checklist, born of long experience, can keep you out of trouble.

Rule 1. Establish written interface standards

Develop clear interface criteria and insist on clearly written specifications, especially if you interface with equipment from other groups. At the end of this article are examples of items that should be specified.

Rule 2. Work with substantial signal-voltage levels

Most control functions have a "normal" state in which the most time is spent. Arrange the logic so that absence of a signal voltage represents the functions in this normal state. For the ON-state signal use a substantial voltage, like 24 to 28 V dc. Avoid 5-V logic levels; keep the signal large relative to the noise level.

Signal levels and circuits should have explicit ON/OFF characteristics. Schmitt-trigger input circuits with their regenerative snap action and hysteresis are one way to get the clean ON/OFF

action needed. Circuits that can dwell in a "gray" zone often behave as highly sensitive noise amplifiers that cause circuit chattering—an effect especially troublesome with CMOS gates because they have a relatively broad class-A region.

Specific signal-voltage characteristics that should be specified include:

- **Minimum signal voltage**—Determine the worst-case minimum signal voltage the system must operate with; be sure to consider all voltage drops and corrections for worst-case temperature conditions.

- **Maximum signal voltages**—Determine the worst-case maximum signal voltage; check whether component power ratings can withstand this voltage continuously under all possible conditions, and whether signal application when the system power is off can be harmful.

- **Threshold voltage**—Specify a signal-level maximum guaranteed not to produce a system response under any combination of conditions. Such a threshold helps prevent false operation on noise, poor grounding and many other sources of trouble. Provide a reasonable spread between the guaranteed minimum ON signal and the threshold

Lloyd Nissley, Product Line Manager/Electronic Timers, Cyclomatic Industries, Inc., 7520 Convoy Ct., San Diego, CA 92111.

voltage. As a practical compromise, you may specify the threshold about halfway between zero and the minimum ON voltage.

▪ **Reverse polarity and short protection**—Provide diodes, clamp circuits, fuses, etc., so that the inadvertent polarity reversal of a signal, or an accidental short, won't cause damage.

Rule 3. Employ time discrimination

Design circuit inputs to accept ON signals only when the signal's are sustained for a specified minimum duration. This simple time discriminating method is the single most effective technique for fighting noise spikes.

An ON-signal rejection time of 0.5 ms minimum has proven practical in many applications, and is especially useful with long control lines. Longer intervals can be used where a fast response is not critical. Momentary-contact pushbutton inputs should require no more than about 25 ms of closure; a longer-closure requirement might miss legitimate inputs.

In systems where response time is not critical, the maximum ON-signal rejection-time allowed can be as much as 10 times the specified minimum. This guideline is based on the usual circuit tolerances using only simple RC circuits to establish the timing.

Between ON signals, the circuit recovery time should be a compromise between instantaneous recovery and some tolerance against a momentary dropout of legitimate signals. But recovery time should not be so slow that it allows a series of closely spaced noise pulses to be interpreted as true signals.

Rule 4. Use low input impedances

Make sure input circuits draw some current, say, 1 to 5 mA, to register an ON condition and help reject noise. The current should be kept low to avoid heating and surge problems, but not so low that metallic switching contacts in the signal path become troublesome because of "dry-circuit" conditions.

Whatever the current drawn, be sure to examine the maximum power that can be dissipated by all the simultaneously energizable inputs. Engineers too often overlook input-signal power, although they seldom forget the device's loads and internal power consumption. With CMOS logic, power dissipation from signal inputs can easily exceed the system's total running power!

Of course, limiting the input current means less noise rejection. Fortunately, noise pulses can be successfully discriminated against on a time basis rather than a power basis. And in any event, you may be forced to use something besides power to overcome noise because electrostatic or electromagnetic coupling of pulses can provide surprisingly high power surges for very narrow spikes.

Rule 5. Test for discrimination against noise spikes

Even though noise spikes don't come in convenient standard sizes in nature, valid testing for both military and commercial systems can still be done by using spike criteria as adopted by some MIL-specs.

Many standard test signals include positive and negative voltage spikes with 50-V peak amplitudes and 10- μ s widths at their bases; however, signals in low-voltage systems may be limited to spike peaks of twice the highest supply voltage in the system. The spike repetition rate should correspond to the highest frequencies expected in the system. Spike timing should sweep randomly through 360° of phase relative to the clock in the device under test.

Be sure the input circuits are designed so that spikes, with or without ON signals, don't exceed any voltage or power ratings.

Positive test spikes of 10 μ s shouldn't register as ON signals; neither should such negative spikes riding on a valid ON signal cause dropouts, since such spikes would tend to cancel the ON-signal voltage.

You may say, "All good stuff. It's great, but it's so complicated that we can't afford it." Wrong!

Three examples of practical input circuits show how simple an inexpensive defensive interface design can be. And these circuits will undoubtedly suggest numerous alternatives.

Examples to the rescue

Example 1. An old-fashioned relay interface

Embarrassingly, electromechanical relays have the desirable interfacing characteristics without even trying. Specifications, of course, depend on relay type, but relays have limitations—low speed, limited life, contact bounce, noise generation, etc.

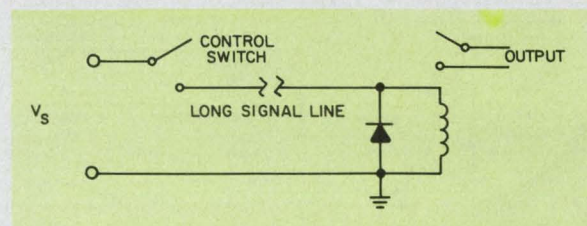

Example 2. A CMOS Schmitt trigger with RC input delay

This simple interface circuit performs well in applications that can tolerate a fairly wide variation of signal discrimination time and threshold voltage. The threshold voltage can be adjusted by changing the 470/330-k Ω divider ratio.

Current is limited by the 470-k Ω timing resistor, so that protection diodes within the CMOS gate can safely clamp signal-voltage transients and polarity reversals. The 10-k Ω input resistor provides a relatively low input impedance. The resistor draws a modest current to ensure that the remote-control switch is not operated in a "dry-circuit" condition.

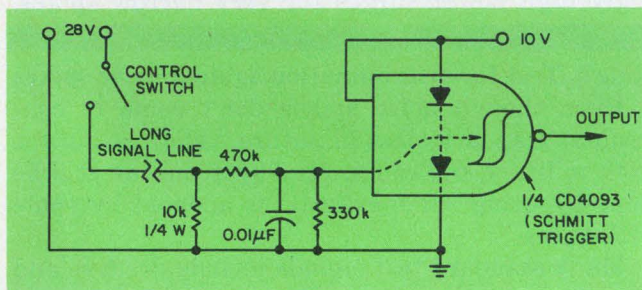

Circuit specifications

Signal states	+ V = ON; floating at 0 V = OFF
Signal voltage	28 V dc (nominal)
Minimum signal voltage	20 V
Maximum signal voltage	35 V
Minimum threshold	8 V (13 V typ.)
Reverse voltage protection	Yes (inherent in CMOS)
Snap-action response	Yes (Schmitt trigger)
Signal input impedance	10 k Ω (nominal)
ON-signal time discrimination	1.7 ms (typical)
minimum	0.5 ms
maximum	5.0 ms
Recovery time	10 ms (maximum)
Voltage spikes	Withstands test spikes (± 50 -V peak, 10 μ s)

Example 3. A CMOS input circuit with digital delay

A digital-delay circuit can provide precise pulse-width discrimination and an independently controlled fast recovery time. When an input pulse appears, ONEs are clocked into a shift register. An output results if the input signal is sustained long enough to clock the ONEs through to the last register stage. If the signal is interrupted for longer than the recovery time set by R_1C_1 , the register resets. Once the register resets, delay must be re-initiated before an output can again occur. The R_1C_1 time constant should be small compared to the shift-register delay time; delay time equals the number of shift-register stages times the clock period. The delay method has an uncertainty up to one clock period, because the signal and clock are not synchronous.

A zener diode in the input establishes the threshold level. Input-circuit variations, such as the use of opto-isolators in place of the transistor, allow the use of balanced lines, which offer the advantage of common-mode noise rejection. ■■

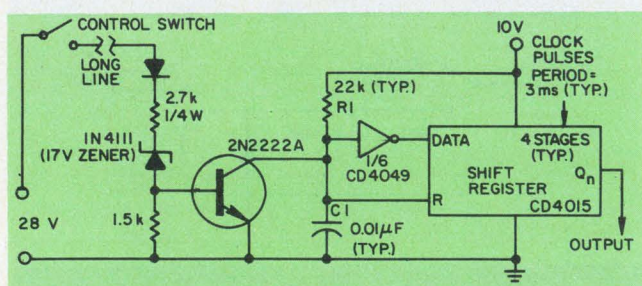

Circuit specifications

Signal states	+ V = ON; floating at 0 V = OFF
Signal voltage	28 V dc nominal
Minimum signal voltage	23 V
Maximum signal voltage	34 V
Minimum threshold voltage	18 V
Reverse voltage protection	Yes
Snap-action response	Yes (shift-register output)
Signal input impedance	6 k Ω (nominal at 34 V)
ON-signal time discrimination	$(n - 0.5) \times$ (clock period) nominal
minimum	$(n - 1) \times$ (clock period)
maximum	$(n) \times$ (clock period) (n = shift-register stages)
Recovery time	Determined by R_1C_1
Voltage spikes	Withstands test spikes (R_1C_1 time constant absorbs signal dropout)

INTERDATA 8/32 MEGAMINI LIFE SUPPORT

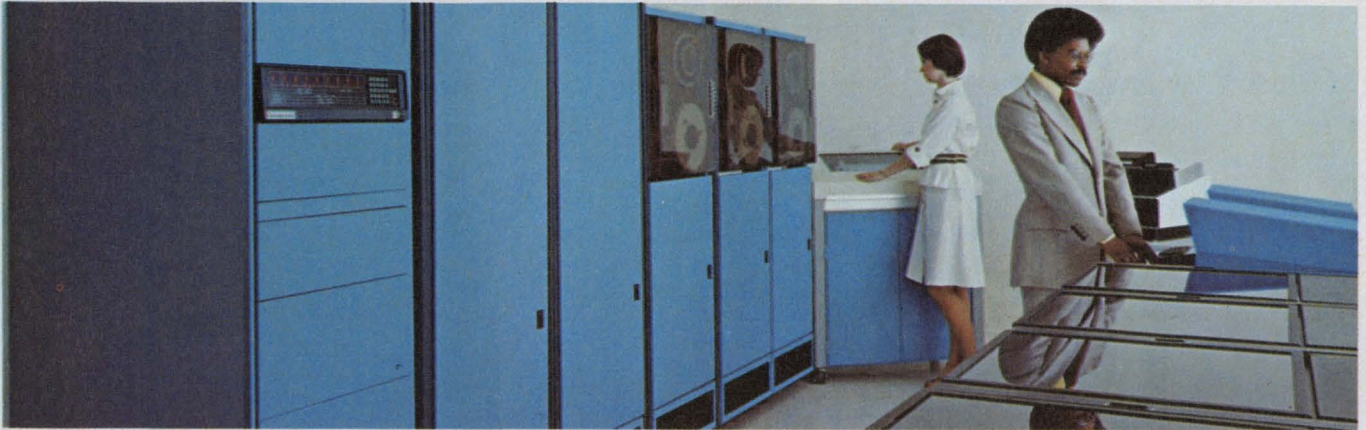

Risk-free computer buying—with power to spare.

You're looking for a computer system so powerful, it takes you over any snags that could cost you extra.

That's why Interdata builds the powerful 8/32 Megamini with 32-bit hardware performance and direct addressing capability of up to one million bytes. With unique software packages that are powerful, flexible and easy-to-use. With Megamini Life Support that means you'll never have to take a risk with:

On-time Delivery. Interdata guarantees on-time delivery of your Megamini. In fact, we've already shipped hundreds of 32-bit computers from production that are completely operational.

Hardware Back-up. Interdata hardware means 32 registers, each 32 bits wide. Fast single- and double-precision arithmetic. Optional, writable control store. And big computer peripherals. It also means that we support you long after your system is operational.

Software To Do the Job. Megamini's software optimizes its hardware and gives you a solid systems environment. It includes program development tools like BASIC II, FORTRAN, MACRO CAL and COBOL. And the versatile real-time OS/32 MT (Multi-Tasking) operating system. Megamini software helps you build simple solutions to your toughest applications problems.

No Surprises. Our customer requirement analysis insures that you never have to add more people than you planned on. Or more hardware than you scheduled.

Megamini Life Support. From the moment you decide on Interdata, until you are completely operational, Megamini's capabilities are carefully spelled out. The Interdata/Perkin-Elmer name stands squarely behind every promise with the viability of a \$300 million corporation. With Interdata and the Megamini, you're guaranteed power to spare.

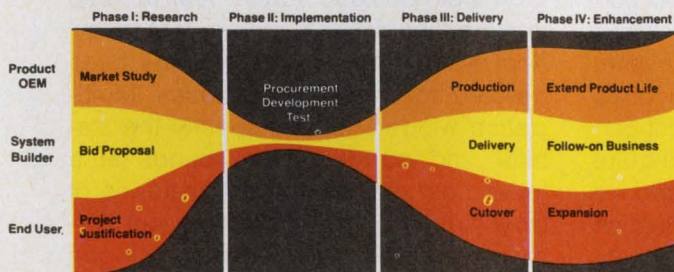

Interdata's computer products and services exist for one reason—to satisfy our customers: The Product OEM, the System Builder and the End User. Each of these computer buyers has a Computer Life Cycle with four specific Phases—Research, Implementation, Delivery and Enhancement. Interdata responds to customer needs during each Phase with Computer Life Support.

Gentlemen:

Send me more about Megamini power.

My needs are:

___ Immediate ___ 6 Months ___ 1 Year ___ For Reference Only

Name _____ Title _____

Company _____

Address _____

City _____ State _____ Zip _____

Telephone () _____

INTERDATA®

Interdata, Inc.
Subsidiary of Perkin-Elmer
Oceanport, N.J. 07757 201-229-4040

Someone has developed a more efficient resistor.



THE new Dale resistors are more efficient to buy. A network of computer terminals throughout our three resistor plants gives you more useful production information than you've ever been able to get—from anyone.

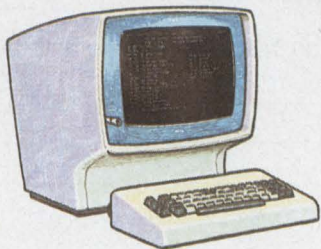

Place an order and in seconds we can tell you whether it can be shipped from stock. Inquire about an existing order and we can tell you its exact production status equally as fast. Discover a need for earlier delivery and we can instantly mark your order for expediting. That's

resistor efficiency you can use. It's part of an expansion program that has seen our floor space devoted to resistors grow from 300,000 square feet in 1970 to more than 400,000 square feet today. And much of this expansion has been devoted to automated facilities. Multi-station winders let you specify the stability and power of wirewounds at a lower cost than ever...and batteries of laser spiralling machines turn out RN-style metal film parts at machine-gun speed. We're making the most efficient resistors you can buy—and we're ready to prove it.

The new Dale resistors are made from more efficient materials than ever. Sophisticated equipment, like this scanning electron microscope, gives us state of the art capability for analyzing, identifying and specifying component materials. It's part of an integrated materials improvement, performance testing and quality control program we initiated 15 years ago in the early days of the Minuteman High Reliability Development Program. Today, one out of every 10 Dale employees is directly involved with Quality Control. Tangible results include: More than 100 separate QPL listings for wirewound and metal film resistors; the world's most reliable wirewound resistor (proven failure rate .000021%/1000 hours). The new Dale resistors will give you less trouble—before and after purchase—than any others you can buy—and that's efficiency! Call 402-564-3131 for wirewound and 402-371-0080 for metal film.

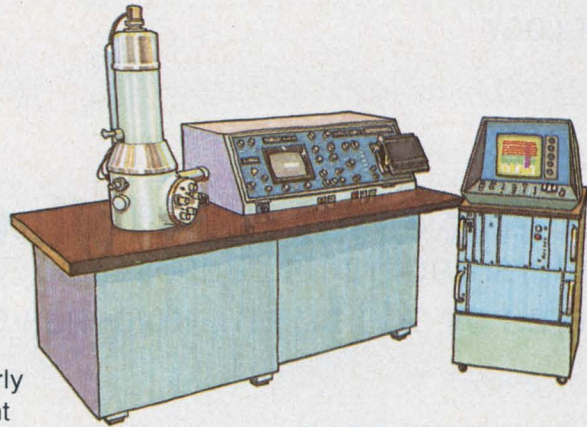

DALE ELECTRONICS, INC.
1300 28th Avenue, Columbus, Nebraska 68601
A subsidiary of The Lionel Corporation
In Canada: Dale Electronics Canada Ltd.
In Europe: Dale Electronics GmbH,
8 München 60, Falkweg 51, West Germany



Our complete product line can be found in Electronic Design's GOLD BOOK.

CIRCLE NUMBER 60

Dale!



Prevent emitter-follower oscillation

by understanding its causes. You can minimize problems by adding an inexpensive resistor or ferrite bead.

You can use graphical analysis and minor circuit changes to prevent oscillation in emitter-follower output stages. For most applications a simplified analysis can pinpoint the causes of oscillation and help you avoid loss of system performance and possible damage to transistors and other components.^{1,2,3}

Oscillations occur at 50 kHz and higher

When emitter-follower circuits break into oscillation, they usually do so at some frequency between 50 kHz and 500 MHz. The frequency, of course, depends on the transistor's f_T and its source and load impedances (Fig. 1).

Because the influential transistor characteristics—notably f_T and C_{ob} —vary with voltage and current, the emitter-follower oscillations sometimes occur in only part of the signal range—coming and going as the signal waveform rises and falls.

Let's first analyze the emitter-follower stability, using a one-pole model for the transistor's current gain, $\beta(f)$. This model will show how interactions among the source and load impedances and the transistor can result in oscillation because of the transistor's negative input resistance at some frequencies.

In analyzing the oscillation problem, different authors use different mathematical techniques to model the circuit. Basically any analysis proceeds as follows:

- At high frequencies, an R-C emitter load is transformed by $\beta(f)$ to appear at the transistor base as a negative resistance in series with a capacitor. (Both the resistance and the capacitance are frequency-dependent.)

- When an inductive source impedance is placed at the base, it results in oscillation if the external resistance of the base circuit is small enough. Then the total resistance in the loop is zero or negative at the frequency at which $X_L = X_C$.

Michael Chessman, Project Engineer, and **Nathan Sokal**, Director of Engineering, Design Automation Inc., 809 Massachusetts Ave., Lexington, MA 02173.

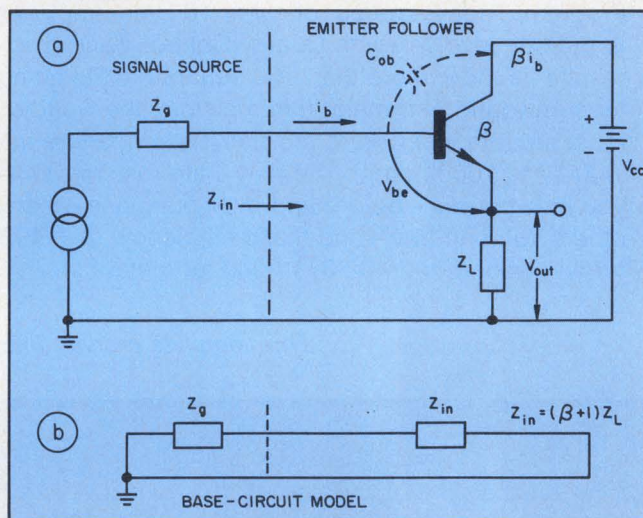

1. The emitter-follower transistor circuit (a) provides large current gain, β , but can be unstable at certain frequencies. A simplified base model (b) allows easy determination of the conditions for stability.

The usual solution to this instability is to overwhelm the apparent negative resistance with an external positive resistor at the base, so that the sum of the resistances is positive. For example, if we assume Z_L to be a parallel R-C load, we must do three things to prevent oscillation:

- (1.) Determine the resulting emitter-follower input impedance, Z_{in} , and show that the real part, $\text{Re}[Z_{in}]$, can be negative.
- (2.) Examine the subsequent circuit conditions required for oscillation.
- (3.) Use remedial techniques to prevent oscillation.

The $r_{b'e}$ and $C_{b'e}$ shown in most common transistor models can be included as part of the expression for the dependence of β (small-signal, common-emitter current gain) on frequency. However, C_{ob} is assumed to be a circuit element external to the basic transistor. If we assume that $Z_L \gg r_e$ (where $r_e = 0.026/I_C$ at 25 C) and that (for the ac components) $V_{be} \ll V_{out}$ the expression for input impedance results:

$$Z_{in} \approx (\beta + 1) Z_L.$$

The stability of the emitter follower is determined by the behavior of Z_{in} with frequency. And

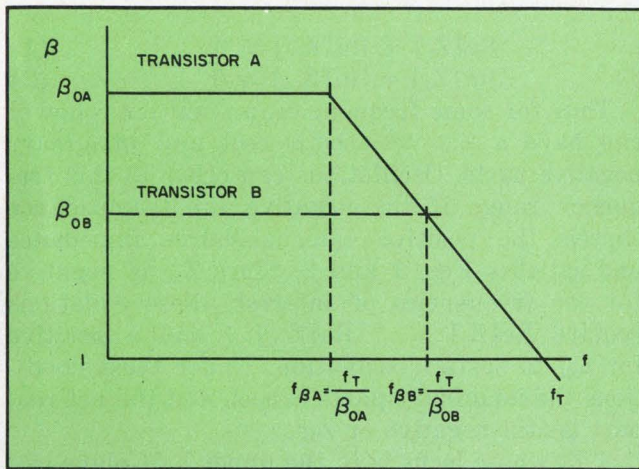

2. A plot of β vs frequency for two different transistors that have the same f_T shows that the high frequency gains are the same even though the low frequency gains are different.

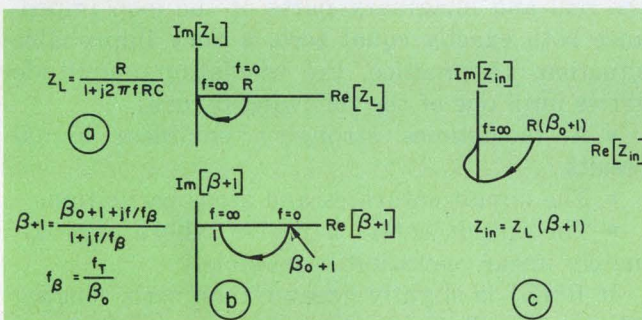

3. The emitter-follower impedance loci plots for the load-impedance locus (a), the $(\beta + 1)$ locus (b) and the input-impedance locus (c) are all basically in the fourth quadrant.

Z_{in} , in turn, depends directly on β , which varies with frequency.

Look at β as a function of frequency

If we assume that β is the current gain of the basic transistor (without C_{ob}) and that the emitter depletion-layer capacitance (C_{ib}) is absorbed into the emitter diffusion capacitance, we can approximate $\beta(f)$ with a one-pole model:

$$\beta(f) = \frac{\beta_0}{1 + j\beta_0 f/f_T}$$

where β_0 is the low-frequency asymptotic value of $\beta(f)$.

The transistor's beta-cutoff frequency, f_T/β_0 , (also called beta corner frequency) is useful for low-frequency analysis. However, f_T is more useful than f_β in characterizing the high-frequency properties of a transistor. There are two reasons:

First, since it is the transistor design that determines f_T , all devices of a given design have similar f_T values. β_0 is much more variable among transistors of a given design, leading to correspondingly large variations in f_β .

Second, most high-frequency applications of

transistors are at frequencies well above f_β . Hence most transistors, regardless of their individual f_β , operate at frequencies in the $\beta \propto 1/f$ region, where all transistors of the same f_T have essentially the same β and the same variation of β with frequency (Fig. 2).

The Z_L impedance locus for the assumed R-C load (Fig. 3a) is in the fourth quadrant for $f > 0$. The locus for $(\beta + 1)$ is shown in Fig. 3b. Note that the phase of $(\beta + 1)$ is always lagging for $f > 0$ and is also in the fourth quadrant. In the product

$$Z_{in} = Z_L (\beta + 1),$$

the individual phase angles add, and this rotates the resulting locus clockwise. Thus, at some frequencies Z_{in} can be in the left half plane, where the real part (resistance) is negative, as in Fig. 3c.

Although this analysis is for Z_L as a parallel R-C load, the reasoning holds for any complex Z_L whose impedance (both resistive and capacitive) is in the fourth quadrant for some frequencies. The details of the loci of $(\beta + 1)$ and of Z_L do not affect the qualitative conclusions because the product, $Z_L (\beta + 1)$, can be in the third quadrant regardless of deviations from this particular Z_L .

The interaction of such a Z_L with $(\beta + 1)$ produces a Z_{in} whose impedance locus is in the third quadrant over some of the frequency range. Then Z_{in} has both a negative real part (negative resistance) and a negative imaginary part (capacitive reactance). These impedance polarities are important when the associated conditions that can lead to oscillation are determined.

It is tempting to model the resulting input resistance and capacitance with fixed-value components. However, both the resistance and the capacitance are functions of frequency: you can model them at only a single frequency, as a fixed-value negative resistor and a fixed-value capacitor.

Check the conditions for oscillation

The total loop impedance around the equivalent base circuit in Fig. 1b is $Z = (Z_g + Z_{in})$. Because a capacitive input reactance accompanies the negative input resistance, an inductive source reactance can supply the additional element needed to make a resonant circuit. If the source resistance is equal to or less than the magnitude of the negative input resistance at the resonant frequency of the L-C resonant circuit, the circuit will oscillate as a negative-resistance oscillator.

Expressed mathematically, oscillation occurs at frequency f_0 if the total loop impedance at f_0 has zero net reactance ($\text{Im}[Z_g + Z_{in}] = 0$) and a zero or negative net resistance ($\text{Re}[Z_g + Z_{in}] \leq 0$):

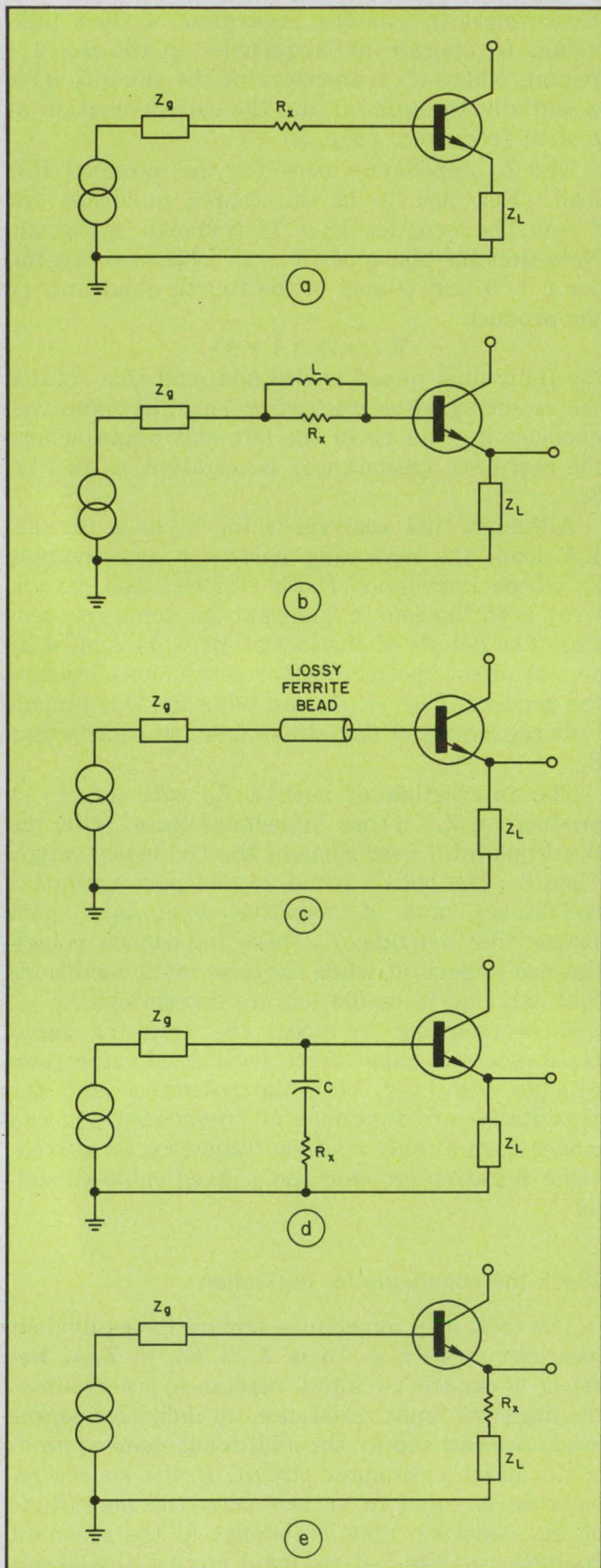

4. Five basic circuit modifications can be used to prevent emitter-follower oscillation. The techniques are as simple as adding a resistor to the base circuit (a), adding a parallel LR circuit to the base (b), placing a ferrite bead on the base lead (c), putting a series RC circuit from the base to ground (d), or adding a series resistor to the emitter circuit (e).

$$\text{Re}[Z_g] + \text{Re}[Z_{in}] \leq 0 \quad (1)$$

$$\text{Im}[Z_g] + \text{Im}[Z_{in}] = 0 \quad (2)$$

Thus for some frequencies, an emitter follower can have a Z_{in} with both real and imaginary negative parts. Oscillations can occur in this frequency range if the negative input impedance cancels the positive external-source impedance and satisfies Eqs. 1 and 2. Since Z_{in} is negative for the frequencies of interest, these equations require $\text{Re}[Z_g] \leq |\text{Re}[Z_{in}]|$ and a positive $\text{Im}[Z_g]$ to sustain oscillation. Under these conditions the imaginary parts cancel, and the net real part is still negative or zero.

A Z_g whose locus is in the upper half-plane can satisfy these requirements for oscillation. A simple example of this is a series L-R combination, whose locus lies in the first quadrant, with positive real and imaginary parts.

Purely sinusoidal oscillation occurs only when the real and imaginary parts of the loop impedance both exactly equal zero, a very improbable situation. In practice, the oscillation amplitude grows until one of the following occurs:

- A (sometimes strongly) nonlinear signal results.
- The circuit saturates and stops oscillation.
- The circuit enters a region where approximately linear operation is possible.

If $\text{Re}[Z]$ is slightly greater than zero, ringing (damped oscillation) occurs in response to input excitation.

In most linear circuits slight nonlinearities that are always present limit the signal growth and sometimes produce good approximations to true sinusoids. In emitter-follower oscillations the transistor nonlinearities typically limit the oscillation amplitude to about 1 V across the load.

Typical circuit element values

The emitter-follower's negative input resistance is typically in the range of 0 to -500Ω . A typical value for the parasitic capacitance of the load wiring is $C \leq 10 \text{ pF}$. Carbon resistors have an equivalent parallel capacitance ranging from about 0.08 pF for 1/8-W resistors to about 1.6 pF for 2-W resistors. And the nonparasitic load capacitance is often much larger than 10 pF.

Parasitic base-circuit inductance, L_b , is typically between 10 and 100 nH, and wiring contributes from 8 to 40 nH/in., depending on the size and separation of the conductors, one of which may be a ground plane. Reference 4 is helpful in estimating wiring inductance.

A circuit whose net loop resistance is positive cannot sustain oscillation. Therefore, one way to prevent or eliminate oscillation is to ensure that the net loop resistance is positive at the frequencies of interest.

The simplest and most obvious method of preventing oscillation is shown in Fig. 4a; just add enough external base-circuit resistance, R_x , to overwhelm the negative real part of Z_{in} . Appropriate values of R_x range from tens of hundreds of ohms. With this method, the dc bias point may be affected because of the dc voltage drop in R_x .

In Fig. 4b an inductor is connected in parallel with the external base resistor. The dc bias is unaffected because the inductor has low dc resistance, but at high frequencies the resistor appears in series with the base to prevent oscillation.

The circuit of Fig. 4c uses the L-R method of Fig. 4b, but you construct the L by threading a lossy ferrite bead onto a circuit lead—in this case, the transistor base lead. At frequencies higher than a few hundred MHz, this method is preferable, because it is easier and because a ferrite bead of the proper material can appear as a pure resistance out to a much higher frequency than can a circuit constructed of a separate L and R. Such lossy ferrite beads are available from Ferroxcube, Stackpole, Indiana General, and others.

Another method (Fig. 4d) uses a shunt resistor, R_x , coupled to the base circuit by the series capacitor, C. Coupling occurs only at the high frequencies at which oscillation may be a problem. Dc bias is not affected by the presence of R_x . However, the value of $G_x (=1/R_x)$ must be larger than the negative real part of Y_{in} in order to achieve a net positive value of $\text{Re}[Y_{in} + Y_x]$. For example, if $G_x = 2 \text{Re}[Y_{in}]$, the effective real part of the input admittance becomes $+\text{Re}[Y_{in}]$.

The last method (Fig. 4e) uses a resistor placed between the load Z_L and the emitter. It effectively moves the Z_L impedance locus away from the third quadrant over some of the frequency range. The output, V_o , is attenuated by the voltage drop in R_x . Resistor R_x must be chosen for acceptable attenuation as well as for transistor and Z_L parameter values. As in Fig. 4b, an inductor can be placed in parallel with R_x to eliminate the dc voltage drop. Or ferrite beads can be added, as in Fig. 4c. ■■

References

1. Kozikowski, J. L., "Analysis and Design of Emitter Followers at High Frequencies," *IEEE Transactions on Circuit Theory*, Vol. CT-11, No. 1, March, 1964, pp. 129-136.
2. Tammaru, E., "Using an Analog Computer to Analyze Transistor Circuit Performance," *Solid State Design*, October, 1964, pp. 28-36.
3. Nichol, W. S., "The Emitter Follower as a Logical Switch," Mitre Corp., Bedford, MA 01803, Working Paper W-4403, Oct. 19, 1961.
4. Rostek, P. M., "Avoid Wiring-Inductance Problems," *Electronic Design*, Vol. 22, No. 25, Dec. 6, 1974, pp. 62-65.



Nurl-Loc[®] ...4-way problem solver

Warp ... only the patented Nurl-Loc[®] design, with 500% more gripping surface, eliminates panel warp by spreading stress.

Spin ... gear-locking action guaranteed not to rotate during wrapping.

Tear ... replace terminals up to 3 times without tearing or crazing panel.

Snap ... no brittle pins to break. Accurate true position without pin straightening.

Interested? Call Allan Klepper (401) 769-3800 or contact Electronic Molding Corp., 96 Mill Street, Woonsocket, Rhode Island 02895.

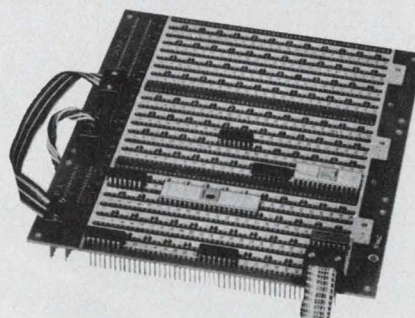

EMC
Interconnection Specialists

CIRCLE NUMBER 61

Ideas for Design

CMOS frequency-to-voltage converter is highly linear over wide frequency range

A very simple frequency-to-voltage converter can be made by inserting a sensing resistor, R_s , into the power-supply line of a CMOS gate at V_{ss} (Fig. 1). Power dissipation in a CMOS gate is a linear function of the input-signal frequency; so is the average current, if the power-supply voltage, $V_{cc} - V_{ss}$, is constant.

Though the circuit uses a CD4050 hex-buffer, the same principle can be applied around any other CMOS gate. Signal-input pulses, E_{in} , enter one of the buffers, G_1 . Supply current, I_{ss} , in flowing through R_s generates voltage pulses that are amplified by another buffer, G_2 , on the same chip. A low-pass filter smooths the output voltage from G_2 .

The plot in Fig. 2 shows the measured frequency-to-voltage characteristic of the circuit. It is essentially linear over the wide range of 1 kHz to 1 MHz.

The total power dissipation of a CMOS gate is a complicated relationship among the input and output-signal rise and fall times, the signal fre-

quency, the supply voltage and the load and the various parameters of the MOS transistors. However, use of a relatively low supply voltage, such as 5 V, eliminates any substantial dependence on rise and fall times, and the load and CMOS parameters remain constant.

Resistor R_s tends to introduce a nonlinearity into the f/V transfer ratio, because the voltage difference, $V_{cc} - V_{ss}$, varies with V_{ss} . Nevertheless, a conservative value for the linearity error, as given by the expression

$$e < 3 \frac{V_{ss}}{V_{cc}},$$

is less than 0.072 percent at 1 MHz. Note that R_s is only 10 Ω and thus V_{ss} is a low voltage measured in millivolts.

Jose L. Monteagudo and F. del Pozo, Universidad Autonoma, Facultad de Medicina, Dpto. Fisiologia, c/o Arzobispo Morcillo, 1, Madrid-34, Spain.

CIRCLE NO. 311

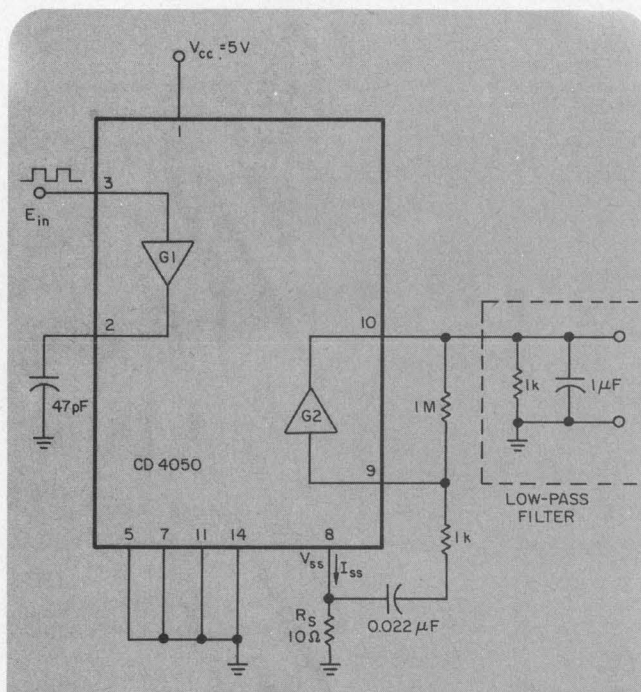

1. A frequency-to-voltage converter makes use of the linear relationship between the power dissipated in a CMOS gate and its input-signal frequency.

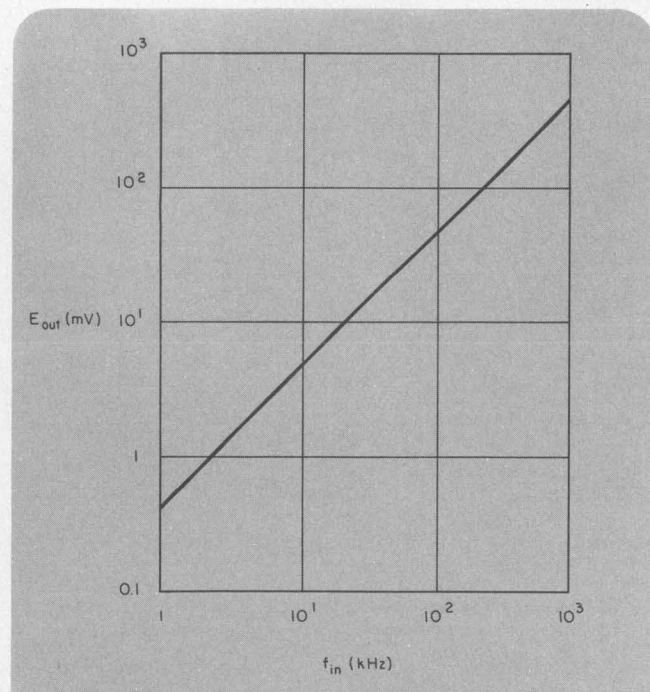

2. Linearity with an error of less than 0.072 percent is attainable over at least three decades of frequency with this very simple CMOS circuit.

The new 60-NA!

Another Super-VOM from Triplet with 50 ranges, 1½% DC accuracy... only \$130.

This portable precision VOM has 50 separate ranges and 1½% DC accuracy for stringent communications or computer design work. And, it's priced right for exacting industrial or service work, too.

A large "easy reader" 4½" mirrored scale eliminates parallax, and just a flick of the multiplier switch enables you to take more readings at the upper portion of the meter scale for greater accuracy.

- 1. Super-safe**—Designed to meet most rigid safety standards to prevent explosive arcs in high energy circuits, up to the 2 Amp/1000 V (20 kW) fuse capacity; completely insulated with newly designed safety leads.
 - 2. Burnout-proof**—Protected by diodes and unusual three fuse arrangement including 1/8 Amp, 1 Amp and 2 Amp/1000 V fuses, up to maximum protection level provided by the 2 Amp/1000 V (20 kW) fuse.
 - 3. Drop-proof**—Virtually indestructible for an accidental drop up to a five foot height with deviation from stated accuracy not exceeding ±4%.
- 50 Ranges**— Including 16 VDC ranges from 150 mV to 1000 V; 10 VAC ranges from 3 V to 1000 V; 10 DC current ranges from 50 μA to 1000 mA; 6 resistance ranges from 1K to 100 Meg (6 ohm center scale); and 8 dB ranges from -20 dB to +52 dB.

Call your Triplet distributor for a demonstration.

TRIPLETT
BLUFFTON, OHIO 45817

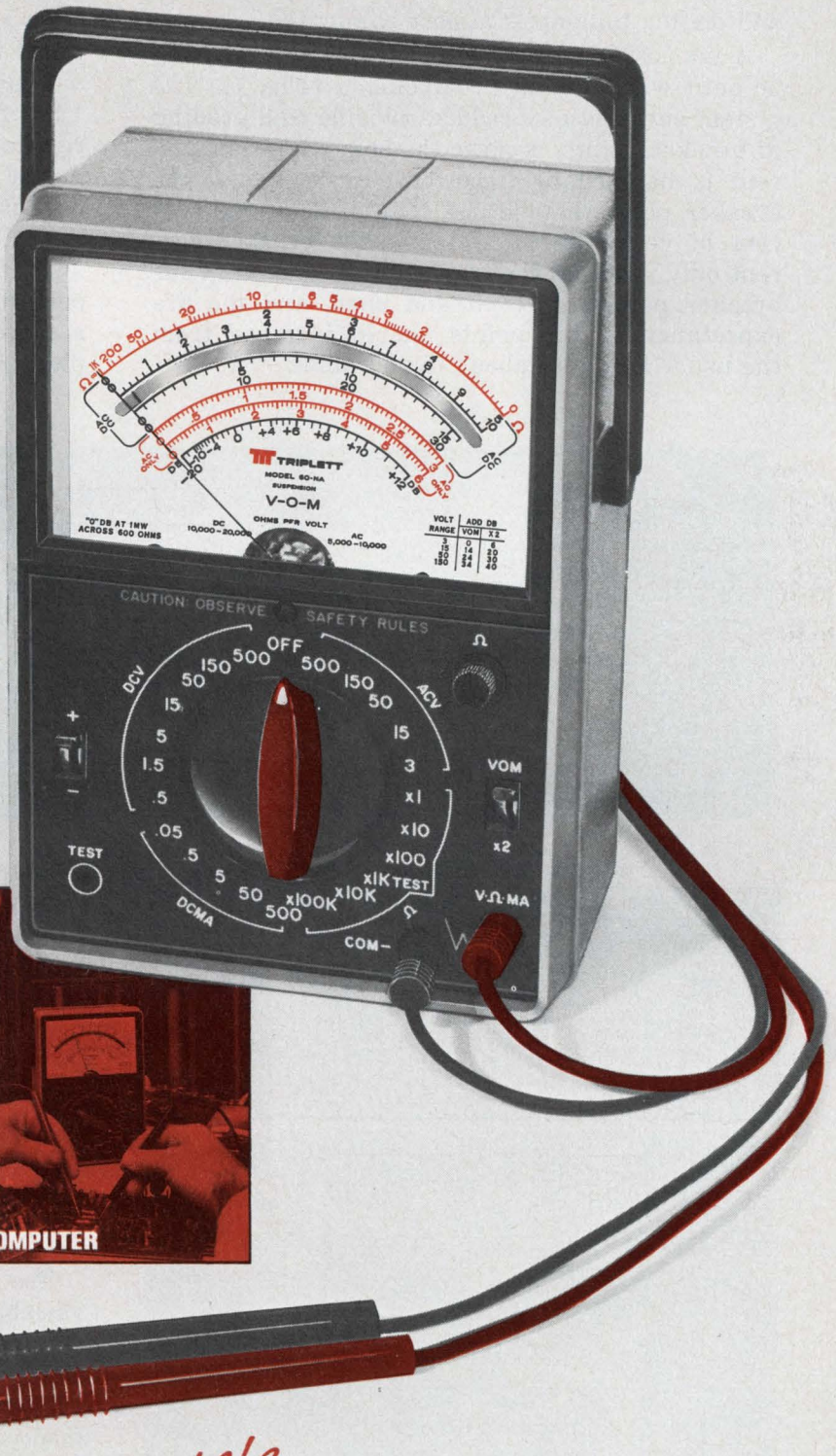
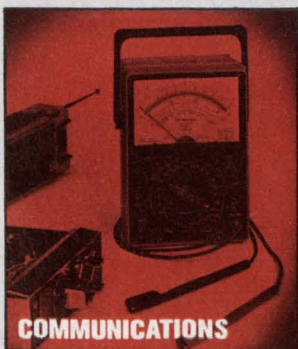

super-safe

Triplet. The easy readers.

Improve conventional ignition systems with a transistor-assisted approach

A transistorized automobile ignition system offers several distinct advantages over conventional systems. A greater amount of current is available to fire the spark plugs; malfunction of the distributor points is almost eliminated; and engine tune-up is almost eliminated.

A transistor-assisted ignition system can easily be built with standard components (Fig. 1). The system substantially reduces blueing and eroding of breaker points, because the heavy ignition current is handled by a power transistor and the breaker points handle less than 10% of the current of conventional systems; the breaker current only switches the transistor on and off. Thus breaker points don't pit and burn, and the life expectancy of the points should increase from the usual 10,000 to about 75,000 miles.

The breaker current density in a conventional system is about 324 A/in² and only 20 A/in² in the transistorized system in Fig. 1.

The inclusion of a two-pole switch in the circuit and the transfer of the high-voltage cable from HV₁ to HV₂ allows a return to the conventional ignition system.

When the breaker points are open, only about 1 mA flows from the battery, through the ballast resistor R₁, the emitter-collector transistor elements and the ignition-coil primary, to the battery negative potential. When the points close, the collector current rises to approximately 8 A.

The graph and chart compare the superior performance of the assisted-ignition system with a conventional system. High voltage to the spark plugs in a conventional system falls off above

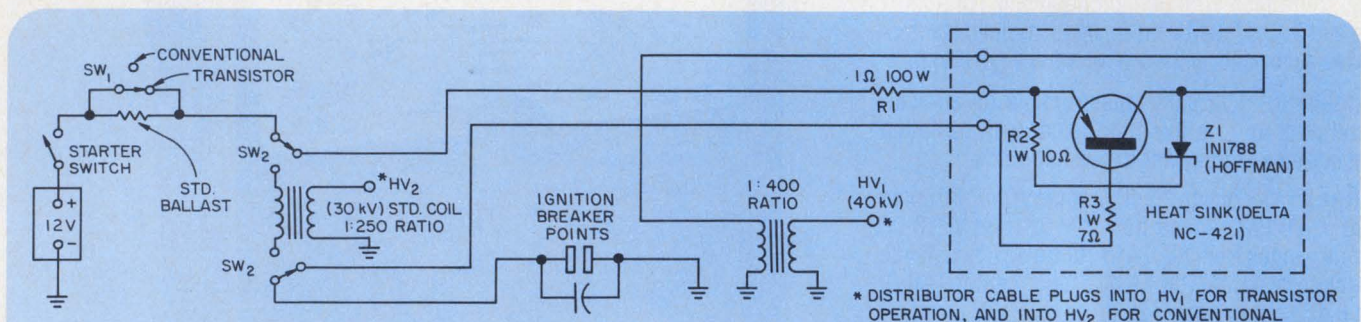

1. Only the transistor's small base current flows through the breaker points. The heavy ignition current flows through the transistor emitter-collector circuit.

rent flows through the transistor emitter-collector circuit.

SPEED/SPARK-LENGTH COMPARISON

ENGINE SPEED (RPM)	SPARK LENGTH (mm.)	
	CONVENTIONAL CIRCUIT	TRANSISTOR CIRCUIT
0	0	0
500	9	15
1000	8	16
1500	11	16
2000	12	16
2500	11	15
3000	9	15
3500	8	16
4000	4	17
4500	3	16
5000	2	15

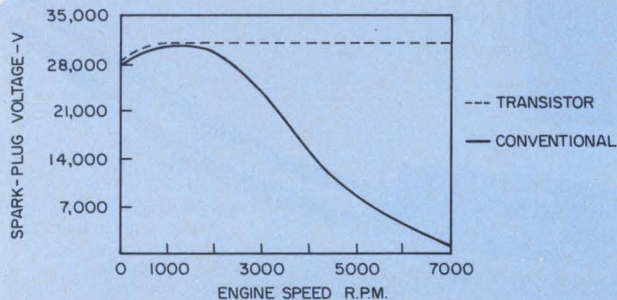

2. Spark voltage and spark length remain substantially constant in the transistorized system, but drop in conventional systems, at high speeds.

2000 rpm, but the transistor system shows no drop up to 7000 rpm. Above 2500 rpm, the spark length in a conventional system drops, but in the transistor system the spark remains almost constant to 5000 rpm.





A fully transistorized system can even eliminate the need for breaker points. One approach uses a pulse distributor similar to a conventional distributor, but a special magnetic pickup replaces the breaker points and a rotating pole piece replaces the breaker cam. Vacuum and centrifugal advance are accomplished in the same manner as in a standard ignition system.

Teeth in the rotating pole piece produce a variable magnetic field and induce a triggering voltage in the pickup coil, which turns the ignition output transistor on and off. However, a fully transistorized system needs some specially made components and is not as easily installed as the transistor-assisted method.

James Nash, 1518 S. Wenonah Ave., Berwyn, IL 60402. CIRCLE No. 312

THE HIGH VOLTAGE SUPER GROUP.



Type	Resistance Range	Power Rating At 70 C	Max Operating Volts	Temp. Coef. Rating (-55 C to +125 C)	Maximum Dimensions (Inches)
Slim-Mox 	1 M Ω to 5000 M Ω	5W	18,000 V	± 250 ppm	Length 2.08 Height .84 Thickness .860
Mini-Mox 	100 k Ω to 10,000 M Ω	.25 W to 1.4 W	1000 V to 5000 V	± 100 ppm to ± 1000 ppm	Length .470 to 1.310 Dia. .140 or .165
Divider-Mox 	4.5 M Ω to 2000 M Ω	1.5 W to 6.0 W	7.5 kV to 30kV	± 100 ppm to ± 1000 ppm overall TCR Tracking ± 25 ppm	Length 2.2 to 5.2 Dia. .345
Maxi-Mox 	10 k Ω to 5000 M Ω	1.5 W to 12.5 W	7.5 kV to 37.5 kV	± 100 ppm to ± 500 ppm	Length 1.122 to 5.2 Dia. .310 or .345
Power-Mox 	20 k Ω to 7000 M Ω	22.5 W to 45 W	20 kV to 45 kV	± 100 ppm to ± 300 ppm	Length 3.96 to 6.96 Dia. .89

MOX resistors from Victoreen. The high voltage experts.

What's your problem? Space? Economy? Stability? Better tolerance? Here's one solution to all of the above. The Victoreen MOX high voltage resistor line.

From Mini-MOX to Power-MOX, you'll find that the people at Victoreen know how to make you happy. We know how to give you resistor performance that allows more design flexibility. And product reliability.

MOX resistors are the high voltage designer's solution to problems caused by other resistors.

The tougher your high voltage resistor requirements, the more you need our advanced, reliable MOX magic.

Send for complete technical data. Write: Victoreen Instrument Division



10101
Woodland
Avenue,
Cleveland,
Ohio 44104

SG SHELLER-GLOBE CORPORATION

CIRCLE NUMBER 65

Self-adjusting trigger level featured in monostable photocell circuit

The photocell amplifier circuit in the figure simply and inexpensively overcomes several problems common to many applications of photocells. With only one op-amp IC, the circuit offers the following features:

- Automatic adjustment of its trigger level to accommodate various light sources, changes in ambient light and misalignments;
- A built-in monostable action to provide only a single output pulse during a preset time;
- Feedback action to raise the threshold level after triggering and to speed switching. The feedback also eliminates the circuit's tendency to oscillate during switching.

The circuit automatically maintains a trip window determined by a one-diode voltage drop. When the photocell is illuminated, a large capacitor, C_1 , charges through the diode from the photocell voltage-divider circuit. The capacitor stores a threshold voltage, V_t , that is always about 0.6-V less than the quiescent voltage across R_1 . In addition, a bleeder resistor, R_2 , draws a small constant current through the diode to establish a forward bias and, under quiescent conditions, provide zero output from the the 741 amplifier.

If the value of R_1 approximates the nominal value of the photocell resistance when illuminated, the circuit adjusts automatically to the actual photocell resistance over a range of $0.15R_1$ to $4R_1$.

Connecting the low side of C_1 to the 741 output provides positive feedback and monostable action. When illumination is cut off and the op-amp output begins to go positive, C_1 starts charging. The charging capacitor temporarily increases the threshold, provides a fast switching time and eliminates oscillation during switching.

Further, the resulting one-shot action prevents the circuit from tripping again until C_1 discharges back to V_t . The one-shot period, T , depends on R_2 and C_1 for a given output swing, V_s , as follows:

$$T = -R_2 C_1 \ln \left(\frac{V_t}{V_t + V_s} \right).$$

Or

$$T = R_2 C_1$$

when

$$V_t = 1/2 V_s.$$

In its original application, the detection of wheeled vehicles passing a point, the circuit's monostable action prevents triggering by the rear wheels, if they pass before the circuit resets.

Jim Edrington, Research Engineer, The University of Texas at Austin, Applied Research Laboratory, P.O. Box 8029, Austin, TX 78712.

CIRCLE NO. 313

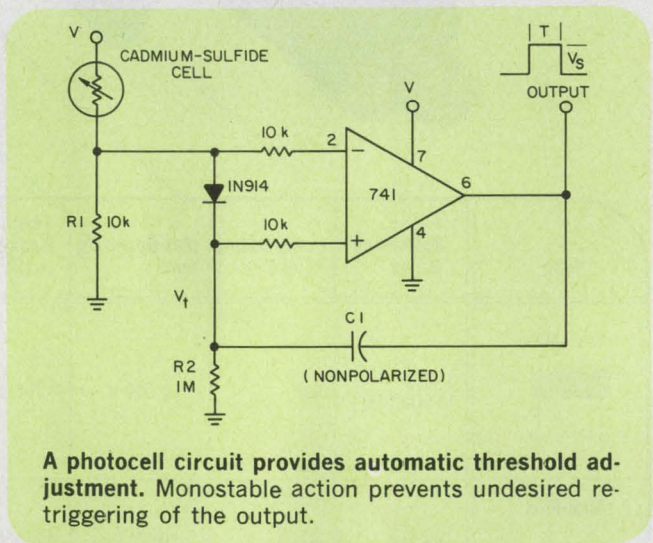

IFD Winner of February 16, 1976

Madhav Kamat, Chief Engineer, Electronic Measurements, 1210-V Block, Rajajinager, Bangalore-560010, India. His idea "Measure Small Capacitance at the End of a Long Cable" has been voted the Most Valuable of Issue Award.

Vote for the Best Idea in this issue by circling the number of your selection on the Reader Service Card at the back of this issue.

SEND US YOUR IDEAS FOR DESIGN. You may win a grand total of \$1050 (cash)! Here's how. Submit your IFD describing a new or important circuit or design technique, the clever use of a new component or test equipment, packaging tips, cost-saving ideas to our Ideas for Design editor. Ideas can only be considered for publication if they are submitted exclusively to ELECTRONIC DESIGN. You will receive \$20 for each published idea, \$30 more if it is voted best of issue by our readers. The best-of-issue winners become eligible for the Idea of the Year award of \$1000.

ELECTRONIC DESIGN cannot assume responsibility for circuits shown nor represent freedom from patent infringement.

When RFI problems get sticky, try **stickn** fingers®

Attaches faster, shields better than anything else!

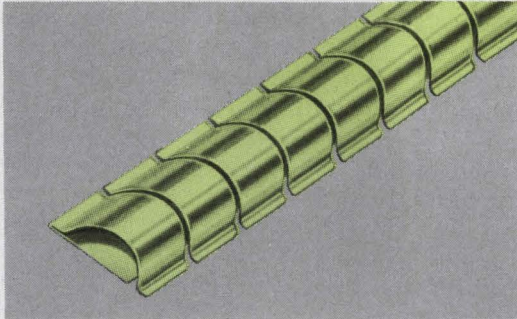

SERIES 97-500 The original Sticky Fingers with superior shielding effectiveness.

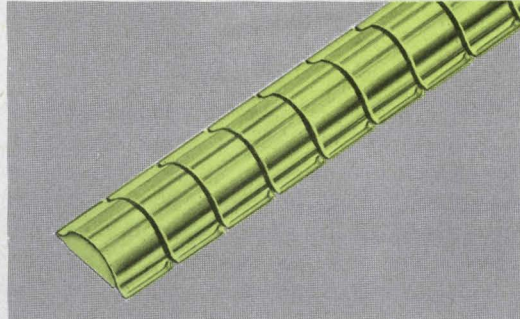

SERIES 97-520 A smaller size Sticky Fingers for high shielding effectiveness in less space.

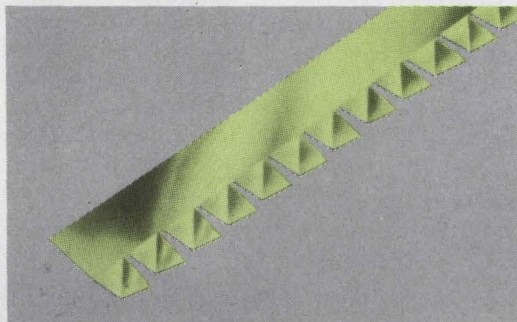

SERIES 97-555 New Single-Twist Series for use when space is at a premium. Measures a scant $\frac{3}{8}$ " wide.

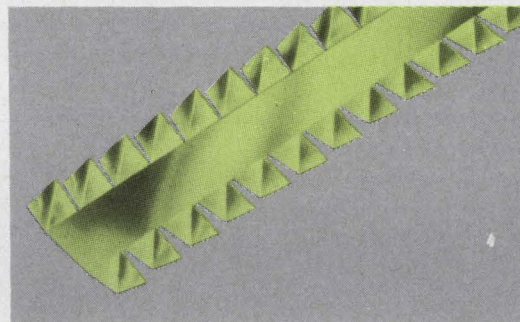

SERIES 97-560 New $\frac{1}{2}$ " wide Double-Twist Series, ideal for panel divider bar cabinets.

Now you can specify the exact type beryllium copper gasket that solves just about every RFI/EMI problem. Perfect for quick, simple installation; ideal for retro-fitting. Self-adhesive eliminates need for special tools or fasteners. Write for free samples and catalog.



INSTRUMENT SPECIALTIES COMPANY, Dept. ED-65

Little Falls, N.J. 07424

Phone—201-256-3500 • TWX—710-988-5732

Ion beams 'sandblast' chip structures

A process under development in the Siemens Laboratories in West Germany uses an ion beam that works as a sandblasting jet to cut out superfine structures in semiconductor chips. The process is superior to conventional semiconductor fabrication.

As semiconductor-chip structures become increasingly small, the wavelengths of the light beams used to create the component contours on the chips in photomasking processes become too long. Electron beams, with their markedly shorter wavelengths, are capable of producing structure spacings of $1\ \mu\text{m}$ and less. But it is then necessary to use different methods to create the structures because the chemical etching processes employed have an undercutting effect, and wash away the side walls from

underneath. This undercutting is ten times the depth of the etch, and consequently cannot be tolerated for superfine structures in the submicrometer range.

In the Siemens process, fast argon ions are produced in a plasma chamber and directed onto the photoresist-coated silicon chips. The advantage of this process is that the side walls of the chip structures are smooth in contrast to those produced by chemical etching. The angle of the side walls has a uniform value of around 65° .

Ion etching is also easily reproducible, only easily checked parameters have to be controlled in the process. Because the etching is done by a dry process, there are no etching and rinsing solutions, and thus less effluent to be processed in the plant.

'Fingerprinting' positions cartridge recording head

A unique method of accurately positioning the recording head of a cartridge-disc drive without the need for a pre-recorded index, has been developed at Data Recording Instrument Co. at Staines, Middlesex, England.

Instead of requiring the use of special cartridges, in which pre-written servo information "homes" the recording head to the required data track, the drives achieve the necessary precision positioning by means of a technique known as fingerprinting.

Fingerprinting was devised by

David Hawthorne, magnetic peripheral designer at DRI. It is a method of programmed error correction to overcome performance differences that are caused by variations in component tolerances. During drive manufacture, the positioning deviations of the actuator are identified by special measurement techniques and confirmed by laser. A read-only memory is programmed to compensate for these deviations, thus creating an electronically stored set of "fingerprints" unique to that actuator, according to Hawthorne.

Digital filter emulates most passive filters

A digital filter developed by Pye TMC of Malmesbury, England, can be electrically programmed to emulate any passive filter realizable by an inductor and capacitor. Digital coefficients are used to control such parameters as resonant frequency, phase and group delays, and Q values.

Prototype devices are entirely digital and are constructed with four-phase, p-channel MOS logic. The filter is highly agile and can be switched from one mode to another in approximately $120\ \mu\text{s}$. More complex filters can be constructed by cascading individual units. Each is a fully recursive, second-order filter.

The filter was developed under a contract from the Royal Aircraft Establishment. Further work is now in progress to extend performance into the rf area.

225-cell logic array triples existing speeds

Two new random-logic arrays have been produced by Ferranti using its three-year-old collector-diffusion-isolation process. One array, high-speed chip, will be three times faster than existing devices. Prototypes of it have been built with propagation delays of $12\ \mu\text{s}$, compared to $35\ \mu\text{s}$ for the current logic arrays.

In addition to increasing array speed, Ferranti Electric Ltd. of England has simultaneously increased circuit density. The new fast arrays have 225 cells on the chip, compared to the original 187. Ferranti also has produced 1000-cell arrays successfully.

Production quantities of the 225-cell, high-speed array and of a slower 500-cell array are expected in the third quarter of 1976.

ANOTHER WINNER

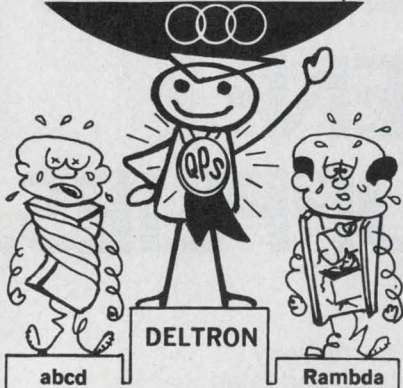

QPS series
Power Supplies **\$21⁵⁰**

One year warranty.
From stock.
U.L. recognition.
Barrier block interface.

Socketed I.C.
regulator.
Crowbar
accessory.

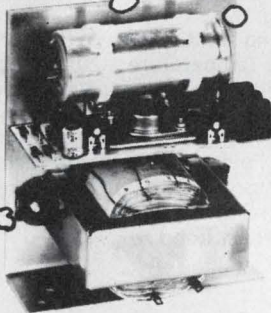

MODEL	QPS-1	QPS-2	QPS-3
RATINGS Volts/Amps	5/3 or 6/2.5	12/1.5 or 15/1.2	24/1
QTY.	1	100	250
PRICE	\$24.00	\$22.50	\$21.50

Deltron inc.

Wissahickon Avenue
North Wales, PA 19454
Tel: 215/699-9261 Twx: 510/661-8061
AC-10

Some open talk about open frame **Q SERIES** power supplies

We're so open about our Q Series Open Frame Power Supplies because we want you to know everything about them. Like our one year warranty. And stock delivery. About our thermal design, the best around, making our heat sensitive parts run cooler and operate longer. And we're the **only** maker of Open Frame Power Supplies where all components operate well within mfrs. specs.

That's why Deltron "Open Frames" save you money three ways: When you buy them. By avoiding costly downtime. And by lasting longer.



Forward and reverse
voltage protection.
Barrier block interface.
Infinite resolution adjustments.
Full interchangeability.
115/230 vac, 47-440 Hz.

Socketed IC regulation system.
Filters meet mfrs. ripple ratings.
Glass epoxy PC boards.
Loss of sense protection.
Designed for U.L. Recognized Component Index.

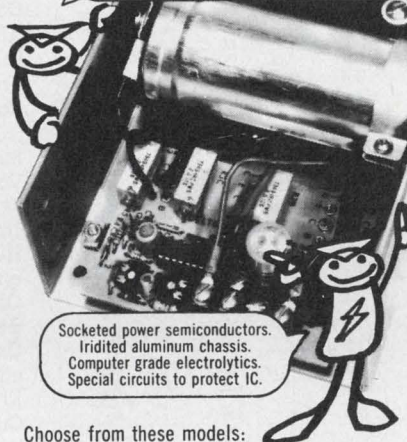

Socketed power semiconductors.
Iridized aluminum chassis.
Computer grade electrolytics.
Special circuits to protect IC.

Choose from these models:

Size A Model No.	Size B Model No.	Size C Model No.	Size D Model No.	Size F Model No.
volts — amps	volts — amps	volts — amps	volts — amps	volts — amps
Q 5 — 3.0	Q 5 — 6.0	Q 5 — 9.0	Q 5 — 12.0	Q 5 — 18.0
Q 6 — 3.0	Q 6 — 6.0	Q 6 — 9.0	Q 6 — 12.0	Q 6 — 18.0
Q 12 — 1.7	Q 12 — 3.4	Q 12 — 5.7	Q 12 — 7.0	Q 12 — 10.8
Q 15 — 1.5	Q 15 — 3.0	Q 15 — 4.8	Q 15 — 6.3	Q 15 — 9.5
Q 18 — 1.3	Q 18 — 2.6	Q 18 — 4.0	Q 18 — 5.2	Q 18 — 7.8
Q 20 — 1.3	Q 20 — 2.6	Q 20 — 4.0	Q 20 — 5.2	Q 20 — 7.8
Q 24 — 1.2	Q 24 — 2.4	Q 24 — 3.3	Q 24 — 4.8	Q 24 — 7.2
Q 28 — 1.0	Q 28 — 2.0	Q 28 — 3.1	Q 28 — 4.2	Q 28 — 6.0
Dimensions: 4 7/8 x 4 x 1 1/8	Dimensions: 5 1/2 x 4 1/8 x 2 1/2	Dimensions: 7 x 4 7/8 x 2 3/8	Dimensions: 9 x 4 7/8 x 2 3/8	Dimensions: 14 x 4 7/8 x 2 3/8
Price: 1 — \$32.00 100 — \$26.00 250 — \$24.00	Price: 1 — \$54.00 100 — \$44.00 250 — \$41.00	Price: 1 — \$67.00 100 — \$54.00 250 — \$51.00	Price: 1 — \$87.00 100 — \$70.00 250 — \$66.00	Price: 1 — \$113.00 100 — \$91.00 250 — \$85.00

For some more open talk about Deltron Q Series and a copy of our Comparative Engineering Reports, write or call collect to Deltron, Inc., Wissahickon Avenue, North Wales, Pa. 19454, Telephone: 215-699-9261, TWX 510-661-8061.

Deltron inc.

CIRCLE NUMBER 68

Bypass the middleman!
Save more than 55%
with unsurpassed quality
and performance!
Delivery from stock!

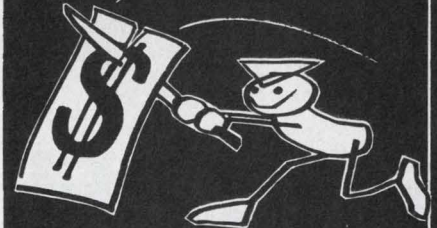

Deltron Slashes the Price of μ Processor Power Supplies

MPS-1: \$77
MPS-2: \$88

In any quantity!

Full one year
guarantee
Designed for U.L.

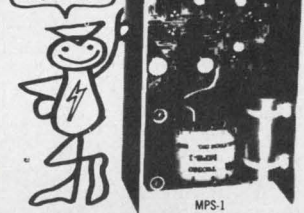

MPS-1

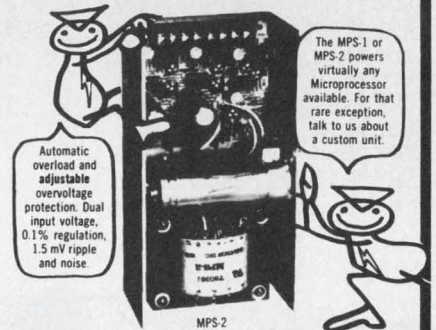

The MPS-1 or
MPS-2 powers
virtually any
Microprocessor
available. For that
rare exception,
talk to us about
a custom unit.

Automatic
overload and
adjustable
overvoltage
protection. Dual
input voltage,
0.1% regulation,
1.5 mV ripple
and noise.

MPS-2

MODEL	VOLTS	AMPS			PRICE ANY QUANTITY
		40°C	50°C	60°C	
MPS-1 7 x 4% x 2%	5 ± 5% Adj.	3.0	2.5	2.0	\$77
	12 ± 5% Adj.	0.6	0.5	0.4	
	9 to 12V Adj. or 5V	0.6	0.5	0.4	
		0.38	0.38	0.38	
MPS-2 9 x 4% x 2%	5 ± 5% Adj.	7.0	6.0	5.0	\$88
	12 ± 5% Adj.	1.0	0.9	0.8	
	9V	1.2	1.1	1.0	
	or 5V	0.75	0.65	0.55	

Why buy brand A?
Deltron's got them
spec for spec
at half the price.

Next time get the best
for a lot less...
write or call collect to:

Deltron inc.

Wissahickon Avenue, North Wales, Pa. 19454
215-699-9261 TWX 510-661-8061

CIRCLE NUMBER 69

SORENSEN IS THE SOURCE: FOR RELIABLE OPEN- FRAME POWER SUPPLIES.

SOC, our new line of open-frame power supplies:

- Standard voltage and package sizes
- 115/208/230 Vac input standard
- Made in U.S.A. with quality components
- No overshoot with turn-on, turn-off or power failure
- Stocked for immediate delivery
- Conservatively designed and rated
- Low heat dissipation, high temperature stability
- One-year warranty, backed by a worldwide service organization

Model No.	Series	Voltage**	Output Current (A dc)*			Price
			@ 40°C	@ 50°C	@ 60°C	
SOC 2-3	A	2V	3.0	2.4	1.8	\$32
SOC 2-6	B	2V	6.0	4.9	3.8	54
SOC 2-10	C	2V	10.0	8.0	6.5	67
SOC 5-3	A	5V	3.0	2.4	1.8	32
SOC 5-6	B	5V	6.0	4.9	3.8	54
SOC 5-10	C	5V	10.0	8.0	6.5	67
SOC 12-1.6	A	12V	1.6	1.3	1.0	32
SOC 12-4.0	B	12V	4.0	3.0	2.5	54
SOC 12-6.0	C	12V	6.0	5.0	4.2	67
SOC 15-1.5	A	15V	1.5	1.2	1.0	32
SOC 15-3.0	B	15V	3.0	2.6	2.2	54
SOC 15-5.0	C	15V	5.0	4.2	3.5	67
SOC 24-1.0	A	24V	1.0	.75	.55	32
SOC 24-2.2	B	24V	2.2	1.9	1.6	54
SOC 24-3.5	C	24V	3.5	2.9	2.4	67
SOC 28-0.8	A	28V	0.8	.64	.45	32
SOC 28-2.0	B	28V	2.0	1.7	1.4	54
SOC 28-3.1	C	28V	3.1	2.6	2.0	67

Common Specifications:

AC Input Power: Vac 105-125 (190-226). (210 to 250 available by using taps on transformer.)

Frequency 50 to 63Hz. (Derate 10% at 50Hz.)

Voltage Regulation (comb. line and load):
±0.15% + 6mV for 105 to 125 Vac and 100% load change.

Voltage Ripple and Noise: 1.5mVrms, 5mVpp.

Temperature Coefficient: 0.03%/°C.

Drift (24 hours): 0.2% after 1-hour warm-up.

Remote Sensing: 100mV maximum drop in each leg.

Operating Temperature: 0°C to 60°C.

Storage Temperature: -20°C to +85°C.

Overvoltage Protection: Available on all models except 2 volt. Specify by adding "VP" suffix to model number and add \$8 to unit price.

Current Foldback: Automatic, factory-set to 140% of rated (40°C) output current.

Cooling: Convection.

Finish: Black anodize.

* Free-air rating — no external heatsink. ** ±5% adjustable.

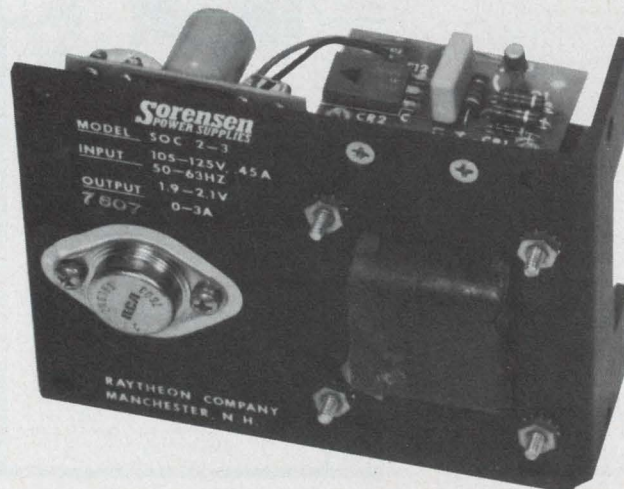

Call us for OEM discounts:

(603) 668-4500.

Sorensen

676 Island Pond Rd.,

Manchester, N.H. 03103.

SORENSEN
POWER SUPPLIES

A Raytheon Company

CIRCLE NUMBER 70

Control a switching power supply with a single LSI circuit

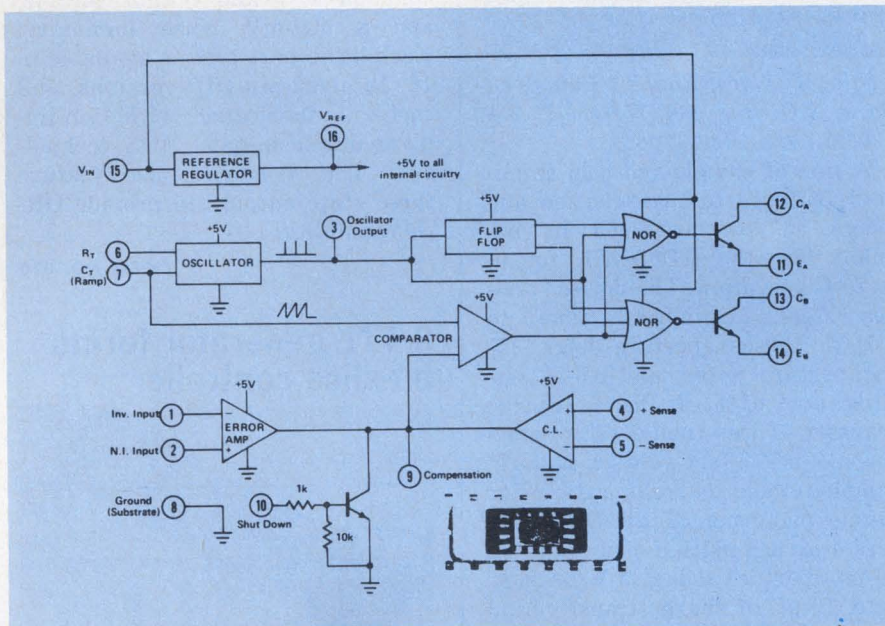

Silicon General, 7382 Bolsa Ave., Westminster, CA 92683. (714) 892-5531. P&A: See text; stock.

Switching power supplies have long offered high efficiency. But development has been hampered by the complex circuitry required to control the power switching transistors. With the introduction of the SG1524 from Silicon General, the bulk of the low-level circuitry has been integrated into a single LSI circuit.

This monolithic chip, housed in a 16-pin ceramic DIP, contains all of the following: voltage reference, error amplifier, fixed-frequency oscillator, pulse-width modulator, pulse-steering flip-flop, dual alternating output switches, and current-limiting and shutdown circuitry.

While this is not the first IC on the market to contain most of the control circuitry needed for a switching power supply, it is the first to have the outputs necessary

for the push-pull output stage used by most designers of switching power supplies.

Two other companies offer ICs aimed at the single-ended switching power supply designs that are favored in low-power applications. Plessey Semiconductors, Santa Ana, CA, has the SL442, which is supplied in a plastic 16-pin DIP for operation from 0 to 55 C, and in a ceramic DIP to cover the 0-to-65-C range. The SL442 can switch at up to a 40-kHz rate and sells in the plastic version for \$6.60 in 100 lots.

Texas Instruments, Dallas, TX, recently introduced the TL497. This can be used either as a wholly contained switching regulator or as a single-ended control circuit. It has an output current capability of 500 mA and a maximum output power of 1 W. Load regulation is typically 0.4% and line regulation is typically 0.2%. The output voltage is adjustable and short-circuit

protected. The regulator can switch at rates of more than 100 kHz or as low as 20 kHz. It comes in a 14-pin plastic DIP, operates over 0 to 70 C and costs \$2.18 in 100 quantities.

Silicon General's SG1524 features line and load regulation of 0.2% and maximum temperature variation of 1%. It can control switching transistors at up to 100 kHz and uses a total supply current of less than 10 mA.

Input voltages of up to 40 V can be handled and each output can go to 100 mA.

In addition to use for double-ended switching supplies, this IC can be used for single-ended supplies of either polarity, transformer-coupled dc-to-dc converters, transformerless voltage doublers and polarity converters, as well as for other power control applications.

There are three versions of the part:

The SG1524 is specified for operation over the full MIL temperature range of -55 to +125 C and sells for \$13.50 in 100 lots.

The SG2524J has the same specs as the MIL part but is only designed for 0-to-70-C operation. It sells for \$10.75 in 100 quantities.

The SG3524 has a 100-unit price of \$6.75 and a temperature range of 0 to 70 C but has slightly degraded specs. Its error amplifier has a maximum offset voltage of 10 mV instead of 5 mV for the other two parts. And the open-loop voltage gain of the error amplifier is 60 dB minimum instead of 72 dB minimum. All other specs are the same. There is no plastic version of the part.

Silicon General	CIRCLE NO. 305
Plessey	CIRCLE NO. 306
Texas Instruments	CIRCLE NO. 307

1 Relay Miss every 2-Billion Cycles

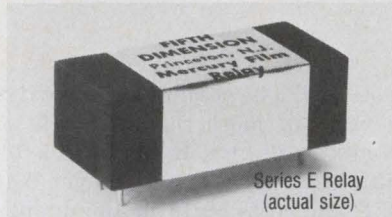

We tested 129 of our new Series E Relays at loads from dry circuits to 3 Amps. After 35-billion operations, only 10 single-cycle misses were monitored.

Series E Relays offer:

- Indefinite life
- No contact bounce
- Operation in all positions
- Contacts stable to ± 0.015 ohms over life
- Reliability at dry circuit or power loads
- Self-healing contacts
- Hermetically sealed contacts
- 1250V rms contact breakdown
- Low cost

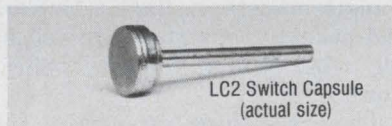

Series E Relay uses a rugged LC2 welded capsule rather than a fragile glass reed switch. This patented design holds a film of mercury securely to the metal walls of the capsule. With every operation, the mercury film renews the switch contacts. You get the reliability of mercury relays, but with complete freedom of mounting orientation. LC2 welded capsule reliability is proven by hundreds-of-thousands of units in the field, as well as billions of cycles under stringent laboratory conditions.

Send for a FREE SAMPLE of the LC2 welded capsule on your letterhead. Circle the reader service card number for Series E Relay information.

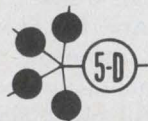

Fifth Dimension, Inc.

P.O. Box 483
Princeton, N.J. 08540
Tel: (609) 452-1200

CIRCLE NUMBER 71

INTEGRATED CIRCUITS

Sample-hold amps spec 4- μ s acquisition

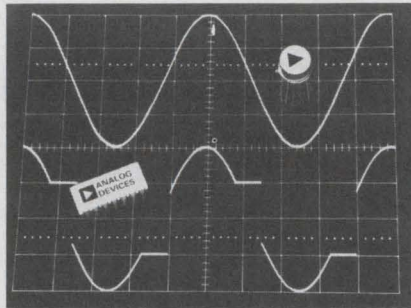

Analog Devices, Route 1 Industrial Park, P.O. Box 280, Norwood, MA 02062. (617) 329-4700.

A line of sample-and-hold amplifiers features fast acquisition and prices as low as \$5.95 in 100 quantities—the AD582KH, for 0-to-70-C operation. The device specifies 6- μ s acquisition time to 0.01%, 150-ns aperture delay, 15-ns aperture jitter, and 0.5-ns settling to 0.01%. It has a charge transfer of less than 2 pC, producing a 2-mV offset voltage, and 10^7 sample-to-hold current ratio. For higher performance, the AD583 offers 4- μ s acquisition time to 0.1%, 50-ns aperture delay, 5-V/ μ s slew rate, 10-pC of charge transfer, and a 10^6 sample-to-hold current ratio. It operates over the commercial temperature range and costs \$14.85 in 100 quantities.

CIRCLE NO. 308

Gyrator replaces filter inductances

Philips, P.O. Box 523, Eindhoven, the Netherlands. \$2.50 to \$3.50.

The TCA580 monolithic gyrator needs only two external resistors and one capacitor to simulate inductances of up to 10^6 henries. The gyrator comes in a 16-pin package. It can be used in audio-frequency applications up to 10 kHz. In LC filters, each inductor may be replaced by a TCA580 and one capacitor. The tolerance on inductance values depends primarily on the external components and a value of $\pm 0.2\%$ is specified. When used in resonant circuits, Qs of 500 to 5000 can be obtained.

CIRCLE NO. 309

1-k static RAMs access in 150 ns

Synertek, 3050 Coronado Dr., Santa Clara, CA 95051. (408) 241-4300. \$9 to \$12.50 (100-999).

A family of 256 \times 4-bit static RAMs offers access times of 150, 175 and 200 ns. The new RAMs are directly TTL compatible and use a 5-V power supply. They have common I/O and output disable, and a 400-mV noise immunity. Each basic part type is available in 16, 18 or 22-pin-DIP versions, and each is fabricated with ion-implanted silicon-gate MOS technology. The memories also feature three state outputs to provide OR-tie capability.

CIRCLE NO. 310

S-TTL generator forms bit-slice controller

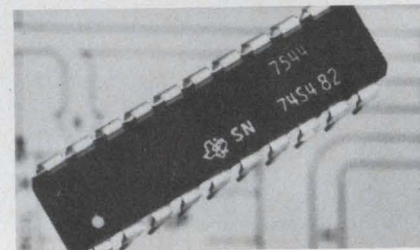

Texas Instruments, P.O. Box 5012, M/S-84, Dallas, TX 75222. (713) 494-2621. \$15 to \$37.50 (100); 8 to 12 wks.

An expandable 4-bit-slice Schottky-TTL control element—the SN54S482/74S482 microaddress generator—contains all the logic needed to implement low-to-medium intelligent controllers or next-address generators. With a complexity of over 200 equivalent gates, the monolithic bit-slice control element provides 4-bit wide functions for a full adder, four-word push-pop FILO, four-wide source-select multiplexer, and a microcontrol memory-address/microstate register. It features an edge-triggered clock, and an independent asynchronous register clear, which means that push-pop updating operations can continue even during the clear mode. The unit comes in a 20-pin DIP, and has a maximum clock-to-output delay of 25 ns.

CIRCLE NO. 320

OK, you Power Schottkys, the heat's on. Talk!

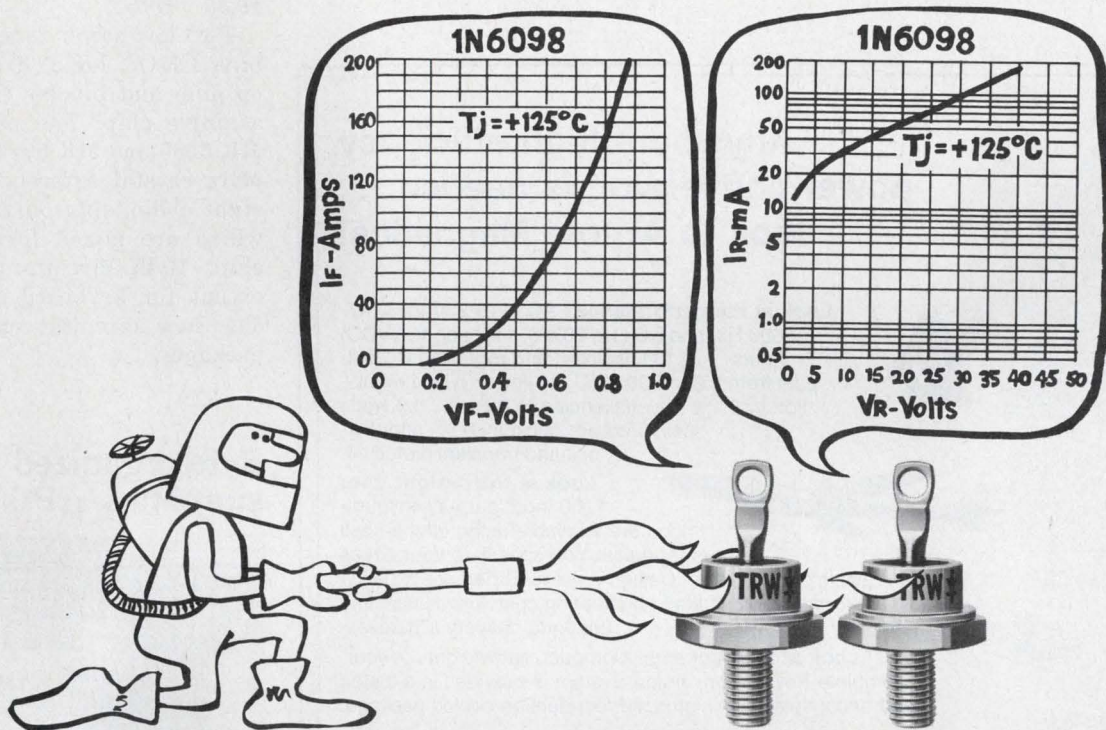

These new TRW Power Schottkys have quite a story to tell and it starts with the fact that they're JEDEC registered. Then they'll tell you that they let you maintain 50 Amps—typically 0.55 Volt forward drop at a T_j of 125° C. The highest operating junction temperatures, lowest reverse leakage typically less than 200mA @ 40V, 125° C, and highest voltages on the market today. (Yet, for all that, they're competitively priced.)

Yes, TRW's Schottky Diodes are now 1N registered. And they're about to be JAN and JANTX qualified.

Let these new Power Schottkys take your heat, try one in your present circuit or in the circuit you're working on, you'll find out they're not just talk.

1N6095	25 AMP	30V	DO-4
1N6096	25 AMP	40V	DO-4
1N6097	50 AMP	30V	DO-5
1N6098	50 AMP	40V	DO-5

If you'd like to hear more about how TRW's Power Schottkys can help you in the design of low-voltage, high-current power supplies, call John Power at (213) 679-4561. Or use the coupon. (These components are available from stock from our distributors.)

TRW Power Semiconductors

An Electronic Components Division of TRW, Inc.,
14520 Aviation Boulevard, Lawndale, California 90260

- Please send me data sheets on TRW's Power Schottky Diodes
- Have a salesman get in touch with me

Name _____

Company Name _____

Position _____

Address _____

City _____

State _____

Zip _____

TRW POWER SEMICONDUCTORS

ANOTHER PRODUCT OF A COMPANY CALLED TRW

INTEGRATED CIRCUITS

Bipolar FPLAs have 14 × 8-bit scheme

Monolithic Memories, 1165 E. Arques Ave., Sunnyvale, CA 94086. (408) 739-3535. \$19.00 to \$50.50 (100-999).

Bipolar field-programmable logic

arrays, using nichrome-fuse elements, have 14 inputs, 8 outputs and 48 product terms. The devices come in 24-pin packages and are available with active or passive outputs in either commercial or MIL temperature ranges. The Data I/O Model X Programmer, modified with a three-board card set, can be used to program the new 6870/5870 FPLAs. Maximum access times are as short as 80 ns.

CIRCLE NO. 321

Complete tone dialer comes on a chip

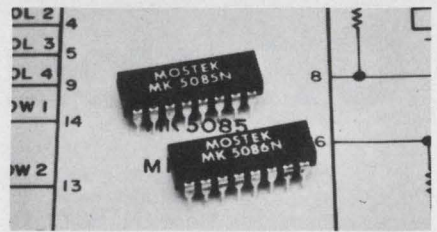

Mostek, 1215 W. Crosby Rd., Carrollton, TX 75006. (214) 242-0444. \$6.30 (100).

Two low-power tone dialers combine CMOS logic, d/a converters, op amp and bipolar transistors on a single chip. The new circuits—MK 5085 and MK 5086—use a 3.58-MHz crystal reference to produce eight audio, sinusoidal frequencies, which are mixed together on the chip. Both circuits are identical except for keyboard configuration. The new circuits come in 16-pin packages.

CIRCLE NO. 322

Anywhere high efficiency power conversion is needed . . . look to Arnold Magnetics!

Look at the performance: AC (115-230 VAC, 47-500 Hz) and DC (12, 28, 48, 115, and 150 VDC) inputs . . . 1 to 6 isolated and regulated DC outputs from 4.2 to 300 VDC . . . line and load regulation to 0.1% . . . efficiencies to 85% . . . 3.9 watts delivered per cubic inch . . . short circuit and transient protected.

Look at the design: Over 1200 input/output configurations are available using off-the-shelf sub-modules. You specify to your needs using our exclusive "Design-As-You-Order" specification form that eliminates engineering cost, lost design time and long delivery schedules.

Look at the package: Compact, lightweight . . . your complete Power Conversion System is provided in a tested and encapsulated miniaturized, conduction cooled package.

Looking for high efficiency power conversion? Look to Arnold Magnetics . . . today!



ARNOLD MAGNETICS CORPORATION

11520 W. Jefferson Blvd.
Culver City, CA 90230
(213) 870-7014

Byte-organized RAM simplifies μ P systems

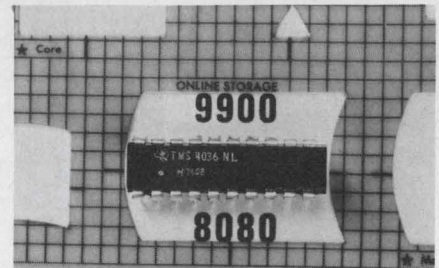

Texas Instruments, P.O. Box 5012, M/S 84, Dallas, TX 75222. (214) 238-2481. \$5.67 to \$6.80 (100); stock.

A 64 × 8-bit NMOS static RAM, the TMS 4036, can be used for byte-oriented CPU systems like those based on the 8080 or TMS 9900. The TMS 4036 provides minimum cost/package count for terminal and controller systems requiring 128 words or less of RAM. Like the 8080 and 9900, the RAM has a common I/O bus, which is fully TTL compatible. The address, read/write control, output enable, and chip enable are also TTL compatible. Three-state output buffers provide OR-tie capability and a fanout of one standard-TTL load. The RAM comes in a 20-pin DIP and in three speed ranges: 1- μ s, 60-ns, and 450-ns access and read or write cycle times.

CIRCLE NO. 323



CIRCLE NUMBER 72

A resistor for all reasons

Here's a way to cut the daylight out of your fixed resistor inventory. Standardize on our Type CC cermet. It's sized like a ¼-watt but you get performance that ranges from ⅛-watt at 125°C to ½-watt at 70°C (250 volt max.) Tolerance is 1% over the complete resistance range of 10 ohms to 22.1 megs or 0.5% from 10 ohms to 499K. TCR is as low as ± 50 ppm/°C. The one resistor for all reasons: industrial, RN55C, RN55D and RLR07 needs to 1% and 2% tolerance. We have what you need; our distributors have it when your need is now. Ask for Publication EC33.

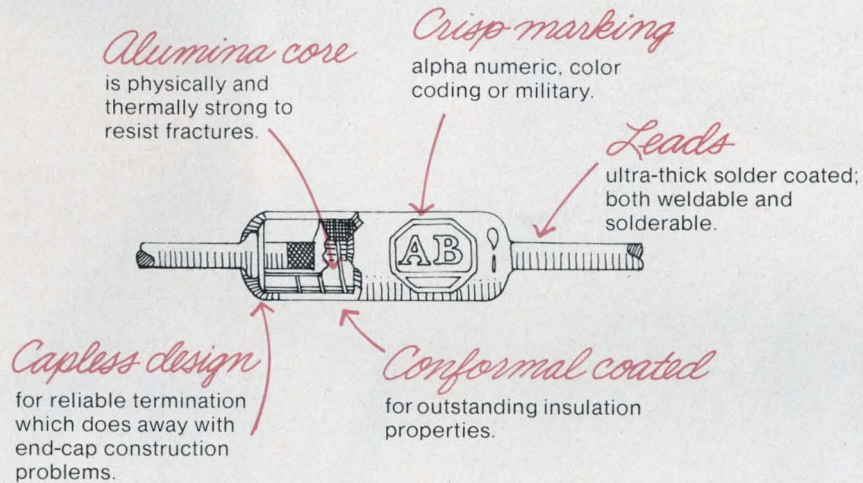

Quality in the best tradition.



ALLEN-BRADLEY
Milwaukee, Wisconsin 53204

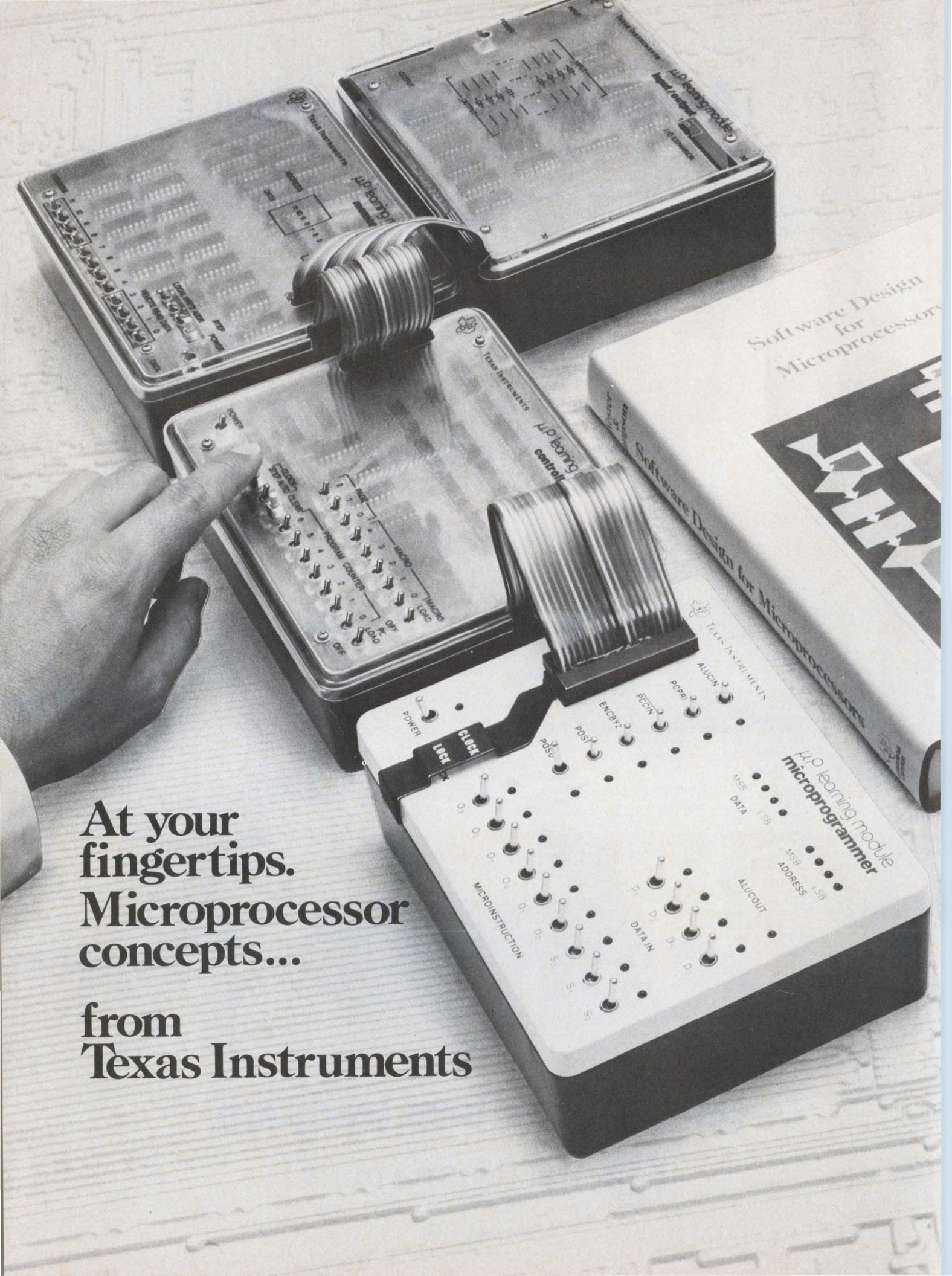

At your
fingertips.
Microprocessor
concepts...

from
Texas Instruments

New. The complete microprocessor learning system. Ready-to-use. Economical. User-paced.

Introducing three new add-ons for TI's basic Microprogrammer Learning Module.

Microprocessors. Now they're simpler to understand, easier to cope with, because of TI's complete new microprocessor learning system.

It's modular...consists of four, portable components: the basic LCM 1001 Microprogrammer Learning Module and three new add-ons: Controller. Memory. And Input/Output.

It's a down-to-fundamentals system for getting "hands on" experience with microprocessors. It focuses your attention on learning microprocessor concepts—not on individual products. You progress from module to module in a logical sequence.

Each module is self-contained. Complete and ready-to-use. No kits to assemble. Nothing to build. Each has its own battery/charger power system. Each has its own instruction manual.

Microprogrammer Module

This is the one you start with. The basic building block (LCM-1001). It demonstrates the most fundamental level of microprocessor operation: Single-clock-step microinstruction. It contains a 4-bit static parallel processor with manual switch inputs, VLED monitors, and pushbutton manual clock. A 40-pin socket lets you link up with the controller. \$149.95*

Controller Module

Add the LCM-1002 Controller Module. Progress from micro to macro level programming. Learn instruction set development and microcomputer architecture. Use the Controller with RAM or additional program memory—12 basic instructions are programmed into the PROM (which may be redefined). Using these, write your own programs. Or, expand the instruction set and customize the system to your needs using the blank locations you define yourself. \$189.95*

Memory Module

Add an LCM-1003 Memory Module to the Controller. Now you're into fully automated digital system operation. The read/write memory is configured as a 1K word by 12-bit structure, for both data and program storage. Switches are provided for manual loading. The memory automatically increments the address. This feature spares you the tedium of cycling the entire memory when loading or changing memory. \$189.95*

Input/Output Module

With the final module, you're in contact with the outside world. There are four 4-bit input ports and four 4-bit output ports with buffers for data transfer synchronization. Operate the ports independently, or in conjunction with each other. For example, two ports can recognize an 8-bit code approach. \$109.95*

Building-block System.

This approach to microprocessor self-instruction is sensible and economical—add another module when you're ready to learn more.

To order your Microprocessor Learning Modules, call your nearest TI distributor. Use the coupon to get a detailed brochure.

New, authoritative
book on microprocessor
software design.
Only \$12.95.*

A working knowledge of microprocessor software is essential. Acquiring such knowledge is now simplified with **Software Design for Microprocessors**.

Helps you fully understand basic microprocessor machine code and assembly language. Suitable for non-technical professionals as well as the technically trained.

In 500 pages are the graphs, tables and data needed to learn the language, special terms, and the underlying concepts that lead to understanding the complex facets of microprocessor software. The text concludes with four fully-worked examples for "real world" situations.

Use the coupon below to order your copy.

* Manufacturer's suggested list price.
Subject to change without notice.

To: Texas Instruments Incorporated

Mail checks and money orders to: P. O. Box 3640, M/S 84, Dallas, Texas 75285
Postage paid. Add state and local taxes where applicable. †

Mail company purchase orders to: P. O. Box 5012, M/S 84, Dallas, Texas 75222
Postage and taxes will be added to your invoice.

Please send me

more information on the TI Microprocessor Learning Modules.

_____ Copies of *Software Design for Microprocessors* @ \$12.95** ea.

I enclose check money order for \$ _____

Name _____

Title _____

Firm _____

Address _____

City _____ State _____ Zip _____

**Subject to change without notice

† AL, AZ, CA, CO, CT, FL, GA, IA, IL, IN, KY, MA, MD, MI, MN, MO, NC, NJ, NM, NY, OH, PA, TN, TX, UT, VA, WA, WI.



LEARNING
CENTER

ED-6

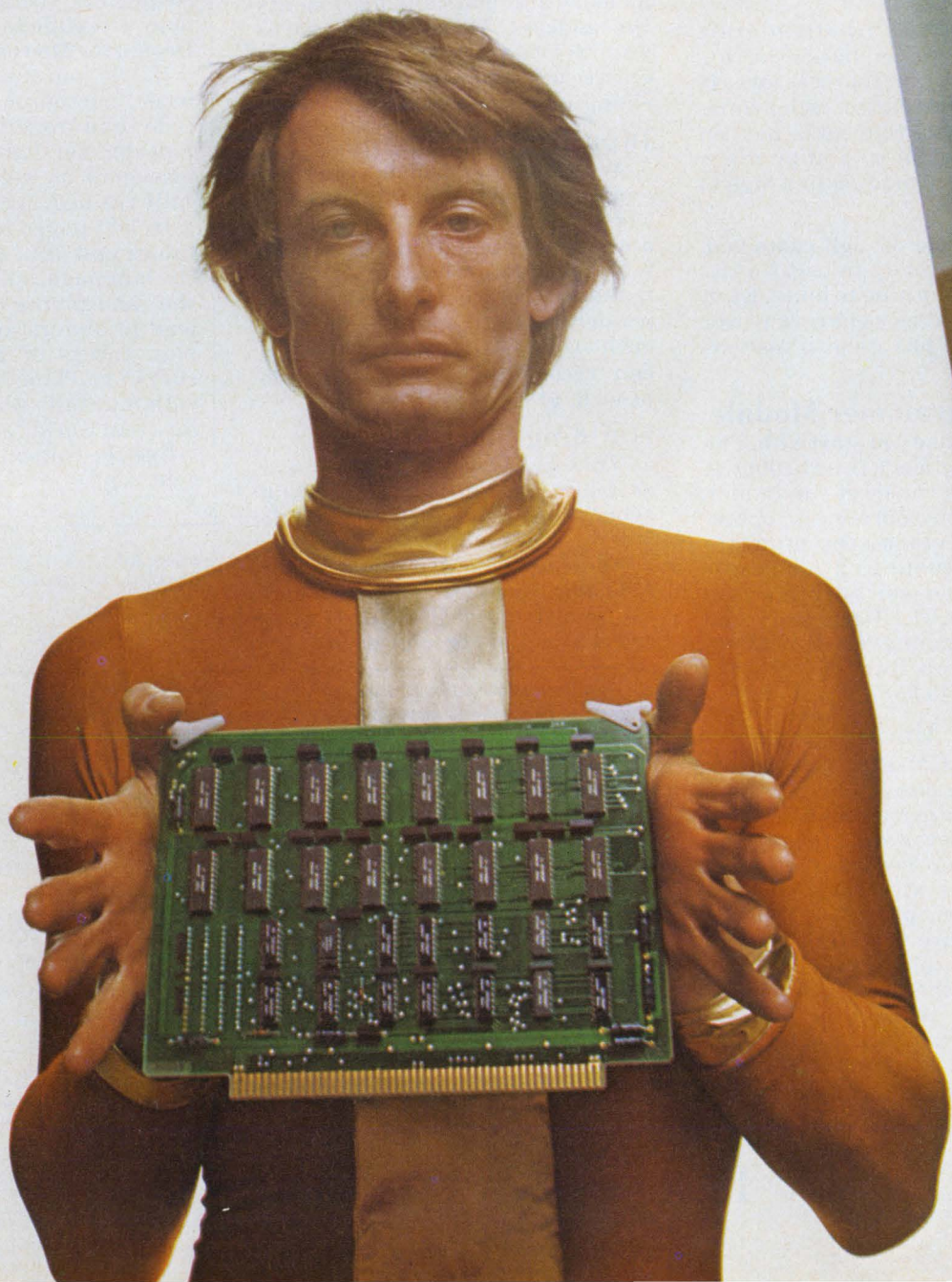

1100 YEARS FROM NOW, YOU'LL STILL BE GLAD YOU BOUGHT OUR MEMORIES.

Eleven hundred years from now, our semiconductor memories will still be going strong.

Because right now we're selling MOS memories with MTBFs per device of from 5 to 10 million hours. Which is well over 1100 years.

Our bipolar memories, on the other hand, will last a few centuries longer. Their MTBFs go up to 14 million hours.

And if you think these terrific figures are just wild claims like you're used to seeing in semiconductor advertising, you probably haven't heard about how we spec our products: in a word, conservatively.

Of course, all this industry-leading

reliability wouldn't mean very much if we didn't deliver it in the kind of state-of-the-art products you need.

But we do.

We sell a comprehensive line of memories that includes everything from a family of 4K MOS RAMs with access times down to 135ns, to the industry's first 2K EEPROM that can match the requirements of microprogrammed control applications.

For the full story, just contact one of our reps or distributors.

Preferably within the current millennium.

NEC Microcomputers, Inc.,
Five Militia Drive, Lexington, MA
02173. 617-862-6410.

NEC microcomputers, inc.

REPS: East - C & D Sales 301-296-4306, Contact Sales 617-273-1520, Trionic Assoc. 516-466-2300; South - Merino Sales 214-233-6002, Perrott Assoc. 305-792-2211, 305-275-1132, 813-585-3327, Space Eng. Sales 205-837-6060, Wolfs Sales Serv. 919-781-0164; Midwest - K-MAR Eng. & Sales 816-763-3466, McFadden Sales 614-221-3363, R.C. Nordstrom 313-559-7373, 616-429-8560, R.F. Specialists 312-698-2044; West - Mike Duffy Assoc. 303-934-7392, Electronic Component Marketing 714-524-9899, 714-295-6122, 213-340-1745, Summit Sales 602-994-4587, Trident Assoc. 415-967-7031, Tri-Tronix 505-265-8409, 206-454-0940; Canada - R.F.Q. Ltd. 416-626-1445, 514-626-8324 DISTRIBUTORS: Century Elect., Harvey Elect., Intermark Elect. (Sunnyvale, Santa Ana, San Diego, Seattle), Lionex Corp., G.S. Marshall (Sunnyvale), Mirco Elect., R-M Elect., Semiconductor Specialists.

"The majority of can



Richard D. Vance
President
AD-VANCE MAGNETICS, INC.



MAGNETIC SHIELD COSTS REDUCED

AD-VANCE PREPARED ECONOMIC SHIELDING

AD-VANCE CUSTOM FABRICATED SHIELDS FOR COMPONENTS AND SYSTEMS

AD-VANCE OFF THE SHELF PERMEABILITY SHIELDS FIT 112 TYPES OF MULTIPLEXER TUBES

AD-VANCE SHEET STOCK — DELIVERY FROM STOCK

STANDARD AD-VANCE TAPE BELT PROTECTORS

AD-VANCE OFF SHELF SHIELDS

AD-VANCE MAGNETICS, INC., 216 S. SEVENIK ST., ROCHESTER, N.Y. 14625 / 716-232-5156 / TTY: 716-232-5156

MAGNETIC SHIELDS—ANY SIZE OR SHAPE

From Ad-Vance Magnetics, Inc., the Problem Solving Magnetic Shielding Specialists

COMPLETE FACILITIES IN 3 LARGE MODERN PLANTS

PHYSICAL CHARACTERISTICS OF AD-VANCE ALLOYS

AD-VANCE ALLOYS PROTECT PERMANENTLY

Typical DC Magnetic Properties For AD-VANCE Alloys

ALLOY	PERMEABILITY	RESISTANCE	TEMPERATURE RANGE	STRENGTH
High Permeability	100,000	100,000	500,000	0.075
Max. Permeability	100,000	100,000	500,000	0.075
Low Permeability	10,000	10,000	100,000	0.015
	10,000	10,000	100,000	0.015

AD-VANCE MAGNETICS, INC., 216 S. SEVENIK ST., ROCHESTER, N.Y. 14625 / 716-232-5156 / TTY: 716-232-5156

GOLD BOOK 75-76

Tell us what you think about the GOLD BOOK. (If it's good, we'd like to hear it. If it's bad, we want to improve it.)

our new business be attributed to the GOLD BOOK."

"*Electronic Design* has done one hell of a job in getting the GOLD BOOK to the places it should be," says Richard D. Vance, President, Ad-Vance Magnetics, Inc., Rochester, Indiana. Ad-Vance describes itself as the industry's largest, oldest, most experienced independent firm exclusively manufacturing magnetic shielding. Mr. Vance continues:

"We're an old company with a new name, so not too well known in the field. Our two-page spread in the GOLD BOOK has made us much better known.

"The GOLD BOOK gave us opportunities to bid from firms who had never heard of us before they saw our GOLD BOOK ad. For example, just today we got to bid on 1,000 CRT magnetic shields for a midwest firm who found us in the GOLD BOOK.

"Engineers don't hesitate to tell us they saw our ad in the GOLD BOOK when they call. I do a lot of sales work in the field, and I run into the GOLD BOOK almost everywhere our magnetic shielding has an application, both in purchasing and engineering. You've done one hell of a job in getting the GOLD BOOK to the places it should be."

Ad-Vance states that over 90% of past and present magnetic shield designs have been fabricated in the Ad-Vance plant during the past 20 years. Its magnetic shielding is used off-planet in spacecraft and satellites, and worldwide in precision industrial, laboratory, military and consumer applications.

Because the GOLD BOOK goes primarily to *Electronic Design's* audience of specifiers, Ad-Vance gets the benefit of 78,000 engineers, engineering managers, purchasing agents and distributors throughout the U.S.A., not to mention 13,000 overseas. These are the men who are ready to talk shielding—the men who have the authority to buy.

**ELECTRONIC DESIGN'S GOLD BOOK IS WORKING
...IT'S WORKING FOR READERS...AND IT'S
WORKING FOR ADVERTISERS, TOO.**

HAYDEN PUBLISHING COMPANY, INC.

WORLD LEADER IN ELECTRONICS PUBLISHING

50 Essex Street, Rochelle Park, N.J. 07662 • (201) 843-0550

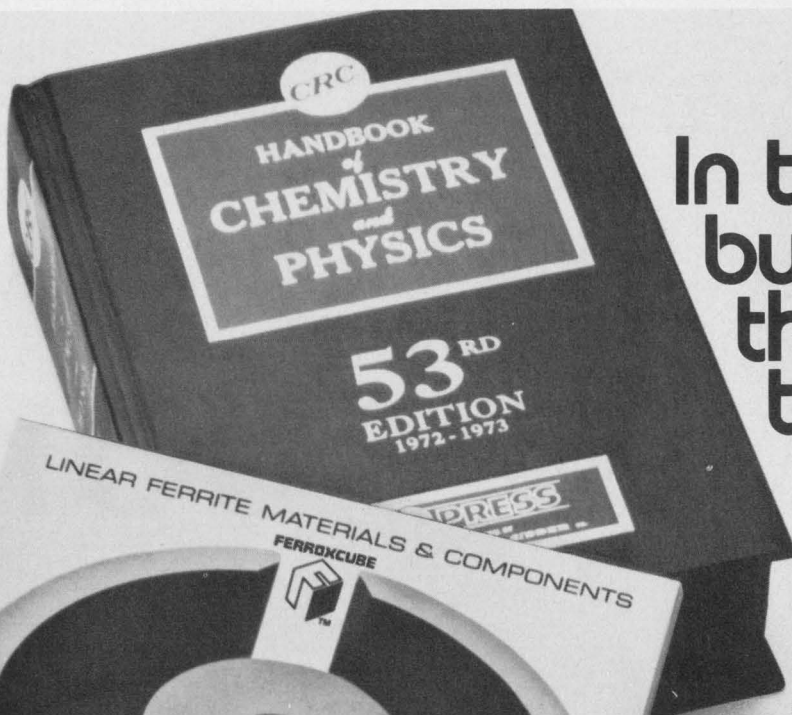

In this business, there are two reliable sources.

Having problems calculating efficiency, voltage or temperatures? Turn to the big book. Having problems designing for applications that demand high Q, high stability of inductance, and minimum volume? Or, low power losses at high flux density? Turn to the little book.

Turn to the Cube.

Ferroxcube offers the most complete, most diversified selection of linear ferrite materials. You get the electrical properties you want. In a broad variety of sizes and shapes. You get consistent quality. And you get delivery, when you want it, where you want it.

We're reliable. Ask the competition.

It's good business to second source yourself. The little book belongs on your bookshelf. Send for your free copy of the new Ferroxcube Linear Ferrite catalog today.

Ferroxcube Corporation

Saugerties, N. Y. 12477



Name _____

Title _____

Business _____

Address _____

City _____

State _____

Zip _____

ED-6-76



FERROXCUBE CORPORATION

A North American Philips Company

THE NO TRADEOFF 1k x 4 PROM

**If greater bit density,
P. C. board savings and high
reliability are essential
in your PROM design,
and you can't afford
to sacrifice speed, and
you need it now, at the
lowest possible price,
this is your part.**

MMI PROMS

DEVICE	OUTPUT	ORGANI- ZATION	PINS	OPERATING RANGE	MAX ACCESS TIME*	100-999 PRICE
6352/53-1	OC/TS	1024 x 4	18	comm	60 ns	\$15.95
5352/53-1	OC/TS	1024 x 4	18	mil	75 ns	33.50
6340/41-1	OC/TS	512 x 8	24	comm	90 ns	15.95
5340/41-1	OC/TS	512 x 8	24	mil	90 ns	33.50
6305/06-1	OC/TS	512 x 4	16	comm	60 ns	7.00
5305/06-1	OC/TS	512 x 4	16	mil	75 ns	15.95
6300/01-1	OC/TS	256 x 4	16	comm	55 ns	3.25
5300/01-1	OC/TS	256 x 4	16	mil	75 ns	7.90
6330/31-1	OC/TS	32 x 8	16	comm	50 ns	2.55
5330/31-1	OC/TS	32 x 8	16	mil	60 ns	5.00
10149 ECL	OE	256 x 4	16	comm	30 ns	17.50

*Access times guaranteed over the full temp range.

For more information call, TWX or write:

United States

Monolithic Memories, Inc.
1165 East Arques Avenue
Sunnyvale, CA 94086
Tel: (408) 739-3535
TWX: 910-339-9229

Europe

Monolithic Memories, GmbH
8000 Munich 80
Mauerkircherstr. 4
West Germany
Tel: (089) 982601, 02, 03, 04
Telex: (841) 524385

Far East

Monolithic Memories, Ltd.
Parkside-Flat Bldg
4-2-2, Sendagaya Shibuya-Ku
Tokyo 151, Japan
Tel: (3) 403-9061
Telex: (781) 26364

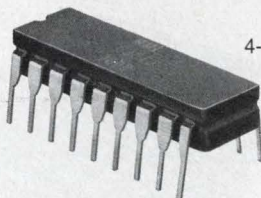

Selection.

MMI 1k x 4 PROMs are available in both commercial and military temperature ranges and with open collector or three state output options.

Compatibility.

MMI 1k x 4 PROMs are available in standard 18 pin cerdip and ceramic packages. The MMI 5352-1 series 1k x 4 PROMs are pin and function identical to the Harris HM-7642-5 series, yet the MMI parts are substantially faster.

Second Sourcing.

If only half the companies who have announced this part are able to deliver it, there will still be adequate second sources.

Availability.

MMI 1k x 4 PROMs were the industry first and have been in high volume production for over 9 months.

Speed.

At 60 nsec max over the full commercial temp and voltage variation the MMI 1k x 4 PROMs are the fastest available.

Support.

MMI applications engineers are available for consultation on your particular application. Programming is available at MMI facilities in Sunnyvale, California, Munich, Germany and Tokyo, Japan as well as at MMI distributors worldwide.

Price.

Our PROM prices are always the lowest, not only for 1k x 4 PROMs, but across the board. Check the table against what you're paying elsewhere and prove it to yourself.

Confidence.

MMI started the PROM revolution with the first 1k, 2k and 4k PROMs and is now the world's largest bipolar memory supplier. The Schottky TTL process and nichrome fuse technology have been proven in a host of high volume production programs. Our reputation for high quality parts and on-time delivery is unmatched.

Family.

The MMI 1k x 4 PROM is not an only child. We offer the most complete and competitive line of PROMs available anywhere.

Monolithic Memories, Inc.

How can you pick the smartest microprocessor system with a dumb evaluation kit?

You can't. But there are plenty of companies that want you to try.

With the AMI 6800, it's a different story. Look at the chart

comparing our new EVK 300 evaluation and prototyping system with theirs. See what you've been missing?

To begin with, on-board EPROMs make the difference between a meaningful tool and a hobby toy. Without them, program development is cumbersome and very expensive.

Then there's the on-board EPROM Programmer. It adds to the cost of the EVK 300. But without it, you pay a much higher price for EPROM programming.

And we give you another exclusive bonus: AMI 6800 Tiny Basic. This high-level interpretive language, derived from the standard Dartmouth Basic, comes to you free when we receive your EVK 300 warranty registration.

You'll find plenty of other essential features that the others don't feature at all. So compare. Then call your local AMI sales office, distributor or representative, and ask to see our EVK 300. (He also has an unassembled kit with one EPROM, and a basic kit with none.) Or write to: AMI, 3800 Homestead Road, Santa Clara, CA 95051.

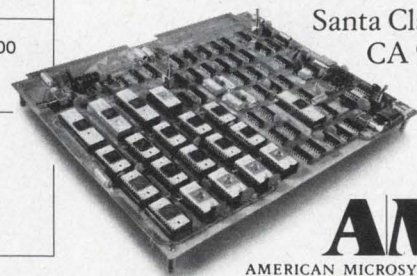

FEATURES	COMPETITORS—TOP OF THE LINE			
	AMI	MOTOROLA	INTEL	FAIRCHILD
Model Designation	6800 EVK 300	6800 MEK 6800	8080 SDK 80	F8 F8S
Board Size	10.5" x 12"	6" x 9"	6.75" x 12"	8" x 10"
Built-In EPROM Programmer (UV Erasable)	Yes	No	No	No
RAM Supplied (Bytes)	1024	256	256	1024
ROM Supplied (Bytes)	2048	1024	0	1024
EPROM Supplied (Bytes)	2048 (UV Erasable)	0	1024 (UV Erasable)	0 (Sockets for 2K Bipolar Fuse Link)
I/O Lines (Parallel)	58	16	24	16
I/O Interface (Serial) • RS232C • 20 mA Current Loop-TTY	Yes Yes	Yes Yes	Yes Yes	Yes No
Provisions for Slow Memory	Yes	No	Yes	No
Power Requirements	+5 VDC @ 3.5A +12 VDC @ 0.035A -12 VDC @ 0.15A -50 VDC @ 0.035A (For EPROM Programming Only)	+5 VDC @ 1.0A +12 VDC @ 0.1A -12 VDC @ 0.05A	+5 VDC @ 1.3A +12 VDC @ 0.35 A -10 VDC @ 0.20A	+5 VDC @ 2.5A +12 VDC @ 0.5A
DMA Modes	3	0	1	0
Interval Timer	Yes	No	No	Yes
Fully Buffered MPU Lines	Yes	No	No	No
Monitor Commands	10	5	6	6
Built-In Software Utility Routines	23	0	2	7
Breakpoints • Print • Snap-Shot	Yes Yes	Yes No	Yes No	Yes Yes
Clock • Crystal Controlled • Alternate Variable Frequency	Yes Yes	Yes No	Yes No	No No
Baud Rate • Selection Range • Crystal Controlled Independent of System Clock	0 to 19,200 Yes	110 to 300 No	75 to 4800 No	110 to 300 No
Price • Assembled • In Kit Form	\$950. \$955. Designated EVK200. Supplied with 512 bytes EPROM. Sockets for 2K bytes.	\$595. \$149.	— \$350.	\$995. —

Prices and specifications accurate 5/1/76, but subject to change.

AMI
AMERICAN MICROSYSTEMS, INC.

Here's AMI:

SALES OFFICES

Long Beach CA • (213) 595-4768
 San Jose CA • (408) 249-4550
 Altamonte Springs FL • (305) 830-8889
 Elk Grove Village IL • (312) 437-6496
 Norwood MA • (617) 762-0726
 Livonia MI • (313) 478-9339
 Minneapolis MN • (612) 559-9004
 Monsey NY • (914) 352-5333
 Cleveland OH • (216) 292-6850
 Ambler PA • (215) 643-0217
 Richardson TX • (214) 231-5721

DISTRIBUTORS

ARROW ELECTRONICS:
 Minnesota—Bloomington (612) 888-5522

CENTURY ELECTRONICS:
 New Mexico—Albuquerque (505) 292-2700
 Utah—Salt Lake City (801) 487-8551

CESCO ELECTRONICS, LTD.:
 Canada—Montreal (514) 735-5511

INTERMARK ELECTRONICS:
 Washington—Seattle (206) 767-3160

SCHWEBER ELECTRONICS:
 California—Costa Mesa (213) 924-5594
 and (714) 556-3880

Connecticut—Danbury (203) 792-3500
 Florida—Hollywood (305) 927-0511
 Georgia—Atlanta (404) 449-9170
 Illinois—Elk Grove Village (312) 593-2740
 Iowa—Cedar Rapids "Lorenz Sales"
 (319) 393-6912

Maryland—Rockville (301) 881-3300
 Massachusetts—Waltham (617) 890-8484
 Michigan—Troy (313) 583-9242
 Minnesota—Edina (612) 941-5280
 New Jersey—Somerset (201) 469-6008
 New York—Rochester (716) 461-4000
 Westbury (516) 334-7474

Ohio—Beachwood (216) 464-2970
 Texas—Austin (512) 837-2890
 Dallas (214) 661-5010
 Houston (713) 784-3600

Canada—Mississauga, Ont. (416) 678-9050

SEMCOMP CORP.:
 California—Newport Beach
 (213) 971-5253 and (714) 833-3070

STERLING ELECTRONICS:
 Arizona—Phoenix (602) 258-4531
 Louisiana—Metairie (504) 887-7610
 Massachusetts—Watertown (617) 926-9720
 New Jersey—Perth Amboy (201) 442-8000
 New Mexico—Albuquerque (505) 345-6601
 Texas—Dallas (214) 357-9131
 Houston (713) 627-9800

Virginia—Richmond "Meridian Electronics"
 (804) 359-0221

R. V. WEATHERFORD CO.:
 Arizona—Phoenix (602) 272-7144
 California—Anaheim (714) 547-0891
 Glendale (213) 849-3451
 Palo Alto (415) 493-5373
 Pomona (714) 623-1261
 San Diego (714) 278-7400

Colorado—Englewood (303) 761-5432
 New Mexico—Albuquerque (505) 842-0868
 Texas—Dallas (214) 243-1571
 Houston (713) 688-7406
 Washington—Seattle (206) 243-6340

REPRESENTATIVES

AMMON & RIZOS:
 Oklahoma—Oklahoma City (405) 373-2748
 Texas—Dallas (214) 233-5591
 Houston (713) 781-6240

BARNHILL FIVE:
 Colorado—Denver (303) 426-0222

BENEKE & McCAUL:
 Missouri—Grandview (816) 765-2998
 St. Louis (314) 567-3399

CAN TEC REPRESENTATIVES, INC.:
 Ontario—Ottawa (613) 225-0363

COULBOURN DEGREIF, INC.:
 Maryland—Baltimore (301) 247-4646

HADDON ASSOCIATES:
 California—San Diego (714) 565-9445

HECHT, HENSCHEN & ASSOCIATES, INC.:
 Arizona—Phoenix (602) 275-4411

LOWREY & ASSOCIATES:
 Michigan—Brighton (313) 227-7067

NORTHWEST MARKETING ASSOCIATES:
 Washington—Bellevue (206) 455-5846

OASIS SALES, INC.:
 Illinois—Elk Grove Village (312) 640-1850

PRECISION SALES COMPANY:
 New York—Syracuse (315) 458-2223

REP INC.:
 Alabama—Huntsville (205) 881-9270
 Georgia—Tucker (404) 938-4358
 North Carolina—Raleigh (919) 851-3007

TECHNICAL REPRESENTATIVES, INC.:
 Indiana—Indianapolis (317) 849-6454

INTEGRATED CIRCUITS

10-bit DAC holds errors to $\pm 0.05\%$

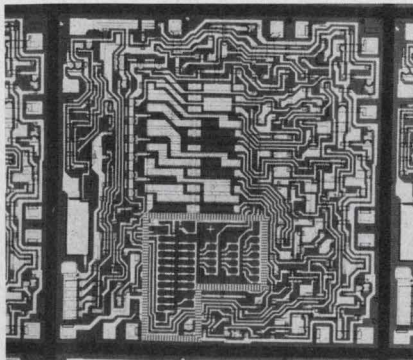

Motorola, P.O. Box 20912, Phoenix, AZ 85036. (602) 244-3464. \$9.95 to \$14.95 (100); stock.

Ten-bit d/a converters combine a price tag under \$10 with a maximum error (relative to full-scale output current) as low as $\pm 0.05\%$. The new MC3510/3410 employs functional laser-trimming to obtain the accuracy. The circuits provide logic-controlled current switches, R-2R resistor-ladder network and output termination networks, though the output-buffer amplifier and reference voltage have been omitted. Typical settling time is 250 ns.

CIRCLE NO. 324

Quad op amp consumes less power than one 741

National Semiconductor, 2900 Semiconductor Dr., Santa Clara, CA 95051. (408) 732-5000. \$8.50 (100).

Combining four popular standard op amps on a single chip, the LM 148/149 consumes less power than one amp. Each of the four amplifiers provides functional characteristics identical to those of the 741. Compared to the standard 741, however, the input offset current is lower—4 nA—and the input bias current is less—30 nA. The new series also features a supply current drain of 0.6 mA/amplifier, low input-offset voltage of 1 mV, and overload protection for both inputs and outputs. The LM 148 is pin compatible with the older LM 124 quad op amp. The LM 149 has the same features as the LM 148, plus a gain-bandwidth product of 4 MHz at a gain of 5 or greater.

CIRCLE NO. 325

Nonvolatile memory has 1-k bit capacity

Nitron, 10420 Bubb Rd., Cupertino, CA 95014. (408) 255-7550. \$20.

A 1-k-bit nonvolatile memory comes with a 256×4 -bit organization. The NCM 7050 has eight address and two mode inputs that electrically control data reading, storing and erasing. A p-channel MNOS circuit, the NCM 7050 retains data indefinitely, even with power supplies disconnected. Other features include: single word alterability, latched inputs, three-level outputs and compatibility with CMOS and TTL product families.

CIRCLE NO. 326

4-k PROMs have standard pinouts

Monolithic Memories, 1165 E. Arques Ave., Sunnyvale, CA 94086. (408) 739-3535. \$17.95 to \$35.00 (100-999).

Four 18-pin 1-k \times 4-bit PROMs—Models 5/6352/53-1—offer industry-standard pinouts. And with maximum access as short as 60 ns, the PROMs are the fastest available 18-pin 1-k \times 4 PROMs. The circuits allow 12-k bits of PROM to be fitted into the same board space required by a 512×8 -bit 24-pin device. Programmability of the 5353 is typically greater than 95%.

CIRCLE NO. 327

CMOS series has uniform features

Motorola, 3501 Ed Bluestein Blvd., Austin, TX 78721. (512) 928-2600. Gates: 26¢ (100-999); stock.

A family of B-series CMOS logic circuits features uniform characteristics that include: buffered outputs on all parts; operational range of 3 to 18 V; drive capability from each output of at least one low-power S-TTL load; and parametric specification (typical and maximum) at 5, 10 and 15 V. The new CMOS series includes 19 simple gates, nine flip-flops/latches, 10 shift registers and 23 counters.

CIRCLE NO. 328

basic black! it's the best color for stand-by batteries

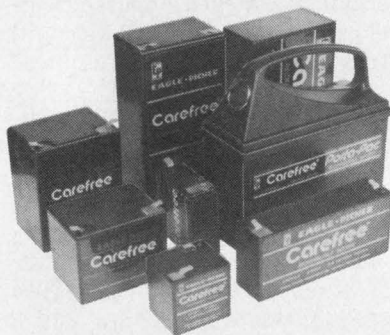

Carefree®

Choose from 32 black beauties. Everyone is sealed, spill-proof and has a dual cover. They are maintenance free and rechargeable. Your most dependable stand-by computer power.

**Reliable,
American-Made
Quality.
The Black Battery.
It's Carefree.**

FAST, NATION-WIDE SERVICE

We're as close as your phone and offer FREE technical consulting to match power sources to your power needs. We also will custom design batteries for special applications.

EAGLE P ICHER
SINCE 1843

EAGLE-PICHER INDUSTRIES, INC.
Commercial Products Department ED
P.O. Box 130, Seneca, Mo. 64855
Telephone (417) 776-2258

CIRCLE NUMBER 75

DISCRETE SEMICONDUCTORS

Clock display modules come in four versions

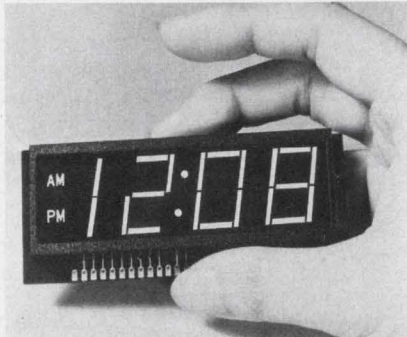

Fairchild Camera and Instrument, Optoelectronics Div., 4001 Miranda Ave., Palo Alto, CA 94304. (415) 962-3816. 1000-up prices: \$5.60 (8000 or 8001); \$6.25 (8024, 8025); stock.

Clock displays that are 0.8 in. come in either 3-1/2 or 4-digit formats. The FCS8000, FCS8001 displays are 3-1/2-digit common-cathode units that require only 8 mA drive current per segment. The displays include AM/PM indicators, and are available in two versions that offer optional spacing between digits. The FCS8024 and FCS8025 are 4-digit modules that permit 24-hour time displays. The two versions offer optional spacing between digits, but do not include AM/PM indicators. All four displays use the company's "light-pipe" construction for maximum brightness.

CIRCLE NO. 329

LED panel indicators just snap right in

Dialight, 203 Harrison Pl., Brooklyn, NY 11237. (212) 497-7600. From \$0.33 (1000-up); stock.

The 558 series of LED indicators just snaps into a panel and requires no additional hardware. The units mount from the front of a panel that can range from 0.031 to 0.062 in. thick. The indicators require a 0.156-in. clearance hole, and can fit on 0.2-in. centers. They are available with red, green or yellow LEDs, with or without integral current limiting resistors. The 558 series comes with either rigid terminals suitable for wrapped wiring or with 6-in. wire leads.

CIRCLE NO. 330

Bidirectional isolators handle up to 1500 V

Optron, 1201 Tappan Circle, Carrollton, TX 75006. (214) 242-6511. \$1.80 (1000-up); stock.

A bidirectional optically coupled isolator uses two LEDs on the input. The LEDs in the Model 2500 are connected in inverse parallel so that both positive and negative inputs can be isolated. Guaranteed minimum current-transfer ratio in either direction of the isolator is 12.5% at an input of 16 mA. The typical current-transfer ratio is 30%. Input-to-output isolation is 1500 V dc. The isolator is housed in a six-pin plastic DIP.

CIRCLE NO. 331

JFETs in mini-DIPs give equivalent performance

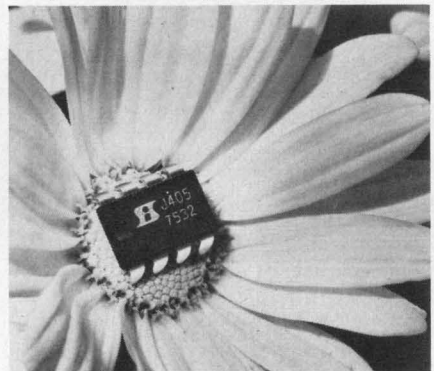

Siliconix, 2201 Laurelwood Rd., Santa Clara, CA 95054. (408) 246-8000. From \$0.88 (100-up); stock.

Two series of monolithic dual JFETs are now available in 8-pin mini-DIPs. The series are the J401 to J406 low-noise n-channel JFETs, and the J410 to J412 general-purpose n-channel JFETs. The J401 to J406 duals have electrical specifications similar to the U401 to U406 metal-can equivalents, except for gate leakage current. Differential gate-source voltage ranges from 5 mV (maximum for the J401) to 40 mV (maximum for the J406). Noise voltage is 20 nV/√Hz maximum at 10 Hz and gate leakage is 10 pA maximum. The J410 to J412 are equivalent to the E410 to E412. Differential gate-source voltages range from 10 mV (maximum for the J410) to 40 mV (maximum for the J412). Noise voltage is 50 nV/√Hz, maximum, at 10 Hz.

CIRCLE NO. 332

Our modular dc supplies have always been UGLY™ because we're designers, not stylists.

But we may have outdone ourselves with our new SOLV-15.

Like all our other single and multiple-output dc supplies, our 15-watt SOLV-15 delivers its full rated output all the way up to +55°C. And its standard features include: a choice of 16 voltages from 5-24V, currents from 3-0.75A; ±0.1% regulation, ripple-and-noise; foldback current limiting; and a 1-year warranty. But even with all this, it still looked stark.

So we took a stab at making it more attractive by getting it UL-listed and adding sense protection (free), reverse diode protection (free) and a fixed OVP (free). We wrapped it all up in a new low-profile package that uses the same mounting holes as the supplies you're probably using now.

And then priced it all a couple of bucks under the nearest competition (\$23.50, 100-pieces).

We just figured that since it was so UGLY, it was really going to have to deliver.



©Elpac Electronics, Inc.

CIRCLE NUMBER 76



**AT \$23.⁵⁰ THIS HAS
TO BE OUR UGLIEST
SUPPLY YET.**

Elexon: the ugliest dc supplies on earth.

Get UGLY at Cramer, Newark, MIL-COMM, QPL and Utronics. Or call 714/979-4440.

DISCRETE SEMICONDUCTORS

Reference diode chips offer choice of tempo

Codi Semiconductor, Pollitt Dr., Fair Lawn, NJ 07410. (201) 797-3900. From \$0.50 (100-up); stock.

Silicon voltage reference chips in the CRD 821 and 921 series are available with a zener voltage of 6.2 V \pm 5%. The chips are unencapsulated and have temperature

coefficients that range from 0.01 to 0.0005%/°C at zener currents of 7.5 mA for the 821 series and 2 mA for the 921 series. All chips are meant to be either eutectically bonded or attached with conductive epoxy pastes to substrate material. The anode metallization is aluminum to facilitate either gold thermo-compression or aluminum ultrasonic bonding. Ribbon leads are available for applications requiring solder attachments.

CIRCLE NO. 333

Bridge rectifiers deliver up to 4.2 A rms

N.V. Philips Gloeilampenfabrieken, Elcoma Div., P.O. Box 523, Eindhoven, the Netherlands.

The BY225 series of full-wave silicon bridge rectifiers includes two units—the BY225-100 and BY225-200—with maximum input voltages of 50 and 80 V rms, respectively. Average output current is 4.2 A for both types and the units can operate with line frequencies of up to 400 Hz. The plastic encapsulated bridges consist of four double-diffused diode chips assembled on a copper comb.

CIRCLE NO. 334

You know our Capacitors, but have you seen our...

ALUMINUM FOIL TRANSFORMERS

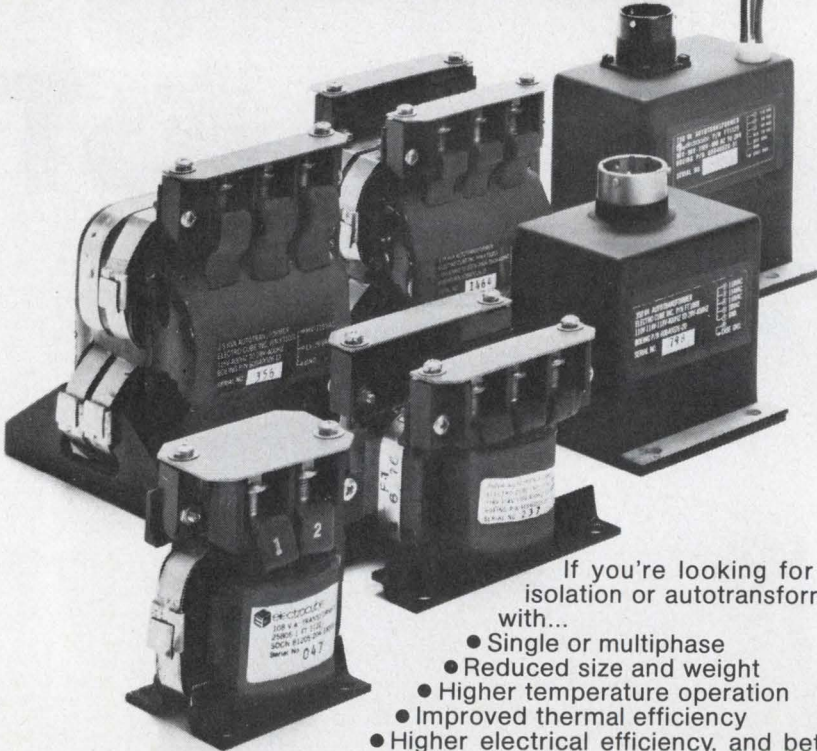

If you're looking for an isolation or autotransformer with...

- Single or multiphase
- Reduced size and weight
- Higher temperature operation
- Improved thermal efficiency
- Higher electrical efficiency, and better regulation

...then our aluminum foil transformer line could be your answer. Units are available in 50/60 Hz, 400 Hz and higher frequencies, in sealed, shell and open-frame versions, with ratings to 5000 VA and outputs through 500 volts. Or send us your requirements for a design and price proposal. Send for our transformer data sheet and technical bulletin today to Electrocube, 1710 So. Del Mar Ave., San Gabriel, CA 91776; (213) 573-3300.



CIRCLE NUMBER 77

Varacter tuning diodes handle 22-V reverse bias

MSI Electronics, 34-32 57th St., Woodside, NY 11377. (212) 672-6500. \$2.70 (100-up); 2 wks.

At a 4-V bias the capacitance of the DHA6520B tuning diode is 20 pF while at 20 V it is 3.5 pF. The diode has a tuning range of 5.7:1, thus providing wide frequency coverage. The diode is packaged in a JEDEC DO-7 glass case. With a voltage-breakdown rating of greater than 22 V, the DHA6520B can accommodate large rf signals to make it more useful in transceivers near the output stages.

CIRCLE NO. 335

Multidigit LED displays come in two versions

Litronix, 19000 Homestead Rd., Cupertino, CA 95014. (408) 257-7910. \$6 (1000-up); stock.

Two displays of 0.5-in-high LED digits are available preassembled on a PC board. One is a 4-digit display (Model DL 4530) and the other a 3-1/2 digit (Model DL 3531) accompanied by plus and minus signs. Both may be end-stacked to create longer displays. The displays have a built in anti-reflection filter that enhances contrast to produce a display that can be read at up to 20 ft at a drive current of 10 mA per segment. A clear lens is standard; a red lens can optionally be ordered. Luminous intensity at 10 mA per segment is 0.8 mcd typical and 0.5 mcd minimum.

CIRCLE NO. 336

The power you need is the power you get.

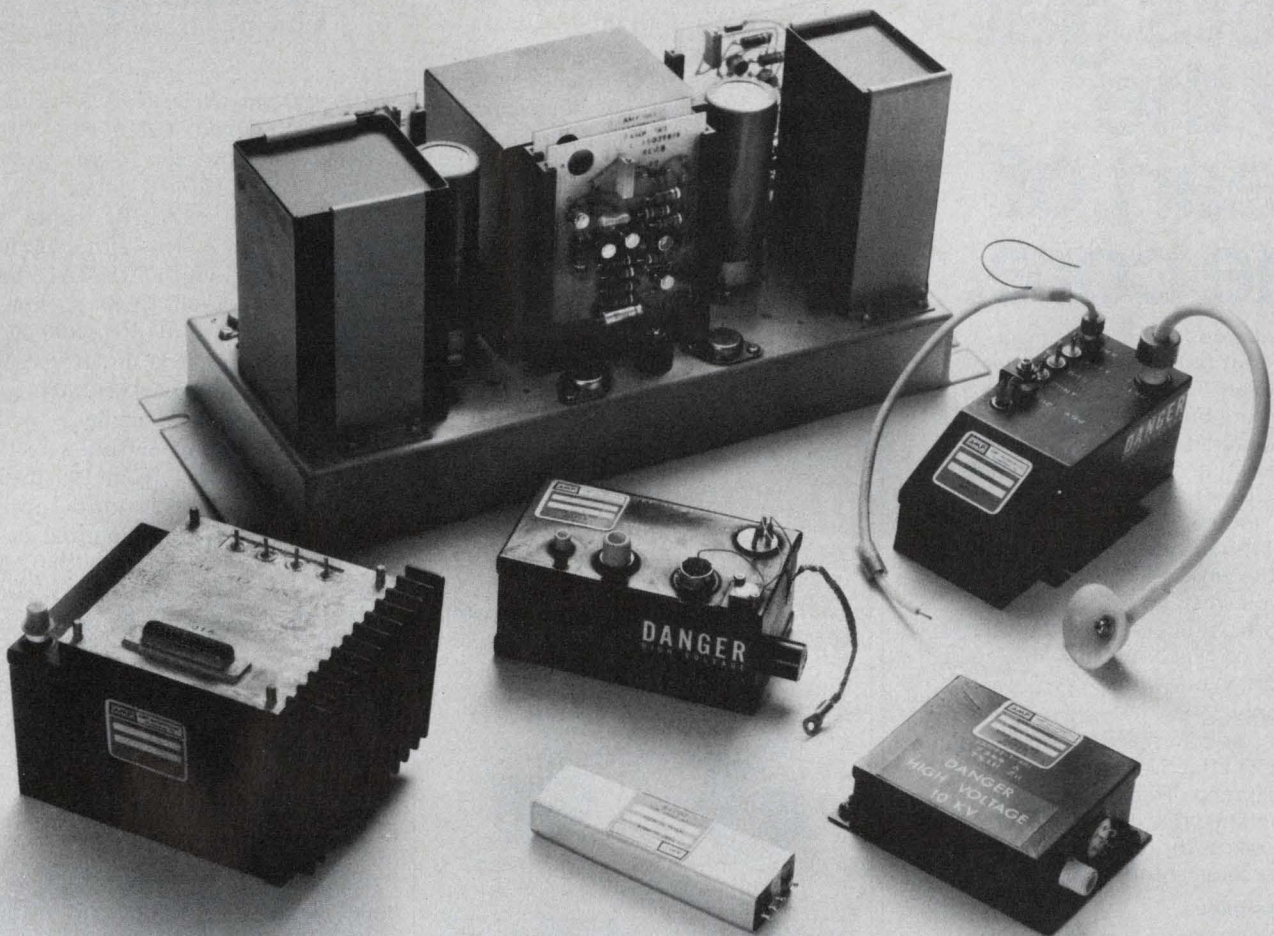

From AMP—the power supply that's a perfect match to the system, any electronic system. We're the specialists.

The power behind multicolor CRT displays, for instance, with a big family of 1 through 18-KV fast-switching supplies. Ones that change output voltage levels in millionths of a second, and do it with long-life dependability in environmental extremes.

Whatever your application, military or commercial—no matter how demanding the complexity, performance and miniature size requirements — we'll fit a power

supply to your need. With over 1000 existing designs—up to 60 KV and 2 KW —your power supply could be “on the shelf.” Or we'll quickly tailor one for you.

And we also engineer some very unusual low-voltage supplies, as well as multiple output types combining both low and high voltages. All feature our unique oil/gas dielectric for high reliability and long life.

Give us your specifications. We'll get data back to you immediately. Contact: AMP Incorporated, Capatron Division, Elizabethtown, PA 17022. (717) 367-1105.

AMP
INCORPORATED

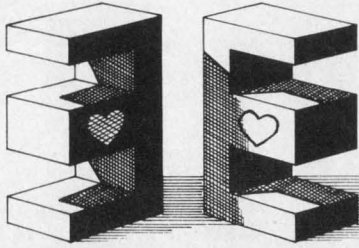

Let's get to the heart of the core.

What do you look for in a manufacturer of ferrite cores for power conversion? Service, that's the heart of the core business. There are several manufacturers whose E and other configuration cores are comparable to Fair-Rite's. There are other materials which are the equivalents of Fair-Rite's #77. But there are very few other than Fair-Rite who are willing to work with you when your requirements deviate from their standard products. It's service which sets Fair-Rite apart. Consider these points....

Economy

Our power conversion cores are made with cost effectiveness as a prime consideration. This is the key to our outstanding price competitiveness. Please ask us for our quotation before you purchase another core.

Accessibility

Next time you have a problem or a question relating to ferrites, call Fair-Rite. You will be amazed at how easy it is to get through to someone with the answer.

Delivery

This is the real heart of the core business. At Fair-Rite, we'll sacrifice anything but quality control to meet our commitments. No delays, no excuses. But don't take our word for it. Ask our customers.

Fair-Rite Power Conversion Cores

Low core losses @20kHz. High saturation flux density. High temp operation. Wide variety of shapes and sizes.

Fair-Rite

PRODUCTS CORP.

Ferrite Cores for the Electronics Industry
Dept. D-6, Wallkill, New York 12589
(914) 895-2055 TWX (510) 249-4819
FR WALK

CIRCLE NUMBER 79

DISCRETE SEMICONDUCTORS

LED numeric display claimed top in size

Fairchild Camera & Instruments, Optoelectronics Div., 464 Ellis St., Mountain View, CA 94042. (415) 962-3816. \$2.70 (1000-up); stock.

A 0.8-in.-high LED display digit developed by Fairchild is claimed to be the largest single digit display available in the industry. The displays are available in common-cathode or common-anode versions with either a left or right-hand decimal point. Common-cathode types are the FND800, right-hand decimal, and the FND850, left-hand decimal. Common-anode types are the FND807, right-hand decimal, and the FND847, left-hand decimal. The displays require 1.7-V per segment at an average drive current of 5 mA. Average intensity per segment is 0.15 mcd. Package dimensions are 1.03 × 0.77 in.

CIRCLE NO. 337

Compact bridge rectifier handles up to 12 A

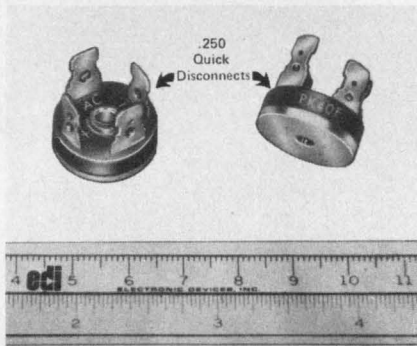

Electronic Devices, 21 Gray Oaks Ave., Yonkers, NY 10701. (914) 945-4400. See text.

The Model PKF circular bridge rectifier uses quick-disconnect terminals. It is designed for 12-A operation and joins existing 6, 8 and 10-A designs. All are available for 50, 100, 200, 400, 600, 800 and 1000-V PIV operation. Surge currents of up to 150 A can be handled and the dielectric strength is 1500 V rms. The bridges have a diameter of 0.89 in. and the connections are 0.25-in. male quick disconnects. Typical 10,000-up price for a 12 A, 400 V, PK 40F is \$1.50. Delivery is from stock.

CIRCLE NO. 338

460-A power SCRs switch in 10 μs

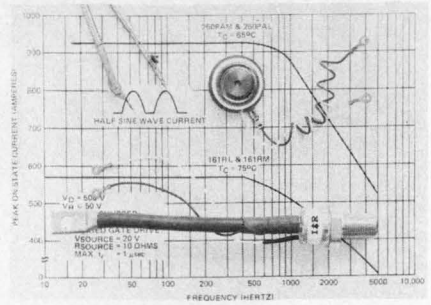

International Rectifier, 233 Kansas St., El Segundo, CA 90245. (213) 678-6281. Typical 10-up prices: \$93.25 (250PAM60); stock.

Two series of SCRs rated for 285 and 460 A rms—the 161RM, RL and the 250PAM, PAL have maximum turn-off times as low as 10 μs. Maximum di/dt is 800 A/μs and the reapplied dv/dt is 200 V/μs. The two part numbers in each series include devices for 10 and 20-μs turn off, with a selection of voltage ratings from 100 to 600 V. The 161RM, RL units are in JEDEC TO-93 stud-mounted cases and rated for 285 A. The 250PAL, PAM units are in JEDEC TO-200-AB pressure-mounted, disc cases and are rated for 460 A.

CIRCLE NO. 339

LED readouts offer 40-ft visibility

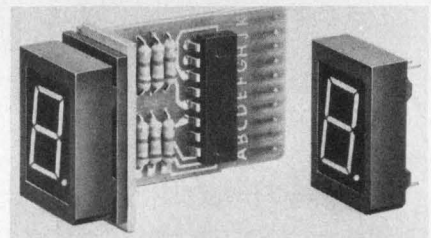

Dialight, 230 Harrison Pl., Brooklyn, NY 11237. (212) 497-7600. 1000-up prices: \$2.55 (6001), \$6.05 (6007); stock to 4 wks.

A high-brightness LED readout, the 730-6001, has a character height of 0.6 in. The readout draws 10 mA/segment or less and operates with standard IC power supply levels. The digit is visible from a distance of 35 to 40 ft. A Model 730-6007 display assembly is also available. It consists of the 6001 LED readout mounted on a PC board, complete with all necessary current limiting resistors and decoder/driver.

CIRCLE NO. 340

It pays to look into Metal Glaze™ from all angles.

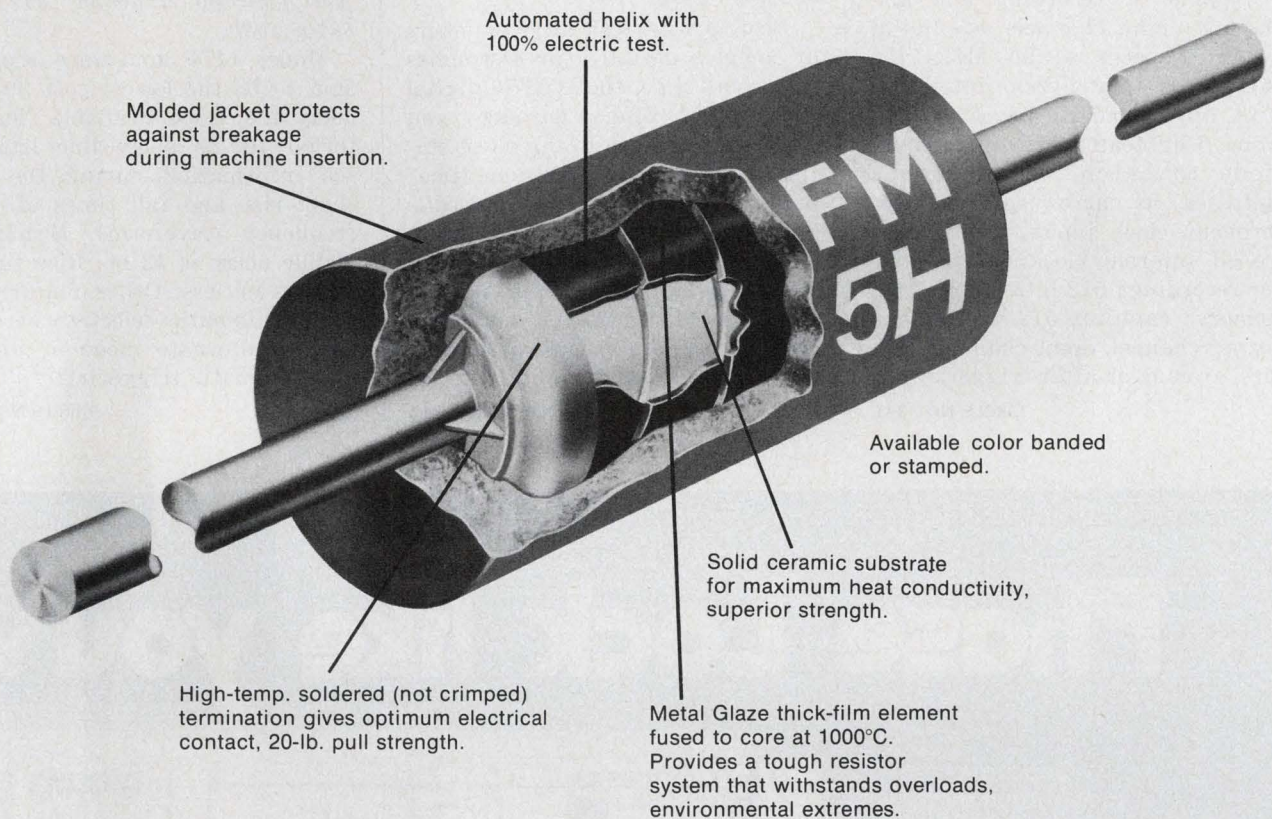

***Metal Glaze is TRW trademark for its thick-film resistors.

We have designs on you. Especially if you're designing any type of low-power circuitry and need resistors with excellent load life stability and cost effectiveness.

TRW/IRC Metal Glaze resistors can take the heat. For instance, their thermal characteristics are outstanding, giving you lower operating temperatures, greater reliability.

Another advantage, you can often double-rate our Metal Glaze resistors so you can use smaller resistors, saving board space.

The ability and toughness of Metal Glaze to take heat and work efficiently have been proven billions of times in all types of electronic equipment, worldwide. And they're available in ratings ≤ 3 watts, $\geq 1\%$ tolerance, with ranges as low as 1 ohm.

For complete resistor choice including Metal Glaze, carbon comp., thin-film, wirewound and networks, contact your local TRW sales representative. Or TRW/IRC Resistors, an Electronic Components Division of TRW, Inc., 410 N. Broad St., Philadelphia, Pa. 19108, (215) 922-8900.

TRW IRC RESISTORS
ANOTHER PRODUCT OF A COMPANY CALLED TRW

CIRCLE NUMBER 80

INSTRUMENTATION

50-MHz logic analyzer grabs 8-channel data



Biomation, 10411 Bubb Rd., Cupertino, CA 95014. (408) 255-9500. \$3575; 30 days.

Capable of recording and displaying eight channels of digital logic at speeds to 50 MHz, the 851-D logic analyzer interfaces with any standard bench oscilloscope. Key features include: latch mode to catch single pulses (glitches) as narrow as 5 ns; synchronous clock input; crystal-controlled internal clocking; pretrigger recording; 512 bits per channel memory; captures 512 words (one bit per channel, eight channels) before, around, or after trigger event.

CIRCLE NO. 341

Digital test system offers up to 3 stations

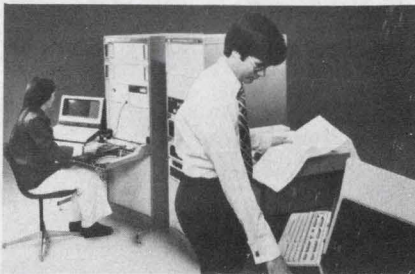

Hewlett-Packard, 1501 Page Mill Rd., Palo Alto, CA 94304. (415) 493-1501. 60 pins, less than \$25,000; July.

Designed to test large numbers of complex digital logic assemblies in a short time, the DTS-70 digital test system offers go/no-go and fault isolation. Up to three test stations can be used at the same time; programs can be written and edited on the system controller while one test station is in operation. Tests are prepared using Testaid III, an advanced digital simulator, which incorporates automatic pattern generation capability.

CIRCLE NO. 342

Dual-trace scope offers 30-MHz bw for \$820



B&K Precision, 6460 W. Cortland Ave., Chicago, IL 60635. (312) 889-8870. \$820.

Model 1474 dual-trace scope is said to be the lowest cost 30-MHz delay-line scope available. The internal 160-ns delay line lets you see information during the very short rise and fall times of high-frequency waveforms. Minimum visible delay is 12 ns. Rise time is 11.7 ns or less. Other features include automatic selection of chopped or alternate mode of display and automatic triggering.

CIRCLE NO. 343

Phase Lock like you've

Separate modulation meter

100 Hz resolution with phase-lock

Wide deviation at all carrier frequencies

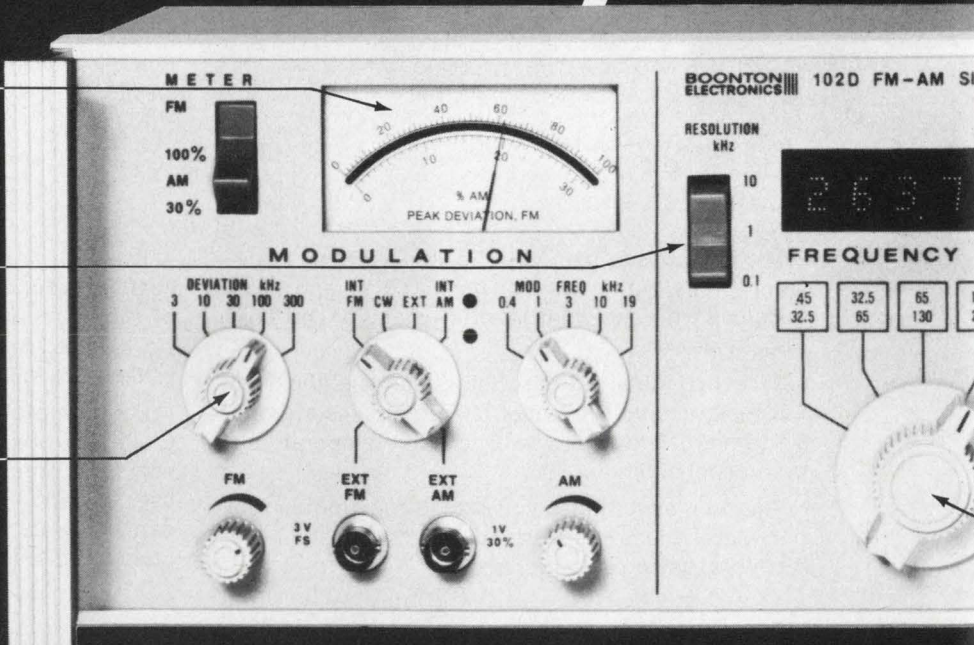

How do you make a great signal generator like our 102A better?

Simple—you not only extend the frequency range to cover 450 kHz to 520 MHz, but you make sure that the frequency you see is the frequency you get... exactly. (And virtually indefinitely.)

With the unprecedented phase-lock stability of this new model 102D, you can be as specific as you like. Simply lock-in the desired frequency with pushbutton ease to get a 6-digit display of the true locked output frequency with full 100 Hz resolution—even when the

vernier is used to tune between lock points. Phase-lock operates with either the stable internal TCXO or an external reference from your frequency standard or other generator.

No one else makes it that easy, even in generators selling for \$2100 more. But

Digital thermometers claim high accuracy



John Fluke, P.O. Box 43210, Mountlake Terrace, WA 98043. (206) 774-2211. 2160A, \$299; 2170A, \$425.

Two new series of digital thermometers claim the highest guaranteed accuracy specifications in the industry. Model 2160A offers 1-degree resolution and the 2170A gives resolution to 0.2 degrees. The thermometers are available with single-point, multipoint and multi-type thermocouple inputs. Both are available as panel mounted (DIN) or bench units and can measure temperatures from -200 to $+2327$ C or 3999 F over 16 available ranges.

CIRCLE NO. 344

Function generator can't burn out



Krohn-Hite, Avon Industrial Park, Bodwell St., Avon, MA 02322. (617) 580-1660. \$495 (bench model), 8 wks.

Model 5100B function generator provides an output-protection circuit that safeguards against burn-out or other damage by accidental application of voltage to the output terminals. The unit offers a dynamic frequency range from 0.002 Hz to 3 MHz in nine steps. It generates eight waveforms: sine, square, triangle, positive ramp, negative ramp, sawtooth, positive pulse, and negative pulse. Main output is 20 V pk-pk (open circuit).

CIRCLE NO. 345

Hand-held DMM measures temperature



Logical Technical Services Corp., 71 W. 23rd St., New York, NY 10010. (212) 741-8340. \$259; 2-4 wks.

Model 12T is a 3-1/2-digit, 14-range temperature/digital multimeter. The unit features auto-ranging, autopolarity and 0.1% accuracy (V dc) in a hand-held plastic probe body. To use, merely press the probe tip to the surface and read the display in degrees directly with 0.1-C resolution. The Model 12T gets up to 4 h of continuous operation from a set of standard AA-sized rechargeable nickel-cadmium battery cells. A battery-charger/line-operated supply is included. Also measured are ac and dc V from 1 mV to 750 V and resistance from 1 Ω to 19.99 M Ω .

CIRCLE NO. 346

never seen before.

GENERATOR LOCK

VERNIERS UNLOCK

TUNING

VOLTS RMS INTO 50 Ω

dBm 50 Ω

POWER ON OFF

OUTPUT LEVEL

μ V	dBm	dBm	mV
300	-60	-50	1
100	-70	-40	3
30	-80	-30	10
10	-90	-20	30
3	-100	-10	100
1	-110	0	300
0.3	-120	+10	1V

OUTPUT

Separate output meter

Phase-lock with unique fine-tuning capabilities

Extended frequency range of 450 kHz to 520 MHz

if you think that's the only reason the 102D is right on the money, look again:

At a panel control layout unmatched for easy-to-understand-and-use convenience; at the separate modulation and output meters; at the wide FM deviation unrestricted at low carrier fre-

quencies...and at all the other specs.

Compare them against the competition's \$6400 unit, and see for yourself why our \$4295 domestic price-tag (\$3575 for the comparable 102C without phase-lock) is generating all the excitement today.

For complete data or a demonstration, write or call Boonton Electronics Corp., Rt. 287 at Smith Rd., Parsippany, N.J. 07054; tel. (201) 887-5110.

BOONTON

CIRCLE NUMBER 238

What makes GENERAL SCANNING OEM RECORDER MODULES

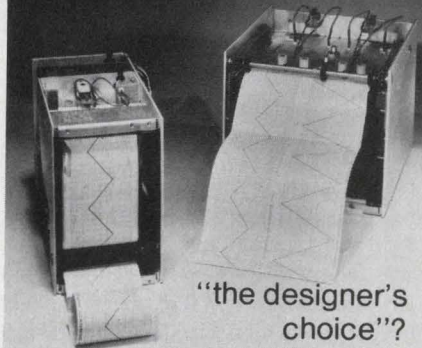

"the designer's
choice"?

A better selection of standard 'specs' to easily fit particular applications. We developed our complete line of strip chart recorder modules — with OEM needs in mind. Needs like reliability, accuracy, compactness, flexibility and, of course, low cost.

Chances are General Scanning has a standard off-the-shelf recorder module just right for your application. If we don't, our modular construction method makes it simple to fill the most unique requirements. A sample of 'specs' to choose from:

- **Number of Channels**
single through eight
- **Channel Widths**
20, 40, 50, 80 & 100 mm
- **Paper Feed**
roll
fan fold
- **Chart Speeds**
multi-speed, electrically
selectable
- **Pen Motor Operation**
open loop
velocity feedback
closed loop
- **Inkless Thermal Writing**

We offer packaged recorders for your lab, portable DC recorders and precision pen motors, too. Make "the designer's choice", call or write for full details. The general awaits your orders.



GS GENERAL SCANNING INC.
150 Coolidge Avenue
Watertown, MA. 02172
TEL: (617) 924-1010

CIRCLE NUMBER 83

INSTRUMENTATION

Logic analyzer generates hard copy

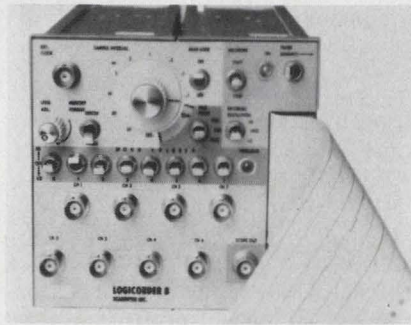

Scanoptik Inc., P.O. Box 1745,
Rockville, MD 20850. (301) 977-
9660. \$4000; 30 days.

LOGICORDER 8 provides direct eight-channel readout of logic timing diagrams from an integral, miniaturized strip-chart recorder. The unit also has an oscilloscope output that can be used independently or simultaneously with the hard-copy feature. The unit is designed to occupy a dual-module space within a Tektronix TM 500 mainframe. Featured are: 10-MHz sample rate on eight channels at 256 bits per channel, (40-MHz sample rate on two channels in a 1024-bit memory mode), and a full 8-bit word trigger.

CIRCLE NO. 347

Amplifier/filter enhances a/d converter

Preston Scientific, 805 E. Cerritos
Ave., Anaheim, CA 92805. (714)
776-6400. \$24,116 (15-bit a/d sys-
tem with 128 inputs); 60-90 days.

A high accuracy, low-level a/d conversion system, the new GMD-10 through -1000, provides a direct-coupled amplifier/filter module (one per channel) for use as a low-level signal enhancement device for the company's GM Series a/d conversion system. The amplifier provides single, fixed gains from 1 to 1000 with a fixed two-pole output filter providing full-power bandwidths from 1 Hz to 60 kHz (-3-dB points) and full-scale output of ± 10 V at 5 mA. This is in addition to the normal high-level multiplexer output to the a/d converter. Other features include 120-dB CMR (at gain 1000X), less than 2 μ V of noise RTI and drift as low as 1.0 μ V/ $^{\circ}$ C RTI.

CIRCLE NO. 348

Rugged VOM features 50-range operation

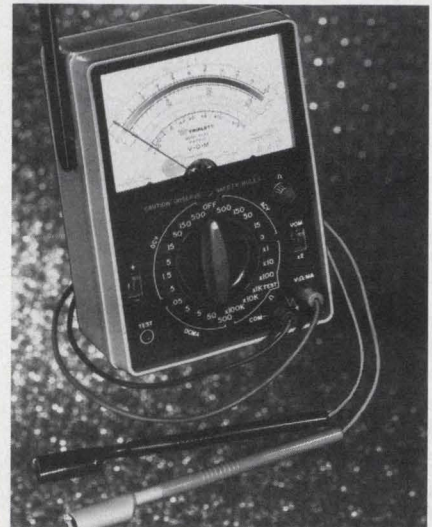

Triplet Corp., Bluffton, OH 45817.
(419) 358-5015. \$130; stock.

Model 60-NA VOM features 50 separate ranges and includes a large 4-1/2-in. mirrored scale meter that eliminates parallax. It has a dc accuracy of $\pm 1\frac{1}{2}\%$ of fs, ac accuracy of $\pm 3\%$, plus a multiplier switch that permits more readings to be taken at the upper portion of the meter scale for greater accuracy. With the husky case and suspension meter, Model 60-NA is virtually indestructible with an accidental drop up to a 5-ft height, with deviation from stated accuracy not exceeding $\pm 4\%$.

CIRCLE NO. 349

Minirecorder zeros in on signal trends

Philips Test & Measuring Instru-
ments, 400 Crossways Park Dr.,
Woodbury, NY 11797. (516) 921-
8880. \$490; 4-6 wks.

PM8110 is a compact, light-weight and portable single-line miniature recorder for laboratory or field work. Despite its 5 \times 8.3 \times 6.6-in. dimensions and 6.62-lb weight, the PM8110 offers four pushbutton ranges—10 mV, 100 mV, 1 V, and 10 V—with 1% accuracy and 0.5% reproducibility; a Z-fold chart system with 120-mm useful chart width; fully adjustable zero point with checking switch; two standard paper speeds—5 and 20 mm/min with 20 and 80 mm/hr; and built-in calibration for span adjustment.

CIRCLE NO. 350

Specially Developed for Switching Regulators 5100 gauss (Bs) High Power H7C1 Material

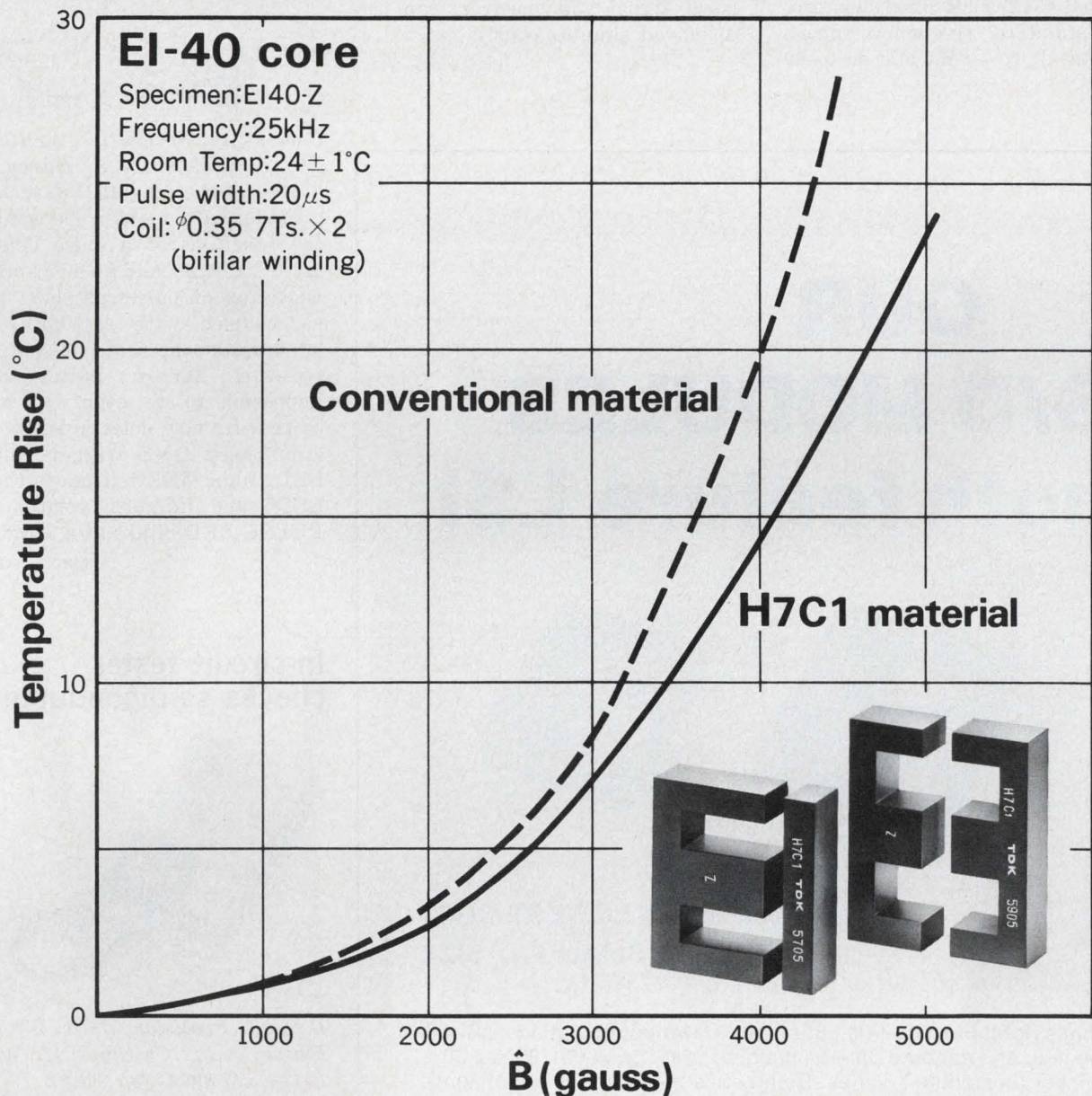

TDK has come up with a new high power ferrite core material. We list it as H7C1 and, as you can see from the graph, its temperature rise compared with conventional material puts it way out in front. TDK ferrite cores

with H7C1 material bring compact, low heat generating power supplies as close as your drawing board.

Interested? Throughout the world, those interested in high reliability switching regulators or

power supplies make it a point to check with the specialists at TDK. We're standing by to show you how you can design higher power, high performance and expanded capabilities into your products.

Representative in U.S.A. & Canada for telecommunication and industrial use ferrites

MH&W INTERNATIONAL CORP.

280, Midland Avenue, Saddle Brook, N.J. 07662 USA

Phone: N.J. (201) 791-6277, N.Y. (212) 244-0695 Telex: 134484, 134545

MH&W INTERNATIONAL (CANADA) LTD.

81 Kelfield Str., Rexdale, Ont. M9W 5A3 CANADA

Phone: 416-245-3606 Telex: 06-965656 TWX: 610-492-2352

TDK
TDK ELECTRONICS CO., LTD.

14-6, 2-chome, Uchikanda, Chiyoda-ku, Tokyo 101, Japan

CIRCLE NUMBER 84

INSTRUMENTATION

FFT analyzer resolves 512 lines

Princeton Applied Research, Box 2565, Princeton, NJ 08540. (609) 452-2111. \$6900.

Model 4512 FFT analyzer provides standard frequency ranges spanning dc to 10 Hz and dc to 40

kHz with 512-line narrowband analysis. The 4512 can update the full spectrum every 35 ms, thereby providing real-time analysis to 16 kHz. A two-tone dynamic range of 60 dB is guaranteed. Transient capture and spectrum-averaging modes are standard. Both the temporal signal and spectrum can be displayed simultaneously.

CIRCLE NO. 351

Logic probe tests various families

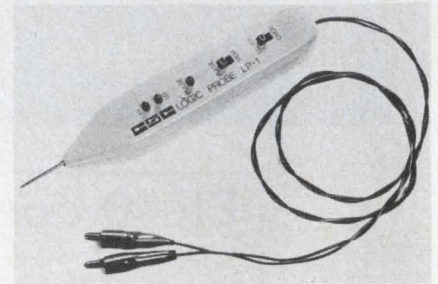

Continental Specialties, 44 Kendall St., Box 1942, New Haven, CT 06509. (203) 624-3103. \$44.95.

Model LP-1 logic probe combines the functions of a pulse detector, pulse stretcher and memory circuit. Detection of pulses as short as 50 ns, coupled with stretching and latching, means that one-shot, low-rep-rate, narrow pulses—nearly impossible to see, even with a fast scope—are now detectable. In operation, logic ONE triggers the HI LED; logic ZERO triggers the LO LED; and in pulse position, the PULSE LED blinks at a 3-Hz rate.

CIRCLE NO. 352

OUR S/D MODULES both feature LSI

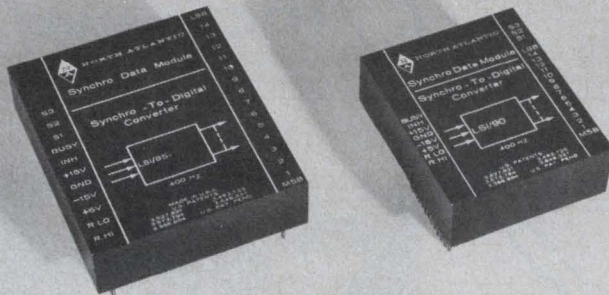

PICK...LSI & LOWEST COST
...OR LSI & SMALLEST SIZE

That's right! Industry-first LSI comes in two configurations; LSI/85, the industry-standard pin-compatible series...and LSI/90, the 33% smaller "matchbox" series. Both series mean better performance and better reliability.

The LSI/85 and LSI/90 feature 3-minute accuracy at speeds to 5 rps. And, operation to +70°C...optional temperature range -55° to +105°C. Plus, a companion D/S in the industry-standard pin-compatible Series 785. Both S/D and D/S meet MIL-STD-202D and come in a full range of models; 11.8V to 90V, synchro or resolver, 60Hz or 400Hz, and a choice of 10-, 12- or 14-bit data plus optional screening to MIL-STD-883. Call today for more good news on cost-effective solutions starting at \$310...and for just one piece too!



NORTH ATLANTIC
industries, inc.

200 TERMINAL DRIVE, PLAINVIEW, NEW YORK 11803
phone: (516) 681-8600

CIRCLE NUMBER 85

In-circuit tester checks semiconductors

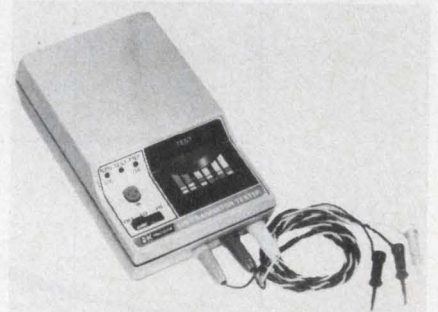

B & K Precision, 1801 W. Belle Plaine Ave., Chicago, IL 60613. (312) 525-3992. \$90; stock.

A new battery-operated automatic semiconductor tester features a HI/LO power drive. Model 510 permits rapid in and out-of-circuit testing of bipolar transistors, FETs, SCRs, and monolithic and hybrid Darlington. The LO power drive provides a positive good/bad indication plus automatic identification of base, collector, and emitter leads. The HI power drive position tests semiconductors in circuits with shunt resistances as low as 10 Ω and shunt capacitances as high as 25 μF .

CIRCLE NO. 353

Digital VOM uses LSI to offer reliability



Simpson Electric, 853 Dundee Ave., Elgin, IL 60120. (312) 697-2260. \$257.

Model 360 Series 2 digital VOM is an all-purpose, portable 3-1/2-digit instrument. It operates on ac power or rechargeable batteries. Its 29 ranges measure ac volts rms, dc volts, ac and dc current and resistance, with automatic polarity and flashing overrange indication. In addition, all ranges are overload protected. Two low-power-ohms ranges (200 mV max. full-scale voltage) allow the user to make in-circuit resistance measurements without turning on most semiconductor junctions.

CIRCLE NO. 354

System tests μ Ps on PC boards

Instrumentation Engineering, 769 Susquehanna Ave., Franklin Lakes, NJ 07417. (201) 891-9300. \$120,000 to \$140,000.

Micro 3/90 computer-controlled system performs high-speed tests of PC boards containing μ Ps and other types of LSI circuits. Standard configuration is an 80-pin system capable of megahertz data rates on all pins simultaneously. Included are a minicomputer, 96-k bytes of core, and a dual 5-M byte disc. Multitest-head/multiterminal systems are realizable.

CIRCLE NO. 355

**MICROTREK
MICROTREK
MICROTREK
MICROTREK
MICROTREK
MICROCOMPUTER
MAGAZINE**

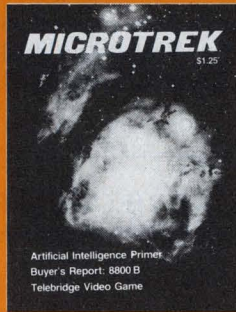

Like you, thousands of engineers and programmers have realized how important it is to master the microcomputer. That's why they've become computer hobbyists and subscribe to MICROTREK MICROCOMPUTER MAGAZINE. Don't miss the vital information (and fun) contained in each monthly issue.

Here's just a sample of what you'll see:

- Low-cost construction projects
- System design methods
- Applications ideas
- Efficient programming techniques
- Computer concepts
- User groups activities
- Latest products and book reviews

Subscribe now with the coupon below. Send only \$10 for 12 monthly issues.

AUTHORS — send for FREE Author's Guide! Mark envelope "Author's Guide". Mail to the address below.

Please enter my charter subscription for the first 12 issues of MICROTREK.

I have enclosed my check or money order for \$10.00.
I am especially interested in the following level:
 Basic Intermediate Advanced

Mail to: Schneider Publications, Inc.
Dows Building
Cedar Rapids, Iowa 52401

PLEASE ALLOW 6-8 WEEKS TO RECEIVE YOUR FIRST ISSUE.
Additional postage: add \$1 for Canada, \$2 for all other countries outside the U.S.

Charge my subscription to: Bank Americard Master Charge

Acct. No. _____ Exp. Date _____

Signature _____

Name _____

Address _____

City _____ State _____ Zip _____

CIRCLE NUMBER 86

Our curve was straight.

Advanced Micro Devices announces the 100-piece price for the Am9080A and Am2901: \$21.00.
Just like we said.

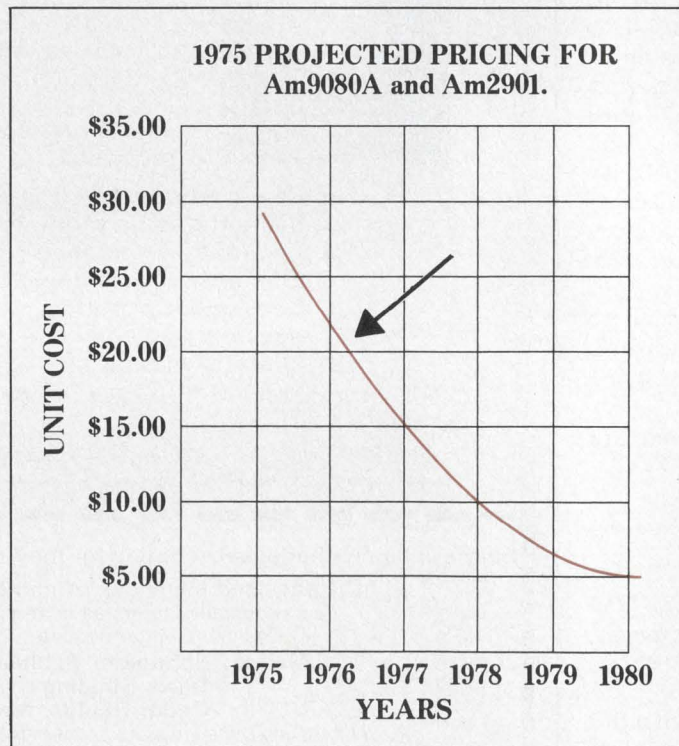

Last year, we predicted the price would be just over \$20.00. We even drew a curve. Now it's happened. And that's only the beginning. Look:

Am9080A. It's built with an advanced ion-implanted, n-channel, silicon-gate process that permits versions with speeds to 250 nanoseconds cycle time (one microsecond instruction time). Our low power (800mW maximum) gives you cooler running systems, less power drain and better reliability. The superior output drive (3.2mA @ 0.4V) gives increased design flexibility and improved margins.

Am2901. It's bipolar, for systems that rely on

high speed. It can do a 16-bit register-to-register add in just 145 nanoseconds. It has 16 working registers in a cycle-saving, two-address architecture, and is controlled by nine instruction lines that permit it to do almost anything you can think of.

Another thing. Advanced Micro Devices offers a full line of support circuits for either unit—support circuits that optimize your system, not compromise it.

Whether you can best use the MOS Am9080A or the bipolar Am2901, you can now do it for less. \$21.00 in 100-piece quantities.

Just like the curve said.

Am9080A System Circuits

AMD Part Number	Description	Availability
CPU		
Am9080A/-2/-1/-4	Speeds to 250 nsec 0 to 70°C	In Dist. Stock
Am9080A/-2	Speeds to 380 nsec -55 to +125°C	In Dist. Stock
Static Read/Write Random Access Memories		
Am9101A/B/C/D	256 x 4 Speeds to 250 nsec	In Dist. Stock
Am91L01A/B/C	256 x 4 Speeds to 300 nsec	In Dist. Stock
Am9102A/B/C/D	1K x 1 Speeds to 250 nsec	In Dist. Stock
Am91L02A/B/C	1K x 1 Speeds to 300 nsec	In Dist. Stock
Am9111A/B/C/D	256 x 4 Speeds to 250 nsec	In Dist. Stock
Am91L11A/B/C	256 x 4 Speeds to 300 nsec	In Dist. Stock
Am9112A/B/C/D	256 x 4 Speeds to 250 nsec	In Dist. Stock
Am91L12A/B/C	256 x 4 Speeds to 300 nsec	In Dist. Stock
Am9130A/B/C/E	1024 x 4 Speeds to 200 nsec	In Dist. Stock
Am9140A/B/C/E	4096 x 1 Speeds to 200 nsec	In Dist. Stock
Dynamic Read/Write Random Access Memories		
Am9050C/D/E	4K x 1 Speeds to 200 nsec	In Dist. Stock
Am9060C/D/E	4K x 1 Speeds to 200 nsec	In Dist. Stock
Mask Programmable Read-Only Memories		
Am9208/B/C/D	1K x 8 Speeds to 250 nsec	Available Now
Am9214	512 x 8 mask programmed Speeds to 500 nsec	Available Now
Am9216B/C	2K x 8 mask programmed Speeds to 300 nsec	Available Now
Erasable Read-Only Memories		
Am9702	256 x 8 Speeds to 1.0 μsec	In Dist. Stock
Am1702A	256 x 8 Speeds to 1.0 μsec	In Dist. Stock
Am2708	1024 x 8 Speeds to 450 μsec	2nd Q. 1976

AMD Part Number	Description	Availability
Processor System Support Circuits		
Am8212	8-bit I/O Port	In Dist. Stock
Am8224	Clock Generator	In Dist. Stock
Am8228	System Controller	2nd Q. 1976
Am8216/26	Bus Transceiver	2nd Q. 1976
Am25LS138	1 of 8 Decoder	In Dist. Stock
Am9555	Programmable Peripheral Interface	2nd Q. 1976
Am9551	Serial Communications Interface	2nd Q. 1976
CPU: 9080A = 480 nsec -2 = 380 nsec -1 = 320 nsec -4 = 250 nsec Mem: A = 500 nsec B = 400 nsec C = 300 nsec D = 250 nsec E = 200 nsec		

Am2900 System Circuits

AMD Part Number	Description	Availability
Am2901	4-Bit Microprocessor Slice	In Dist. Stock
Am2902	Carry Lookahead Chip	In Dist. Stock
Am2905	4-Bit Transceiver For Open Collector Bus	In Dist. Stock
Am2906	4-Bit Transceiver For Open Collector Bus With Parity Generator/Checker	In Dist. Stock
Am2907	4-Bit Transceiver For Open Collector Bus With Single Data Input	In Dist. Stock
Am2909	Microprogram Sequencer	In Dist. Stock
Am2911	Minimicroprogram Sequencer	2nd Q. 1976
Am2914	8-Level Priority Interrupt	3rd Q. 1976
Am2915	4-Bit Transceiver For Three-State Bus	2nd Q. 1976
Am2916	4-Bit Transceiver For Three-State Bus With Parity Generator/Checker	2nd Q. 1976
Am2917	4-Bit Transceiver For Three-State Bus With Single Data Input	2nd Q. 1976
Am2918	1 By 2 Port Register	In Dist. Stock
Am2919	Priority Interrupt Expander	2nd Q. 1976
Am2950/51	256-Bit RAM, Open Collector Or Three-State	In Dist. Stock
Am2952	1024-Bit RAM, Open Collector	2nd Q. 1976
Am2954/55	16-Word By 4-Bit Two Address Register Stack, Open Collector or Three-State	2nd Q. 1976
Am2970/71	256 By 4 PROM's With Open Collector or Three-State Outputs	In Dist. Stock

Advanced Microprocessors



Advanced Micro Devices • 901 Thompson Place, Sunnyvale, California 94086 • Telephone (408) 732-2400

Distributed nationally by Hamilton/Avnet, Cramer and Schweber Electronics

CIRCLE NUMBER 88

HIGH EFFICIENCY STABILIZED AC-DC PRIMARY SWITCHER POWER SUPPLIES

Designed for tight packaging
or critical thermal applications
with densities up to
1.4 watts/Cu. In.



EF/EFE SERIES

- Modular construction
- Multi-surface mounting
- 4.5-30VDC, power to 300 watts
- Non-audible range operating frequency
- 115/230 - 220/240 VAC Source
- Convection cooling, ambient rated to 71°C

BACKED BY 5-YEAR WARRANTY

TECHNIPOWER, INC.

A **BENRUS** DIVISION

BENRUS CENTER Ridgefield, Conn. 06877 (203) 431-1300

SEND FOR FREE 66-PAGE DESIGN/DATA CATALOG

CIRCLE NUMBER 89

INSTRUMENTATION

VLF receiver calibrates 60-Hz line to NBS



Spectracom Corp., 87 Wedgewood
Dr., Penfield, NY 14526. (716) 381-
4827. \$1300; stock-60 days.

Model 8160A WWVB receiver is available with a 60-Hz comparator option that continuously monitors power-line phase drift with respect to the NBS standard frequency transmitted by station WWVB. Resolution of the phase measurement is ± 0.1 degree (about $5 \mu\text{s}$), and analog readout is provided by an accessory 0 to 1 mA meter or strip-chart recorder. A 60-Hz reference frequency phase locked to the NBS standard signal is provided as an output.

CIRCLE NO. 356

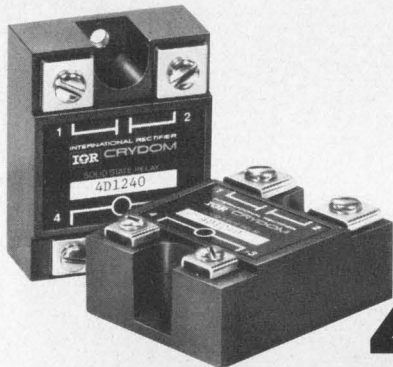

NEW 400 Hz SSR FROM CRYDOM

Crydom now has eight 400 Hz versions of their industry standard high-power solid state relay. 100-140 VAC or 200-280 VAC with current ratings from 2.5A to 40A. They're perfect for avionics and ground support systems. TTL compatible too, for computer systems and mass memories where 415 Hz AC power is a requirement. In stock for immediate delivery. So write or call Crydom today for complete data.

Features:

- Inverse parallel SCR's
- Standard Crydom package
- 360-440 Hz
- All solid state
- Photo-isolated
- Zero voltage switching

INTERNATIONAL RECTIFIER **IOR** CRYDOM
DIVISION

1521 Grand Avenue, El Segundo, California 90245 • (213) 322-4987

CIRCLE NUMBER 90

Current-tracer and pulsar probes team up

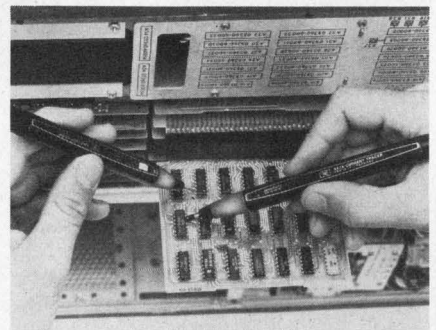

Hewlett-Packard, 1501 Page Mill
Rd., Palo Alto, CA 94304. (415)
493-1501. 547A, \$350; 546A, \$150.

Two hand-held probes are designed for digital logic-circuit troubleshooting. Model 547A current tracer locates low-impedance faults by tracing the flow of current pulses rather than voltage changes in circuit conductors. Model 546A logic pulsar is a miniature pulse generator that supplies pulse streams of 1, 10 or 100 Hz or bursts of exactly 10 or 100 pulses, as well as single pulses.

CIRCLE NO. 357

CUSTOM PRODUCTS
AT
STANDARD PRICES
IMPOSSIBLE?

PUT US TO THE TEST.

We'll lay out a design in conceptual form that meets your exact requirements at no cost. HEI can do it because our building block concept uses standard components to make custom products. Look at these examples.

LIGHT
PEN



\$85.00
CRT Displays

SHAFT
ENCODER



\$45.00

Instruments/
Business
Machines

HIGH SPEED
OPTICAL SWITCH



Dual Channel
with Schmitt
Trigger Output

\$16.00

General Purpose

HEI's Hybrid/Optoelectronic technology offers:

- High Reliability (No Moving Parts)
- Small Size
- Hybrid Thick Film Circuits (Built In)
- TTL Compatibility
- Precision Alignment

HEI also has available a complete line of standard optical switches and arrays from \$1.25. Whatever your requirements, custom or standard, at HEI you'll find the quality product you need backed by technical competence and service. So, put us to the test. Contact your nearest HEI representative or Richard Hasselman at (612) 448-3510.

HEI inc.

Jonathan Industrial Center
Chaska, Minn. 55318

CIRCLE NUMBER 91

Storage scope combines
real time and refresh

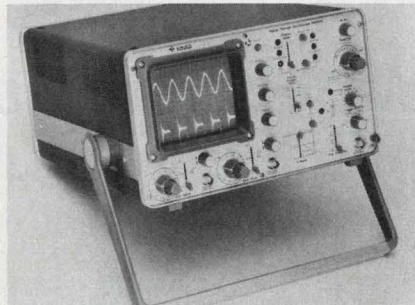

Gould, 3631 Perkins Ave., Cleveland, OH 44114. (216) 361-3315. \$3500; 90 days.

Model OS-4000 digital storage scope marks the company's entry into the oscilloscope market. The unit combines the performance of a dual-trace, wideband, 10-MHz triggered scope with digital storage of signals to 450 kHz. In normal mode, vertical sensitivity ranges from 5 mV/cm to 20 V/cm. In refreshed mode, the input signal is viewed via the store. In roll mode, display is similar to that of a strip-chart recorder, with the right-hand edge of the display showing instantaneous time and the trace moving across the face of the CRT. Thus any low-speed waveform can be viewed as it occurs.

CIRCLE NO. 358

3-1/2-digit DMM
responds to rms



Ballantine Laboratories, P.O. Box 97, Boonton, NJ 07005. (201) 335-0900. \$279.

Model 3028A is a portable 3-1/2-digit multimeter with rms responding capability. The unit offers six functions, 30 ranges and a 0.43-in-high LED. In its ac voltage and current modes, the 3028A provides rms response for waveforms that have significant distortion (up to 10% and crest factors of 1.2 to 1.6) beyond 110 kHz. Low end is 15 Hz.

CIRCLE NO. 359

Want to
make
waves?

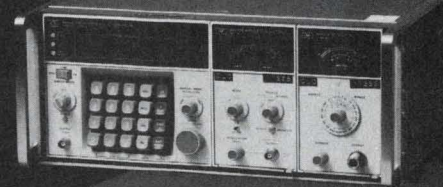
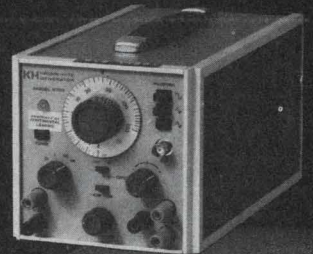

Call the "Instrument Professionals". They can tell you which generator, oscillator or synthesizer best fits your needs. They'll have it on your dock tomorrow — guaranteed to make all the waves you need. Renting the right gear will keep your head above water!

Write or call for data on our other specialties: Instrument Leasing • Computer Peripherals • Equipment Sales • Instrument Service.

Call  Get our
FREE
Catalog

Continental
Rentals

Div. Continental Leasing Co., Inc.
175 Middlesex Turnpike, Bedford,
MA, 01730 (617) 275-0850

Metuchen, NJ (201) 549-8500;
Gaithersburg, MD (301) 948-4310; TX
(214) 357-1779; Elk Grove, IL (312)

439-4700; Costa Mesa, CA (714)
540-6566; Santa Clara, CA (408)

735-8300; Los Angeles, CA (213) 477-7521

CIRCLE NUMBER 92 ►

Keystone THERMISTOR TASK MINDERS

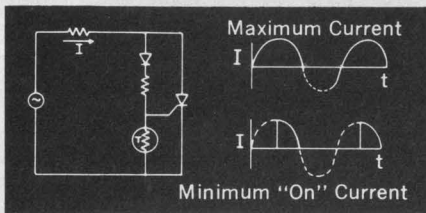
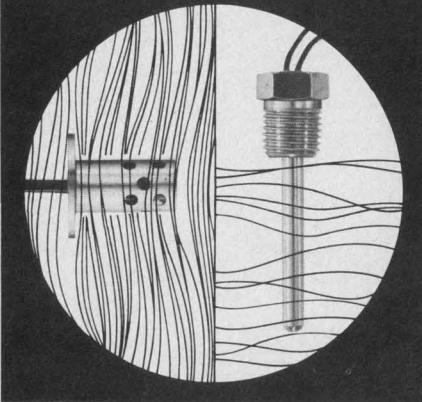

LOW-COST TEMPERATURE CONTROL

As the resistance of the thermistor decreases, a larger voltage is required to fire the SCR. In this circuit, conduction angles from 90° to 180° can be achieved. Thus, the minimum "on" current will be 50% of the maximum "on" current.

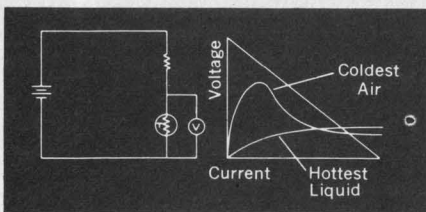

LIQUID LEVEL DETECTION

Taking advantage of the difference in dissipation constant between a liquid and a gas enables thermistors to serve as liquid level sensors over a wide range of temperatures.

Send for 12-page thermistor probe catalog detailing 23 styles and 6 applications.

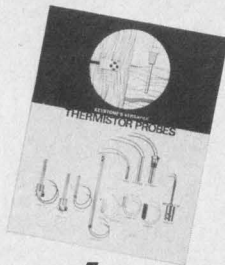

Keystone
CARBON COMPANY
Thermistor Division
St. Marys, PA 15857
814/781-1591 • Telex 91-4517

CIRCLE NUMBER 93

MODULES & SUBASSEMBLIES

Wideband rms-to-dc module has high accuracy, low cost

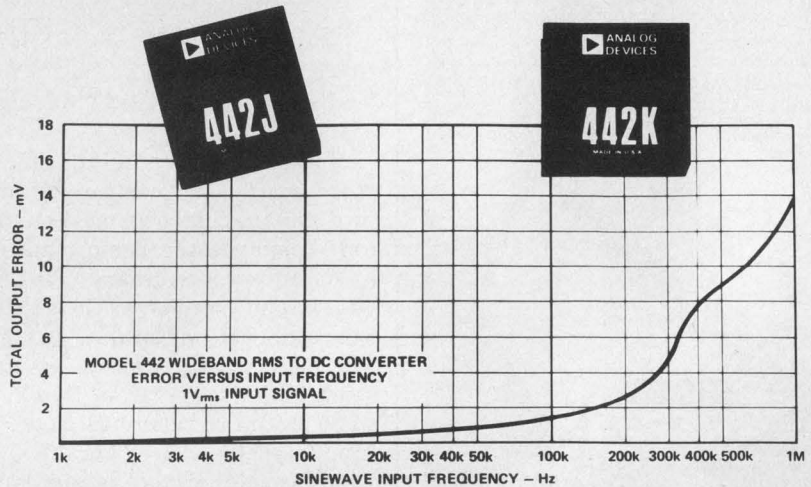

Analog Devices, Route 1 Industrial Park, P.O. Box 280, Norwood, MA 02062. (617) 329-4700. P&A: See text.

You can cut costs and improve over-all system accuracy by using the Model 442 rms-to-dc converter. The 442, introduced by Analog Devices, has an accuracy of ± 2 mV $\pm 0.15\%$ of reading, maximum, for signals with amplitudes ranging from 0 to 2 V. Cost is only \$95 in unit quantity.

The true-rms-to-dc converter maintains its guaranteed accuracy over a dc-to-20-kHz frequency range. It has a bandwidth of dc to 8 MHz (for -3 -dB response) and a guaranteed accuracy of 1% for input signals of up to 800 kHz. Noninteractive external trims for scale factor and output offset can further improve the accuracy to ± 0.5 mV $\pm 0.05\%$ of reading.

The 442 keeps its accuracy for signals as low as 10 mV by the use of proprietary compensation circuitry. Response time to changing inputs is 5 ms for readings to within 1% accuracy.

There are three versions of the rms-to-dc converter module available: the 442J has a drift error of ± 100 μ V/ $^{\circ}$ C $\pm 0.01\%$ of reading, while the 442K and L versions have drifts of 50 and 35 μ V, re-

spectively. All units use a log-anti-log design and are specified for operation over the 0-to-70-C temperature range.

Several other companies offer rms-to-dc converter modules that can compete with the 442 from Analog Devices. The Model 592 from Intech (Santa Clara, CA) offers slightly better accuracy but can't handle the wide input-signal range. It costs \$121 in singles. Intronic (Newton, MA) offers the R301 or R310 units. Both of these units cost a bit more but have lower drifts than the units from Analog Devices.

Burr-Brown (Tucson, AZ) also has several units that can stack up to the test. For wide bandwidths, the company's thermal rms-to-dc converter responds to signals with bandwidths of up to 50 MHz—but you may need several seconds for the unit to reach thermal equilibrium. Price for the Burr-Brown unit is slightly higher than the 442 from Analog Devices.

All the competing modules are larger than the 442. Competing units start at $2 \times 2 \times 0.4$ in. and range up to $3 \times 2 \times 0.4$ in. in size compared with $1.5 \times 1.5 \times 0.4$ in. for the 442. Except for the Intech unit, all power requirements are higher than the 442's 360-mW dis-

sipation spec.

The 442 can operate from ± 6 to ± 18 -V power supplies and draws only ± 12 mA of quiescent current at ± 15 -V nominal supply levels.

Prices of the 442 series units start at \$95 for the 442J and increase to \$120 and \$145 for the K and L versions, respectively. Delivery of all units is from stock.

Analog Devices	CIRCLE NO. 301
Burr-Brown	CIRCLE NO. 302
Intech	CIRCLE NO. 303
Intronics	CIRCLE NO. 304

Big DIP holds mini 8-channel data system

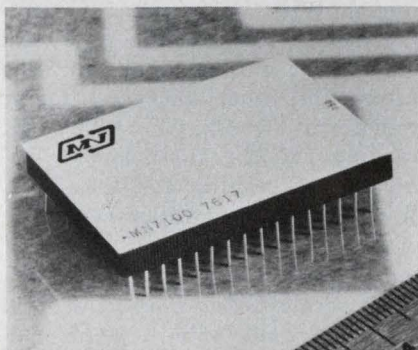

Micro Networks, 324 Clark St., Worcester, MA 01604. (617) 852-5400. P&A: See text.

Taking advantage of thin-film and hybrid technology, Micro Networks has developed what is claimed to be the most compact data-acquisition system available. A 32 pin hemetic DIP, which measures 2.14×1.16 in., houses the complete MN7100 eight-channel, eight-bit system. Typical power consumption of the system is 1.2 W. Over the 0-to-70°C temperature range, linearity is ± 0.5 LSB and absolute accuracy is ± 2 LSB. The typical acquisition time of 5 μ s, the aperture time of 50 ns and the a/d conversion time of 6 μ s add up to a throughput of 90,000 conversions/s. Each of the MN7100's eight channels accepts ± 10 V maximum signals and has an input impedance of 10 M Ω . The system includes a multiplexer, address counter, sample-and-hold, a/d converter and an internal clock. Price of the MN7100 is \$195 for single units and delivery is from two to four weeks.

CIRCLE NO. 300

CIRCLE NUMBER 94

Schottky Barrier Rectifiers

- Five series: 1A, 3A, 5A, 15A & 30A (I_o) with 20V, 30V and 40V (V_{RRM}).
- Extremely fast recovery (t_{rr}), very low forward voltages (V_F), high reliability and low cost.
- VSK 120, 130 & 140-1A series in DO-41 packages. 550 mV (V_F). 40A peak 1/2 cycle surge (I_{FSM}). 10 mA (I_R) at T_L=100°C.
- VSK 320, 330 & 340-3A series. Epoxy package, axial leads. 475 mV (V_F). 150A surge. 30 mA (I_R) at T_L=100°C.
- VSK 520, 530 & 540-5A series. Epoxy package, axial leads. 450 mV (V_F). 250A surge. 75 mA (I_R) at T_L=100°C.

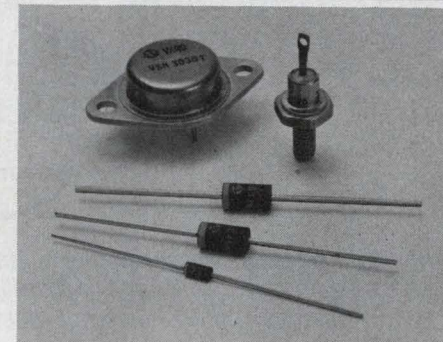

- VSK 1520, 1530 & 1540-15A series in DO-4 metal stud cases. 600 mV (V_F). 300A surge. 75 mA (I_R) at T_c=100°C.
 - VSK 3020T, 3030T & 3040T-30A series. Center-tapped, common cathode, 15A per leg in TO-3 package. 630 mV (V_F). 300A surge. 75 mA (I_R) at T_c=100°C.
- All series have junction operating temperature range of -65°C to +150°C.

Call Mike Hawkins
214/272-4551
for more information



Design us in . . . we'll stay there
VARO SEMICONDUCTOR, INC.

P.O. BOX 676, 1000 N. SHILOH, GARLAND, TEX. 75040 (214) 272-4551 TWX 910-860-5178

EUROPEAN OFFICE: UK: VARO SEMICONDUCTOR INTERNATIONAL, INC.

Deepdene House, Bellegrave Road, Welling, Kent, England DA163PY, 01-304-6519/0

CIRCLE NUMBER 95

MODULES & SUBASSEMBLIES

Communications filter has elliptic response

Kinetic Technology, P.O. Box 1222, Campbell, CA 95008. (408) 371-5880. \$12.25 (1000-up); stock to 4 wks.

The FL-523, a D-3 low-pass tele-

communications filter, provides elliptic-function response with more than a 40-dB attenuation at 4600 Hz. It operates over a 0-to-70-C temperature range and has a 3-dB cutoff frequency of 3600 Hz. The cutoff is factory adjustable from 3400 to 3800 Hz on special order. A 1 x 1-in. edge-pin ceramic package houses the filter.

CIRCLE NO. 361

True-rms-to-dc converter modules handle ±10 V

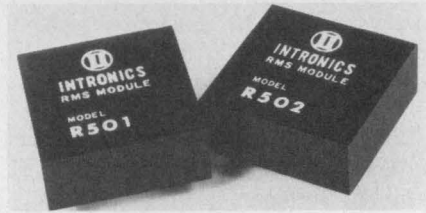

Intronics, 57 Chapel St., Newton, MA 02158. (617) 332-7350. \$68 (501); \$80 (502); stock to 2 wks.

Models R501 and R502 true-rms-to-dc converters are accurate to within 0.25% of reading. The converters maintain their accuracy with input waveforms having crest factors (peak input/true rms) of 10:1. For waveforms with crest factors of up to 20:1, less than 1% of reading error can be expected. With input voltages ranging from -10V to +10 V, the total unadjusted output error for sine waves and other low crest factor waveforms is 10 mV ±0.2% of reading for the R501 and 5 mV ±0.1% of reading for the R502. With two external adjustments, the errors can be reduced to 3 mV ±0.1% and 1 mV ±0.5%, respectively. Scale factors are set to yield 7.07 V dc out with a 10-V peak sine-wave input. The modules are 1.5 x 1.5 x 0.6 in.

CIRCLE NO. 362

Allied Handles 205 Manufacturers' Products and Delivered 87.8% of Lines Written FROM STOCK in April!

Also, on Over 50% of Back-Ordered Lines, Partials Were Shipped!

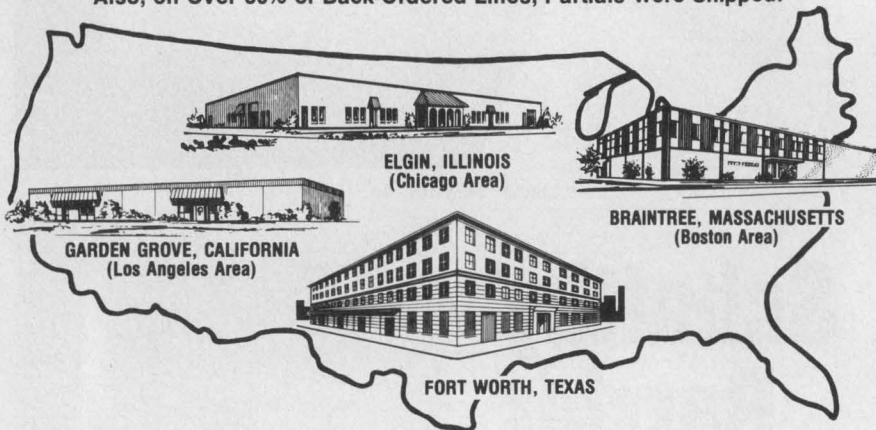

Allied Recognizes Its Responsibility to Ship Your Order Complete Within 1 Week . . . If Allied Does Not Perform this Distributor Service, Allied Will Pay Shipping Charges* on All Items Not Meeting this Responsibility . . .

89.0% Week End. 4-30-76	86.4% Week End. 4-23-76
88.8% Week End. 4-16-76	88.6% Week End. 4-9-76
86.4% Week End. 4-2-76	From Sales Memos Issued by Allied's

Does your distributor deliver promises instead of parts? Allied's service performance speaks for itself—we delivered 87.8% of lines written FROM STOCK in April, 1976 to our customers. And, on over 50% of any back-ordered lines, partials were shipped! So, here's an offer hard to turn down . . . place your order from our current 760 Engineering Manual and Purchasing Guide now. **Any item not shipped within one week, we will pay the shipping charges to you on that item.*** (Does not apply to Export, Pack & Hold, or Ship Complete orders). Our usual shipping policy is day ARO—where items are located in other warehouses, 1 week. If you don't have our guide, phone today—we stock the majority of call-outs IN-DEPTH.

Sign up right now for your FREE copy of the 1977 Allied Electronics Engineering Manual and Purchasing Guide due off press in early September. Send your name and address on company letterhead to: **ALLIED ELECTRONICS, DEPT. ED6, 401 EAST 8TH ST., FORT WORTH, TEXAS 76102.**

FOUR FACILITIES EAGER TO SERVE YOU:

- Braintree, MA.**
One Century Circle
Campanelli Ind. Park
ZIP 02184
(617) 848-4150
- Elgin, IL.**
1355 Sleepy Hollow Road
ZIP 60120
(312) 697-8200
- Fort Worth, TX.**
401 East 8th St.
ZIP 76102
(817) 336-5401
- Garden Grove, CA.**
12311 Industry St.
ZIP 92641
(714) 894-7581

ALLIED ELECTRONICS
A DIVISION OF TANDY CORPORATION

CIRCLE NUMBER 96

Time and temp card delivers parallel BCD

Nationwide Electronic Systems, 1536 Brandy Pkwy., Streamwood, IL 60103. (312) 289-8820. \$194 (card); \$35 (temp probe); stock.

A time and temperature card contains both a 6-digit clock and digital thermometer. The clock uses the 60-Hz line frequency as a time base but has an internal oscillator that permits battery operation during power failures. The thermometer reads from -20 to +140 F with 0.6-F accuracy. A platinum probe provides stability and accuracy. For the metric minded, Celsius scaling is available, too. Parallel-BCD outputs of time and temperature are available. Three-state output buffers offer flexibility for systems interface. The time and temp card measures 4.5 x 7.5 in.

CIRCLE NO. 363

Beyond the ordinary!

DigiTec printers are precision crafted instruments, offering reliability, workmanship and features that distinguish them from the ordinary. Ideal for laboratory, systems or OEM applications. Their sought-after features include: floating decimal, selective data blanking, systems interface, red and black print, data grouping and front panel paper loading and ribbon changing without exposure of electronic components.

Selected models include a crystal clock, an events counter, and 10 to 21 column recording capability.

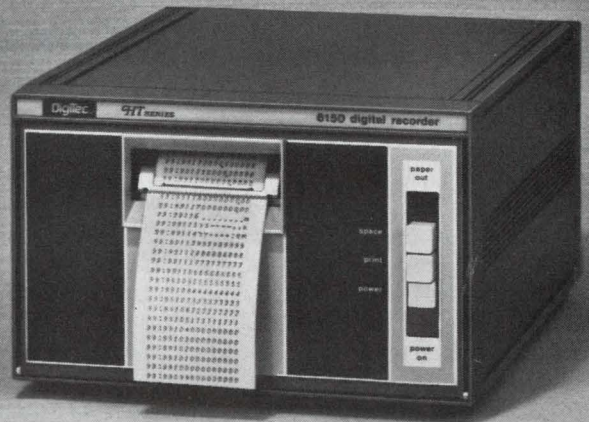

DigiTec UNITED SYSTEMS CORPORATION

918 Woodley Road, Dayton, Ohio 45403
(513) 254-6251, TWX (810) 459-1728

DigiTec: precision measurements to count on.

*These instruments available under
GSA contract GS-00S-27741.*

FOR INFORMATION ONLY CIRCLE #241

FOR DEMONSTRATION ONLY CIRCLE #242

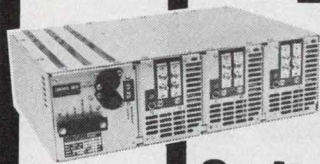

LOW NOISE MODULAR DESIGN Switching Power Supplies!

A new line of compact, modular-design switchers that simplify design for 300-600 watt applications and sell for less than 90¢ per watt! End users benefit from low EMI noise levels and highly reliable operation plus easy add-on and maintenance features. Get everything you need to know to evaluate this high quality, money-saving line from:

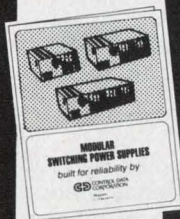

Magnetic Components Group

GS CONTROL DATA CORPORATION

7801 Computer Avenue South, Minneapolis, MN 55435
(612) 830-5800 TWX 910 576 2978

CIRCLE NUMBER 98

ELECTRONIC DESIGN 13, June 21, 1976

NEW!



A mighty big catalog about some mighty small switches.

This 44 page catalog consolidates the complete line of C&K small switches into a single, fact-filled, easy-to-read volume. It includes everything you need to know about toggles, rocker and lever handles, printed circuit mountings, snap-acting pushbuttons, 6 AMP alternate action and momentary pushbuttons, subminiature and microminiature pushbuttons, illuminated rockers, miniature power, slide, and thumbwheel switches—plus how-to-order information and a complete list of worldwide C&K distributors. Ask for your free copy and we'll show you a million and one ways to turn on the juice.

C&K Components, Inc. 103 Morse Street, Watertown, MA 02172
TEL: (617) 926-0800 TWX: 710 327-0460 TELEX: 92 2546
Free Engineering Samples on Request.

CIRCLE NUMBER 99

151

Synchro-to-dc converters deliver sine & cosine

Computer Conversions, 6 Dunton Ct., East Northport, NY 11731. (516) 261-3300. Under \$200 (prod. qty.); stock to 3 wks.

A series of synchro-to-dc converters changes three-phase synchro or two-phase resolver inputs into corresponding dc sine and cosine outputs at up to 400 conversions/s. The converters have a peak angular error of ± 2 min. and deliver 0 to ± 10 V dc. The SD-100 series of converters accepts the output of a standard 11.8-V or 90-V, three-wire synchro, or four-wire resolver. The input is transformer isolated and balanced line to line. Synchro input quadrature is rejected. Input impedance is 40 k Ω nominal, and the reference input required is 26 V $\pm 10\%$ at 400 Hz. The converter has an operating temperature range of -55 to $+71$ C and measures 3 \times 3 \times 0.625 in.

CIRCLE NO. 364

Compact IR amplifier has built-in supply

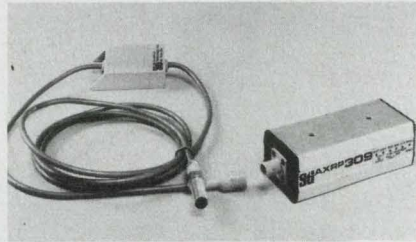

Scientific Technology, 1201 San Antonio Rd., Mountain View, CA 94043. (415) 965-0910. \$78 unit qty.; 2 wks.

The AXRP-309 series amplifier-power supply is a complete IR transmitter, receiver and power supply. The self-contained unit is packaged in an enclosure 4 \times 1.75 \times 1.5 in. (10.3 \times 4.4 \times 3.8 cm) that is totally epoxy encapsulated, water tight and shock proof. Input power required by the unit is 12 V ac, 12 V dc or 24 V dc. A standard 10-V-dc logic signal capable of sourcing 1 mA and sinking 100 mA is available as the output. The AXRP-309 can work with any of the company's standard solid-state IR sensor heads.

CIRCLE NO. 365

Line transient detector holds peak values

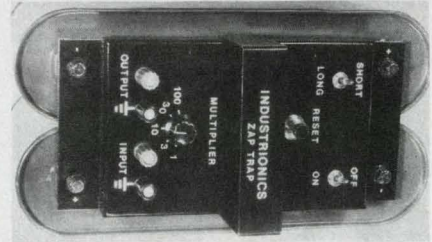

Industronics, 115 Pleasant St., Millis, MA 02054. (617) 376-8147. \$75 (less batteries); stock.

The Zap Trap—a peak holding circuit—can help to detect and measure transient voltages. All you do is add your voltmeter to the output terminals and connect the line to the input. The circuit offers a choice of holding times as long as 15 minutes with less than 10% decay or as short as the damping constant of the meter used. The Zap-Trap can be used with ac or dc lines to detect transients ranging from 10 to 1000 V. Transients as fast as 2 μ s can be trapped for display. The detector operates from two 12-V batteries (NEDA #922) and is portable.

CIRCLE NO. 366

POWER MINI'S FOR LOGIC OR OP AMPS



Terminal strip input/output connections on these miniature power modules eliminate the need for sockets or soldering. They mount in an area only 3.5" \times 2.5". Ratings: 5 volt models to 2.5 amps, ± 15 volts to .5 amps. Other models from 1 to 75 volts, all with 3-day shipment guaranteed.



Corp., Easton, Pa. 18042 Tel: (215) 258-5441

CIRCLE NUMBER 100

SUPPLIES THAT FIT IN THIN SPACES



Measuring only 1.68" high, Acopian narrow profile power supplies fit where many others cannot. Available in a wide range of ratings from 1 to 150 volts, to 4 amps. Regulation to $\pm 0.005\%$. Tracking dual output models for op amps also available. Guaranteed 3-day shipment.



Corp., Easton, Pa. 18042 Tel: (215) 258-5441

CIRCLE NUMBER 101

Dual motor controller handles X-Y functions

Standard Logic, 2215 S. Standard Ave., Santa Ana, CA 92707. (714) 979-4770. \$2500.

A dual stepping-motor controller and driver suitable for a wide range of X-Y functions includes all power supplies and circuits. The PD-370A can control two 4-phase stepping motors with drive currents of up to 4 A per motor winding. The unit has two independent motor control circuits. Inputs to each circuit select stepping rate and direction, and control the amount of drive current supplied to the motor. All inputs are TTL compatible. Outputs from each circuit are from two current sources and four transistor switches to ground. The PD-370A is assembled on a 19 x 14-in. panel, which can be mounted in a standard 19-in. relay rack. A step pulse generator produces pulses at any one of four rates. The LOW, MED and HI rates are factory set to customer specification. The JOG rate is approximately 30 pps.

CIRCLE NO. 367

High-resolution a/d's deliver 13 & 14-bit data



Intech, 282 Brokaw Rd., Santa Clara, CA 95050. (408) 244-0500. Unit prices: \$375 (13-bit), \$450 (14-bit); stock.

Two high-resolution a/d converters, the Model A-855-13 and A-855-14, 13 and 14-bit units, have conversion times of 25 and 30 μ s, respectively. The converter modules are completely self-contained and require no external adjustments or components to meet rated specifications from 0 to +70 C. A BUSY output is provided with a fanout of 5 TTL loads for system synchronization. Additional features include a maximum nonlinearity error of ± 0.5 LSB, a fanout of five TTL loads on the parallel data outputs and a comparator output capable of generating serial data.

CIRCLE NO. 368

Pre-settable counter has adjustable output

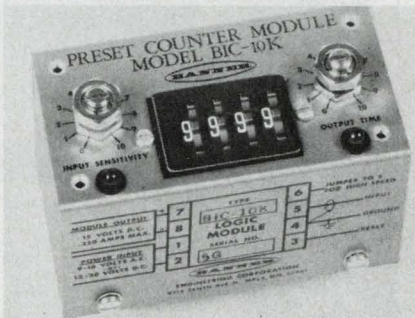

Banner Engineering, 9714 10th Ave. N., Minneapolis, MN 55441. (612) 544-3164. Under \$200; stock.

A preset counter module, the BIC-10 k, permits the user to enter any number up to 9999 in decimal notation switches. The module counts input pulses until the preset number is reached, then generates an output pulse and resets automatically. Both the output pulse duration and the amplifier input sensitivity are adjustable. High and low-speed inputs are included. It is completely self-contained and has a male octal plug for standard mounting.

CIRCLE NO. 369

SINGLE, DUAL PLUG-IN POWER

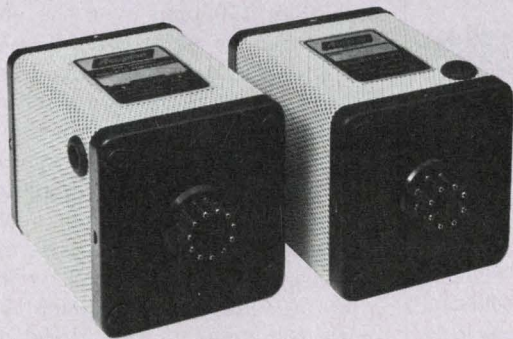

A plug-in power module can be installed in seconds. Simply plug it into a standard octal-type socket. Single output models from 1 to 200 volts. Duals combining two matched or dissimilar outputs in one case available in over 10,000 combinations. Warranty: 5 years. Shipment: 3 days.

Acopian

Corp., Easton, Pa. 18042 Tel: (215) 258-5441

GUARANTEED 3 DAY SHIPMENT

ACOPIAN

**POWER
SUPPLY
CATALOG
1976-1977**

Every power module listed in the Acopian 48-page catalog is shipped within 3 days of order. Guaranteed! Miniaturized supplies, narrow profile and plug-in modules, premium performance models, and a wide choice of other types are described in detail. Ask for your copy.

Acopian

Corp., Easton, Pa. 18042 Tel: (215) 258-5441

CIRCLE NUMBER 102

ELECTRONIC DESIGN 13, June 21, 1976

CIRCLE NUMBER 103

153

DC to HV with PC mounting

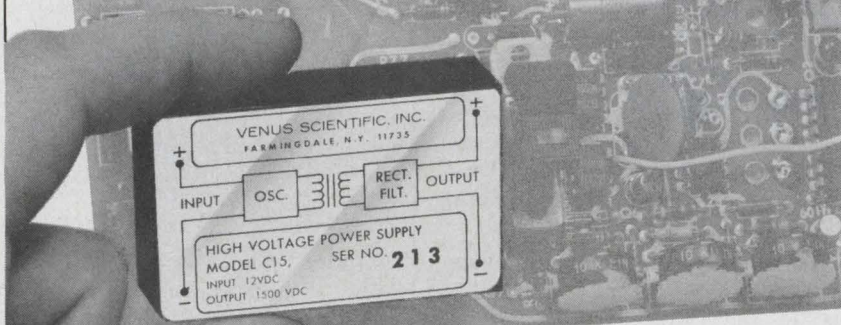

Model C-15 / **Model C-30**
Output to 1500VDC @ 1ma / **Output to 3000VDC @ 500ua**

- Small, Flat, Lightweight • Low Cost • Input/Output Floating
- Short Circuit and Reverse Polarity Protected
- Output Proportional to Input • Operates on Only 12V DC
- Mounts on Printed Boards • MTBF 105,000 Hours



VENUS SCIENTIFIC INC
 399 Smith Street, Farmingdale, N. Y. 11735
 Telephone (516) 293-4100 • TWX:510-224-6492

CIRCLE NUMBER 104

MODULES & SUBASSEMBLIES

Time delay modules span nanoseconds to 10 μ s

Evans Associates, P.O. Box 5055, Berkeley, CA 94705. (415) 848-6839. \$95; stock to 3 wks.

A programmable time delay module, the Model 4141, provides relative delays ranging from nanoseconds to 10 μ s. Programming can be done by either an external voltage source, or an on-board potentiometer. Several output channels are available and the jitter and drift in all channels is within $\pm 0.1\%$. The input will accept either positive or negative-going transitions, and either positive or ground-true outputs are available. The output pulse widths are adjustable over more than a 10:1 range.

CIRCLE NO. 370

100-kHz v/f converters resolve to 16-bits

Analogue Devices, Route 1 Industrial Park, P.O. Box 280, Norwood, MA 02062. (617) 329-4700. See text.

A 100-kHz voltage-to-frequency converter, the Model 452, has a low full scale maximum nonlinearity of $\pm 0.015\%$. The v/f converter costs only \$39 in 1 to 9 quantities. The Model 452 offers a 100-dB dynamic range and can accept either current or voltage inputs. Its nonlinearity error is guaranteed to be less than 150 ppm over the entire signal ranges of either 100 μ V to 11 V or 5 nA to 550 μ A. Resolution of better than 16 bits with 12-bit accuracy is maintained with no missing codes as is monotonic performance over the complete 0-to-70-C operating range. Three versions with different drift specs are available: Model 452L with 50 ppm/ $^{\circ}$ C maximum, Model 452K with 100 ppm/ $^{\circ}$ C and Model 452J with 150 ppm/ $^{\circ}$ C maximum. The converters meet MIL-STD-202E environmental testing and are packaged in 1.5 \times 1.5 \times 0.4 in. (38 \times 38 \times 10.2 mm) modules. They require ± 15 V dc and draw +25 mA, -10 mA quiescent current. The three versions cost \$59, \$49, and \$39, respectively, in 1 to 9 quantities.

CIRCLE NO. 371



Total Reliability in Elapsed Time Indicators and Event Counters

Most dependable sub-miniature indicators you can buy... for critical HOW-LONG/HOW-MANY records for aerospace, military and industrial applications. ETI's conform to MIL-M-7793D, operate in ambients -65° C to $+125^{\circ}$ C, with digit or dial readouts.

Event Counters meet MIL specs, operate in ambients up to 425° F, with 4, 5 or 6 digits. AC and DC models, hermetically sealed, with wide choice of mountings, housings and other modifications to suit.

Write or Call for full catalog



MINELCO DIVISION OF
GENERAL TIME
 A TALLEY INDUSTRIES COMPANY

135 South Main St., Thomaston, Conn. 06787 Phone (203) 283-8261

CIRCLE NUMBER 105

Checkmated by high pushbutton switch costs?



These three new Centralab Pushbutton Switch products are real money savers, yet they offer the high-quality features of all Centralab switches. Contact your Centralab Distributor for details. Ask for a copy of Centralab's New Pushbutton Switch Catalog, Series No. 301.

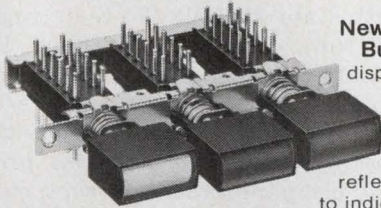

New Status Indicator Button. Adds visual display to non-lighted switches. The button, with a unique fluorescent display, uses reflected ambient light to indicate switch status. 6 display colors available.

Low Cost Lighted Switch uses T-1 $\frac{3}{4}$ wedge base lamp. Many lens and color options.

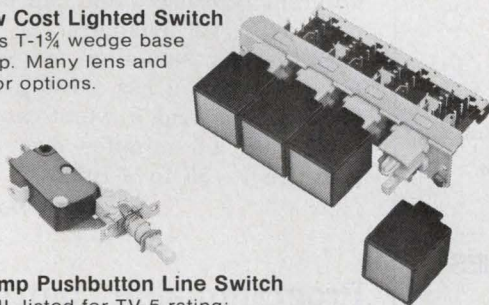

5 amp Pushbutton Line Switch is UL listed for TV-5 rating: 120V, 5A, 78A peak inrush current.

Check These Centralab Distributors For 3 New Ways To Cut Switch Costs.

CALIFORNIA
Kieruff Electronics, Inc.
Los Angeles
213/685-5511

Kieruff Electronics, Inc.
Palo Alto
415/968-6292

Kieruff Electronics, Inc.
San Diego
714/278-2112

COLORADO
Kieruff Electronics, Inc.
Denver
303/371-6500

FLORIDA
Hammond Electronics
Orlando
305/849-6060

INDIANA
Radio Distributing
Co., Inc.
South Bend
219/287-2911

MASSACHUSETTS
Sterling Electronics
Watertown
617/926-9720

MINNESOTA
Gopher Electronics Co.
St. Paul
612/645-0241

NEBRASKA
Radio Equipment Co.
Omaha
402/341-7700

NEW YORK
Electronic Equipment
Co., Inc.
Hempstead
516/538-5510

Peerless Radio Corp.
Lynbrook, L.I.
516/593-2121

Summit Distributors, Inc.
Buffalo
716/884-3450

NORTH CAROLINA
Kirkman Electronics, Inc.
Winston-Salem
919/724-0541

OHIO
ESCO Incorporated
Dayton
513/226-1133

Pioneer-Standard
Electronics, Inc.
Cleveland
216/587-3600

PENNSYLVANIA
Cam/RPC Industrial
Electronics
Pittsburgh
412/288-2600

Herbach & Rademan, Inc.
Philadelphia
215/426-1700

Pytronic Industries, Inc.
Montgomeryville
215/643-2850

TEXAS
Southwest Electronics Inc.
Stafford
713/494-6021

WASHINGTON
Almac/Stroom Electronics
Seattle
206/763-2300

Isostat Licensed

DISTRIBUTOR PRODUCTS



CENTRALAB
Electronics Division
GLOBE-UNION INC.

5757 NORTH GREEN BAY AVENUE
MILWAUKEE, WISCONSIN 53201

CIRCLE NUMBER 106

FARATRON

open frame OEM Series
power supplies run 50% cooler...
and cost less than LAMBDA
and Powertec!

If you can prove otherwise we'll give you a 5V/3A
OEM Module **FREE!**

If you've been looking at those other guy's open
frames...take a good look at ours. 36 cooler OEM
models, 5 package sizes, single, dual, and triple
outputs. 5VDC to 28VDC, 0.8 amps to 30 amps.
Prices start at \$22.00 in quantities of 250...
So why pay more and have a hot potato on your
hands.

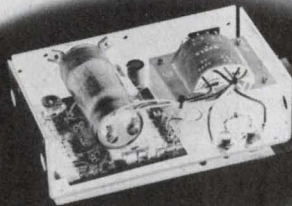

Call or write for complete specifications today!
Ask for helpful Vic Plessner.

FARATRON 280 Green St., So. Hackensack, N.J. 07606
TWX 710-990-5022 Phone 201-488-1440
The COOLEST Power Supply People in the World!

CIRCLE NUMBER 107

ELECTRONIC DESIGN 13, June 21, 1976

CONCORDE NEEDED THE FINEST ...THEY CHOSE JANCO!

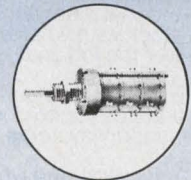
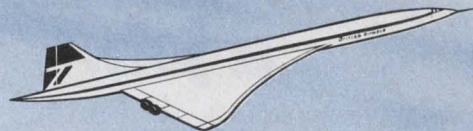

JANCO ROTARY SWITCHES

The reliability, performance, and long life of Janco
Rotary Switches has been demonstrated over and
over again since 1947. Today, as Janco continues to
extend the frontiers of its technology around the
world and beyond...we are prepared to offer a down-
to-earth solution to your switching problem, too!

Janco
CORPORATION

3111 Winona Ave., Burbank, California 91504
Phone 213-845-7473 • TWX 910-498-2701

CIRCLE NUMBER 108

Scanbe·gram

RE: LASTING CONTACTS WITH US-2 SOCKETS

GONE FOREVER - FUNKY I.C. SOCKET CONTACTS...SCANBE'S NEW US-2 LOW PROFILE SOCKETS FEATURE UNIQUE EDGE WIPE CONTACT...UTILIZE GAS-TIGHT DESIGN CONCEPTS... PLUS HIGH TENSILE STRENGTH NICKEL-SILVER ALLOY.

GONE TOO - SOLDER WICKING...PATENTED ANTI-WICKING BARRIER DOES IT, WITHOUT WAFERS...NO MORE FLUX ENTRAPMENT OR INTERMITTENT SHORTS.

US-2 MEETS OR EXCEEDS EIA STDS...ALL POPULAR SIZES.

GET ALL SPECS AND DETAILED MATERIAL INFO...SEND FOR FREE US-2 SOCKET, TEST REPORT, SPEC SHEET.

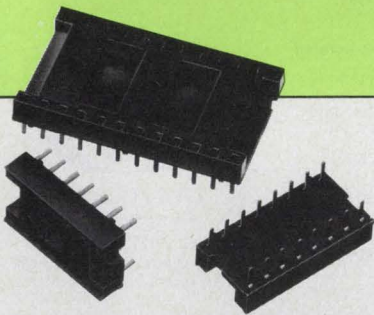

"Imitated . . . never duplicated."

SCANBE
CANOGA INDUSTRIES

Scanbe Manufacturing Corp.
3445 Fletcher Ave., El Monte, CA 91731
Tel: (213) 579-2300 • TWX: 910-587-3437

CIRCLE NUMBER 109

Finding the right power supplies shouldn't be a job.

Use Power/Mate power supplies. We'll save you time and money because we make more power supplies for more applications than any other power supply manufacturer in the business.

And that's not all. We'll service you from stock with whatever you need for whatever the job and usually ship it out the same day.

Power/Mate's building block approach even enables you to design customized power supply systems from off the shelf units.

And everything we sell is unconditionally guaranteed. Call or write for our 84 page catalog today.

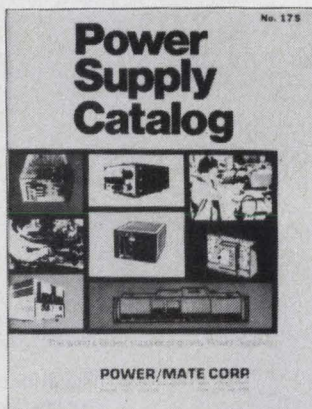

Free Catalog.

PMIC

POWER/MATE CORP.

World's largest manufacturer of quality power supplies.
514 South River Street/Hackensack, N.J. 07601 / Phone (201) 343-6294 TWX 710-990-5023

CIRCLE NUMBER 110

MODULES & SUBASSEMBLIES

S/d converter card has 8 multiplexed channels

ILC Data Device Corp., Airport International Plaza, Bohemia, NY 11716. (516) 567-5600. \$3990 (1 to 9); 12 wks.

The CAT 6325 multiplexed synchro-to-digital converter plugs directly into the AN/VYK-19 rugged Nova computer mainframe. It is a 14-bit, 8-channel system that contains all I/O logic. The s/d converter system is compatible with most programming methods: priority chain, program interrupt, etc. The 6325 can accommodate three different references and can be expanded to 32 channels. It uses simultaneous sampling (to eliminate data skew), has a 150- μ s conversion time and a worst-case accuracy of ± 6 minutes over temperature (-55 to $+105$ C).

CIRCLE NO. 372

Programmable control simplifies program entry

Struthers-Dunn, Systems Div., P.O. Box J, Bettendorf, IA 52722. (319) 359-7501. See text.

A programmable logic controller, the Model 1001, offers more features for the money (under \$1000) and four features not available in any other single PLC. The unit permits direct entry of relay ladder diagrams into the controller, has programming and editing features of a CRT terminal without the price tag, has an extra programming card that permits functions to be added and it has a test panel that enables testing of both program and processor on an individual go/no-go basis. The PLC uses an 8-bit microprocessor with no hardware assist and the basic configuration contains programmable digital timers, counters, latches, shift registers, step switches and dual preadjustable counters. It can accommodate up to 64 input/output circuits, includes a built-in fault monitoring system, individually isolated inputs and outputs with status lights. The standard unit is available with 1-k words of reprogrammable memory and operates from 120 or 220 V, 50/60 Hz.

CIRCLE NO. 373

POWER SOURCES

Unit powers common μ Ps

Elxon Power Systems, 3131 S. Standard Ave., Santa Ana, CA 92705. (714) 979-4440. \$49 (100).

Model μ PS-35 is a triple-output microprocessor supply. The unit can be used to power Intel 8080, TI TMS 8080, AMD 9080, Mostek F8, Motorola 6800 and other microprocessors with similar power requirements. Three outputs are provided: 5 V/3 A (0.1% regulation); 5 V/0.6 A (0.3% regulation); and 12 V /0.3 A (0.3% regulation). It delivers full rated current over the entire temperature range from 0 to 55 C with 115/230 V, 47-to-63-Hz inputs. Standard features include: IC regulation, isolated outputs for positive or negative operation, remote sensing; foldback current limiting, and spike suppression. Over-voltage protection can be provided for all outputs, and the supply can be certified to meet UL requirements. Other supplies deliver outputs up to 110 W to power microprocessor systems with peripherals.

CIRCLE NO. 374

Seven converters form new family

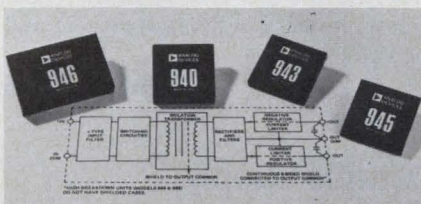

Analog Devices, Rte. 1 Industrial Park, P.O. Box 280, Norwood, MA 02062. (617) 328-4700. \$62 to \$79.

A full line of dc/dc converters features 60% efficiency at full load, $\pm 0.5\%$ maximum error, 1-mV rms and 35-mV pk-pk maximum noise in a 20-MHz bandwidth. Each of the seven converters offers $\pm 0.05\%$ maximum line and load regulation and constant-current limiting. Each uses a pi-type input filter to reduce reflected input-ripple current. Models 940, 941, 942, 943 and 945 are high-efficiency (typically over 60% at full load) designs that feature six-sided continuous shielding. Models 944 and 946 feature 8000-V-dc input-to-output breakdown.

CIRCLE NO. 375

Programmable supply aims at ATE

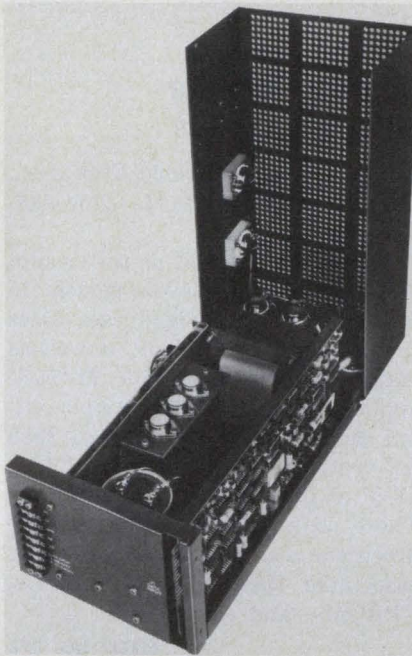

Lambda Electronics, 515 Broad Hollow Rd., Melville, NY 11746. (516) 694-4200. \$1000.

LF-9-04 programmable supply provides plus or minus 0.50 V at 2 A with the following: 8, 12, or 24-bit BCD or ASCII programming time for full voltage compliance (programming time is the time after data entry required for the supply to settle within 0.05% full scale); 15-mV accuracy for 50-V BCD programming, 30-mV accuracy for 50 V of ASCII programming (basic accuracy is the maximum deviation from programmed value at 25 C constant temperature, 115 V ac and no load).

CIRCLE NO. 376

Dc voltage calibrator offers 0.005% accuracy

Berkeley Instruments, 1701 Reynolds, Irvine, CA 92714. (714) 556-0623. \$695.

Model 462A dc voltage calibrator offers an accuracy of 0.005% of setting and 3 ppm of range. This new instrument is completely solid state and adjustable. It features a polarity reverse switch that speeds up calibration, and it also offers a 0.05- μ V resolution. Two outputs of 0 to 11 V and 0 to 110 mV are provided. An output current of 20 mA can be drawn on the 11-V range.

CIRCLE NO. 377

Give YOUR System a New Lease on Lifetime



These modular Supplies® keep Your system going:

- ES5S2000 5VDC @ 2A
- ES12S800 12VDC @ 800 mA
- ES12D500 ± 12 VDC @ 500 mA
- ES15D500 ± 15 VDC @ 500 mA

Here's why. They're up to 80% efficient, so they run cool. As cool as 15°C above ambient under high line/full load conditions. That's why ES Series power supplies have MTBF's >150,000 hrs. That's why they'll let your system run cool, and cool means reliable.

Model	Unit Price	Regulation Line & Load
ES5S2000	\$68.00	0.15%
ES12S800	58.50	0.15%
ES12D500	106.50	0.15%
ES15D500	106.50	0.15%

These 2.5"W x 3.5"L modular encapsulated Supplies deliver full rated output through +71°C. Other models are available.

Circle number for further information. We'll include a copy of our New 34-page April '76 catalog free of charge



SEMICONDUCTOR CIRCUITS, INC.

306 RIVER ST. • HAVERHILL, MA 01830
TEL. (617) 373-9104 • TWX. 710-347-0269

CIRCLE NUMBER 111

More power to you...

at less cost, with Intronic's Modular Power Supplies.



Intronics' SM2000/5 modular power supply offers you more power for your money . . . up to 10 watts of output power. Plus, a compact size that makes this unit the natural choice to power your IC logic circuitry.

All Intronics' modular power supplies are designed for easy use and trouble free operation. Outstanding characteristics include: preset voltages to $\pm 0.5\%$, output short circuit protection, low ripple, wide operating temperature range with no derating, 50 to 440 Hz operation and 50 meg ohm transformer isolation.

Exercise your buying power. Specify Intronics' Model SM2000/5 modular power supply for your IC logic circuit applications.



intronics

57 Chapel Street, Newton, Massachusetts 02158 U.S.A.
617-332-7350. TWX 710-335-6835

Overseas call:

Brussels, Belgium 13-73-84	Munich, Germany 524181
Maidstone, England 54224	The Hague, Holland 678380
Helsinki, Finland 11-123	Milan, Italy 9043983
Paris, France 9077844	Zurich, Switzerland 93-31-61

CIRCLE NUMBER 112

POWER SOURCES

Microprocessor power supplies

Alpha Power, Inc., 9020 Eton Ave., Canoga Park, CA 91304. (213) 998-9873. \$31.96 (100).

Micro-pro series of dc power supplies consists of seven models in four industry standard case sizes covering microprocessor, as well as standard triple-output 5-V, 12/15-V applications. The 1CMP triple-output model, designed for small 8080 μ P systems, is rated at 5 V at 1 A, 12 V at 0.25 A, and 5 V at 0.4 A. These units can power any microprocessor available today including associated RAMs, ROMs, PROMs, FEPROMs, and clock chips.

CIRCLE NO. 378

Slim supplies slip into competitor's shoes

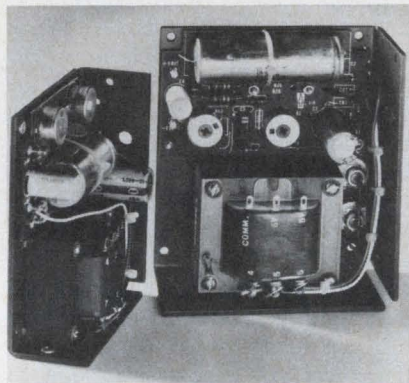

Standard Power, Inc., 1400 S. Village Way, Santa Ana, CA 92705. (714) 558-8512. SPS32, \$31.00; SPS42, \$51.

SPS32 and 42 are the first two series in a new line of economical, narrow-silhouette, open-frame dc power supplies that are interchangeable with other makes. Named the "Slim Line," they are fully rated from 47 to 440 Hz at universal input voltages of 115/230 V ac $\pm 10\%$. The 32 provides nominal outputs of 5, 12, 15 and 24/28 V dc at 3.0, 1.8, 1.6 and 1.2/0.9 A (max) respectively, while the 42 has the same nominal output voltages but at maximum currents of 6.0, 3.5, 3.0 and 2.3/1.8 A. Output voltages are adjustable to within $\pm 10\%$ of nominal.

CIRCLE NO. 379

More microprocessor power supplies

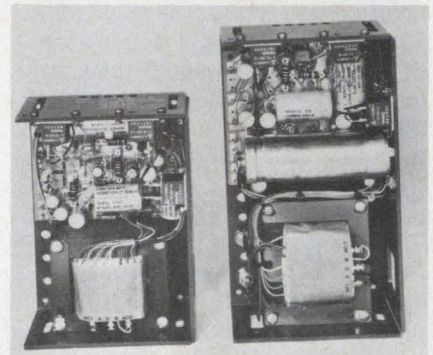

Lambda Electronics, 515 Broad Hollow Rd., Melville, NY 11746. (516) 694-4200. MPU1, \$125; MPU2, \$195.

Two new power supplies can power any microprocessor and its associated clock, ROMs, FEPROMs, RAMs, PROMs, memories and I/O chips. Called the MPU-1 and MPU-2, these triple-output units are designed for laboratory, breadboard, engineering prototype and pilot production as well as for limited production systems. The outputs for the MPU-1 are: 5-V $\pm 5\%$ adjustable, 12-V $\pm 5\%$ adjustable and 9-to-12-V adjustable. The outputs for the MPU-2 are: 5-V $\pm 5\%$ adjustable, 12-V $\pm 5\%$ adjustable and 9-V fixed.

CIRCLE NO. 380

Simple supply, low price

Elcom Industries, 79R Terrace Hall Ave., Burlington, MA 01803. (617) 272-6232. Start at \$14.50 (25); stock.

Looking for no-frill power supplies? Three basic configurations are available: a single-output 5 V (500 to 1200 mA) series, a ± 12 V or ± 15 V (150 mA) dual-output supply and a triple-output, +5 V and ± 12 V or ± 15 -V supply. Each unit is mounted on a PC card and uses monolithic IC regulators that provide 2% load and 1% line regulation. Full short-circuit protection, low ripple (10 mA) and low internal impedance are features of this line.

CIRCLE NO. 381

Still more μ P power supplies

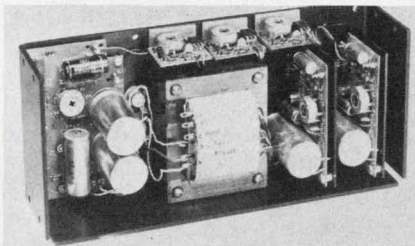

Dynage, 1331 Blue Hills Ave., Bloomfield, CT 06002. (203) 243-0315. Start at \$175.

A power supply designed for microprocessor based systems, Model 3MA-MP provides power for the CPU module plus peripheral modules, including memories in systems applications. Three outputs are furnished, including 5 V at 6 A, 12 V at 1.5 A and a third output usable between 5 V at 1 A and 9 V at 1.5 A. All outputs are provided with independent overvoltage protection, temperature compensation and are adjustable. Input is 115 V or 230 V ac, selectable by the customer.

CIRCLE NO. 382

Dc/dc converter gives 1500-V I/O isolation

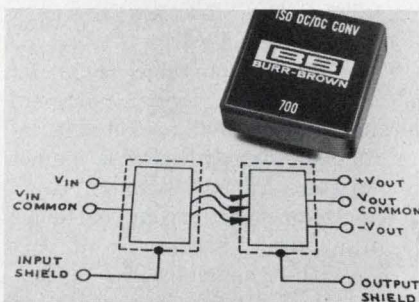

Burr-Brown, International Airport Industrial Park, P.O. Box 11400, Tucson, AZ 85734. (602) 294-1431. \$27 (100).

Model 700 dc/dc converter offers continuous 1500-V-dc isolation between input and output. Model 700 accepts a dc input voltage in the range of 10 to 18 V and provides dual-output voltages of the same magnitude with 30-mA current capability on each output or a combined total of 60-mA output for unbalanced loads. Leakage current specification across the isolation barrier is 1 μ A max at 240 V rms, 60 Hz. The unit comes in a modular package that measures just 1.13 \times 1.13 \times 0.4 in.

CIRCLE NO. 383

Photomultiplier supply converts 35 V to 1.5 kV

Brandenburg Ltd., 939 London Rd., Thorton Heath, Surrey CR46JE, England.

Model 455A high-voltage power supply is designed for photomultipliers, and can provide a positive output up to 1.5 kV from an input

voltage of 35 V dc \pm 10%. Output can be preset between 1.1 and 1.5 kV and the maximum ripple and noise is 500 mV pk-pk at maximum output voltage. Load regulation is better than 2% for a load change from zero to full load, and line regulation is better than 1% for a \pm 10% change in the dc supply.

CIRCLE NO. 384

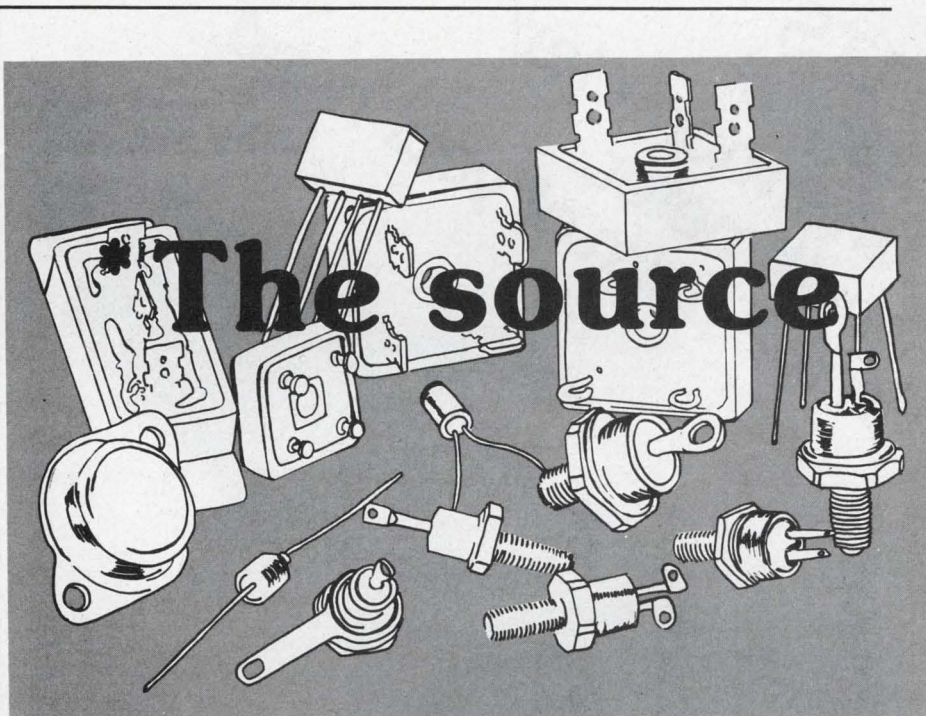

* NAE for power "semi's"

Many of you know NAE as a source for military components; *but*, did you know that we are also a source for a complete line of off-the-shelf power supply components for industrial applications . . . at competitive prices. A source for power "semi's" to fit your particular application.

For immediate attention from the **source** call Rick Kassiotis at 617/598-4800.

----- I am interested in knowing NAE as a source for power semi's. Please send your complete catalog -----



Free!

Name _____ Title _____

Company _____

Address _____

City _____ State _____ Zip _____ Tel. _____

My particular application is _____



SEMICONDUCTORS

69 Bennett Street • Lynn, MA 01905 • 617/598-4800 • TWX: 710-334-0254

CIRCLE NUMBER 113

Portable terminal has three printing modes

Computer Devices, Inc., 9 Ray Ave., P.O. Box 421, Burlington, MA 01803. (617) 273-1550. \$2185.

The Model 1203 portable time-sharing terminal offers a keyboard with three operating modes. The

unit can operate in either teletypewriter, standard typewriter or numeric-only modes. In the typewriter mode, the unit prints upper and lower case letters. Also the model can transmit 10, 15 or 30 char/s. The unit has an internal modem and acoustically couples to a telephone head set. It weighs approximately 14 lb, plus carrying case. The terminal has a solid state thermal printhead.

CIRCLE NO. 385

Connect 32 data lines under digital control

Counterscan Systems, P.O. Box 536, E. Hwy. 6, Sutton, NE 68979. (402) 773-3875. \$1600.

The "Transfer Switch" connects one group of 32 data lines with any other group of 32 lines in a total of eight groups. Selection is done by application of a binary address code. Switching is accomplished by LSI CMOS transmission gates. Current may flow in either direction through the switch. The unit will pass 30 V pk-pk at data rates up to 1 MHz.

CIRCLE NO. 386

LTS digital thermometer/multimeter... in the palm of your hand. Only \$259.*



- 3½ Digits
- 0.1% Accuracy for DC Volts
- Autoranging and Autopolarity
- Measures Surface and Ambient Temperature
- Rechargeable NiCd Batteries Included
- Plug-in Tips for Temperature and Multimeter Functions

- Temperature:** -55° to 153.5°C, ±1°C from 0° to 100°C
DC Voltage: 1 mV to 750 V, input impedance 10 megohms
AC Voltage: 200 mV_{rms} to 750 V_{rms}, input impedance 10 megohms shunted by 14 pF
Resistance: 1 ohm to 19.99 megohms
- includes ac adaptor/charger, carrying case, operator's manual

DMM without temperature **\$198.***



LOGICAL TECHNICAL SERVICES CORP.

71 West 23rd Street, New York, N.Y. 10010
 (212) 741-8340 Telex #12-7698

Representative and dealer inquiries invited.

CIRCLE NUMBER 116

Portable calculator provides printout



Hewlett-Packard, 1501 Page Mill Rd., Palo Alto, CA 94304. (415) 493-1501. \$500; 2 wks.

The HP-91 portable printing calculator is a more powerful version of the HP-45 pocket calculator. It has more addressable memory registers and some extra functions. It operates from batteries or an ac line. Weighing in at only 2.5 lb. with dimensions of 9 × 8 × 2.5 in., the unit fits in a standard briefcase. The printing capability can be used in three modes: in "manual," the printer operates only when the "Print X" or list function keys are pressed; in "normal," all entries and functions are printed; or in "all," digit entries, functions, and results are printed. The calculator prints and displays in engineering notation (values with exponents in multiples of three), fixed decimal and scientific notation. A 220-page owner's handbook is included with the calculator. It contains user instructions and a comprehensive application section that gives the most efficient keystroke sequences for solving problems.

CIRCLE NO. 387

MODULAR HIGH VOLTAGE PRECISION POWER SOURCES



HUNDREDS OF UNITS IN OPERATION
FOR CRITICAL MONITORING FUNCTIONS
IN NUCLEAR POWER PLANTS.

10-2000 VDC, 0-20 MA
10-3000 VDC, 0-10 MA
10-5000 VDC, 0-5 MA

The UPMD series of high voltage sources are compact modular units designed for critical applications where high stability, low noise and flexibility of output voltage control are important considerations.

They are ideal for such applications as photomultipliers, Geiger-Muller counters, proportional detectors, CRT sources, high resolution video displays, electrostatic lenses, etc.

Remote control of the high voltage output is achieved by means of an external potentiometer operating at low potentials with respect to ground. Output voltage resolution is a function of the resolution of this control. Options are available for remote voltage control at any desired input/output voltage ratio or for digital operation with an external D/A converter.

A unique overvoltage/arc suppression system is incorporated to protect the supply and its load in the event of loss of output voltage control or an overvoltage due to L di/dt transients generated by sustained load arcing. The circuit operates to clamp the output

voltage to approximately 200 volts above any setting, hold this clamp for approximately two seconds and shutting down the supply electronically if the fault persists. The supply may be manually re-set by momentary interruption of the AC line.

An internal 1% multiplier permits connection of an external meter for monitoring. A zener diode across the metering terminals minimizes shock hazard.

The compact size (4½" x 6" x 7½"), excluding the high voltage connector and light weight (8 lbs.) is achieved through the use of high frequency inverter technology in conjunction with a fast series regulator. RFI and EMI is held to low levels through the use of careful shielding and low pass AC line and DC output filters.

High voltage transformers and high voltage components encapsulated in readily replaceable epoxy modules. Low voltage components are accessible on epoxy coated PC boards.

An SHV (Safety High Voltage) BNC receptacle is utilized for the output voltage. A mating connector is furnished with each unit.

Characteristics

INPUT: 105-125 V, 47-440 Hz, 60 w
MTBF: Over 50,000 Hrs.

OUTPUT: See Table

REGULATION: .001% or 10 MV (whichever is greater), for line or load variations.

NOISE AND RIPPLE: 10 MV peak-to-peak to 1 MHz

STABILITY: Less than .01% or 15 MV (whichever is greater) Per 24 Hrs.

TEMPERATURE: 0-50°C

TEMPERATURE COEFFICIENT: Less than 50 PPM/°C

PROTECTION: Current limiter and over-voltage system limits output to safe levels.

SIZE: 4½" x 6" x 7½"

WEIGHT: 8 lbs.

MOUNTING: In any plane

Table

MODEL	*OUTPUT POLARITY	VOLTAGE RANGE	OUTPUT CURRENT	**UNIT PRICE
UPMD-220N	NEGATIVE	10-2000 VDC	0-20 MA	\$385.00
UPMD-220P	POSITIVE	10-2000 VDC	0-20 MA	395.00
UPMD-310N	NEGATIVE	10-3000 VDC	0-10 MA	385.00
UPMD-310P	POSITIVE	10-3000 VDC	0-10 MA	395.00
UPMD-550N	NEGATIVE	10-5000 VDC	0-5 MA	440.00
UPMD-550P	POSITIVE	10-5000 VDC	0-5 MA	450.00

*Corresponding output terminal connected to chassis. **Subject to change without notice. FOB Westbury, N.Y.

OPTIONS 1. Remote voltage programming (specify ratio) \$50.00
2. Isolation up to 250V above chassis \$50.00

POWER DESIGNS

POWER DESIGNS INC.
1700 SHAMES DRIVE ■ WESTBURY, N.Y. 11590
Tel: 516-333-6200 ■ TWX 510-222-6561

POWER DESIGNS PACIFIC INC.
3381 MIRANDA AVENUE ■ PALO ALTO, CALIF. 94304
Tel: 415-493-6111 ■ TWX 910-373-1251

CIRCLE NUMBER 167



Behind every Rotron fan and blower... Application Engineering

No product is any better than the job it will do for you.

That's why Rotron's staff of Application Engineers are always available to help you use air most effectively—avoiding the potential problems of incorrect choice of fan or blower—assuring you the most for your air moving money.

They know their business. They draw upon more than 25 years of experience in the application of precision air moving devices. They have available to them the best equipped laboratories for testing and evaluation of specific air mover to system combinations. And, of course, they know their product.

That doesn't mean you'll need a factory-based application engineer every time you use a Rotron fan and blower. The variety and quality of products available to you, the wealth of knowledge that exists throughout the sales and distributor organization—and your own knowledge—will usually combine to provide just the right air mover for you.

But when a question does arise . . . when you *do* need help . . . your Rotron Application Engineer is there . . . on the phone or at your plant . . . with the answer.

Why settle for less when the best costs no more?



ROTRON INC.

Woodstock, N. Y. 12498 □ 914 • 679-2401 □ TWX 510-247-9033
Pacific Div., Burbank, Cal. 91506, 213-849-7871 • Rotron B.V., Breda, Netherlands, Tel: 79311, Telex: 844-54074

CIRCLE NUMBER 168

18951

The high voltage supply you've been waiting for:

Specifications



Low cost • Compact Reliable • Available

This is *the* high voltage power supply for copiers, medical electronics, and CRT displays.

It gives you up to 6700 VDC output from a 24 VDC input in a compact little package at a compact little price.

And just as important, it's a *Scott* supply. This insures you of high production quality from power supply specialists. That means fewer problems for you.

Take a look at our specs. Ask for a quote. You'll be impressed.

ELECTRICAL

Input Voltage:	24 VDC \pm 1%
In Rush Current:	2.5 amps max.
Voltage Breakdown:	150% of Input Voltage for 1 minute
Output Voltage:	Adjustable (5300 VDC to 6700 VDC)
Max. Load:	400 microamps
Ripple:	5% (Output Voltage peak to peak)
Response Time:	100 ms max. (turn-on from 0 volts to set value)
Overshoot:	5% maximum
Duty Cycle:	10 sec. on 10 sec. off (can be modified)
Output Current:	Adjustable (150 microamps to 400 microamps) CONSTANT CURRENT
Regulation:	\pm 3 micro amps or 1% from set point over any combination of input voltage and load variation within a \pm 10% range
Short Circuit Operation:	5 milliamps 120% of set value

ENVIRONMENTAL

Operating Temperature:	60° to 120°F (15.56° to 48.89°C)
Storage Temperature:	10° to 140°F (23.33° to 60°C)
Relative Humidity:	10-80%
Reliability:	Calculated: 20000 hours MTBF. (.95 for 1000 hours of operation)

MECHANICAL

Dimensions:	4¼" x 4¼" x 4¾" (approx.)
Mounting:	Horizontal tab & slot

NCR Scott Electronics Division 584 South Lake Emma Road
P. O. Box 898 Lake Mary, Florida 32746 Telephone (305) 323-9250
NCR Corporation

CIRCLE NUMBER 169

The best talents in your business can be bought...

PRACTICAL DESIGN FOR ELECTROMAGNETIC COMPATABILITY

edited by ROCCO FICCHI

A complete guide to electromagnetic compatibility for electronic systems and equipment. Includes the current techniques for analyzing, predicting, controlling and reducing unwanted signals, along with numerous charts, graphs and nomographs. Recent advances in filtering and shielding, and exhaustive treatment of the special problems encountered in computers, semiconductors and solid-state devices. #5685-0, \$17.20

PRACTICAL VALUE ANALYSIS METHODS

by JOHN H. FASAL

This step-by-step guide transforms sophisticated VA-VE theory into concrete techniques and methods enabling you to literally take apart and scrutinize every facet of your operation—streamline everything from product costs to worker efficiency. An unlimited planning tool in the hands of today's ambitious executive or manager. #5845-4, \$13.75

MODERN DATA COMMUNICATION

by WILLIAM P. DAVENPORT

An on-the-job handbook mapping out the latest techniques, systems and services for the most efficient data transmission. Includes simplified coding techniques; ways of dealing with distortion, distraction, interference; efficiency and control techniques; modulating and multiplexing methods; and advice on using today's commercially available services. #5810-1, \$10.30

BASIC TELEPHONE SWITCHING SYSTEMS

by DAVID TALLEY

Offers the full array of switching techniques—from the early step-by-step type, through the common electro-mechanical group, to today's sophisticated electronic system. Special attention given to the No. 1 ESS type being installed by many companies. Here's a versatile, clearly-written handbook for the engineer, executive, and trainee alike. #5750-4, \$6.60

RELIABILITY, MAINTAINABILITY AND AVAILABILITY ASSESSMENT

by MITCHELL O. LOCKS

All the techniques and formulas you need for calculating the reliability, maintainability and availability of your repairable and non-repairable systems and components. You'll find sample models using point and interval values, and time-to-failure and time-to-repair data; binomial and other bernoulli-type distributions; simplified goodness-to-fit techniques, and much more. #9204, \$15.95

VIBRATION AND ACOUSTIC MEASUREMENT HANDBOOK

edited by MICHAEL BLAKE & WILLIAM S. MITCHELL

This giant, field-tested, 680-page manual enables you to master today's vibration equipment and techniques—shows you how to spot up to 90% of equipment problems months in advance and take corrective action before trouble starts. Uses scores of actual industrial problems and solutions in outlining specific procedures and techniques. #9195, \$34.50

on a 15-day money-back guarantee.

I'm buying! Please send me the books listed below to read and use FREE for 15 days. At the end of that time I will send payment, plus postage, or return the book(s) and owe nothing.

Number	Title	Price
_____	_____	_____
_____	_____	_____
_____	_____	_____
_____	_____	_____
		TOTAL _____

Name _____

Firm _____

Street _____

City/State/Zip _____

I want to save money! Payment enclosed. Publisher pays postage. Same 15-day guarantee. 75-50



Hayden Book Company, Inc., 50 Essex St., Rochelle Park, N. J. 07662

Simple to use kit prints ASCII set



Hycom, 16841 Armstrong Ave., Irvine, CA 92714. 557-5252. \$399.

The Model CE-21AP kit allows evaluation of a printer at low cost. The kit consists of a nonimpact printer in a 5 × 7 × 3-in. cabinet, a separate interface card with 64 character buffer and a power supply. The printer produces 126 characters/s in 5 × 7 dot matrix in 21 columns. An 8-bit parallel ASCII bus with control lines allows simple interfacing to a computer system.

CIRCLE NO. 388

Unit patches 24-wire RS-232 cable for test



Atlantic Research Corp., 5390 Cherokee Ave., Alexandria, VA 22314. (703) 354-3400. \$1200 (16 channels), single qty.

The Atlantic Research DATA-PATCH system offers complete 24-conductor patching. Any EIA RS-232C/CCITT V.24 circuit can be accommodated by any DATA-PATCH module. The unit connects or patches modems, multiplexers, terminals and computers where rapid servicing or testing is required. No patching is required for normal operation. A typical DATA-PATCH system consists of a rack mounted assembly equipped with up to 16 DATA-PATCH modules and an adapter module. Since the system can be expanded by adding modules on a per circuit basis, only the required number of modules need be installed.

CIRCLE NO. 500

2400 line/min printer available at low cost

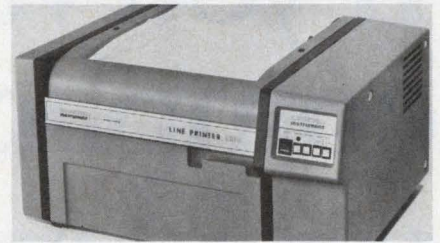

Houston Instrument, One Houston Square, Austin, TX 78753. (512) 837-2820. See text; 120 days.

The Model 8210, with a 2400 line/min printing rate, sells for \$3000. Output is 80 columns wide on 8-1/2 in. paper. A 132 column-wide format on 14-7/8-in. paper is also available (Model 8230); it prints at 1400 lines/min and sells for \$3785. Among the features included on both are full print-line buffer memory, automatic top-of-form advance, 400 in./min paper-advance speed and the ability to use both roll and fan-fold paper interchangeably. The units print on electrostatic paper and employ a stepper drive using no gears, light wheels, or servo loops.

CIRCLE NO. 598

"ACROSS THE BOARD"

STANDARDIZE ON

WESTON

YOUR TOTAL REQUIREMENT LINE OF
"TOTAL CONTROL" TRIMMERS

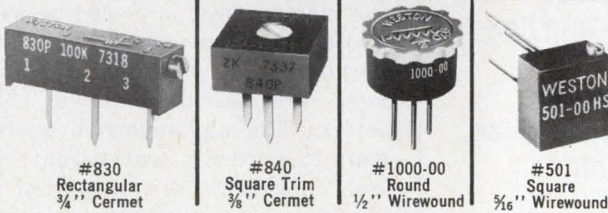

#830
Rectangular
3/4" Cermet

#840
Square Trim
3/8" Cermet

#1000-00
Round
1/2" Wirewound

#501
Square
5/16" Wirewound

CERMET AND WIREWOUND GENERAL PURPOSE POTS
Square • Rectangular • Round. Full range of types, shapes, sizes . . . military grade also available.

Concerned about quality control? Centralize responsibility and assure uniformity by standardizing on Weston for all your requirements.

Weston "Total-Control" Trimmers are produced under controlled environmental conditions. Step by step the design concept provides for rigid quality requirements beginning with material through parts production, assembly and final test and inspection. Product control for the ultimate in reliability extends even to kilning our own ceramics for the Weston Cermet Line. Custom-design service is available where no Standard Model in any series meets exact individual requirements. Consult your Weston Representative.

WRITE FOR WESTON BULLETIN — "LOTS OF POTS."

WESTON

Schlumberger

WESTON COMPONENTS
ARCHBALD, PENNA. 18403
TEL. (717) 876-1500
TWX 510 656-2902
TELEX 83-7443

CIRCLE NUMBER 117

ELECTRONIC DESIGN 13, June 21, 1976

MICROPROCESSOR SERIES NO. 1

OUR EASIEST-TO-USE 2650: NOW MULTI-SOURCED.

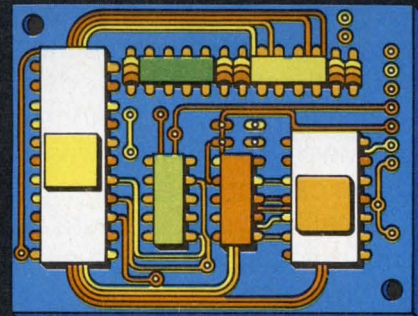

All the 2650's you need, in stock at Signetics, authorized distributors. Advanced Memory Systems (AMS) and Philips, too.

Clip coupon to letterhead. Or call (408) 739-7700, Ext. 2982/3. Please rush me my FREE 2650 Short Form Catalog.

Name _____ Title _____

Tel. _____ M.S. _____

811 E. ARQUES, SUNNYVALE, CA. 94086

THINK

Signetics μ P

a subsidiary of U.S. Philips Corporation

CIRCLE NUMBER 118

161

If you've got a complicated problem with EMI we've got a simple solution

Electromagnetic Interference. It shows up as static on radio and snow on TV. It can make computer terminals register input error. Make a pacemaker or an EKG malfunction. And interfere with sensitive navigation equipment.

Obviously, you've got to shield your equipment against EMI. You can use sheet metal. Or foil. Or a plating process. These are fine for small enclosures with flat surfaces. But when it comes to large cases and complex shapes, you need a better solution.

And here it is. Electrodag® coatings. We've engineered a whole range of them. To give you from 10-70 dB attenuation, from 1 MHz to 10 GHz. With varied physical properties that let you apply them to almost any material.

This means that you can build your enclosures out of light plastic, coat them with Electrodag, and still get perfect skintight shielding. Even on honeycomb structures and flexible parts made from foamed resins.

And you can forget about expensive techniques like plating, metallizing and vacuum deposition. With Electrodag, all you need is a spray gun, a simple dipping technique, or a paintbrush.

You can use these new coatings for everything from CB radios and EKG units to data terminals and microphones.

This is a new field, but we're the oldest company in it. With the greatest experience, the biggest R&D staff and the most EMI coatings. For technical advice on specific applications, write: Acheson Colloids Company, Electrical Products, Port Huron, Michigan 48060. Or call (313) 984-5581.



CIRCLE NUMBER 119

DATA PROCESSING

Dot-matrix printer features variable fonts

C. Itoh Electronics, 5301 Beethoven St., Los Angeles, CA 90066. (213) 390-7778. \$185 (single qty); 6 wks.

An alphanumeric printer, Model 7040L, can print large characters of variable density and shape under software control. The printer employs a dot-matrix print head and has 40-column capacity with 1.25 line/s printing speed.

CIRCLE NO. 599

Briefcase contains data-line monitor



Digi-Log Systems, Inc., Babylon Rd., Horsham, PA 19044. (215) 672-0800. See text.

The Series-400 Data-Line Monitor and 5-in. video display is a data-communication system diagnostic tool and fault isolator. It fits in a briefcase. Parity, framing and sync errors, as well as RS232 control line status, are monitored and indicated with LEDs, allowing quick pinpointing of hardware or software faults. In operation, the monitor unit is placed between two EDP devices and all data that normally flow between these devices are displayed on a video screen. The alphanumeric equivalents of normally transparent control characters are displayed as blinking characters for easy recognition. The system is transparent to the data line being monitored. Either receive, transmit or both receive and transmit data may be selected for display. The complete system consisting of Model 445 Data Line Monitor, 5-in. video display and briefcase weighs less than 20 lb and costs under \$2500 in single quantities. Lease programs are available for as little as \$65 per month.

CIRCLE NO. 600

Rugged tape system boasts low cost

Emerson Electric Co., Industrial Controls Div., 3300 S. Standard St., Santa Ana, CA 92702. (714) 545-5581. 2004, \$70 (large qty); 2005, \$2295 (single).

A low-cost magnetic-tape system consists of a tape drive (Model 2005) and cartridge (Model 2004). The cartridge uses 1/2-in.-wide computer-compatible tape. The system is designed for dusty, humid, or otherwise rugged environments. The drive is plug compatible with others using standard phase encoded or NRZI formatters. It has a bidirectional read/write speed of 25 in/s and recording densities run from 200 to 3200 bit/in. Up to nine tracks of data can be stored on the tape. The tape cartridge can hold up to 1000 ft of tape. It has a spring-loaded cover, reel brakes and a short exposed tape path for reliable operation.

CIRCLE NO. 601

Acquisition system mates with IMP-16C

Data Translation, 109 Concord St., Framingham, MA 01701. (617) 879-3595. \$1195 (16 channels).

The DT1722 is a data-acquisition system for the National Semiconductor IMP and PACE series of microcomputers. The card fits in one standard slot of the IMP or PACE prototyping systems, or can be interfaced to the IMP-16C single board computer. Up to 64 analog inputs can be accommodated in the DT1722 with power supplied from the computer mainframe. The DT1722 offers 12-bit resolution, accuracy of $\pm 0.03\%$, either single-ended or differential configuration and a throughput rate of 25 kHz. Channel addressing is selectable by program control. Device address and analog input ranges are all selectable by jumper plug. The acquisition can handle analog current inputs from 20 mA.

CIRCLE NO. 602

Core memory boasts lower price than semis

Dataproducts Corp., 6219 De Soto Ave., Woodland Hills, CA 91364. (213) 887-8465. \$2400 (in large qty.); 120 days.

Designated the STORE/3220, this completely tested and assembled system sells for less than most semiconductor memory components in OEM quantities. It is a three-wire, 3-D planar memory unit featuring 750-ns cycle time and 300-ns access time. The system provides 32 k \times 20-bit capacity on a single board. The STORE/3220 is expandable to 131-k words in a 5-1/4-in. chassis including a power-supply option. Up to eight 32-k modules can be daisy-chained to form a system with a capacity up to 262 k \times 20 in two 5-1/4-in. chassis. Core arrays and all electronics are housed in a module that measures 11.7 \times 15.4 \times 0.98 in. and consists of two circuit boards.

CIRCLE NO. 603

bottom line bargain

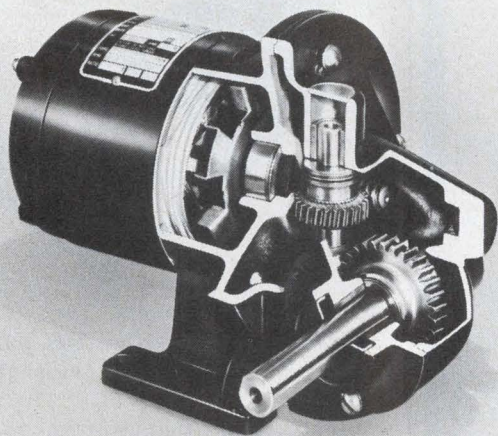

Bodine puts more into its fhp motor and drive system design to give you greater bottom line profit in the long run. We call it ADE (After Delivery Economies). You get fewer rejects from the start and less profit robbing service headaches. Motor to motor, lot to lot, Bodine's consistent quality pays big performance dividends.

If you're concerned about costs, profitability and tomorrow's repeat sales, take a close look at Bodine. You won't find a better fhp buy—1/2000 thru 1/4 Hp.

ADE (After Delivery Economies) make Bodine a better fhp buy

**BODINE
ELECTRIC
COMPANY**

Bodine Electric Company, 2500 W. Bradley Place, Chicago, IL 60618.

CIRCLE NUMBER 120

ELECTRONIC DESIGN 13, June 21, 1976

MICROPROCESSOR SERIES NO. 2

2650 DEVELOPMENT HARDWARE FOR ALL COST/CAPABILITY LEVELS.

Here now:

- PC1001 Prototyping Card
- PC2000 4K Byte RAM Card
- DS2000 Demo Base with P.S.
- PC3000 Smart Typewriter Democard
- KT9000 Prototyping Kit

More Soon!

Clip to your letterhead. Send me the Short Form Catalog including the foregoing data sheets.

Name Title

Tel. M.S.

811 E. ARQUES, SUNNYVALE, CA. 94086

THINK SIGNETICS μ P

a subsidiary of U.S. Philips Corporation

CIRCLE NUMBER 121

DATA PROCESSING

Low cost CRT terminal displays full color

Intelligent Systems Corp., 2405 Pine Forrest Dr., Norcross, GA 30071. (404) 449-5961. See text; 60 to 90 days.

Termed the Intecolor 8001, this new terminal offers a color CRT at low cost. The complete unit with

an eight-color, 19-in. tube and keyboard costs \$1995 in quantities of 100 and \$2495 in single quantity. It includes an 80-char \times 25-line ASCII format and sockets for an optional 64 special characters. Also included is a 4-k \times 8-bit RAM, sockets for additional EPROMs and space for up to 32 k of RAM memory. An RS-232 serial interface provides a simple I/O with selectable baud rates up to 9600.

CIRCLE NO. 604

Portable minicomputer programs in Basic



Wang Laboratories Inc., 836 North St., Tewksbury, MA 01876. (617) 851-4111. \$5400.

The Wang Model 2200 PCS is a full minicomputer completely contained within a 55-lb desktop console that plugs directly into a wall socket. The PCS consists of a CPU, 8-k bytes of RAM and 42.5-k bytes of ROM, a 9-in. CRT display with keyboard plus a tape cassette drive. Memory is expandable to 32-k bytes of RAM. The minicomputer programs in Basic with more than 200 programs available.

CIRCLE NO. 605

HP's Small Wonders

Coaxial Attenuators, DC to 18 GHz

- Ideal for general purpose use; 3, 6, 10, 20, 30, 40, 50 & 60 dB Models.
- Excellent price/performance; 100% computer tested with NBS traceable calibration points.
- Low SWR with superior phase linearity for fast pulse or wideband work.
- Type N, SMA, APC-7 options. Priced from \$65 to \$190*

These and more than 300 other microwave measurement items are described in our new 80 page coaxial and waveguide catalog. You can get a copy from your nearby HP field office, or write.

*Domestic US prices only.

HEWLETT  PACKARD

Sales and service from 172 offices in 65 countries.
1501 Page Mill Road, Palo Alto, California 94304



04604

CIRCLE NUMBER 122

Instrument bus mated to calculator system

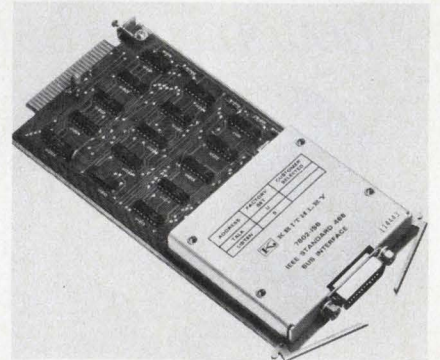

Keithley Instruments, Inc., 28775 Aurora Rd., Cleveland, OH 44139. (216) 248-0400. \$795 (unit qty); 90 days.

Instruments that conform to the IEEE Standard #488-1975 instrumentation bus can now easily be interfaced with the Keithley System 1—a calculator-based instrumentation control and data-analysis system—by use of the Model 7802-1SB interface card. The card comes with an extensive software package. Up to 14 bus-compatible instruments can be connected into the System 1 with each card, and as many as six cards can be installed in each system.

CIRCLE NO. 606

DATA PROCESSING

Dual disc drive features small size

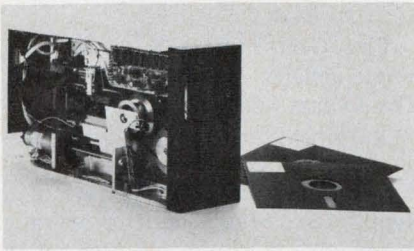

PerSci, Inc., 4087 Glencoe Ave., Marina Del Rey, CA 90291. (213) 821-5545. \$880 (50 qty); 30 days.

The Model 270 dual diskette drive features smaller size than many single diskette drives and faster access to data than two independent drives. It measures 8.5 x 4.4 x 15.0 in. This dual drive can accommodate 1.9 megabits on each diskette in IBM 3740 format. A double-density option increases storage capacity to 12.8 megabits.

CIRCLE NO. 607

Communications set tests and analyzes data

Nu Data Corp., 32 Fairview Ave., Little Silver, NJ 07739. (201) 842-5757. \$3875; 30 days.

The Model 922 G portable communications test set can monitor, test, store, playback and display information sent over serial data lines. The unit can be used in synchronous and asynchronous modes at speeds from 37.5 to 9600 b/s. As a test generator, the unit makes test messages of 70, 80 or 128 characters per line in any one of four standard codes. It has selectable characters at the beginning and end of the test message plus characters for terminal addressing and special patterns, and has selectable distortion of up to 50%. As an analyzer, the test set can measure and display distortion, display received characters, flip from send to receive for remote tests or answerback, check parity errors and accumulate error counts.

CIRCLE NO. 608

Interactive graphics added to computer

Scientific Process and Research Inc., 24 N. 3rd Ave., Highland Park, NJ 08904. (201) 846-3477. \$5000 plus cost of computer.

An interactive graphics system called SPAR/GRAPHICS can be added to a Data General Nova 3 or Eclipse processor having a disc memory. The system contains a 21-in. graphic display, a high-speed CRT terminal and complete software. The user can generate figures of almost any complexity. The figures may be enlarged or reduced, moved, stored or recalled on command. The system can display three as well as two-dimensional displays and show objects in motion. Programs are available in high-level languages such as FORTRAN, ALGOL, COBOL, and BASIC. The display needs no refreshing by the host computer, so the computer remains available for other duties.

CIRCLE NO. 609

Rose enclosures. New. Beautiful. Quality. Standards.



Rose Enclosures, made specifically for electronic use, culminate years of design, engineering and production experience. Extra high quality, precision-finished units provide functional protection, easy access, excellent esthetics. Available materials: Lexan, Aluminum, Polyester and ABS. Clear plastic covers with Lexan and ABS. A competitively-priced stock of Rose Enclosures is maintained in Belding, Mich. for immediate shipment. Contact us at (616) 794-0700.

STAHLIN
BROTHERS, INC.
Belding, Michigan 48809

CIRCLE NUMBER 123

MICROPROCESSOR SERIES NO. 3

2650

HIGHER LEVEL LANGUAGE SPEEDS YOUR DEVELOPMENT.

Available:
(A) PL μ S Compiler for 16- & 32-bit computers and on Time-share, (B) 16- & 32-bit Assemblers and Simulators.

Clip to letterhead. Send me quickly the 2650 Short Form Catalog including data sheets on the foregoing software.

Name _____ Title _____
Tel. _____ M.S. _____
811 E. ARQUES, SUNNYVALE, CA. 94086

THINK
SYNTHETICS μ P
a subsidiary of U.S. Philips Corporation

CIRCLE NUMBER 124

Low drift costs less in these new IC instrumentation amplifiers

The new laser-trimmed 3626 offers modular performance in a DIP package... at low gain or high. Choose from three versions: The 3626CP is the best with input offset drift $< 2 \mu V/^{\circ}C @ G=5$ and $< 1 \mu V/^{\circ}C @ G=1000$ for just \$19.50 (100's). The 3626AP—the lowest cost version in this family—has spec's of $< 8 \mu V/^{\circ}C @ G=5$ and $< 6 \mu V/^{\circ}C @ G=1000$ for \$13.00. The family provides $2 \mu V$ p-p input noise, input impedance of $5 \times 10^{10} \Omega$, and CMR > 80 dB @ $G=10$ to 1000.

For still lower prices, our new 3662 family provides $< 2.4 \mu V/^{\circ}C$ drift (KP version for just \$14.95 in 100's) and $< 6 \mu V/^{\circ}C$ drift for the JP version at \$9.75. Input impedance for these units is $2 \times 10^{10} \Omega$, and CMR is > 104 dB @ $G=1000$.

Our instrumentation amplifier family lets you select from the very low cost monolithic 3660 to the high performance 3620. And there's lots in between. Get all the details by contacting Burr-Brown, International Airport Industrial Park, Tucson, Arizona 85734. Telephone (602) 294-1431.



CIRCLE NUMBER 125

DATA PROCESSING

Printer makes standard bar codes for products

Nomax, 3303 Harbor Blvd., Building D-11, Costa Mesa, CA 92626. (714) 546-0941. \$6850 (standard size).

The Model 1200 printer produces standard bar-code symbols with corresponding numeric characters. Bar symbols include the Universal Product Code, Distribution Code and National Drug Code and can be printed on roll-form pressure-sensitive labels. The Model 1200 uses a nonimpact printer and has only two moving parts. The unit generates more than 200 labels/min and is controlled by a microprocessor. The data input port accepts serial ASCII and is a 20-mA current loop. Modifications of the standard unit could allow printing multiple line alphanumeric characters of varying sizes with or without code symbols.

CIRCLE NO. 610

Data recorder operates off-line



Fluidyne Instrumentation, 1631 San Pablo Ave., Oakland, CA 94612. (415) 444-2376. \$4950 (16 channel).

The Model 750 cassette recorder will acquire, format and compress data from up to 64 high level or 40 low level inputs onto a Philips type cassette for later feeding into a Wang 2200 or WCS series programmable calculator. Operation of the recording system is under the control of an interpretive program initially entered onto a 512-byte RAM through the Wang calculator. The system can use Fluidyne's 7200 special-purpose plug-in function cards including multiplexers, a/d converters and others. The cassettes hold an equivalent of 16,000 three-digit numbers with sign and overrange information.

CIRCLE NO. 611

Diskette drive features double density storage

General Systems International, Inc., 1440 Allec St., Anaheim, CA 92805. (714) 956-7183. \$500. (100 up); 30 days.

The GSI-110 is a double or single-density flexible disc drive. The format can be IBM compatible or variable. For double-density applications, the unit will store up to 6.4 Mbits of data on one side of a floppy disc. Single density storage in variable formats provides up to 3.2 Mbits of data. The GSI-110 is also fully IBM compatible and will read and write IBM 3740 formatted diskettes. The GSI-110 also offers daisy-chain capability to drive 1-4 units, parallel ready lines plus unit select and track-00 sensing.

CIRCLE NO. 612

Acquisition system is microprogrammed

E-H Research Labs, 515 11th St., Box 1289, Oakland, CA 94604. (415) 834-3030. \$5200; stock.

The Dataquire is a microprogrammed data-logger/acquisition system. It comes equipped with 10 input channels and can be expanded to 1000. A 9-digit real-time clock with independent display and a multirange timer with a range from 0.1 s to 99 h are included with the system. Independent channel monitoring and a random channel-skipping feature are standard and easily accessed at the front panel. The system can measure from $1 \mu V$ to 20 V dc, as well as inputs from all popular thermocouples, strain gauges, photomultipliers and most analytical instruments. Digital inputs from contact closures, BCD counters or other instruments are also accepted. Output to any recording device (teletypewriter, 9-track magnetic tape, paper-tape punch, etc.) or external processor (minicomputer, programmable calculator, large computer, etc.) directly or via phone line or terminal is possible. Feedback controls in the form of contact closures, D/A, VCO or BCD registers are also available and can be used for output data modification, exception reporting or feedback control action to the test.

CIRCLE NO. 613

Wire-wrappable socket contains a solder rivet

Berg Electronics, Route 83 South, New Cumberland, PA 17070. (717) 938-6711.

The Tri-Socket, a free standing wire-wrappable pin, contains a solder rivet positioned immediately above the staking area. The solder requires only fluxing, and can be reflowed by submersion in hot oil or by condensation soldering. After reflow, the Tri-Socket retention force exceeds 40 lb. The Tri-Socket accommodates a variety of lead sizes for insertion in 1/16 through 1/8 in. PC boards. The design has tri-cornered fins in the staking area, which extend outside the hole diameter. When inserted, the fins retract, allowing gentle entry into the board. The three-point contact gives the unit stability and straightness without causing damage to through-plating.

CIRCLE NO. 614

Contact lubricant comes in squeeze tube

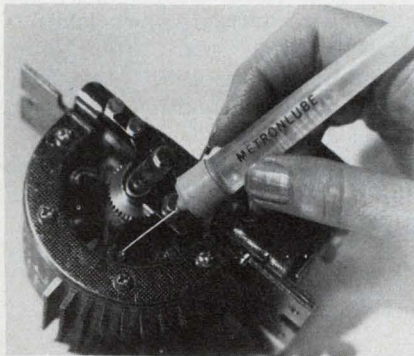

Metron Optics, P.O. Box 690, Solana Beach, CA 92075. (714) 755-4477. \$3.95 (single qty).

Metronlube is a lubricant that comes in a long, pen-like applicator. The applicator allows precise placement of a thin film of the liquid in places where access is difficult. Lubricant flow is controlled by finger pressure on the pen body. Metronlube is useful where contact force is high; it reduces the coefficient of friction on copper, silver and gold-plated surfaces to 0.05-0.15.

CIRCLE NO. 615

Machine inserts DIP sockets at up to 3000/h

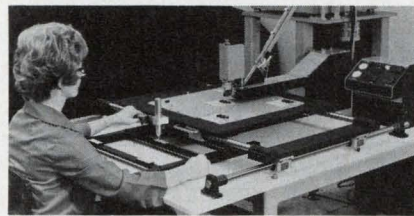

Precision Engineered Products, Inc., 808 N. Batavia St., Orange, CA 92667. (714) 639-0150. \$18,800, 60 days.

The Model 1500 inserts DIP sockets into a PC board at rates up to 3000 per hour. The socket inserter has a manually positioned X-Y table and a vibratory socket-feeding system. The 120-Hz vibratory feeder orients the socket-pin location for PC-board loading. Component pins may be clinched inwards or outward, by changing various clinching blocks, or eliminated entirely. The Model 1500 will accommodate boards with an insertion area of 18 x 18 in. Components can be spaced on 0.400 centers and up to 0.395 in. wide.

CIRCLE NO. 616

New Transducer modules

measure electric power

NEW!



These new power transducers compute instantaneous ac electrical power. Simple design and high quality yield excellent reliability at an **unprecedented price**. New capabilities meet the needs of hundreds of previously difficult or uneconomical applications. These include, $\pm 0.50\%$ accuracy, **50 Hz to 10 kHz** frequency range, one and three phase operation, accurate operation with non-sinusoidal waveforms, better than $\pm 0.25\%$ power factor influence and a $100\mu s$ response time.

Each transducer is encased in a small, tough nylon case for easy installation. Use the **inquiry card** to get complete technical data.

4949 Freeway Drive E
Columbus, Oh 43229
614/888-7501
TWX: 810-337-2851

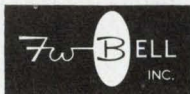

A subsidiary of The Arnold Engineering Company

CIRCLE NUMBER 126

ELECTRONIC DESIGN 13, June 21, 1976

MICROPROCESSOR SERIES NO. 4

2650 SUPPORT CKTS ARE ALL MULTI-SOURCED.



Available:
interface, ROM,
RAM, PROMs/
EROMs. Coming:
PPI, PCI, A-D
Converters, SDLC.
Specials from
AMS, too.

Attach to your letterhead.
Put me on your reservation list for
the first mailing on upcoming 2650
Interfacing Circuits.

Name	Title
Tel.	M.S.
811 E. ARQUES, SUNNYVALE, CA. 94086	

THINK SIGNOTICS μ P

a subsidiary of U.S. Philips Corporation

CIRCLE NUMBER 127

Heatless shrink tape bonds chemically

Insulation Systems Inc., 2698 Marine Way, Mountain View, CA 94043. (415) 964-1459. See text.

A heatless shrink tape adheres to

surfaces by a chemical bonding process. Conventional adhesives have been eliminated. The process produces a virtually homogeneous environmental seal after cure. Rated at -35 to 105 C, this PVC tape provides insulation protection at 600 V/mil. It is available in 1/2, 1 and 2-in. widths. A spool of tape 40-in. long and 1-in. wide costs \$1.30 (100 qty).

CIRCLE NO. 617

PC card ejectors are color coded

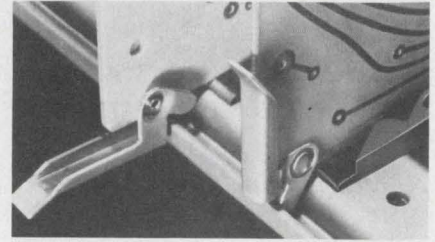

Unitrack Div., Calabro Plastics, Inc., 8738 W. Chester Pike, Upper Darby, PA 19082. (215) 789-3820. \$0.12 to \$0.22; stock.

A full line of color-identified metal PC-card ejectors for 0.060, 0.093, 0.125 and 0.156-in.-thick cards uses minimum card space—only 0.250 × 0.1 in. at one or both corners. Unitrack ejectors cam lever against the side rails to insert or eject cards easily. They also serve as a lock to hold the cards. Split-pins are furnished for attachment to cards. Riveting can also be used.

CIRCLE NO. 618



New from Standard Grigsby

P/relTM

the programmable rotary encoded logic switch everyone will be talking about...

... because no other rotary switch has as much versatility with as low a cost as Standard Grigsby's P/rel switch!

The economy is twofold. This switch not only lends itself to full automation, but installed costs are lower by the use of our printed circuit terminals (solder terminals are also available).

A specially processed printed circuit disc is fully

programmable to the truth table of any code. We provide 100% program disc inspection to customer specifications. Up to 60 detent positions are available with our new double ball Dual Flex™ detent. And, the use of concentric shafts allows up to 120 detent positions from a single switch!

Everyone will be talking about P/rel . . . so will you!

Send for your free "Yes" button and literature.



standard grigsby, inc.

920 Rathbone Avenue, Aurora, Illinois 60507, Phone (312) 897-8417

CIRCLE NUMBER 128

Chemical easily removes silicone compounds

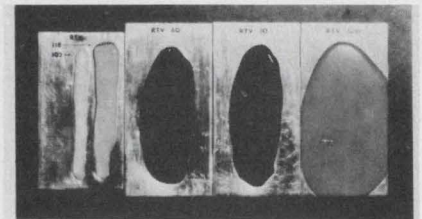

BEFORE

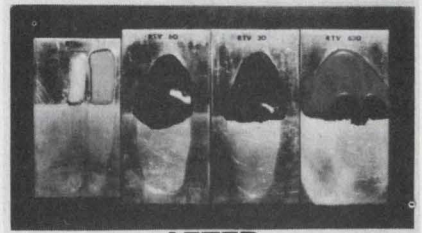

AFTER

McGean Chemical Co. Inc., 9520 E. Cee Bee Dr., Downey, CA 90241. (213) 773-3922. \$36.75 (5 gal.); stock.

The C-105H.F. silicone remover completely dissolves potting without affecting encapsulated parts. The chemical strips most types of silicone-rubber potting compounds, sealants and adhesives by simple immersion at room temperature. The company claims that it is safe for use on all common metals and on delicate structures.

CIRCLE NO. 619

Manual dicing saw suitable for short runs

Aremco Products, Inc., P.O. Box 429, Ossining, NY 10562. (914) 762-0685. \$1750.

The Accu-Cut Model 5025, a manual dicing saw for dicing and scribing ceramic, glass, silicon, and other semiconductor wafers, is designed for prototype lab work or short runs. The unit is console mounted on a 2 x 2-ft Formica top. The spindle turns at 5000 rpm and includes a self-contained coolant flow system. The work is mounted on an X-stage, accurate to 0.001 in. with a travel of 4 in. A Z-control permits depth adjustment to the 0.001 in. necessary in scribing work. The work is advanced manually under the diamond wheel. The machine will accommodate diamond wheels as thin as 0.004 in.

CIRCLE NO. 620

Microwave absorbent conforms to contours

Emerson & Cuming, Inc., Canton, MA 02021. (617) 828-3300. \$64.70/sheet: FGM-125, \$26.40/sheet: FGM-40.

Eccosorb FGM is a series of thin, flexible, broadband absorbers useful across the complete microwave frequency band. The series is based on silicone rubber. At present there are two members of the series. Eccosorb FGM-125 is approximately 1/8-in. thick and has an average reflectivity of -12 dB from 2 to 12 GHz; FGM-40 is approximately 40-mils thick and has an average reflectivity greater than -10 dB from 4 to 10 GHz. The material, in 12 x 12-in. sheets, is readily cut to size and shape. It can be used to line cavities in which antennas operate, applied to the masts of ships to improve radar performance or bonded to objects to reduce radar cross-section or back-scattering.

CIRCLE NO. 621

LSI socket molded into 94 V-O housing

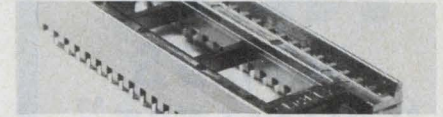

Molex Inc., 2222 Wellington Court, Lisle, IL 60532. (312) 969-4550. \$0.24: 24 position in tin (5000 up).

The 6097 closed-entry LSI socket combines Molex's Soldercon 1938 dual-beam contact with a new 94 V-O flame-retardant polyester housing. This new housing design incorporates many features such as a closed-entry cap—a tapered lead-in ramp to ensure positive positioning of the LSI in the contact areas—and a closed socket base to prevent solder wicking during wave soldering. The socket is available in 24, 28 and 40 positions on 0.1 x 0.6-in. spacing. Contact platings and materials are available in tin, selective gold and over-all gold on brass or phosphor-bronze material.

CIRCLE NO. 622

HEATH

Schlumberger

POWER SUPPLIES

with **MORE VALUE** for your dollar

Today's design engineer has to get the absolute most out of design dollars. And that's how Heath Power Supplies can help...with enough versatility to let you satisfy even the most specific, demanding supply applications...at a price that sets new value standards. Compare Heath Power Supplies for precision and performance...learn about quality that counts.

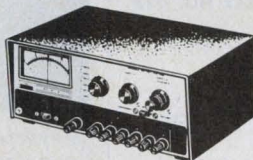

SP-2718 Tri-Power Supply



2700 Series Digital and Analog Power Supplies

Send today for your **FREE** Heath/Schlumberger Instrument Catalog

Heath Company,
Dept. 511-180
Benton Harbor,
Michigan 49022
EK-489



FREE!

Send for your catalog of value-proven instrumentation

CIRCLE NUMBER 129

MICROPROCESSOR SERIES NO. 5

2650 CRASHPROOF DEVELOPMENT SYSTEM: TWIN WITH DUAL FLOPPY DISKS.

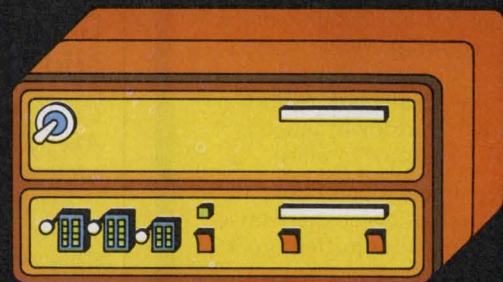

TestWare INstrument (TWIN) lets you develop software and hardware together in an actual environment.

Clip to letterhead. Mail now. Please send me 2650 Short Form Catalog full data on TWIN.

Name Title

Tel. M.S.

811 E. ARQUES, SUNNYVALE, CA. 94086

THINK **Signetics** μ P

a subsidiary of U.S. Philips Corporation

CIRCLE NUMBER 130

NEW WORLD'S "SMALLEST" LOWEST COST OPEN FRAME POWER SUPPLY

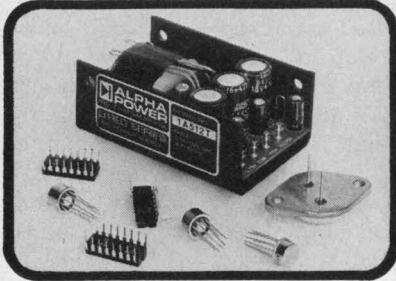

MICRO-REG SERIES

* SINGLE OUTPUT \$13⁵⁶
(5V @ .5A)

* DUAL OUTPUT \$19¹⁶
(±15V @ .1A)

* TRIPLE OUTPUT \$24⁷⁶
(5V @ .25A, ±15V @ .05A)

FEATURES:

- Single, dual and triple output models available in 3 case sizes and popular voltages
- ± 3% total tolerance fixed output voltage design reduces parts count, increases reliability
- Fully protected including thermal shutdown and built-in OVP on some models
- Repairable open-frame design is extremely cost effective replacement for potted types

*100 PC. PRICING "A" CASE
(FOR 1 PC. ADD 25%)

FOR INFORMATION CONTACT:



9020 Eton Avenue
Canoga Park, California 91304
Phone (213) 998-9873

CIRCLE NUMBER 131

PACKAGING & MATERIALS

Wire-wrappable board is single sided

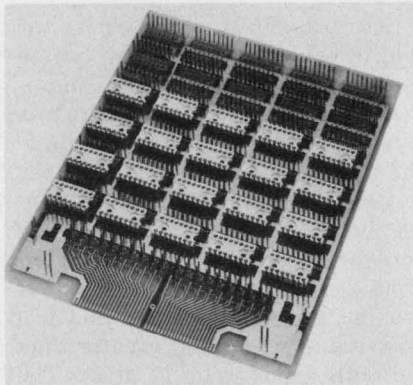

Garry Manufacturing Co., 1010 Jersey Ave., New Brunswick, NJ 08902. (201) 545-2424. \$1 to \$1.50 per IC; 2 to 4 wks.

A new single-sided wire-wrapable IC packaging panel allows boards to be mounted with unusually close board-to-board spacing . . . as close as 0.5-in. centers. The boards are available with standard DIP low-profile header assemblies or with individual-lead sockets. Unlike standard wire-wrapable panels, this new board has both the sockets and the wrappable pins on the same side. A particular advantage is that the panel is compatible with two-sided PC boards, and it can interface directly with existing PC-card panels or cage assemblies.

CIRCLE NO. 623

Grommeting fits odd shapes, large holes

Union Plastics Corp., 260 Schuyler Ave., Kearny, NJ 07032. (201) 997-5300. Stock.

Grommeting for irregular, odd shapes and large openings is possible with flexible Caterpillar Grommets. They provide insulation and scuff protection for wire bundles or tubing passing through bulkheads. Standard lengths (nylon—12-3/4 in., Teflon—19 in.) are available for bulkhead thicknesses from 0.015 to 0.510 in. The grommets are qualified to MS-21266 with nylon to 275 F and Teflon to 500 F. Grommets can be supplied pre-cut to length or in standard lengths.

CIRCLE NO. 624

Dispenser applies adhesive without mess

3M Co., P.O. Box 33600, St. Paul, MN 55133. (612) 733-5755.

A compact, mess-free adhesive system makes parts pressure sensitive for in-plant assembly work. Called Scotch Brand Assembly Aid, the system consists of a compact T-635 dispenser and a 6-in. wide roll of No. Y-909 positionable adhesive, 1.5-mils thick. When most smooth or irregular-surface parts are pressed against the dispenser, a specially formulated acrylic adhesive breaks cleanly and adheres only to the part as it is pulled away. The nondrying adhesive also permits repositioning of parts if inaccurate placement occurs.

CIRCLE NO. 625

Barrier terminal strips provide extra resilience

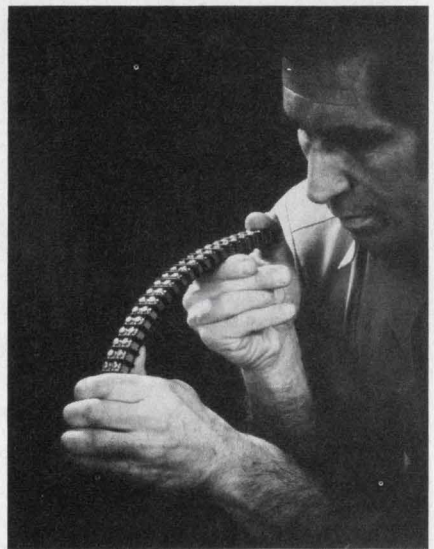

Vernitron Electrical Components, P.O. Box 10, Laconia, NH 03246. (603) 524-5101.

Three new series of extra-resilient barrier terminal strips provide a double-row of terminals that virtually eliminate breakage. They are made of a highly resilient glass-filled thermoplastic, offering many times greater impact strength than phenolics. The strips are available with 1-to-30 terminals. Two series are rated for 15-A service, and they have 3/8-in. terminal centers; one has 5-40 × 1/4-in. screws, the other 6-32 × 1/4-in. The third series is for 20-A use and has 7/16-in. terminal centers and 6-32 × 1/4-in. screws.

CIRCLE NO. 626

COMPONENTS

Rotary switches provide 0.1-in. pin spacing

Stackpole Components Co., P.O. Box 14466, Raleigh, NC 27610. (919) 828-6201.

The Series 80 subminiature rotary switch features the reliability and modular package of the Series 100 and 600, but its body is just $13/16 \times 9/16$ in. Unlike conventional configurations, in which contacts are added to the body, this rotary switch has contact decks separated by themoset insulation. Unnecessary terminals are removed from the periphery; internal shorting and nonshorting cuts may be varied to provide a large variety of configurations. For PC-board insertion, pin centers are 0.1 in. between pins and decks to fit standard configurations. Also, the contacts may be soldered or harness connected.

CIRCLE NO. 627

Miniature motor employs hollow-rotor design

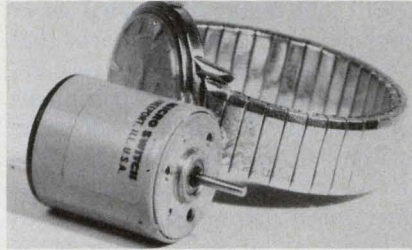

Micro Switch, a division of Honeywell, 11 W. Spring St., Freeport, IL 61032. (815) 232-1122. \$10 (OEM qty).

A high-performance dc motor, the 126 EM, only 1-in. long and 1 in. in diameter weighs less than 3 oz. The motor's hollow-rotor design offers ripple-free torque and quick response. Long life is ensured by its precious-metal construction, according to Micro Switch. A special epoxy coating provides environmental protection. Options such as ball bearings, alternate mounting, lead wires and a variety of windings are available.

CIRCLE NO. 628

LED display matches thumbwheel switches

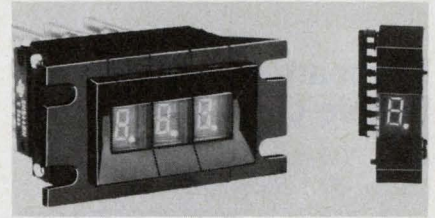

Cherry Electrical Products Corp., 3600 Sunset Ave., Waukegan, IL 60085. (312) 689-7702. \$9.86 with driver (1000 up).

A new seven-segment LED indicating unit in a thumbwheel package, T51-02, can be used with any BCD-coded thumbwheel switch. The unit features bright-red, 1/4-in.-high digits that operate at logic-level voltages. Dimensionally similar to Cherry's popular T50 series thumbwheel, it measures $0.315 \times 0.709 \times 0.984$ in. In addition to BCD inputs, the T51-02 is also available in blanking-input/ripple-blanking-output versions with automatic zero-suppression control.

CIRCLE NO. 629

togetherness!

Murata's new Piezoelectric Tuning Forks and Companion Hybrid I.C.'s for Precision Signaling and Control!

There's a new dimension in solid state tone signaling and control with Murata's microminiature EFM-GA/GC piezoelectric tuning forks and companion hybrid I.C. systems. Vastly improved temperature stability, reliability, resistance to shock and vibration, and greatly increased flexibility through the frequency independence of components combine to provide a "plug-in" encoding and decoding capability second to none. Find out how these new systems can be put to work for you. Write for complete technical details.

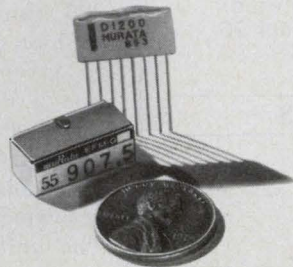

muRata
CORPORATION OF AMERICA
2 WESTCHESTER PLAZA, ELMSFORD, NEW YORK 10523
Phone: 914-592-9180 Telex: 13-7332

CIRCLE NUMBER 132

ELECTRONIC DESIGN 13, June 21, 1976

MICROPROCESSOR SERIES NO. 6

2650. APPS ENGINEERS: IN STOCK NOW.

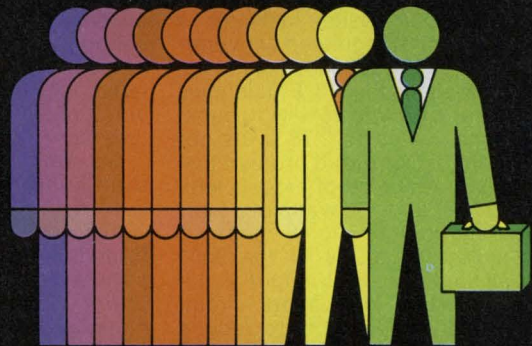

Dozens of people to support systems, hardware, testware, devices in USA and Europe. More coming.

Attach to your letterhead. Mail. Send me the list of 2650 Applications Engineers with addresses & phone numbers.

Name _____ Title _____

Tel. _____ M.S. _____

811 E. ARQUES, SUNNYVALE, CA. 94086

THINK
Signetics μ P
a subsidiary of U.S. Philips Corporation

CIRCLE NUMBER 133

171

COMPONENTS

Keyboard switch offers double cross-point set

Data Interfaces, Inc., 12 Cambridge St., Burlington, MA 01803. (617) 272-7456. \$0.25 (500,000 up).

The Model DI-104 keyboard switch is a companion to the pre-

viously announced Model DI-100, the Double Cross-Point. The new unit has less than 0.5-in. profile height and features a double set of cross-point gold-alloy contacts that are enclosed to prevent foreign-particle contamination. Terminals are sealed to allow soldering. Switch life is 20-million operations and over 4-billion test operations have been accumulated without failure.

CIRCLE NO. 630

Stackable thermal heads print 10 columns



Gulton Industries, Inc., Metuchen, NJ 08840. (201) 548-2800. \$47.25 (100-499); 4 wks.

The DM1150 thermal printhead for medium-speed applications contains a single row of 10 groups of five heater dots for printing up to 10 columns of 5 × 5 or 5 × 7 matrix characters. The printhead employs close dot spacing for a high-density high-legibility print-out. Additionally, the design allows for stacking printheads edge-to-edge to expand the column capability. The printheads can be interconnected for multiplexed operation with the chip-isolation diodes included onboard. Only the paper is stepped. Speeds to 8 lines/s can be obtained. Nominal dot pulse power is 1.36 W for 10 ms on 3M, No. 161 thermographic paper.

CIRCLE NO. 631

EFFICIENCY EXPERT.

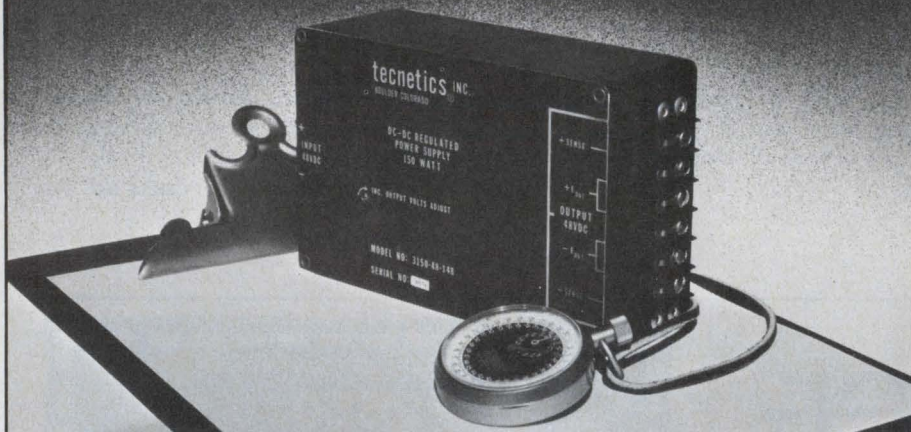

Up to 86% efficiency in Tecnetics DC to DC regulated converters.

When your design calls for a highly efficient regulated converter in a compact package, Tecnetics' 3000 series fits the bill. Efficiencies range from 66% to 86% with packing densities up to 2.78 watts per cubic inch. Our broad product line gives you a choice of models with 25, 50, 100 and 150 watts of power and outputs from 5 to 48 volts.

Standard features of the 3000 series include input-output isolation, overload and short circuit protection, input filters to reduce conducted EMI, and remote error

sensing to insure that the proper voltage is maintained at the point of load. All units are fully encapsulated and designed to meet the vibration, shock, humidity and altitude specs of MIL-E-5400.

So, when you are looking for state-of-the-art power converters, look to Tecnetics, the company with proven expertise. For more information and prices on the 3000 series, or three-hundred other power supplies, write for our 26 page catalog.

3000 SERIES HIGH EFFICIENCY REGULATED CONVERTERS

Output Power	150, 100, 50, & 25 watt models
Output Voltages	13 standard outputs from 5 to 48 V
Input Voltages	28VDC or 48VDC (48 VDC only on 150 w units)

Price range: \$395-\$525.

Dimensions (excluding terminals):

25 & 50 watt:	4x4x2 inches 36 oz. Fully encapsulated
100 & 150 watt:	6x4x2½ inches 60 oz. Fully encapsulated

Regulation:

Line (LL to HL)	0.3%
Load (½ to FL)	0.1%
Load (NL to FL)	0.4%
Temp	0.01% / °C

tecnetics® The Power Conversion Specialists P.O. Box 910,
1625 Range Street, Boulder, Colorado 80302 (303) 442-3837 TWX 910-940-3246

CIRCLE NUMBER 134

Solid-state relay features low cost

Sigma Instruments Inc., 170 Pearl St., Braintree, MA 02184. (617) 843-5000. \$3.80 (1000 up).

Solid-state relay, Series 226, can switch 1.5 A ac with its integral heat sink or to 7 A with an external heat sink. Connections to the 226 can be made via standard push-on connectors; or the unit can be inverted and inserted directly into a PC board for wave soldering. The case allows submersion in PC-board cleaning solvents. A LED opto-isolator in its input can be activated by standard TTL gates. The unit's integral heat sink has the shape of a TO-3 power transistor; thus permitting the use of any of the many standard TO-3 heat sinks for additional heat dissipation.

CIRCLE NO. 632

Time-delay relay blinks to tell cycle progress

Automatic Timing & Controls Co., King of Prussia, PA 19406. (215) 265-0200. List: \$40.

A new time-delay relay, the 328 TDR, features multiranges, three modes of operation and a variable-rate blinking pilot light that allows low-cost elapsed-time indication. A dial range of 1 to 10 seconds, minutes or hours can be selected from the front of the panel. Once range is established, the knob can be removed to prevent unauthorized changes. An 11-pin blade socket allows programming the unit for on-delay, off-delay (3-wire start circuit) or interval modes. Before timing, a display LED is off. During timing, an ever increasing rate of blinking occurs. The LED blinks once every 3-1/2 s during the first 10% of the cycle, twice during the second 20%, etc. At time-out, the LED pulses at a high, constant rate. Electrical rating is 1/10 hp or 5 A at 125 or 250 V ac.

CIRCLE NO. 633

Pressure switches have adjustable trip points

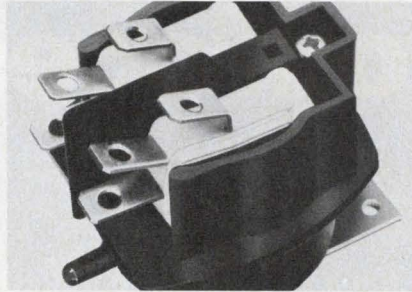

Logicomp Electronics, Inc., 52 Fayette Rd., Scarsdale, NY 10583. (914) 723-3334. \$4.68; 6801 SPDT (100 up); stock.

This Series 6800 pressure switch trips at pressures in the range of 4 to 100 in. of water. The trip pressure can be changed with only one adjusting screw. Model 6808 is vacuum operated. The switches come in a variety of contact configurations up to 2PDT and ratings up to 15 A, 250 V. A double-action model operates one set of contacts at a low pressure and another at a higher pressure.

CIRCLE NO. 634

Encoding systems adapt to industrial use

Astrosystems Inc., 6 Nevada Dr., Lake Success, NY 11040. (516) 328-1600. From \$550 (1-4); stock.

An expanded line of modularized position-encoding systems is available for both single-turn and multi-turn applications with absolute resolution to 100,000 counts. Electromagnetic transducers are available as small as 1.1-in. dia or in NEMA 12 housings. Shared electronics provide a cost-effective solution to multi-axis position read-out. A complete range of digital resolutions with binary or BCD outputs and visual displays is available. Offset units provide zero reset and preset capability over the entire encoder range. A maximum of eight wires are required between the transducer and the electronics packages, regardless of resolution. Transducers can be located up to 200 ft from the electronics unit. Logic level outputs are DTL/TTL compatible.

CIRCLE NO. 635

We started a counter revolution

... in 1964, when we introduced the Hecon line ... every kind of electro-mechanical, electronic and pneumatic/fluidic counter imaginable, from totalizing to predetermining to batching ... every single one tested before it leaves our plant.

Find out for yourself. Contact us for free catalog today.



HECON CORPORATION
P.O. Box 247
Tinton Falls, N.J. 07724
Phone (201) 542-9200
HECON CANADA INC.
80 Galaxy Blvd.
Rexdale, Ontario M9W-4Y8
Phone: (416) 678-2441

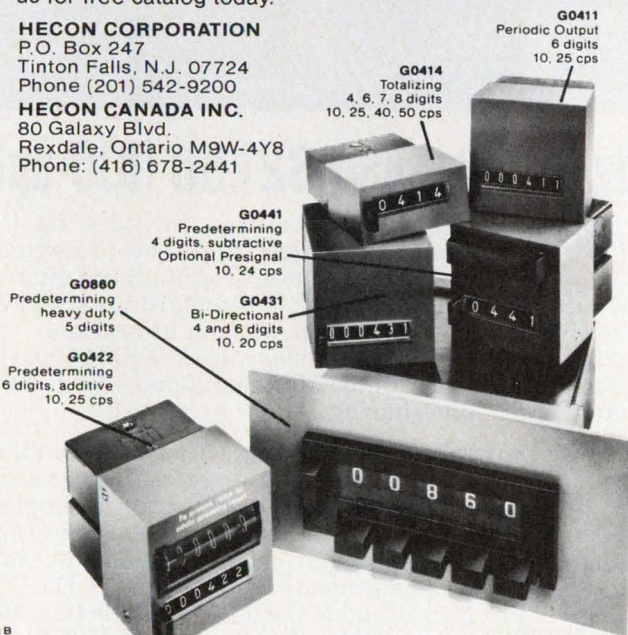

CIRCLE NUMBER 135

ELECTRONIC DESIGN 13, June 21, 1976

MICROPROCESSOR SERIES NO. 7

**BY SEPTEMBER
THE 2650 IS OVER
30% FASTER.**

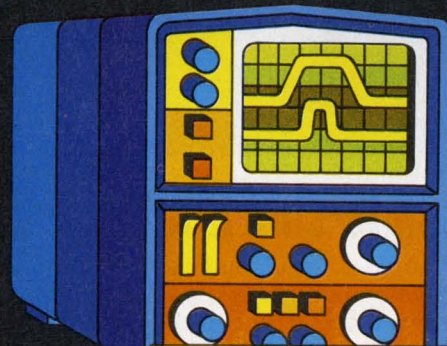

Your system's features can be extended with the speedier 2650. Current 2650 software will apply.

Clip to your letterhead. Put me on your reservation list for the first mailing of the faster 2650 data sheet.

Name _____ Title _____
Tel. _____ M.S. _____
811 E. ARQUES, SUNNYVALE, CA. 94086

THINK

Signetics μ P
a subsidiary of U.S. Philips Corporation

CIRCLE NUMBER 136

The easiest-to-use microprocessor

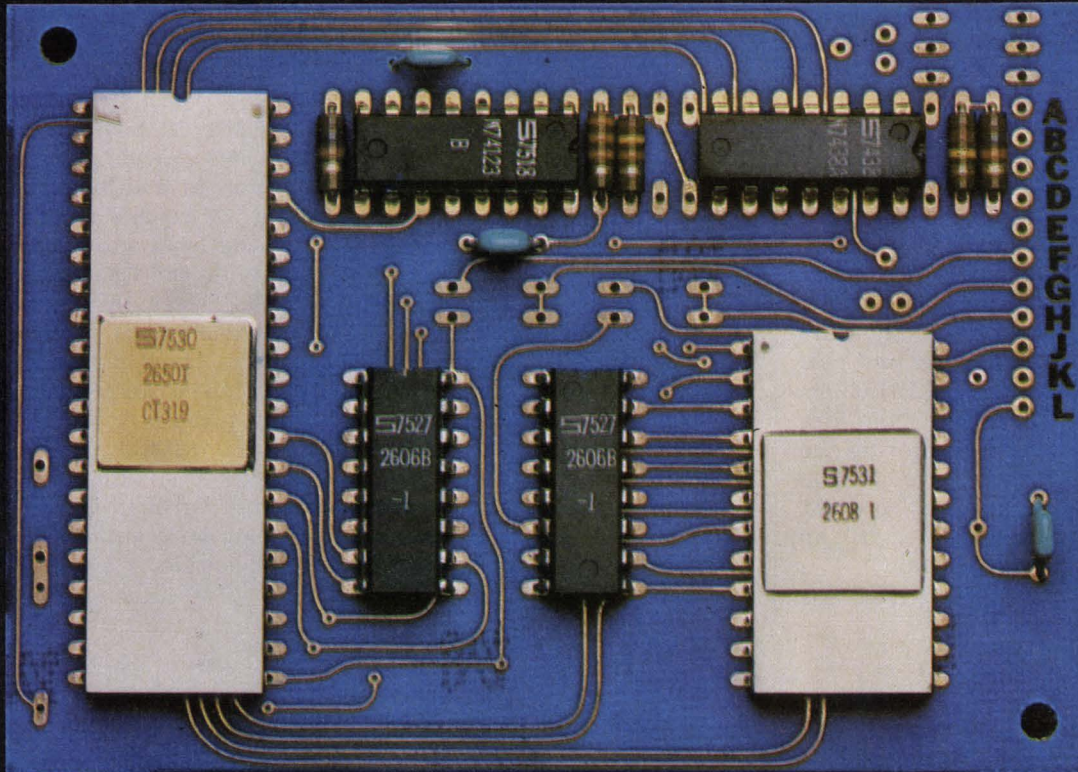

(Photograph approximately 2x actual size.)

The single-chip 2650 is easiest-to-buy, too. Now only \$21.50 (100-up).

Full support of customer and product is the key to ease of development with the 2650. Applications engineers in the U.S. and abroad are at your beck and call at every stage. Software for almost anyone's requirements and machines. Development hardware is versatile and inexpensive. All circuits are multi-sourced.

Flow Chart: How to travel safely and quickly from spec sheet to your μ C.

- 1 Applications Engineers — in the field now, more coming. Specific assistance to you is available around the USA, and in Belgium, Holland, Germany, France, Sweden, Britain, Italy, etc.
- 2 Multi-sourced 2650 — available in any quantity from Signetics, at the unprecedented low price of \$21.50. Also available from AMS and Philips, and from Signetics' authorized distributors.

- 3 Development Software — includes the PL μ S, an extremely efficient High Level Language (compiler) that reduces programming effort and cuts development time. ANSI standard Fortran IV executes on most machines without alteration. 2650AS1000/1100 Assembler and 2650SM1000/1100 Simulator are available in both 32- and 16-bit, on GE and NCSS time-sharing.

- 4 Multi-sourced Support Circuits — You'll need MOS and/or Bipolar Memories, Interface and Logic. Signetics has *everything* for a complete system. Back up any item from other sources. Coming soon from Signetics are: Programmable Peripheral Interface and Communications Interface, A-D Converters, Synchronous Data Link Controller, 16k NMOS & Bipolar ROMs, 4k & 8k NMOS EROMs, and 8k Bipolar PROMs.

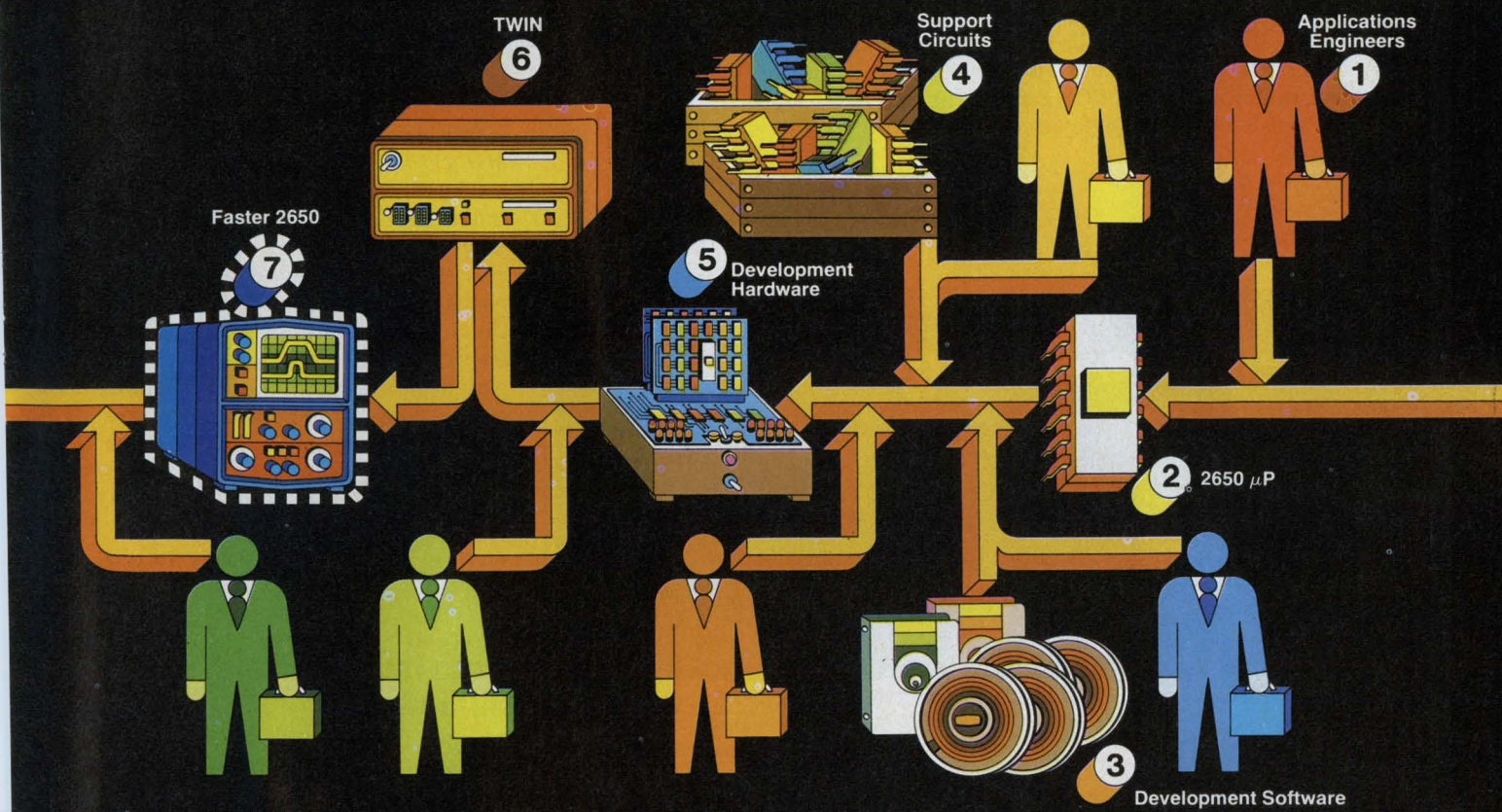

makes the easiest-to-develop microcomputer.

- 5** Development Hardware — Design/develop/prototype with a variety of cost/capability levels of hardware support. Including prototyping cards and kits, smart typewriter demo card, 4k-byte RAM card, and more. Applications help if you need it.
- 6** TWIN With Floppy Disks — “crashproofs” your system checkout. With DOS, Resident Assembler, and Text Editor. You develop programs and circuits together in an actual system environment with TWICE (TestWare In Circuit Emulator). PROM programming, too.
- 7** Over 30% Faster 2650 — By the time you’ve proven out your μ C, you’ll have available a faster 2650 if you want it. Uses the same software. For still higher speeds, call Signetics Bipolar Microprocessor Marketing about our 2650 emulator using 3000 series μ P.

You go from gleam-in-your-eye to proven prototype in less time for less cost, and the μ C you develop is easier and cheaper to produce in quantity, when you start with the 2650. Start now by mailing the coupon.

Attach this to your letterhead for fast response.

Send me complete 2650 short form catalog.
 Have a Field Applications Engineer call me for appointment.
 My need is: immediate 6 months information only
 My application is _____

 Name Title
 Telephone Mail Stop

THINK signetics μ P
a subsidiary of U.S. Philips Corporation

811 E. Arques Ave., Sunnyvale, Ca. 94086

COMPONENTS

Cermet-film resistors have 50 ppm/°C TCs

Allen-Bradley, 1201 S. Second St., Milwaukee, WI 53204. (414) 671-2000. \$0.11 (1000 up); 4 to 6 wks.

Allen-Bradley's Type CC cermet-film resistor, a single-sized

"universal" component offered in many variations, is now available with a temperature coefficient of resistance of 50 ppm/°C in tolerances of 1% and 0.5%, approved to MIL-R-10509F for style RN55C. Type CC is the only resistor of its type approved for values from 10 Ω through 499 k Ω for style RN55C; others are approved only for the limited range of 49.9 Ω through 100 k Ω .

CIRCLE NO. 636

Improved solenoids use high-perm steel

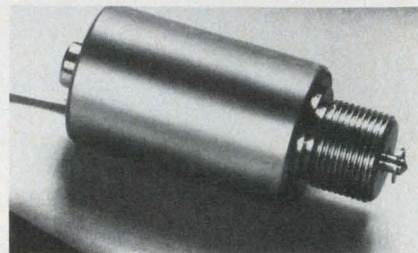

North American Philips, Frederick, MD 21701. (301) 663-5141.

The high-permeability steel cylinder that encloses the solenoid's magnetic field allows the 7004 Series tubular solenoid to provide positive and efficient plunger action. Close-tolerance parts ensure operation efficiency, and a nickel-plated plunger and phenolic bobbin ensure long life. Solenoid designs provide pulls from 2 to 28 oz with strokes from 1/32 to 1/4 in. Available voltages include 6, 12, 24, 48, 90 and 115 V dc.

CIRCLE NO. 637

Reliable AC line filters

Advanced engineering of inductors combined with the unique ceramic capacitor technology acquired from Allen-Bradley offers the reliability your equipment demands. Spectrum power line filters are designed for:

125/240VAC @ 125°C 0-400 HERTZ

Proven Reliability

Controlled thermal characteristics

Limited AC voltage rise

Volumetric efficiency

Available in C, Pi, L, T

Mil-F-15733

TYPICAL PARTS	I Amps	Volts AC	Insertion Loss —Db		
			150KHz	10MHz	1GHz
54-367-006	15	125	12	53	65
51-353-112	3	125	13	70	70
51-320-023	1	240	24	70	70

For other ratings — see EEM 1-576 to 1-583

AVAILABLE from stocking distributors

HALL-Mark ELECTRONICS 215-355-7300 MOLTRONICS 213-773-6521
METUCHEN CAPACITOR 201-442-0500 ROSE ELECTRONICS 415-697-0224

ELECTRO 76 Boston Booths 2624/2626

IEEE EMC Symposium Wash. D.C. Booths 31/32

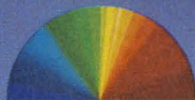

SPECTRUM CONTROL INC.
152 EAST MAIN ST. · FAIRVIEW, PENNSYLVANIA 16415



SPECIALISTS IN ELECTRO-MAGNETIC COMPATIBILITY

For a complete EMC solution let us test and analyze your equipment.

Opto-isolated relays minimize rfi

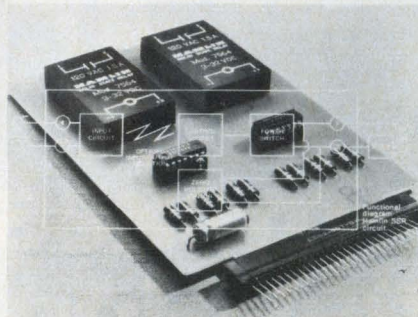

Hamlin Inc., Lake and Grove Sts., Lake Mills, WI 53551. (414) 648-2361. \$8.80 to \$13.65 (500 up); stock.

Opto-isolated solid-state relays, Series 7500, that mount on PC boards incorporate a circuit that reduces rfi to a minimum, according to Hamlin. Zero-level switching takes place at as low a voltage as possible in the ac cycle. The window measures 4 to 10 V with a threshold voltage of only 4. Features include: IC compatibility, 1500-V-ac input/output isolation, and ratings up to 1.5 A at 240 V ac. Miniature and low-profile versions are available. NOSPST is standard for all units; NCSPST is an available option.

CIRCLE NO. 638

Replace lamp from front in lighted PB assembly

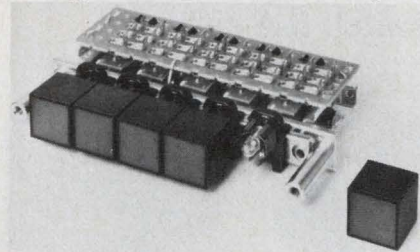

Oak Industries Inc., Crystal Lake, IL 60014. (800) 435-6106. \$1.65 per button (OEM qty); stock.

Designated Series 1300, a new family of lighted-pushbutton switches is suitable for a wide range of applications. The single-lamp can be replaced from the front. Lenses come in white, red, green, yellow, orange and blue. Buttons are on 3/4-in. centers with a maximum of 21 pushbuttons per bank. Low-power models offer up to a 10-pole switching capability per button with contacts rated at 1 A, 28 V dc. Standard contact material is silver-plated brass with options including a wide range of precious metals. A power-rated type has one DPDT switch per button with a single-sided stator or a 4PDT with a double-sided stator. Coin-silver contacts are rated at 6 A, 125 V ac.

CIRCLE NO. 639

Wire-wound resistors rival film prices

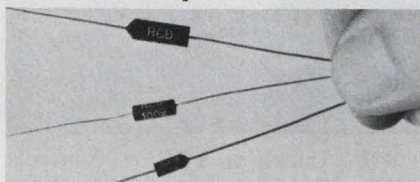

RCD Corp., 8 Blueberry Lane, Bedford, NH 03102. (603) 669-0054. Typical \$0.39 (100 up); 3 to 4 wks.

Low priced Series Q precision instrument-grade resistors sell at approximately half the price of equivalent metal-film resistors, according to RCD. The resistors are available in five axial-lead styles, which are exact counterparts to the RN55, RN60, RN65, RN70 and RN75 types. They are available in tolerances of 0.01%, a temperature coefficient of 0 ± 2 ppm/ $^{\circ}$ C, any resistance value from 0.05 Ω through 40 k Ω , a thermal emf $\leq 2 \mu$ V/ $^{\circ}$ C and noise levels ≤ 40 dB.

CIRCLE NO. 640

"You can design your own ICs"

-H.R. Camenzind
Creator of the 555 Timer

Monochip is the way to do it. It's a low cost, fast way to make custom IC's. \$1800 gets you 50 prototypes in three weeks. Very simple. We taught the old IC technology some new tricks and built a multi-million dollar business around it. With volume delivery and second sourcing.

Get started with our \$39 Monochip Design Kit. It contains easy-to-follow instructions, parts and design aids, everything you need to Monochip your circuit.

interdesign

The Real Custom IC House.



555

THRESHOLD

10k

1255 Reamwood Avenue, Sunnyvale, CA 94086 (408) 734-8666

Interdesign

Name _____ Company _____

Address _____ City _____

Phone _____

State _____ Zip _____

My check is enclosed for the Monochip Design Kit (\$39)

Send only technical details on Monochip.

CIRCLE NUMBER 139

MAGNETIC SHIELDING

MATERIAL

- CO-NETIC AA Alloy
High Permeability
.002" to .100" thick

EXCLUSIVE

Perfection Annealed — No further anneal required if severe forming is avoided.

- NETIC S3-6 Alloy — High Saturation Induction.
.004" to .095" thick
- Immediate Shipment from Stock

SEND FOR NEW MG-3

Material, Application & Fabrication Guide



MAGNETIC SHIELD DIV.



PERFECTION MICA CO.

740 N. Thomas Dr.
Bensenville, Ill. 60106
Ph. (312) 766-7800
TWX (910) 256-4815

*The Preferred Source
for Magnetic Shielding*

CIRCLE NUMBER 140

Kertron makes the Big Switch

**High Voltage • High Current
Fast Switching
Power Transistors**

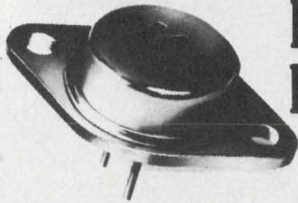

For use in switching power supplies. Safely switch inductive loads. High Reliability construction with ultrasonic lead attach and hard solder die bonding.

KERTRON

INCORPORATED

7516 Central Industrial Dr.
Riviera Beach, Fla. 33404

Tel. 305/848-9606 TWX 510/952-7611

2N5038	2N6306	2N6542
2N5039	2N6307	2N6543
2N5671	2N6308	2N6544
2N5672	2N6338	2N6545
2N6249	2N6339	2N6546
2N6250	2N6340	2N6547
2N6251	2N6341	

All standard JEDEC packages and special hybrids available.

Other products include a full-line of NPN and PNP power transistors, both Darlington and Discretes with current capability to 100 Amps and voltage ratings to 750 Volts.

CIRCLE NUMBER 141

COMPONENTS

Lightweight relays switch 5-A current

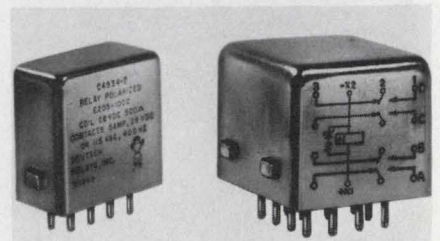

Deutsch Relays Inc., 65 Daly Rd., East Northport, NY 11731. (516) 864-6000.

A two-pole relay, E205, for switching aircraft power, weighing less than 1/2 oz and occupying less than 1/4 in³ is rated at 5 A for 28 V dc or 115/200 V ac, 400 Hz. A companion four-pole, three-phase model, E405, weighs only 0.85 oz and occupies 0.42 in³. They are said to be the smallest and lightest relays ever made that can switch substantial power and meet MIL specs. Maximum operating time at 25 C is 7 ms; maximum release time 5 ms. Life at rated load is 100,000 cycles minimum.

CIRCLE NO. 641

Magnetic latching reduces contact bounce

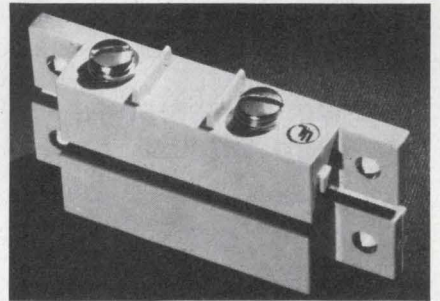

North American Philips Controls Corp., Cheshire Industrial Park, Cheshire, CT 06410. (203) 272-0301. \$1.60: form A (100 up); stock.

The 9220-series mechanical relay is a UL-listed surface-mounted proximity switch used primarily in security alarm systems. It features improved magnetic latching to reduce the chance of a contact bounce induced by shocks or vibration. Gold-flashed contacts resist corrosion and assure reliable switching over extended periods of time. The switch is available in 50-mA, 130-V dc, SPDT, SPNO or SPNC models. Housings are white or grey, ultrasonically welded plastic.

CIRCLE NO. 642

Independent on/off adjustments on TDR

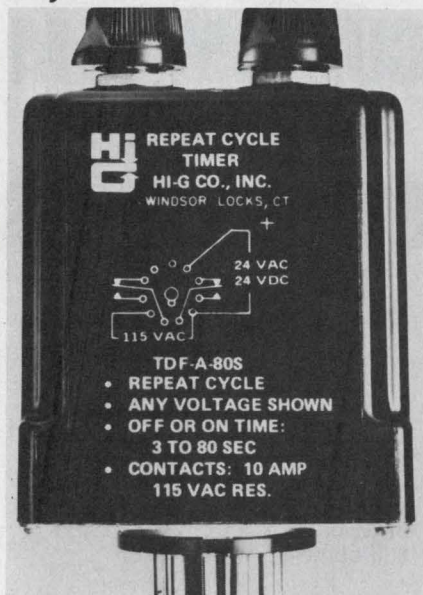

Hi-G Co., Inc., 580 Spring St., Windsor Locks, CT 06096. (203) 623-2481. \$40 (1 to 9); distributor stock.

A new continuous on/off cycling time-delay relay operates on any one of three input voltages—24 or 120 V ac, or 24 V dc. Featuring CMOS digital circuitry, Model TDF has noninteracting independent controls to adjust the on/off time ratio. The hookup operates from 45 to 440 Hz. DPDT output contacts handle 10-A resistive loads. Three different delay ranges to 300 s are stocked with delays to 2 h available.

CIRCLE NO. 643

Feed-through filter handles 200 A

Sprague Products Co., North Adams, MA 01247. (413) 664-4481.

A heavy-duty feed-through filter to suppress alternator and generator noise in mobile CB radios, Type QXI-600, is rated 0.5 μ F at 600 V dc. It has a current-handling capability of 200 A, making it the heaviest-duty noise filter in the Sprague Q-Line. Typically, the QXI-600 will suppress up to 30 dB of unwanted noise in the range of 4 to 30 MHz. The filter is hermetically sealed in a metal case. It has flattened-rod terminals with vibration-resistance screw connections. The filter comes pre-packaged with a 7-in. accessory cable and complete installation instructions.

CIRCLE NO. 644

Vibrator feeds delicate parts

Sensonics, Inc., 25 Louis St., Hicksville, NY 11801. (516) 938-7520. \$37.40 (1-9); stock.

Model 340 Vibratrap miniature vibrators can be mounted directly on hoppers, trays and chutes to facilitate the feeding of small delicate parts for dispensing, moving,

grading, counting, sorting and packaging applications. They also can be attached easily to containers and tubes for liquid or solid-particle agitation. The unit comes equipped with a three-wire line cord, switch and grounded plug for 110/120-V-ac use. The compact, 1-1/4-oz unit (1-1/4 \times 1-1/4 \times 3/4-in.) mounts with screws or double-sided tape.

CIRCLE NO. 645

It's all over.

Surprisingly enough, the best kept secret in town was patented over eight years ago. That's right. ICC is the largest and oldest independent manufacturer of light pens in the world. So we can offer performance at the right price — right off-the-shelf.

Our fast-response pens work well with vector and alphanumeric computer graphics, radar displays, automated signs, IC mask or schematic designs, and even color graphics.

So if you're looking for light pens, your search is over. Information Control Corporation, (213) 641-8520.

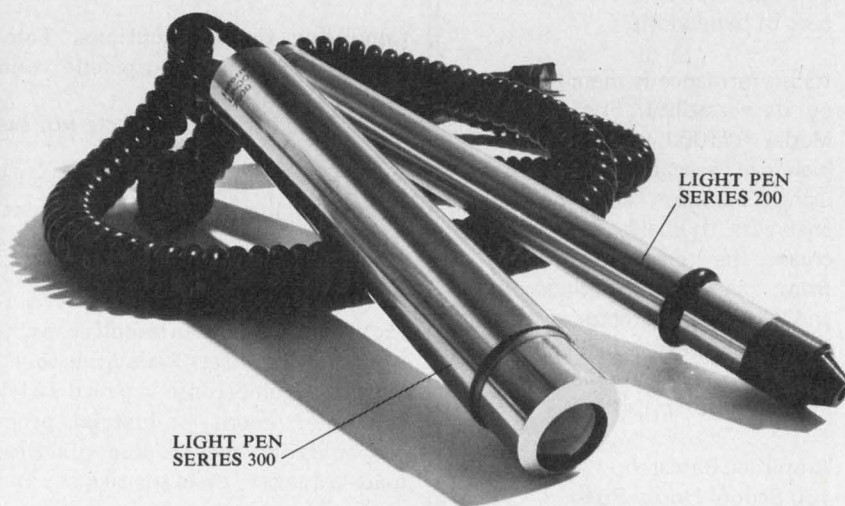

FREE. Go for it.

Send us this coupon now. We'll send you our "Understanding Light Pens" book.

Name _____ Date _____

Company _____ Phone _____

Address _____

City/State/Zip _____

ICC, 9610 Bellanca Avenue, Los Angeles, California 90045

CIRCLE NUMBER 142

NEW

ULTRA WIDEBAND AMPLIFIER



Model 1W1000

1 to 1000 MHz 1 Watt Linear

Here's a unique, all-solid-state amplifier that delivers 1 watt of swept power output from 1 to 1000 MHz instantaneously. It's the Model 1W1000 from Amplifier Research. A reliable, unconditionally stable unit, the new Model 1W1000 provides 1 watt of linear power over three decades of bandwidth.

Its performance is matched only by its versatility. For example, Model 1W1000 can be used with high-level sweepers, VSWR measuring systems and network analyzers. It's also used to increase the sensitivity of spectrum analyzers, oscilloscopes and wideband detector systems. It has all the bandwidth you'll ever need. For complete information, write or call:

Amplifier Research
160 School House Road
Souderton, PA 18964
215-723-8181



Your Best source for RF Power Amplifiers

CIRCLE NUMBER 143

Vendors Report

Annual and interim reports can provide much more than financial position information. They often include the first public disclosure of new products, new techniques and new directions of our vendors and customers. Further, they often contain superb analyses of segments of industry that a company serves.

Selected companies with recent reports are listed here with their main electronic products or services. For a copy, circle the indicated number.

General Instrument. Semiconductors, components, cable TV and data products.

CIRCLE NO. 646

Lloyd's Electronics. Radios, tape recorders and players, calculators and home stereo systems.

CIRCLE NO. 647

Ampex. Professional audio and video equipment, data products and peripherals, cores and core memory storage systems and magnetic tape.

CIRCLE NO. 648

Computer Communications. Telecommunications equipment and systems.

CIRCLE NO. 649

Penril. Point-of-sale terminals, data modems and test equipment.

CIRCLE NO. 315

Gulf & Western Industries. Energy products, automotive/aviation, public safety, machine tools, electrical/electronic products, consumer goods, industrial process controls, metals and plastics, heat-transfer components and natural resources.

CIRCLE NO. 800

Perkin-Elmer. Analytical instruments, electro-optical systems and precision optics, digital computers, avionic instruments, flame-spray equipment and supplies, and high vacuum equipment and systems.

CIRCLE NO. 801

High Voltage
CRT Power Supplies...

CUSTOM OEM DESIGN AT STOCK PRICES

When you need a high voltage power source for your CRT applications, the first problem you're faced with is that old make-or-buy syndrome.

But high voltage is very irritable stuff. Unpredictable, too, unless you've got guys in your shop who've specialized in taming it.

You can go to a hell of a lot of work, time and expense and still come up with a loser.



But
not any more.

Now you can skip all that nonsense. Keltron specializes in custom OEM design at stock prices. Our packaged HV Power Sources give you optimum performance at surprisingly low cost in tested, fully burned-in, totally silent modules.

Your choice of outputs: 10 through 20 KV @ 5 or 10W max; line and load regulation of .1%; inputs of 24 VDC, 115 or 230 VAC; totally short-circuit and arc-proof. With full replacement warranty for one full year.

The price? Just \$60.60 and up (for one, yet), from stock. We deliver standards in three weeks; only 8 to 12 weeks for custom OEM design.



Let us
know
your needs.



KELTRON CORPORATION

High Voltage Division
225 Crescent St., Waltham, Mass. 02154
(617) 894-0525

CIRCLE NUMBER 144

ELECTRONIC DESIGN 13, June 21, 1976

Application Notes

Holding PCB components

"The Stabilizer Process," a 12-page booklet, describes a method for temporarily attaching components to PC boards. The paper contains 14 photographs, which illustrate the various stages in the stabilizing process; and five tables, which contain test data results. Hollis Engineering, Nashua, NH

CIRCLE NO. 802

YIG products

A 14-page brochure covers YIG-tuning, its outstanding capabilities but also some inherent limitations. A number of YIG applications are described. Sivers Lab, S-126 12 Stockholm 42, Sweden.

CIRCLE NO. 803

Poor man's stepper

How to make a low-cost synchronous motor do the job of a stepper motor is the subject of a new app note. Detailed examples are given in a TV tuner and an electrostatic precipitator. North American Philips Controls, Cheshire, CT

CIRCLE NO. 804

Solder basics

A 16-page booklet on the selection and use of solder recounts important solder applications and suggests advantages of the soldering process over alternative joining methods. Lead Industries Association, New York, NY

CIRCLE NO. 810

Phase-noise measurement

The use and application of the company's Model 800B phase noise analyzer is covered in a four-page brochure. The note discusses the method of taking phase noise and spectral density measurements on microwave signals in the 1-to-12.4-GHz range to within less than 1 Hz of the carrier with resolution of better than 1°. Frequency Engineering Laboratories, Farmingdale, NJ

CIRCLE NO. 811

The finest switches are also the easiest to install

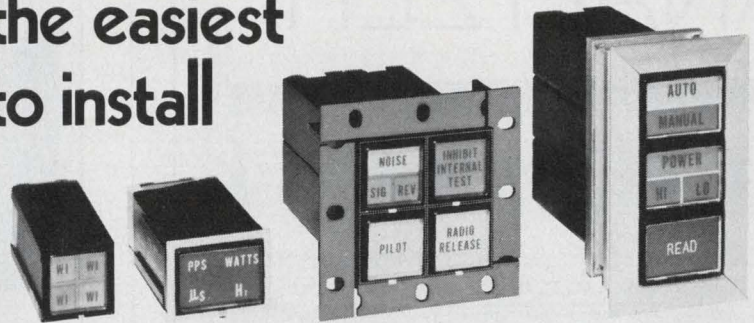

Quick and easy to mount, Stacoswitch individual and matrix illuminated push-button display switches save installation time and cost. Matrix available with rear mounting flanges or a new front mounting dress bezel that will enhance the most modern panel design. And where dependability is a prime requirement Stacoswitch will keep working long after lesser switches have failed. Choice of switch action and contact arrangement, 2PDT or 4PDT. Wide selection of display colors and legend styles. You can't do better than with Stacoswitch. Write today for General Catalog giving complete description and specifications. When you think switch... think Stacoswitch.



1139 BAKER STREET, COSTA MESA, CALIF. 92626
(714) 549-3041 TWX: 910/595-1507

Other STACO Company products: Custom Transformers, STACO, INCORPORATED, Richmond, Indiana; Variable Transformers, STACO, INCORPORATED, Dayton, Ohio.

CIRCLE NUMBER 145

Encapsulated Power Supplies

Call Toll free 1-800-327-8983

(Except Florida (305) 974-5500)

For Same Day Shipment

From the World's Largest Manufacturer of Encapsulated Power Supplies

Popular Ranges

	CHASSIS MOUNT	PC MOUNT		CHASSIS MOUNT	PC MOUNT
5V,500mA	\$69	\$51	± 15V,100mA	\$ 64	\$51
5V,1000mA	\$79	\$72	± 15V,200mA	\$ 79	\$72
5V,2000mA	\$99	\$89	± 15V,350mA	\$109	\$99
± 12V,240mA	\$79	\$72	± 15V,500mA	\$124	—

34 other models available from 3.6 to 28V
2 Year Warranty



Computer Products, inc.

FT. LAUDERDALE, FLA.

CIRCLE NUMBER 146

6800 μ P ANALYZER

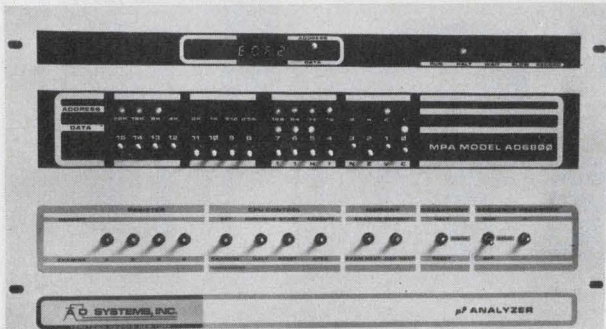

... a new low cost, high performance development tool that provides:

- Complete control of any 6800 system, with simple interconnection.
- READ/WRITE (memory, PC, and registers), HALT, RUN, SINGLE STEP, BREAKPOINT/MONITOR, etc.
- Compatibility with any 6800 system. No software or address constraints.

~~\$825~~ \$695.

Call or write for information (Brochure AO6800).

AO SYSTEMS, INC.

1736 Front Street, Yorktown Heights, N.Y. 10598 • (914) 962-4264

CIRCLE NUMBER 147

HV DC POWER SUPPLIES POWER PACKS



POWER SUPPLIES:

A complete line of unregulated high voltage units:

- Output voltages from 1 to 300 KV.
- Current outputs from 3.3 ma to 25 amperes.

NOTE: Consult factory for data on units with higher voltage and current ratings.

Model 8120-8-120KV @ 8 ma, with controller and HV section.

POWER PACKS:

- A wide range of compact, miniaturized, hermetically-sealed cans, with output voltages from 2.5 to 60 KV.
- Standard units with simplified controls.

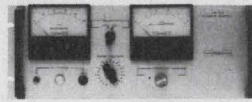

Model R20B



Models 50B,
15B & 10B

Send for our new 8-page catalog, HP 7206.



HIPOTRONICS, INC.

Brewster, N.Y. 10509 • (914)279-8091

TWX:710-574-2420 • AMEX Symbol: HIP

CIRCLE NUMBER 149

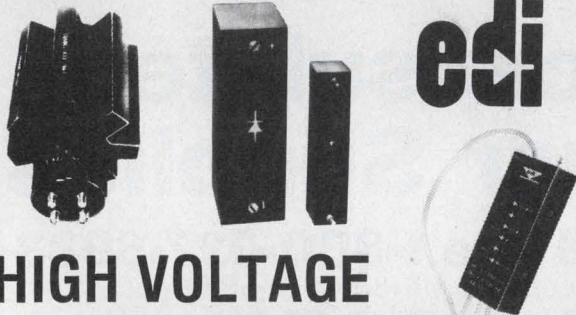

HIGH VOLTAGE RECTIFIER ASSEMBLIES

After all our years of being a leading manufacturer of custom high and low voltage rectifiers, multipliers, and assemblies, we can produce anything you need, fast, and economically. Just send us your design: any size, shape, recovery, encapsulation, surge rating, mounting, temperature, quantity, etc. for a quick quote.

Write for QUOTES, SAMPLES (maybe, if not too expensive!) and CATALOG.

buy from the specialist

edi® **electronic devices**
21 Gray Oaks Ave., Yonkers, N.Y. 10110
(914) 965-4400, TWX 710 560-0021

CIRCLE NUMBER 148

LOOKING FOR A DISTRIBUTOR NEAR YOU?

Electronic Design's GOLD BOOK lists 5,700 distributors with access both **alphabetic**, by distributor name, and **geographic** by location.

When you need
information . . .

**Electronic Design's
GOLD BOOK
IS THE PLACE
TO LOOK**

New Literature



Capacitors

A 64-page condensed catalog includes essential size, performance, electrical characteristics and rating information for solid tantalum, monolithic ceramic and precision film capacitors. Union Carbide, Greenville, SC

CIRCLE NO. 812

Stainless-steel tubing

"Stainless Steel Tubing," a 60-page illustrated booklet, contains comprehensive technical information on all of the stainless grades produced by the company and a number of specialty products. Superior Tube, Norristown, PA

CIRCLE NO. 813

Bus bars

Literature on the Mini/Bus line of PC-board bus bars includes a product folder, design sheets and schematic drawings, order form for a Mini/Bus evaluation kit and a series of articles on bus-bar applications. Rogers Corp., Chandler, AZ

CIRCLE NO. 814

Automatic test systems

Three new versions of the company's FF101 automatic test systems are described in a 16-page brochure. Faultfinders, Latham, NY

CIRCLE NO. 815

Power amplifiers

Thirty-seven broadband power amplifiers are grouped into four series and presented on four quick-reference charts, which enable the reader to select the proper amplifier to meet his needs. Included are both linear and nonlinear power amps with power ranges from 0.3 to 5000 W and frequency ranges from 100 Hz to 1 GHz. Amplifier Research, Souderton, PA

CIRCLE NO. 816

IC testing

"Economic Considerations for Incoming Inspection," a seven-page bulletin, sums up discussions on IC incoming inspection, analysis of test costs and criteria for tester selection. Alma, Div. of Develco, Sunnyvale, CA

CIRCLE NO. 817

Relays

Subminiature PC-board relays, miniature PC-board relays, instrumentation and communication types are some of the relays featured in a 36-page catalog. ITT Components Group, North Andover, MA

CIRCLE NO. 818

Temp measurement

"Temperature Measurement Handbook and Catalog" contains over 7500 temperature measurement products in its 176 pages. Omega Engineering, Stamford, CT

CIRCLE NO. 819

Motors and gearmotors

Motors and gearmotors ranging from 1/10 to 1/500 hp are described in a four-page brochure. Specifications and applications of synchronous and stepper motors are also included. Molon Motor & Coil, Rolling Meadows, IL

CIRCLE NO. 820

Logic modules

General-purpose logic modules, peripheral device controllers and wrapped-wire boards for Nova computer users are described in a folio of technical information. MDB Systems, Orange, CA

CIRCLE NO. 821

EMR Model 1172
Digital Frequency
Response Analyzer
(Transfer Function
Analyzer)

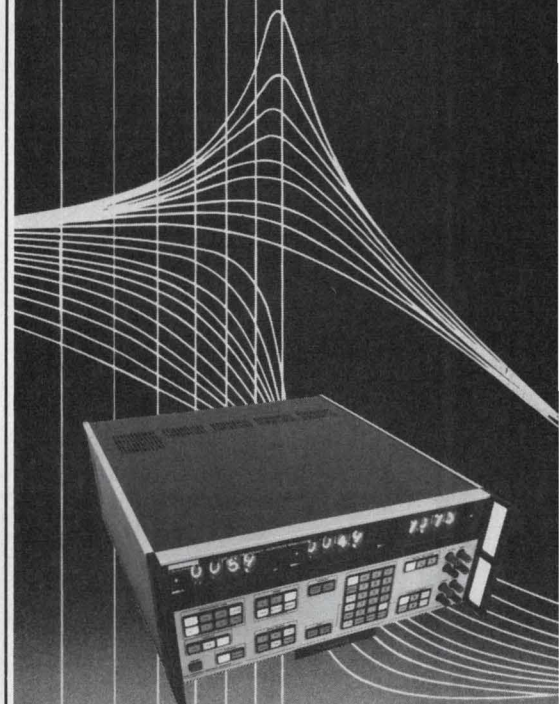

**0.1 phase
accuracy**

**0.1 dB amplitude
accuracy**

**140 dB dynamic
range**

2 channels

The ultimate in frequency response measurement, the EMR 1172 uses all-digital signal processing to provide the highest-ever accuracy and operational flexibility. Consisting of a synthesizer sweep generator and two independent fully floating measurement channels, the 1172 offers full frequency coverage from 0.0001 Hz to 9.999 kHz. Analysis results can be displayed as Bode, Nyquist or Nicholls plots. In addition to servo system analysis, the 1172 is ideal for applications including mechanical impedance measurement, hydraulic actuator dynamic response measurement, material testing, and environmental testing. For more details, write or call: EMR-Telemetry, Weston Instruments, Inc., Box 3041, Sarasota, Florida 33578; (813) 371-0811.

EMR Schlumberger

MONOLITHIC CRYSTAL FILTERS



SPEAKING TO THE DEAF

Our monolithics find their way into some fascinating and unusual applications. For instance — a narrow-band FM system which allows children with severely impaired hearing to participate in normal classroom activities. One of the requirements of the system was that both the students' receivers and the teacher's transmitter allow unhindered movement by the wearer. Another was freedom from interference, including interference from other systems in nearby classrooms. Cost was also an important factor. One of our standard 10.7 MHz tandem monolithic crystal filters in each receiver takes care of the interference. Its size is consistent with the needs of the wearer. Its cost is consistent with educational budgets.

HAVE IT YOUR WAY

As regular readers of this column know by now, we offer the broadest line going of standard monolithic crystal filters. It may be worth mentioning that we're just as interested in helping you with a custom monolithic as we are in showing you new ways to use our regular models. We've done hundreds of production "specials" from 5 to 180 MHz. May we do one for you?

What's your production application? Talk with us about it. We may be able to help. And if your interests include teaching the deaf, we'd be happy to put you in touch with the manufacturer of this equipment.

Pi

Piezo Technology Inc.

2400 Diversified Way Orlando, Florida 32804
305-425-1574

The Standard in monolithic crystal filters.

CIRCLE NUMBER 151

NEW LITERATURE



Photosensitive devices

Detailed specifications, dimensional diagrams and photographs of photosensitive devices are included in a catalog. Hamamatsu, Middlesex, NJ

CIRCLE NO. 822

Programmable memories

Programmable memory products, including ROM emulators, PROM programmers, FPLA programmers and program calibrators, are described in four data sheets. Data I/O, Issaquah, WA

CIRCLE NO. 823

Capacitors

Twenty-nine "VY" porcelain, 23 "VK" ceramic and 16 chip capacitors are covered in an eight-page catalog. Photos plus part drawings, specifications, ordering instructions, typical curves and cross-reference material are included. Vitramon, Bridgeport, CT

CIRCLE NO. 824

Data-acquisition system

Specifications and application data on the modular AN5400 system, which can provide up to 512 channels in a single chassis or be extended to over 4000 input channels and over 500 output channels using expansion chassis, are included in a 22-page booklet. Analogic, Wakefield, MA

CIRCLE NO. 825

Power-line analyzer

The Series 606 power line disturbance analyzer is described in an eight-page catalog. Dranetz Engineering, South Plainfield, NJ

CIRCLE NO. 826

Flexible circuits

A 12-page brochure aids the design engineer in creating the most efficient flexible circuitry for his specific applications. Buckbee-Mears, St. Paul, MN

CIRCLE NO. 827

pH products

Physical and performance specifications for the company's 10 pH meter models, 64 electrodes and pH accessories are described in a 20-page catalog. Corning Glass Works, Science Products Div., Corning, NY

CIRCLE NO. 828

Lamps, lampholders

Specifications and ordering information on solid-state, incandescent, and neon cartridge lamps and mating cartridge lampholders are listed in a 20-page catalog. Littelfuse, Des Plaines, IL

CIRCLE NO. 316

Custom ICs

An eight-page booklet describes custom IC chip manufacturing and the economics of using custom ICs in place of many standard ICs. Silicon Systems, Santa Ana, CA

CIRCLE NO. 317

Digital instruments

Features, specifications and prices of digital panel voltmeters, counters, printers, data-process monitors, remote displays, comparators and low-level multiplexers are given in a 12-page catalog. Newport Laboratories, Santa Ana, CA

CIRCLE NO. 318

Tools

"Tools for Electronic Assembly and Precision Mechanics," a 128-page catalog, describes over 2800 hard-to-find tools. Jensen Tools and Alloys, Phoenix, AZ

CIRCLE NO. 319

LOOK AT DEL'S
HARD / HDRD SERIES
CATHODE RAY TUBE POWER SUPPLIES
 IF YOU'RE LOOKING FOR
ON-TIME, LARGE VOLUME DELIVERY
LOW COST PER UNIT
SUPERIOR TECHNICAL PERFORMANCE

Del's HARD/HDRD series offers a well-regulated source of high voltage at power levels from 2 to 20 watts. The automatic shutdown during short and low stored energy makes them ideal for use in CRT, PMT and all other applications calling for a precise, stable source of high voltage in a compact modular form.

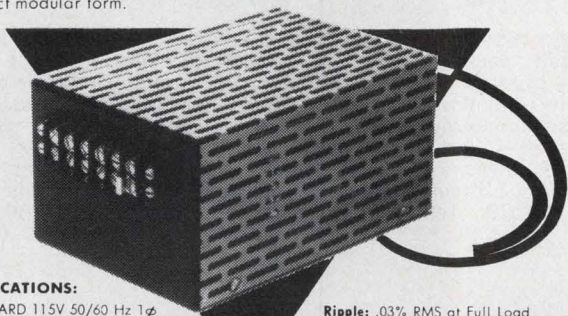

SPECIFICATIONS:

Input: HARD 115V 50/60 Hz 1 ϕ
 HDRD 28 V DC \pm 10%

Output: Variable via resistive program
 from 50% to 100% of rated output

Regulation: Line: \pm .005% for \pm 10% line
 Load: \pm .005% for 0 to Full Load

Ripple: .03% RMS at Full Load

Temperature Range: -20°C to +55°C

Temperature Coefficient: \pm .02%/°C

Send for our complete catalog of high voltage equipment and capacitors.



DEL ELECTRONICS CORP.

250 East Sandford Boulevard, Mt. Vernon, New York 10550

CIRCLE NUMBER 152

MICROPAC
 LOW-COST OFF-THE-SHELF
HYBRID VOLTAGE
REGULATORS

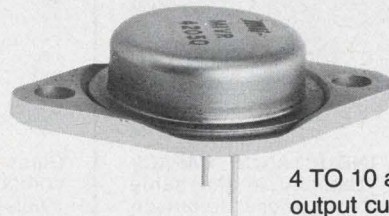

4 TO 10 amp
 output current

- 5 to 36 fixed voltage range
- Positive & Negative voltages
- 120 Watts power dissipation
- Internal short circuit protection
- External components not required
- Standard TO-3 Package
- Available from stock
- Economically priced

CUSTOM PRODUCTS ALSO AVAILABLE
WRITE FOR OUR FREE FACILITIES BROCHURE



MICROPAC INDUSTRIES, INC.

905 E. WALNUT ST. GARLAND, TEXAS 75040 Tel. 214-272-3571
 TWX 910-860-5186

CIRCLE NUMBER 153

new from Hayden!

*"... well-organized, extremely well written ...
 highly recommended for practicing engineers..."*
 IEEE Transactions

DIGITAL SIGNAL ANALYSIS

Samuel D. Stearns

This is an ideal master handbook on today's signal processing procedures and systems, containing recent advances, new design material, and a comparison between continual and digital systems that's extremely helpful to newcomers to the field. Featuring a foreword by Richard Hamming, the book contains a review of linear analysis; sample-data systems; analog-to-digital and digital-to-analog conversion; the discrete Fourier transform and the fast Fourier transform algorithm; spectral computations; non-recursive and recursive digital systems; computer simulation of continual systems; analog and digital filter designs, and more. 288 pages

FORTRAN served up just right for the engineer...

FORTRAN FUNDAMENTALS

Jack Steingraber

You'll find this a fast and efficient guide to the fundamentals of FORTRAN. The main objective here, in fact, is to provide an abbreviated means of learning the language and of becoming familiar with language manuals — so it's just right for the engineer whose main interest may lie elsewhere. You'll find lots of sample problems along with complete solutions, although you're constantly encouraged to try various routines and analyze your own success or failure. The step-by-step format is perfect for self-study. 96 pages

HAYDEN BOOK COMPANY, INC.
 50 Essex Street, Rochelle Park, New Jersey 07662

ELECTRONIC DESIGN 13, June 21, 1976

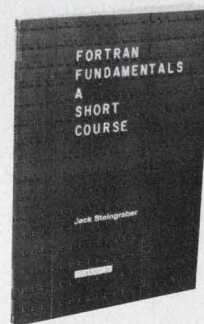
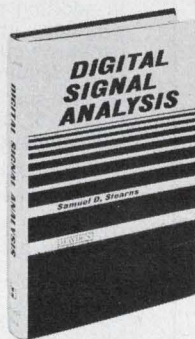

Order today—15-day examination!

Please send me the following book(s) to read and use FREE for 15 days. At the end of that time, I'll either send the amount indicated, plus postage and handling, or return the book(s) with no obligation.

- DIGITAL SIGNAL ANALYSIS, #5828-4, \$18.95
- FORTRAN FUNDAMENTALS, #5860-8, \$4.45

Name _____

Company/Institution _____

Address _____

City/State/Zip _____

SAVE MONEY! Payment Enclosed. Publisher will pay all shipping and handling charges. Same 15-day return privilege and full refund if not satisfied.

\$10.00 minimum for free exam orders. Because of higher billing and collection costs, we must ask for payment in full with any order for less than \$10.00. Books will be shipped postpaid. Same 15-day return privilege for full refund if not satisfied. 76-28

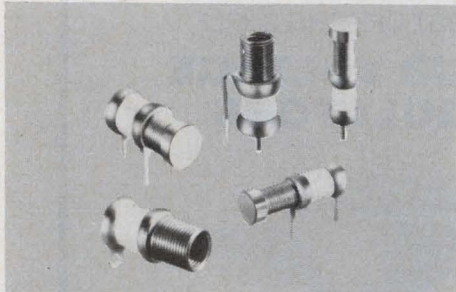

MINIATURE LOW INDUCTANCE CAPACITORS, 50% more capacity in the same size is now available in these Johanson extended range capacitors. Beautiful for microwave, VHF and UHF applications, they offer fine tuning, ultra high Q, low temperature coefficients and "sizes" for hybrid and microcircuit as well as standard applications. Featured are capacitance range .5 to 5.0 pf, $Q > 10,000 @ 100 \text{ MHz}$, and extra fine tuning. Johanson Manufacturing Corporation, Rockaway Valley Road, Boonton, NJ 07005 (201) 334-2676.

MINIATURE CAPACITORS 181



NEW!
GLASS EPOXY
PULTRUSION MOLDED
STRUCTURAL
RODS

Glass laminated epoxy 155°C cases for component and circuit packaging are available in thousands of sizes. Thin wall tubes and headers offer optimum protection in all applications. Infinite lengths of 1/4" diameter rods — 30% lower prices — delivery 2-3 weeks. Stevens Tubing Corp., 128 North Park Street, East Orange, New Jersey 07019. Telephone 201-672-2140.

EPOXY CASES AND RODS 184

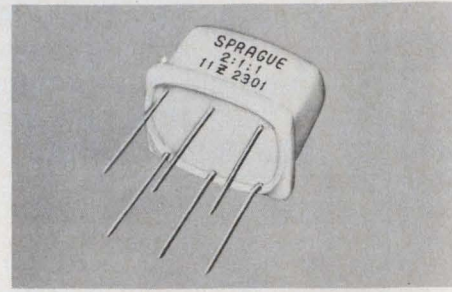

LOW COST TRIGATE® PULSE TRANSFORMERS. The industry's most economical SCR triggers. Single-ended with pin leads for printed boards. Protected by thermoplastic sheath. Balanced pulse characteristics, minimum saturation effect, fast pulse rise time. Axial lead and pre-molded case designs also available. Sprague Electric Co., 347 Marshall St., No. Adams, MA. 01247. (413) 664-4411.

TRIGGER TRANSFORMERS 187

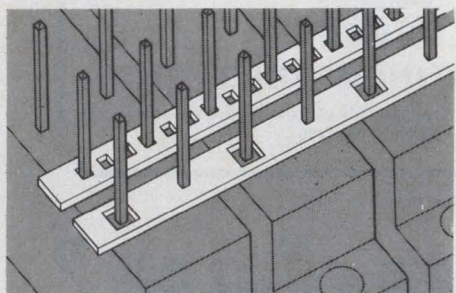

STRIP/BUS BY ROGERS. Low Cost Bussing Systems; easy installation, reliable solder joints; greater pin exposure. Write or call for details. Rogers Corporation, Rogers, CT 06263. Phone (203) 774-9605.

STRIP/BUS 182

NEW CATALOG
features
160
models
Write for your
FREE copy



**POWER SUPPLIES
INSULATION TESTERS**

In addition to our standard line of power supplies, insulation testers and power packs, we custom design units to meet exacting requirements.

We also specialize in the design and manufacture of unusual auxiliary high voltage hardware and accessories.

KILOVOLT CORP. 201 488-7373
240 High Street, Hackensack, N. J. 07602

**HIGH VOLTAGE
POWER SUPPLIES**

185

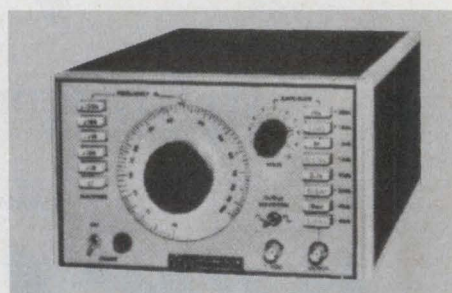

10 Hz to 10 MHz Sine/Square Generator features 0.025 db frequency response .10VRMS output. Distortion less than 0.1%. Calibrated push-button attenuator. Wein Bridge oscillator generates true sine waves without discontinuities or peaks. Model 4300A \$550. KROHN-HITE, AVON INDUST. PARK, AVON, MA 02322.

SINE/SQUARE GENERATOR 188

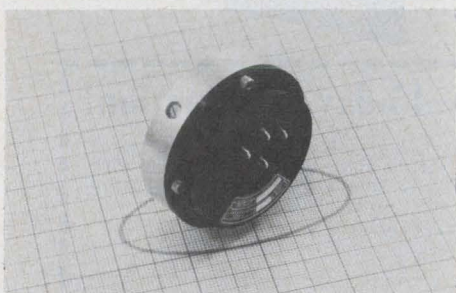

LOW COST PENDULUM CP17-0601-1 provides vertical references for monitoring and control of pitch and roll angular displacements. Replaces expensive vertical gyros for many instrument and control system applications. Potentiometric output; hermetically sealed; fluid damped; range of $\pm 45^\circ$; resolution less than 0.20° ; linearity within 0.5; total error band of $\pm 1\%$ full scale. Wide range of models available. Humphrey, Inc., 9212 Balboa Ave., San Diego, CA 92123. Tel. (714) 565-6631

PENDULUM 183

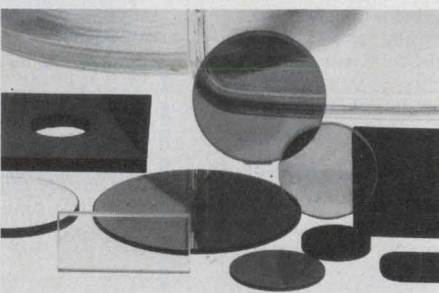

COLOR FILTER GLASSES — Schott produces more than seven dozen colored glass types with proper chromaticity for any technical color application. Special filter glasses for contrast enhancement in LED applications. Stocked in raw ground squares or polished standard sizes, Schott color filters are produced promptly in special exact sizes and shapes in small or large quantities. For more information and engineering assistance, contact Schott Optical Glass Inc., York Avenue, Duryea, Pa. 18642. Area 717, 457-7485.

COLOR FILTER GLASS 186

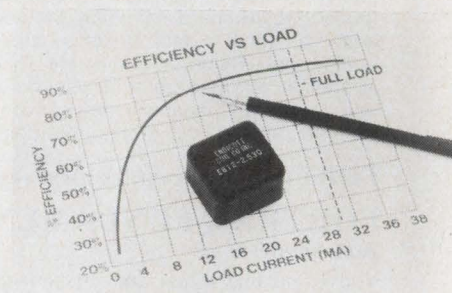

Activate gas discharge readouts! DC-to-DC power supplies convert low DC line voltages of 5, 9, 12 or 15 volts to nominal 200 and 250 volt DC levels required to run gas discharge information displays. Ideal for battery powered applications! Both regulated and unregulated. Ask about our custom power supplies, too! Free literature. Endicott Coil Co., Inc., 31 Charlotte Street, Binghamton, N.Y. 13905. (607) 797-1263

POWER SUPPLY 189

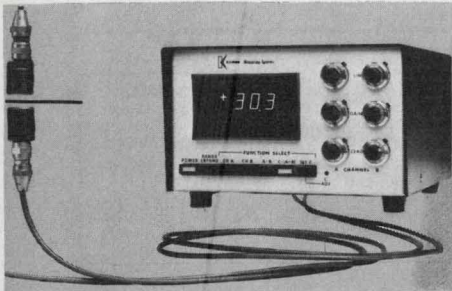

New Electronic Gage, Easy To Use. Thickness, Alignment . . . diameter or deviation measurements, concentricity, orbit tracing, etc. Accuracy up to \pm micro-inches (\pm 0.001 inch), resolution \leq 10 microinches. Utilizes non-contacting inductive measuring techniques—unaffected by oil, grease, or water. Replaces LVDT, air gage, dial indicator, micrometer, \$1,995. Ask for information on KD-2602-2S. Kaman Sciences Corporation, P.O. Box 7463, Colorado Springs, Colorado 80933. (303) 599-1500

ELECTRONIC GAGE

190

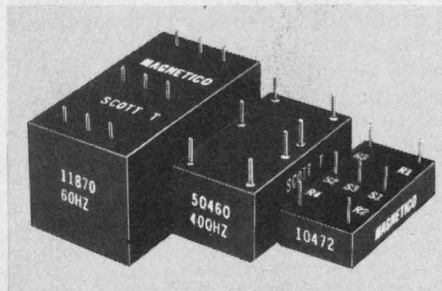

Scott T Transformer. 11870: 60HZ, 90v, L-L in. 1.1x2.1x1.1. 50460: 400 HZ, 90v, L-L in. 7/8x1-5/8x11/16. 50642: 400HZ, 11.8v, L-L in. 7/8x5/8-11/16. 10472: 400-HZ, 11.8v, L-L in. 3/4x1-1/2x3/8. All with 6v RMS sine & cosine output. MAGNETICO, INC., 182 Morris Ave., Holtsville, N.Y. 11742 516-654-1166.

TRANSFORMER

193

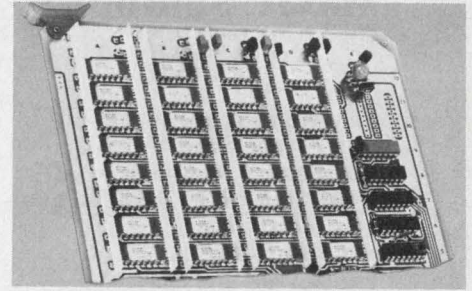

FOR MOS MEMORY CIRCUITS, Mini/Bus®, the off-board power distribution system, does things: saves PC board space and eliminates multi-layers; drastically reduces de-coupling capacitors; suppresses, reduces and isolates noise; makes PCB design easier. Full details on how and why Mini/Bus serves so well are in Rogers' Application Note No. 1976. For a copy, write or call Rogers Corporation, Chandler, AZ 85224. Phone: (602) 963-4584

MEMORY CIRCUIT FILTER BUS

196

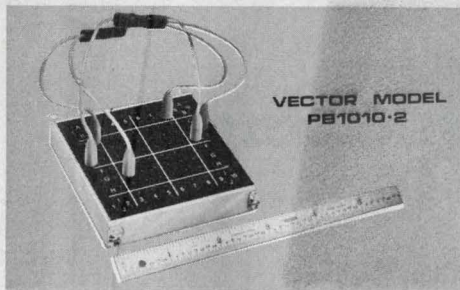

Machine, process, and test control programming is simple and inexpensive using Vector patchboards. Stock models have 50 to 300 gold plated beryllium copper contacts for years of reliable service. Special sizes and markings available to order. Preprogramming models available. For prices and spec. sheets write Vector Electronics Company, Inc., Dept. PB, 12460 Gladstone Avenue, Sylmar, CA 91342.

REFER TO VOL 2/383,412 GOLD BOOK 191

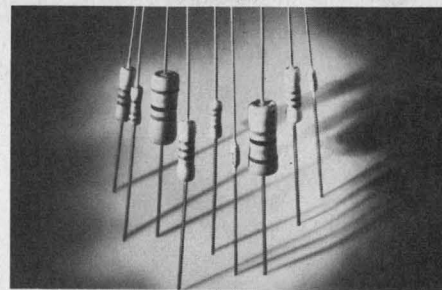

RCA FLAMEPROOF FILM RESISTORS. Design engineers prefer them because they won't flame or short under the most severe conditions. These resistors have a 2% tolerance, and are available in 1/4 watt, 1/2 watt, 1 watt, and 2 watt ratings. Resistance values range from 10 Ohms to 1.5 Megohms, depending on wattage rating. 475 film resistors to choose from. RCA Distributor & Special Products Division, Sales Promotion Services, Cherry Hill, N. J. 08101.

FILM RESISTORS

194

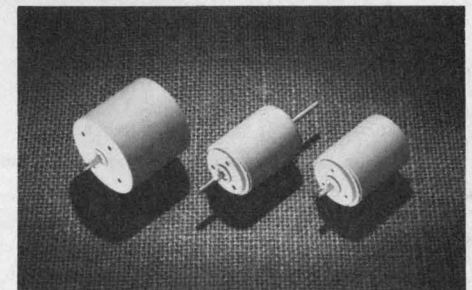

MINIATURE IRONLESS ROTOR DC MOTORS offer efficiencies to 80%, low inertia, rapid response and high starting torque. 24 and 12 VDC models available. Motor time constants are 17 and 23 MS respectively. Rotor torque is 100 and 50 gcm and starting torque 600 and 230 gcm, respectively. 12 VDC units can be ordered with either a single or extended double shaft. Tach versions also available. For reel and capstan drives, chart and pen drives etc. North American Philips Controls Corp., Cheshire, Conn. 06410. (203) 272-0301.

IRONLESS ROTOR

197

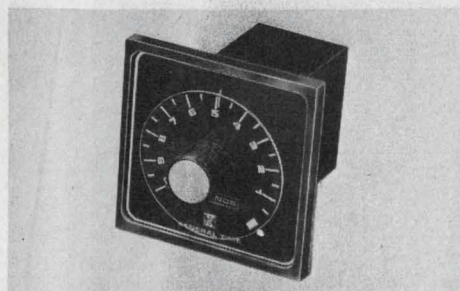

CMOS DIGITAL TIMERS by General Time. Low prices enable their use in lieu of both low and high accuracy analog timers and many electromechanical timers. \pm 0.5% typical repeat accuracy. On-delay, off-delay, and interval modes available in four different packages; AC and DC. Short reset, recycle and abort times; fast startup. From the industrial control specialists at Industrial Controls Division, General Time, Main Street, Thomaston, CT. 06787. Tel. (203) 283-5881. Telex 96-2445. Helpful literature available on request.

CMOS DIGITAL TIMERS

192



The LINEAR DISC LINC TAPE LINC TAPE expands your program development, editing, loading, and data acquisition capabilities through direct, block addressable "disc like" format in a convenient and inexpensive medium ■ Reduces access time ■ Simple, rugged reel-to-reel drive without capstan ■ Storage — 335,872 bytes/reel ■ Transfer Rate — 8400 bytes/second. Computer Operations, Inc., 9700-B George Palmer Hwy., Lanham, MD 20801 (301) 459-2100 • Telex 89-8327

LINEAR DISC—LINC TAPE

195

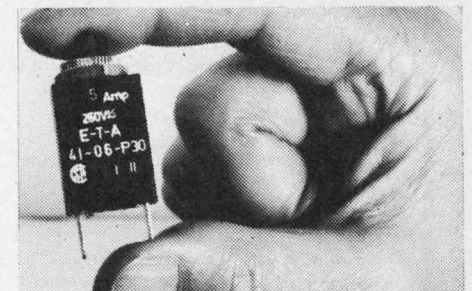

Overcurrent Protector, manual reset eliminates fuse replacement. Convenient panel mounting. 19 fractional ratings from 0.1 to 5 amp. Other models up to 400 amp. Trip-free and fool-proof, UL and CSA approved. High quality, low cost \$1.33 ea. in 1000 lots. E-T-A Products Co. of America, 7400 N. Croname Rd., Chicago, Ill. 60648. Tel: (312) 647-8303. Telex: 253780.

CIRCUIT BREAKER

198

USC'S UMI most compact ULTRA MINIATURE CONNECTORS

7 UMI Series -- Standard & Closed-Entry MIL-C-28748/7, 8 and others.

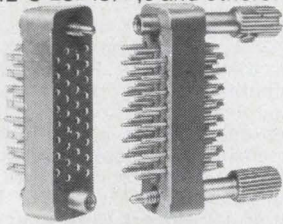

Highest reliability -- proved in Gemini/Apollo flights! 1 of over 20,000 types of connectors. Write or phone for UMI Series catalog -- today!

U.S. COMPONENTS, INC.

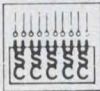

Leader in advanced engineering & design
1320 Zerega Avenue, Bronx, N.Y. 10462
(212) 824-1600 TWX: 710-593-2141
Cable: COMPONENTS, NYK

CIRCLE NUMBER 155

Circuit Savers



Here's positive low cost protection for your IC's, transistors, power supplies and pc cards.

The LVC-1A crowbar switches to a short circuit whenever the voltage across it exceeds a specified level.

Any trip voltage level between 4.7V and 200V \pm 10% can be selected. The unit will handle a peak current of 50 Amps (8ms) and 3A continuously. MIL Temperature range. Call Mike Coyle for applications assistance.

Full line of protection modules for every hi-lo voltage/current requirement. Write or call for Catalog 749.

279 Skidmore Road
Deer Park, New York 11729
Telephone: 516 - 586-5125

MCG Electronics

CIRCLE NUMBER 156

Electronic Design

ELECTRONIC DESIGN's function is:

- To aid progress in the electronics manufacturing industry by promoting good design.
- To give the electronic design engineer concepts and ideas that make his job easier and more productive.
- To provide a central source of timely electronics information.
- To promote communication among members of the electronics engineering community.

Want a subscription? ELECTRONIC DESIGN is sent free to qualified engineers and engineering managers doing design work, supervising design or setting standards in the United States and Western Europe. For a free subscription, use the application form bound in the magazine. If none is included, write to us direct for an application form.

If you do not qualify, paid subscription rates are as follows: \$30.00 per year (26 issues) U.S., \$40.00 per year (26 issues) all other countries. Single copies are \$2.00 U.S., \$3.00 all other countries. The Gold Book (27th issue) may be purchased for \$30.00 U.S. and \$40.00 all other countries.

If you change your address, send us an old mailing label and your new address; there is generally a postcard for this bound in the magazine. You will have to requalify to continue receiving ELECTRONIC DESIGN free.

The accuracy policy of ELECTRONIC DESIGN is:

- To make diligent efforts to ensure the accuracy of editorial matter.
- To publish prompt corrections whenever inaccuracies are brought to our attention. Corrections appear in "Across the Desk."
- To encourage our readers as responsible members of our business community to report to us misleading or fraudulent advertising.
- To refuse any advertisement deemed to be misleading or fraudulent.

Microfilm copies are available of complete volumes of ELECTRONIC DESIGN at \$19 per volume, beginning with Volume 1, 1952 through Volume 20. Reprints of individual articles may be obtained for \$3.00 each, prepaid (\$.50 for each additional copy of the same article) no matter how long the article. For further details and to place orders, contact the Customer Services Department, University Microfilms, 300 North Zeeb Road, Ann Arbor, Michigan 48106 telephone (313) 761-4700.

Want to contact us? If you have any comments or wish to submit a manuscript or article outline, address your correspondence to:

Editor
ELECTRONIC DESIGN
50 Essex Street
Rochelle Park, N.J. 07662

classified ad

HEXADECIMAL CALCULATOR

8 digits, credit balance-complement, pocket size, leather case: \$35.95

OCTAL CALCULATOR

6 digits, credit balance-complement, pocket size, leather case: \$14.95

Prepaid orders sent postpaid. COD's plus postage. Rated firms invoiced plus postage. Literature free. Radix Precision, Box 95114-E, Atlanta, GA 30347

Perform a death-defying act.

Stop smoking.

Give Heart Fund
American Heart Association

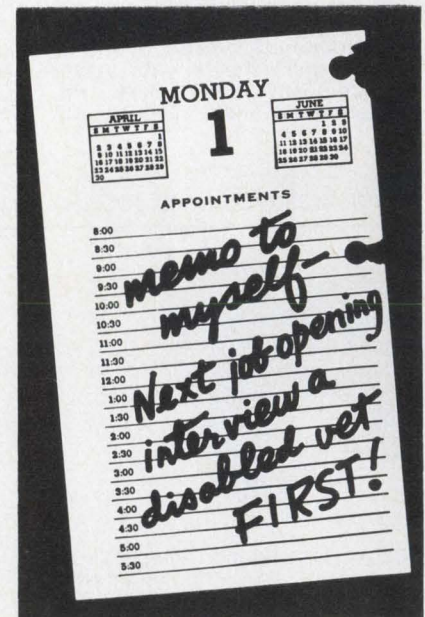

The President's Committee
on Employment of the Handicapped
Washington, D.C. 20210

Advertisements of booklets, brochures, catalogs and data sheets. To order use Reader-Service Card (Advertisement)

Advertising Sales Staff

Tom W. Carr, Sales Director
Jean Bunfield, Sales Coordinator

Rochelle Park, NJ 07662

Robert W. Gascoigne
Daniel J. Rowland
Thomas P. Barth
Stan Tessler
50 Essex St.
(201) 843-0550
TWX: 710-990-5071

Philadelphia

Thomas P. Barth
(201) 843-0550

Boston 02178

Gene Pritchard
P.O. Box 379
Belmont, MA 02178
(617) 489-2340

Chicago 60611

Thomas P. Kavooras
Berry Conner, Jr.
200 East Ontario
(312) 337-0588

Cleveland

Thomas P. Kavooras
(312) 337-0588

Los Angeles 90045

Stanley I. Ehrenclou
Burt Underwood
Neil Canavin
8939 Sepulveda Blvd.
(213) 641-6544

Texas

Burt Underwood
(213) 641-6544

San Francisco

Robert A. Lukas
3579 Cambridge Lane
Mountain View, CA 94040
(415) 965-2636

London

Constance McKinley
50 Essex St.
Rochelle Park, N.J. 07662
Phone: (201) 843-0550

Amsterdam, Tokyo, Seoul

Sanders, B. V.
Raadhuisstraat 24
Graft-De Ryp, Holland
Phone: 02997-1303
Telegrams: Euradteam-Amsterdam

Haruki Hirayama
Electronic Media Service
5th Floor, Lila Bldg.,
4-9-8 Roppongi
Minato-ku, Tokyo, Japan
Phone: 402-4556
Cable: Electronicmedia, Tokyo

Mr. O-kyu Park, President
Dongbo Intl Corp.—
World Marketing
C.P.O. Box 4010
Seoul, Korea
Tel. 76-3910/3911
Cable: DONGBO SEOUL
Telex: EBKOREA K27286

FOR DESIGNERS & USERS OF METAL FABRICATION



Available at no cost is a 12 page, 8½ x 11 catalog on metal fabrication from AMALCO. All under one roof are Engineering and Designing Services, Samples, Testing, Tool Making, Deep Drawing to 24" Deep x 20" Diameter, Hydroforming, Spinning, Stamping, Brake Fabrications, all types of Fastening, Heat Treating, Anodizing and Painting. Fabrications can be made in most metals. A large number of drawn cans, carrying cases and aluminum bottles are made from existing dies. Write or fill in reader service card for your copy.

American Aluminum Company
230 Sheffield Street
Mountainside, N.J., 07092

CIRCLE NO. 171

FREE HIGH VOLTAGE CAPACITOR CATALOG

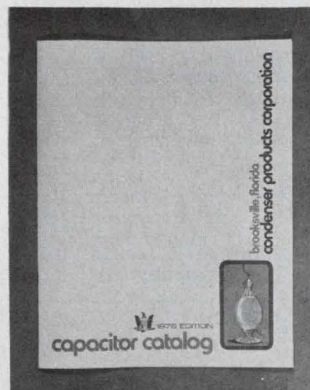

Complete source listings for over 1000 power, pulse, high voltage, and special purpose capacitors and high voltage power supplies in glass, plastic and CP72 styles. Special low inductance types for laser and high energy applications. Many "custom" designs are standard with us. High reliability, long life, moderate cost, and fast delivery assured. To get your catalog, just drop us a line.

CIRCLE NO. 172

Condenser Products Corporation
P. O. Box 997
Brooksville, Florida 33512

Are you using the #1 training courses in electricity & electronics?

BASIC ELECTRICITY and BASIC ELECTRONICS

By Van Valkenburgh, Nooger & Neville, Inc.

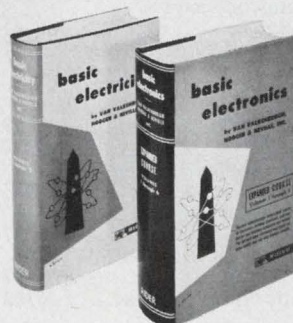

Derived from the COMMON-CORE Training Program initially developed for the U.S. Navy, these unique texts are now about to enter their third decade of use in schools, industries, and communication utilities. They continue to be exemplary training texts in their subjects. Carefully integrated illustrations comprise almost half the course material. These perform a remarkable job of visualizing complex theory and applications. Readers are able to grasp essential concepts right away without having to wade through pages of wordy explanation. Thorough, comprehensive coverage. Available in separate paperbacks or one cloth volume. Write for FREE brochure.

CIRCLE NO. 173

Hayden Book Company
50 Essex St. Rochelle Pk, N.J. 07662

Advertiser's Index

Advertiser	Page	Advertiser	Page	Advertiser	Page
AMP, Incorporated	37	Gould Inc., Instrument Systems Division	114, 115	*Philips Electronic Components and Materials	22
AMP, Incorporated, Capatron Division	135	HEI, Inc.	147	Piezo Technology	184
AO Systems Inc.	182	Hayden Book Company, Inc.	64, 64A-B, 65, 160D, 185, 189	Potter & Brumfield, Division of AMF, Incorporated	31
Abbott Transistor Laboratories, Inc.	6	Heath Company	169	Power Design	160A
Acheson Colloids Company	162	Hecon Corporation	173	Power/Mate Corp.	156
Acopian Corp.	152, 153	Heinemann Electric Company	39	Power Supply Survey Card	96A-B
Advanced Micro Devices	60, 61, 144, 145	Hewlett-Packard	1, 11, 35, 49, 84, 85, 96, 164	Power Tech, Inc.	54
Allen Bradley Co.	128A	Hipotronics, Inc.	182	Powertec, Inc.	76, 77
Allied Electronics, Division of Tandy Corp.	150	Humphrey, Inc.	186	Princeton Electronic Products, Inc.	43
Alpha Power Inc.	170	ISS Sperry Univac	57	RCA Distributor & Special Products Division	187
American Aluminum Company	189	Indiana General	53	RCA Solid State	Cover IV
American Microsystems, Inc.	130, 131	Industrial Controls, Division General Time	187	RO Associates, Incorporated	46
Amplifier Research Corporation	180	Information Controls Corp.	179	Rotron Inc.	160B
Arnold Magnetics Corp.	128	Interdata, Inc.	107	Rental Electronics, Inc.	22
Bell, Inc., F. W.	167	Interdesign	177	Rockwell International	101
Bodine Electric Company	163	International Rectifier	66, 67	Rogers Corporation	186, 187
Boonton Electronics Corporation	138, 139	Instrument Specialties Company	121	Scanbe Manufacturing Corp.	156
Bourns, Inc., Trimpot Products Division	Cover II	Intronics, Inc.	158	Schneider Publications	143
Burr-Brown Research Corporation	166	Janco Corporation	155	Schott Optical Glass, Inc.	186
C & K Components, Inc.	151	Johanson Manufacturing Corp.	186	Semiconductor Circuits Inc.	157
CTS Corporation	16	Johnson Company, E. F.	10	Semtech Corporation	33
Centralab Distributor Products, Globe-Union Inc.	155	Kaman Sciences Corp.	187	Signetics Corporation	161, 163, 165, 167, 169, 171, 173, 174, 175
Circuit Technology, Inc.	149	Keltron Corp.	180	Siliconix, Incorporated	12, 13
Computer Automation, Inc.	8, 9	Kepco, Inc.	50	Simpson Electric Company	47
Computer Operations, Inc.	187	Kertron, Incorporated	178	Solitron Devices, Inc.	97
Computer Products, Inc.	181	Keystone Carbon Company	148	Sorensen, A Raytheon Company	124
Condenser Products	189	Kilovolt Corp.	186	Spectrum Control, Inc.	176
Continental Rentals, Division of Continental Leasing Co., Inc.	147	Krohn-Hite Corporation	186	Sprague Electric Company	21, 186
Control Data Corporation, Magnetic Components Div.	151	Logical Technical Services Corp.	160	Stacoswitch, A Staco Inc. Company	181
Control Products Division, Amerace Corporation	95	MCG Electronics	188	Stahlin Bros., Inc.	165
Crydom Controls, Division of International Rectifier	146	Magnetic, Inc.	187	Standard Grigsby, Inc.	168
Dale Electronics, Inc.	108, 109	Magnetic Shield Division, Perfection Mica Company	178	Stanford Applied Engineering, Inc.	17
Data General Corporation	29	Micropac Industries, Inc.	185	Stevens Tubing Corp.	186
Datatron, Inc.	Cover III	Minelco Division/General Time Corp.	154	TDK Electronics	141
Del Electronics	185	Molex, Incorporated	59	TRW/IRC Resistors, an Electronic Components Division of TRW, Inc.	137
Deltron, Inc.	123	Monolithic Memories, Inc.	129	TRW Power Semiconductors, an Electronic Components Division of TRW, Inc.	127
Dialight, A North American Philips Company	45	Mostek Corporation	18, 19	Technipower, Inc., A Benrus Subsidiary	146
EECO	25	Motorola Semiconductor Products, Inc.	4, 5, 40, 41	Tecnetics, Inc.	172
EMR Telemetry, Weston Instruments Inc.	183	MuRata Corporation of America	171	Teledyne Philbrick	20
E-T-A Products Co. of America	187	NAE Inc.	159	Teledyne Relays, A Teledyne Company	2
Eagle-Picher, Inc.	132	NCR Corp.	160C	Teledyne Semiconductor	62
Electrocube Corp.	134	NEC Microcomputer Division of North Electric	128 D-E	Teradyne, Inc.	48
Electronic Design	191	National Semiconductor Corporation	26, 27	Texas Instruments, Incorporated	128A-B
Electronic Devices	182	North American Philips Controls Corp.	187	Theta-J Relays, Inc.	44
Electronic Molding Corporation	113	North Atlantic Industries, Inc.	142	Triplett Corporation	117
Elexon Power Systems	133	Omni Spectra, Inc.	36	U. S. Components, Inc.	188
Endicott Coil Co., Inc.	186	Optron, Inc.	7	United Systems Corporation	151
Erie Technological Products, Inc.	15			Unitrode Corporation	14
Fabri-Tek, Inc.	42			Varo Semiconductor, Inc.	149
Fair-Rite Products Corp.	136			Vector Electronics Company, Inc.	187
Farotron	155			Venus Scientific, Inc.	154
Ferroxcube Corporation	128H			Victoreen Instrument Division, Shellar-Globe Corporation	119
Fifth Dimension Inc.	126			Weston Components	161
Galileo Electro-Optics	102, 103				
General Scanning, Inc.	140				
Gold Book, The	*26, *27, 128 F-G, *152, *153, 182				

*Advertisers in non-U.S. edition

MAIL TO:

Electronic Design

P.O. BOX 13803, PHILADELPHIA, PA. 19101

FREE SUBSCRIPTION APPLICATION

Do you wish to receive (continue to receive)

ELECTRONIC DESIGN? Yes No

Date:

Signature: Does not obligate me or my company

I wish to receive (do not wish to receive) other solicitations. Yes No

ALL SUBSCRIBERS: Please fill out completely, the name and address portion, even if the information on your label is the same. (For prompt, accurate processing remember to affix label in the space provided above.) Do not use periods, commas etc.

To qualify please answer all questions carefully. Independent consultants must attach business card.

MR.
MS.

Area Code						Office Telephone					

1st Initial	2nd Initial	Last Name	Title
Company Name (Do not abbreviate if possible)		Division	
Parent Company (if subsidiary) (Do not abbreviate if possible)			
Department		Internal Mail Code	
Company Street Address or P.O. Box No.			
Company City		State/Country	Zip Code/Postal Code
Home Address			
Home City		State/Country	Zip Code/Postal Code

8 Products you specify or authorize purchase of:
(Check all codes that apply.)

<input type="checkbox"/> 1 Resistors and Capacitors	<input type="checkbox"/> 12 Computer Peripherals
<input type="checkbox"/> 2 Connectors	<input type="checkbox"/> 13 Computer Components
<input type="checkbox"/> 3 Switches and Relays	<input type="checkbox"/> 14 Cabinets and Enclosures
<input type="checkbox"/> 4 Function Modules: Op Amps, Converters, etc.	<input type="checkbox"/> 15 Panel Meters, Analog or Digital
<input type="checkbox"/> 5 Potentiometers	<input type="checkbox"/> 16 Readout and Display Devices
<input type="checkbox"/> 6 Test and Measurement Equipment	<input type="checkbox"/> 17 Rotating Components
<input type="checkbox"/> 7 Computers, Medium and Large	<input type="checkbox"/> 18 Cooling Products
<input type="checkbox"/> 8 Electronic Power Supplies	<input type="checkbox"/> 19 Printed Circuits
<input type="checkbox"/> 9 ICs and Semiconductors	<input type="checkbox"/> 20 Calculators
<input type="checkbox"/> 10 Microwave Devices	<input type="checkbox"/> 21 Indicators including LEDs
<input type="checkbox"/> 11 Minicomputers	<input type="checkbox"/> 22 Materials, Potting and Stripping
	<input type="checkbox"/> 23 Communications Equipment

7 Please write in box total number (other than self) to be served by this subscription at this address and list individuals and their titles below. If no other person is served please indicate "0" in the box at left.

Name (Please Print)	Title

9 Do you specify or buy through distributors?
 YES NO

10 Minicomputers at this address:

	Model	Qty.	Model	Qty.
3	Cincinnati Milacron			
C	Computer Automation			
D	Control Data			
E	Data General			
F	Digital Equipment			
I	General Automation			
K	Hewlett Packard			
M	Honeywell			
O	IBM			
N	Interdata			
7	Microdata			
	Modular Computer			
	ROLM			
V	Systems Engineering Labs			
9	Texas Instruments			
x	Varian			
	Other			

This questionnaire conforms to the guidelines of the Business Publication Audit of circulation for eliciting comparable data. The publisher reserves the right to serve only those individuals who qualify for a free subscription.

ELECTRONIC DESIGN is sent free to qualified engineers and engineering managers doing work, supervising design or setting the standards in the United States and Western Europe.

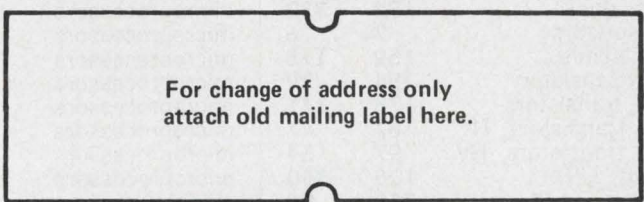

Use this form for Change of Address or New Subscription Only.

1 Title: (Insert letter)

A President	J Project Engineer
B Vice President	K Senior Engineer
C Vice President of Engineering	L Group Leader
D Technical Director	M Dept. Head
E Chief Engineer	N MTS
F Principal Engineer	O Engineer
G Research Director	P Consultant
H Section Head	R Scientist
	S Physicist

2 Your principal job function: (Insert code)

- General and Corporate Management
- Design and Development Engineering (circuits, components, equipment systems)
- Engineering Services (evaluation, quality control, reliability, standards, test)
- Basic Research
- Manufacturing and Production
- Engineering Assistants (draftsman, lab assistant, technician)
- Purchasing and Procurement
- Marketing including Sales
- Other Personnel (explain)

3 The primary end product (or service performed) at your plant, and the product (or service) that is your own work. (Insert code in each box even if the same)

Plant	Your own work
A	A Large Computers
B	B Mini-Computers
C	C Computer Peripheral Equipment
D	D Data Processing Systems (Systems Integration)
T	T Office and Business Machines
E	E Test, Measurement and Instrumentation Equipment
F	F Communications Systems and Equipment
H	H Navigation and Guidance Systems and Equipment
J	J Consumer Entertainment Electronic Equipment
G	G Consumer Electronic Appliances
N	N Other Consumer Electronics
K	K Industrial Controls, Systems and Equipment
L	L Components and Sub Assemblies
M	M Materials and Hardware
Q	Q Aircraft, Missiles, Space and Ground Support Equipment
P	P Oceanography and Support Equipment
R	R Medical Electronics
U	U Industrial Companies within the OEM incorporating Electronic Equipment in their end product, not elsewhere classified
V	V Independent Research, Test and Design Laboratory and Consultant. (Only if you are not connected with a manufacturing company.)
X	X Government Agency and Military
2	2 Industrial Companies using and/or incorporating any Electronic products in their manufacturing, research or development activities.
1	1 Commercial Users of Electronic Equipment
3	3 Distributor
4	4 School, University or Library
5	5 Other (explain)

4 Your design function: (Insert each letter that applies)

A I do electronic design or development engineering work
B I supervise electronic design or development engineering work
C I set standards for, or evaluate electronic design components, systems and materials

5 Your principal responsibility: (Insert code)

1 Management other than Engineering	3 Engineering
2 Engineering Management	

6 Please estimate: (Insert letter)

The number of electronic engineers at this address:
(A) 1 (B) 2-5 (C) 6-19 (D) 20-49 (E) 50-99
(F) 100-249 (G) 250-499 (H) 500-999 (J) Over 1000

Product Index

Information Retrieval Service. New Products, Evaluation Samples (ES), Design Aids (DA), Application Notes (AN), and New Literature (NL) in this issue are listed here with page and Information Retrieval numbers. Reader requests will be promptly processed by computer and mailed to the manufacturer within three days.

Category	Page	IRN	Category	Page	IRN	Category	Page	IRN
Components			suppressors	33	23	system, development	56	391
capacitors	21	261	transistors	5	4	system, microcomputer	56	390
coaxial attenuators	164	122	Instrumentation			Modules & Subassemblies		
components	150	96	a/d converter	140	348	card, time & temp	150	363
converters, I/O	2	3	board tester	138	342	controller,		
crowbar, dc	188	156	chart recorder	140	350	programmable	156	373
crystal filters	184	151	counters	173	135	converter, rms-to-dc	148	301
display, LED	171	629	DMM	147	359	converter, s/d	156	372
elapsed time indicators	154	105	digital thermometers	139	344	converters, a/d	152	368
line filters	176	138	digital VOM	143	354	converters, rms-to-dc	150	362
motors	163	120	frequency analyzer	183	150	converters, v/f	154	371
optical products	147	91	function generator	139	345	custom hybrids	149	94
potentiometer	11	252	IC test system	48	35	instrumentation		
relay, mercury film	126	71	IC testers	111	253	amplifiers	166	125
relay, solid-state	39	27	logic analyzer	138	341	s/d modules	142	85
relays	31	22	logic probe	142	352	system, data acq.	149	360
relays, solid-state	44	31	logic probes	146	357	Packaging & Materials		
resistor	109	60	logic state analyzer	49	36	adhesive dispenser	170	625
resistors, cermet film	176	636	OEM recorder modules	140	83	boards, wrapped-wire	170	623
resistors	119	65	pulse generator	11	9	coatings	162	119
resistors	137	80	recorders, direct writing	115	63	connectors	36	25
switches	45	32	rental electronics	147	92	connectors	188	155
switches	151	99	rental instruments	22	18	connectors, leaf-spring	37	26
switches	155	106	scope	138	343	enclosures	165	123
switches	181	145	semiconductor tester	142	353	ferrite cores	136	79
switches, DIP	16	13	signal generator	139	238	ferrite cores	141	84
switches, pushbutton	177	639	spectrum analyzer	142	351	gasket, beryllium copper	121	66
switches, rotary	155	108	storage scope	147	358	magnetic shielding	178	140
switches, rotary	171	627	temp/DMM	160	116	packaging hardware	17	14
thermistors	148	93	VOM	140	349	socket board	25	19
transducers	167	126	VOMs	47	34	socket, LSI	169	622
transformers	134	77	VOMs	117	64	socket pin	113	61
trimmers	161	117	Integrated Circuits			sockets	156	109
tuning forks	171	132	CMOS series	131	328	terminal blocks	95	52
Data Processing			controller	126	320	Power Sources		
calculator, computing	85	51	DAC	131	324	batteries	132	75
data recording system	166	613	FPLAs	128	321	converters, dc/dc	172	134
disc drives, OEM	57	40	HiNIL	62	43	dc/dc converter	157	375
interface, IEEE	164	606	ICs	177	139	dc/dc converter	159	383
light pens	179	142	memory	131	326	modular supplies	157	111
memory systems	42	29	op amps	131	325	open-frame supplies	158	379
minicomputer	35	24	PROMs	131	327	power converters	128	73
portable calculator	160	387	RAM	126	323	power supplies	6	5
portable minicomputer	164	605	regulator, switching	125	305	power supplies	15	12
printers	151	241	sample/hold amps	126	308	power supplies	123	67
Discrete Semiconductors			tone dialers	128	322	power supplies	133	76
assembly, bridge	136	338	Microprocessor Design			power supplies	135	78
display, LED numeric	136	337	kit	58	393	power supplies	146	89
display, numeric	134	336	microprocessors	19	15	power supplies	155	107
displays	96	53	microprocessors	61	42	power supplies	156	110
displays, clock	132	329	microprocessors	130	73	power supplies	158	112
GTO SCRs	14	11	microprocessors	145	88	power supplies	170	131
indicators, panel	132	330	microprocessors	161	118	power supplies	181	146
JFETs, dual	132	332	microprocessors	163	121	power supplies	182	149
opto-isolators	7	6	microprocessors	165	124	power supplies	185	153
power semis	159	113	microprocessors	167	127	power supplies, digital	50	37
power transistor	54	39	microprocessors	169	130	programmable supply	157	376
power transistors	178	141	microprocessors	171	133	regulators, HV	185	155
power transistors, HV	67	47	microprocessors	173	136	switchers	77	49
power transistors, HV	97	54	microprocessors	175	137	switching power		
readout, LED	136	340	microprocessors	58	392	supplies	151	98
rectifiers	149	95	module, memory	55	389	μP supplies	158	380
SCR, high power	136	339	system, computer					

Dramatic breakthrough in IC testing!

Model 410:

One-station. I/O voltages to 30 V, and/or currents to ± 100 ma. Bias supply: voltages to ± 20 V, and/or currents to ± 300 ma. 16K core. Single-shift capacity: 1 to 5 million ICs per year. \$49,000.



Model 420:

The Model 410 with Extended Measurement Capability. I/O voltages to ± 160 V, and/or currents to ± 500 ma. 32K core. \$65,000.

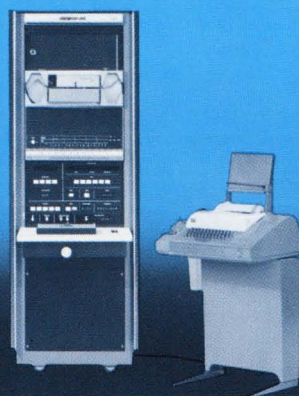

Model 430:

Two stations. Tests two different devices simultaneously in multiplexed mode. 32K core. Single-shift capacity: up to 10 million ICs per year. \$70,000.

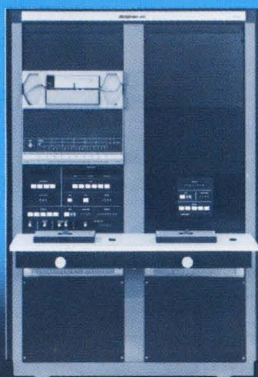

Model 440:

The Model 430 with Extended Measurement Capability. \$85,000.

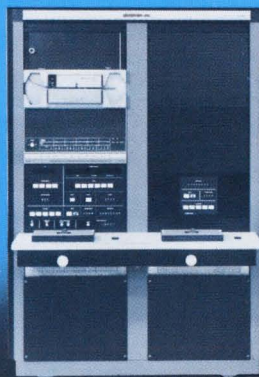

4 New Computer-Controlled IC Testers Give You Instant Access by Telephone to More Than 1000 Device Programs

Need to develop your own programs eliminated

Install a Series 400 IC tester, and we give you 50 FREE device programs. We also give you Instant Program Access (IPA). That means 1000 additional device programs are at your fingertips — instantly accessible from our Central Program Library (CPL) via a national time-sharing network.

Here's how it works

You select the device programs required to test your mix of 24-pin SSI and MSI devices. With a Teletype terminal, you then access and retrieve those programs from our CPL, over regular telephone lines. Your cost: \$50 for each program and then the program is yours.



50 device programs free!

Programming expense avoided

IPA wipes out the programming expense that usually burdens computer-controlled IC tester users. There's no need for experienced programmers; no lost time developing and debugging your own device programs. But, just in case, Datatron's conversational (English language) software makes it easy for nonprogrammers to modify our programs or create new ones. It's all done via the Teletype terminal communicating with the system computer — without interrupting production testing.

IPA only part of the story

Our Series 400 models combine the versatility of

computer-control with the operating ease of a simple benchtop tester. Although the concept is new, the elements of the systems are field-proven. Series 400 models are no-frills versions of our big testing systems. Each Series 400 model can perform *all* classes of IC testing on up to 90 percent of the devices you're ever likely to inspect. That includes T²L, DTL, CTL, RTL, HTL, ECL, I²L, CMOS, and all MOS devices. Throughput ranges up to 10 million devices per year — single-shift capacity with optional automatic handlers.

Series 400 testers have a lot going for them. For the complete story, call, write, or TWX us right away.

Datatron, Inc.
TEST SYSTEMS DIVISION

Announcing a BiMOS breakthrough...

The RCA 3140. Most useful op amp since the 741.

For the price of a 741, the CA3140 is a lot more op amp. One that is often far more cost effective, considering circuit and component savings, than BI-FET and other higher priced op amps.

MOS/FET input makes the difference.

In fact, CA3140 is a giant step closer to the ideal. It gives you the big advantages of MOS/FET input...*plus* bipolar speed and high supply voltage operating capability: 4 to 44 V, dual or single supply. MOS/FET input means very high input impedance: 1.5 T Ω typ. Very low input current: 10 pA typ. at ± 15 V. Low input offset voltage: as low as 2 mV max. Wide common-mode input voltage range — can be swung 0.5 V below negative rail. In addition, output swing complements input common-mode range, permitting full utilization of low supply voltages (down to 4 V). When it's driving power transistors, the output swings to within 0.2 V of the negative rail. And PMOS input devices are

CA3140 vs. 741 at a glance		
	CA3140T,S	CA741CT,S
Input Resistance R_i (M Ω)	1,500,000	2
Input Current I_i (pA)	10	80,000
Slew Rate, SR (closed loop) (V/ μ s)	9	0.5
Gain-Bandwidth Product, f_T (MHz)	4.5	1.0

protected by rugged bipolar diodes.

Versatile building block

The CA3140 can perform standard and many other applications. Such as ground-referenced single-supply amplifiers. Sample and hold amplifiers. Long-duration timers/multivibrators. Photocurrent instrumentation. Peak detectors. Active filters. Tone controls. Function generators. Power supplies. Intrusion alarm systems.

Send for 13 useful circuits.

To show you how useful the CA3140 is, we've designed it into 13 typical circuits. To get these circuits plus other information, contact your RCA Solid State distributor. Or RCA. Write: RCA Solid State, Box 3200, Somerville, N.J. 08876; Ste. Anne de Bellevue H9X 3L3, Canada; Sunbury-on-Thames, U.K.; Fuji Bldg., Tokyo, Japan.



MOS/FET

BiMOS

BIPOLAR

RCA

RCA. Full house in Linear ICs.