

Electronic Design[®]

FOR ENGINEERS AND ENGINEERING MANAGERS

VOL. 25 NO.

1

JAN. 4, 1977

The curtain's going up on 1977. And waiting in the wings is a star-studded cast of significant new products and technological developments. Minis and micros

team up with instruments to steal the scene. Consumer electronics continues to get rave reviews. LSI is also playing a key role. Get into the act on page 34.



Top Ten Contest!
Important you Enter
See Page 176

The \$2 Pot with the \$5 Linearity...

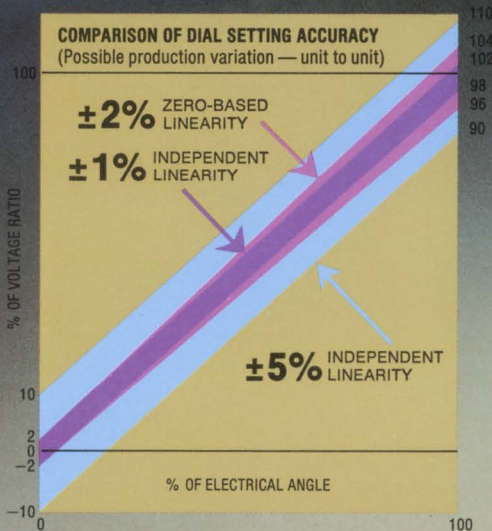

Your alternative to lower performance controls and higher cost precisions.

LASER-TRIMMED SAVINGS

Now, for about \$2*, the Bourns® Model 87/88 semi-precision, single-turn potentiometer delivers $\pm 2\%$ zero-based linearity. Compare the accuracy to the \$5 precision pot with $\pm 1\%$ independent linearity that you're buying now . . . especially the performance at the low end setting, where dial setting accuracy is most critical. Laser trimming and advanced element design† deliver performance and savings in a $\frac{5}{8}$ " square modular package.

MOVE UP FROM INDUSTRIAL GRADE CONTROLS

Again, for about \$2, the Model 87/88 offers 200-300% greater panel setting accuracy over industrial grade controls. They're perfect for applications requiring close, consistent calibration of output-to-panel setting and versatility of design.

MODEL 87/88 — THE ALTERNATIVE

Don't compromise your application with lower performance controls or pay a premium for precision pots. Specify the alternative — Bourns Model 87/88. Write or call today for complete technical information.

\$2 SEMI-PRECISION MODULAR POTS . . . BEAUTIFUL!

TRIMPOT PRODUCTS DIVISION, BOURNS, INC., 1200 Columbia Avenue, Riverside, California 92507, Telephone (714) 781-5122 — TWX 910 332-1252.

PERFORMANCE/COST COMPARISON			
Type	Element	Linearity	Approx. Cost
HIGHER COST PRECISION POTS	Conductive Plastic	$\pm 1\%$ Independent	\$5.00
BOURNS 87/88 SEMI-PRECISION POTENTIOMETERS	Conductive Plastic	$\pm 2\%$ Zero-Based	\$2.00
	Cermet	$\pm 2.5\%$ Zero-Based	
LOWER COST CONTROLS	Conductive Plastic/Cermet	$\pm 5 - 10\%$ Independent	\$1.00

* Production quantities, Domestic U.S.A. price only
† Patent Pending

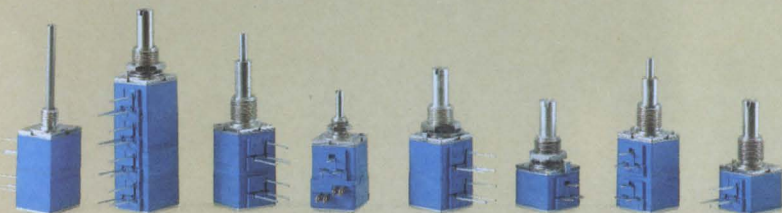

Int'l Mktg. Offices: European Hdqtrs. — Switzerland 042/23 22 42 • Belgium 02/218 2005 • France 01/2039633 • Germany 0711/24 29 36
• Italy 02/32 56 88 • Netherlands 70/87 44 00 • United Kingdom 01/572 6531 • Japan 075/921 9111 • Australia 02/55-0411 03/95-9566

CIRCLE NUMBER 282

SURPRISE!



Our New Display Can Say A Lot For You

Our new HDSP-2000 Alphanumeric Display can spell it out for you in bright, crisp LED characters. The full 5x7 dot matrix can display ASCII or custom character sets including lower case and symbols.

Compact and complete with on-board electronics, the HDSP-2000 dramatically reduces display system size and complexity. Each 12 pin DIP contains 4 characters with row drivers and storage. End stackable and easy to interface, they're ideal for "smart" instruments, medical systems or business terminals, military applications, and almost any mobile, portable or hand-held device.

The price is \$47.00* per 4-character cluster in quantities of 125 clusters. They're in stock today at HP's franchised distributors. In the U.S. contact Hall-Mark, Schweber, Wilshire or the Wyle Distribution Group (Liberty/Elmar) for immediate delivery. In Canada, contact Zentronics, Ltd. *U.S. Domestic price only.

HEWLETT  **PACKARD**

Sales and service from 172 offices in 65 countries.
1507 Page Mill Road, Palo Alto, California 94304

SSR UPDATE

We've got 87 answers to your AC solid state relay needs.

Teledyne Relays can handle virtually any AC solid state relay switching application. The reason? A family of AC SSRs with 87 models — and more on the way. We offer a broad range of voltage ratings up to 600V peak, with current ratings from 0.5 to 40 Amps. Add to that a variety of packages for pc board, chassis, or heat sink mounting and you have the industry's most complete line of AC SSRs.

But hardware isn't the only answer. You need assurance of the best available applications' engineering support.

And we've got it — backed by seven years as a pioneer and leader in SSR technology to enable you to use our SSRs to their maximum advantage.

That know-how, for example, is reflected in Teledyne's new 970 Series MOV transient suppressors designed specifically to protect our AC solid state relays against high voltage transients.

Contact your local Teledyne Relays people. You'll find we have the experience, technical support and products to meet your SSR needs.



- A. **601 Series***
5 and 10A (to 600V peak). Optically isolated, zero voltage turn-on. Screw terminals, quick disconnects, and pcb pin options.
- B. **611 Series***
10, 15, 25 and 40A (to 600V peak). Optically isolated, zero voltage turn-on. Dual purpose screw/quick disconnect terminals.
- C. **675 Series***
Low profile (0.5" max.) pc board SSRs. Output rating 3A, up to 600V peak. Optically isolated, zero voltage turn-on.
- D. **671 Series**
I/O Converter Modules. Special purpose SSRs for use in programmable controllers, machine tool controls, etc. Mounting panel available.
- E. **SerenDIP® Series***
TO-116 DIP package. Output rating 1A/280VRMS. Logic compatible 3.8 to 10VDC input.
- F. **970 Series MOVs**
High voltage transient suppressors designed specifically for use with all Teledyne AC SSRs.

* UL recognized/CSA certified.

 **TELEDYNE RELAYS**

3155 West El Segundo Boulevard, Hawthorne, California 90250
Telephone (213) 973-4545

CIRCLE NUMBER 3

NEWS

- 27 **News Scope**
What's ahead in 1977—An Electronic Design special report—
- 34 **μ Cs on a chip and integrated d/a's** about to usher in an IC harvest.
- 38 **Out in space or on the road**, discrete devices are on the job.
- 42 **'Smartly dressed instruments** will save you real money this year.
- 46 **Minicomputers are banding together** to replace central processors.
- 50 **Digital is still the way to go** for consumer-electronics products.
- 54 **Analog-to-digital switch is on** in military, civilian communications.
- 67 **Washington Report**

TECHNOLOGY

- 75 **Microprocessor Design**
- 90 **Software is a vital part of any computer.** For a specific application, instructions and hardware/software tradeoffs may determine the μ P selection.
- 100 **Put all input a/d channels under DMA control.** A simple modification to the data-acquisition unit unburdens your system's computer.
- 104 **Stop counter errors.** Check for gating problems with a simple test system, and your IC chip won't go 'down for the count.'
- 110 **Good grounding and shielding practices** are essential for stable, noise-free performance. Do it right initially and avoid future problems.
- 116 **Compute coupled-microstrip line configurations** with a simple BASIC program that synthesizes dimensional ratios and analyzes the impedances.
- 122 **Watch that transistor phase lag.** If you ignore excess phase lag, poor frequency response—even instability—of your amplifier circuit may result.
- 126 **Ideas for Design:**
Don't let shield currents defeat the purpose of shielding.
Very long shift registers can be built with RAMs.
Bill Hearn of Berkeley Laboratory wins annual 'Ideas for Design' award.
Keyboard for 64-key ASCII code features very low power consumption.
- 136 **International Technology**

PRODUCTS

- | | | | |
|-----|-------------------------|-----|-------------------------|
| 141 | Integrated Circuits | 155 | Components |
| 144 | Instrumentation | 158 | Power Sources |
| 146 | Data Processing | 162 | Discrete Semiconductors |
| 149 | Modules & Subassemblies | 164 | Microwaves & Lasers |
| 152 | Packaging & Materials | | |

DEPARTMENTS

- | | | | |
|-----|-------------------------------------|-----|----------------------------|
| 87 | Editorial: Winning arguments | | |
| 7 | Across the Desk | 172 | Advertisers' Index |
| 166 | Design Aids | 174 | Product Index |
| 166 | Application Notes | 176 | Information Retrieval Card |
| 167 | New Literature | | |

Cover: The stage of the Metropolitan Opera, Lincoln Center, New York City. Photo by J. Heffernan, Metropolitan Opera staff.

Now AMP's most versatile interconnection system is even more so.

We've added a whole family of pin headers.

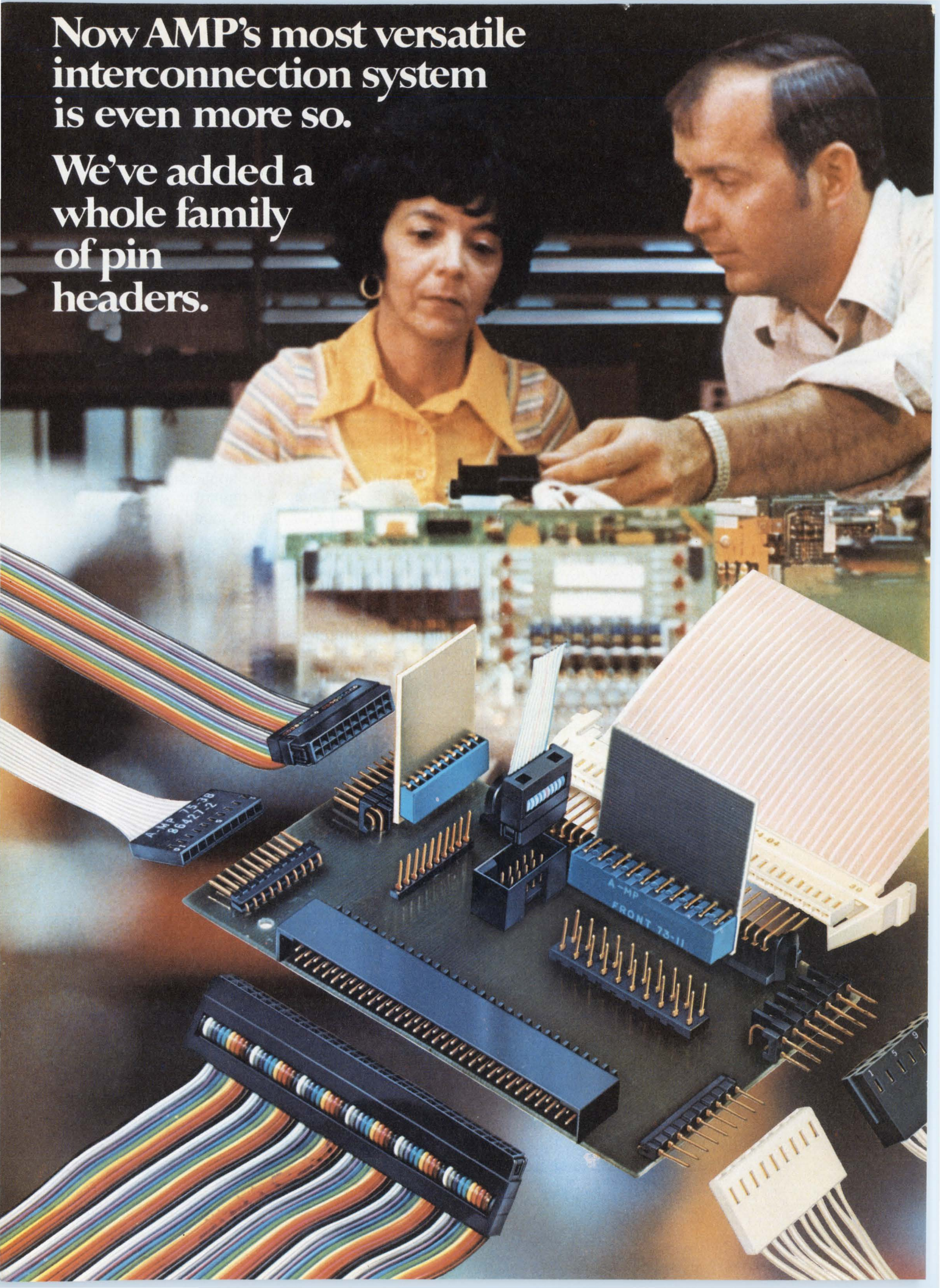

Top performance in a tiny space. AMPMODU posts, receptacles and headers make your packaging designs as tight as necessary.

We've also made it easier to place pins on a board. Forget about positioning pins one at a time. Forget costly front-end insertion equipment. Because AMP engineering ability shows up in our recently introduced AMPMODU pin headers.

Pins are fully protected. Headers are polarized and have self-retention locking latches. Headers fit everywhere on a board, including board center.

Ten basic header styles offer several thousand possible variations. You can approach mass termination with AMPMODU headers. Up to 80 positions.

These headers now complement the AMPMODU interconnection system, which features dual cantilever spring beams in the receptacle, five basic contact types and board to board or board to wire versatility. The forgiving nature of the receptacle design also ensures a uniform, positive electrical contact with the mating posts, everytime.

At AMP our application, service and sales engineers are located throughout the world, and are ready to help you with prototyping as well as providing a complete after-sale service.

For more facts about AMPMODU headers, write or call Customer Service. (717) 564-0100. AMP Incorporated, Harrisburg, PA 17105.

SEE US AT
MILAN BIAS SHOW

AMP
INCORPORATED

CIRCLE NUMBER 4

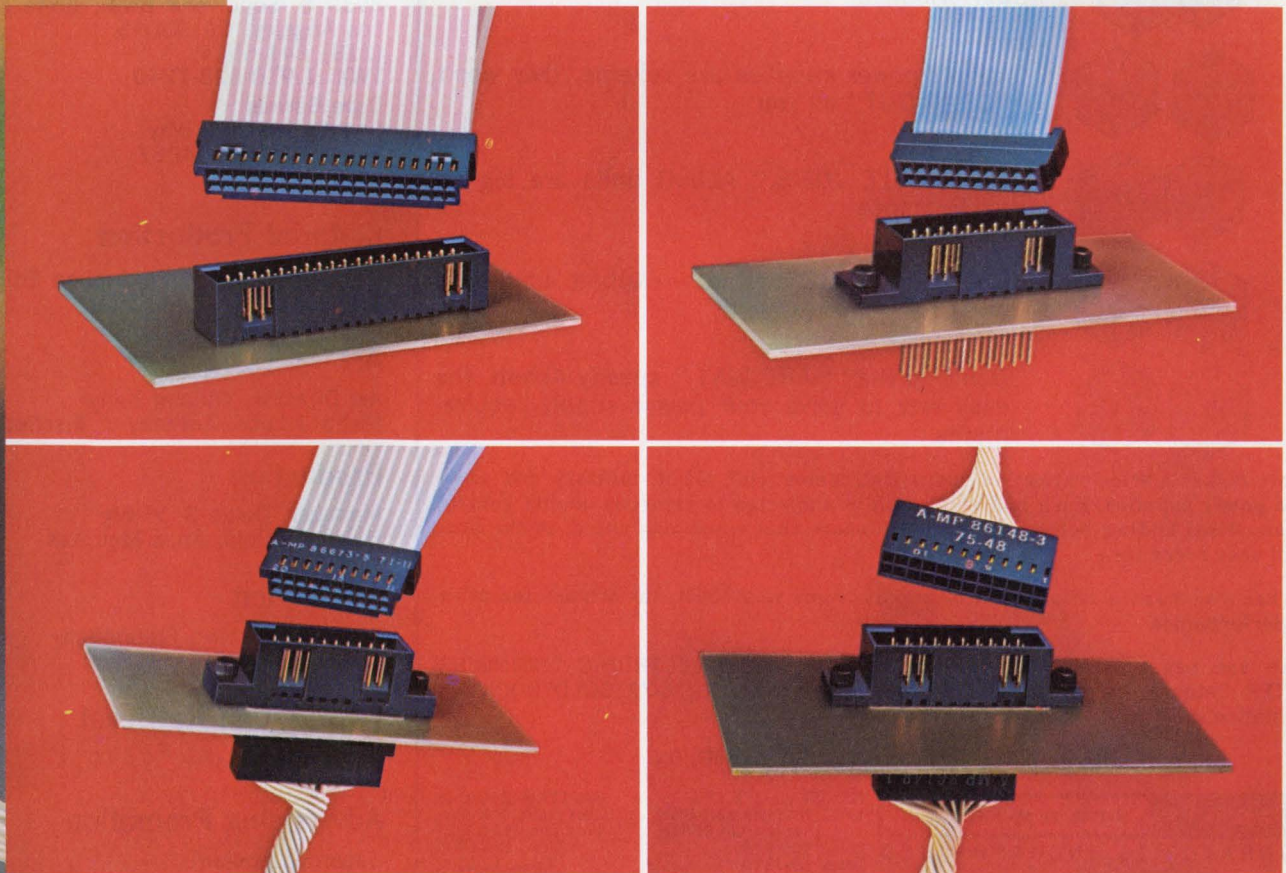



TAKE THE GAMBLE OUT OF SPECIFYING POWER SUPPLIES

When you specify power supplies manufactured by Abbott Transistor Laboratories, you minimize your risks and maximize your return.

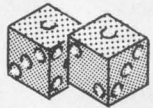

No "SNAKE EYES" with Abbott, only winning performance

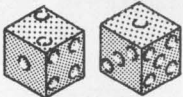

Abbott power supplies are reliable, they won't "CRAP OUT" on you

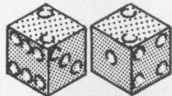

No "LITTLE JOE'S," Abbott units are big on performance

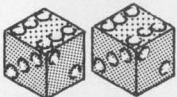

No "BOX CARS" either — Abbott units are compact

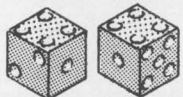

Don't go the "HARD WAY," specify Abbott, the easy way to solve your power supply requirements

Abbott makes a wide variety of industrial/commercial, OEM, military and aerospace power supplies. Each and every unit is subjected to rigorous quality control and electrical testing before shipment to insure that when you put it on the line, it will pass every time.

So when you want a reliable power supply, come to Abbott, the winner for price and performance.

Please see pages 1836-1848 of your 1976-77 EEM (ELECTRONIC ENGINEERS MASTER Catalog) or pages 672-682 Volume 2 of your 1976-77 GOLD BOOK for information on Abbott Modules.

Send for our new 60 page FREE catalog.

abbott transistor
LABORATORIES, INCORPORATED

GENERAL OFFICES
5200 W. Jefferson Blvd.
Los Angeles, CA 90016
(213) 936-8185
Telex 69-1398

EASTERN OFFICES
1224 Anderson Ave.
Fort Lee, NJ 07024
(201) 224-6900
Telex 13-5332

CIRCLE NUMBER 5

Sr. Vice President, Publisher
Peter Coley

Editors

Editorial Offices
50 Essex St.
Rochelle Park, NJ 07662
(201) 843-0550
TWX: 710-990-5071
Cable: Haydenpubs Rochellepark

Editor-in-Chief George Rostky

Managing Editors:

Ralph Dobriner
Michael Elphick

Senior Associate Editor

Stanley Runyon

Associate Editors:

Sid Adlerstein
Dave Bursky
Samuel Derman
Morris Grossman
John F. Mason
Max Schindler
Michael Shunfenthal

Contributing Editors:

Peter N. Budzilovich, John Kessler
Alberto Socolovsky, Nathan Sussman

Editorial Field Offices

East

Jim McDermott, Eastern Editor
P.O. Box 272
Easthampton, MA 01027
(413) 527-3632

West

Dick Hackmeister, Western Editor
8939 S. Sepulveda Blvd., Suite 510
Los Angeles, CA 90045
(213) 641-6544
TWX: 1-910-328-7240

Dave Barnes
844 Duncardine Way
Sunnyvale, CA 94087
(408) 736-6667

Editorial Production

Marjorie A. Duffy, Production Editor
James Keane, Copy Editor

Art

Art Director, William Kelly
Richard Luce, Anthony J. Fischetto

Production

Manager, Dollie S. Viebig
Helen De Polo, Anne Molfetas

Circulation

Director, Barbara Freundlich
Trish Edelmann

Information Retrieval

Paula Greenleaf

Advertising Promotion

Susan G. Apolant

Across the Desk

There is a standard, militarywise

In response to Bill Walkup's statement that "There is no standard, military or otherwise, and there is no progress toward a standard" (ED No. 16, Aug. 2, 1976, p. 43):

There is a standard military electronic module and it's the Navy's Standard Electronic Module (SEM) Program. To date, it has over 60 separate system applications that span virtually every equipment operating environment, resulting in a commitment to service of over 4-million modules. Foreign military (U.K., French, the Netherlands, among others) are also making serious efforts to become involved in the program.

The cornerstone of the program is that it standardizes on electronic functions, including memories, shift registers and microprocessors; functionally specifies such functions so that they don't depend on either technology or a specific vendor; and imposes a stringent quality-assurance program to ensure their interchangeability and high reliability.

Standardizing merely on card size is only one small part of the problem of achieving more economical and reliable hardware; and, for the military, it has been proven that if improved operational effectiveness is to be achieved, it must be done with a disciplined electronics-hardware methodology. The SEM Program, which addresses this problem with a philosophy of functional and physical standardization requirements, stiff vendor quality control and the natural ingredients to develop a competitive and innovative com-

mercial market, has proven that, at least for the military, SEM is the way to go.

*Richard Kowalin
Technical Consultant*

Hydrospace-Challenger, Inc.
2150 Fields Rd.
Rockville, MD 20850

Misplaced Caption Dept.



O.K. He gets the contract.

Sorry. That's Marinus Van Reymerswaele's "A Banker and his Wife," which hangs in the Prado Museum in Madrid.

Space engineers suffer wage and/or job cuts

A widespread problem in the government services industry is the government-solicited contract competition for predominantly engineering and scientific services. The primary reductions in cost occur due to a process known as "wage-busting." Through this method, a new contractor can bid for the contract by cutting the salaries of professional employees by even 50%.

According to Irving Feerst, mes-
(continued on page 12)

Electronic Design welcomes the opinions of its readers on the issues raised in the magazine's editorial columns. Address letters to Managing Editor, Electronic Design, 50 Essex St., Rochelle Park, NJ 07662. Try to keep letters under 200 words. Letters must be signed. Names will be withheld on request.

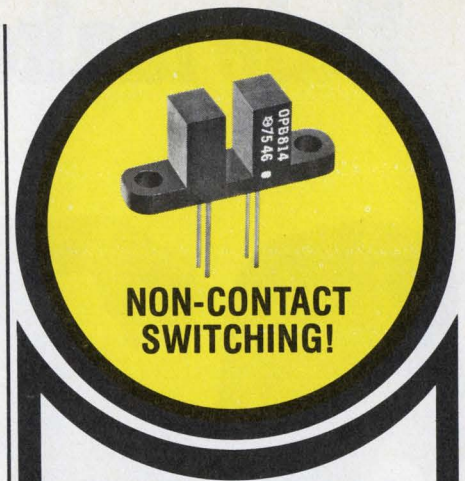

OPTICALLY COUPLED INTERRUPTER MODULES

OPTRON OFFERS IMMEDIATE DELIVERY OF NEW, LOW COST SERIES

OPTRON's new, low cost optically coupled interrupter module series combines non-contact switching and solid state reliability for applications requiring sensing of position or motion of an opaque object such as motion limit, paper edge or shaft encoding.

The new OPB 813, OPB 814 and OPB 815 consist of a gallium arsenide infrared LED coupled with a silicon phototransistor in an economical molded plastic housing. With a LED input of 20 mA, the OPB 813 and OPB 815 have typical unblocked current outputs of 2.0 mA and 3.0 mA, respectively. Typical output of the OPB 814 is 3.0 mA with a 10 mA input. The entire series is available from stock.

Background illumination noise is eliminated by a built-in infrared transmitting filter and dust cover in each device type. The OPB 813 also is available with a 0.010 inch aperture for high resolution applications.

New OPTRON optically coupled interrupter modules are interchangeable with similar products as follows:

OPTRON	GE
OPB 813	H13A1
OPB 813	H13A2
OPB 814	H13B1
OPB 814	H13B2

Detailed technical information on these and other OPTRON standard interrupter and reflective modules, as well as versions for specific applications is available on request.



OPTRON, INC.

1201 Tappan Circle
Carrollton, Texas 75006, U.S.A.
214/242-6571 • TELEX-73-0701
TWX-910-860-5958

Dale makes your basics better.



More muscle in your resistors

Wirewound, metal film, carbon film, tin oxide... Dale's resistor line is stronger than ever. To match expanded capacity, we've installed a network of computer terminals to speed shipments and aid you in production planning. In addition, we've upgraded our quality assurance programs so that one out of every 10 Dale employees is directly involved with quality control. As a result, the Dale resistors you order are the best we've ever made... and the most efficient for you to buy.

CIRCLE NO. 351

More stretch in your connectors

Don't let the costs of tooling a special connector scrap your design. Dale's innovative ED line gives you dual readout .050" and .100" edgeboards that expand in length and number of contacts without tooling charges. This "stretchability" is also available in a line of digital display connectors. In addition, Dale can provide a variety of .156" edgeboards plus dip solder and rack and panel models. To find out more about the advantages of Dale connectors, circle the reply number or call 605-665-9301 today.

CIRCLE NO. 352

More punch in your trimmers

A trimmer's power rating should give you leeway to derate for assured long-term stability. Dale trimmers do. Our low profile 700 Series provides 1 watt at 70°C in both wirewound and cermet models and cermet models give you 1% CRV in the bargain. In single-turn square trimmers Dale's 3/8" 100 Series gives you a half watt clear up to 85°C in a choice of 5 top adjust and 3 side adjust models. Compare. We're the new source you've been looking for.

CIRCLE NO. 353



Higher Q in your inductors

Dale is steadily growing as a source for a wide range of inductors including: Flame retardant coated chokes with performance and durability comparable to molded models at a much lower price; filter inductors with a wide selection of Q vs frequency; trigger transformers interchangeable with 11Z types. In addition, we offer a versatile line of transformers including low power, converter and pulse models. Get complete price and delivery information by calling 605-665-9301 today.

CIRCLE NO. 354

More versatility in your networks

Dual-in-line, single-in-line standard or special circuits... Dale has what you need in thick film resistor networks. For custom circuits our SDP and SSP Series offer two ceramics with space for up to 28 resistors. New low profile SIP models and machine insertable DIP's solve packaging problems. We were the first to qualify to MIL-R-83401 and now offer 10 models meeting this spec. For network help, call 402-371-0080 today.

CIRCLE NO. 355

Your man from Dale has a lot of ways to help you ... call him today.

DALE ELECTRONICS, INC.
1300 28th Avenue,
Columbus, Nebraska 68601
A subsidiary of The Lionel Corporation
In Canada: Dale Electronics Canada Ltd.
In Europe: Dale Electronics GmbH,
8 Munchen 60, Falkweg 51, West Germany

Our complete product line can be found in Electronic Design's GOLD BOOK.

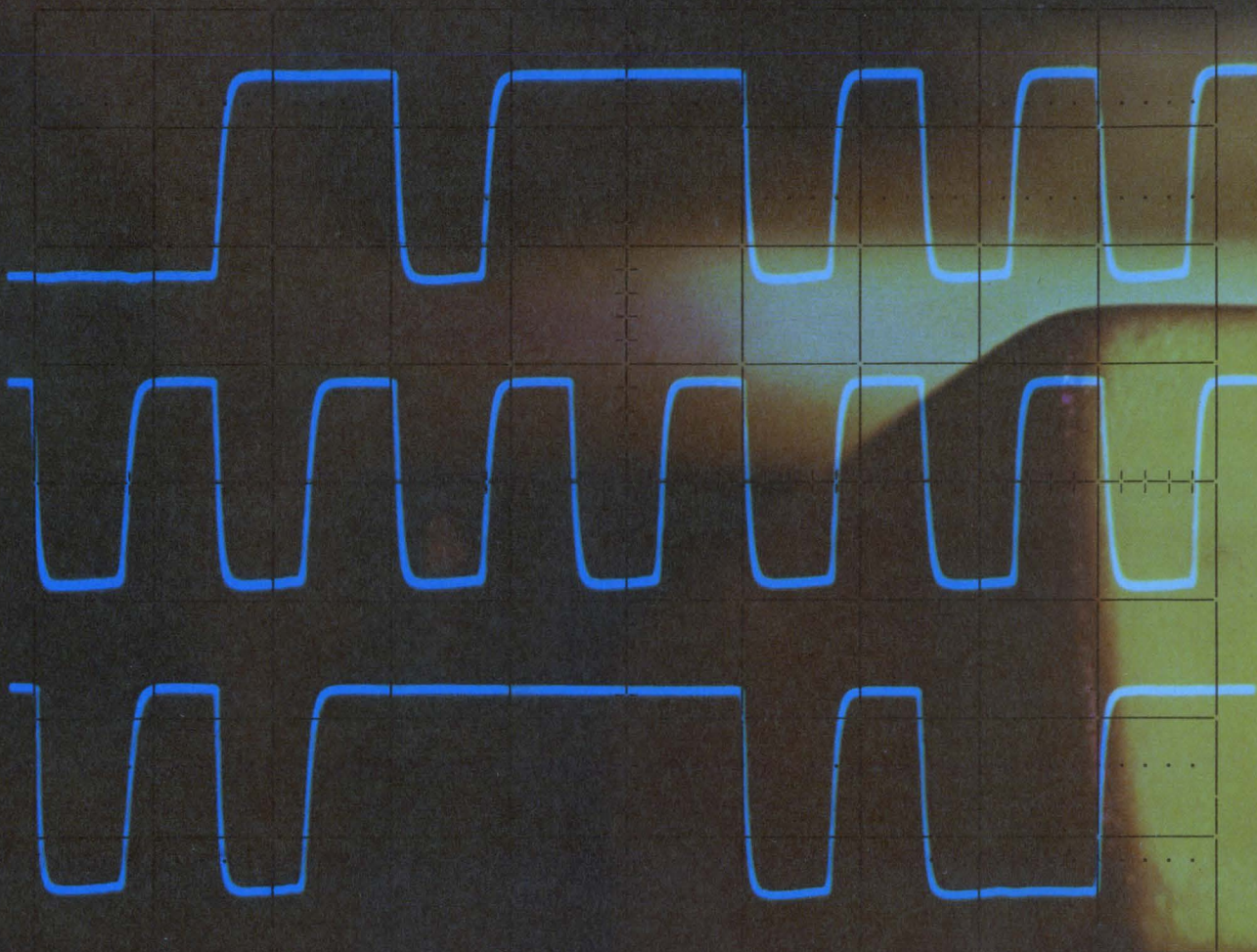

1000	1000	0000	0110
0000	0000	1000	1000
0000	0000	0000	0000
1000	1000	0000	1100
1000	1000	0000	1110
1000	1000	1000	0000
1000	1000	1000	0000

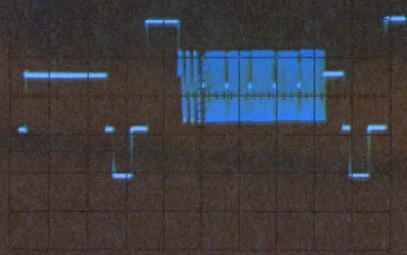

Want a different view with the touch of a button?

HP's the Answer.

And the 100 MHz **1740A** is your scope. With HP's push-button **third-channel trigger view**, you can see your trigger signal along with channel A and B—three traces in all—so you can make timing measurements between all three simultaneously. In most applications, that means three-channel capability for the cost of a two-channel scope.

Here are two more timesaving features you can get at the touch of a button. For data-domain applications, you can combine the 1740A with HP's 1607A Logic State Analyzer and trigger the scope with the analyzer's pattern-trigger or delayed-trigger output. Add the "**Gold Button**" (an optional logic-state push button in lieu of A versus B) for just \$105* and (with the 1607A) you have push-button selection of either logic-flow or real-time display. That means you can view the logic states of operational circuitry for pinpointing a problem. Then push the "Gold Button" and see the waveforms you've selected at that specific point in time. Or, add the **TV sync** (optional for just \$180*) and tailor the 1740A for TV broadcast and TV R&D applications simply by pulling a knob.

The 1740A also has an **X5 vertical magnifier** with the touch of a button for 1 mV/div sensitivity on both channels to 40 MHz without cascading. Again, measurements are simplified because

you can directly monitor low-level signals such as outputs of read/write heads of disc or mag units, power-supply ripple, or medical sensor outputs. You also get selectable input impedance (1 megohm or 50 ohms) plus the time-tested 8 x 10 cm CRT used in the 180 System lab scopes.

At just \$2095*, HP's 1740A, with its three-trace capability, is an exceptional scope value. Call your local HP field engineer today for all the details.

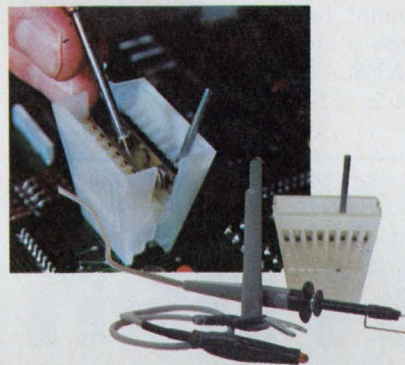

And here's something **NEW** for scopes. HP's **Easy-IC Probes**. A new idea for probing high-density IC circuits that eliminates shorting hazards, simplifies probe connection to DIPs and generally speeds IC troubleshooting. Ask your HP field engineer about them.

*Domestic U.S.A. price only.



HEWLETT  PACKARD

Sales and service from 172 offices in 65 countries.

1507 Page Mill Road, Palo Alto, California 94304
For assistance call Washington (301) 948-6370 Chicago (312) 677-0400
Atlanta (404) 434-4000 Los Angeles (213) 877-1282

086/16

CIRCLE NUMBER 8

ACROSS THE DESK

(continued from page 7)

siah of the working engineer, there are senior engineers (BSEE +10 years experience) at the Kennedy Space Center who are paid as little as \$14,500 per year. However, "blue-collar" workers are protected by the 1965 Service Contracts Act, which fixes their rates. The professional employees, such as engineers, analysts, mathematicians and scientists, are specifically exempted from that protection, and so they suffer the brunt of the funding cuts.

The effectiveness of the Act was seen in 1972, when the professional employees were offered a choice of termination or a 15% pay cut, while unionized technicians covered by the Act were receiving substantial raises.

It was previously believed that this discrimination was an oversight of Congress, but recently, an attempt by the Coalition of Aerospace Professional Employees (CAPE, P.O. Box 2251, Satellite Beach, FL 32937) to obtain relief

was rebuffed. Tens of thousands of professionals across the nation suffer, yet our Congressional representatives have asserted that extending the protection would endanger passage of an amendment to shelter the technical (unionized) employees.

As members of these unions have recently received 7 to 10% raises, it is becoming increasingly difficult to stave off the tendency of professional employees to welcome unionization. Professional idealism has a very weak appeal when many technicians can command a greater salary than experienced engineers and scientists.

Frank R. Leslie

150 Norwood Ave.
Satellite Beach, FL 32937

Attention, old timers

ELECTRONIC DESIGN is 25 years young this year and we feel as jaunty as anybody should feel at that age. We hope to make our birthday a very happy one for all of you. While we were meditating about the kind of birthday cake we might have, we wondered how

many readers have been with us since 1952. If you are one of them we would appreciate your taking the trouble to **Circle 315** on the reader-service card.

And if by chance you have complete files of ELECTRONIC DESIGN we would appreciate it further if you would also **Circle 316** on the reader-service card.

Publish methods we can all understand

Generally, when you publish articles on the characteristics of electrical insulators, you propose ASTM methods to test arc resistance. Due to the worldwide circulation of ELECTRONIC DESIGN, I suggest that you use whenever possible methods that are accepted worldwide and recognized. Only in this manner will it be possible for all your readers to fully understand the very useful comparisons made in your articles.

With regard to the arc-resistance problem: there is the IEC (International Electrotechnical Commission) publication 112, "Recom-

When it's time to swit

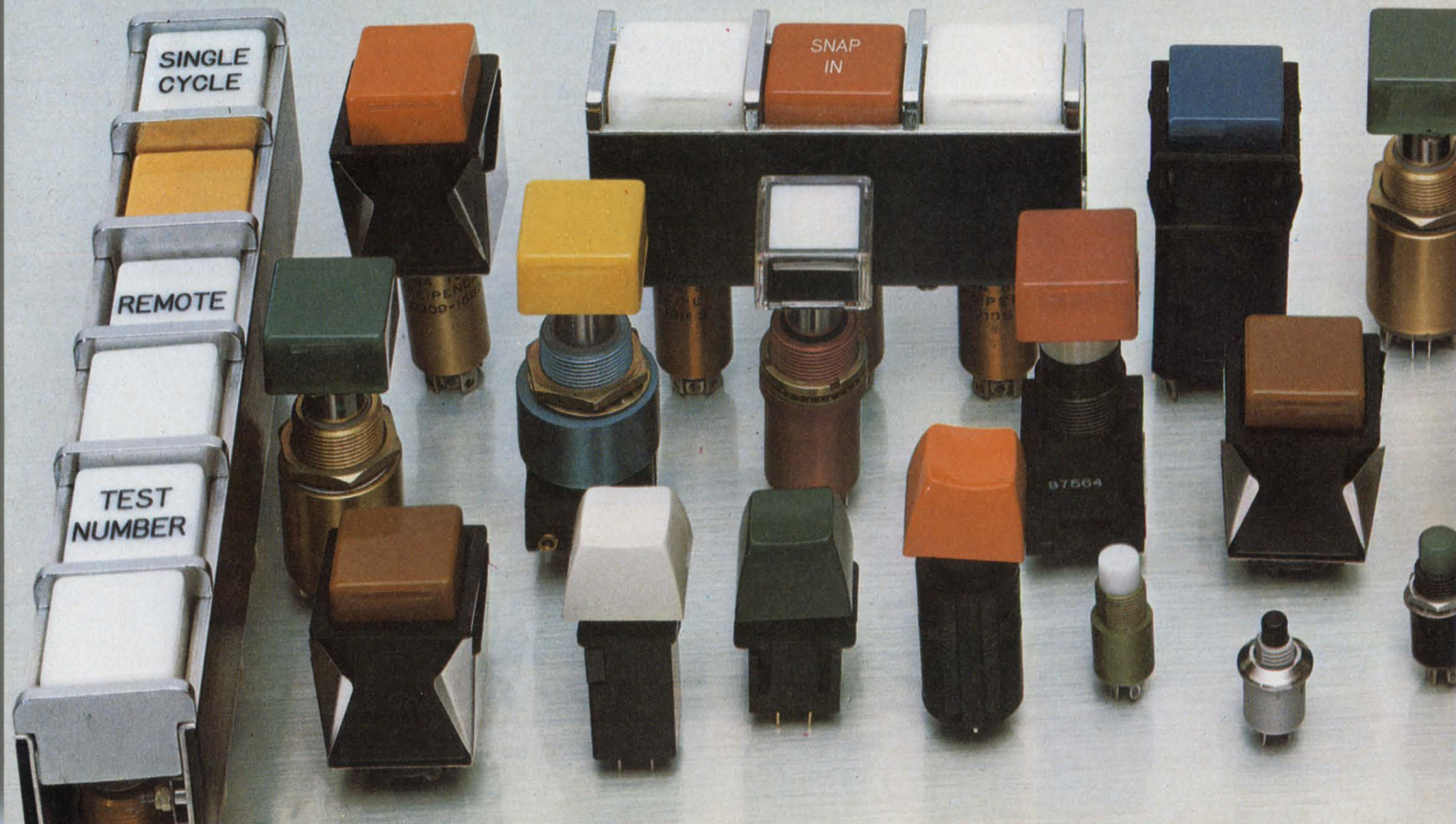

mended Methods for Determining the Comparative Tracking Index (CTI) of Solid Insulating Materials under Moist Conditions," which is accepted all over and referred to by all other IEC publications. Since the U.S. is a member of IEC, it would be useful if ELECTRONIC DESIGN would pay more attention to methods contributing to a growing awareness of this test method in the U.S. By doing so, ELECTRONIC DESIGN will help U.S. and foreign engineers speak the same language and harmonize tests.

Dr. Ing. Luigi Totaro
Approvals Manager

Zeus Rapizzi
Milan, Italy

Blame the marketplace, not the nonstandards

The article on RFI (ED No. 20, Sept. 27, 1976, p. 24) was very interesting, but glossed over some important details. RFI in consumer electronic products is a much larger problem than indicated. For instance, the horizontal-oscillator radiation from my TV set is so great that it interferes with the

reception of half of the stations on the AM broadcast band that make it through the radiation from my neighbor's TV set. My FM receiver is designed in such a way that the speaker leads act as a full-size antenna that picks up signals from nearby HF transmitters, and feeds them to the input of the audio amplifier where they are detected, amplified and fed to the speakers.

Such poor engineering is not caused by a lack of industry-wide standards, as stated in the article, but by a consumer marketplace that values cosmetic packaging and initial purchase price more than quality and long-term cost of ownership.

James Long
Sorenson Instructor of
Electrical Engineering

California Institute of Technology
Pasadena, CA 91125

Misplaced caption, Part 2

Regarding the misplaced caption for Antonio Pollainolo's "Hercules and Antaeus" (ED No. 17, August 16, 1976, p. 16), I should have

thought a more appropriate caption would have been "Who loves ya baby?"

H. A. Cole

AERE Harwell
Electronics & Applied Physics
Div.
Oxfordshire, England

Right state, wrong city

Thank you for printing "Watchdog' Circuit Protects Sig Gen" (ED No. 18, Sept. 1, 1976, p. 116). However, the location of Krohn-Hite Corp. is not Cambridge, but Avon Industrial Park, Avon, MA 02322.

Mary E. Fleischer
Administrative Assistant

Lettermen, Inc.
19 Muzzey St.
Lexington, MA 02173

Oops, we slipped a digit

In the Sept. 13, 1976, issue of ELECTRONIC DESIGN (No. 19, p. 56), the telephone number for E & L Instruments was printed incorrectly. The correct phone number is (203) 735-8774.

ch...switch to CLARE.

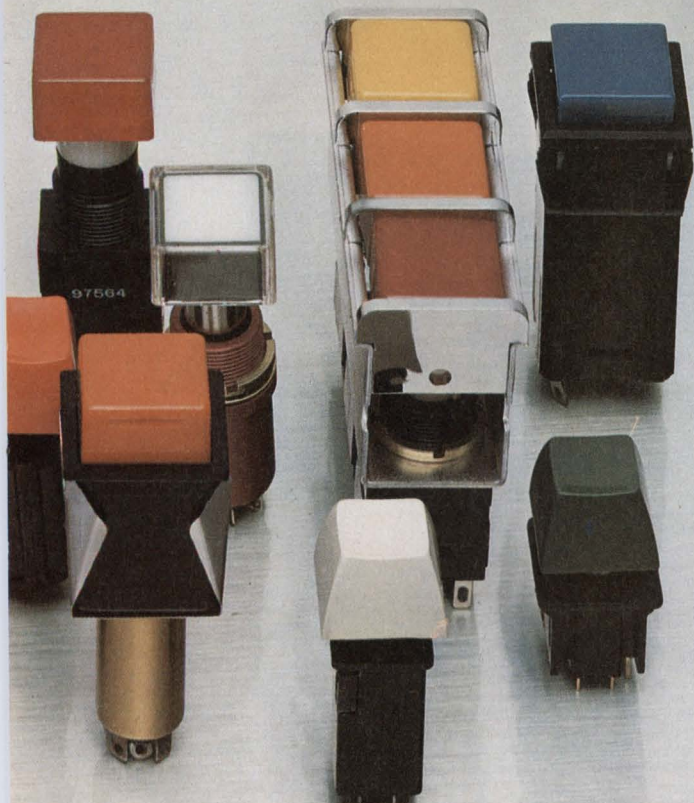

There's an outstanding CLARE SWITCHING DEVICE waiting for your application.

From switchlights to indicators. Interlocked gangswitch assemblies to advanced key switch designs. All backed by a quarter century of Clare-Pendar quality and reliability . . . combined with the proven service capabilities of C. P. Clare.

Ready for a switch? Contact your local distributor. Or, C. P. Clare & Company, 3101 W. Pratt Avenue, Chicago, Illinois 60645. Phone (312) 262-7700.

C. P. CLARE & COMPANY
GENERAL INSTRUMENT CORPORATION



CIRCLE NUMBER 10

NEW FROM KEITHLEY: TWO "BEST BUY" DMMs. 4½ DIGITS. 30000 COUNTS. UNDER \$500.



Model 173



Model 172

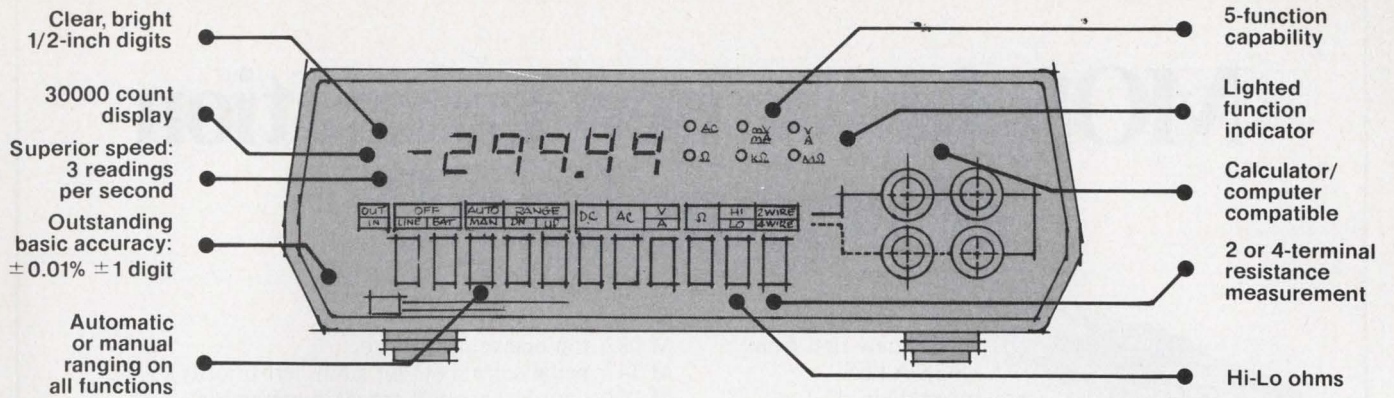

Take a look at the remarkable features of the new Keithley Digital Multimeters. They're unmatched in the industry.

Now consider price. At \$499 we think you'll agree the Keithley 172 is the best buy in a general purpose 4½-digit DMM.

There isn't another 4½ that matches the price-performance value of the 172. Except for its higher-rated companion, the Keithley 173.

For \$499: the exceptional 172.

To begin with, you get a dependable, durable, portable, easy-to-use, autoranging instrument with five functions. Designed for research, engineering or production applications.

Measure from 10 microvolts to 1200 volts dc, 10 microvolts to 1000 volts ac, 10 milliohms to 300 megohms, 10 microamps to 2 amps, ac or dc. DC accuracy is 0.01% ± 1 digit.

There's more: 3 month recal cycle. No-nonsense, full-year guarantee on parts, workmanship, and specs. 30000-count display yields maximum accuracy for 15, 18, 24 and 28-volt measurements.

For \$625: the even more exceptional 173.

The Keithley 173 is our top-rated 4½-digit DMM. It gives you all the performance and accuracy of the 172 plus superior autoranging current measurements from 10 nanoamps to 3 amps. This makes the 173 the most complete and versatile general purpose 4½-digit DMM in the world—at any price.

More versatility. Now or later.

Options and accessories expand the 172 or 173 to your specific needs: Rechargeable battery pack you can buy now or add later. Digital output/control. RF probe. 50-amp shunt. Clamp-

on ammeter. High-voltage probe. Rack mount kits. Test lead sets. Carrying case. IEEE 488 interface.

Make this easy decision.

For most 4½-digit DMM applications, the new Keithley 172 is your best buy. When you require more current measuring capability, the 173 is.

For convincing proof, send for detailed specs or request a demonstration. Or if you're already convinced, send your order to: Keithley Instruments, 28775 Aurora Road, Cleveland, Ohio 44139. (216) 248-0400. Europe: Heiglhofstrasse 5, D-8000 München 70, West Germany. (089) 7144065.

DMMs for all your needs.

We know you have a variety of measurement requirements. So we offer a growing family of DMMs — 3½ to 6½ digits — to satisfy your application. And your budget.

3½ digits	4½ digits	5½ & 6½ digits
Model 168 General purpose. Low cost. Model 160B 1 µV and 10 pA sensitivity. Model 616 Super-sensitive. 0.1 pA full-scale.	Models 172 and 173 Two "Best-Buys" Model 171 1 µV sensitivity. 5-functions. Model 174 0.1 µV sensitivity. (coming soon) Model 180 30 nV sensitivity.	Model 190 Multi-function. Low cost. Model 5900 0.001% accuracy. High stability. Model 6900 Accuracy, stability and sensitivity measured in ppm.

New guide available: "How to get more from your DMM." Send for yours today.

KEITHLEY
 The measurement engineers.

MOS for the new generation of organs (easy!)

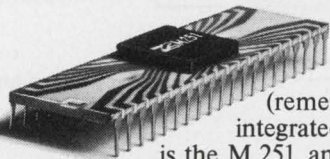

A new first from SGS-ATES (remember their integrated rhythm generator?) is the M 251, an automatic accompaniment generator integrated on a single MOS-LSI chip.

You've already selected your rhythm, and now you can correctly key-in the automatic accompaniment (chords, walking bass and arpeggio) for your melody, by pressing, that's it, just one key. A memory ensures that you can then proceed with your favorite "hands-off" operation.

All this thanks to SGS-ATES' MOS experience and many years of collaboration with major organ producers. Apart from the M 251, SGS-ATES manufactures a complete range of MOS integrated circuits for electronic musical instruments:

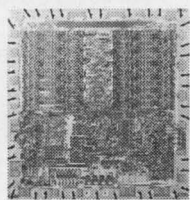

- M 087 top octave synthesizer
- M 147 pedal sustain (13 bit latch, left priority)
- M 251 chords, bass and arpeggio generator
- M 252 rhythm generator (15 rhythms, 8 instruments)
- M 253 rhythm generator (12 rhythms, 8 instruments)
- M 254 rhythm generator (8 rhythms, 12 instruments)
- M 255 rhythm generator (6 rhythms, 5 instruments)
- HBF 4727 7-stage frequency divider (2+2+1+1+1)
- HBF 4737 7-stage frequency divider (3+2+1+1)
- and in bipolar technology
- H 629 1x12 multiplexer
- H 632 2x6 multiplexer

And that's why



SGS-ATES SEMICONDUCTOR CORPORATION
Newtonville, Mass., tel: 617-9691610





HERE'S YOUR
CHANCE TO

• **SHARE \$32,000**

WORTH OF PRIZES

• **TEST YOUR SKILL**

• **WIN A FREE CARIBBEAN
VACATION**

IN **Electronic Design's**

Top Ten Contest

REPEATED BY READER REQUEST
NO GIMMICKS — NOTHING TO
WRITE — NO SLOGANS

SEE NEXT TWO PAGES FOR DETAILS

ATTENTION ALL ENGINEERS!

Design yourself a free vacation for two!

Yes, you can win an all-expense-paid Caribbean vacation plus \$1,000 cash — or one of 99 other valuable prizes!

There's nothing to buy, nothing to write, no slogans or gimmicks.

All you have to do is pick the ten advertisements that our readers will best recall having seen in this issue.

It's *Electronic Design's* popular TOP TEN CONTEST — the contest that can pay off handsomely for you *and* for your company.

Win a free vacation for yourself

Think of it! Clear sky... warm sun... expanses of blue water. The Caribbean is at its best when viewed from the deck of a sailing ship.

Top prize is a fabulous week's Windjammer Cruise for two. You can choose trips among the Bahama Out Islands, the U.S. and British Virgin Islands, or the exotic Windwards and Leewards.

Visit colorful ports with their old world charm and duty-free shops. Swim, fish, snorkel, relax, or lend a hand with the ship.

And it's all free! The prepaid cruise is worth many hundreds of dollars — not to mention the \$1,000 cash for travel and incidentals.

Win for your company

More and more companies are urging their engineers to enter this contest. Why? Because a large sample of *Electronic Design* subscribers will determine the top-scoring ads. The ten best will be rerun free of charge. Your company can win one of these reruns, worth up to several thousand dollars! (To receive this prize, your company must have an ad in the contest issue.)

Separate contest for advertisers and their agencies

The TOP TEN CONTEST is actually two contests with separate sets of prizes (1) for engineers and engineering managers (readers) and (2) for company executives, marketing and advertising personnel and their advertising agencies. Urge your top brass to enter. Xerox this page and pass it on to them. Maybe they can pick the top ten ads and walk off with one of the separate prizes.



Here's all you have to do to enter

First, read the rules contained in this issue. Then:

(1) Examine the advertisements carefully.

(2) Pick the ten ads that you think *Electronic Design* subscribers will best recall having seen. List these ten ads by company name and reader service number on the entry card. Mail before February 28, 1977.

Your selections will be checked against Reader Recall, *Electronic Design's* method of measuring readership.

100 reader prizes in all

This is the January 4 Top Ten Contest issue. Try your skill. This year, maybe *you* can sail away with the top prize.



PRIZES READER CONTEST

1st PRIZE

A WINDJAMMER CRUISE (FOR TWO)
IN THE CARIBBEAN
(Choice of itineraries and dates)

PLUS

\$1,000 CASH FOR TRANSPORTATION
AND INCIDENTALS

2nd PRIZE

GTE SYLVANIA PORTABLE COLOR TV SET
(\$325 value)

3rd, 4th & 5th PRIZES

DIGITAL WRISTWATCH
(\$100 value)

6th through 100th PRIZES

TECHNICAL BOOKS
(title to be announced)

PRIZES ADVERTISER CONTEST

1st PRIZE

WINDJAMMER CRUISE (FOR TWO)
IN THE CARIBBEAN
(Choice of itineraries and dates)

PLUS

\$1,000 CASH FOR TRANSPORTATION
AND INCIDENTALS

2nd PRIZE

GTE SYLVANIA PORTABLE COLOR TV SET
(\$325 value)

3rd PRIZE

DIGITAL WRISTWATCH
(\$100 value)

SEE PAGE 176 FOR COMPLETE RULES; ENTRY BLANK ON READER SERVICE CARD



NOTE TO ENGINEERING MANAGERS
Urge your staff to enter.
The winning ads will receive
free reruns worth \$ thousands
for your company.

THIS IS THE
**1977
TOP TEN
CONTEST
ISSUE!**

100 Hz TO 1000 MHz

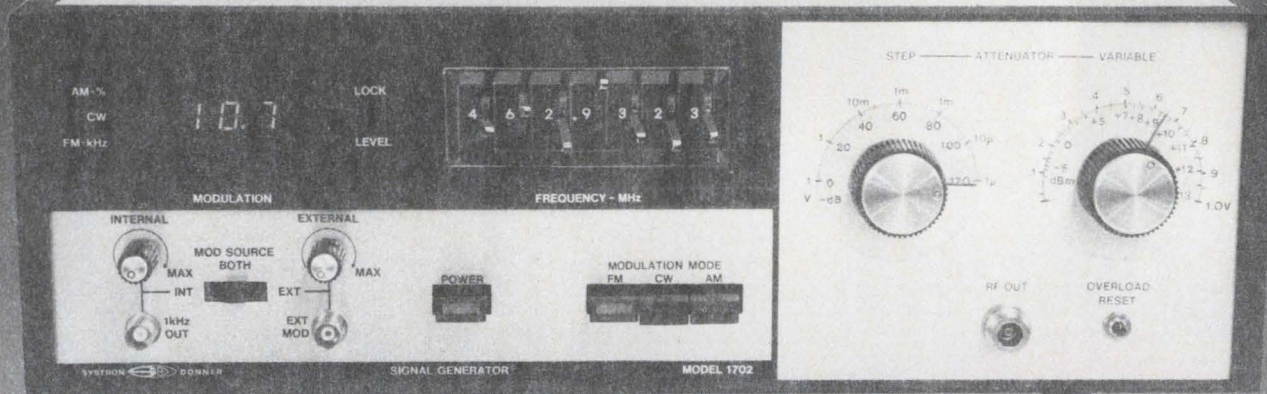

ONLY S-D'S NEW SIGNAL GENERATOR GIVES YOU SUCH WIDE COVERAGE—IN ONE RANGE— WITH 100 Hz RESOLUTION!

Many of today's test requirements go well beyond 520 MHz. That's why Systron-Donner's new Model 1702 AM/FM Signal Generator covers 100 Hz to 1,000 MHz in one range with the stability and accuracy of a synthesizer.

Output accuracy 1 dB. Obviously output level accuracy of a signal generator is critical; a small variation makes a big difference. Systron-Donner's attenuator accuracy of 1 dB is significantly better than other signal generators costing much more

than our price of \$4,150 (U.S. only).

Model 1702 is a synthesized generator with external reference capability and digital display of amplitude and frequency modulation. Modulation may be controlled internally, externally or a combination of internal and external.

Why pay more for an obsolescent signal generator? Please contact Scientific Devices or Systron-Donner at 10 Systron Drive, Concord, CA 94518. Phone (415) 676-5000.

SYSTRON  DONNER

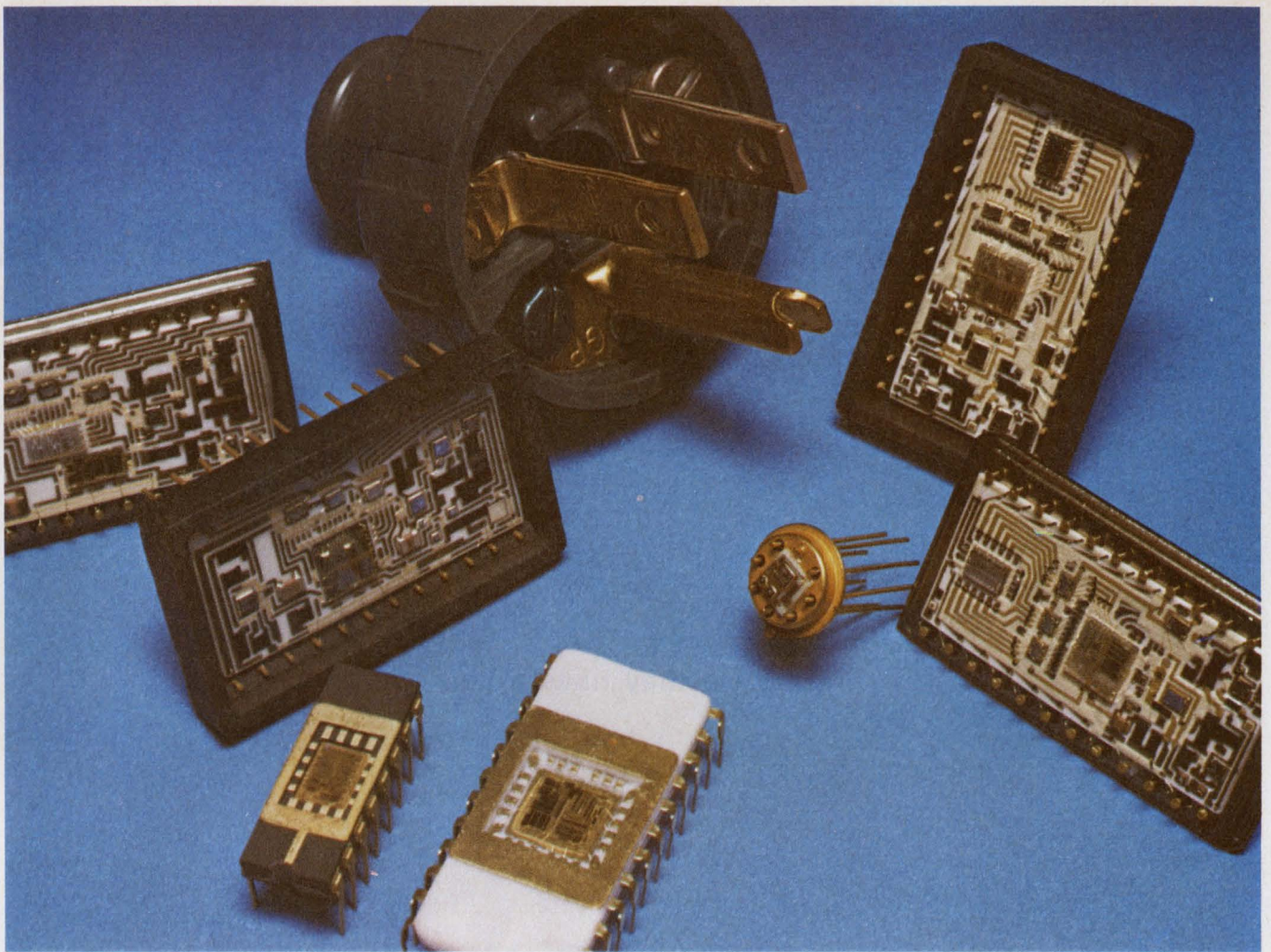

Our new low-cost industrial converter products are standard, too.

Standards, like that plug, make life less complicated.

That's why we're leading the campaign to standardize converter products.

And the group you see here is just part of a growing family that starts as low as \$19.50 in the 100-piece quantity.

They're on-the-shelf, for quick delivery. A new line of DAC's and ADC's for designers who can use standard functions. Plus thin-film ladder networks and a precision voltage reference to give exceptional design flexibility.

These competitively priced, industry-standard converter products can save you engineering, manufacturing, and inventory time and money. And you have a wide selection of package types and temperature ranges to fit your exact applications.

Learn more about Beckman-quality, Beckman-backed hybrids. They'll make your life easier, too.

For data, write or call Helipot Division, Beckman Instruments, Inc., 2500 Harbor Blvd., Fullerton, CA 92634. Phone: (714) 871-4848, Ext. 1776.

BECKMAN®

HELIPOT DIVISION

If you need hybrids, you should know about Beckman.

CHERRY

and keep on working.

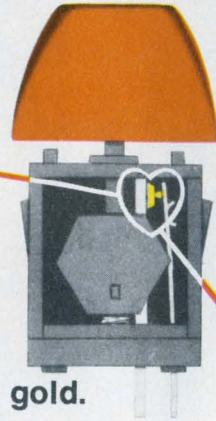

RELIABLE
because they have a heart of gold.

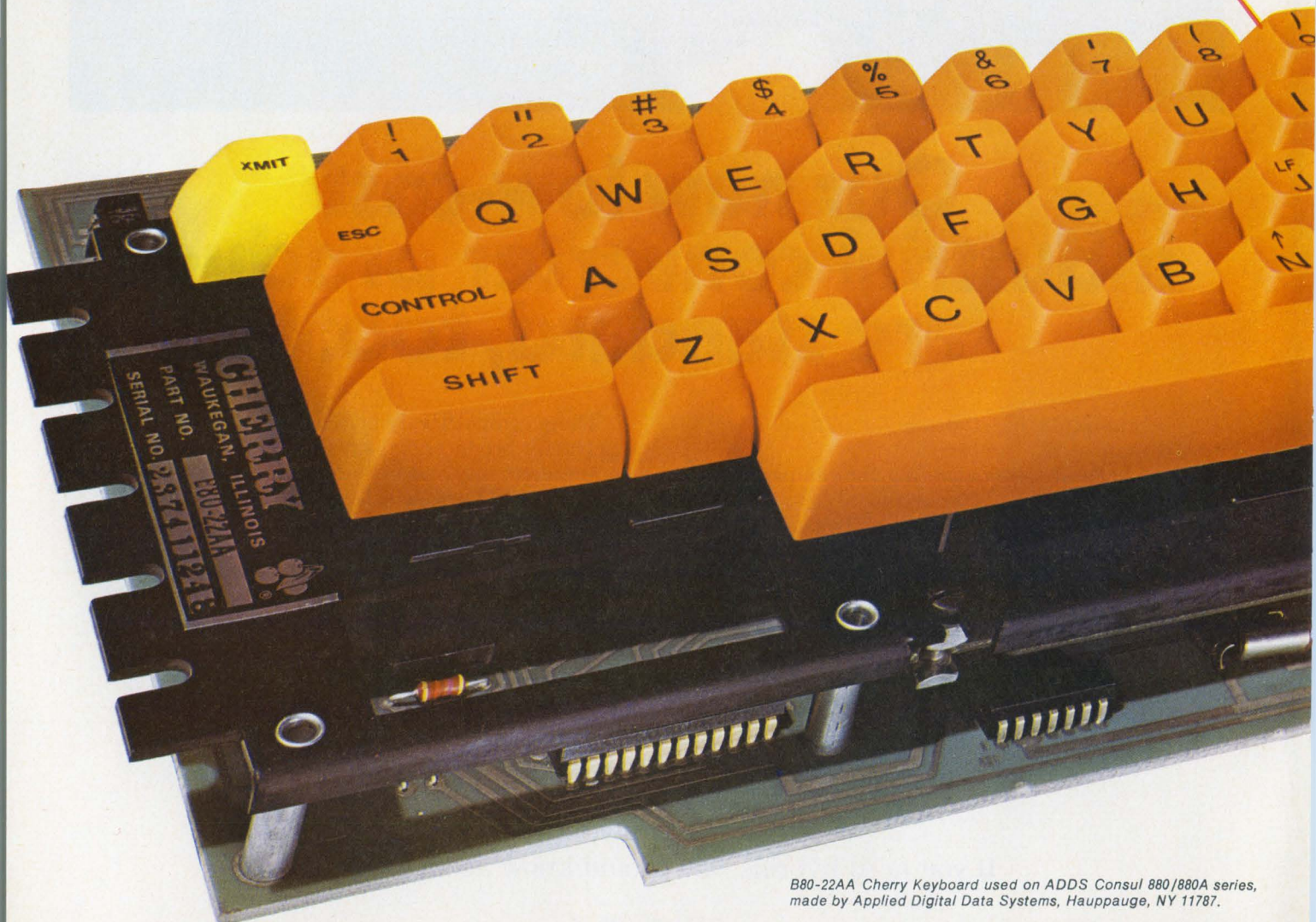

B80-22AA Cherry Keyboard used on ADDS Consul 880/880A series,
made by Applied Digital Data Systems, Hauppauge, NY 11787.

keyboards work year...after year...after year.

Why are Cherry keyboards so reliable? One reason is that the gold crosspoint contacts at the heart of the keyswitches *just can't fail*. The knife-edge contact area is so small (9 millionths of a square inch) . . . the contact force so great (approximately 5,000 psi) . . . and the gold alloy so pure and film-free . . . you're absolutely assured of positive contact every time.

Another reason for Cherry keyboard dependability is our uniquely simple design that combines the most advanced technology with a minimum of component parts. This yields a product whose susceptibility to field failure is inherently low. A fact substantiated by the remarkable record Cherry keyboards have achieved in all kinds of environments and demanding applications—like remote terminals, data com-

munications and point of sale equipment.

Still another reason for this excellent field performance is that we build our keyboards from scratch. We start with raw materials and go all the way to the two-shot molded keycaps right in our own plant. Even the printed circuit board is a product of our in-house design and fabrication. Painstakingly bonded to this are the gold crosspoint contact key modules, TTL and other electronic components with all connections 100% wave soldered. Finally, a sturdy frame protects against shock.

Cherry's keyboards draw low power—both quiescent and in use—and generate clean IC logic signals. They are not temperature or humidity sensitive and can be designed to meet your specific requirement at surprisingly low cost.



PUT OUR "KEY MEN" TO WORK ON YOUR APPLICATION

Phone 312/689-7741 to talk directly with our Keyboard Group specialists. Or, get started with the help of these exclusive keyboard aids . . . free! Keyboard Designers' Specification Sheet Keycap Workbook Complete Keyboard and Switch Catalog.



SWITCHES and KEYBOARDS
Available locally from authorized distributors.

CHERRY



CHERRY ELECTRICAL PRODUCTS CORPORATION
3609 Sunset Avenue—Waukegan, IL 60085

CIRCLE NUMBER 16



It also comes assembled.

If you need dials, we have dials. If you need handsets, we have handsets. If you need Touch Calling keysets, we've got 'em by the thousands. Ringers and hookswitches, too. Or, if you need complete telephones, we have them for you in all the latest styles and colors.

You get communications components faster from GTE Automatic Electric because, outside of the Bell System, we're the largest manufacturer of telephone equipment in the U.S. If you need it, we have it.

Use the coupon below for a complete

catalog. Or if you're in a real hurry, call John Ashby at (312) 562-7100, extension 250.

When it comes to quality components, call THE SOURCE: GTE Automatic Electric.



- Please send your catalog of communications components.
- Please send more information and prices on _____ of _____
(Quantity) (Product)

Name _____ Title _____
 Company _____
 Address _____
 City _____ State _____ Zip _____
 Telephone _____

Mail to: Mr. J. D. Ashby, B-4, GTE Automatic Electric, Northlake, Illinois 60164.

GTE AUTOMATIC ELECTRIC

down to basics

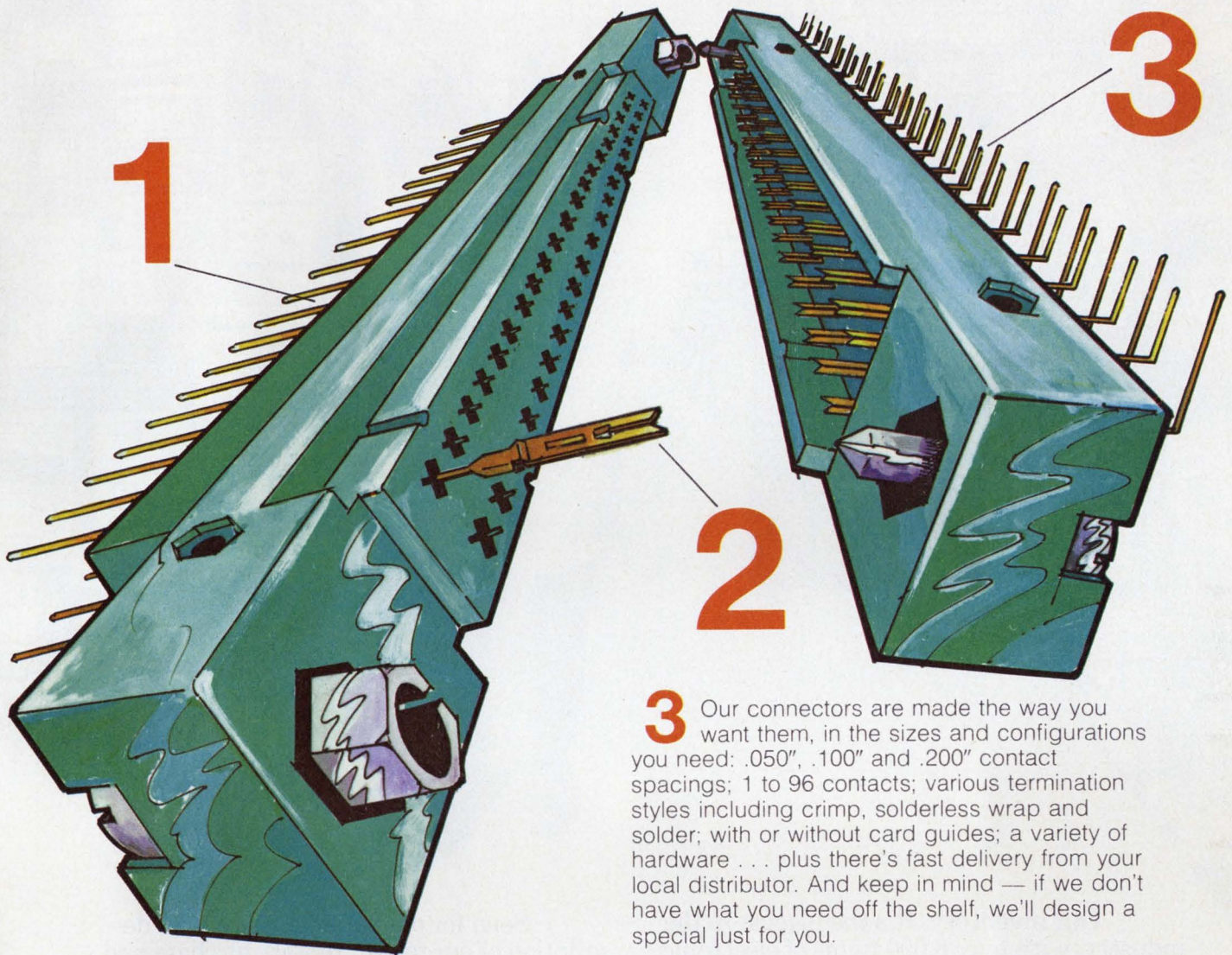

1 Our two-piece metal-to-metal pc connectors meet or exceed tough military specifications. They're QPL approved for the high reliability required by military applications. That shows how good they are!

2 They feature our hermaphroditic Varicon™ contacts which are interlocking and self-cleaning with gas-tight mating surfaces for unequalled performance and reliability. And that's a proven fact.

3 Our connectors are made the way you want them, in the sizes and configurations you need: .050", .100" and .200" contact spacings; 1 to 96 contacts; various termination styles including crimp, solderless wrap and solder; with or without card guides; a variety of hardware . . . plus there's fast delivery from your local distributor. And keep in mind — if we don't have what you need off the shelf, we'll design a special just for you.

Get down to basics with our great connections . . . worldwide.

Elco Corporation
2250 Park Place, El Segundo, Ca. 90245
TWX 910-325-6602
213 675-3311

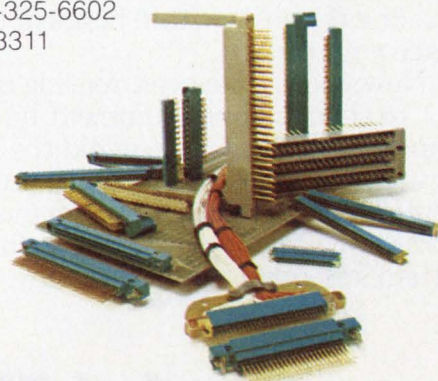

Elco Corporation
a Gulf + Western manufacturing company

Here's why REI can rent you what you want when you want it.



Our inventory. It's the biggest in the industry, with over 8,000 items of electronic test equipment in stock and ready to go. And it's getting better all the time, because we add more state-of-the-art equipment every month. This means we can deliver one special instrument... or a dozen... within hours of the time you place your order.

Now, more than ever, renting makes sense... to stretch your equipment budget, to fill temporary needs, and to avoid the long delivery lead times associated with purchasing. And renting from REI makes even more sense... because we're better equipped to fill your needs than any other rental company.

Send for our catalog today for a description of our rental, rental/purchase and leasing plans, and for our low rental prices. Or call the instant inventory center nearest you for immediate assistance.

Rental Electronics, Inc.,
99 Hartwell Avenue, Lexington, Mass. 02173.
Please send me your free instrument rental catalog:

Name _____ Title _____

Company _____

Address _____

City _____ State _____ Zip _____

Tel. Number _____

Rental Electronics, Inc.

Burlington, MA (617) 273-2770 • Gaithersburg, MD (301) 948-0620 • Oakland, NJ (201) 337-3757 • Ft. Lauderdale, FL (305) 771-3500
Des Plaines, IL (312) 827-6670 • Dallas, TX (214) 661-8082 • Mountain View, CA (415) 968-8845 • Anaheim, CA (714) 879-0561
Rexdale, Ontario (416) 677-7513

CIRCLE NUMBER 20

JANUARY 4, 1977

Process makes optical strands long and strong

Long, hair-thin, optical-fiber strands with a tensile strength greater than steel—600,000 lb per sq. in.—can now be manufactured with a process developed at Bell Laboratories, Murray Hill, NJ. The method overcomes a major obstacle to future optical-communications systems, producing glass fibers that are thin enough, durable enough and—most important—long enough to interconnect telephones and computers via utility poles.

Flaws that limit the practical length of optical fibers by causing them to break under stress are reduced in size by Bell Lab's process. Indeed, with Bell's process, the only limitation to length is the spooling technique for the finished fiber.

The thinner the strands of glass are drawn, the greater their light-transmitting efficiency.

The process is applied to a rod of synthetic silica, which is extremely

pure glass. The rod, with a 1-cm diameter, is first heated by an oxyhydrogen torch (upper chamber in photo) to remove air bubbles, scratches, and other surface blemishes.

Passing into the second chamber, the rod travels through a hollow laser beam. The beam is manipulated into its tubular shape by an eccentric, rotating lens. Directed along the rod's length by an arrangement of mirrors, the beam finally encounters a conical mirror that focuses it onto the surface of the glass rod, to heat its diameter evenly. This heating provides an extremely clean surface for the drawing and coating phase.

Next, the rod is drawn through a 100-micron orifice and immediately coated with an organic resin, which protects and strengthens the emerging hair-thin fiber.

A 1-cm diameter rod, only 1.5 ft. long, drawn through a die can yield as much as 3 kilometers of continuous, communications-grade optical fiber with very high tensile strength, according to a Bell Labs spokesman.

Thin-film SAW units are very temperature-stable

Surface acoustic wave (SAW) devices produced with a thin-film fabrication technique have a temperature stability high enough to eliminate the need for temperature-controlled ovens. In addition, the temperature coefficient of the thin-film SAW units is an order of magnitude better than the best previous devices that have been used without ovens—ST-cut quartz units.

Developed by Dr. Charles B. Willingham and Dr. Thomas E. Parker, researchers at Raytheon, Lexington, MA, the technique con-

sists of overlaying a lithium-tantalate piezoelectric SAW device with a thin film of quartz. The quartz film's acoustic-wave velocity has a temperature variation that is nearly opposite that of the tantalate crystal.

In this case, Parker explains, the lithium tantalate has a coefficient of 35 ppm, the quartz, in bulk, —60 ppm. But this figure varies with film thickness. The depth of film, which is rf-sputtered onto the SAW device, is 0.5 of the acoustic wavelength. So, for example, for a 300-MHz device with a 10- μ m wavelength, the film is 5- μ m thick.

The temperature coefficient of Raytheon's device is close to that of an AT-cut quartz crystal, which is about a 10-ppm change in delay over a temperature range of —40 to 80 C.

Previously, the best temperature characteristics had been found in ST-cut quartz SAW devices. This type of device has a zero first-order TC and a second-order TC of $32 \times 10^{-9}/^{\circ}\text{C}^2$. However, the lithium-tantalate-quartz element has a zero first-order TC and a $3 \times 10^{-9}/^{\circ}\text{C}^2$ second-order TC—better than 10:1 improvement.

Without the quartz film, the lithium-tantalate device's TC is about 35 ppm/ $^{\circ}\text{C}$.

The Raytheon SAW device may have a slightly higher propagation loss than the ST-cut quartz unit, but the latter has a higher insertion loss. And in the minds of Raytheon staffers, their proprietary device will prove highly useful to stable narrowband filters and SAW-controlled oscillators.

Voice recorder uses digital-data compression

A solid-state digitizing voice recorder for brief messages is the first commercially available audio record-and-playback system with no moving parts. The problems of size and cost of the digital memory are solved with MOS memory and a data-compression method that cuts down the amount of data to be stored without seriously reducing voice quality.

Developed by Comex Systems, Inc., of Hudson, NH, the Model VSU/500 consists of two PC boards—one devoted to the MOS



Glass rod is heated in an oxyhydrogen torch to remove surface flaws and air bubbles.

memory—in an EMI-shielded module $7 \times 8 \times 7/8$ in. All connections are made via a 20-pin ribbon connector.

"Our unit replaces endless-loop tape machines, eliminates moving parts, has 12-bit effective resolution, 70-dB dynamic range, and the subjective quality of a high-quality tape recorder," says Gary Stapleford, President of Comex. "Data compression is the key to the economy of this design. We cannot tell you more about the signal processing algorithm until it is further along in the patent process."

Stapleford, credited with several tone-synthesizer patents that are used in Comex radio-paging encoders, did say that a front-end, analog-to-digital converter's 12-bit binary words are compressed to 6-bit words by the signal processor of the VSU/500 before they are stored in the memory. During playback, they are returned to 12-bit form by the playback signal processor.

"The signal processing throws away some information, of course, but it's information that the ear hardly misses," says Stapleford. "When it plays back a soft whisper without any audible digitizing noise, you've got to be impressed with the dynamic range."

Another voice-record and playback unit, the Model VSU/600, will be available soon. Designed as a "voice-output" peripheral for computer systems, it differs from the Model VSU/500 only in having a 10-s memory that is divided into 16 sectors, each holding a word or a brief phrase. The computer sends the recorder a 4-bit parallel control code to select and activate one sector at a time. Priced just above the VSU/500 range, the Model VSU/600 is the same in technology.

The VSU/500 comes in various capacities, ranging from 2.5 to 12.5 s, and without a power supply. Dc voltages needed are a +12 V, -12 V, 5V.

Prices run from \$385 to \$1200.

Low-cost electro-optical disc stores clear images

A simple-electric-optical device that could cost as little as \$10 can store high-resolution, high-contrast images. It promises to find widespread use in image and optical in-

formation-processing systems.

The element is a thin polished disc of lead-lanthanum-zirconate-titanate (PLZT) ceramic, with transparent electrodes deposited on both sides.

An image can be stored through what is termed the photoferro-electric (PFE) effect. When 100 V is applied to the electrodes, and collimated, near-UV light with wavelengths of 3700 Å or shorter is projected through a photo negative and the PFE element, a positive image forms in the ceramic. The image can then be reversed to a negative by simply reversing the polarity of the applied voltage.

The image can be either projected by direct transmission with a common visible-light source such as a projection lamp, or viewed by reflection off the element's surface with a Schlieren optical system.

Invented by researchers Cecil Land and Paul Peercy at Sandia Laboratories in Albuquerque, NM, the PFE device overcomes a limitation that has restricted the Cerampic, its predecessor at Sandia, to laboratory use. The Cerampic stores images with visible light. But this method requires deposited contacts as well as a photoconductive layer of cadmium sulfide or zinc-cadmium-sulfide on one surface. Difficulties inherent in depositing a uniform photosensitive layer have prevented the Cerampic from reaching the production stage.

The key to the new PFE-element operation is its use of optical energy at or above the band gap of the PLZT material. Its ability to use UV energy eliminates the need for a photoconductive layer.

Experimental PFE elements 0.2 to 0.3-mm thick and 2 to 5 cm in diameter have been fabricated. But there shouldn't be any problem producing elements 10 or 15 cm across

with hot-pressed ceramic materials, according to Land.

Resolution is excellent, with 30 to 40 line pairs/mm representative of direct transmission viewing and a 50% improvement in those figures for reflective viewing.

Both transmissive and reflective projection is possible because the image is stored in the PFE device in two ways, Land explains. For transmission, the image is stored as a spatial distribution of optical scattering centers. For reflection, it is stored as a spatial distribution of surface deformations.

Although fabricating this element in the lab costs \$20 to \$30, producing it should cost \$10 or even less, according to Land. Principal applications will be in the direct-transmission viewing mode. The reflective mode will also prove useful, Land points out. It can converge an image stored with non-coherent light and permit it to be read out by coherent light.

Small business computer has a small price tag

Using IBM-compatible diskettes, a small μ P-controlled business computer can accommodate 20 to 64 bytes of MOS memory—and it costs less than \$9000. Developed by Tealtronic of America, Cranford, NJ, the Series 2500 stand-alone processor allocates 16 kbytes to stored programs and from 4 to 48 kbytes to the user.

A desk-top CRT unit provides visual display and operator prompting. Also, the user can choose one of three printers that operate at 45 and 165 characters per second.

The system's programming language is ACL (application control language).

News Briefs

The fixed media-disc drive will make big gains on the removable disc drive in 1977, according to Per-tec Computer Corp. Faced with having to choose between less costly fixed media and more expensive removable media units, the majority of OEMs will specify the fixed media drives, Per-tec believes. Any loss in flexibility will be compensated by cost savings

up to 30%.

The Air Force is developing a beacon transponder for ground-based forward air controllers. The transponder will use a fighter-bomber's radar and computer to direct it to a target some distance from the beacon itself. Applied Devices, Hauppauge, NY, will build 12 pre-production sets for acceptance testing.

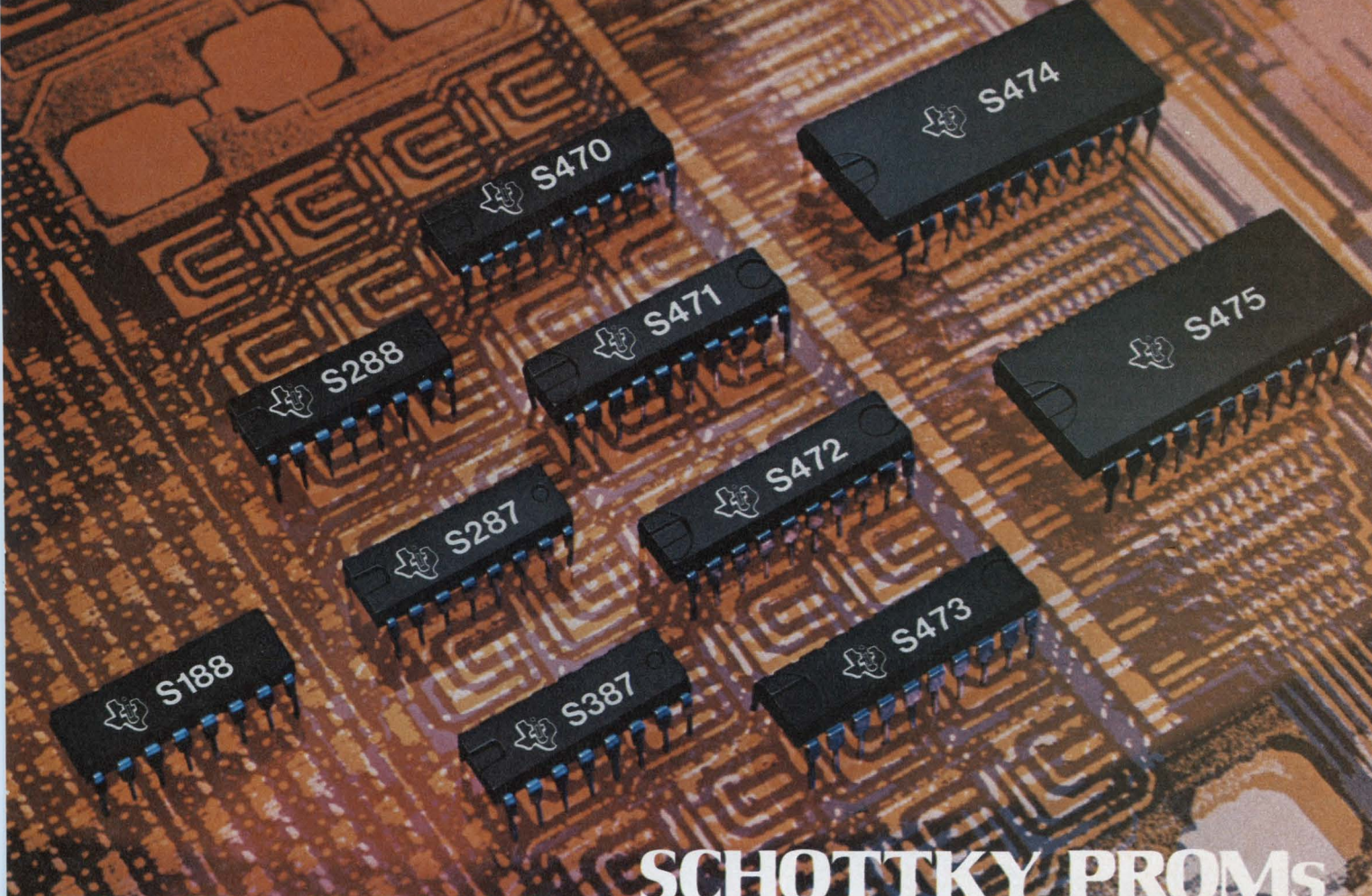

SCHOTTKY PROMs

The PROM family. It means more flexibility. Higher efficiency. And lower costs.

TI's broad 10-member family of matched PROMs means plenty of options. And options mean you can design within the PROM family.

So all your PROMs are manufactured using the same process technology. The same design rules. The same packaging. And, what's especially important when using PROMs: All share common programming techniques. This way you not only get more efficient designs but a cost savings too.

Consider these options: You need a small amount of read-only memory. So, use the smaller family members, the 256 or 1K 16-pin PROMs. No need to pay for more memory than you need.

Suppose you're into new designs and want the highest possible board density offered. OK, take advantage of TI's 2K and 4K, space saving 20-pin PROMs. Some designers have

cut PC board area by as much as 54%. And they have a wide 8-bit output for use in today's, and tomorrow's, microprocessor based designs.

On the other hand, if you have an older design already committed to the large 24-pin package, TI has you covered there,

too. No need to move away from TI's broad family of Schottky PROMs.

All are Schottky clamped for superior speed/power characteristics and are relatively insensitive to variations of temperature and supply voltage. All have low-current, pnp inputs for interface with MOS as well as Bipolar microprocessors.

And finally, all TI PROMs are made with titanium-tungsten fuse links—the result of a unique metallurgical technique in use for over five years. It makes low voltage programming fast and reliable.

Available Now

Order TI PROMs from your authorized TI Distributor. For a copy of TI's Schottky Memory brochure, contact your local TI sales Office, or write Texas Instruments Incorporated, P. O. Box 5012, M/S 308, Dallas, Texas 75222.



TI Schottky PROM Line Summary			
Part Number	Description	Address Access Time	Power Dissipation
SN54S/74S188	32W x 8B, 0-C, 16 pins	25ns	400mW
SN54S/74S288	32W x 8B, 3-S, 16 pins	25ns	400mW
SN54S/74S287	256W x 4B, 3-S, 16 pins	42ns	500mW
SN54S/74S387	256W x 4B, 0-C, 16 pins	42ns	500mW
SN54S/74S470	256W x 8B, 0-C, 20 pins	50ns	550mW
SN54S/74S471	256W x 8B, 3-S, 20 pins	50ns	550mW
SN54S/74S472	512W x 8B, 3-S, 20 pins	55ns	600mW
SN54S/74S473	512W x 8B, 0-C, 20 pins	55ns	600mW
SN54S/74S474	512W x 8B, 3-S, 24 pins	55ns	600mW
SN54S/74S475	512W x 8B, 0-C, 24 pins	55ns	600mW

TEXAS INSTRUMENTS
INCORPORATED



ACTIVE FILTER 2ND ORDER STATE

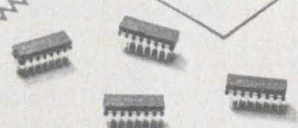
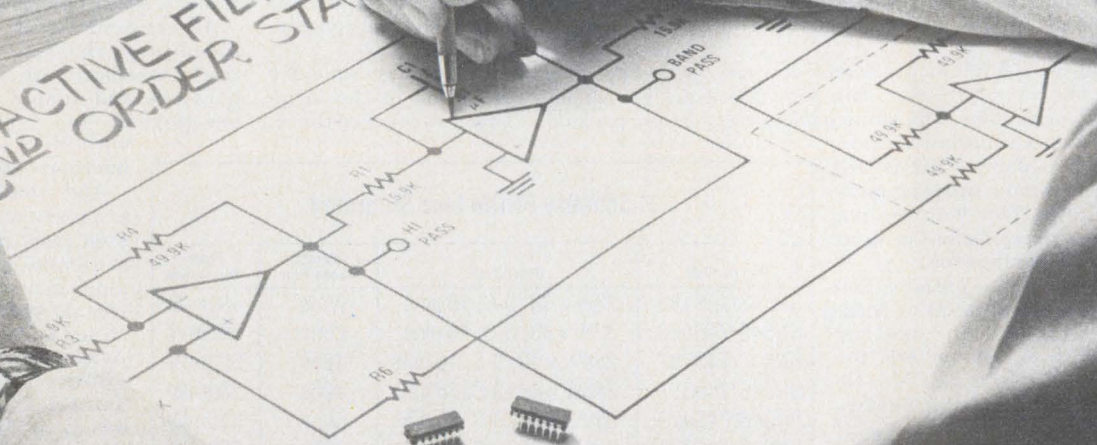

Introducing The Most Advanced Quad OP Amps Ever Made. Nothing Performs Quite Like Them.

The HA 4602/4622 high performance quad operational amplifiers are keys to a whole new concept in amplifier design. They're unique in that they have bipolar, CMOS, and dielectric isolation all in one chip. So they give you a full measure of confidence like you've never known before in general purpose amplifiers.

For example:

- Eight times the slew rate and bandwidth of the 741 at only three-fifths quiescent power.
- High accuracy and stability, even at high gains, over the specified temperature ranges.
- Monolithic construction to provide optimum parameter matching and temperature tracking.
- High performance and a quad structure which is ideal for active filter applications.

STANDARD FEATURES. Both Harris high performance quad amps have standard features you won't find in any other quad amps. The 4602 typically offers a slew rate of $4V/\mu\text{sec}$, unity gain bandwidth of 8MHz, input noise voltage of $8\text{NV}/\sqrt{\text{Hz}}$ and input offset voltage of 0.3mV. The 4622 is uncompensated and provides stability at $A_v=10V/V$, gain bandwidth of 70MHz and a slew rate of $25V/\mu\text{sec}$.

PERFORMANCE/PRICE.

Impressed with this high performance? You'll be just as impressed by the price. For military use the HA 4622-2 and HA4602-2 cost \$9.90. For commercial, the HA 4625-5 and the HA 4605-5 cost \$4.95 (100 up prices).

ECONOMY TOO. For those of you more inclined to go the economy route, there's our very popular HA 4741 quad op amp. With its superior typical bandwidth of 3.5 MHz, slew rate of $1.6V/\mu\text{sec}$ and input voltage noise of

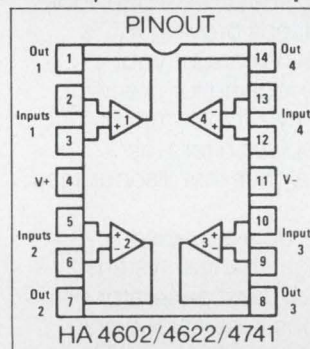

$9\text{NV}/\sqrt{\text{Hz}}$, it offers you a lot of amp for not a lot of money. For instance, the HA 4741 for military usage costs just \$4.60, while the HA 4741-5 for commercial is just \$2.48.

AND FAST DELIVERY... Right now we have a full inventory of our new quad op amps. So whether you prefer high performance, or economy, rest assured your order can be honored immediately.



P.O. Box 883, Melbourne, Florida 32901 (305) 724-7412

OEM SALES OFFICES: CALIFORNIA: Long Beach (213) 426-7687; Palo Alto (415) 964-6443 FLORIDA: Fort Lauderdale (305) 971-3200; Melbourne (305) 724-7430 ILLINOIS: Hinsdale (312) 325-4242 MASSACHUSETTS: Wellesley Hills (617) 237-5430 MINNESOTA: Minneapolis (612) 835-2505 NEW YORK: Endwell (607) 754-5464; Melville, L.I. (615) 249-4500 OHIO: Dayton (513) 226-0636 PENNSYLVANIA: Wayne (215) 687-6680 TEXAS: Richardson (214) 231-9031

SALES REPRESENTATIVES: ALABAMA: Huntsville (205) 533-6640 ARIZONA: Scottsdale (602) 948-5590 CALIFORNIA: Los Angeles (213) 870-9191; Mountain View (415) 961-8121; San Diego (714) 565-9444 COLORADO: Denver (303) 773-0666 CONNECTICUT: East Norwalk (203) 838-1493 FLORIDA: Boca Raton (305) 395-6108; Oviedo (305) 365-3283; Tampa (813) 933-1759 ILLINOIS: Elk Grove Village (312) 640-1850 INDIANA: Indianapolis (317) 849-6454 IOWA: Cedar Rapids (319) 377-8275 KANSAS: Wichita (316) 943-6221 MARYLAND: Lanham (301) 459-1556 MASSACHUSETTS: Burlington (617) 273-1313 MICHIGAN: Farmington (313) 476-2446 MISSOURI: Hazelwood (314) 731-5799; Independence (816) 737-1100 NEW JERSEY: Keasbey (516) 567-5900; West Caldwell (516) 567-5900 NEW MEXICO: Albuquerque (505) 265-5655 NEW YORK: Albany (518) 489-7408 or 4777; Huntington Station (516) 567-5900 NORTH CAROLINA: Winston Salem (919) 722-5151; OHIO: Cleveland (216) 831-8292; Dayton (513) 890-2150 OREGON: Beaverton (503) 643-1644 PENNSYLVANIA: Allison Park (412) 487-4300; King of Prussia (215) 265-0634 SOUTH CAROLINA: Greenville (803) 268-1125 TEXAS: Dallas (214) 691-4592; Houston (713) 661-3007 VIRGINIA: Charlottesville (804) 973-6672 WASHINGTON: Bellevue (206) 454-0300 CANADA: Mississauga, Toronto (416) 676-1042; Montreal (514) 626-6723; Ottawa (613) 749-0740.

NATIONAL DISTRIBUTORS: Hamilton/Avnet; The Harvey Group, Inc.; Schreiber Electronics R.V. Weatherford Company. CANADA: Prelec Electronics Ltd.

THE LOGICAL CHOICE: Third in a series

SYMMETRICAL AND UNSYMMETRICAL PULSES
0.5Hz-5MHz.

CONTINUOUS, MANUAL ONE-SHOT & EXTERNAL TRIGGER OPERATION
External triggering to 10MHz

INDEPENDENTLY-CONTROLLABLE PULSE WIDTH & SPACING
100 nanosec-1 sec in 7 overlapping ranges 10:1 duty cycle range



INDEPENDENT CMOS AND TTL OUTPUTS Fan-out to 40 TTL loads

SYNCHRONOUS OUTPUT GATING

100mV-10V POSITIVE OUTPUT Less than 30 nanosec rise/fall times

CSC'S DESIGN-MATE™ 4: \$124.95. NO OTHER DIGITAL PULSE GENERATOR GIVES YOU SO MUCH, FOR SO LITTLE.

Sounds hard to believe... but even a brief look at Design-Mate 4's specifications proves CSC's engineers have done it again. Whatever your application — whether you're looking for precision, flexibility or just plain economy — this compact source of fast, clean digital pulses offers the performance you need... at a price that discourages procrastination.

Use it as a clock source, delayed pulse generator, synchronous clock, manual system stepper, pulse stretcher, clock burst generator or in dozens of other applications. Use it alone or in tandem with other DM-4's for gated control. The

wide range of controls and multiple outputs give you enormous versatility... plus compatibility with all major logic families, for research, design, development, quality control, production testing, maintenance, troubleshooting... you name it.

Now, read the specs that follow... and check the price again. Or better yet, try DM-4 for yourself at your local CSC distributor. Once you do, we think you'll find it's as hard to do without as it is easy to own.

For more information about CSC's other fine products, and a list of distributors, please call or write.

DM-4 SPECIFICATIONS

Frequency Range: 0.5 Hz to 5 MHz	ONE-SHOT Pushbutton for single pulse. Output pulse occurs each time push-button is pressed
Pulse Width and Spacing Controls: 100 nanosec to 1 sec. in 7 overlapping decade ranges. A single-turn vernier control provides continuous adjustment between ranges.	OUTPUTS:
Duty Cycle: 10 ⁻¹ to 1 Range: adjustable over entire pulse width/spacing range, 100 nanosec "ON" 1 sec "OFF" to 1 sec "ON" and 100 nanosec "OFF"	VAR OUT Amplitude 0.1-10 V positive Rise/fall time Less than 30 nanosec Impedance 400Ω max.
Operating Modes:	TTL OUT Fan-out 40 TTL Loads Sink 160 milliamps—0.8 V max. Rise/fall time Less than 20 nanosec
RUN 0.5 Hz to 5 MHz as per width/spacing and amplitude control settings	SYNC OUT Pulse width Approx. 40 nanosec. Other sync pulse spec's same as TTL out
TRIG DC to approx. 10 MHz	POWER Pulse lead time 117 VAC ± 10%, 50/60 Hz, 5 watts (220 VAC, 50/60 Hz also available, at slightly higher cost.)
Input requirements: Sine waves 2 VP-P, pulses 1 V peak, >40 nanosec wide; maximum input ± 10 V. (Input Impedance: Approx. 10KΩ DC coupled.)	SIZE (WxLxH) 7.5 x 6.5 x 3.25"
GATE Synchronous gating. Leading edge of gate signal turns generator "ON". Last pulse is completed, even if gate ends during pulse.	WEIGHT 191 x 165 x 83 mm 2 lbs. (0.91 Kg)
Input requirements: Same as "TRIG" Mode.	

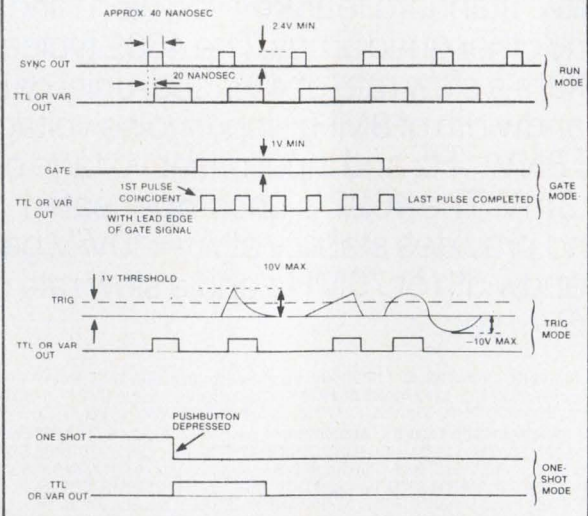

CONTINENTAL SPECIALTIES CORPORATION



EASY DOES IT

44 Kendall Street, Box 1942 New Haven, CT 06509 • 203-624-3103 TWX: 710-465-1227
West Coast office: Box 7809, San Francisco, CA 94119 • 415-421-8872 TWX: 910-372-7992

© 1976, Continental Specialties Corp.

POWER SUPPLIES

for Logic
for Op Amps
for Microprocessors

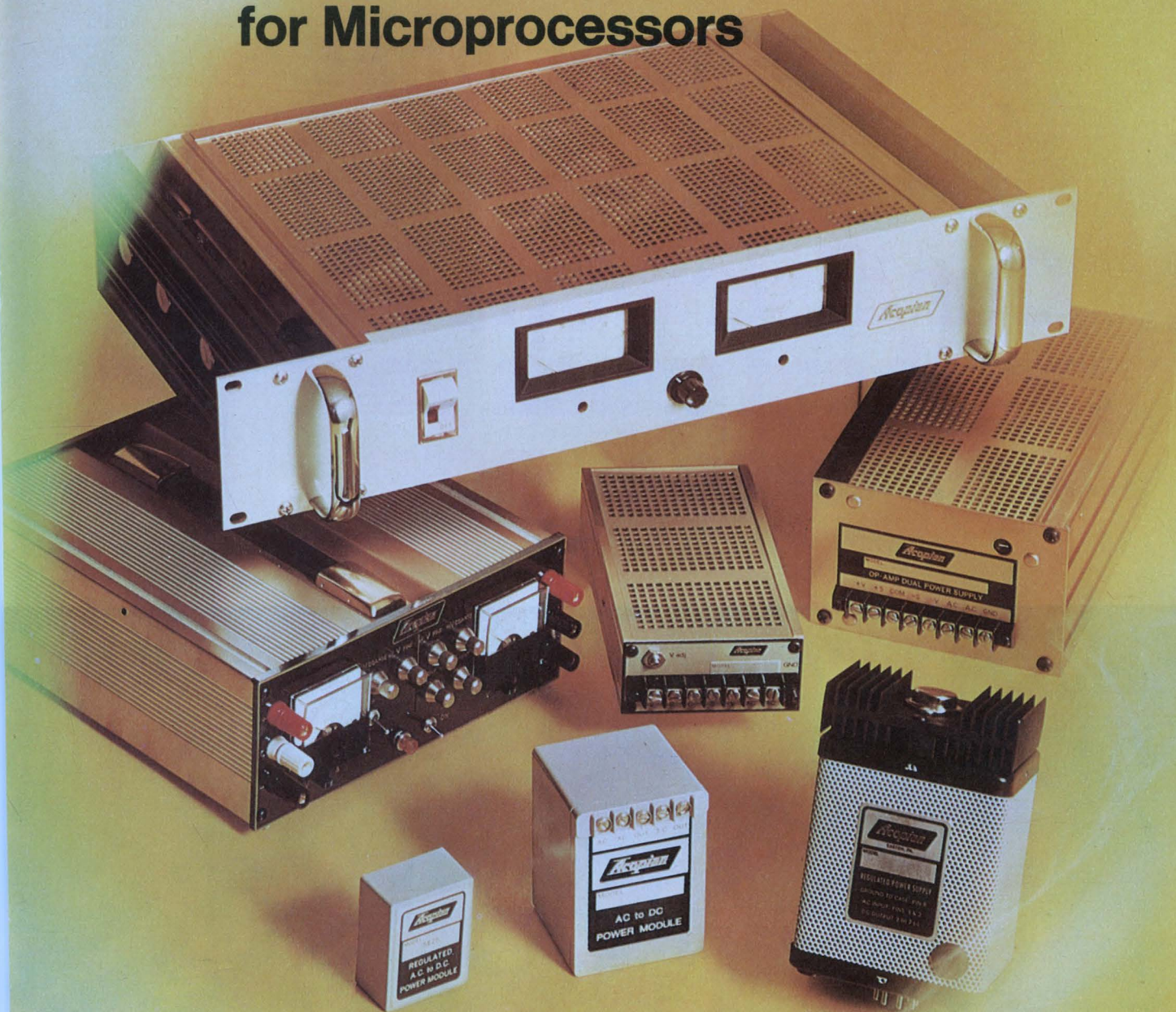

Single, dual, and triple output supplies having output ratings from 1 to 28 volts; from 30 ma to 60 amps. A choice of performance levels, with regulation ranging from $\pm 0.005\%$ to $\pm 0.5\%$. Many provide dual and triple isolated outputs, matched or dissimilar, in both standard and user-selectable combinations. Others have balanced, tracking outputs.

The variety of shape factors and the mounting versatility of these supplies provide easy answers to mechanical layout problems. Miniaturized models are available for either PCB mounting or, with screw terminals, for chassis mounting. Narrow profile units fit into thin

spaces. Metered benchtop supplies are handy sources of power for experimental circuitry. Plug-in modules mount in seconds.

Ask for a copy of our full color, 28-page brochure. It contains complete specifications, outline drawings, prices, and — just as important — it also details our guarantee to ship within 3 days after receiving your order.



Corp., Easton, Pa. 18042 • Tel: (215) 258-5441

Allen-Bradley Trimmers:

**We have what
you need.**

**Our distributors have
them when your
need is now.**

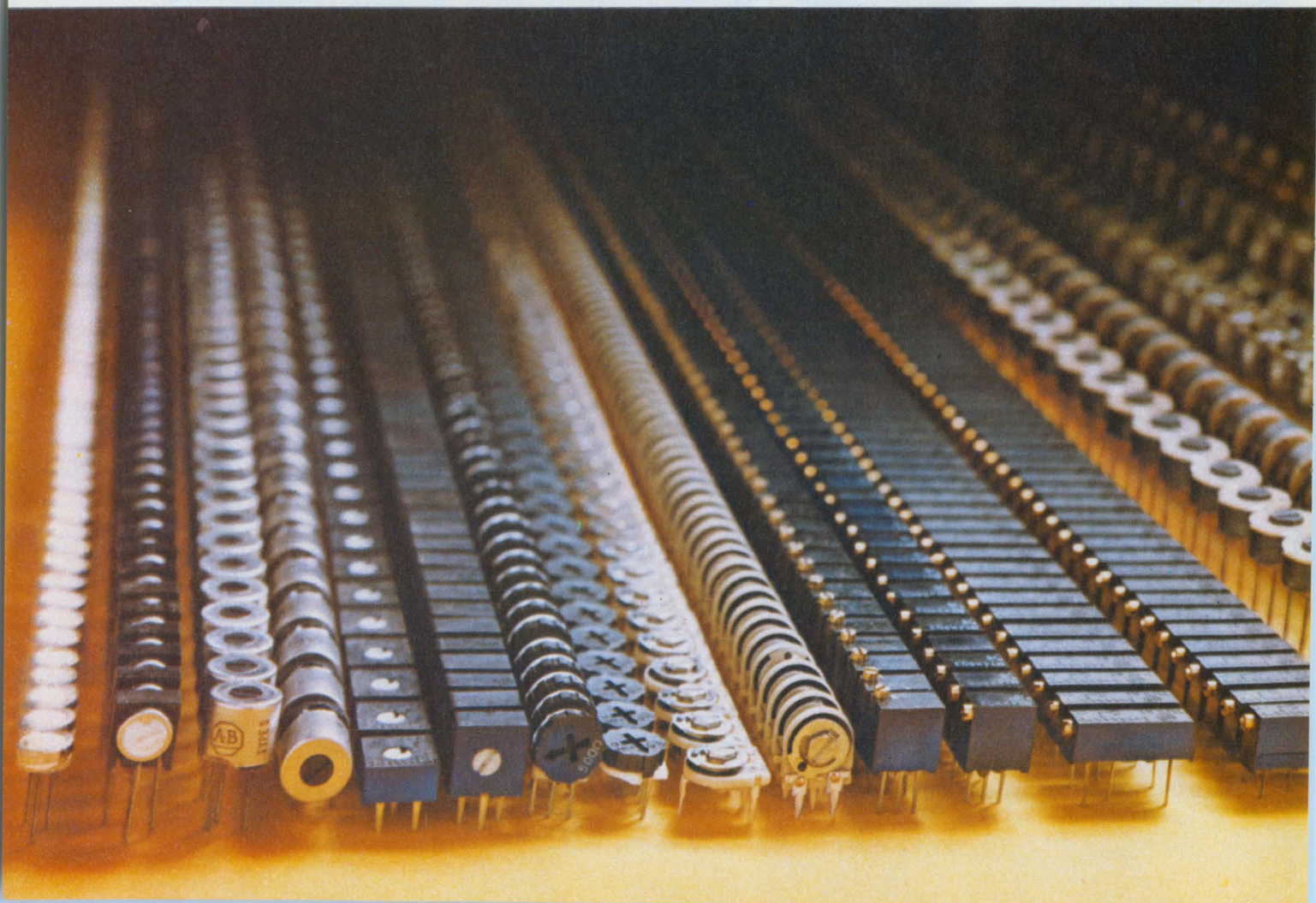

CERMET TRIMMERS



Type A: ¼" diameter, single turn, 10 ohms to 2 megs ±10%, 0.5W at 85°C, immersion sealed, 3 terminal options, Publication 5238. **1000 piece price \$1.12 to 1.68.**



Type S: ⅜" dia., single turn, 50 ohms to 1 meg ±10%, 0.5W at 85°C, immersion sealed, top or side adjust, Publication 5208. **1000 piece price \$1.15 or 1.40.**



Type E: ⅜" square, single turn, 10 ohms to 2 megs ±10%, 0.5W at 70°C, immersion sealed, 13 terminal options, Publication 5219. **1000 piece price \$0.49.**



Type D: ⅜" diameter, single turn, 10 ohms to 2 megs ±20%, 0.5W at 70°C, dust cover, 6 terminal options, Publication 5240. **1000 piece price \$0.42.**



Type 90: Approx. ⅞" square, single turn, 100 ohms to 2 megs ±20%, 0.5W at 70°C, open frame, 2 terminal options, Publication 5242. **1000 piece price \$0.55.**



Type MT: ⅜" square, 20 turn, 10 ohms to 2 megs ±10%, 0.5W at 70°C, immersion sealed, 3 terminal options, Publication 5241. **1000 piece price \$1.18.**



Type RT: ⅜" long, 20 turn, 10 ohms to 2 megs ±10%, 0.75W at 70°C, immersion sealed, 3 terminal options, Publication 5237. **1000 piece price \$0.65 or 0.93.**

CARBON COMPOSITION TRIMMERS



Type Y: ½" dia., single turn, 100 ohms to 5 megs ±10% or 20%, 0.25W at 50°C, dust/splash resistant, 5 styles, non-linear tapers, Pub. 5209. **1000 piece price \$0.90 to 1.59.**



Type F: ½" dia., single turn, 100 ohms to 5 megs ±10% or 20%, 0.25W at 70°C, immersion sealed, 6 styles, non-linear tapers, Pub. 5234. **1000 piece price \$1.00 to 1.62.**



Type O: ½" dia., single turn, 100 ohms to 5 megs ±10% or 20%, 0.40W at 70°C, immersion sealed, 4 styles, non-linear tapers, Pub. 5235. **1000 piece price \$1.20 to 1.58.**



Type FD: ½" dia., 2 sec., 1 turn, 100 ohms to 5 megs ±10% or 20%, 0.25W at 70°C, immersion sealed, 4 styles, 5 tapers, 2 atten. Pub. 5231. **1000 piece price \$2.65 to 4.10.**



Type BT: ½" dia., 2 section, 1 turn, for 75 ohm Bridged-T pad applications, dust/splash resistant, side and top adjust versions. Pub. 5236. **1000 piece price \$2.49.**



Type N: 1¼" long, 25 turn, 100 ohms to 2.5 megs ±10% or 20%, 0.33W at 50°C, immersion sealed, Publication 5206. **1000 piece price \$2.50 or 2.65.**



Type R: 1¼" long, 25 turn, 100 ohms to 2.5 megs ±10% or 20%, 0.25W at 70°C, immersion sealed, bushing mount option, Pub. 5205. **1000 piece price \$2.87 to 3.73.**

Quality in the best tradition.



ALLEN-BRADLEY

Milwaukee, Wisconsin 53204

CIRCLE NUMBER 152

EC120

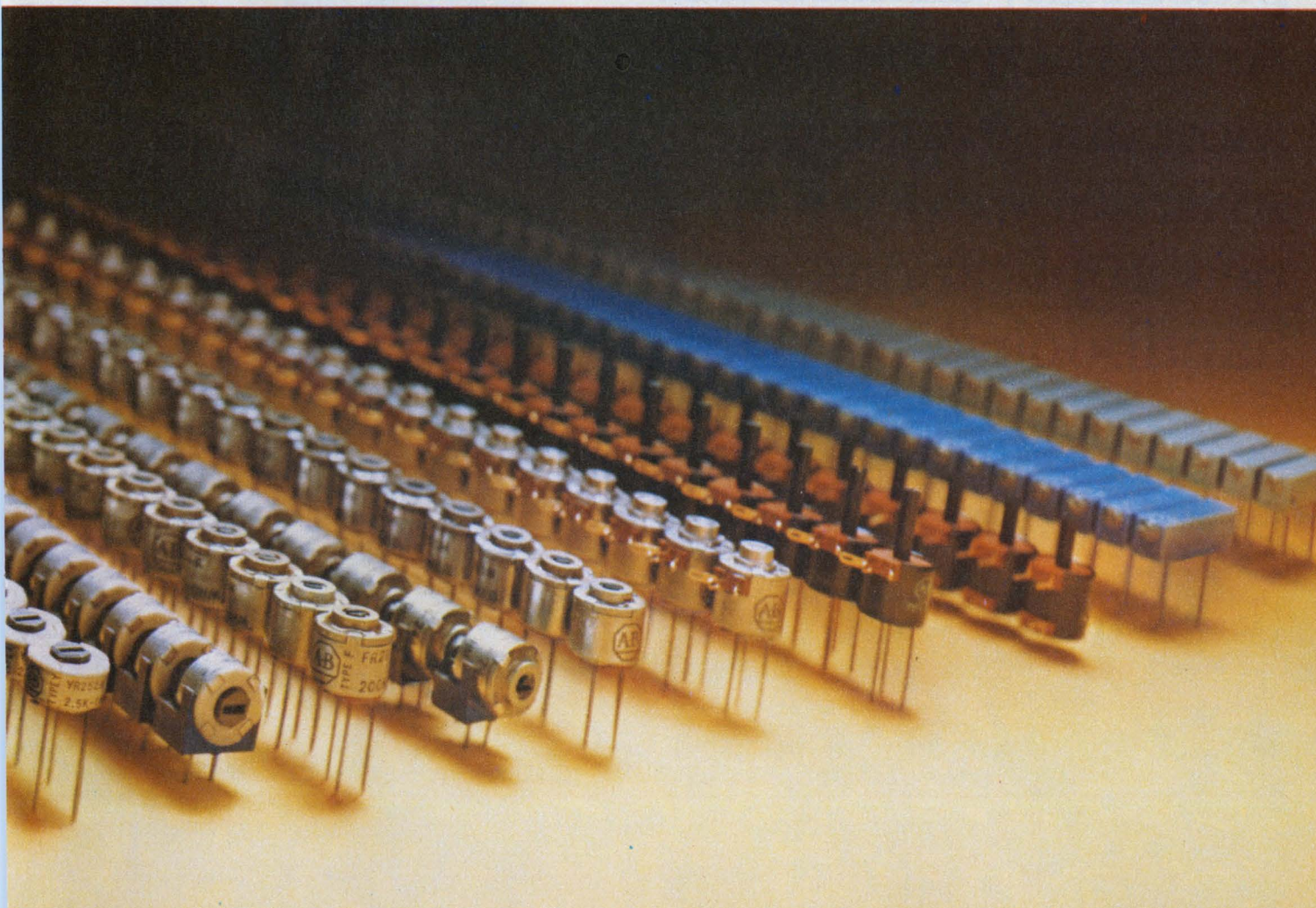

“Our DG300 analog two new ways to make system

“Siliconix’ new DG300 CMOS analog switches give you an unprecedented combination of high speed, low power and economy. Along with our much copied DG180-190 JFET switches and our low cost DG170 PMOS switches, you have such a broad selection that design compromise is practically eliminated. And to help you get the most out of analog switches, we’ve got a new applications handbook.”

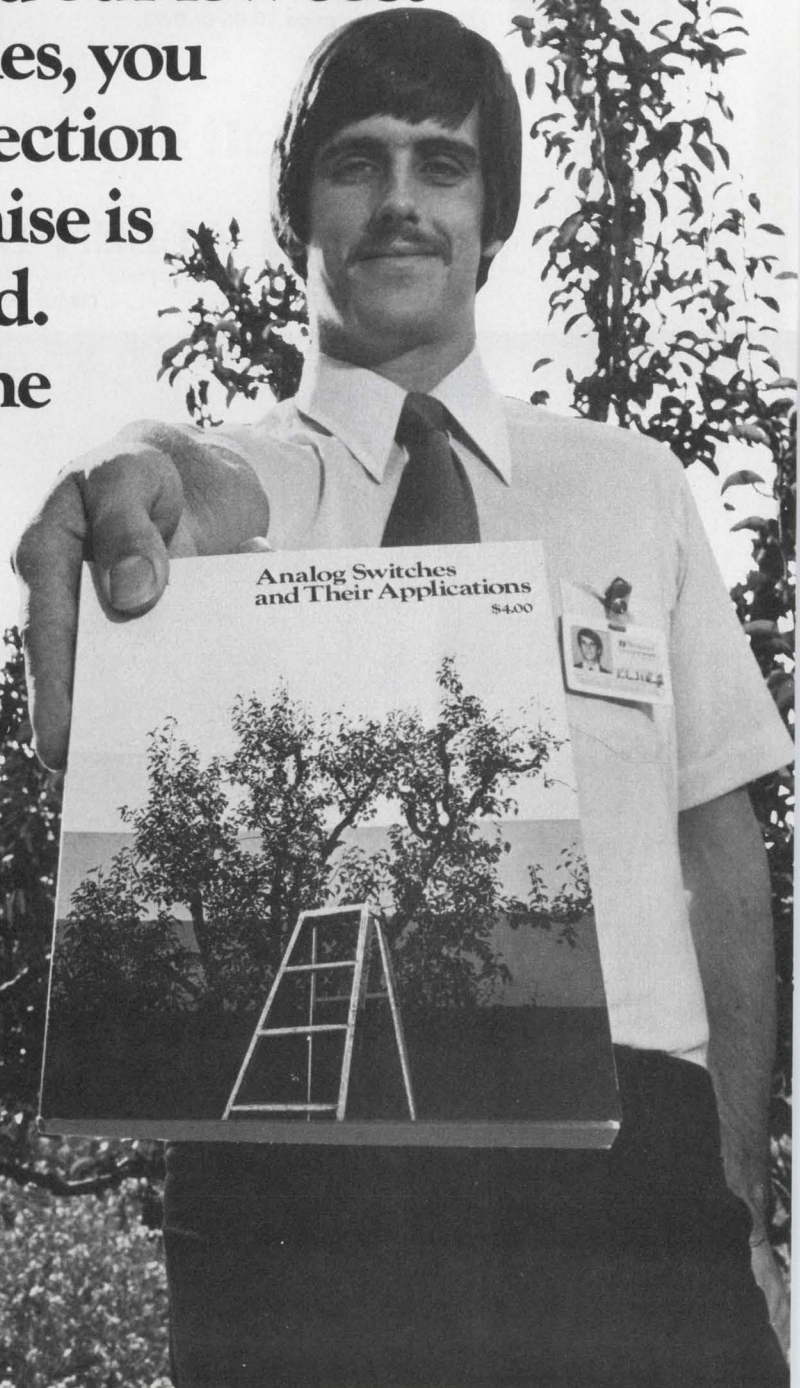

switches and this handbook - design easier than ever."

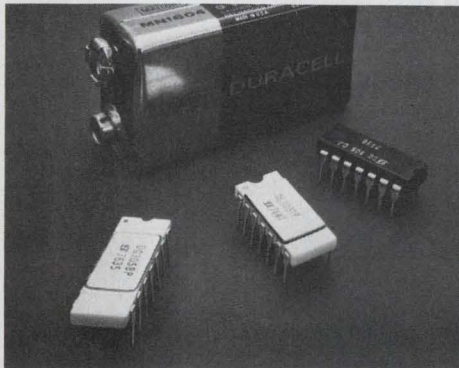

	Siliconix DG300 Series	Analog Devices 75 Series	Harris HI Series	Intersil IH Series	National LF Series	Texas Instruments TL Series
t _{off} (typ)	70 ns	400 ns	280 ns	500 ns	90 ns	350 ns
t _{on} (typ)	110 ns	700 ns	370 ns	1000 ns	500 ns	175 ns
Power Requirement	1 μ W	4 mW	1.5 mW	1.5 mW	135 mW	120 mW

Our new DG300 series of eight CMOS analog switches is one more reason why design engineers come to Siliconix.

The DG300 virtually quadruples the speed of previous CMOS switches, with quiescent power dissipation up to ten times lower. It operates over a 30 volt signal range with low, nearly constant "on" resistance, has negligible leakage currents and isolates 30 volts peak to peak.

Yet prices for the DG300 are lower than or comparable to other CMOS switches that can't match its performance. You can use the DG300 in many applications as a low cost alternative to JFET switches, or to multiply the performance of low power designs.

A choice of CMOS-compatible logic inputs makes the DG300 series ideal for micropower applications. DG300, 301, 302 and 303 interface with low voltage CMOS, open collector TTL or DTL and operate on a few milliwatts. Typical t-on/t-off times are 150/130 ns. DG304, 305, 306 and 307 interface with higher voltage CMOS and need only a few hundred microwatts, with typical t-on/t-off times of 110/70 ns.

Both groups of switches are available in four different configurations: dual SPST, SPDT, dual DPST and dual SPDT. Guard terminals on the SPDT and dual SPST packages further improve isolation.

And for extra reliability, these CMOS switches are immune to latchup and are protected against static on all terminals. And they are available in commercial, industrial and military versions at prices very competitive with previously available CMOS switches.

For more detailed information, write for the 24-page DG300 series design catalog.

Or, to take full advantage of the 52 different analog switches Siliconix delivers, and to smooth out the wrinkles in designing with analog switches, send \$4 for our authoritative 352 page handbook—"Analog Switches and Their Applications."

It includes six informative chapters on analog switch theory, covering basic FET switch information, switch and driver circuits, multiplexing, sample and hold circuits, N-path filters, and signal conversion using analog switches. Each chapter is concluded with useful application circuits, and a seventh chapter is devoted entirely to application notes.

You can order all Siliconix products and literature from our franchised distributors: Components Plus, Elmar, Hamilton/Avnet, Pioneer, Quality Components, Semiconductor Specialists, Wilshire or RAE.

Yes, I'd like more information:

- Send me the free DG300 series design catalog.
- I've enclosed a check or money order for \$4. Rush me a copy of "Analog Switches and Their Applications".

Name/title _____

Company _____

Address _____

City/State/Zip _____

Siliconix Incorporated, Publications Dept., 2201 Laurelwood Road, Santa Clara, CA 95054 (408) 246-8000.

Siliconix incorporated

CIRCLE NUMBER 153

UNRETOUCHED

MICROPHOTOS



Note rough, jagged edges always present.

Your IC lead frames look like **this** at 30X enlargement (unretouched). Because they are punched out of metal, the edges are rough, jagged and irregular. In contrast, the flat sides of the lead frame are smooth, even and perfectly plated.

Arrows indicate scars and abrasions made by rough edge of lead frame.



22X magnification, unretouched.

THEIRS

An ordinary edge-bearing socket contact after 5 insertions of DIP lead frame. Contact has been spread apart to show inside faces of contact. Notice how the contact has scars and abrasions from rough, irregular edge of IC lead frame. Electrical contact is degraded and resistance is increased. Reliability is obviously reduced.

Lead frame in place in an ordinary edge-bearing contact.



Arrows indicate contact surface still smooth, clean, free from abrasions.



22X magnification, unretouched.

OURS

ROBINSON-NUGENT "side-wipe" socket contact after 5 insertions of DIP lead frame. Contact has been spread apart to show inside faces of contact. See how the RN contact—because it mates with the smooth, flat side of the IC lead frame—retains its surface integrity. This 100% greater lead frame contact results in continued high reliability.

Lead frame in place in RN "side-wipe" contact.

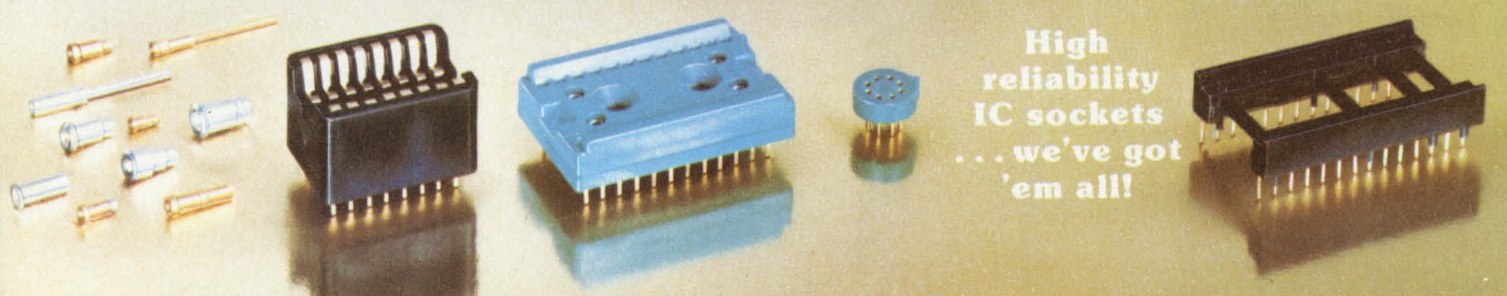

High reliability IC sockets ... we've got 'em all!

expose 'junk' socket problems

Secret of RN high reliability 'side-wipe' DIP sockets revealed by microphotos

Here's microscopic proof that high reliability Robinson-Nugent "side-wipe" DIP sockets make 100% greater contact than any edge-bearing socket on the market. This advance design provides constant low contact resistance, long term dependability—trouble-free IC interconnects. Yet RN high reliability DIP sockets cost no more than ordinary sockets!

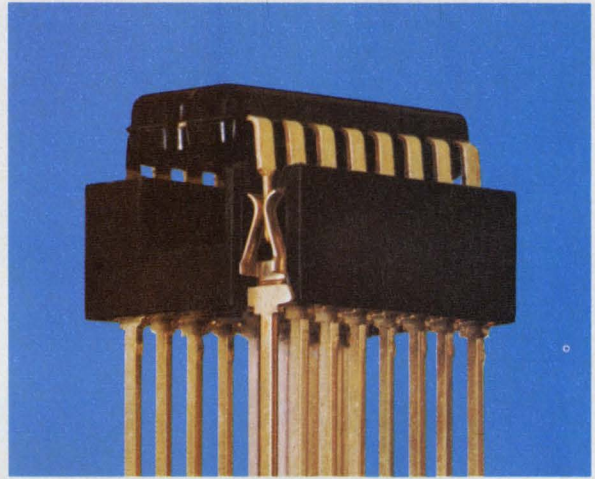

Get the high reliability that eliminates trouble. RN "side-wipe" DIP sockets make contact with the wide, flat sides of your IC leads. You get 100% greater surface contact for positive, trouble-free electrical connection.



WRITE TODAY

for catalog and informative book "What to Look for in IC Interconnects." Free from Robinson-Nugent—the people who make more kinds of high reliability IC sockets than anyone.

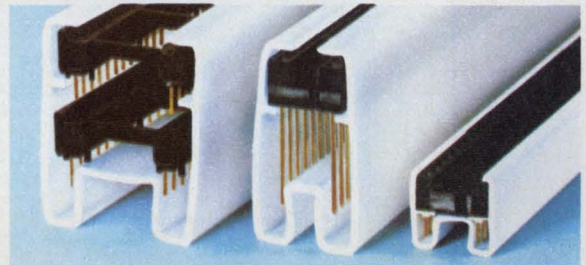

They're even packaged for high reliability. "Protecto-pak"® packaging delivers consistently perfect RN sockets to your production line—for automated or manual assembly.

RN ROBINSON NUGENT, INC.

800 East Eighth Street, New Albany, Indiana 47150 • Phone: (812) 945-0211

CALL ME, I'M INTERESTED CIRCLE #178

SEND PRODUCT INFORMATION CIRCLE #269

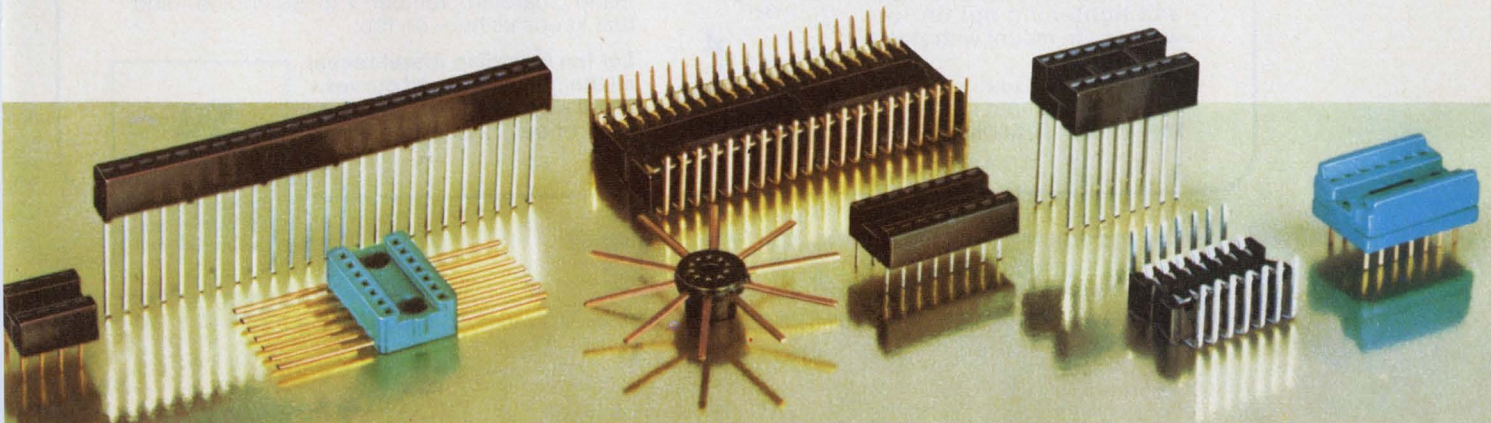

MORE PULL in a smaller package?

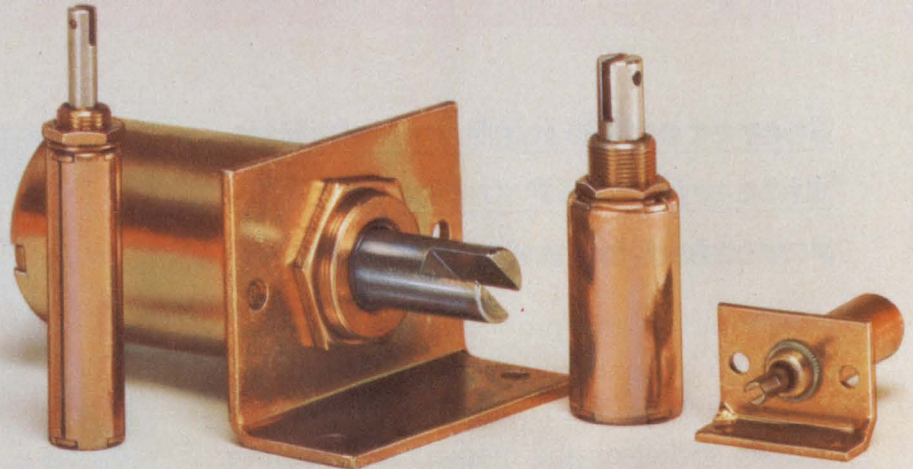
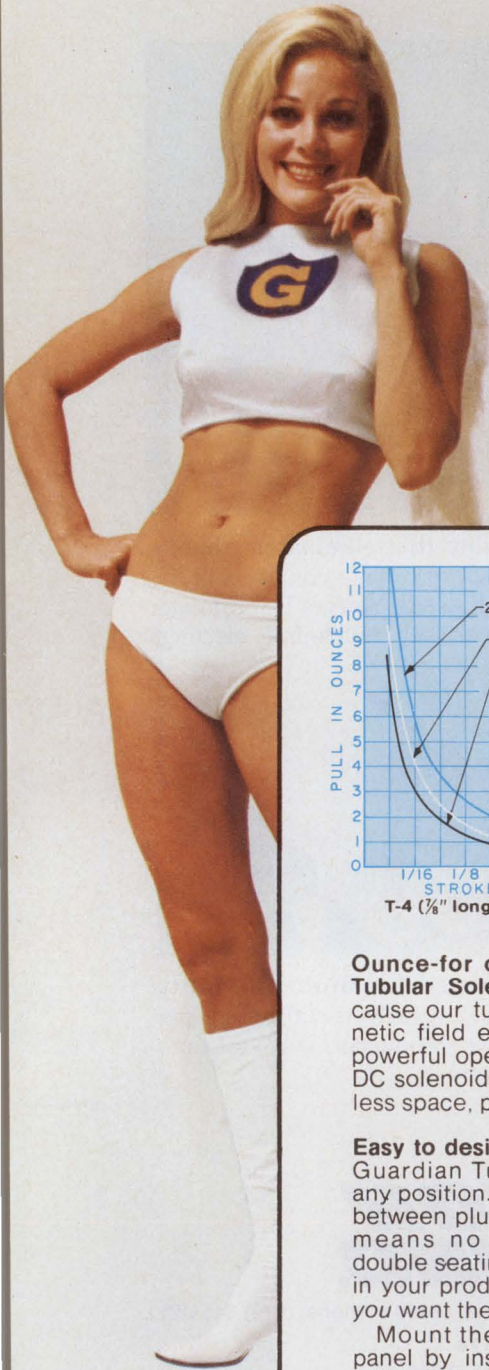

Check these curves.

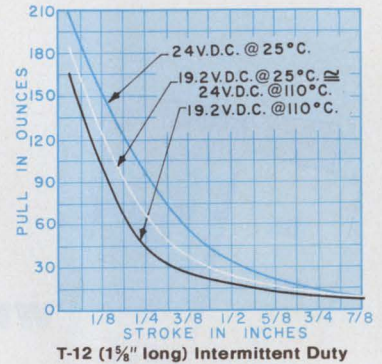
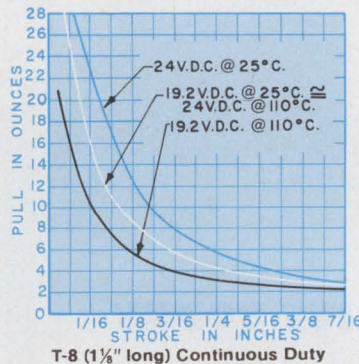
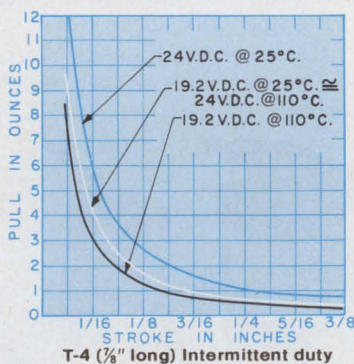

Ounce-for ounce, inch-for-inch Guardian Tubular Solenoids pack more power... because our tubular designs assure total magnetic field enclosure and result in efficient, powerful operation. More efficient than other DC solenoids. They give you more power in less space, plus U/L and CSA recognition.

Easy to design-in. Easy to install. By design. Guardian Tubulars work in any position. Close tolerance between plunger and bobbin means no possibility of double seating. So they work in your product just the way you want them to work.

Mount them directly into panel by inserting threaded bushing thru installation hole and tightening nut on lock washer. Or, mount with standard bracket.

Either way, Guardian Tubulars install without damage to the solenoid. Look how the

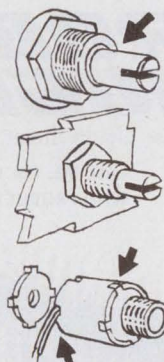

notched tube-steel shell mates with notched end plate. Result? A stronger assembly that takes more torque when installing...with no chance of damage. The leads emerge thru a notch in the steel shell, so they *will* not, *can* not be sheared by rotation during installation.

Once you put a Guardian Tubular in your product...forget it. Typical mechanical life is 20 million. That's probably longer than your product's life expectancy...due primarily to the unique Valox[®] 420 molded bobbin.

Variations and specials? Guardian's got 'em. Any DC voltage from 6 to 240. Push type or pull type operation. Return springs, silencers, termination variations, special mountings... you name it and we'll deliver it with the high quality craftsmanship and low prices that have made Guardian Number 1 in Solenoids—and that keeps us here on top.

Let the Guardian Angel reveal all the pull charts and curves in full size. Send for your free copy of our 72 page catalog.



This mark indicates recognition under the component program of Underwriters Laboratories, Inc.



GUARDIAN[®]

GUARDIAN ELECTRIC MANUFACTURING CO. 1572 West Carroll Avenue—Chicago, Illinois 60607 • 312/243-1100

CIRCLE NUMBER 154



Plugs into any teletype, terminal, computer or microprocessor development system with a serial 20ma current loop interface. Programs, lists, duplicates and verifies. RS232 and a parallel interface optional.

Program or duplicate your PROMs for under \$1,450.

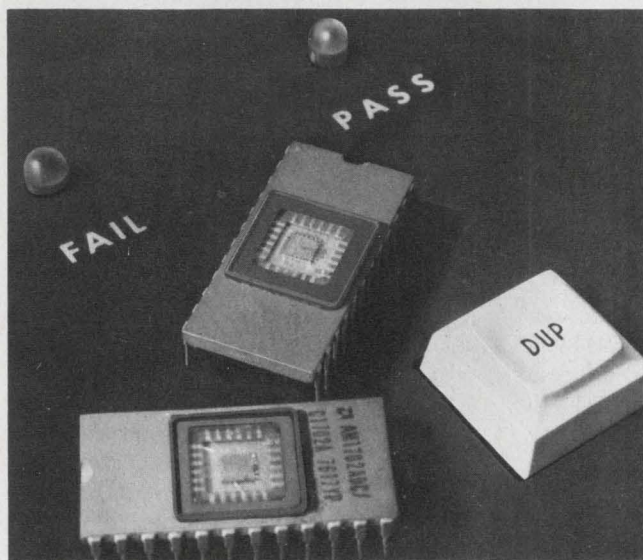

Duplicates PROMs automatically at the push of a single button. Has quick load, zero insertion force PROM sockets and pass/fail lights.

Use our new Series 92 two ways, as a peripheral PROM programmer, or as a stand-alone PROM duplicator.

It uses the same field-proven personality modules as our popular Series 90 PROM Programmer. We already have modules for more than 100 PROMs with more on the way, so your expansion capability is virtually unlimited.

The price—only \$995 for a master control unit, \$450 or less for a personality module.

And if you need a stand-alone programmer, don't forget our well-established Series 90.

It comes with a hexadecimal display and keyboard. Options include TTY, parallel and RS232 interfaces, and paper tape reader.

Write or call for data sheets, our Prom User's Guide, and our new price list which includes an up-to-date personality module listing.



**Pro-Log Corporation
2411 Garden Road
Monterey, CA 93940
(408) 372-4593**

μ Cs on a chip and integrated d/a's about to usher in an IC harvest

Last year's bumper crop of new IC technologies and processing refinements will bear fruit in 1977. This year will see microcomputers on a chip, with ROM, RAM and I/O capabilities built in and specialized peripheral circuits, some more complex than the original microprocessors. Also 16-k dynamic RAMs will be available in production-volume quantities rather than limited sample quantities.

Linear circuits have benefited also from last year's improvements—full digital-to-analog converters (including the reference) are now available as a single IC—and mixed technology products, such as JFET and bipolar devices on the same chip, are becoming the standard rather than the exception.

μ P developments set the pace

Even with high-level integration, the ubiquitous microprocessor is becoming even denser. Fine-line geometries and careful layout have cut the chip sizes almost in half. And refinements in n-channel MOS processing, improved integrated injection logic (I²L) design, and high bipolar densities will permit designers to nearly double the complexity of digital ICs made in 1976.

MOS Technology, Norristown, PA, Motorola, Austin, TX, and Signetics, Sunnyvale, CA, are preparing depletion-load versions of their own NMOS processors. In general, power and size will be reduced 30 to 50%, and cycle times will get faster by 40 to 50%. And the cuts in power and size will probably reduce packaging costs by similar percentages since plastic can be used instead of ceramics. Moreover a silicon-on-sapphire version from RCA, Somerville, NJ, of

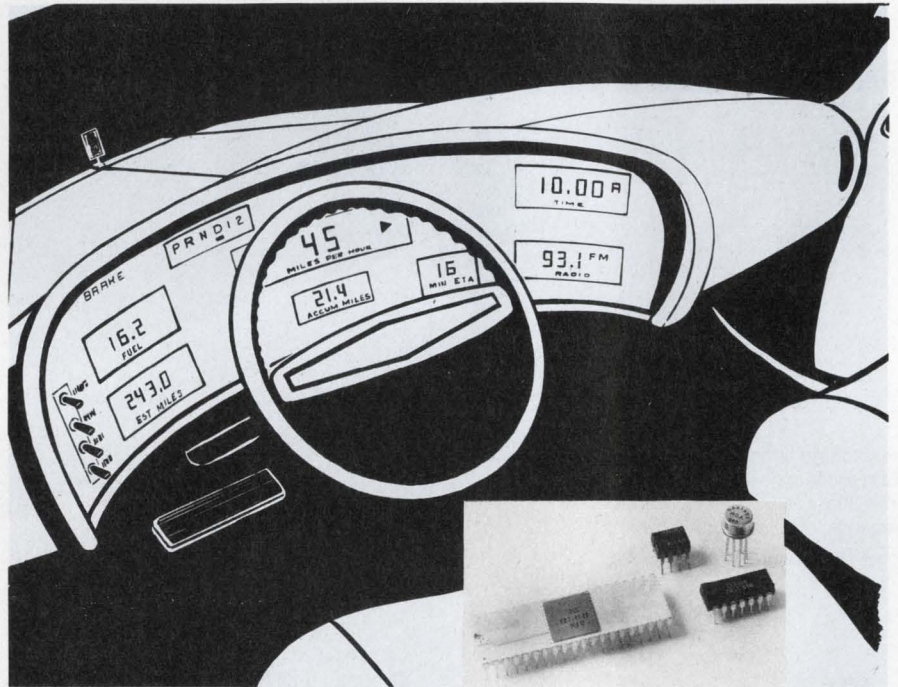

Taking control in future cars, the microprocessor will monitor the braking and the entire dashboard. RCA's 1802 μ P is one of the leading contenders for this tough, cost-conscious application.

its CMOS 1802 μ P will offer similar performance improvements.

But size cuts and speed boosts aren't the only design tweaks bursting into prominence. Chips with more functions are already out. For example, the recently introduced 8085 μ P from Intel has a clock oscillator and a considerable amount of control capability, yet maintains full 8080 software compatibility. The 8085 operates with a 6-MHz crystal to generate a 3-MHz system clock. Although the pin count matches the 8080's, the 8085 isn't pin-compatible; the address bus is partially multiplexed to make room for the additional control pins.

The 8048/8748, also from Intel, are designed to be all-in-one chips. On the 8048 are 1-k byte of mask-programmable ROM, 64 bytes of RAM and a full 8-bit processor ca-

pability with 96 instructions. The 8748 is a development version that contains 1-k byte of ultraviolet-erasable PROM, 64 bytes of RAM and a full 8-bit processor capability. Also available is the 8035, a processor-only version (no on-chip memory) of the 8048.

An 8-bit processor recently announced by Motorola, the 6802, is a full 6800 μ P with an oscillator, 128 bytes of RAM and a parallel I/O port all on a single chip. And a simpler version of RCA's 1802, called the 1803, is expected to arrive in early 1977 and be housed in a 28-pin DIP.

Larger word-length microprocessors with minicomputer capabilities will pop up from about half a dozen vendors. Of course, four single-chip 16-bit μ Ps are available now: the NMOS and I²L versions of the 9900 from Texas Instru-

Dave Bursky
Associate Editor

ments, Dallas, TX; the PMOS PACE from National Semiconductor, Santa Clara, CA; the NMOS CP1600 from General Instrument, Hicksville, NY; and the NMOS microNova from Data General, Southboro, MA. But these four will soon have company: a 16-bit NMOS μ P from MOS Technology, and a 16-bit I²L processor from Fairchild Semiconductor, Mountain View, CA. Motorola is considering a pseudo-16-bit μ P, but has not yet committed itself to production.

Specialized microprocessors with on-chip ROM, RAM and I/O ports will soon appear in many consumer and industrial control applications. Fairchild's single chip F-8 μ P is already being designed into electronic games since it can be mask-programmed with up to 2-k byte of ROM as well as having I/O capability on the chip.

But smart controllers lead

Modified forms of current microprocessors are being applied in appliances and industrial control. And specially developed controller circuits, such as the COPS series from National Semiconductor and the single-bit CMOS controller from Motorola, offer the cost-conscious commercial manufacturer a viable alternative to μ P control.

Other control circuits provide programmable alternatives to much of the hard-wired logic necessary to support μ P systems. Circuits that include multiple I/O lines, some RAM or ROM and a programmable timer are available as support for some of the recently introduced μ Ps—Intel's 8155, Motorola's 6846, Signetics' 2656 and General Instrument's PIC1640 and 1650.

Most of these circuits are ROM-based, with development still limited to large hardware systems. Not so in 1977. Along with Intel's 8085, comes an ultraviolet-erasable PROM and I/O circuit, the 8755. It has 2-k bytes of programmable storage as well as two, programmable, 8-bit I/O ports. To top it all off, the 8755 operates from 5 V—the first of a new breed of UV PROMs that require a single 5-V supply.

Peripheral controllers are available for many applications, but one of the most complex is the control of a floppy-disc memory drive.

Only a few such circuits are currently available: Rockwell, Newport Beach, CA, has a circuit designed only for use with its PPS series of μ Ps and Western Digital, also in Newport Beach, has a general unit, the FD1771. Motorola expects to have a disc-control circuit by mid-1977 and several other companies are currently working on prototypes.

Communications circuits are also receiving design tweaks. For example, the ASTRO, an asynchronous/synchronous receiver-transmitter developed by Western Digital will soon have a second source. A pin-compatible version is expected from SMC Microsystems, Hauppauge, NY, along with other specialized communication circuits

—like the COM5025, a bit or byte-oriented universal synchronous receiver/transmitter designed to handle all synchronous interfaces.

Many of the communications applications feed terminals and, with the large growth in video terminals, many IC vendors have looked inside to see if they can reduce the MSI circuits into one or two LSI chips to cut the terminal cost. The CRT5027, a video timer and controller from SMC, exemplifies this approach. It is a user-programmable circuit that contains the logic functions required to generate all the timing signals for the presentation and formatting of interlaced and noninterlaced video.

Programmable arrays get gated

The programmable logic array, in both mask and field-programmed forms, has become a valuable design tool for simplifying control sequencing. However, the logic designer will soon have a new tool—the programmable gate array. The PGA, developed by Signetics, can eliminate much of the simple logic "glue" by replacing the SSI circuits with one all-in-one array. Programming is done much the same as with PROMs or programmable logic arrays—by zapping fuse links with current pulses. The PGA contains nine independent 16-input NAND gates, with each of the 16 inputs actually internally

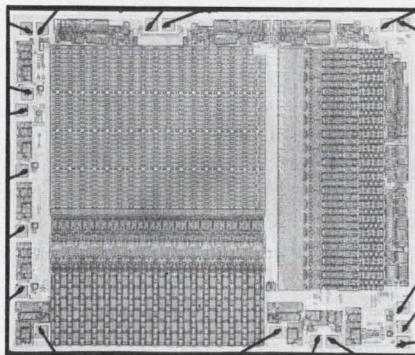

The first of a family of CMOS PROMs, the HA6612 series of fusible-link PROMs developed by Harris Semiconductor, requires less than one-tenth the power of comparable bipolar units.

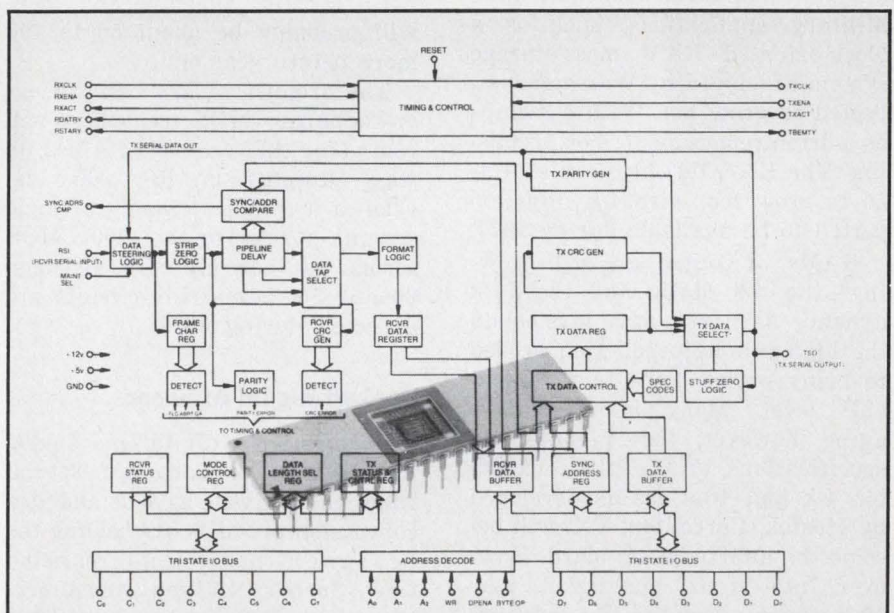

By handling both bit and byte synchronous data, the COM5025 developed by SMC Microsystems offers the designer a choice of protocols, full or half-duplex operation, and even some self-checking capability.

available in both true and complement forms.

Programmable memory arrays will also receive a face lift. Traditionally, PROMs have been fabricated with bipolar technology to get high speed and, unfortunately, high power requirements. But in 1977, several CMOS PROMs from Harris Semiconductor will change all that with nearly bipolar access times and only a fraction of the power consumption. These PROMs from the HM6610/11/12 series will be available in 256×4 organizations and in either 16 or 18-pin configurations.

Normal bipolar PROMs will be available during 1977 with $1\text{-k} \times 8$ organizations. Moreover, a 16-k bipolar PROM is expected by year end. Faster access times for bipolar PROMs will be available—40 to 60 ns will be standard.

In the first quarter of this year emitter-coupled logic PROMs, organized as 256×4 , will be announced by Harris Semiconductor and Motorola, Phoenix, AZ. The ECL devices are expected to have a 25-ns access time.

Electrically alterable ROMs (EAROMs) built with NMOS technology have been lab curiosities at General Instrument, Nitron, Cupertino, CA, and Westinghouse, Baltimore, MD, for several years. During 1977, they will finally start appearing in many consumer items, such as games, electronic TV tuners and communications equipment. Military applications, such as a block-oriented RAM mass-storage system developed by Westinghouse, expected to grow too. With 4-k chips as a drum replacement, look promising. The EAROM chips are expected to grow too, with 4-k chips expected to be available during 1977.

RAMs, of course, are still growing—the 4-k static and the 16-k dynamic memories have just begun the high-volume production needed to bring prices down to a reasonable level. Many manufacturers agree, however, that pinouts and specifications of the pin compatible 4-k and 16-k RAMs developed by Mostek, Carrollton, TX, will become the unofficial standard. However, Intel is still pushing its new 16-k designs very hard by relaxing the timing requirements, and several companies will offer second source products.

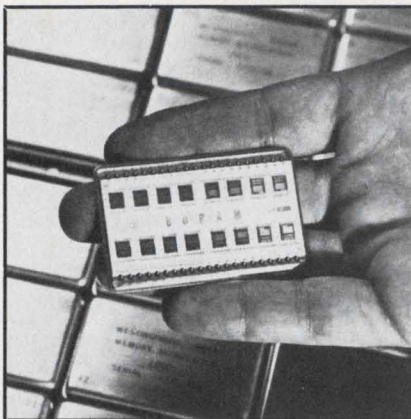

Electrically alterable ROMs developed by Westinghouse are starting to replace mechanical drum memories. The hybrid circuit (shown) contains 16 2-k EAROM chips that are used in a block-oriented RAM developed for the Army.

New 4 and 16-k RAM organizations are just up the road. Manufacturers are examining the market closely for a 512×8 static device as well as a $4\text{-k} \times 4$ and a $2\text{-k} \times 8$ dynamic. And around the end of 1977, a 16-k static memory and some working samples of a 65-k dynamic RAM just might appear, according to some optimistic manufacturers.

Even the standard logic families are undergoing some behind-the-scenes revitalizations. The combination of Schottky and low-power TTL technologies has produced a new 74LS family of logic circuits. There are currently about 150 74LS circuits available and there will probably be about 50 to 100 more before year end.

The promise of low cost silicon-sapphire CMOS technology will come true this year if RCA has its way. Designers at RCA have developed a complete family of logic circuits similar to the 4000 CMOS series, but entirely SOS. Between 30 and 50 "standard" circuits are expected during 1977.

Convert digital to linear

Spanning the digital and analog worlds, a wide range of special functions as well as a/d and d/a conversion products are helping the designer cut project-turnaround time. Such specialized communications circuits as delta-modulator encoders and decoders from Harris Semiconductor, Motorola and American Microsystems, Santa

Clara, CA, will make their debut, along with companding d/a converters such as the Comdac originally developed by Precision Monolithics, Santa Clara, CA, and soon to be copied.

Raytheon Semiconductor, Mountain View, CA, is hard at work on a pulse-code modulation circuit. And almost every company is eyeing the telephone-interconnect market with its need for telephone-dialing, tone-detecting and signal-switching circuits.

Conversion circuits with built-in voltage references and all other necessary components are only now coming out. The NE1508 from Signetics, a microprocessor-compatible d/a converter with a built-in, 8-bit latch and a voltage reference, is now completely developed. An I²L a/d converter developed by RCA for Analog Devices, Norwood, MA, will be available soon. Used in a line of digital panel meters, the circuit requires about a dozen components, including the display and pull-up resistors. Also available from Analog Devices is a 10-bit all-in-one d/a converter—the AD561.

High-performance products, built by combining two or more technologies, are toppling the old cost-vs-performance criterion. Low-cost op amps, with performance almost matching that of discrete-component circuits, have been developed by National Semiconductor, Harris Semiconductor, RCA and many other vendors. National's BiFET products in the LF155 series combine a JFET front end with a bipolar op amp. Even though Harris has opted to use MOSFETs on its monolithic chopper-stabilized op amp, the company will also be introducing BiFET products.

Quad op amps, with 70-MHz gain bandwidths and $25\text{-V}/\mu\text{s}$ slew rates as well as a family of single op amps with gain-bandwidth products of 150 MHz, will soon be available from Harris.

Cutting a few corners on performance and shaving price to the bone, RCA has developed a multi-technology line of products with its 3130 series of op amps. These circuits use a MOSFET front end, a bipolar gain stage and a CMOS output stage. Soon to be released is the CA3160 a compensated version of the 3130. ■■



A chip off the old block.

As you can see, this chip is housed in ceramic and mounted in a forty pin, dual in-line package.

As you can't see, it's a NOVA[®] computer.

Inside that packaging sits a full 16-bit, silicon gate, NMOS microNOVA CPU. The mN601.

The mN601 is the first microprocessor designed and manufactured by a minicomputer company. And it's the highest performance NMOS microprocessor on the market. With our 160 nanosecond RAM, it has a memory cycle time of 960 nanoseconds and the fastest instruction times going. Like an Add of 2.4 microseconds. And a Load of 2.9 microseconds.

The mN601 has the 16-bit NOVA instruction set including hardware stack for easy programming. And 16-bit data for efficient memory use.

It also has hardware multiply/divide for fast program execution. Integral data channel logic for easy interfacing to high performance peripherals. Control and timing for high density RAM memories. Integral hidden refresh logic that overlaps instruction execution timing. Plus a unique I/O encoding scheme for efficient easy interface design. Even the real-time clock is included. All of which reduces the chip count.

And all that computer is in a single chip.

And because the mN601 is a NOVA, it uses the most mature, field-proven software you can get with any micro. So you can cut back on development time and cost by using compatible software like our diskette-based Disc Operating System and our Real-Time Operating System.

Also, the mN601 comes with the full documentation support you'd expect from a minicomputer company like Data General.

If you want more than a chip, you can get it. There's a whole chip set, a 4K computer-on-board and a fully-packaged 9-slot microNOVA MOS mini. And there's more.

Don't stop here.

Sign up for a technical seminar on the microNOVA. They'll be held in major cities around the country from New York to Los Angeles. They'll last a half-day. And they're free.

For more information call our toll free number, 800-225-9497 (Unless you're in Massachusetts. In which case, call 1-617-485-9100 Ext. 2509.)

microNOVA:

A giant reduction in the NOVA line.

DataGeneral

Data General, Route 9, Southboro, Mass. 01772 (617) 485-9100. Data General (Canada) Ltd., Ontario.
Data General Europe, 15 Rue Le Sueur, Paris 75116, France. Data General Australia, Melbourne (03) 82-1361

NOVA is a registered trademark of Data General Corp.

CIRCLE NUMBER 25

Out in space or on the road, discrete devices are on the job

Low-cost satellite communications equipment, digital automobile dashboard displays and small, efficient power supplies are just a few of the applications heralding growing importance of discrete devices. Despite the major impact of the integrated circuit, major R&D efforts in discrete components will continue.

Microwave FETs, which already provide reliable service as small-signal amplifiers up to and even beyond the 12-GHz region, are being pushed to perform at still higher frequencies. And noise figures even better than today's low values are being sought.

At the other end of the power spectrum, high-power microwave FETs are being called upon to play an increasingly significant part in satellite communications by boosting signal power to levels higher than any attained today.

A potentially vast market looms in the next few years for electro-optical devices as auto manufacturers consider using such equipment to replace or supplement conventional dashboard displays.

Resistors and capacitors will not be neglected. The impedance of filter capacitors is steadily being lowered to permit power-supply manufacturers to build smaller, more efficient supplies. Resistors are being designed to handle increased power dissipation—with no increase in physical size.

Versatile microwave FETs

Small-signal devices and power FETs are two major areas of gallium arsenide (GaAs)-FET technology that will continue to occupy center stage for some time to come.

Samuel Derman
Associate Editor

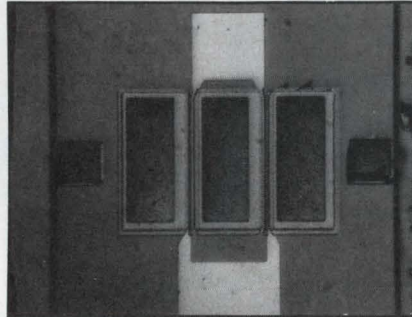

The first of its kind, a dual-gate microwave GaAs FET from NEC, Model NE463 can be operated as a mixer or modulator, as well as with automatic gain control. It provides low noise wideband operation up to X-band.

R&D is concentrated in the 12-to-18-GHz region; and work will continue into the region beyond. Major efforts are currently underway at American, British and Japanese companies.

Noise-figure reduction continues to be a concurrent goal. Present devices are already providing noise figures as low as 1.7 dB at 8 GHz.

Work on small signal-amplifier devices has been spurred by a number of diverse, potentially large-volume applications. To improve the reliability of receivers used in radar and electronic countermeasures (ECM), designers would like to replace current tunnel-diode amplifiers, which are susceptible to burn out, with FETs. And as the FET noise figure is brought down, even very low noise—but relatively expensive and massive—paramps eventually may be replaced by the much cheaper FET amplifiers.

In addition, there has been "some dialogue" with manufacturers for possible TV applications, reports Randall Burke, marketing manager for Plessey Microwave Systems, a British firm (Towcester, England). GaAs FET devices

are being considered for the front-end amplifiers of TV receivers, but these devices are still too expensive, Burke adds. Their cost must drop to between \$1.00 and \$1.50 per FET—a long way off from the current \$10 and \$20 range.

Power GaAs FETs to see wide use

A bright future looms just around the corner for power GaAs FETs, too. The biggest application will be to replace bulky-power-consuming traveling-wave tube amplifiers (TWTs) in satellite ground stations.

Another benefit of the GaAs FET power amplifier is its efficiency (rf output power divided by total dc input power), points out Dave Struthers of Hewlett-Packard's Microwave Semiconductor Division, Palo Alto. A FET's efficiency can run from about 12% to 30%, while a comparable silicon Impatt device runs from 6 to 12%.

Power GaAs FETs with 1-W output power beyond 8 GHz are already commercially available, with efforts aimed at increasing both the power and the frequency.

A harbinger of a new trend in microwave FETs is the dual-gate, Model 463 microwave FET from Nippon Electric Co. (NEC), Japan. This is the first dual-gate microwave device on the market. The additional gate allows the FET to be used as a modulator or mixer or to be gain-controlled very easily. Even when the 463 is matched to produce a minimal noise figure (1.6 dB), a high gain of 19 dB at 4 GHz can be obtained.

Passive displays become active

"There will be more and more passive-type (nonlight-emitting)

The answer to 8080 Power Problems

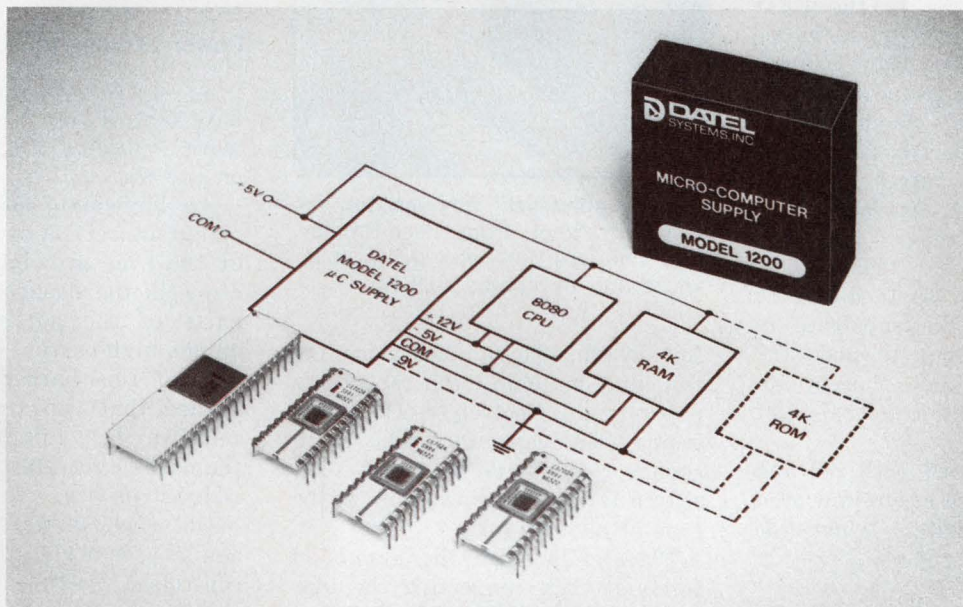

Datel has it ... the new 1200 microcomputer switching supply.

Model 1200 is unique. This DC/DC converter delivers clean, well-regulated output voltages of +12, -9, and -5 VDC from +5VDC input to power an 8080 Micro-processor CPU and 4K of memory. Features include line and load regulation of 0.05%, a max. output

ripple of 1mV RMS, a transient recovery time of 50 μ sec., full load efficiency of 48%, and a max. TC of 0.02% / $^{\circ}$ C.

And all from a 2 x 2 x 0.75 inch micropackage weighing just 4.5 ounces. In fact, everything about the 1200 is micro-compatible, including the price (\$89 in singles, \$54 in 100's*).

Model 1200 — and a choice selection of more than 180 modules and open-frame power supplies designed and manufac-

tured by Datel — is detailed in a new, 40-page Power Supply Handbook. Send for your free copy today.

*U.S.A. domestic prices only.

DATEL
SYSTEMS, INC.

1020 Turnpike St., Canton, MA 02021
Phone: (617) 828-8000

- Santa Ana, CA (714) 835-2751
- Santa Ana, (L.A. Exchange) (213) 933-7256
- Sunnyvale, CA (408) 733-2424
- Gaithersburg, MD (301) 840-9490

displays. This trend may be years away, but we see it coming," declares Bob Sepp of Dialight Co., Brooklyn, NY, adding: "Liquid-crystal displays are the first of these types to come out on the market, but there are others, and they're being worked on now."

Although R&D work in this area is guarded to the extent that almost no information is divulged, all passive-display manufacturers agree on one thing. The automobile is a potentially large area of the passive-display market.

"I think the auto manufacturers are looking more towards a passive display for dashboard requirements. I really don't think they want a LED," states Sepp.

The aversion to using LEDs in automobiles stems partly from the LEDs' inability to operate more than marginally at the temperature extremes encountered in normal auto use, Sepp reports.

Those using active displays will find that LEDs are becoming brighter. The trend in the LED industry is to more efficient materials, reports HP's Gary Spear. New LED materials already increase light output from 2 to 4 times that of earlier diodes. A gallium phosphide substrate replaces the GaAs used previously.

Unlike its predecessor, the gallium phosphide is transparent. Thus, a reflecting surface can be mounted behind the substrate to reflect the light out towards the front or emitting side, thereby appreciably brightening normal light output.

The efficiencies of both red and yellow LEDs have been improved by using the gallium phosphide substrates, Spear reports.

Trends in capacitors

Capacitors have been around for so long that one doesn't often think of them in terms of trends. Nevertheless, designs of power-supply filter capacitors will continue to move in very well defined directions in the years to come, according to Ed Geissler, national marketing manager for Sprague Electric Co., North Adams, MA.

To minimize the size of the filter capacitor (and inductor), many power-supply manufacturers rectify the 60-cycle input power, chop it at a high rate (20 to 40 kHz),

then rerectify and filter this high-frequency current. Since the capacitive reactance varies inversely with the frequency, a relatively small value is required for the filter capacitor.

Moreover, at high frequencies the capacitor can be made to resonate with its own self-inductance—typically, 30 to 40 nH—reducing the reactance virtually to zero. The higher the frequency, the easier it is to attain this goal. Frequencies even higher than today's 40 GHz may be used tomorrow, Geissler predicts.

Minimizing the resistive component of the filter capacitor's impedance consists of optimizing the



A new "universal" film resistor, the type-cc cermet from Allen-Bradley, has standard 1% and 0.5% tolerances and dissipates 1/2 W.

foil design, placing taps along the foil, and matching the capacitor's paper to the electrolyte. The paper inside the capacitor acts as a sponge to hold the electrolyte. Research is underway to optimize the type of paper used.

Placing taps on the aluminum foil and then connecting the taps in parallel produces the same effect as dividing the capacitor into segments with all segments electrically in parallel. The result is a reduction in the filter capacitor's over-all resistance.

Film resistors advance

Designing specific devices for specific applications may be the trend in filter capacitors, but the direction in fixed, thin-film resistors is nearly the opposite. The aim is to provide more standard configurations in terms of resistor wattage ratings.

Improved thin-film technology has already increased the power-handling capacity of standard thin-film resistors, reports John Covey of Mepco, Morristown, NJ.

A line of resistors from Mepco, Model SPR4045, has the compactness of a 1/4-W unit yet provides the power-handling capability of a 1/2-W resistor. Ranging from 10 Ω to 22 M Ω , this series will cover the power-dissipation range from 1/2 W on down. A similar 1-W device will soon join the SPR4045 on the market.

Applications for these resistors exist wherever precision resistors with very low reactance (low series L, low shunt C) are needed.

A line of "universal" film resistors, type CC cermet devices, will soon be introduced by Allen-Bradley Co., Milwaukee. A resistance temperature coefficient of 50 ppm/ $^{\circ}$ C in tolerances of 1% and 0.5% will be available in the 10 Ω to 22 M Ω range. Wattage rating will be 1/2 W at 70 C.

Power devices revving up

Traditionally, power devices have been a slow grower. Not any more. A dramatic expansion is well on the way.

An immediate goal of the auto manufacturers is to reduce the size of the ever growing harness that connects the dashboard to various parts of the automobile. Heavy-gauge, high-current cables make up part of this harness. Devices are needed that can remotely control relatively heavy dc currents so that the dashboard cable harness can be reduced in size.

One such device soon to become available is a gate turn-off, silicon-controlled rectifier from RCA's Semiconductor Division, Somerville, NJ. Operating from the standard automobile 12-V supply, this SCR, Model G4000, can remotely switch up to 15 A as well as operate at temperatures up to 125 C. Controlling amps of current with only milliamps to the control gate will reduce the gauge of the cable tremendously.

Small-signal SCRs for replacing electromechanical controls in such equipment as office dictating machines, and larger SCR units for controlling industrial machinery are being developed by Texas Instruments, among others. ■■

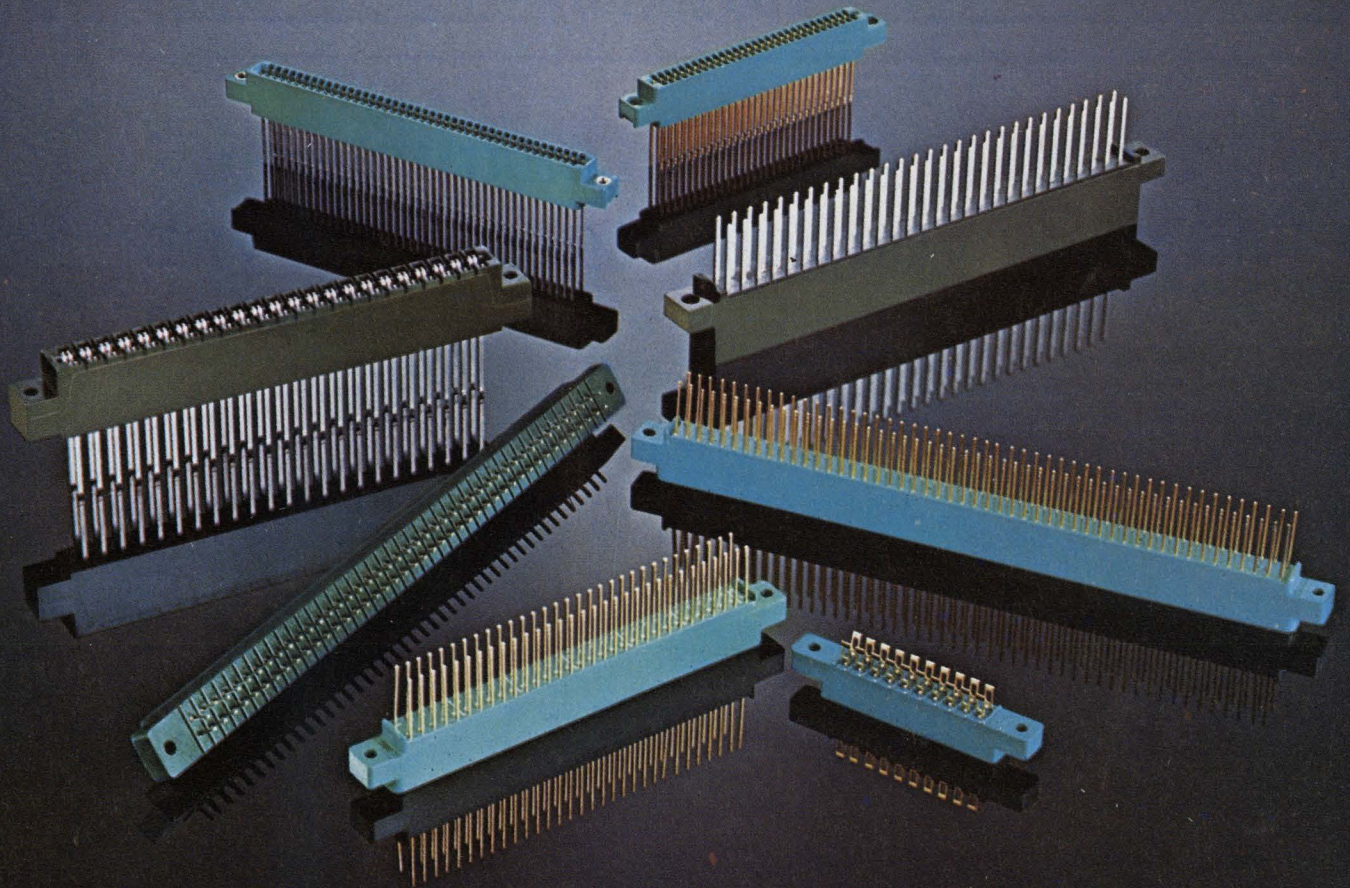

PC Connectors give our family the edge. We can give you the edge with fast

delivery and wide variety in off-the-shelf PC connectors.

In .100, .125, .156 and .200 inch spacing you can take your choice for motherboard or automatic wiring applications.

You can also pick the contact you want —gold-dot or gold-plated. These include bifurcated bellows, cantilever beam and bifurcated cantilever beam designs.

Connector housings are available in glass-reinforced phenolic, diallyl phthalate and glass-reinforced polyester thermoplastic. A variety of mounting configurations are also readily available.

All have been designed to meet the applicable performance requirements of MIL-C-21097, and they're all available now.

So be sure to have a shipping date in mind when you contact GTE Sylvania, CPO, Box 29, Titusville, Pa. 16354 Phone 814-589-7071.

Remember, good connections run in our family.

GTE SYLVANIA

'Smart'ly dressed instruments will save you real money this year

In 1977, the well-dressed instrument will wear a microprocessor. However, the μ P affects much more than appearance—usually. Scratch a brainy instrument, and inside you will find ICs. The chips not only set the trend toward smarter and smaller test gear, but produce such valuable fringe benefits as greater convenience, cleaner front panels, digital interfacing and more versatility. While μ Ps are mostly used to expand instrument capability, they can also bring prices down. To many prospective buyers this may well be the most important trend.

When you shop for test gear this year, your first question will be, as always: Is it functional—Does it do what I want? If, for example, you need a digital multimeter, you can get a lot of capability for less than \$100—the B&K Dynascan Model 280, for instance, has a 3-digit readout and 22 ranges. On the other hand, if you also need to see the waveform of your signal, you may choose something like Tektronix' Model 213, which sells for \$1200. At 3.7 lb, it is a very portable scope. Moreover, its screen doubles as the display for a 3-1/2-digit multimeter. For versatility, 1977 is a very good year.

Like functionality, safety features are not negotiable. OSHA regulations have accelerated the trend to safer instruments. Doubly insulated cases, as on some Philips scopes, and multiple interlocks are becoming very popular. But ultimate safety will come from ICs. Once all the test gear runs on 9-V batteries, everyone will feel a lot safer—especially when wired into medical-electronics equipment.

Because of ICs, power consumption is dropping rapidly. Today, an autoranging, liquid-crystal DMM may consume an incredible 10 mW. In 1977, look for even more battery-operated instruments and for longer battery life. Less power consumption usually means less weight—even for the ac/dc breed—especially when the power transformer is eliminated, as in some Philips scopes. Since power transformers are not only heavy but also expensive, switching power supplies that can do without them are bound to gain ground.

Time is money—sometimes

This year's equipment is smarter than ever, and frequently more ex-

pensive than its less intelligent forebears. This additional expense is worth it if the smarter instruments save testing time or the often tremendous cost of converting raw data.

The Hewlett-Packard 1611A logic analyzer, for instance, uses a microprocessor to check out other microprocessors. But it does so in a time-saving way. The 1611A reads instructions back to you in mnemonics instead of machine code.

GenRad's Digibridge exemplifies good μ P application. For \$995, it measures R, L, C, D and Q automatically and chooses the range setting that yields the highest accuracy. For an automatic bridge with these capabilities you would have paid from \$4000 to \$7000 a few years ago. Look for more such time saving instruments in 1977.

The uncluttered front panel of the Digibridge is another result of effective μ P use. All you see are eight self-explanatory pushbuttons and the readout. The 8080-controlled Fluke 8500-A DMM, the Wavetek 172 waveform source and the Systron-Donner 7115 automatic DVM also feature clean, easy-to-use control panels.

As digital test circuitry replaces analog, knobs generally yield to buttons as control elements. But watch out: An array of pushbuttons won't guarantee convenience. "Sometimes only the inventor can remember which buttons to push in what sequence," quips Dick Lee, engineering manager at Boonton Electronics (Parsippany, NJ), which expects to introduce some smart instruments of its own during 1977.

Everything to everybody?

With today's miniaturized components, the test-equipment designer enjoys nearly absolute freedom

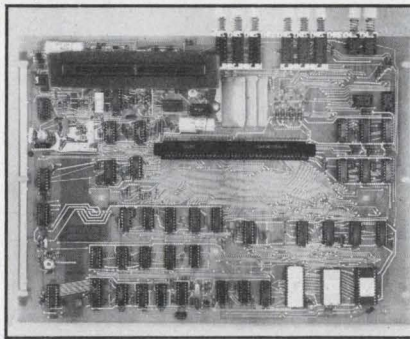
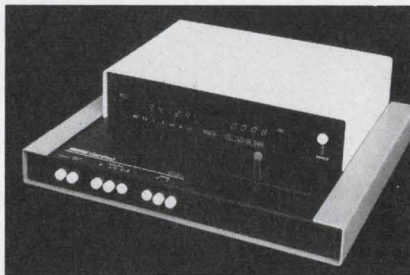

1. The GenRad Digibridge measures R, L, C, D and Q of components automatically, using only a few self-explanatory buttons (top). Without a μ P and other ICs (bottom), such an instrument would have a price tag several times greater than the one it has: \$995.

Protection that adds value . . .

What's your handle?

We want to make you look good. So we've designed our circuit breakers with the industry's broadest selection of handle styles and colors.

Rather than hiding fuses or cheap thermal breakers, you can put a Heinemann hydraulic-magnetic breaker right on the front panel, where it can double as a power switch . . . just one more way our products add value to your products.

And one more reason Heinemann is No. 1 in OEM circuit protection for everything from computers to coffee machines. Not just for overcurrent and short circuits, but also for overvoltage, undervoltage, and a surprising variety of switching, calibration, and control functions.

Ask for your Protector Selector—a handy reference chart loaded with specs, capabilities, and dimension drawings for twelve top-selling protector lines (of which our Type J series, shown below, is but a single example). Contact your nearby Heinemann representative (listed in EEM) or Heinemann Electric Company, Trenton, NJ 08602. (609) 882-4800.



Ours is Flip, Rock, Push, Switch, and Color-Me-Red.

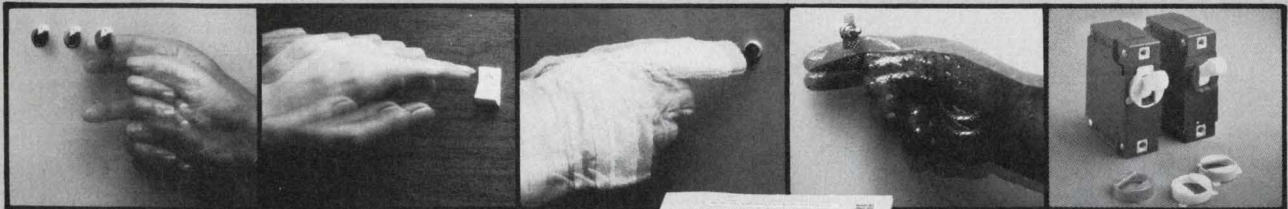

another reason Heinemann is No. 1 in OEM circuit protection.



HEINEMANN

We keep you out of trouble.

Factories in Trenton, Montreal, Dusseldorf, Johannesburg, and Melbourne.



to pack additional functions into his box. Today, a signal generator, multimeter, scope and power supply can all be combined in a single housing. A complete test set is attractive, but the well known disadvantages of centralization may curb this trend.

Perhaps you've experienced the havoc centralized computers can wreak. One failure, and there goes the whole operation. Should you risk losing your whole test set when one 10-cent diode fails?

Dr. Eberhardt Rechtin, chief engineer at Hewlett-Packard, considers distributed computing one of the dominant trends in laboratory instrumentation. Now that instruments can talk to each other, thanks to μ Ps and the 488 bus, there is little functional need to combine a number of instruments in one housing, except, of course, if you need a portable unit. The availability of inexpensive mini and microcomputers has, in fact, already generated a counter-trend toward simpler equipment for production testing.

"A piece of special test equipment is usually more efficient than

general-purpose systems in terms of hardware and software for testing specific ICs, such as watch chips. General-purpose systems usually cost two or three times as much and require weeks to program, rather than hours or days," notes Tom Newman, product manager for small test systems at Teradyne, (Boston, MA). A general-purpose system for complete circuit boards may cost several hundred thousand dollars, while a simple solder-short tester, costing \$12,000, can weed out 70 to 80% of the rejects.

After the wristwatch receiver . . .

IC test equipment such as Teradyne's is largely responsible for today's inexpensive chips. Without fast LSI testing, the pocket calculator or electronic wristwatch would still be a dream. Will low-cost ICs also bring signal generators and frequency counters that can fit into a wristwatch? What are the limits of microminiaturization?

Today's instruments are built on circuit boards that provide the in-

terconnections for DIPs that, in turn, provide the interconnections for LSI chips. The total analog and digital circuitry on a 4-1/2 x 9-1/2-in. board may amount to half a square inch. So "wristwatch" instruments are technically feasible. But will you be able to buy any in 1977? Now that I²L technology permits linear and binary circuits on the same chip, the road to further miniaturization is indeed open. But "mixed" chips are still rare.

Chip interfaces may be minimized if the raw signal can be transformed into binary form immediately, and a μ P can do the "massaging." Charge-coupled-device technology may even start a trend back to analog circuits, which would also eliminate interfaces, according to John Tates, vice president of engineering at Fluke.

While you will see more pocket-sized instruments in 1977, progress may be slower than expected. New, and even more powerful LSI chips are flooding the market—yet most are being ignored. Even those coming from trusted names in electronics. The reason: Equipment designers simply refuse to incorporate any chips that are not double—even triple—sourced. Such obvious trends as the incorporation of the IEEE, or IEC, bus (expected to be adopted by mid-1977) will not take hold as long as there aren't any double-sourced interface chips on the market.

. . . on to the wristwatch scope?

With LSI technology advancing and power consumption decreasing, "wristwatch" instruments are almost conceivable. Almost, because the industry is still groping for the best display.

A growing number of instrument makers is switching to liquid crystals. Without LCDs, a DMM like the Weston 6000 would not be able to run for six months on a set of batteries. The 6000's 3-1/2 digits and 3 IC chips consume no more than 10 mW. Liquid-crystal response time has reached 0.1 s and will hit 25 ms in the near future, predicts Austin Tom Kelly, operations manager at Weston, Newark, NJ. The "switching" will then no longer be perceived by the human eye.

Waiting in the wings are plasma



2. Hewlett-Packard's Logic State Analyzer can save much testing time by expressing computer instructions in human-language mnemonics.



3. Instruments that talk back, like this Wavetek 172 Waveform Source, would not be practical without μ Ps. Neither would the complex 172's front panel.

Building a microprocessor system? Here's a bus-compatible solution for your analog output.

You no longer need to assemble D/A converters, address decoders and interface logic to obtain analog output from your microprocessor-based systems. Burr-Brown has solved the problem completely—for most of today's popular microprocessors—with 32-pin DIP's that provide two analog output channels each and look like memory to your CPU.

For 8080A and 8008 type μ Ps you need our new MP10. And for 6800, 650X and 9002 types, our MP11. Both of these bus-compatible Analog Output Microperipherals are self-contained, requiring no external components for most systems. And since they're treated as memory by the CPU, just one 8-bit memory location is required per channel, and a single instruction is all you need to output data to both channels.

For analog input applications, you can combine one channel of an MP10 or MP11 with a few external components and use the microprocessor to perform the logic of a successive approximation A/D converter. The second channel continues to function as an analog output. Both the MP10 and MP11 provide $\pm 10V$ outputs

with 8-bit resolution and throughput accuracy better than $\pm 0.4\%$ of full scale range. With a price of just \$99 (100's), it just doesn't make sense to design your own analog I/O solutions. Send for details today.

Write or call C.R. Teeple, Burr-Brown, International Airport Industrial Park, Tucson, Arizona 85734. Telephone (602) 294-1431.

BURR-BROWN
BB

*Specialists in
microcomputer I/O.*



displays, such as the Owens-Illinois Digivue. HP's Dr. Rehtin expects them to be much more rugged than CRTs, and thus preferable for mobile equipment. The PLATO (programmed logic for automated teaching operations) system at the University of Illinois is providing the first field test for plasma displays. Some may get on the market in 1977.

LEDs still corner the digital instrument market, even with their voracious appetite for power. Another LED shortcoming: what good is a portable DMM to a telephone linesman if he can't read the meter after sunrise? Studies indicate that liquid crystals should overtake LEDs around 1982.

In oscilloscope and computer-terminal applications, CRTs will dom-

inate for years to come. Bandwidths of 3 to 4 GHz are a reality now and still improving, according to Howard Vollum, co-founder and chairman of the board of Tektronix. Because of the CRT's inherent speed, there is nothing on the horizon to challenge its lead as a fast-display device. And you will see more storage scopes, Vollum predicts, because they can maintain an image without refreshing.

The 'bit-hams' are coming!

As if the evolution of test equipment were not exciting enough, there's a revolution brewing in the tea leaves that often casts its shadow over chats with industry's gurus. The home-computer craze is sweeping the country, and, not sur-

prisingly, thousands of engineers are embracing the new hobby.

How will this computer revolution affect test equipment? Just as radio amateurs accelerated the growth of communications technology, engineers will carry the new hobby experience to their jobs. In the laboratories of engineering schools, improvised digital circuitry is much in evidence. The ease of improvising digital interfaces for existing instruments will no doubt emphasize economy, and may spell an end to some superfluous bells and whistles.

But don't hold your breath—and equipment purchases—while you await instrument utopia. Mature technologies seem to hang on forever. *Tubes* are still going into original equipment. ■■

FORECAST '77

Minicomputers are banding together to replace central processors

Minicomputers are becoming less expensive and more powerful so quickly that groups of them are being combined into powerful networks.

Standards for intercomputer communications are being developed, and agreement between the computer makers and common carriers is near.

The trend is toward distributed processing, where a group of minis takes over processing functions originally handled by one powerful processor.

Central processors and memories are getting cheaper because high-performance ICs, particularly 4-k memory chips are being filtered into more products. And, more powerful software-controlling minicomputer operation is being developed to support the hardware.

Performing functions with mini-

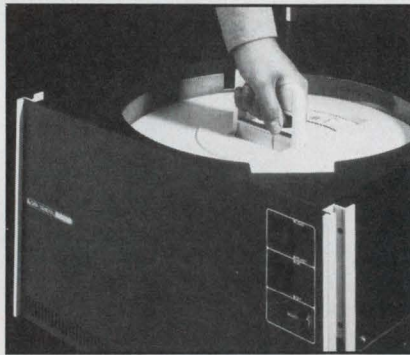

1. A disc drive series costs 20% less than those previously sold by Data General. The series consists of four models, numbered 6045 through 6048, which store 10, 20, 30 and 40 Mbytes, respectively.

computer hardware is becoming much less expensive. "Prices of minicomputers are declining at a 30% annual rate, while throughput—a measure of how fast the computer processes data—goes up 50% per year," observes Bob Brannon, product manager of Hewlett-Packard's Data-System Division.



2. A small—for the company—processor, dubbed the Series/1 Model 5, has been introduced recently, along with another model, by IBM. They come with minimal software support. IBM expects to develop their own.

Two years ago, a typical 16-bit minicomputer system with 128 kbytes of semiconductor memory and 20 to 50 Mbytes of disc storage cost \$100,000. Now, its price ranges from \$35,000 to \$60,000.

Richard Clayton, vice president of computer-systems development at Digital Equipment Corp., May-

Michael Shunfenthal
Associate Editor

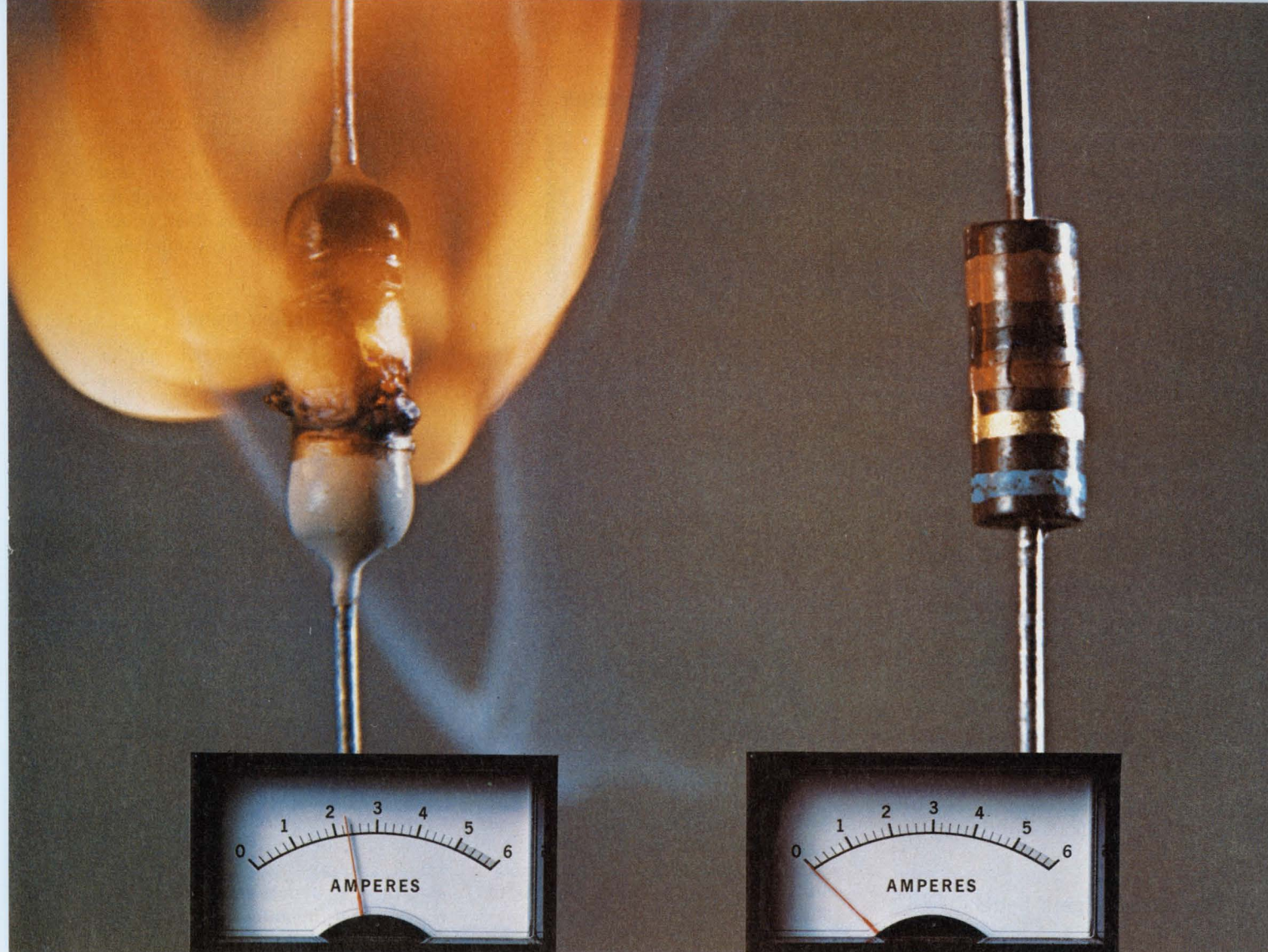

The failure. A 16 W overload causes this 1/2 W carbon film resistor to burst into flame. The initial failure mode is a short circuit, causing even more current to be drawn as shown on the meter.

The successful failure. The TRW 1 W rated BW-20F (1/2 W size) stays cool and fuses quickly and safely under identical power surge conditions. The failure mode, as shown, is an open circuit.

A failure your circuit can live with.

Failsafe, Fusible, Wirewounds Offer Built-In Circuit Protection.

Cool wirewounds like our BW failsafe series have a dual personality.

They provide stable resistance to normal operating current. But at specific overloads, they open circuit like a good fuse. So, as shown above, they'll protect your circuit from excess heat and fire in places where severe fault conditions are encountered.

The BW failsafe series, UL listed per Document 492.2, can save cost by eliminating the need for both resistor

and fuse. Save space, too, because they're about half the size of standard 1 and 2 W devices.

Depending on your specific circuit parameters, other TRW film and wirewound resistors can be engineered to meet your requirements.

For more information on resistors your circuit can live with, contact TRW/IRC Resistors, an Electronic Components Division of TRW, Inc., 401 N. Broad St., Phila., Pa. 19108. Tel. 215-922-8900. Telex: 710-670-2286.

TRW IRC RESISTORS
ANOTHER PRODUCT OF A COMPANY CALLED TRW
CIRCLE NUMBER 30

nard, MA, agrees that minicomputers are getting less expensive rather quickly: "The overriding trend in reduced minicomputer cost is decreases in memory, due primarily to the 4-k RAM chip replacing the 1-k chip."

For instance, a 16-kbyte MOS memory board from Data General with built-in bit-error checking and correction, cost \$5400 in 1974. A 64-kbyte board with the same specifications costs \$8000 in 1976. That's a reduction from \$3.50 per kbyte to \$1.25 per kbyte in two years, or about 35% per year. "It is likely that minicomputer memories will come down to \$0.50 per kbyte in the near future," Brannon adds.

Peripherals are costing less, as well. "Economies of scale have allowed minicomputer manufacturers to make peripherals cheaper," says John Scanlon, marketing manager for Data General's large minicomputers. "We are manufacturing our own disc drives, instead of buying them from Diablo and reselling them." Data General which used to charge \$12,500 for 10-Mbyte drives now sells its own for \$10,000.

The software gets better

Besides the more powerful hardware—and because of it—the mini makers are developing more sophisticated software.

A multiprogramming, advanced operating system (AOS) from Data General enables the company's minis to control multiple time-sharing, batch and real-time operations simultaneously. Until recently this sophisticated control has been available only on larger computers.

Another powerful software tool hitherto available only on large computers is finding use on minicomputers; data-base management. Where separate files might contain different information on a single subject, a data base holds all information relating to the subject in one file. Since separate files might be stored in different forms on different computers, recalling all of them at one time for review and change would be impossible.

The software is quite complex, because it must combat unauthorized access to the data file. Parts of the file can be read and altered, but the more sensitive information

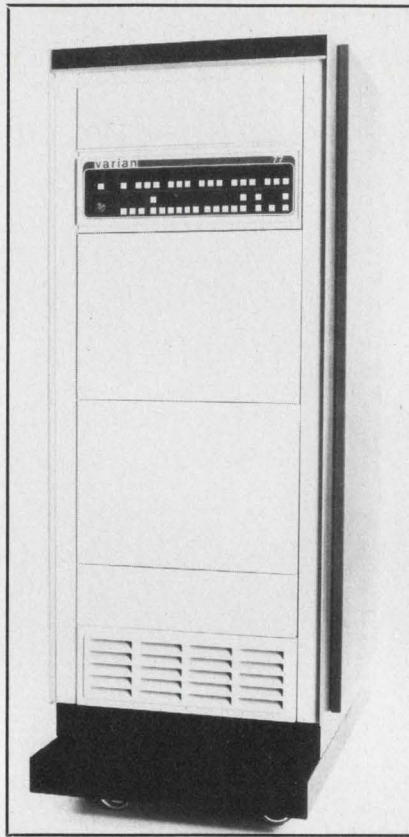

3. The V77-600 is the top of Varian's latest line of minicomputers. It has features originally introduced on large computers, such as user micro-programmability, and a cache-memory. It also uses memory mapping to address one-million 16-bit words.

can be assessed only by entering a security code.

Because the software is so complex, it requires a large computer throughput and memory, which, according to Brannon, "only recently increased to the point where HP and others could offer a data-base management system."

Some minis are actually credited with performance equal to the larger computers. But how can even these powerful minicomputers take over the workload of, say, an IBM 370/158 with time-shared terminals?

With a 32-bit word length and a direct-addressing capacity of 16 Mbytes, Interdata's Model 8/32 mini can perform a floating-point-multiply instruction in 3 μ s, which the manufacturer claims is comparable to the IBM model.

However, approaching the performance of large computers is only a minor reason for the mini's increasing popularity. Distributed processing is the main reason.

Nevertheless, distributed processing is only the first wave of minipower. Soon, several minicomputers will be able to talk to each other in networks. Computer makers and the common carriers are working on standards for easier data transfer from computer to computer.

A packet switching trend

"The trend is toward packet switching, a new common carrier service—from Telemet—the only company offering it now—and possibly Ma Bell," says Art Lynch of Data General. "When one computer wants to send data over a dedicated wire to another, it digitally makes the connection through the network. The cost of transferring data is based only on the amount transferred in that packet."

Today one may use a dedicated network and be billed on a per-mile-per month basis, regardless of how much data are transferred. Or, one can pay monthly charges for a switched network—and take 10 to 15 seconds for a connection.

Moreover, current computers must make connections using the same communications protocols: software instructions establishing the connection and controlling the message transfer.

These protocols are no small consideration for minicomputer manufacturers, because, so far, there has been very little standardization. So the American National Standards Institute is using IBM's SDLC (synchronous data-link control), the first level of protocol that establishes the physical link, or dialog, between sender and receiver computers, as a model for standardization. A universally accepted version, called ADCCP (advanced data-communication-control procedure), is in the works.

Once the connection has been made, another protocol level handles the messages in the packet. This level resides in a computer's operating system. The ANSI is working on a standard protocol (called X25) for this level.

The minicomputer makers are unveiling a series of even more powerful software and hardware that will transfer data continuously between distributed processors, rather than exchange data only on demand. ■■

Introducing push-button microprocessor system debugging.

HP's 1611A Logic State Analyzer ... Dedicated to all 8080 or 6800 based systems.*

View program flow in mnemonics. With CRT data and addresses selectable in either hexadecimal or octal formats and external lines in 1's and 0's.

Maintain testing control. LED indicators show status at all times. You can monitor system operation at normal speed or stop the microprocessor and give control to the 1611A for single or multiple keyed steps.

Enter data quickly and easily. The hexadecimal keyboard makes trigger and qualifier data entry as easy as operating a calculator. And the CRT display gives you a quick visual check on your entries.



Choose your display. Either mnemonic or absolute (op codes). Roll the display to view any 16-line slice of the 64-byte memory.

Pinpoint virtually any specific event. Trigger on address, data, or external signals... or on any combination of the three. You can also qualify the trigger by bracketing the address and opting to trigger on the nth occurrence of the trigger word. TRIGGER ENABLE and DISABLE keys act as arm and disarm circuits providing unparalleled pinpointing flexibility.

Move the display window. Delay up to 65,472 qualified clocks or memory transactions from the trigger word. Or, pre-trigger to see up to 63 bytes leading up to the trigger word (negative time).

Obtain program and timing data. Qualify the display with TRACE TRIGGER and see only those bytes that match your trigger inputs... all write instructions, for example. Press COUNT TRIGGERS and the 1611A displays the number of trigger occurrences between the TRIGGER ENABLE and TRIGGER DISABLE entries. Push TIME INTERVAL and you get a display of actual elapsed time between selected points in your program on your hardware.

The 1611A should be on hand when you start up your microprocessor-based system. Imagine the time you'll save with push-button operation and an unparalleled view of your system's operation; viewing things dynamically that you never could see before. And there's more... self test; trigger outputs to drive external equipment; error messages to warn of improper operation or setup; and the choice of two initial "μP personality modules" that let you tailor the 1611A to either 8080 or 6800 based systems.



Let HP's 1611A, priced at \$5,000** help you speed development, production-line testing or service. Ask your local HP field engineer for all the details. Ask him about HP's digital seminars too. He can tell you when one will be held in your area and how you can attend.

*and more modules for other microprocessors to come. **Domestic U.S.A. price only.

HEWLETT  PACKARD

Sales and service from 172 offices in 65 countries.

1507 Page Mill Road, Palo Alto, California 94304
For assistance call: Washington (301) 948-6370 Chicago (312) 677-0400
Atlanta (404) 434-4000 Los Angeles (213) 877-1282

CIRCLE NUMBER 31

Managing the data domain.

Digital is still the way to go for consumer-electronics products

Digital technology will continue its inroads into consumer equipment in 1977. A major trend will be the use of digital phase-locked-loop (PLL) frequency synthesizers for channel selection in both CB transceivers and TV tuners. But their use will demand higher design standards to satisfy the FCC's spurious-response requirements.

Digitally controlled varactor tuning systems for TV will compete strongly with the PLL systems.

Digital count-down circuits will eliminate a TV picture's vertical and horizontal-hold controls. Moreover, these circuits will make it easier to extract information, such as for color control, from the vertical-retrace interval.

The use of I²L will grow in many different products, including TV sets, CB sets, and electronic watches and clocks.

Liquid-crystal displays will make a comeback in watches and clocks because of recent improvements in their reliability.

Solar cells will be incorporated into such items as calculators, watches and electric razors to trickle-charge their batteries.

Digital watch chips will have increasingly complex timing functions, but the big breakthroughs will occur in built-in personal data storage and in communications-oriented watch systems.

PLLs take over, but with problems

The CB industry has unanimously shifted to PLL-frequency synthesizers for the new 40-channel sets slated to go on sale January 1. But getting the PLL's type-accepted will be difficult.

"When you use digital synthesizers, the subdivision of the main



Video discs and video-disc players are in pilot production at this RCA facility in Indianapolis. Philips has announced that its version of video players and discs will be marketed in 1977.

oscillator produces spurious signals all over the place," says Frank Cooperich, senior engineer on type acceptance at the FCC's testing laboratory in Laurel, MD. Although the levels are lower than those of the crystal-type synthesizers and the digital synthesizers' spurious responses are not concentrated in the power frequency, there's more work for us and the manufacturer in measuring them."

Other new features are being designed into CB sets. For example, the CB-300 4-channel transceiver from Tennelec Corp., Oak Ridge, TN, features a dedicated microcontroller chip that provides scanning functions.

The problem with CB scanning has been that with so much traffic on the channels, the scanner would stop at one channel and stay there. But this problem has been solved with the incorporation of three scanning modes into the CB-300's Channel Finder.

In one mode the Channel Finder

dwells on each channel for about three seconds and allows the user to listen for friends or a topic of interest.

In another mode the set can selectively scan open channels, and stop on low-level distant signals. In a third mode, the scanner can be set to stop strong local signals alone.

In TV, it's PLL vs varactor tuning

Digital PLL tuning has been predicted for the last two years, but some IC manufacturers are now confident that it will finally arrive sometime in 1977—despite a trend to the less expensive varactor tuning systems.

"I think we'll finally see digital phase-lock tuning reach high production this coming year," says Stephen Field, marketing manager of consumer systems for National Semiconductor, Sunnyvale, CA. "We have several custom programs that have been going on, and we have new standard products to be

Total Low-Power Schottky From Raytheon 25LS/9LS/54LS/74LS

Raytheon offers the full performance range of low-power Schottky devices: The new military standard 9LS, the high-performance 25LS, the old military standard 54LS and the industrial/commercial standard 74LS.

Raytheon specifies the more stringent JAN 38510 AC load measurements, as well as the standard 15pF and 2K ohms load. The AC parameters for both loads are specified across the full operating temperature range. Raytheon has compiled the most comprehensive specifications available in the industry. See for yourself that Raytheon standard products will meet or exceed your most demanding requirements.

Development Plan

	NOW	1977	TOTAL
GATES	29	0	29
FLIP-FLOPS	9	0	9
MSI	41	31	72
TOTAL	79	31	110

Raytheon is one of the largest suppliers of both flat packs and dual-in-line ceramic packages to the military market. We

have 79 types available now, including the hard-to-get 160 and 190 series of 4-bit counters, with 31 new products in development.

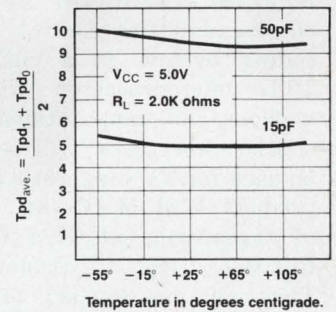
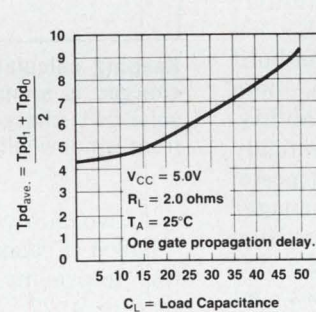

For your own full digital product catalog, contact your local distributor or Raytheon Company, Semiconductor Division, Dept. LS, 350 Ellis Street, Mountain View, California 94042, (415) 968-9211.

Low-Power Schottky Families

Parameter	Old Military Standard 54LS	New Military Standard 9LS	High-Performance 25LS
I_{OL}	4mA ($V_{OL(MAX)} = 0.4V$)	4mA ($V_{OL(MAX)} = 0.4V$)	8mA ($V_{OL(MAX)} = 0.45V$)
I_{OSL}	15mA-100mA	15mA-100mA	15mA-100mA
t_{PLH}	20nS Max.	10nS Max.	10nS Max.
t_{PHL}	20nS Max.	10nS Max.	10nS Max.
Fanout	11	11	22



SEMICONDUCTOR DIVISION

CIRCLE NUMBER 32

announced in 1977.

"You'll also see from us, and others, new partitioning and combining of circuits in TV ICs to make things more digital. For example, with the properly designed count-down circuit, you can eliminate vertical and horizontal hold controls and have the set remain in sync." Field observes, adding: "If the vertical and horizontal information is decoded digitally, then line 19's vertical-interval-reference signal, which carries color information from the station, can be extracted with little extra cost."

A petition is up before the FCC for a rule to have line 21 transmit captions for the deaf—which is further reason for digital decoding of the TV signal, Field points out.

Only General Electric uses the line-19 signal for automatic chroma and tint control. GE's decoding system is a custom-built TTL microprocessor with both memory and computational ability.

Microprocessors will eventually be used for TV diagnostic purposes, predicts Will M. Quinn, manager of engineering at GE's Television Business Dept., Lynchburg, VA. They can monitor key biases and currents and present them on a screen readout of a separate display.

"The μP may also be used for doing part of the decoding work that you associate with such features as remote control, muting, and volume control, and thus reduce the number of discrete components in the systems," Quinn observes.

Currently, the trend in the TV industry is to the use of the varactor type tuner. But the varactor system is thermally sensitive, Quinn points out, and careful temperature compensation is required.

And because it is voltage-operated, the varactor system is also sensitive to voltage changes in the power supply. For all these reasons the PLL will make the optimum system, Quinn believes. But when depends largely on when the cost of the ICs for such a system is sufficiently reduced.

Digital technology in the form of an electrically alterable ROM (EAROM) is found in General Instrument's Omega remote-control TV tuning system. It is a four-chip, varactor-type system. Three

of the chips include a control circuit that accepts either a keyboard or a remote control input, a display circuit that presents the channel number on the screen, an a/d/a CMOS circuit that converts the output of the selected channel signal to coarse and fine-tuning signals.

The fourth chip is the EAROM that stores all channel and fine-tuning information permanently.

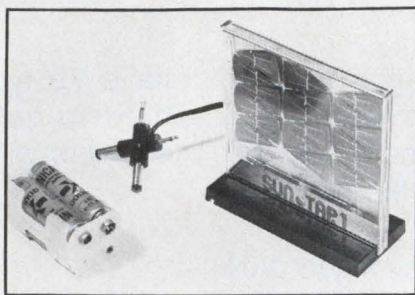

Keeping calculator or radio batteries charged is simple with this Sun Tap solar-cell charger. It operates best from window-sill exposure to the sun.

A two-chip version of the Omega—called Economega—will find its way into many of the lower-priced sets in 1977. All the control and display are built into one chip, while the other chip still contains the EAROM for tuning information.

LCDs make a comeback

Liquid crystals for digital-watch displays sport a black eye because the display seals have been unreliable. Crystals have also been known to fade when the watch is set in a sunny location. But now these problems are substantially diminished, says Murray Siegel, director of special products and systems at Intersil, who predicts that in 1977 the liquid-crystal displays (LCDs) will reappear to take over a good portion of the watch market for two important reasons. First, projected life of the latest LCDs is three years or better. And second, with LED watches getting slimmer, there is less room for battery capacity, hence reduced battery life for the LED units.

Innovative time-keeping functions will continue to appear in all classes of electronic watches. For example, a six-function, four-digit alphanumeric watch chip from

Intersil, Cupertino, CA, can be used with LCDs. Intersil's ICM-721A reads out hours, minutes, day, date, month and seconds, and has a "perpetual" calendar that requires resetting only once every four years.

Another watch module developed recently by Hughes Aircraft Company's Solid State Products Division, Newport Beach, CA, has a six-digit LCD display. Its feature is the ability to function as a stopwatch that is accurate to 0.01 s. The hours, minutes and seconds, as well as the month and date are also featured.

But LED units will appear within the next year or two, not only with new features, such as flick switches that turn the LEDs on, but also as entirely new products, says John Bergey, president of Pulsar Time Computer.

One class of new products he foresees is a personal information retrieval system worn on the wrist—this feature represents an extended development of the Pulsar calculator-watch.

Another group of products is communications-oriented personal devices—for example, a Dick Tracy wristwatch receiver or transceiver. Small consumer pocket pagers are already available, Bergey points out.

A third group will be physiological monitoring devices.

"I think you'll see genuine products evolve in those fields," predicts Bergey, "because the technology for such developments in both digital I²L and linear circuitry is now available."

Charging batteries a problem

The problem of keeping batteries charged in portable items like calculators and radios will be solved, to some extent, by designing solar cells into the unit or by using small solar-cell charger panels.

For example, the Royal Solar I marketed by Royal Typewriter Co., Hartford, CT, is an eight-digit calculator with a liquid crystal display. It contains 46 small solar cells. The cells produce an output in either artificial light or sunlight.

The solar-cell panel by Sun Tap, Arlington Heights, IL, can charge the four AA nickel-cadmium batteries in the pack (see photo). In full sunlight the unit produces 6 V

TYPICAL "SWAP" ADVANTAGES

Up to 100
SSI's and MSI's



Savings to the customer of 50% or more in IC direct material costs

Significant reduction in IC's required per system... one SWAP circuit replaces 5 to 100 standard devices

Reduced manufacturing costs per customer system... fewer IC insertions... simplified system check-out and repair

Small physical size

into

one SWAP chip

Less Expensive PC boards and hardware

Improved reliability

Smaller and less expensive system power supplies

Reduced inventory control, procurement activity, and simplified documentation

Fully compatible with DTL, TTL, and CMOS IC's and discrete transistors

for maximum cost savings!

SWAP-- Custom-Designed Logic Systems Now Available at Mass Production Prices!

Wouldn't you like your own custom LSI chip that can consolidate up to 50 or 100 of the standard SSI's and MSI's you are using into one circuit? Well, now it's yours with "SWAP" - Stewart-Warner Array Programming - and it will save you lots of money, too!

SWAP is a major *price breakthrough* in custom logic circuits. Forget about the usual custom-chip penalties, the large tooling costs, the huge entry fees, and the gigantic production order requirements. For as low as \$1800 you can have delivery of your first custom I²L SWAP prototypes in

just 4 weeks, and you will also cut your gate prices by as much as 50% on production orders.

SWAP is ready if you are. Send the coupon now for your SWAP Design Kit (or the "bingo card" for a brochure).

- The SWAP Design Kit consists of:
1. the SWAP Design Manual (complete with vellum work sheets);
 2. fifteen (15) sample devices illustrating some of the functional blocks that can be used in a SWAP design.

Okay, here's my \$25.00 (or P.O. No. _____) Rush me your I²L SWAP Design Kit.

I need more information, Please have a representative call me.

Tell me about your standard DTL, TTL, and CMOS circuits. (We have products now.)

SYMBOL OF EXCELLENCE **SW** STEWART-WARNER MICROCIRCUITS DIVISION
STEWART-WARNER CORPORATION
730 E. Evelyn Ave. • Sunnyvale, Ca. 94086 • (408) 245-9200

Name _____

Company _____

Phone _____

Address _____

City _____ State _____ Zip _____

CIRCLE NUMBER 33

at 50 to 60 mA.

Other solar-powered units now on the market include watches and an electric razor, with other consumer designs currently under development.

TV games growing fast

Home TV games are on the verge of becoming as popular as CB sets, with two basic types being developed. One is the lower-cost, dedicated chip set that provides fairly simple paddle games like ping pong and tennis. Representative suppliers of such chip sets are General Instrument and National.

The other type includes the more expensive programmable games developed around microprocessors. These are currently being refined by such suppliers as Fairchild, whose F-8 μ P has led the way, by RCA with its 1802 CPU programmer and by National with an 8080. These games will use preprogrammed ROM cartridges.

TV-game producers surveyed point out several new developments to look for in 1977. Keyboards and touch plates will replace potentiometers and joy sticks.

New background and object generators will provide substantially more variation in the playing field of the dedicated-chip games. For instance, Magnavox has already added player images to its new Odyssey 500 game. And color effects will be used much more substantially than in 1976.

The μ P-controlled games will tend to be more educationally oriented and will have a substantial library of games that can be



Hockey, tennis and handball with paddle-size adjustments controlled by the players are featured in the Adversary home-TV game by National Semiconductor. When used with a color TV, game formats appear in different colors. Adversary is one of many dedicated-chip games now in millions of homes.

chosen simply by purchasing the right ROM cartridge. Interaction with the players will be a key feature.

Personal computers' new look

The third generation of personal computers will appear in 1977 as neatly packaged machines, without switches or lights on the front panel. They will talk to the user and require no skills other than the ability to write a check out to purchase them.

A forerunner of these developments for the nonkit builder and nonsoftware-oriented users is the 8080-based SOL microcomputer by Processor Technology, Emeryville, CA. The SOL comes in a walnut-trimmed cabinet and looks like a typewriter. It uses an ASCII keyboard designed for the system. Unlike previous microcomputers,

whose front panels are cluttered with bit switches and LEDs, the SOL's front panel is blank except for a switch to turn it on.

A 10 by 16-in. main PB board is inside the cabinet. Everything the microcomputer needs is plugged into the board: video-display module, RAMs, ROMs, cassette interface, I/O ports, and other functional modules.

SOL can function as a stand-alone computer, with Basic language residing in one of the ROMs. Its output is fed to a regular TV. Up to 1000 characters can be presented on a TV screen with the video-display module. The computer can also be used as a terminal.

With the proper program, the computer can simply be turned on to talk to the user in Basic. It both requests and gives instructions through the TV screen. ■■

FORECAST '77

Analog-to-digital switch is on in military, civilian communications

The move to digital data communications will accelerate in 1977 in both the civilian and military sectors.

John F. Mason
Associate Editor

"There'll be a transition period from analog to digital, of course," says Major General Gerd S. Grombacher, commander of the U.S. Army Communications Command, Fort Huachuca, AZ. "We can't just throw the analog systems out the

window. We'll go through a long period of hybrids until we eventually cleanse the inventory of analog systems."

The upsurge in data traffic, both commercial and military, calls for a variety of equipment: d/a

The Contortionist.



A 5 volt, 50 amp, 250 watt switching power supply that will fit into places never before possible.

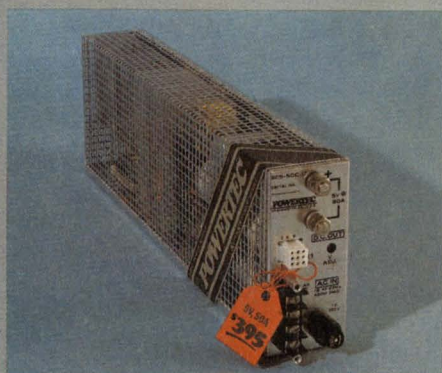

You asked for it . . . Powertec's new 9E SuperSwitcher™ in the package configuration most requested by power supply users.

An ultra low-profile switching regulated power supply with size, shape and power to meet modern requirements of computers, office equipment, and miniaturized instrumentation.

A true contortionist, the 9E stands thin in a rack . . . just 5" high, 2 1/4" wide, 15" long, and a weight of under 6 pounds. It flattens out alongside, above, below, or behind . . . mounts vertically, horizontally, or crosswise. A perfect fit for CRT display terminals (dumb or smart), CPU's, mini/microcomputers, printers, and card files.

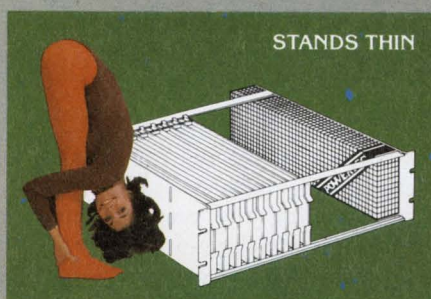

STANDS THIN



LIES FLAT

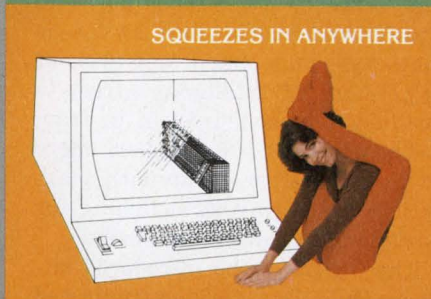

SQUEEZES IN ANYWHERE

Ideal for test and burn-in equipment because of low energy consumption. Perfect, too, for the office or lab environment. Thanks to its convection-cooled, 40-kHz operation, there is absolute zero noise to annoy personnel or interfere with "quiet zones." The 40-kHz switching rate helps make the 9E the most densely packaged off-the-shelf switching power supply available. Over 80% operating efficiency produces a remarkable 1.4 watts/inch³!

There's more, too. A.C. input is 115/230V with a +10/-20% line tolerance. This, coupled with a 20msec voltage carryover, allows smooth, continuous functioning even under abnormal line conditions. Five proprietary features* guard against operating conditions that can shut down or possibly destroy other switchers. And there are all the standard features you could ever want, such as OVP, over current and temperature protection, remote sense, voltage programming and logic inhibit.

Priced at \$395 (lower for OEM's), the 9E fits tight budgets as well as tight places. So phone or write for complete 9E specs and delivery schedules.

*Patent Pending

Powertec, Inc.

9168 DeSoto Avenue, Chatsworth, CA 91311
(213) 882-0004 • TWX 910-494-2092

POWERTEC

and a/d converters, message concentrators, message control, switching systems, storage and modems.

Not all these components will be needed permanently. For example, message switching will soon become obsolete. And concentrators are gradually being replaced by front-end switching equipment—specialized computers for control functions in data communications.

The Army wants a digital telephone with an a/d converter right in the hand set. For the battlefield, it wants small, easily portable facsimile terminals and small manpack satellite terminals with whip antennas.

"We also want higher bit rates," adds General Grombacher. "We've had a problem in Europe where the long-haul systems can't keep up with the logistics traffic. We've been operating at 2400 bauds going into the world-wide Autodin communication system. But that's not fast enough. Last year, we attempted to update one of our circuits to 4800 bauds but the switches couldn't handle it, so we dropped back to 3600 or 3800, which really isn't fast enough."

The Army is responsible for developing a new family of digital radios and switching equipment for the Defense Communications System. Like the Tactical Satellite System, DCS will use Time Division Multiple Access technology.

Other military trends:

- High frequency radio is on the way out—satellite communications is on the way in.

- Troposcatter and microwave transmission will eventually be run out by the earth-orbiting stations.

- All communications are becoming secure.

The next revolution in telephony

Three important developments in the telecommunications field are taking place simultaneously, notes Dr. Lee Davenport, president of GT&E Laboratories, Inc., Stanford, CT:

- The conversion to large-scale integrated circuits is accelerating.

- The move to digital communications is picking up momentum.

- Optical technology, now under development, is "the next revolution in telephony."

The telephone companies are well

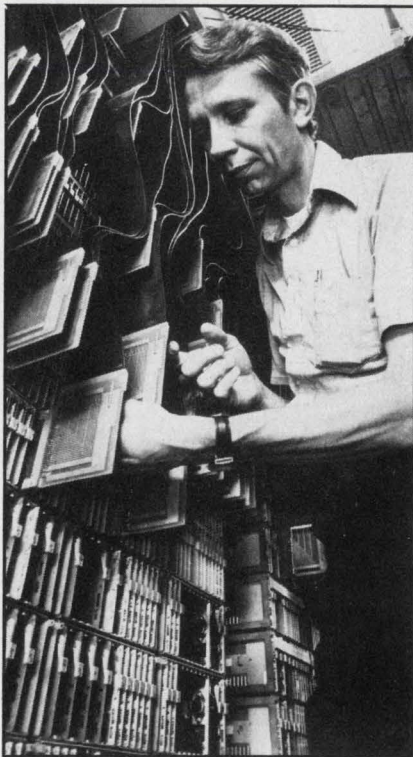

Technician inserts circuit packs in the 1A stored-program control unit of Bell Telephone's 4 ESS for long-distance calls. The hanging cables are connected to test equipment.

on their way to solving one of their most pressing problems: automatically switching the growing number of local and long-distance telephone calls. The answer is a family of "super switchers," built with the most advanced ICs and LSI technology, microcomputers and sophisticated logic.

GT&E has developed and partially installed three of these switches. The 1EAX (electronic automatic exchange) is a stored program-controlled system for large local and tandem exchanges that serve two-wire and four-wire transit exchanges. This switch is the single most important element in GT&E's \$1/2-billion contract to install a telephone system in Iran.

The 2EAX is a smaller, more advanced system, built with magnetically latched reed switching for intermediate capacity exchanges.

The 3EAX, to be introduced later in 1977, is a very sophisticated toll switch that will be used as an interface for digital traffic between a local telephone company and the long-distance system. The switch employs digital technology for large 4-wire transit exchanges

serving up to 60,000 trunk terminations.

Bell Telephone's equivalents are, respectively, the 1 ESS, which is designed for large local offices in metropolitan areas (there are close to 700 installed); the 2 ESS, and the updated 2B ESS, for use in suburban offices (300 are now operating); and the 4 ESS, the world's highest-capacity system for switching long distance calls. Recently installed in Chicago, Kansas City, Jacksonville, and Atlanta, 20 of them will be operating by the end of 1978.

The 4 ESS can route up to 550,000 calls an hour, or four times as many as the most advanced electromechanical toll-switching equipment ever used by the Bell System. Its heart is the 1A processor, a new stored-program control unit with advanced integrated circuitry and an improved magnetic core memory. The 1A processor executes call-processing instructions four to eight times faster than earlier electronic switching systems.

The 4 ESS uses time-division switching instead of the traditional space-division technique. Words and data are transmitted in digital pulses that travel separately along a common switching path, with a time interval between each pulse of millionths of a second. Switching is accomplished by shifting a call's time position on the path.

An entirely new signaling concept in the 4 ESS—called Common Channel Interoffice Signaling (CCIS)—will also appear in future processor-controlled switching systems. Normally, the information needed to establish the connection for a call is carried on the same circuit as the call itself. With CCIS, that information will travel over a separate data link, and significantly increase signal-transmission speed and the amount of call information that can be carried between two switching machines.

Today, it usually takes about 10 seconds to establish a long-distance call. But as CCIS systems are installed nationwide, that time will be cut to about two seconds.

The 4 ESS is capable of diagnosing developing problems in its own circuitry and then switching to alternate equipment before a customer becomes aware that a

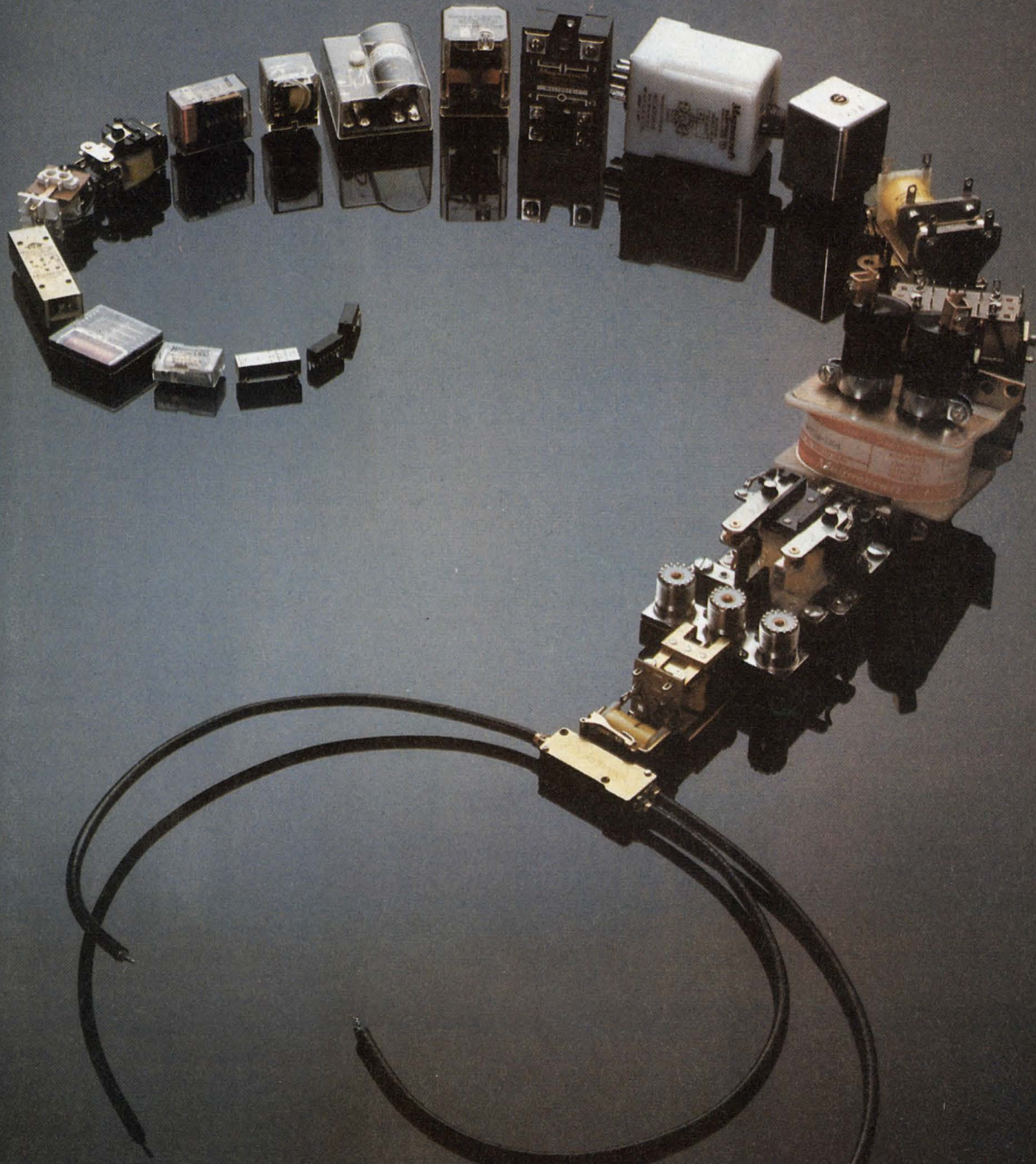

**Buying relays needn't be
a monstrous undertaking.**

**With 1200 stock relays,
we're the only name
you need to know.**

Magnecraft[®]
ELECTRIC COMPANY 5575 NORTH LYNCH AVENUE ● CHICAGO, ILLINOIS 60630 ● 312-282-5500
WRITE FOR OUR STOCK CATALOG NO. 277

problem exists.

The 4 ESS requires only 62% of the electrical power needed to run previous systems handling the same volume of traffic. And it requires only 9000 square feet of floor space, much less than the 36,000 required by comparable machines.

Smaller and faster

The main feature in the new 2B ESS is a new processor that's one-fifth the size, but with twice the capacity of its predecessor in the 2 ESS. The modified switch handles 38,000 busy-hour calls—twice as many as the 2 ESS. The processor in the 2B ESS is smaller than its predecessor because it's built with ICs rather than with the individual transistors, resistors and other components used in the 2 ESS processor.

The 2B has twice the call-processing capacity of the 2 ESS because its processor operates almost 2-1/2 times faster than the 2 ESS processor. Why? The information can be taken out of the memories more quickly. And the logic circuits in the processor's central-control units can interpret the information faster.

The memories in the 2 ESS are permanent-magnet twister modules and ferrite sheets. The 2B's memory incorporates insulated-gate FET ICs, which allow a 65,536-word memory to fit in a unit $10 \times 26 \times 12$ in. The comparable 2 ESS memory fills two such equipment frames.

Bell looks ahead

Currently less than 1% of Bell's telephones and PBX systems are electronic. But by the mid-1980s, Bell predicts, electronics will dominate both key telephone and PBX systems and allow the equipment to be programmed to suit the individual business. Data and voice will be integrated to a higher degree in business-communications systems. Moreover, the business customer will have greater control over the usage, hence the cost, of telecommunications—through minicomputers, for instance, which will automatically select the most economical calling method.

Voice-storage capabilities in

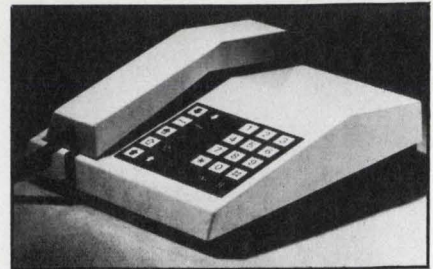

Electronic automatic exchanges, like the intermediate-capacity 2EAX (left), work with "the most advanced subscriber equipment that exists today," the ATEA 8000 touch-tone telephone. Both are built by GT&E.

ESS central offices will provide answer, record, playback and message-forwarding services without additional equipment on the customer's premises.

"The most advanced subscriber equipment that exists today," GTE's Dr. Davenport says, "is the company's ATEA 8000 touch-tone telephone. Built with MOS, LSI, and ICs, the instrument switches digitally and uses four multiplexed wires for its six key sets instead of the conventional 52." (Key sets are the lighted buttons at the bottom of the instrument face to switch lines.)

Communications by light

GT&E's first optical cable network will be set up in the Los Angeles area, with an initial capacity of 24 channels. One of its optical fibers—with the thickness of a human hair—will carry roughly 1500 one-way telephone calls. A second fiber will carry the voices back.

Bell Laboratories has a light-wave communications experiment under way in its Western Electric facility in Atlanta. The company hopes the tests will prepare the way for widespread use by telephone companies—beginning with links between telephone-switching centers—by the early 1980s.

The most promising method, Bell officials say, is pulsed (digital) transmission of signals on light pulses through cables containing lightguide fibers.

Each lightguide is connected at one end to a transmitter module that contains a solid-state laser light source. The other end of the lightguide is connected to a receiver module that contains a tiny

photodetector device. The device converts light pulses to electrical signals compatible with those transmitted within the nationwide Bell System network.

Though only a half-inch in diameter, the cable contains 144 lightguides and can carry the equivalent of nearly 50,000 telephone calls.

The laser source will probably be a new semiconductor, made of gallium arsenide antimonide, which emits light at the infrared wavelength of about 1 micrometer—just where fiber lightguides transmit light most efficiently.

Until recently, the only semiconductor laser close to practicality has been the GaAs laser that emits at wavelengths between 0.8 and 0.9 micrometers. A longer wavelength—one in the vicinity of 1 micrometer—is expected to produce a much lower signal loss and less distortion, which will permit fibers nearly twice as long to be used between light-generating repeaters.

Progress on the new laser is promising. Gallium arsenide antimonide lasers built to date have lasted 21 hours. This is encouraging, Bell scientists say, because GaAs lasers, which last over two years, lasted only a few minutes in their first laboratory version.

The problems with fiber optics, which may be remedied this year, according to an industry spokesman, is the lack of standardized components needed for this technology. Using the nonstandardized LEDs, connectors and photodetectors wreaks havoc on design. All of these components are in a fairly chaotic state in terms of predictable efficiencies in frequency, response and sensitivity. ■■

NATIONAL ANTHEM



A Review of New Products and Literature from

National Semiconductor • No. 5, Oct. 1976

Bi-FET™ Line-Up Continues to Grow

By this time we hope you know about our proprietary process that lets us marry JFET and bipolar technologies on a single, monolithic chip. We call this technique Bi-FET™ technology,

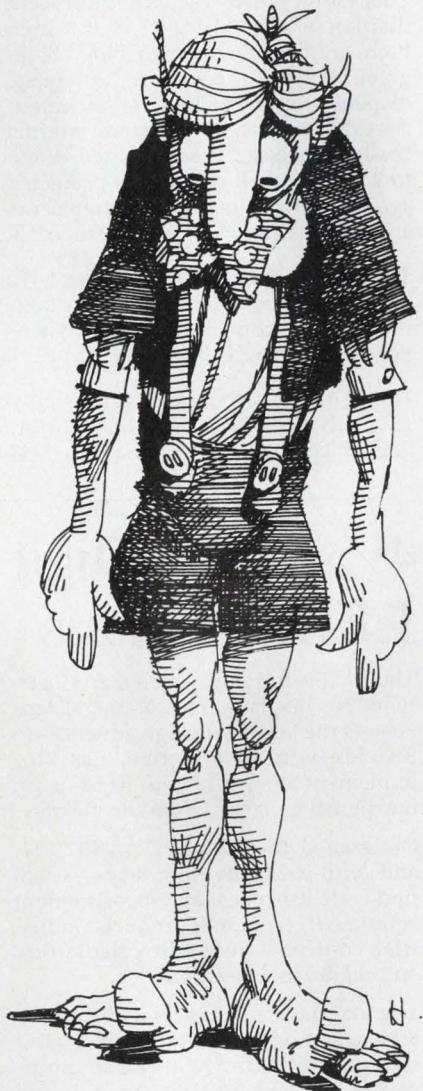

and to date each circuit built with this technology has set new standards of performance for the industry to match.

In fact, we introduced the industry's first Bi-FET products, our LF156 op amp series, almost a year ago. The available specs on these parts— I_B , I_{OS} , V_{OS} , V_{OS} drift, slew rate, and settling time—make the 156 series about the most advanced op amps in the world. And if you've heard otherwise, we'd like to

New Keyboard for SC/MP Kit Replaces Teletype™

National's new Keyboard Kit now gives SC/MP Kit users a low-cost input/output capability. The Keyboard and SC/MP Kits together form an inexpensive learning and development tool for anyone without access to a Teletype™ machine. The new kit replaces the Teletype previously required by the SC/MP Kit, yet still allows you to evaluate the SC/MP CPU and to develop a variety of application software.

The heart of the Keyboard Kit is a 512-byte ROM firmware package called SCMPKB, which replaces the 'Kit Bug' ROM supplied with the SC/MP Kit. SCMPKB lets you use the hex keyboard display to execute programs, examine or modify the contents of memory and the SC/MP registers, and monitor program performance.

The Keyboard Kit comes complete with a manual, all required ICs and

resistors, a keyboard cable-connector assembly, pre-cut wires, and wire-wrap connectors; we even supply a hand-held wire-wrap tool.

The SC/MP PC card already has a hole pattern for additional ICs. Simple instructions in the Keyboard Kit manual tell you how to add the extra circuits to the SC/MP card, replace the 'Kit Bug' ROM with the new SCMPKB ROM, and connect the preassembled keyboard cable-connector to the card. With these steps done, you're ready to go.

The Keyboard Kit is another step in the tradition of simple, cost-effective solutions to your microprocessor needs. For Keyboard Kit specifics, call your local National distributor and ask for information on the ISP-8K/400. 

Bi-FET™ n-Channel Analog Switches

Our new family of analog switches combines n-channel JFETs and bipolar transistors on a single chip for the first time—a technique made possible by our Bi-FET™ technology. And the switches built this way provide the industry's only low ON-resistance, high-speed, monolithic, n-channel, JFET analog switches.

The new switches are ideal for A/D and D/A converters, data acquisition, signal multiplexers, sample-and-holds, video switchers, and so on.

At 25°C, the Series AM181 switches (for -55° to +125°C operation) feature a 30-Ω maximum ON-resistance,

matched to 2 Ω (typical); this resistance is constant for signals to ±10 V. Switching times are 105-ns turn-on/95-ns turn-off (typ.) for a break-before-make action. Isolation and cross-talk are down 60 dB (typ.)

Four versions of Series AM181 switches are available: dual driver, SPST; dual driver, DPST; single driver, SPST; and dual driver, SPDT. Series AM181 switches are pin-for-pin, spec-for-spec compatible with the Siliconix Series DG181 hybrid parts.

The Series AM281 switches—dual driver, SPDT—are intended for operation between -20° and +85°C, and have slightly relaxed specifications. 

point out that National does indeed supply a plastic minidip version; just ask about our LF356N—it's been around for several months now.

We've also got the LF13741 op amp, which replaces the 741 wherever you need extremely-low input current; the LF13331 family of analog switches, which has no latch-up or static blow-out problems; the LF352 instrumentation amplifier, which combines low

input-current demand and excellent linearity; and the new LF198/398 sample-and-holds with short acquisition times, high accuracies, and low droop rates.

Of course, more Bi-FET parts are on their way. But we suggest that you find out what the unique specs of our already available Bi-FET parts can do for you now. We're sure you'll be pleasantly surprised. 

Programmer, Frequency Synthesizers for CB Use

National announces a new family of phase-locked-loop circuits for 40-channel frequency synthesizer applications in CB transceivers.

The MM55104, MM55114, MM55106, and MM55116 are for use in single- or double-I.F. systems, and operate from a single power supply (either +5 V or +8 V, depending on the type number). Each circuit contains a reference oscillator, an oscillator divider chain (10-kHz or 5-kHz outputs), a binary-input programmable divider for channel selection, and a phase detector. A 5.12-MHz or 10.24-MHz crystal determines the reference frequency.

The MM55104/114 provide a 2ⁿ-1 division of the input frequency, while the MM55106/116 provide a 2ⁿ-1 division. These latter two synthesizers also have 5.12-MHz outputs, which may be tripled for use as a reference oscillator frequency in two-crystal systems.

Division of the input frequency is controlled by standard binary signals, which may be set up by mechanical switches or by an external electronic programmer.

National has such a programmer. It's called the MM57150, and it generates the binary codes necessary to control 40-channel PLL synthesizers. Our space here precludes a full description of the host of features available on the MM57150, so we'll simply list a number of its more important ones:

- Initial power-up on Channel 19
- Direct, calculator-style keyboard entry of channel number is available.
- Two-speed, up/down slewing
- Direct access to Channel 9, the emergency channel, via a single contact closure
- Programmable memory bank for scanning up to ten channels in any sequence of your choosing
- Rollover on Channels 1 and 40 (i.e., . . . 38, 39, 40, 1, 2, 3 . . .)
- Scan rate of four channels/second
- Two-channel, alternating channel capability via a single push button
- Automatic monitoring of a preselected channel for 0.25 second every 10-15 seconds while active on another channel; squelch/lock capability on the monitored channel
- Adjustable squelch
- Illegal channel entry prohibited
- Transmit key locks programmer on channel (scanning stops) 

Super Savings on Super-Strong TO-126 Types

We now second-source fifty of the most popular types of TO-126 packaged power transistors. Our TO-126 products are encapsulated in National's tough Epoxy B—so strong that you'll strip the 4-40 screw mountings before you'll damage the package.

Added to our TO-126's toughness is a large cost savings. National can save you 25 percent, typically, over the competition's pricing.

We're stocking our distributors' shelves right now. And in November our distributors will advise their customers, by mail, of the new TO-126 types from National. If you're not already on such a list, call your local National distributor now to make sure you get the information on these hot new ones from National Semiconductor Corp. 

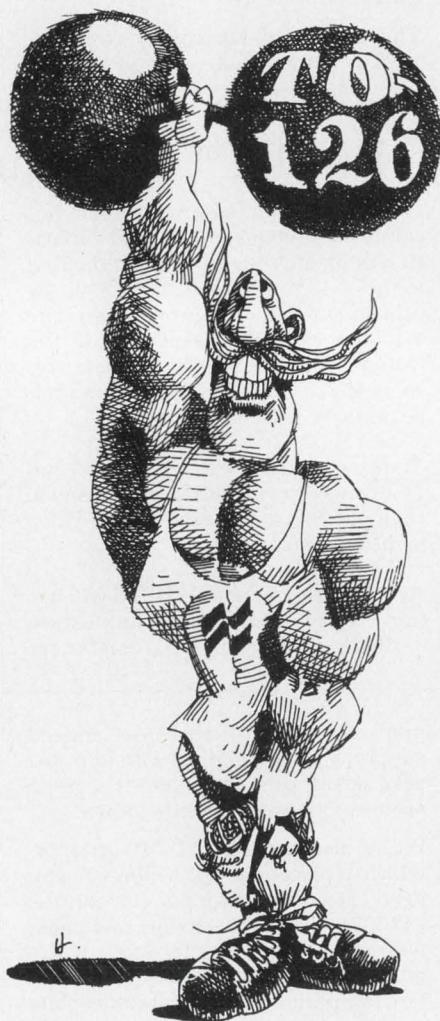

Clock Module Designed for Instrumentation, Automotive Uses

The MA1003 is a self-contained time-keeping module for a host of 12-Vdc applications; just add switches and a lens, and it's ready-to-go in bench and battery-powered instruments, CB base stations, aircraft/marine/auto clocks, and so on.

The bright, green, vacuum fluorescent display of the MA1003 is 0.3-inch high, and is filterable to blue, blue-green, green, and yellow; automatic display-brightness logic is included. Accurate timekeeping, via an internal crystal timebase, is maintained down to 9 Vdc, and all circuitry is protected against automotive supply transients and reversals.

Timesetting controls operate at a 1-Hz rate with no rollover; to prevent tampering, timesetting is locked out whenever the display is blanked.

The MA1003 PC board measures only 1.75 x 3.05-inches overall; a 6-pin, built-in connector is optional. 

4 1/2- and 5-Digit LED Displays

The 5900-series of 0.5-inch GaAsP LED reflective displays from National represents the latest in design advances to provide you an effective, easy-to-implement answer to your need for an inexpensive, large, numeric display.

Designated the NSB 5917, NSB 5921, and NSB 5922, the new displays will find wide use in test and measurement equipment, consumer products, industrial controls, desk-top calculators, and digital instruments.

The displays offer versatility, with both common-anode (NSB 5922) and common-cathode (NSB 5921) multiplexed versions available for five full digits, and an optional direct-drive overflow/polarity indication with four digits in a common-anode multiplexed format (NSB 5917). Electrical connection is by PCB-type terminals on the edges of the display.

The optical design of this series assures a distinct, easy-to-read display with a wide viewing angle (120° total), and excellent on-off contrast and segment-to-segment uniformity. 

APPLICATIONS CORNER

High Performance, Low Power Memories from Inexpensive Parts

You can use standard, inexpensive, bipolar PROMS to build high-performance memories of low power dissipation. The secret is to power-down the chip when it is not being accessed.

The technique illustrated here results in a power savings beyond that possible with bipolar PROMS having on-chip power-down, and the cost is much less than that of CMOS PROMS of the same capacity. In fact, because the access time of the circuit shown here is less than 80 ns, the power savings can be greater than 10 to 1 if the circuit is cycled every microsecond. Longer cycle times, or decoding of the power switching to multiple packages, yields even more impressive ratios.

National's PROMS are well behaved in this application. With power removed, our Tri-State® parts revert quickly to their third state (a high-impedance open). Because there are no clamp diodes from the outputs to V_{CC} , the powered-down device presents only leakage to the output bus.

Note that in a CMOS system, passive pull-ups are desirable to establish the CMOS input level at V_{CC} when the PROM is powered down. If the CMOS input is more than a threshold away from both supply rails, the input stage of the

CMOS device may draw supply current, which will increase system power dissipation. Here it is desirable to clock the PROM outputs directly into a CMOS holding register to reduce the time that the PROM must be powered up. Also, the pnp core driver pass elements can be driven directly by an MM74C42 1-of-10 decoder output without pull-up or current limiting resistors, with some increase in effective access time.

The MM74C42 would replace the 74LS04 shown here.

In any system that switches a device's supply lead to conserve power, the power supply bypassing must be performed on the supply side of the power switch; that is, at the pnp emitter. Any capacitance at the collector of the pnp will increase both system power dissipation and access time. ■

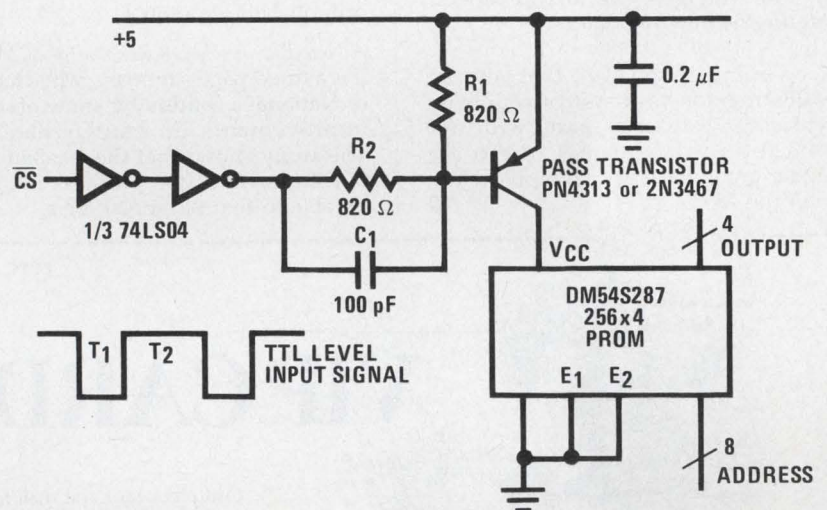

True RMS-to-DC Converter

Our LH0091 will compute the rms value of virtually any combination of ac or dc input signals from dc to 2 MHz. At frequencies below 70 kHz the accuracy is 0.05 percent; the crest factor rating is 10.

The LH0091 is thus ideal for DVMS, DMMS, for measuring audio and noise signals (or both in combination), for vibration and harmonic analysis, etc.

An extra, uncommitted, internal op amp is available, which you can use as a summing amplifier, to buffer the input or the output, to adjust the gain, or whatever.

The LH0091 also is available as the LH0091CD for commercial temperature range uses, and as the LH0091D for the military range—all at prices you cannot walk away from. ■

16,384-Bit Si-Gate n-Channel ROM

National's MM5246 static read-only memory is organized in a 2048-word x 8-bit format. It uses n-channel enhancement and depletion mode silicon-gate technology, which, boiled down, means that it's DTL/TTL-compatible and needs only a single, +5.0-V supply.

Very useful in microprogramming, control logic, and table look-up applications, and in random-logic synthesis, the MM5246 provides expandable memory through its three programmable Chip Select inputs, which control its Tri-State® outputs. The MM5246 has a maximum access time of 450 ns, and is fully decoded.

And look for still another 16k ROM that will soon be coming along. Designated the MM5247, it's organized 4kx4; all other specifications are identical to the MM5246. ■

National Announces Oxide-Isolated RAMs

The DM93415/DM93415A (open-collector) and the DM93425/DM93425A (Tri-State®) are 1024-word x 1-bit random-access, read/write memories—the first of our family of oxide-isolated, bipolar memory products.

Designed for buffer control storage and high-performance main memory applications, the DM93415/425 offer maximum access times of 70 ns, while the suffix 'A' versions offer a 45-ns access.

Other features include full on-chip decoding, separate Data In and Data Out lines, and an active LOW Chip Select and Write Enable. Fully DTL/TTL-compatible, the DM93415/415A/425/425A have a 16-mA drive capability, and dissipate 0.5 mW/bit. ■

7900-Series Regulators from National

National Semiconductor now second-sources the popular 7900-Series three-terminal voltage regulators. In particular, we now offer the 7900MK/MH/CK/CH/CT and the 79M00CP.

Since each of these parts is available in nine voltages, we are, in effect, offering 54 new regulators.

Keep in mind, however, that you can easily upgrade your system simply by replacing 7900-series parts with our LM320-series regulators; these are higher grade parts spec'd more tightly than the 7900s.

New CMOS Guides Now Available

National's new four-page *CMOS Status/Cross Reference Guide* is a concise, handy guide to 90 CD4000-series and 70 MM74C-series parts. Each part is briefly described functionally, and its production status and 38510 status at National are noted; RCA, Motorola, Fairchild, Harris, and SSS equivalent designations are listed. The guide ends with a tabulation of complete ordering information.

A New Era in CMOS Reliability—CMOS II is a three-page summary, with charts, of National's continuing study of, and improvements in, CMOS reliability. The study shows that the reliability of our improved CMOS products is comparable to that of bipolar logic.

Saturating-Output Display Drivers

We have introduced a series of saturating-output display drivers to interface MOS calculator chips with common-cathode LED displays. The series consists of the DS8871 (an 8-digit driver), the DS8872 (9-digit), the DS8873 (9-digit, with low-battery indicator), and the DS8977 (7-digit, with low-battery indicator).

You can operate these drivers in calculator systems with a supply voltage range of 4.5 V to 9.0 V. In a 9-V system you can use the low-battery feature of the DS8873 and DS8977 to turn on the decimal point of the digit '9' when the supply voltage falls below 6.5 V. This alerts the user that the battery should be replaced, even though the calculator will still function for awhile yet.

Each driver can sink 40 mA, and is designed for multiplexed operation. The saturating-output feature permits operation with power supply voltages lower than possible in Darlington-type output display drivers, and also results in lower power dissipation in the LED driver; standby power consumption is zero. Input and output pins are located to make wiring easy.

The new series is functionally and pin-for-pin equivalent to our DS8855, DS8864, DS8865, and DS8866 family of LED display drivers.

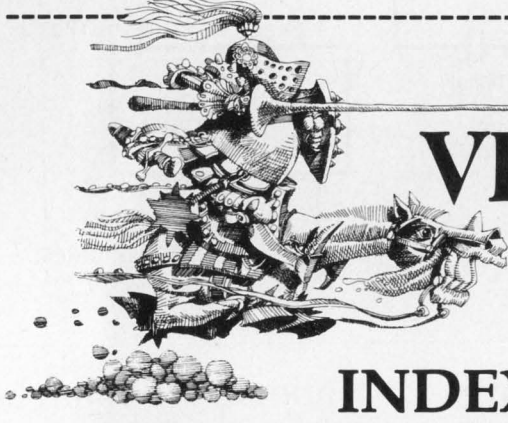

ED14

VIP CARD

Complete card and mail to
NATIONAL SEMICONDUCTOR
 Attn: Marketing Services
 2900 Semiconductor Drive
 Santa Clara, CA 95051

INDEX

Please send me the information that I have checked:

- | | |
|---|---|
| <input type="checkbox"/> Bi-FET Line-Up, Pg. A, Col. 1 | <input type="checkbox"/> 4½/5-Digit Displays, Pg. B, Col. 3 |
| <input type="checkbox"/> SC/MP Keyboard Kit, Pg. A, Col. 2 | <input type="checkbox"/> RMS/dc Converter, Pg. C, Col. 1 |
| <input type="checkbox"/> AM181/AM281 Switches, Pg. A, Col. 2 | <input type="checkbox"/> MM5246 16-K ROM, Pg. C, Col. 2 |
| <input type="checkbox"/> CB Freq. Synthesizers, Pg. B, Col. 1 | <input type="checkbox"/> DM93415/425 RAMs, Pg. C, Col. 3 |
| <input type="checkbox"/> CB Channel Programmer, Pg. B, Col. 1 | <input type="checkbox"/> CMOS Status Guide, Pg. D, Col. 2 |
| <input type="checkbox"/> TO-126 Power Types, Pg. B, Col. 2 | <input type="checkbox"/> CMOS-II REL Guide, Pg. D, Col. 2 |
| <input type="checkbox"/> MA1003 Clock Module, Pg. B, Col. 3 | <input type="checkbox"/> LED Display Drivers, Pg. D, Col. 3 |

Please send me the literature that I have checked:

- | | |
|---|--|
| <input type="checkbox"/> AN-163 Mate SC/MP
w/Cassette Recorder | <input type="checkbox"/> AN-165 3½ Digit DVM
w/CMOS Interface |
| <input type="checkbox"/> AN-164 A Data Concentrator Using PACE | <input type="checkbox"/> AN-167 DM8678 Bipolar Character Gen. |

Your End Product or Application: _____

Have Salesman Call YES NO

Please print clearly; this information will be used for our mailing list.

NAME _____ TITLE _____

COMPANY _____

ADDRESS _____

CITY _____ STATE _____ ZIP _____



Dialight Switches

A switch for all reasons.

Reason 1: Dialight offers three switch configurations to meet all your needs—*snap-action switches with silver contacts* for moderate-level applications, *snap-action switches*

with gold contacts for intermediate-level applications, and *wiping-action switches with gold contacts* for low-level applications. Each of these ranges is served by two switching actions—momentary (life: 750,000 operations) and alternate (life: 250,000 operations).

Reason 2: Dialight's snap-action and wiping-action switches come in a new modular design concept . . . a common switch body for either high or low current operation. All 554 series switches and matching indicators have the same rear-panel projection dimensions.

The snap-action switching mechanism guarantees a fast closing and opening rate. This insures that contact force and contact resistance

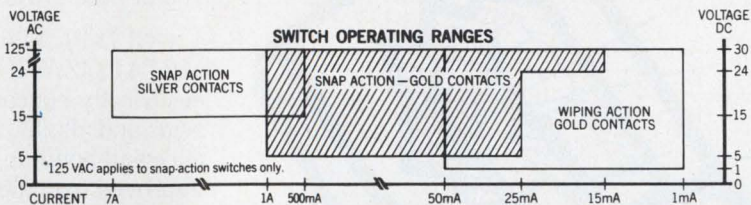

Reason 3: Dialight offers a wide variety of panel and snap-in bezel mounting switches with momentary and alternate action configurations in SPDT and DPDT

types. There are over 240 switch variations to choose from.

The 554 illuminated switch, designed for front of panel lamp replacement, gives you a choice of five different bezel sizes . . . $\frac{3}{4}$ " x 1", $\frac{5}{8}$ " x $\frac{3}{4}$ ", $\frac{3}{4}$ " square, $\frac{5}{8}$ " square, and $\frac{1}{2}$ " square. The first four sizes are also available with barriers. You also get a choice of six cap colors . . . white, blue, amber, red, green, and light yellow . . . four different underlying filter colors . . . red, green, amber, and blue and a variety of engraved or hot-stamped legends . . . over 300 cap styles . . . over 100,000 combinations.

There is also a variety of terminal connections . . . solder blade, quick connect, and for PC board insertions.

Reason 4: Dialight's 554 series is designed as a *low cost switch with computer-grade quality.*

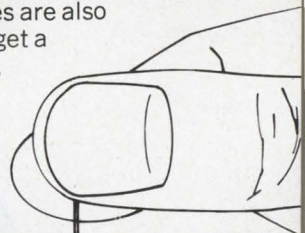
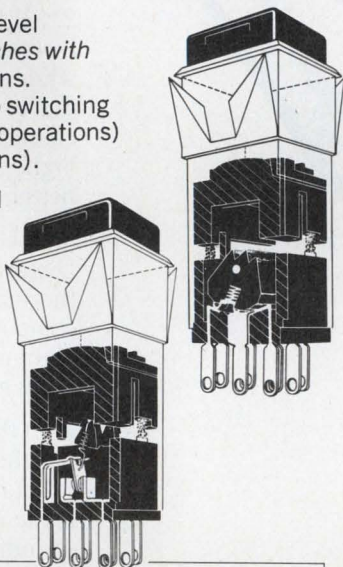

\$1.65 EACH

P/N 554 - 1121
(1K PRICING)

See Dialight

PRODUCT SELECTOR GUIDE						
SWITCHING ACTIONS	Snap-Silver contacts		Snap-Gold contacts		Wiping-Gold contacts	
	SPDT	DPDT	SPDT	DPDT	SPDT	DPDT
MOMENTARY	○	○	○	○	○	○
ALTERNATE	○	○	○	○	○	○
OPTIONS						
	PUSH BUTTON CAP SIZES					
	$\frac{1}{2}$ " Sq.	$\frac{5}{8}$ " Sq.	$\frac{5}{8}$ " x $\frac{3}{4}$ "	$\frac{3}{4}$ " Sq.	$\frac{3}{4}$ " x 1"	
BEZEL MOUNTING TO ACCOMMODATE	○	○	○	○	○	
BEZEL MOUNTING WITH BARRIERS TO ACCOMMODATE		○	○	○	○	
PANEL MOUNTING TO ACCOMMODATE	○	○	○	○	○	
MATCHING INDICATORS	○	○	○	○	○	

are independent of the switch's actuation speed.

In the wiping-action switch, the contacts are under constant pressure (A unique Dialight design). This insures long life with a minimum build-up of contact resistance.

Both switch types are tease-proof.

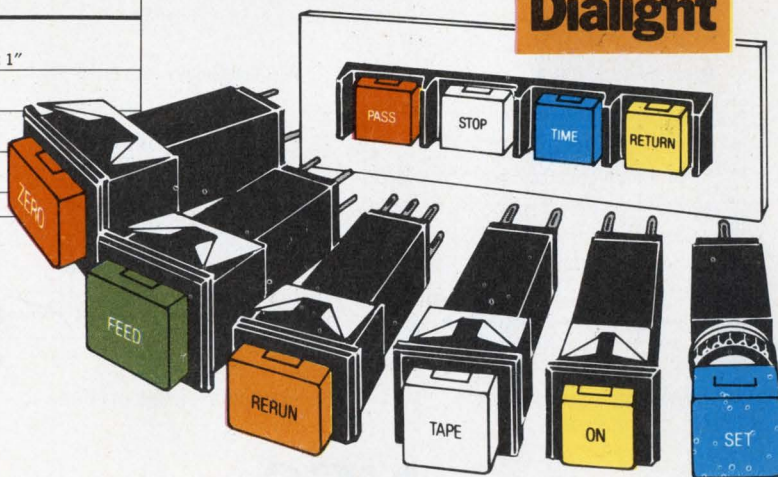

DIALIGHT

A North American Philips Company
203 Harrison Place, Brooklyn, N.Y. 11237
(212) 497-7600

PLASTICS BETTER THAN HERMETICS?

See for yourself.

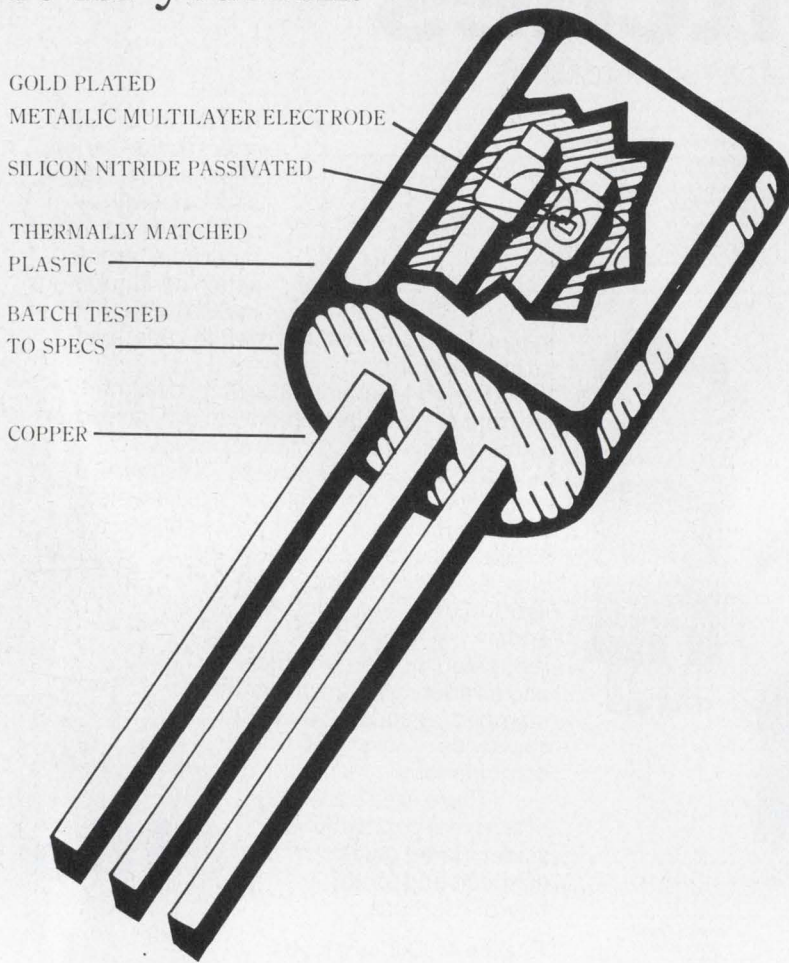

GOLD PLATED
METALLIC MULTILAYER ELECTRODE
SILICON NITRIDE PASSIVATED
THERMALLY MATCHED
PLASTIC
BATCH TESTED
TO SPECS
COPPER

○ High Reliability TO-92 Transistor (Pc MAX.=300 mW)
● TO-18 Metal Case Transistor (Pc MAX.=300 mW)
--x-- Conventional Mold Transistor (Pc MAX.=250 mW)

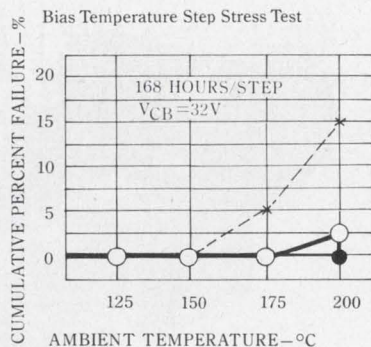
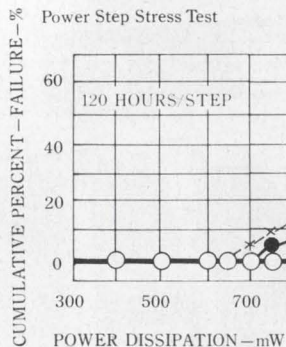

“Standard practice” can now change for the better — and cheaper. Up to now, industrial transistors have been specified in cans, to get reliability under heat and humidity. Consumer products have been able to tolerate the less expensive but less stable plastics. Now NEC has incorporated 5 technical advances that make these TO-92 plastics the equal of any hermetic metal case for most applications — and you get the lower price to boot!

- 1. GOLD-PLATED, MULTILAYER METALLIZATION.** Because gold is electrically noncorrosive and inert to acids and alkalis. And moisture resistance and bonding strength are greatly improved over aluminum construction.
- 2. SILICON NITRIDE PASSIVATION.** Increases moisture resistance, while protecting against unreliability due to impurities. And, the operating characteristics improve, such as higher dc amplification factor and better noise figure.
- 3. A UNIQUE PLASTIC MATERIAL.** Developed especially to match thermally the lead wires and other component parts. This minimizes or eliminates internal stress on the bonding wires.
- 4. COPPER LEAD WIRE.** Thermally matched to the plastic, copper also resists corrosion. A significant bonus is the much greater power dissipation stemming from copper's high heat conductivity.
- 5. RIGID QC.** Every production batch is thoroughly tested, and quality certification tests of the production process are run monthly. This stringent, continuous monitoring insures the best quality in the world, bar none.

THEY ADD UP TO SUPER SPECS. The two charts shown are only a sampling — NEC's 8-page brochure of TO-92 specifications is the real convincer. Write or call for your copy if you're seriously interested — our line of small-signal transistors for telecommunications, instrumentation, etc. is so broad we can provide almost any device you may require in TO-92. And if you're into hybrids, ask for data on our MINI MOLD transistors — plastics uniquely configured for reliability with big savings in assembly time and cost.

NEC America, Inc., Electron Devices Division, 3070 Lawrence Expressway, Santa Clara, CA 95051.
Tel: (408) 738-2180. TLX: 35-7475.

NEC
NEC America, Inc.

CIRCLE NUMBER 37

FIELD PROOF



For high reliability and economy, GTH QIKSTACK connectors are used in Honeywell's new Series 60, Level 6 minicomputer.

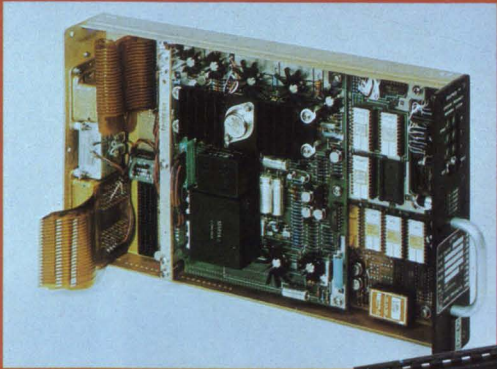
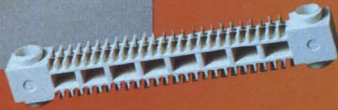

For design flexibility and reliability, GTH FLEXLOK connectors are used by Aero Products Division of Litton Industries in the DIGIPROX™ ground proximity warning system.



For closer packaging density and high reliability, the GTH chassis Co-Planar connectors are used in Quasar's remote control television.

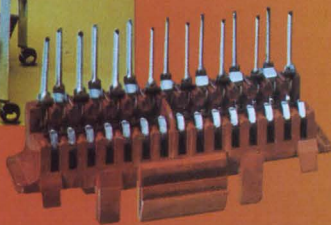

With Burndy GTH connectors, you enjoy the performance characteristics of gold — without suffering its high cost. If that's too hard to believe, just study the performance comparison chart.

The secret behind the amazing performance of GTH is the use of high pressure plastic deformation to achieve a gas-tight, corrosion-free contact, and a contact geometry that provides an ingenious mechanical interlock to insure good metal-to-metal contact despite vibration or thermal expansion.

Burndy GTH contacts not only eliminate the need for gold in the connector, they eliminate gold in the mating component as well. You save both ways — without sacrificing performance or reliability.

Here's

Burndy's exclusive GTH gas-tight, corrosion-free

High-pressure plastic deformation forms gas-tight, corrosion-free contact without the use of gold.



ADVANTAGES OF GTH CONNECTIONS

- **Low cost, high reliability:** Helps you cut interconnection costs up to 33% and more — without sacrificing reliability.
- **Interchangeability:** May be used with existing gold, tin or solder-plated components with no loss in reliability.
- **Design Flexibility:** Compact design for close packaging densities, simplified handling, installation and field serviceability.
- **Ease of Installation:** Requires no special tooling or operator training. Installs like any ordinary connector.

Unbelievable? Send for more proof. Write for documented GTH test data: Burndy Corporation, Norwalk, Connecticut 06856.

Burndy GTH connectors: Your golden opportunity to cut connector costs up to 33%.

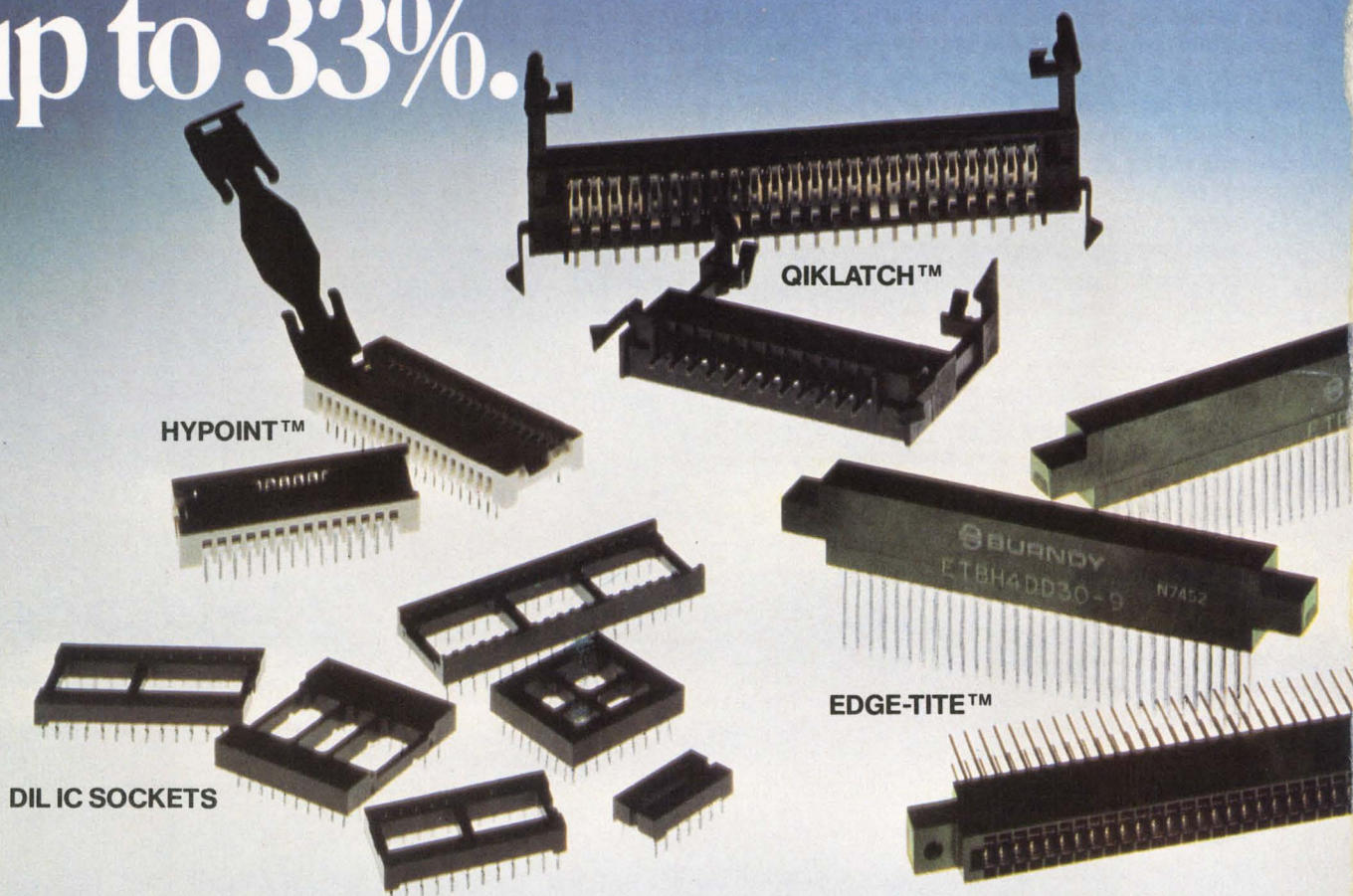

Burndy GTH connectors are available in all types of designs for all types of applications. All of them are currently being used to help control connector costs by some of the best known names in the electronics field. Names like Quasar Electronics, Litton Industries, Honeywell, National Semiconductor, Dictaphone, and Wang Laboratories, to name just a few. Write for more information on how GTH can help you keep your competitive edge. We'll send you data that's worth its weight in gold.

QIKLATCH™ zero-entry Mother/Daughter PC connectors in sizes from 8 through 24 positions on .156" centers.

EDGE-TITE™ PC connectors in sizes from 10 through 50 positions on .100" centers.

QIKSTACK™ feed-thru connector. Board-to-board spacing from .250" to .625". Up to 30 contact positions.

EDGE-ON™ board-to-board receptacle. Up to 15 positions on .100" centers.

DIL IC SOCKETS for leaded packages, in sizes from 8 through 42 positions.

LED CONNECTOR board-mounted PC receptacle in a wide range of sizes and viewing angles on .100" centers.

FLEXLOK™ connectors for flexible circuitry and flat conductors in sizes from 6 through 21 positions on .100" centers.

CO-PLANAR solderless-wrap chassis connector in 15 positions on .156" centers.

HYPOINT™ leadless IC receptacles in sizes from 24 through 48 positions.

© 1976 Burndy Corporation
Printed U.S.A.

 **BURNDY**
Norwalk, Connecticut 06856

proof!

concept insures high-pressure, contact without the use of gold.

See us at
NEPCON WEST '77
Booth No. 238

Spring force maintains contact pressure. Absorbs vibration, prevents fretting corrosion.

Unique contact geometry concentrates pressure at point of contact for gas-tightness.

Whisker-free tin-alloy plating.

Ordinary soft solder target rather than gold.

LABORATORY PROOF

TYPICAL CONTACT RESISTANCE VALUES (Milliohms)

After Environmental Test, at Dry Circuit Levels.
(Range of Values Within 99.9% Confidence Level)

Environmental Test	GTH Contacts	Conventional Geometry Contacts			
	Tin-Alloy Plate	15 Microinch Gold Flash	30 Microinch Gold Plate	50-100 Microinch Gold Plate	Tin or Tin-Alloy Plate
Initial	4.0 - 6.0	4.5 - 13.3	4.5 - 8.6	4.4 - 8.3	4.1 - 12.0
Thermal Shock	4.0 - 8.6	6.0 - 15.0	5.0 - 8.0	5.2 - 7.2	6.0 - 15.0
Humidity	4.5 - 7.0	10.1 - 31.8	5.0 - 9.0	4.9 - 8.8	5.3 - 75.1
Industrial Atmosphere	4.0 - 6.0	10.9 - 20.3	5.0 - 20.0	5.0 - 13.0	28.7 Open Circuit
Gas Tightness	4.0 - 6.5	Not Applicable	Not Applicable	Not Applicable	4.0 Open Circuit
Thermal Cycling	4.0 - 7.0	8.5 - 15.5	5.0 - 10	4.6 - 9.0	4.0 Open Circuit
Durability	4.0 - 5.5 100 cycles	10.1 - 12.2 100 cycles	5.0 - 9.0 100 cycles	5.3 - 9.3 500 cycles	13.9 - 57.9 100 cycles
Vibration	4.0 - 5.5 5-500-5 Hz	9.0 - 15.0 10-55-10 Hz	4.0 - 8.0 10-2000-10 Hz	5.3 - 9.3 10-2000-10 Hz	4.0 - 15.0 10-55-10 Hz

IMMUNITY TO FRETTING CORROSION

Relative Lifetimes Under Accelerated Fretting Conditions
Without Lubrication

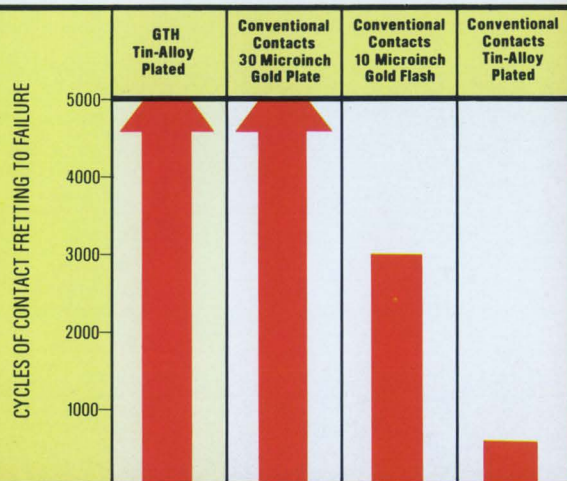

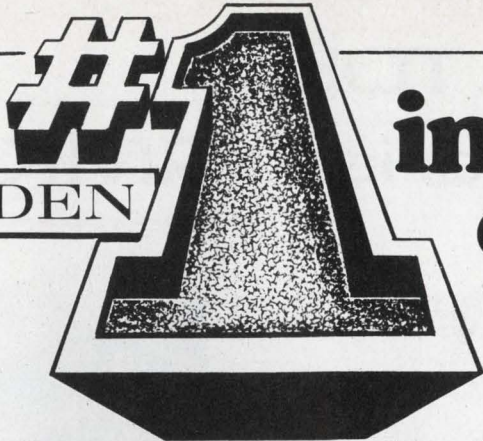

HAYDEN

in personal computing books!

See for yourself the reasons why:

- 1. MICROPROCESSORS: New Directions for Designers** by Edward A. Torrero, #5777-6, paper, 1975, 144 pp., 8½ x 11, illus., \$10.95.
- 2. GAME PLAYING WITH COMPUTERS** Rev. 2nd Ed., by Donald D. Spencer, #5103-4, cloth, 1976, 320 pp., 6 x 9, illus. \$16.95.
- 3. FUNDAMENTALS AND APPLICATIONS OF DIGITAL LOGIC CIRCUITS** by Sol Libes, #5505-6, paper, (\$6.95), #5506-4, cloth, (\$9.95), 1975, 192 pp., 6 x 9, illus.
- 4. COMPUTERS IN ACTION: How Computers Work** by Donald D. Spencer, #5861-6, paper, 1974, 160 pp., 6 x 9, illus., \$5.50.
- 5. COMPUTERS IN SOCIETY: The Wheres, Whys and Hows of Computer Use** by Donald D. Spencer, #5915-9, paper, (\$5.50), #5916-7, cloth, (\$7.50), 1974, 208 pp., 6 x 9, illus.
- 6. PROGRAMMING PROVERBS** by Henry F. Ledgard, #5522-6, paper, 1975, 144 pp., 6 x 9, illus, \$6.50.
- 7. PROGRAMMING PROVERBS FOR FORTRAN PROGRAMMERS** by Henry F. Ledgard, #5820-9, paper, 1975, 144 pp., 6 x 9, illus., \$6.50.
- 8. COBOL WITH STYLE: Programming Proverbs** by Louis J. Chmura, Jr., and Henry F. Ledgard, #5781-4, paper, 1976, 144 pp., 6 x 9, illus. \$5.45.
- 9. MINICOMPUTERS: Structure and Programming**, by T.G. Lewis and J.W. Doerr, #5642-7, cloth, 1976, 288 pp., 6 x 9, illus., \$12.95.
- 10. PATTERN RECOGNITION** by M. Bongard, #9165, cloth, 1970, 256 pp., 6 x 9 illus., \$14.90.
- 11. DIGITAL SIGNAL ANALYSIS** by Samuel D. Stearns, #5828-4, cloth, 1975, 288 pp., 6 x 9, illus., \$19.95.
- 12. BASIC BASIC: An Introduction to Computer Programming in BASIC LANGUAGE** by James S. Coan, #5872-1, paper, (\$7.95), #5873-X, cloth, (\$9.95), 1970, 256 pp., 6 x 9, illus.
- 13. ADVANCED BASIC: Applications and Problems**, by James S. Coan, #5856-X, cloth, (\$8.95), #5855-1, paper, (\$6.95), 1976, 192 pp., 6 x 9, illus.
- 14. FORTRAN FUNDAMENTALS: A Short Course** by Jack Steingraber, #5860-8, paper, 1975, 96 pp., 6 x 9, illus., \$4.95.
- 15. DIGITAL TROUBLESHOOTING: Practical Digital Theory and Troubleshooting Tips** by Richard E. Gasperini, #5708-3, paper, 1976, 180 pp., 8½ x 11, illus., \$9.95.
- 16. DIGITAL EXPERIMENTS** by Richard E. Gasperini, #5713-X, paper, 1976, 192 pp., 8½ x 11, illus., \$8.95.

Write for 15-day examination copies of any of these books!

At the end of 15 days, please remit payment plus postage and handling, or return the books and owe nothing. Prices subject to change without notice. If payment

accompanies order, we pay postage and handling. Outside USA, cash must accompany order — include \$2.00 per book for shipping and handling.



Hayden Book Company, Inc.

50 Essex Street, Rochelle Park, New Jersey 07662

phone: (201) 843-0550



from **KEPCO** by **TDK**

the series

RMK

25 KHz SWITCH-MODE POWER SUPPLIES

- 75% efficiency
- 90-130V a-c input (brownout protection)
- d-c input
- $\pm 10\%$ output adjustment
- adjustable current limit
- adjustable overvoltage
- logic level on-off
- 1 millisecond recovery
- $< 2\%$ envelope, (load, line and temperature)
- 50°C rating (uprating for lower temperature)

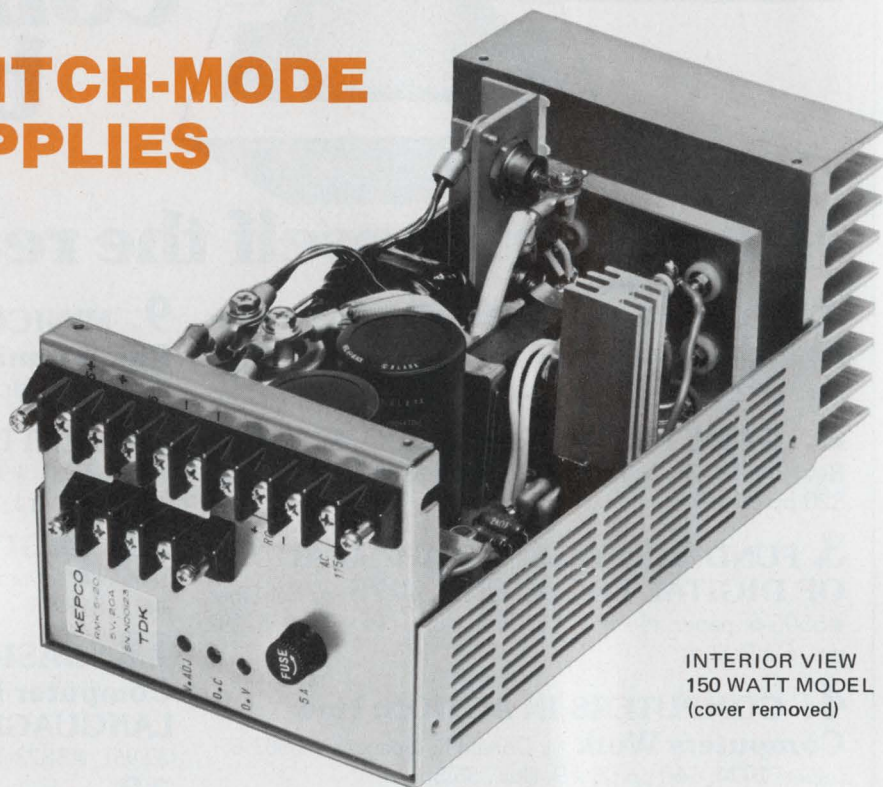

INTERIOR VIEW
150 WATT MODEL
(cover removed)

BLOCK DIAGRAM OF
THE RMK SWITCH-MODE
POWER SUPPLY

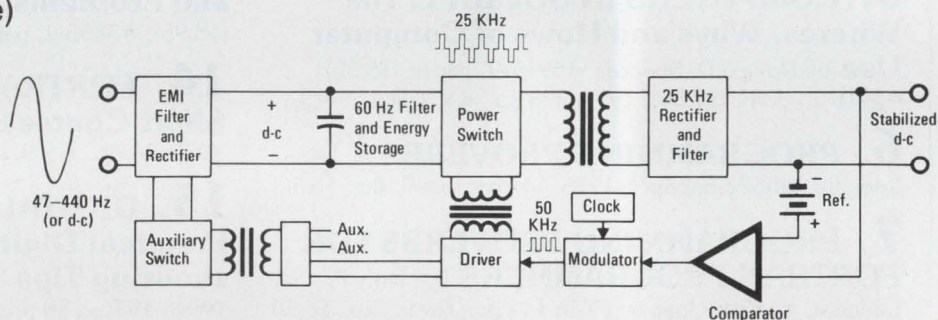

AVAILABLE OUTPUT
RATINGS FOR THE
KEPCO RMK MODELS

Volts	5V	9V	12V	15V	24V	SIZE	WGT.	PRICE
Amps	10A	6A	5A	4A	2A	2 3/16" x 5 1/8" x 7 1/2"	3.0 lbs.	\$210.00
Amps	20A	10A	8A	8A	4A	3 3/32" x 5 1/8" x 8 3/4"	4.75 lbs.	299.00
Amps	30A	16A	12A	12A	6A	4 1/16" x 5 1/8" x 8 3/4"	5.25 lbs.	399.00

CALL YOUR KEPCO REP FOR AN IMMEDIATE DEMONSTRATION
ask him to show you the clean layout, the cool operation,
the silent performance. Put an RMK to your test, check
the excellent stability, the low noise, the rapid response.
Compare Kepco's 5-year warranty.

Call or write Department FL-05
for a 4-page Specification Folder.

KEPCO®

Washington Report

DOD to decide cruise-missile future

The Navy's Tomahawk sea-launched cruise missile and the Air Force's Air Launched Cruise Missile (ACLM) are candidates for full-scale development and a major share of funds in the new federal budget to be presented January 17. The Pentagon's Defense Systems Acquisition Review Council is scheduled to meet January 6 to decide whether one or both missiles gets the go-ahead.

If, because of a tight budget, the choice is restricted to one cruise missile, the Tomahawk is believed to have the edge, with 14 consecutive successful flights through mid-December. The ACLM has recorded four successful flights this year, but also two crashes.

The Tomahawk is also believed to be more adaptable to all the roles being planned for cruise missiles: launch from B-52 bombers against strategic targets, launch from attack submarines and surface ships against enemy ships and shore targets, and a possible ground-based version for deployment in Europe to support NATO forces.

More than 2000 missiles will be procured under current defense plans, and all will use the McDonnell Douglas terrain contour-matching (Tarcom) guidance system.

NBS cutting back time/frequency service

The National Bureau of Standards will discontinue transmission February 1 on three of its six assigned short-wave frequencies. The economic cutbacks will affect the 2.5, 20 and 25-MHz time and frequency signals from WWV Fort Collins, CO, and the 20-MHz signal from WWVH on the Hawaiian island of Kauai.

Increasing energy costs, which have doubled the stations' electricity bill to more than \$100,000 a year, make the frequency cutback necessary, according to NBS officials. As a result of the move, power consumption is expected to be reduced 12%. Both stations will continue broadcasting at 5, 10 and 15 MHz, with unchanged power outputs of 10 kW, WWVH will also continue at 2.5 MHz with its regular output of 5 kW.

Tokamak fusion reactor is set for Princeton

A \$228-million nuclear fusion reactor will be constructed at Princeton University by the Energy Research and Development Administration. Work will begin in 1977 and is scheduled to be completed in 1981.

Known as the Princeton Tokamak Fusion Test Reactor (TFTR), the experimental system is aimed at solving the problems hindering development of a commercial fusion reactor. (Tokamak is the Russians' term for

the toroidal magnetic chamber they invented in 1955.)

One major problem is to heat the highly ionized gas to 100 million degrees Celsius—85-million degrees more than the sun's interior—and magnetically confine it to prevent the gas from touching the sides of its container. Princeton's solution is to confine the plasma in a magnetic field within a toroidal vacuum vessel.

Heat energy produced by the fusion of hydrogen nuclei into helium will be used to drive a turbo-electric power plant. The TFTR will be fueled by deuterium (derived from sea water) and tritium.

Two companies will participate with Princeton in the fusion-reactor project: Ebasco Services, New York City, to perform most of the engineering, design, development, procurement, installation and assembly, and Grumman Aerospace, Bethpage, NY, to aid Ebasco.

Army pushes for nape-of-earth communications

Three communications modes are being evaluated by the Army in an attempt to provide its helicopters a single-channel aircraft voice communications system by the mid-1980s that will be capable of operating within the nape of the earth (NOE) up to 50 km.

Launched one year ago with an agreement between the Army Training and Doctrine Command and the Development and Readiness Command, the NOE program is undergoing development testing at Fort Hood, TX. The three technical approaches being evaluated are:

An improved airborne VHF-FM system in the 30-to-50-MHz range that will increase signal reliability and intelligibility, and extend signal penetration for maximum line-of-sight tactical communications in areas of marginal signal reception.

An HF air and ground system in the 2-to-30-MHz range that will be optimized to take maximum advantage of the nearly vertical-incident sky-wave mode by improving short-range HF-communications coverage where terrain masking obstructs a radio's line of sight. Included in this mode will be evaluation of a single sideband above 12 MHz for line-of-sight communications and a determination of the operational benefits to be gained from a combination VHF/HF mode.

A VHF/FM nonline-of-sight communications system will employ ground and airborne retransmission as an alternate means of communication.

Capital Capsules: NATO has tentatively accepted a revised U.S. proposal on the **Airborne Warning and Control System (AWACS) radar aircraft**. The new proposal earmarks nearly \$500 million for European firms of the projected cost (in 1976 dollars) of \$1.8-billion for 27 aircraft. Great Britain will get a third of the work, and Germany a third—including the time-division multiple-access data link. The U.S. plans to buy 24 additional aircraft. . . . The Navy again is seeking high-accuracy (on the order of a few feet) **tactical missile to replace the Condor** when the new budget goes to Congress. Congress canceled Condor last year after costs soared and defense officials were reprimanded for accepting hospitality from prime contractor Rockwell International. . . . Presidential science advisor Dr. H. Guyford Stever has activated the **Federal Coordinating Council for Science, Engineering and Technology**, which consists of the top technical officials of 13 government agencies. The council will recommend government-wide science policies.

HP quality, convenience and low prices mean big value in DMM's.

\$225*—The HP 3476A—3½ Digits—Autoranging, automatic polarity and automatic zero make the 3476 a big value. It's a convenient size to hold in your hand or carry in your briefcase. Just \$225* for the "A" version for AC line operation in your lab or \$275* for the portable "B" version (with built in batteries and recharging circuit).

\$375*—The HP 970A—3½ Digits—Handheld, autoranging, automatic polarity and zero, the 970 is totally self-contained and totally convenient. And the readout can be inverted with a flick of your thumb for easy reading. On the job measurement has never been easier.

\$400*—The HP 3435A—3½ Digits—Autoranging or manual operation and wide-range operation, plus built-in batteries and recharging circuits bring you laboratory

accuracies and portability in the same unit. If you don't need battery operation, option 001 gives you line operation only for just \$335*.

\$500*—The HP 3465B—4¼ Digits—1μV sensitivity gives you performance you'd normally expect from a 5½-digit multimeter. Fully portable too, with its own nickel-cadmium batteries and recharging circuit. Dry-cell operation and a rack-mount version are available in the 3465A for as low as \$425*.

Confidence in low-cost DMM's comes from knowing you've made the right decision. HP's quality and service give you assurance. Contact your local HP field sales engineer or write today for more information.

*Domestic U.S.A. price only.

**HP DMM's...
the right decision.**

097/42



HEWLETT **hp** PACKARD

Sales and service from 172 offices in 65 countries.

1507 Page Mill Road, Palo Alto, California 94304
For assistance call: Washington (301) 948-6370, Chicago (312) 677-0400
Atlanta (404) 434-4000, Los Angeles (213) 877-1282

CIRCLE NUMBER 41

GET YOUR ACT TOGETHER:



It takes a lot of drive to make ends meet today.

We hate to see OEM frustration—the kind caused when you can't close the gap between advancing computer technology, and your peripherals' ability to fit in with your plans. Just coming "sort of close" won't do anymore.

Getting things together is a specialty at Pertec. We're industry-watchers, as well as seasoned participants—trust us to pinpoint exactly what you're going to need...often even before you do. To help you realize the full potential of state-of-art CPUs. With much greater cost-effectiveness.

Take our tape drives. (Please.) Already available in more than 400 line-variations—but we didn't stop there. Not Pertec. We anticipated your need for a super-fast, sophisticated tape transport, to handle high volume dp throughput.

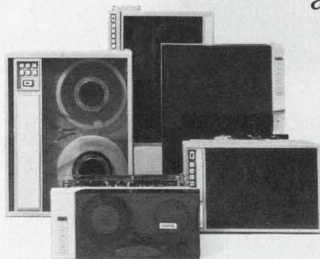

The result: our new T1000 family, a *new-generation* in vacuum column drives. 75 to 125 ips; dual density for now, but designed to handle GCR high density recording.

We're devoted to your disk demands too. Rigid or flexible. Both fixed-and-removable. From 0.25 mB to 50 mB.

And we didn't give you 50 megabytes by forcing a switch in technology. We simply *expanded* our D3000 Series to include 25-50 mB units. As extensions to an *existing* line. With technology and parts commonality you're already used to. 50 mB, without major logistic support changes...without special pre-recorded media.

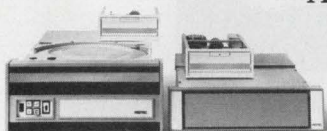

All Pertec drives are built to *stay* together too. Reliability's a big number with us. Like testing at every manufacturing stage, with 40-hour burn-ins. Like setting up the biggest direct sales and service organization of any independent peripherals manufacturer. Like our toll-free

800 line, for 24-hour, 7-day emergency assistance from strategically located parts-and-repair depots around the world.

Pertec's product families are ready when you are. With on-target solutions—regardless of capacity, speed and performance specs...it's a snap with Pertec.

Get together with Pertec peripherals: write Pertec, 9600 Irondale Avenue, Chatsworth, California 91311. Or call the Pertec regional sales office nearest you: Los Angeles (213) 996-1333. Chicago (312) 696-2460. Hudson, New Hampshire (603) 883-2100. London (Reading) 582-115.

PCC PERTEC

a division of Pertec Computer Corporation

CIRCLE NUMBER 42

Right before your eyes

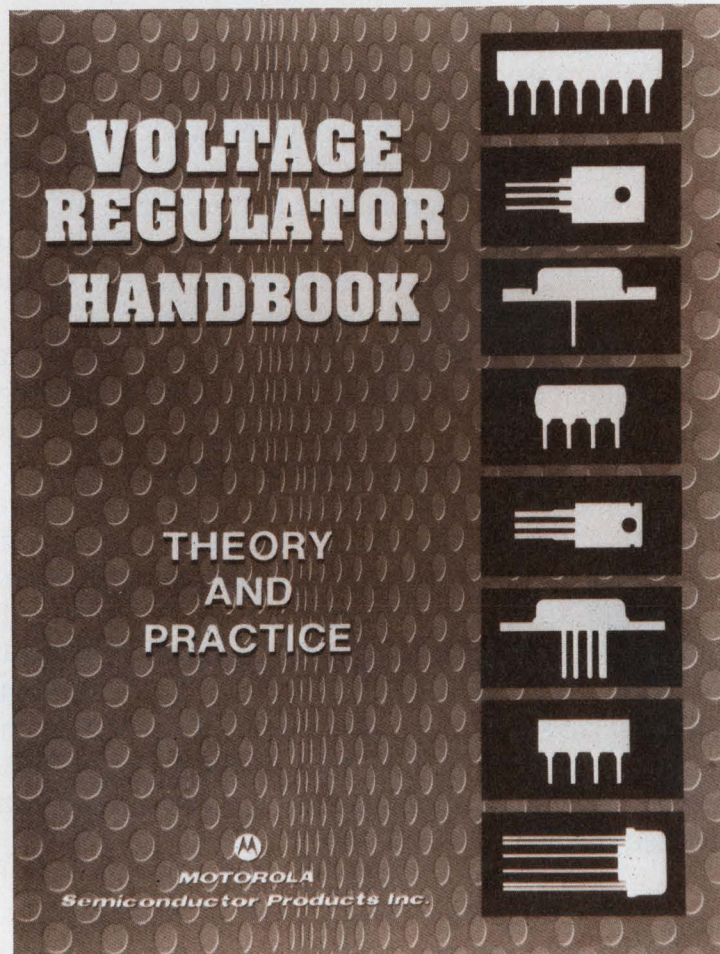

The Magic Book

It's as easy as 1, 2, 3. Motorola discloses basic regulatory theory along with circuit configuration and practical design examples. Also reveals series pass elements, heatsinking, construction and layout, input power supply design, reliability and trouble-shooting. In addition to complete Motorola regulator data sheets, it crystal-balls new regulator products. Selection guides and an industry cross-reference complete the act. All for the magically low price of just \$2.50.



Motorola turns voltage regulation into child's play

Nominal Voltage	3-Terminal Regulators											
	Positive						Negative					
	Maximum Current						Maximum Current					
	1500mA		750mA		500mA		100mA		1500mA		100mA	
2	-		-		-		MC78L02C,AC		MC7902C		-	
3	-		-		-		-		-		MC79L05C,AC	
5	MC7805C		MC7705C		MC78M05C		MC78L05C,AC		MC7905C		-	
5.2	-		-		-		-		MC7905.2C		-	
6	MC7806C		MC7706C		MC78M06C		-		MC7906C		-	
8	MC7808C		MC7708C		MC78M08C		MC78L08C,AC		MC7908C		-	
12	MC7812C		MC7712C		MC78M12C		MC78L12C,AC		MC7912C		MC79L12C,AC	
15	MC7815C		MC7715C		MC78M15C		MC78L15C,AC		MC7915C		MC79L15C,AC	
18	MC7818C		MC7718C		MC78M18C		MC78L18C,AC		MC7918C		MC79L18C,AC	
20	-		MC7720C		MC78M20C		-		-		-	
24	MC7824C		MC7724C		MC78M24C		MC78L24C,AC		MC7924C		MC79L24C,AC	
Voltage Tol.	C = ±5%		C = ±5%		C = ±5%		C = ±10% AC = ±5%		C = ±5%		C = ±10% AC = ±5%	
Package	TO-3	TO-92	TO-220	TO-39	TO-220	TO-39	TO-92	TO-39	TO-220	TO-3	TO-92	TO-39

Out of the hat soon . . . LM117, a 3-terminal, positive, adjustable regulator for voltages from ±1.2 to 30 V, up to +1.5 A. Packaged in TO-3 and TO-220 it'll appear 1st quarter, '77.

The Magic Numbers

Abracadabra, Motorola

Send me The Magic Book. Make economy and simplicity materialize in my voltage regulator circuits. Presto! Here's my \$2.50 check, payable to Motorola, Inc.

I have an immediate need for Motorola voltage regulators. Have your salesman appear.

My phone's _____.

Name _____

Title _____

Company _____ Division _____

Address _____

City & State _____ Zip _____

Send To Motorola, Inc., P.O. BOX 20912, Phoenix, AZ 85036

Semiconductors

-And you thought we were just a production house.

WIRE-WRAPPABLE PACKAGING ASSEMBLY ACCEPTS INTEL 8080 AND 8080A MICROPROCESSORS

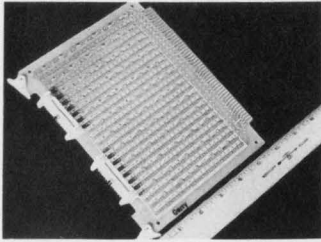

NEW BRUNSWICK, N.J. —A wire-wrappable packaging assembly for interfacing with Intel 8080 and 8080A microprocessors is now available from Garry Manufacturing Co., of New Brunswick, N.J. This new board fits the standard Intel processor rack. It is UL approved and includes two Input/Output connectors to mate with flat conductor cable wiring.

The new packaging assembly has wide application in computerized automation equipment for the machine tool industry and it will be useful in developing special or custom CPU's with associated RAM and PROM chips.

Garry also manufactures boards to interface with microprocessors made by National Semiconductor, Data General, Texas Instrument, and Digital Equipment Corporation.

For complete information, use the Reader Service Card, or contact: Garry Manufacturing Co., 1010 Jersey Avenue, New Brunswick, N.J. 08902; telephone: 201-545-2424.

SERIES OF MODULAR IC PLUGGABLE PACKAGING ASSEMBLIES

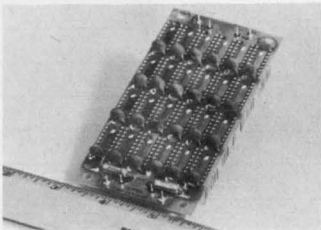

NEW BRUNSWICK, N.J. —A full range of Modular IC Pluggable Packaging Assemblies is now available from Garry Manufacturing Co., of New Brunswick, N.J.

These new packaging assemblies are available with both committed and non-committed power and

ground places. All come equipped with low-frequency tantalum capacitors as standard, and with options of 0.01 uf ceramic capacitors adjacent to each IC position.

The boards are UL approved and are manufactured with one, three, or six groups of either 20 or 24 IC positions, for 14- or 16-pin ICs. One-, two-, or three-level wire-wrappable posts are available, as are a variety of platings including various thicknesses of gold or tin over nickel.

For complete information, use the Reader Service Card, or contact: Garry Manufacturing Co., 1010 Jersey Avenue New Brunswick, N.J. 08902; telephone: 201-545-2424.

PACKAGING SOCKETS FOR TO-5 ICs NOW AVAILABLE IN VARIOUS STYLES

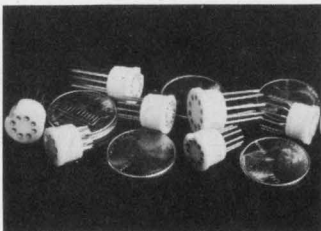

NEW BRUNSWICK, N.J. —Packaging sockets that will permit TO-5 case size ICs to plug into a variety of circuits are now available from Garry Manufacturing Co. of New Brunswick, N.J. The new sockets come with 6, 8, 10, and 12 contacts, in standard pin circles. They accept leads from 0.016 to 0.019 in. diameter.

The sockets are available with terminals for most applications: printed circuit, turret, solder pot, and wire-wrappable. Bodies of the sockets are resilient Teflon for snug push fit into circuit-board mounting holes. Terminal sleeves are brass, contacts are beryllium copper, plating is gold over nickel. Sockets are also available with recessed contacts, for "hot case" applications.

For complete information, use the Reader Service Card, or contact: Garry Manufacturing Co., 1010 Jersey Avenue New Brunswick, N.J. 08902; telephone: 201-545-2424.

Joan Borst is doing 5 to 10 on a bum wrap.

Joan should've talked to Garry. Instead of condemning her to a faulty Wire Wrap*, we would've given her a wrap that worked. With pin squareness that's exactly .025 inch. A precision beryllium spring clip that has the most consistent IC insertion/withdrawal rate in the industry. And the widest line in the industry.

In short, we would've given her a good wrap. Backed up by a complete IC packaging facility (boards, headers, wrapping, racks), as well as dependable service, good prices and fast delivery.

Ask us about it. We won't pin a bum wrap on you. Garry Manufacturing, 1010 Jersey Avenue, New Brunswick, New Jersey 08902. (201) 545-2424.

*Registered trademark of Gardner-Denver Co.

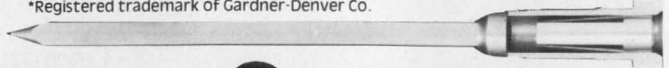

Garry

Manufacturing Co.

We won't pin a bum wrap on you.



Microprocessor Design

'Modularize' μ P chip functions and improve your testing results

The versatility and complexity of μ Ps have made them difficult to test. Rick McCaskill, manager of applications services at Macrodata Corp., Woodland Hills, CA, discusses a new approach to constructing a μ P chip-test program.

Microprocessor chips are tested generally by applying various input combinations and measuring or observing the output levels. Macrodata has come up with a testing scheme that the company considers more efficient and accurate than current test methods.

A microprocessor chip is essentially a mixture of interconnected MSI functions on a common substrate: registers, some memory, an arithmetic unit, an instruction decoder, a counter and so on. So we divide the chip's functions into "modules," and test each logic function individually through the device's instruction set and buses.

Usually, this means starting with those functions that have immediate access to the address and data buses. You can begin by loading the accumulator and reading it back out, or you can test the program counter by running through 2^n consecutive no-ops. Once you have confidence in the "outermost" functional modules, you can

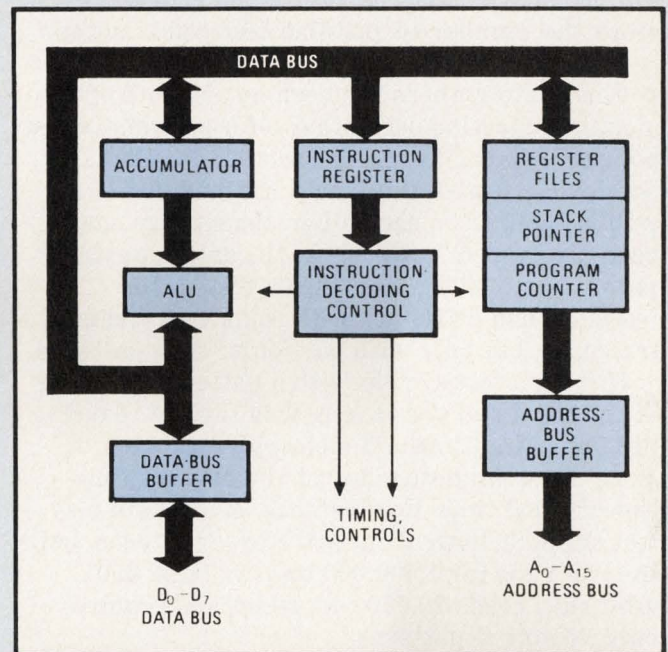

use them to gain access to those sections deeper inside the chip—its arithmetic unit, stack pointer, flags, and so on.

(continued on page 76)

Redesigned disc tester uses 8080 μ P for flexibility

A completely redesigned tester for floppy-discs, the FD-33M from Three Phoenix, uses an 8080 to provide test flexibility at reasonable cost. Not only does the tester use programmed tests, but it can also be programmed with custom test requirements.

The FD-33M permits Drop-Out, Extra-Pulse, Modulation, Amplitude and Resolution testing. Tests normally done on an AQL basis can be eliminated by switch selection for faster throughput. Threshold calibration levels are set via a potentiometer, which is then read out on a three-digit LED display.

Three Phoenix Co., 10632 N. 21st Ave., Phoenix, AZ 85029. (602) 944-2222.

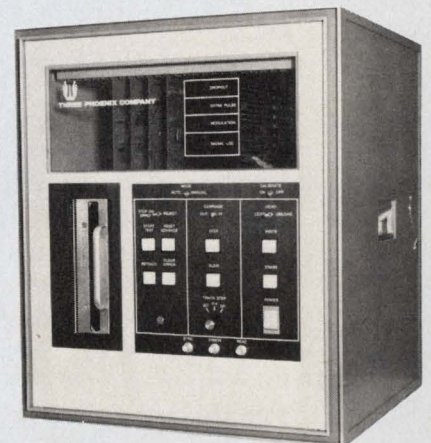

CIRCLE NO. 507

MICROPROCESSOR DESIGN

(continued from page 75)

Having determined that a particular module is working, you can run different combinations of data through it, and search for sensitivity to data patterns. Ideally, you should test each module with all possible combinations of data. But this is frequently unrealistic because of the long test time involved—sometimes approaching several minutes. Unless you are working on a research program and not concerned with product throughput, you'll have to make an intelligent compromise between certainty and efficiency, since the number of possible test combinations is very large.

Fortunately, there has been no evidence of modules affecting each other—for example, stack pointer influencing the instruction decoder. In the devices tested, the functional modules seem well isolated from each other. Sensitivity has been discovered, however, in the data-transfer paths. Some of the first 8080s tested, for instance, had difficulty with register-to-register transfers, but only with particular data patterns.

Having a test system with a pattern generator at the front end goes a long way toward reducing programming time and memory requirements, since it can emulate many of the device's functions in real time. For instance, Macrodata may test the 8080 with about 500 stored patterns, but the test runs for 1,500,000 test cycles. A 2901, 4-bit slice needs 20,000 test cycles and requires only 70 stored patterns.

Testing the microprocessor chip for output levels at specified load is, of course, important, but the over-all significance of parametric testing diminishes with increasing chip complexity.

Buried behind several levels of logic, functional areas of the device can be externally tested only for intelligence, not for voltage or current.

When preparing a microprocessor-chip test program, you must be thoroughly familiar with all device specs published. You must realize that you will be putting information into the chip, storing it, retrieving it, manipulating it and extracting it. You must know the state of the test data at any given clock pulse, especially if you are evaluating or characterizing the device. You must have the facilities to replicate the final form of the test data, compare it with the actual result and explain all discrepancies.

All the information necessary to create a complete test program can be culled from the manufacturer's data sheet: block diagram, instruction repertoire, timing diagrams, input and output levels. Start by loading the accumulator or one of the working registers; they are controlled directly by the instruction decoder. Read the data out immediately and check for validity. This check verifies the basic operation of the data bus, the instruction decoder and the module under test. Load and read back out different combinations of data to gain confidence in the module's over-all operation, since it will be used to access and test other functional modules.

Once any module is checked out, be sure to exercise it with all the other instructions that control that module—load immediate, direct and indirect—so that you have confidence in the instruction decoder. By the time you finish, you have created a chain of minitests, all linked together to exercise each of the device's functional modules and all valid instructions. For greater flexibility, your test system should be able to treat these minitests as subroutines.

Symbolic programming language operates on Intel microcomputers

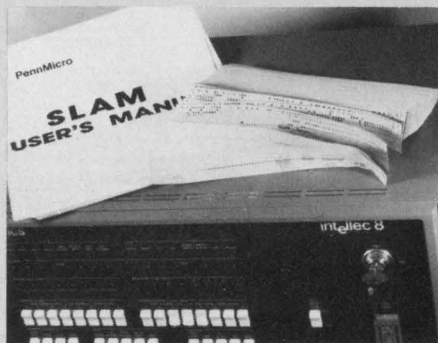

Requiring only 3200 bytes of memory, a text editor and high-level language interpreter named SLAM operates on Intel's Intellec 8/MOD 80 and MDS microcomputers. Developed by PennMicro, the operating system uses a language similar to Basic.

Programs can be written with the help of the text editor and then run on a microcomputer with only a terminal for control. SLAM uses 16-bit signed decimal numbers and performs bit-masking operations as well as a variety of conditional and subroutine commands. The language is totally symbolic—registers and memory

addresses need not be assigned.

Supplied on paper tape, SLAM can be loaded with the Intel system-monitor program. The tape and a complete instruction manual cost \$99 and delivery takes two weeks. An order must specify what version is desired—Intellec or MDS—and if provisions for interrupts are necessary.

PennMicro, P.O. Box 5073, Lancaster, PA 17604. Carol Simpson, (717) 569-8032.

CIRCLE NO. 508

NEED FAST DELIVERY ON HIGHEST QUALITY CAPACITORS?

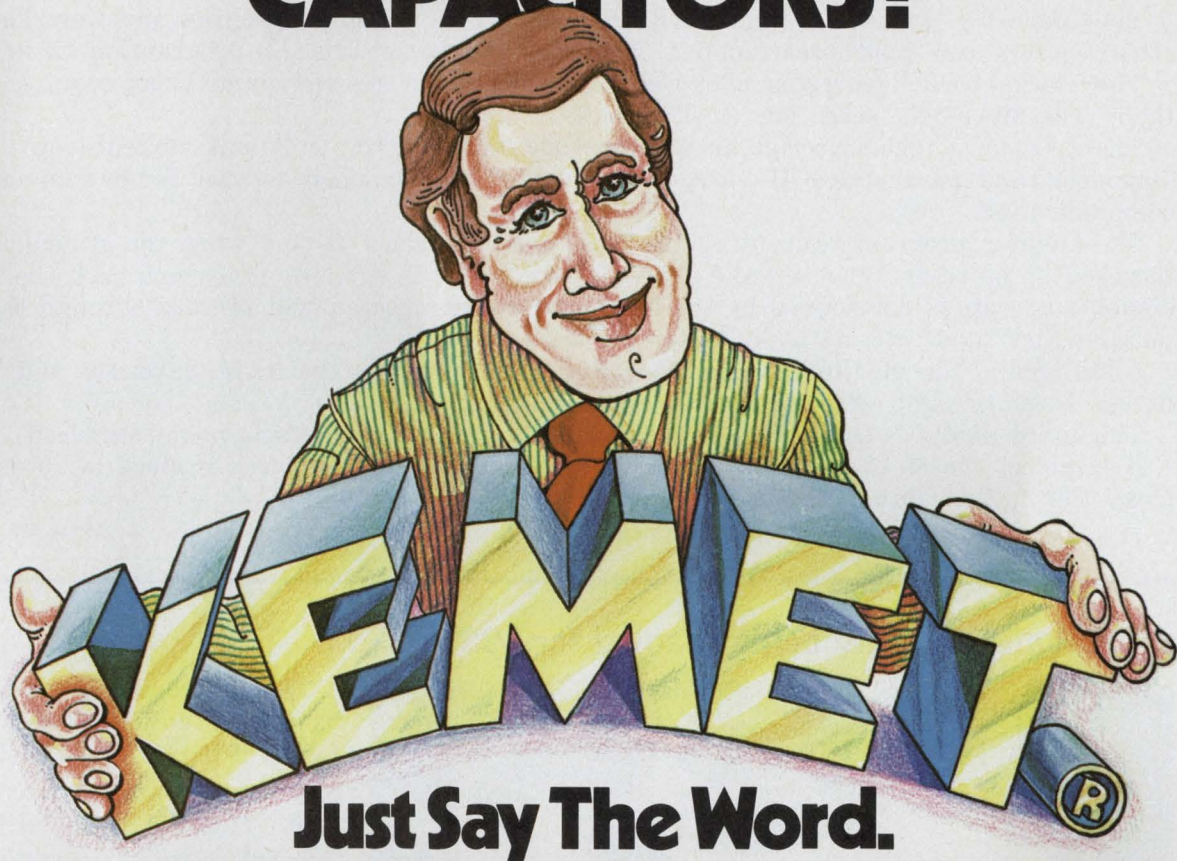

Just Say The Word.

KEMET offers you a broad range of highest quality capacitors. With fast delivery. Now.

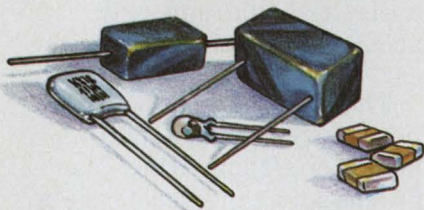

Solid Tantalums. In ratings of .0047 uF to 1000 uF, 6 to 125 VDC. Commercial, MIL-Spec, Graded Reliability types. Space-saving chips. All cases — molded, dipped, hermetic. Axial or radial leads. Polar and non-polar.

Monolithic Ceramics. CK05-CK16, CKR05-CKR16, MIL-C-20. "Solder Guard," "Gold Guard," or Established Reliability Chips. Ultra-Stable NPO, Stable BX or General-Purpose Z5U dielectric. Available with axial or radial leads. Transfer molded or "Blue Max" epoxy dipped.

Precision Thin-Film. "Flat Kap" Parylene and metallized polycarbonate Thin-Film Capacitors combine small size with outstanding electrical characteristics. Values of .001 uF to .22 uF. Exceptional stability. To MIL-C-83421, 39022, 55514 or to customer specification.

With EPIC Delivery. See your KEMET Capacitors representative or distributor now. What he doesn't have, he can get in a

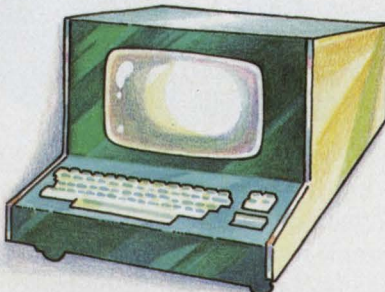

hurry through the exclusive KEMET Electronic Product Inventory Control — EPIC, for short. It's a computerized parts

control and order entry system that gives instant access to all KEMET plant inventories.

In less time than it takes to read this page, he can tell you the status of the parts you need, list all same-rating alternatives, give you pricing data — and enter your order.

No hassle. Just lots of hustle. **KEMET offers you more.**

Components Department,
Union Carbide Corporation, Box
5928, Greenville, SC 29606;
phone: (803) 963-6300; TWX:
810-287-2536; Telex: 57-0496.



COMPONENTS DEPARTMENT

In Europe: Union Carbide Europe, S.A.
5, Rue Pedro-Meylan, Geneva 17, Switzerland
Phone: 022/47 4411 Telex: 845-222-53

KEMET is a registered trademark
of Union Carbide Corporation.

MICROPROCESSOR DESIGN

Advanced μ P comes on a board with RAM, and an EPROM programmer

A microcomputer board, the 80AI, is one of the first to use Zilog's Z-80 μ P—a "third generation" μ P. It also has a built-in EPROM programmer for the 2704 and 2708 type ultraviolet erasable devices. In addition the board contains 1-k of RAM, a 2.5-MHz clock generator, and three types of I/O ports; two serial and one parallel.

The board has sockets for four EPROMs; one EPROM holds a program monitor. The other sockets can hold user-supplied EPROMs. One socket can also program an EPROM.

The clock circuit generates 8080-compatible signals for support circuits that require them. The 80AI only needs one clock signal.

The I/O ports include serial lines compatible with RS232C or 20-mA current-loop standards, and parallel ASCII lines. Only one port at a time may be used for continuous communication.

The monitor program resident on the 80AI samples each I/O port when the system is powered up or reset. When a valid carriage return code is entered on any one port, the signal baud rate is determined by the 80AI, and communication will proceed through that port, at that baud rate, until the system is again reset.

Additionally, the monitor program controls data entry into the RAM, examines and dumps memory, and sets breakpoints for debugging.

The board pinout is compatible with the MITS Altair bus (a de facto hobby standard).

Assembled, the 80AI costs \$600, and the kit sells for \$450. Delivery is stock to 30 days. Quay Corp., P.O. Box 386, Freehold, NJ 07728. (201) 681-8700.

CIRCLE NO. 509

μ P-based car safety system being readied for 1985



The electronically controlled car will be closer to reality if the μ P-based dashboard and braking system from Minicars, Inc., Goleta, CA, gets adopted by auto manufacturers. And once the system is fully developed (around 1985, if all goes well) it should add only about \$200 to the cost of the car.

The dashboard is a total information system that monitors all operating conditions and can even brake a car in an emergency. Most of the dashboard development is from RCA under a contract with Minicars, Inc. The developmental car built by Minicars uses two RCA COSMAC microprocessors—

one for the electronic dashboard and the other for a radar-controlled braking system.

Both standard information and such new data as fuel-consumption rate, engine rpm, time and trip mileage are relayed to the μ P dashboard. Should a malfunction occur, the dashboard flashes a three-second warning every 30 seconds until the malfunction is corrected. The display is a plasma panel with 32-character capability.

To avoid collisions, the μ P-controlled radar system provides audible warning signals in potentially dangerous situations. But when a serious crash cannot be avoided, the system can automatically actuate a special braking system to minimize the damage.

FREE FROM SCHWEBER. HP'S SCHOTTKY DIODE. THE WORLD'S 1ST IN A DO-35 PACKAGE.

Hewlett-Packard's HSCH-1001 (IN6263) Schottky barrier diode is the perfect replacement for several hundred germanium diode types.

With its low forward voltage, picosecond switching speed, high temperature rating and rugged, low-cost packaging, the Schottky gives you a

reliable, high performance alternative for your general switching diode needs.

The HSCH-1001 Schottky can be used for wave shaping, sampling, clipping, clamping and low level detecting. Be among the first to get your free samples simply by sending us this coupon.

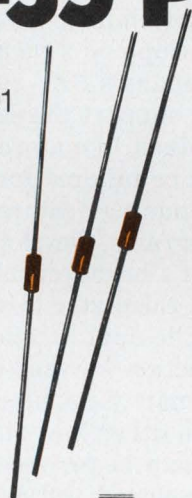

HEWLETT  PACKARD

- Please send me two free samples of the HSCH-1001 for evaluation. Include data sheet, application bulletins and Germanium Diode Replacement Guide.
- I am not familiar with Schottky diodes. I am familiar with Schottky diodes.

My application(s) would be:

- Detecting Clamping/Clipping Analog Switching
 Pulse Shaping Sampling Digital Switching/Logic Other

My intended yearly usage is: _____

Name _____ Title _____

Company _____

Address _____

City _____ State _____ Zip _____

Mail coupon to: Bill Gordon, Schweber Electronics, Westbury, New York 11590

Westbury, N.Y: 516/334-7474 Somerset, N.J: 201/469-6008 Danbury, Conn: 203/792-3500
Waltham, Mass: 617/890-8484 Rockville, Md: 301/881-3300 Atlanta, Ga: 404/449-9170
Beachwood, Ohio: 216/464-2970 Chicago, Ill: 312/593-2740 Horsham, Pa: 215/441-0600
Eden Prairie, Minn: 612/941-5280 Dallas, Texas: 214/661-5010 Detroit, Mich: 313/583-9242
Rochester, N.Y: 716/461-4000 Hollywood, Fla: 305/927-0511 Houston, Texas: 713/784-3600
SchweberWest: 213/537-4321 714/556-3880 © 1976, SCHWEBER ELECTRONICS CORPORATION



MICROPROCESSOR DESIGN

For your interest . . . microprocessor-development workshop

A call is going out for papers for the June, 1977 μ PIEEE Workshop on Bench Programming of Microprocessors. Workshop members will share experiences and learn about both the pitfalls and shortcuts in developing firmware. Papers are due before February 1, 1977.

The workshop will take place June 10, 11 and 12 at the Moore School, University of Pennsylvania, Philadelphia, PA 19174. For more information, contact Miss Helen B. Yonan, c/o Philadelphia IEEE, at the University.

Microcomputer-programming system permits full development



Developed to be a self-contained microcomputer-programming tool, Intel's Prompt 80 lets designers enter, develop and save machine-language programs. Based on the company's SBC 80/10 single-board computer, the system can support the design of any 8080 system.

Much like a programmable calculator, the Prompt 80 can be tailored for an application by using its self-programming features to add new routines to its operating programs. Development programs are entered via the unit's hexadecimal keyboard, which also doubles as a hex calculator to speed data conversion.

The dual-function keyboard is part of a command/function key-and-display group. The display is used primarily for program and memory examination, as well as for hex calculations and entry. Two other key/display groups are used for register and I/O manipulations and a key-only group is for reset and interrupt control.

For debugging, programs can be developed and executed in increments from 16 bytes to 2 kbytes. Large programs can be developed as modules—up to 2 kbytes—or continuously, by expanding the resident memory.

At a cost of only \$1495, the Prompt 80 provides a ready-to-use facility that can directly duplicate or closely emulate many 8080 systems. The system comes completely assembled and tested and includes two 8708 EPROMs, three 8308 ROMs and a library of design manuals.

Intel, 3065 Bowers Ave., Santa Clara, CA 95051. John Doerr (408) 246-7501.

CIRCLE NO. 510

Micro Capsules

A single-chip microcomputer that will contain $2\text{-k} \times 8$ of mask programmable ROM, 128×8 of static RAM, a clock generator and up to eight programmable I/O lines will be ready by late 1977, predict officials at Signetics, Sunnyvale, CA. Soon to be introduced, though, are three enhanced versions of the 2650 μ P. The 2650A will have a smaller chip size, the 2650B smaller size, two extra instructions and three-state control lines, and the 2650B-1 will have a 60% speed improvement, which cuts the cycle time to 1.5 μ s. . . A mid-1977 introduction is planned for a 16-bit microprocessor that is software-compatible with the 6502. The new processor, developed by MOS Technology, Norristown, PA, reportedly will have an 8-bit data bus and an instruction set of about 120 commands. . . An enhanced version of the CP1600, 16-bit microprocessor is expected to be introduced by General Instrument, Hicksville, NY, in late 1977. The μ P will offer an expanded instruction set and greater speed. . . The complete microcomputer on a chip is getting one step closer with the development of the 6802 μ P by Motorola, Austin, TX. Contained on the 6802 are 128 bytes of RAM, a full 6800 processor, a clock oscillator and half of a PIA. The 6802 is expected to be software compatible with the 6800 and available by mid-1977.

BEST COST/PERFORMANCE

resin-coated SOLID-TANTALUM

CAPACITORS

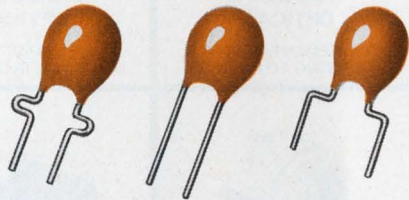

New Sprague Type 199D Capacitors Give You the Most for Your Money

LOWEST COST, YET IMPROVED PERFORMANCE. Prices competitive with any other capacitors of this type, domestic or offshore. Max. impedance in ohms @ 10 Kz guaranteed for every capacitor. Lower d-c leakage currents, lower dissipation factor.

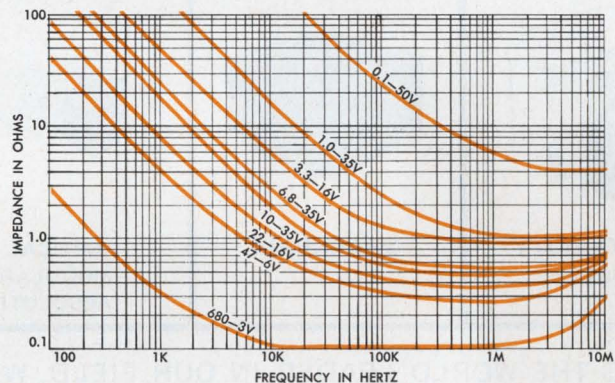

Plus these additional advantages . . .

SUPERIOR EPOXY ENCAPSULANT

Flame-retardant, moisture-resistant resin will not crack or chip under temperature extremes.

CHOICE OF LEAD CONFIGURATIONS

Straight, hockeystick, or hairpin crimp with .100", .200", .250" lead spacing.

STANDARD TOLERANCES: $\pm 20\%$, $\pm 10\%$

$\pm 5\%$ available on special order.

PROVEN CAPACITOR TECHNOLOGY

From the pioneer in solid-electrolyte tantalum capacitors.

RAPID DELIVERY

Up to 999 pieces off-the-shelf from Sprague Industrial Distributors. Larger quantities 4 to 8 weeks ARO.

For price and availability information call your Sprague district office or sales representative. For complete technical data, write for Engineering Bulletin 3547A to: Technical Literature Service, Sprague Electric Company, 347 Marshall Street, North Adams, Mass. 01247.

THE BROAD-LINE PRODUCER OF ELECTRONIC PARTS

CIRCLE NUMBER 44



LITTON SHAFT POSITION ENCODERS

 <p>MODEL 70 OPTICAL INDUSTRIAL INCREMENTAL</p>	 <p>MODEL 71 OPTICAL MODULAR INCREMENTAL</p>	 <p>MODEL 72 OPTICAL SIZE 25, LOW COST, INCREMENTAL</p>	 <p>MODEL 73 OPTICAL INCREMENTAL FOR MOUNTING TO MOTORS</p>	 <p>MODEL 74 OPTICAL SIZE 15, LOW COST, INCREMENTAL</p>
 <p>MODEL 76 LOW COST OPTICAL ABSOLUTE</p>	 <p>HOLLOW SHAFT OPTICAL INCREMENTAL & ABSOLUTE</p>	 <p>SIZE 25 & 35 ABSOLUTE OPTICAL COMMERCIAL & MILITARY</p>	 <p>SIZE 25 & 35 INCREMENTAL OPTICAL COMMERCIAL & MILITARY</p>	 <p>SIZE 11 PIN CONTACTS ABSOLUTE & INCREMENTAL</p>
 <p>HEAVY DUTY ABSOLUTE</p>	 <p>TRACKBALL</p>	 <p>OPTICAL MODULAR ABSOLUTE</p>	 <p>MILITARY SPECIALS</p>	 <p>OUTER SPACE APPLICATIONS</p>

BEING THE WORLD LEADER IN OUR FIELD, WE HAVE DESIGNED ENCODERS TO MEET THE FULL SPECTRUM OF USER APPLICATIONS RANGING FROM THE SIMPLEST, LOW COST MODULAR ENCODERS TO THE MOST SOPHISTICATED ENCODERS FOR MILITARY AND NASA REQUIREMENTS.

IF YOU NEED DATA ON OUR PRODUCTS OR ASSISTANCE IN SELECTING THE RIGHT ENCODER FOR YOUR APPLICATION, PLEASE CONTACT:

THE MARKETING DEPARTMENT
LITTON ENCODER DIVISION
20745 NORDHOFF STREET
CHATSWORTH, CALIFORNIA 91311
TELEPHONE: (213) 341-6161 / TWX 910-494-1229



ENCODER DIVISION

The fringe benefits of picking the wrong power supply can include knowing the night janitor by his first name.



Problems You Don't Need

Sensitivity to power line disturbances including brownout, instability caused by dynamic loads, oversize, overweight, overheating, poor system protection in case of supply failure - all these can be eliminated by picking the Dependables: the only family of Switching Regulated Power Supplies backed by 19 years of development.

The Dependables

The Dependables are designed primarily for OEM digital applications requiring superior line and dynamic load regulation. Their low RFI/EMI and low output ripple (less than 3 mV peak-to-peak at line frequencies) also make them attractive for sensitive analog applications. And logic designers plagued with switching transients appreciate a power supply whose typical transient response of a 5-volt output to a 25% load step is 20 mV.

Brownoutproof to Keep Your System Up

The Dependables ignore most line variations and continue to supply their specified regulated outputs **at full load** over input variations from 92 to 138 or 184 to 250 VAC. And they'll continue to do so for several minutes even if input voltage drops to 70 or 140 VAC. If AC fails completely, the supplies will hold up for 30 milliseconds, allowing orderly shutdown or transfer to optional battery back-up.

DC to DC Units Too

The Dependables are also available as DC input versions with 48, 120, or 220 VDC as standard source voltages. Pioneer Magnetics can provide units that operate from both AC and DC sources allowing ease of switching to battery back-up for UPS applications.

Supplies to Fit Your Application

A complete family of standard models provide output voltages ranging from 2 to 48 VDC with output power to 2000 Watts. Single and multiple output configurations with a wide range of options are available. For complete specifications, call or write Pioneer Magnetics today.



**Pioneer
Magnetics**

1745 Berkeley Street • Santa Monica, CA 90404
Telephone (213) 829-6751 • TWX 910-343-6249

IMSAI PRESENTS THE INTELLIGENT BREADBOARD SYSTEM

IMSAI, one of the world's largest manufacturers of microcomputer systems—the high-performance IMSAI 8080, has achieved another breakthrough—The IMSAI Intelligent Breadboard System. What you can do with the IMSAI Intelligent Breadboard is enough to qualify you and your IMSAI 8080 computer as a microprocessor R&D department. Our Intelligent Breadboard is a complete system for development of discrete logic circuits and microprocessor

software circuits. It connects directly to the IMSAI 8080, communicating with the 8080's bus and 48 TTL level I/O lines.

Use the Intelligent Breadboard to implement circuits in hardware and transfer them to software in a step-by-step fashion. Because the computer and Intelligent Breadboard communicate, hardware-software tradeoffs may be studied and new circuit designs tested extensively. It is a flexible, easy-to-use instructional tool ready to serve your development ideas under conditions of total control.

Circuits can be built using the bus logic

of the 8080 while remaining outside the computer chassis. Think of that for ease of construction and analysis! There are dozens of uses for this new and unique laboratory tool. Examples:

- As a learning tool to teach replacement of discrete devices in digital logic circuits with microprocessors and computer software.
- A sophisticated classroom laboratory for logic design courses.
- To simulate hardware circuits in software.

- To develop new I/O interfaces and memory systems that connect directly to, yet are physically outside, the computer. And much, much more.

Best news of all, pricewise the IMSAI Intelligent Breadboard, like the IMSAI 8080, is as affordable as it is useful: \$435 kit; \$625 assembled. Immediate delivery. Call or write for a complete illustrated brochure describing the IMSAI 8080, options, peripherals, software, prices and specifications, plus everything you want to know about the IMSAI Intelligent Breadboard.

Call for the name of your nearest IMSAI dealer. Why not the very best? Dealer inquiries invited.



IMSAI

IMS Associates, Inc.

14860 Wicks Blvd., San Leandro, CA. 94577 • (415) 483-2093 • TWX 910-366-7287

Big 0.6" double and single digits.

Our new super bright orange double- and single-digit displays are available in both common cathode and common anode configurations. These 0.6" digits (with overflow) incorporate our latest rounded-corner solid segment font to give you a display that's easy to read and easy to like.

The package is new, too. It has a colored face for optimum ON/OFF contrast. It's just under an inch in length and packs densely to provide digits on .50" centers.

The light emitting material is our new GaAsP:N on GaP, so you get all the benefits of this new high brightness technology—including direct MOS drive—plus all the inherent shock resistance and long life of solid state. Not bad.

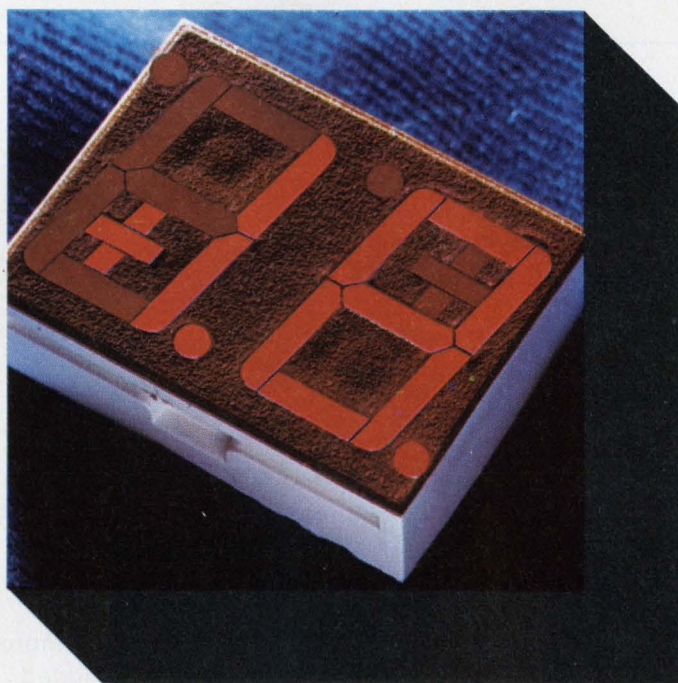

Model Number	Description	Color	Luminous Intensity*
MAN 6610	2 Digit; Common Anode, RHDP	Orange	510 μ cd
MAN 6630	1½ Digit; Common Anode, Overflow (± 1.8), RHDP	Orange	510 μ cd
MAN 6640	2 Digit; Common Cathode, RHDP	Orange	510 μ cd
MAN 6650	1½ Digit; Common Cathode, Overflow (± 1.8), RHDP	Orange	510 μ cd
MAN 6660	Single Digit; Common Anode, RHDP	Orange	510 μ cd
MAN 6680	Single Digit; Common Cathode, RHDP	Orange	510 μ cd
MAN 6710	2 Digit; Common Anode, RHDP	Red	125 μ cd
MAN 6730	1½ Digit; Common Anode, Overflow (± 1.8), RHDP	Red	125 μ cd
MAN 6740	2 Digit; Common Cathode, RHDP	Red	125 μ cd
MAN 6750	1½ Digit; Common Cathode, Overflow (± 1.8), RHDP	Red	125 μ cd

*Minimum digit average @ 10mA, DC per segment

So if it's bright you want, and your application calls for 0.6" displays, call your Monsanto man in and have a look at the MAN6600 and MAN6700 series. They're terrific.

Monsanto:
the science
company.

IN EUROPE CONTACT: Monsanto Europe S.A.,
Electronics Division, Avenue de Tervuren 270-272,
B-1150, Brussels, Belgium

Please send me a data sheet on your MAN6600 and MAN6700 series digits.

Name Title

Company Street

City State Zip

Mail to Monsanto Electronics Division,
Dept. MCD, 3400 Hillview Ave., Palo Alto,
CA 94304. Phone (415) 493-3300.

© Monsanto Company Electronics Division, 1976

CIRCLE NUMBER 50

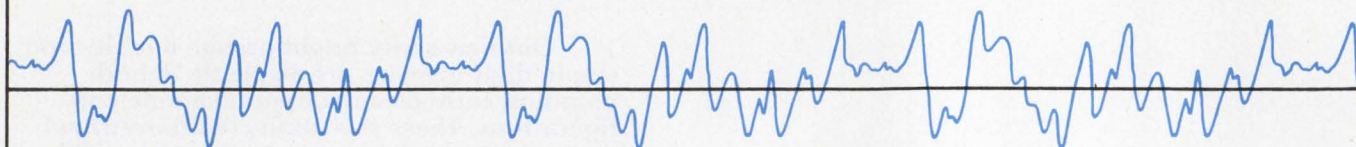

Stop noise problems with High Noise Immunity Logic.

Noisy environments simply cease to be a problem when you design with High Noise Immunity Logic from Teledyne. HiNIL provides high immunity to any and all types of electrical noise, without the cost and inconvenience of special filtering or shielding.

Use HiNIL in place of your conventional I/O logic. It interfaces easily with TTL, DTL, MOS and CMOS. It will protect your CMOS inputs against static charge damage and SCR latchup. And it gives you a guaranteed dc noise margin of 3.5 V (as compared to 1.0 V for CMOS

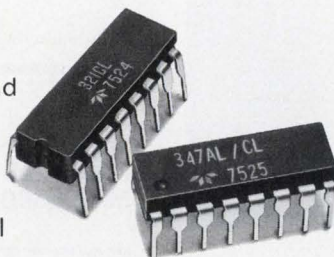

and 0.4 V for TTL) without added filter circuits or tight supply regulation.

Or design entirely with HiNIL. You will get even better noise protection and a simpler design, and you can use a low cost, loosely regulated power supply. The complete HiNIL family includes more than 40 devices, with more being added all the time. They're available in ceramic or molded plastic DIPs.

Get complete details on the full family of HiNIL logic circuits from your local Teledyne Rep or Distributor. Or contact us at the address below.

TELEDYNE SEMICONDUCTOR

1300 Terra Bella Avenue, Mountain View, California 94043 Tel: (415) 968-9241 TWX: 910-379-6494 Telex: 34-8416

SALES OFFICES:

DOMESTIC: Salem, N.H. (603) 893-9551; Stony Brook, N.Y. (516) 751-5640; Des Plaines, IL (312) 299-6196; Los Angeles, CA (213) 826-6639; Mountain View, CA (415) 968-9241 • INTERNATIONAL: Hounslow, Middlesex, England (44) 01-897-2503; Triengen, West Germany 7741-5066; Kowloon, Hong Kong 3-240122; Tokyo, Japan 03-405-5738.

CIRCLE NUMBER 51

ELECTRONIC DESIGN 1, January 4, 1977

Winning arguments

Charlie hates me. Some time ago I wrote an editorial about a chap whose professional behavior I didn't admire, and Charlie thought I was writing about him.

I wasn't. Or, at least, I wasn't writing about him deliberately. But I had apparently shot an arrow into the air and it landed in Charlie. He didn't like it. So there's a lesson for me. If I want to avoid making enemies, I ought not shoot arrows.

But there's a lesson for Charlie and the rest of us, too. Charlie found the behavior I described less than desirable, else he wouldn't have been offended. But finding the behavior objectionable, he turned his anger against me—not against himself, nor against that part of himself responsible for that behavior. And Charlie's not alone.

When I am criticized, I often find my immediate reaction is to find fault with the critic—to lash out at one of his deficiencies. That's easy because everybody has some flaws. If my reaction is "successful," I deflect the criticism of me and direct the conversation to the faults of my critic.

In opposing critics, or in opposing ideas I don't like, I find it easiest to wave diverting flags. I find my critic a reactionary, or a radical; he's too far behind the times, or too far ahead; he's made terrible blunders in the past; he understands too little about modern engineering, or modern management, or human nature. And, of course, everybody knows he has this weakness.

If I'm the man's boss, I don't have to resort to these diversions. I can then use powerful arguments that can't be refuted: "You're wrong. Take my word for it." "You're being negative." "You're being childishly enthusiastic." "When you're in this business as long as I have been, you'll know that this is the way to do it." "You're being dogmatic." "You don't see the whole picture. This element is the most important part." The beauty of these arguments is that they work only in one direction. You can't use these arguments against your boss, but he can use them to defeat you.

If you're skilled at changing the subject when your ideas are under attack, you can win many arguments. If you're boss, you can win them all.



George Rostky

GEORGE ROSTKY
Editor-in-Chief

NEW SIMPSON

SERIES 2850 DIGITAL PANEL METER



NOW... at the right price...
a single DPM for popular
domestic and IEC/DIN cutouts



STANDARD CUTOUT
1.682" x 3.622"
(42.72 mm x 92 mm)



IEC/DIN CUTOUT
1.77" x 3.622"
(45 mm x 92 mm)



OTHER DOMESTIC CUTOUT
1.682" x 3.92"
(42.72 mm x 99.57 mm)

- 3½ digit readout
- Automatic zero and polarity
- 0.1% of reading accuracy
- BCD output is standard
- Input/output edge connector included
- Highly reliable LSI circuitry
- Choice of 120/240 VAC, 50-400 Hz or 5 VDC operation
- OEM quantity prices available upon request.

Model 2850 120/240 VAC input; 0.55" planar gas discharge display complete with panel mounting clips, edge connector and manual. **\$138**

Model 2851 5 VDC input, 0.55" planar gas discharge display complete with panel mounting clips, edge connector and manual. **\$138**

Model 2852 120/240 VAC input, 0.43" LED display complete with panel mounting clips, edge connector and manual. **\$138**

Model 2853 5 VDC input, 0.43" LED display complete with panel mounting clips, edge connector and manual. **\$138**

STOCK DC CURRENT RANGES: 20 & 200 uA; 2, 20 & 200 mA
STOCK DC VOLTAGE RANGES: 200 mV; 2, 20 & 200 V
OTHER RANGES ON SPECIAL ORDER

ORDER FROM YOUR ELECTRONICS DISTRIBUTOR



SIMPSON ELECTRIC COMPANY

853 Dundee Avenue, Elgin, Illinois 60120 • (312) 697-2260

CABLE: SIMELCO • Telex: 72-2416

IN CANADA: Bach-Simpson, Ltd., London, Ontario

IN ENGLAND: Bach-Simpson (U.K.) Ltd., Wadebridge, Cornwall

IN INDIA: Ruttonsha-Simpson Private, Ltd., Vikhroli, Bombay

CIRCLE NUMBER 52

KATY INDUSTRIES



INDUSTRIAL
EQUIPMENT
GROUP

Some companies can build a pretty good case for their instrumentation amplifiers.



We've built the best case for "worst case" conditions.

It's the hermetically-sealed, electrostatically- and electromagnetically-shielded metal dual-in-line package that protects our new AD522 precision IC Instrumentation Amplifier.

The AD522 is designed for people who need very accurate and economic amplification of low-level transducer-generated signals in environments that are characterized by noise, fluctuating temperatures, and unbalanced signal impedances. The inherent stability of its thin film substrate is also a major advantage in environments in which the location of the amplifier may be sufficiently remote so as to make recalibration difficult.

The AD522 precision IC Instrumentation Amplifier uses hybrid technology to present a bold new solution to the problems of performance, cost and measurement accuracy. It offers module performance and IC reliability at IC prices (as low as \$13 in 100's). So that it fits both your "error budget" and your "cost budget".

Its rugged, MIL-quality package allows the AD522 to maintain its high accuracy under "worst case" operating conditions: output offset voltage drift below $10 \mu\text{V}/^\circ\text{C}$, input offset voltage drift of less than $0.5 \mu\text{V}/^\circ\text{C}$, CMRR above 80 dB at unity gain (110 dB at $G = 1000$), maximum gain non-linearity of 0.001% at unity gain, and typical input impedance of 10^9 ohms. To make our point, in a typical application as a data acquisition amplifier, the AD522 contributes an error of less than $\frac{1}{2}$ LSB of 12-bit relative accuracy.

Yes, we've got a case for you. And it encloses the best precision IC Instrumentation Amplifier available. The AD522. For complete facts, send for our data sheet and application notes on the AD522. Analog Devices, the real company in Instrumentation Amplifiers.

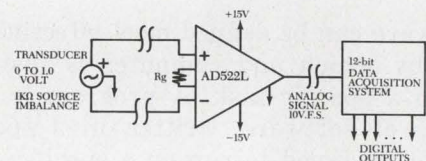

ERROR BUDGET ANALYSIS

Error Source	Specification	Relative Accuracy, % of F.S.
Gain Nonlinearity	$\pm 0.002\%$ max.	± 0.002
Voltage Drift	$\left(\frac{50}{G} + 0.5\right) \mu\text{V}/^\circ\text{C}$ max.	Negligible
CMR	86dB min.	± 0.005
Noise (0.1 to 100 Hz)	$15 \mu\text{V}$ p-p RTO	± 0.0015
Offset Current Drift	$\pm 50 \text{ pA}/^\circ\text{C}$	Negligible
Gain Drift	$60 \text{ ppm}/^\circ\text{C}$	Negligible
TOTALS		0.0085 ($< \pm \frac{1}{2}$ LSB of 12 bits)



The real company in IC instrumentation amplifiers
 Analog Devices, Inc., Norwood, Massachusetts 02062
 East Coast: (617) 329-4700, Midwest: (312) 894-3300, West Coast: (213) 595-1783, Texas: (214) 231-5094, Belgium: 03 38 27 07, Denmark: 97 95 99, England: 01/94 10 46 6, France: 686-77 60, Germany: 089/53 03 19, Japan: 03/26 36 82 6, Netherlands: 076-122555, Switzerland: 022/319704 and representatives around the world.



Software is a vital part of any computer

regardless of its size. For a specific application, instructions and hardware/software tradeoffs may determine the μ P selection.

Software has been regarded by many hardware-oriented engineers as more art than science, even though designing software is remarkably similar to designing hardware. Designing? Yes, the same systematic design procedure used by good hardware designers is also used by good software designers. And just like hardware design, software design can be broken down into building blocks. The difference is that the hardware designer uses gates, flip-flops, registers and other integrated circuit elements to design logic, while the software designer uses instructions, subroutines, tables, and other standard software modules.

Plunging directly into writing code is usually not a good way of designing software. In fact, this approach often proves disastrous when debug time arrives and stays . . . and stays. Systematic techniques can be followed to minimize errors and reduce over-all design time, and cost.

Software can be defined most effectively as any means by which any computer is instructed to perform a specific task. A program is a specific example of software, written in a specific language or designed to run on a specific computer. Distinguishing between software and programs can have a profound effect on how well you ultimately learn to program computers. Without this distinction, you may apply previously experienced limitations to a new machine or language where they no longer exist.

Always keep in mind whether you are devising a solution to a problem (software) or implementing that solution on a specific computer (programming). The conceptual software is strategy, the specific program for a specific machine is merely tactics. Programming starts with the selection of a suitable algorithm. This is the precisely defined procedure by which the computer converts raw data into processed data. One algorithm turns your computer into an accountant,

another into a process controller. Creating programs that make maximum use of machine resources requires good strategy *and* good tactics.

There's software, and then there's software

Software is divided into systems software and applications software. Systems software controls the actual operation of the computer system, and greatly affects the required effort in writing applications programs. The common types of systems programs have different functions:

- Monitor programs (also called supervisors, executives, and operating systems) enable you to communicate with all of the system hardware and software. They allocate available resources as efficiently as possible, and range from simple microcomputer monitors to complex time-sharing systems.
- I/O driver programs control data transfer between the computer and its peripheral devices.
- Data management programs (or file systems) enable the computer system to identify and organize individual blocks of data within the computer's memory hierarchy. Since most small microcomputer systems don't have a data-management system, you must keep track of memory allocations yourself.
- Editor programs enable you to display, delete, change, insert and otherwise modify data in the computer, mostly while inputting and debugging programs.

01000111 01001111 00100001 means GO!

It takes a string of 24 binary digits to spell "GO!" to your computer. You certainly cannot write a whole program that way. But a class of systems programs known as language processors do it for you.

A language processor is a program that translates data from one form to another. The input to a language processor is called a source program, its output an object program. The source program consists of statements that enable you to specify your program in a form you can under-

stand. The object code is the machine language which the computer understands, and from which it executes the program.

Language processors free you from the tedious mechanical details of machine-language programming, help you avoid errors, and make you more efficient. Three basic levels of language processor are in common use: assemblers, macro-assemblers, and compiler/interpreters.

Assemblers allow you to represent numeric machine instructions, addresses, and data by character strings called symbols. The assembler automatically translates the symbols in the source program into corresponding numerical values in the object code.

Mnemonics are symbols which represent a valid machine instruction, designed to help you remember instructions more easily. So clear A can be CLA, store A can be STA, and so on.

Besides freeing you from the task of remembering all the machine codes, the assembler also keeps track of storage locations for you. You can use "labels" for symbolic addressing, and the assembler assigns a memory location to each label, where that label is defined. Every time you change the program, the assembler reassigns all the address labels and symbols.

Symbols can also be used to define data constants. The assembler allows you to assign a symbol such as "DATOUT" to, say, output port 10. When the program is assembled, all references to DATOUT are assigned that numeric value. If, later, you decide to change the printer to output-port 20, you have to change only one assignment statement.

Whereas an assembler produces one machine code for every symbol in the source code, a macro-assembler expands this capability so that a single symbol can represent a group of machine instructions. Such a symbol is called a macroinstruction. When a macro-assembler encounters

such a symbol, it automatically inserts the proper group of instructions into the program.

Fortran spoken here

Life would be easier for engineers if they could write programs in their natural languages, such as English or math. Unfortunately, computers cannot yet accept them efficiently. Higher-level languages were developed as a compromise. Unlike assemblers, higher-level language processors produce machine code from statements that do not resemble mnemonics. For example, the single statement $B = C * A + D$ produces the sequence of machine instructions required to solve the equation. You need not worry about what machine code is produced, but can concentrate on solving your problem.

Higher-level language processors are either compilers or interpreters. A compiler translates the entire source program at once to produce the entire object code. An interpreter translates each statement as it is encountered during program execution. If a statement is executed 10 times, it will be translated 10 times. Any language can be implemented as either a compiler or an interpreter. Usually, however, Fortran, Cobol, Algol, and PL/1 are compiled, while Basic, APL, and Focal are interpreted.

Compilers are generally chosen for large systems because they can produce far more efficient machine code than interpreters. The object code loaded into memory runs independently of the translator. However, compilers are considerably harder to develop and require separate memory-storage areas for the compiler, the source program and the object program. Worse, even your smallest program correction requires complete recompilation, while you are chafing at the bit.

Interpreters are preferred for small systems. Their program execution is slower, and the inter-

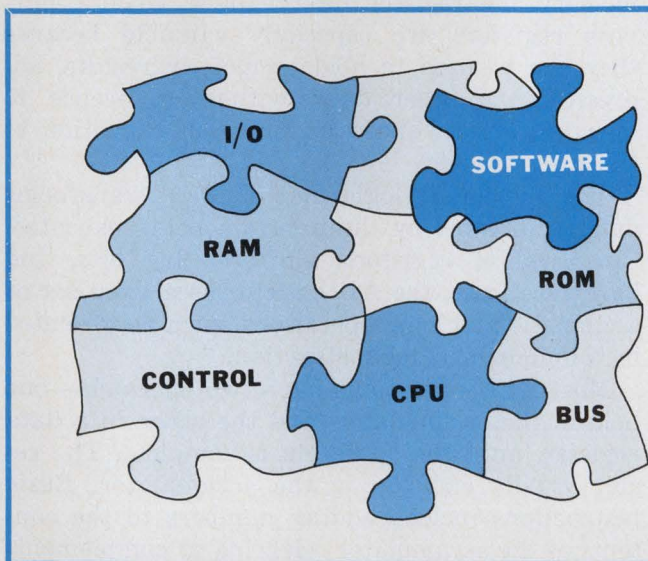

This article is the first in a series devoted to microprocessor software design for hardware-oriented engineers. Readers without previous digital design experience may wish to refer to background material first, such as the article Microprocessor Basics, Part 1 (ED 9, April 26, 1976, p. 58). It is a good starting point for a review of μ P hardware.

The series is based on the author's Modu-Learn course, and focuses on systematic "structured" programming techniques. Topics include basic computer concepts, evaluating a μ P, hardware/software tradeoffs, analyzing software problems, basic programming techniques, computer arithmetic, I/O techniques, higher level languages and system synthesis.

preter program as well as the source program must be present in memory. But interpreters are easier to implement in a small memory space than compilers.

Show me the bottom line

You probably want a computer simply to help you solve your problems economically. To you, computer software is essentially applications software. While many "canned" programs are available, chances are that you will need to develop (and test and debug) most of your own programs.

The choice of language for writing application programs ranges from fundamental machine code, all the way to natural language. Compared with higher-level language, machine code and assembly language are difficult to program, and require longer development time, but result in less code, less storage, and higher execution speed. Natural language, at the other extreme, can be understood by few, if any computers. Such higher-level languages, as Fortran, Basic, Cobol and PL/1, are compromises which offer reasonably easy program development without excessive storage requirements or execution time. In any specific application, the nature of the problem, the skill of the programmer, and the importance of development cost in relation to production cost determine the choice of the most suitable language.

Data bus to memory lane

Microcomputers, like their bigger brothers, are constructed from the functional elements in Fig. 1: data representation, the registers, the arithmetic/logic functions, the memory organization, the input/output structures, the data paths, the control sequences, and other features that enable the computer to transform data.

The organization of these elements in a specific computer is its "architecture." It affects all aspects of the computer's operation, including the signals necessary to control data transfers between main memory, input devices, output devices, and the ALU/control unit. The ALU and control unit together are often called the "central processing unit" (CPU).

The data paths (or "buses") determine how data can be moved around in the computer. The more freely data can be transferred between registers, memory, and I/O devices, the more powerful and versatile the computer.

Every computer has at least one bus, but many have two or more. Multiple buses permit several data transfers simultaneously, resulting in a higher processor speed. Multiple bus structures can also simplify the required control logic.

Microprocessors frequently have one bus for data and one bus for memory addresses.

Just as important as the number of buses is the number of bits a bus will carry at one time. This is often referred to as a word or a data element. Word size not only determines the size of the other architectural elements but also affects the way the computer represents data, instructions, and memory addresses. For example, a common microprocessor word length is 8 bits. An 8-bit machine can represent only $2^8 = 256$ unique data values. If a single word is to be used for arithmetic, only 256 data values can be represented. If the word is a machine instruction, the machine can have only 256 instructions.

One way around these limitations is to use instructions made up of several words. Single-chip microprocessors usually use words of 4, 8, or 16 bits. Minicomputers are commonly available with word sizes of 12, 16, 18, and 24 bits, while larger computers come in word sizes of 24, 32, and even 60 bits.

Are the buses fully loaded?

Word length determines not only the capacity of buses, but also the size of registers and memory. While most registers fit the size of the computer's basic data word, register length can also be either smaller than, or a multiple of, the word length.

Registers are classified according to the function they perform in the CPU. Address registers, data registers, instruction registers, index registers, counters, status registers, general-purpose registers, accumulators, and program counters, are all commonly used registers.

When comparing microprocessors, the registers you are really interested in are extra accumulators, index registers, and general-purpose registers. These enable you to construct complex operations with a minimum number of acrobatic memory and register interchanges. General-purpose registers are especially valuable because they can be used to hold temporary results, addresses, and other data, without reference to memory, and so speed up program execution to the programmer.

The arithmetic logic unit (ALU) transforms data as dictated by the program being executed. Composed of registers, shifters, flag bits, and hardware logic, the ALU performs a fixed set of arithmetic and logic operations, each represented by a unique machine instruction.

Most ALU operations have two operands—one held in the accumulator, and the other in a data register, until the operation is complete. The result usually ends up in the accumulator. Basic instructions include adding numbers to the contents of the accumulator; clearing or complement-

ing the accumulator; and incrementing or decrementing the registers. By using sequences of these basic functions, you can build up arbitrarily complex functions. More sophisticated computers provide subtraction, multiplication, division, complex logic functions, floating-point arithmetic and BCD arithmetic.

Flag down that bus

The ALU often indicates the result of its operations with "flags" that can be tested by the control unit. Their status may determine subsequent operations. Commonly used flags include carry, zero, sign, parity, interrupt status, cycle status, and I/O status.

Although registers can be used for temporary storage, the computer usually stores the program, input data, partially processed data, and data ready for output in memory. Every instruction code, every data word, and every result must be

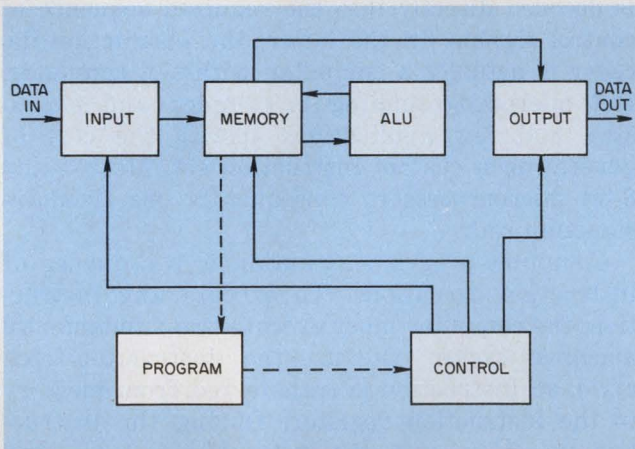

1. These components are present in all computers, regardless of size. The control unit and arithmetic/logic unit are sometimes combined and labeled CPU.

stored in memory of some sort.

Computer memory (or "storage") can be broadly divided into random-access memory (RAM), sequential-access memory, and off-line storage. RAM devices include core memory, semiconductor read/write memory and semiconductor read-only memory. Sequential-access devices such as discs, magnetic tapes, and paper tapes have access times that depend on the location of the desired data with respect to the read head. Off-line storage devices (primarily tape) have access times that depend on the speed with which the operator can find and mount the tape.

Because of the different access speeds, storage capacities, and costs of the various memory media, computers usually contain memory "hierarchies." Primary memory devices have access times ranging from 100 ns to 1 μ s, with—in microcomputers—1000 to 65,000 locations.

The most common on-line sequential-access storage is the magnetic disc, which provides from 150,000 to over 20 million bytes with access times between 5 and 100 milliseconds. But once the first element of a block has been located, transfer rates are high—from 250,000 to 2-million bytes per second.

Off-line storage devices, such as magnetic tape, have large, inexpensive storage capacity (for example, 30-million bytes) with access times ranging well into minutes.

Back to the main memory. It is usually organized in "banks" of parallel word-sized locations, each with its own unique address. One bank usually contains 1024 ($= 2^9$), 4096 ($= 2^{11}$), or 16,384 ($= 2^{13}$) words.

The memory is accessed by entering the parallel-address word of the desired location in the memory-address register, together with a read or write signal. The memory then either inputs the parallel data for that location to the memory-data register or outputs the data from the register. Microcomputer main-memory banks frequently consist of read-only memory and read/write random-access memory.

Traffic control for the data buses

Now you need to know one more thing: how data words get from one computer component to the other. There are five basic ways to reach words stored in memory.

- **Direct addressing**—The address of the operand's memory location is included as part of the current instruction.

- **Indirect addressing**—the current instruction contains an address, which in turn contains the address of the operand.

- **Immediate addressing**—the operand to be used, and the instruction are contained in the same word. In a microprocessor with only an 8-bit word this may not be possible. In this case, the memory location immediately following the instruction is often used to store the required data.

- **Relative addressing**—similar to indirect addressing, except that the address of the operand's memory location is computed by adding the contents of the program counter to the immediate data included with the instruction.

- **Indexed addressing**—similar to relative addressing, except that an index register takes the place of the program counter.

But even the fanciest computer will do you no good if you can't get data in and out. In many applications, therefore, the I/O structure is much more important than either a sophisticated instruction set or thousands of bytes of extra address space. Input devices range in complexity from toggle switches to extremely sophisticated

optical-page readers and spoken-language translators. Hardware-input operations such as smart terminals, data acquisition, data transformation, code conversion and buffering all increase the processor's efficiency. Sophisticated input devices often transfer data into the computer with direct memory access (DMA).

Output devices range from a row of pilot lamps to the most complex real-time interfaces controlling entire refineries. Even a computer can become the output device for another computer. Paper tape, magnetic tape and similar devices are often considered output devices although, technically, they are storage.

In some computers, the I/O devices are addressed in the same manner as memory locations. The I/O addresses are then actually part of the system memory space and all the various memory addressing modes can be used for I/O transfers as well. Such "memory mapped I/O systems" offer significant advantages because memory addressing is usually more versatile than I/O addressing.

Suppose you want to feed in data through an input device. How do you get the busy processor to listen? The interrupt structure of the computer comes to your help. It can range in complexity from a single interrupt line shared by all input devices to an elaborate scheme of independent lines and priorities.

The interrupt structure also determines how the processor responds to a particular interrupt. When, for instance, a DMA device transfers data, it stops program execution momentarily and takes control of the memory. Once the transfer is complete, the CPU is released to continue program execution.

Input and output routines account for a significant portion of the system's over-all performance. Because I/O software works so intimately with the system hardware it is especially important that I/O software and hardware mesh properly. You pay a steep price if they don't.

Who works the traffic lights?

The control sequencer, which resides in the CPU, translates instructions into sequences of signals that control computer operation. Instructions from the instruction register are decoded by the logic network in the control section. The outputs of this decoder, the signals and flags which indicate computer status, and the output of the "clock," are combined in the control sequencer. It, in turn, produces the signals that control data flow throughout the computer. Based on the instructions received, bus transfers, memory operations, I/O operations and ALU operations are all controlled by the control sequencer in this fashion.

The two most common control architectures are

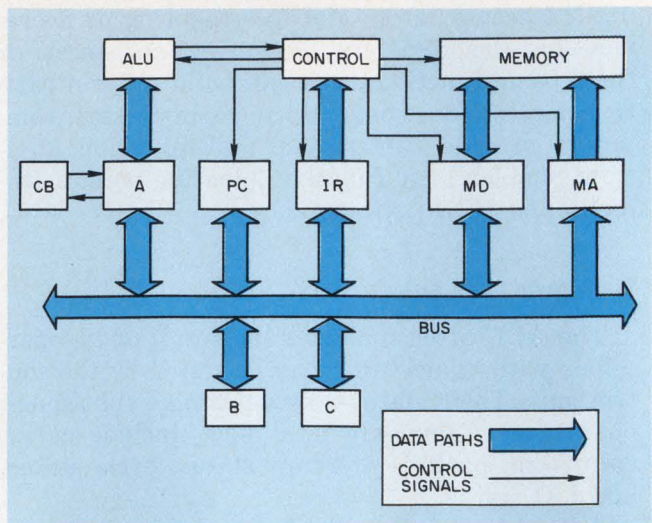

2. An example of computer architecture shows the interaction of the various building blocks through control signals and data transfers.

the fixed-logic and the microprogrammed structures. In the former, the instruction to be executed is decoded directly into the required sequence of control signals. In the latter, the instruction decoder is actually a computer within a computer. But microprogramming is complex and expensive, and few applications justify the cost of generating a custom instruction set. Most 4 and 8-bit microprocessors consequently use fixed instruction sets.

Computer-program execution is a sequence of instruction executions. To execute any instruction, the computer must execute two fundamental machine cycles. During the instruction-fetch cycle, an instruction is transferred from memory to the instruction register. During the instruction-execution cycle, the instruction is translated into control signals to the various "architectural" elements.

Look at the computer architecture shown in Fig. 2. This machine has one accumulator (A) with a carry bit (CB), two general-purpose registers (B and C), a program counter, an instruction register, a memory-data register and a memory-address register. To execute an instruction, the computer must be told which operation to perform, where the required operands are located, where to place the result of the operation, and how to find the address of the next instruction. The instruction fetched from memory provides only part of this information. The rest of the information originates in the control sequencer and is based on the "format" of the instruction.

Different instruction formats have different timing requirements. Detailed timing waveforms for each instruction format are usually provided in manufacturer's specifications.

Before sitting down to write software (or a purchase requisition for the hardware), be sure

that the intended computer is appropriate for your application. First, you must evaluate the instruction set.

Group instructions into four classes

Data-transfer instructions move data from one location to another in the computer system. Fig. 3 shows a matrix that helps in the analysis of such instructions. It lists all the data sources, such as memory and input devices, along the Y-axis, and all the data destinations (registers, output devices and memory) along the X-axis.

Now go through the instruction set and place the machine-language code in the proper grid locations to identify every data transfer that can be performed by the computer.

Fig. 3 uses two source/destination matrices for the 8080A microcomputer, one for 8-bit and one for 16-bit transfers. The top matrix lists the 8080's 8-bit registers (A,B,C,D,E,H,L,D8), 16-bit register pairs (BC,DE,HL), and memory locations. Except for I/O, registers and memory can be used as data sources or destinations.

The notation, (x), means "Contents of data source x." The notation, [yz], means "Memory location addressed by yz." Thus [(addr)] means "Contents of the memory location addressed by addr." This notation allows you to represent any data transfer in a clear and direct manner in the matrix. For instance, the instruction MOV C,B means "Move the contents of 8-bit register B to 8-bit register C," or in the general terms of Fig. 3, MOV D(estination), S(ource).

The source/destination matrix for the 8080's data transfer instruction set reduces several pages of text to one compact, easy-to-read document. All possible data transfer that can be performed with the 8080's registers, memory, and I/O devices are clearly represented.

Arithmetic/logic instructions, unlike data transfer instructions, modify the contents of an internal register or flag with an arithmetic or logic operation. These operations take data from one or more specified data sources, perform an arithmetic or logic operation on them, and place the result in a specified data destination. The contents of the data sources are called operands. For example, the operation ADD B uses two operands: the contents of the A and B registers. It performs the arithmetic operation of $A + B$ with them and places the result in the A register. In Fig. 4, this operation is entered as ADD S(ource). The location of the second operand and the destination of the result are understood to be the A register.

Fig. 4, the source/destination matrix for the arithmetic/logic instructions of the 8080, specifies the data sources along the Y-axis as before. However, along the X-axis, Fig. 4 specifies not only

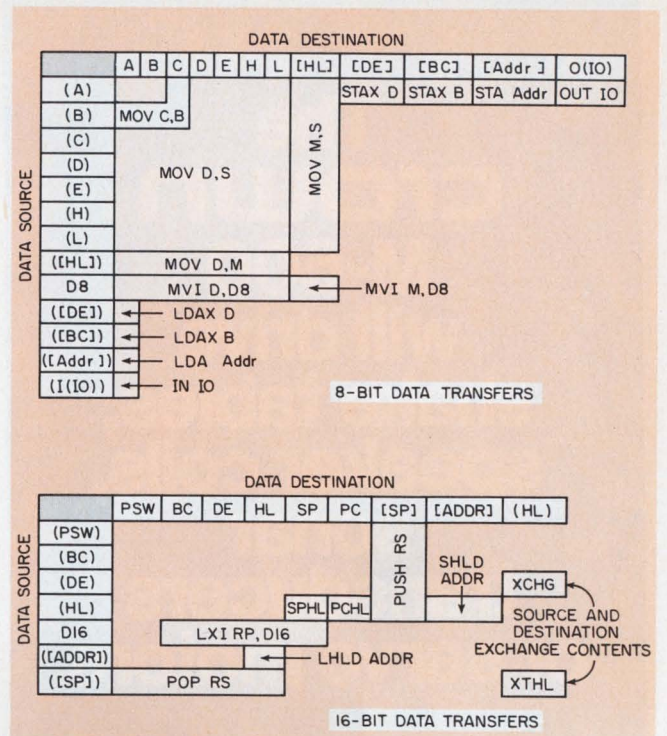

3. Data transfer instructions move data from their sources to their destinations. These instructions can be combined in matrices like the ones shown here for the 8080 microprocessor.

the data destinations, but also the operation performed and the flags affected (if any). Set and reset during arithmetic/logic operations, the flags can be tested and used to determine if conditional operations are to take place.

Processor-control instructions are usually used for enabling and disabling all or part of the I/O structure, conditioning the computers, response to interrupts, and halting program execution.

The 8080 has four control instructions. One is an instruction which does nothing (often needed, believe it or not), the second a computer halt, the third enables the interrupt structure and the fourth disables it.

Transfer of control instructions are used to transfer the program execution from the current program counter location to some other location in memory. These instructions are either "returning" or "nonreturning." A returning transfer saves the address from which it transfers; a nonreturning transfer does not.

The 8080 microprocessor offers both returned ("call") and unreturned ("jump") transfers of control. All these instructions are available in conditional and unconditional forms, and all four flags may be tested to determine if a transfer is to take place.

Subroutine calls are constructed as returning transfers. When the main program calls a subroutine, the processor saves the main program address where execution is to continue and trans-

(continued on page 96)

The CROWN M-600 will drive shake tables, speaker coils, sonar transducers or servo motors.

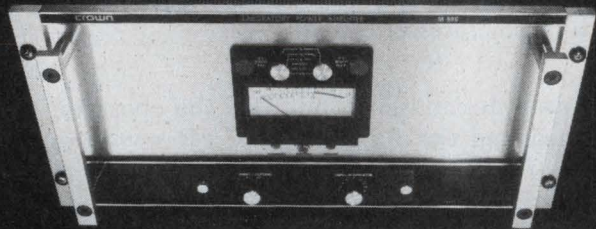

The Crown M-600 Amplifier is good at driving transducers, no matter what they're used for.

It's immune to damage from shorted, open or mismatched loads.

It operates continuously at full rated power.

It will give you up to 78 volts RMS. It will give you up to 1000 watts into 4 ohms, DC to 15 KHz. It works into any impedance. Compare the M-600 to any other amp in its frequency range, no matter what it's used for.

We're especially interested in helping you answer any application questions you might foresee for the M-600. Tell us your problem. We may already know a solution.



1718 W. Mishawaka Road, Elkhart, Indiana 46514

219/294-5571

CIRCLE NUMBER 54

	X = FLAG AFFECTED			O = FLAG CLEARED			BLANK = FLAG NOT AFFECTED			
C*	X	X	X	X	O	O	O	X		
Z	X	X	X	X	X	X	X	X	X	
S	X	X	X	X	X	X	X	X	X	
P	X	X	X	X	X	X	X	X	X	
	(A) + (S) → A	(A) + (S) + C → A	(A) - (S) → A	(A) - (S) - C → A	(A) ^ (S) → A	(A) * (S) → A	(A) / (S) → A	(A) - (S)	(S) + I → S	(S) - I → S
A										
B										
C										
D	ADD S	ADC S	SUB S	SBB S	ANA S	XRA S	ORA S	CMP S	INR S	DCR S
E										
H										
L										
[HL]	ADD M	ADC M	SUB M	SBB M	ANA M	XRA M	ORA M	CMP M	INR M	DCR M
DB	ADI DB	ACI DB	SUI DB	SBI DB	ANI DB	XRI DB	ORI DB	CPI DB		
(BC)										
(DE)										
(HL)										
(SP)										

* C = CARRY Z = ZERO S = SIGN P = PARITY
ARITHMETIC INSTRUCTIONS NOT CONFORMING
TO FORMAT : CMA, DAA

DAD RP	HL → RP
INX RP	(RP) + I → RP
DCX RP	(RP) - I → RP

4. Arithmetic instruction in the form of a source/destination matrix replace pages of definitions. Shown is the set for the 8080 microprocessor.

fers control to the subroutine. The subroutine performs its operations and its final instruction returns to the main program, using the saved address. Execution then continues.

ROMs can't return your call

Call/return systems can be implemented several ways. In minicomputers the main program-return address is often placed in memory at the location called by the subroutine. Actual execution then begins at the subroutine's second location. As the final step, the subroutine executes a jump to its first location, so control is returned to the address stored there.

This method doesn't work when the subroutine is stored in ROM, because there is no way to write the required return address into a read-only memory. To circumvent this problem, some computers have a special return-address stack (frequently just called "the stack") that operates as a "Last In, First Out" (LIFO) memory. This means the last address "pushed" into the stack is the first one to "pop" out. Thus, the last subroutine called is the first one returned.

All transfers of control, be they jumps, calls or returns, can be based on the state of internal processor flags. The specified transfer takes place when the specified condition is met. If the condition is not met, the instruction is ignored, and execution proceeds to the next instruction.

Transfers which first test the condition of flags are called conditional transfers. The mnemonic JNZ, for instance, means "jump only if the operand is not zero." Unconditional transfers are executed regardless of the state of the flags. ■■



Meet the Brite-Lites.[®] The brightest LED lamps in the business.

There are many excellent reasons why you should design our Brite-Lite[®] LED lamps into your next panel or printed circuit board. One of the best is ours are 25x brighter than most LED lamps. Simply, we offer you traditional incandescent-type brightness with proven solid-state reliability. That reliability amounts to at least 100,000 hours per lamp. In most cases, that's more than 10x the life of standard incandescent lamps.

Brite is colorful. Brite-Lites[®] are available in red, green, and amber. With the widest selection of clear and diffusing lens options you could imagine.

The combination of your choice. In addition to designing the brightest LED lamps in the business, we've come up with the most complete selection of packages. From convenient snap-ins to space-saving T² Lites[®] which enable you to design panel lamps right onto your PC boards. And, there are a number of current/voltage combinations you can specify. From 1.6 to 28 volts—10 to 35 milliamps. Complete with current-limiting resistors.

An outstanding delivery. Feature for feature, Data Display Products outperform, as well as outshine, the competition. Best of all, we don't keep you waiting. After all, fast delivery is an important part of its performance!

Let every design shine. One of the brightest things you can do is call or write us today. Get us in at the design stage of your project, where we can offer you the benefit of our thousands of applications. Then let us dazzle you with availability and performance. And when all is said and done, we'll do everything we can to make your design shine!

**"The brightest LED lamps
in the business."**

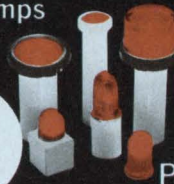
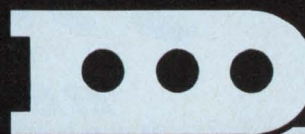

**DATA
DISPLAY
PRODUCTS**

5428 W. 104TH ST., LOS ANGELES, CA. 90045 (213) 641-1232

Meter Switch. New from Beede.

The optoelectronic switching device that combines analog indication with digital control in one compact, economical unit.

If you're an OEM project engineer with a control problem, discover how Beede has already solved it with the new Meter Switch . . . the advanced state-of-the-art analog indication/digital control device that's no larger than an ordinary panel meter.

Here are the facts about the Beede Meter Switch:

- Modern method of measuring and controlling variables gives you indication and control in same unit. Requires no designing time or costs on your part.
- Uses reliable optoelectronic switching. The optoelectronic switching circuits and panel meter are built into a single space-saving package. Takes up less behind panel space than other devices.
- Optical isolation eliminates the need for signal conditioning of input signal. Protects

from noise and ground loop problems. Provides for greater flexibility in selection of input signal transducers.

- Meter switch is flexible. Can be used to control, provide alarm, monitor any variable such as temperature, pressure, speed, current, voltage, force, weight, liquid level and many more.
- Can handle solid state switching devices such as SCRs and TRIACs, or system logic including TTL and CMOS.
- Available with L.E.D. optics (optional) for limited supply current applications and long term dependability.

- Priced as low as \$40.00 each in OEM quantities.

For complete details on this unique new product as well as application engineering assistance, write, wire or phone Beede today.

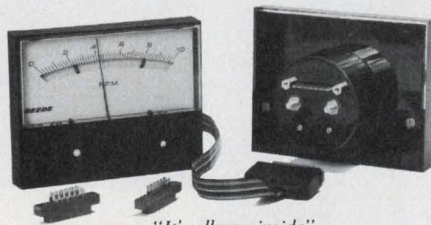

"It's all new inside"

BEEDE

Meters Indicating Excellence

BEEDE ELECTRICAL INSTRUMENT CO., INC., Penacook, New Hampshire 03301 (603) 753-6362 TWX 710-364-6977

CIRCLE NUMBER 242

MARK IV CONNECTION SYSTEM

It lowers your total installed cost.

Want to save on assembly time? Increase production? Buy in bulk? Reduce inventory? Simplify tooling? They're your system's real costs—your total installed cost—and we can cut them with our new flame-retardant plastic, UL-recognized Burgun-D Mark IV D Subminiature Connection System. It's a whole, low-cost, reliable production system built around our universal Burgun-D.

Crimp, removable contacts • Printed-circuit contacts, straight or 90° • Screw machine or stamped contacts • Semi-automatic strip and crimp—crimp



machine: 1500-2000 contacts per hour • 5 different connector sizes • 9, 15, 25, 37, 50 contact arrangements • #20-#30 wire sizes • Rugged metal shells • Complete accessories • Interchangeable, interchangeable, intermountable, layout for layout with

all D Subminiatures • Available at any authorized Cannon distribution center throughout the world.

Applications: computer peripherals; data machines; telecommunications; machine tools; consumer electronics.

Send for our "Cannon Cost Cutters" brochure today. ITT Cannon Electric, 666 East Dyer Road, Santa Ana, Calif. 92702. **Toll-free, 24-hr (800) 854-3573;** in Calif., **(800) 432-7063.**



Six decades on the leading edge of interconnect technology.

CANNON ITT



**Here in Wabash, Indiana
 Jim Smith gets to meet them all...
 Xerox... 3M... Eastman Kodak... RCA... Zenith...**

They stop at the station for gas and directions when they come to talk to Wabash engineers about transformers and high voltage power supplies.

Wabash, you see is an outstanding source of transformers to a long list of blue chip customers who have come to rely on the custom engineering, sophisticated product, automated winding, high volume production capability and competitive pricing Wabash offers.

Jim doesn't own the Chippewa Service Station—

but the bait house next door. His buddy, Hal Roser, often goes mushroom hunting up in Michigan and that's when Jim gets a chance to meet all these people. And Jim is pretty happy about it—especially since word has gotten back that Xerox, RCA, Eastman Kodak, 3M and Zenith enjoyed meeting Jim.

And, that's just another thing Wabash offers that none of the hundreds of other transformer manufacturers can. A chance to meet Jim Smith.

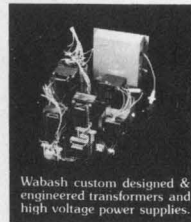

Wabash custom designed & engineered transformers and high voltage power supplies.

Coils, Relays & Transformers
wabash
 of
Wabash, Indiana
 and Huntington, Indiana; Farmington, Missouri;
 Tipton, Iowa and South Boston, Virginia
 For information and quotes write or call:
 Wabash, Inc., Dept. TA-1, 810 N. Cass St., Wabash, Ind. 46992 Tel: 219/356-8300 TWX 810-333-1533
 CIRCLE NUMBER 243

If you're considering a LOGIC ANALYZER or DATA GENERATOR, see the one that's both



It's a DIGITESTER...3 digital test instruments in 1.

Here are 3 ways you can use a DIGITESTER to reduce your digital logic design costs

INITIAL DESIGN...

It's a DATA/WORD GENERATOR

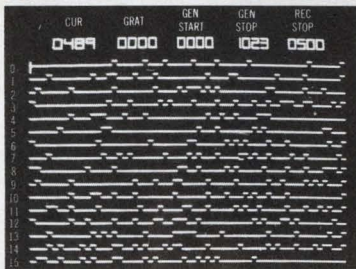

Generate 1024 serial bits to help you develop your communication products.

TROUBLESHOOTING...

It's a LOGIC ANALYZER

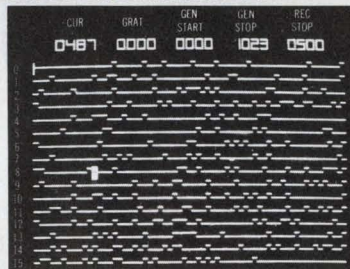

Serial look forward—look back lets you see up to 1023 bits on either side of Trigger Point.

TEST/RECEIVING INSPECTION...

It's a DATA COMPARATOR

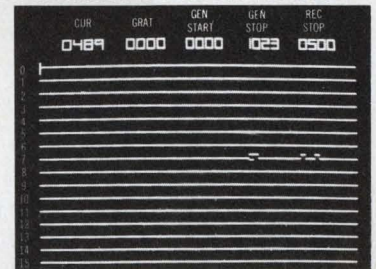

Compare serial response with known program in memory and see disagreement appear.

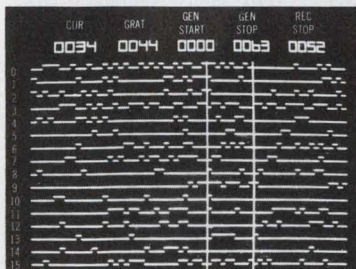

Generate up to 64, 16 bit words parallel so you can test your interfaces.

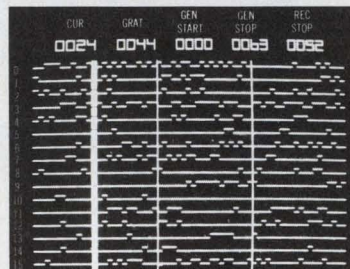

Parallel look forward—look back. Check "fault" symptoms on both sides of selected pattern.

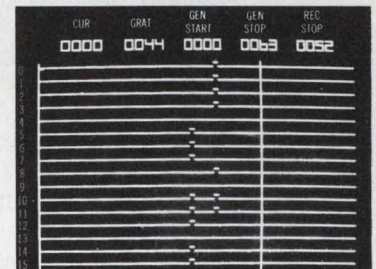

Compare input data with expected pattern in memory and see errors as difference bits.

The DIGITESTER Model 777 is the most valuable test instrument you can get for developing or testing digital logic products...including microprocessors.

To begin with, no other test instrument is quite like the DIGITESTER. It offers you unequalled flexibility for simultaneous or independent logic generating, logic receiving/analysis or comparison. Programs are stored in 1 of 4 internal memories, ready for transfer at variable data rates up to 20 MHz, internally or externally controlled.

You can generate any program with any number of "1" or "0" bits, by using the integral scratch pad keyboard...or an external source if you prefer.

Data is displayed jitter-free, on a 5" CRT. Cursor, graticule, generator start, generate stop and receive stop positions are numerically displayed on the CRT.

Of course the DIGITESTER has all front panel controls needed to make digital development and test work fast, easy and accurate.

You get 3 precision instruments in 1 with exceptional versatility for \$9495.00.

Contact the factory or your local Moxon sales engineer to find out about all the DIGITESTER'S capabilities and discover the savings you'll accrue compared to home-built pattern generators... plus you'll have the added savings of a logic scope. The DIGITESTER can pay for itself in a year. So be sure you see the DIGITESTER...it's the only one that's both a Logic Analyzer and Data Generator.



MOXON INC. • 2222 Michelson Drive • Irvine, California 92715 • Phone: (714) 833-2000 • TWX: 910-596-1362

CIRCLE NUMBER 244

THE SWITCHING SUPPLY HAS TANTALIZED YOU LONG ENOUGH!

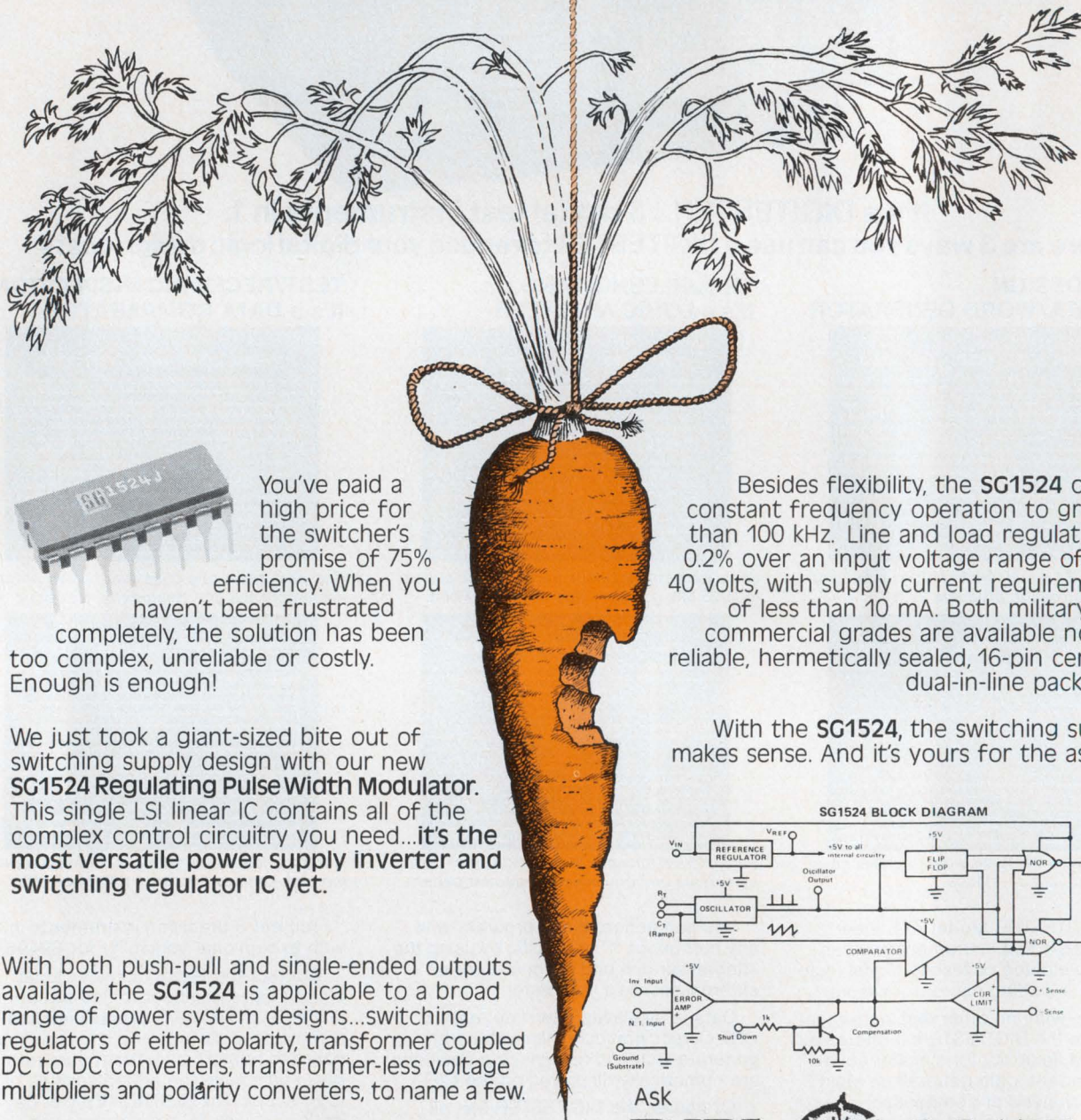

You've paid a high price for the switcher's promise of 75% efficiency. When you haven't been frustrated completely, the solution has been too complex, unreliable or costly. Enough is enough!

We just took a giant-sized bite out of switching supply design with our new **SG1524 Regulating Pulse Width Modulator**. This single LSI linear IC contains all of the complex control circuitry you need...it's the most versatile power supply inverter and switching regulator IC yet.

With both push-pull and single-ended outputs available, the **SG1524** is applicable to a broad range of power system designs...switching regulators of either polarity, transformer coupled DC to DC converters, transformer-less voltage multipliers and polarity converters, to name a few.

Besides flexibility, the **SG1524** offers constant frequency operation to greater than 100 kHz. Line and load regulation is 0.2% over an input voltage range of 8 to 40 volts, with supply current requirements of less than 10 mA. Both military and commercial grades are available now in reliable, hermetically sealed, 16-pin ceramic dual-in-line packages.

With the **SG1524**, the switching supply makes sense. And it's yours for the asking.

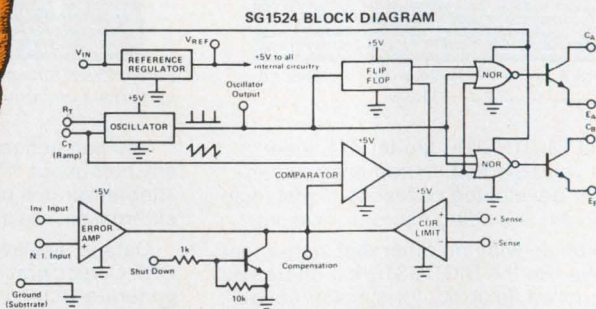

SILICON GENERAL
THE IC REGULATOR LEADER

Ask
DIPL MAT

For Immediate Delivery

With Diplomat Electronics, We're On Our Way.

Woodbury, N.Y. (516) 921-9373/Sunnyvale, Calif. (408) 734-1900/Clearwater, Fla. (813) 443-4514/Elk Grove Village, Ill. (312) 595-1000/Chicopee Falls, Mass. (413) 592-9441
Holliston, Mass. (617) 429-4120/Farmington, Mich. (313) 477-3200/Minneapolis, Minn. (612) 788-8601/St. Louis, Mo. (314) 645-8550/Little Falls, N.J. (201) 785-1830
Dayton, Ohio (513) 228-1080/Salt Lake City, Utah (801) 486-7227/International (516) 921-7920 Telex: 144678

CIRCLE NUMBER 245

MINI POWER

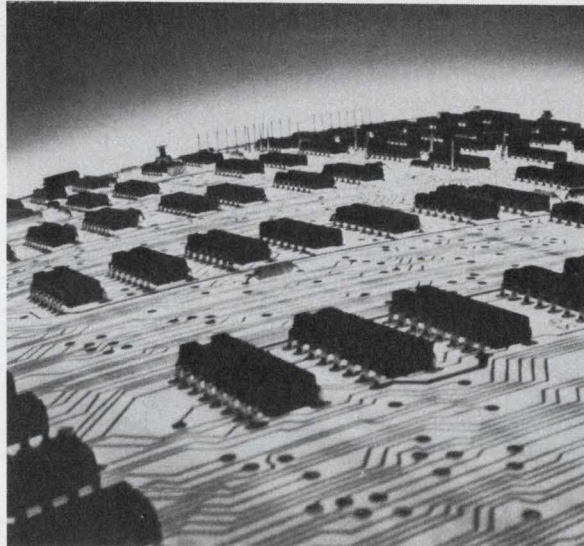

**OEMs Get Both
With The 5/16**

Interdata's 5/16 offers full scale mini-computer performance coupled with the economy of a microprocessor system.

By allowing OEMs to interface with I/O devices for the 8080 and 6800, the 5/16's unique Micro Bus substantially cuts total system cost. And, its Multiplexor Bus makes the 5/16 compatible with higher performance Interdata processors for simple upgrading.

Housed on a single board, the 5/16 is a full 16-bit processor with 16 general purpose registers and 114 instructions. Up to 64KB of 600 nanosecond NMOS memory. And field proven software, such as batch and multi-tasking operating systems, FORTRAN and BASIC.

The 5/16 delivers top power at a bottom price... \$868 in quantity. Standard benefits of Interdata's OEM minicomputer family.

Get the best of the mini and micro worlds. Call or write us today for a complete brochure with all the specs.

INTERDATA®

A UNIT OF

PERKIN-ELMER DATA SYSTEMS
OCEANPORT, N.J. 07757 (201) 229-4040.

\$868 MICRO PRICE

Compare Multiwire:™

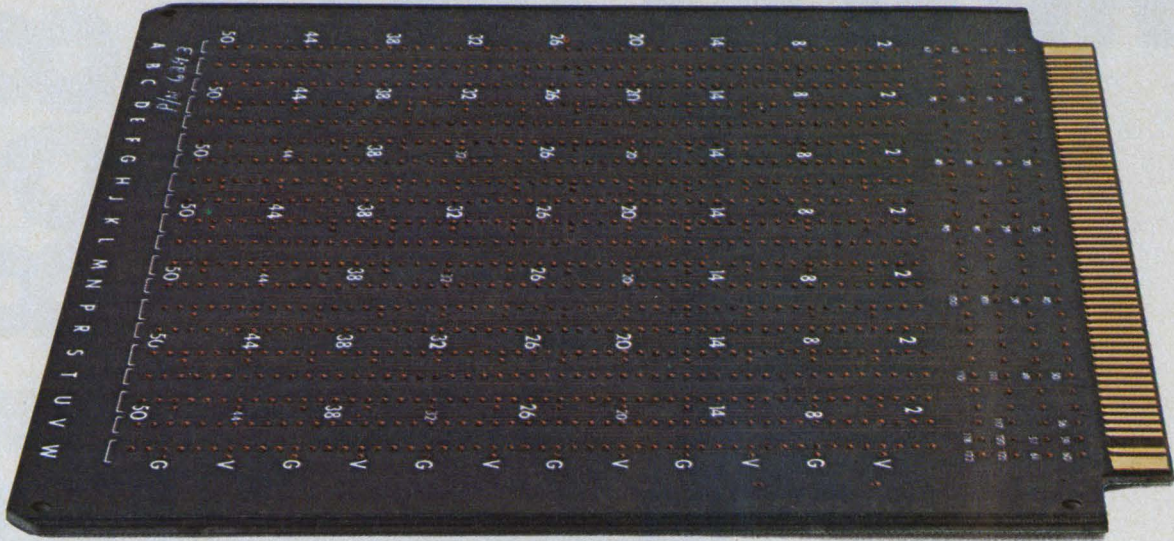

costs less than wirewrapping...

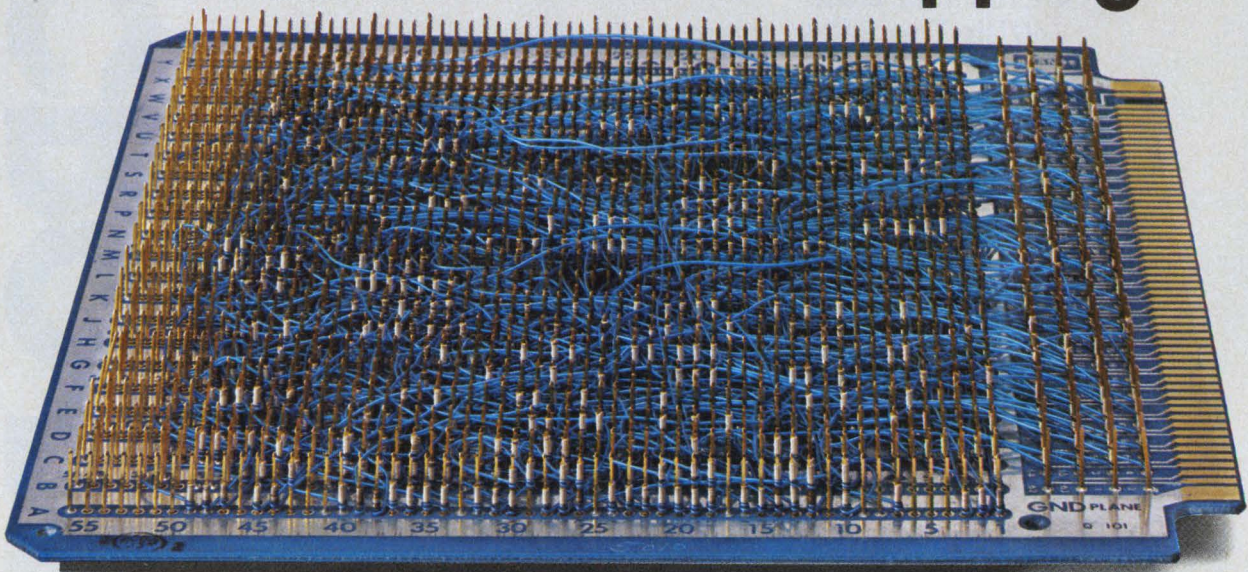

works better than multilayering.

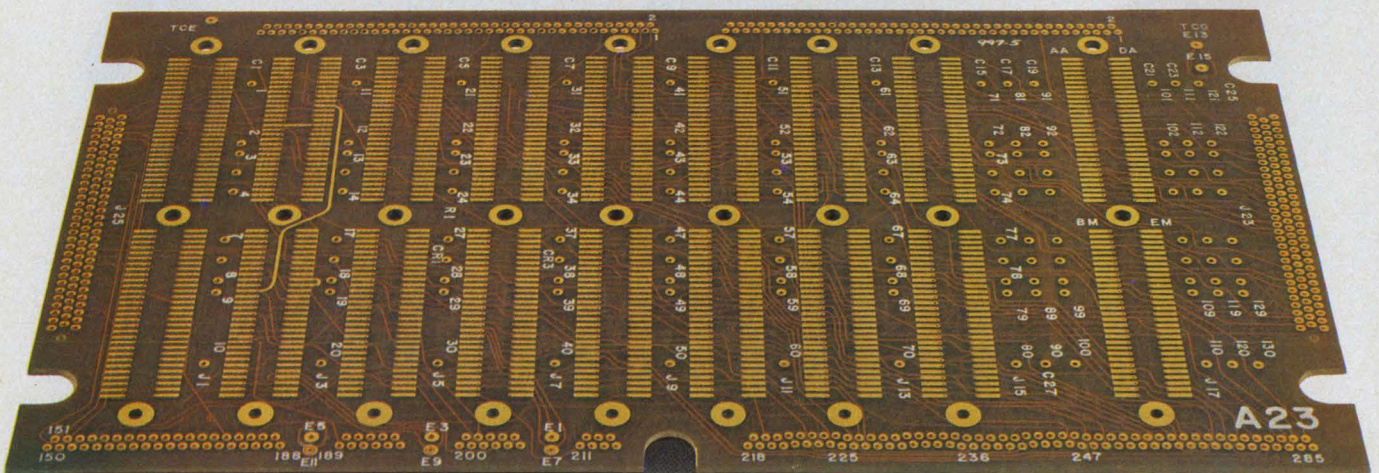

Two major systems—wirewrapping and multilayering—have been used for complex electronic interconnection in the last 15 years. Despite improvements and refinements, each still has inherent disadvantages. That's why Multiwire was created by Photocircuits. It overcomes the disadvantages of wirewrapping and multilayering.

A Multiwire board is basically a customized pattern of insulated wires laid down on an adhesive-coated substrate by a machine operating under numerical control.

Multiwire vs. wirewrapping.

Today, interconnection costs are more important than ever. So take a long, hard look at a key advantage of Multiwire panels. They cost much less than wirewrapping in small or production quantities. Multiwire prices also include a 100% continuity check.

But cost is not the only reason for the superiority of Multiwire over wirewrapping. There are also design advantages. For example, Multiwire offers two-dimensional packaging density equal to wirewrapping. But with Multiwire panels, you reduce board-to-board spacing. And Multiwire weighs much less too. So it can contribute substantially toward improving the envelope or three-dimensional package of your product.

Electrically, Multiwire is also superior. The extreme repeatability of the manufacturing process provides much higher electrical reliability as received—this is an important cost-saving factor. In addition, you get the controlled impedance characteristics required without variations.

Multiwire vs. multilayering.

With Multiwire, reliability goes up and inspection cost goes down. Multiwire doesn't need extensive inspection—like multilayering does—for nicks, pinholes, hairline cracks, spacing violations and bridging. Yet Multiwire regularly yields better than 99% reliability at incoming inspection.

Compared to multilayering, designing a new Multiwire board is a far simpler operation. Component locations and a wiring list are all we need. Our computer-aided system does the rest. Since the computer also handles deletions and/or additions, engineering changes are simplified. What's more, Multiwire makes it easier to find paths for interconnections, because the insulated wires can cross one another. For these reasons we can deliver finished Multiwire boards to your door in weeks rather than months.

The advantages of Multiwire over wirewrapping and multilayering vary from case to case. We'd like to help you evaluate possible time, cost, design and reliability benefits. For information and price estimates, call the Multiwire Marketing Department at 516-448-1117.

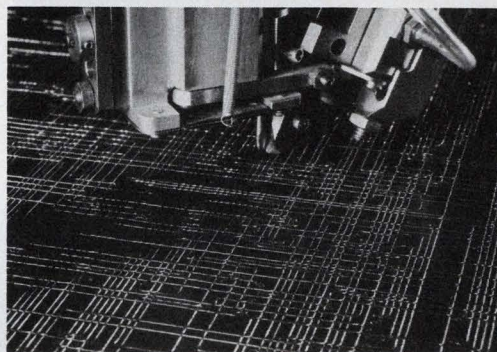
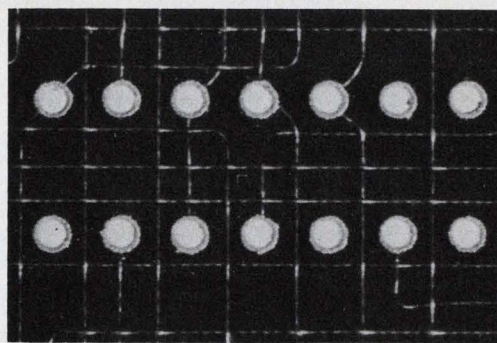

	Wrapped panels	Multi-layers	Multi-wire
Design & tooling cost	Low	Very High	Low
Design & tooling time	Short	Very Long	Short
1st piece delivery	Short to Very Short	Long	Short
Board cost in small quantities	High	High	Medium
Board cost in production quantities	High	Medium	Medium
2 dimensional packaging density	High	High	High
3 dimensional packaging density	Medium	High	High
Weight	High	Low	Low
Ease of changes	Excellent	Poor	Good
High speed electrical characteristics	Fair to Poor	Excellent	Excellent
Interchangeability with other techniques	Fair	Excellent	Excellent
Repairability	Excellent	Poor	Good
Controlled impedance	Poor	Good	Good
Electrical reliability as received	Fair	Good	Excellent

Visit us at Nepcon West, Booth 738.

Multiwire from Photocircuits

Division of Kollmorgen Corporation, Glen Cove, New York 11542

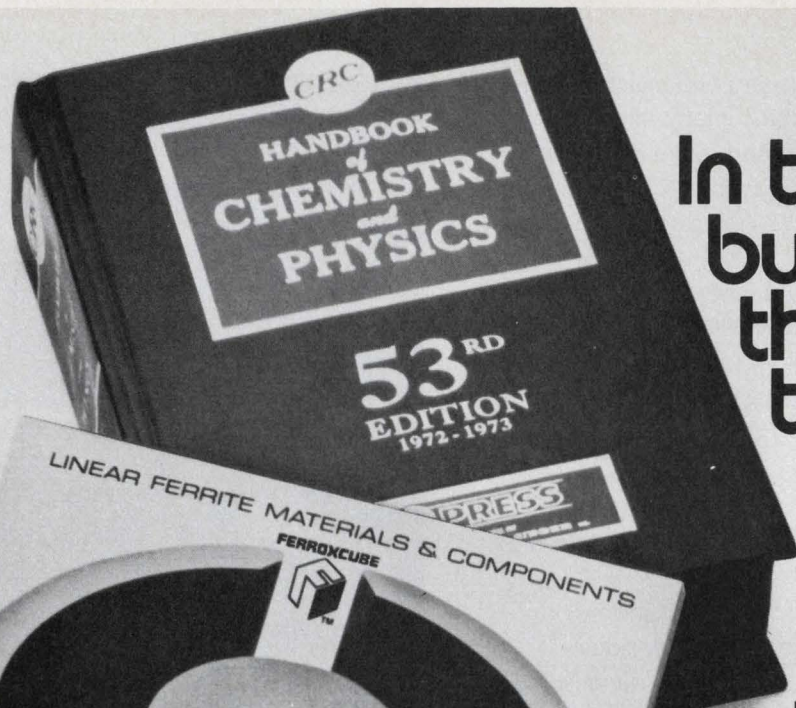

In this business, there are two reliable sources.

Having problems calculating efficiency, voltage or temperatures? Turn to the big book. Having problems designing for applications that demand high Q, high stability of inductance, and minimum volume? Or, low power losses at high flux density? Turn to the little book.

Turn to the Cube.

Ferroxcube offers the most complete, most diversified selection of linear ferrite materials. You get the electrical properties you want. In a broad variety of sizes and shapes. You get consistent quality. And you get delivery, when you want it, where you want it.

We're reliable. Ask the competition.

It's good business to second source yourself. The little book belongs on your bookshelf. Send for your free copy of the new Ferroxcube Linear Ferrite catalog today.



Ferroxcube Corporation

Saugerties, N. Y. 12477



Name _____

Title _____

Business _____

Address _____

City _____ State _____ Zip _____

ED-6-76



FERROXCUBE CORPORATION

A North American Philips Company

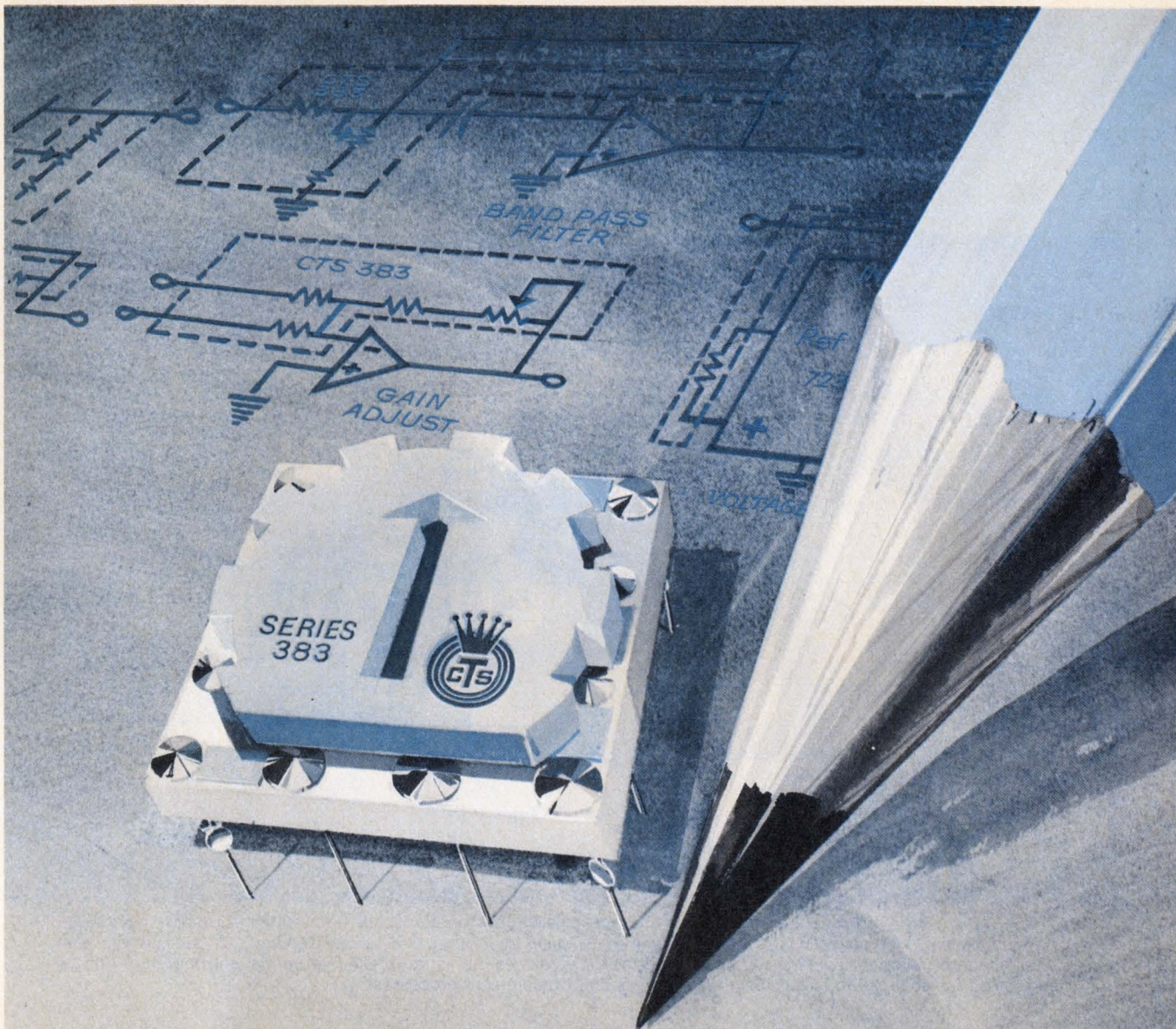

Specifying both resistors and trimmers? Here's a single solution from CTS.

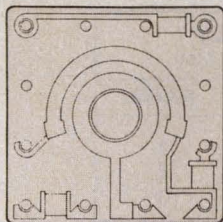

CTS proudly presents a single solution to many of the problems you face in specifying resistors and trimmers ... the Series 380 thru 384 Cermet Resistor/Trimmer combinations.

Have Board Space Problems? The Series 384 offers you up to eight fixed resistors plus a trimmer in a .46" square (.275" high) package.

Need Hefty Power Capability? All units in this Series can handle one watt at 70°C and ¾ watt at 85°C.

Need Cermet Stability? ± 250 ppm/°C is the standard temperature coefficient in this Series with ± 100 ppm available for your critical needs.

Want Rock Bottom Prices? The Series 383 (shown above) provides you combinations of three fixed resistors plus a trimmer for only 35¢ in production quantities. The Series 380 trimmer only is priced under 25¢. This economical space saving form factor is available as a trimmer only, in resistor/trimmer networks, and as resistor networks only. Let the Application Engineer from CTS Microelectronics help you decide which Series is best for your design.

CTS MICROELECTRONICS, INC., 1201 Cumberland Avenue, West Lafayette, Indiana 47906. Phone (317) 463-2565.

CTS CORPORATION

Elkhart, Indiana

A world leader in cermet and variable resistor technology.



ITT CANNON FOUND OUT...



Electronic Design IS BEST READ BY ITS CUSTOMERS AND PROSPECTS

Theodore Knudson, an American dedicated to assisting the European aerospace community at ESTEC, Noordwijk, Holland, states: "I usually read each issue of *Electronic Design* for its unique features. I also find E.D. useful in the form of a resource material depicting recent state-of-the-art advances that is not totally theoretical and therefore can be suggested for application in our real life designing and procurement processes."

If you read *Electronic Design*, you're in good company. Almost 90% of those firms who have taken the trouble to find out which magazines their customers read, rank *Electronic Design* in first position.

For example: ITT Cannon mailed 1,000 questionnaires to a portion of their prospect list (respondents to advertising and publicity releases in many publications).

The survey asked: "Designate in order of importance those publications which you are now receiving and read on a regular basis." Here are the top winners:

PUBLICATION	READ REGULARLY (ITT Cannon Prospect List)	
	REPLIES	RANK
ELECTRONIC DESIGN	732	1
EDN	668	2
ELECTRONICS	416	3

PASS THE WORD

Maybe your advertising brass doesn't know as much about the power of *Electronic Design* as you do. If your company wants to reach engineers and engineering managers . . . *pass the word*. Tell your sales, marketing and advertising people which publication will bring highest readership among the engineers who make the wheels go round in this industry . . . *Electronic Design*.

Electronic Design

BEST READ ELECTRONICS PUBLICATION IN THE WORLD

Now from IR the power people...

97 new High Energy Epi Base Power Transistors built to last!

We see no reason why all power transistors shouldn't live longer. That is why we're introducing 97 high energy, epi base power transistors and Darlington's, rated 40 to 140 Volts V_{CEO} sus, and 170 Volts V_{CEX} sus, with the same tough, hard glass passivation used on our high voltage line. It reduces high temperature leakage current to 1/10th that of others.

You benefit from our years of development of glass passivation processing by getting the added high temperature stability at no extra cost. It's typical of the extra value we've been putting into power semiconductors for more than 30 years.

These new transistors have higher switching speeds and lower V_{CE} saturation levels than single diffused types, a wide safe operating area, and high gains at 150°C junction temperature.

Delivery is off-the-shelf. Contact your nearest IR Salesman for prices, spec sheets and samples, or write to International Rectifier, 233 Kansas St., El Segundo, CA 90245. Telephone (213) 322-3331.

97 Types Now Available from IR

VOLTS	PNP	NPN	VOLTS	PNP	NPN
5 AMPERES			12 AMPERES		
100V	2N6226	2N5758	60V	2N6050*	2N6057*
120V	2N6227	2N5759	80V	2N6051*	2N6058*
140V	2N6228	2N5760	100V	2N6052*	2N6059*
8 AMPERES			15 AMPERES		
60V	2N6053*	2N6055*	40V	2N6469	2N6470
	IR900*	IR1000*	60V	2N5879	2N3055
80V	2N6054*	2N6056*		2N6246	2N5881
	IR901*	2N6534*			2N6471
		IR1001*	80V	2N5880	2N5882
		2N6535*		2N6247	2N6472
		2N6536*	100V	2N6029	2N5629
120V		2N6537*	120V	2N6030	2N5630
10 AMPERES					IR3773
40V		2N6383*	140V	2N6031	IR6302
60V	2N3789	2N3713			2N5631
	2N5791	2N5715	20 AMPERES		
	2N5875	2N5877	60V	2N5745	IR3772
	IR2500*	2N6384*		2N6285*	2N6282*
	IR645*	IR1010*	80V	2N6286*	2N5303
		IR1020*			2N6283*
		IR3000*	100V	2N6287*	2N6284*
		IR640*	25 AMPERES		
80V	2N3790	2N3714	60V	2N5883	2N5885
	2N3792	2N3716	80V	2N5884	2N5886
	2N5876	2N5878	30 AMPERES		
	IR2501*	2N6385*	40V	2N4398	IR3771
	IR646*	IR3001*			2N5301
		IR641*	60V	2N4399	2N5302
100V	2N6229	2N5632*	90V	IR4502	IR802
	2N6248	IR642*			
120V	2N6230	2N5633			
140V	2N6231	2N5634			

*Darlington

International Rectifier

... the innovative semiconductor people



Bodine offers a broad line of fhp motors, gearmotors and speed controls.

More than 4000 standards. Hp from 1/2000 thru 1/3. Torques . . . 0.3 Oz-in. thru 350 Lb-in. Customs and specials . . . available in small and large quantities. Bodine distributors STOCK more than 425 motors, gearmotors, speed/torque controls. Call 312-478-3515 . . . or write for Catalog S. Bodine Electric Co., 2500 W. Bradley Place, Chicago, Illinois 60618.

**BODINE
ELECTRIC
COMPANY**

BODINE MOTORS
GEARMOTORS
SPEED CONTROLS

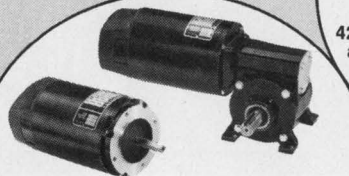

New 32A Permanent Magnet D-C Motors and Right Angle Gearmotors. Only 3.55" in diameter. TENV Hp 1/12 thru 1/8 at 2500 Rpm. Many gear ratios available.

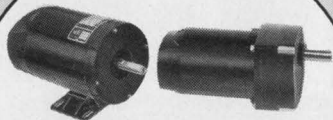

42A Permanent Magnet D-C Motors and Parallel Shaft Gearmotors. Just 4.30" in diameter. Motors TENV 1/8, 1/6, 1/4 Hp. Gearmotors have helical steel gearing.

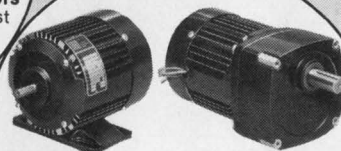

42R Induction Motors and Parallel Shaft Gearmotors. Motors 1/20 thru 1/4 Hp. All A-C winding types. Gearmotor ratios to 300:1. Helical steel gearing.

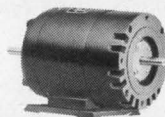

Torque Motors. Selected K-2, N-line and 48R motors for holding, positioning and winding applications. Intermittent and continuous duty. Standard ratings 7 thru 92 Oz-in.

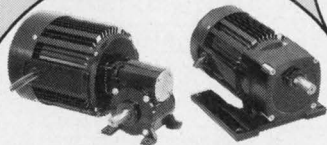

48R Induction Motors . . . Right Angle and Parallel Shaft Gearmotors. Motors thru 1/3 Hp. Available 115/230V in 50 or 60 Hz. Gearmotor ratios thru 30:1.

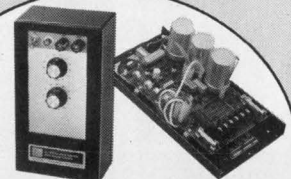

Encased and Chassis-type Speed Controls for Permanent Magnet Drives. Provides not only speed adjustment, but also adjustment of torque output. Available from stock.

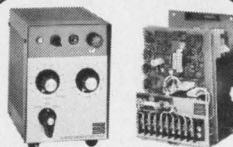

Encased and Chassis-type D-C Motor Speed Controls for Shunt Wound D-C Control Motors and Gearmotors. Nine encased models and four chassis models stocked.

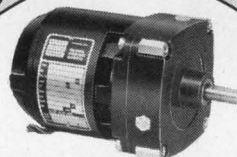

N-1S Gearmotors. Special purpose gearmotors for applications not requiring the ruggedness of the N-1D. In-line shaft. Only 3.41" square. 100 lot minimum order.

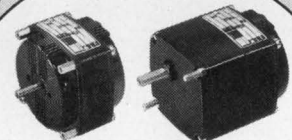

K-2 Line A-C Motors and Gearmotors. Instrument quality. Normal slip, high slip, and synchronous windings. Gearmotor torques thru 120 Oz-in. Only 2.405" square. Stocked.



N-Line Motors. Three basic sizes: 3.36", 4.50" and 5.68" in diameter. Stock ratings from 1/125 thru 1/4 Hp. All popular windings are available.

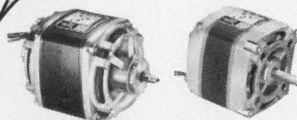

K-4 Motors. Special purpose motors for high volume applications. Standard ratings from 1/60 thru 1/20 Hp. Only 2.88" square. 500 lot minimum order.

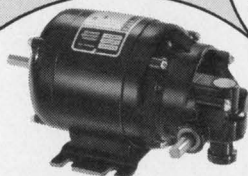

N-1R Gearmotors. Single and double reduction right angle worm gearmotors. Stock ratings thru 5 Lb-in. Many ratios available for a wide range of speed selection.

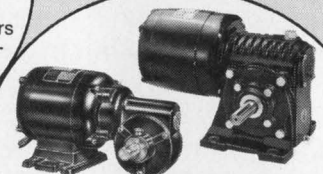

Single Reduction Right Angle Worm Gearmotors. 6 frame sizes with stock ratings to over 200 Lb-in. Ratios thru 60:1. Ample reserves for overloads.

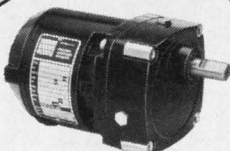

N-1D Gearmotors. Parallel shaft helical and spur gearing. Ratings thru 40 Lb-in. Ratios thru 900:1. Only 3.41" square.

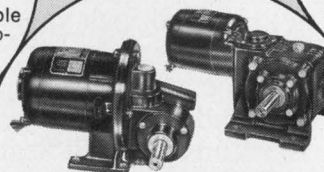

Double Reduction Right Angle Worm Gearmotors. Provide high torques at low speeds. Stock ratings over 200 Lb-in. Ample reserves for overloads.

SORENSEN IS THE SOURCE: FOR RELIABLE OPEN- FRAME POWER SUPPLIES.

SOC, our new line of open-frame power supplies:

- Standard voltages and package sizes
- 115/208/230 Vac input standard
- Made in U.S.A. with quality components
- No overshoot with turn-on, turn-off or power failure
- Stocked for immediate delivery
- Conservatively designed and rated
- Low heat dissipation, high temperature stability
- One-year warranty, worldwide service organization
- UL recognized

Model No.	Series	Output (Vdc)**	Output Current (A dc)*			Price
			@ 40°C	@ 50°C	@ 60°C	
SOC 2-3	A	2	3.0	2.4	1.8	\$32
SOC 2-6	B	2	6.0	4.9	3.8	54
SOC 2-10	C	2	10.0	8.0	6.5	67
SOC 5-3	A	5	3.0	2.4	1.8	32
SOC 5-6	B	5	6.0	4.9	3.8	54
SOC 5-10	C	5	10.0	8.0	6.5	67
SOC 12-1.6	A	12	1.6	1.3	1.0	32
SOC 12-4.0	B	12	4.0	3.0	2.5	54
SOC 12-6.0	C	12	6.0	5.0	4.2	67
SOC 15-1.5	A	15	1.5	1.2	1.0	32
SOC 15-3.0	B	15	3.0	2.6	2.2	54
SOC 15-5.0	C	15	5.0	4.2	3.5	67
SOC 24-1.0	A	24	1.0	.75	.55	32
SOC 24-2.2	B	24	2.2	1.9	1.6	54
SOC 24-3.5	C	24	3.5	2.9	2.4	67
SOC 28-0.8	A	28	0.8	.64	.45	32
SOC 28-2.0	B	28	2.0	1.7	1.4	54
SOC 28-3.1	C	28	3.1	2.6	2.0	67

* Free-air rating — no external heatsink.

** $\pm 5\%$ adjustable.

Common Specifications:

AC Input Power (VAC): 105-125, (190-226, 210 - 250 available by using taps on transformer.)

Frequency 50 to 63Hz. (Derate I_o 10% at 50Hz.)

Voltage Regulation (comb. line and load): $\pm 0.15\% + 6mV$ for 105 to 125 Vac and 100% load change.

Voltage Ripple and Noise: 1.5mVrms, 5mVpp.

Temperature Coefficient: 0.03%/°C.

Drift (24 hours): 0.2% after 1-hour warm-up.

Remote Sensing: 100mV maximum drop in each leg.

Operating Temperature: 0° to 60°C.

Storage Temperature: -20° to +85°C.

Overvoltage Protection: Available on all models except 2 volt. Specify by adding "VP" suffix to model number and add \$8 to unit price.

Current Foldback: Automatic, factory-set to approx. 140% of rated (40°C) output current.

Cooling: Convection.

Finish: Black anodize.

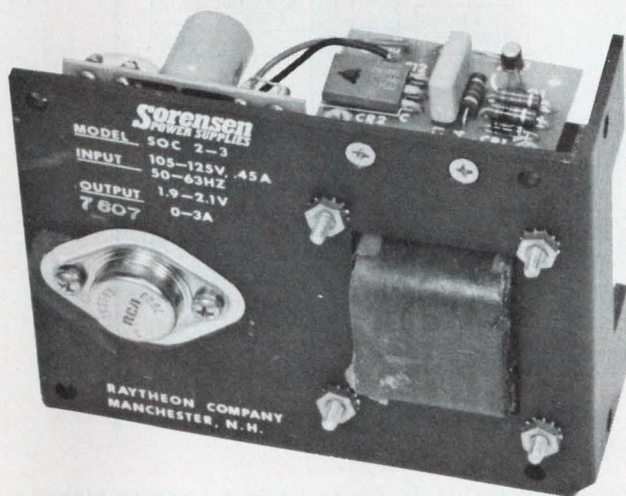

Call us for OEM discounts:

(603) 668-4500.

Sorensen

676 Island Pond Rd.,

Manchester, N.H. 03103.

SORENSEN
POWER SUPPLIES

A Raytheon Company

CIRCLE NUMBER 57

Put all input a/d channels under DMA control. A simple modification to the data-acquisition unit unburdens your system's computer.

Faced with a need for more input channels, faster responses and multiprogramming, today's data-acquisition systems go the direct-memory-access (DMA) route whenever possible. Although DMA is commonplace for modern minis and even micros, many converters still require program control for all but one channel. Fortunately, you can modify many existing multiplexed-analog input units to operate under DMA.

For example, you can boost from 1 to 16 channels the DMA capability of the 16-channel version of DEC's popular LPS-11 multiplexed data-acquisition system: simply replace one chip and

use two formerly spare gates.

The LPS-11 (Laboratory Peripheral System) consists of:

- The LPS-11S mounting unit, with front-panel and decimal display, bus control and power supply.
- The LPSAD-12, with 12-bit a/d converter, sample and hold circuit, 8-channel multiplexer and a/d control.
- The LPSAM expansion multiplexer.
- The LPSAD-NP direct-memory access.

In the beginning . . . one DMA channel

In this configuration, the unmodified LPS (Fig. 1) can handle 16 channels of 12-bit a/d under the computer's direct program control. Any one channel can be selected to operate under DMA. Under DMA, throughput speed is 50 kHz; under

Capt. Steven A. Oliva, Electronics Engineer, and **Capt. Richard L. Donovan**, Physicist, Armed Forces Radiobiology Research Institute, Bethesda, MD. **Allan H. Shimer**, Engineering Supervisor, LDP Engineering, Digital Equipment Corp., 1 Iron Way, Marlboro, MA.

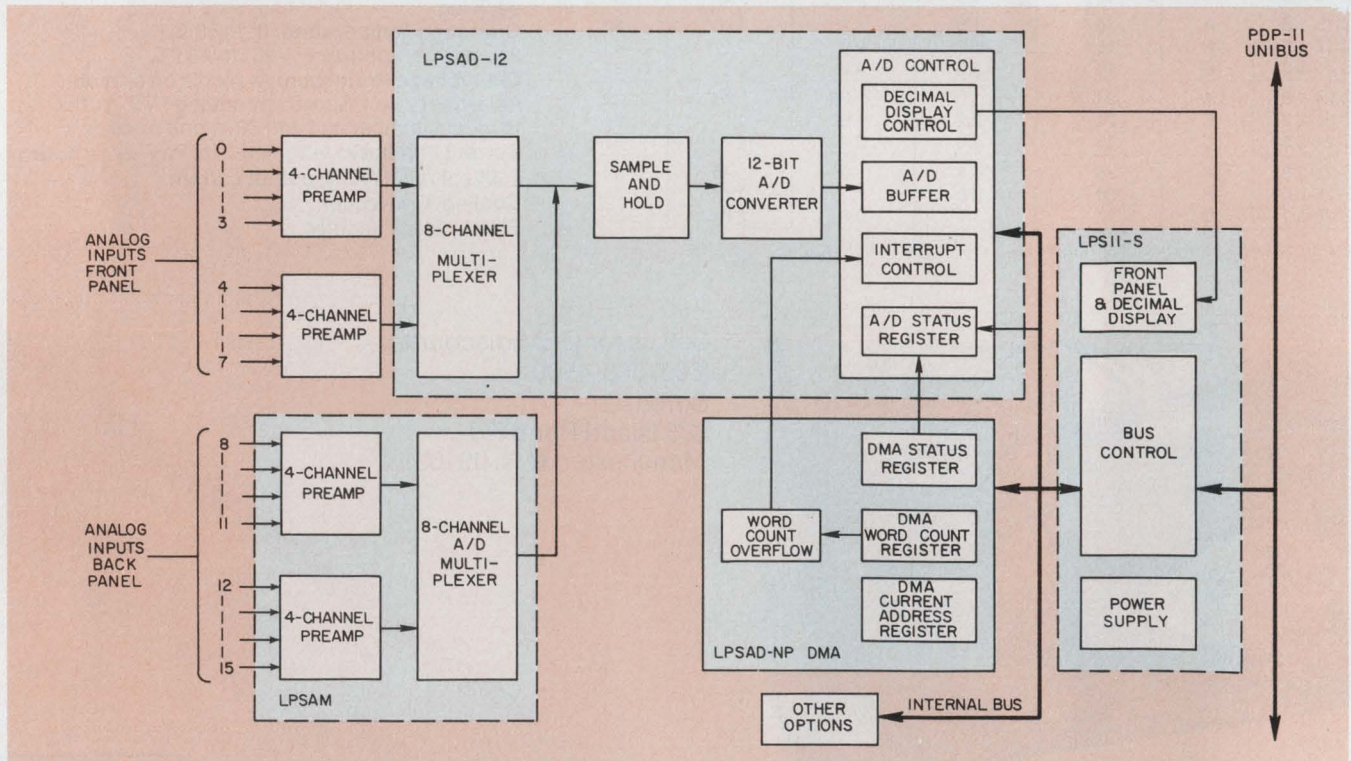

1. The basic data-acquisition system ties PDP-11 series computers to eight analog-input channels. System capa-

city is expandable up to 64 channels by adding eight-channel multiplexer units to the basic system.

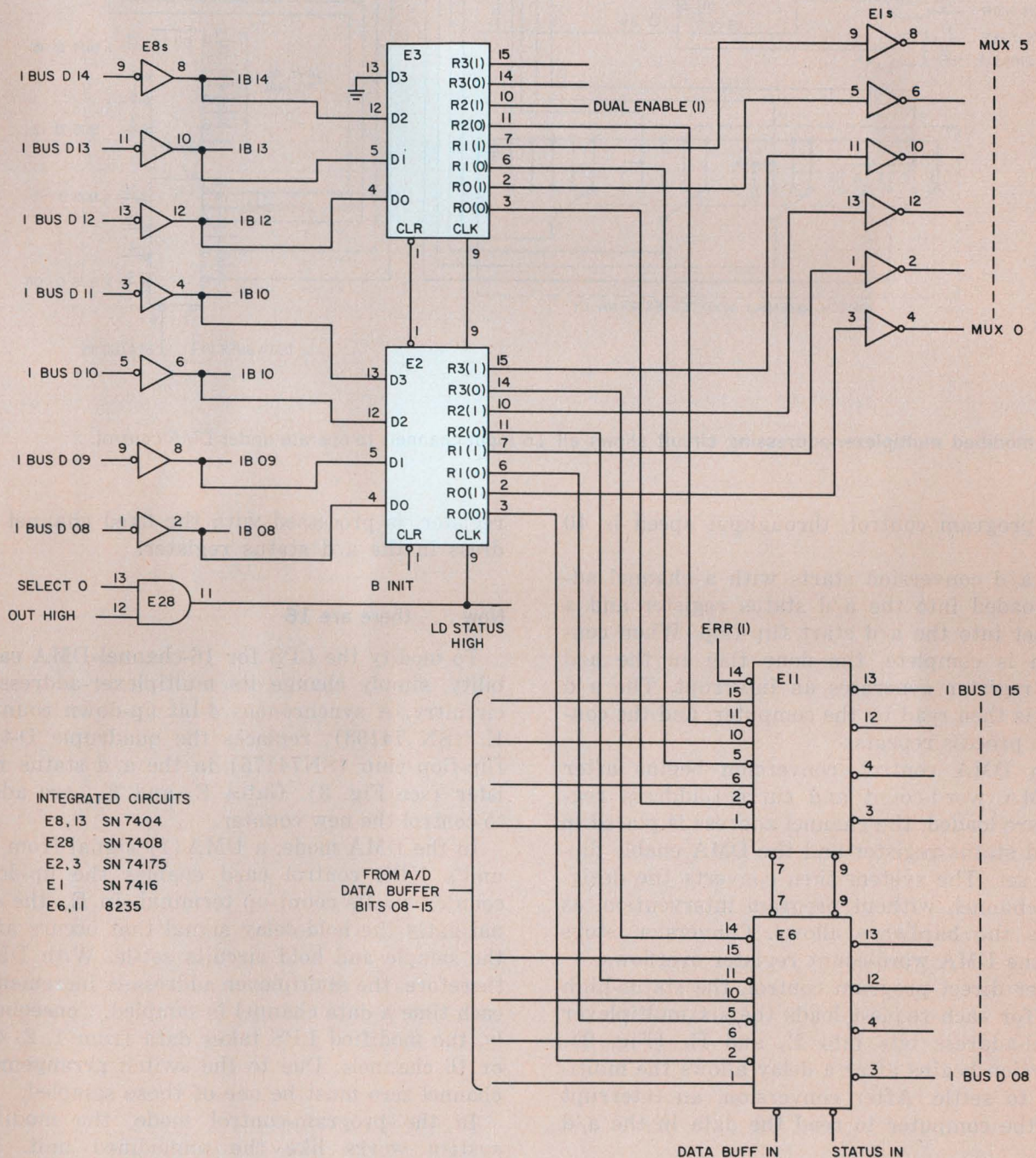

2. The original multiplexer-addressing circuit allows only one input channel to operate under DMA control.

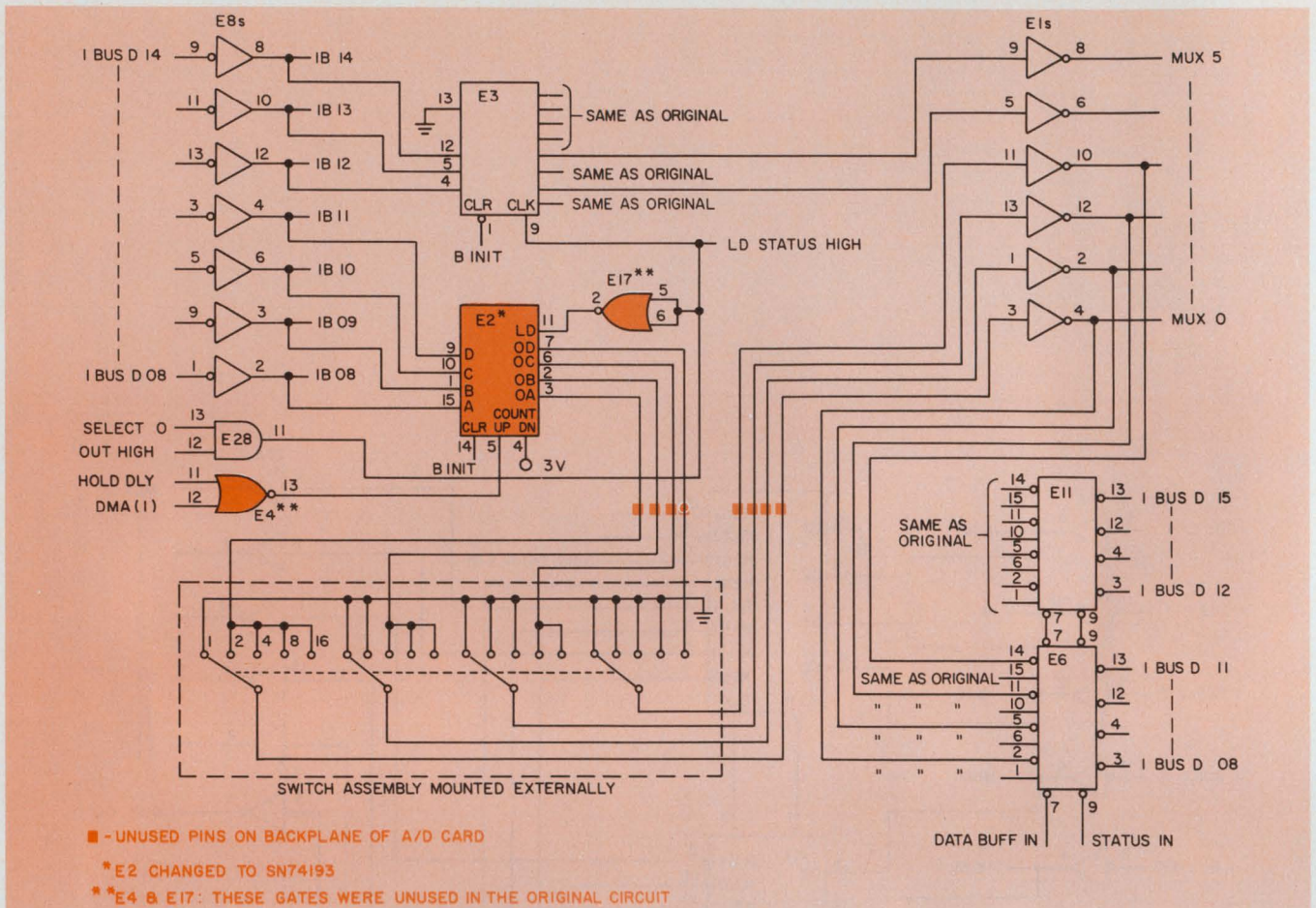

3. The modified multiplexer-addressing circuit allows all 16 input channels to operate under DMA control.

direct program control, throughput speed is 40 kHz.

The a/d conversion starts with a channel address loaded into the a/d status register and a ONE set into the a/d start flip-flop. When conversion is complete, the done flag in the a/d status register generates an interrupt. The a/d buffer is then read by the computer, and the conversion process repeats.

With DMA control, conversion begins after the DMA word-count and current-address registers are loaded, the channel address is placed in the a/d status register and the DMA enable flip-flop is set. The system then converts the designated channel, without program intervention, as fast as the hardware allows. Conversion stops when the DMA word-count register overflows.

Under direct program control, the status-high signal for each request loads the six multiplexer channel-address bits into E₂ and E₃ (Fig. 2). Conversion begins after a delay allows the multiplexer to settle. After conversion, an interrupt alerts the computer to read the data in the a/d buffer.

With DMA, the six address bits are loaded on the computer's start request. Then, the entire block of data, as determined by the word-count

register, is processed with the fixed channel address in the a/d status register.

Now . . . there are 16

To modify the LPS for 16-channel-DMA capability, simply change its multiplexer-addressing circuitry. A synchronous 4-bit up-down counter, E₂ (SN 74193), replaces the quadruple D-type flip-flop chip (SN74175) in the a/d status register (see Fig. 3). Gates E₄ and E₁₇ are added to control the new counter.

In the DMA mode, a DMA(1) signal from the unit's NPR control card enables the up-down counter via its count-up terminal. In E₄, the signal gates the hold-delay signal that occurs after the sample and hold circuits settle. With DMA, therefore, the multiplexer address is incremented each time a data channel is sampled. Consequently, the modified LPS takes data from 1, 2, 4, 8 or 16 channels. Due to the switch arrangement, channel zero must be one of those sampled.

In the program-control mode, the modified system works like the unmodified unit. The counter acts as a register. With the switch in the "16" position, E₂ is loaded through inverters, as before, by the load-status-high signal. ■■

Just as you can count on Newton's law,



you can count on Synchron[®] motors.

The synchronous motor you install in your product is likely to be the most important single component. So everything about that motor should be exactly right for your product. The speed, the torque, the price and the delivery, of course. The performance, the quality and the dependability. But, especially, its rightness for you.

What's exactly right for someone else may be exactly wrong for you. That's why it's almost impossible to find a ready-made synchronous motor



that meets your specs in every way.

We custom-make every Synchron motor. At a competitive price. To fit your needs, not ours. Delivered on time. Designed and built right, to do the job right. That's the only way we do business.

Call or write for our specification sheets and the name and location of our representative in your area.

Choose from five principal styles of Synchron motors—60 or 50 Hz—from one revolution per week to 900 rpm—from 8 thru 98 oz-in torque at 1 rpm—from hundreds of different outputs.

MALLORY



HANSEN MANUFACTURING CO.
a division of P. R. MALLORY & CO. INC.
Princeton, Indiana 47670

We make every Synchron motor as if our name were on your product

Stop counter errors. Check for gating problems with a simple test system, and your IC chip won't go 'down for the count.'

Use simple ripple counters whenever possible to avoid gating problems. But if you can't get away from synchronous counters, you must devise circuitry to guarantee a minimum pulse width at the counter input. Otherwise, problems stemming from inaccurate counting can snowball.

To determine the necessary width, set up and evaluate standard IC counters with a suitable test system (Fig. 1).^{1,2} Gating circuits can then be developed to compensate for any problems that may occur because the last gated clock pulse is an unpredictable narrow glitch (Fig. 2). This can be the culprit for many surprising results, particularly when you cascade several counter modules. For example, the glitch can cause counters to go from 15 to 0 or from 15 to 31, rather than to 16.

For each counter under test, the counter-test system shown in Fig. 1 generates a reset, a gate, and a counter-clock line, as well as a convenient oscilloscope synchronization line. Basic gate time is determined by the gate-time inputs to the pre-settable counter.

The one-shots in Fig. 1 provide for a variation in the leading and trailing edges of the counter gate. In the manual mode, a test cycle is generated only when you depress the manual reset button. The auto mode generates a test cycle every four milliseconds.

To catch a glitch

The test cycle is arranged so that both the leading and trailing edges of the counter gate can coincide with any desired portion of a clock pulse (Fig. 3). Both clock and counter-gate signals are sent to the counter under test, and the counter output can be observed with LED indicators. In the auto mode, the 4-ms period is so much longer than the actual counting time that LED flicker is not noticeable.

To test a counter like the 74193, use a simple

Otto R. Buhler, Senior Associate Engineer, IBM, P.O. Box 1900, Boulder, CO 80302.

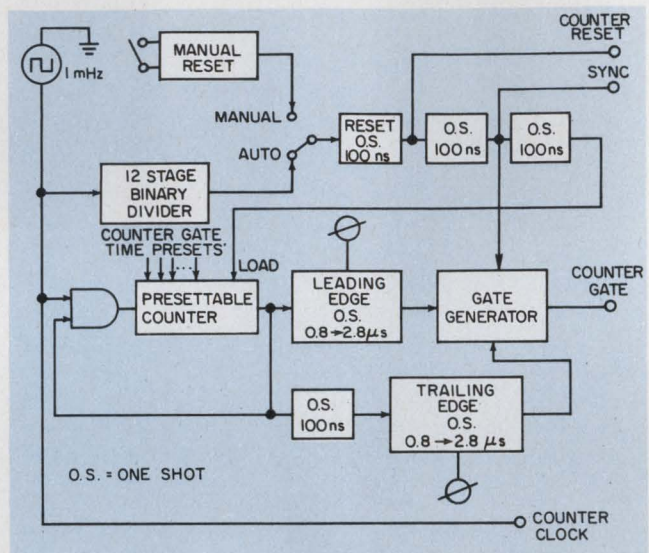

1. Counter test system generates signals to check for asynchronous gating problems in IC counters. The system provides both manual and automatic operation.

gating structure set to pass approximately 16 clock pulses (Fig. 4a). With the counter set to count up, adjust the trailing edge one-shot between the 15th and 16th clock pulses. At this point, glitch problems should begin.

For very narrow glitches occurring on the 16th clock pulse (CT UP), the counter remains at count 15. As the glitch widens, the counter returns to zero. As the glitch widens even more, the counter finally registers 16. Note the other in-between states—like count eight—that occur.

All told, the uncertainty region—where the counter does not register the true total—runs about 12 ns, from 18 ns to 30 ns. Apparently, there is sufficient energy in the clock pulse to reset the first counter module, but not to carry to the second counter module. Similar erratic operation exists in the count-down mode of operation.

One solution to the 74193 gating problem requires a $\overline{\text{CLK}}$ pulse prior to changing the status of the 74193 gating (Fig. 4b). This pulse ensures that a full CLK pulse is delivered without any glitches to the 74193. However, the circuit must produce the CLK and $\overline{\text{CLK}}$ pulses without

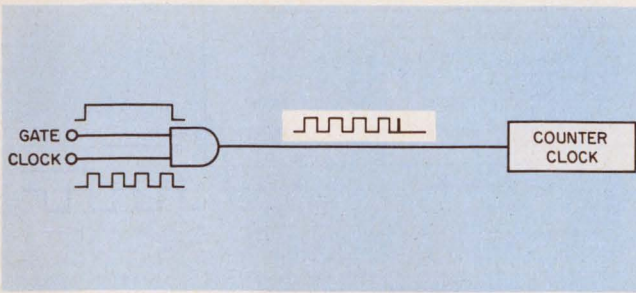

2. Bad counts can be traced to an unpredictable glitch in the series of pulses being gated to the counter.

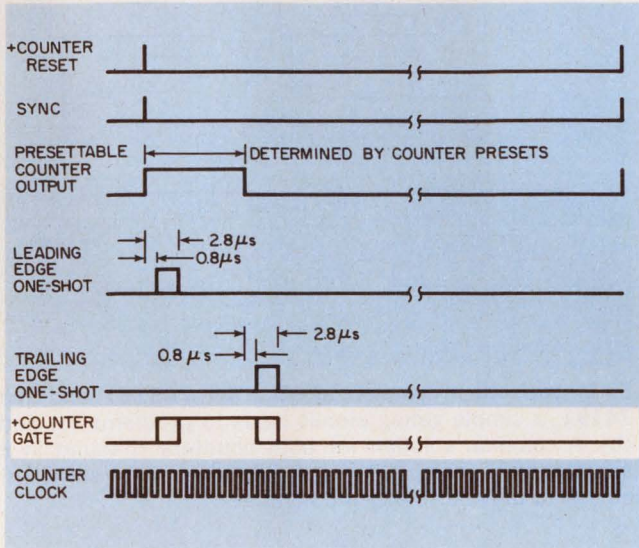

3. Counter-test cycle is arranged so that the leading and trailing edges of the gate pulse can be placed anywhere with respect to the clock pulses.

a time-skew overlap that can produce a glitch of its own.

A simple 7404 inverter or a 74265 complementary-output element cannot do it. But either the circuit in Fig. 4c or a 74193 gating circuit with a smaller module count can (Fig. 4d).

Getting energy where it's needed

In another standard counter, the 74S161, evaluating a simple gating structure (Fig. 5a) reveals a narrow region where, again, the count increases from 15 to 31 instead of to 16. There appears to be enough energy to carry to the next counter module, but insufficient energy to reset the first counter module. This situation is the opposite of the problem experienced with the 74193 counter.

Before seeking a solution, first look at one other counter module, the 74191. The counter gate is set up as shown in Fig. 5b. An evaluation reveals that a count of 20 is achieved—instead of 15 or 16—if the gate turns positive during most of the negative portion of the clock pulse.

Both pulse problems can be avoided with the

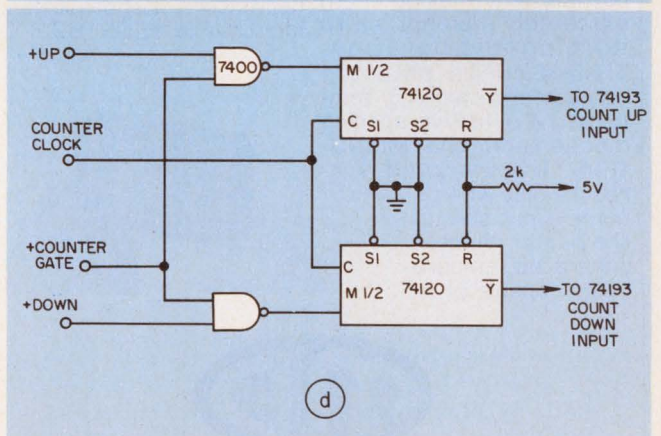
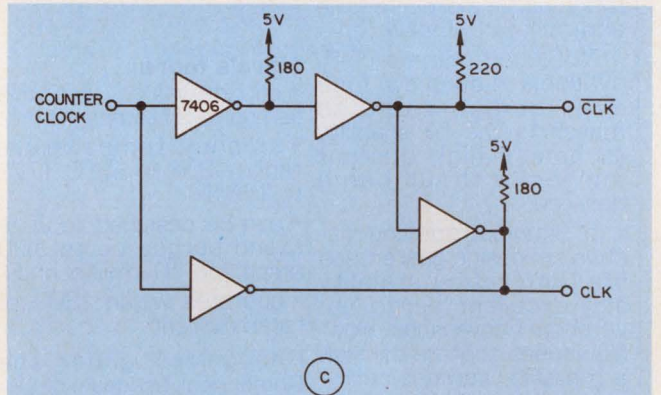
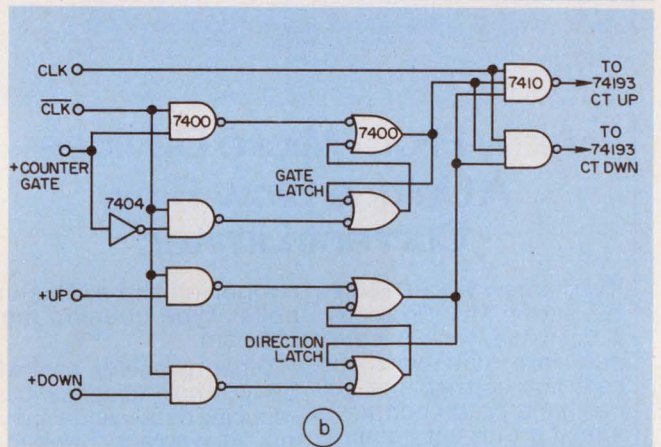
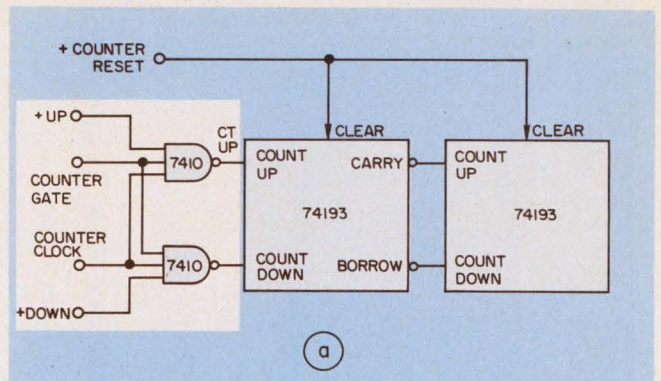

4. With a simple gating arrangement, a 74193 IC counter is found to have a gate-width region in which counts are unreliable (a). An alternative gating circuit does away with glitches (b). The circuit in "c" ensures that the necessary CLK and CLK signals don't overlap and so produce their own glitches. In "d," reliable gating is achieved with fewer modules.

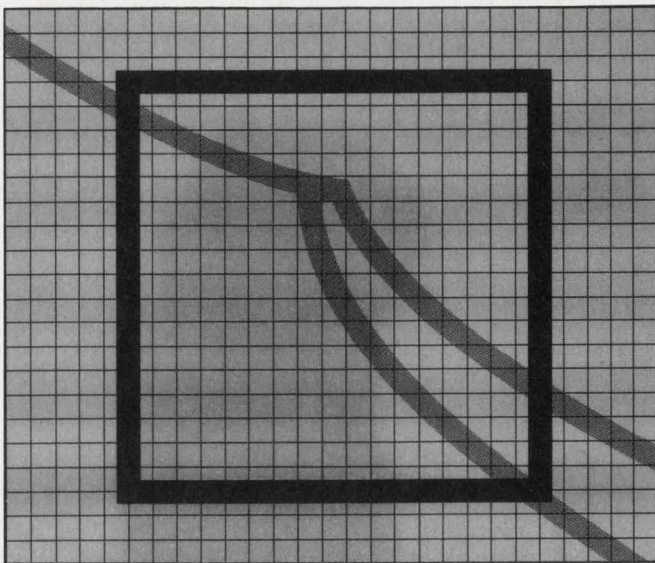

New From Micro Devices A Unique Slow-Blow Current Limiter.

It's the new MICROTEMP 5P Series MultiProtector. A versatile, yet extremely accurate slow-blow current limiter that lets you design-in protection for a specific current requirement within a precise time and current window.

No other commercially available slow-blow fuse even comes close to matching the 5P's ability to handle high current surges without being derated.

5P's unique opening mechanism design guarantees life time rating stability and excellent surge absorption. Conventional slow-blow fuses operate through a metallic, current carrying element making them extremely susceptible to surging and derating. Thanks to its patented non-current carrying temperature sensitive opening mechanism, the MICROTEMP® thermal cutoff reacts only when current put through the heater element generates temperatures capable of

triggering the exclusive pellet-type opening mechanism.

When properly applied, 5P will not nuisance trip reducing costly and annoying "in warranty" service calls.

Here's more:

- current values—500 milliamps to 3.5 amps
- ambient temperature range—25° to 65°C. (77° to 146°F.)
- can be designed to withstand surges up to 100 amps for 10 milliseconds
- operates within 130% of rated current

Recognized under the Component Program of Underwriters' Laboratories, Inc. UL File #E59187.

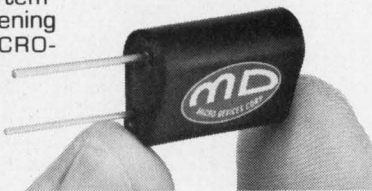

MICRO DEVICES

 DIVISION OF EMERSON ELECTRIC CO.
1881 SOUTHTOWN BLVD.
DAYTON OH 45439 513-294-0581
EMERSON®

CIRCLE NUMBER 59

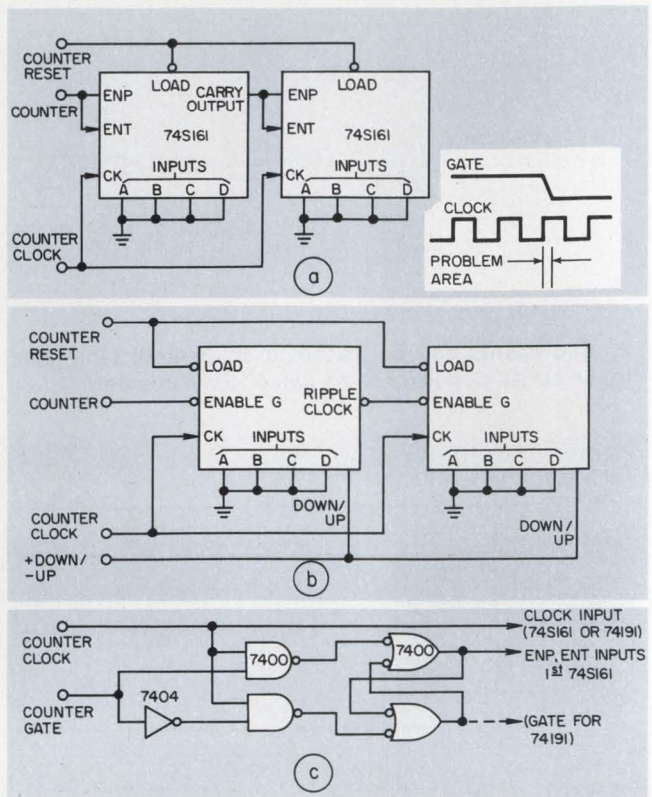

5. In two other commercial ICs, the 74S161 and the 74191, a simple gating circuit leads to problems (a) and (b). A common solution for both counters is found in a slightly more complex circuit that supplies sufficient energy to prevent timing problems (c).

same gating circuit. The circuit in Fig. 5c ensures that the gate changes state only after the clock goes positive. Sufficient energy is then provided to prevent the 74S161's timing problem. The 74191's inaccurate count can be corrected simply by taking the enable line from the gating circuit's negative latch output instead of from the positive.

Warning: A one-shot, sometimes used to generate a minimum-width input pulse, can generate glitches of its own when driven by glitch inputs. Connect a 74121 one-shot to a gated clock pulse from the counter-test system. The 74121 produces glitch outputs when the negative, edge-triggered input is driven by a negative-going glitch or when the positive edge-triggered input is driven by a positive-going glitch.

This test system touches only the surface. A complete system should be able to change the counter resets and direction in bidirectional counters. And observing the counter outputs with a digital-to-analog converter in the auto mode improves transient-failure detection. ■■

References

1. *The TTL Data Book for Design Engineers*, CC-411 First Edition, Engineering Staff of Texas Instruments, Components Group, Dallas, 1973, p. 333.
2. Morris, R. L. and Miller, J. R., Editors, *Designing with TTL Integrated Circuits*, McGraw-Hill, New York, 1971, p. 272.

The price of tin plated DIP sockets just took a big dip.

We've just snipped a big 20% off the price of our entire line of tin plated wire wrap DIP sockets. But we didn't cut any of the features. For example, you still get a 200 microinch minimum plating of tin. Universal mounting and packaging. Stand-off tabs on the base for solder flush. 94 V-O U.L. rated insulation material. Individually removable pins. And redundant contact points for low contact resistance, high reliability, and repetitive insertion.

The sockets are designed for automatic wire wrapping. And they're available in pin arrays from 8 to 40, including our new 20 pin configuration.

A lot of our other prices are low too.

We'd like to send you some free samples of our tin plated DIP sockets. We'll include literature and specs, of course. And just for good measure, we'll throw in our latest price list on everything we make. We think you'll find some surprises. Because a lot of our prices are lower than you think.

Just mail this coupon to Texas Instruments Incorporated, Attleboro, Massachusetts 02703. Or call Connector Systems Marketing, (617) 222-2800, Ext. 268 or 269. Reduced prices effective in U.S. and Canada only.



Texas Instruments Incorporated
Connector Systems Marketing
MS W-1, Attleboro, Mass. 02703

Name _____

Title _____

Company _____

Address _____

City _____

State _____ Zip _____

Please have a TI Field Engineer call

ED 1-77

TEXAS INSTRUMENTS
INCORPORATED

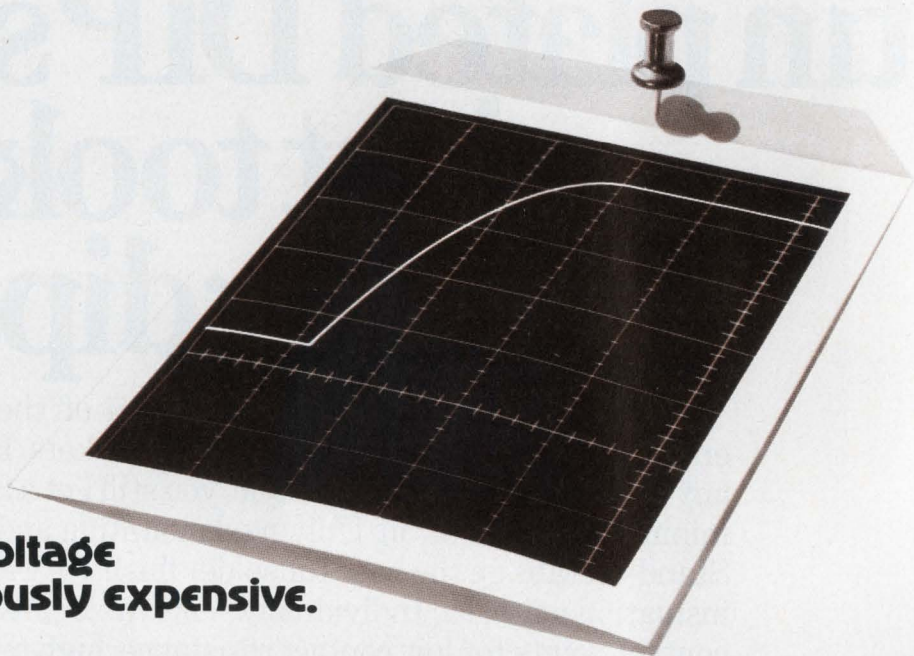

**Common overvoltage
condition. Ruinously expensive.**

**If you don't want to
pay a lot for this later,**

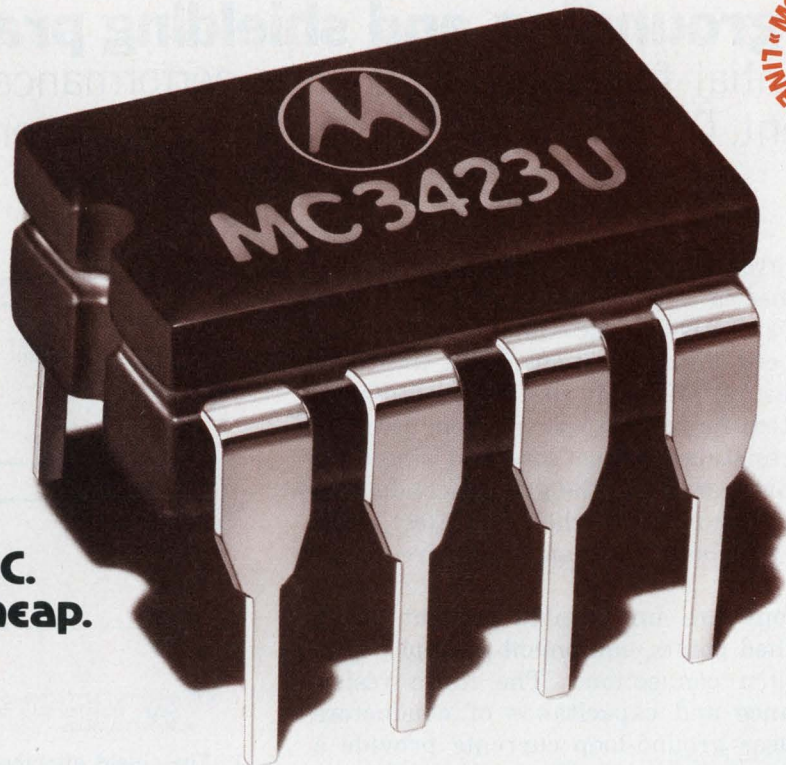

**Unique OVP IC.
Amazingly cheap.**

pay a little for this now.

The MC3423 over-voltage protector was specifically designed by Motorola to protect against transients or regulator failure that can destroy devices tied to power supply outputs.

And it's great at doing just that.

Coupled with an external SCR crowbar, like the new 25 A 2N6504, it senses overvoltage, triggers the SCR and shorts the supply output. This forces it into current limiting or opens the fuse or breaker.

Protection threshold is resistor-adjustable. And it can be programmed for min duration of overvoltage condition before tripping thus supplying noise immunity.

Voltage to Load

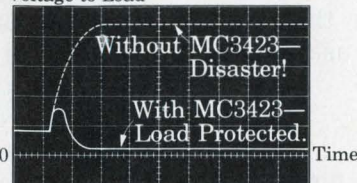

Now, isn't this better?

Turn-on propagation is just 0.5 Ms. Or you can remote-activate the CMOS/TTL-compatible

'3423 independent of whether or not overvoltage is present and make an orderly, sequenced shutdown of system power during faults. Neat, right?

And all you pay is a buck-seventy-five, 100-999. Cheap at twice the price.

Contact Motorola Semiconductor Products, Box 20912, Phoenix, AZ 85036 or your authorized distributor for data and samples.

We've got the original now, others may copy it later.



MOTOROLA Semiconductors
—and you thought we were just a production house

Good grounding and shielding practices

are essential for stable, noise-free performance of electronic equipment. Do it right initially and avoid future problems.

Improper grounding and shielding of power and signal lines is a major cause of noise interference in sensitive electronic equipment, especially in high-speed digital systems. And improper grounding occurs primarily because equipment designers often forget that every conductor to ground has resistance, inductance and shunt capacitance. Moreover, when the ground conductors form so-called ground loops, they can inject, radiate or pick up both low and high-frequency interference.

Ground loops are undesirable current paths coupling earthed points, equipment-ground points or signal-return connections. The finite resistance, inductance and capacitance of conductors that carry these ground-loop currents provide a common cross-coupling impedance to inject unwanted signals, noise and crosstalk into sensitive input circuits.

Obviously, resistance and inductance can be minimized with heavy cable and short lengths. Also, when connecting several facility equipments to earth, approximately equal cable lengths and sizes should be used. And each cable should go to a single ground point independently. Equal impedances to a single earthed point help equalize potentials between different units and reduce both the intercoupling of interference and shock hazards. Independent cables to a single earthed point eliminate common impedance paths among different equipment units. And a single earthed point avoids the ground-current circulation that can occur when several earthed points are used.

Grounding isn't enough

Although absolutely necessary for noise-free performance, proper equipment grounding is only a start. Since signal-carrying lines and cables are particularly vulnerable to noise pickup, they need special treatment. In addition to correct termination with the line's characteristic impedance, the following guidelines should be practiced:

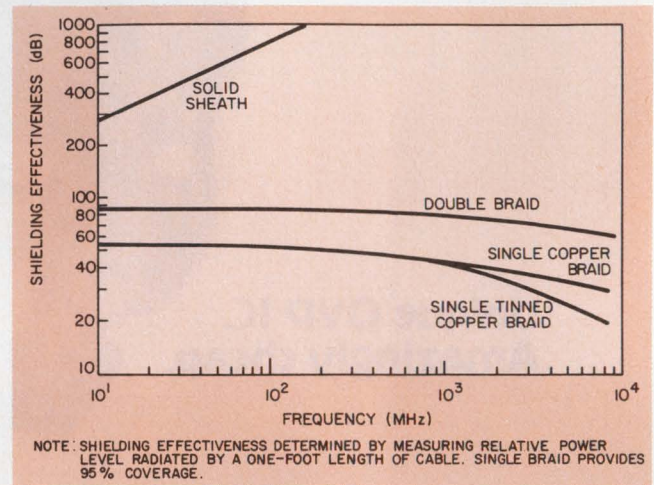

1. The shield effectiveness of braid and even solid conduit varies with frequency. Clearly, the tighter the braid, the more effective the shielding.

- Equipment chassis and shields should never be used for signal-return paths.
- Signal circuits preferably should be balanced and used with twisted pairs or with shielded, balanced coaxial lines.
- Individual shields of balanced coaxial cables, when contained by a common shield, should be insulated from one another and from the common shield.
- Cables that carry high-level signals should not be bundled with cables carrying low-level signals, whether shielded or not.

Inductive pickup (and radiation) can be minimized effectively by reducing the loop area of the signal-to-ground return path. Clearly, then, using the equipment chassis and shields for ground returns is foolish. The designer who does, has no control of loop area, since the signal path is indeterminate and usually far-ranging. Furthermore, the impedance of such chassis returns can be high. And when carrying many different signals, such a common impedance becomes a fertile way of coupling crosstalk and other kinds of interference.

Each signal line, then, should have its own independent return line running as close as possible to the signal line. In this way, the loop area is

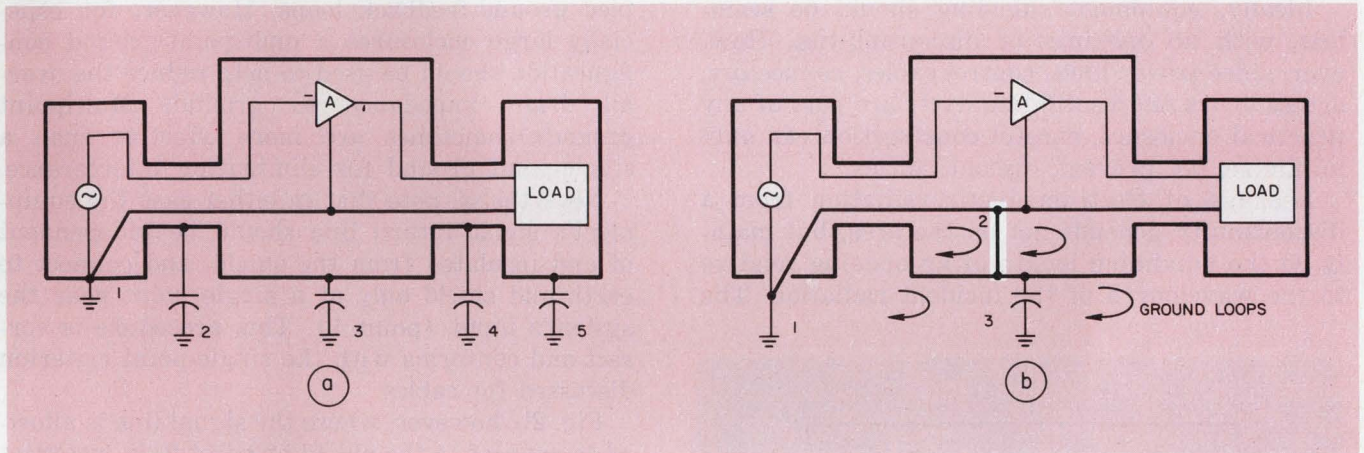

2. To handle shield and signal-path return grounding correctly, return the signal via paths that are independent and insulated from the shield. Also, earth both the shield and signal returns to a common point with very

short leads (a). Incorrect grounding (b) creates ground-loop current paths. Such paths can pick up interference, and cross-coupling impedances can inject crosstalk and noise into signal inputs.

reduced, and common impedances with other signals avoided.

Better still, uniformly twisting the signal and return lines together ensures a minimum pickup-loop area, and the voltage induced in one twist tends to cancel an oppositely induced voltage in the adjacent twist.

Cable shielding for added protection

Shielding signal cables adds a final touch needed for interference-free signal handling. And cables carrying substantial power, which can induce interference into signal cables, also should be shielded—especially when both signals and power must flow in close proximity. Available types of shielded cable include single-wire, multi-wire, twisted-pair, coaxial and multiple-shield.

Shields for all these types are made of braided metal, solid conduit or metal foil. Braided shielding is light and easy to handle. But its shielding effectiveness decreases with increasing frequency (Fig. 1), because of discontinuities and openings inherent in the weave.¹ Shielding effectiveness, of course, depends on the type and thickness of the material used for the braid and the tightness of the weave. Both solid and foil shields are very

effective, especially at high frequencies; the solid material has no discontinuities or openings. However, both solid and foil shielding exhibit low fatigue life when subjected to bending, and cannot be handled so easily when being installed or repaired.

To be fully effective, the shields also must conform to proper grounding methods. In general, the best way is to bond the entire periphery of only one end of the shield (preferably the driving end) to the ground with, of course, as short a lead as possible. This avoids capacitive-coupled ground-feedback loops.

Multiple grounds for long runs

For shields that enclose high-energy carrying lines over long runs, improved results are often obtained with a departure from single-point grounding. Over long lengths, the relatively high impedance of the long path to ground, when combined with the high energy, can produce undesirable levels of interference radiation.

Grounding both ends of the shield, or even using multiple grounds for exceptionally long runs, to lower the impedance of the shield-current drain path, often can reduce interference levels.

Though not good practice in general, such multi-point grounding can be effective in some high-energy cases. But the best ground points must be experimentally determined. Different grounding points must be tested with the system in operation to find the best combination.

Not only cables, but also entire equipments may need shielding. But, again, the shielding must be properly fabricated and grounded.

Seamless shields are best

Ideally, equipment shielding should be seamless, with no openings or discontinuities. However, since power lines, control cables, connectors, access doors and ventilation ducts are part of any practical enclosure, careful construction can only minimize, not prevent, discontinuities.²

Leakage of electromagnetic radiation from a discontinuity depends not on the area, but mainly on the maximum length of an opening relative to the wavelength of the incident radiation. The

radiation leaked through a discontinuity in a shield becomes more intense as the aperture lengthens, but varies little as it widens. Generally, an aperture just starts to radiate when its length becomes greater than 1/100 of a wavelength, and above 1/4 of a wavelength, the radiation can become very troublesome.

As with cable shields, the best general method of grounding an equipment shield, as shown in Fig. 2a, is to ground it at one point only, and also make sure all segments of the enclosure are tightly bonded together to avoid capacitive-coupled ground-feedback loops. However, for especially large enclosures a multipoint-ground configuration should be used to help reduce the overall drain impedance to ground. Multipoint grounds sometimes are more effective than a single-point ground for eliminating interference.

Nevertheless, note that in either case the equipment's signal-return line should be independent of and insulated from the shield, and connect to earth and shield only at a single point near the system's input (point 1). This procedure is correct and conforms with the single-point criterion discussed for cables.

Fig. 2b, however, where the signal line is allowed to connect to the shield at point 2, is incorrect because signal current can mix and cross-couple with shield currents in the ground loops formed.

Shield and signal return must be joined

Occasionally, a circuit is enclosed in, but inadvertently not connected with, a shielding structure. Such a configuration can lead to instabilities very difficult to diagnose, but easy to cure when recognized.

Consider a self-powered amplifier of gain A , enclosed (shielded) within a metal box (Fig. 3a). Note the stray and wiring capacitances C_{14} , C_{24} and C_{34} that couple the amplifier at points 1, 2 and 3 to the shield at point 4. The equivalent circuit (Fig. 3b) shows that the capacitive coupling and shield path form a feedback structure around the amplifying element that can cause unwanted feedback and oscillations. These stray capacitances usually can't be avoided, but the feedback loop can be eliminated by shorting the shield enclosure (point 4) to the signal-return conductor (point 3), and as in the case of a cable shield, preferably at the driving end only (Fig. 3c). ■■

References

1. Denny, H. W., et al, "Grounding, Bonding and Shielding Practices and Procedures," Vol. 1, Report No. FAA-RD-75-215, I, Georgia Institute of Technology, December, 1975, pp. 5-64 to 5-69.
2. Cowdell, R. B., "Need Rf-tight Enclosures?" *Electronic Design*, March 15, 1976, pp. 90-92.
3. Morrison, R., "Grounding and Shielding Techniques," John Wiley & Son, Inc., New York, NY, 1967.

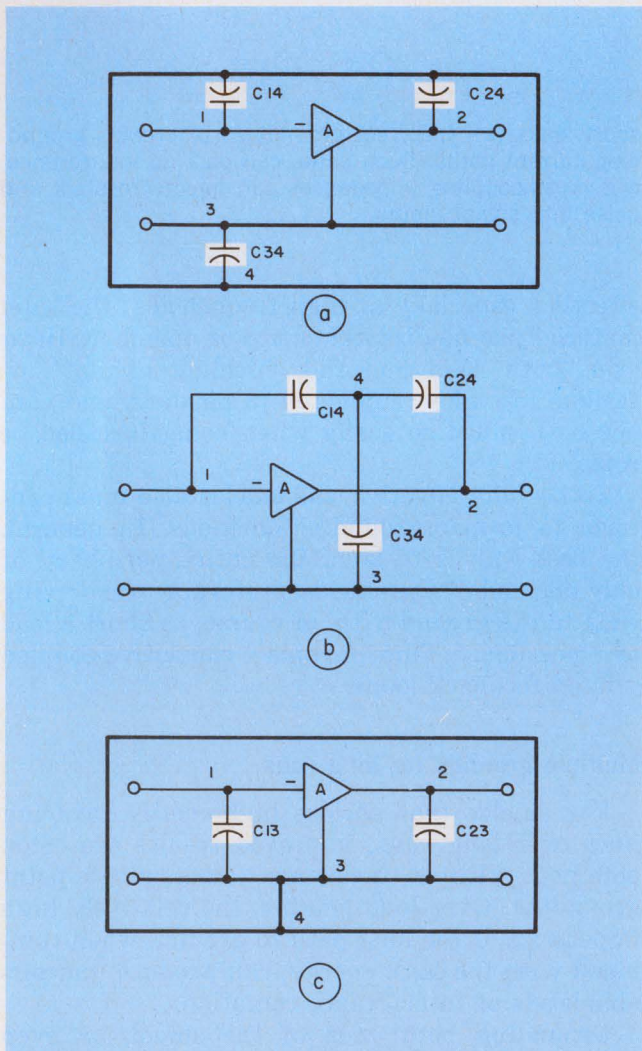

3. The shield around electronic equipment should never "float." A floating shield can act as a feedback path that seriously interferes with circuit performance.

Industry asked us for hundreds of variations of these switches. Evidently we're pushing the right buttons.

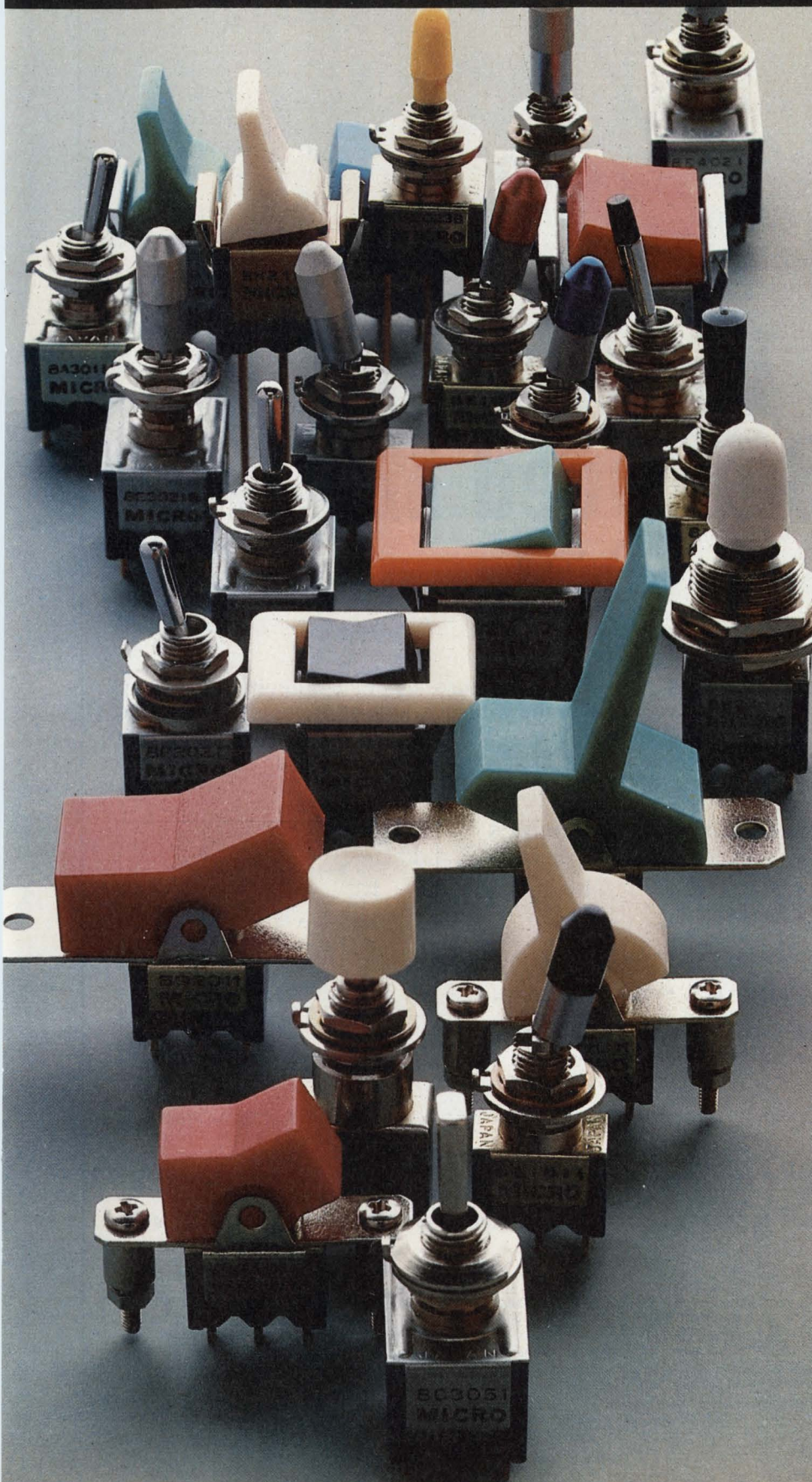

And we intend to keep pushing them.

So that every time one of your new ideas creates a design problem, MICRO SWITCH will be ready with the miniature manual switch that solves it.

At last count, we offered hundreds.

The Series 8 lineup of miniature manuals includes toggles, pushbuttons, paddles and lighted or unlighted rockers. They're UL listed at 6 amps, 125 VAC. And every one is available in a low energy version as well.

Choose terminal variations ranging from solder to quick-connect to PC board or wire wrap. There's also a choice of panel and bushing-sealed pushbuttons and toggles. And non-threaded bushings on PC mounted toggles. Even colored sleeves and integral colored tips for the toggles.

And of course, you'll find one feature you won't find anywhere else — the quality you've come to expect from MICRO SWITCH. Series 8 switches are inspected to a 1% Acceptable Quality Level (AQL).

That's quality you can put your finger on.

For your immediate product needs, see your nearest MICRO SWITCH Authorized Distributor. If you have other requirements, contact a MICRO SWITCH Branch Office or call 815/235-6600.

MICRO SWITCH
FREEPORT, ILLINOIS 61032
A DIVISION OF HONEYWELL

MICRO SWITCH products are available world-wide through Honeywell International.

CIRCLE 271 FOR DATA; 272 FOR SALESMAN CALL

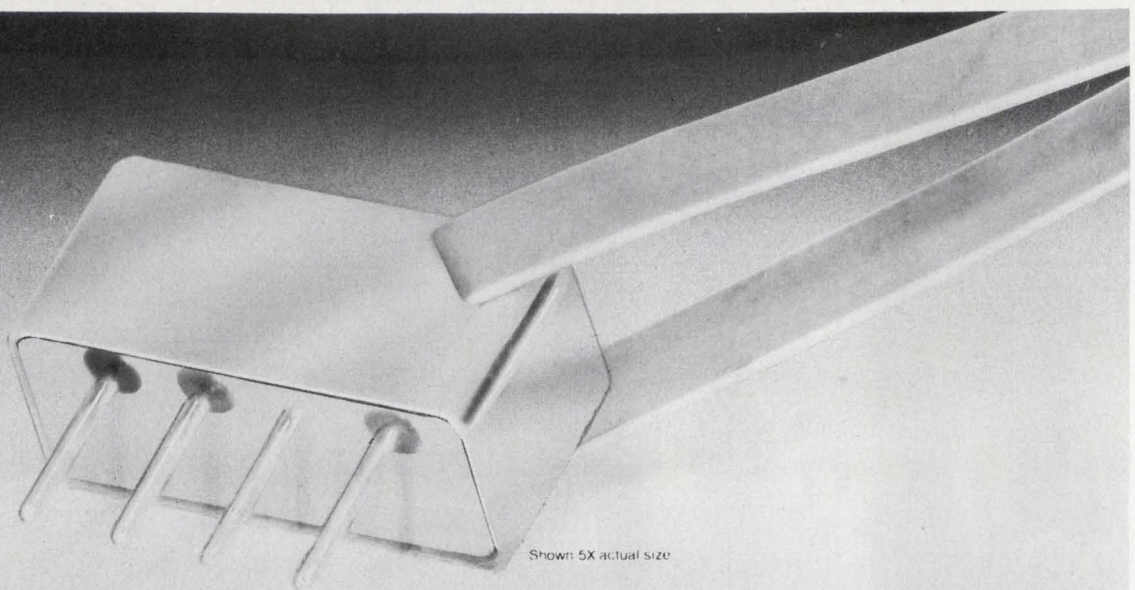

Shown 5X actual size

DC - 1000 MHz Double-Balanced Mixers

FOR ONLY **\$9.95!** (In 500 quantities)

* \$11.95 (6-49)

THIS PRICE/PERFORMANCE BREAKTHROUGH is possible because of Mini-Circuits extensive experience in high-volume production of high reliability units with guaranteed repeatability. That's why engineers at more than 1,000 companies throughout the world are specifying Mini-Circuit mixers, directional couplers and power splitter/combiners as the industry's standard.

Model TFM-2

Outstanding Features:

MOUNTING VERSATILITY

- plug in upright on PC board
- mount sideways as flatpack

SMALLEST SIZE AVAILABLE

- 0.025 cu. in. volume
- mounting area 0.5 x 0.25

EXCELLENT CHARACTERISTICS

- RF/LO 1-1000 MHz
- IF DC-1000 MHz
- High isolation 40 dB
- Low conversion loss 6 dB

SIMPLE PC LAYOUT AND WIRING

- only four leads to solder
- choose from a wide selection of layout possibilities

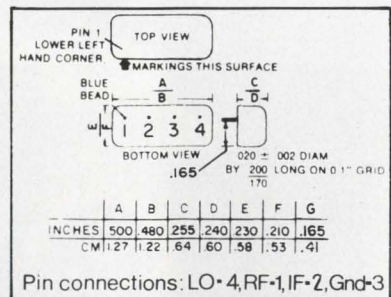

For complete specs, performance curves and drawings, see pgs 192-193 of the 1976-77 MicroWaves Product Data Directory.

World's largest supplier of double balanced mixers

Mini-Circuits Laboratory
A Division Scientific Components Corp

837-843 Utica Avenue, Brooklyn, NY 11203

(212) 342-2500 Int'l Telex 620156 Dom. Telex 125460

International Representatives: AUSTRALIA General Electronic Services, 99 Alexander Street, New South Wales, Australia 2065; ENGLAND Dale Electronics, Dale House, Wharf Road, Frimley Green, Camberley Surrey; FRANCE S. C. I. E. - D. I. M. E. S., 31 Rue George - Sand, 91120 Palaiseau, France; GERMANY, AUSTRIA, SWITZERLAND Industrial Electronics GMBH, Klüberstrasse 14, 6000 Frankfurt/Main, Germany; ISRAEL Vectronics, Ltd., 69 Gordon Street, Tel-Aviv, Israel; JAPAN Densho Kaisha, Ltd., Eguchi Building, 8-1 1 Chome Hamamatsucho Minato-ku, Tokyo; EASTERN CANADA B. D. Hummel, 2224 Maynard Avenue, Utica, NY 13502 (315) 736-7821; NETHERLANDS, BELGIUM, LUXEMBOURG: Coimex, Veldweg II, Hattem, Holland. NORWAY Datamatik AS, Ostensjoveien 62, Oslo 6, Norway

US Distributors: NORTHERN CALIFORNIA Cain-White & Co., Foothill Office Center, 105 Fremont Avenue, Los Altos, CA 94022 (415) 948-6533; SOUTHERN CALIFORNIA, ARIZONA Crown Electronics, 11440 Collins Street, No. Hollywood, CA 91601 (213) 877-3550

Creeping up on daylight

We've just brought the integrated dc-to-daylight frequency synthesizer a couple of steps closer to reality.

The new Plessey IC's offer a quick and easy way to lower synthesizer costs while increasing loop response and channel spacing all the way from dc through the HF, VHF, UHF and TACAN bands.

Start with one of our IC prescalers. They feature input ports for VHF and UHF, self-biasing clock inputs, TTL/MOS-compatibility and variable input hysteresis for wideband operation.

Then add one of our two-modulus dividers. All of them provide low power consumption, low propagation delay and ECL-compatibility, and most of them are available in commercial and MIL-temp versions.

Finally, to make things even simpler, add the Plessey SP8760 control chip and phase lock your synthesizer to any crystal up to 10 MHz. All the stability you need with none of the usual headaches and hassle.

If it all sounds too good to be true, contact us today for details and application notes.

Once you've seen the data, you'll see the light.



PLESSEY SEMICONDUCTORS

1674 McGaw Avenue, Irvine, CA 92714
Tel: (714) 540-9945. TWX: 910-595-1930
Represented world-wide.

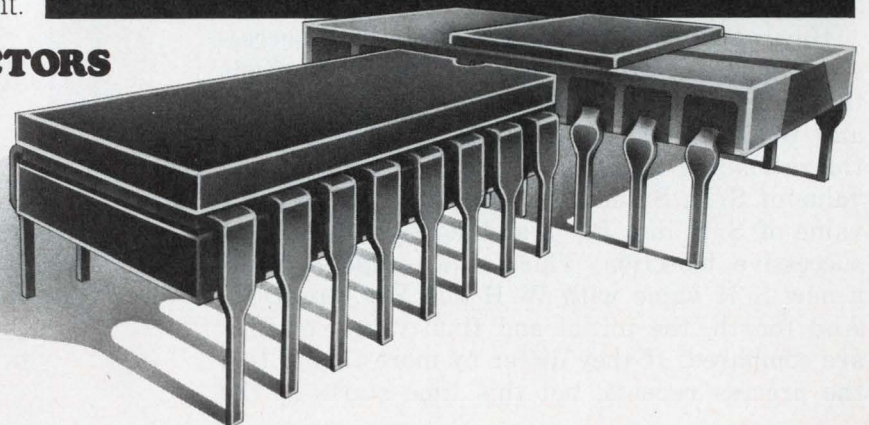
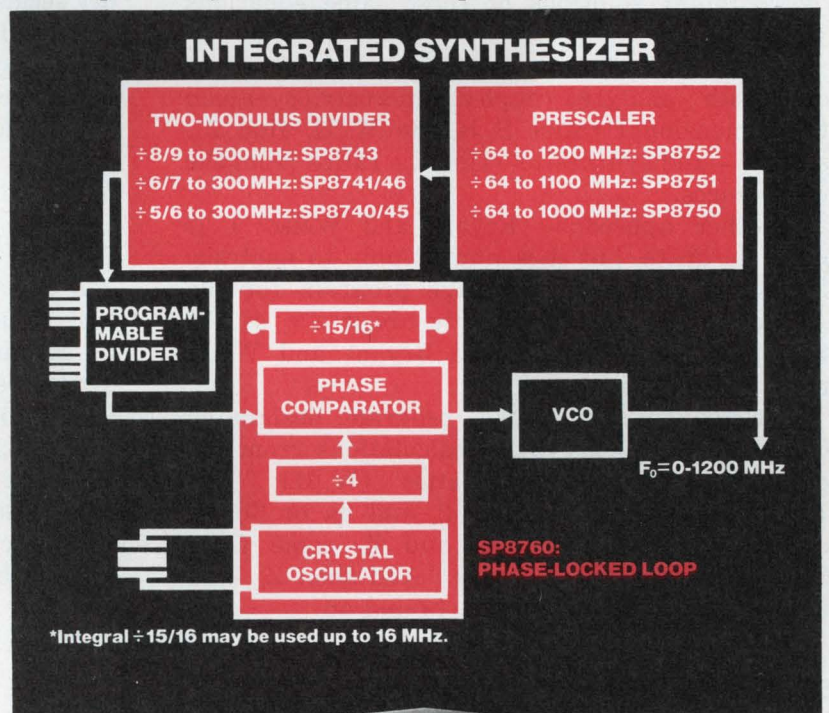

State-of-the-art brought down to earth

Fixed and programmable dividers Linear and digital communications circuits

CIRCLE NUMBER 64

Compute coupled-microstrip line configurations with a simple BASIC program that synthesizes dimensional ratios and analyzes the impedances.

A recent article (Shamanna¹) provides a nomogram-and-chart method for determining the dimensions and spacing of parallel-coupled microstrip lines from the even and odd-mode characteristic impedances, Z_{oe} and Z_{oo} , of the lines (Fig. 1). The method is based upon the equations for equivalent single microstrip lines (Akhtarzad²). However, much greater accuracy can be obtained by computer solutions of these same equations (Table 1).

Simple to program, the Akhtarzad technique can both analyze coupled microstrips—given the dimensional ratios S/H and W/H , find Z_{oe} and Z_{oo} —and synthesize—find the ratios from the impedances.

Another approach (Bryant and Weiss^{3,4}) is more accurate, but it is limited only to analysis. Moreover, a BASIC language program for the Akhtarzad method takes only about 2% of the time needed to execute the Bryant and Weiss method.

For analysis, the BASIC program, designated CMSARJ, performs direct calculations from the equations in Table 1. Ratios $(W/H)_{se}$ and $(W/H)_{so}$ follow from Eqs. 2, and 3a or 3b, as applicable. Impedances Z_1 and Z_2 come from Wheeler's analysis formulas.⁵ And then Z_{oe} and Z_{oo} are calculated from Eqs. 1a and 1b.

Synthesis requires approximations

However, synthesis requires a series of successive approximations. First, the computer finds the ratios $(W/H)_{se}$ and $(W/H)_{so}$ with Eq. 1 and Wheeler's synthesis formulas and then uses the ratios and Eq. 4 to calculate an approximate value of S/H . Second, the computer "plugs" this value of S/H into Eq. 2 and solves for W/H by successive bisection. Third, the computer finds a new S/H value with W/H and Eqs. 3a or 3b. And fourth, the initial and final values of S/H are compared. If they differ by more than 0.1%, the process repeats, but this time starts at the

second step with an S/H equal to the mean of the initial and final values.

Values of W/H and S/H found by this synthesis program then become inputs to the program's analysis section to check the accuracy of the approximation procedure.

Finally, to determine the wavelength ratio, L_R , an empirical approach must be resorted to. Theory seems to fail (see note at bottom of Table 1). Trial-and-error methods show that the wavelength ratio of a single line with a characteristic impedance equal to Z_{oe} is within 2% of the mean of the odd and even-mode wavelength ratios. The program calculates this mean value for L_R .

Checking the program's accuracy

A Bryant and Weiss program provides reference values to assess the accuracy of Z_{oe} , Z_{oo} and L_R calculated by the Akhtarzad approach. Akhtarzad reports the accuracy of the impedance values to be within 6% in all cases tested for $S/H \leq 2$. In most cases the error was found to be less than 3%. Although errors as high as 14% have been reported for some values of Z_{oe} , this inaccuracy stems not from the approximation method, but from using Wheeler's wide-strip for-

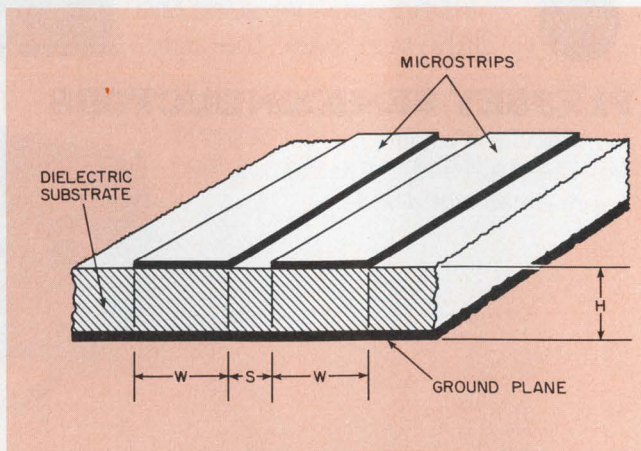

1. A simple BASIC program can analyze or synthesize a coupled pair of microstrip transmission lines on a dielectric substrate and provide either the impedances, given the dimensions, or the dimensions, given the impedances.

Table 1. Parallel-coupled microstrip equations

(1a)	$Z_{oe} = 2Z_1$		
(1b)	$Z_{oo} = 2Z_2$		
(2)	$(W/H)_{se} = (2/\pi) \cosh^{-1} \left(\frac{2h - g + 1}{g + 1} \right)$		
(3a)	$(W/H)_{so} = (2/\pi) \cosh^{-1} \left(\frac{2h - g - 1}{g - 1} \right) + \frac{4}{\pi(1 + K/2)} \cosh^{-1} \left(1 + 2 \frac{W/H}{S/H} \right)$ for $K \leq 6$		
(3b)	$(W/H)_{so} = (2/\pi) \cosh^{-1} \left(\frac{2h - g - 1}{g - 1} \right) + (1/\pi) \cosh^{-1} \left(1 + 2 \frac{W/H}{S/H} \right)$ for $K \geq 6$		
	$g = \cosh [(\pi/2) (S/H)]$ $h = \cosh [\pi (W/H) + (\pi/2) (S/H)]$		
(4)	$S/H = (2/\pi) \cosh^{-1} \left\{ \frac{\cosh [(\pi/2) (W/H)_{se}] + \cosh [(\pi/2) (W/H)_{so}] - 2}{\cosh [(\pi/2) (W/H)_{so}] - \cosh [(\pi/2) (W/H)_{se}]} \right\}$		
K:	Substrate dielectric constant	$(W/H)_{se}$:	Relative width of equivalent even-mode single line
H:	Substrate thickness	$(W/H)_{so}$:	Relative width of equivalent odd-mode single line
S:	Conductor spacing	Z_1 :	Impedance of even-mode equivalent single line
W:	Conductor width	Z_2 :	Impedance of odd-mode equivalent single line
Z_{oe} :	Even-mode characteristic impedance	* L_R :	Ratio of free-space to microstrip wavelengths; the square root of the effective dielectric constant
Z_{oo} :	Odd-mode characteristic impedance		

*Reference 2 states that L_R ratios for even and odd modes can be found by calculating the ratios of the equivalent single strips. This is incorrect. The characteristic impedance of the odd mode is lower than that of the even mode, thus the odd mode's equivalent single strip is wider and its effective dielectric constant is higher. However, reference 3 shows that the odd-mode effective dielectric constant is actually lower than that of the even mode.

mulas when the narrow-strip formulas should have been used.

For synthesis, the program described in this article makes the calculations initially with the wide-strip formulas. Then, if the resulting value of W/H is less than one, the calculations are repeated with narrow-strip formulas.

Unfortunately, when $SH > 2$ the results become very inaccurate. In fact, the successive-approximation process used for synthesis doesn't even converge if S/H is greater than 3.

The program is BASIC

The Akhtarzad-based program is compatible with most BASIC interpreters and compilers. The only system-supplied functions are ABS, EXP, LOG, and SQR.

Table 2 lists the program. Table 3 is a sample run that includes calculated values of W and S for a 15-dB quarter-wave directional coupler both on 60 mil glass/Teflon board and 25-mil alumina substrate. Since W/H and S/H are the basic parameters calculated, the units in which W and S are expressed are the same as for H .

The total program consists of 153 lines, including the comment lines, numbered 10 through 75. Lines numbered 100 through 595 constitute the main program, and lines numbered 600 through 655 provide the subroutines for evaluation of Eqs. 2 and 3. Lines 660 to 790 (the end) contain Wheeler's equations. ■■

References

1. Shamanna, K.N.; Rao, V. S.; and Kosta, S. P., "Parallel-Coupled Microstrip-Line Geometry Is Easy to Determine with Nomograms," *Electronic Design*, May 24, 1976, pp. 78-81.
2. Akhtarzad, S.; Rowbotham, T.R.; and Johns, P. B., "The Design of Coupled Microstrip Lines," *IEEE Trans Microwave Theory Tech*, Vol. MTT-23, June, 1975, pp. 486-492.
3. Bryant, T. G. and Weiss, J. A., "Parameters of Microstrip Transmission Lines and of Coupled Pairs of Microstrip Lines," *IEEE Trans Microwave Theory Tech*, Vol. MTT-15, December, 1968, pp. 1021-1027.
4. Bryant, T. G., and Weiss, J. A., "MSTRIP (Parameters of Microstrip) Computer Program Description," *IEEE Trans Microwave Theory Tech*, Vol. MTT-19, April, 1971, pp. 418-419.
5. Wheeler, H. A., "Transmission-Line Properties of Parallel Strips Separated by Dielectric Sheet," *IEEE Trans Microwave Theory Tech*, Vol. MTT-13, March, 1965, pp. 172-185.

(continued on page 118)

Table 2. Coupled-microstrip program in BASIC

```

10 REM: DEFINITIONS OF VARIABLES—
15 REM: ZOE, ZOO: EVEN AND ODD MODE CHARACTERISTIC IMPEDANCES
20 REM: K: RELATIVE DIELECTRIC CONSTANT
25 REM: H: DIELECTRIC THICKNESS MEASURED BETWEEN MICROSTRIP
30 REM: CONDUCTOR AND GROUND PLANE
35 REM: W: MICROSTRIP CONDUCTOR WIDTH
40 REM: S: SPACING BETWEEN CONDUCTORS
45 REM: LR: RATIO OF FREE SPACE WAVELENGTH
50 REM: TO MICROSTRIP WAVELENGTH
55 REM: PROBLEM TYPES:
60 REM: 1. SYNTHESIS: GIVEN ZOE AND ZOO, FIND W AND S
65 REM: 2. ANALYSIS: GIVEN W AND S, FIND ZOE AND ZOO
70 REM: ENTER VALUE 0 FOR ZOE OR W TO RETURN TO PROGRAM START
75 REM: ENTER 0 FOR PROBLEM TYPE TO END EXECUTION
100 DEF FNA(X)=LOG(X+SQR(X*X-1))
105 DEF FNC(X)=(EXP(X)+EXP(-X))/2
110 LET E1=EXP(1)
115 LET P1=3.141593
120 LET P2=2/P1
125 PRINT "COUPLED MICROSTRIP LINES—"
130 PRINT "LIST PROGRAM FOR DEFINITIONS OF VARIABLES"
135 PRINT
140 PRINT "TYPE";
145 INPUT I1
150 IF I1<1 THEN 790
155 PRINT "K, H";
160 INPUT K1, H1
165 IF I1>1 THEN 495
170 PRINT "ZOE, ZOO";
175 INPUT Z1, Z2
180 IF Z1<=0 THEN 135
185 LET Z5=Z1/2
190 GOSUB 660
195 LET W6=W5
200 LET Z5=Z2/2
205 GOSUB 660
210 LET W7=W5
215 LET T1=FNC(W6/P2)
220 LET T2=FNC(W7/P2)
225 LET S0=P2*FNA((T1+T2-2)/(T2-T1))
230 LET D0=1E3
235 FOR J1=1 TO 15
240 LET G4=FNC(S0/P2)
245 LET W2=.05
250 LET W3=10
255 LET D1=0
260 FOR J2=0 TO 25
265 GOSUB 600
270 LET D2=W4-W6
275 IF ABS(D2/W6)<1E-4 THEN 320
280 IF D1*D2>0 THEN 295
285 LET W3=W2
290 GOTO 305
295 LET W1=W2
300 LET D1=D2
305 LET W2=(W1+W3)/2
310 NEXT J2
315 GOTO 460
320 FOR J3=0 TO 3
325 LET S2=.02
330 LET S3=5
335 LET D1=0
340 FOR J2=0 TO 25
345 GOSUB 615
350 LET D2=W4-W7
355 IF ABS(D2/W7)<1E-4 THEN 410
360 IF D1*D2>=0 THEN 375
365 LET S3=S2
370 GOTO 385
375 LET S1=S2
380 LET D1=D2
385 LET S2=(S1+S3)/2
390 NEXT J2
395 LET W2=0.9*W2
400 NEXT J3
405 GOTO 460
410 IF J3=0 THEN 430
415 IF J1>4 THEN 460
420 LET D0=1E3
425 GOTO 450
430 LET D1=ABS(S2-S0)
435 IF D1/S2<1E-3 THEN 475
440 IF D1>=D0 THEN 460
445 LET D0=D1
450 LET S0=(S0+S2)/2
455 NEXT J1
460 PRINT "NO SOLUTION"
465 PRINT
470 GOTO 170
475 LET W1=W2*H1
480 LET S1=S2*H1
485 PRINT " W="; W1, " S="; S1
490 GOTO 520
495 PRINT "W, S";
500 INPUT W1, S1
505 IF W1<=0 THEN 135
510 LET W2=W1/H1
515 LET S2=S1/H1
520 GOSUB 615
525 LET W5=W4
530 GOSUB 705
535 LET Z2=2*Z5
540 GOSUB 605
545 LET W5=W4
550 GOSUB 705
555 LET Z1=2*Z5
560 LET Z5=Z1
565 GOSUB 660
570 GOSUB 705
575 PRINT "ZOE="; Z1, "ZOO="; Z2, "LR="; L5
580 IF S2<2 THEN 590
585 PRINT "S/H="; S2, "RESULTS ARE NOT ACCURATE"
590 PRINT
595 GOTO 165
600 LET H4=FNC(P1*W2+S0/P2)
605 LET W4=P2*FNA((2*H4-G4+1)/(G4+1))

```

```

610 RETURN
615 LET G4=FNC(S2/P2)
620 LET H4=FNC(P1*W2+S0/P2)
625 LET W4=P2*FNA((2*H4-G4-1)/(G4-1))
630 LET T1=FNA(1+2*W2/S2)
635 IF K1>=6 THEN 650
640 LET W4=W4+4*P2*T1/(K1+2)
645 RETURN
650 LET W4=W4+T1/P1
655 RETURN
660 LET T1=60*P1*P1/(Z5*SQR(K1))
665 LET W5=P2*(T1-1-LOG(2*T1-1))
670 LET W5=W5+((K1-1)/(P1*K1))*(LOG(T1-1)+.293-.517/K1)
675 IF W5>=1 THEN 700
680 LET T1=Z5*SQR((K1+1)/2)/60
685 LET T2=LOG(2*P2)/K1-LOG(P2)
690 LET T1=T1+(T2/2)*(K1-1)/(K1+1)
695 LET W5=8/(EXP(T1)-2*EXP(-T1))
700 RETURN
705 LET K5=1
710 FOR J5=1 TO 2
715 IF W5<1 THEN 740
720 LET T1=W5+P2*LOG(4)+((K5-1)/(P1*K5*K5))*LOG(E1*P1/16)
725 LET T1=T1+((K5+1)/(P1*K5))*LOG(P1*E1*(W5+1.88)/4)
730 LET Z5=120*P1/(T1*SQR(K5))
735 GOTO 760
740 LET T1=LOG(2*P2)/K5-LOG(P2)
745 LET T1=T1*(K5-1)/(2*(K5+1))
750 LET T1=LOG(8/W5)+W5*W5/32-T1
755 LET Z5=60*T1/SQR((K5+1)/2)
760 IF J5=2 THEN 780
765 LET K5=K1
770 LET Z6=Z5
775 NEXT J5
780 LET L5=Z6/Z5
785 RETURN
790 END

```

Table 3. Sample computer run

```

COUPLED MICROSTRIP LINES—
LIST PROGRAM FOR DEFINITIONS OF VARIABLES

TYPE? 2
K, H? 9.6, 1
W, S? .1, .1
ZOE= 164.319           ZOO= 53.7813           LR= 2.37279
W, S? .5, .2
ZOE= 88.9415           ZOO= 41.1178           LR= 2.43264
W, S? 1, .5
ZOE= 59.7088           ZOO= 39.469            LR= 2.49649
W, S? 2, 1
ZOE= 37.6394           ZOO= 31.2224           LR= 2.6439
W, S? 0, 0

TYPE? 1
K, H? 9.6, 1
ZOE, ZOO? 164.3, 53.78
W= .10033               S= 9.92181E-02
ZOE= 164.292           ZOO= 53.6216           LR= 2.3728
ZOE, ZOO? 88.94, 41.12
W= .516101              S= .207692
ZOE= 87.563            ZOO= 41.091            LR= 2.43469
ZOE, ZOO? 59.71, 39.47
W= 1.00649              S= .50572
ZOE= 59.4471           ZOO= 39.4489           LR= 2.49734
ZOE, ZOO? 37.64, 31.22
W= 2.00034              S= 1.00238
ZOE= 37.6303           ZOO= 31.2272           LR= 2.64395
ZOE, ZOO? 0, 0

TYPE? 1
K, H? 2.45, 60
ZOE, ZOO? 59.85, 41.77
W= 164.967              S= 25.8933
ZOE= 59.9274           ZOO= 41.82             LR= 1.43524
ZOE, ZOO? 0, 0

TYPE? 1
K, H? 9.8, 25
ZOE, ZOO? 59.85, 41.77
W= 23.6897              S= 15.8953
ZOE= 59.5699           ZOO= 41.7323           LR= 2.51919
ZOE, ZOO? 0, 0

TYPE? 0
PROCESSING 9 UNITS

```

VACTEC brings you BLUE



Unlike our little Japanese friend, photodetectors have always been insensitive to blue. Until now.

Vactec's latest development is a new Blue Enhanced Silicon (BES) photodiode with exceptionally low dark current for efficient response in the blue region (200 - 400 nm). Made in Missouri, U.S.A., it performs equally well in an expensive Japanese SLR camera or in an American-made colorimetric analyzer as well. And you'll like the price, which could be as big a breakthrough as blue sensitivity. Vactec also introduces a new line of PIN photodiodes that operate at high voltages, low noise levels, and fast rise times, with about half the blue sensitivity of the BES photodiode. For larger areas, Vactec offers a complete range of Blue Enhanced Silicon photovoltaic cells up to 1 1/8" diameter.

Vactec now supplies the broadest line of photodetectors in the industry, including:

- silicon solar cells
- hi-speed/low-leakage silicon cells
- NPN phototransistors
- NPN photodarlington
- CdS & CdSe photoconductors
- CMOS & bi-polar custom ICs
- opto-couplers
 - a) LED/photoconductor
 - b) LED/phototransistor or darlington
 - c) lamp/photoconductor
- selenium photovoltaic cells

Call or write today:

Vactec, Inc.

2423 Northline Industrial Blvd.
Maryland Heights, Mo. 63043
(314) 872-8300

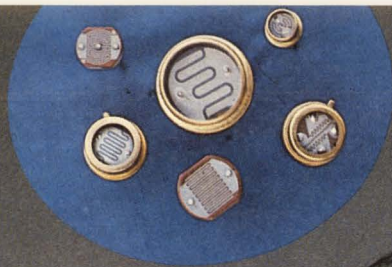

Announcing a BiMOS breakthrough...

The RCA 3140: most useful op amp since the 741.

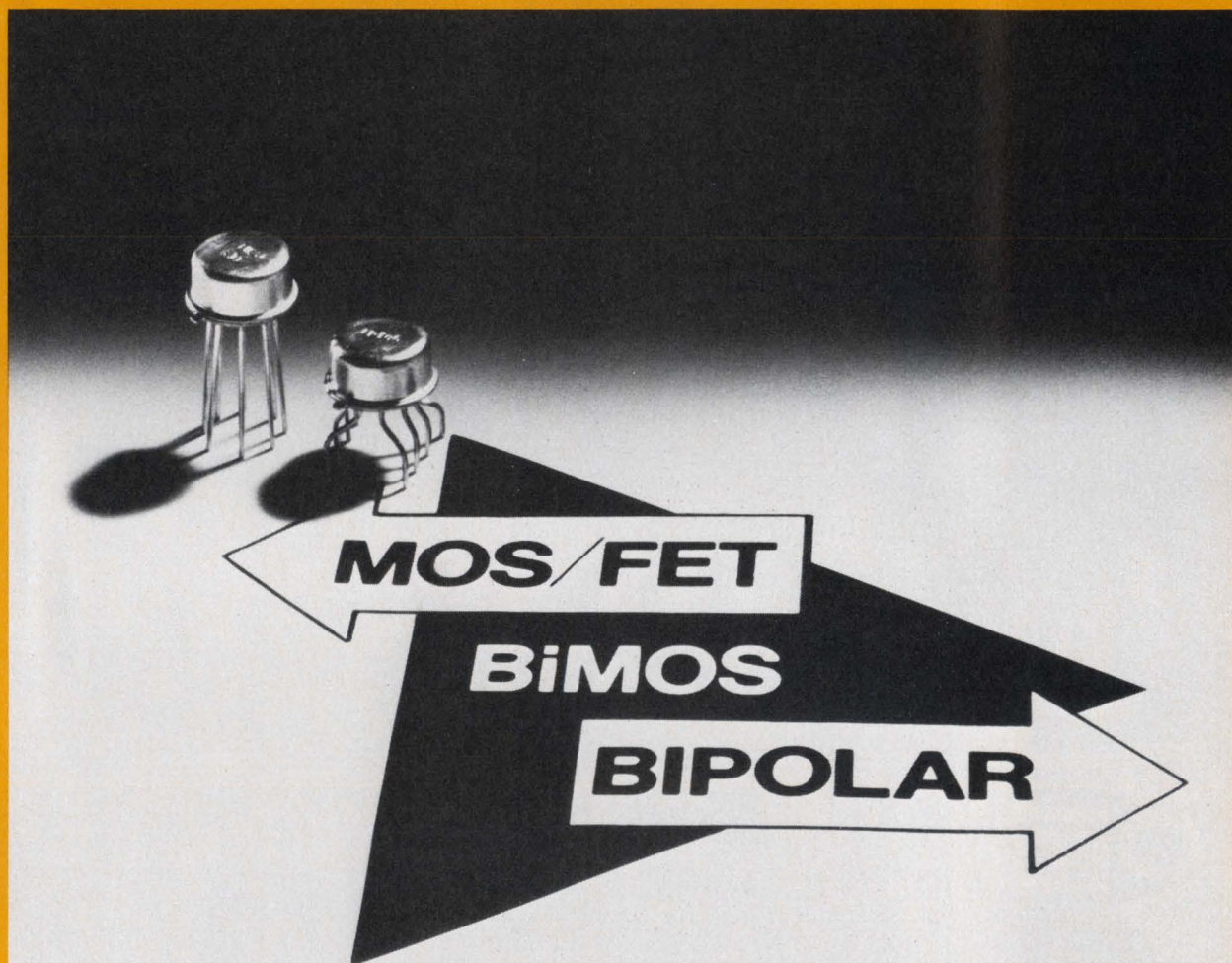

For the price of a 741 you get
a lot more op amp.
MOS/FET input makes the difference.

Every so often a new advance greatly expands op amp versatility. In 1965 there was the general-purpose 702. Followed in 1966 by the 709, with higher voltage, gain and input impedance. Along came the 101 with still higher voltage and gain. Then in 1968 the remarkable 741 gave you the added benefits of on-chip compensation and low cost.

Now, RCA announces a new giant step toward the ideal op amp. The CA3140 Series of BiMOS op amps.

It gives you the big advantages of MOS/FET input...plus bipolar speed and high supply voltage operating capability: 4 to 44 V, dual or single supply. That means very high input impedance: 1.5 T Ω typ. Very low input current: 10 pA typ. at ± 15 V. Low input offset voltage: as low as 2 mV max. Wide common-mode input voltage range—can be swung 0.5 V below negative rail. In addition, output swing complements input common-mode range, permitting full utilization of low supply voltages (down to 4 V). And PMOS input devices are protected by rugged bipolar diodes.

BiMOS vs. 741

You get all of those features for the price of a 741. 69 cents at the 100 unit level for the CA3140T, S. Plus big circuit savings. BiMOS minimizes bias circuitry. Allows single supplies in portable, automotive and instrumentation equipment.

BiMOS vs. BI-FET

Compared to recently announced higher-priced BI-FET types, the CA3140 offers lower input currents, higher input resistance, improved offset current and comparable offset voltage—all with high slew rate and bandwidth. So chances are, you don't have to pay the higher prices.

In fact, in most existing circuits using premium op amps, the CA3140 permits cost reductions and/or improved performance with minimum circuit redesign. And if you have an application where you ruled out op amps altogether because of cost...reconsider. The CA3140 is cost effective in many places where other op amps are not.

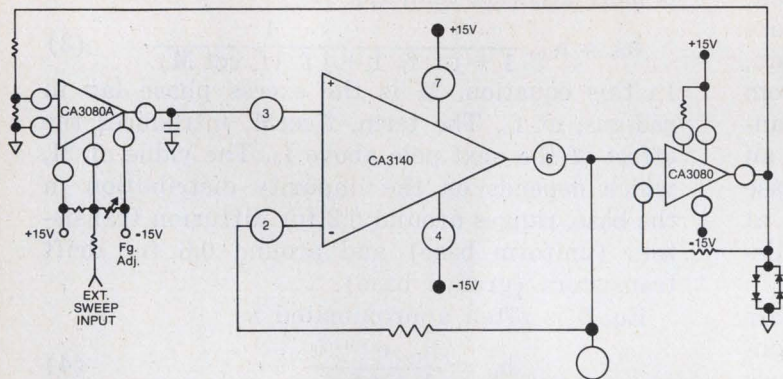

Basic Function Generator

The CA3140 gives 1,000,000:1 range, single control when used as a buffer readout for the integrating capacitor in this basic function generator. The RCA data sheet (File No. 957) tells you how to build this circuit.

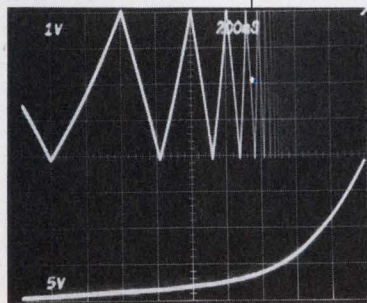

Low circuit cost

The CA3140 needs no external compensating circuitry. It is characterized for low-cost TTL systems requiring operation at 5 V and maintains operation down to 4 V. Its wide bandwidth—4.5 MHz unity gain—makes possible low-cost video and audio circuits. For low-cost sample and hold and other data acquisition systems, it offers fast settling time: 1.4 μ s typ. to 10 mV. When it's driving power transistors, the output swings to within 0.2 V of the negative supply, eliminating the need for level-shifting circuitry.

CA3140 vs. 741 at a glance

Characteristics	Limits						Units
	CA 3140T, S			CA741CT,S			
	MIN	TYP	MAX	MIN	TYP	MAX	
at Supply Volts: $V_+ = +15, V_- = -15$ @ 25°C							
Input Resistance, R_i	300,000	1,500,000	—	0.3	2	—	M Ω
Input Current, I_i	—	10	50	—	80,000	500,000	pA
Input Offset Current, I_{IO}	—	0.5	30	—	20,000	200,000	pA
Input Offset Voltage V_{IO}	—	5	15	—	2	6	mV
Slew Rate, SR (Closed Loop)	—	9	—	—	0.5	—	V/ μ s
Gain-Bandwidth Product f_T	—	4.5	—	—	1.0	—	MHz
Common-Mode Input Range, V_{ICR}	-15	-15.5 to +12.5	+11	-12	± 13	+12	V
Output Swing $R_L = 2K\Omega$	-14	-14.4 to +13.0	+12	-10	± 13	+10	V
Large Signal Voltage Gain A_{OL} $R_L = 2K\Omega$	—	20,000	—	—	20,000	—	

Versatile building block

Beyond standard op amp uses, the CA3140 can perform in many other applications. Such as ground-referenced single-supply amplifiers. Sample and hold amplifiers. Long-duration timers/multivibrators. Photocurrent instrumentation. Peak detectors. Active filters. Comparators. Tone control circuits. Function generators. Power supplies. Portable instruments. Intrusion alarm systems.

Six commercial versions are available: in the TO-5, the standard CA3140T and the premium types CA3140AT and CA3140BT; the CA3140S, CA3140AS and CA3140BS are the DIL-CAN versions of the TO-5. Also available is the chip version—CA3140H. The CA3140 series is available processed to all levels of MIL-M-38510/883.

Send for 13 useful circuits.

To show you how useful the CA3140 is, we've designed it into 13 typical circuits. To get these circuits plus other information, contact your RCA Solid State distributor. Or RCA. Write: RCA Solid State, Box 3200, Somerville, N.J. 08876; Ste Anne de Bellevue H9X 3L3, Canada; Sunbury-on-Thames, U.K.; Fuji Bldg., Tokyo, Japan.



RCA. Full house in Linear ICs.

Watch that transistor phase lag.

If you ignore excess phase lag, poor frequency response—even instability—of your amplifier circuit may result.

Phase lag cannot be taken lightly. If the transistor-circuit designer lays out a feedback amplifier, the phase lag of its output signal determines not only if the amplifier has a smooth or peaked frequency response, but even if it turns into an oscillator. If the designer miscalculates the phase lag in a phase-locked loop, the lock-in frequency range may be shifted from the desired band.

These bad effects are produced by "excess phase lag," which is nothing more than the error stemming from widely used design approximations. Few engineers realize that this excess phase lag is considerable, even at frequencies as low as 1% of the cutoff frequency, f_T . The undesirable side effects can be eliminated by reducing the feedback system gain, calibrating out the error, or—in extreme cases—by adding compensating phase-lead networks.

Transistor phase lag is the angular component of the common-base current gain, h_{rb} , or the more frequently used common-emitter current gain, h_{re} . Both parameters are usually calculated from one-pole approximations. For diffused-base transistors, however, this simplified model yields an increasingly inadequate description of the phase lag of h_{re} at frequencies above $0.01 f_T$. Even at this low frequency the error can exceed 10 degrees.

For a multistage feedback amplifier, the phase error applies to each stage. A three-stage amplifier may thus produce a phase lag that exceeds the predicted value by more than 30 degrees at a frequency as low as $0.01 f_T$.

Too few poles is no joke

The one-pole approximation to the common-base current gain is:

$$h_{rb} \approx \frac{h_{rbo}}{1 + j f / f_\alpha} \quad (1)$$

where h_{rbo} is the value of h_{rb} at low frequencies,

and f_α is the α -cutoff frequency.

The one-pole model for the common-emitter current gain, h_{re} , is derived from Eq. 1:

$$h_{re} = \frac{h_{rb}}{1 - h_{rb}} \approx \frac{h_{rbo}}{1 - h_{rbo}} \frac{1}{1 + (j f / f_\alpha) / (1 - h_{rbo})} \approx \frac{h_{re0}}{1 + j f / f_\beta} \quad (2)$$

Here, h_{re0} again denotes the value of h_{re} at low frequencies, and:

$$f_\beta \approx f_\alpha (1 - h_{rbo})$$

is the common-emitter cutoff frequency.

At frequencies above $0.01 f_T$, the heretofore ignored higher-frequency poles of h_{rb} and h_{re} contribute additional phase lag. This extra lag is called "excess-phase" effect, because the actual phase lag exceeds that calculated from the one-pole mode in Eqs. 1 and 2.

At higher frequencies, the following expression is more accurate than Eq. 1:

$$h_{rb} = h_{rbo} \frac{1}{1 + j f / f_\alpha} \frac{1}{1 + j f / (f_\alpha \cot M)} \quad (3)$$

In this equation, M is the excess phase lag in radians, at f_α . The term, $f_\alpha \cot M$, introduces the effect of the next pole above f_α . The value of M , which depends on the impurity distribution in the base, ranges around 0.2 for diffusion transistors (uniform base) and around 0.6 for drift transistors (graded base).

Eq. 3 is often approximated as

$$h_{rb} = \frac{h_{rbo} e^{-j M f / f_\alpha}}{1 + j f / f_\alpha} \quad (4)$$

This expression ignores the effect of amplitude roll-off caused by the pole at $f_\alpha \cot M$ and yields an excess phase lag which is linear with frequency. However, Eq. 4 should not be interpreted to mean that the excess phase lag is caused by a nondispersive transport delay.

Usually, the circuit designer is not so much interested in h_{rb} , as in h_{re} . This h_{re} can be derived from Eq. 3, by substituting:

$$h_{re} = \frac{h_{rb}}{1 - h_{rb}} \quad (5)$$

To determine the excess phase of h_{re} , the phase lag obtained from Equations 3 and 5 is simply subtracted from the phase lag due to Eq. 2. Fig. 1

Nathan O. Sokal, Director of Engineering, and Michael Chessman, Project Engineer, Design Automation, Inc., 809 Massachusetts Ave., Lexington, MA 02173.

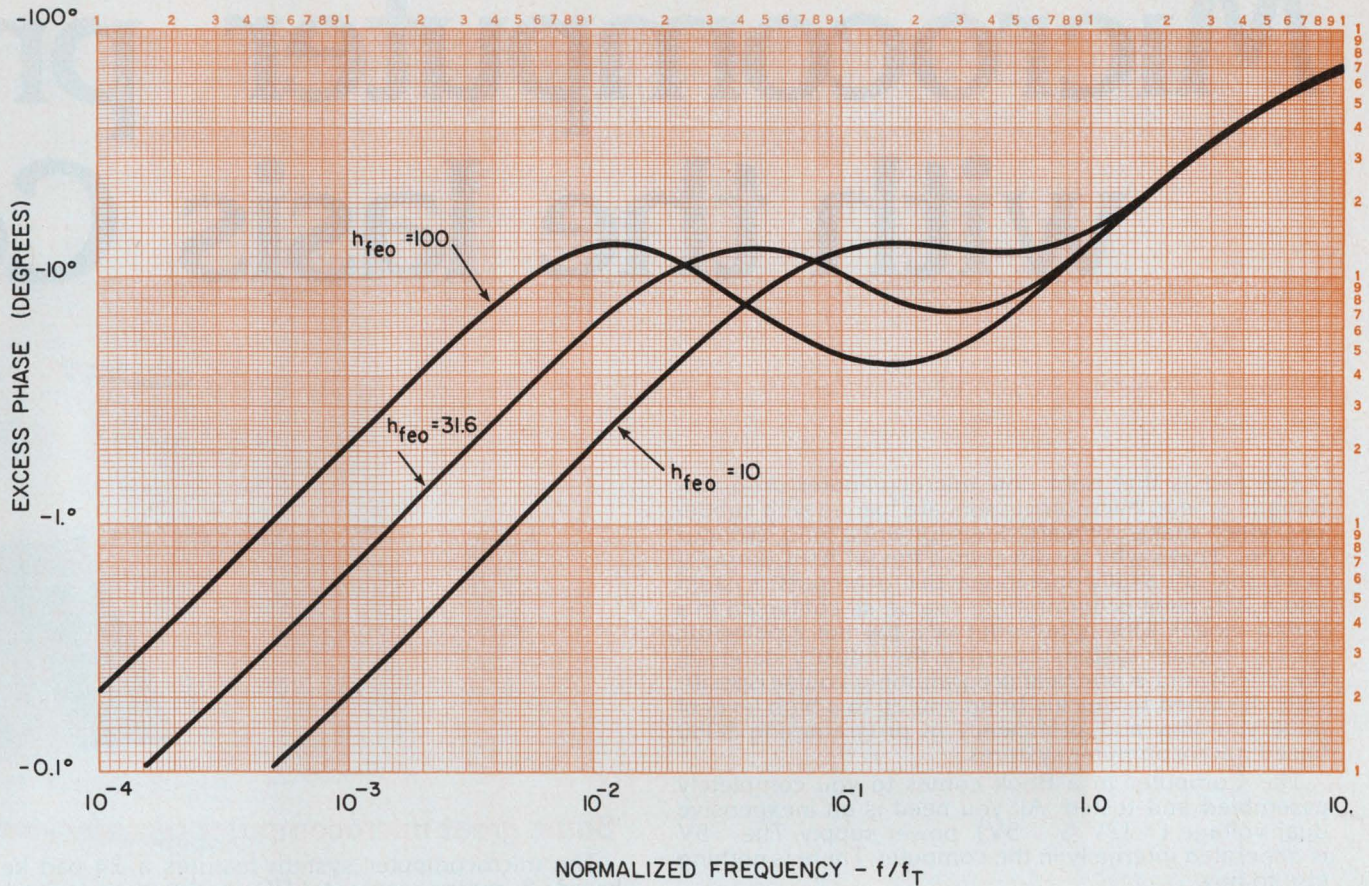

1. Excess phase lag is shown as a function of the normalized frequency, f/f_T , with the common-emitter cur-

rent gain h_{fe0} as a parameter. The term h_{fe0} is used for h_{fe} at low frequencies.

shows this difference for diffused-base transistors ($M=0.6$), at $h_{fe0} = 10, 10\sqrt{10}$, and 100.

This phase-lag correction applies to the forward gain, h_{fe} , of the intrinsic transistor alone. The effects of the emitter-depletion layer (or emitter transition) capacitance, C_{ib} , the collector-base overlap capacitance, C_{ov} , and the package parasitics, remain to be considered.

All the additional circuit elements are shown in Fig. 2, where the intrinsic transistor of the hybrid-pi model is identified by the white background. Naturally, these elements produce additional currents and voltages that add vectorially to those of the intrinsic transistor. If high accuracy is required, they must be included in the analysis. ■■

Bibliography:

Abraham, R. P., "Transistor Behavior at High Frequencies," *IRE Transactions on Electron Devices*, January, 1960, pp. 59-69.

Fines, N. R., "Chart Provides Alpha Components," *Electronics Handbook of Circuit Design*, First ed., ch. 14-4, McGraw-Hill, New York, NY, pp. 121-122.

Ghansi, M. S., *Principles and Design of Linear Active Circuits*, McGraw-Hill, New York, NY, 1965, p. 227.

Thomas, D. E., and Moll, J. L., "Junction Transistor Short-Circuit Gain and Phase Determination," *Proceedings IRE*, June, 1958, pp. 1177-1184.

Watson, H. A., Editor, *Microwave Semiconductor Devices and Their Circuit Applications*, McGraw-Hill, New York, NY, 1969, pp. 545-546.

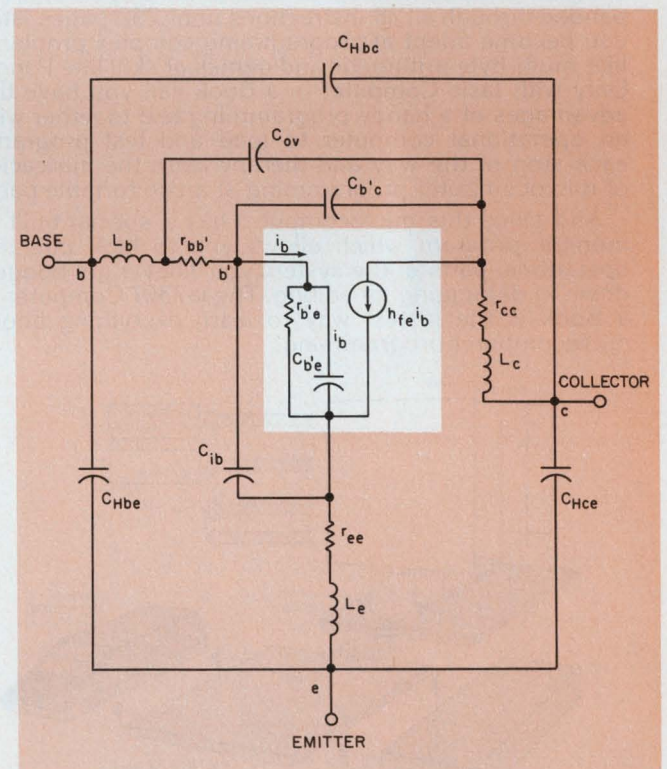

2. The complete circuit model of a transistor includes many elements besides the intrinsic hybrid-pi model (white background). Only the intrinsic model is considered in the calculations.

Microcomputer pro with the Iasis Co

The fact is that right now microcomputer programming is a bear. Microprocessors are loaded with subtleties which make software development a long, arduous process. That's why we developed the ia7301 Computer in a Book*. It's a fully operational microcomputer system and a 250 page programming course all contained in a 3-ring binder. This is not a kit or a toy but a powerful, microcomputer system (based on the industry standard, the 8080) and a practical programming course specifically designed to quickly bring you up to a high level of understanding and proficiency in programming 8080 based microcomputer systems.

The Computer in a Book comes to you completely assembled and tested. All you need is an inexpensive dual voltage (+12V & +5V) power supply. The -5V is generated internally in the computer. There is nothing else to buy.

A super programming course

The programming course text is easy to follow and begins with a one instruction program to determine if a switch is open or closed. This is built upon and expanded through all 78 instructions until 250 pages later, you become adept at programming complex problems like multi-byte arithmetic and games of skill like Pong™. Only with Iasis Computer in a Book can you have the advantages of a handy programming text together with an operational computer to load and test programs each step of the way and thereby learn the intricacies of microcomputer programming at a comfortable pace.

And since this microcomputer has a special built in monitor program which allows you to look into the operational parts of the system you'll never get bogged down in debugging or editing. The ia7301 Computer in a Book is the fastest way to learn everything about microcomputer programming.

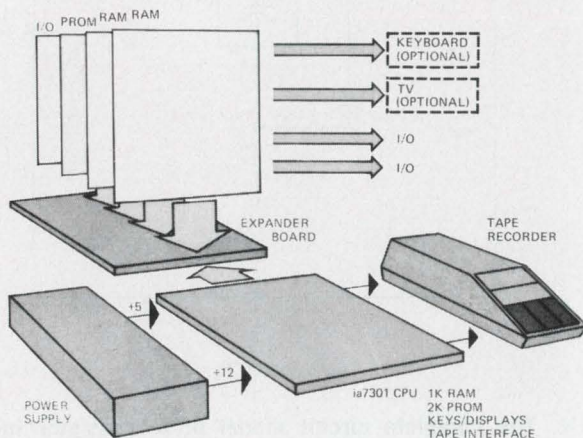

*U.S. Patent Pending
Pong is a trademark of Atari, Inc.

Some great microcomputer features, too

The microcomputer system features a 24 pad keyboard, 8 seven segment LED readouts that display information in hexadecimal code which is far more versatile and advanced than binary or octal coded systems, and an onboard cassette tape interface for saving programs. The hexadecimal keyboard also contains 6 special mode keys which allow you to call up and change any data or instructions in the CPU registers or in the system's RAM memory. Likewise programs can be executed instantly or they can be stepped through one instruction at a time using the appropriate mode key, so that you learn your way around the inner working of an entire microcomputer system.

Also the write tape and read tape mode keys have been carefully designed for accurate and convenient operation with any home cassette tape recorder that has an earphone and remote microphone jack. Two LED indicator lamps tell how long it takes to dump or reload programs from the system's memory onto tape and back again. But in the reloading cycle, if any errors have occurred such as a lost piece of data or the volume knob is too low, the readout displays will indicate errors. This little feature prevents untold problems in debugging a reloaded program.

Upwards expandability from the start

We designed the Computer in a Book to be upwards expandable and not become a kluge in the process. The microcomputer contains 1K bytes of RAM memory, 1K bytes of PROM memory (containing the monitor program), and 2 I/O ports. The Computer in a Book is expandable to virtually any level you want, i.e. up to 65K bytes of memory and 256 I/O ports.

Optional expander boards are available and attach to the ia7301 computer at the top edge connector. A wide variety of standard interface boards can be plugged into the system to give add on memory, TV and teletype interface, and much more.

Thus what served as an educational system can now be upgraded for many new applications. We've included a machine language coding pad for writing and documenting programs, working out subroutines and pro-



programming is a snap computer in a Book

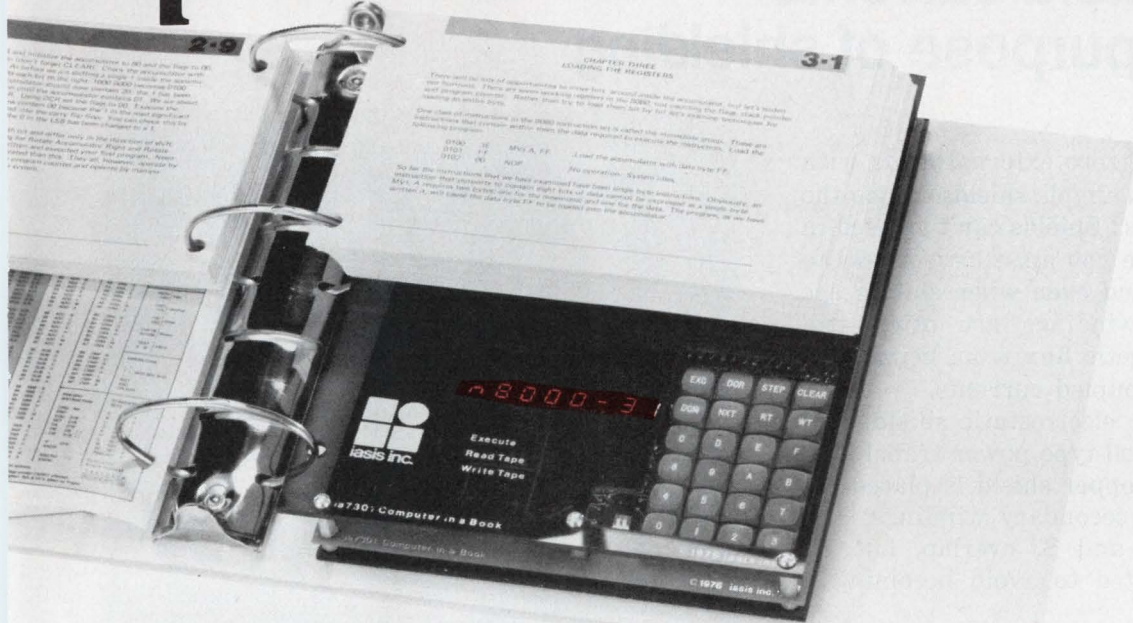

A free bonus

If you order your Computer in a Book before March 15, 1977, Iasis will give you an \$8.00 Microcomputer Applications Handbook

as a free bonus. It contains 144

pages of text, diagrams, and tables on hardware design and microcomputer applications. Order today. If the Computer in a Book isn't everything we say it is, then return it within 15 days for a full refund and keep the Applications Handbook as a gift. We're sure you'll find that microcomputer programming is a snap with the ia7301 Computer in a Book.

viding general support to a development system when extensive programming or debugging is necessary. The Computer in a Book may also be used to train field service technicians by putting verbal information and programs on cassette tapes. We are coming out with preprogrammed PROMs and extension tapes containing new application packages such as floating point arithmetic and micro-assembler programs. Our goal is simple. We want to provide microcomputers that are useful and practical.

A college assistance program

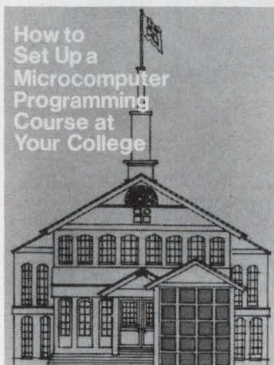

Educators interested in exposing their students to a comprehensive background in Microcomputer programming should look into the Iasis Microcomputer Instructional Courses for their college or university. Send for our free pamphlet which describes ways of setting up short microcomputer programming courses. It offers some advice on structuring a coordinated and comprehensive program, so your students can learn

programming and get valuable hands-on experience with operational systems at very reasonable prices.

The price

The complete Computer in a Book which includes an operational 8080 based system, 250 page programming course, machine code pad, hexadecimal conversion card all in a 3-ring binder is offered for only \$450. The Computer in a Book has a 90 day parts and service warranty. Iasis also provides a check out list and start up instructions with each system. Please allow 30 days for delivery.

Here's my check or money order for _____ complete ia7301 Computer(s) in a Book at \$450 each. Since I ordered my Computer in a Book before Mar. 15, 1977, I want the Microcomputer Applications Handbook as a free bonus. (Calif. residents add 6½% sales tax).

Charge my order to the credit card below:
BankAmericard No. _____
Master Charge No. _____
For Master Charge card, put 4 digit number from above name here _____
My Signature _____
Credit card expiration date _____

Name _____
Firm _____
Address _____
City _____ State _____ Zip _____

Please send me your pamphlet on setting up a Microcomputer Programming Course.

Mail to: Iasis Inc., 815 W. Maude, Suite 25, Sunnyvale, CA 94086
(408) 732-5700

Don't let shield currents defeat the purpose of shielding

Why bother to obtain zero external fields with sophisticated coils¹ when simple shields can do the job alone? The answer is: Shields can't be used in many applications where you must have access to the coil's center hole. And even when shields are used, "super toroid" windings are often still needed to prevent magnetic flux from being generated by capacitance-coupled currents.

Consider the familiar electrostatic shield used in some of the better shell-type power transformers (Fig. 1), where a copper shield is placed between the primary and secondary windings. The shield ends, labeled F and S, overlap, but, of course, they are insulated to avoid becoming a shorted turn.

Frequently and improperly, the shield drain lead is connected to one of these ends. If the drain connects to point F, then voltage transients on either winding can cause a flow of current clockwise to F and out the drain. Clearly, such a current flow produces magnetic flux that couples directly to the windings and defeats the purpose of the shield. However, if the drain is connected at half-way point M, one-half of the shield current will flow in a clockwise direction and the other counterclockwise. The opposing magnetic fluxes cancel each other.

Fig. 2 compares a conventional toroid with a "super toroid" having a regressive winding. Both toroids are housed in shielded cans. The conventional toroid induces current flow in the shield, even if the coil terminals are balanced with respect to the shield ground. In the regressive winding, appreciable capacitance current flows between adjacent turns, but electrostatic fields at distances larger than the winding pitch are negligible. If the coil terminals are balanced with respect to shield ground, no appreciable currents will flow in the shields.

Reference

1. Gross, T. A. O., "Super Toroids with Zero External Field Made with Regressive Windings," *Electronic Design*, Sept. 1, 1976, pp. 110-112.

T. A. O. Gross, Consulting Engineer, T. A. O. Gross & Associates, Lincoln, MA 01773.

CIRCLE No. 311

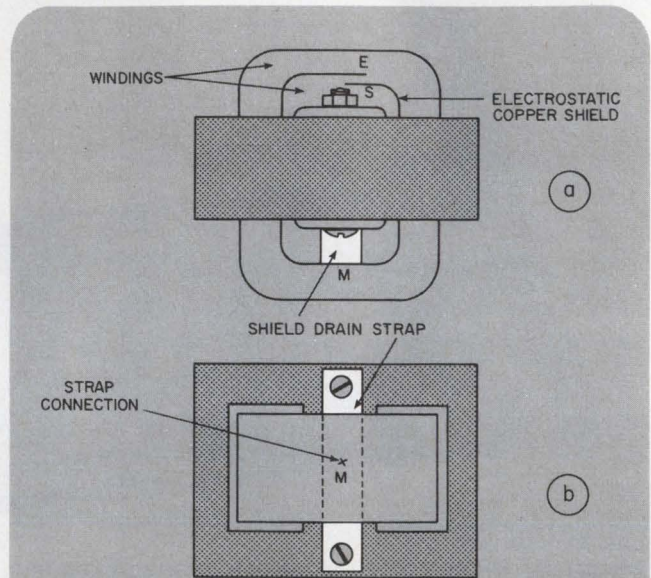

1. An electrostatic shield is often placed between the primary and secondary windings of a power transformer (a). If the shield-drain lead is connected to any point on the shield except M, the currents coupled into the shield are unbalanced, and the resulting magnetic flux can induce unwanted voltages in the windings. Symmetry, and thus, improved flux cancellation results, if the drain lead to point M takes the form of a strap to the frame (b).

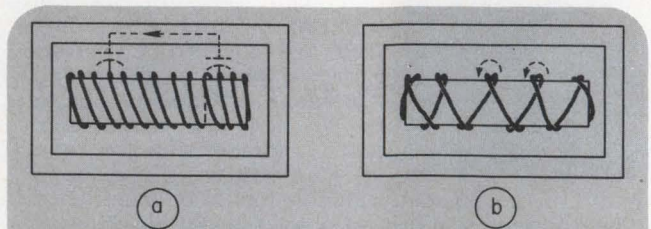

2. A conventional toroidal winding (a) can have substantial voltage differences between various portions of the coil, which can capacitively couple current flow in a shield can. This current flow can cause substantial unwanted radiation of magnetic flux. A "super toroid" with a regressive winding effectively neutralizes the stray capacitance between coil and shield (b).

How to tell a Super-VOM from just the everyday garden-variety Brand X.

ONLY THE SUPER-VOM (Triplett's New 60) HAS ALL THESE FEATURES:

X'TRA RUGGED CONSTRUCTION
(For an accidental drop up to a five-foot height)

BUILT-IN "CONFIDENCE-TEST"
for periodic meter reassurance checks after overload/drops.

OVERLOAD PROTECTED
(All ranges; 3-fuse arrangement including diodes and 2 Amp/1000 V protection fuse)

SINGLE-RANGE SELECTOR SWITCH
(Most VOM's have 2 or more. Single switch minimizes range selection errors)

SAFETY DESIGNED FOR YOU
(Completely insulated; new Safety Leads; prevents explosive arcs from high energy circuits up to 20 KW)

48" SAFETY ENGINEERED TEST LEADS
(Especially designed recessed safety connectors and heavily insulated alligator clips)

ONLY 2 RECESSED INPUT JACKS
(Makes lead changes unnecessary - Some VOM's have as many as seven)

DETENTED HANDLE POSITION



\$99

Nobody else offers these features in a VOM at any price. So for only \$99, the Model 60 is the safest, most versatile, most honestly priced quality VOM you can buy. And, for just \$7 more, you can have the Model 60-A that has 1½% DC accuracy, plus a mirrored scale.

That's the kind of Triplett one-upmanship appreciated the world over by value conscious users in industrial production and maintenance, TV - Radio - Hi-Fi shops, vocational training and hobbyists, airconditioning, appliance and automotive service, R & D, and application engineering . . . anyone who wants to be more productive with the latest in VOM technology. Model 60 Type 2 Approved by MESA, Approval 2G-2880.

Drop in on your nearest Triplett distributor or Mod Center and drop the new Model 60. Ask for a no-obligation demonstration of every feature. Compare it with any other VOM. You'll know why Triplett Models 60 and 60-A eliminate over 90% of the costly repairs from VOM misuses. Cultivate a profitable habit for selecting Triplett design-firsts.



TRIPLETT

BLUFFTON, OHIO 45817

Circle # 131 For Information

Circle # 132 For FREE Demonstration

Triplett. The easy readers

Very long shift registers can be built with RAMs

With little additional hardware, random-access memories can be used as long shift registers (> 100 bits) with a good speed capability.

For example, Fig. 1 shows a 1000-bit shift-register design that uses a 1024 × 1 RAM and a binary 10-bit down-counter, preset to 999. With this design, the shift-register's length can be varied from 1 to 1024 bits merely by changing the counter's preset input. But, although this scheme is very versatile, it suffers in speed capability. Time must be allowed for a read to be followed by a write for each address location.

The design in Fig. 2 can operate at four times the speed. The increase results from a serial-to-parallel-to-serial (S/P/S) operation similar to the scheme used in some CCD LARAM (line-addressed RAM) chip designs, now available. The input operation requires two small registers: the first converts the serial stream to a parallel output, which is strobed every four bits into the second, and held for four bit durations. Thus, the RAMs see four bits at a time, and only one-quarter the processing time is needed.

The output of a divide-by-four counter clocks the address counter and the RAM's write/enable (W/E). A read is performed when the W/E signal is high, and a write when it is low.

Four bits are parallel dumped into the output P/S register at the end of the read period to allow the maximum possible time for a read operation after a RAM location is addressed.

With enough parallel RAMs, almost any practical speed can be obtained. For example, with $N = 4$ (N is the number of paralleled RAMs) and the use of four Fairchild F10415A, 1024 × 1 RAMs, shift registers up to $4096 + 7$ (circuit's delay) = 5003 bits can be obtained at typical speeds up to approximately 65 Mb/s. With $N = 8$, the same type of RAMs can be used for registers of up to 8199 bits at typical speeds up to 130 Mb/s.

Note: The 7-bit delay is calculated from the relationship $N + N/2 + 1$. If the P/S strobe had occurred at the same time as the S/P strobe, the total delay of the S/P-P/S combination would be only N . But because the P/S strobe is offset from the S/P strobe by $N/2$, $N/2$ bits of delay are added. The extra single bit of delay derives from the P/S strobe acting at the end of a data period. Thus, for $N = 4$, as in Fig. 2, the delay—excluding the RAMs—is 7 bits.

Brady H. Warner, Jr., Member Tech. Staff, COMSAT Laboratories, Clarksburg, MD 20734.

CIRCLE NO. 312

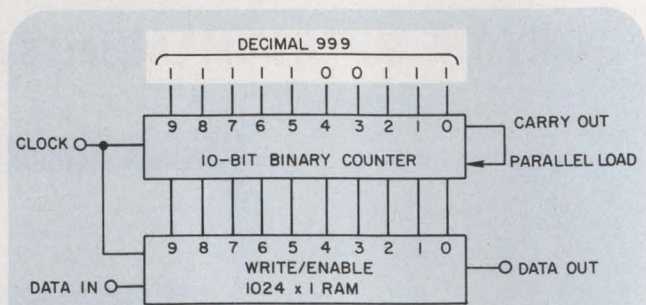

1. This shift-register's length can be varied from 1 to 1024 bits by changing the counter's preset input number.

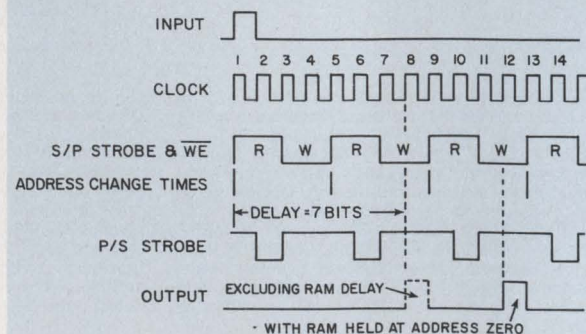
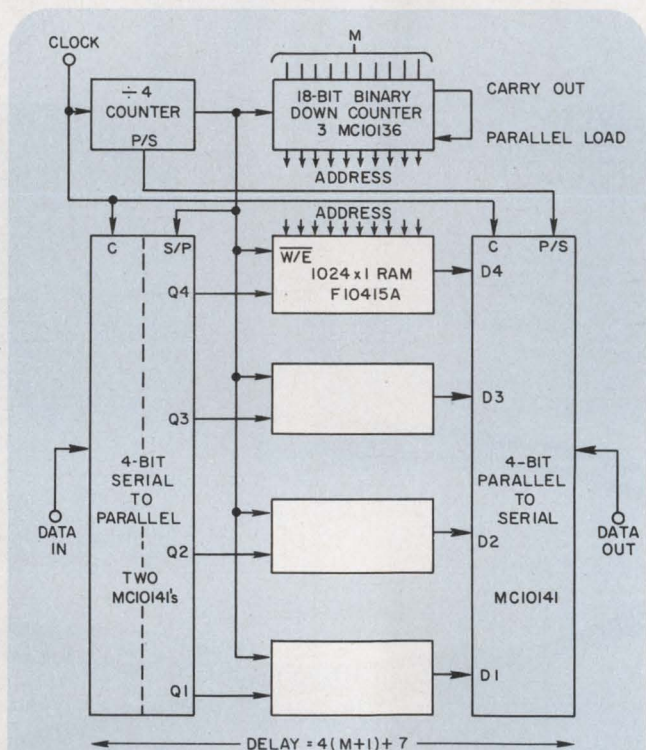

2. By operating several RAMs in parallel, you can design proportionately higher-speed shift registers.

PMI announces the new 108A.

Do you want to know the real inside story of our new 108A/308A precision low power op amp? Here it is, without names in order to protect our customer. Fact is, this customer came to us and asked if we could make some 108A's that met 108A specs. We tried and couldn't. But we found out why nobody else could, either; it was simply designed wrong.

So we redesigned it as a 108A. Corrected the unbalance which caused the high TCV_{OS} . Gave it our zener zap treatment. Plus ion implantation. And the kind of pricing high volume production parts deserve.

Result? Check with your distributor. He has 108A's on his shelf right now. And they work. Up to MIL-M-38510/101B-04 specs.

Processed to MIL-STD-883A Level B.
 V_{OS} 0.5mV Max.;
 TCV_{OS} $5\mu V/^{\circ}C$ Max.

Just ask for it by name: PMI's new 108A/308A. The one that works.

It works.

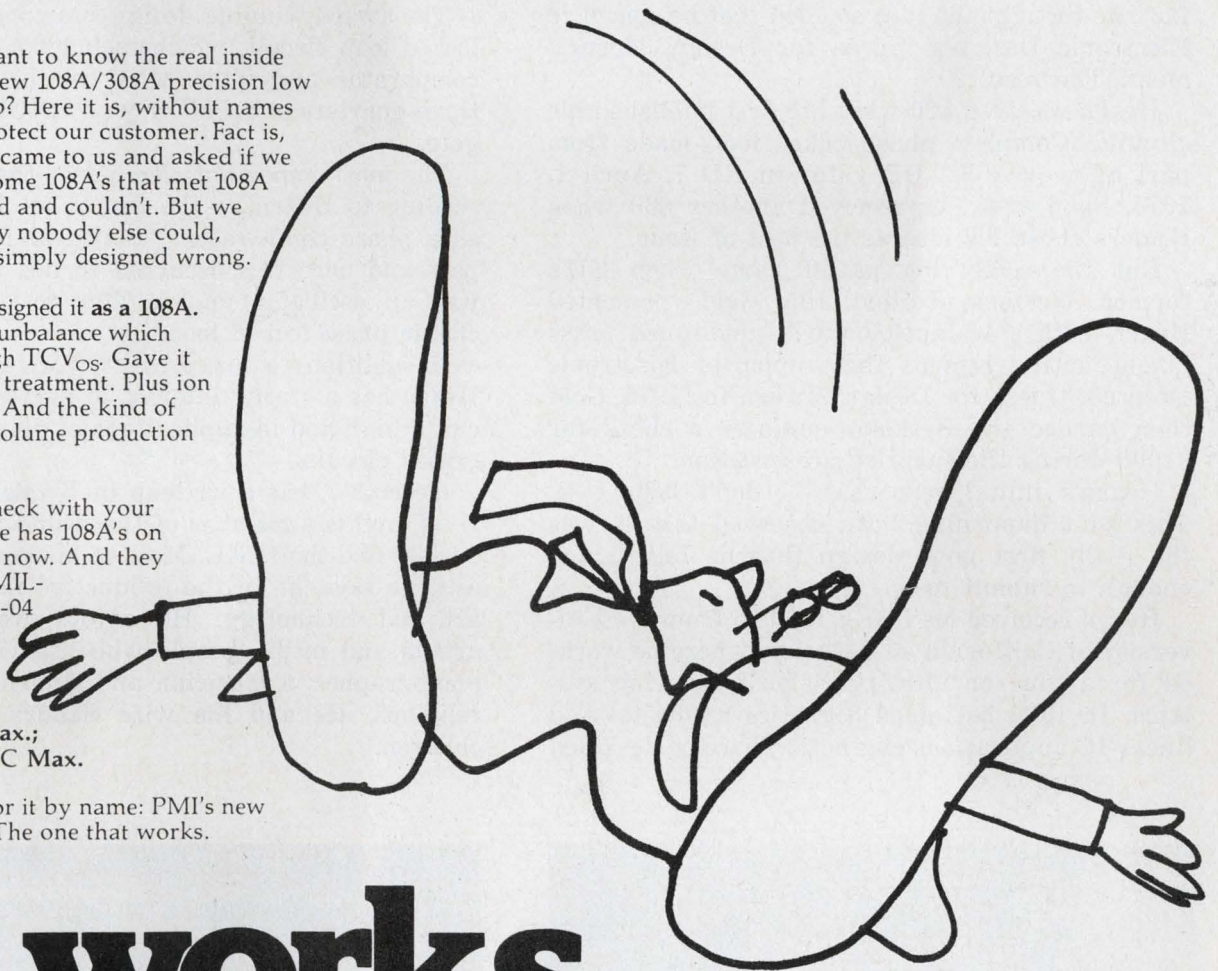

Precision Monolithics Incorporated
1500 Space Park Drive, Santa Clara, CA 95050
(408) 246-9222. TWX 910-338-0528
⊗ Cable MONO.

Bill Hearn of Berkeley Laboratory wins annual 'Ideas for Design' award

Next year your picture might be here. All you have to do is send us your clever Ideas for Design and you're in the running for the \$1000 prize.

Some time ago, Bill Hearn, an electronics engineer at Lawrence Berkeley Laboratory at the University of California, thought up a neat way to wire a complete phase-locked loop circuit. In fact, he thought the idea so good that he sent it to Electronic Design's "Ideas for Design" department. The result?

Hearn received \$20 when we first published his circuit, "Complete phase-locked loop made from part of a quad EX-OR gate" in ED 7, April 1, 1975. Soon after, he received another \$30 when readers chose his idea as the best of issue.

But the really big payoff came when ED's former Western Editor, Jim Gold, presented Hearn with a walnut-mounted, gold-toned brass plaque, citing him as the winner of Electronic Design's "Ideas for Design" award for 1975. Gold then handed the Berkeley engineer a check for \$1000 during the surprise presentation.

Hearn's initial response: "I don't believe it. This isn't happening." He observed that it was the really first good design that he felt "cute" enough to submit to ED.

Hearn received his BSEE in 1966 from the University of California at Berkeley, where he worked for a time on ultra-precision measuring systems. In 1968 he joined Signetics as digital and linear-IC applications engineer. There he designed

the 531 fast slewing op amp. After a brief fling as a curator at the "Exploratorium"—a science museum in San Francisco—Hearn started his own company, Electronics Associates of Berkeley in 1972, producing video products and video synthesizers. In 1973 he joined Berkeley Labs and designed instrumentation for a variety of applications.

The award-winning design is a complete phase-locked loop circuit, which includes a VCO, phase comparator and filter, that can be made from three-quarters of a CMOS quad EXCLUSIVE-OR gate.

The most important element of the circuit, according to Hearn, is the use of an EX-OR gate as a phase comparator. "It's ideal for this purpose and once this occurred to me, all I needed was an oscillator and a filter to complete the classic phase-locked loop."

In addition to his present work at Berkeley, Hearn has a strong interest in modern video circuit design and in applications of monolithic integrated circuits.

Hearn, 37, has a writeup in *Who's Who in the West*, and is a member of the Audio Engineering Society and the IEEE. Most of his personal interests, he says, lie in the productive interaction of art and technology. He enjoys working with artists and media people who use video. He's a photographer, a musician and student of ancient religions. He and his wife Sandra have three children.



Winner Bill Hearn (center) is about to receive a plaque from editor Jim Gold. Attending are fellow members of



Berkeley Labs (left to right) Dick Mack, Henry Lancaster and Walt Hartsough.

*If you buy
a prom programmer
before you read this
you're making a
big mistake!*



You can spend a lot of money and get practically nothing if you aren't careful.

Here's what to test for:

1. Is the programmer universal? Does it equip you for "tomorrow?" Will it program every available PROM type? (At last count there were over 165.)

2. Are programming techniques approved by the semiconductor manufacturers?

3. Can the programmer be calibrated? By you? Can performance be verified to PROM manufacturers' current specifications?

4. Is the programmer supported by direct sales, installation, training and service?

If the programmer is from Data I/O, it passes the test. Today, more than 1500 companies use Data I/O programmers. We build a complete range of machines including the Programmer V which has outsold every other automatic programmer in the

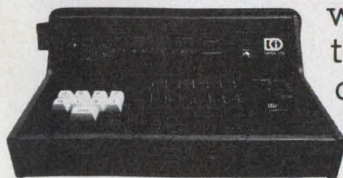

world (including the former world champ, the Data I/O Programmer I).

Data I/O total three point service.

1. Every Data I/O customer receives a quarterly update on currently available PROMs.

2. Through our direct (computerized) mailing program, Data I/O customers are kept constantly up-to-date on PROM specification changes and technological innovations.

3. Nine field offices in the U.S.A. and 22 distributors worldwide provide our customers with direct sales support, installations, operator training and service.

Get the facts

If you would like to know more about our products, or want copies of our quarterly PROM Comparison Chart and PROMBITS (our periodic technical bulletin on PROM applications and innovations), mail this coupon or call one of our offices. Data I/O Corporation, P.O. Box 308, Issaquah, Washington 98027.

Name _____

Title _____

Company _____

Address _____

City/State/Zip _____



Data I/O

Keyboard for 64-key ASCII code features very low power consumption

The substantial power consumption of most MOS alphanumeric keyboard encoders, typically 400 mW, is undesirable for portable and other power-critical applications. Fig. 1 shows an encoder circuit that draws nanowatts in standby and less than 0.5 mW at 5 V when any key is depressed. The keyboard encoder circuit uses only three standard CMOS ICs and a few discrete parts, and can encode up to 64 keys in the ASCII-6 character code (see table). Further, the circuit requires no clocks, and contains circuitry to remove keyswitch contact bounce.

The keyswitches are arranged in an 8 × 8 electrical matrix, with the position of each switch determining the corresponding ASCII bit pattern.

A CD4532 binary encoder encodes eight lines

into three lines. Its gate-select output (GS) goes HIGH whenever any input, D0 to D7, is HIGH at the same time that its enable input (EI) is HIGH.

When a key is pressed, a connection is made between the base of one of the transistors that drives a keyswitch-matrix row and an input of the column encoder. The resulting current flow saturates the transistor, raises its collector voltage close to V_{dd} and presents a positive input to the column encoder to produce a HIGH at the column-encoder's GS output. A Schmitt trigger and filter made of inverters and associated circuitry remove contact bounce from the GS output, which becomes the strobe-out signal.

When the strobe-out signal goes HIGH, it indi-

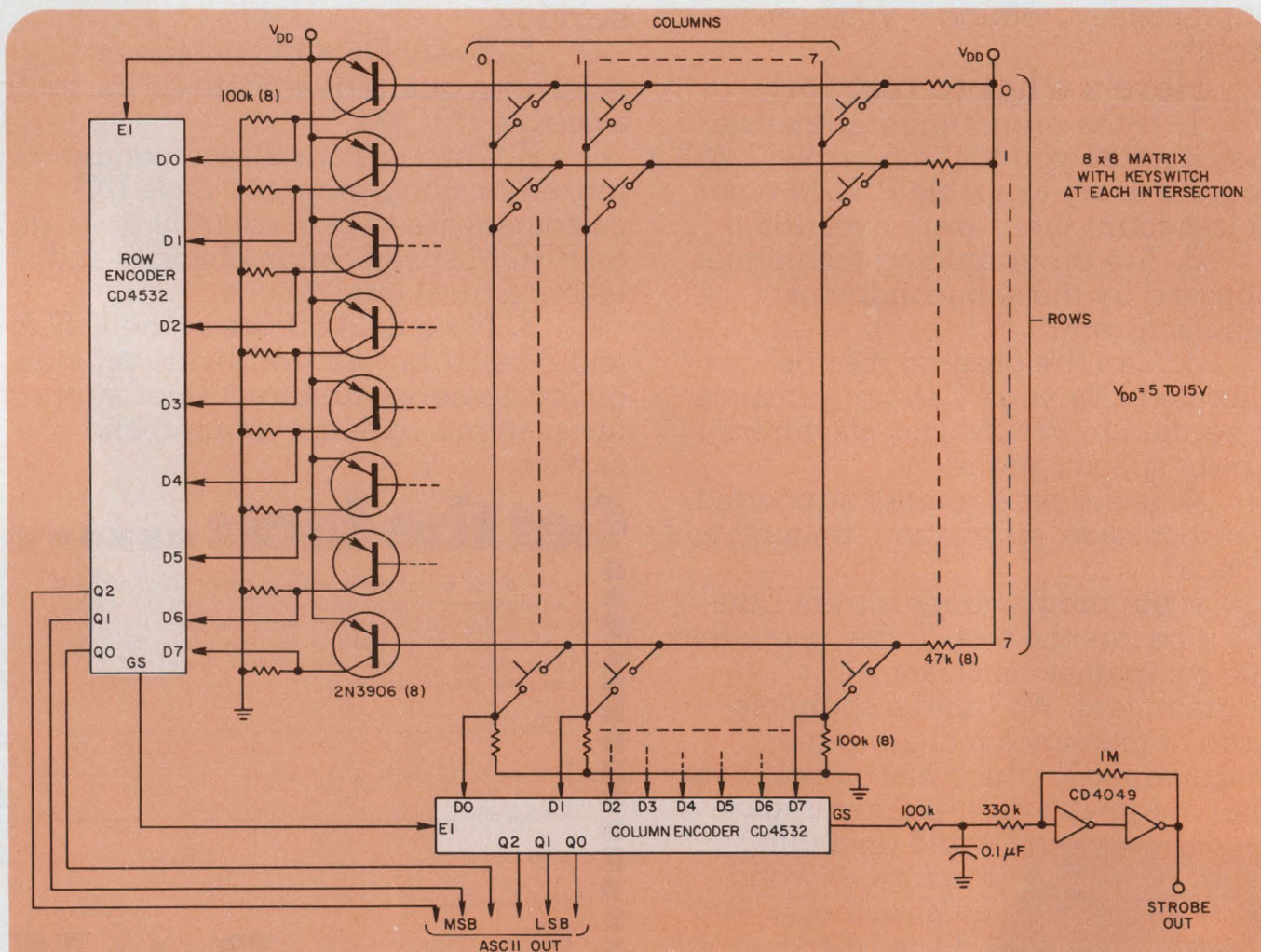

1. Few components are needed to build this 64-key ASCII encoder. Low-power consumption—only nano-

watts when in standby—allows its use in portable and other low-power applications.

Borrow my coffee cup... but never my C-Meter.

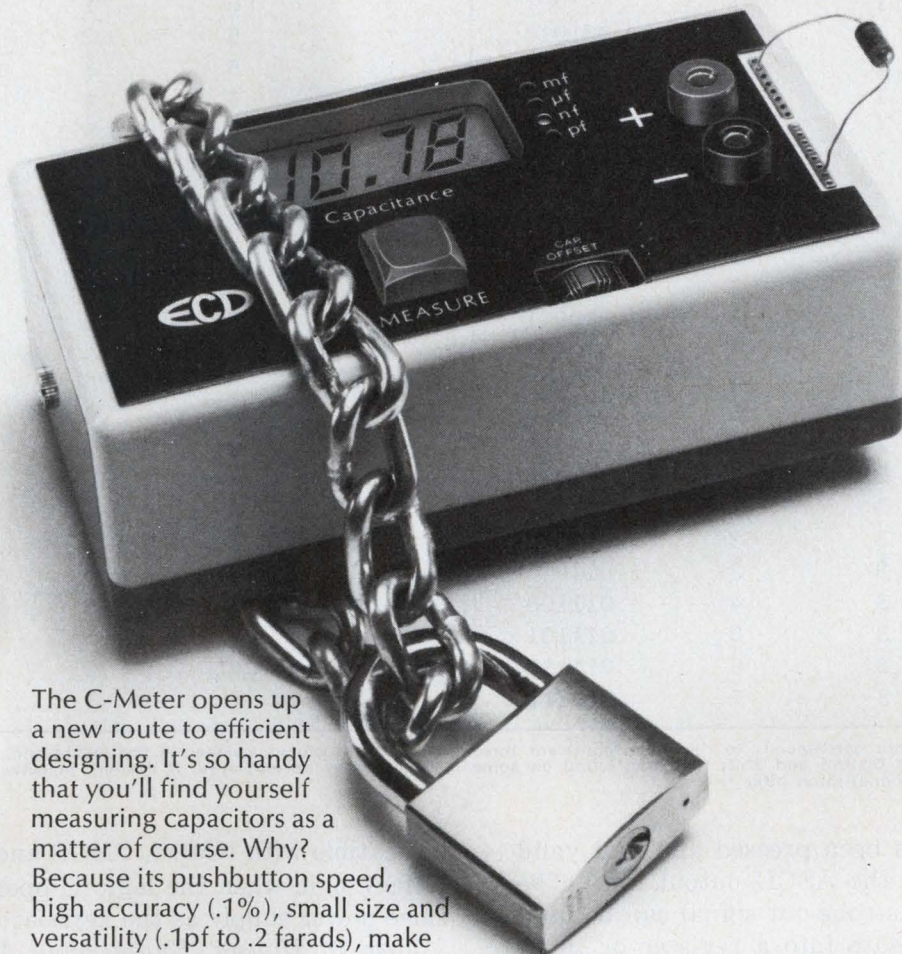

The C-Meter opens up a new route to efficient designing. It's so handy that you'll find yourself measuring capacitors as a matter of course. Why? Because its pushbutton speed, high accuracy (.1%), small size and versatility (.1pf to .2 farads), make capacitors easier to measure than resistors.

With the C-Meter, you'll waste no time twiddling, and nulling, and you'll cut the need for expensive tight-tolerance capacitors or tweak pots in your circuits. You'll be a much more efficient engineer. And popular too, because people just can't keep their hands off the C-Meter.

You owe it to yourself to try one. Our reps are stocking them at **\$289.**



ECD CORP.

196 BROADWAY, CAMBRIDGE, MASS. 02139
(617) 661-4400

SALES OFFICES: AL, Huntsville (205) 533-5896; AZ, Scottsdale (602) 947-7841; CA, Costa Mesa (714) 540-7160; CA, Sunnyvale (408) 733-8690; CO, Denver (303) 750-1222; FL, Winter Haven (813) 294-5815; GA, Chamblee (404) 457-7117; IL, Elk Grove Vill (312) 593-0282; IN, Indianapolis (317) 293-9827; MD, Silver Spring (301) 622-4200; MA, Burlington (617) 273-0198; MN, Minneapolis (612) 781-1611; NJ, Camden (215) 925-8711; NM, Albuquerque (505) 299-7658; NY, Great Neck (516) 482-3500, (212) 895-7177, Syracuse (315) 446-0220; NC, Raleigh (919) 787-5818; OH, Centerville (513) 433-8171; TX, Houston (713) 688-9971; TX, Richardson (214) 231-2573.

CIRCLE NUMBER 71

The ASCII-6 code: keyswitch matrix

Character	Row	Column	ASCII	Character	Row	Column	ASCII
@	0	0	000000	(space)	4	0	100000
A	0	1	000001	!	4	1	100001
B	0	2	000010	"	4	2	100010
C	0	3	000011	#	4	3	100011
D	0	4	000100	\$	4	4	100100
E	0	5	000101	%	4	5	100101
F	0	6	000110	&	4	6	100110
G	0	7	000111	'	4	7	100111
H	1	0	001000	(5	0	101000
I	1	1	001001)	5	1	101001
J	1	2	001010	*	5	2	101010
K	1	3	001011	+	5	3	101011
L	1	4	001100	,	5	4	101100
M	1	5	001101	-	5	5	101101
N	1	6	001110	.	5	6	101110
O	1	7	001111	/	5	7	101111
P	2	0	010000	0	6	0	110000
Q	2	1	010001	1	6	1	110001
R	2	2	010010	2	6	2	110010
S	2	3	010011	3	6	3	110011
T	2	4	010100	4	6	4	110100
U	2	5	010101	5	6	5	110101
V	2	6	010110	6	6	6	110110
W	2	7	010111	7	6	7	110111
X	3	0	011000	8	7	0	111000
Y	3	1	011001	9	7	1	111001
Z	3	2	011010	:	7	2	111010
[3	3	011011	;	7	3	111011
\	3	4	011100	<	7	4	111100
]	3	5	011101	=	7	5	111101
↑	3	6	011110	>	7	6	111110
←	3	7	011111	?	7	7	111111

Note: The row-encoder output corresponds to the most-significant three bits and the column encoder to the least-significant three bits of a "trimmed" ASCII code. The Control and Shift functions found on some keyboards may be employed, if desired, in software presenting their lines to a CPU as two additional input bits.

cates that a key has been pressed and that valid data are present on the ASCII output lines. The leading edge of the strobe-out signal can be used to gate the ASCII data into a register or input port, or to provide a keyboard-interrupt request to a central processor. The outputs are directly

compatible with NMOS, CMOS and low-threshold PMOS logic when the logic is operated from the same power supply as the keyboard.

Max W. Hauser, Engineering Associate, Plasma Research Laboratory, Cory Hall, University of California, Berkeley, CA 94720.

CIRCLE NO. 313

IFD Winner for September 1, 1976

T. A. O. Gross, Consulting Engineer, T. A. O. Gross & Associates, Lincoln, MA 01773. His idea "Super Toroids with 'Zero' External Field Made with Regressive Windings" has been voted the most Valuable of Issue Award.

Vote for the Best Idea in this issue by circling the number of your selection on the Reader Service Card at the back of this issue.

SEND US YOUR IDEAS FOR DESIGN. You may win a grand total of \$1050 (cash)! Here's how. Submit your IFD describing a new or important circuit or design technique, the clever use of a new component or test equipment, packaging tips, cost-saving ideas to our Ideas for Design editor. Ideas can only be considered for publication if they are submitted exclusively to ELECTRONIC DESIGN. You will receive \$20 for each published idea, \$30 more if it is voted best of issue by our readers. The best-of-issue winners become eligible for the Idea of the Year award of \$1000.



Series 97-520*
A smaller size Sticky Fingers for high shielding effectiveness in less space.

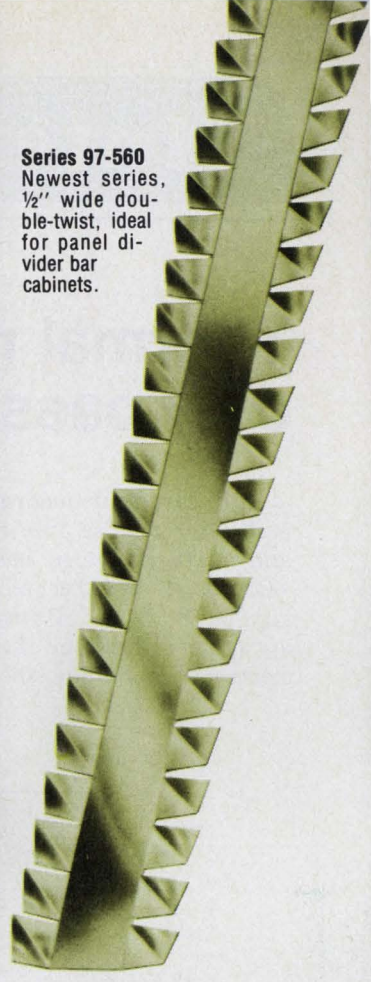

Series 97-560
Newest series, 1/2" wide double-twist, ideal for panel divider bar cabinets.

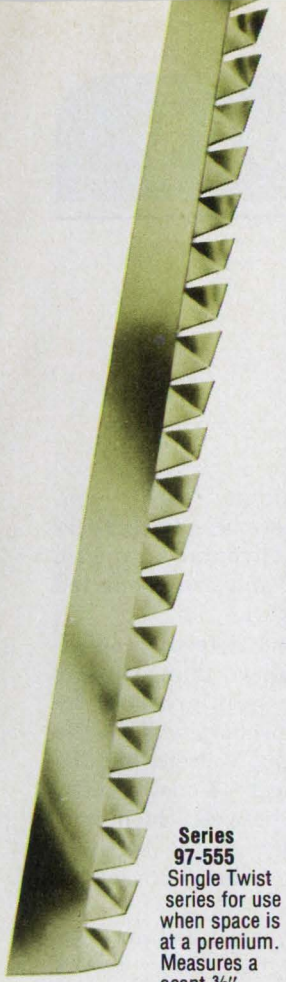

Series 97-555
Single Twist series for use when space is at a premium. Measures a scant 3/8" wide.

stickn fingers®

RFI/EMI SHIELDING from Instrument Specialties attaches faster, shields better than anything else!

Instrument Specialties line of Sticky-Fingers beryllium copper gaskets provides *the* answer for just about every RFI/EMI problem.

Each strip is backed with a strong, *really* sticky self-adhesive that attaches quickly, grips and holds securely. There's no need to drill holes, no need for metal fasteners. You merely cut the strip to the desired length, peel the backing, and apply.

What's more, you get shielding effectiveness of up to 126 dB at 10 GHz plane wave, or greater than 90 dB at 1 MHz magnetic. Whether you want to keep interference in or out—in new installations or retrofits—with standard or narrow flanges—there's a Sticky Fingers contact strip to do your job *better!*

Our complete catalog of RF shielding strips and rings is available free. Write today to Dept. ED-85.

INSTRUMENT SPECIALTIES CO., INC.

Little Falls, New Jersey 07424

telephone: 201-256-3500 twx: 710-988-5732

Specialists in beryllium copper since 1938

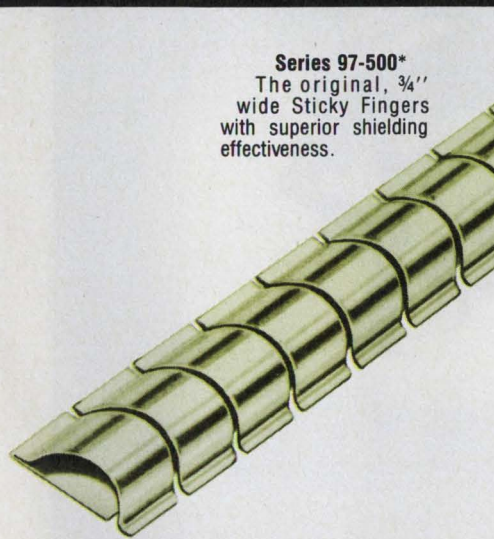

Series 97-500*
The original, 3/4" wide Sticky Fingers with superior shielding effectiveness.



Series 97-505*
A 90°-configuration version of 97-500.

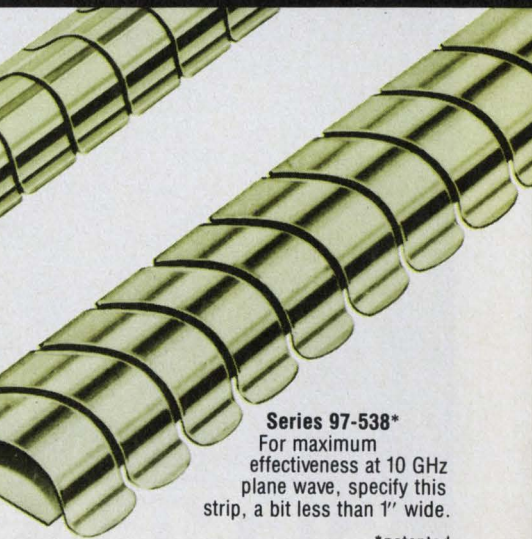

Series 97-538*
For maximum effectiveness at 10 GHz plane wave, specify this strip, a bit less than 1" wide.

*patented

International Technology

Thermal multiplier needs only passive components

A linear, four-quadrant thermal multiplier that is free from offset and drift problems has been developed at the Technical University of Budapest, Hungary. Based on a thermal rather than a purely electronic technique, the multiplier

uses only passive components and is compatible with conventional IC technology.

The multiplier is formed from three identical thermal-function blocks. In each block a diffused resistor acts as a heat source, and

six silicon-aluminum (Si-Al) contacts act as thermoelectric transducers. The Si-Al contacts produce about $1 \text{ mV}/^\circ\text{C}$ and are connected as shown in Fig. 1.

The heater and detector components are smaller than bipolar transistors. The heat produced by the resistor is proportional to the square of its input voltage, but the detector is linear. Consequently, the relationship between the output and input voltages of the thermal-function block follows a square law.

A true multiplier is obtained by interconnecting the three blocks (see Fig. 2). If the two input

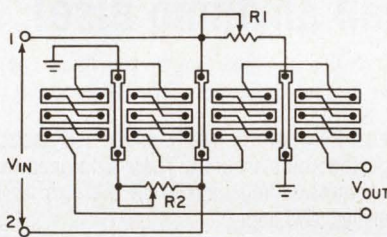
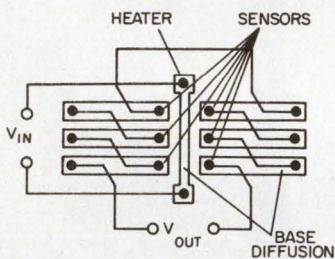

When "Real Estate" is important measure our Capacitors against their capacitors.

If your circuit boards are victims of the capacitor population explosion, Siemens can help solve your problem. We produce over 5 million capacitors a day and know how to put the most c-v value into the smallest package.

Our stacked film capacitors, for instance, can reduce your circuit board real-estate by 60% compared to competitive units. But this is only one alternative available. And that's our strength. Being able to offer a wider range of capacitor types than others - to guarantee you the right capacitor for your application.

To learn the full story on our tantalum, film, metallized film, stacked film, aluminum electrolytic and ceramic capacitors, contact:

Siemens Corporation, Components Group
186 Wood Ave. South, Iselin, N.J. 08830 (201) 494-1000

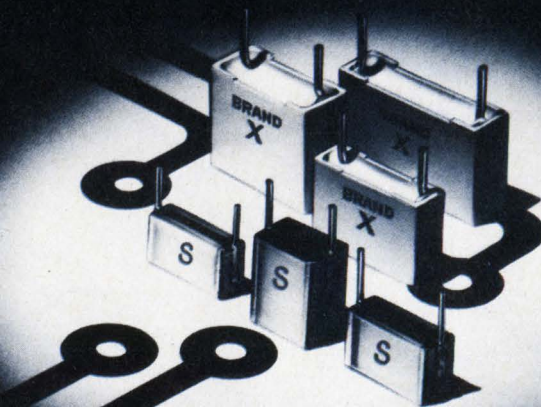

SIEMENS

voltages are V_1 and V_2 , the first block is driven by $V_1 - V_2$, the second by V_1 alone and the third by V_2 . The three outputs are connected in series, but in such a way that the second and third outputs have a polarity opposite to the first output's. The output voltage, therefore, proportional to $(V_1 - V_2)^2 - V_1^2 - V_2^2$ gives the required multiplication.

Since parts of the sensor arrays are common for neighboring blocks (Fig. 2), both the device area and the output resistance are reduced. Trim resistances R_1 and R_2 equalize the sensitivities of the three blocks.

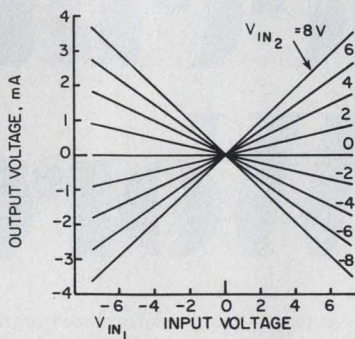

Chip dimensions of experimental devices have been $710 \times 560 \mu\text{m}$. The dc-output voltage is equal to $6 \times 10^{-5} V_1 V_2$ and good linearity zero offset has been obtained (Fig. 3).

The thermal multiplier has two limitations. Its small output voltage means that the circuit must be followed by an amplifier, and

the cut-off frequency (3-dB point) is a low 8 kHz. However, experimental circuits have been fabricated with a relatively large $12\text{-}\mu\text{m}$ line-width process.

Smaller line widths can reduce device dimensions considerably and cause both a linear increase in sensitivity and a quadratic increase in output cut-off frequency.

Don't bend optical fibers blast them with sparks

A simplified way to cleanly fracture optical waveguide fibers produces smooth, flaw-free, parallel end faces. Developed in West Germany at the Bochum Institut, the method eliminates special fixtures and tools required by the conventional fracturing procedure. Moreover, it can be optimized for different types of glass fibers.

The fiber to be fractured is first bombarded by sparks and then simply broken by hand. The usual method of producing smooth end faces calls for bending the fiber, under tension, around a cylinder with a special radius of curvature, and then scoring the fiber with a

diamond blade.

Working with the West German procedure requires a standard spark coil producing high-voltage pulses at a rate of about 500 kHz; a $100\text{-k}\Omega$ series resistor; and about 1-m of coaxial cable. The open end of the cable terminates in a 1 or 2-mm spark gap.

In experiments using a 1-m coax cable, the optimum parameters for breaking fibers have been found to be a 5-s exposure of the fiber to the spark developed across a 1.5-mm gap. The length of the cable determines the duration of the individual sparks jumping the spark gap.

Thank you for the Vendor Excellence Award, Raytheon...our Zeners worked hard for it.

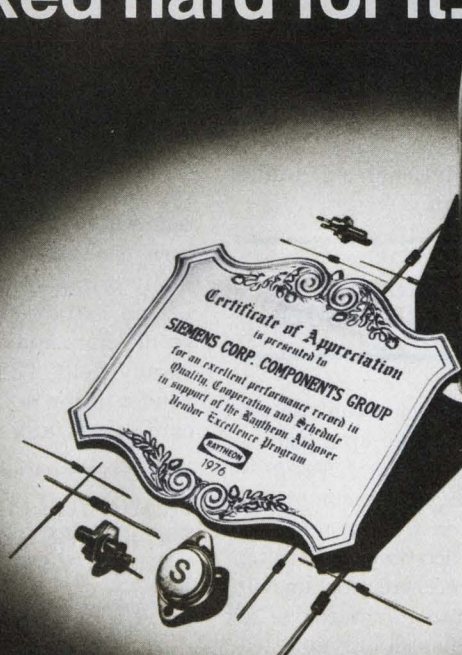

Hi-Rel Zener Diodes are one of our most important product lines. And when Raytheon commended Siemens for our excellence in this area we were understandably proud. (We were one of 30 vendors so honored, out of an evaluation group of 4000.)

The award cited Siemens for its quality, reliability and on-time delivery, plus an attitude of cooperation.

What we did for Raytheon at Andover, Mass., we can do for you. Our Hi-Rel Manufacturing facilities in Scottsdale, Arizona, produces JAN, JANTX, JANTXV, S1N Zener Diodes and specially processed devices for the Hi-Rel market.

To learn more about making our Zeners work for you . . . send for our new free Zener Diode wall chart.

Siemens Corporation, Components Group
186 Wood Ave. South, Iselin, N.J. 08830 (201) 494-1000

SIEMENS

TO ALL OUR READERS:

A Special Word



James S. Mulholland, Jr., President
Hayden Publishing Company, Inc.

As *Electronic Design* begins its 25th Anniversary Year, it seems fitting to take time out to express our sincere thanks and appreciation to you — our readers.

This is no small task, as the *Electronic Design* "family" has grown from 20,000 in 1952 to this year's high of more than 93,700 paid and qualified subscribers, with 14,000 overseas. Those of you who share your copies with other engineers push the total *Electronic Design* audience to more than 1/3 million readers — worldwide!

Your contributions, loyalty, and continued support, have not only helped make *Electronic Design* one of the world's outstanding technical journals, but insure its continued success as an exceptionally powerful na-

tional and international electronics advertising medium.

THANK YOU FOR THE ARTICLES YOU CONTRIBUTE

Technical articles contributed by our subscribers make up a significant portion of *Electronic Design's* editorial pages. They complement and extend staff-written feature material and receive wide acceptance. Nothing can match the direct, practical knowledge engineers gain in the course of their work. The information submitted is unique, timely and essential to problem-solving for a broad range of readers. It's not easy to prepare an ar-

ticle to meet our editors' stringent requirements. We are grateful for the hours you spend and your willingness to share your hard-earned experience with your fellow engineers.

THANK YOU FOR YOUR LOYALTY AND PROMPT RENEWAL

One of the significant costs of publishing any magazine, paid or free, is the cost required to attain prompt subscription renewals. Not so with *Electronic Design!* We are indebted to you for responding so quickly to our renewal requests. The percentage return is fantastic. Our first call normally brings in two-thirds of the list. It's an extraordinary, unheard-of response from audiences in this field . . . or any field. Thank you. And thank you for filling in that long subscription card so carefully and so completely!

THANK YOU FOR RESPONDING ENTHUSIASTICALLY TO INDUSTRY RESEARCH

Electronic Design has pioneered many research projects in support of marketers in this industry. From time to time, most of you have been sam-

of Thanks

pled with questionnaires asking what you need, what you buy, or what preferences you have in many areas.

We realize how much time it takes to deal with these research questionnaires so thoughtfully and to go into so much detail with your answers.

Our Reader Recall readership surveys require some of you to go through an entire issue marking up the pages for ads that you remembered having seen or read. It must take at least an hour. Yet more than 50% of you respond to every survey. Your response is always higher than the usual averages. (One questionnaire for the GOLD BOOK asked 5,200 questions. It received an astonishing 26% return!)

The entire industry joins us in thanking you for your cooperation and support on these vital research projects.

THANK YOU FOR THOSE CARDS AND LETTERS

Electronic Design's editors spend as much time as possible in the field, visiting plants, talking to engineers, taking the pulse of the industry. But they can't be everywhere. Your response to our reader "hotline" has been outstanding. Thousands of

tips, comments, ideas and suggestions pour in after every issue hits the mails. Many of your feed-back comments, even "one liners" often develop into a major article or series of articles, that in turn stimulate even further feed-back. By pointing out those areas where we can better serve you, you help us as we strive to improve editorial quality and professionalism.

THANK YOU FOR YOUR INQUIRIES

Electronic Design is the most "inquired to" magazine in the world. Not only in this but in all other industrial fields. Your use of our reader service cards has approached or topped the 1,500,000 mark each year for the past several years. That's a lot of buying power. The score from 1952 to date is 23 million inquiries! Your response gives this magazine an enormous position of leadership in the marketplace, which in turn helps us bring you a better magazine.

THANK YOU FOR VOTING ELECTRONIC DESIGN . . .

- **Most Helpful**
- **Most Useful in Your Work**

- **The Magazine You Would Choose if You Could Only Have One**
- **The Magazine You Prefer and Believe In**

BUT MOST OF ALL . . . THANK YOU FOR YOUR READERSHIP!

When companies conduct readership studies across their customer and prospect lists, time after time — in fact in almost 90% of all studies recorded—*Electronic Design* is voted #1, . . . the magazine scoring highest in "Read Regularly," in "Preference," and in "Most Helpful." Why? Because you take the trouble to cast your ballot . . . to stand up and be counted as a member of the *Electronic Design* family. These survey results have proved beyond a shadow of a doubt that *Electronic Design* is the best read electronics magazine in the world!

So, thank you, readers. Merci . . . Danke Schön . . . Grazie. We think you are the *best audience* in the world.

Sincerely,

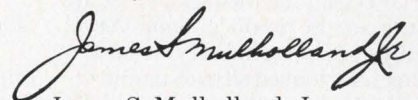

James S. Mulholland, Jr.
President
Hayden Publishing Company, Inc.

Oliver Germanium.

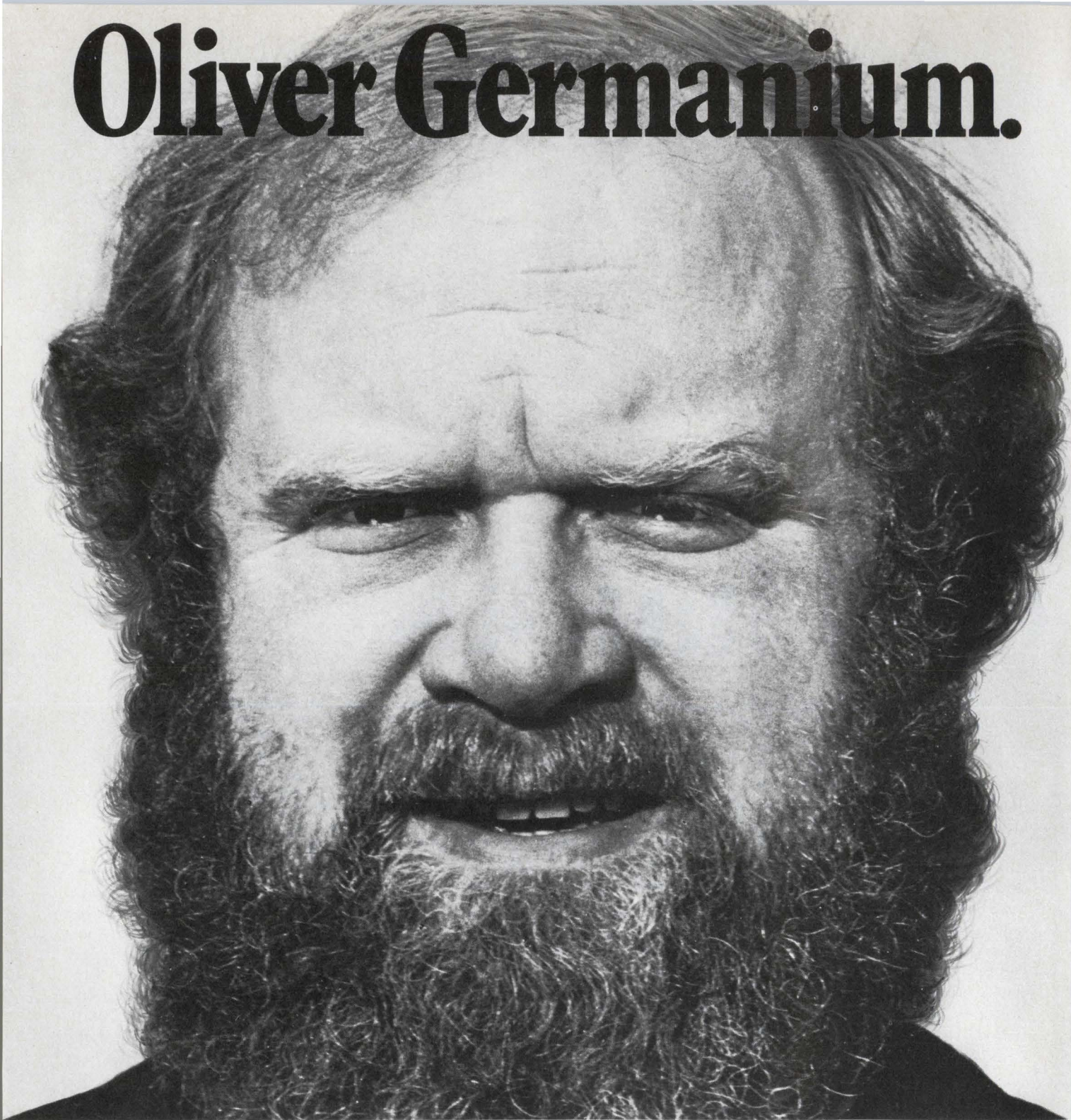

Real name, Oliver Ward.

President, Germanium Power Devices Corporation.

Easily the biggest name in Germanium. And the only one making a complete range of Germanium devices from 1A upwards.

The GPD manufacturing facilities are excellent, as are the products. Some very shrewd buyers, from some very shrewd companies, have looked all over us and appointed us No.1 source.

You could do the same.

So that, whenever Germanium is better than Silicon (as it is in many power applications), you can design our devices in with complete confidence. We'll be making these for years to come.

Or, if you have existing circuits using Germanium technology, there's no hurry to redesign. At least, not for that reason.

And for a top-quality manufacturer, our prices are very reasonable.

In our catalogue you'll find 19 different packages with 12 different junction types, from 1 to 75A, some with external heat sink.

We manufacture direct plug-in replacements for the discontinued Motorola range, from 2N4276 to 2N4283, from 2N4048 to 2N4053, and DTG-MP 500 to 506 and 2000 to 2400A. We also make to all the well-known specs: JAN, EIA and PRO-ELECTRON AD, ADY, ADZ, ASZ, AUY.

If you have a Germanium supply problem, call us. We'll solve it. And keep it solved, for years.

GPD, Box 55, Shawsheen Village Station, Andover, Mass, 01810.

Telephone: (617) 475-5982.

Telex: 94-7150 GPD Andr.

Germanium Power Devices Corporation

The Germanium Manufacturers



New Products

Multiplying d/a settles its output in 300 ns

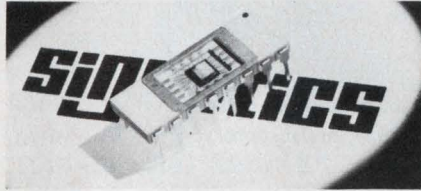

Signetics, 811 E. Arques Ave., Sunnyvale, CA 94086. Peter Guest, (408) 739-7700. From \$2.95 (100-up); stock.

The MC1408 multiplying converters handle 8-bit digital inputs and have a 300-ns settling time. Converter accuracy is $\pm 0.19\%$. The MC1408 has noninverting digital inputs that are TTL and CMOS compatible. Its multiplying rate is 4 mA/ μ s and the output voltage swing goes from +0.5 to -5 V. Standard supply voltages for the converters are +5 V and -5 V to -15 V. Units are available in either 16-pin plastic or 16-pin ceramic DIPs. The MC1408 d/a converters are pin compatible with the Motorola MC1408.

CIRCLE NO. 301

Dynamic & static RAMs double memory capacity

Advanced Memory Systems, 1275 Hammerwood Ave., Sunnyvale, CA 94086. George Landers (408) 734-4330. From \$18 (100-up); stock.

Two 8-k RAMs offer double the capacity of available 4-k RAMs, but remain pin compatible with previous components. The 7008 is an 8192 \times 1 dynamic RAM, housed in a 22-pin DIP. It uses the unused pin 16 of the popular 22-pin 4-k units as the extra address. Access time of the RAM is 150 ns and the total power dissipation of the 7008 is the same as that of 22-pin 4-k's. The 7003 is a 2048 \times 1 static RAM, also packaged in a 22-pin DIP. It is pin compatible with the AMS 7001, a 1-k device. The 7003 operates with a 60-ns access time and requires only 15- μ W/bit standby power.

CIRCLE NO. 302

Monolithic op amp delivers ± 30 -V swings

National Semiconductor, 2900 Semiconductor Dr., Santa Clara, CA 95051. (408) 737-5000. From \$4.50 (100-up); stock.

A general-purpose, high-voltage op amp, the LM144, operates over a range of 36 V. The op amp combines the advantages of low input current (40 nA max.), comparable to those of other "super op amps," high gain and high slew rate. For example, the LM144 with a gain of 10 can provide an output swing of 30 V in either direction with a slew rate of 30 V/ μ s and a 120-kHz full power bandwidth. The LM144 is guaranteed for operation over -55 to +125 C, while the LM-344H operates over 0 to 70 C.

CIRCLE NO. 303

IC decoding circuit forms electronic lock

Telenetics, 4120 Birch St., Suite 109, Newport Beach, CA 92660. (714) 752-6363. \$36 (1 to 9); stock.

The 7511-01 address selector IC can be used to form an electronic combination lock. The circuit, housed in a 28-pin DIP, delivers an output only when it receives a predetermined sequence of pulses on its 12 input lines. Out of sequence inputs and/or too long an interval between successive inputs resets the circuit and no output results. Complementary outputs, Q and \bar{Q} , are available and can be set to toggle or latch. A 10-kHz clock must be fed into the circuit for all timing and an on-chip divider provides a 1-Hz output. User-settable options include three momentary output enable intervals and five address code lengths 2, 3, 4, 7 or 10 digits. Also available is a factory bonding option to provide a fixed interdigit interval of 5, 10, 20 or 30 seconds (5 seconds is standard). The 7511 operates from a 13.8-V supply (+30%) and draws 1 mA on standby.

CIRCLE NO. 304

CMOS a/d converters draw only 20 mW

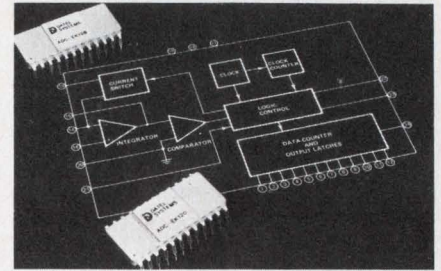

Datel Systems, 1020 Turnpike St., Canton, MA 02021. (617) 828-8000. From \$13.50 (1 to 9); stock to 4 wks.

The ADC-EK series of monolithic CMOS a/d converters operates with only a 20-mW power drain from ± 5 -V-dc supplies. There are three binary-coded output models with resolutions of 8, 10 and 12 bits and a BCD-coded output model with a resolution of three BCD digits. All models have a typical linearity and relative accuracy of $\pm 1/4$ LSB with a worst-case figure of $\pm 1/2$ LSB. The maximum conversion times are 1.8 ms for 8 bits, 6 ms for 10 bits, and 24 ms for 12 bits; and 12 ms for three BCD digits. All converters are housed in 24-pin ceramic DIPs and require an external voltage reference and several noncritical passive components. Over the 0-to-70-C range, all ADC-EK converters are monotonic, have no missing codes, have a gain tempo of ± 40 ppm/ $^{\circ}$ C, maximum, and accept 0 to +10-V inputs.

CIRCLE NO. 305

LED driver designed for fiber optics

Radiation Devices, P.O. Box 8450, Baltimore, MD 21234. F. Rybak (301) 628-2240. \$35 (1 to 9); stock to 3 wks.

The FDM-1D-D fiber-optic LED driver operates with both infrared and visible LEDs to make a 7.5-MHz TTL-compatible transmitter. LED currents are limited to 100 mA by an internal resistor. Provisions for an external resistor permit operation from very small currents to 300 mA, average. A strobe capability permits data distribution from a common data source via several fiber-optic links. The driver is housed in a 24-pin, plastic DIP and operates over 0-to-70 C.

CIRCLE NO. 306

INTEGRATED CIRCUITS

3 terminal regulators get boosted breakdowns

Signetics, 811 E. Arques Ave., Sunnyvale, CA 94086. (408) 739-7700. From \$1.56 (100-up); stock.

An improved series of 7800-type high-voltage regulators, designated 78HV00, is available with breakdown voltage ratings 50% higher than competitive units. The devices are 1-A units and have a guaran-

teed input breakdown of 60 V. The devices directly replace standard 40-V versions of 7800 regulators. The 78HV00 regulators require no external components in most applications and offer internal thermal overload protection. Units in the line are available with output voltage ratings of 5, 6, 8, 12, 15, 18 and 24 V, in either TO-220 or TO-3 packages. Operating junction temperature ranges for the new units span -55 to +150 C.

CIRCLE NO. 307

UV PROM has 450-ns access and cycle times



Texas Instruments, P.O. Box 5012, Dallas, TX 75222. (214) 238-2011. \$64 (100-up); stock.

Designated the TMS 2708JL an 8-k UV PROM is pin-for-pin compatible with the Intel 2708. Maximum access and minimum cycle times are 450 ns and power consumption is less than 450 mW. The memory circuit is organized as 1024 8-bit words and comes in a 24-pin, 600-mil-wide DIP. All inputs can be driven by Series 74 TTL circuits with the use of external pull-up resistors. Each output can drive one Series 74 TTL circuit without external resistors. A pin-compatible mask-programmed ROM, the TMS 4700, is available for large volume systems.

CIRCLE NO. 308

Frequency dividers offer binary division patterns

American Microsystems, 3800 Homestead Rd., Santa Clara, CA 95051. (408) 246-0330. \$2.70 (100-up); stock.

Three frequency divider circuits, the S10129, 130 and 131, are intended for use in organs, synthesizers, frequency generators, N-stage dividers and binary counters. The S10129 provides seven stages of binary division in a 3-2-1-1 configuration. It has high-impedance inputs and low-impedance push-pull outputs. Either sine or square-wave inputs can be handled. The S10129 is a replacement for the AY-5-1007 chip made by General Instrument. The S10130 and S10131 circuits are both six-stage binary dividers; the S10130 has a 3-2-1 configuration; the S10131 a 2-2-1-1 order. Other features of the two chips are similar to those of the S10129.

CIRCLE NO. 309



New S-D Communication Counters

Automatically measure up to 4,500 MHz!

Four new S-D Communications Counters offer the latest technical advances in high speed, precision frequency measurement. They are small and light, but they pack enormous capability.

- **Ranges:** 100 MHz, 512 MHz, 1250 MHz, and 4500 MHz.
- **Sensitivity:** 10mV RMS (Models 6241A, 6242A, 6243A). Model 6244A: 10mV RMS to 500 MHz, -13 dBm above 500 MHz.
- **Overload protection:** Withstands high input signal levels without damage.
- **Display:** 8 LED digits, 0.1 Hz resolution.
- **Tone measurement (opt.):** Example: measure 1020.01 Hz automatically in 1 sec.
- **Meet the whole family:**
 - 100 MHz Model 6241A—\$ 595
 - 512 MHz Model 6242A—\$ 795
 - 1250 MHz Model 6243A—\$ 995
 - 4500 MHz Model 6244A—\$2150

For sales assistance, contact Scientific Devices or Systron-Donner at 10 Systron Drive, Concord, California 94518. Phone (415) 676-5000.

SYSTRON  DONNER

CIRCLE NUMBER 75



THE LINE FORMS ON THE RIGHT

You may want to get your coupon in early.

Because what \$5 buys you now is a high-performance dc-dc converter that occupies less than one-third of a cubic inch, weighs under two-tenths of an ounce and costs less than one-fifth of what you're used to paying.

It's another UGLY™

The converter is one of our DC500 Series, the latest addition to the Elexon line of UGLY dc power supplies.

For starters, we've got four models: +12, -12, +15 and -15 volts out. All with 0.5% typical regulation for 3-7 volt inputs; 300 mW drive capability; and 60-70% typical efficiency.

With any one of them, you can: minimize the number of voltages in your main supply; add 12 or 15 volts without reconfiguring your main supply; or generate high-efficiency 12 or 15 volt outputs from a battery source.

Just \$5 for a limited time

And for the next month, all this is yours at the 50-piece price in any quantity. Just send the coupon and your \$5 bill(s) to Elexon Power Systems, 3131 S. Standard Avenue, Santa Ana, CA 92705. Tel: (714) 979-4440.

Name _____
 Company/MS _____
 Address _____
 City/State/ZIP _____
 Telephone _____

I've got to see it to believe it, Elexon, so send me the following converter(s):

+12 V _____ (qty) +15 V _____ (qty)
 -12 V _____ (qty) -15 V _____ (qty)

Enclosed is \$ _____ (cash, check or money order).
 company P.O. # _____.

And while you're at it, tell me more about:

- your off-the-shelf open-frame dc power supplies.
- your low-cost, rapid-turn-around custom dc power supplies.

Elexon Power Systems
 3131 S. Standard Avenue, Santa Ana, CA 92705
 Telephone (714) 979-4440 ©Elpac Electronics, Inc.



Actual Coupon

The \$5 dc-dc converter from Elexon

RF power

We've made the most of it...
You can, too!!

All wrapped up in a neat little package, our Model 510L is an ultra-wideband RF power amplifier whose wide range of frequency coverage and power output provide the user with the ultimate in flexibility and versatility in a laboratory instrument. Easily mated with any signal generator, this completely solid state unit amplifies AM, FM, SSB, TV, pulse and other complex modulations with a minimum of distortion.

Constant forward power is continuously available regardless of the output load impedance match making the 510L ideal for driving highly reactive loads.

Unconditional stability and instantaneous fail-safe provisions in the unit provide absolute protection from damage due to transients and overloads.

This outstanding unit covers the frequency range of 1.7 to 500 MHz with a linear power output of more than 9.5 watts and there is no tuning.

For further information or a demonstration, contact ENI, 3000 Winton Road South, Rochester, New York 14623. Call 716-473-6900 or TELEX 97-8283 E N I ROC

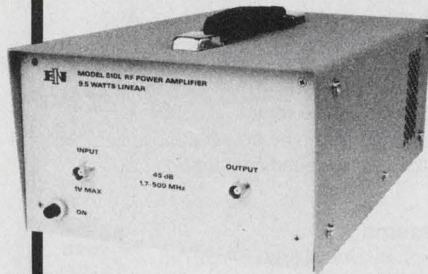

ENI

The world's leader
in solid state power amplifiers

SEE
Electronic Design's
GOLD BOOK
FOR COMPLETE
PURCHASING
INFORMATION

CIRCLE NUMBER 77

INSTRUMENTATION

LSI tester controlled by CRT terminal

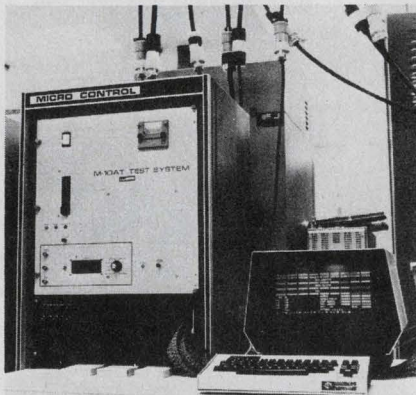

Micro Control Co., 1601 37th Ave. NE, Minneapolis, MN 55421. (612) 781-2612. Start at \$30K; 30 days.

Model M-10AT is a CRT terminal-operated memory and LSI test system for production and engineering environments. Features of the μ P-based system include: operator control from a CRT terminal keyboard/display; 1-ns timing resolution with a range of 0 to 65 μ s; 10-MHz operation; 16 data bits, expandable to 72 bits; 16 address bits, expandable to 24. Optional topological scrambler available; tape cartridge storage of test programs; software is included.

CIRCLE NO. 320

Two sister DMMs count to 30,000

Keithley, 28775 Aurora Rd., Cleveland, OH 44139. (216) 248-0400. 172, \$499; 173, \$625; stock-30 days.

These new 4-1/2s offer a 30,000-count display, half-inch digits, automatic or manual range selection, high/low ohms, two or four-terminal resistance measurements and a price tag as low as \$499 for a five-function, general-purpose DMM. Models 172 and 173 measure dc voltages from 10 μ V per digit to 1200 V, ac voltages from 10 μ V to 1000 V rms and resistance from 10 m Ω per digit to 300 M Ω . The units differ only in current measuring capability. The 172 handles ac and dc currents from 10 μ A/digit to 2 A, and the 173 offers a broader span of 10 mA/digit to 3 A.

CIRCLE NO. 321

CB tester updated to handle 40 channels

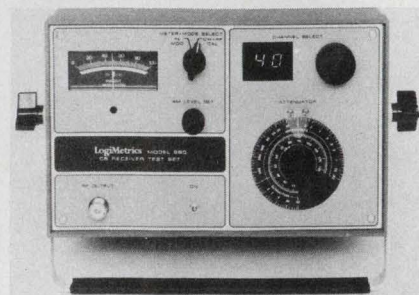

Logimetrics, 121-03 Dupont St., Plainview, NY 11803. (516) 681-4700. \$1195; 60 days.

Citizens-band receiver test set, Model 980, can now test all 40-channel CB receivers. All units currently being shipped have the 40-channel selector. Users of units previously shipped with 23-channel selectors are being supplied new 40-channel logic cards on an exchange basis at no charge. Model 980, which weighs 16 lb, has a fully levelled rf output for selecting the present 40 channels. A large LED displays the channels selected by a rotary switch.

CIRCLE NO. 322

Unit measures transfer function to 1 MHz



EMI Technology, P.O. Box 1264, Danbury, CT 06810. (203) 744-3500. Start at \$6700; stock-30 days.

Series SM2001A transfer-function (frequency-response) analyzer can provide the dynamic transfer function of any system or component, from an electronic filter to a battleship gun turret. Display is cartesian, polar or log/polar. Frequency range of the mainframe SM2001A extends from 1 cycle/day to 1 kHz, with output amplitude adjustable from 0 to ± 10 -V peak. Frequency can be programmed by front-panel controls, by BCD logic signals or by an external source. Accuracy is $\pm 0.5\%$ of reading ± 1 count.

CIRCLE NO. 323

DMM offers touch-&-hold probe option



Hewlett-Packard, 1501 Page Mill Rd., Palo Alto, CA 94304. (415) 493-1501. \$500; probe, \$40; stock.

Model 3465B battery/ac portable 4-1/2-digit, five-function digital multimeter offers a "touch-hold" probe as an accessory. The probe lets the user "freeze" the reading on the display. The unit measures 1 μ V to 1 kV dc with a mid-range accuracy of $\pm(0.02\%$ of rdg. + 0.01% of range) for one year. The ac measurement range covers 10 μ V to 500 V with a mid-range accuracy of $\pm(0.15\%$ of rdg. + 0.05% of range) over a 40-Hz-to-20-kHz bw. Input protection is provided to 1 kV on any dc range, 500 V rms on any ac range, and 350 V pk on any resistance range. A front-panel fuse protects the instrument from overload when measuring current.

CIRCLE NO. 324

Semiconductor tester stresses data handling

Fairchild Systems Technology Div., 1725 Technology Dr., San Jose, CA 95110. (415) 962-3816. \$230,000.

A new computer-controlled semiconductor test system uses multi-processor techniques to offer improved throughput and enhanced data management capabilities. The Sentry VII hardware and software are designed to interface with the company's new Integrator host computer in a distributed test network that removes the data processing load from the tester. However, data-management capability is designed into the Sentry VII software to enable it to be used as a stand-alone tester. Sentry VII features up to 19 k of 24-bit computer memory and up to 4 k of high-speed (10 MHz) local memory. The IEEE 488 interface simplifies the use of additional programmable instrumentation.

CIRCLE NO. 325

PROM programmer works in hexadecimal

Technitrol, 1952 E. Allegheny Ave., Philadelphia, PA 19134. (215) 426-9105. \$2150; 4 wks.

PROM programmer, Model 501, features a complete set of hexadecimal displays and a convenient hexadecimal keyboard to eliminate the need to translate address and/or data from binary. Master and

copy PROMs address and data are displayed simultaneously. Model 501 uses an 8-bit μ P to achieve versatility. The unit provides (1) zero field test; (2) automatically incremented address; (3) straight duplication PROM to PROM; (4) duplication with change in section of copy PROM; (5) verification; and (6) step-by-step reading of PROM contents.

CIRCLE NO. 326

Beauty comes in different shapes and sizes.



These smart looking Optima Accent Cases bring you a wide choice of standard sizes, colors and finishes. But in case you want to bring the world something different, you're not boxed in. We'll cut these special beauties to your own specs. With solid walnut or metal sides, sloped or vertical front panels or whatever. We ship knocked-down to save you money.

Send for our catalog. For freedom of design, we give you freedom of choice.

We make you look better

OPTIMA[®]
Scientific-Atlanta

2166 Mountain Industrial Blvd., Tucker, Ga. 30084 • Tel: (404) 939-6340
Europe: Macmerry, East Lothian, Scotland EH33 1EX

CIRCLE NUMBER 78

DATA PROCESSING

Cassette recorder takes little power



Datel Systems, Inc., 1020 Turnpike St., Canton, MA 02021. (617) 828-8000. \$325 (1-9).

A cassette data-logging recorder, the ICT-WZ, features low power consumption. The unit takes 1 W when recording and only 6 mW when standing by. Up to 2.2-million bits may be recorded on a 300-ft cassette using nonreturn-to-zero dual-track recording. The unit records with a density of 615 bit/in.

CIRCLE NO. 327

Printing calculator does squares and roots

Facit-Addo, Inc., 55 Field Point Rd., Greenwich, CT 05830. (203) 622-9150. \$249.

The Model 1191 electronic calculator prints and displays 12 digits. It calculates squares and square roots, and raises to a power. It also does automatic percentage add-on or discount calculations, and keeps a separate grand total. Either two, three, four, six or floating decimals can be selected for calculations.

CIRCLE NO. 328

Box switches between two modems

International Data Sciences, 100 Nashua St., Providence, RI 02904. (401) 274-5100. \$240; stock.

The Model 8509 switches between a main and a spare modem. The dimensions of the 8509 are 4 × 5.25 × 7.5 in. Up to four modules may be mounted in a rack having a width of 19 in.

CIRCLE NO. 329

Memory board allows double accessing

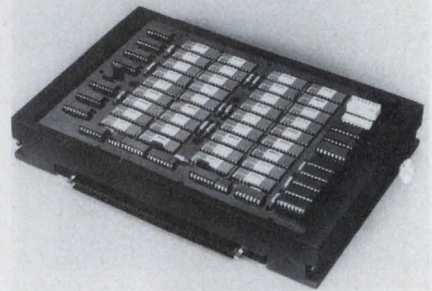

EM&M, Severe Environment Products Div., 20630 Plummer St., Chatsworth, CA 91311. (213) 998-9090. \$3000 (OEM qty); 4 mo.

The SEMS-12L solid-state memory system consists of two storage assemblies. Each assembly stores 16 k × 9 bits of memory connected by a board-mounted plug. Separate mode-control input signals allow independent read or write on two 9-bit bytes during a memory cycle. The access and cycle periods are 400 ns and 1 μs, respectively. Operating power runs 10 W. The operating temperature range is -55 to +85 C.

CIRCLE NO. 330

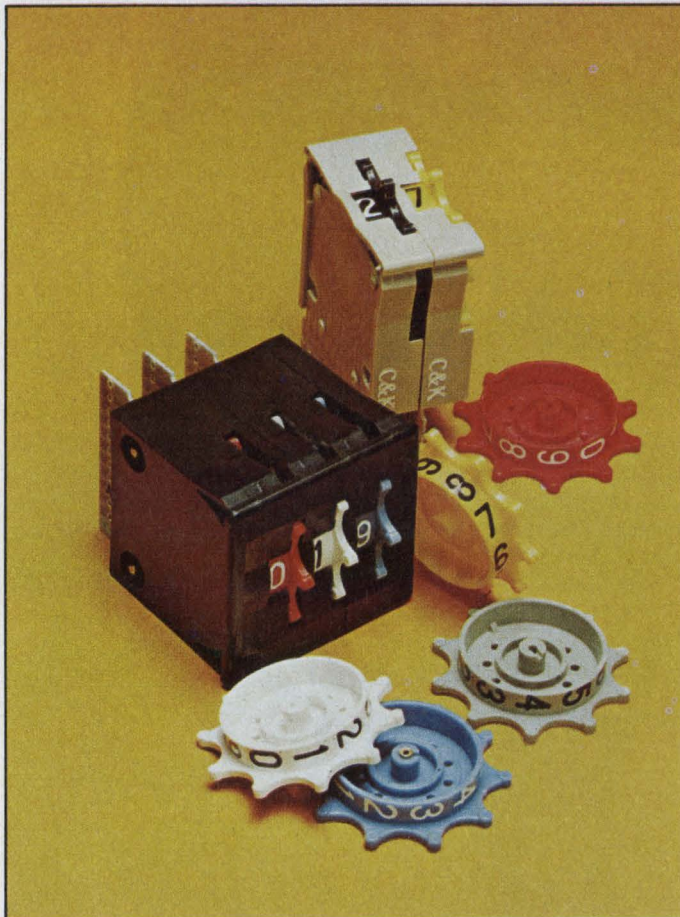

Three cheers for the Red, White & Blue Thumbwheel... ...and three more cheers for the Black, Yellow & Gray.

C&K's versatile miniature Thumbwheel switches are now available with wheels in your choice of 6 designer coordinated mix & match colors. The 10-positional switch wheel may be ordered in red, white, blue, black, yellow, or gray. The switch body is available in either matte black or matte gray.

C&K's Thumbwheel is a uniquely adaptable switch. Each section is a switch unto itself, or the sections may be stacked together in a single housing to handle the most complex switching tasks. In addition, C&K's Thumbwheel switches are available in both front and rear mounting models. For all of the colorful details, make contact with C&K today!

C&K Components, Inc., 103 Morse Street, Watertown, MA 02172 Tel: (617) 926-0800 TWX: 710 327-0460 TELEX: 92 2546

Free engineering sample on request.

CIRCLE NUMBER 79

Disc controller works with μ P systems

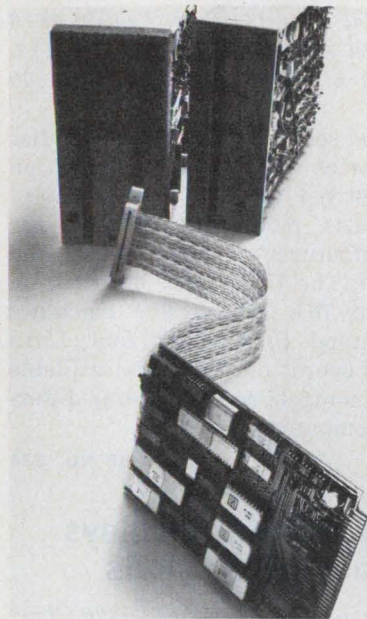

PerSci, Inc., 4087 Glencoe Ave., Marina Del Rey, CA 90291. (213) 821-5545. 1-up prices: \$1195 (Model 70), \$1495 (Model 270); 30-60 days.

A diskette-drive system for microcomputer systems communicates by file name and does other housekeeping functions usually performed by the host computer. The Model 70 system contains a single drive, and the Model 270 has a dual drive. Both systems also include cabling and controller. The diskette-drive controller itself uses an 8080 μ P and can supervise up to four drives. The software commands include seek, write, read, delete and initialize. The drives have a voice coil positioner that allows a 33-ms random-average-seek period.

CIRCLE NO. 331

Adapter drives card punch from serial lines

Digital Laboratories, 600 Pleasant St., Watertown, MA 02172. (617) 924-1680. \$1350; 2 wk.

The PC-29 serial-interface unit fits inside IBM's 029 card-key-punch terminal. With the PC-29 installed, ASCII-coded data and commands control the keypunch. The 029 automatically feeds up to 500 cards from its input hopper and punches Hollerith code from the PC-29's RS232 or 20-mA serial lines. Installation takes 15 min.

CIRCLE NO. 332

Still chained to wire?

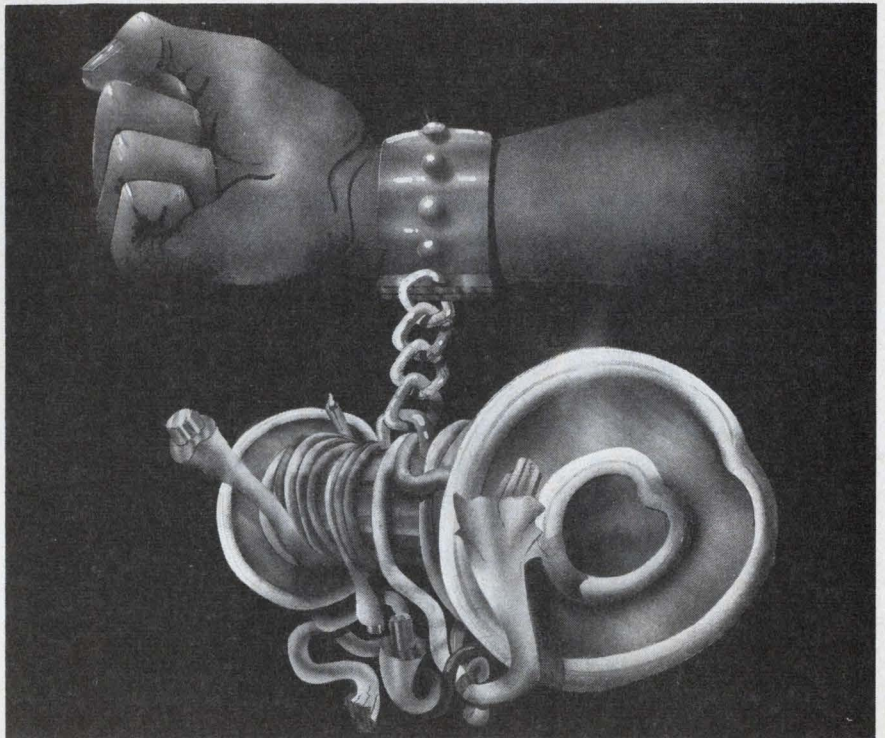

Break the wire habit with Repco's modular RF links and discover new design freedom.

Repco's modular RF links are used in hundreds of applications including remote and supervisory control, voice communications, alarm and reporting systems... all become more versatile and effective through the use of Repco's rugged, reliable RF transmitters and receivers.

Repco's RF links are packed with performance features: *multiple transmission modes designed to carry tone, voice or low-speed digital data; a wide VHF/UHF frequency range; all units meet FCC and DOC requirements.*

Best of all, Repco's RF links are *economical*. They beat hard wire system costs over the long haul, thus affording you maximum performance at minimum expense. Now is the time for you to link up... with Repco's versatile RF links! Write or call today for free specs brochure, application booklet and special evaluation offer.



TX

Repco Inc.

A subsidiary of Scope, Inc.
1940 Lockwood Way
Orlando, FL 32804
(305) 843-8498

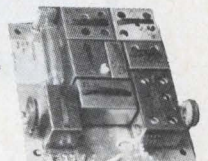

RX

World's leading manufacturer of modular communication products.
CIRCLE NUMBER 80

DATA PROCESSING

Printing calculator costs \$100

Unitrex of America, Inc., 689 Fifth Ave., New York, NY 10022. (212) 688-3400. \$100

A hand-held printing calculator displays eight digits on a green readout. The 9HMDP calculator

comes with rechargeable nickel-cadmium batteries and an ac adapter/charger. It offers a choice of print-and-display or display-only modes, and has a key that enables printing of displayed numbers, even in the nonprint mode. The 9HMDP also has a percent key for automatic add-on and discount, a double-function, clear-entry and total key, a constant switch and a memory.

CIRCLE NO. 333

5½ DIGIT ACCURACY. 4½ DIGIT PRICE.

The 4600 is our brand new 4½ digit multimeter. It gives you the accuracy and resolution of typical 5½ digit multimeters. At half the cost.

And the 4600 stays accurate longer than other DVM's. DC accuracy stays within 0.01% ± one digit for six months at a time. We guarantee it.

80dB normal mode noise rejection produces a 10,000:1 reduction of excess noise. A full decade better than the 1,000:1 reduction of comparable instruments.

Loading errors are virtually eliminated by the 4600's 10,000MΩ input impedance on the two lowest DC voltage ranges.

There's a lot more. Send for a free catalog on our new 4½ digit 4600 multimeter. And find out how to get 5½ digit accuracy without paying for it.

Dana Laboratories, Inc.,
2401 Campus Drive, Irvine,
California 92715. 714/833-1234.



DANA

Others measure by us.

"AVAILABLE THROUGH ELECTRO-RENTS"

FOR PRODUCT DEMONSTRATION
CIRCLE # 126

FOR LITERATURE ONLY
CIRCLE # 159

Fixed-head disc drives slash costs per bit

Digital Development Corp., 8615 Balboa Ave., San Diego, CA 92123. (714) 278-9920. \$8500-\$29,500; 90 days.

The series 7510 fixed-head disc memories offers a 50% reduction in cost per bit. The disc memories are also more rugged than the manufacturer's series 7300 and 73100. The 7510 series stores from 9.6 to 76.8 Mbits. The machines withstand 10 g shock for 11 ms while operating. They are available with controllers for several different computers.

CIRCLE NO. 334

CRT monitor displays data transmissions

Atlantic Research Corp., 5390 Cherokee Ave., Alexandria, VA 22314. (703) 354-3400. \$3150; 60 days.

A CRT monitor, called Interview, displays data-communications transmissions. The monitor is used with the manufacturer's control console. The monitor displays 1024 characters in ASCII or EBCDIC text, or hex or octal notation. A test message may be displayed on the same screen as an actual transmission for direct comparison. Or, the screen can continuously display data until they are frozen on receipt of an error or negative-acknowledge signal. The Interview operates in full or half duplex modes. It looks at data lines transmitting up to 56-k baud in BISYNC or SDLC protocols.

CIRCLE NO. 335

Plug-in card for mini keeps its own time

Digital Pathways, Inc., 4151 Middlefield Rd., Suite 105, Palo Alto, CA 94306. (415) 493-5544. \$495 (1-9).

The TCU-100 timing control unit plugs into a peripheral slot in DEC's PDP-11 minicomputer. When addressed by the PDP-11, the TCU-100 outputs the month, day, hour and minute. Since the unit operates from an internal rechargeable battery, it needs no supervision by the mini. The TCU-100 can also generate an interrupt after a preset time or periodically.

CIRCLE NO. 336

MODULES & SUBASSEMBLIES

Synchro converter is shrunk by half

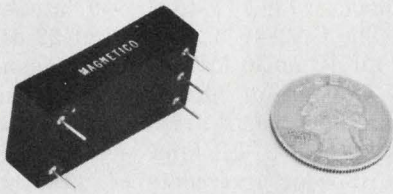

Magnetico, 182 Morris Ave., Holtsville, NY 11742. (516) 654-1166. \$22 (100 qty); stock to 4 wk.

Measuring $0.625 \times 1.25 \times 0.5$ in., the Model 52450 synchro-to-resolver converter is claimed to be 60% smaller than other 90-V, 400-Hz Scott-T transformers. The unit converts 90-V line-to-line 400-Hz synchro information into its sine and cosine components at 6 V rms. The device's accuracy of 5 arc-minutes is solely a result of the magnetic transformation ratio, rather than relying on adjustments, so its accuracy is independent of temperature or age. The module provides isolation from high common-mode synchro-bus voltages and transients. In addition, synchro-bus grounding is not needed.

CIRCLE NO. 337

Amplifier spans wide frequency range

Watkins-Johnson Co., 3333 Hillview Ave., Palo Alto, CA 94304. (425) 493-4141. \$90 (1 to 9); stock to 30 days.

A single-stage, high-dynamic-range amplifier, the WJ-A77, boasts a min gain of 16 dB, and a power output of +15 dBm, across the 5-to-500-MHz frequency band. Typically, its intercept is +30 dBm and its VSWR is 1.3:1. The amplifier offers full output power when used with a 15-V power supply, yielding a reduction of approximately 40% in dc-power consumption compared to an equivalent 24-V unit. The unit's dc-bias is stable from -54 to +100 C. The power-supply voltage may be varied from 15 to 8 V without any significant change in gain. At 8 V, the unit provides over 7 dBm output power with a typical noise figure of 3.5 dB. The device comes in a 4-pin, hermetically sealed TO-8 package.

CIRCLE NO. 338

from Electronic Measurements ...

10 to 60 KW DC Power Supplies

Time was when high power DC power supplies were available on a custom basis only.

No more, though.

Now, for the first time, you can get high power 3Ø SCR DC in a standard product.



E/M's EMHP series of standardized modular assemblies are custom-packaged for your specific industrial and scientific applications, and give you:

- Greatly reduced costs
- Greatly reduced delivery time
- Greatly increased efficiency
- Greatly increased performance

Model	Voltage (V)	Current (A)	Voltage Ripple (V rms)	Current Ripple (A rms)	Typical Price*
SERIES 15 (20 KW max., 19" panel, 26% package)					
EMHP10-1000	0-10	0-1000	0.10	10	\$3700
EMHP20-750	0-20	0-750	0.15	5.7	
EMHP40-400	0-40	0-400	0.25	2.5	
EMHP80-250	0-80	0-250	0.50	1.6	
EMHP150-130	0-150	0-130	0.75	0.7	
EMHP600-30	0-600	0-30	3.00	0.2	
SERIES 25 (30 KW max., 24" panel, 32" package)					
EMHP10-1500	0-10	0-1500	0.1	15	\$4700
EMHP20-1000	0-20	0-1000	0.15	7.5	
EMHP40-600	0-40	0-600	0.25	3.8	
EMHP80-375	0-80	0-375	0.5	2.4	
EMHP150-200	0-150	0-200	0.75	1.0	
EMHP600-50	0-600	0-50	3.0	0.3	
SERIES 40 (60 KW max., 24" panel, 47% package)					
EMHP10-3000	0-10	0-3000	0.10	30	\$8500
EMHP20-1500	0-20	0-1500	0.15	12	
EMHP40-900	0-40	0-900	0.25	6	
EMHP80-600	0-80	0-600	0.50	4	
EMHP150-350	0-150	0-350	0.75	2	
EMHP600-100	0-600	0-100	3.00	0.5	

*Each application is priced at time of order. Please consult factory for complete details.

Any other combination of ratings to 3000 amps and 600 volts is available within the power rating of each series.

To order, or for any technical information, call
TOLL FREE (800) 631-4298



ELECTRONIC MEASUREMENTS INC.

405 Essex Road, Neptune, N.J. 07753

Phone (New Jersey) 201-922-9300 (Toll free) 800-631-4298

Specialists in Power Conversion Equipment

CIRCLE NUMBER 82

Custom designs
or off-the-shelf...



Tiny but tough... Grayhill push-button switches

from logic levels
to UL-listed
power switching

- As small as .250" diameter, .675" over-all length
- Wiping or butt contacts; momentary or alternate action; SPST, SPDT, DPDT
- Bezel, bushing, or sub-panel mounting, variety of button colors and shapes

There's a wide range of options in the Grayhill miniature push-button switch line, but all offer high reliability over a long life span. Off-the-shelf availability of standard types is augmented by a superior custom design capability for unusual circuitry, environmental, usage, or size requirements. For details, consult EEM or write for free literature from Grayhill, Inc., 561 Hillgrove Avenue, La Grange, Illinois 60525, Phone (312) 354-1040



CIRCLE NUMBER 83

MODULES & SUBASSEMBLIES

Accurate s/h units work at 1.5 μ s

Dynamic Measurements, 6 Lowell Ave., Winchester, MA 01890. (617) 729-7870. \$149 (singles); stock.

The 1404 sample-and-hold amplifier provides a max acquisition time of 1.5 μ s for a 10-V input step. The unit settles to 0.01% of full scale within 300-ns max and delivers full power over a 200-kHz min bandwidth. The module boasts a max departure from linearity to within 0.005% and a droop rate of 0.5 μ V/ μ s over 0 to 70 C. Offset drift for the device is 10- μ V/ $^{\circ}$ C, max. Input offset-voltage is factory pre-trimmed to \pm 10-mV max and can be externally adjusted to zero. Typical aperture uncertainty is \pm 2 ns. The package is 2 \times 2 \times 0.4 in.

CIRCLE NO. 339

IC plus four R's gives 2nd-order filter

National Semiconductor, 2900 Semiconductor Dr., Santa Clara, CA 95051. (408) 737-5000. From \$4.95; stock.

With four external resistors, the AF100 series of state-variable filters can be programmed for second-order functions up to 10 kHz. With the filter's basic building blocks you can construct responses such as Butterworth, Bessel, Cauer, and Chebyshev. Low-pass, high-pass and bandpass functions are available simultaneously at separate outputs, and notch and all-pass functions can be generated by combining outputs in the internal summing amplifier. If higher-order systems are required, several units can be cascaded. In all configurations, the Q, gain and center-frequency adjustments are independent and require no iterative trimming. Other features of this active-filter series include a Q range of up to 500 and frequency accuracy of either \pm 1% or \pm 2.5%. Operating power-supply range is from +5 to \pm 18 V and supply current is 4.5 mA max. The series is available in either a 16-pin plastic dual-in-line package or a 12-pin TO-8 can for operation from -25 to +85 C, and in a TO-8 can for operation from -55 to 125 C.

CIRCLE NO. 340

Hybrid amp bridges rf and i-f bands

TRW RF Semiconductors, 14520 Aviation Blvd., Lawndale, CA 90260. (213) 679-4561. \$50; stock.

The CA2840 has a gain of 22 dB \pm 1.0 dB at 30 MHz and a frequency response of 30 to 300 MHz. The amplifier boasts a maximum noise figure of 6 dB and second and third-order intercepts of 43 dBm and 65 dBm, respectively. The thin-film hybrid IC operates from a 24-V supply over the -40 to +100 C range.

CIRCLE NO. 341

Hybrid op amp weds speed and low drift

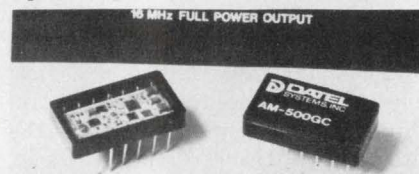

Datel Systems, 1020 Turnpike St., Canton, MA 02021. (617) 828-8000. \$75-\$125; stock to 6 wk.

You get an open-loop-gain roll-off of 6 dB/octave to beyond 100 MHz and an input-offset-voltage drift of 1 mV/ $^{\circ}$ C with AM-500 series hybrid op amps. Output-settling time is 200 ns max to 0.01% for a 10-V step change. Slew rate is 1 kV/ μ s for positive-output transitions, 1.8 kV/ μ s for negative transitions, giving an undistorted pk-pk 20-V sine-wave output into a full load to 16 MHz. Settling time to 1% for a 10-V step is 70 ns. The dc characteristics include: 106-dB open-loop gain, 30-M Ω input impedance and 1-mA bias current. Although these units do not operate differentially, a dc-offset voltage of \pm 15-V-dc power and draw 22-mA input terminal. Output-voltage noise over the midband frequency range of 100 Hz to 10 kHz is 1-mV rms. Input offset voltage is \pm 0.5 V. These devices operate from \pm 15-V dc power and draw 22-mA quiescent current (operating range is \pm 10 V to \pm 18 V). Output current capability is \pm 5 mA and output short-circuit protection is standard. Three 14-pin hermetically sealed or metal, 0.765 \times 0.45 \times 0.145 in., packages are available for 0 to 70, -25 to +85 and -55 to +125 C operation.

CIRCLE NO. 342

Speed floating point, use hardware

Interface Engineering, 386 Lindelof Ave., Stoughton, MA 02072. (617) 344-7383. \$140 (1-9); 30 days.

Just one program instruction to the DD154 gives you a full 16-line shift in less than 5 μ s. The unit, a hardware utility operator for floating-point data-manipulation, provides both automatic left-and-right justify and controlled-shift modes of operation. In the automatic-up-justify mode the device accepts 16-bit data and a 4-bit exponent and shifts the message up, until a ONE appears in the MSB position on the output lines. The module keeps track of the number of shifts required and delivers a corrected 4-bit exponent. The automatic-down-justify mode reverses the process: data shifts right, until the exponent is zero. In the controlled shift mode, the data on the input lines can shift up or down, by up to 15 places. In this mode the 4-bit shift-command lines control the number of shifts. The unit is internally clocked. Input and output logic-levels are TTL compatible. The module plugs directly into DIP sockets.

CIRCLE NO. 343

Store your inputs in this d/a

Micro Networks, 324 Clark St., Worcester, MA 01606. (617) 852-5400. \$39 (1-24); stock.

The MN 3020 is the only 8-bit d/a converter in a DIP containing a storage register. The unit also includes a reference and an output amplifier. When the device's converter-enable input is high, its registers hold the input data and the analog output will not change with further changes in the digital input. When the converter-enable input is low, the analog output follows all changes in the input. The d/a gives you linearity to within $\pm 1/2$ LSB and accuracy to within 1 LSB. Settling time is 3- μ s max. The 18-pin DIP converter's linearity and accuracy are guaranteed over 0 to 70 C for the standard unit, while it's -55 to +125 C for the military version (MN 3020 H) that sells for \$69.

CIRCLE NO. 344

Solid-state cam offers 20 slots

Matrix, 2260 Distributors Dr., Indianapolis, IN 46241. (317) 248-2036. From \$915.

Quantachron V, a time-based programmer, replaces mechanical cam timers, stepping switches and banks of time-delay devices. The unit handles up to 20 functions with a timing accuracy of 1% of

cycle time. It operates relays, solenoids, and small motors directly. Cycle time is continuously variable from 0.5 to 1000 s in three overlapping ranges. The device consists of: time-base module, manual control module, interlock module (optional) and switching modules. Switching modules have two channels per module, with a maximum of 20 channels per unit.

CIRCLE NO. 345

NEW PRODUCT

Acoustics
Mechanical test
Rotating machine maintenance

Easier to understand low frequency signals.

Enhance the meaning of your spectrum with our new 444 MINI-UBIQUITOUS[®] FFT Computing Spectrum Analyzer —an expanded version of our widely used 440A.

Built-in microprocessor in the 444 helps you by computing...

- calibration in linear engineering units, volts, V_r, dBV or dBR
- ratio and difference comparisons of spectra stored in dual memories
- 1/3 or 1/1 octaves in two additional memories (4 total)*
- A-weighted sound spectrum
- total signal RMS energy
- readings in CPM (RPM)
- harmonically related frequencies
- do-it-yourself logic troubleshooting*

Its basic performance features...

- 400-line resolution, increased by as much as 2000:1 with built-in expander*
- ranges from 0-1 Hz to 0-100,000 Hz
- all-digital stability and accuracy
- report-ready digital plots fully labeled (thru RS232 interface*)
- ease-of-use by semi-technical personnel as well as engineers

*optional

For a demonstration on your data at your facility, call Dick Rothschild at 201-767-7100.

NSC NICOLET SCIENTIFIC CORPORATION
(Formerly Federal Scientific)
245 Livingston St. Northvale, NJ 07647
U.K. Tel. (0926) 44451 and 44452.
Germany Tel. (0611) 812075.
Canada Tel. (416) 625-3901

Circle #264 for lit. only. (For demo only, circle #265.)

Free Sample! CARD EDGE CONNECTORS

from

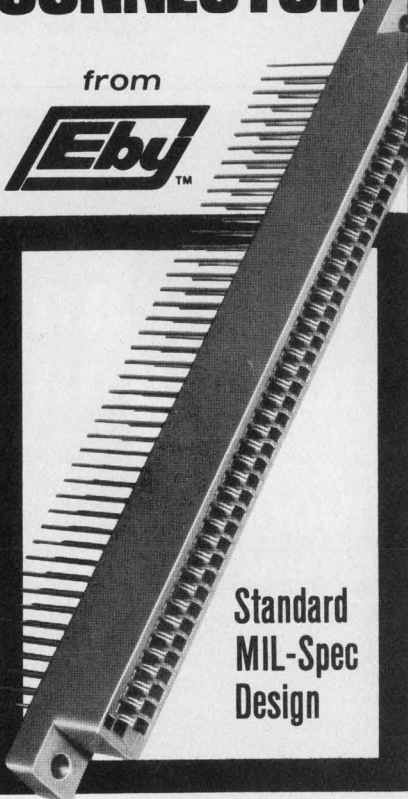

Standard
MIL-Spec
Design

Here's a whole family of connectors . . . immediate availability . . . in a number of different terminations including wire wrap, solder hole and printed circuit. Other sizes and variations available upon request.

.100 CENTERS . . . in wire wrap and printed circuit . . . with single or dual readout as follows:

15/30	43/86
22/44	50/100
36/72	

.156 CENTERS . . . in printed circuit and solder hole . . . with single or dual readout as follows:

10/20	22/44
15/30	36/72
18/36	43/86

SEND FOR A FREE SAMPLE
ON YOUR COMPANY LETTERHEAD!



HUGH H. EBY CO.

4701 GERMANTOWN AVENUE
PHILADELPHIA, PA. 19144
(215) 842-3000

a division of REDM Corp.

E 108

CIRCLE NUMBER 84

PACKAGING & MATERIALS

Feedthrough terminal comes in two parts

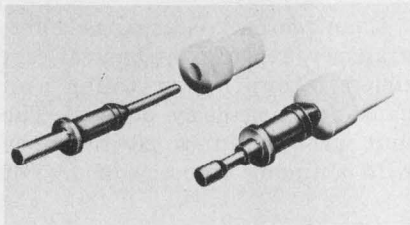

Sealectro, Zone Industrielle Toulon-Est, 83087-Toulon Cedex, France.

An insulated feedthrough terminal, number FR/093/01, has a tinned-brass lug and a white Teflon insulating bushing. The bushing is first inserted into a 0.093 in. diameter punched or drilled hole. When the lug is driven into the bushing, the assembly resists an axial pull of 5 lb. The lug of the FR/093/01 protrudes 0.288 in. above the chassis and accepts soldered connections on both ends.

CIRCLE NO. 346

PC board holds many different relays

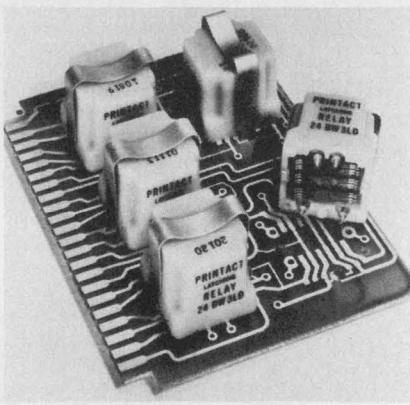

Executone, Inc., Printact Relay Div., 29-10 Thomson Ave., Long Island City, NY 11101. (212) 392-4800. \$7.50 (small qty).

A PC board, Model A-47170, holds several kinds of relays. The board holds any five relays in the manufacturer's line of nonlatching or dual-coil-magnetic-latching types. Relay contacts are either brought out to a 22-pin, double-sided edge connector or to solder pads. An individual coil termination is provided for each of the relays. The other side of the relay coils go to a common contact. The PC board, with relays, measures 3 x 4 x 1.062 in.

CIRCLE NO. 347

PC board with edge contacts can be etched

Circuit-Stik, Inc., 24015 Garnier St., Torrance, CA 90505. (213) 530-5530. 1-up prices: \$12.95 (8117), \$13.95 (8118).

Two etchable PC boards have edge contacts. The boards come either single sided (type 8117) or double sided (8118). The gold-over-nickel plated contact fingers are protected by masking them when the board is etched. The single-sided card has 22 contacts, and the double-sided version has 44 contacts, on centers of 0.156 in. The cards measure 4.5 x 6.5 in.

CIRCLE NO. 348

Socket takes 20-pin DIP components

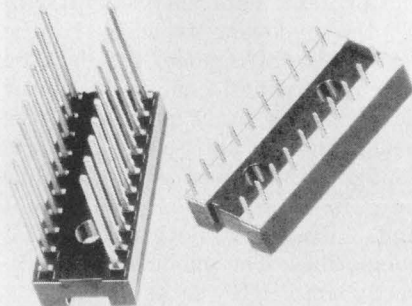

Robinson-Nugent, Inc., 800 E. Eighth St., New Albany, IN 47150. (812) 945-0211. 20¢ (prod. qty); 4 wk.

A 20-pin DIP socket, the Model ICN-203-S3, accepts 4-k RAMs and interface circuits. It is available in solder DIP, wire-wrap and burn-in configurations.

CIRCLE NO. 349

Plastic containers come in five sizes

Richard Manufacturing Co., P.O. Box 2910, Van Nuys, CA 91404. (213) 786-2441. 1-oz size: 9¢ (1-9).

Polyethylene containers, called Poly-Cons, come in five sizes: 0.25 oz, 0.5 oz, 1 oz, 2 oz and 4 oz. The 1-oz size is available in two versions. One version measures (d x h) 2 x 0.875 and the other measures 1.5 x 1.5 in. The containers have an attached hinged lid, which snaps shut, forming an air-tight seal. All sizes except 4 oz come in eight colors. The 4-oz size is available in three colors.

CIRCLE NO. 350

SKYDYNE INTRODUCES . . .

THE "SERIES 400" DRAWN ALUMINUM CASES

Rugged • Lightweight • Low Cost

450 MODELS

featuring:

- Seamless drawn aluminum shells
- Vulcanized rubber closure
- Nickel-plated steel latches
- Nickel-plated steel hinges
- Steel reinforced thermoplastic handle
- Light gray finish
- RFI capabilities



460 MODELS

featuring:

- Seamless drawn aluminum shells
- Extruded aluminum seal and closure
- Nickel-plated steel latches
- Nickel-plated hinges
- Steel reinforced thermoplastic handle
- Light gray finish
- RFI capabilities



470 MODELS

featuring:

- Seamless drawn aluminum shells
- Gasketed aluminum closures
- Steel clamp assemblies
- Nickel-plated steel hinges
- Spring loaded steel handle
- Light gray finish
- RFI capabilities
- Meets MIL Specifications



This Is
SKYDYNE®

A Division
of Brooks & Perkins, Inc.
River Road
Port Jervis, New York 12771
(914) 856-6655



Send for our
free catalog

CIRCLE NUMBER 85

ELECTRONIC DESIGN 1, January 4, 1977

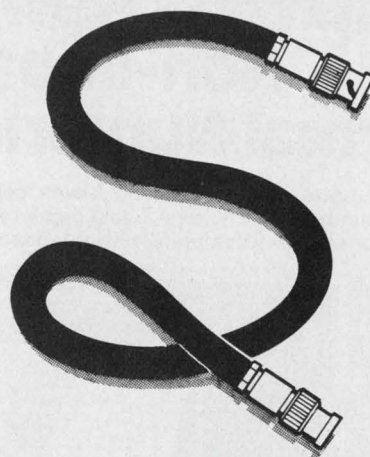

VITEK's Filter Cable* can solve your VHF & UHF filtering & interconnecting problems INEXPENSIVELY!

- Looks like coaxial cable —
- Pliable like coaxial cable —
- Has the longevity of coaxial cable —
- Can be fitted with connectors
or solder-joined like coaxial cable —

But there's one major difference —
IT'S A FIRST-RATE FILTER!

For any filtering and interconnecting problem up to 1 GHz, neither price nor the physical viability of the filter has to be a determining factor in the solution. Vitek's innovative filter cable is priced way below any comparable filter on the market.

**So the other thing our cable looks
like is SAVINGS . . . with a Capital S.**

For further information regarding our filter cable or for assistance with your filtering and interconnecting problems, call or write to:
VITEK ELECTRONICS, INC., 200 Wood Avenue,
Middlesex, N.J. 08846, Tel: (201) 469-9400

VITEK ELECTRONICS,
INC.

*Patent Pending

CIRCLE NUMBER 86

Gulton's New Quiet Non-Impact Thermal Numeric Printer

Featuring...ultra quiet operation...seven columns of numbers or six columns of numbers with \pm sign...fast paper roll loading...up to four line per second print rate...complete with interface electronics...compatible with all popular digital panel meters.



Introducing Gulton's answer to noisy, complicated mechanical printers. The NP-7 panel-mounting printer requires only one moving part, the paper advance motor, which sends the paper silently beneath a non-impact thermal print head. You'll be pleased at the price, too.

Write or call for detailed catalog.

gulton[®]

Measurement & Control Systems Division
Gulton Industries Inc., East Greenwich, Rhode Island 02818
401-884-6800 • TWX 710-387-1500

CIRCLE NUMBER 87

SHAPE FOIL INTO MAGNETIC SHIELDS

in minutes... with scissors... low cost

No waiting. Solves many shielding problems. Use a single formula (ask us) to determine thickness and number of layers. Combine this with practical trial and error. After cutting, hand trim AD-MU foil to the correct outline and fit it around the component to be shielded.

If you need relatively few shields, or are experimenting, that's it. You've eliminated designing, tooling and manufacturing costs for prefabricated shields.

Especially good also for hard-to-get-at places and to make assemblies more compact by placing magnetically reacting components closer together without performance degradation.



Ask For NEW 48-PAGE
Time-Saving Reference
Data/Catalog on
Magnetic Shielding
Techniques &
Problem
Solving



AD-VANCE MAGNETICS, INC.

226 E. SEVENTH ST., ROCHESTER, IND. 46975
(219) 223-3158 TWX 810 290 0294

Our 3rd Decade of Magnetic Shielding Leadership

CIRCLE NUMBER 88

PACKAGING & MATERIALS

**Protective coating
seals hermetically**



Thermo-Cote, Inc., 267 Vreeland Ave., Paterson, NJ 07513. (201) 345-6206. \$59.95.

The Dip-Kit contains 5 lb of strippable coating material and a one-quart thermostatically controlled electric melting pot. The coating provides a hermetically sealed, rust proof, protective cushion to tools or parts. To coat a part, the material is first melted in the pot. Then, the part is dipped into the molten liquid. The material cools in less than a minute. To remove and reuse it, peel it off.

CIRCLE NO. 356

**Heat sink forms three
sides of a case**

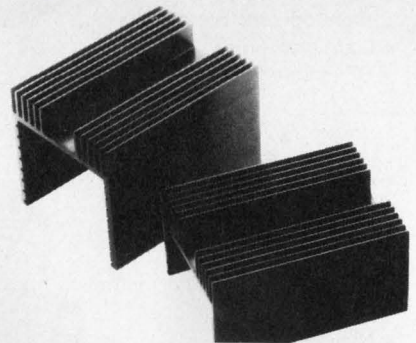

WEI Corp., P.O. Box 10577, Santa Ana, CA 92711. (714) 540-4688. 1-up prices: \$59.82 (3000), \$49.26 (3002).

Two heat-sink extrusions, Models 3000 and 3002, form three sides of an enclosure. Its top has fins for heat dissipation and the inside has slots to accept PC boards. The extrusions, which can be cut, come in a standard length of 75 in. The wall thickness is 0.25 in. The 3000 has cross-section dimensions of 4 x 4 in., and the 3002 is 3.820 x 4 in.

CIRCLE NO. 357

COMPONENTS

Small power relay low in cost

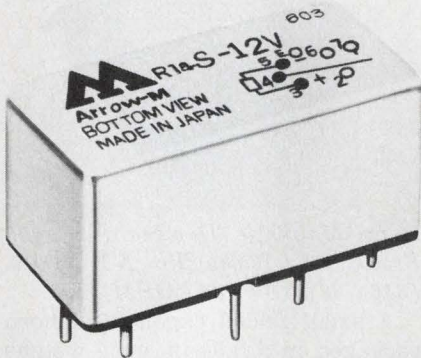

Arrow-M Corp., 250 Sheffield St., Mountainside, NJ 07092. (201) 232-4260. \$1.62 (1000 up); stock.

A low-cost miniature power relay, designated as R1a-S with one form A contact, is about the same size as a conventional glass-encapsulated reed relay. The relay can handle dry electronic circuits with signal levels as low as 100 μ A or considerable power to 20 W at 1 A. Single and two-coil latching types also are available. Features include more than 10^9 mechanical operations, at least double the life of a conventional relay; speed to 500 cycle/s; very-low pull-in power, only 40 to 100 mW; and magnetic shielding for EMI-free performance.

CIRCLE NO. 358

Touch switches sport many colors

REFAC Electronics Corp., P.O. Box 809, Winsted, CT 06098. (203) 379-2731. \$0.32 (1000 up); stock.

Noise-free MM Series touch switches are low-profile, SPST, NO switches available in a wide range of pleasing colors. These Micro-Movement touch switches are designed with some actuation feel to minimize the problem of inadvertent switching common to capacitive switches. The switches are rated 24 V ac or dc at 100 mA, operate in a temperature range from -20 to 65 C and have a life to 1-million cycles at rated load.

CIRCLE NO. 359

Ladder network suited for MOS switches

Hycomp Inc., 146 Main St., Box 250, Maynard, MA 01754. (617) 897-4578. \$22 (100 up).

The HC-210 is a 12-bit R-2R resistor network with a standard impedance of 50 k Ω \pm 5%. This high-impedance ladder network is suited to work with MOS or other high saturation-resistance analog switches. The maximum accumulated

positive or negative error will not exceed 0.012% of full scale. The temperature tracking coefficient is 1 ppm/ $^{\circ}$ C. Ratio accuracies are held to \pm 0.01%, and the user can select "application resistors" for various types of feedback configurations, one of which is identical to Analog Devices' AD 855. The networks are also available in 16-pin DIP or flatpack versions or as a passivated chip.

CIRCLE NO. 360

Every Allied Office Is A Stocking Location . . . And Now There Are THREE NEW Locations to Better Serve Your Electronic Needs . . .

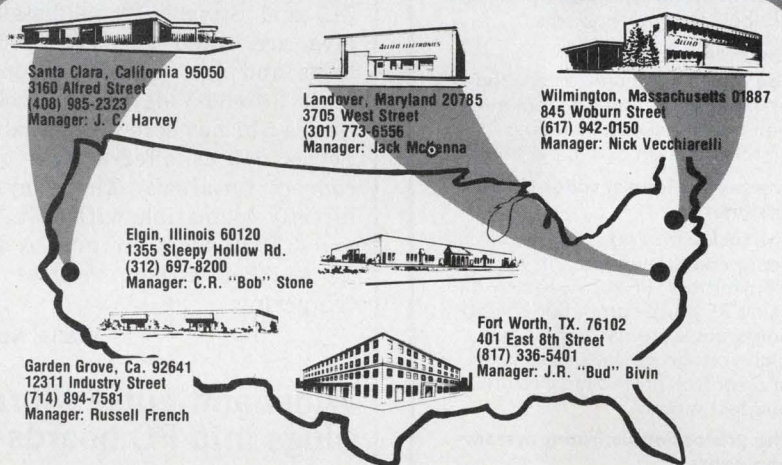

Allied Shipped Complete FROM STOCK 90.1% of All Line Items Written During September and October of 1976

Also, on Over 50% of the Balance, Partials Were Shipped!

Need parts instead of promises? Put Allied's staff of trained sales personnel to work for you! Get the parts you need when you need them — our six coast-to-coast stocking locations are ready and eager to help you. While others have less than a 75% fill from stock, we are continuing to improve on our higher (90.1%) percent fill. And, we put our money where our mouth is! Any catalogued line item that Allied does not ship within one week, Allied will pay the shipping charges. This applies to all orders with the exception of Export, Pack and Hold, Ship Complete and Drop Ships.

NEW 1977 ALLIED ELECTRONICS ENGINEERING MANUAL AND PURCHASING GUIDE NOW AVAILABLE FOR YOU . . .

Our 1977 Guide fully describes thousands of electronic parts, components and replacement devices for Design Engineers, maintenance people, planners, estimators, buyers — anyone who specifies and uses electronic products. FREE to readers of this publication. Circle Reply Number below ad or send your request on company letterhead to:

Allied Electronics, Dept. ED/77-1, 401 East 8th Street,
Fort Worth, Texas 76102.

"Number One Parts Place"



ALLIED ELECTRONICS

A DIVISION OF TANDY CORPORATION

CIRCLE NUMBER 89

Electro-optics, Optomechanics, Infrared, Laser, Computer Hardware Development, Radar

The professionals: EEs, physicists

The tasks: advanced and conceptual design; electro-optical sensor analysis; performance analysis; advanced image and signal processing; stabilization/tracking analysis; systems design, including space-based programs; circuit design that uses MOS or bipolar; design of CCDs and microprocessor/microcomputer techniques.

The professionals: EEs, physicists, MEs

The tasks: device development; high-energy-laser alignment-control systems; servos; precision gimbals and mechanisms.

The professionals: EEs

The tasks: computer-controlled test equipment and system integration and checkout, including systems design and application.

The professionals: radar circuit designers

The tasks: analog or digital circuit design and development; radar transmitters; RF subsystems—all using RF power-amplifier components/subsystems, modulators, high-voltage power processing, and control/protection circuits and techniques.

The professionals: radar systems engineers

The tasks: systems design using Fourier analysis, pattern recognition, and radar signal processing using digital techniques.

Degree from an accredited institution required. Please send resume to: Professional Employment, Hughes Aircraft Company, 11940 West Jefferson Blvd., Culver City, CA 90230.

HUGHES

HUGHES AIRCRAFT COMPANY

AEROSPACE GROUP

US citizenship required
Equal opportunity M/F/H/C employer

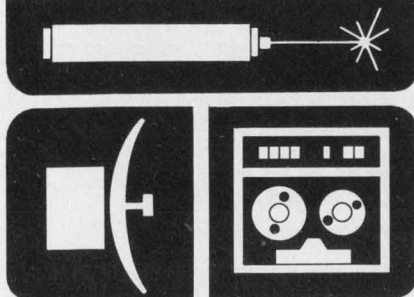

CIRCLE NUMBER 90

COMPONENTS

10-A solid-state relay switches at zero volts

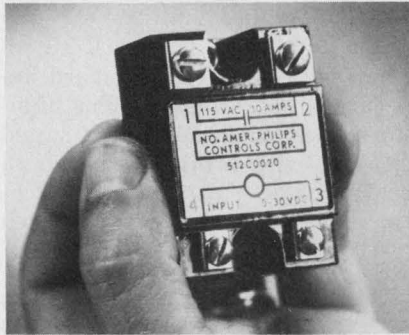

North American Philips Control Corp., Husky Pk., Frederick, MD 21701. (301) 663-5141. \$13.75 (OEM qty); 6 to 8 wks.

Capable of handling 10 A with zero-voltage switching, the Series 512 and Series 513 solid-state relays are rated for 115-V, 60-Hz loads and are designed to operate with 3-to-30-V-dc control voltage. Series 512 has screw terminals and Series 513 is offered with quick-connect terminals. The relays are directly compatible with TTL, DTL and CMOS logic circuits. A built-in snubber circuit reduces false triggering.

CIRCLE NO. 361

Wideband pulse Xformer plugs into PC boards



Magnetico, Inc., 182 Morris Ave., Holtville, NY 11742. (516) 654-1166. \$2.60 (1000 up); stock to 6 wks.

Problems of handling and installing a new line of pulse transformers, designated the 12999 series, are simplified by a PC approach that allows plug-in board insertion. The 3/8-D x 1/4-H-in. epoxy-coated units have a frequency response from 10 kHz to 2 MHz. Primary inductance is 1 mH. Ratios of primary to secondary of 1:1, 2:1 and 4:1 are standard. A rise time of 0.2 μ s is typical. A tough coating gives the transformer environmental protection and uniform performance from unit to unit.

CIRCLE NO. 362

Beeper cube contains folded exponential horn

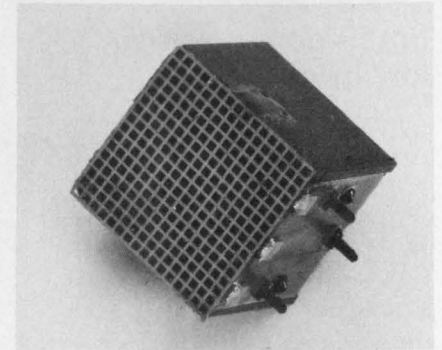

Dyna Magnetic Devices Inc., 200 Frank Rd., Hicksville, NY 11802. (516) 681-5100. \$3 (OEM qty).

A small folded exponential horn packaged in a 0.64-in. cube weighs less than 6 g. The special construction reduces over-all size and lengthens the channels through which sound from the transducer must pass. Sound emerges from four corner exit ports located on one face of the cube. The DMD unit, though tuned to approximately 2100 Hz, produces good sound in the entire 300-to-3000-Hz range and also can handle voice input. Sound output at 1-in. distance is a minimum of 105 dB in a free field between 2000 and 2200 Hz, when driven with an optional 80-mW oscillator. Peak power handling is 200 mW at 2 kHz.

CIRCLE NO. 363

Tiny shock indicator sells for less than \$1

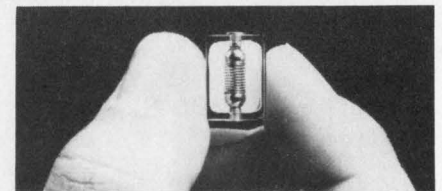

Impact-O-Graph Corp., 4943 McConnell Ave., Los Angeles, CA 90066. (213) 822-2332. \$25: 10-piece sample (100 g); \$0.65 (OEM qty); stock.

Shock-Fuse, a subminiature shock indicator, measures 0.375 x 0.375 x 0.750 in. and weighs 3 g. Any direction of shock or impact above a factory preset value (5 to 500 g) permanently trips the unit and provides a clear visual indication of excessive shock exposure. Shock-Fuse attaches with a self-stick adhesive backing, and once attached, is tamper-proof.

CIRCLE NO. 364

E-Z-MICRO HOOK ■ E-Z-MINI HOOK X100W AND XL1 ■ E-Z-MACRO HOOK XH AND XHL ■ E-Z-NAILCLIPS

E-Z-PROBES XP AND XPL ■ TEST LEADS AND JUMPERS ■ ADAPTORS

THE BETTER TROUBLE SHOOTERS MADE EVEN BETTER

We've redesigned our plunger to fit your finger, without changing the form, fit or function, making the Finger-eze Hypo Action even easier. Both models still combine all the proven features that have made E-Z-Hook products the most sought after test aids available. Insulated to a single contact point for true readings.

Construction One-Piece Beryllium Copper, Gold-Plated Hook. Durable Heat and Chemical Resistant Nylon Body. Stainless Steel Spring. Available in two sizes: X100W Model-2.25" long and XL-1 Model-5" long. Each available preconnected to a wide variety of interface connectors.

NEW... HIGH TEMPERATURE MODEL X100WX Body molded of mineral reinforced nylon.

Colors Red, Black, Blue, Green, Orange, Yellow, White, Brown, Violet and Gray. Specify color when ordering.

EXCLUSIVE FIELD SERVICING FEATURE

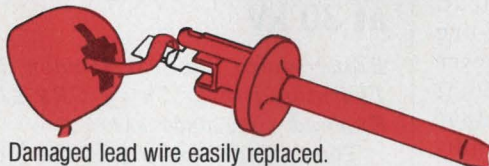

Damaged lead wire easily replaced.

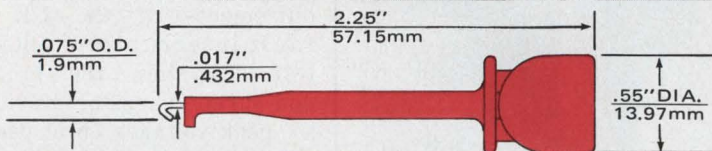
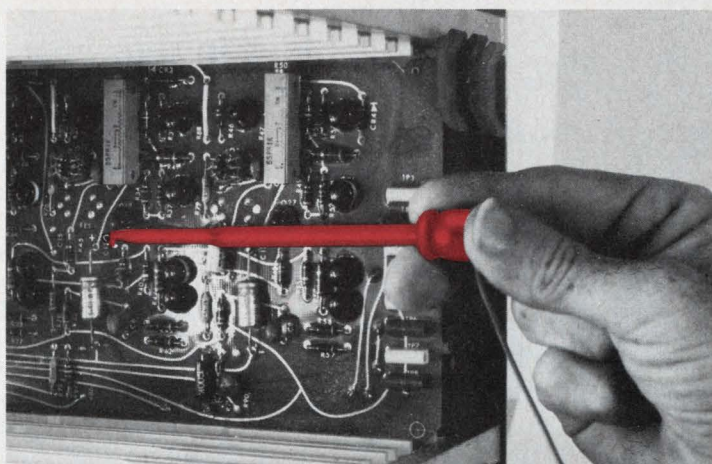

MODEL X100W SHOWN ACTUAL SIZE WITH HOOK EXTENDED

SEND FOR COMPLETE NEW CATALOG AND PRICE LIST

EZ-HOOK
A DIVISION OF TEKTEST, INC.

114 EAST SAINT JOSEPH STREET
ARCADIA, CALIFORNIA 91006
(213) 446-6175 / TWX 910 582 1614

E-Z-PROBES 52 AND 54-1 ■ BNC, UHF, SMA AND STACKING DOUBLE BANANA COAXIAL TEST CABLES

CIRCLE NUMBER 91

PATCH CORDS ■ COAXIAL JUMPERS ■ E-Z-HOOK CLIP 61-1 AND 61-2

IN WIRE-WRAPPING **ok** HAS THE LINE... HOBBY-WRAP-30 FOR AWG 30 WIRE ON (.025 SQUARE POST)

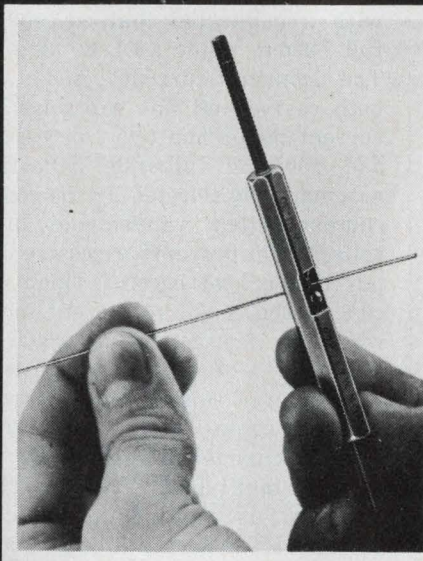

STRIP

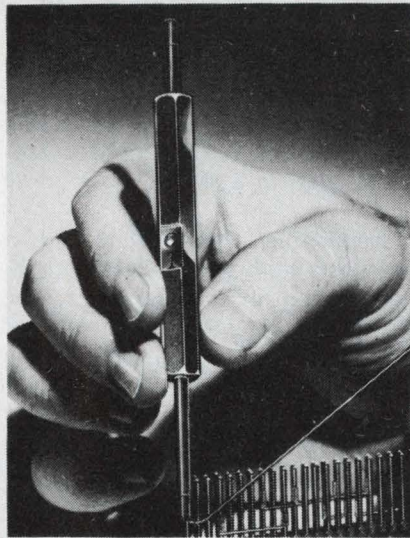

WRAP



UNWRAP

\$5.95

OK MACHINE & TOOL CORPORATION

3455 CONNER STREET, BRONX, NEW YORK, N.Y. 10478 U.S.A. • PHONE (212) 694-8600

TELEX: 125091 TELEX: 232395

NOW! All Dynamic Measurements

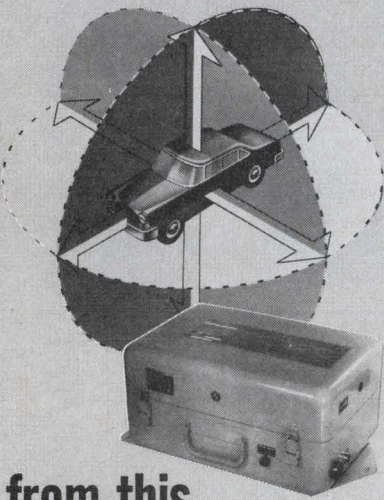

from this ONE Box

A complete, gyro-stabilized inertial reference system in one environmentally-sealed box that can be bolted to any vehicle frame or installed in almost any remote location. It gives you the most comprehensive dynamic measurements possible on all types of land, water, or airborne vehicles.

It provides acceleration and direction measurements referenced to vertical and horizontal planes. Has outputs for 3-axis position, 3-axis acceleration, and 3-axis angular rate measurements. Gyros are electrically caged and uncaged. 12V DC or 28V DC systems available. Write for full details and costs: Humphrey, Inc., 9212 Balboa Ave., San Diego, California 92123 Dept. ED177 Telephone (714) 565-6631

FREE BROCHURE



Humphrey Inc.
SAN DIEGO • WICHITA • PHILADELPHIA

CIRCLE NUMBER 93

POWER SOURCES

Plug-in zaps your input power

Key Tek Instrument Corp., 220 Grove St., P.O. Box 109, Waltham, MA 02154. (617) 800-6200. See text.

The Model PN 261 programmer network, a plug-in pulse-forming network, used with the Model 424 surge generator and monitor, generates a 100 kHz ac-transient-wave for testing industrial and residential power lines. The system produces ac surges that meet the requirements of the UL ground-fault-interrupter voltage-surge test. Together, the programmer and surge generator provide 0 to 6 kV peak voltages (first peak either + or -), 0.5 μ s rise time (10 kV per μ s) and fully floating output. The combination simulates ac-line surges typical in secondary-power networks. Features include: 50 Ω output impedance, isolated output via a high-voltage connector, built-in floating peak monitors for direct-digital and go/no-go readouts of peak voltage and current. The PN 424 costs \$6950 and is available in 45-60 days. The plug-in PN 261 starts at \$1695 and is available in 30-40 days.

CIRCLE NO. 365

800-Hz power sources meet Air Force needs

Aiken Industries, California Instrument Div., 5150 Convoy St., San Diego, CA 92111. (714) 279-8620. \$700 to \$48,500; stock to 30 days.

Employing the principle of a precision high-power linear amplifier driven by an oscillator, the Invertron provides a novel series of ac power sources. Just plug in the proper oscillator, and the unit supplies 800-Hz avionic line power from 100-VA single-phase to 30-kVA, three phase. Voltage taps, stacking capability, square-wave power, and computer-programmability are among the features. Other specs include distortion of less than 0.9%, line regulation and amplitude stability of 0.25%, overload protection, and a 0-to-55-C operating range.

CIRCLE NO. 366

MIL supplies offer high efficiency

Century Electronics, 2688 S. La Cienega Blvd., Los Angeles, CA 90034. (213) 870-1083. \$650-\$820; 4 wk.

Efficiencies from 75 to 88% are featured by MSP (200 W) and MSQ (500 W) MIL-E-5400 power supplies. In each series, 12 models offer 5-to-48-V-dc outputs from 115-V, 400-Hz input. The units operate from -55 to +100 C with only conduction cooling through the baseplate. They deliver 0.2% regulation for normal line and load variations and 25% for full load. Overload protection with self-recovery is standard.

CIRCLE NO. 367

Get constant current at 30 kV

Brandenburg Ltd., 939 London Rd., Thornton Heath, Surrey CR4 6JE, England (01) 689-9441/5.

The current stability of the Model 820 is better than 0.1% of the set current, which is variable between 10 and 500 μ A, at up to 30 kV. The output can be stabilized in either the constant-voltage or constant-current mode (selected by a front-panel switch), with both voltage and current displayed on panel meters. In the constant-voltage mode, a single three-turn control with a calibrated dial covers the full output range (0.1 to 30 kV). The constant-current mode has both coarse and fine controls. The current meter has two ranges, 250 and 500 μ A full-scale deflection, automatically selected by the coarse current switch. An electronic over-voltage trip prevents excessive output if the load becomes open circuit in the constant current mode, while a fast-acting overcurrent trip and a fuse give protection against overloads or short circuits in either mode. The output polarity may be changed by reversing the voltage multiplier. The all-solid-state unit uses high-frequency conversion to generate high-voltage, dc power without the hazard of high energy storage in the output filter circuit. The unit, designed for bench use or rack mounting, measures 445 \times 320 \times 150 mm and weighs 10.5 kg.

CIRCLE NO. 368

Built to last

Our new 3½-digit LED autopolarity digital VoltOhmyst® is quality-constructed for long, hard service.



WD-750A
\$267.00

© VIZ

- Fast and accurate measurement of ac and dc volts, current, and resistance.
- Built-in analog panel meter for peaking and nulling.
- Hi- or Lo-power ohms selector.
- 120V/240V ac or battery operation with built-in charger.
- RF shielded, with rugged vinyl-clad case.

VIZ Test Instruments Group

of VIZ Mfg. Co.

335 E. Price St.
Phila. PA 19144

6645

Formerly
RCA
Instruments

CIRCLE NUMBER 94

MODEL SP-G11

SPEEDEX RECORDER

Model SP-G11 is equipped with a built-in A/D converter in addition to common analog recorder functions. Since output terminals are also provided. It can be readily used in computation and for connection to a printer or paper tape punch.

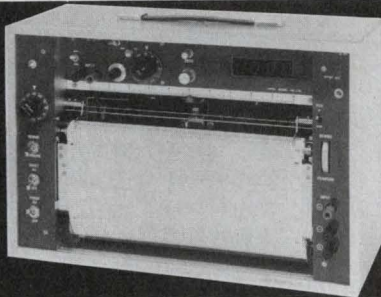

• FEATURES

1. Digital output terminal (10-bit binary or 3-digit BCD)
2. External clock terminal permits chart drive by external clock.

• SPECIFICATIONS

1. Chart width 250mm
2. Pen speed 0.8 secs full scale
3. Measurement voltage 0.5, 1, 5, 10, 50, 100, 500mV, 1, 5, 10, 50, 100V full scale
4. Chart speed 10, 20, 50, 100, 300, 600mm/hr
20, 50, 100, 300, 600mm/min
5. Digital output (A or B) A...10-bit binary full scale at 1000 digit.
1 digit 0.1%
B...3-digits BCD 10²10¹10⁰ full scale 999

• Please write us on your letterhead for detailed information.

Riken Denshi Co., Ltd.

5-5-2, Yutenji, Meguro-ku, Tokyo, Japan.
TEL: 711-6656 TELEX: 0246-8107

CIRCLE NUMBER 95

ELECTRONIC DESIGN 1, January 4, 1977

New Press Top Coolers are today's best buy for a nickel.

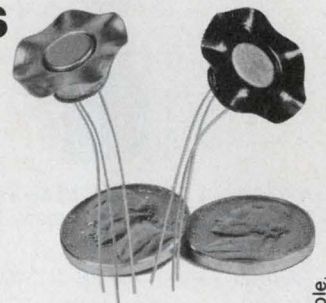

Here's how to really cut cooling costs for TO-5 packages. Wakefield's new 298 Press Top Coolers cost only 5¢ each in 5,000 quantity. This is less than the price of comparable IERC Fan Tops or Thermalloy devices . . . and at no sacrifice in performance. With ΔTc-A less than 70 °C/W.

The unique wave design of the cooler is responsible for the high cooling efficiency while new automatic tooling allows the low price.

Try one free:

298 Coolers need no board space. See for yourself how they can solve heat problems and improve transistor performance. Send for a free sample.



WAKEFIELD ENGINEERING INC.

77 AUDUBON ROAD, WAKEFIELD, MA 01880 (617) 245-5900.
TWX 710-348-6713 AN E&G COMPANY

CIRCLE NUMBER 96

Cut out and mail for a free sample.

**SPRAGUE
GOODMAN**

TRIMMER CAPACITORS

Our only business!

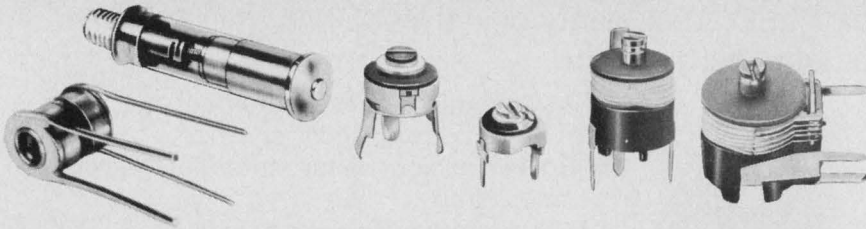

PISTONCAP® Multi-Turn Tubular

- Low-Loss, Glass or Quartz
- High Stability/High Reliability
- Simple, Long-Life Adjust Mechanism
- Professional / Military Applications, MIL Approved

CERAMIC Single-Turn

- Compact, Conserves Board Space
- Variety of Mounting Configurations
- Low Cost for Commercial/Industrial Applications

FILMTRIM* Single-Turn Film

- PTFE, Polypropylene, Polycarbonate
- Most Stable Trimmer for Size
- Very Wide Capacitance Ranges
- Low Cost for Commercial/Industrial Applications

*Trade Mark

Tired of broken delivery promises and poor quality? Deal with the trimmer capacitor specialist, for quality products delivered on schedule! Call on us for custom designs too, we deliver!

TRIMMER CAPACITORS — OUR ONLY BUSINESS!

Sprague-Goodman Electronics, Inc.

(An Affiliate of the Sprague Electric Company)

134 FULTON AVE., GARDEN CITY PARK, N.Y. 11040-516-746-1385-TLX: 14-4533

CIRCLE NUMBER 98

POWER SOURCES

Switch remotely without extra wiring

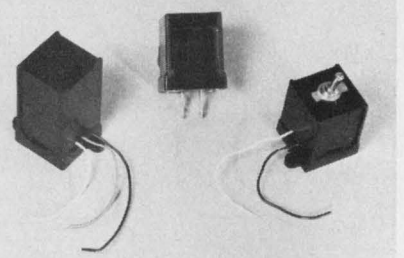

Southwood Electronic Co., P.O. Box 673, Greenwood, IN 46212. (317) 888-0238. \$28.50 up (1-9 units).

The Southwood remote switching system turns ac power from a common transformer on and off via high-frequency signals. The ac wiring is used to transmit the signal, and switch the power load from any location in the distribution system even between buildings. Both transmitters and receivers are available for wire-in (receiver at left, transmitter at right) and plug-in (center). By choosing different rf channels, several units can be operated simultaneously.

CIRCLE NO. 369

Batteries power line of reference sources

General Resistance, 75 Haven Ave., Mt. Vernon, NY 10553. (914) 699-8010. \$1050 to \$1400; 60 days.

Ten models of Dial-A-Source reference-calibration sources offer eight-hour operation from internal rechargeable batteries. Eight models give you full-scale output ranges of ± 1 and 10 V dc, resolutions to 0.1 μ V, and accuracies to $\pm 0.0015\%$ of setting. Two other models supply full-scale outputs of ± 1 , 10 and 100 V dc with resolutions to 1 μ V, and accuracies to $\pm 0.0025\%$ of setting. Load-current capability for all units is 30 mA. Four instruments have standard built-in constant-current capability and adaptors are available for the others. All sources feature an overnight-recharge period and remote sensing. In addition to internal battery operation, the units can be operated from the ac line. A flashing LED indicates a low-battery condition.

CIRCLE NO. 370

TRIO LABS' MAXI-POWER® 682



A 750 watt (5VDC at 150a) Switching Power Supply that has so many features it surpasses comparison.

- Input 208VAC nominal (115VAC-Model 683).
- Low Line -30% (146VAC).
- High Line +10% (229VAC).
- Ride through 35ms @ nominal.
- Efficiency up to 85%.
- Output 2-48VDC standard.
- Power Out up to 800w (750w @ 5VDC out).
- Output voltage adjust.
- Overcurrent protection foldback (standard) or constant current.
- Overvoltage protection crowbar SCR.
- Self Cooling
- Parallelable.
- U.L. recognized (approved).
- 5x8x11"
- Up to 2 watts/in³.
- As low as 63¢/watt.

**TRIO
LABS**

The
Switcher
Source®

80 Dupont St.
Plainview NY
(516) 681-0400

CIRCLE NUMBER 99

KEEP

Electronic Design's

GOLD BOOK HANDY

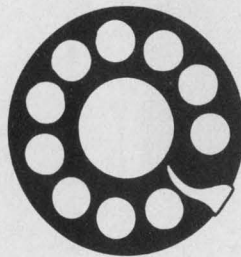

When You Call

Save time when you contact suppliers. Check their catalog pages first in *Electronic Design's* GOLD BOOK. Maybe the information you need is right at your fingertips.

Cool switchers pack 1 W per cubic inch

Gould, 3631 Perkins Ave., Cleveland, OH 44114. (216) 361-3315. \$250 to \$485; stock.

With typical efficiencies of 65 to 75%, the compact MG and MGT switching dc power supplies provide output power densities in excess of 1 W/in³. They are convection cooled and under normal operating conditions require no forced air cooling. Standard features include remote sensing, remote programming, over current protection, and overvoltage protection. Their MTBF is over 36,000 h. Nine MG models provide dc outputs of 5, 12, 15 or 24 V at from 4 to 60 A. The MGT triple-output model is a 5 V, 20 A unit with two auxiliary outputs of 12 or 15 V, 1.75 A. Output voltages are adjustable $\pm 5\%$ from a front-panel pot. Regulation is 0.1% max for the worst case combination of 0-to-100% load change and $\pm 10\%$ line change, and ripple does not exceed 10-mV rms or 50-mV pk-pk measured over a 30-MHz bandwidth. The operating temperature range is -10 to 70 C with full output ratings to 50 C and derating of 2.5%/°C to 70 C. Input power is 115 V $+10\%$ -20% (220/240 V available) 45-440 Hz. Output is maintained for 28 ms after a loss of ac input power.

CIRCLE NO. 371

Dc/dc converters can swallow 30-ms glitch

Pioneer Magnetics, 1745 Berkeley St., Santa Monica, CA 90404. (213) 829-3305. \$550 up; 50 days max.

The dc-to-dc converters of the 2700 series operate from a dedicated 48 or 125-V-dc input, and are available in two groups. PM-2721 covers the 250-to-400-W range, PM2722 covers 500 to 750 W. They provide full rated power to 50 C, which remains regulated for a minimum of 30 ms if input power is lost. Load steps of 25% produce less than 50-mV transient excursion. Standard outputs include 2, 5, 12, 15, 18, 24, and 28 V dc, and optional versions with power fail signal, logic inhibit, remote programming and margin checks are available.

CIRCLE NO. 372

M-tron Quartz crystals



AT CUT Crystals 800 KHz to 200 MHz

COMMERCIAL

- Nation's largest capacity for commercial use crystals.
- Frequencies available for:
 - CB, Toy and Scanner Radio applications.
 - Color TV, Video Games and Clock applications.
 - Microprocessor and Mini-computer applications.
- Computer-aided Crystal Design Program assures fast delivery.
- 100% Quality Audit of Critical Parameters.

HIGH RELIABILITY

- QPL approvals to MIL-C-9038.
- Advanced hermetically sealed packaging techniques.
- Frequencies available for Avionic and Marine Radio applications.

PHONE 800-843-6842 • TWX: 910-668-3603

M-tron

INDUSTRIES, INC.,

Box 630, Yankton, S.D. 57078
A Div. of Lynch Corp.

CIRCLE NUMBER 100

Select One...

One of these tachometer generators is suited to your application. We offer them in two-bearing and single-bearing versions, no-bearing overhung versions and in sealed housings for use in environments containing oil and hydraulic fluids. Outputs range from 2.6V/1000rpm to 45V/1000rpm; brush life up to 100,000 hours—that's over ten years!

FREE CATALOG of rotating components available.

Be Selective, Turn To...

SERVO-TEK®
PRODUCTS COMPANY
1086 Goffle Road, Hawthorne, NJ 07506 • 201-427-3100
Servo-Tek of California, Inc.
8155 Van Nuys Blvd., Van Nuys, CA 91402 • 213-786-0690

Contact our Hawthorne Headquarters for Names of Overseas Representatives

SERVO-TEK
ALL AMERICAN
ENGINEERED

CIRCLE NUMBER 101

SERIAL/PARALLEL DATA AND TIMING GENERATORS

... Excitation sources for testing digital IC's, circuitry and memory systems

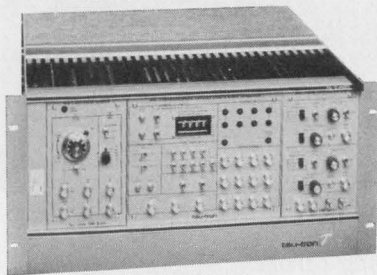

Model MG-3

User features of this line include parallel words at 100 MHz; serial data at 500 MHz. Output signal shaping; manual or computer controlled.

tau-tron
INC

11 Esquire Road, North Billerica, Mass. 01862
Tel: (617) 667-3874

CIRCLE NUMBER 102

Circuit Savers



\$3.00
1000 pcs

DC
CROWBAR



Here's positive low cost protection for your IC's, transistors, power supplies and pc cards.

The LVC-1A crowbar switches to a short circuit whenever the voltage across it exceeds a specified level.

Any trip voltage level between 4.7V and 200V \pm 10% can be selected. The unit will handle a peak current of 50 Amps (8ms) and 3A continuously. MIL Temperature range. Call Mike Coyle for applications assistance.

Full line of protection modules for every hi-lo voltage/current requirement. Write or call for Catalog 749.

160 Brook Ave.
Deer Park, N.Y. 11729
Telephone: 516 - 586-5125

MCG Electronics

CIRCLE NUMBER 103

DISCRETE SEMICONDUCTORS

0.6-in. GaAsP displays switch at high speed

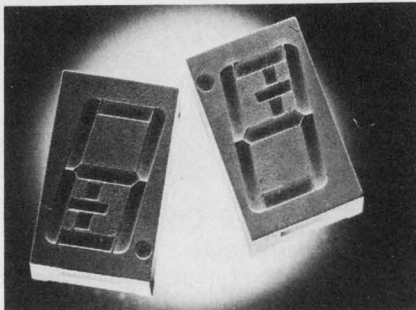

Monsanto Commercial Products Co., 3400 Hillview Ave., Palo Alto, CA 94304. (415) 493-3300. \$3.84 (100-999); stock to 6 wks.

Orange LED 0.6-in. displays, MAN6660 and 6680, feature the brightness of GaAsP on GaP-substrate technology and high speed for multiplexing and logic control. The new display is compatible with Monsanto's MAN6600 series of double-digit displays. MAN6660 has a common-anode configuration and MAN6680 a common-cathode. Both units radiate at a wavelength of 630 nm. Minimum brightness is specified at 510 mcd/segment average, at a forward-current of 10 mA. A 10-ns rise time compares to a typical gas-discharge device rise time of 25 μ s. The units are 0.48-in. wide, so that they mount easily on 0.5-in. centers.

CIRCLE NO. 373

Power Darlington handle 15 A at 250 V

International Devices Inc., 3370 Livonia Ave., Los Angeles, CA 90034. (213) 559-4741. \$2.25 (100 up); stock.

The series 8000 monolithic power Darlington transistors feature a V_{cbo} up to 250 V, an I_c of 15 A and rise times under 500 ns. The 8000-8002 units, all similar except for voltage ratings (150 V for IDI 8000, 200 V for 8001 and 250 V for 8002), include an integral rapid turn-off diode and resistor network in their TO-3 packages. They are capable of dissipating 90 W at 25 C. Secondary breakdown energy is 70 mJ. Other specifications include a V_{CE} (sat) of 10 A, an h_{fe} of 50 at 10 A and a storage time of 3 μ s.

CIRCLE NO. 374

Schottky diode low-cost for general purposes

Hewlett-Packard, 1501 Page Mill Rd., Palo Alto, CA 94304. (415) 493-1501. \$0.45 (1000 up); stock.

The HSCH-1001 low-cost Schottky barrier diode offers the advantages of low forward voltage and fast switching speed to general-purpose switching applications. Other advantages are high rectification efficiency, excellent diode-to-diode uniformity and high on-to-off ratio. Offered in a hermetic package with JEDEC outline DO35, the diode can survive a 10-lb lead pull and fits automatic insertion equipment. Switching speed is in the picosecond range, with a maximum effective carrier lifetime of 100 ps. Breakdown voltage is 60 V minimum and leakage current is less than 200 nA at 50 V, reverse Forward voltage is 410 V maximum at 1 mA. Forward current is greater than 15 mA at 1 V.

CIRCLE NO. 375

Combustible gas sensor receives UL approval

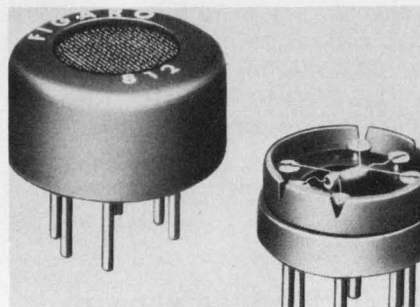

Figaro Engineering, Inc., 3303 Harbor Blvd., Suite D8, Costa Mesa, CA 92626. (714) 751-4103. \$3 (unit qty); 2 wks.

The Figaro semiconductor gas sensor, Model TGS, is claimed to be the first and only UL approved detector of natural or propane gas. The unit is a sintered n-type semiconductor bulk device mainly composed of SnO_2 whose conductivity increases in the presence of combustible gases. Featuring extremely high sensitivity, the device senses the lower explosive-limit percentage of a particular gas. Change from normal levels activates a buzzer or relay alarm. Output from the gas sensor is sufficiently large to allow use of simple circuits. Life expectancy of the TGS sensor is 5 yr or more.

CIRCLE NO. 376



Series X-20
Actual Size

WE'RE WARNING YOU...SM

... panel mounting is made very easy with these new piezo crystal audio indicators. They fit a 1.125" (28.6mm) diameter opening in panels as much as 0.125" (3.2mm) thick. Behind panel depth only .500" (12.7mm)! Can be used for computer terminals ... or remote control warning, fault detection and alarm devices ... or to replace other, larger alarms. Continuous tone 35mm diameter sounding element really gets attention. Rated to 85 dbA at 3.3 kHz; 6 to 16 vdc; current drain just 10 mA. Terminals accept 0.187" (4.76mm) disconnects, screws or solder. Ask for free catalog and a demonstration.

Where to buy an audio indicator for every need:



3680 Wyse Road, Dayton, Ohio 45414
Tel. (513) 890-1918, TWX 810-450-2523

Distributors throughout the world.

CALIFORNIA, COSTA MESA
MarVac Electronics
COLORADO, DENVER
Waco Electronics Inc.
MASSACHUSETTS, SHARON
Adcour
MICHIGAN, FARMINGTON
CMP Distributor Co.
MISSOURI, ST. LOUIS
Olive Industrial Elec.

NEW YORK, ROCHESTER
Ossmann Component Sales
OHIO, CLEVELAND
CMP Distributor Co.
OHIO, CINCINNATI
COLUMBUS
Hughes Peters, Inc.
TEXAS, DALLAS
K. A. Electronic Sales

UTAH, SALT LAKE
Newark Electronics
WASHINGTON, SEATTLE
Frank Jackson & Associates
WISCONSIN, MILWAUKEE
Taylor Electric Co.

B. C., VANCOUVER
Deskin Sales Corp.
ONTARIO, TORONTO
Deskin Sales Corp.
ONTARIO, WILLOWDALE
Electro Sonic, Inc.
QUEBEC, MONTREAL
Deskin Sales Corp.

CIRCLE NUMBER 104

SEIKO'S MECHANICAL FILTERS AND OSCILLATORS

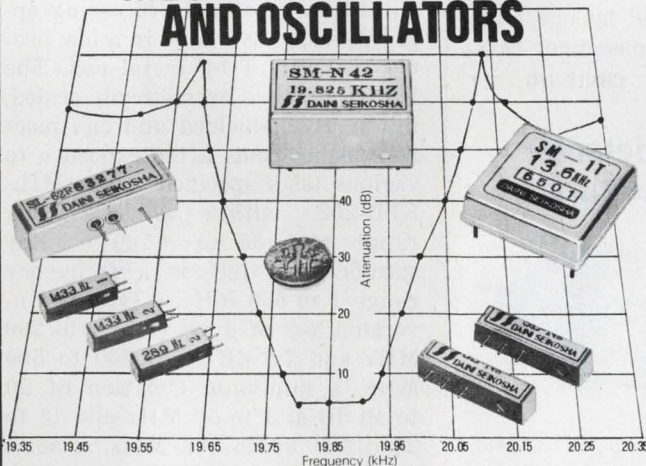

1. Utilizes the precision machining technology of SEIKO, manufacturer of fine timepieces.
2. A wide assortment of types from miniature filters ideal for pagers to high performance filters used in communications equipment are available.
3. Frequency range from 280Hz to 100kHz.
4. See the 1976 edition of the "GOLD BOOK" for details.

• Sales Office:

SEIKO INSTRUMENTS, INC.
2990, West Lomita Blvd., Torrance, Calif.
90505, U.S.A.
Phone: (213) 530-3400
Telex: 259103477307 SEIKOINST TRNC

• Manufacturer & Exporter

DAINI SEIKOSHA CO., LTD.
Industrial Electronics Div.
31-1, 6-chome, Kameido, Koto-ku, Tokyo
136, Japan.
Phone: (03) 682-1111
Telex: 2622410 DSEIKO J

SEIKO mechanical filters have been developed and commercialized through the precision machining technology of SEIKO.

CIRCLE NUMBER 105

ELECTRONIC DESIGN 1, January 4, 1977

SWITCHES FOR KEYBOARDS

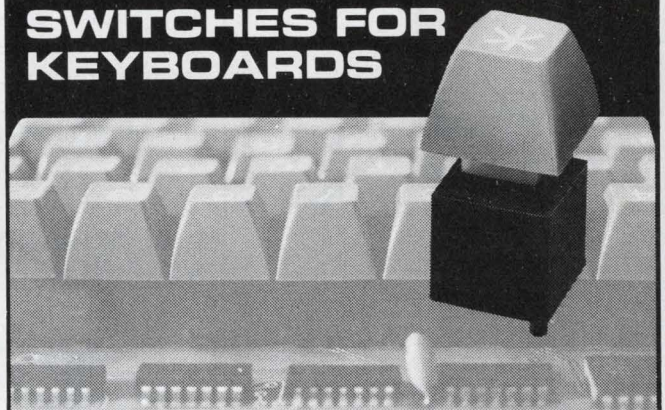

We offer the following for OEM's producing their own keyboards.

- Keyswitch sizes for 5/8" or 3/4" centers
- Gold Bar mechanical contacts or sealed contacts
- Front panel relampable lighted models
- Single and double pole contacts including NC
- Alternate action models
- Doubleshot molded keytops for 3/4" or 5/8" mounting
- Easy change legend systems
- 100,000 pc. quantity prices as low as \$0.21 each

Letterhead request or phone call brings free sample switch w/keytop.

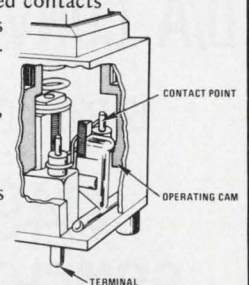

MECHANICAL ENTERPRISES, INC.

8000 Forbes Place Springfield, Virginia 22151
(703) 321-8282 TWX 710-832-0942

In Germany - NEUMÜLLER GMBH, MUNICH
In U. K. - TEKDATA Ltd., STOKE-ON-TRENT

CIRCLE NUMBER 106

We squeeze time

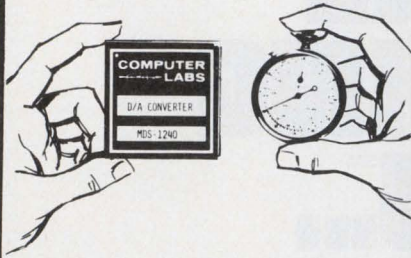

...in our new...

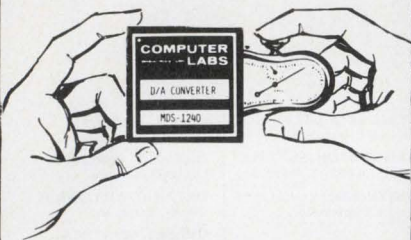

12-bit D/A!

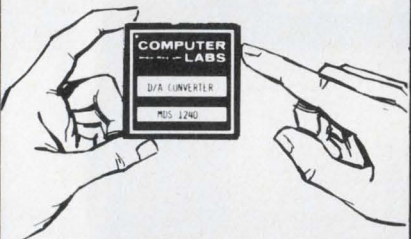

MDS-1240
D/A CONVERTER

12-Bits, 40NS

\$149

COMPUTER LABS

505 EDWARDIA DRIVE
GREENSBORO, N. C. 27409
(919) 292-6427

CIRCLE NUMBER 107

MICROWAVES & LASERS

Backpack your own microwave relay

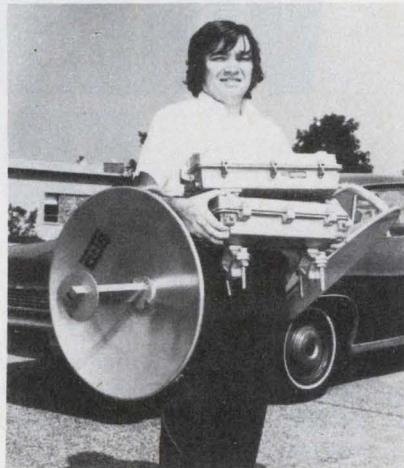

RHG Electronics Laboratory, 161 E. Industry Court, Deer Park, NY 11729. (516) 242-1100. \$9950 up; 75 days.

"MTV" series FM microwave links consist of a receiver, a transmitter and two antennas, available at standard as well as other frequencies from 1 to 15 GHz. They are weatherproof, EMI shielded, and self-contained for unattended operation. The compact units are MIL-grade constructed, feature low-noise receiver input and field-tunable transmitters and receivers. Units can be carried by one man, and transported in passenger cars.

CIRCLE NO. 377

Flat Schottky detector has inflated bandwidth



Narda Microwave Corp., Plainview, NY 11803. (516) 433-9000. \$160; stock to 2 wks.

Schottky detectors in the 453 series are small (1/2 x 1/2 x 1-1/2 in., approx) and sensitive. Depending on bandwidth, typical flatness is around ±0.5 dB, except for the 4536 which covers 8 to 18 GHz, with ±0.7-dB flatness. These rugged detectors require bias in the range of 150 to 350 μA. Matched sets are available.

CIRCLE NO. 378

2.1 dB NF guaranteed for GaAsFET amplifier

Avantek Inc., 3175 Bowers Ave., Santa Clara, CA 95051. (408) 249-0700. From \$2000; 4 to 8 wks.

The AM/AW-4240 series of low-noise earth-terminal preamplifiers offer guaranteed 2.1-dB (180-K) noise figures across the full 3.7-to-4.2-GHz band. The GaAsFET amplifiers are available with waveguide or coaxial connectors. The units can be factory tuned to any 100-MHz portion of the band, with 1.8-dB NF guaranteed in this range, while maintaining 2.3 dB NF across the full band.

CIRCLE NO. 379

Double-balanced mixers have 0.3-in. high cases

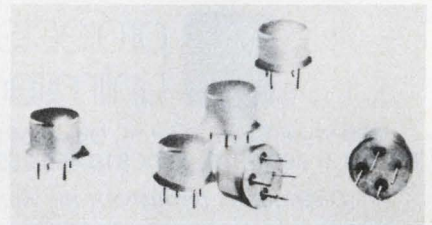

Merrimac Industries, 41 Fairfield Pl., West Caldwell, NJ 07006. (201) 228-3890. \$25 (low qty.); stock to 4 wks.

A double balanced mixer, designed for rf signal processing applications, is available in a low profile (0.3 in.) TO-5 metal can. The M-109 mixer is hermetically sealed, totally RFI shielded and can meet its specifications after exposure to various tests specified under MIL-STD-202, within an operating range of -55 to +100 C. Key specifications include a frequency range 1 to 500 MHz, a typical conversion loss of 6 dB from 1 to 200 MHz and 7.5 dB from 200 to 500 MHz, a minimum isolation of 30 to 40 dB at 1 to 50 MHz and 18 to 25 dB at 50 to 500 MHz, a noise figure with ±1 dB of conversion loss, a compression point (at 1 dB) of +3 dB minimum, a desensitization level (at 1 dB) of 0 dBm minimum, a dc offset of typically +1 mV, a typical third order intercept of +14 dBm, maximum peak current for i-f port of 50 mA and a maximum input power of 50 mW. All of these specifications are measured in a 50-Ω system with LO at +7 dBm.

CIRCLE NO. 380

Bridge mixer spans all channels

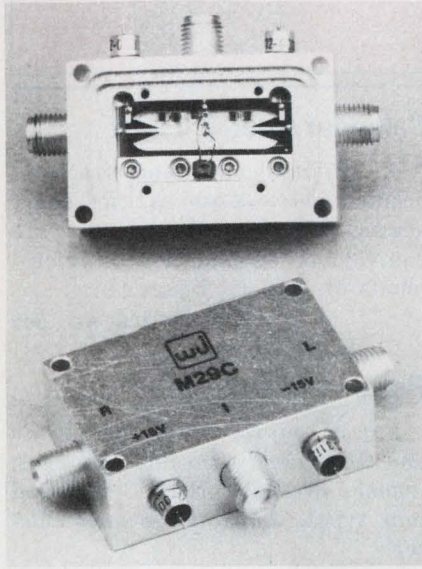

Watkins-Johnson Co., 3333 Hillview Ave., Palo Alto, CA 94304. (415) 493-4141. \$560 (1-4).

Do you need a high-performance, single-balanced 4-diode bridge mixer? The Model WJ-M29C has a frequency range of 1 to 18.5 GHz, and is biasable. Conversion loss is typically 12 dB, with 10-dBm local oscillator drive and ± 15 V dc bias. At a drive level of 0 dBm, conversion loss and sensitivity to oscillator drive are minimized. Isolation is typically greater than 20 dB. The package measures 1.5 by 0.96 by 0.56 in., the same as for the manufacturer's M25C and M28C, announced recently. The latter models cover 1-12 GHz and 1-18.5 GHz respectively, and are optimized for high isolation (25 dB typ). Prices are \$360 for the M25C, and \$490 for the M28C.

CIRCLE NO. 381

Solid-state amplifier covers 18 to 26 GHz

Aercom Industries, 1050F E. Duane Ave., Sunnyvale, CA 94086. James E. Mitchell (408) 736-7600. \$6425; 8 wks.

The combination of tunnel-diode input with Gunn-effect output, in the Model AD181201, yields 30-dB small signal gain, +5 dBm saturated power from 18 to 26 GHz, and a 12-dB noise figure. Other models with up to +20-dBm output power are available. All units measure 7.3 x 3.7 x 1.1 in.

CIRCLE NO. 382

How to make your green go farther.

Think pink.

Great Jumpers™ and Great Daisy Jumpers™, the fully pre-assembled and fully pre-tested flat cable/connector system from A P Products, can cost about half as much as what you're using now.

Take your choice of the three most popular connectors, the five most popular flat cable widths, solid or stranded Electric Pink or rainbow cable, single ended, double ended or daisy chained. And Great Jumpers are directly-interchangeable replacements for the jumpers you're using now.

Our connectors are molded on. They provide both an integral cable strain relief and complete line-by-line probeability. And because they come to you factory assembled and tested, they're faster and easier to use.

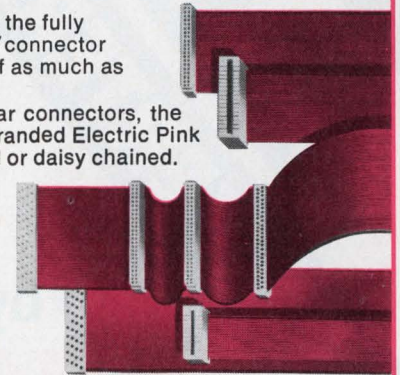

Connect with the A P rep nearest you.

(203) 868-7748	(219) 447-9623	(314) 434-6242	(512) 443-9687	(617) 272-8163
(206) 822-8223	(301) 484-5400	(315) 437-8343	(513) 433-0966	(713) 691-3961
(212) 682-5844	(303) 420-4646	(414) 421-2300	(602) 946-4437	(714) 560-6266
(214) 238-0408	(305) 894-3351	(415) 328-3232	(602) 949-8424	(714) 833-1802
(215) 923-5195	(312) 298-4830	(416) 638-1322	(609) 429-4013	(816) 765-2998
(216) 333-4120	(313) 356-2161	(503) 223-3374	(612) 922-7011	

Faster and easier is what we're all about.



A P PRODUCTS INCORPORATED

Box 110-F Painesville, OH 44077 (216) 354-2101 TWX: 810-425-2250

CIRCLE NUMBER 108

VECTOR-PAK SYSTEM SOLVES PACKAGING PROBLEMS

- CAGES NOW AVAILABLE FULLY OR PARTIALLY ASSEMBLED.
- NEW EASY-TO-ORDER NUMBERING SYSTEM.
- BUILT IN ADJUSTABILITY AND FLEXIBILITY TO SOLVE YOUR PACKAGING PROBLEMS.

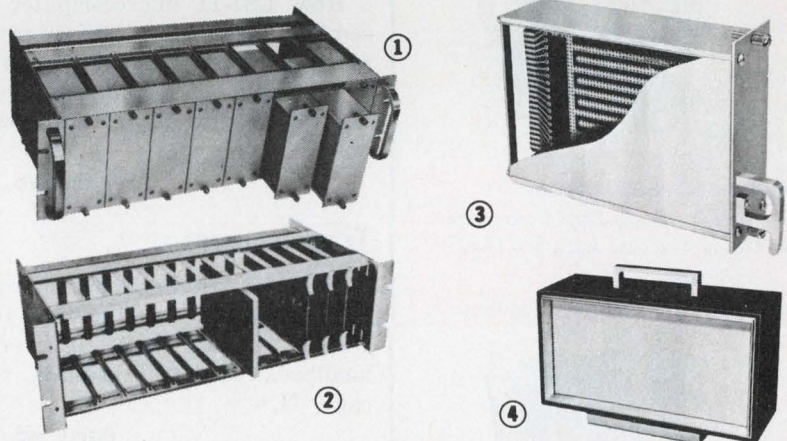

- ① Rack mountable cage and module systems available in 3½", 5¼", 8¾" heights and 9", 12", 15" depths. Immediate availability — assembled or kit versions.
- ② Card Cages with plastic or aluminum guides located on .15", .25", or .3" multiples.
- ③ EFP cases with card slots, slide out sides — many sizes.
- ④ Multi-Mod Cases with card slots enclose circuitry for elegant instruments.

Also Available — Plug-in cards for microprocessors, ICs, etc. — many sizes and patterns.

Send for new specification sheets.
NIM bins and modules also available.

Vector ELECTRONIC COMPANY, INC.
12460 Gladstone Ave., Sylmar, California 91342
Call Toll-Free 1-800-423-5659



32476

CIRCLE NUMBER 109

MILITARY
APPLICATIONS

A/D CONVERTERS

by

MSK

Accuracy

Speed

Size

Repairability

Military

Temp. Range
-55°C to +125°C

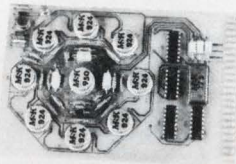

- 4 Bit/50 nSec; Low Cost
- Ideal for Radar Scan Converters
- Holds Absolute Accuracy Over Temperatures
- Tracks a 10 MHz Analog Input

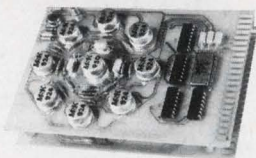

- 9 Bit/200 nSec.
- < 2 Bit Drift Over Temperature
- Insensitive to Clock Frequency

For Further Information Call or Write
M.S. Kennedy Corp.
Pickard Drive, Syracuse, New York 13211
Tel. 315-455-7077

CIRCLE NUMBER 110

Application Notes

A/d and d/a parameters

"Specifying and Testing Analog to Digital Converters" and "Specifying and Testing Digital to Analog Converters" are designed to improve user understanding of parameter definitions and measurement techniques. Teledyne Philbrick, Dedham, MA

CIRCLE NO. 383

Fhp motors, gearmotors

Complete data on dynamic braking of fractional-hp motors and gearmotors are presented in a technical paper. Bodine Electric, Chicago, IL

CIRCLE NO. 384

Troubleshooting instruments

Eight application notes describe the use of logic-state troubleshooting instruments to analyze commonly used microprocessor systems. Hewlett-Packard, Palo Alto, CA

CIRCLE NO. 385

μ C assemblies

How LSI-11 microcomputer assemblies are being used in a variety of applications is explained in a series of application notes. Digital Equipment, Marlborough, MA

CIRCLE NO. 386

Transformers

Transformer design and selection parameters are covered in a 16-page catalog and engineering handbook. Inglet Electronics, Chicago, IL

CIRCLE NO. 387

Line printers

A bulletin describes the operation of the 8200 series line printers. The bulletin includes information on the writing technique used, toning of the paper and the paper drive system. Houston Instrument, Austin, TX

CIRCLE NO. 388

Design Aids

Calendar/metric chart

A 1977 calendar and fraction-decimal-metric equivalent chart shows the decimal and metric equivalents of fractions in increments of 1/64 in. Boker's.

CIRCLE NO. 389

Power transistors

Power Transistor Selection Guide and OEM Price Schedule, 16-pages, indexes over 550 JEDEC npn and pnp types. Ampower Semiconductor.

CIRCLE NO. 390

Preamplifiers

A 23 x 35-in. preamplifier wall chart is packed with graphic and tabular information about low-noise plug-in and free-standing preamplifiers and transformers. Princeton Applied Research.

CIRCLE NO. 391

Cavity devices, antennas

Two wall charts, each measuring 21-1/2 x 28 in., function as quick-reference selector guides for cavity devices and base-station antennas. Phelps Dodge Communications.

CIRCLE NO. 392

V/f converters

A v/f and f/v-converter wall-chart/calendar presents block diagrams of the converters as well as a 1977 calendar. Teledyne Philbrick.

CIRCLE NO. 393

Wires and cords

Selection Guide to Appliance Wires and Cords, a pocket-sized 24-page book, contains information on conductors and descriptions of insulation, jacket materials and protective coatings. Industry standards for appliance and apparatus wires and flexible cords and fixture wires are included. General Electric.

CIRCLE NO. 394

New Literature

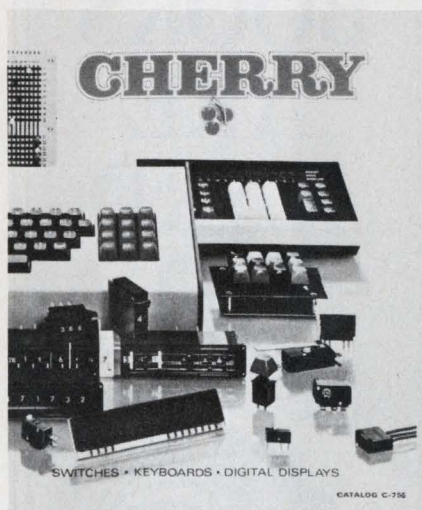

Switches, keyboards

An 84-page catalog includes the latest listings, drawings, operating characteristics and technical data on the company's switches, keyboards and gas-discharge displays. Cherry Electrical, Waukegan, IL

CIRCLE NO. 395

Encoded logic switch

Specifications, dimensional drawings and ordering information for a programmable rotary encoded switch are included in a four-page brochure. Standard Grigsby, Aurora, IL

CIRCLE NO. 396

Radar calibration

A radar precision frequency and calibration system covering the 0.1-to-18-GHz frequency range is described in a 75-page literature package. Watkins-Johnson, Palo Alto, CA

CIRCLE NO. 397

Thermistors

Thermistor E-I Curve Manual, 20 pages, presents a complete story on the use of thermistors in the self-heat mode and is complemented with detailed graphs, charts, working tables and practical problems with solutions and/or answers. Fenwal Electronics, Framingham, MA

CIRCLE NO. 398

Barrier blocks

Barrier blocks for use by equipment design engineers are described in a catalog. National Tel-Tronics, Meadville, PA

CIRCLE NO. 399

Tools

Unusual and hard-to-find tools are described in a 128-page catalog. Jensen Tools and Alloys, Phoenix, AZ

CIRCLE NO. 400

Power supplies

The "Quad" series four-output microprocessor power supplies are featured in a two-page bulletin. Deltron, North Wales, PA

CIRCLE NO. 401

Contacts, brushes, discs

A 56-page catalog describes the company's series of low-energy electrical contacts. Included with the standard line of contacts, brushes, discs and molded assemblies is a description of properties and application for selection of alloys. The J.M. Ney Co., Bloomfield, CT

CIRCLE NO. 402

Counters, adapters

Digital counters, angle drive adapters, wire, cable and tubing are illustrated in a 48-page pocket-sized catalog. The catalog contains engineering drawings, prices and a new order numbering system for all ENM standard products. ENM Co., Chicago, IL

CIRCLE NO. 403

Power transformers

A 12-page catalog covers power transformers, audio transformers, transistors, miniature audio units and dc power supplies. Triad-Utrad, Huntington, IN

CIRCLE NO. 404

μ C programming course

A four-page brochure contains a description and outline of Modu-Learn, a complete home-study course in programming for microcomputers. Logical Services, Mountain View, CA

CIRCLE NO. 405

Q. How do you resolve two signals spaced 1 Hz apart at 2 MHz?

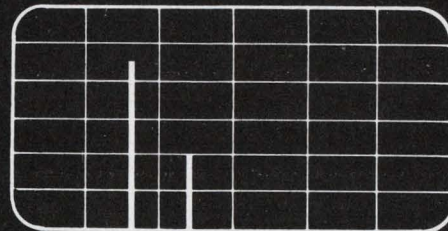

A. With EMR's new Model 1520 Digital Spectrum Translator and Model 1510-03 Digital Real-Time Spectrum Analyzer.

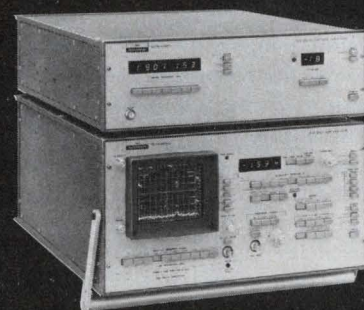

Why go partway in analyzing data? Get the resolution/performance edge of our Model 1510-03 Digital Real-Time Spectrum Analyzer, then go it one better. Enhance frequency resolution still more by adding the Model 1520 Digital Spectrum Translator to concentrate the full resolution of the Analyzer about a selectable point of interest in the spectrum. For that matter, why stop there? Step up from 25.6 kHz to a full 2 MHz upper frequency limit by adding the optional Model 1521 Range Extension Module, too!

Other features of the unequalled 1520 Translator: nine translatable frequency ranges from 25.6 Hz to 10.24 kHz; center frequency selectable in 1-Hz steps and automatic gain ranging — each with an easy-to-read LED display; plus, an automatic frequency sweep. Full-scale out-of-band signal to minimum-detectable in-band signal exceeds 100 dB.

EMR Schlumberger

EMR Telemetry
Weston Instruments, Inc.
Box 3041, Sarasota, Florida 33578
(813) 371-0811

HELP WANTED

THE LIBRARY OF CONGRESS DIVISION FOR THE BLIND AND PHYSICALLY HANDICAPPED

GS-14 \$28,725 - \$37,347 (Only one
GS-15 \$33,789 - \$39,600 Vacancy)

The Library of Congress invites applications for the position of Supervisory Electronics Engineer (Assistant Chief for Production) of the Materials Development Office of DBPH in the Reader Services Department. The incumbent is responsible for supervising all activities related to the design, development and production of cassette and phonograph machines, and, recorded and braille books.

Candidate must have 6 years of experience including extensive experience in the administration of manufacturing operations involving electronic and electro-mechanical equipment for consumer use, plus experience in design, development, testing, production, program planning, program management, quality assurance, and production control procedures. Must have knowledge of human factors engineering and reliability engineering in addition to state-of-the-art techniques in audio frequency electronic circuit design and electronic packaging. Grade level will be determined by the amount of specialized experience.

Educational Requirement: Bachelor's degree in Engineering.

The information stated above only highlights the requirements of the position. For complete details, call Head, Office Services, 202-426-6304, or Recruitment & Placement Office, 202-426-5620.

To apply, send Standard Form 171, (Personal Qualifications Statement) to:

The Library of Congress
10 First Street, SE, (BC/ED/4098)
Recruitment and Placement Office
Washington, D. C. 20540
Civil Service Status Not Required.
Equal Opportunity Employer

Electronic Design

ELECTRONIC DESIGN's function is:

- To aid progress in the electronics manufacturing industry by promoting good design.
- To give the electronic design engineer concepts and ideas that make his job easier and more productive.
- To provide a central source of timely electronics information.
- To promote communication among members of the electronics engineering community.

Want a subscription? ELECTRONIC DESIGN is sent free to qualified engineers and engineering managers doing design work, supervising design or setting standards in the United States and Western Europe. For a free subscription, use the application form bound in the magazine. If none is included, write to us direct for an application form.

If you do not qualify, paid subscription rates are as follows: \$30.00 per year (26 issues) U.S., \$40.00 per year (26 issues) all other countries. Single copies are \$2.00 U.S., \$3.00 all other countries. The Gold Book (27th issue) may be purchased for \$30.00 U.S. and \$40.00 all other countries.

If you change your address, send us an old mailing label and your new address; there is generally a postcard for this bound in the magazine. You will have to requalify to continue receiving ELECTRONIC DESIGN free.

The accuracy policy of ELECTRONIC DESIGN is:

- To make diligent efforts to ensure the accuracy of editorial matter.
- To publish prompt corrections whenever inaccuracies are brought to our attention. Corrections appear in "Across the Desk."
- To encourage our readers as responsible members of our business community to report to us misleading or fraudulent advertising.
- To refuse any advertisement deemed to be misleading or fraudulent.

Microfilm copies are available of complete volumes of ELECTRONIC DESIGN at \$19 per volume, beginning with Volume 1, 1952 through Volume 20. Reprints of individual articles may be obtained for \$3.00 each, prepaid (\$.50 for each additional copy of the same article) no matter how long the article. For further details and to place orders, contact the Customer Services Department, University Microfilms, 300 North Zeeb Road, Ann Arbor, Michigan 48106 telephone (313) 761-4700.

Want to contact us? If you have any comments or wish to submit a manuscript or article outline, address your correspondence to:

Editor
ELECTRONIC DESIGN
50 Essex Street
Rochelle Park, N.J. 07662

GOOD BOOKS ARE HARD TO FIND.



WHY HIDE YOURS?

We are always looking for well-written manuscripts, or book proposals, for works on topics of interest to professional engineers that will advance their understanding of the state of their art.

What have you been working on?

What can we do for each other?

Let me know.

S. WILLIAM COOK
EDITORIAL DIRECTOR



Hayden Book Co., Inc.
50 ESSEX STREET
ROCHELLE PARK, N.J. 07662

Electronic Design

ELECTRONIC DESIGN's function is:

Advertising Sales Staff

Tom W. Carr, Sales Director
Jean Bunfield, Sales Coordinator

Rochelle Park, NJ 07662

Robert W. Gascoigne
Daniel J. Rowland
Thomas P. Barth
50 Essex St.
(201) 843-0550
TWX: 710-990-5071

Philadelphia

Thomas P. Barth
(201) 843-0550

Boston 02178

Gene Pritchard
P.O. Box 379
Belmont, MA 02178
(617) 489-2340

Chicago 60611

Thomas P. Kavooras
Berry Conner, Jr.
200 East Ontario
(312) 337-0588

Cleveland

Thomas P. Kavooras
(312) 337-0588

Los Angeles 90045

Stanley I. Ehrenclou
Burt Underwood
Neil Canavin
8939 Sepulveda Blvd.
(213) 641-6544

Texas

Burt Underwood
(213) 641-6544

San Francisco

Robert A. Lukas
3579 Cambridge Lane
Mountain View, CA 94040
(415) 965-2636

London

Constance McKinley
50 Essex St.
Rochelle Park, N.J. 07662
Phone: (201) 843-0550

Amsterdam, Tokyo, Seoul

Sanders, W. J. M.
Raadhuisstraat 24
Graft-De Ryp, Holland
Phone: 02997-1303
Telegrams: Euradteam-Amsterdam
Telex: 13039-SIPAS

Haruki Hirayama

Electronic Media Service
5th Floor, Lila Bldg.,
4-9-8 Roppongi
Minato-ku, Tokyo, Japan
Phone: 402-4556
Cable: Electronicmedia, Tokyo
Mr. O-kyu Park, President
Dongbo Intl Corp.—
World Marketing
C.P.O. Box 4010
Seoul, Korea
Tel. 76-3910/3911
Cable: DONGBO SEOUL
Telex: EBKOREA K27286

Design Data from Manufacturers

Advertisements of booklets, brochures, catalogs and data sheets. To order use Reader-Service Card (Advertisement)

GIANT FREE CATALOG

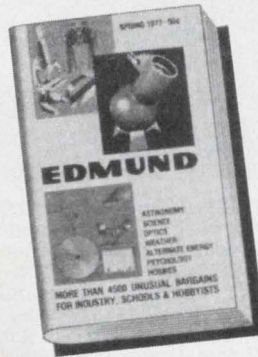

New 164-page catalog! Packed with 1,000's of hard-to-find buys in Optics, Science, Electronics. Loaded with optical, scientific, electronic equipment available from stock. Rare surplus buys. Many "one-of-a-kinds". Ingenious scientific tools. Components galore: lenses, prisms, wedges, mirrors, mounts, accessories. 100's of instruments: pollution test equipment, lasers, comparators, magnifiers, microscopes, projectors, telescopes, binoculars, photo attachments, alternate energy sources. Shop, save by mail! Request free Catalog "DA".

Edmund Scientific Co.

America's Largest Science-Optics-Electronics Mart
300 Edscorp Bldg., Barrington, New Jersey 08007 (609) 547-3488

CIRCLE NO. 171

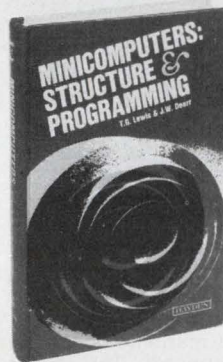

Join the MINI explosion MINICOMPUTERS: Structure and Programming,

by T. G. Lewis and J. W. Doerr.

This valuable text makes an outstanding introductory guide to both the hardware and software of today's minicomputers. Its broad coverage includes assembly language, machine architecture, and small machine algorithms. Especially valuable are its chapters on communications, peripherals, and microprogramming—chapters not usually available in introductory books. Section I (Preliminaries) covers number conversion, codes, and provides a basic review. Section II (Minicomputing) defines a minicomputer and includes an exceptional chapter on computer organization communications and peripheral devices. Section III (Software Engineering) covers the programming of the PDP-11 minicomputer and algorithms for small machines and ends with a chapter on microprogramming. #5642-7, 288 pp., \$12.95. Circle the Info Retrieval No. to order your 15-day exam copy. When billed, remit or return book with no obligation.

Hayden Book Company

50 Essex St., Rochelle Pk., N.J. 07662

CIRCLE NO. 172

Play it safe with

INTEGRITY AND RECOVERY IN COMPUTER SYSTEMS,

by T. K. Gibbons, National Computing Centre, Ltd.

Here is the guidebook which places at your fingertips all the techniques and strategies you need for locating and correcting errors and failures and for re-establishing complete system integrity and reliability as quickly as possible. The fundamentals and terminology of system reliability are discussed. A complete catalog of possible system errors and failures tells how to quickly locate each. And all the up-to-date recovery techniques and strategies are covered, including valuable advice for reconstructing and restarting the data base after different kinds of minor and major failures occur. #5454-8, 144 pp., \$9.95. Circle the Info Retrieval No. to order a 15-day exam copy. When billed, remit or return book with no obligation.

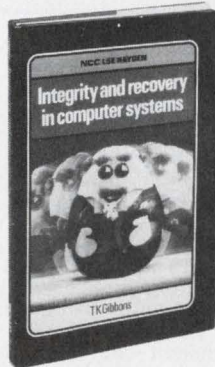

Hayden Book Company

50 Essex St., Rochelle Pk., N.J. 07662

CIRCLE NO. 173



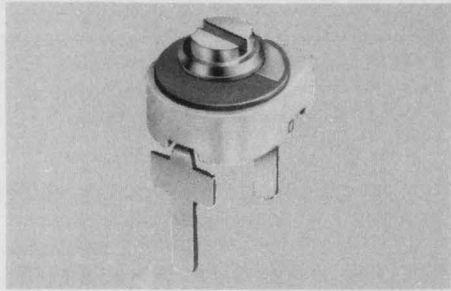

MINIATURE CERAMIC TRIMMER CAPACITORS 9371 series of ceramic trimmer capacitors are compact, economical and rugged. They are 50% smaller than other trimmers of this type yet provide high capacitance values. Available in 4 capacitance ranges, 1.5 to 4, 3.0 to 10, 3.5 to 18 and 5.0 to 25 pf with Q's > 300 at 10 MHz. They have an overall diameter of .225" with .215" above board height. JOHANSON MANUFACTURING CORPORATION, Rockaway Valley Road, Boonton, N.J. 07005 201-334-2676
TRIMMER CAPACITORS 181

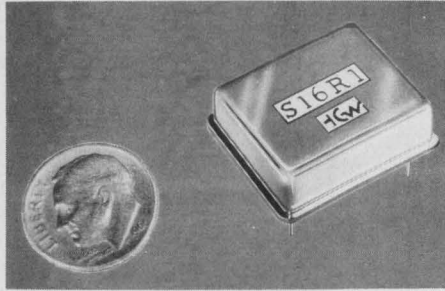

HERMETICALLY SEALED ANALOG OSCILLATOR starts easily at any fixed frequency from 500 kHz to 6 MHz, frequency accuracy $\pm .001\%$ 0° to 50° C to $\pm .005\%$ -55° C to +125° C; non-cumulative aging ± 5 ppm for first 30 days, then ± 1 ppm/month, drives 10 TTL Gates, I sink 16 ma, Logic One $\geq 2.4V$, Logic 0 $\leq 0.4V$, duty cycle 51/49, 49/51 supply voltage 5 Vdc $\pm 5\%$, 40 ma maximum, measures 0.98" x 0.8" x 0.29". Availability 6 wks ARO. CONNOR-WINFIELD CORP, West Chicago IL 60185 (312) 231-5270
OSCILLATOR 184



STURDILITE ELECTRONIC WORK STATIONS designed to meet exacting requirements for electronic testing, production and assembly. Electrical outlets available in almost any quantity and in convenient locations. Free catalog. Also, free planning service is available. Angle Steel Div., Kewaunee Scientific Equipment Corporation, Plainwell, Mich. 49080 Phone (616) 685-6831
TECHNICAL WORK STATIONS 187

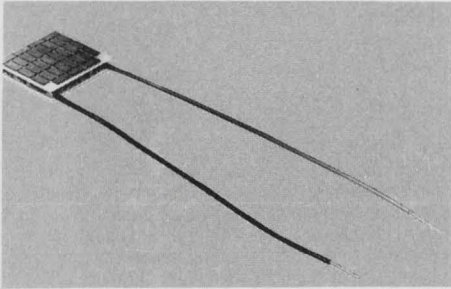

THERMOELECTRIC MODULE, a remarkable value for only \$20 (ppd.), can be used in water coolers, small refrigerators, hot and cold temperature sources, spot cooling for electronic components and other applications. Operates at 3.5 VDC, 8.5 amps, ΔT Max at Qc Zero is 60°C, Th is 50° C, Qc Max. at ΔT Zero is 19 watts, Max. Op. temp is 100° C. Price includes Thermoelectric handbook. CAMBION, 445 Concord Avenue, Cambridge, MA 02138.
THERMOELECTRIC MODULE 182

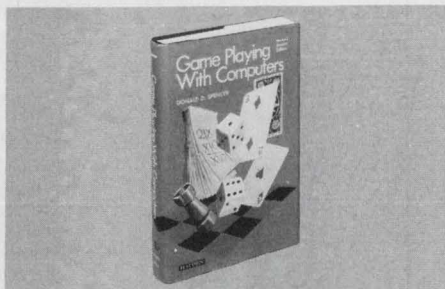

GAME PLAYING WITH COMPUTERS, Revised Second Edition, by Donald D. Spencer. This volume presents over 70 games, puzzles, and mathematical recreations for a digital computer. The reader will also find brand-new "how to" information for applying mathematical concepts to game playing with a computer. #5103-4, 320 pp., \$16.95. Circle the Info Retrieval Number to order your 15-day exam copy. When billed, remit or return book with no obligation. Hayden Book Co., 50 Essex St., Rochelle Park, N.J. 07662.
GAME-PLAYING GUIDE 185

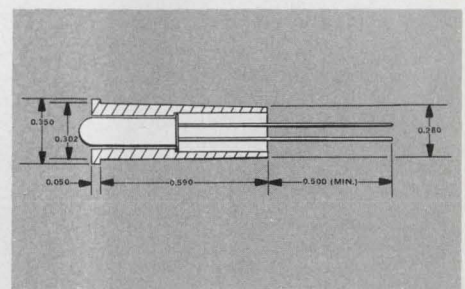

THE LOWEST COST LED LAMP ASSEMBLY In The Industry. Imtronics Light Emitting Diode Lamp Assemblies, consisting of a durable thermoplastic holder and LED are available with either white or black holders and with a variety of lamp colors. Rugged construction and wire wrappable leads allows for easy installation & high reliability, low power consumption, compatibility with ICs and long life ideal in many applications. IMTRONICS INDUSTRIES LTD., 813 2nd St., Ronkonkoma, N.Y. 11779 (516) 981-3434
LED LAMP ASSEMBLY 188



MULTI-TURN ABSOLUTE ENCODER ± 1 part in 100,000 system accuracy—Electro-Magnetic Transducer +5 digit LED Display + BCD, Binary, and DC output — 10, 64 or 100 turns — adjustable scale factor (0 to 999,999) — Hi noise immunity — zero offset — unambiguous cross-overs. Units less than \$995.00/axis. Computer Conversions Corporation, East Northport, N.Y. 11731 — (516) 261-3300
MULTI-TURN ABSOLUTE ENCODERS 183

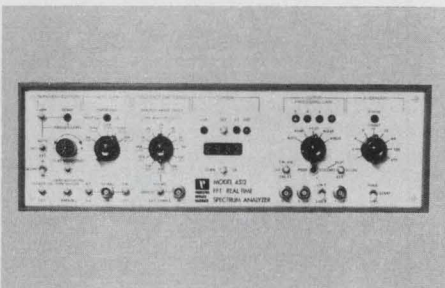

Princeton Applied Research announces the Model 4513 FFT Real Time Spectrum Analyzer. The magnitude spectrum is available with 1024 lines of resolution spanning dc-10 Hz to dc-20 kHz, in twelve ranges. Transient capture and spectrum averaging modes are standard features. Both the temporal signal and spectrum can be displayed simultaneously. A four digit LED display provides direct readout of frequency and amplitude. Price: \$8150 F.O.B. Princeton. Applied Research Corp., Box 2565, Princeton, NJ 08540
FFT REAL TIME SPECTRUM ANALYZER 186



NEW! Solid state digital timer: The new electronic digital timer measures time in hours, minutes and seconds. - Time measurement, forward - Time measurement, backward - 24- /100 hours operation - High recycling accuracy - quartz time base - Easy reading - Incorporated powerpack - Panel mount case 72 x 72 x 160 mm. Request literature for complete details. N. ZIVY & CIE SA., Box 412
DIGITAL TIMER 189

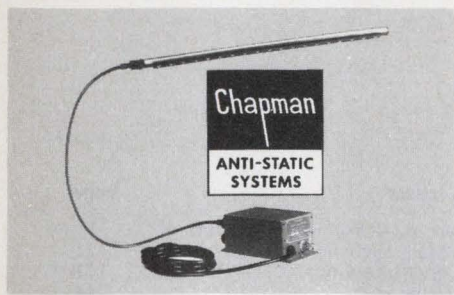

ANTI-STATIC SYSTEMS FOR PRINTERS, OCR COM and other machines. Static causes rapidly moving paper and film to jam. . . cause arc tracks on undeveloped film. . . attract and hold dust to photographic negatives causing imperfections on printed circuit boards. Numerous products, of interest to both OEM and user, are detailed in new 32 page catalog to solve these problems quickly, reliably and economically. Chapman Anti-Static Div., Portland Co., 58 Fore St., Bx 427, Portland, ME 04112. (207) 773-4726

ANTI-STATIC SYSTEMS 190



MAGNETIC SHIELDING Take advantage of Eagle's 23-year background in shield design and production. Custom and standard models. Full service includes design, engineering, fabrication, heat treating, finishing, testing. Also wide selection of sheet and foil so you can form your own shields. For helpful design and cost data, request Bulletin E-77. Eagle Magnetic Co., Inc., Box 24283, Indianapolis, IN 46224, 317-297-1030.

MAGNETIC SHIELDING 193

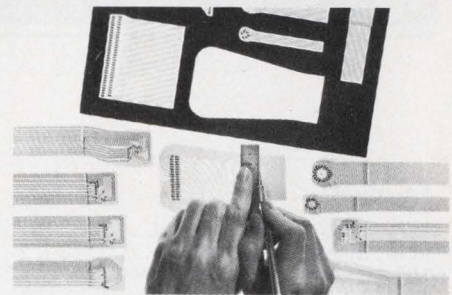

PROTOTYPE YOUR OWN FLEXIBLE CIRCUITS Exacto knife, soldering iron, plus our kit make all circuits shown—and more! Kit includes sheet of 1 oz. copper conductors on 1 mil polyimide film, plus matching sheets with about 15 connector patterns. 100's of combinations possible. . . . Easy instructions, parts list, dimensional drawings included. Flexible Circuit Kit, \$25 from stock. Rogers Corporation, Chandler, AZ 85224 (602) 963-4584. (EUROPE: Mektron NV, Ghent Belgium; JAPAN: Nippon Mektron, Tokyo)

FLEXIBLE CIRCUITS KIT 196



MINICOMPUTERS: Structure and Programming, by T. G. Lewis and J. W. Doerr. An introduction to computer science using small computers, this book thoroughly covers all the essentials needed to understand and use minicomputers: assembly language, machine architecture, and small machine algorithms. #5642-7, 288 pp., \$12.95. Circle the Info Retrieval Number to order your 15-day exam copy. When billed, remit or return book with no obligation. Hayden Book Co., 50 Essex St., Rochelle Park, N.J. 07662.

MINICOMPUTERS TEXT 191

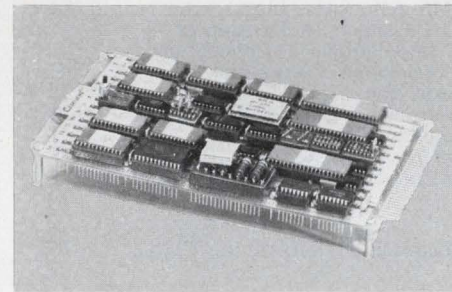

MICROPROCESSOR BOARD FOR MOTOROLA M6800 EVALUATION CHIP SET. \$197.50 from CMBION distributors. Pre-wired board saves hours interconnecting M6800 evaluation kit. Wire-Wrap® tool and pre-cut wires for circuit changes included plus circuitry and components to interface with teletype machine, pre-wired sockets for three more MC6810L, connections for 12 more IC's, instructions and hardware. Cambridge Thermionic Corp., 445 Concord Ave., Cambridge, MA 02138.

MICROPROCESSOR BOARD 194

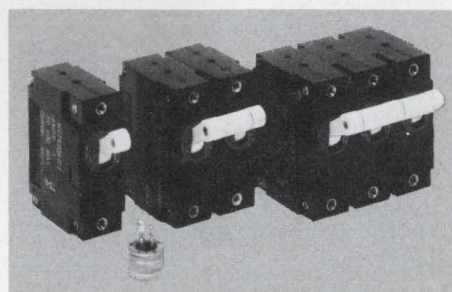

Mini-Mag Circuit Breakers. Compact magnetic-hydraulic units Trip times from instantaneous to .16 sec. according to Trip curve selected. Temperature stable from -49° C to +85° C. Trip-free mechanism allows contacts to open even if manually held in reset. 250 VAC and 50 VDC maximum operating voltages. New code designations allow specification of units to your needs. Potter & Brumfield Division AMF Inc., Princeton, IN 47671. 812-386-1000.

CIRCUIT BREAKERS 197



Free New '77 catalog contains over 34,500 quality power supplies from the world's largest manufacturer, Power/Mate Corp. Power Supplies for every application including submodulars, open frame, variorated, encapsulated, laboratory & system. All units UL approved and meet most military and commercial specs for industrial and computer uses. Power/Mate Corp., 514 S. River St., Hackensack, NJ 07601 (201) 343-6294

POWER SUPPLIES 192

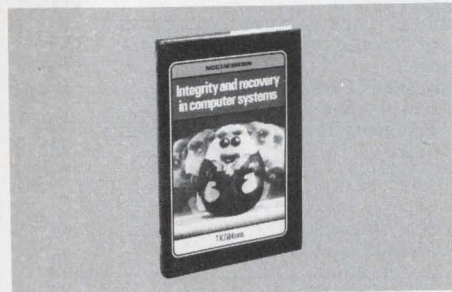

INTEGRITY AND RECOVERY IN COMPUTER SYSTEMS, by T. K. Gibbons. Here is a step-by-step guidebook that places at your fingertips all the techniques and strategies you need for locating and correcting errors and failures and for re-establishing complete system integrity and reliability as quickly as possible. #5454-8, 144 pp., \$9.95. Circle the Info Retrieval Number to order your 15-day exam copy. When billed, remit or return book with no obligation. Hayden Book Co., 50 Essex St., Rochelle Park, N.J. 07662.

INTEGRITY & RECOVERY 195



MAY I HELP SPEED LEAD BENDING OPERATIONS? Cut costs by 50%! Fast, exact, thumbwheel control adjusts to precise measurements. Match pointers with eyelet holes in circuit boards by adjusting knurled wheel with thumb, automatically spacing bends for insertion of component into boards. All axial lead components accommodated. From 1/2" x 1 1/2" long with max. distance between inside of bends of 1.725". Harwil Co., 1548 17th Street, Santa Monica, CA. 90404. (213) 829-2310

COMPONENT LEAD BENDER 198



FREE Fiber Optics Catalog

Features the complete AO line of fiber optics products—from Inspection Fiberscopes and Light Guides to Illuminators, Image Conduits, Faceplates and Custom Components. Includes the four newest remote inspection fiberscopes now available.

Describes the principle, technology and techniques used to make flexible light and image transmissions a proven, practical fact. Write today for your FREE copy of the AO Fiber Optics catalog to American Optical Corporation, Fiber Optics Division, Southbridge, Mass. 01550.

AO
American
Optical

CIRCLE NUMBER 114

goes anywhere

Battery servo recorder: Get yours in 72 hours

Here's the most versatile, portable, self-contained servo recorder you can buy for field use in studies, monitoring, maintenance—any application including those remote from power lines. This compact battery Miniservo® sets up quick: switch-select spans of 1, 5, 10, 50, 100 and 500 mVDC and 1, 5, 10, 50, and 100 VDC. Zero settable to anyplace on the 100 mm Z-fold chart. 8 chart speeds from 6 cm/hr to 20 cm/min. Throwaway ink/pen cartridge for smooth, dependable writing. Simple adapter for AC operation and battery charging. Order Stock No. S22243-1A. Or request Bulletin F613 from Esterline Angus Instrument Corporation, P.O. Box 24000, Indianapolis, IN 46224. Tel: 317-244-7611.

ESTERLINE ANGUS
AN ESTERLINE COMPANY

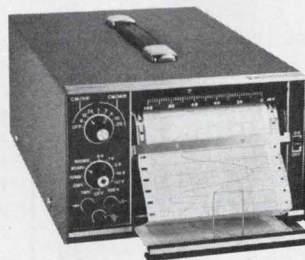

Miniservo® Self-contained Recorder

CIRCLE NUMBER 115

INGENUITY

in creating Stepper Motors.

Like our Model LMS: 7½° step angle. Torque ranges to 10 oz. in. at 75 P.P.S. Start-stop rates of 450 steps/second. Slew capability to 1100 steps/second.



And that's not all you get at

MOLON

3737 Industrial Ave., Rolling Meadows, Ill. 60008
Phone: (312) 259-8700

CIRCLE NUMBER 116

ELECTRONIC DESIGN 1, January 4, 1977

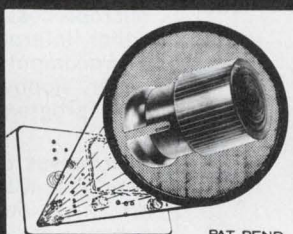

CLIPLITE™
COMBINATION LENS AND MOUNTING DEVICE FOR T 1 3/4 LED

REQUIRES NO TOOLS AND....

INSTALLS IN 6 SECONDS

THE CLIPLITE COMBINES THE BENEFITS OF THE PRESENT LED DISPLAY PANEL MOUNTING METHODS AND ELIMINATES THEIR DEFICIENCIES

SNAP CLIPLITE

SIMPLE TWO-STEP INSTALLATION

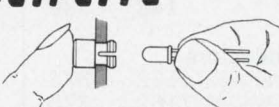

INSERT LED

AVAILABLE IN TRANSPARENT RED - GREEN - AMBER - CLEAR & YELLOW
ORDER YOUR TRIAL SAMPLE TODAY
Special Pricing for Trial Order Only

VISUAL COMMUNICATIONS COMPANY
P.O. BOX 986 EL SEGUNDO, CALIFORNIA 90245 (213) 822-4727

PLEASE SHIP: 100 CLIPLITES \$10.00 LITERATURE

NAME _____ COMPANY _____

ADDRESS _____

CITY _____ STATE _____ ZIP _____

CIRCLE NUMBER 117

Product Index

Information Retrieval Service. New Products, Evaluation Samples (ES), Design Aids (DA), Application Notes (AN), and New Literature (NL) in this issue are listed here with page and Information Retrieval numbers. Reader requests will be promptly processed by computer and mailed to the manufacturer within three days.

Category	Page	IRN	Category	Page	IRN	Category	Page	IRN
Components			DPMs			Packaging & Materials		
alarm, sound	156	363	generators	162	102	aluminum cases	153	85
capacitors	74	44	IC tester	145	325	cages	165	109
capacitors	77	45	LSI tester	144	320	coating, hermetic	154	356
capacitors, trimmer	161	101	PROM programmer	145	326	connection systems	139	73
circuit breakers	43	28	pulse generator	32	23	connectors	III	283
coils, relays, transformers	89	53	recorder	159	95	connectors, card-edge	152	84
crystals, quartz	161	100	rental instruments	26	20	connectors, PC	41	27
current limiter	106	59	servo recorder	173	115	containers, plastic	152	350
displays	85	50	signal generator	20	14	coolers	159	96
fiber-optics catalog	173	114	spectrum analyzer	167	111	copper gaskets	135	72
indicator, audio	163	104	volt ohmmeter	159	94	DIP sockets	32G	269
indicator, impact	156	364	Integrated Circuits			enclosures	145	78
motors	103	58	converters, a/d	141	305	filter cable	153	86
motors, gearmotors	98	56	converter, d/a	141	301	heat sink	154	357
photodetectors	119	65	decoder	141	304	hooks	157	91
pulse transformers	156	362	displays	1	2	interconnection system	5	4
relay	155	358	dividers, frequency	142	309	jumpers	165	108
relays	57	35	driver, LED	141	306	magnetic shields	154	88
relays, solid-state	2	3	HiNIL	86	51	PC board	152	347
relays, solid-state	156	361	op amp, high voltage	141	303	PC boards	152	348
resistor ladder network	155	360	op amps, power	129	69	sockets, DIP	107	60
resistors	9	351	op amps, quad	31	22	sockets, IC	152	349
resistors, wirewound	47	30	PROM, μ V erasable	142	308	terminal feedthrough	152	346
solenoids, tubular	32H	154	PROMs	29	21	tool, wrapped-wire	157	92
switches	13	10	PROMs	131	70	Power Sources		
switches	63	36	RAMs, 8 k & 2 k	141	302	ac surge simulator	158	365
switches	113	271	regulators, voltage	142	307	converter, dc/dc	161	372
switches	155	359	switches, analog	32E	153	crowbar, dc	162	103
switches, PB	150	83	Microprocessor Design			power source, 800 Hz	158	366
switches, thumbwheel	146	79	editor/interpreter	76	508	power supplies	6	5
trimmers	32C	152	microcomputer	78	509	power supplies	32A	151
Data Processing			tester, floppy-disc	75	507	power supplies	149	82
adapter, card punch	147	332	tool, programming	80	510	power supply	161	371
breadboard sys., intelligent	84	49	Microwaves & Lasers			power supply	158	368
calculator printing	146	328	amplifier, K-bd	165	382	power supply	160	99
calculator, printing	148	333	amplifier, low-noise	164	379	power supply	160	370
cassette transport	146	327	detector, broadband	164	378	power supply, dc MIL	158	367
computer	37	25	generators, rhythm	16	12	remote power switch	160	369
computer peripherals	71	42	ICs	115	64	new literature		
CRT monitor, data	148	335	mixer, double-balanced	164	380	barrier blocks	167	399
disc drive	147	331	mixer, 4-diode	165	381	contacts brushes, discs	167	402
memory board	146	330	relay link	164	377	counters, adapters	167	403
memory, fixed head	148	334	Modules & Subassemblies			encoded logic switch	167	396
rf links	147	80	active filters	150	340	power supplies	167	401
switch, modem	146	329	amplifier	96	54	power transformers	167	404
timer, PC board	148	336	amplifier	149	338	radar calibration	167	397
Discrete Semiconductors			amplifier, power	144	77	switches, keyboards	167	395
Darlingtons, power	162	374	amplifier, rf	150	341	thermistors	167	398
diode, Schottky	162	375	amplifier, s/h	150	339	tools	167	400
diodes, Schottky	79	46	computer operator	151	343	μ C programming course	167	405
display, LED	162	373	controller, industrial	151	345	application notes		
gas sensor, combustible	162	376	converter, d/a	151	344	a/d and d/a parameters	166	383
transistors	64	37	converter, dc/dc	143	76	fhp motors, gear motors	166	384
transistors	97	55	converters, a/d	166	110	line printers	166	388
Instrumentation			encoders	82	47	microcomputer		
analyzer	144	323	filters and oscillators	163	105	assemblies	166	386
CB tester	144	322	inertial reference system	158	93	transformers	166	387
C-meter	133	71	interrupter modules	7	6	troubleshooting instru-		
counters	142	75	op amp	150	342	ments	166	385
DMM	145	324	printer	154	87			
DMMs	15	142	transformer, Scott-T	149	337			
DMMs	144	321						
DMMs	148	159						

Q

WHICH OF THE
ANNUALS DO
ELECTRONICS ENGINEERS
CONSULT MOST?

A

Electronic Design's
GOLD BOOK

83%

OF THE ENGINEERS WHO RESPONDED TO
A TECHNICAL TRENDS ANALYSTS SURVEY SAY
THEY CONSULTED THE GOLD BOOK
WITHIN THE PAST MONTH

(Survey date: February, 1976)

IF IT'S ELECTRONIC...IT'S IN THE
GOLD BOOK

(91,000 copies of the 1976/77 edition are now off the presses
and are being used throughout the U.S.A. and overseas!)



1977 TOP TEN CONTEST RULES

Reader Contest

**PICK THE TOP TEN ADVERTISEMENTS IN THIS ISSUE...
WIN A WINDJAMMER CRUISE FOR TWO...\$1,000 CASH...100 PRIZES IN ALL.**

Examine this issue of *Electronic Design* with extra care. Pick the ten advertisements that you think your fellow engineer-subscribers will best remember having seen. List these ten advertisements on the special entry form bound in at right. (Be sure to check the box marked "Reader Contest.")

This year your selections will be measured against the ten ads ranking highest in the "Recall Seen" category of Reader Recall, *Electronic Design's* method of measuring readership — see item 6.

In making your choices do not include "house" advertisements placed by *Electronic Design* or Hayden Publishing Company, Inc. (such as this ad describing the contest). Don't miss your chance to be a Top Ten Winner! All entries must be postmarked no later than midnight, February 28, 1977. Winners will be notified in March, 1977.

READER CONTEST RULES

1. Enter your *Top Ten* selections on the entry blank provided, on the Reader Service Card or on any reasonable facsimile. Be sure to indicate the name of the advertiser and *Information Retrieval Number* for each of your choices. Do not use page number. (Ads placed by Hayden Publishing Company in *Electronic Design* should not be considered in this contest.)
2. No more than one entry may be submitted by any one individ-

ual. Entry blank must be filled in completely, or it will not be considered. The box on the entry blank marked "Reader Contest" must be checked. *Electronic Design* will pay postage for official entry blanks only.

3. To enter, readers must be engaged in electronic design engineering work, either by carrying-out or supervising design engineering or by setting standards for design components and materials.
4. No cash payments, or other substitutes, will be made in lieu of any prize, (except the \$1,000 prize).
5. Contest void where prohibited or taxed by law. Liability for any taxes on prizes is the sole responsibility of the winners.
6. Entries will be compared with the "Recall Seen" category of Reader Recall (*Electronic Design's* method of measuring readership). That entry which in the opinion of the judges most closely matches the "Recall Seen" rank will be declared the winner.
7. In case of a tie, the earliest postmark will determine the winner. Decisions of *Top Ten* contest judges will be final.

**FOR A COMPLETE DESCRIPTION OF PRIZES
FOR BOTH READER AND ADVERTISER CONTESTS
SEE PAGES 18 AND 19**

USE SPECIAL ENTRY BLANK ON READER SERVICE CARD

(bound in back of this issue)

Advertiser Contest

**PICK THE TOP TEN ADVERTISEMENTS IN THIS ISSUE... WIN A WINDJAMMER CRUISE FOR TWO
... \$1,000 CASH... COLOR TV... DIGITAL WRISTWATCH.**

There's a separate contest open to all marketing and advertising personnel in companies, and to advertising agencies.

Examine this issue of *Electronic Design* with extra care. Pick the ten advertisements that you think will be best SEEN by *Electronic Design's* readers. List these ten advertisements on the special entry blank on the Reader Service Card of this issue. (Be sure to check the box marked "Advertiser Contest".)

FREE RERUNS FOR THE TOP TEN ADS

In addition to valuable contest prizes, all ads that place in the Top Ten will be given free reruns. These free reruns will be made only from existing plates or negatives. If the advertisement qualifying for a free rerun is an insert, the winner may run up to a two-page spread from existing plates or negatives in up to 4-colors. Hayden Publishing Company, Inc. reserves the right to schedule reruns at its discretion.

ADVERTISER CONTEST RULES

1. All rules for the Reader Contest will similarly apply for this contest, with two exceptions: readers engaged in electronic design engineering work, as defined in the reader contest rules, are not eligible to participate in this special contest. The box on the entry blank marked "Advertiser Contest" must be checked.
2. Entrants in this contest may use the official reader contest entry blanks or any reasonable facsimile.
3. This special contest is open to marketing and advertising personnel only at all manufacturing companies and advertising agencies whether or not their companies or agencies have an advertisement in the contest issue.

**FOR A COMPLETE DESCRIPTION OF PRIZES
FOR BOTH READER AND ADVERTISER CONTESTS
SEE PAGES 18 AND 19**

USE SPECIAL ENTRY BLANK ON READER SERVICE CARD

(bound in back of this issue)

Situation Wanted:

Name—Amphenol® 97 Series connector. For consumer, industrial, business equipment. And more. Here's the old pro of standard circular power connectors. It's for service from 250 to 4200 VDC (200 to 3000 VAC, RMS) and wire gauges from 4 to 16. So 97 Series connectors are ideal for all kinds of equipment—TV, computers, machine tools, communications, you-name-it.

And still more qualifications. Including MIL-C-5015. And our pre-aligned non-rotating contacts that mean quick, easy soldering. The 97 Series is also built strong to work hard. With diallyl phthalate insert material (it's highly stable at high temperatures). Molded barriers between contacts for higher voltage ratings. And a few more features you'll want to find out about.

Literally hundreds of configurations. Take your pick of inserts—for a number of wires, all of the same gauge. Or for lots of wire, all of different gauges. And choose the receptacle you want: wall, cable, or box. And the plug you want: straight, quick-disconnect, angle, or panel-mount.

Availability: Whenever you're ready. Amphenol 97 Series connectors are available now for off-the-shelf delivery from your Amphenol Industrial Distributor. Call him soon. Or to find out how Amphenol 97 Series connectors can be tailor-made to match your specific application, just write or call: Bob Ashley, Amphenol Connector Systems, Bunker Ramo Corporation, 900 Commerce Drive, Oak Brook, Illinois 60521. (312) 986-3763.



**HEAVY EXPERIENCE
SEEKS CHALLENGE
REASONABLY PRICED**

The right idea
at the
right time.

AMPHENOL Connector Systems **BUNKER RAMO**®

RCA announces...

COS/MOS-B. The new standard in CMOS.

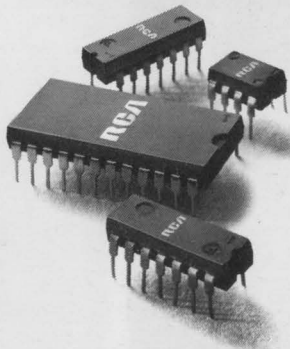

COS/MOS-B is a comprehensive series of 130 high-voltage digital ICs which set new performance standards—yet conform fully to all JEDEC specs. This is what COS/MOS-B offers:

Unprecedented performance

- 20-volt rating
- 100% tested for quiescent current at 20 V
- Maximum input current (leakage) of $1 \mu\text{A}$ at 18 V over full package-temperature range; 100 nA at 18 V at 25°C
- Standardized symmetrical output characteristics
- 5, 10 and 15 V parametric ratings
- Noise margin (over full package-temperature range): 1 V at $V_{DD} = 5 \text{ V}$; 2 V at $V_{DD} = 10 \text{ V}$; 2.5 V at $V_{DD} = 15 \text{ V}$

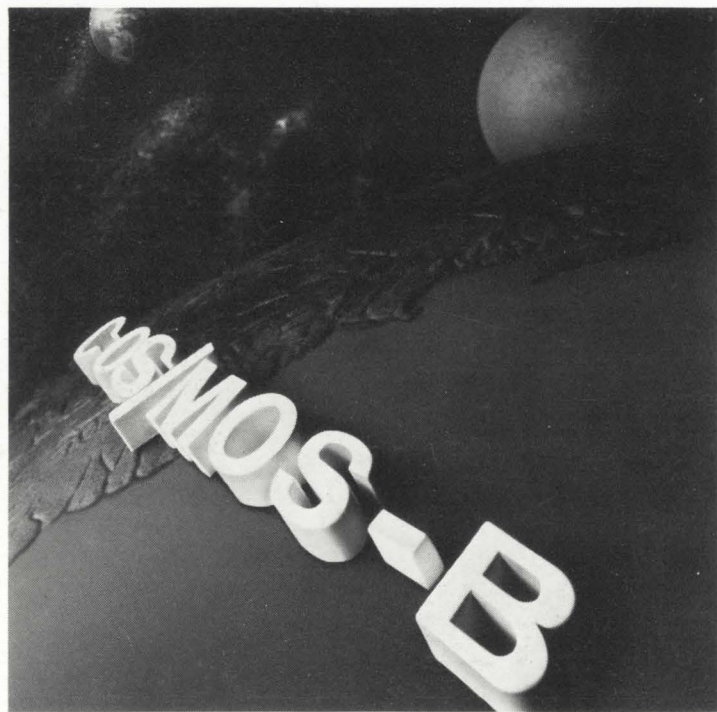

New design options

You can either take advantage of these higher ratings—or gain some extra insurance by electing not to design to maximum limits.

Add all this performance and flexibility to the inherent advantages of COS/MOS, plus the multiple-source advantage that comes from conformance to JEDEC specs, and you have an IC product line in a class by itself.

The RCA COS/MOS-B product guide gives you all the basic information you need to move into your new high-voltage design. For your copy, contact your RCA Solid State distributor. Or RCA.

Write: RCA Solid State,
Box 3200, Somerville,
NJ 08876; Sunbury-on-
Thames, Middlesex
TW16 7HW, England;
Ste.-Anne-de-Bellevue,
Quebec, Canada; Fuji
Bldg, Tokyo, Japan.

RCA

RCA. First house in CMOS.

CIRCLE NUMBER 284