

Electronic Design

FOR ENGINEERS AND ENGINEERING MANAGERS

APRIL 12, 1977

The fastest spectrum analyzer lets you work out to 60 GHz. At frequencies to 12 GHz, you can look at spectra with 30-Hz resolution — the best you can get.

Specs for residual FM and noise are tops, too. With uP control and digital storage, you get no-flicker, automatic operation. For more details, turn to p. 183.



Look inside our new Precision Pot...

ONE-PIECE CONTACT

MOLDED-IN
TERMINALS

SILVER
DEPOSITION

For reliability, performance and savings.

Since our new potentiometer looks like others on the outside, here's the inside story... that's where Bourns makes the difference:

The total construction of this new 1% linearity, conductive plastic, single-turn pot is ingeniously simple. Our one-piece precious metal contact delivers tens-of-thousands more trouble-free revolutions than the typical failure-prone two-piece type. Then, our exclusive silver deposition between the molded-in terminals and the element guarantees a connection that won't migrate or weaken during installation and operation. And, proven techniques like low temperature firing and thermal swaging replace unreliable solder, conductive epoxy and silver cement throughout the potentiometer. No one matches our performance, and our price is just as eye opening — less than \$6.00 in production quantities.

With fewer parts, unique packaging and solid connections, the result is obvious — the most reliable precision potentiometer you can specify for the price.

The 7/8" diameter model is available in either bushing (Model 6637) or servo mount (Model 6537) styles. The larger 1 1/8" diameter bushing mount (Model 6657) also offers a full line of non-linear functions... all with the same outstanding design and price advantages.

Take a look inside any other precision pot and you'll see why Bourns makes the difference.

Send for our new catalog today for complete details.

TRIMPOT PRODUCTS DIVISION, BOURNS, INC., 1200 Columbia Avenue, Riverside, California 92507,
Telephone (714) 781-5200 — TWX 910 332-1252.

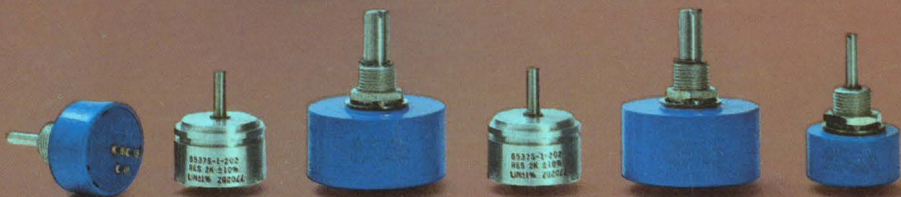

Wavetek's just put new life into the function/pulse generator business. Our Model 145 function generator not only doubles as a pulse generator, it does so without sacrificing any features.

The Model 145 is a 20 MHz function generator with sine, square, triangle, and DC output to 30V peak-to-peak.

Turn the function switch to pulse and you have a full-fledged pulse generator

with independent pulse width and delay control, plus single and dual pulse outputs. In addition to the 30V output, you get simultaneous ECL and TTL outputs.

Whether you use it as a pulse generator or a function generator, it offers triggering and gating manually or remotely, and external voltage control of frequency/period for frequency-shift keying and FM operation.

So if you've been coming down with a case of "should I buy a pulse or function generator-itis," the cure is obvious: Wavetek's Model 145. Just \$895. Circle our reader service number for details.

WAVETEK, P.O. Box 651,
San Diego, CA 92112.
Phone (714) 279-2200,
TWX 910-335-2007

WAVETEK®
CIRCLE NUMBER 2

**"Doctor, this
function
generator
has a
pulse!"**

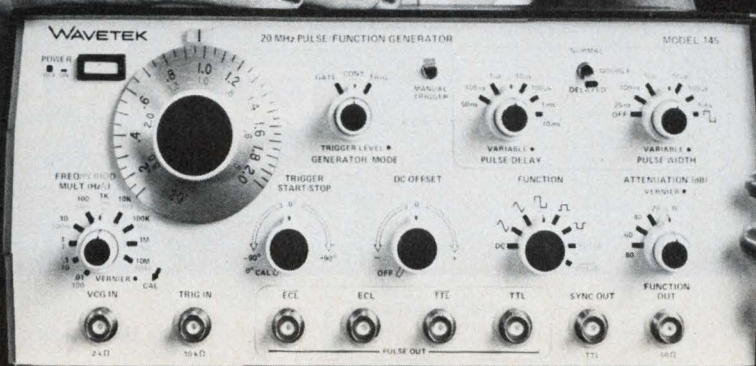

The most significant price breakthrough in DOUBLE-BALANCED MIXERS!

...from Mini-Circuits of course!

\$2.95
500 pieces
\$3.95 (10-49)



For demanding industrial and commercial applications, where low-cost and high-performance are critical; model SBL-1 will fill your need.

Don't let the low price mislead you. As the world's number one manufacturer of double-balanced mixers, Mini-Circuits' has accumulated extensive experience in high-volume production and testing, a key factor in achieving a successful low cost/high performance line of products.

The tough SBL-1 covers the broad frequency range of 1-500 MHz with 6 dB conversion loss and isolation greater than 40 dB. Only well-matched, hot-carrier diodes and ruggedly constructed transmission-line transformers are used. Internally, every component is bonded to the header for excellent protection against shock, vibration and acceleration. Here are some of the steps taken to ensure quality: Every SBL-1 is RF tested two times, every solder connection is 100 per cent inspected under a high power microscope, all transformer leads are double-wrapped, and all components are rated for more than + 85 °C operation. Of course, our one-year guarantee applies to these units.

Model SBL-1,
metal case, non hermetic-seal

Frequency Range, MHz
LO 1-500 RF 1-500 IF DC-500

Conversion Loss, dB	Typ.	Max.
One Octave from Band Edge	5.5	7.5
Total Range	6.5	8.5

Isolation, dB	Typ.	Min.
Lower Band Edge to LO-RF	50	35
One Decade Higher LO-IF	45	30
Mid Range LO-RF	45	30
LO-IF	40	25
Upper Band Edge to LO-RF	35	25
One Octave Lower LO-IF	30	20

Signal, 1dB Compression Level +1dBm
Impedance, All Ports 50 ohms
Electronic Attenuation Min (20mA) 3dB

World's largest manufacturer of Double-Balanced Mixers

Mini-Circuits

MINI-CIRCUITS LABORATORY A Division of Scientific Components Corp.

837-843 Utica Avenue, Brooklyn, NY 11203 (212) 342-2500 Int'l Telex 620156 Domestic Telex 125460

International Representatives: AUSTRALIA: General Electronic Services, 99 Alexander Street, New South Wales, Australia 2066. ENGLAND: Dale Electronics, Dale House, Wharf Road, Farnley Green, Camberley, Surrey. FRANCE: S. C. I. E. - D. I. M. E. S., 31 Rue George, Sand 91120 Palaiseau, France. GERMANY, AUSTRIA, SWITZERLAND: Industrial Electronics (IMB), Klüberstrasse 14, 6000 Frankfurt, Main, Germany. ISRAEL: Velectronics Ltd., 69 Gordon Street, Tel Aviv, Israel. JAPAN: Denshi Kaisha Ltd., Epoch Building, 4-1-1 Chome, Hamamatsucho, Minato-ku, Tokyo. EASTERN CANADA: B. D. Hummel, 2224 Maynard Avenue, Ulica, NY 11502 (415) 736-7821. NETHERLANDS, BELGIUM, LUXEMBOURG: Cimex, Veldweg 11, Hattem, Holland. NORWAY: Datamatik AS, Ostensjoveien 62, Oslo 6, Norway.

U.S. Distributors: NORTHERN CALIFORNIA: Cain White & Co., Fulthill Office Center, 105 Fremont Avenue, Los Altos, CA 94022 (415) 948-6533. SOUTHERN CALIFORNIA, ARIZONA: Crown Electronics, 11440 Collins Street, No. Hollywood, CA 91601 (213) 877-3550.

NEWS

- 25 **News Scope**
- 32 **'Roots' of improving CBs** can be traced to varied technologies.
- 34 **Rf beam welds and cuts** metals, ceramics and cement.
- 36 **CMOS puts new a/d technique** ahead of dual-slope method.
- 49 **Washington Report**

54 **Electro 77**—A special section devoted to this year's big New York show.

TECHNOLOGY

- 73 **Microprocessor Design**
- 90 **Take advantage of 8080 and 6800** data-manipulation capabilities. The circuits' ability to handle arrays can simplify many data handling applications.
- 100 **Ceramics, ceramoplastics and glasses** often perform well where plastics fail. To select the right insulators, learn their relative advantages.
- 110 **Use a pulse-width-modulated switcher** for your low-voltage, high-current dc supply. You gain efficiency and can get rid of the input-line transformer.
- 118 **Break loose from fixed IC regulators.** With adjustable three-terminal power monolithics you get top performance along with versatility.
- 126 **Verify transistor ratings** the right way and avoid erroneous results or even damage. A clamped switching circuit gives safe, accurate results.
- 132 **Excite your SAW device** with pulsed rf to learn the time-domain performance. With the correct pulse width, you can see all the outputs.
- 138 **Stan Kukawka of Allen-Bradley** Speaks On Getting the Small-Company Spirit in a Large Engineering Organization.
- 144 **Ideas for Design:** Generate nonlinear sweep functions across a capacitor with a feedback circuit . . . Consider pulse-width modulation for transmitting data by cable . . . A programming controller for the 2708 EPROM copies data in-circuit.
- 150 **International Technology**
- 154 **Annual Index**

PRODUCTS

- 183 **Instrumentation:** 60-GHz spectrum analyzer squeezes bandwidth to 30 Hz.
- 186 **Instrumentation:** Don't rub your eyes—it's the first dual-display counter.
- 194 **Packaging & Materials:** Breadboards route clean power to your DIPs.
- 200 Power Sources
- 208 Components
- 220 Data Processing
- 228 Microwaves & Lasers
- 230 Modules & Subassemblies
- 238 Integrated Circuits
- 244 Discrete Semiconductors

DEPARTMENTS

- 87 **Editorial:** The test
- 7 Across the Desk
- 163 Top Ten Winners
- 246 Evaluation Samples
- 246 Application Notes
- 248 New Literature
- 250 Bulletin Board
- 254 Advertisers' Index
- 256 Product Index
- 258 Information Retrieval Card

Cover: Photo by Ed Dull Studios, courtesy of Tektronix.

ELECTRONIC DESIGN is published biweekly by Hayden Publishing Company, Inc., 50 Essex St. Rochelle Park, NJ 07662. James S. Mulholland Jr., President. Printed at Brown Printing Co., Waseca, MN. Controlled circulation postage paid at Waseca, MN and New York, NY, postage pending Rochelle Park, NJ. Copyright © 1977. Hayden Publishing Company, Inc. All rights reserved. POSTMASTER: Please send form 3579 to ELECTRONIC DESIGN, P.O. Box 13803, Philadelphia, PA 19101.

**24 bits
of D to A
from
AMD.**

Three new 8-bit monolithic digital-to-analog converters from Advanced Micro Devices: the AmDAC-08, Am1508 and SSS1508A. They're all MIL-STD-883 for free, and more. Look:

More:

	Non-Linearity Max Over Opr. Temp Range	Settling Time	Resolution	Available
AmDAC-08	.1%	135ns (max)	8 bits	NOW
Am1508	.19%	300ns (typ)	8 bits	NOW
SSS1508A	.19%	250ns (typ)	8 bits	NOW

And soon, there'll be even more members of this family. Call or write Advanced Micro Devices and ask for the Linear Integrated Circuits Data Book. No home should be without one.

Advanced Micro Devices

Bipolar LSI. N-Channel, silicon gate MOS. Low-power Schottky.
Multiple technologies: One product: excellence.



Advanced Micro Devices • 901 Thompson Place, Sunnyvale, California 94086 • Telephone (408) 732-2400 •
Distributed nationally by Hamilton/Avnet, Cramer and Schweber Electronics, and regionally by Arrow, Bell and Century Electronics.

CIRCLE NUMBER 10

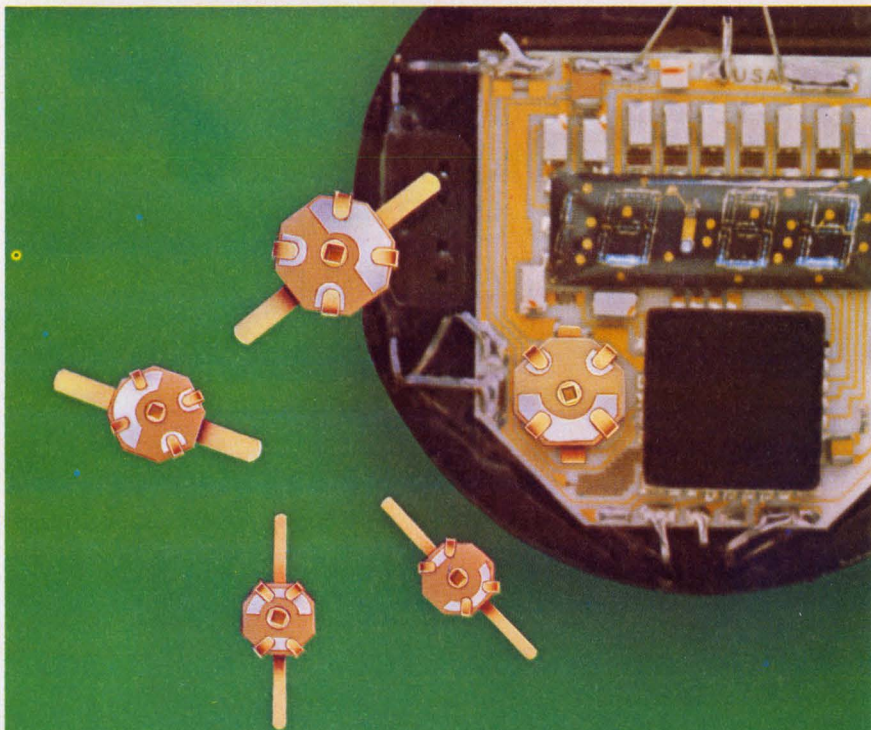

Thin-Trim[®] capacitors

Tucked in the corner of this Pulsar Watch is a miniature capacitor which is used to trim the crystal. This Thin-Trim capacitor is one of our 9410 series, has an adjustable range of 7 to 45 pf, and is .200" x .200" x .050" thick.

The Thin-Trim concept provides a variable device to replace fixed tuning techniques and cut-and-try methods of adjustment. Thin-Trim capacitors are available in a variety of lead configurations making them easy to mount.

A smaller version of the 9410 is the 9402 series with a maximum capacitance value of 25 pf. These are perfect for applications in sub-miniature circuits such as ladies' electronic wrist watches and phased array MIC's.

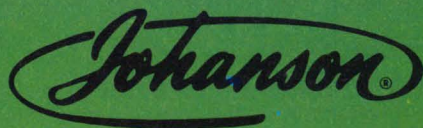

Johanson Manufacturing Corporation
Rockaway Valley Road
Boonton, New Jersey 07005
(201) 334-2676 TWX 710-987-8367

Sr. Vice President, Publisher

Peter Coley

Editors

Editorial Offices
50 Essex St.
Rochelle Park, NJ 07662
(201) 843-0550
TWX: 710-990-5071
(HAYDENPUB ROPK)
Cable: Haydenpubs Rochellepark

Editor-in-Chief George Rostky

Managing Editors:

Ralph Dobriner
Michael Elphick

Senior Associate Editor

Stanley Runyon

Associate Editors:

Sid Adlerstein
Dave Bursky
Morris Grossman
John F. Mason
Andy Santoni
Max Schindler

Contributing Editors:

Peter N. Budzilovich, Jules H. Gilder,
John Kessler, Alberto Socolovsky,
Nathan Sussman

Editorial Field Offices

East

Jim McDermott, Eastern Editor
P.O. Box 272
Easthampton, MA 01027
(413) 527-3632

West

Dick Hackmeister, Western Editor
8939 S. Sepulveda Blvd., Suite 414
Los Angeles, CA 90045
(213) 641-6544
TWX: 1-910-328-7240

Dave Barnes
844 Duncardine Way
Sunnyvale, CA 94087
(408) 736-6667

Editorial Production

Marjorie A. Duffy, Production Editor
James Keane, Copy Editor

Art

Art Director, William Kelly
Richard Luce, Anthony J. Fischetto

Production

Manager, Dollie S. Viebig
Helen De Polo, Nancy Hurey

Circulation

Director, Barbara Freundlich

Information Retrieval

Paula Greenleaf

Advertising Promotion

Susan G. Apolant

Reprints

Maxine Correal

Across the Desk

Idea for Design violates design rules

Several readers have written to comment on "Interface CMOS to TTL with Diodes and Save the Cost of Expensive Buffers," an Idea for Design that appeared in ED No. 23, Nov. 8, 1976, p. 74.

To save space, several critical quotes have been extracted from the reader responses:

"While the circuit may work on a breadboard, I wouldn't want to use it in any equipment produced in quantity. . ."

"This circuit may work in a laboratory environment with selected devices and a supply voltage for the CMOS greater than 5 V, but I am totally mystified how it can be expected to perform as a production item. . ."

"Mr. Sarpangal apparently did not give enough consideration to the worst-case parameters for the devices in the circuit. . ."

"The article violates some basic design rules concerning CMOS and TTL ICs. . ."

The reasoning behind these criticisms is summarized by Jeffrey Lowenson, Project Engineer with MB Associates, San Ramon, CA 94583:

"The current-sinking capability, I_{DN} , of a CD4029 varies from 0.28 to 1.2 mA with 0.8 mA, typical, depending upon V and temperature. However, the low-level current, I_{IL} , from a 7441 is a maximum 1.6 mA. The 4029 may therefore have a hard time sinking a 7441, unless the device's characteristics happen to overlap.

"When the CMOS output is high, the diode is reverse-biased and the TTL input floats—not a recommended mode of operation. A very

small noise pickup can cause the device to switch.

"The author states that the 0.6-V drop across the diode is well below the specified low level for TTL. That is true, because the maximum specified low level input voltage, V_{IL} , for TTL devices is 0.8 V. However, the presence of the diode reduces the noise immunity of the interface from 800 to 200 mV.

"It turns out that a CD4050A hex buffer, which can easily drive a TTL load, costs \$0.84 in small quantities, whereas a CA3039 diode array costs \$1.07."

Mr. Sarpangal replies

I would like to bring out a few points regarding the usefulness of the CMOS/TTL interfacing circuit and a few hints to get the best results:

When you are thousands of miles and weeks away from delivery of low-cost buffer ICs, the diode circuit can be made to work and solve an interfacing problem. Not all Ideas for Design are intended for production.

The following measurements were made on a properly functioning circuit with the output of the CMOS in a ZERO state:

$V_{OL} = 0.15$ V (across CMOS output)

$I_{DN} = 0.6$ mA (diode forward-biased)

V (input to TTL) = 0.75 V.

Although, as the data sheets for CD4029 show, the I_{DN} can be as high as 1.2 mA, there is no need to sink all the 1.2 mA. The max I_{DN} that actually flows for proper operation of the circuit is only 0.5 to 0.6 mA, as can be seen from the

(continued on page 8)

Marcoflex. The switch that turns people on.

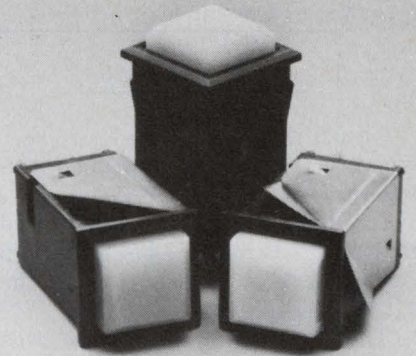

"... amazingly simple and reliable."
"Why didn't I think of it?"

People are really getting turned on by our new Marcoflex 650 switches.

Which doesn't surprise us. After all, its patented flexing spring action is something of a *break-through*.

An incredibly simple design gives you electrical and mechanical characteristics associated with larger switches in a miniature, .625-inch package at an economical price.

Features include wiping action, multiple-point (bifurcated) contact, true snap action, high contact force, and positive tactile feel.

Plus alternate or momentary action, and excellent reliability.

Get turned on by Marcoflex yourself. Contact us today for full details.

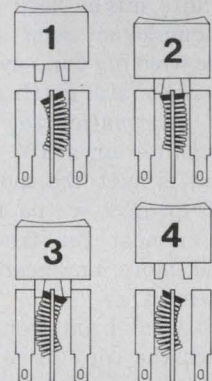

The patented Marcoflex mechanism.

ILLUMINATED PRODUCTS INC.

A subsidiary of OAK Industries Inc.
2620 South Susan St., P.O. Box 11930
Santa Ana, CA 92711
Telephone: 714/540-9471 TWX 910-595-1504

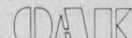
 COMPONENTS GROUP

CIRCLE NUMBER 5

Electronic Design welcomes the opinions of its readers on the issues raised in the magazine's editorial columns. Address letters to Managing Editor, Electronic Design, 50 Essex St., Rochelle Park, NJ 07662. Try to keep letters under 200 words. Letters must be signed. Names will be withheld on request.

ACROSS THE DESK

following calculations:

$$I_{DN} = \frac{V_{cc} - [2 \times (\text{diode drops})] - V_{DL}}{(6.7 \times 10^3) \Omega} \\ = \frac{5 - (2 \times 0.6) - 0.15}{6.70}$$

$$= 0.5 \text{ mA,}$$

where 6.7 k Ω is the limiting resistor in 7441.

Inputs of the TTL should be tied to its V_{cc} through 120-k Ω pull-up resistors. The contribution to the I_{DN} is negligible.

The circuit in the article was only an illustrative example. Other CMOS-to-TTL devices can use this technique. I have successfully incorporated this technique into a digital-printer interface for Hewlett-Packard's type 5055A digital recorder in a PCM telemetry data-processing and recording system.

Germanium diodes such as the 1N30A, with forward drops much less than silicon units, can be used advantageously. The diodes protect the COSMOS from permanent damage in the case of a short or heavy-current drawn by the input of a faulty TTL.

I agree and I believe

I read Alan Rosenbaum's comments on engineering-design contests (ED No. 24, Nov. 22, 1976, p. 7) and agreed with him 100%. I believe (no proof!) that every 100 such circuits might keep one engineer unemployed who could be otherwise working for, say, \$10,000. So companies are getting \$10,000 worth of information for the price of a calculator or a TV. It is obvious who is hurt the most. Every little side project we do for someone else, almost for free, pushes more and more engineers toward unemployment.

Here is what I am going to do. I will attach the copy of Mr. Rosenbaum's letter to every such WIN-A-PEANUT ad and mail it to the magazine running the ad. I will also ask for the magazine's voluntary support in stopping the appearance of such contests, which only hurt the engineers.

I know that single-handed, piecemeal effort may not bring any results. But the least all of us em-

ployed engineers can do is to avoid becoming a roadblock in the job prospect of an unemployed engineer.

Dave Parikh

Fridley, MI

Misplaced Caption Dept.



They said I'd have a good time at Electro, but I didn't expect this.

Sorry. That's Paolo Caliari (Il Veronese)' "Allegory of Virtue and Vice," which hangs in the Frick Collection in New York City.

Inhibit the glitches

Mr. Binder's letter, "Real World Can Be a Rough Place" (ED No. 4, Feb. 15, 1977, p. 7) is well taken. Some D flip-flops *do* glitch when faced with having to resolve synchronous data input. Indeed, all the-

oretically have this potential if the rise and fall times of the data and clock are much less than the propagation delay time of the gates.

However, stretching the rise/fall times is not a solution. In many cases this problem never materializes, and the only effect is uncertainty as to when the data are recognized. Such is the case for some low-power—hence slower—logic. Nevertheless, the general case is not satisfied, and the problem needs to be resolved. I offer the circuit depicted in the attached logic diagram.

The object is to prevent a transition in the data input to D of FF₁ during a positive clock transition or, more specifically, during the specified set-up and hold interval of the FF₁. Generating an inhibit pulse during a data transition prevents the transition. The inhibit pulse anticipates a data edge and holds the clock of FF₀ low.

After the edge has passed and the input to D of FF₀ has stabilized, the clock is enabled. The data are entered either immediately or on the first positive edge of the clock. It should be noted that the input to D of FF₁ is still asynchronous, but the transitions don't coincide with the clock. The output of FF₁ is synchronous, however.

While the circuitry shown to the left of the dotted line may be necessary in some critical circuits, many practical designs may not require the additional hardware. If needed, selection of the gates and the amount of delay is dictated by the characteristics of the logic.

Leland Langston

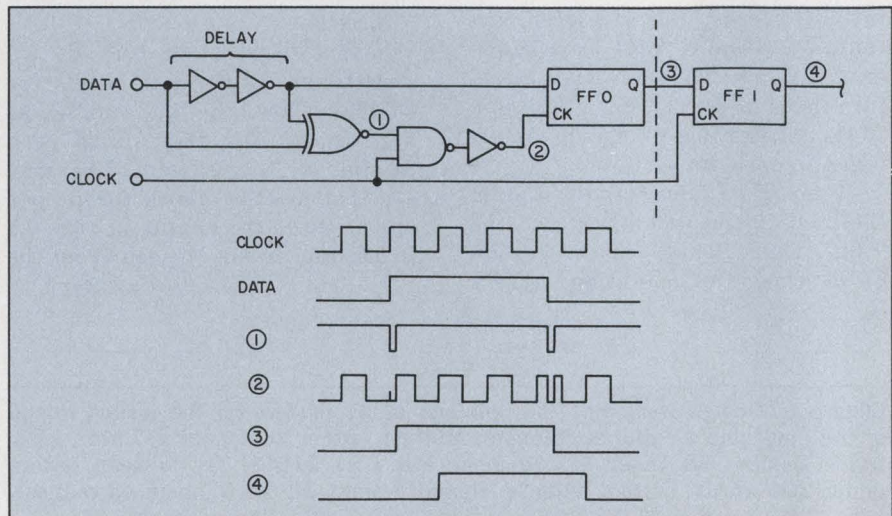

hp MEASUREMENT COMPUTATION **news**

product advances from Hewlett-Packard

APRIL 1977

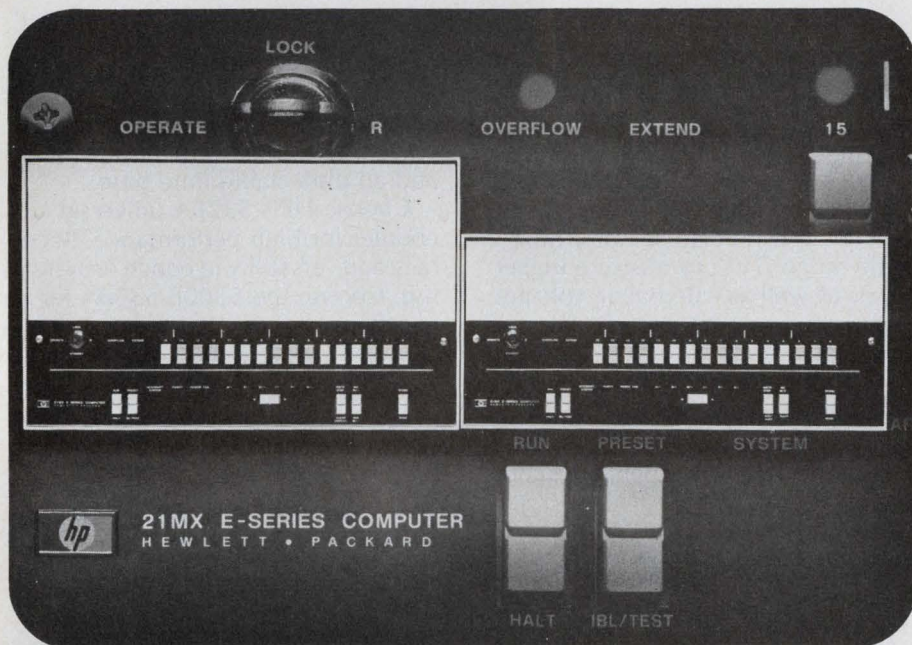

Hewlett-Packard simplified VMT by dividing micro-instructions into two classes—those less than 175 ns and those between 175 ns and 280 ns.

New computers execute programs 70 to 100 percent faster with VMT

Variable microcycle timing (VMT) in the new 21MX E-Series 24-bit processors decreases instruction run time by dynamically allocating cycle times.

Microcode fine-tuning has brought worst-case conditions down to 280 ns.

The two new models utilize the latest in MSI technology, Schottky TTL technology plus design innovations with a minimal cost increase over the Hewlett-Packard M-Series.

The E-series also offers much more opportunity for growth. A 16k-word computer, chosen today for its

economy in a dedicated application, can later become a 304k-word, multi-user, multi-programmed distributed system central computer with a full complement of supporting equipment, and, it won't be necessary to rewrite software, switch computers, or change I/O devices.

Upgrading is possible at any time. Three features make this possible. First, the user has access to 8.5k control-processor address space, sufficient to write his own operating system, if desirable. Second, to make it easy to exploit the control space available, microprogramming software is offered, including micro-assembler, micro-editor, loader, and debug (continued on third page)

in this issue

Plot easier-to-read graphs in four colors

1 μ VDC sensitivity in 5-function DMM

Real-time data entry with fewer errors

HP's LSI repertoire now includes silicon-on-sapphire

The first accomplishment to be revealed from HP's SOS/CMOS laboratory is a new 16-bit parallel microprocessor. We call it MC² (Micro CPU Chip).

Optimized for input/output efficiency in control applications, it will bring significant performance to products soon to be featured in these pages.

An article on this high-speed, low-power, high-density chip appears in the April issue of the Hewlett-Packard Journal. For your copy, check Q on the HP Reply Card.

of Hertz and Gigahertz.....part 2 in a series

Universal counters

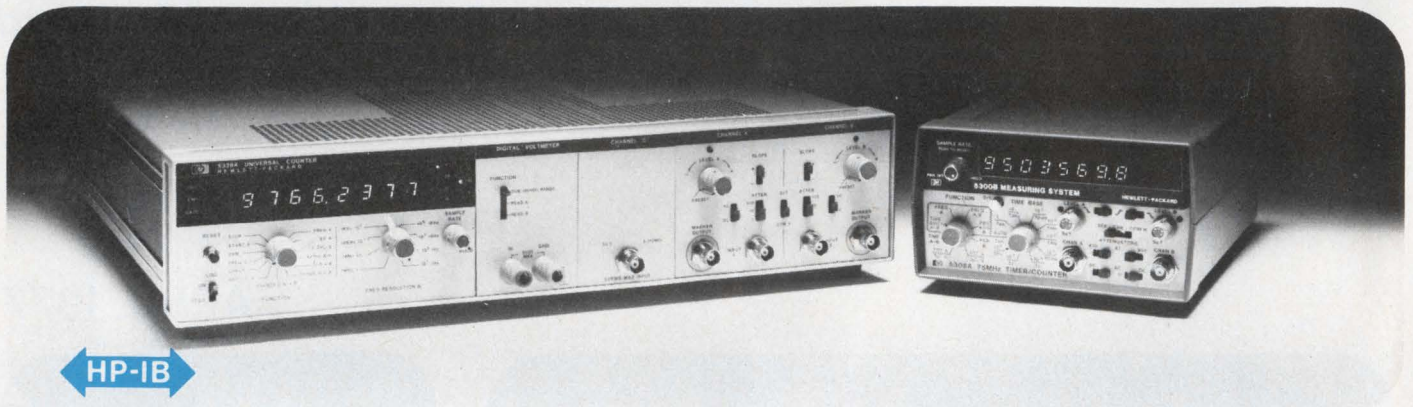

HP-IB

Modular design allows you to choose exactly the measurement capability that you need. Add more capability later as your needs and/or budget expand.

Universal counters are highly popular because one counter permits you to make almost any time interval and frequency measurement up to microwave. In addition to frequency, frequency ratio, period and time interval measurements that universal counters usually make, Hewlett-Packard's models offer many highly useful features to make your measurements easier, more certain or more versatile.

Depending upon the model

selected, features include: outstandingly easy, rapid, and accurate trigger level setting via a full complement of controls and indicator lamps; a built-in wide range DVM to measure trigger levels as well as external dc voltages; frequency up to 1300 MHz; time interval down to 10 ns single-shot or 10 ps for repetitive events via time interval averaging; burst frequency measurements; HP-IB (Hewlett-Packard Interface Bus) operation; a portable battery

pack; 50 Ω input at high frequencies and an ultra stable time base.

Choose HP's 5328A universal counter for high performance, accuracy and versatility in bench or systems use. Choose the 5300B/5308A for an excellent combination of features in a low-cost portable instrument.

Check I on the HP Reply Card.

Current tracer locates elusive logic faults

HP's 547A Current Tracer solves some of digital troubleshooting's most difficult problems--locating low impedance faults by tracing current to sources or sinks.

With it, you can find the one bad IC on a stuck node, or pinpoint hairline solder bridges or backplane shorts, and thus troubleshoot wired-AND/OR and three-state busses...faster than before...in all logic families...without cutting circuit traces or removing good circuit elements.

This sophisticated instrument has a precision inductive pickup sensitive only to AC currents with fast transitions (200 ns) and incorporates a wide band amplifier with adjustable sensitivity of 1mA to 1A. A single-lamp readout unambiguously displays relative current levels along the circuit.

Team it up with HP's programmable

546A Logic Pulser to get pulses wherever you'd like them in the tested circuit. It gives a single pulse, a 1, 10 or 100 Hz stream, or a burst of exactly 10 or 100 pulses, so you can quickly and easily set a system to it's 852nd clock pulse state, if needed.

Use HP's Logic Probe and Clip, too, for voltage-based troubleshooting; then pick up the current tracer and pulser to locate puzzling low impedance faults that defy easy detection by any other method.

And, you can use these IC troubleshooters to locate faults right down to the bad part when you're using automated board testers.

For more information, check C on the HP Reply Card.

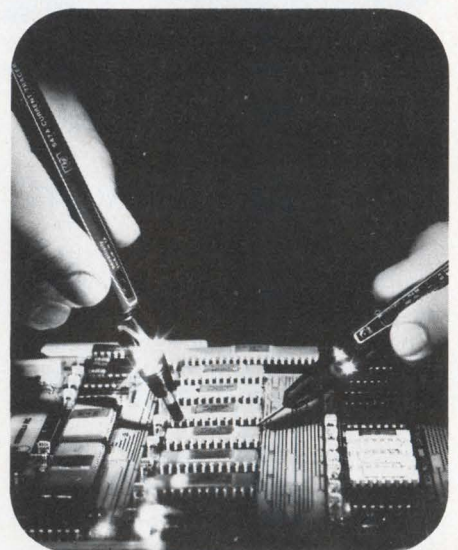

Deceptively simple in appearance, the current tracer (left) and pulser (right) are sophisticated test instruments for digital troubleshooting.

Freeze the reading on the multimeter display with touch-hold probe

New design concepts have reduced the cost of the sensitive, portable multimeter. One microvolt dc sensitivity enables you to measure low-level signals from sensitive circuits or from such devices as strain gauges or thermocouples.

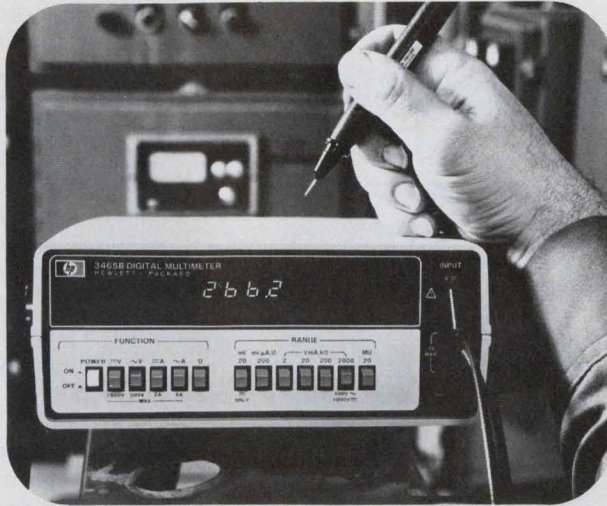

This new low-cost 4½-digit, five-function digital multimeter, the HP 3465B has a 'touch-hold probe' available as an accessory.

The HP 34112A probe provides greater utility by allowing the operator to focus his attention on the point of measurement in hard-to-reach circuits. The probe, which plugs into the front panel input connectors, holds the DMM reading at the touch of a pushbutton.

The 3465B has a 20-mV full-scale dc voltage range with a resolution of 1 μ V. Midrange dc accuracy is $\pm 0.02\%$ ± 1 digit. Frequency range for ac measurements is 40 Hz to 20 kHz.

The maximum resolution on ac voltage measurements is 10 μ V, on measurements of current (ac or dc) it is

10 nA, and on resistance, 10 m Ω .

This high-sensitivity multimeter is packaged in a portable, streamlined carrying case with handle and is powered by AC, or with rechargeable Nicad batteries with internal charger.

Hewlett-Packard has achieved this performance level at a low cost through extensive use of computer-aided testing, laser-trimmed fine-line resistors in the attenuator, and a single-referenced bipolar A/D converter thus eliminating one reference supply. The fine-line resistors are also significant in their contribution to savings in cost and space.

For more information, check G on the HP Reply Card.

On-line, on-location data collection with new data entry terminal

The new HP 3070A data entry terminal assures fast, easy communication between user and computer.

A data entry network can extend as far as 4 km (2.4 mi) with terminals distributed randomly along the single twisted-pair Serial Link Cable. Depending on the application, as many as 56 HP 3070 terminals can be controlled by a single "smart" HP controller board in an HP 1000 computer.

The HP 3070 also includes all the commands and protocol to communicate with HP-IB compatible devices. High noise immunity and the ability to interface a wide range of instruments to a remote HP computer makes the 3070A terminal an excellent choice for data gathering in a manufacturing environment and for test and measurement applications.

The new terminal can also be easily integrated into systems for inventory control, shipping and receiving, as well as commercial applications in banks, insurance companies and other service businesses.

For more information, check F on the HP Reply Card.

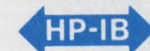

The HP 3070A can be keyboard customized for use in industrial and commercial applications. It is well suited for users with little or no experience using computers.

21MX computer performance doubled *(continued from first page)*

utilities. Develop, assemble, edit and test microprograms on line. Third, it is now possible, under software control, to transfer routines from disc or other sources directly into microcode store, making the fast control processor available, dynamically, as a resource under operating system control.

The 21MX E-Series, using fully asynchronous interface with memory, allows the utilization of new memory technology as it becomes feasible, simply by changing memory boards.

The 21MX E-Series computers, dis-

tinguished by their gold trim, are offered in two models. The smaller unit, 2109A, has space for 9 I/O cards, and up to 5 memory cards (up to 80k words main memory). The 2113A will support 14 I/O cards and 10 memory cards (maximum memory 160k words).

For details, check B on the HP Reply Card.

Multi-color X-Y plotter expands uses for HP desktop computers

New miniature easy IC probes access tight places on dense circuit boards

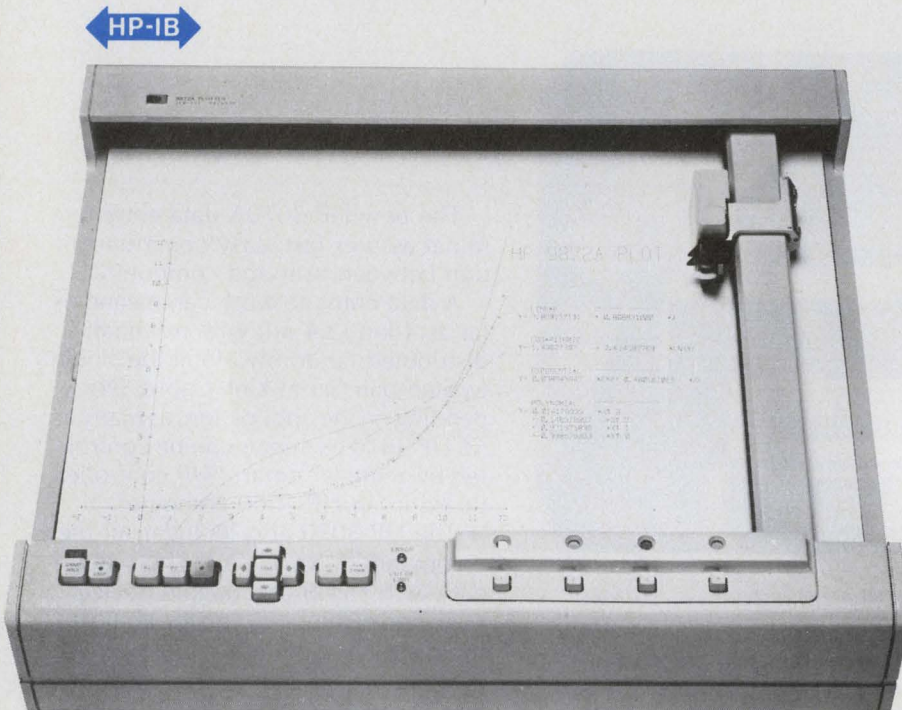

Now, you can create four-color graphs automatically. Color will enhance your graphs, make them easy to interpret, understand and explain.

HP's new microprocessor-based plotter (A-3 size), produces data in permanent, multicolor graphic form. A number of features provide excellent plot quality at higher speeds and with greater resolution than have been previously available.

In applications where curves and plots are difficult to distinguish and interpret, the 9872's four-color plotting, seven dashed-line fonts, five built-in character fonts, user-defined characters and symbol mode plotting combine to produce clear, easy-to-read plots.

Thirty-eight different instructions are built into the 9872's microprocessor to provide such features as point digitizing, labeling and character sizing directly through the plotter's HP-IB interface. (HP's implementation of IEEE Standard 488-1975) Point digitizing with the 9872A allows reproduction of charts and graphs from other sources. Window plotting is our term for describing the ability to handle off-scale data. The 9872A graphs to the point of the off-scale data and continues graphing at the point where on-scale data is again encountered. Com-

binning point digitizing and window plotting gives you sections of your original graph at any proportion you choose for more detailed analysis.

The 9872A is designed to be especially useful in the areas of statistics, medicine, numerical control, surveying and engineering design.

Pen speed is 360 mm/sec on the X and Y axes. In program mode, pen speed may be adjusted to any one of 36 speeds beginning at 10 mm/sec. Plotting speed is typically 3/sec for 2.5 mm (0.01 in) characters. This precision velocity control produces high-quality graphics not only on paper, but on such other media as mylar or acetate.

The five character sets built in are ANSI ASCII, 9825A ASCII, and three European sets: Spanish, Scandinavian and French/German characters. Or, you can easily design your own unique characters—even a complex logotype.

Use the 9872A plotter either with the 9825A desktop computer or the newest addition, the HP 9831A.

For a four-color brochure, check M on the HP Reply Card.

HP's new high impedance miniature 'scope probes connect readily either to individual pins on modern dual-in-line packages (DIP's) or to small, insulated conductors used on IC circuit boards—without the customary hazards of shorting.

It is possible to encompass an entire DIP using the Test Clip and an accompanying set of demountable probes. The basic part of each probe can be inserted by itself into the DIP clip at any pin position, or 15 can be inserted simultaneously.

The probe itself is a small (0.1" dia. x 1.0" long) cylinder with a sharp tip. The tip is sharp enough to make contact through the insulation coating of conductors commonly used on IC circuit boards.

The series, beginning with Model 10017A, includes probes suitably compensated for most oscilloscopes with input capacitances of 9 to 14 pF and 20 to 30 pF. 1:1 probes are also available. Either 1-meter or 2-meter cable lengths can be specified.

If you need to attach directly to dual-in-line packages for high-speed measurements and the area to be tested is densely packed with today's miniaturized components, these new probes will give you easy access and decreased capacitive loading of the circuit under test.

For more information, check O on the HP Reply Card.

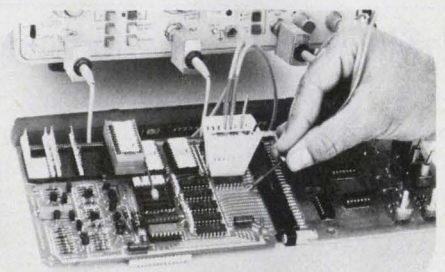

The narrow shaft on the new easy IC probes makes measurements easier in congested areas of today's electronic devices and circuit boards. The probe tip can make contact at any pin of a bare DIP without the likelihood of shorting to adjacent pins.

“Entry level” business computer also handles technical computing



A new desktop computer combines scientific data analysis as well as general administrative data handling capability.

The HP 9896 is a computer system for small-to-medium sized businesses available with software to handle many commercial jobs including accounts receivable/payable, payroll, inventory control, and general ledger.

The 9896 is also used as a high performance flexible disk system for a wide range of computations including medical data analysis, structural and civil engineering data analysis plus general scientific problems.

Controlling the system is the new HP 9831A desktop computer (see article to the right).

The 9896 system consists of:

- the 9831 desktop computer with integral keyboard and display, read/write memory is 7,162 bytes
- two flexible disk drives for rapid access to stored programs and data
- 9871A 96-character impact printer (30 cps) provides typewriter-quality printouts
- systems desk to provide work station convenience.

You can upgrade the memory in 8k bytes up to 32k bytes. Two additional disk drives may be added; each disk provides about 500k bytes storage. Other peripherals could include a high-speed (200 lpm) printer, a thermal printer, paper tape reader and punch, card reader and data cartridge cassette memories.

Hardware and software installation options are available and are quoted on an individual account basis.

For more information, check N on the HP Reply Card.

Fast BASIC language desktop computer with software saves you time

The HP 9831A is Hewlett-Packard's new medium-priced desktop computer. Designed to either stand alone or to be linked with peripherals in a system (such as the HP 9896 Business Information Management System described to the left), the 9831 brings a new dimension of computing power, capabilities and speed to fields of engineering, construction, medicine, and general computation.

For example, the 9831A can work through a 5-variable stepwise regression in 1¼ minutes, reduce the data from a 100-tube RIA kit in 5 minutes, or analyze a 6-story, 4-span construction frame in 7 minutes.

Internal read/write memory is 8k bytes, expandable to 32k bytes in 8k byte increments as needed. BASIC language software will get you started quickly. The String Variables capability enables the 9831 to manipulate alphanumeric data. The maximum size of each string is limited only by the 9831's memory size. Advanced Programming II operations are built in as a ROM. Much of the software pacs originally written for the HP 9830A/B are directly compatible with the 9831.

The LED display is 32 characters wide, with upper and lower case alphanumeric readout and covers the full ASCII character set.

The built-in tape drive is bi-directional. Each cartridge holds 250k bytes and has a 2,750 bps transfer rate. Search/rewind speed is 90 ips, and read/write speed is 22 ips. Average access to any place on the tape is 6 sec.

Start with the basic desktop computer. When you need the capability to handle larger data bases, adding peripherals will allow the 9831 to grow with you. HP offers 13 different peripherals for use with the 9831.

Adding an HP 98223A/B Matrix/Plotter ROM will allow you to invert a 20×20 matrix in about 8 seconds. The 98218A Flexible Disk ROM allows you to expand storage capacity; each disk holds 499,200 bytes of information, almost twice the capacity of other available disks.

The HP 9831 is a powerful, reliable, efficient, and cost-effective total package design.

For more details, check L on the HP Reply Card.



HP-IB

New desktop computer has many built-in time-saving features. And, you can expand its usefulness with read-only memories (ROMs), memory, peripherals and HP developed software.

Application Pacs broaden uses for HP 67/97 calculators



All software for the HP-97 programmable printing calculator (left) and the HP-67 programmable pocket calculator (right) is completely interchangeable.

Dozens of programs in Hewlett-Packard application pacs mean that you can instantly begin using the programming power of the HP-67 or the HP-97 Programmable Calculator to solve problems in your discipline. Just pass one of the prerecorded program cards through the calculator's card reader, then follow the simple procedure outlined in the instruction book.

Application pacs are now available in the areas of electrical engineering, business decisions, mathematics, statistics, mechanical engineering, clinical lab and nuclear medicine, and surveying. And don't forget the new Games Pac, containing 19 entertaining and fun-filled calculator games like Space War, Biorhythms, and Golf.

You can write your own programs for the HP-67 and the HP-97, too. The HP-97 Programmable Printing Cal-

culator contains 224 steps of program memory, and each programmable operation, whether one, two, or three keystrokes, occupies only a single one of these steps. Using the printer on the portable, battery-operated HP-97, you can print a program, print results, or trace an executing program.

Any program card recorded on an HP-97 can be used on an HP-67, and vice versa. All programmable operations on the two calculators are exactly alike, except that the printing functions of the HP-97 occur as special display enhancements on the HP-67.

Check A on the HP Reply Card and we will send you detailed information on both of these powerful computational tools and the software pacs.

Microwave testing to 26.5 GHz with new coaxial detectors

Two new microwave coaxial detectors are available with capabilities to 26.5 GHz. Model 8473B covers the frequency range 0.01 to 18 GHz and Model 8473C, 0.01 to 26.5 GHz.

Both detectors use the new APC-3.5 sub-miniature connector which has superior repeatability due to a rugged mechanical interface. Long life is especially important on such test accessories because of frequent reconnections. The APC-3.5 connector is fully compatible electrically and mechanically with the industry-standard SMA series.

Response is at ± 0.3 dB to 12.4 GHz, ± 0.6 dB to 18 GHz on the 8473B. SWR < 1.5 . 8473C has the same ± 0.6 dB flatness to 20 GHz and follows a -3.3 dB linear slope within ± 1.5 dB from 20 to 26.5 GHz. SWR < 2.2 .

Output polarity is negative from a BNC connector. Maximum operating input is 200 mW. Matched pair and positive polarity options are available.

For details, check K on the HP Reply Card.

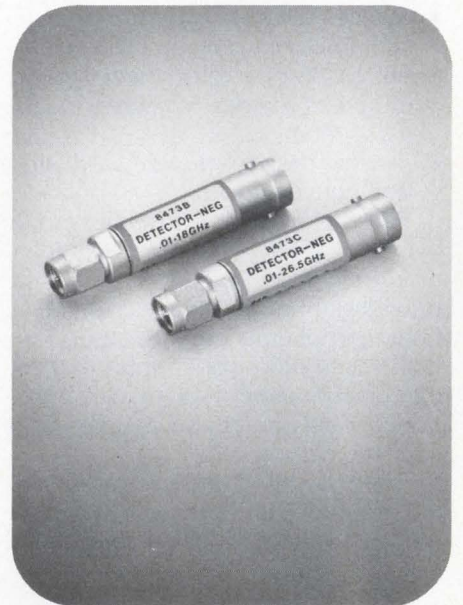

Coaxial crystal detectors offer flat frequency response with rugged input connector.

HEWLETT-PACKARD COMPONENT NEWS

New matched arrays for ease of insertion and alignment

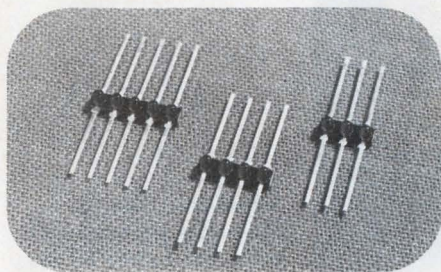

New compact subminiature red solid state lamps are available in a choice of 3, 4 or 5 elements.

The HLMP-6200 series arrays are comprised of several GaAsP lamps molded as a single bar. Arrays are tested to assure uniformity between elements and matching between arrays. Each element has separately accessible leads and a red diffused lens which provides a wide viewing angle and a high on/off contrast ratio. Center-to-center spacing is 2.54 mm (.100 in) between elements. Arrays are end stackable on 2.54 mm centers.

For more specifications, check J on the HP Reply Card.

New RF and Microwave semiconductor catalog aids selection of HP components

This new 128-page Diode and Transistor Designer's Catalog contains complete product specifications and design data for Hewlett-Packard's line of RF and microwave semiconductors.

Included are: HF thru UHF Schottky and PIN diodes; microwave Schottky, PIN, IMPATT and step recovery diodes; microwave bipolar and field effect transistors; devices for hybrid circuits; JAN/JANTX diodes and HP standard test programs for "off-the-shelf" high reliability semiconductors.

For your free copy, check P on the HP Reply Card.

Two low cost general purpose microwave transistors

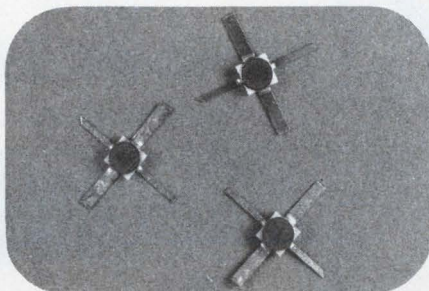

Two small signal transistors for general purpose use in the 1—6 GHz frequency range are added to the HP microwave transistor line.

Model HXTR-2101 is a low cost, gain-specified device. At 4 GHz, tuned gain is 9 dB minimum and power output at 1 dB power compression is typically 70 mW.

Model HXTR-6105 is specified at 4.2 dB maximum noise figure and 8 dB minimum associated gain at 4 GHz. Power output (1 dB compression) at these conditions is typically 25 mW. At 1.5 GHz, noise figure is typically 2.2 dB with 15 dB associated gain.

For more technical information, check D on the HP Reply Card.

New high-speed isolator with built-in line input circuitry

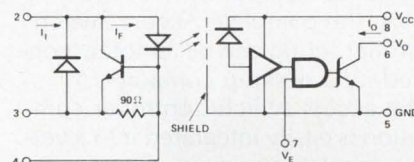
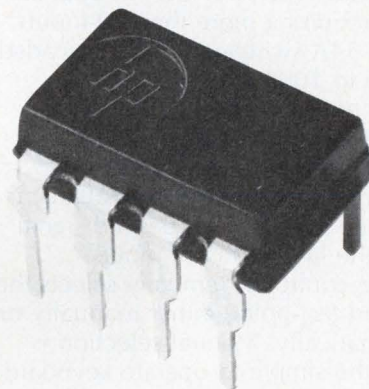

Shown above is a schematic of the HCPL-2602. Applications include computer-peripheral interfacing, microprocessor system interfacing, instrument input/output isolation, analog to digital and digital to analog interfacing and the elimination of ground loops.

This new optically-coupled line receiver includes an internal input current regulator to serve as a line termination for line receiver applications. Accepting a broad range of drive conditions, the built-in regulator clamps the line voltage and regulates the LED current so line reflections do not interfere with circuit performance.

The HCPL-2602's are useful in high noise environments that conventional line receivers may not tolerate. Immunity to differential noise has been improved and the internally shielded detector provides orders of magnitude improvement in common mode rejection with little or no sacrifice in speed.

Its high speed of 10 megabits per second is limited in most cases only by transmission line speed.

For details, check E on the HP Reply Card.



New access switch speeds measurements through a switch network

Make accurate, repeatable, RF measurements through a switch network over the frequency range 10 kHz to 25 MHz using Hewlett-Packard's new 3754A Access Switch and the 3755A Switch Controller.

The access switch is a 10-input to 1-output switch device. For applications requiring more than 10 inputs, the 3754A switches can be cascaded for up to 1000 inputs. The 111 switches required for 1000-input selection are controlled by a single 3755A controller. A 3-digit code, transmitted by the 3755A, is all that is required to select the desired signal from the large array of inputs.

The controller remotely selects the desired test-point, either manually or automatically. Manual selection is from the simple-to-operate keyboard. With HP-IB compatibility in the 3755A, the complete Access Switch/controller set-up can be remotely controlled by a desktop computer.

The access switch/Controller combination is easily integrated into a versatile signal-accessing system. Sending the control signal along the same path as the RF signal minimizes the amount of cabling required, making it easy to locate access switches remotely from the controller and to

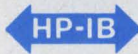
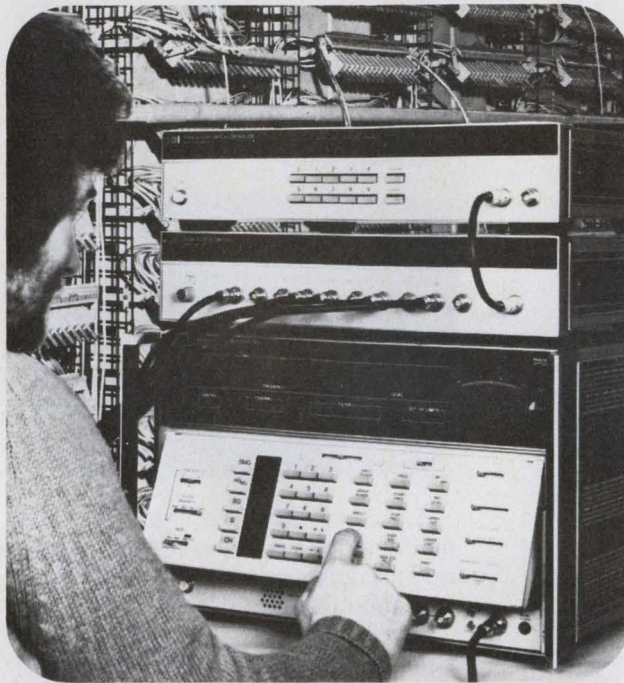

change configurations with a minimum of effort.

The analog performance of the access switch (insertion loss of ± 0.1 dB and typically < -100 dB of crosstalk at 18 MHz) makes it an ideal choice for the maintenance and production test-

ing of frequency division multiplex (FDM) systems. Both 75 ohm and 50 ohm versions are available.

For more information, check H on the HP Reply Card.

Access up to 1000 test points from one central location with the new Access Switch and Access Switch Controller.

East-4 Choke Cherry Road, Rockville, MD 20850,
Ph. (301) 948-6370.

South-P.O. Box 10505, Atlanta, GA 30348,
Ph. (404) 434-4000.

Midwest-5201 Tollview Dr., Rolling Meadows, IL 60008,
Ph. (312) 255-9800.

West-3939 Lankershim Blvd, North Hollywood, CA
91604, Ph. (213) 877-1282.

Europe-7, rue du Bois-du-lan, P.O. Box, CH-1217, Meyrin-2,
Geneva, Switzerland, Ph. (022) 41 54 00.

Japan-Yokogawa-Hewlett-Packard Ltd., Ohashi
Bldg., 1-59-1 Yoyogi, Shibuya-ku,
Tokyo 151, Ph. 03-370-2281/92.

HEWLETT  **PACKARD**

MEASUREMENT **news**
COMPUTATION
product advances from Hewlett-Packard

March/April 1977

New product information from

HEWLETT-PACKARD

Editor: Iona M. Smith

Editorial Offices:

1507 Page Mill Road
Palo Alto, California, 94304 U.S.A.

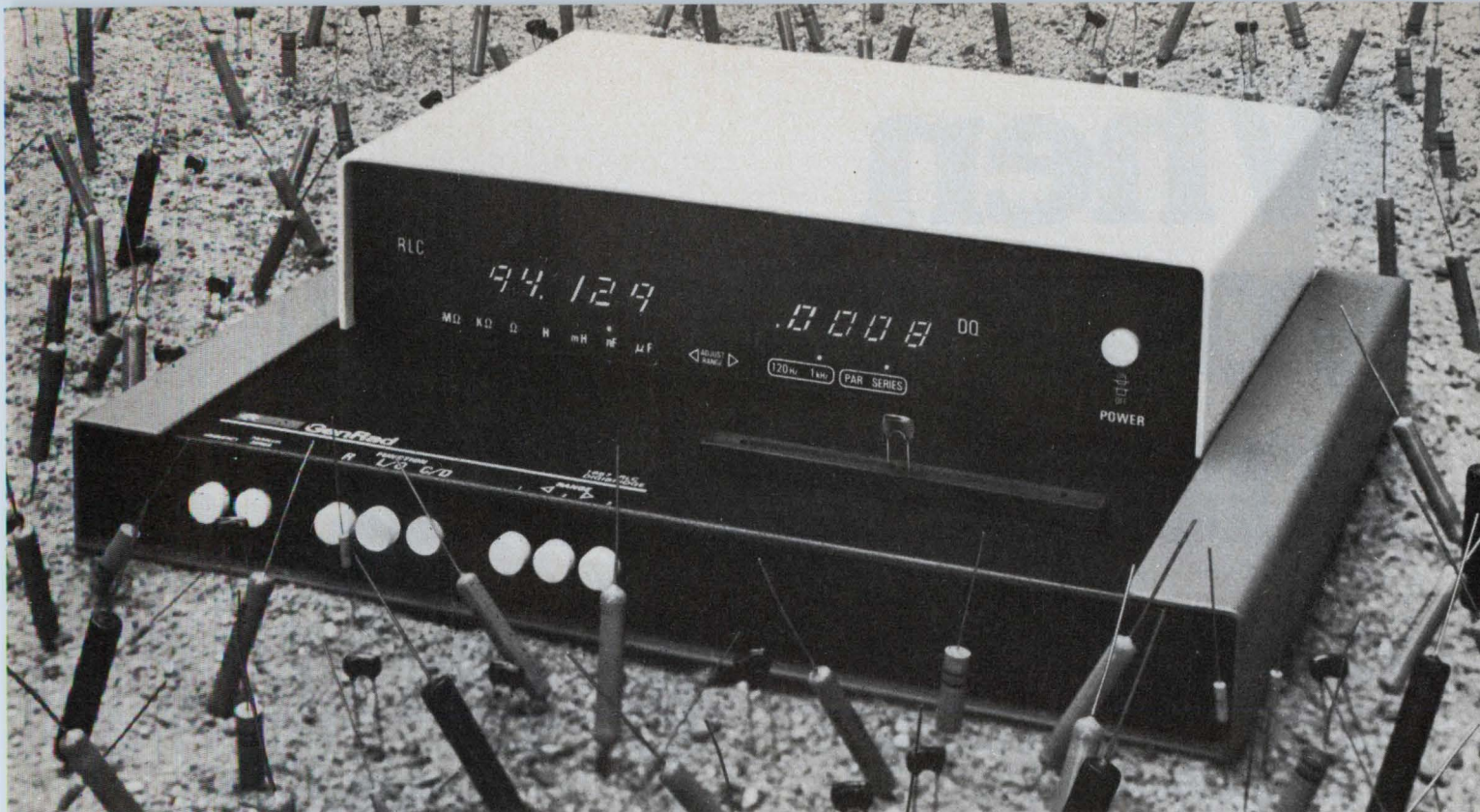

An automatic RLC tester for \$ 995? you've got to be kidding!

There's more to the new GR 1657 RLC Digibridge™ than its low \$995* price. It's designed with features to lower your R, L, and C component testing cost. That's what it's all about — isn't it?

Measures R, L, C, D and Q.

A **microprocessor** performs a combination of measurement and control functions in addition to lowering the GR 1657 unit cost.

Fast testing time of three measurements per second, **unqualified**.

0.2% Accuracy for R, L, and C.

Five full-digit LED display for R, L and C and **four full digits** are displayed for D and Q. All numbers go to 9.

Wide measurement ranges allow you to test a greater number of component values. Test R from 00.001 Ω to 99.999 M Ω , L from 0.0001 mH to 9999.9 H, C from 0.0001 nF to 99999. μ F, D from .0001 to 9.999, and Q from 00.01 to 999.9.

Microprocessor-directed ranging takes the guesswork out of setting the correct range. Lighted arrows on the front panel indicate which range

button is to be depressed and the correct range is identified automatically.

Three range positions provide measurements in multiples of 100, since each range has two full decades of measurement capability, a feature made possible by automatic decimal point positioning.

Automatic decimal point positioning causes the measurement to be made on the lowest possible range, so maximum resolution is always achieved.

Selectable test frequencies of 1 kHz or 120 Hz (100 Hz) are switched by the operator.

Selectable series or parallel measurement modes are operator specified across the full measurement range of every test parameter.

Hi-Rel Kelvin test fixture accommodates axial and radial lead components.

Now you know there's more to the GR 1657 RLC Digibridge than its low price. We're not kidding!

**U.S.A. domestic price only.*



GenRad

When your show must go on,

In an industry where aspiring new IC's emerge daily, it helps to know there's an old pro **D/A converter** you can count on to carry the show.

Our DAC-100, introduced in 1970 as the AIM DAC, is an established performer. Proven in a multitude of applications ranging from avionics to commercial monitoring equipment, it's available in over 50 varieties. There are 4 nonlinearity specs, 2 full scale output options, 4 T.C. choices. Temp ranges include $-55^{\circ}\text{C}/+125^{\circ}\text{C}$, $-25^{\circ}\text{C}/+85^{\circ}\text{C}$, and $0^{\circ}\text{C}/+70^{\circ}\text{C}$.

The DAC-100 cuts heat and cost dramatically without sacrificing speed or performance. Its fast settling time will give you more data per second. So our DAC-100 doesn't need to prove itself a star. It has already played the circuit.

Free App. Notes

We have a great bunch of Applications Notes supporting the Old Pro. We'll be glad to send them to you. Just write, phone or TWX us. The numbers are below.

call in our Old Pro.



Precision Monolithics, Incorporated
1500 Space Park Drive, Santa Clara, CA 95050
(408) 246-9222. TWX: 910-338-0528
Cable MONO.

CIRCLE NUMBER 7



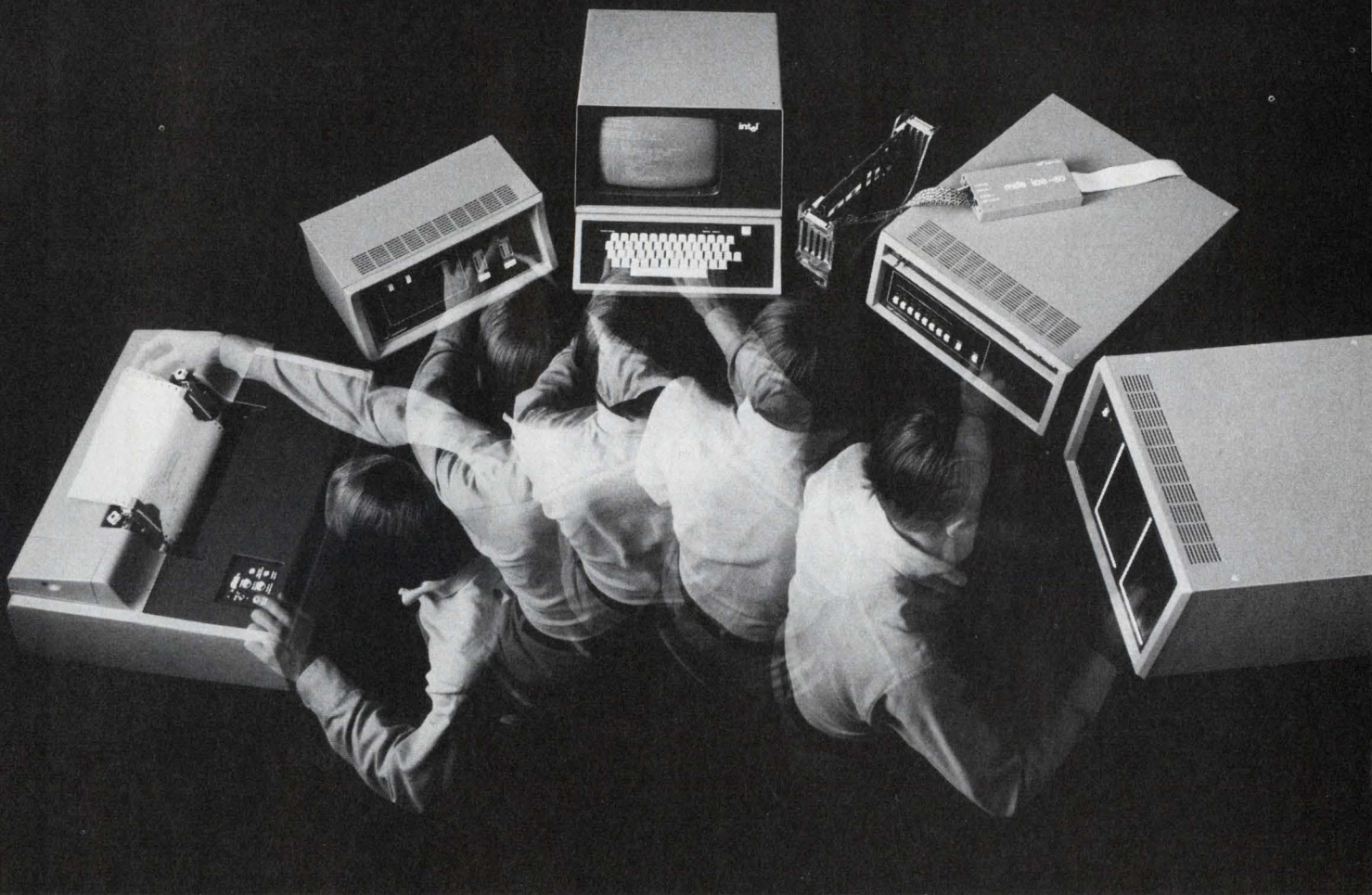

Intel delivers resident PL/M for the Intellec[®] Microcomputer Development System. Say goodbye to monthly computer bills.

Now Intel has a resident PL/M compiler available with the Intellec microcomputer development system. Resident PL/M can give you a competitive edge because it can drastically cut your software development time and help you get new products to market quicker.

Having PL/M resident on the Intellec system means the end of monthly computer time sharing bills too. And eliminates delays waiting for computer availability. It makes it easier than ever to take advantage of a high level programming language.

You can lease an Intellec system for \$610* a month with ICE-80,[™] dual diskette drives,

CRT terminal, line printer and resident PL/M compiler.

Or if you already own an Intellec system you can add resident PL/M for \$975.* Once. Not monthly.

That gives you everything you'll need for fast, reliable programming of Intel[®] 8080 or 8085 microcomputers or our SBC-80 Single Board Computers and System 80 packaged microcomputer systems.

Under the new Intellec ISIS-II diskette operating system, PL/M provides the capability for fully modular programming. This means that programs can be developed and debugged in small, manageable modules,

and easily linked together, or linked with general purpose sub-routines from a software library. And because the Intellec system supports your total development task, you save the cost and inconvenience of separate systems for hardware and software development and systems integration.

To arrange a demonstration of the Intellec system with resident PL/M contact your Intel sales office. For additional information use the reader service card or write Intel Corporation, 3065 Bowers Avenue, Santa Clara, California 95051.

intel[®] delivers.

*Domestic U.S.A. prices only.

CIRCLE NO. 256 FOR TECHNICAL INFORMATION
CIRCLE NO. 257 FOR TECHNICAL INFORMATION AND A DEMONSTRATION

Unmatched portability. Unsurpassed performance.

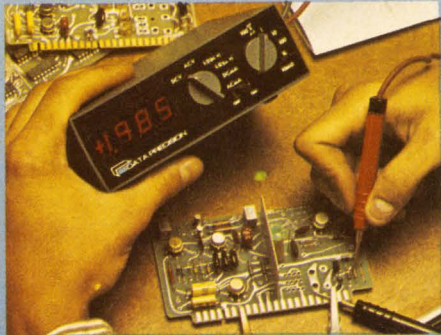

Data Precision's family of miniature portable digital multimeters—Model 175, Model 245, and Model 248—have firmly established our leadership in the field of portable instrumentation.

More performance per cubic inch.

Data Precision's portable multimeters are remarkably small ($1\frac{3}{4}$ " H x $5\frac{1}{2}$ " W x $3\frac{1}{2}$ " D); light, and easy to carry, yet no portable DMM is more accurate.

Each rugged multimeter features a bright, extra large display for easy reading at the bench or in the field, 100% Overrange for optimum resolution, all-electronic Over Voltage Protection, allowing immediate recovery to in-spec operation without loss of calibration accuracy or damage to the instrument, and Tri-Phasic™ Automatic Zero.

The Model 175 3½ digit DMM—\$189.

Model 175 is a 3½ digit full-function multimeter with $100\mu\text{V}$ resolution and a DC accuracy of $\pm 0.1\%$ input ± 1 l.s.d. for one year. Unsurpassed for accuracy and sensitivity, the Model 175 measures: DC Volts from $\pm 100\mu\text{V}$ to $\pm 1000\text{V}$; AC Volts from $100\mu\text{V}$ to 500V (30Hz to 50 kHz); DC Current from $\pm 0.1\mu\text{A}$ to $\pm 2\text{A}$; AC Current from $0.1\mu\text{A}$ to 2A (30Hz to 50kHz); Resistance from $100\text{m}\Omega$ to $20\text{M}\Omega$ in two modes. Hi/Lo Resistance Measurement feature allows in-circuit resistance measurement without turning on semiconductor junctions.

The Model 245 4½ digit DMM—\$295.

The most popular 4½ digit DMM ever made... and with good reason! This 5-function instrument offers a basic DC accuracy of $\pm 0.05\%$ of input ± 1 l.s.d. It measures ACV $100\mu\text{V}$ to 500V RMS, DCV $\pm 100\mu\text{V}$ to $\pm 1000\text{V}$, Resistance to $100\text{m}\Omega$ to $20\text{M}\Omega$ AC and DC Current 1 micro-Amp to 2 Amps, AC voltage and current response, 30Hz to 50kHz.

The Model 248 4½ digit DMM with True RMS—\$345.

No other True RMS 4½ digit portable multimeter combines such high performance, small size, and low price with so many measurement functions. True RMS allows direct measurement of all but the most bizarre analog wave forms. The Model 248's sensitivity is $10\mu\text{V}$ DC and AC, with $\pm 0.05\%$ DC accuracy ± 1 l.s.d., guaranteed for a full year. This high-resolution instru-

ment measures Resistance $100\text{m}\Omega$ to $20\text{M}\Omega$, DC Volts $\pm 10\mu\text{V}$ to $\pm 1\text{kV}$. True RMS AC Volts $10\mu\text{V}$ to 500V , both DC Current and True RMS AC Current 10 nanoAmps to 2A .



No extra costs.

Everything you need to put your Data Precision Portable DMM into immediate service is supplied with the unit. You get the rechargeable NiCd battery module, a pair of test leads, line cord with charger, carrying case, full instruction manual, and test data.

Every Data Precision instrument is furnished with individual test documentation—a complete report on your instrument including temperature test results. No one else does it so thoroughly.

Optional accessories provide even greater versatility.

You can further extend your DMMs capabilities with inexpensive optional accessories, including a high voltage probe, clamp-on AC Current

Portability.

probe, bench stand, rack mount, adapter from standard to mini-banana connection, deluxe leather case and high impact fiberglass carrying case.

All specifications are covered by our one year warranty on all parts and labor. Service and application engineering are available from our worldwide service centers.

For complete information or a demonstration, call your local Data Precision representative or Data Precision Corporation, Audubon Road, Wakefield, MA 01880, U.S.A., (617) 246-1600. TELEX (0650) 949341.

Prices U.S.A.

ELECTRO '77 BOOTHS 1814-16-18

DATA PRECISION[®]
...years ahead



Model 175



Model 245



Model 248

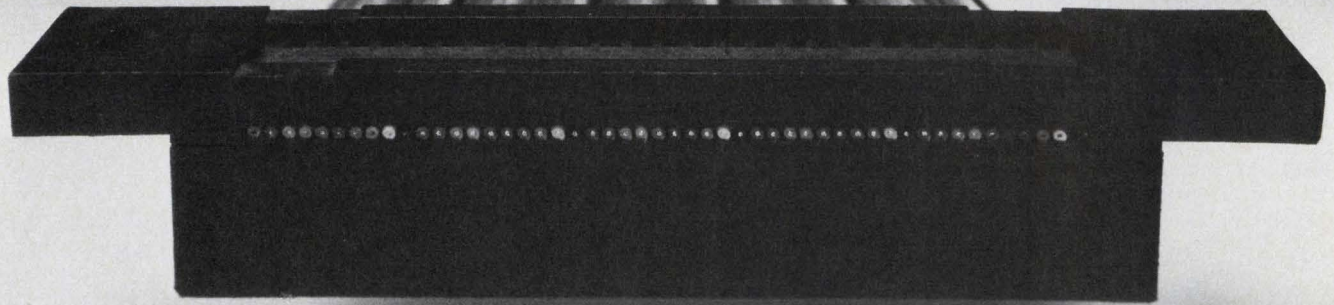

MULTI-TERM: HAPPY ENDING

Putting together a system that uses flat flexible cable? Watch out for these five key factors.

1. Cable Contacts

Insulation displacement requires a sharp edge. Any roughness or irregularity can nick the conductor and weaken it. Only SAE uses precision coining to produce a perfect contact surface.

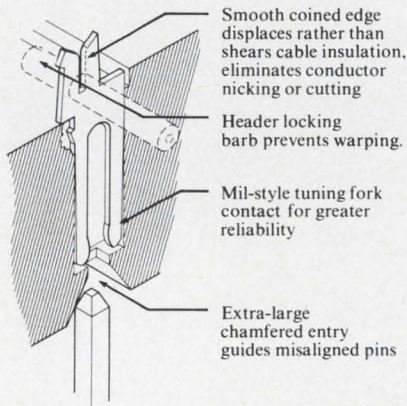

2. Mating Contacts

A lot of systems use a beam-type contact. SAE uses a military-type tuning fork configuration. It grabs the pin and produces maximum electrical reliability.

3. Header Security

Only MULTI-TERM™ contacts have locking barbs that bite into the header at every conductor position. Built-in pre-retention keeps header, contact and conductor securely mated. Vibration resistance is superior, and headers won't warp or bow.

4. Cable Quality

The best termination system in the world can't overcome irregular cable. Specify SAE ribbon cable as part of your system and you'll get more than just economy. You'll get dimensional stability.

5. Production Tooling

MULTI-TERM tooling speeds

production. Alignment is automatic, cuts and terminations are square, and the final result is as pleasing to the eye as it is effective and reliable.

SAE manufactures all the parts. PC connectors, header connectors, I/O headers, 14 and 16 pin DIP connectors and socket connectors. Tooling. Fixtures. Cable. You can buy any component you need.

Better yet, call SAE during your design phase. Let our engineers help work out a complete MULTI-TERM System for your flat cable runs. Your project, and your cable, will have a happy ending.



The OEM Connection

Stanford Applied Engineering, 340 Martin Avenue, Santa Clara, CA 95050. (408) 243-9200. TWX 910-338-0132

APRIL 12, 1977

High-energy electron beam powers 100-kW laser

Promising to be 10 times more powerful and 2.5 times more efficient than the most powerful lasers today, a laser at Stanford University can even be tuned to produce radiation over a broad-band—from 10 μm in the far infrared, through the visible spectrum, to 0.1 μm in the invisible ultraviolet. Conceived by Dr. John M.J. Madey, senior research associate in the Stanford Physics Dept., the laser makes use of a 40-MV electron beam to achieve its special properties.

Until now, the power output and efficiency of all lasers have been limited by having to use solids, liquids, or gases that heat up in the lasing process and waste energy. But with electrons in a vacuum tube, there is nothing to heat up. A high percentage of the energy put into the system comes out as radiation.

Incorporated in a superconducting electron accelerator in the California University's High Energy Physics Laboratory, the laser system operates in a 17-ft vacuum tube made of copper. A magnetic field is generated along the tube's length by a coil of superconducting wire.

When the beams of laser energy and electrons are sent together through the pipe, the laser beam is reflected back and forth between the mirrors, as in conventional lasers. But in the Stanford device, the reflected energy picks up energy from the electron beam each time it passes through the pipe's magnetic field.

In feasibility tests, the energy of a 0.1- μW laser beam was multiplied 100-billion times to produce a 10-kW output. To further boost power and eliminate the energy loss that occurs by "dumping" the electron beam after it has passed through the long tube, the experi-

menters plan to install the laser in an electron-storage ring that will circulate electrons with a small amount of radio-frequency power. In this way, the electrons can be used over and over.

A storage ring with a 1-A, 240-MV electron beam would produce a 100-kW tunable laser, Madey estimates. Its efficiency would be 50% or better. The highest-powered nontunable lasers now available commercially give about 10-kW of coherent radiation. The highest efficiency, 20%, is achieved by carbon-dioxide lasers. Current tunable lasers are only about 0.1 to 1% efficient, Madey points out.

Strongest magnetic field takes little power

"The most intense steady magnetic field ever achieved" has been produced with only 4-1/2 MW of power by a large, superconducting magnet surrounding a smaller, water-cooled magnet. A record-high 254,000 gauss is generated by this hybrid, according to an official announcement by its designer and developer, the Massachusetts Institute of Technology. Roughly 12 MW would have been required of a water-cooled copper magnet with the same size and field.

The superconducting magnet is made of materials whose electrical resistance drops to zero at ultra-low temperatures. Moreover, the only electric power consumed while the device generates its field is that needed to provide cooling.

High magnetic fields are needed to study the properties of improved high-field, superconducting materials and to gain knowledge of semiconductors and the magnetic materials used in a wide variety of other useful devices. High fields are also needed to develop

advanced radiation sources in the submillimeter-wave region of the electromagnetic spectrum.

Construction of the magnet was sponsored jointly by the Faculty of Science of the Catholic University, Nijmegen, the Netherlands, and by the National Science Foundation.

Before sending the magnet to the Netherlands, where it will be used for research, MIT will operate it for scientific studies, notably an attempt to generate a field of 300,000 gauss. Such a field would require 10 MW of power, which can be supplied by the generators in the MIT laboratory. Once a 300-kilogauss field is demonstrated feasible, another magnet will be built.

Jumbo serial memories now off the shelf

Available for some time on a made-to-order basis, two jumbo serial memories can now be bought commercially: a 65-k CCD memory chip and a 92-k bubble memory—both by Texas Instruments in Dallas. Within a year, TI says, much larger versions of both (up to 256-k) will also be sold off-the-shelf.

Grown on a gadolinium-gallium garnet substrate, the magnetic epitaxial film that holds the 5- μ diameter magnetic bubbles has a permalloy metal deposited on it to define the path of the bubbles.

The chip has 157 loops, each consisting of 641 bubble positions. Moreover, as many as 13 of the loops can be defective or not used (spares), which leaves 92,304 bits for actual use.

Dubbed the TBM 0103, the bubble memory operates as a 100-kHz clock, has an access time of 4 ms for the first bit and dissipates about 0.5 W. Since the bubble memory is nonvolatile, it is unaffected by power outages, can operate over a 0-to-50-C range and can hold data from -40 to 85 C. The memory is externally organized as a 92,304 \times 1 bit and comes in a 1 \times 1.1 \times 0.4-in., dual-inline, 14-pin package.

The TMS3064 CCD memory is produced by combining a new two-phase coplanar electrode structure with TI's standard double polysilicon n-channel process. The

structure of the device creates ion-implant storage wells to permit a simple two-phase nonoverlapping clock to be used.

Housed in a 16-pin 400-mil-wide DIP, the TMS3064 65-k CCD chip is organized to look like a $65,536 \times 1$ memory. Internally, the chip has 16 addressable 4-k serial-parallel-serial loops. Worst-case access time at a 5-MHz clock is 800 μ s while the power dissipated is just 300 mW. Standby power is less than 30 mW.

Not to be left out, Fairchild, in Mountain View, CA, has also announced a 65-k CCD memory. Called the CCD464, it has an average access time of 400 μ s and comes in a 300-mil-wide, 16-pin DIP.

For Bubble info **CIRCLE NO. 317**
For CCD info **CIRCLE NO. 318**
For Fairchild **CIRCLE NO. 319**

Iso/instrumentation amp even powers transducer

A combination instrumentation/isolation amplifier can now give designers the best of both—and in a single package. The 3456 isolation/instrumentation amplifier from Burr-Brown, Tucson, AZ, provides not only up to 2000 V of isolation between input and output, but gains of up to 1000.

In addition, the internal dc-to-dc isolated supply used to power the amplifier provides up to ± 10 mA at ± 15 V that can power a transducer. Transformer windings isolate the input amplifier from the power source and from the output; the 60-Hz isolation-mode rejection is 120 dB.

The true instrumentation amplifier used on the 3456 has a three-wire input and can be set, via a single external resistor, for gains of 1 to 1000. Common-mode rejection holds at 110 dB for a balanced load at a gain of 100, and drops to 100 dB for a 5-k Ω unbalance at the same gain. At unity gain, the rejection drops to 80 dB.

At the input, the unit's common-mode impedance is $5 \times 10^9 \Omega$, shunted by 3 pF, and its differential-input impedance is $10^7 \Omega$, shunted by the same 3 pF. The amplifier's 3-dB response points are 2.5 kHz for gains of 400 to 1000 and 1 kHz for 1 to 400.

The amplifier's signal is coupled

via a pulse-width modulated carrier through an isolating transformer at a carrier frequency of 100 kHz. A 0.02% linearity can be attributed to the PWM and an additional demodulator feedback loop that linearizes the modulator's transfer function.

After being coupled through the isolation transformer, the analog signal is demodulated and then buffered by a two-pole active filter that strips away the 100 kHz.

The 3456 is a small module— $2.3 \times 3.5 \times 0.7$ in. and has an operating range of -25 to $+85$ C. Temperature-induced offset voltage drift determines whether to specify the 3456's "A" version, with a drift less than $4 \mu\text{V}/^\circ\text{C}$ at a gain of 100 or the tighter "B" version, with a drift of $2 \mu\text{V}/^\circ\text{C}$.

The 3456/A costs \$109 in lots of 100, the 3456/B slightly more, \$124. Delivery is 4 to 6 weeks.

CIRCLE NO. 316

Second source coming for single-board μ C

The popular SBC 80/10 single-board 8-bit μ C originated by Intel will soon be available from a second source. The BLC 80/10 is being produced by National Semiconductor as well as a family of expansion cards that are plug-compatible equivalents in the Intel family. A complete microcomputer on a 6.75×12 -in. board, the 80/10 includes an 8080A μ P, 4 k of EPROM and 1 k of static RAM.

Since this is the first major μ C to be alternate sourced and many OEMs prefer units backed by two or more suppliers, the 80/10 may now become an industry standard, according to some OEMs.

Although the performance specs from the two Santa Clara, CA, firms are identical, the BLC 80/10 features some design improvements. The cards use jumper plugs rather than wire-wrap switches for on-board selection. Thick-film resistor DIPs replace some of the discrete resistors. Moreover, the total chip count of National's 80/10 is lower—more LSI chips. And whereas the SBC 80/10's dynamic RAMs are soldered, the BLC 80/10's are socket-mounted.

At least three more card types are slated for volume shipments in

the third quarter of 1977: the I/O expansion card, the memory-I/O expansion card, and the 16-k ROM/PROM expansion card. Prices for National's 80/10 and accessories, according to Bill Sweet, National's marketing manager for μ C systems, should be about 10% less than Intel's.

Another interface for IEEE-488 bus

As the popularity of the standard instrumentation interface bus, IEEE-488, increases, so does the number of bus-compatible instruments and systems. For example, a hardware and software package from Digital Equipment Corp. makes it easy to interface the firm's LSI-11 computer systems to the IEEE bus. The IBV-11 consists of a printed circuit board and a cable that ends in a 488-standard connector, along with a software package and sample programs.

"The software is going to make the bus invisible to the user," says John L. Hughes, manager of technical support for the LSI-11 in Marlborough, MA. To tie instruments into systems via the bus, all the user will have to do is program the address of each instrument.

The \$750 IBV-11 does have some limitations, but these shouldn't hamper the majority of IEEE-488 users, says Hughes. While the IEEE standard calls for a maximum data-transfer rate of 1 Mbyte/s, the IBV-11 is limited to 40 kbytes/s. And while the bus is capable of running under the control of a number of computers, calculators, or other devices that transfer management between themselves, the IBV-11 is designed for single-controller systems.

The first lot of DEC interfaces has already been shipped, notes Hughes, and production runs should begin within a month. Hewlett-Packard, which conceived the standard-bus system, has been selling an interface package for its 21MX and 2100-series minicomputers through its Data Systems Division in Cupertino, CA, since last spring. Bob Brannon, the division's product marketing manager, expects other minicomputer makers to introduce interface systems similar to his firm's 59310B.

Now from Amperex— a group of high-performance, 4- and 5-GHz PNP's at prices between \$2.40 and \$3.15.

The ever-growing Amperex line of high-performance, economical, small-signal GHz transistors now opens up still more design possibilities in the GHz region. These six new low-noise PNP's offer the key to both new and retrofit/upgraded circuits for portable pagers and transceivers...for high bit rate communications gear...for high frequency spectrum analyzers and oscilloscopes...for counters...and for CATV/MATV amplifiers.

Like their NPN complements, the six new PNP's have f_T of 4- or 5-GHz at I_C 's from 14 to 30 mA and offer high linearity and low noise; they provide maximum available gain as high as 19 dB. Two of them, the BFR92 and the BRF93 are in the new SOT-23 microminiature plastic

package for high frequency hybrid circuit applications.





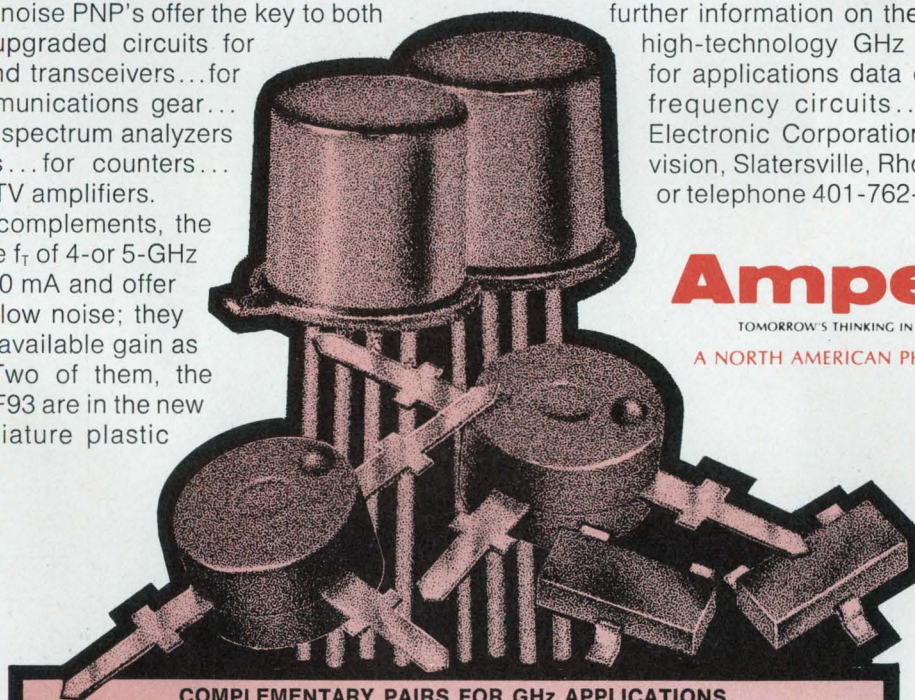

There's simply nothing else like them available at anything like our prices anywhere else today. For further information on the Amperex line of high-technology GHz transistors...and for applications data on PNP's in high frequency circuits...write Amperex Electronic Corporation, Slatersville Division, Slatersville, Rhode Island 02876, or telephone 401-762-9000.

Amperex®

TOMORROW'S THINKING IN TODAY'S PRODUCTS

A NORTH AMERICAN PHILIPS COMPANY



COMPLEMENTARY PAIRS FOR GHz APPLICATIONS				
New PNP Types			Complementary NPN Types	
TYPE	FEATURES	PRICE*	TYPE	PRICE*
A440 (TO-72) 	f_T ... 5 GHz @ 14 mA NF ... 2.3 dB @ 200 MHz G_{max} ... 18 dB @ 500 MHz	\$2.40	A400 (TO-72)	\$1.65
A441 (TO-72) 	f_T ... 5 GHz @ 30 mA NF ... 2.4 dB @ 200 MHz G_{max} ... 14 dB @ 500 MHz	\$2.65	A401 (TO-72)	\$1.75
ON586 (SOT-37) 	f_T ... 5 GHz @ 14 mA NF ... 2.5 dB @ 500 MHz G_{max} ... 19 dB @ 500 MHz	\$2.85	BFR90 (SOT-37)	\$2.25
BFQ23 (SOT-37) 	f_T ... 5 GHz @ 30 mA NF ... 2.4 dB @ 500 MHz G_{max} ... 15 dB @ 500 MHz	\$3.15	BFR91 (SOT-37)	\$2.45
BFT92 (SOT-23) 	f_T ... 4 GHz @ 14 mA NF ... 2.7 dB @ 500 MHz G_{max} ... 17.5 dB @ 500 MHz	\$2.53	BFR92 (SOT-23)	\$2.30
BFT93 (SOT-23) 	f_T ... 4 GHz @ 30 mA NF ... 2.4 dB @ 500 MHz G_{max} ... 15.5 dB @ 500 MHz	\$2.70	BFR93 (SOT-23)	\$2.45

* In 1000 piece quantities

Our fast

low pitch.

SC/MP II microprocessor

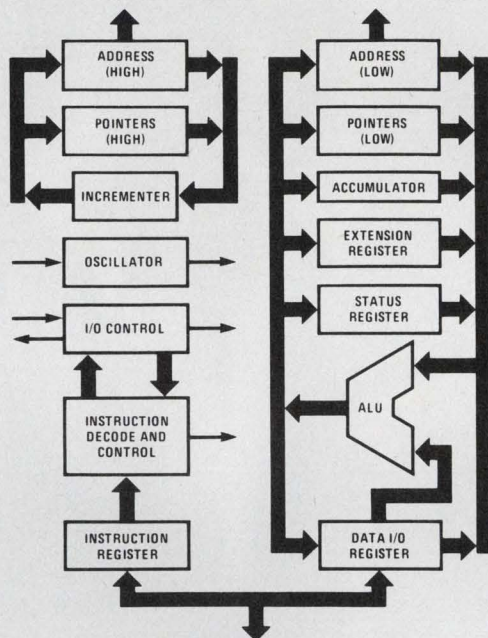

Introducing a new "fast and low" version of our SC/MP: SC/MP II. Fast? *Twice* as fast. And low as you can get. In fact, the lowest-power n-channel MPU on the market. 225mW typical.

Another plus is that it now requires only a single + 5V power supply.

What doesn't change are the things that made SC/MP so almost-irresistible in the first place. Multiprocess-

ing capability built-in, easy expandability, low parts count, built-in serial I/O register, control flags and sense inputs, built-in delay timer instruction, the availability of good design tools, and a training program that teaches you how to use them.

It's available off your distributor's shelf. And of course, it's cheap. (Otherwise, why would we call it our Simple Cheap Micro-Processor?)

And that's our pitch.

National Semiconductor
2900 Semiconductor Drive
Santa Clara, CA 95051

Please send details of your
 SC/MP II (ISP-8A/600D)
 SC/MP II Training Program

Name _____

Company _____

Address _____

City _____

State _____ Zip _____

National Semiconductor manufactures a full line of microprocessors, including the 8-bit INS 8080A, the single-chip 16-bit PACE, the bit-slice 16-bit IMP, the four-bit INS 4004, and low cost COPS microcontrollers.

ED4-12

National Semiconductor Microprocessors

People around the world use
AMP multi-national
connectors.

We speak their language.





And we speak it in many ways. Our entire MI Series Connector line, for example, is designed to true metric dimensions. And that includes everything from contact centers to housing dimensions.

In addition, the MI Series meets the general requirements of national and international testing and approval groups—ranging from UL and IEC to CSA and VDE.

Even more important, wherever you may use MI connectors, in New York or Sydney, you can depend on first-rate AMP technical service. Because AMP has long been a worldwide corporation with major factories and engineering facilities in the leading countries. And that means true in-depth support at home and abroad. Plus practical first hand advice on international technical requirements when you need it.

Even without international technical aid, AMP MI Series Connectors are economical. Because they are part of AMP's exclusive Multimate Family. That means you can use common contacts with a variety of connector families and save on both tooling and inventory.

So if your product plans are international in nature, be sure to get complete information on AMP MI Series Connectors. Just call Customer Service (717) 564-0100. Or write AMP Incorporated, Harrisburg, PA 17105.

AMP has a better way.



AMP
INCORPORATED

CIRCLE NUMBER 14

'Roots' of improving CBs can be traced to varied technologies

Surface acoustic waves now have something in common with a fighter pilot's helmet, and both share something with solar cells. That "something" is citizens'-band (CB) radio. Not only are diverse technologies combining to sustain the explosive growth of CB radio, but they are also advancing the state of the art by providing clever design opportunities for OEMs, both large and small.

One firm, noted for both its radio and semiconductor expertise, has blended its talents to produce an OEM kit for manufacturing CB sets. A 40-channel CB-radio kit from Plessey Microsystems, Irvine, CA, can be purchased, assembled and tested for about \$55. With its high degree of integration—the whole transceiver can be assembled in just 45 minutes and aligned in 15—the CB kit lends itself to automatic-insertion techniques.

Because of the kit's surface acoustic wave (SAW) filters, tuning slugs needn't be used, for the most part. So selective are the SAW filters that fixed inductors replace most of the conventional tuning slugs; only three adjustments have to be made. What's more, SAW filters at the front end help attenuate the superheterodyne image frequency by 40 dB, so a single-conversion receiver can be used. Conventional CB designs use double-conversion techniques (two oscillators, two mixers, two i-f strips), which tend to be costly.

100 dB won't make a difference

The Plessey kit should not be troubled by any hike in the Federal Communications Commission's

specification second-harmonic attenuation.

Because the second harmonic of many CB channels falls right into the commercial TV channels, the Federal Communications Commission rigorously restricts spurious rf emissions from CB transmitters.

Currently, the FCC spec on second-harmonic attenuation is fixed at 60 dB. But many commercial broadcasters feel this is insufficient—they want it hiked to 100 dB to eliminate all interference with their programming. A more plausible outcome is a compromise—perhaps 85 dB.

"Even if the spec does go to 100 dB," says Brian Comer, "it won't affect the kit because the transmission frequency is so clean. The

synthesizer operates 'on channel'."

Moreover, on-channel frequency synthesis results in spectral purity. Without having to mix down, the carrier is less burdened by harmonics and requires less filtering. In the past, "on-channel" synthesis has been avoided because the antenna can feed back into the oscillator and cause excessive frequency modulation. Plessey's kit, however, is so highly integrated that this effect is nil.

Five manual controls are provided—volume, squelch, rf-gain, noise blanker threshold and a 40-detent rotary switch. Selected channel numbers are displayed on two seven-segment LEDs, and an "S" meter provides a measure of the incoming signal strength. By

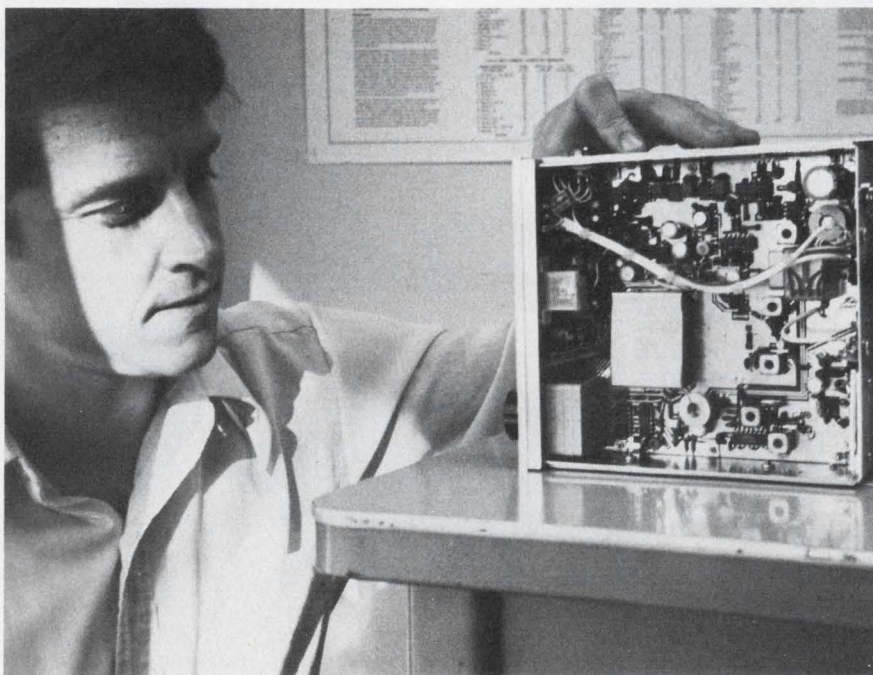

SAW filters and a high degree of circuit integration make this 40-channel CB transceiver "kit" from Plessey Microsystems easy for OEMs to assemble and align. Supplied in a variety of configurations, it incorporates bipolar ECL circuitry, has full 4-W output, accepts power from 11 to 17 V and can be adapted to single side-band operation.

Dick Hackmeister
Western Editor

The CB explosion

Ten-million CB transceivers were purchased in 1976 alone—more than the aggregate number of all sets for the preceding 28 years. "At the present time, one out of every 11 automobiles in the United States has a CB radio in it," says John Sodolski of the Electronic Industries Association. "And by 1980," he predicts, "over half of all the passenger cars, long-haul trucks and recreational vehicles in our country will be equipped with them." There seem to be enough to go around.

sliding a switch, the kit can also be used as a 5-W audio amplifier.

Pilot mike fits the bill

While SAW filters are improving CB tuning, a very small microphone, initially intended for a high-altitude pressurized Navy helmet, is helping to clear up voice transmission. Normally, CB radios are used in high-ambient noise locations. By picking up the wearer's voice through his cheek, the microphone, developed by JMR Systems, Salem, NH, bypasses ambient noise. A small acoustic chamber isolates the mike from the surrounding air and noise.

Although the wearer's voice encounters a great deal of distortion while passing through his cheek, the mike is designed to compensate acoustically. The audio signal detected by the microphone is amplified by a built-in FET that matches impedance, too. An external 7-V battery is used to bias the FET. The system costs \$70.

An active signal-booster antenna called the "solar hot rod" uses solar energy from eight solar cells to power itself and provides an additional 20-dB gain to the front end of a CB or any other vhf radio receiver.

A red, plastic housing passes solar energy to the solar cells, whose peak response is in the infrared region, centered at 900 nm. Cloud cover has little effect on this wavelength; what's more, direct sunlight is not required for the antenna to operate.

A number of struts inside the dome support the antenna itself

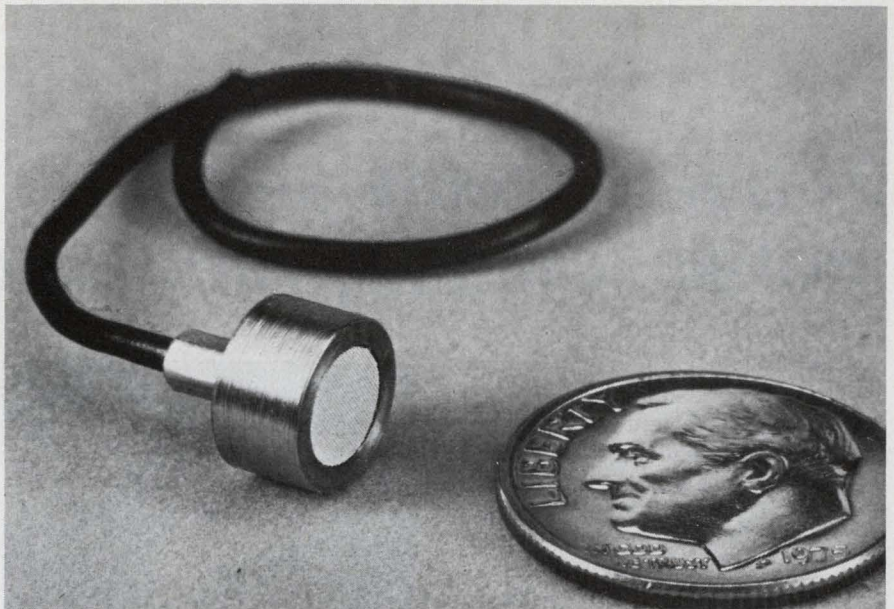

This microphone used by Navy pilots inside their pressurized helmets is well suited to CB radio, which is used in cars and trucks. Mounted in a small acoustic chamber, it touches the wearer's cheek and picks up his voice through skin contact, while bypassing most of the ambient noise.

(see photo). These struts are shaped in such a way as to integrate the full day's sunlight without additional circuitry. Peak responses occur early in the morning and late in the afternoon. The overall effect is to extend the solar cells' useful daytime duty cycle.

"The solar array produces about 20 mW—more than 60 times the power required to run the booster," says inventor Dan Roberts, who is

also president of Raymalee, Inc., El Paso, TX. "Excess power is stored in a NiCd battery, which alone can run the unit for six weeks."

Generating direct current, solar energy is a particularly noise-free power source, well suited to noise-sensitive applications and remote, unmanned installations: The whole assembly looks like a passive antenna, and costs \$50. ■■

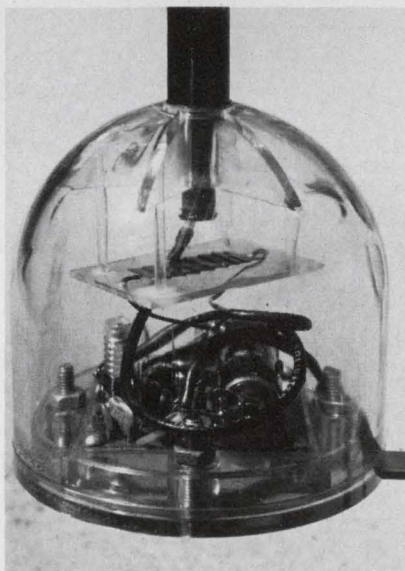

Eight solar cells provide more than enough energy to power this CB-booster antenna. Incoming signal strength is hiked by 20 dB and the receiver's overall noise figure improved. Support struts inside the dome focus the sun's morning and afternoon IR rays onto the cell array, and improve the duty cycle. Red plastic dome conceals active elements and passes solar energy at 900 nm.

Rf beam welds and cuts metals, ceramics and cement

Slowly but surely, an rf-generated, electron-beam torch that can boil ceramics, cements and metals in one to 10 seconds has been gaining in reputation—and users. Known and patented as the Energy Beam, and developed by Energystics, Inc., Toledo, OH, the device can weld, fuse and cut ordinary material ranging from cast iron and steels to such exotic materials as titanium and tantalum. Any of the metals can be welded together, or to materials as dissimilar as cement and ceramics.

The system is more efficient than a laser, according to Thomas E. Fairbairn, inventor of the Energy Beam and Energystics' senior vice president of research and development. It requires only 18-kW input to yield 10-kW output, while a typical laser requires 100-kW input for 10-kW output. But they work well together as a team, Fairbairn adds, to perform such operations as welding, brazing, heat treating and hole drilling "at efficiencies that can't be approached by a laser alone."

Not a follower

While not entirely understood in principle, the Energy Beam has been described by Dr. D. B. Fenneman, a theoretical physicist, as "a totally new technology that does not follow the physical characteristics of other known technologies," and is set apart from any other concepts of energy transfer.

"The Energy Beam," adds Fenneman, who works at the Applied Technology Branch of the Naval Weapons Center, China Lake, CA, "represents a high-pressure, radio-frequency discharge plasma that serves as a conduit to carry and focus rf energy."

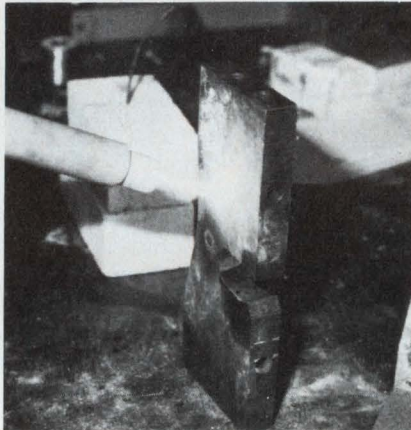

Energy Beam output of 4 kW directed at a 3/4-in.-thick plate of low-carbon steel causes a bright red-yellow molten spot in less than five seconds.

The process begins with an rf generator that converts electricity to 13.56-MHz radio waves, which are beamed and directed along a copper coil. At a certain point along the coil, the rf energy is drawn off to a nozzle, which is basically a tube within a tube—the inner one acts as an electrode while the outer one, which is ceramic, carries the gas enclosing the energy emitted by the electrode.

The beam itself is relatively cool and has no combustion properties. Heat is caused by energy released from the work material impinged by the beam. The temperature level depends on the characteristics of the material. For example, the beam raises a 1-in.

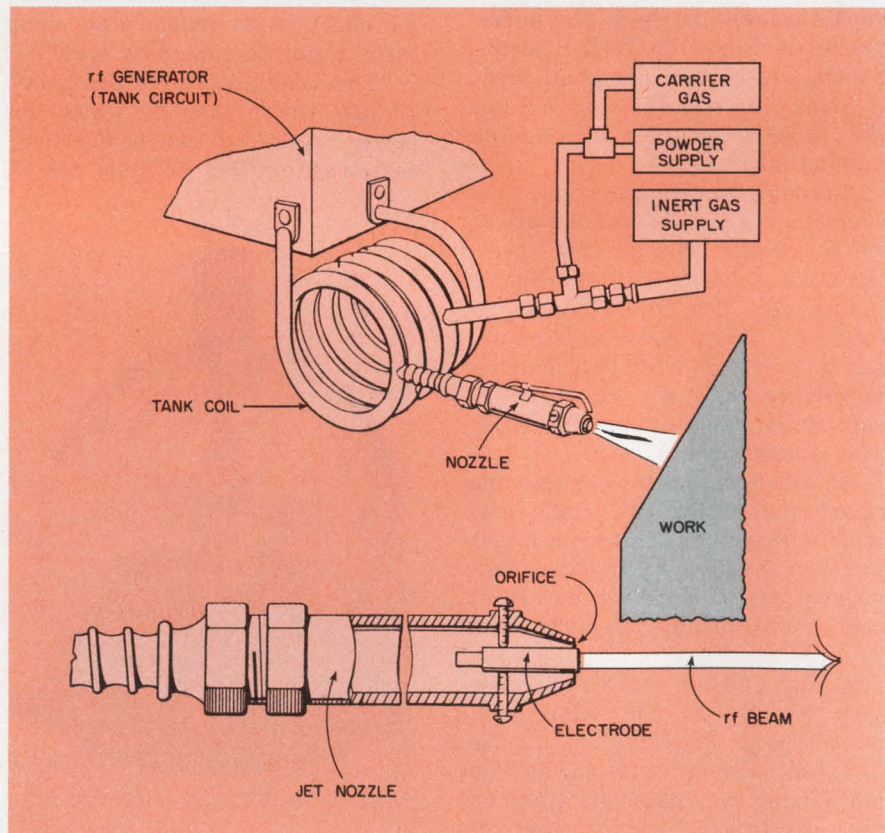

An rf generator converts electricity to 13.56 MHz radio waves, which are directed through a copper coil containing gas. At a certain point along the coil, the rf energy is drawn off to a nozzle, which is basically a tube within a tube—the inner one, an electrode; the outer, for gas.

Here's how Data General's NOVA 3/D system stacks up against the competition.

Systems Software:
Multitasking real-time disc operating system, FORTRAN IV, Extended BASIC, ALGOL, SORT/MERGE, and Utilities.

NOVA 3/D Processor:
Hardware-protected dual partitions, 700-nanosecond arithmetic operations, 48K-word MOS memory with parity, RTC, and APL.

Video Display:
1920-character screen, upper/lower case characters, detached keyboard, numeric keypad, programmable function keys and character highlighting, display rotates on two axis.

Cabinet:
72-inch high, holds all rack mounted components.

DASHER Terminal Printer:
60/30 cps; 132-columns; typewriter keyboard, upper/lower case.

Diskette Subsystem:
315KB for program/data interchange, diagnostics and software distribution; convenient, industry-standard offline storage.

Cartridge Disc Subsystem:
10 megabytes (5 fixed, 5 removable); 50 ms. average access time, shares controller with diskette.

\$37,610
List*

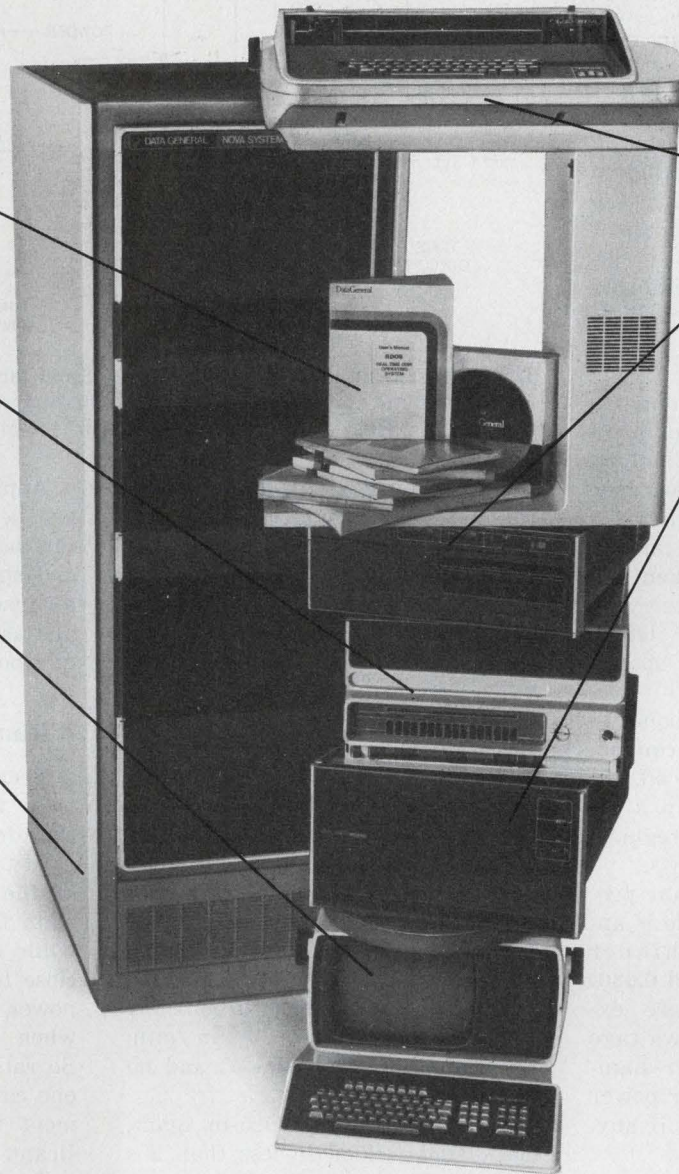

The facts speak for themselves. For \$37,610, Data General's new NOVA 3/D gives you more system, software and support than any comparable computer. And we deliver in 60 days.

Any way you look at it, it all stacks up in your favor. For more information and our brochure, call or fill out and return the coupon.

*Quantity and OEM discounts available.

Data General, Westboro, MA 01581
Sounds like smart business. Send me more information.

NAME _____
TITLE _____
COMPANY _____
ADDRESS _____ TEL. _____
CITY _____ STATE _____ ZIP _____

NOVA is a registered trademark of Data General Corporation.
DASHER is a trademark of Data General Corporation.

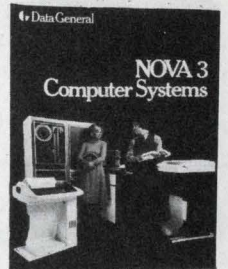

Data General
It's smart business.

Data General, Westboro, MA 01581, (617) 485-9100. Data General (Canada) Ltd., Ontario. Data General Europe, 15 Rue Le Sueur, Paris 75116 France. Data General Australia, Melbourne (03) 82-1361.

CIRCLE NUMBER 15

segment of a 1/8-in. tungsten rod to the vaporization point, 5970 F, from ambient temperature within one second at 3-kW rf-generator output.

Gas combinations heat it up

"The Energy Beam has generated temperatures sufficiently high to melt the most heat-resistant materials we could find, including tungsten, platinum, alumina refractory and silicon refractory," says Fairbairn. What's more, certain combinations of gases improve the system's welding capability enough to either reduce or oxidize work materials.

In some cases, helium alone is best. But other gases, when introduced either alone or with helium, boost the system's performance substantially. One combination, for example, called Energen, capitalizes on properties of hydrogen and carbon dioxide to produce very clean welds in mild steel. Other mixtures are under test for special applications.

The Beam does not respond to magnetic fields, but it is a conductor. It also turns on and off instantly and operates quietly. Controllability is achieved by regulating power input or gas flows.

The diameter of the beam produced with a standard nozzle is approximately 5/32 in. Thinner beams are being studied and 0.030-in.-to-0.050-in. diameters are expected. Work with higher-wattage units indicates that larger-diameter beams carrying greater power are feasible, but the limits, if any, have yet to be determined.

Penetration with a standard 5/32-in. beam operating for 15 seconds at 2 kW on 1/2-in. thick cast iron will produce a melt zone approximately 3/8 in. to 1/2 in. in diameter and 1/16-in. deep. Directed at an alumina refractory brick

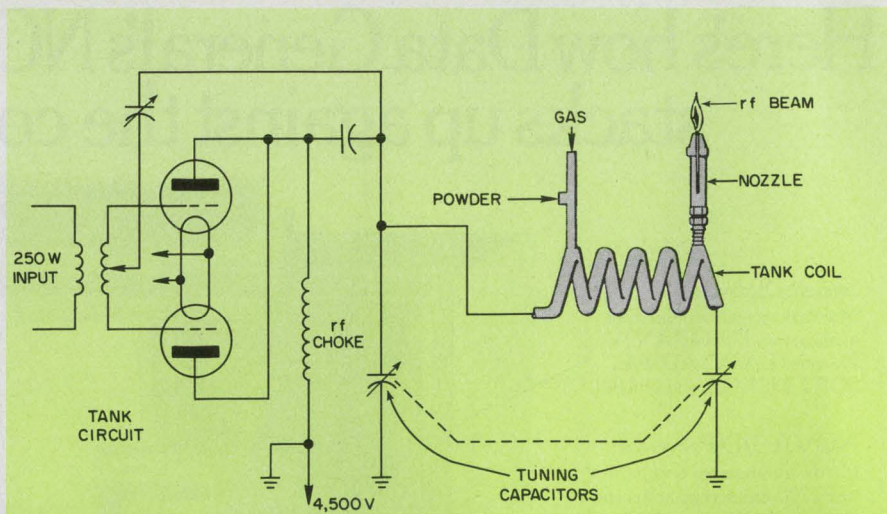

The rf generator consists of a conventional tank circuit modified to operate with the tank coil, which conducts very high currents. A key factor is the number of turns in the tank coil which is selected to maximize output power.

for 15 seconds at the same power, this beam will produce a melt zone with the same diameter and 1/4 in. to 3/8 in. deep.

Typical power densities are in the range of a megawatt/cm² when the Energy Beam operates at 10 kW incident-input power, and its nozzle, equipped with a 5/32-in. electrode, is 1/2 in. from the work-piece.

The following are some examples of welding performance recorded by the company:

- Multiple 1/16-in. thick plates of 1010 steel edge—welded 24 in./min. with Energen gas, 2 kW, and no oxidation.
- Two 1/4-in. thick carbon-steel plates—edge-welded 20 in./min. with Energen gas, 3.5 kW, and no oxidation.
- Tantalum wire 0.025-in. diameter—spot welded in less than 2 s with Energen gas, 750 W.
- Titanium butt less than 0.2 in. thick butt—welded 18 in./min. with helium and 2 kW.
- Two 0.040-in. aluminum strips—welded 30 in./min. with helium, 4 kW.

Applications other than welding are being studied, including heating both residential and commercial space, making spectrochemical analyses of a variety of substances, and assisting in propulsion systems and pollution control.

A team player, too

Because the Energy Beam and a laser work well together, a weak, therefore inexpensive, laser can be used to let the rf beam carry most of the load. The average cost per watt for the Energy Beam is \$5, while a laser's cost per watt runs close to \$50. But the laser's higher power requirements are kept low when the two are used together. So rather than buy a 10-kW laser, one can use a 2-kW laser and augment its power with the Energy Beam.

Typical prices for the systems are \$25,000 for a 5-kW system, \$36,000 for a 10-kW, and \$45,000 for a 15-kW. All these systems include rf generator, coaxial cable, network module, standard nozzle and gas-flow meters. ■■

CMOS puts new a/d technique ahead of dual-slope method

An analog-to-digital conversion method based on pulse-duration modulation does the same digitizing job as the dual-slope method usually used in digital-panel meters—but

takes better advantage of the capabilities inherent in CMOS technology.

The dual-slope approach requires linear circuits—an integrator and

a comparator—that are more difficult to produce in CMOS. But the pulse-width approach, developed by National Semiconductor, Santa Clara, CA, for use in an innovative

three
The ~~one~~ and only...

Three Series of Amphenol® connectors are now qualified to MIL-C-26482, MIL-C-38999 and MIL-C-83723.

One company offers connectors qualified to all three specs—Amphenol Connector Systems, Bunker Ramo Corporation.

These three connector series are preferred under military standard MIL-STD-1353A. They're designed for general-purpose and high-density applications in ground-support and airborne equipment.

Polymer retention is a big plus. Each of these Amphenol connectors uses a one-piece, molded polymer retention disc. (It's an advanced design we pioneered. For a closer look at how it works, see the cross-sectional view at lower left.) Polymer retention eliminates as many as 128 troublesome metal clips. And you know the fewer parts there are, the less can go wrong.

To learn more, call or write. Ask about the wide range of shell sizes, insert arrangements and termination tooling available for the Amphenol Connector 118, 418 and 518 Series. And ask for a free catalog, too. Call Vince Pusateri, (312) 986-3761. Or write: Amphenol Connector Systems, Bunker Ramo Corporation, Dept. C47A, 900 Commerce Drive, Oak Brook, IL 60521.

MIL-C-83723/Series III
Amphenol Connector 518 Series

MIL-C-38999/Series I & II
Amphenol Connector 418 Series

MIL-C-26482/Series 2
Amphenol Connector 118 Series

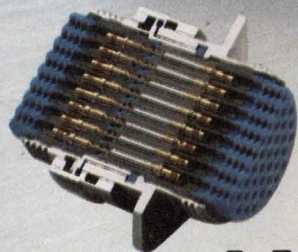

The right idea
at the
right time.

AMPHENOL Connector Systems **BUNKER RAMO**®

CIRCLE NUMBER 16

Protection that adds value . . .

What's your handle?

We want to make you look good. So we've designed our circuit breakers with the industry's broadest selection of handle styles and colors.

Rather than hiding fuses or cheap thermal breakers, you can put a Heinemann hydraulic-magnetic breaker right on the front panel, where it can double as a power switch...just one more way our products add value to your products.

And one more reason Heinemann is No. 1 in OEM circuit protection for everything from computers to coffee machines. Not just for overcurrent and short circuits, but also for overvoltage, undervoltage, and a surprising variety of switching, calibration, and control functions.

Ask for your Protector Selector—a handy reference chart loaded with specs, capabilities, and dimension drawings for twelve top-selling protector lines (of which our Type J series, shown below, is but a single example). Contact your nearby Heinemann representative (listed in EEM) or Heinemann Electric Company, Trenton, NJ 08602. (609) 882-4800.



Ours is Flip, Rock, Push, Switch, and Color-Me-Red.



another reason Heinemann
is No. 1 in
OEM circuit protection.



HEINEMANN

We keep you out of trouble.

Factories in Trenton, Montreal, Dusseldorf,
Johannesburg, and Melbourne.



...and you can
get breakers
fast from these
Heinemann
stocking
locations.

California, Burlingame 94010

G. O. Johnson Co., Inc.
840 Mahler Road
(415) 697-2965

California, Woodland Hills 91367

POCO Sales
6311-F DeSoto Avenue
(213) 999-0171
Telex 69-1603

Illinois, Chicago 60646

NEDCO Electronics, Inc.
6232 N. Pulaski Road
(312) 286-5565

Maryland, Baltimore area

Automation Industrial Control
9070 Chevrolet Dr., Box 627
Ellicott City, MD 21043
(301) 465-3616

Michigan, Detroit area

Michigan Lectrols Corp.
24301 Telegraph Road
Southfield, MI 48034
(313) 353-1350
TWX 810-224-4654

New Jersey, West Trenton 08628

Automation Controls & Equipment
210 Scotch Road, P. O. Box 7153
Toll-free: (800) 792-9738 or
(800) 257-9085

North Jersey/New York City area

Power/Electro Supply Co., Inc.
P. O. Box 306
Ridgewood, NJ 07451
(201) 444-6990
N.Y.C. no: (212) 964-4640

New York, Binghamton 13902

Harvey Electronics, Inc.
P. O. Box 1208
(607) 748-8211

North Carolina, Charlotte 28204

Joyce Sales Company
P. O. Box 4245
(704) 377-1555

Ohio, Cleveland area

Radio & Electronic Parts Corp.
6835 Cochran Rd.
Solon, OH 44139
(216) 248-8900

Ohio, Dayton 45401

Duellman Electric Company
131 Wayne Ave., Box 771
(513) 461-5010

Oregon (see Washington area)

Texas, Dallas 75231

Hall-Mark Electronics Corp.
9333 Forest Lane
(214) 231-6111

Washington, Seattle area

J & A Sales
7616 S.E. 24th Street
Mercer Island, WA 98040
(206) 232-0463
From Portland: (503) 222-2662

HEINEMANN
We keep you out of trouble.

© Heinemann

6850

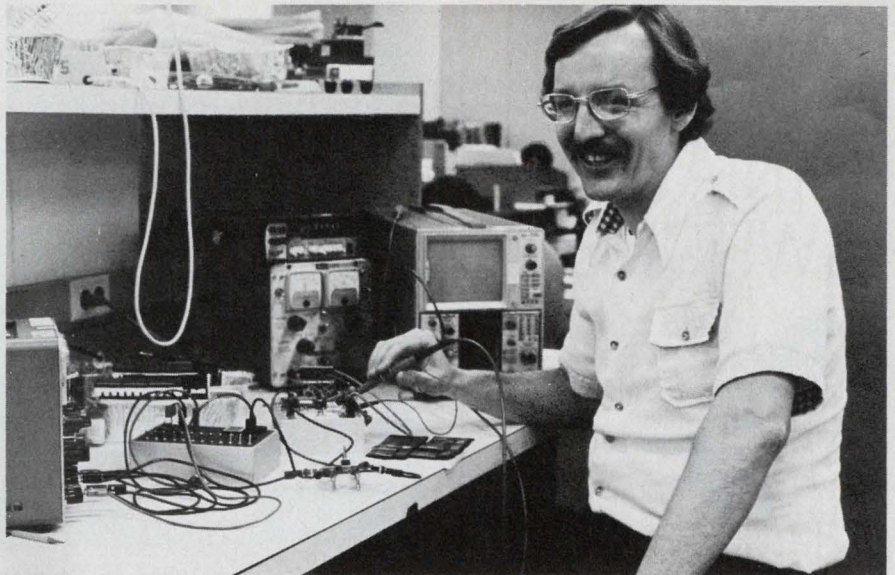

"CMOS is good for switching, poor for linear, so even in the comparator we maximized the use of switching circuits," explains Tom Redfern, the National Semiconductor staff engineer who invented a new a/d conversion method based on pulse-duration modulation.

CMOS DPM chip, eliminates virtually all linear circuits. It uses a comparator made up of CMOS inverters that are similar to those used in CMOS digital logic, and integrates with digital circuits by counting pulses.

Like the dual-slope technique, the new method integrates the input signal to reduce measurement errors due to noise and 60-Hz contamination of the signal. But while the dual-slope method uses an opposite-polarity reference, the new method uses a reference voltage of the same polarity as the signal to be measured. Consequently, the pulse-width method is better for applications that can use a single power supply for both transducer excitation and the reference source.

Start with the output counters

Fig. 2 illustrates how the new a/d method measures a voltage. Counter 2 sets the duration of each a/d conversion by accumulating 2000 consecutive pulses of the clock, f_{IN} . Counter 1, which feeds information to the LEDs via a ROM, obtains the numeric value of the measured voltage by accumulating the clock pulses passed by the gate. The key input to the gate is Q, from the Q flip-flop. Its transitions are at clock times, but its average duty cycle is proportional to V_{IN} .

Slaving the duty cycle of Q to the magnitude of V_{IN} is the responsibility of the oscillating analog loop made up of the comparator, the Q flip-flop, and the pair of switch transistors, SW_1 and SW_2 . During the conversion, the analog loop makes the feedback voltage, V_{FB} , closely approach V_{IN} . The loop keeps flipping between opposite states—makes V_{FB} oscillate around V_{IN} —while remaining within a fraction of a millivolt of V_{IN} .

Making the connections

The spot-switch pair connects R first to the reference voltage V_{REF} , then to ground. Since feedback voltage V_{FB} is the RC-filtered output of the switch, it is controlled by the duty cycle of Q. Each clock time, the comparator decides whether Q should be on or off to keep V_{FB} tracking V_{IN} with the smallest error.

In this way, the comparator forces the average duty cycle of Q to approach the ratio of the clock pulses, V_{IN}/V_{REF} , which is gated into Counter 2.

The complete measurement takes 100 ms when the clock frequency is 20 kHz. The actual master clock, which may be generated on the chip or externally supplied, is 640 kHz, from which the 20-kHz rate is derived. To develop the various tim-

RCL MINIATURE SWITCHES...

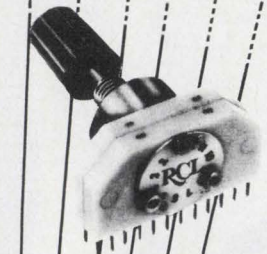

...ON
THEIR
WAY
TO YOU
IN
HOURS
NOT
MONTHS

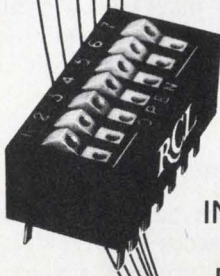

INDUSTRY'S
BEST
DELIVERY!

Send For New '77 Catalog or Call
our Hotline For Name Of Your
Local Representative Or Stocking
Distributor.

(201) 374-3311

AMF

RCL Electronics

General Sales Office:
700 So. 21st Street
Irvington, N. J. 07111

CIRCLE NUMBER 20

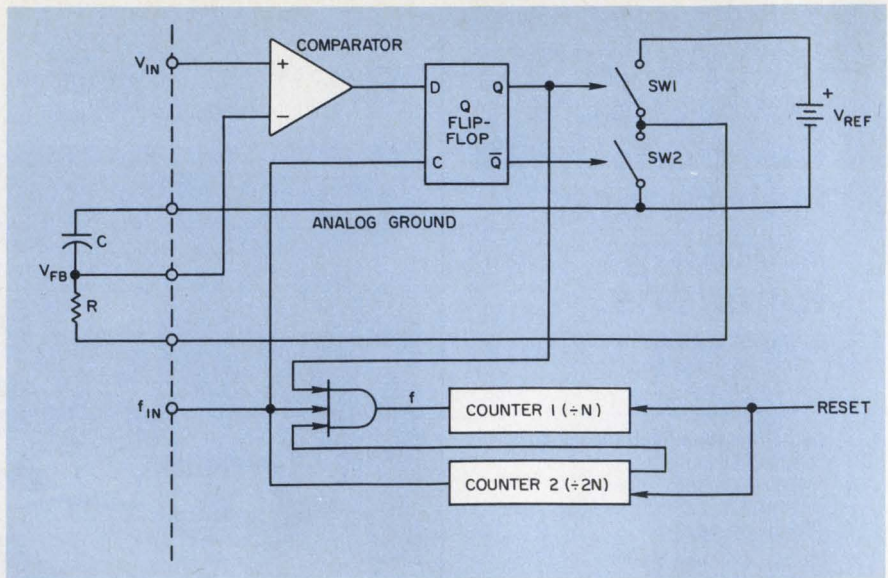

Number of pulses gated to Counter 1 (output value) is controlled by the duty cycle of a clocked Q flip-flop; the duty cycle is slaved to input voltage.

ing signals for the comparator, the 640 kHz is divided by 8. One of the eight 80-kHz outputs is further divided by four by prescalers at the inputs of Counters 1 and 2.

The successive-approximation

method of a/d conversion is faster than either dual-slope or pulse-width methods. But it is rarely used for DPM applications because it lacks the noise-reduction advantage of an integrating approach. ■■

Magnetic shielding strengthened 'softly'

A glassy magnetic material has been developed that prevents the substantial drop in permeability that usually occurs when objects are magnetically shielded with conventional, grain-oriented material. The amorphous material—Metglas 2826, produced by Allied Chemical's Metglas Products Division in Florham Park, NJ—demonstrates an excellent magnetic stability under handling and forming operations that would normally reduce the permeability of competitive, grain-oriented materials as much as 50%. Such a reduction requires costly annealing to bring the permeability back to its maximum values.

Soft but strong

Metglas 2826's permeability and yield strength are much better than, for example, the conventional 80%-nickel alloy's. As fabricated, the former has a permeability

of 65,000 H/m and a value of 300,000 H/m when annealed at 325 C. The latter must be hydrogen-annealed at 1200 C to attain a permeability of 275,000 H/m. Furthermore, Metglas 2826's yield strength is 250,000 psi—the 80%-nickel alloy's is 25,000 psi.

The highly permeable Metglas 2826 gets its amorphous structure from a rapidly quenched iron-nickel-phosphorus-boron alloy ($\text{Fe}_{40}\text{Ni}_{10}\text{P}_{14}\text{B}_6$) that is mechanically strong and ductile. The rate of cooling ranges from 10^3 to 10^6 deg/s. Consequently, the material must be fabricated in thin, ribbonlike sections, which are 2 mils thick and 70 mils wide.

To form shielding, the Metglas ribbons are woven into a flexible 7-in.-wide fabric that is coated with epoxy. Increased shielding can be obtained by using two or more layers. The maximum temperature at which Metshield can be used is 100 C. ■■

CIRCLE NUMBER 21 ►

The \$5⁸⁸ circuit breaker. Lower cost protection than the \$1³⁷ fuse.

A fuse is destroyed with the first overload. It must be replaced. Not so with our Mini-Mag Circuit Breaker. It is there, protecting the circuit, again and again. Fast enough to protect solid state switches, too, because it is current, not temperature, sensitive.

When a fault in a circuit occurs, the Mini-Mag's toggle goes to "off," indicating a problem. Not so with a current-limiting fuse. A technician must make voltage and resistance checks to see if the fuse has indeed blown. That can mean a lot of expensive downtime.

Our Mini-Mag merely requires resetting. In the event a line surge caused the problem, your

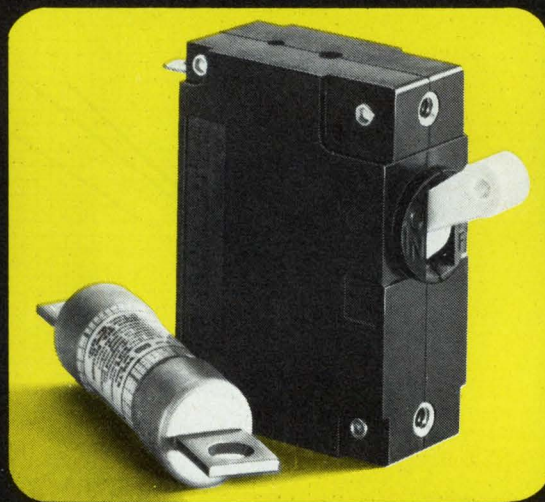

equipment is back on-line. If a short exists, the breaker will open, virtually instantaneously. What's more, it will stay open even though the toggle is held in the "on" position. That's protection!

Potter & Brumfield Mini-Mag circuit breakers, UL and CSA recognized, can add an important selling feature to your products. Get the full story from your

P&B representative or more than 100 authorized distributors. Or call Potter & Brumfield Division AMF Incorporated, 200 Richland Creek Drive, Princeton, Indiana 47671. 812/386-1000.

AMF
Potter & Brumfield

Potter & Brumfield

MOS MEMORY



OUR NEW 4027 IS GOING TO PUT A LOT OF 4K RAMs OUT TO PASTURE.

Introducing Fairchild's M4027.

The only pin-for-pin, spec-for-spec, function-for-function official alternate source for the MK4027 MOS RAM memory.

As you know, the MK4027 is the ultimate successor to the industry standard 4096 memory series.

Since Fairchild has been a major supplier of the 4096 memories for years, it stands to reason we'd produce their successor.

A FAST WAY TO SAVE MONEY.

The new M4027 is the most cost-effective 4K dynamic RAM on the market. It has a smaller die requiring fewer processing steps, which results in higher yield and lower cost than previous 4K RAMs. It is specifically designed for high-speed applications where performance of other 4K RAMs is insufficient.

The new memory offers access times in the range of 150 ns to 250 ns.

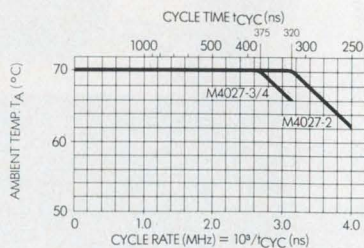
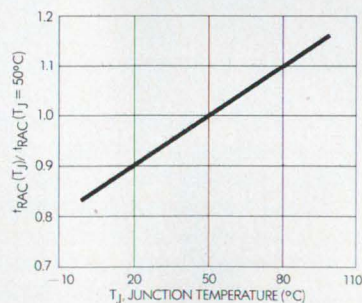
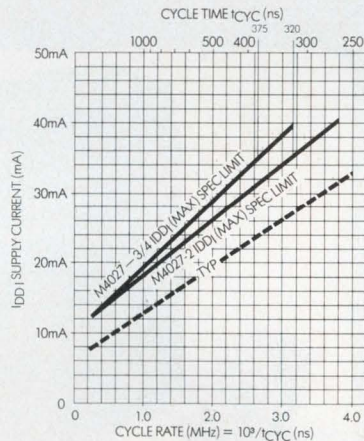

Also, it is the only 4K RAM that offers true 16K RAM compatibility.

And speaking of compatibility, you should see how it gets along with the 4096.

In most applications an M4027 will plug directly into a 4096 socket. Here are a few specs to whet your appetite:

M4027 SERIES COMPARED TO 4096 SERIES DYNAMIC RAMs				
Parameter	4096 Series	M4027-2	M4027-3	M4027-4
Access Time Range	250-350 ns	150 ns	200 ns	250 ns
Row Address Hold Time Range	50-80 ns	20 ns	25 ns	35 ns
Column-To-Row-Strobe Lead Time Range	-50 to +50 ns	$\overline{\text{CAS}}$ can stay LOW to end of cycle.		
Clock High Voltage Minimum	2.7 V	2.4 V	2.4 V	2.4 V
Input High Voltage Minimum (Except Clock)	2.4 V	2.2 V	2.2 V	2.2 V
Page Mode Operation?	NO	YES	YES	YES
" $\overline{\text{RAS}}$ -Only" Refresh Cycle?	NO	YES	YES	YES

A SCHMOO PLOT BIG ENOUGH TO DRIVE A TRUCK THROUGH.

What we did is take the guaranteed specs and surround them with more performance than you'd normally expect out of a 4K RAM.

The schmoos comes out looking like this:

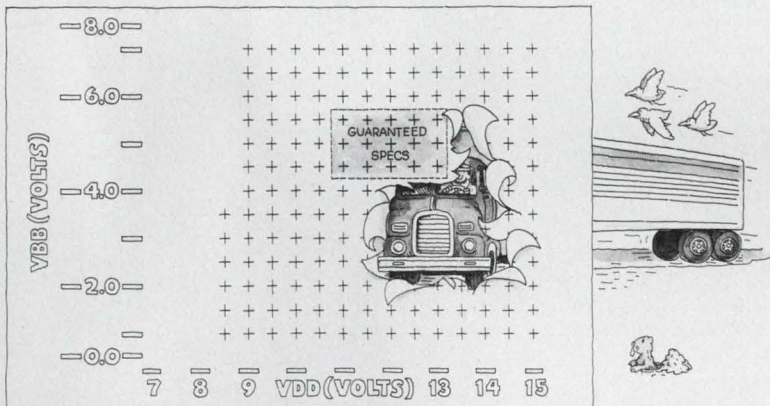

BUY SECOND SOURCE FIRST.

For immediate delivery of more information or products, write or call your favorite Fairchild distributor, sales office or representative today. Or use the direct line at the bottom of this ad to reach our MOS Division. Fairchild Camera & Instrument Corp., 464 Ellis Street, Mountain View, California 94042. Tel: (415) 962-3941. TWX: 910-379-6435.

FAIRCHILD

**CALL US ON IT.
(415) 962-3941**

BENDIX BRISTLE BRUSH BUNCH.

Opens new horizons for PCB design.

Free and easy are now the bywords for board and board support design with the 70% to 90% reduction in mating and unmating forces offered by the new Bristle Brush Bunch connector series from Bendix.

The need for costly board support systems is minimized.

You get extended interconnection contact counts and versatility—up to 400 contacts per connector.

You can choose from a broad product line:

- 2-, 3- and 4-row Mother Board, Daughter Board, PC receptacle and Input/Output body styles.
- Removable crimp, solderless wrap, straight or 90-degree PC stud and willowy tail termination.

For complete information, contact The Bendix Corporation, Electrical Components Division, Sidney, New York 13838.

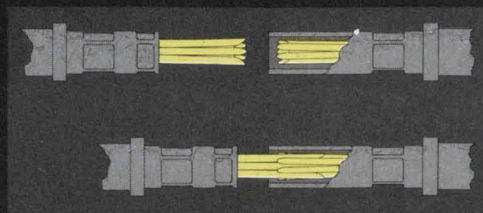

CONTACT INNOVATIONS

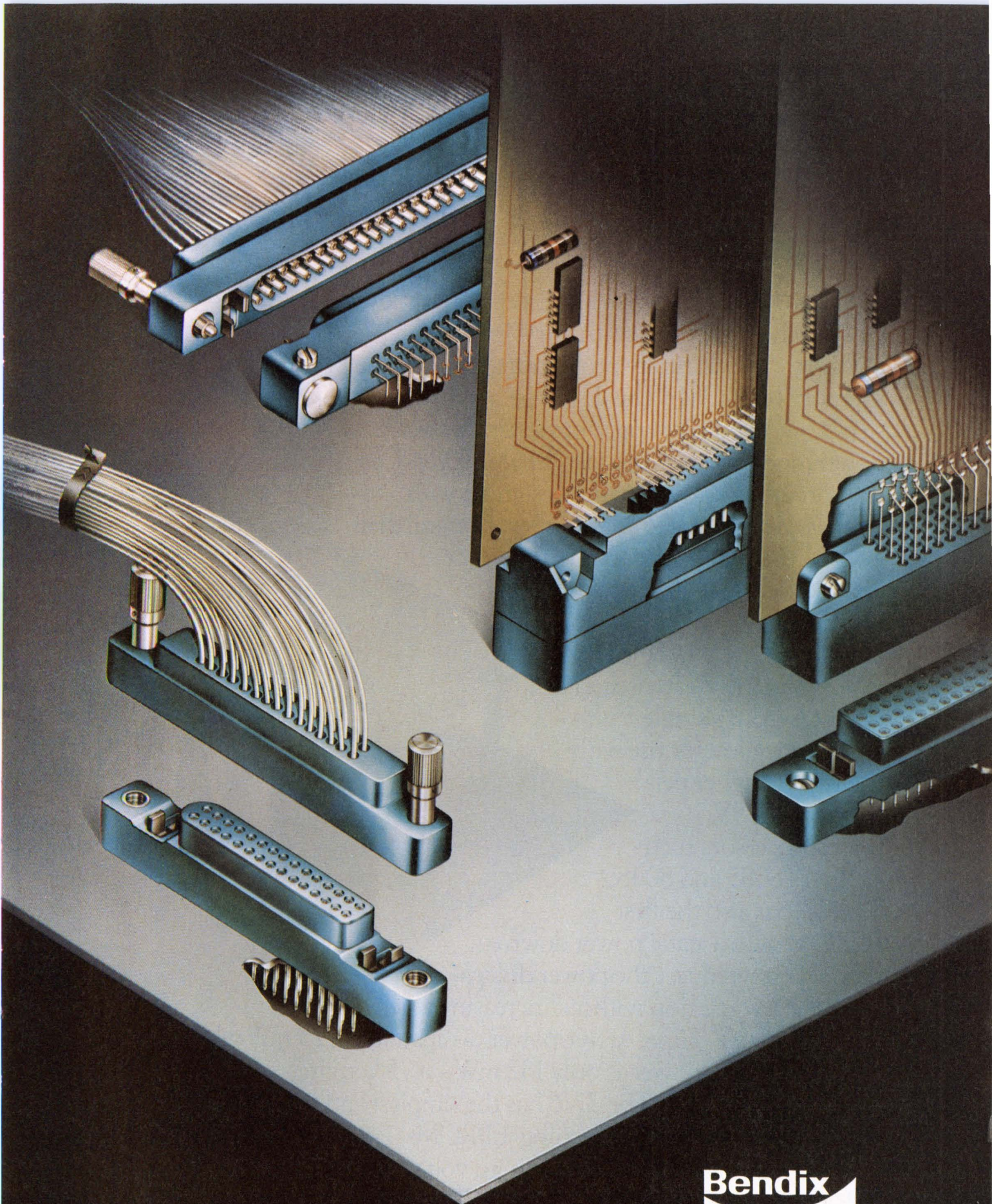

Bendix

Intel delivers the first

The Intel® 2716 is the first 16K UV-erasable and electrically programmable read only memory (EPROM). The 2716 operates from a single 5 volt power supply, has a static power down mode and features fast, single address location programming. It makes designing with EPROMs faster, easier and more economical than ever before. Then, when you're ready for production quantities, move rapidly to Intel's new pin-for-pin compatible 16K ROM, the 2316E.

Since the 450 nsec 2716 operates from a single 5 volt supply it is ideal for use with the newer higher performance +5V microprocessors such as Intel's 8085 and 8048. The 2716 is also the first EPROM with a static power down mode which reduces the power dissipation

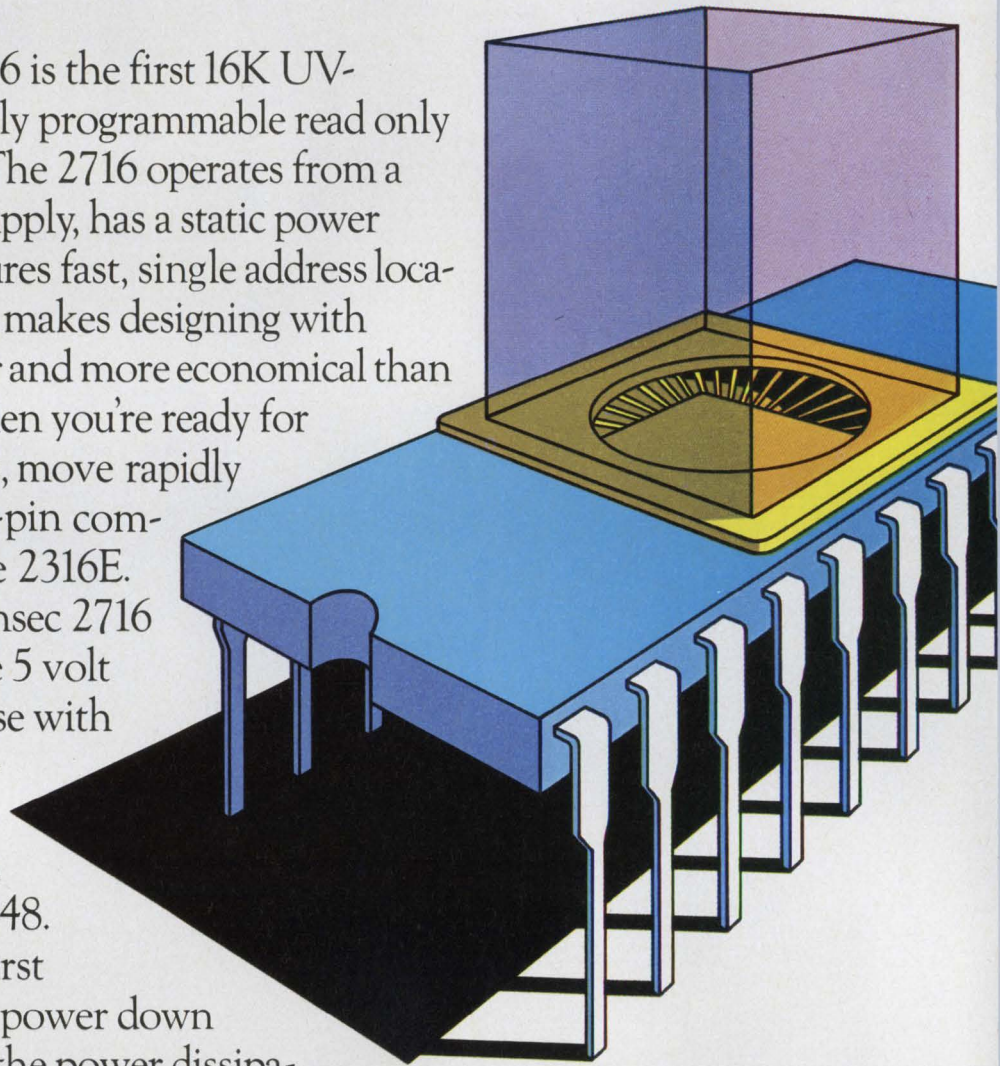

without increasing access time. Active power dissipation is 525 mW while standby power is only 132 mW—a 75% savings.

The 2716 has the simplest and fastest method yet devised for programming EPROMs—single pulse TTL level programming. No need for high voltage pulsing because all programming controls are handled by TTL signals. Now you can program on-board, in the system, in the field. You can program any location at any time—either individually, sequentially or at random, with the 2716's single

5 volt 16K EPROM.

address location programming. Total programming time for all 16,384 bits is only 100 seconds.

The 2716 EPROM is pin compatible and directly interchangeable with Intel's new 420 nsec 2316E mask programmed ROM. Debug your systems using

EPROM and when the pattern is firm, order the 2316E ROMs and plug them directly into the 2716 sockets. Turn around time on ROMs

INTEL EPROM & INTERCHANGEABLE ROM FAMILY					
EPROM	Interchangeable ROM	Size	Organization	Power Supply	Max. Access Time
2716	2316E	16K	2K x 8	+5, only	450 nsec
2708	2308	8K	1K x 8	+12, ±5	450 nsec
1702A	1302	2K	256 x 8	+5, -9	1 μsec

has been reduced to 6 weeks ARO. If you prefer, ship the first few products with 16K EPROM and switch to 16K ROM in the field. Either way you get the flexibility of EPROM and the economies of ROM. Both from Intel.

Double the size of your program memory, improve performance, and get your product to market faster with Intel's reprogrammable 2716. And save money in production with the compatible high speed mask programmable 2316E ROM.

The fastest way to get started is to order the new 2716 16K EPROM from your local Intel distributor. Contact: Almac/Stroum, Components Specialties, Cramer, Elmar, Hamilton/Avnet, Industrial Components, Liberty, Pioneer, Sheridan or L.A. Varah. And for quick turn around on the 16K mask programmable 2316E contact your local Intel sales office.

For technical information and a copy of "The New 16K EPROM" article reprint (AR-42) use the reader service card or write: Intel Corporation, 3065 Bowers Avenue, Santa Clara, California 95051.

intel® delivers.

Touch switches are

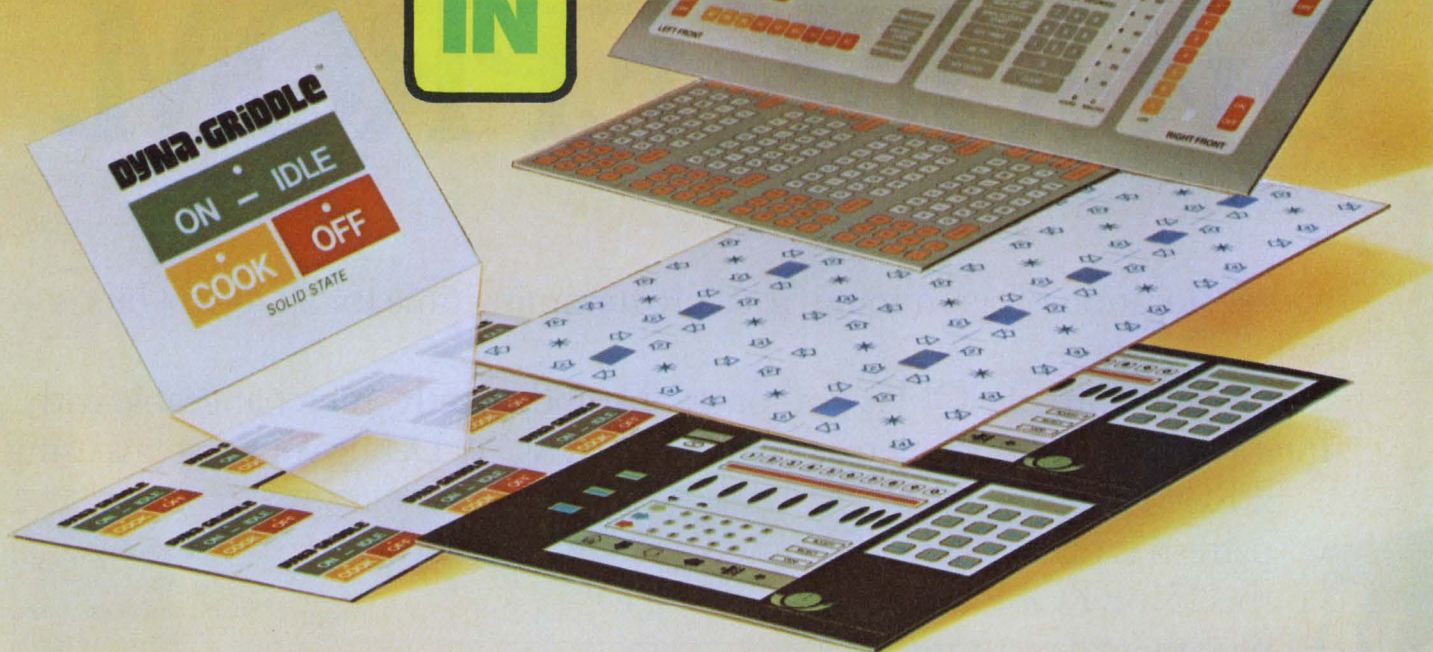

...and CENTRALAB has them NOW

When Centralab introduces touch switches you can be sure they're "In". Backed by 40 years of switch know-how, and after years of intensive research and testing, Centralab is now delivering, in batch-process volume, a complete touch switch system. We call it MONOPANEL.

MONOPANEL is a thin, light, flat, front panel subassembly containing micro-motion touch switches already mounted and interconnected . . . with LED's, nomenclature, graphics and colors to meet your functional and aesthetic requirements.

Batch-Processed For Economy With Quality

MONOPANELS are batch-processed as 11" X 17" master panels only .075" thick, each containing up to 700 switches. Every Monopanel is a complete, 100% pre-tested subassembly containing switches, front panel and graphics.

60,000,000 Cycles Without Failure!

The basic MONOPANEL switch has been operated for sixty million switching cycles without mechanical or electrical failure. And MONOPANEL has been tested and proven against 22 separate mechanical, electrical and environmental standards.

Custom Designed For Your Application

On each 11" X 17" panel you can custom-design individual boards to meet your front panel needs. The illustration

above shows just a few of the almost endless variations possible from each master panel.

Unlimited Graphics Available

The flat, smooth, front panel surface permits unlimited choice of graphics. Functions may be grouped by color, with 480 colors available. Thirty choices of type style and size. And whatever visual symbols meet your specific needs.

THIS IS MONOPANEL:

- A complete touch switch sub-assembly, ready to mount.
- All switches and graphics on a .075" thin panel.
- Flat, spill-proof surface wipes clean.
- Noiseless.
- 100% tested.
- Choice of terminations.
- Operating voltage: 50 V max.
- Operating current: 100 mA max.
- Contact resistance: 0.2 ohms typical.



CENTRALAB

Electronics Division
GLOBE-UNION INC.

5757 NORTH GREEN BAY AVENUE
MILWAUKEE, WISCONSIN 53201

Standard 12 and 16 position keyboards are available through Centralab Industrial Distributors. For more information on *custom* MONOPANELS, call Bill Klug, (414) 228-2604, or send for this **FREE** brochure today.



Quality Products For Your Design: Ceramic Capacitors ● EMI/RFI Filters ● Thick Film Circuits ● Rotary, Slide and Pushbutton Switches
● **Touch Switches** ● Potentiometers and Trimmers.

CIRCLE NUMBER 24

Washington Report

Carter tries to keep Renegotiation Board alive

Despite opposition from industry and some Congressmen, President Carter has moved to strengthen the Renegotiation Board by appointing board member Goodwin Chase chairman, to succeed acting chairman Rex Mattingly. President Carter is also expected to seek new legislation to keep the board going. The board was established in 1951 to root out excessive profits from government contracts dating back to World War II.

Until last year, the board's life had been extended by each Congress. But since Congress did not pass the necessary enabling legislation last year, the Renegotiation Board has not been able to review any new contracts this year. As a result a backlog of contracts amounting to \$125-billion has piled up.

If new legislation is not enacted, the Renegotiation Board will expire on Sept. 30, the end of the current government fiscal year, when its appropriations run out. The board is vigorously opposed by the Electronic Industries Association and the Aerospace Industries Association, among other trade groups.

Martin, Northrop compete for helicopter avionics

Martin Marietta's Orlando Div. and Northrop's Electro-Mechanical Div. are the finalists in the Army's seven-firm competition to develop a new helicopter avionics system for day-and-night operations (see "Washington Report," ED, No. 2, Jan. 18, 1977, p. 35).

Martin received \$25.1-million and Northrop, \$29.6-million to work on the Target Acquisition and Designation System/Pilot's Night Vision System (TADS/PNVS). The program will take about three years. Some time during the second year, the two firms will fly their prototype hardware on the Advanced Attack Helicopter (AAH) being tested by Hughes Helicopters.

The winning firm will outfit the 536 projected AAH aircraft with the system, which includes forward-looking infrared (FLIR) sensors and direct-view optics. With an estimated cost per aircraft of \$300,000, the market should be worth more than \$150-million. But the Army is also considering TADS/PNVS for its proposed Advanced Scout Helicopter. That program has not been approved by Congress, but the Army has a tentative requirement for up to 723 of the scout helicopters.

New federal procurement standards implemented

Following the lead of the Defense Department, other major government agencies are implementing the new government-wide policy of requiring additional "front-end" planning before beginning the acquisition of a

major new system (see "Washington Report," ED, No. 5, March 1, 1977, p. 35). Some of the latest agencies to comply are NASA, the National Science Foundation and Department of Transportation.

As required by A-109, the agencies have established thresholds for programs to be covered by the new policy—\$75-million for research and development programs and \$300-million for production programs at the Pentagon, \$10-million for R&D and \$50-million for production programs at Transportation, and \$100-million for all programs at NASA.

A-109 has been severely criticized in Congress, particularly by staff members of the House Armed Services Committee, as leading to further delays in moving from development to production of new systems. Before the new policy, the Polaris submarine was put into operation in just four years, they claim. But new programs, like the Aegis ship-defense system, are taking as long as 20 years from conception to deployment.

Big Pentagon role seen for Perry

Dr. William J. Perry, president and one of the founders of electronic warfare firm ESL Inc., Sunnyvale, CA, is expected to become the Pentagon's research director around the middle of April. But if President Carter has his way, he won't have the job long.

Under a reorganization plan being formulated to create a new upper level of management consisting of three under-secretaries of defense, Perry is due to take over responsibility not only for all the Pentagon's research, but also all its development and procurement activities. The other two under-secretaries would be in charge of operational and financial management aspects.

If confirmed by the Senate, as expected, Perry would be designated the Pentagon's principal acquisition executive and would have deputies reporting to him for the R&D and installations and logistics functions.

Capital Capsules: Three synchronous Navstar global positioning satellites may be placed by the Air Force over Europe to provide jam-resistant reference points for tactical forces. The planned Navstar system consists of 24 satellites in low earth orbit, but these are believed to be vulnerable to enemy electronic countermeasures. . . . The Navy's EA-6B jamming aircraft is also being considered by the Air Force to supplement its own EF-111A tactical jamming aircraft in Europe. Both aircraft are produced by Grumman Aerospace, and both use the ALQ-99 jammer. . . . Under a project known as Seaguard, the Defense Advanced Research Projects Agency has found that acoustic-signal propagation in the ocean is far more coherent than previously believed. As a result, spatial filtering of noise signals and advanced signal-processing techniques developed for radar and seismic applications can be used in antisubmarine warfare. . . . The House voted to authorize NASA to spend \$15 million for preliminary research on a supersonic transport. . . . To combat the evils of "wage busting" the Senate has introduced S 969 as a companion bill to the House of Representatives' 314 (ED, No. 4, Feb. 15, 1977, p. 26). The Senate bill is co-sponsored by Lawton Chiles and Richard Stone (both D-FL) and John Sparkman (D-AL). Meanwhile, another bill, HR 4873, has been introduced in the House by Florida Representative Don Fuqua (D) and Louis Frey, Jr. (R), which would attempt to avoid wage busting by requiring that the procuring agency, rather than the Labor Dept., see that the engineers' salaries are "in keeping with their professional contributions."

Now 1% time measurements are this easy...

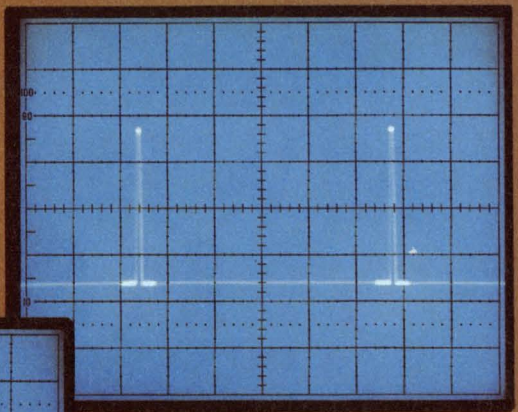
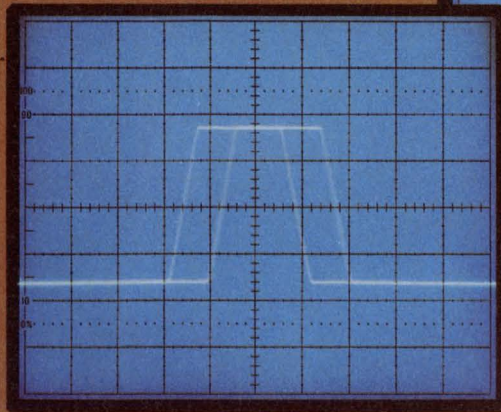

1 Position intensified spots at beginning and end of time interval.

2

Switch to delayed sweep mode and use Δ Time dial to superimpose beginning and end of interval.

1.132



3 Read time interval directly.

Faster Timing Measurement

Differential time measurements are made faster when the new DM 44 with *Delta Delayed Sweep** and direct numerical readout is included on a TEKTRONIX Portable Oscilloscope. At the same time, measurement repeatability is improved, the chance for computational errors is eliminated, and 1% accuracy is consistently achieved. Frequency measurement (on periodic waveforms) with 2% accuracy is obtained by simply pushing the 1/Time button.

Built-in DMM as a Bonus

There's no need to carry a separate multimeter. DM 44-equipped TEKTRONIX Portables also measure dc voltage with 0.1% accuracy and temperature from -55°C to $+150^{\circ}\text{C}$ simultaneously with oscilloscope display of related waveforms. And you get ohms measurement with 0.25% accuracy as well.

Your Choice of Oscilloscope Performance

The DM 44 is available on five high-performance portable oscilloscopes to best match your performance and price needs. Choose bandwidth of 100, 200, or 250 MHz. Or select from two fast storage models. One actually stores single-shot signals at its full 100 MHz bandwidth.

Due to highly cost-effective design, the outstanding DM 44 option adds only \$410 to the price of the basic portable oscilloscope chosen. All DM 44-equipped TEKTRONIX Portable Oscilloscopes, and seven more models as well, perform analysis on up to 16 channels in the digital domain by simply adding the

LA 501W Logic Analyzer. Capabilities of the DM 44 are also available in the TEKTRONIX 7000 Series of plug-in oscilloscopes.

Let Us Show You

To see how the DM 44 makes faster, more accurate measurements in your application, contact your Tektronix Field Engineer. Or write to Tektronix, Inc., P.O. Box 500, Beaverton, Oregon 97077 for complete information. In Europe, write to Tektronix, Limited, P.O. Box 36, St. Peter Port, Guernsey, Channel Islands.

*Two independently adjustable delayed sweeps.

U.S. Sales Price FOB Beaverton, Oregon

Tektronix®

COMMITTED TO EXCELLENCE

FOR TECHNICAL DATA CIRCLE #251
FOR DEMONSTRATION CIRCLE #252

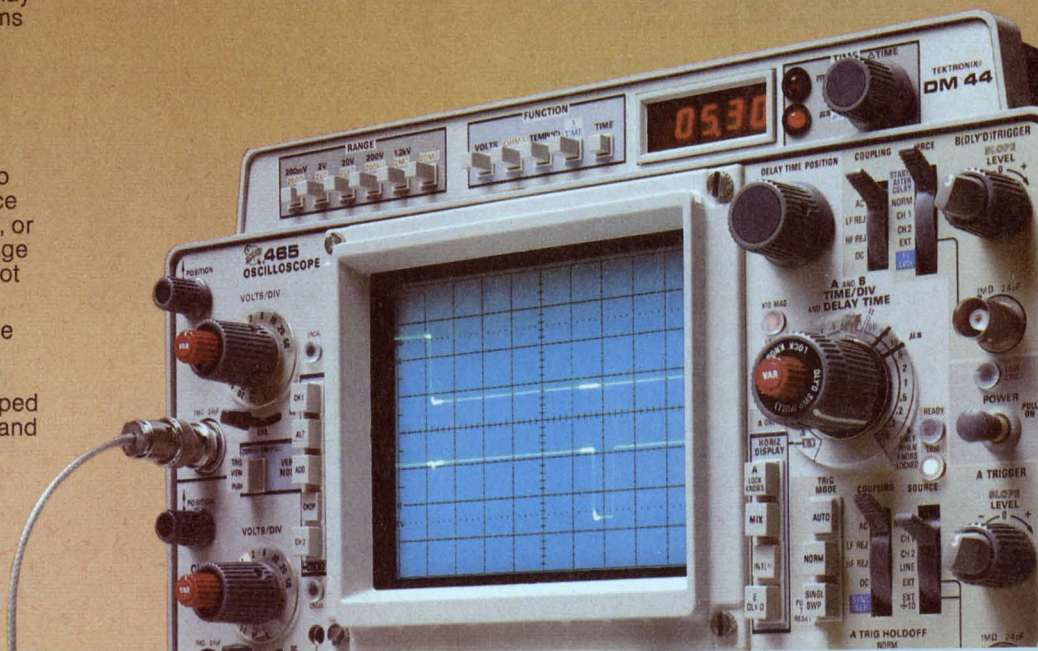

ANNOUNCING THREE NEW BREAKTHROUGHS IN SOLDERLESS BREADBOARDING.

Whether you design or build circuits for fun or for profit, you owe it to yourself to discover how fast and easy CSC solderless breadboarding can be. Now, more than ever. Because of three new breakthroughs in breadboard design. And our new EXPERIMENTOR™ sockets** that make the most of them.

1. Price Who says a quality breadboard has to be expensive? For as little as \$9.95, CSC's EXPERIMENTOR sockets let you design, assemble and modify circuits as fast as you can push in—or pull out—component leads. On a rugged one-piece socket with 550 solderless tie-points (94 five-point terminals and two 40-point bus strips).

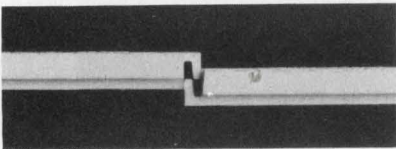

Sockets lock together, snap apart to handle any size circuit with ease.

But don't let the low price fool you: EXPERIMENTOR sockets are precision-molded of durable, abrasion-resistant material, and feature CSC's non-corrosive, prestressed nickel-silver contacts for positive connections and longer life. All contacts are identified, too... with molded-in designations for easier circuit assembly and diagramming.

2. Compatibility CSC EXPERIMENTOR sockets end the "big-chip blues." They're the only ones with full fan-out capabilities for microprocessors and other larger DIP's, as well as 4-16-pin units. EX-

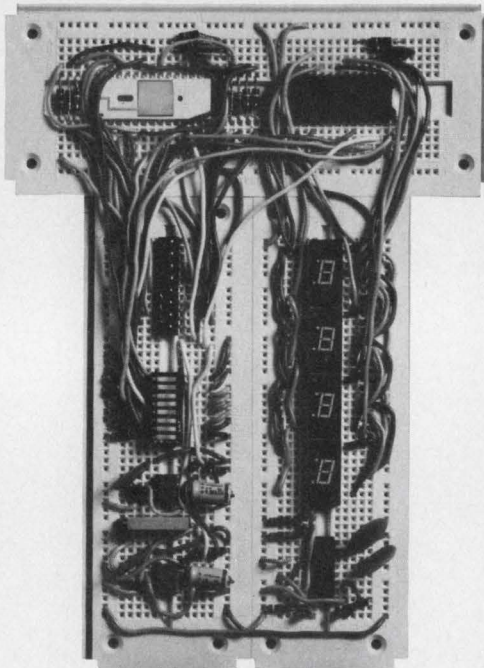

PERIMENTOR 600's 6/10" center is ideal for microprocessor's, clock chips, RAM's, ROM's, PROM's, etc. While EXPERIMENTOR 300's smaller 3/10" center is perfect for smaller DIP's. Both units, of course, accept transistors, LED's, resistors, capacitors, pot's—virtually all types of components with plug-in ease. As well as #22-30 solid hook-up wire for interconnections. Eliminating heat and lead damage to expensive components. And saving you more money, on parts.

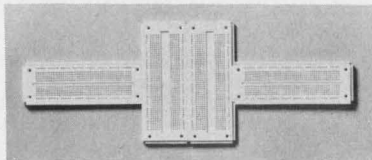

Mix or match both models; arrange them vertically or horizontally.

3. Flexibility With CSC EXPERIMENTOR sockets, you can arrange your breadboard to suit your circuit... instead of vice versa. An exclusive snap-together inter-

locking system lets you instantly connect them. Vertically or horizontally. So you can mix or match 3/10 and 6/10" centers... expanding or contracting to meet your requirements.

CSC EXPERIMENTOR sockets can be used alone, or mounted on any convenient flat surface, thanks to molded-in mounting holes and vinyl insulation backing that prevents shorts. You can mount them with 4-40 flat-head screws from the front, or 6-32 self-tapping screws, from the rear. But however you use them, EXPERIMENTOR sockets are an unbeatable way to build and test twice the projects in half the time.



Both models feature 94 five-point terminals (vertical lines) and two 48-point bus strips (one strip shown).

WHY WAIT? CSC EXPERIMENTOR sockets are available now from your CSC dealer, or by phone from CSC, at \$9.95* for the 300 and \$10.95* for the 600. Call 203-624-3103 (East Coast) or 415-421-8872 (West Coast)—major credit cards are accepted.

*Manufacturer's suggested list price. Prices subject to change without notice. U.S. Pat. No. D235,554

CONTINENTAL SPECIALTIES CORPORATION



44 Kendall Street, Box 1942, New Haven, Ct 06509
203-624-3103/TWX: 710-465-1227
West Coast office: Box 7809, San Francisco, CA 94119
415-421-8872/TWX: 910-372-7992

See us at NEWCOM Booth #C42 and C44.

CIRCLE NUMBER 26

For Your D/A Converter Analysis,

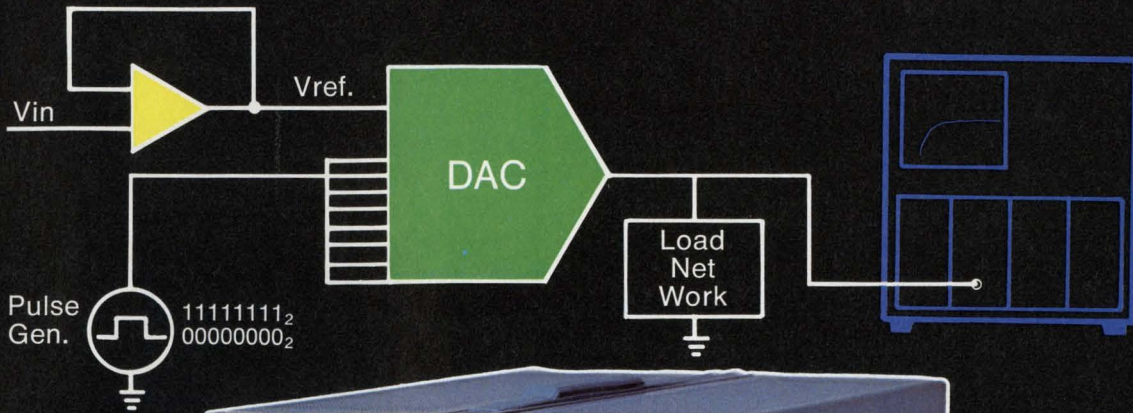

Use this dual-trace scope to make easy, accurate D/A converter settling time and amplitude measurements... and to analyze and verify the performance characteristics of other high-speed components.

Configured in a 7904 mainframe*, the 7S14 Sampling plug-in lets you examine settling time anomalies as narrow as 500 ps, to vertical sensitivities down to 2 mV/div. The internal delaying time base lets you select the whole waveform, or any portion, for observation.

The 7D12/M2 Stroboscopic Voltmeter and 7B92A Dual Time Base plug-ins help you easily measure the overall amplitude of the device output, and the P6201 Active Probe conveniently captures the DAC's output with minimum circuit loading.

Get Reliable, Repeatable Settling Time Measurements

No significant distortions will be introduced into your settling time measurement because the 7S14 Sampler minimizes the scope's vertical amplifier recovery time effect. The high-impedance probe minimizes loading the circuit under test.

With high vertical sensitivities, small perturbations can be measured to less than 1 least significant bit depending upon circuit loading.

The result is accurate measurements time after time.

Put Together a Complete System
You can measure overall output amplitude to within 0.25% with the strobing voltmeter and dual time base plug-ins included in the plug-in scope system. And it couldn't be easier: the intensified zone generated by the time base points out



Expand Your System to Include Real-Time Performance

By adding a 7A24 Dual Channel Amplifier plug-in, you'll have a real-time system with two channels of 350-MHz performance and sweep speeds as fast as 500 ps/div. Or you can also choose from other amplifier plug-ins that will give the full mainframe bandwidth of 500 MHz.

Your oscilloscope needs may change as the speed of system components continues to increase. So whatever your choice may be, a Tektronix plug-in scope can give you unmatched value now and in the future.

To order the plug-in system described here or to receive selection assistance, call your local Tektronix field office.* For a full product demonstration, clip the logo from this ad to your letterhead and send it to us at Tektronix, Inc., P.O. Box 500, Beaverton, OR 97077. We'll have a Field Engineer contact you. Or circle the bingo number, and we'll send you a copy of our application note, "D/A Converter Measurements: A Sampling Oscilloscope's Approach."

pick this plug-in scope

which part of the waveform you're measuring and the amplitude is read out digitally on the crt.

Extend Your System's Sampling Performance

This sampler allows you to display time windows as narrow as 500 ps at sweep speeds to 100 ps/div. Choose from 4 other sampling plug-ins and 10 sampling heads for time window measurements ranging from 25 ps to 1 ns. All these sampling plug-ins, including the 7S14, will operate in any 7000 Series Mainframe. All will significantly minimize the recovery time limitations you might encounter with amplifiers in a real-time scope. And some sampling plug-ins include TDR capability.

The 7000 Series... more than an oscilloscope.

*Ordering information:

7904 Oscilloscope	\$4,500.
7S14 Sampler	\$2,650.
7D12/M2 Stroboscopic Voltmeter	\$1,550.
7B92A Dual Time Base	\$1,795.
P6201 Active Probe	\$ 680.

U.S. sales prices FOB Beaverton, OR.
*Storage Mainframes are often preferable when the signal repetition rate is below 100 KHz.

Tektronix
COMMITTED TO EXCELLENCE

FOR TECHNICAL DATA CIRCLE #271 ON READER SERVICE CARD
FOR DEMONSTRATION CIRCLE #272 ON READER SERVICE CARD

Electro 77

Another show—



another opening

Having opened successfully in Boston last year, Electro—the IEEE international convention and product exposition—returns to the scene of its many other successes, New York City.

Electro '77 will be held April 19 to 21. As in previous years, the exhibition will occupy the New York Coliseum and the technical program the Hotel Americana. The three-day convention is expected to attract 25,000 visitors, who will flock to view the products of 300 exhibitors in 550 booths at the Coliseum.

The Electro Keynote luncheon features an address by Isaac Asimov, the nationally known science writer and academician. A special exhibit, titled "Energy Conservation," will be displayed at the Coliseum. Not only will it feature energy-conserving products and services, but it will also demonstrate how the electrical and electronics industries are working to increase efficiency in the production and use of energy.

The technical program consists of 42 half-day sessions and a special Wednesday evening session on U.S. and Soviet psychic research. This year the program emphasizes microprocessors and microcomputers, semiconductor memories, digital testing, and antenna design in communications.

Some of the more significant technical papers on microcomputers are offered in Session 17, "Designing With the New Single-Chip Microcomputers," and Session 16, "Software Strategies for Successful Microcomputer Programming." They deal with recent advances in semiconductor-device technology that have made possible the integration of CPU, ROM, RAM, clock and I/O on a single integrated circuit.

A spectrum of microprocessor design tools available to the application-software designer highlights Session 16. For example, one of the

Computers

One-chip microcomputers arrive
and they're very capable..... 56

Test & Measurement

Microprocessor boards are here;
Now they have to be tested..... 58

Memories

Faster, denser, cheaper:
And what an assortment..... 61

Communications

Linear/loop antenna may resolve
Quad-vs-Yagi controversy..... 64

papers discusses the second generation of simplified development systems that provides the means to evaluate microprocessors with a minimum investment of \$100 to \$700.

With the increasing use of microprocessors, electronics manufacturers are discovering that testing μ P-board assemblies can be a major headache—a quantum jump beyond present test methods. The papers in Session 25 show that a clearly accepted philosophy—as well as equipment that reflects it—has not yet emerged, although progress is being made.

No less than three Electro '77 sessions deal with semiconductor memories. Session 5 covers major trends in dynamic and static RAMs, ROMs and PROMs. Session 12 provides a review of current developments in bubble memories, while Session 19 examines the current status of charge-coupled-device memories.

In communications, the emphasis this year is on antenna design. Session 2 presents the latest in hf and vhf/uhf antenna design, while Session 26 examines the design and field performance of circularly polarized antennas.

The New York Coliseum will house the products of 300 exhibitors at the Electro 77 show.

One-chip microcomputers arrive —and they're very capable

A new generation of microcomputers is emerging—single-chip devices. These newcomers, to be described in Session 17 at Electro '77, range in complexity from simple calculatorlike structures to sophisticated microcomputer controllers. Families of these one-chip micro devices are being produced by manufacturers like Intel, Fairchild Semiconductor and Signetics.

One group of single-chip microcomputers has been developed, whose members combine the capabilities of at least five second-generation microprocessor family chips, or 100 to 200 TTL devices. The Series 40 from Signetics, Sunnyvale, CA, encompasses three microcomputers, the 2641, the 2645 and the 2648, which are designed to cut the manufacturing and service costs of high-volume consumer, industrial and business applications, according to Alex Goldberger, manager of Signetics' microprocessor applications. He will compare them in his Session 17 paper.

Different, yet so alike

The chips are fabricated with ion-implanted n-channel silicon-gate technology. And although each of the Series 40 chips is optimized for a specific application area, they all have the same basic features:

- Eight-bit CPU, ROM, RAM and I/O.
- 1920 × 8 ROM, 128 × 8 RAM and up to 28 I/O lines.
- Programmable 8-bit timer-event counter with prescaler.
- Internal or external power-on reset.
- Internal clock generator.
- Over 110 basic instructions with multiple addressing modes.
- A 2- μ s machine cycle and minimum instruction execution time.
- Multilevel interrupt structure.
- Expandable memory and I/O.
- Single 5-V supply.
- TTL-compatible inputs and outputs.

The 2641 chip is designed as a user-programmable peripheral device that may be integrated into multichip distributed processing systems where another microcomputer serves as the



Personal computing systems are getting to be as sophisticated as commercial and industrial counterparts. This SOL personal computer and its peripherals, by Processor Technology, Menlo Park, CA, is one of the new systems to be evaluated in the Electro '77 "Home and Hobby Computers" session.

master. The 2645 is suited for applications that do not require ROM or RAM beyond the 2k of memory contained on the chip. The 2648 allows the memory to be expanded up to 4k by adding external ROM, PROM or RAM. In this version, the eight least significant bits are multiplexed onto the bus with data whenever an external memory reference is made.

Another series of single-chip microcontrollers for the high-volume consumer and control markets, to be described in Session 17, is Fairchild Semiconductor's MicroMachines. The first two to be produced, the F8 MicroMachine 1 and 2, are single-chip, 40-pin versions of existing two-chip F8 microcomputers. Both the MM1 and MM2 have a fast 8-bit CPU that executes the complete set of over 70 machine instructions available with the existing F8 family. The MM1 has 1 kbyte and the MM2 has 2 kbytes of ROM.

Since each is essentially a custom circuit, con-

ventional testing cannot be performed in the MicroMachine circuits, according to Van Lewing, a program manager of Fairchild's Micro Systems Div., San Jose, CA. Additional logic is incorporated on the chips in the form of two test modes.

Because the MM1 and MM2 have only I/O ports for communications paths, Fairchild has provided special aids for debugging and circuit-emulation prototyping. The Formulator/Mark II MicroMachine In-Circuit Emulation System provides the capability for complete software code debugging.

Intelligent controllers

A third family of single-chip devices to be described at Session 17 serves as intelligent peripheral controllers for 8-bit master processors like the 8080 and 8085. Developed by Intel Corp., Santa Ana, CA, the Universal Peripheral Interface (UPI) series enhances over-all system performance and provides a cost-effective alternative to custom LSI interface designs.

For increased design flexibility, the UPI is available in two different chips: the 8741 with a UV-erasable memory, and the 8041 with a mask-programmed ROM memory. The 8741 allows the user to modify his program during system development and is pin-programmable with the 8041. Both parts are fabricated with n-channel MOS technology and operate from a single 5-V supply.

Both UPI chips can be user-programmed to perform a variety of low-speed interface functions, says Don Phillips, product manager of Intel's Microcomputer Division. In particular, he will point out, the UPI allows these low-speed peripheral control functions to be developed in software rather than hardware, with significant savings in cost and design time.

The Intel UPI chips both contain 1 kbyte of program memory, 64 bytes of data memory, two 8-bit I/O ports, two software testable inputs, a programmable timer-event counter, a clock generator, an 8-bit CPU, a status register, and a data-bus buffer register interface directly with a master processor.

Low-cost development systems simpler

Another key development, which will be discussed at Session 16, is the use of the newer low-cost prototyping systems for designing on a tight budget with microprocessors. Until recently, incorporating microprocessors into low-volume applications has been inhibited by the high costs of the powerful development systems offered by semiconductor manufacturers. But not anymore. The reason? A second generation of simplified development systems provides the means to evaluate microprocessors with a minimum investment

Low-cost microprocessor prototyping systems

Mfr.	Model	μ P	RAM	PROM	Cost, \$
AMI	EVK99	6800	512	1k	152
Apple	Apple Computer	6502	8k	1k	667
Fairchild	MicroPro	F8	1k	1k	185
Intel	SDK-80	8080	256	2k	350
Intersil	Intercept, Jr.	IM6100	256	1k	281
Mostek	Survival Kit	F8	1k	1k	185/107
National	LCDS	SC/MP	256	512	99
RCA	CDP18S020	CDP1802	256	512	249
Signetics	ABC	2650	512	1k	190
Zilog	Z80-MCB	Z80	4k	512	475

Table courtesy of RCA, Somerville, NJ.

of \$100 to \$700.

These systems can be configured by the small volume manufacturer to perform a design for far less in terms of time and money than a dedicated design would require, according to Dennis Block, applications engineer at RCA Solid State Div., Somerville, NJ, who will discuss system features in a Session 16 paper.

A major drawback of the first-generation low-cost systems was having to use an expensive teletypewriter to communicate with the system. But new, low-cost hand-held terminals, announced by National and RCA, apparently meet this need. For about \$125, they provide a hex keyboard for program and data entry, function-control keys, and their own monitor program in ROM.

An example of a low-cost prototyping system outfitted with a hand-held terminal is the RCA

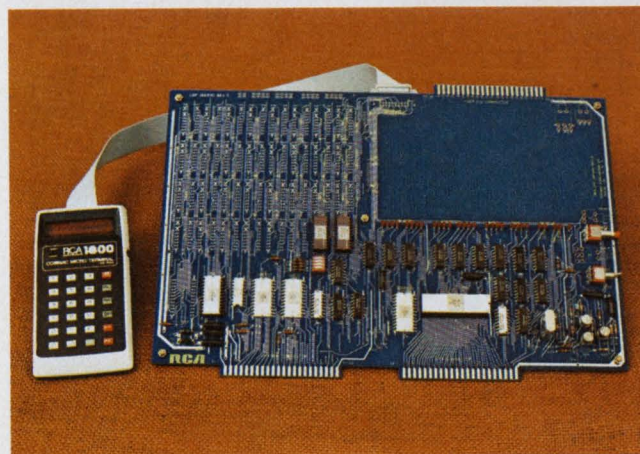

The low-cost, hand-held Micro Terminal permits the RCA-evaluation-kit user to communicate with the COSMAC microprocessor by providing hexadecimal program and data entry and control of other computer functions.

COSMAC evaluation kit CDP18S020, and Micro Terminal, CPD18S021, for I/O communication. With a user-supplied 5-V, 1-A power supply, the system is a complete microcomputer that supports the CPD1800 series microprocessor family.

In general, Block points out, these low-cost systems don't provide resident software development aids such as an assembler or editor, because of limited memory capacity. But some manufacturers offer more expensive board-type systems that still cost less than the sophisticated development systems.

Other suppliers provide an upgrading capability so that the system can handle an editor and assembler. While these systems have minimum hardware and software, several of them

provide a surprising amount of microprocessing power.

Furthermore, while the least expensive systems may offer only program entry and storage on paper tape or magnetic cassette systems, most systems have a monitor-debug program that runs at the terminal interface and permits readout or entry at any address.

The monitor program allows a designer to tackle an application problem immediately. The engineer evaluating various microprocessors can find the most suitable for an application with a minimum investment of time and money in each system. Even the high-volume manufacturer can find these boards useful as a breadboard for preliminary designs and prototype field tests. ■■

Test & Measurement

Microprocessor boards are here; now they have to be tested

The test and measurement sessions at Electro '77 will concentrate on testing production-run lots of digital printed-circuit boards and the automatic test systems needed to do the job. Learning new test techniques will bring engineers to the next stage in the development of microprocessor-based products—past the microprocessor-circuit design and troubleshooting procedures that were the focus of sessions at Electro and Wescon last year.

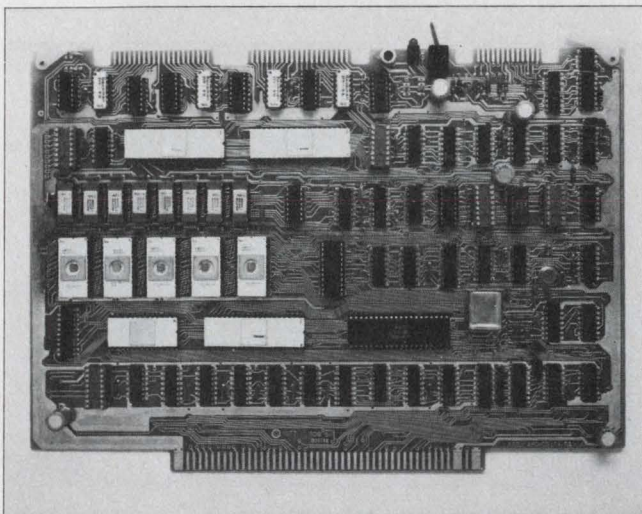

As microprocessors find their way onto more boards, like this Mostek Z-80 CPU card, new and more effective board test procedures are being developed.

“Recent surveys of digital-equipment manufacturers indicate that over half have microprocessor-based products either in production or under development,” says Noel Lyons, sales manager at Fluke’s Trendar subsidiary, Mountain View, CA. In a paper to be presented at Session 25, Lyons maintains that it is time for users to consider how they should test PC boards containing microprocessors on the production line. What’s needed are detailed specifications not only for the test methods that verify the performance of chips and boards, but also for the automatic systems capable of performing the tests.

Pulling it out isn't enough

Removing the microprocessor to simplify test requirements is only a marginally acceptable stop-gap, says Lyons. “In order to properly test such boards, advanced board test capabilities must be provided.”

Trendar’s solution, of course, involves using one of its own board-test systems. The company’s latest, the Model 3040A, exercises digital PC boards, including those containing microprocessors, by feeding in pseudorandom data patterns at rates up to 5 MHz and user-defined test sequences at rates up to 1.5-million input words/s. The two test-word types can be intermixed to gain the simplicity of programming inherent in pseudorandom pattern generation while main-

taining the capacity to generate the specific patterns required to test microprocessors.

An alternative approach will be described by Jon Turino, vice-president for customer support at Instrumentation Engineering Inc., Franklin Lakes, NJ. Boards containing microprocessors can be tested effectively by combining real-time software simulation, dynamic test hardware, and a real-time diagnostic probe system, Turino says in his Session 25 paper.

Real-time software simulation is designed to overcome two major problems: the cost of generating the test and the difficulty of verifying that such tests are truly comprehensive in separating good boards from bad.

Manually generating a set of input-stimuli signals for a PC board containing 100 ICs may take an engineer up to 400 hours, observes Turino. The engineer must know the inner workings of each of the devices on the board—to keep track not only of the functions performed as the devices interact, but also the vast quantity of data that are part of the test-generation process.

Software-simulation programs have been developed to overcome these difficulties, says Turino. A computer stores the details of each device via a component library, calculates the interaction of the circuit elements, and stores and manipulates the data. "Using a software-simulation program can result in a labor savings of up to four to one," says Turino, so that a test program for a 100-IC board can be written in about 100 man-hours.

Grading the exam

An important feature of software simulation is its ability to grade the comprehensiveness of the test program, Turino continues. The computer can determine the percentage of possible faults that can be uncovered by the test program, and flag undetected faults. The engineer can then develop additional test vectors to catch the previously undetected faults—"easily," says Turino.

The simulator should also be able to handle parametric measurements such as timing. To measure logic timing accurately to the nanosecond level, the simulator must be able to operate in the time domain, not merely measure unit delays. The tester might be called upon to detect the levels on bidirectional bus pins on a microprocessor before and after an instruction is executed. "If a simulator cannot provide these data, the test system hardware, no matter how fast or flexible it is, cannot be programmed effectively," Turino maintains. Without sufficient resolution, the test will be less than adequate, "with minimal hope for automatic diagnostics."

But even when an effective test pattern has been generated and the test system hardware has

Technical session order form

Please send me the following Electro 77 technical session preprints at \$3.00 per session (average: four papers per session), plus \$1 mailing charge per complete order. I understand this order will be mailed to my address within three weeks after receipt. Offer good until July 1, 1977.

Session No.	Quantity	Session No.	Quantity
2		21	
3		22	
4		23	
5		24	
6		25	
7		26	
8		29	
9		30	
10		31	
11		32	
12		33	
13		34	
14		36	
15		37	
16		38	
17		39	
18		40	
19		41	
20		Psychic Research	

All Electro 77 sessions will be available on audio tape cassettes below. Price is \$6.25 each, six for \$35, or 12 for \$65 (including binder). Indicate tape requests by session number and include remittance as noted.

No. _____
 Total Sessions × \$3 = \$ _____
 Psychic Research × \$5 = \$ _____
 Tape Cassettes × \$6.25 = \$ _____
 Plus \$1 Mailing Charge = \$ _____
 Total Cost = \$ _____

Make check payable to Electro 77 and mail with this form to:

Electro 77
999 North Sepulveda Blvd.
El Segundo, CA 90245

Date _____

Name _____

Firm _____

Street Address _____

City, State, Zip Code _____

executed the go/no-go procedure, the problem of repairing defective boards remains. Of all the manual and automatic fault-isolation techniques available, Turino opts for using both a fault dictionary and a guided probe: "The fault dictionary minimizes probing by looking inside the faulty unit under test to determine the most likely faults; the probe then takes over to isolate the faulty component accurately."

Another way to dig out faulty components is to contact the board's printed-wiring pattern through a bed-of-nails fixture instead of a separate probe. This method can simplify fault finding on any kind of board, be it analog, digital, or some combination of the two.

"Up to 95% of the faults on our printed-circuit boards were due to shorts (both in the PC conductors and components), missing components, wrong-value components, reversed components, or component values not to specification," says David Fucci of Data General Corp., Southboro, MA. As board density increases, so do workmanship errors, says Fucci, who will give a paper at Session 18. A test system must be able to uncover such problems.

Since Data General's tester interface to the board under test via a card-edge connector, adding fault diagnosis would have required writing an extensive program. "The time and cost for writing an effective diagnostic program would have erased any savings and still result in time-consuming manual probing," according to Fucci.

Adding tests

Data General chose to add an in-circuit tester manufactured by Faultfinders Inc., Latham, NY. The tester interfaces to the board under test via a bed-of-nails fixture that contacts each node on the printed circuit board. Thus, the tester can uncover shorts, opens, and missing components as well as look for wires and etch cuts added by engineering changes in the board's design.

The results of adding in-circuit testing to the functional testing that Data General had already been performing were gratifying. "Printed-circuit boards arriving at their dedicated-test stations were averaging less than 0.2 defects per unit compared with the 2.3 defects per unit we were experiencing," Fucci recalls. "The general-purpose logic testers averaged less than 0.9 defects per unit—another decrease from 2.3 defects per unit. Total test time dropped as much as 60% on most products."

Another advocate of bed-of-nails testing is S. R. Purks of GenRad Inc., Concord, MA. A bed-of-nails fixture can facilitate testing, says Purks, "by increasing visibility and reducing diagnostic probing. This increased visibility improves fault detection and can reduce the need to simulate fault

Testing techniques for LSI boards

Testing Techniques	Advantages	Disadvantages
Software Modeling (versus gold board reference hardware)	Fault simulation for test validation and diagnostics Identification of X, indeterminate, states No maintaining gold reference hardware	Incurred modeling cost Relies on thorough LSI characterizations even for illegal inputs
Gate Equivalence Model (versus high-level functional model)	Compatible with existing simulators Tentative insight into chip internal faults and into outputs for illegal inputs	LSI model complexity involving huge number of gates Equivalence info is hard to obtain and keep up to date Tentative modeling often is inaccurate or misleading
Hardware (Gold Chip) Model of LSI Chip Within Software Simulation	Fault simulation without modeling hard emulated chip Provides tentative model of behavior for illegal inputs Relatively fast setup without precise chip characterization Emulation hardware not needed during testing	Has difficulty handling X propagation Concern with timing and initialization Requires a test system with emulation hardware during simulation
Test With Microprocessor Removed	Reduces testing complexity Avoids chip modeling Avoids risk of chip electrical damage	Requires socket for the microprocessor Overlooks failures especially in timing Risks handling damage
Single Stepping The Microprocessor	Requires less test system speed Avoids synchronization problems Simplifies modeling Free running self-test may be a subset of the testing	Misses most timing faults Will not maintain some dynamic components Not possible for all microprocessors May require added fixture hardware
High-Speed Latching	Enables fast tests on slow test system Flexible and may be customized on the device adaptor	Requires special hardware and interfacing overhead Limited size of high-speed activity burst
Current Sensing Probes and Continuity Checking	Improves diagnostic resolution especially for a bus structure	Requires special hardware and additional probing
Bed-of-Nails	Improves fault detection Reduces need to simulate fault propagation Reduces manual probing	Expensive and awkward fixtures required May encounter problems with board tolerances in inexpensive modules

propagation." If a fault exists, the bed of nails can find it right where it first appears in the board's logic. Faults needn't be propagated through layers of logic to the board-edge connector, nor a sophisticated diagnostics used to track the fault back to the failing component.

Bed-of-nails testing is not without its drawbacks, however. Because they require that the board be held against the test pins by a cumbersome vacuum system, the fixtures themselves are much more expensive and awkward to handle than card-edge connectors. And when inexpensive modules are being tested, the test pins might not strike the right points because of wide board-wiring dimensional tolerances.

A variety of tests works

In his Session 32 paper, Purks advocates several test techniques on boards containing LSI components (see table). Modeling the board can

be effective, he says, "yet the proliferation of new chips, especially custom LSI chips, makes software modeling of every LSI chip impractical." Under such conditions, other techniques may be better.

Unplugging a microprocessor before testing a board simplifies the test and protects the chip against electrical hazards stemming from board problems. But there are two disadvantages: the socket cost and the risk of damaging the microprocessor being handled. Testing with the microprocessor removed "also depends on external verification of the microprocessor's operation, and it tends to overlook faults associated with microprocessor interactions—especially timing problems," says Purks.

"An attractive combination of techniques is testing the board thoroughly for manufacturing faults with the microprocessor unplugged, followed by simpler functional testing with the microprocessor inserted," says Purks. ■■

Memories

Faster, denser, cheaper: And what an assortment!

Higher speeds and greater bit densities, but lower power and cheaper prices—plus more functions per chip. These major trends in semiconductor memory development have produced today's bewildering array of memory alternatives, including dynamic and static RAMs, ROMs, PROMs, EPROMs and EAROMs.

This semiconductor-memory revolution will be highlighted in Session 5, which will attempt to pinpoint some of these trends.

A new family of bipolar PROMs with built-in output registers saves PC-board space while cutting power consumption and cycle times, according to a Session 5 paper on the impact of registered PROMs on computer architecture by John Birkner of Monolithic Memories, Sunnyvale, CA. For a 64-bit-wide PROM of 1 k or 2 k words, the savings amount to 20 ns in cycle time, as much as an ampere of supply current, and the space for eight external register DIPs.

Two versions of registered PROMs are described, an asynchronous-enable type with simple clocking and a synchronous-enable type, used when two or more registered PROMs are bused together to increase word length. In both versions, the rising edge of the clock loads the

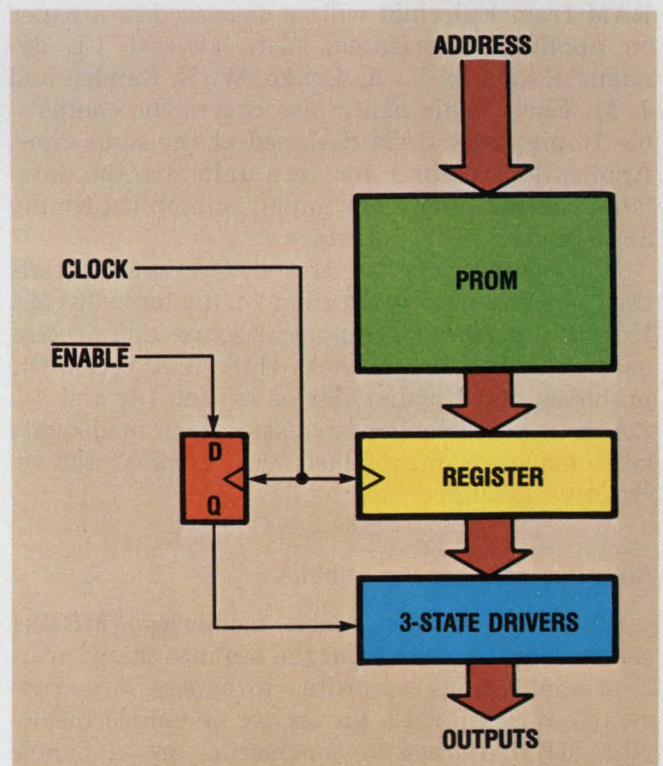

Bipolar PROM from Monolithic Memories contains built-in output register.

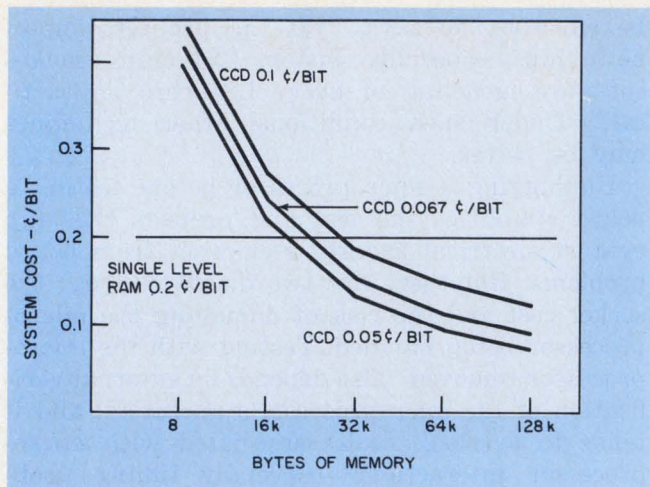

CCD memory with a small, fast buffer becomes cost-competitive with RAMs above 32 kbytes.

PROM output into the master-slave flip-flops of the register.

Upward-compatible 1024 × 4-bit and 2048 × 4-bit units are offered in 300-mil wide skinny-DIP packages with 18 and 20 pins, respectively. A 20-pin socket allows 1-k/2-k interchange.

Applications for EPROMs, according to Bob Greene and Jim Oliphant of Intel Corporation, Santa Clara, CA, range from circuit designs for PROM programming—both in-circuit and stand-alone—to power-saving techniques for multi-PROM systems. The UV-erased 16-k Intel 2716 has higher bit density than its 2708 predecessor.

The 100-ns (access time) 16-pin, 4-kbit I³L RAM from Fairchild will be discussed in a paper on applications-oriented, fast, low-cost I³L dynamic RAMs by T. A. Longo, W. B. Sander and J. M. Early. This paper also covers the compatible 16-pin, 16-k RAM designed at the same time. Application features for both units are the data-latch control, single 5-V supply, simplified timing and standard TTL interface.

But Derrell Coker of Mostek Corporation calls the 16-k the new generation of dynamic RAMs. He will describe the chip architecture and process used to make the Mostek 4116, and recall the problems and peculiarities of earlier 1-k and 4-k RAMs—excessive power dissipation, inadequate noise margins, unexplained “soft errors,” and restrictive timing.

An influx of magnetic bubbles

At last, magnetic bubble memories (MBMs) seem ready to move from the lab into many practical applications, according to papers to be presented at Session 12, an update of bubble memories. MBM storage is nonvolatile, and a bubble system uses no power while in stand-by. The bubble itself is a cylindrical island domain of

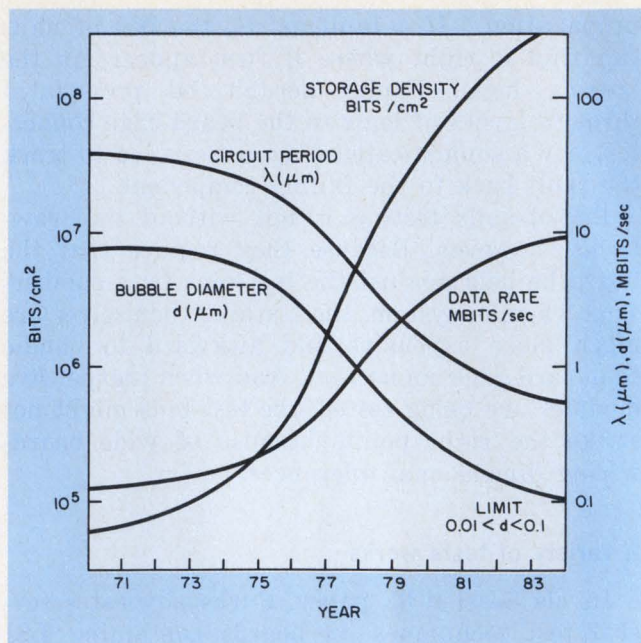

Forecast of magnetic bubble technology by Bell Laboratories indicates bright future.

reversed magnetic polarity, afloat in a thin, flawless magnetic film of epitaxially grown garnet.

Developing bubbles has taken a dozen years. Now, suddenly, practical devices are available in prototype quantity from Texas Instruments and Rockwell. “The characteristics of magnetic bubble memories match the mass-storage requirements for μ P-based systems exceedingly well,” J. Egil Juliussen of Texas Instruments, Dallas, TX, reports. “For small mass-storage systems requiring less than a few megabits, MBMs are now competitive in every respect, from entry price and bit price to small size and interfacing simplicity. MBMs are the only nonvolatile memories that scale down economically to give you fewer bits than a minifloppy and for less money. The low cost of the controller is what makes it all fly.”

Juliussen’s paper on bubble memories as small-mass storage will compare MBMs against moving-head discs, floppy discs, MOS RAMs and charge-coupled devices, and list both the advantages and disadvantages of MBMs.

The advantages of using MBMs rather than moving-head discs (MHDs) are lower access time, smaller physical size, and cheaper entry price (e.g., lower minimum-systems price), according to Juliussen. However, MHDs have a lower price per bit, a higher transfer rate and removable media.

MBMs have the same advantages over floppy discs as they have over MHDs, Juliussen continues, and the same disadvantage—lack of media removability. Bubble memories will be price-competitive with floppy discs at the system

Timetable to the technical sessions at Electro/77

Tuesday April 19	10 am 1 Switching Power Supplies	2 Trends in HF and VHF/UHF Antenna Design	3 Microcomputers for Fun and Profit	4 New Technology for CB Applications	5 The Semiconductor Memory Revolution	6 CCD Imaging	7 Future Shock for Engineers
	2 pm 8 Military and Aerospace Systems	9 RF and EM Pollution	10 Home and Hobby Computers	11 Serviceability and Maintainability in the Design Equation	12 Update on Bubble Memories	13 New CCD Signal Processing Applications	14 Tools for Managing Your Career
Wednesday April 20	10 am 15 Advances in Digital Communications Methods	16 Software Strategies for Microcomputer Programming	17 Designing with New Single-Chip Microcomputers	18 Test Effectiveness on Assembled PCBs	19 CCD Memories: The "Takeoff" Year	20 Update on Computer-Aided Circuit Design	21 Consumer Electronics in Western Europe
	2 pm 22 Wide-Band Telecommunications Systems	23 Tomography: A New Medical Diagnostic Tool	24 High-Level Languages: "Microprocessor Spoken Here"	25 Testing Microprocessors on Boards	26 Circularly Polarized Antennas: An Advance in TV Technology	27 What's New in Design Automation?	28 Finding the Money for New Companies
Wednesday Evening April 20, 8 pm SPECIAL SESSION: THE STATE OF THE ART IN PSYCHIC RESEARCH							
Thursday April 21	10 am 29 Fiber Optic Communications	30 Electronic Security Systems	31 Microprocessor Emulation: Hardware & Software Choices	32 Testing Complex Digital Assemblies	33 Programs for Energy Conservation	34 Future of Computer-Based Instruction	35 Managing the Creative Engineer
	2 pm 36 Public Services Satellite Communications	37 A/D and D/A Converter Applications	38 Applications of Bit-Sliced Microprocessors	39 The New ATLAS Standard Test Language	40 Solar Energy: A Status Report	41 TV Games—Just the Beginning	42 The Engineer After 40 (Panel)

level and thus have similar price per bit, Juliusen projects.

The advantages of MBMs over MOS RAMs are nonvolatility, lower bit price and a higher packing density that results in more bits per chip. But the RAMs have a much better access time, a higher transfer rate, and simpler interfacing.

MBMs also have the advantage over charge-coupled devices (CCDs) in nonvolatility and higher packing densities, Juliusen notes. And although the price per bit is currently a standoff, the MBMs' greater packing densities should eventually enable them to cost less per bit than CCDs. On the other hand, CCDs have better access times and higher transfer rates.

A Bell paper by Jim Williams will describe the use of the Western Electric 29A bubble device (four chips in one DIP, 272 kbits total) in a general-purpose, serial-store application, and in a voice announcement system (see "Recorded Messages to be Stored in Bubble Memory," ED No. 5, March 1, 1977, p. 18).

The Bell Labs device records and announces standard, repetitive 12 or 24-s "call-assist" messages for up to 500 telephone lines—all at the same time.

The bubble method has a number of advantages over its predecessors, which record digitized voices on a magnetic drum. While messages on a magnetic drum unit eventually degrade and must be re-recorded, message quality in the bubble memory remains good. And while the earlier systems can handle but one message, the new ones record and announce up to eight.

CCDs take off from 64 k

If MBMs are coming alive this year, charge-coupled devices are really taking off, in the opinion of R. A. Minet of RCA, Somerville, NJ,

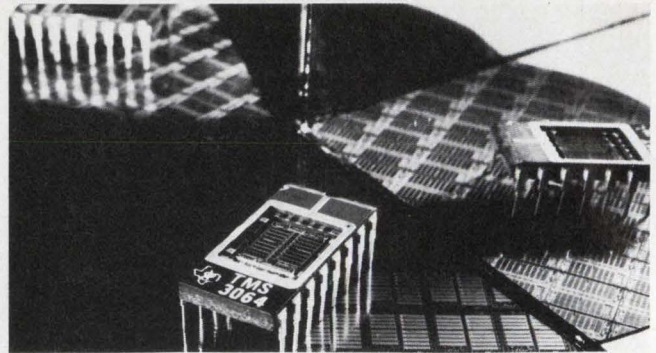

Packing 65,536 bits of data into a single chip, the TMS3064 CCD memory developed by Texas Instruments permits an access time of 800 μ s.

organizer of Session 19. They will grab the designers' attention in 1977 "like the two-by-four hitting the donkey over the head," he quips. "It's fairly definite that we'll have a half-dozen manufacturers in the 64-k CCD field. And these will be truly cost-effective memories, since for the next few years CCDs will offer four times as many bits per DIP as RAMs, at about the same cost per DIP."

"If in fact CCDs can be made for a fraction of RAM cost, it is clear that paging discs or drums will be replaced in most cases by CCDs—if nonvolatility is acceptable," A. V. Pohm of Iowa State adds in his paper on the impact of CCD-memory applications in computer systems. Talking of large computing systems whose throughput potential is memory-limited, he continues: "As the simulation results show, the drum could be free and still not represent the most cost-effective solution in a system."

But the importance of CCDs extends also to small systems and to μ C systems when a small, fast buffer (cache) is used to enhance the performance of CCDs as extended main memory. ■■

Communications

Linear/loop antenna may resolve Quad-vs-Yagi controversy

Which is the better antenna, the Quad or the Yagi?

For a long time, this has been the subject of a lively debate among radio amateurs and designers.

The solution, says Wayne Overbeck, engineering professor at Pepperdine University, Malibu,

CA, may be a combination of both. Overbeck tells why at Electro '77's Session 2, devoted to trends in hf and vhf/uhf antenna design.

Other topics to be discussed at Electro '77's communications sessions include

- Steerable phased-array radio antennas that provide 360° coverage.

No matter what your viewing pleasure, you'll find it at Digital.

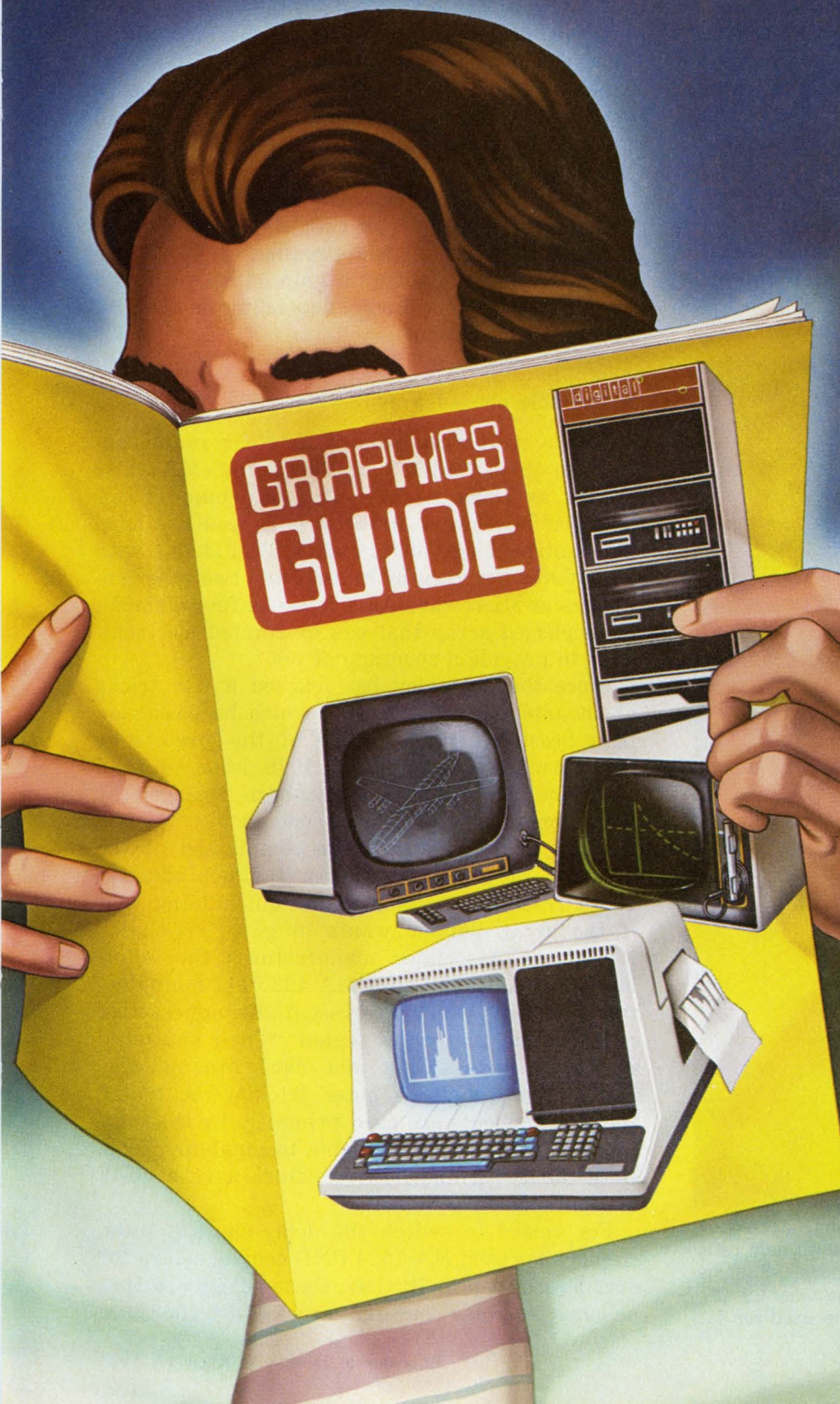

If you're looking into graphics systems, look at the company that offers you more graphics hardware, software and service than anyone else. Look at Digital.

We give you the chance to design your program first, then choose the right size graphics system to fit it. For example, you can choose our low cost VT55 graphics terminal. Or our medium performance VT11 and high performance VS60 display systems. Choose between our PDP-11/04, 11/34, 11/55 and 11/70 computers. Choose either stand-alone systems or intelligent terminals. You can even choose between our GT41, 43, 46 and GT62 processor-based systems.

And, since you're choosing Digital today, you never have to worry about adding more capability tomorrow. Because every piece of DECgraphic-11 equipment is hardware and software compatible. What's more, every system uses standard FORTRAN subroutines. So you can write your applications programs, then add on more equipment at any time. Without adding on more software.

Finally, choosing Digital means choosing the number one minicomputer manufacturer in the world. With over 4,000 sales, software and support specialists ready to lend you a hand in over 350 different cities around the world.

For all the graphic details, contact your nearest Digital sales office. Or fill out the coupon and mail to Digital Equipment Corporation, MR2-4/E14, Marlborough, MA 01752. Telephone: (617) 481-9511, ext. 6933. European headquarters: 81 route de l'Aire, 1211 Geneva 26. Tel: 42 79 50. In Canada: Digital Equipment of Canada, Ltd.

Digital Equipment Corporation, MR2-4/E14, Marlborough, MA 01752

- I am interested. But my need is long range. Please send me graphics literature.
- I am very interested. Please have your nearest sales engineer contact me.

Name _____

Title _____

Company _____

Address _____

City _____

State _____ Zip _____

Phone _____ Ext. _____

digital

ED4127

■ Using circularly polarized radio broadcasting antennas for television.

■ Applying fiber optics to military avionics systems.

In recent years, Overbeck points out, there's been a growing consensus that the full-wave loop offers significant advantages over a half-wave dipole—notably, an improved directivity that results in perhaps a 1.5-to-3-dB gain over the dipole. Both amateur and professional investigators, however, have recently reported that these advantages of the loop-Yagi-driven element aren't present in the parasitic elements of long-loop-Yagi arrays. In fact, they say, there is some evidence that linear dipoles are superior to full-wave loops serving as parasitic elements in arrays that are longer than two wavelengths.

Quad + Yagi = Quagi

Overbeck's design, he feels, takes advantage of the best features of both the linear and loop ele-

ments. The design combines a full-wave, loop-driven element and reflector with several linear parasitic directors of less than one-half wavelength. The resulting hybrid antenna, called a Quagi, combines the conventional Yagi and the cubical Quad (a loop-Yagi antenna using a square or diamond configuration).

The Quagi has frequently outperformed both loop-Yagis and conventional Yagis of similar boom length in antenna gain measurements, Overbeck says. Moreover, it is simple, inexpensive, reliable, easily duplicated, and avoids many of the practical problems inherent in the use of a dipole-driven element at very high frequencies.

After a number of experiments, Overbeck standardized on one design that he felt offered a good tradeoff among size, weight and directivity. The resulting antenna consists of six linear parasitic directors with full-wave loops (in a square configuration) for the driven element and reflector. The antenna is approximately two wavelengths long and delivers a gain of between 11.5 and 13.0 dB over a dipole, depending on the frequency of operation.

A steerable phased-array

During two week-ends of amateur radio contests in 1976, "W1CF" of Burlington, MA (also known as Dana Atchley, Jr., chairman of the board at Microwave Associates, Lincoln), landed 96 countries on 80 meters alone. He did this with an antenna designed by himself and two other engineers at Microwave Associates—a four-element, 80-m phased array that can be rotated electronically to provide a coverage of 360°.

Since then, Atchley has learned a few tricks about antennas of this type, which he passes on in a Session 2 paper. Some of the circuits he recommended in the April, 1976 issue of *QST* magazine, for example, have been replaced by better ones, as well as components.

Many array builders have complained of the difficulty of finding a source for noninductive 100- Ω resistors, Atchley points out, adding that if the array builder wants to go "first-class," Microwave Associates manufactures the 100- Ω MA 422-851112 and 50- Ω MA 422-0117 noninductive resistors, which are essentially nonreactive well into the microwave region. "Their sputtered refractive metalization and hard brazing disc make them reliable," notes Atchley. Although these components are used primarily by the military, they should be available to amateurs soon. Both the 100- Ω and 50- Ω resistors have a 50-W dissipation.

For relays to switch the delay-phasing lines, Atchley has used MA 7524 PND coaxial relays for over a year. Up to 12 GHz, these relays are flat, he notes, and may represent overkill. On the other



Circularly polarized TV transmitting antenna, located on Mt. Oso, west of Modesto, CA, has a CP power-gain ratio of 16 and is capable of 220 kW of input power. Built by Jampro, a subsidiary of Cetec Corp., Sacramento, CA, this is said to be the first CP antenna to be used for TV.

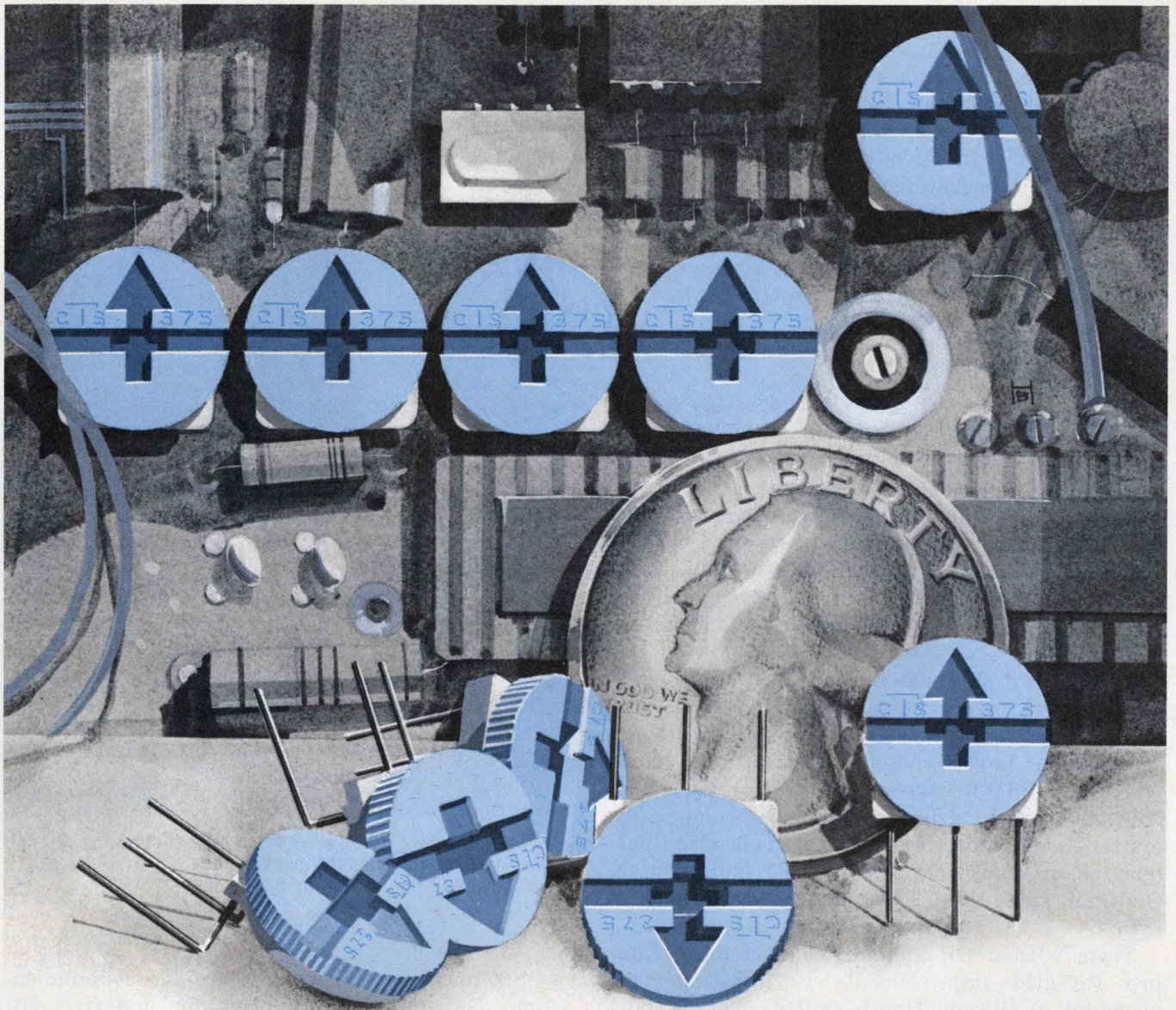

CTS mini cermet trimmers... low in price, high in performance.

Fantastic! Small $\frac{3}{8}$ " dia. (10mm), great performance and CTS reliability are only three reasons you should use our NEW series 375 single turn cermet trimmers. The low 25¢ price tag is still another.

CTS 375's, in six popular terminal styles, feature a low ± 100 ppm/ $^{\circ}$ C standard temperature coefficient—throughout the resistance range. Power rating, 1 watt at 40° C; $\frac{1}{2}$ watt at

70° C. CRV of 2%. Settability of .03%.

And the serrated adjustment knob doubles as a dust cover to protect the element from dirt, oil and other contaminants. It's a lot for so little. But you expect that from a company that's put millions into electronics for industry. For complete information, write **CTS OF WEST LIBERTY, INC.**, 6800 County Road 189, West Liberty, Ohio 43357 or phone (513) 465-3030.

CTS CORPORATION

ELKHART, INDIANA

A world leader in cermet and variable resistor technology.

CIRCLE NUMBER 29



hand, Atchley adds, the excellent pattern he has achieved is due, in part, to the tremendous isolation in the components.

If cheap, open-frame relays are used, he warns, some unwanted coupling may take place unless care is taken in the layout. For powers up to 100 W, and when operating at frequencies above 30 MHz, the builder should consider the MA 8334 series on PIN switch modules. Available in SP2T, SP3T, and as transfer-relays, Atchley says these have proven effective as relay replacements.

Televising a better picture

Circularly polarized (CP) broadcasting antennas, which have been popular with FM radio broadcasters for 10 years, can also be of great value to TV broadcasters, says Peter K. Onnigian, president of Jampro, a subsidiary of Cetec Corp., Sacramento, CA. Onnigian will present field-test results at KLOC-TV (uhf) and performance forecasts for the spiral CP antenna at Session 26, which will explore the possibilities of CP antennas for TV.

To date, CP antennas haven't been used by TV broadcasters, Onnigian believes, because TV transmission imposes stringent requirements on an antenna. Lower channels require 11% bandwidth and VSWR values of 1.1 to 1 or lower. An omnidirectional azimuth pattern complicates matters even more. Further, any elevation-pattern beam scan is intolerable. To be effective, Onnigian says, the TV antenna needs good axial ratios.

Tests with a CP antenna conducted by Jampro revealed improvements in ghosting (reduced by 20 dB), multipath, spotty coverage, bow ties, loops, misorientated antennas, as well as in co-channel and adjacent-channel interference and the poor reception often obtained with rabbit ears. Picture quality on all types of TV receivers was improved at 64% of the locations checked.

The greatest increase in signal strength came from indoor antennas, which averaged an increase of 3.8 dB, equivalent to a station increasing its power 2.4 times.

Optical links for data

Fiber optics is very effective in military avionic systems for transmitting and multiplexing data within an aircraft. This is the message the Navy will bring to Session 29 in a paper presented by T. A. Meador and G. M. Holma, engineers at the Naval Electronics Laboratory Center, San Diego, CA.

The system they describe has racked up 130 hours of flight time in an A-7 attack aircraft as part of a program known as ALOFT (airborne light-optical-fiber technology).

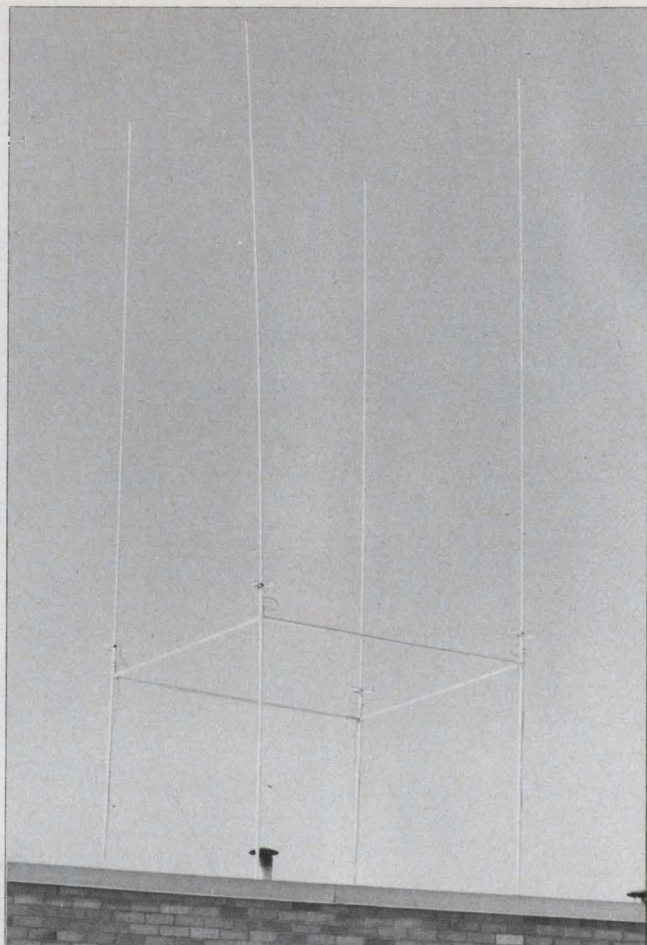

A four-element, 80-m phased-array antenna, which can be rotated electronically to provide a coverage of 360°, picked up 96 countries on 80 m alone.

Six multiplex subsystems provide communications between a central computer and five outlying terminals, which serve a total of nine avionic equipments and a variety of discrete switches. Transmission between computer and terminals is provided over multifilament fiber-optic cables terminated in standardized single and multiple channel connectors.

The fiber-optic link uses a GaAs LED to generate an optical signal at a 910-nm wavelength. The receiver uses a PIN photodiode.

One of the major potential advantages of optical fibers, compared to currently used twisted wire pairs and coaxial cable, is its extremely high communication-channel bandwidth. Another advantage: attenuation is independent of bandwidth, so the bandwidth can be upgraded to its pulse dispersion limit without paying an attenuation penalty.

How this large-bandwidth potential can be exploited will be revealed in Session 29 by S. M. Stone and G. J. Meslener, GTE Laboratories, Waltham, MA, in a paper describing an experimental 100 Mb/s optical guided wave communication system. ■■

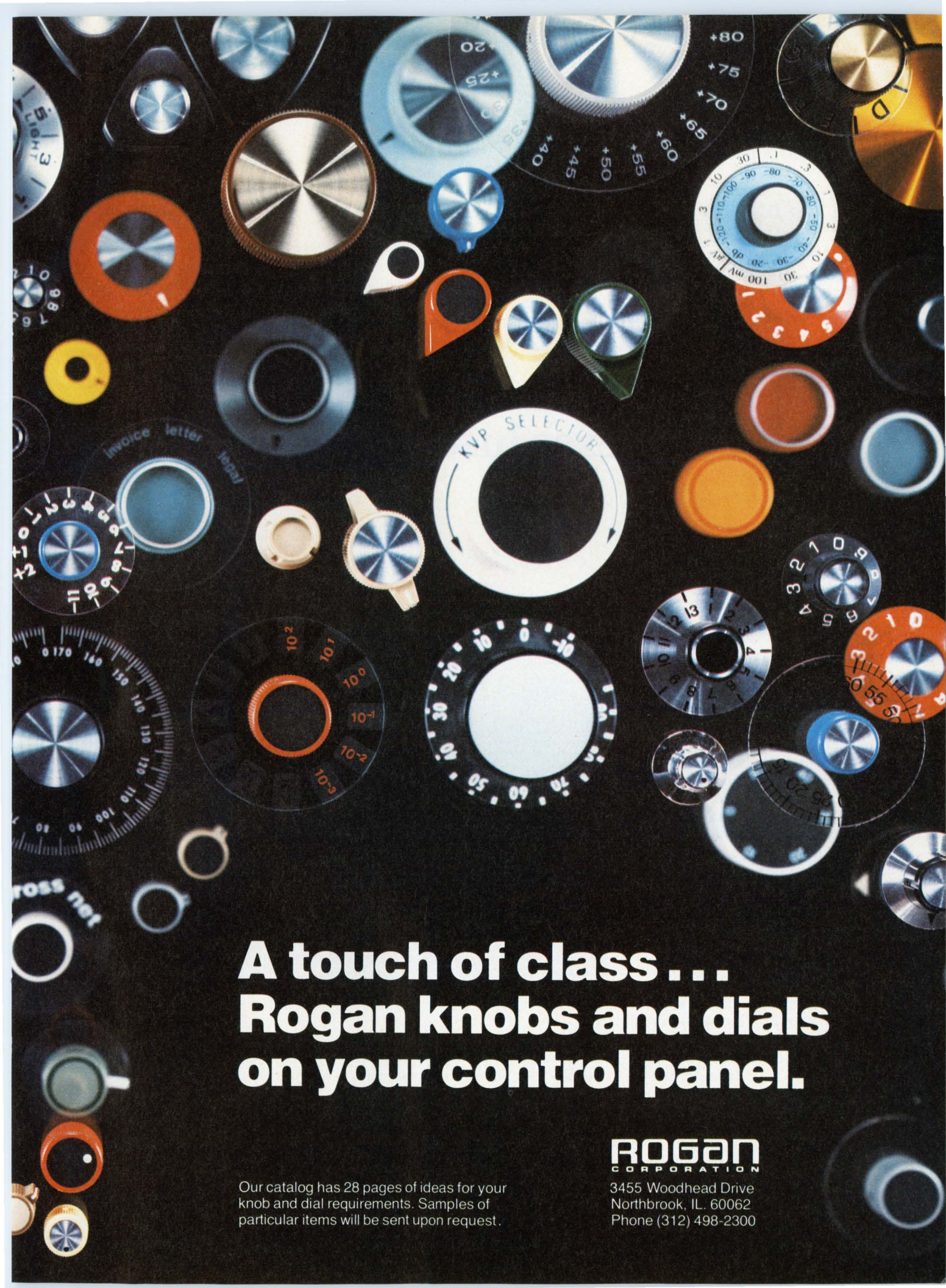

**A touch of class ...
Rogan knobs and dials
on your control panel.**

Our catalog has 28 pages of ideas for your knob and dial requirements. Samples of particular items will be sent upon request.

ROGAN
CORPORATION

3455 Woodhead Drive
Northbrook, IL. 60062
Phone (312) 498-2300

Nine new memories

from the leader...

Texas Instruments

Progress in memories comes quickly at Texas Instruments. Here are nine new memory devices. Spanning a wide range of technologies ... from NMOS to firsts in advanced processes — a magnetic bubble memory and a charge-coupled device memory.

There's higher performance, too. And broader choice. All reflecting memory leadership. Enabling you to explore new concepts. Upgrade existing designs. Achieve greater cost effectiveness. And improve system operation.

92K magnetic bubble memory ... doesn't forget to remember

The first commercially available bubble memory. TI's solid-state TBM 0103 ... 92,304 bits.

Non-volatile, it remembers when the power is off. A natural for innovative applications requiring portability. Programmable calculators. Data loggers. Voice storage. Measurement and test equipment.

Use the TBM 0103 in intelligent terminals. Word processing. Controllers. As an alternative to disk and drum storage. And the new

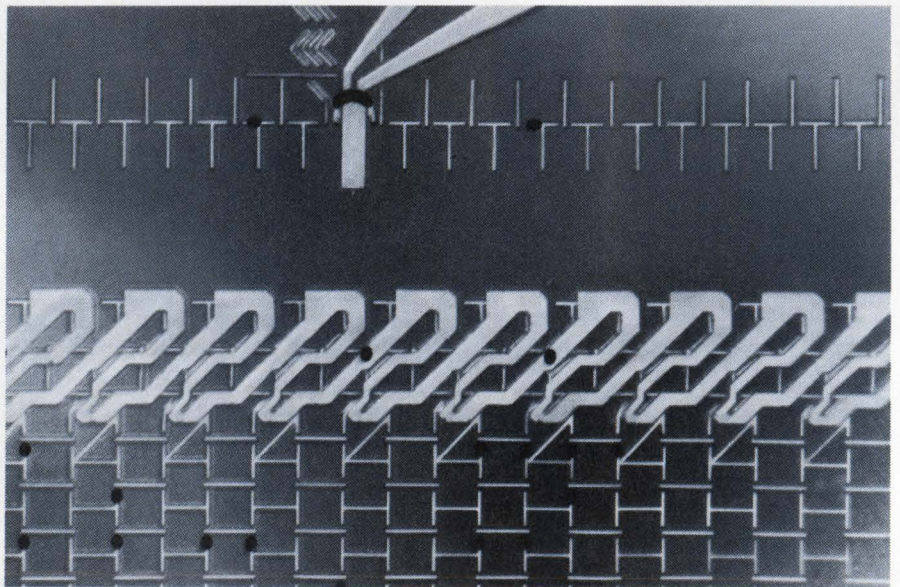

TBM 0103, with its microprocessor-compatible interface family, can handle your microprocessor mass memory function.

Data is written into and read out of a major loop, stored in minor loops. Result: Serial input I/O with random access to 641 pages 144 bits wide. Average access time: 4.0 milliseconds. Data rate: 50 kilobits per second.

Single-chip construction enhances reliability. A 1.02 by 1.1 by 0.4 inch 14-pin dual-in-line package contains the bubble chip and all necessary magnetics. Combines low initial price with system packaging flexibility and efficiency.

Prototype quantities are available now. Coming soon: new interface peripherals, including an N-channel MOS controller.

CIRCLE NUMBER 291

ELECTRONIC DESIGN 8, April 12, 1977

65K CCD memory

... plugging a gap

TI's new TMS 3064 is the first 65K charge-coupled device (CCD) memory on the market. Meets the need for a low-cost, high-performance memory between high-speed RAMs and low-speed, serial-access magnetic memories.

A new two-phase coplanar electrode CCD structure developed by TI, coupled with the standard double poly N-channel silicon gate process, is the key to the cost effectiveness of the TMS 3064.

Only two non-critical MOS-level clocks are required. Operating at 5 megabits per second, the TMS 3064 has a typical power dissipation of 300 mW.

In a 16-pin 400-mil ceramic DIP, the TMS 3064 will be available in May in sample quantities.

CIRCLE NUMBER 292

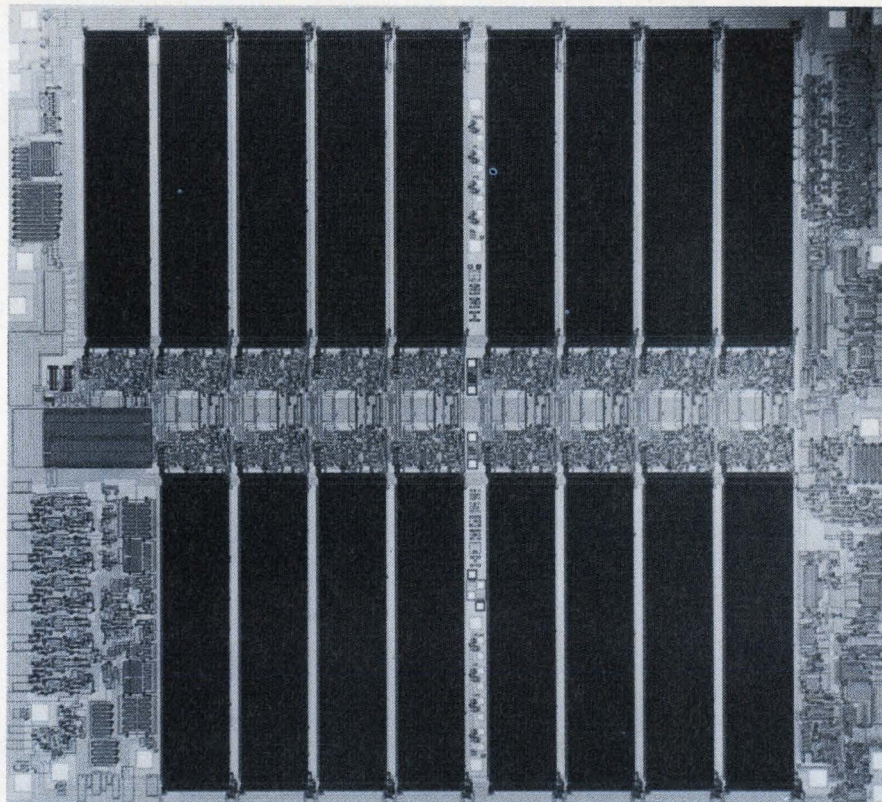

4K static RAMs

... high performance and density

Your choice of NMOS 4K memories is substantially broader with TI's new static RAM family. Fully static design eliminates the need for clocks and reduces support circuitry.

These new 4K RAMs operate from single +5 volt supplies and are fully TTL compatible. A chip select and three-state output simplify memory expansion.

They come in four speeds: 450, 300, 200, and 150 ns maximum access times. And two organizations. The TMS 4044 and 4046 are organized as 4096 words of one bit; the 4045 and 4047 as 1024 words of four bits. Typical power dissipation at 200 ns is less than 325 mW.

All four new RAMs offer identical performance, with the TMS 4046 and 4047 series having the additional advantage of a unique power-down mode - less than 10 mW power consumption.

The TMS 4044 and 4045 come in a space-saving 18-pin ceramic or plastic package; the TMS 4046 and 4047 in a compatible 20-pin configuration. Sample quantities are available now.

CIRCLE NUMBER 293

16K EPROM

... a 2708 times two

TI's new TMS 2716 is a 16,384 bit device that plugs into existing 2708 sockets. You get twice the EPROM memory in the same space. So it's ideal for upgrading present designs. Same basic chip design and circuitry as the TMS 2708. Same production-proven N-channel process. Same power supplies. At 375 mW typical, the TMS 2716 dissipates less total power than most 2708s that have half the memory.

The TMS 2716 is a natural addition to TI's 8K EPROMs - the standard TMS 2708 and the low-power TMS 27L08. All are available now.

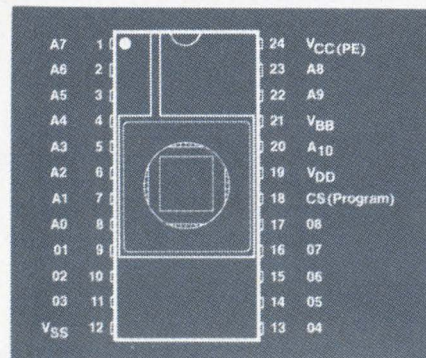

CIRCLE NUMBER 294

16-pin 4K & 16K Dynamic RAMs

In addition to the industry standard 22 and 18-pin 4K RAMs from TI, a new high-performance 16-pin TMS 4027 is available in sample quantities.

A 16K dynamic RAM - the TMS 4070 (300 ns) - is available now. With an improved performance TMS 4071 (150, 200 and 250 ns) coming in the second quarter.

CIRCLE NUMBER 295

For more information on any of these new memories, call your nearest authorized Texas Instruments distributor or TI field sales office. Or write Texas Instruments Incorporated, P.O. Box 1443, M/S 669, Houston, Texas 77001. Please identify the memory you are interested in by giving its TI part number.



TEXAS INSTRUMENTS
INCORPORATED

10 REASONS WHY YOU SHOULD CONSIDER THE MODEL 40 OEM PRINTER FOR UNDER \$2000 INSTEAD OF SOMEONE ELSE'S FOR MORE.

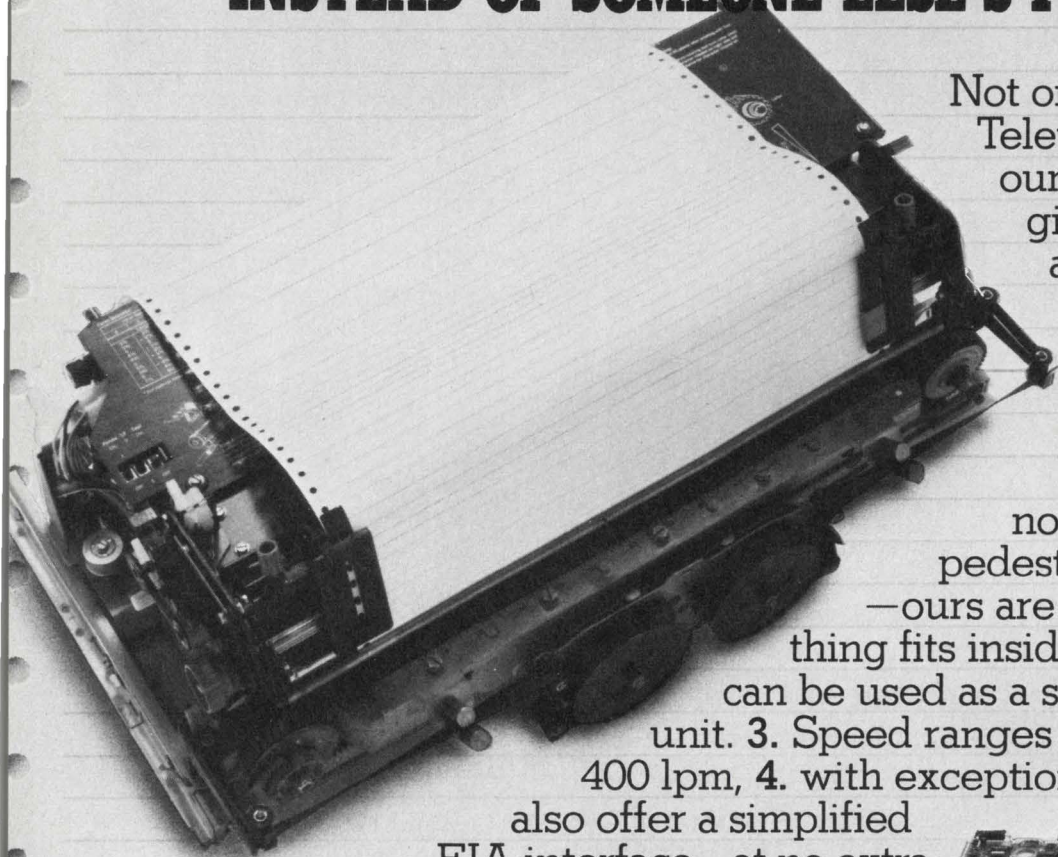

Not only do we at Teletype charge less for our printers, we also give you more quality and features for your money. 1. Like a modular, compact design with 2. state-of-the-art CMOS/LSI technology. Don't look for a pedestal full of electronics —ours are so advanced everything fits inside the printer so it can be used as a stand-alone table-top unit. 3. Speed ranges from 200 to over 400 lpm, 4. with exceptional reliability. 5. We also offer a simplified EIA interface —at no extra cost. 6. Field maintenance is simple, too. Service intervals are 2000 hours, and built-in diagnostics cut trouble-shooting time. 7. There's nationwide service back-up, plus an exchange repair service on everything from printed circuit cards to major assemblies. 8. Print quality from our fully-formed characters is sharp and crisp—from the original to the sixth copy. And we're now offering an optional block-style character font. 9. Parts commonality between all three printer models is 80%, for fewer logistical problems. 10. Last but not least, the model 40 printers are backed by a company people have depended on for nearly 70 years. Teletype.

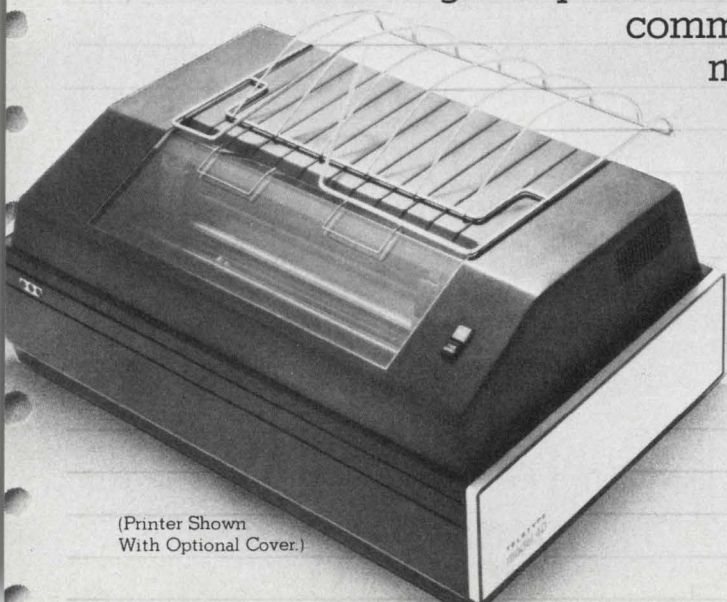

(Printer Shown With Optional Cover.)



**THE TELETYPE® MODEL 40 OEM PRINTER.
NOTHING EVEN COMES CLOSE.**

Teletype is a trademark and service mark registered in the United States Patent and Trademark Office.

Microprocessor Design

Keyboard-to-microprocessor interfaces: Should you use an encoder or the μ P?

For a while, at least, microprocessors will continue to get much of their input data via mechanical or electronic keyboards. However, in many minimal systems the keyboard often turns out to be one of the more costly components. To cut back on cost, many manufacturers are considering stripping the keyboard to just the switches—and letting the μ P do all the encoding.

“There’s a tradeoff point at about 20,000 units a year,” claims Bill Sanderson, MOS LSI marketing manager for National Semiconductor, Santa Clara, CA. He continues: “Below 20,000,

it’s usually cheaper for the manufacturer to buy a completely encoded keyboard—especially if he can make use of a standard, available unit. And above the 20-k mark he can probably do the encoding more economically by software.”

Two different types of encoders are available: the full keyboard encoder, which provides an X-Y key matrix current source/sink and delivers an ASCII code, and a simpler encoder that also delivers the X-Y current source, but just provides an X-Y coordinate output that the μ P can encode into anything the user wants.

(continued on page 74)

Prototype board permits field programming of single chip F-8

To aid the development and field testing of systems using the MK 3870, an F-8-compatible μ P, Mostek has developed the EMU-70 emulator board. The emulator is electrically equivalent to the MK 3870, but is field-programmable rather than mask-programmable.

Performing all the functions of the MK 3870, the EMU-70 provides 2 kbytes of PROM, 64 bytes of scratchpad RAM, four eight-bit, TTL-compatible latched I/O ports, a software-programmable timer and vectored interrupts.

The emulator operates from a 2-MHz clock and a 5-V supply. Two 1-k \times 8-bit 2708 UV erasable PROMs provide nonvolatile storage of the users’ programs. Without the PROMs, the EMU-70 costs \$200 and delivery is from stock. Complete documentation is provided that describes the internal operation of the EMU-70 circuit board and system-design techniques. Mostek, 1215 W. Crosby Rd., Carrollton, TX 75006. Don Ward (214) 242-0444.

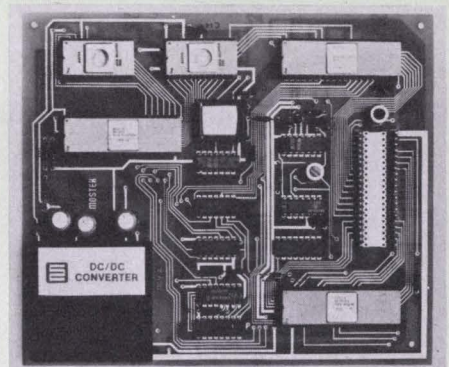

BOOTH NO. 2271 CIRCLE NO. 501

Time to expand

Due to the large reader interest in microprocessors, the Microprocessor Design department is no longer large enough to provide adequate coverage of new developments. Starting with the next issue, we will transfer microprocessor coverage from the Microprocessor Design department into the three major sections of ELECTRONIC DESIGN—News, Technology and New Products. In the April 26 issue, look for microprocessor/microcomputer-related products in the new MICRO/MINI COMPUTING products department. All other microprocessor coverage will continue to appear in the News and Technology departments.

MICROPROCESSOR DESIGN

(continued from page 73)

For less than a 5% overhead in time and 100 bytes of ROM, a μ P system can reduce a hexadecimal keypad to just 16 ohmic contact switches and a PC board. Add a few diodes, and the matrix even provides N-key rollover capability. The μ P does it all with four output lines going to the four rows of the switches (assume a 4×4 switch matrix) and four input lines to connect to the four column lines. Any contact closure, when coincident with an output strobe, can be sensed on its corresponding input line.

"The additional software may take a little longer to write," explains Dan Hammond, an applications engineer at Mostek, Carrollton, TX, "but the cost savings and reliability increase can both be large." And once the effort is put into software, it's paid for, Hammond adds. There are no parts to buy, to inventory or to assemble.

Even the four inputs and four outputs don't necessarily limit the designer to 16 key selections. If software is used to determine rollover codes,

two simultaneous key closures can be used to represent a new function or character. The number of possible combinations far surpasses the number of ASCII codes. However, the user must learn a more complex key manipulation.

System software can also do the routine jobs, like debouncing the switch contacts, determining rollover codes and performing N-key rollover lockout if the rollover is insignificant.

"Another benefit offered by software encoding is flexibility," points out Verne Wilson, senior staff engineer at Fairchild Semiconductor, San Jose, CA. "The program code can be modified and updated at any time to change the keyboard layout, or add or delete key functions."

In systems that don't use a μ P to its fullest, the added software overhead can probably be handled by the processor. "However, when the software burden becomes too great, you have a choice," suggests Ralph Ungermann, Vice President of Zilog, Cupertino, CA. "You can either use a second μ P to handle the keyboard or use a completely encoded keyboard and remove the burden altogether." By using the extra μ P, Ungermann claims, "you not only get a flexible keyboard, but you also allow for future system expansion."

Microprocessor development system does software and hardware



With the introduction of the 8001 and 8002 microprocessor labs, Tektronix offers the designer two microprocessor development systems that can be used with several popular μ Ps. Initially, the 8001 (left) and 8002 (right) will fully support system development that uses the 8080 or 6800 microprocessors: but support for additional devices is on the way.

The top-of-the-line 8002 μ P Lab simplifies software development for microprocessor-based systems and eases the integration of software with hardware. Specifically, the 8002 can enter the control program in disc memory via a terminal, including interactive editing of the program; assemble the source code into object code; run the assembled program under debug control; correct program errors easily; and emulate the microprocessor and control memory via an in-circuit emulation cable between the 8002 and the microprocessor socket on the prototype hardware. An optional built-in PROM-programming capability

(continued on page 76)

BUS DRIVER'S SPECIAL

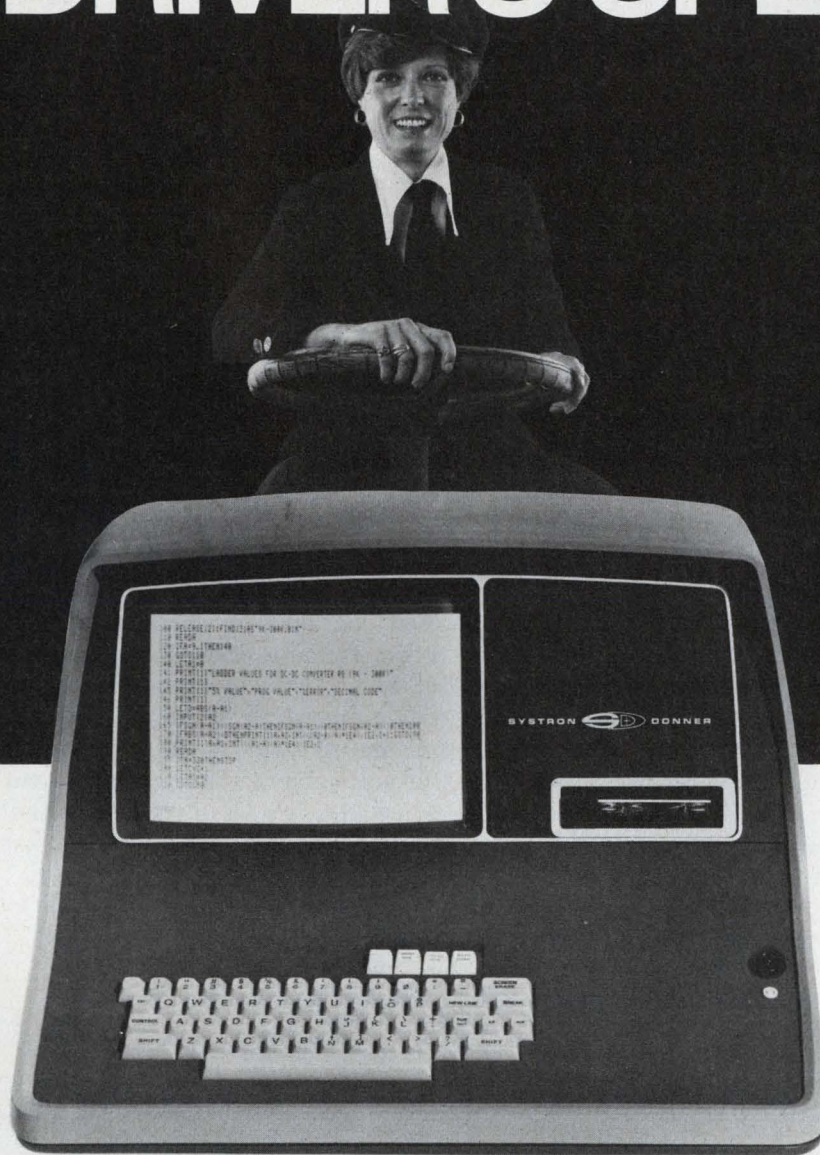

For all IEEE 488 compatible 'passengers'

Jump aboard! S-D's new Model 3530 Instrumentation CONTROLLER will comfortably accommodate up to 14 "passengers"—DVM's, power supplies, synthesizers—any instrument compatible with IEEE Standard 488-1975. The first Controller designed specifically for the bus instrumentation user, the Model 3530 features:

- Simple, typewriter-like keyboard.
- CRT display with up to 24 lines and 80 characters/line of programming or data to give you a commanding view of all pertinent information. Plotting? Yes.
- Complete in one package, including the following interfaces: IEEE bus, RS-232C, (includes TTY current loop), and microprocessor bus.
- Comprehensive, high performance 8080A microcomputer system and up to 32K bytes of memory.
- Powerful,

- high-level language, BASIC, with IEEE Bus commands to simplify programming.
- High speed magnetic tape cartridge for rapid access to programs.
- Math functions and operators for calculator-type performance.

Compare S-D's bus driver with the competition. You'll find our terminal quality keyboard/display, standardized language, and extensive memory gives you and your "passengers" the best ride for the money.

Especially when our bus driver is less than \$6,000 (U.S. only)—well below the competition!

You're in the driver's seat. For literature, contact Systron-Donner, Data Products Division, 935 Detroit Avenue, Concord, CA 94518. Phone: (415) 798-9900.

SYSTRON  DONNER

See us at ELECTRO 77 Show Booth 1527-30

MICROPROCESSOR DESIGN

(continued from page 74)

permits the 8002 to program both 1702 and 2704/2708 UV PROMs.

Three elements make up the basic 8002 system: a main chassis housing the CPU, memory, control, and interface cards; a dual-disc drive; and an interactive terminal. TTY terminals, paper-tape reader/punches, modems and printers can be added to meet the users needs.

A master CPU controls all 8002 operations via a disc-operating system. Up to three slave CPU cards for emulating different microprocessor types can be plugged in at one time. A separate CPU (also slaved to the master CPU) is used for program assembly.

Software has been optimized. A table-driven, relocatable macroassembler provides a high degree of commonality from one microprocessor type to another. Its relocatability means that when changes to the source-code program are made, only the routines affected need be reassembled into object code.

Users who already have computer facilities for developing and assembling source-code programs need not purchase the entire 8002. They can choose the 8001 μ P Lab, which offers the in-circuit emulation features of the 8002, but does not include the capabilities for entering and assembling source code into object code. It has a ROM-operating system rather than disc. The 8001 can be upgraded to an 8002 at any time by adding a master memory card, an assembly CPU card, a disc drive, and disc operating software.

The basic 8002 μ P Development System mainframe (including the disc drive) costs \$9950, which includes two microprocessor assemblers. The program-emulation and debug system option adds \$1850 to the 8002's price, the real-time prototype analyzer \$1950, the PROM programmer board \$500 and a 16-k RAM board for extra workspace \$1100. Delivery of the system is 30 days.

Tektronix, Inc., P.O. Box 500, Beaverton, OR 97077. Bill Furlow (503) 644-0161.

Booth No. 1513-1521, 1514-1522, 1613-1621.

Circle No. 502

Resident software system speeds 8080 and 6800 development



A complete "in-memory" operating system for developing 8080 or 6800 microcomputer programs, Quickrun requires 32 kbytes of memory. The system consists of a monitor debugger, editor and assembler, which all reside in memory, along with source-code and object-code work spaces. Designed to operate on Microkit's 8/16 universal development system, the

software provides enough space for a 1000-statement source program and a 4-kbyte object area.

The Quickrun development system is also available with an in-circuit emulator, called the microemulator, which provides in-circuit emulation, hardware breakpoints, single-step execution, trace execution, 2708/2704 EPROM programming, and the Quickrun's software development tools.

Price for the 8/16 microcomputer with Quickrun for either the 8080 or 6800 and complete with 32 k of memory, dual cassette tapes and CRT console is \$5275. The

(continued on page 80)

Announcing the first major advance in magnetic shielding in 50 years.



METSHIELD™ Fabric

...the first magnetic shielding product made from METGLAS® alloys. METSHIELD fabric can be handled and shaped without performance degradation.

Now you have such a shielding. It's METSHIELD™ magnetic shielding fabric—a wholly new flexible product made from Allied Chemical's METGLAS® amorphous metal alloys.

Because of its exceptional strength and flexibility, METSHIELD fabric retains its full shielding effectiveness during fabrication and use.

This reliability of performance—plus the ease with which METSHIELD fabric can be handled and shaped—promises you a significant reduction in the overall cost of shielding.

You can use METSHIELD fabric for a variety of applications, including cathode ray, photomultiplier, vidicon, and image tubes.

To find out how METSHIELD fabric can help solve your shielding problems, phone John Dismukes at 201-455-4031 or Jack Thorp at 201-455-3306. Or send in the coupon.

The time is right for a revolutionary concept in magnetic shielding.

Increased sales of electronic equipment, a trend toward miniaturization, and intensified regulatory considerations have put increased emphasis on electromagnetic compatibility.

Consequently, electronics manufacturers need cost-effective magnetic shielding not plagued by fabrication problems and use limitations associated with conventional nickel alloys.

Send me information on METGLAS® alloys and METSHIELD™ fabric.

Name/Title _____

Company _____

City/State/Zip _____

Mail to: Metglas Products, Allied Chemical Corporation
7 Vreeland Road, Florham Park, NJ 07932



See us at Electro 77, booth 2011
CIRCLE NUMBER 34



Our 100/200 megabyte OEM disk drives. Best for you. Best for your customers.

The new ISS 733-10/11 disk drives are the most advanced random access storage devices ever designed for the OEM market. With features that benefit you *and* your customers.

For example, exceptional speed in head positioning and start/stop times. Compactness. Quietness. Easy waist-high pack loading.

The big news, however, is their field-upgrade capabilities. The 100-megabyte 733-10 can be easily field-upgraded to 200 megabytes. Or you can have 200 megabytes immediately with ISS 733-11. And both can be ordered with, or field-upgraded to, dual port.

Advanced interface design

Our interface permits functional compatibility between ISS 733-10/11 and most current 40, 80, 100, 150, 200, and 300-megabyte drives. This means minimal controller modifications, if any.

Performance features

Integral power supply. Tolerates wide power variations, reduces susceptibility to cycle sags and brown-outs.

Module select plug. Permits flexibility in disk address assignments in multi-drive systems.

Data separation and write data

precompensation. All data encoding/decoding is performed in the drive.

Absolute cylinder addressing. Disk addressing done in the drive, not the controller. Simplifies programming.

Industry standard media. 3336-1 and 3336-11 or equivalent disk packs.

Programmable sector mark. Allows user to select sector size to fit his application.

Rotational position sensing. Signals the system when the desired sector is approaching the read/write heads. Increases system throughput.

Daisy chaining. Greatly reduces cabling.

Important options

Dual port. ISS 733-10/11 can be upgraded from single to dual port in the field. Or dual port can be installed prior to delivery.

Address mark format. Permits variable record lengths.

Round-the-clock ISS support

ISS maintains a complete support facility. Not just spares, but also technical assistance is available round-the-clock. Just call.

We'll be glad to send more information about the ISS 733-10/11. Write or call ISS Marketing, 10435 N. Tantau Ave., Cupertino, CA 95014, (408) 257-6220. ISS is an operating unit of Sperry Univac.



ISS

Technological leadership
for the generations ahead.

Sperry Univac is a division of Sperry Rand Corporation

Accuracy. GOULD/Brush Recorders have it.

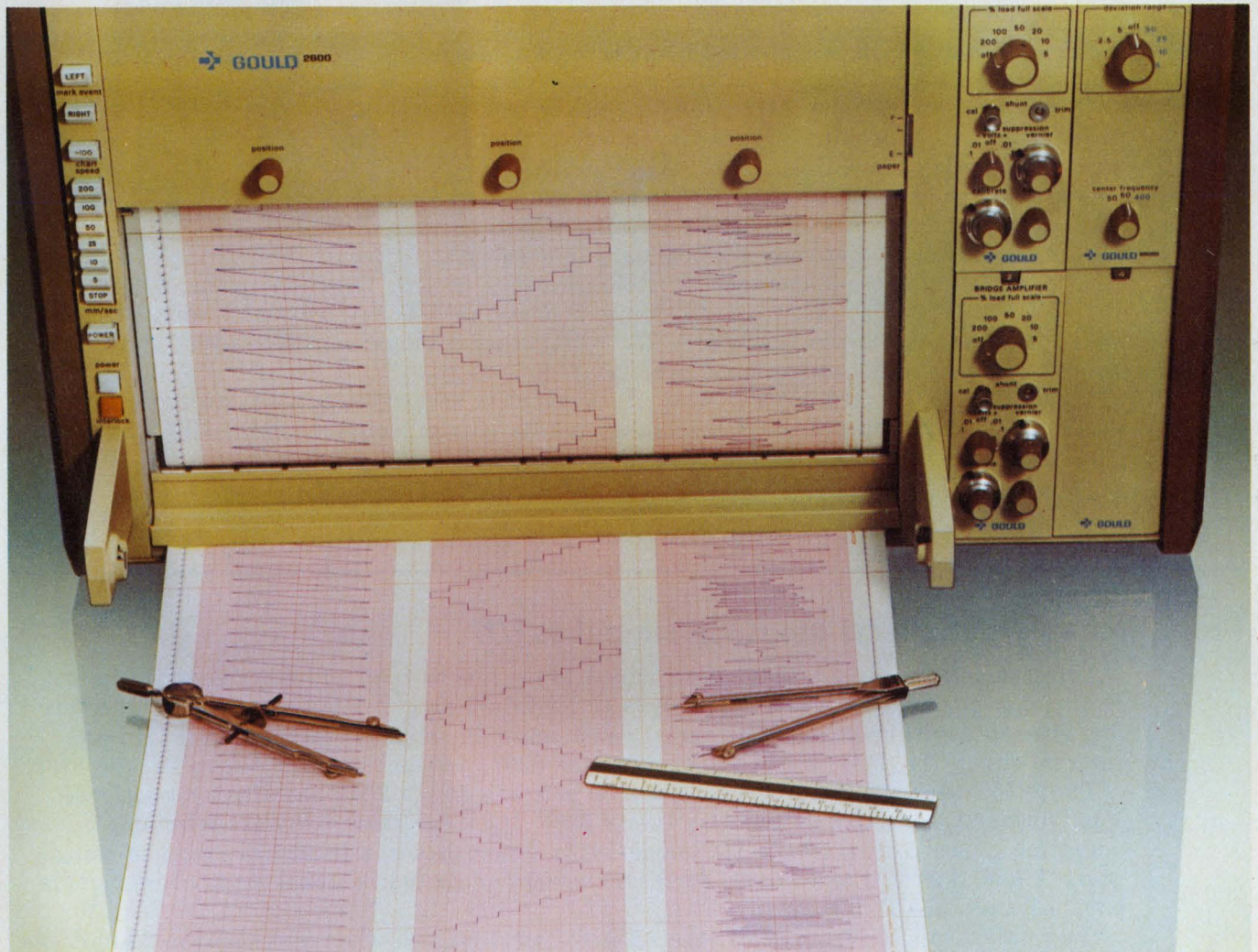

99.65% linearity.

Only GOULD Recorders offer you this exceptional accuracy because only GOULD Recorders give you a 100 gm/mm High Stiffness Pen Motor, a non contact METRISITE® position feedback

element having infinite resolution, and a unique servo drive system which anticipates changes in signal amplitude and velocity.

Accuracy is built into every GOULD direct writing recorder.

For more information on the best, write Gould Inc., 3631 Perkins Ave., Cleveland, Ohio 44114. Or Gould Allco S.A., 57 rue St. Sauveur, 91160 Ballainvilliers, France.

For brochure, call Gould toll-free at (800) 325-6400, Ext. 77.
In Missouri: (800) 342-6600

CIRCLE NUMBER 36

 **GOULD**
The product development company

MICROPROCESSOR DESIGN

(continued from page 76)

Quickrun system is available for delivery in less than 30 days.

Microkit Inc., 2180 Colorado Ave., Santa Monica, CA 90404. Robert Schaaf (213) 828-8539.

CIRCLE NO. 503

CPU card offers 4-MHz system clock rate

A CPU card based on the 4-MHz Z-80 μ P offers users of 8080-based systems a fast way to enhance system performance. The card uses the defacto standard "S-100" computer bus, developed by MITS for the Altair microcomputer, which is supported by more than a dozen manufacturers.

The crystal-controlled 4-MHz clock provides twice the throughput available with 8080 cards. However, the new card is also compatible with 2-MHz systems—an on-card switch can select a 2 or 4-MHz clock rate.

Upon power turn-on a simplified operating feature lets the processor jump to any 4-k boundary in memory, thus eliminating the rudimentary control previously needed. When using the 4-MHz clock, the CPU card can also operate with slower memory or I/O devices since jumper-selectable wait states are built into the board. The CPU board is plug-compatible with the Altair 8800 and Imsai 8080 microcomputers.

Included with the card are a Z-80 monitor, complete documentation, source code, and paper-tape object code. A Z-80 assembler and Basic interpreter are optionally available. The card costs \$295 in kit form or \$395 assembled. Delivery is 30 days.

Cromemco, 2432 Charleston Rd., Mountain View, CA 94043. Joe McCrate (415) 964-7400.

CIRCLE NO. 504

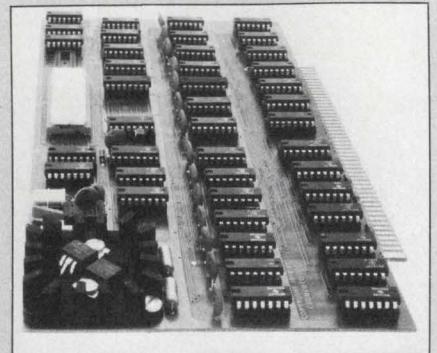

Programmable peripheral interface simplifies I/O

More peripheral circuits have been added to the line of 8080 support devices made by National Semiconductor. Now available is the INS8255 programmable peripheral interface and soon to be available are a universal communication interface circuit, the 8251; an interval timer, the 8253; a DMA controller, the 8257; and an interrupt controller, the 8259.

The 8255 comes with 24 programmable I/O pins in a 40-pin DIP, has direct bit-set/reset capability and is pin-compatible with Intel's 8255. Its three basic software-selectable operating modes are: a simple I/O mode without handshakes, a handshaking mode using ports A and B as I/O and Port C for handshaking, and a bidirectional mode over a single port. All lines are TTL-compatible.

Currently available from stock, the 8255 costs \$11.90 each when purchased in 25-unit lots. National Semiconductor, 2900 Semiconductor Dr., Santa Clara, CA 95051. Art Gruszynski (408) 737-5000.

CIRCLE NO. 505

Cross-assembler programs handle 8048 and Z80 μ Ps

Written in ANSII standard Fortran IV, a cross-assembler for the Intel 8048 and a cross-assembler for the Zilog/Mostek Z80 can operate on any computer whose word length is greater than or equal to 16 bits. Both assemblers provide all of the standard features including symbolic addressing, relative addressing, and constant generation. Also included are a macro facility, conditional assembly statements, and an option to list cross-reference tables. The Z80 Assembler will assemble both the Z80 mnemonics defined

MICRO-DIP.

The world's smallest binary coded DIP-Switch. Free from Schweber and EECO.

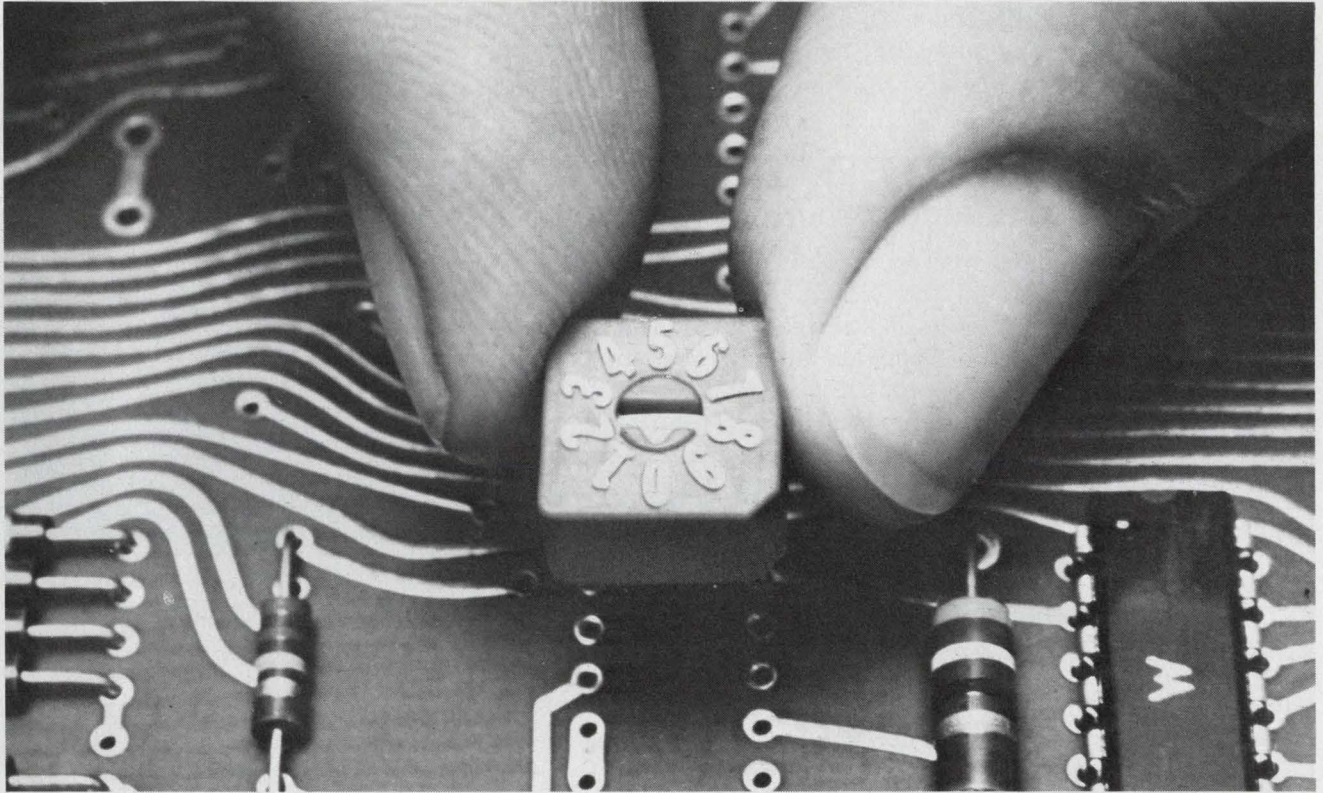

Switches are basic.

And the new EECO MICRO-DIP dual-in-line switch from Schweber is basic when you need an economical, space-saving approach to programming electronic equipment.

The unique, low-profile MICRO-DIP is designed for direct mounting on PC boards and requires no mounting hardware. Its miniature size makes it compatible with multi-layer PC boards, inter-connects, socket pins and receptacles.

And MICRO-DIP is the designer's choice as a "PROM" and data entry device for applications in computers, test equipment, process controllers, medical instruments and every area using digital electronics.

EECO's amazing new MICRO-DIP Switch from Schweber. Cost is \$1.58* in 100 piece quantity. Now you can get it with our basic instant delivery of off-the-shelf stock.

Best of all, now you can try it free from Schweber.

*For standard BCDSwitch.

Schweber. Your Basic Distributor.

**I'll take a MICRO-DIP. The
2300 Series from EECO.**

Name _____

Title _____

Company _____

Address _____

City/State/Zip _____

Phone _____

Intended Application(s) _____

Estimated Yearly Usage: _____

I am presently using: _____

**Mail Coupon to: Schweber Electronics
Westbury, New York 11590**

Westbury, N.Y: 516/334-7474
Somerset, N.J: 201/469-6008
Danbury, Conn: 203/792-3500
Rochester, N.Y: 716/461-4000
Waltham, Mass: 617/890-8484
Rockville, Md: 301/881-3300
Horsham, Pa: 215/441-0600
Atlanta, Ga: 404/449-9170
Hollywood, Fla: 305/927-0511
Beachwood, Ohio: 216/464-2970
Detroit, Michigan: 313/583-9242
Eden Prairie, Minn: 612/941-5280
Chicago, Ill: 312/593-2740
Dallas, Texas: 214/661-5010
Houston, Texas: 713/784-3600
SchweberWest: 213/537-4321
714/556-3880



CIRCLE NUMBER 37

MICROPROCESSOR DESIGN

(continued from page 80)

by Zilog/Mostek and the 8080 mnemonics defined by Intel.

Either program costs \$800 and can be delivered on several types of computer-readable media. A detailed manual, a source listing, and a test program with a sample output listing accompany each program.

Microtec, P.O. Box 60337, Sunnyvale, CA 94088. Paul Greenfield (408) 733-2919.

CIRCLE NO. 506

Complete microcomputer system accepts up to 16 k of RAM

A stand-alone microcomputer, dubbed the SDB-80, is designed around the Z80 microprocessor family. The board offers not only all the features of the Z80 μ P, but also more on-board firmware and RAM memory than any single-board microcomputer previously offered.

For software development, the SDB-80 may be purchased with a complete package of system firmware in five 2-k \times 8 ROMs located on the board. This 10-k firmware package enables its user to generate, edit, assemble, execute and debug Z80 programs. In addition to the system firmware, the SDB-80 software development package includes interface cables for both EIA/RS-232 terminals and Model 33 teletypewriters, a complete set of documentation, and either 4 or 16 kbytes of RAM memory.

The SDB-80 costs \$1195 with the 4 kbytes of RAM, \$1395 with the 16 kbytes, and \$995 without the software ROMs. For system expansion, a complete set of optional add-on circuit boards will be available, including: a 16 or 64-kbyte RAM board, the RAM-80; a debug board, the AIM-80; an interface board, the MDSX-80, that permits the SDB-80 to communicate with an Intel MDS system; and a dual floppy-disc drive interface, the FLP-80.

Mostek, 1215 W. Crosby Rd., Carrollton, TX 75006. Don Ward (214) 242-0444.

CIRCLE NO. 507
BOOTH NO. 2221

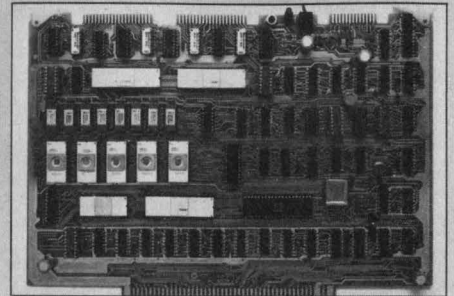

Microprocessor-based controller speeds up line printers

By controlling the print head with a microprocessor, engineers at Control Data, Minneapolis, have boosted the throughput of two line printers, the 9317 and 9318. A throughput of 125 lines/min. is possible with the 8080A-based controller, which computes the closest position on the next line to print and directs the print head's movement to that point. And, as an added bonus, mechanical wear is reduced.

Both the 9317 and 9318 use the controller to print 132-character lines. The 9318 also splits the line into two 66-column halves and uses two print heads, one for each half of the line.

Each printer includes a full-line, 132-character buffer memory. However, the 9317 can operate in an interactive mode that allows each character to be printed as it is loaded into the buffer. This mode makes the printer compatible with keyboard data-entry devices.

Options tailor the 9317 and 9318 for special applications. Normally, the units print 10 characters/in. and are provided a set of 64 ASCII characters. For high-volume requirements, the Model 9317 can print in a compressed pitch format: 16.5 characters/in. and up to 217 characters/line. A 217-character buffer is included with this version. Where symbols outside the ASCII 64-character set are needed, Control Data can supply 96 and 128-character sets.

Prices begin at \$2035 for the 9317 and \$2535 for the 9318.

CIRCLE NO. 508

(continued on page 84)

DELCO'S NEW 25-AMPERE HIGH VOLTAGE DARLINGTONS WITH THE SPEED AND ENERGY CAPABILITY YOU ASKED FOR.

Good news for motor speed control designers who have expressed a need to upgrade horsepower ratings. The 25-ampere gain of these new Darlings permits increased horsepower ratings of existing AC motor speed control systems and a reduction in paralleling in new designs. However, grouping of t_{off} is available for current sharing in designs with parallel Darlings. A speed-up diode is built into the DTS-4074 and DTS-4075 permitting data sheet t_f typicals of $1.0 \mu s$. Drive circuit techniques involving $I_{B2} \geq 2A$ and a Baker clamp produce t_f typicals in the $0.4-0.6 \mu s$ range for the DTS-4066, DTS-4067, DTS-4074, and DTS-4075.

Our experience with tolerances, faults, transients, and start-

still conditions in most systems convinces us that these Darlings have the right trade-off between speed and peak power handling capability. Note the greater than $10kVA$ region of the reverse bias safe operating graph. All this, and you still get Delco's traditional solid copper TO-3 hermetic package that has a conservative $0.75^\circ C/W$ thermal resistance.

These Darlings are already in high volume production and are available on distributor shelves. For prices, applications literature and data sheets, visit your nearest Delco sales office or Delco distributor, or mail in the coupon on the right.



MAJOR PARAMETER LIMITS

Type	h_{FE} @ 25A	h_{FE} @ 10A	V_{CEO} (sus)	V_{CE} (sat) @ 20A	I_{CEO} @ 600V
DTS-4066	5	75	350V	3.5V	0.25mA
DTS-4067	10	150	350V	2.0V	0.25mA
DTS-4074	5	75	350V	3.5V	0.25mA
DTS-4075	10	150	350V	2.0V	0.25mA

TYPICAL SWITCHING

	DTS-4066 DTS-4067	DTS-4074 DTS-4075
t_r	$0.5 \mu s$	$0.5 \mu s$
t_s	$5.0 \mu s$	$3.2 \mu s$
t_f	$4.5 \mu s$	$1.0 \mu s$

NPN triple diffused silicon Darlings are packaged in solid copper cases conforming to JEDEC TO-3 outline dimensions.

SAFE OPERATING CURVES

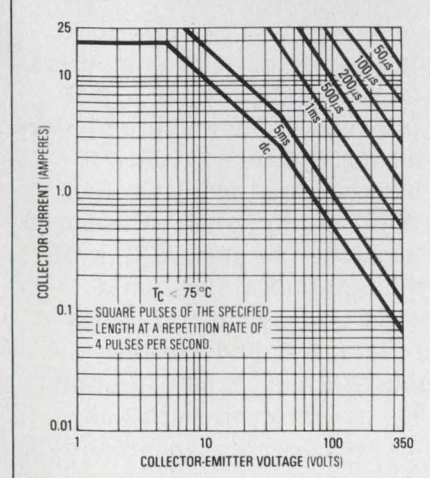

CLAMPED INDUCTIVE SWITCHING PERFORMANCE

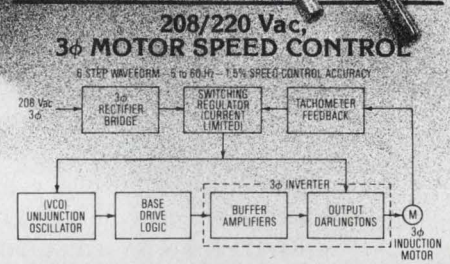
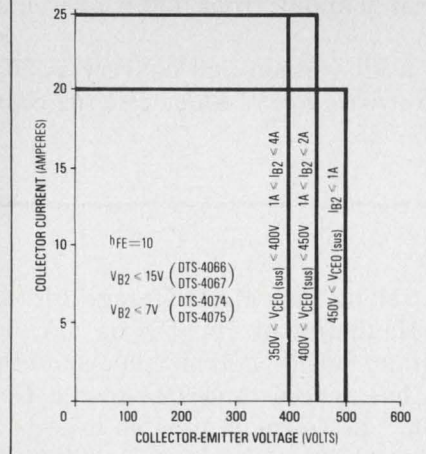

FOR MORE INFORMATION ABOUT DELCO'S NEW 25-AMPERE HIGH VOLTAGE DARLINGTONS, MAIL THIS COUPON TO:

Delco Electronics Division
General Motors Corporation
Marketing Services MS A-213
700 E. Firmin Street
Kokomo, Indiana 46901

NAME _____ TITLE _____
 COMPANY _____
 ADDRESS _____
 CITY _____ STATE _____ ZIP _____
 PHONE _____

Delco Electronics



DELCO ELECTRONICS SALES OFFICES
 Kokomo, Indiana (317) 459-2175
 Charlotte, North Carolina (704) 527-4444
 Van Nuys, California (213) 988-7550

MICROPROCESSOR DESIGN

Static memory card offers 4-MHz maximum operating speed

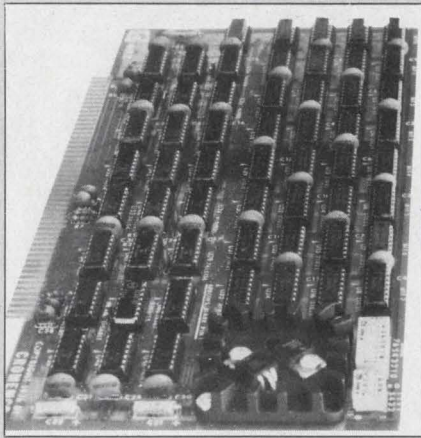

Able to operate at a 4-MHz clock rate, the 4KZ static memory card can hold 4 kbytes of RAM and has built-in bank-select switches for expandability. The switches make expanding the memory to 500 kbytes feasible, since the cards can be set up to look like eight banks of 64 k each.

An address-anticipation addressing scheme helps achieve enough speed for 21L02 memory ICs to be used. The scheme applies addresses to the memory chips before address information appears on the address bus. On-board address counters are incremented at the end of each machine cycle in preparation for the subsequent cycle. If the next address appearing on the address bus is not consecutive, a wait state is inserted for the processor,

cutting speed back to 2 MHz.

The 4KZ RAM card is compatible with the de facto "standard" bus structure developed by MITS for its Altair microcomputer.

Two versions of the RAM card are available: The kit model costs \$195 and the completely assembled card is \$295. Delivery is from stock.

Cromemco, 2432 Charleston Rd., Mountain View, CA 94043. Joe McCrate (415) 964-7400.

CIRCLE NO. 509

Z-80-based processor board mates with 8080 systems

Compatible with the de facto Altair bus standard originated by MITS, the ZPU, a Z-80 based CPU card can replace the 8080-based CPUs in Altair-bus microcomputers. The ZPU board is claimed to effectively increase microcomputer power by up to 500%.

The Z-80 board provides 158 instructions and 696 opcodes. Currently available are both 1 and 2-k monitors, a line and character oriented text editor, a relocating macro-assembler, and 8 k Basic, a TECO text editor, a word-processing system, and a full ANSI Standard FORTRAN IV compiler will soon be available.

The ZPU is available either as a kit or an assembled and tested module. The PC boards are made of FR4 epoxy, all ICs are socketed, and each package has full documentation including the Z-80 technical manual from Zilog, as well as the 1 k monitor and its source code.

Prices start at \$269 for a kit version and delivery is 30 days.

Technical Design Labs, Research Park, Bldg. H, 1101 State Rd., Princeton, NJ 08540.

Chris Rutkowski (609) 921-0321.

CIRCLE NO. 510

Micro Capsules

Look for OEMs to start selling bulk RAM storage for consumer-oriented microcomputers. Electronic Memories and Magnetics of Hawthorne, CA, now offers 16-kbyte static RAM boards that mate with Altair, Imsai, Polymorphic and other bus-compatible microcomputers. . . . ITT's Intermetall Div. has agreed to second-source General Instrument's 16-bit microprocessor, the CP1600. The German division expects to have samples available by mid-1977. . . . The Medic, an all-in-one-support circuit for the IM6100 μ P, is being developed by Intersil, Cupertino, CA. The circuit will contain a memory expander to permit 32 k of memory to be addressed, a programmable real-time clock for timing applications and a DMA controller that permits data entry on a cycle-stealing basis. . . . Seeking to reach a second-source agreement, both National Semiconductor, Santa Clara, CA, and Western Digital, Newport Beach, CA, are sitting at the bargaining table. National hopes to obtain Western's FD1771 floppy-disc controller, Astro UART and 1933 synchronous data link controller, while Western wants National's NMOS SC/MP μ P as well as an asynchronous communications circuit and a memory, both yet to be announced.

Even with our cast of thousands,

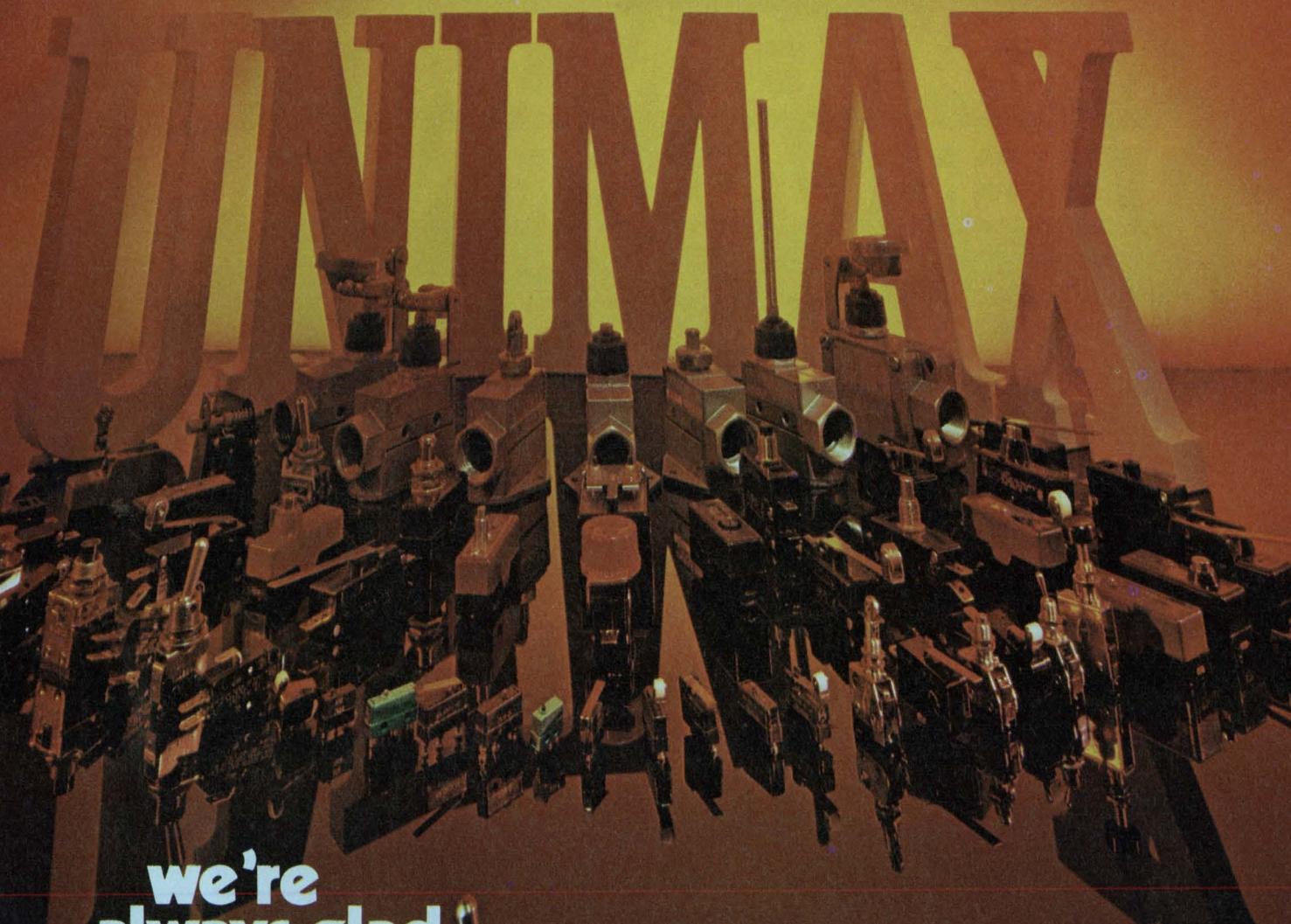

**we're
always glad
to do a
special.**

The Unimax catalog contains the industry's widest selection of precision, general purpose, miniature, subminiature and miniature subminiature snap-action switches, as well as toggle and push-button switch assemblies and metal cased limit switches.

Literally, a cast of thousands. Which isn't really surprising. Particularly when you consider that snap-action switches in one form or another are our *only* business.

But what may surprise you is our willingness to do something special to help meet your needs for a non-standard switch—whether it be in form, fit or function requirements.

In fact, "specials" represent a large part of our volume. And our experienced staff of designers and engineers will be pleased to work closely with you on the development and production of a switch that meets your specific requirements.

At affordable, competitive prices.

But before you decide on something special, take a quick look through our catalog. There's a good chance you'll find something standard that will do the job.

For a free copy of our latest catalog of snap acting switches, call or write: UNIMAX SWITCH CORP., Ives Rd., Wallingford, Conn. 06492 Tel. (203) 269-8701

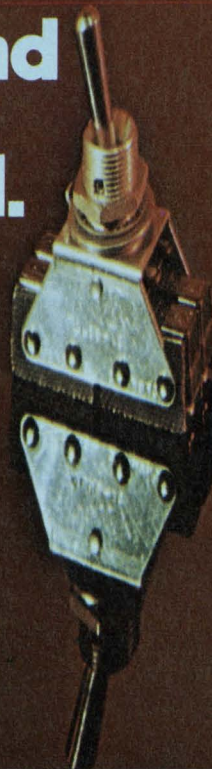

Unimax  **Switch**

FEATHERWEIGHT MINIATURE PANEL MOUNT THERMAL PRINTER!!



DPP-7 QUICK SPECS

Printing Rate:

3 lines per second

Inputs

Full parallel BCD
TTL logic inputs, selectable
positive or negative true

Printouts:

Six digits and sign, 99±9999,
±999999 or 9±99999
(Hexadecimal optional)

Input Storage

BCD data must be valid only 15
microseconds during print command

Data Capacity

9000 lines on 150 foot x 1.75 inch
(44.5mm x 45m) thermal paper rolls

Power Supply:

Choice of: +5VDC, +12VDC, or
+28VDC, or 100, 115 or 230VAC,
47 to 440 Hz.

Size Case:

4.50" wide x 2.72" high
(115mm x 69mm)

Depth:

5V, 12V,
or 28V Models:
6.2" (158mm)
AC Models: 8.7"
(221mm)



COVERED BY
GSA CONTRACT
NO. GS-00S-27959

Datel's new model DPP-7 Digital Panel Printer uses only 2 moving parts for OEM reliability. At only 2.3 Lbs. (1,1Kg) it is one of the lightest panel-mounting recording instruments available.

Includes all electronics.

The \$475* single quantity price includes everything required for full parallel BCD/TTL data inputs *plus* an input storage register for multiplexed bus applications *plus* an AC power supply! There are no extra boards to design or bulky cables and power supplies needed. The DPP-7 is ready to use.

Thermal printing means no messy inks, banging hammers or twirling print-wheels. Nothing to jam or run out of ink.

Use the miniature DPP-7 for simple data logging systems, automatic test fixtures or with a digital panel meter for accurate unattended data measurement.

The **small size** of the DPP-7 makes it ideal for panel-mounting in analytical instruments and compact data systems. Up to six digits and sign may be printed to identify channel number and data.

The DPP-7 uses +5VDC power in a very short 6.2" (158mm) deep version or 100, 115 or 230 VAC or +12V or +28VDC power in an 8.7" (221mm) deep version.

D DATEL
SYSTEMS, INC.

Send for your FREE Brochure
1020 Turnpike St., Canton, MA 02021
Phone: (617) 828-8000

- Santa Ana, CA (714) 835-2751
- Santa Ana, (L.A. Exchange) (213) 933-7256
- Sunnyvale, CA (408) 733-2424
- Gaithersburg, MD (301) 840-9490

*U.S.A. domestic price only.

CIRCLE NUMBER 40

The test

It was clear now that Jack wasn't really much good. His boss, Charlie, had been wondering about it for some time. So he gave Jack ample opportunity to prove his merit.

First, Charlie asked him to design a new counter to meet a competitive threat. A week or two later, Charlie asked Jack to prepare a comprehensive report on all competitive counters on the market. And just as Jack was dipping into that project, Charlie told him to go to Chicago for a few days to visit a large customer who was having trouble with an older counter. As soon as Jack returned, he was rushed to the DVM product line, where the reject rate had suddenly soared.

When Jack solved that problem and, with a sigh of relief, began to immerse himself in the counter project, Charlie called a series of meetings to discuss the company's vacation policy. When those meetings were over, Jack had to attend a meeting on how to cope with a competitor's new pricing policy and still another meeting to discuss unified front-panel design for all the company's instruments.

And since he already had experience preparing comprehensive reports, Jack was told to do another report—this one on the relative merits and capabilities of available microprocessors. And when that was done Charlie asked Jack: "How's the counter coming along?"

"The counter!" Jack almost shrieked. "I've hardly touched it." And that just proved that Charlie's concern was well founded. After all, he'd given Jack the counter assignment many weeks ago. Surely he should have made substantial progress by now. Yet almost nothing was done. In fact, come to think of it, Charlie had given Jack 10 or 12 other assignments in the past few weeks, and most of those hadn't been completed either.

Well, Charlie told himself, he'd certainly been fair. He had given Jack not one, but many tests. Jack had failed.



GEORGE ROSTKY
Editor-in-Chief

Low-leakage current for half the currency.

Replaces expensive tantalum and film capacitors. Our new Low-Leakage Series of Aluminum Electrolytic Capacitors have been specifically designed to meet the most stringent low-leakage design specifications. Yet they cost up to **50% less** than tantalum or film-type capacitors. These V Series radial type capacitors offer a maximum leakage of .002 CV or 0.4 μ A (whichever is greater) with a capacitance range from 0.1 μ F to 100 μ F. It's operating temperature range is -40°C through $+85^{\circ}\text{C}$. Low-Leakage Aluminum Electrolytics



nichicon
The pulse of the industry.

NICHICON (AMERICA) CORPORATION
6435 N. Proesel Ave. • Chicago, IL 60645 • (312) 679-6530
Division of NICHICON CAPACITOR LTD., Kyoto, Japan

are just one example of our continuing emphasis on reliability as the dominant design criterion. We manufacture every type of capacitor including other types of aluminum electrolytics, ceramic discs, film, oil filled—without PCB's, metallized paper and wax paper capacitors for standard or specialized applications.

Send for your free catalog and engineering samples today. Simply write to us on your company letterhead.
You'll hear from us soon.

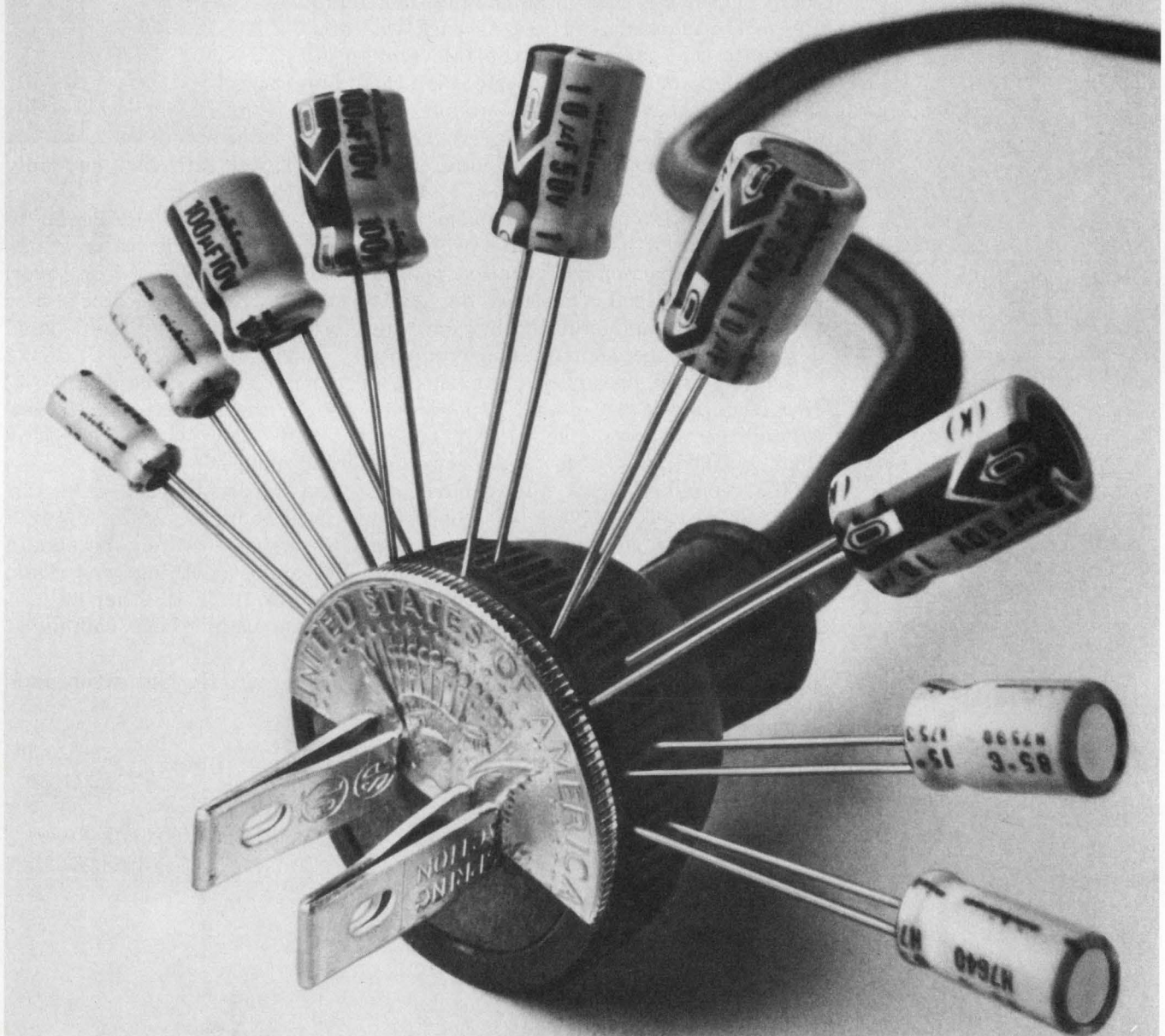

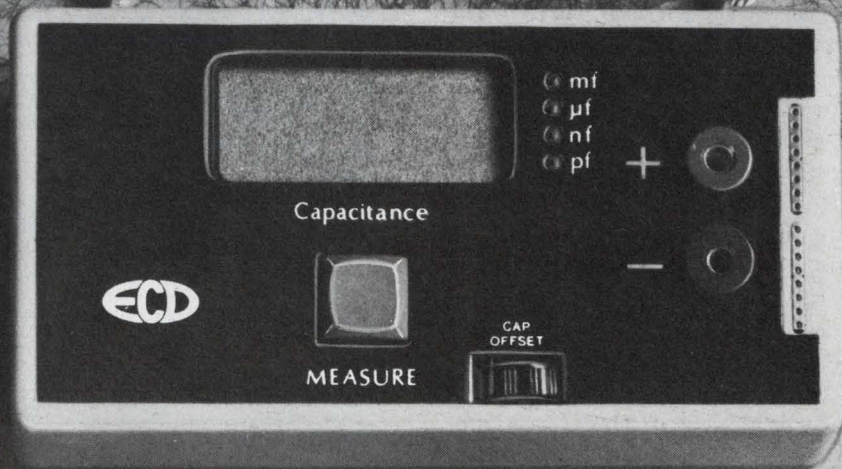

My shirt, yes...my C-Meter, no.

Test the kind of guy who'll give you the shirt off his back: ask him for his C-Meter.[®]

He knows that his C-Meter gives him a definite edge. It exposes an obvious efficiency: capacitors are easier to measure than resistors.

No more twiddling and nulling. No need for expensive, tight-tolerance capacitors or tweak pots. With its pushbutton speed, high accuracy (0.1%), small size

and versatility (0.1 pf to 0.2 farads), the C-Meter makes you a more productive engineer.

You owe it to yourself to try one on. It'll cost no more than a fine suit: stocked locally at only **\$289.00**.

ECD CORP.
196 Broadway, Cambridge
Mass. 02139 (617) 661-4400



CIRCLE NUMBER 42

Visit us at Electro '77, Booth #1311

SALES OFFICES: AL, Huntsville (205) 533-5896; AZ, Scottsdale (602) 947-7841; CA, Costa Mesa (714) 540-7160; CA, Sunnyvale (408) 733-8690; CO, Denver (303) 750-1222; FL, Winter Haven (813) 294-5815; GA, Chamblee (404) 457-7117; IL, Elk Grove Vill (312) 593-0282; IN, Indianapolis (317) 293-9827; MD, Silver Spring (301) 622-4200; MA, Burlington (617) 273-0198; MN, Minneapolis (612) 781-1611; MO, Kansas City (816) 358-7272; NJ, Camden (215) 925-8711; NM, Albuquerque (505) 299-7658; NY, Great Neck (516) 482-3500, (212) 895-7177; Syracuse (315) 446-0220; NC, Raleigh (919) 787-5818; OH, Centerville (513) 433-8171; TX, Houston (713) 688-9971; TX, Richardson (214) 231-2573.

Take advantage of 8080 and 6800 data-manipulation capabilities. The circuits' ability to handle arrays can simplify many data handling applications.

Every microprocessor has special instructions and methods for applying the same basic program repeatedly to a set of data. And making the best use of counters, pointers and program loops can simplify this data manipulation. Specific examples of 8080 and 6800 microprocessor software will illustrate how you can form data structures—lists, arrays and strings—and handle them efficiently.

Seldom is a μP used to handle a single data word at a time. Often, the μP must collect data, and then process it all at once, as in averaging or plotting analog readings, editing strings, preparing blocks of data for output, performing a series of tests or operations, or just performing mathematical operations. Even simple results often have to be totalled and stored on block-oriented media such as cassettes or discs, or saved for subsequent analysis by a larger computer.

Simple manipulation starts with the formation of a structure (call it an array) from the data, then a repetition of processing instructions for each array element. However, there are three questions that you must answer before handling the array:

1. How is the array formed from individual data inputs or results?
2. How are the same instructions used to process different array elements?
3. How are operations on the array initiated and concluded?

Counters, pointer registers and program loops can be used to solve the problems posed. (For more about the different addressing techniques the microprocessors use, see reference 1).

Start by collecting the data

Collecting data and filing an array calls for a counter and a pointer. (A pointer is simply a register or memory location that contains the address of the data rather than the actual data.) The counter lets the μP keep track of how many

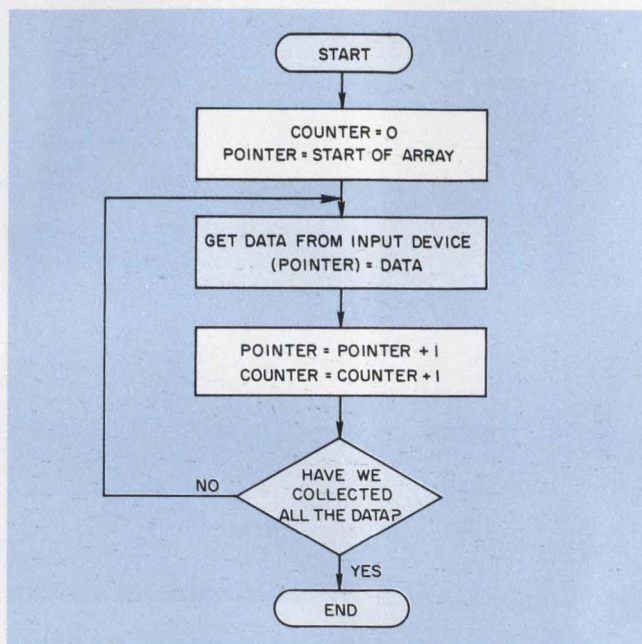

1. The simplest data-collection routine uses counter and pointer registers to keep track of all inputs.

items are being stored, and the pointer tells the system where to look for the data. The pointer acts just like a cursor in a graphics display: Incrementing or decrementing a pointer is like moving the cursor forward or backward before entering a character.

When each data item simply occupies a single work in memory, the data collection can be organized as shown in Fig. 1 and described as follows:

Step 1: Initialization

- a. Pointer = starting address of array.
- b. Counter = 0

Step 2: Acquisition

- a. Get data from input device and hold in accumulator.

Step 3: Storage

- a. Store data in location specified by pointer
- b. Counter = Counter + 1
- c. Pointer = Pointer + 1

Step 4: Decision and loop

- a. If all data have not been collected, return to Step 2, otherwise stop.

Dr. Lance Leventhal, Instructor, Engineering and Technology Dept., Grossmont College, 8800 Grossmont College Dr., El Cajon, CA 92020.

Two iterations of the sequence of events are shown in Fig. 2. However, now comes the problem of actually implementing the sequence of events on a μ P. In the simplest case, where the only task is to collect data, registers can act as the pointer and counter. On both the 8080 and 6800 μ Ps, you must remember that the pointer and other addresses are 16-bits wide, while the counter and data are only 8 bits wide.

Register indirect addressing sets the table

For the 8080, register indirect addressing can be used to set up arrays. Indicated by the register code M in the assembler notation, this addressing mode means that data are transferred to or from the memory address stored in register pair H of the 8080. (For more about the 8080, see reference 2.) Register pair H consists of two 8-bit registers, called H (for high address) and L (for low address).

The instruction MOV M, A means "Move the contents of the accumulator to the memory location addressed by register pair H." The 8080 has special instructions for loading register pair H (LXI and LHLD), storing its contents (SHLD), incrementing it or decrementing it (INX or DCX), and even adding its contents to another register pair (DAD). All these instructions handle 16-bit addresses even though most 8080 instructions handle 8-bit data.

Fig. 3 shows the execution of the MOV M, A instruction. The μ P places the 16-bit contents of address registers H and L on the 16-bit address bus and places the 8-bit contents of register A on the 8-bit data bus. Be especially careful when dealing with arrays to remember the distinction between data and addresses—particularly when they have different lengths.

Whenever the processor uses the data bus, it can only transfer eight bits at a time. So even when a single instruction causes a 16-bit quantity to be loaded or stored, executing that instruction involves two separate 8-bit transfers. The only difference between an instruction moving a 16-bit quantity and two instructions each moving eight bits is that in the first case the μ P has to fetch one less instruction. However, the 8080 and other similar units have 16-bit-wide internal-address buses and incrementer/decrementers so that some internal activities (e.g., incrementing the program counter) can be done 16 bits at a time.

The 8080 has the following data-collection program:

```

LXI H, START ; POINTER = START
MVI C, 0     ; COUNTER = 0
SAVE1: IN DPORT ; GET DATA
MOV M, A    ; PLACE DATA IN ARRAY
INX H      ; POINTER = POINTER + 1
INR C     ; COUNTER = COUNTER + 1
JMP SAVE1  ; CONTINUE COLLECTING DATA

```

This program has been greatly simplified to show

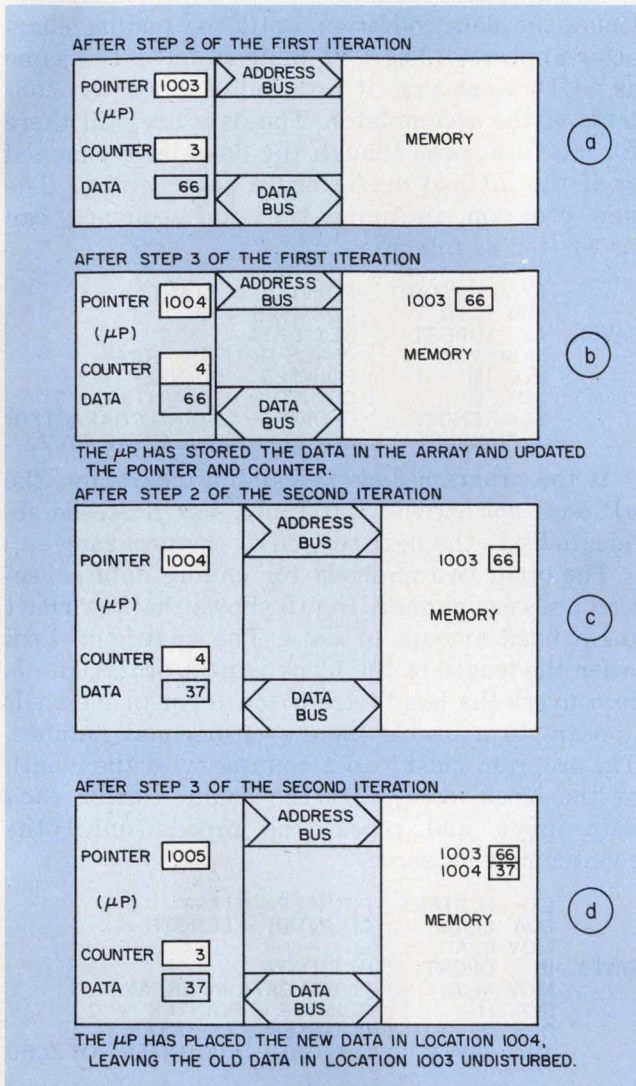

2. After two iterations of the data collection process, data get stored in sequential memory locations and the pointer and counter registers are updated.

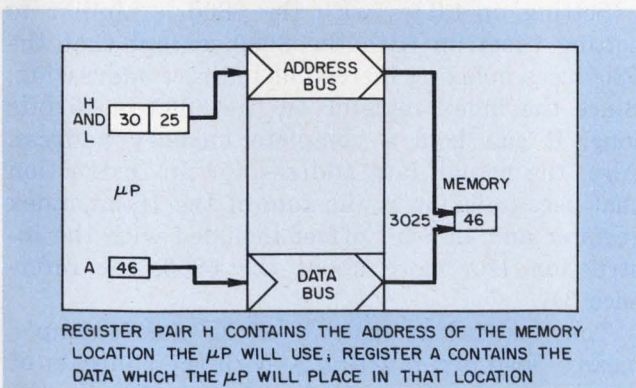

3. Execution of a MOV M,A instruction on the 8080 uses the H and L registers to get the data's address on the address bus.

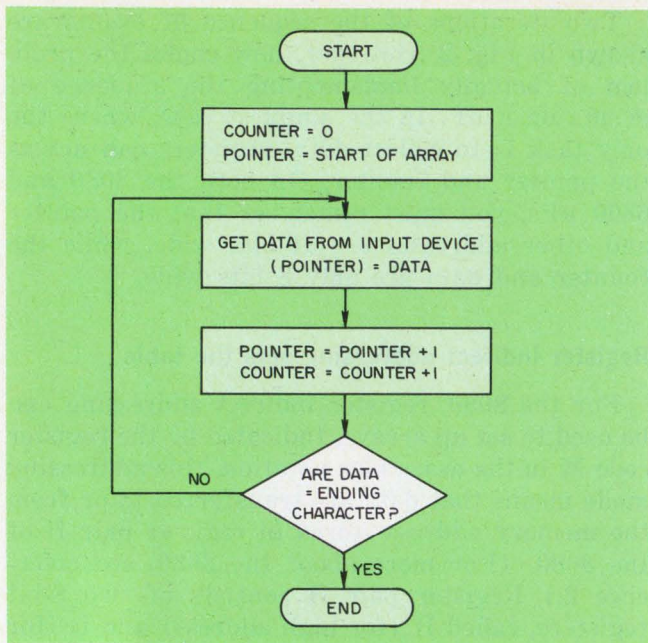

4. Modifying the basic data-collection routine to search for a final character instead of checking for a count value is an alternate method to end an array.

just the basic collection procedure. Presumably, the input device has new data ready for each input operation, and no control signals or delays are necessary. The actual input process depends on the specific application and input device.

Modify the program to stop

Even allowing for such license, the program still has a serious deficiency—it will never stop. It will just go on and on collecting data and storing it in memory. The counter and pointer will continuously increment until they exceed their capacities and start all over again. So the program must be modified to stop after a certain number of data inputs.

Actual methods to stop the program depend on the particular application, but here are some simple techniques:

1. Look for an ending character, such as a carriage return or a period in a line of text, or an ETX ASCII input character in a message.
2. Wait for a fixed amount of data, such as in a message with fixed length, a data entry with a fixed number of digits, or a line with a fixed number of characters.
3. Make the length of the data part of the data itself, as in a tape record that makes the length of the record the first data item.

Fig. 4 shows the revised flow chart of the data collection when the μP must find an ending character. The Intel 8080 program uses a subtract instruction (SUI or CPI) to ascertain if the data and the ending character are the same. This instruction subtracts the ending character from

the contents of the accumulator. If the result is zero, the two operands are equal. The Zero flag indicates the result:

Zero = 1 if the two operands are equal,
and 0 otherwise.

The instruction Jump On Not Zero (JNZ) continues the data collection until the ending character appears. (The CPI instruction is the same as SUI except that it does not change the contents of the accumulator. The data are still there for later use, even though the flags have changed as if the μP had performed a subtraction.) The new program, including the stop sequence, can be written as follows:

```

LXI H, START ; POINTER = START
MVI C, 0 ; COUNTER = 0
SAVE1: IN DPORT ; GET DATA
MOV M, A ; PLACE DATA IN ARRAY
INX H ; POINTER = POINTER + 1
INR C ; COUNTER = COUNTER + 1
SUI ENDC ; IS DATA = ENDING CHARACTER?
JNZ SAVE1 ; NO, KEEP COLLECTING DATA
  
```

If the program finds the ending character, the μP does *not* execute the Jump, but proceeds sequentially to the next section of the program.

The other two methods for ending data collection are very similar. Fig. 5 shows the flow chart for a fixed amount of data. The additional task when the length of the block is part of the data is to convert the length from the form in which it appears to a usable binary or decimal number. The program must load a counter with the length of the block, decrement the counter after each data input, and repeat the process until the counter reaches zero:

```

LXI H, START ; POINTER = START
LDA LENG ; COUNTER = LENGTH
MOV C, A
SAVE1: IN DPORT ; GET DATA
MOV M, A ; PLACE DATA IN ARRAY
INX H ; POINTER = POINTER + 1
DCR C ; COUNTER = COUNTER - 1
JNZ SAVE1 ; CONTINUE IF COUNTER NOT ZERO
  
```

In this program, the counter counts down instead of up so that the program can use the Zero flag as an ending condition.

Set the table with a 6800

Setting up tables with the 6800 is similar to setting them up with the 8080, except that the 6800 uses indexing instead of indirect addressing. Since the index register on the 6800 is 16 bits long, it can hold a complete memory address. Also, the actual data address for an instruction that uses indexing is the sum of the 16-bit index register and an 8-bit offset included with the instruction (for more about the 6800, see reference 3).

The instruction LDAA 20,X, for example, means "load accumulator A with the contents of the memory location whose address is 20 plus the contents of the index register" (Fig. 6). The processor must add 20 to the contents of the in-

dex register, place that result on the address bus, then place the data from that address in accumulator A.

The 6800 has special instructions for loading the index register (LDX), storing its contents (STX), and incrementing or decrementing it (INX or DEX). As with the 8080, these instructions handle 16-bit addresses rather than 8-bit data and all data transfers are 8 bits long. Only a few simple internal operations handle 16 bits at a time.

The 6800 data-collection programs follow a format much like that written for the 8080:

Basic data-collection program

```

LDX #START    POINTER = START
CLRB          COUNTER = 0
SAVE1 LDAA PIADRA  GET DATA
STAA X        PLACE DATA IN ARRAY
INX           POINTER = POINTER + 1
INCB         COUNTER = COUNTER + 1
BRA  SAVE1    CONTINUE COLLECTING DATA
  
```

Looking for the ending character ENDCH

```

LDX #START    POINTER = START
CLRB          COUNTER = 0
SAVE1 LDAA PIADRA  GET DATA
STAA X        PLACE DATA IN ARRAY
INX           POINTER = POINTER + 1
INCB         COUNTER = COUNTER + 1
SUBA #ENDCH   IS DATA = ENDING CHARTER?
BNE  SAVE1    NO, KEEP COLLECTING DATA
  
```

A CMPA instruction can replace SUBA so as not to change the data.

Counting the amount of data

```

LDX #START    POINTER = START
LDAB LENG     COUNTER = LENGTH
SAVE1 LDAA PIADRA  GET DATA
STAA X        PLACE DATA IN ARRAY
INX           POINTER = POINTER + 1
DECB         COUNTER = COUNTER - 1
BNE  SAVE1    CONTINUE IF COUNTER NOT ZERO
  
```

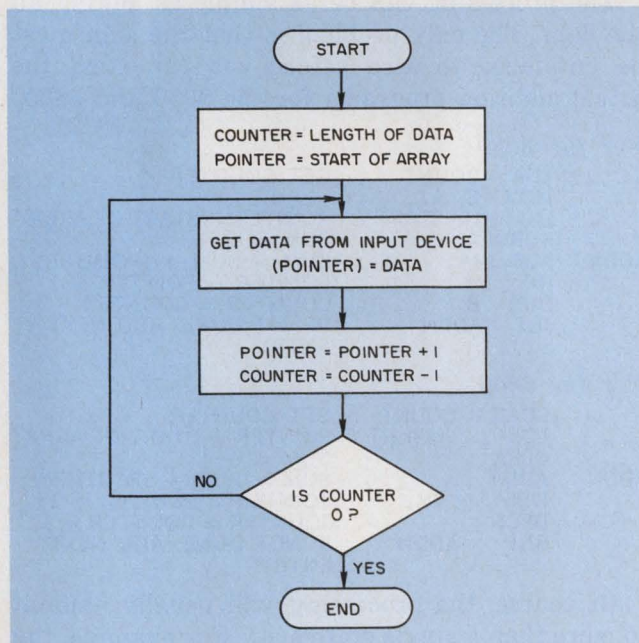

5. To collect a fixed or known amount of data, the counter can be preset to the desired value, then decremented until it reaches zero.

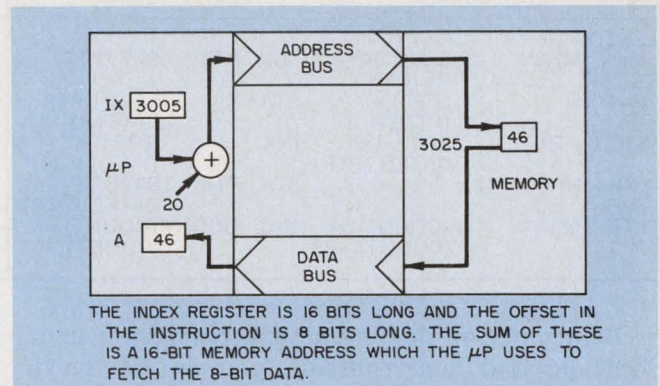

6. When performing an indexed addressing operation, the 6800 adds an offset value to the contents of the index register to produce the data's storage address.

Note, however, that a zero-indexed offset can be omitted and that a # means "immediate" (the data are right there). And remember that the 6800 has no special input/output instructions; I/O ports are treated just like memory locations. So loading data from a peripheral interface adapter (PIA) data register (LDAA PIADRA) is the same as an input operation on the 8080 (IN DPORT).

Do more than just collect data

Of course, a program often does more than just fetch the data. It may have to interpret the data (as in entries from a keyboard), linearize the data (as in entries from an analog source), convert the data to a different code, check the data for errors, or filter the data before placing the information in the array.

Various processing applications may require many or all of the internal μP registers. When the internal registers are overloaded, memory locations can be used to act as the pointer and counter. Remember that the pointer is 16 bits long, therefore occupies two 8-bit words of memory. If the counter is in memory location COUNT and the pointer in locations PTR and PTR + 1, the procedures are as follows:

1. Initialize COUNT to zero, PTR to STRT

8080 routine			6800 routine		
SUB	A	; GET ZERO	CLR	COUNT	(COUNT) = ZERO
STA	COUNT	; (COUNT) = ZERO	LDX	#STRT	GET STRT
LXI	H, STRT	; GET STRT	STX	PTR	(PTR) = STRT
SHLD	PTR	; (PTR) = STRT			

Note the distinction between the fixed address STRT and the variable (e.g., indirect) address, which is in memory locations PTR and PTR + 1.

2. Store data, update COUNT and PTR by 1

8080 routine		6800 routine	
LHLD PTR	; GET (PTR)	LDX PTR	GET (PTR)
MOV M, A	; SAVE DATA	STAA X	SAVE DATA
INX H	; IN (PTR)	INX	IN (PTR)
SHLD PTR	; (PTR) = (PTR) + 1	STX PTR	(PTR) = (PTR) + 1
LXI H, COUNT ;	; SAVE UP-DATED (PTR)	STX PTR	SAVE UP-DATED (PTR)
INR M	; (COUNT) = (COUNT) + 1	INC COUNT	(COUNT) = (COUNT) + 1

Remembering the distinctions between memory locations and their contents, you can handle the ending conditions for both 8080 and 6800 routines the same way.

Handle multiword data with ease

If each entry requires more than one 8-bit word, several storage operations will be necessary in each iteration. The 8080 has extra registers for the multiple-word entries; the 6800 can use the stack for additional storage, if necessary. Typical instruction sequences for storing 16-bit data in an array are the following:

For the 8080

```
LHLD PTR ; GET (PTR)
MOV M,C ; STORE 8 LSBs AT (PTR)
INX H ;
MOV M,B ; STORE 8 LSBs at (PTR) + 1
INX H ; UPDATE (PTR)
SHLD PTR ; SAVE UPDATED (PTR)
```

For the 6800

```
LDX PTR GET (PTR)
STAB X STORE 8 LSBs AT (PTR)
INX
STAA X STORE 8 MSBs AT (PTR) + 1
INX UPDATE (PTR)
STX PTR SAVE UPDATED (PTR)
```

Here the contents of PTR increase by two during each iteration.

Sometimes, an array starts with constant values that may represent base levels, default values or continuations from previous work. The length of the array must be fixed or known. A single starting value is entered by the following:

For the 8080

```
LXI H, START ; POINTER = START
MVI B, NUMBR ; COUNT = NUMBR
MVI C, VALUE ; LEVEL = VALUE
SAVE1: MOV M, C ; (PTR) = LEVEL
INX H ; POINTER = POINTER + 1
DCR B ; COUNT = COUNT - 1
JNZ SAVE1 ; CONTINUE FILLING ARRAY UNTIL COUNT = 0
```

For the 6800

```
LDX #START POINTER = START
LDAB #NUMBR COUNT = NUMBR
LDAA #VALUE LEVEL = VALUE
SAVE1 STAA X (PTR) = LEVEL
INX POINTER = POINTER + 1
DECB COUNT = COUNT - 1
BNE SAVE1 CONTINUE FILLING ARRAY UNTIL COUNT = 0
```

Once data have been collected, the array can be processed the same way that the data were

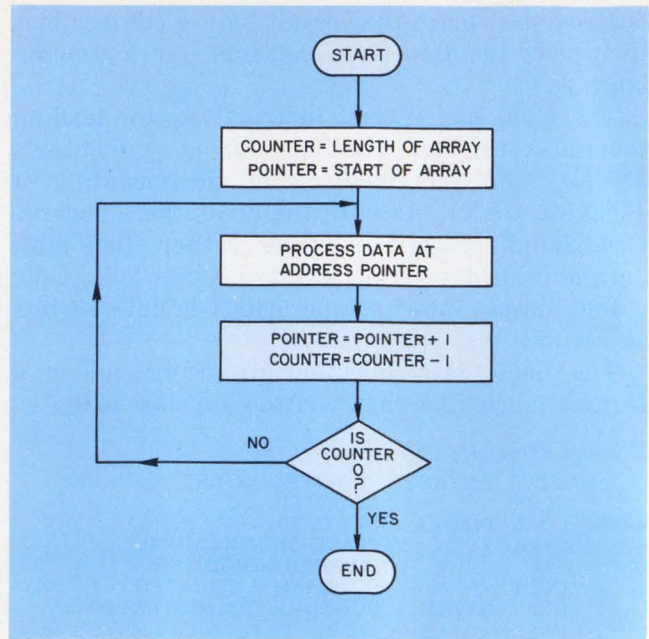

7. Processing an array of data requires that a pointer locate the data in memory. The program must update the pointer and array counter after each manipulation.

collected—with a pointer and counter. Fig. 7 outlines how this procedure works:

Step 1: (initialization)

Pointer = start of array

Counter = length of array

Step 2: Process data from address pointer.

Step 3: Increment pointer and decrement counter.

Pointer = Pointer + 1

Counter = Counter - 1

If counter = 0, return to step 2.

The processing can be as simple as adding all the data. The only problem is that the sum must be initialized to zero before you can start the actual addition programs for the 8080 and 6800:

For the 8080

```
LDA COUNT ; GET COUNTER
MOV B, A
LXI H, START ; POINTER = START OF ARRAY
SUB A ; SUM = 0
ADDN: ADD M ; SUM = SUM + (PTR)
INX H ; POINTER = POINTER + 1
DCR B ; COUNTER = COUNTER - 1
JNZ ADDN ; IF NOT DONE, ADD NEXT ENTRY
```

For the 6800

```
LDAB COUNT GET COUNTER
LDX #START POINTER = START OF ARRAY
CLRA ; SUM = 0
ADDN ADDA X SUM = SUM + (PTR)
INX ; POINTER = POINTER + 1
DECB ; COUNTER = COUNTER - 1
BNE ADDN IF NOT DONE, ADD NEXT ENTRY
```

Of course, the processing will usually amount to more than a single statement. For example, the flow chart of Fig. 8 and the following programs show how to find the maximum of an array of unsigned 8-bit numbers:

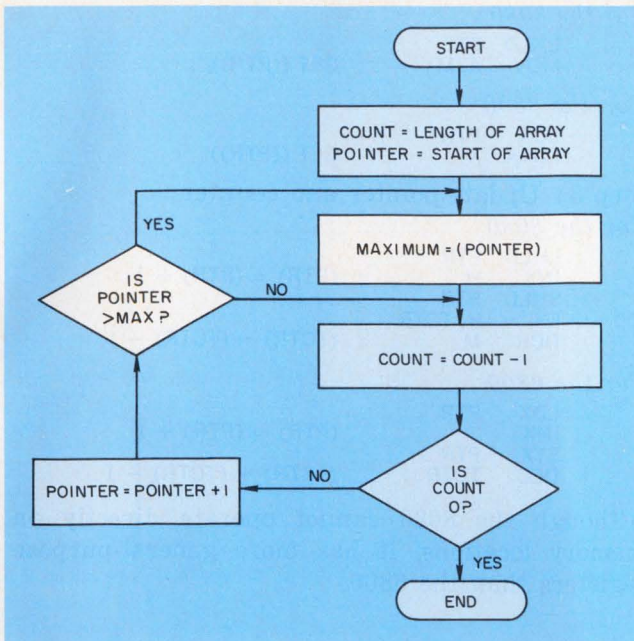

8. To search through an entire array to find the maximum value, you must pull each data item from memory and compare it with the previous maximum.

For the 8080

```

LDA COUNT ; GET COUNTER
MOV B, A
LXI H, START ; POINTER = START OF ARRAY
NEWMX: MOV A, M ; GET NEW MAXIMUM
NEXTX: DCR B ; COUNTER = COUNTER - 1
JNZ DONE
INX H ; POINTER = POINTER + 1
CMP M ; IS NEXT ELEMENT >
MAXIMUM?
JC NEWMX ; YES, REPLACE MAXIMUM
JMP NEXTX ; NO, KEEP LOOKING
DONE: HLT
  
```

For the 6800

```

LDAB COUNT GET COUNTER
LDX #START POINTER = START OF ARRAY
NEWMX: LDAA X GET NEW MAXIMUM
NEXTX: DECB B COUNTER = COUNTER - 1
BNE DONE
INX H POINTER = POINTER + 1
CMPA X IS NEXT ELEMENT >
MAXIMUM
BCS NEWMX YES, REPLACE MAXIMUM
BRA NEXTX NO, KEEP LOOKING
DONE: WAI
  
```

Multiword operations are simple

Often, each data item occupies more than one word. During each iteration, then, the program must get the appropriate number of words of data from the array. Just as before, the program uses 8-bit operations for each 8-bit data word to handle the array. For arithmetic operations the carry bit transfers information between words. The following programs, for example, provide a 16-bit sum:

For the 8080

```

LDA COUNT ; GET COUNTER
MOV B, A
LXI H, START ; POINTER = START OF ARRAY
LDI D, 0 ; SUM = 0
ADDW: MOV A, M ; GET 8 LSBs
ADD E ; LSBs SUM = SUM + (POINTER)
  
```

```

MOV E, A
INX H
MOV A, M ; MSBs = SUM + (POINTER + 1)
ADC D
MOV D, A
INX H ; POINTER = POINTER + 2
DCR B ; COUNTER = COUNTER - 1
JNZ ADDW ; IF NOT DONE, ADD NEXT ENTRY
  
```

For the 6800

```

LDAA COUNT GET COUNTER
STAA TCTR
LDX #START POINTER = START OF ARRAY
CLR B SUM = 0
ADDW: ADDB X ; LSBs SUM = SUM + (POINTER)
ADCA 1, X ; MSBs SUM = SUM + (POINTER + 1)
INX H ; POINTER = POINTER + 2
INX H
DEC TCTR ; COUNTER = COUNTER - 1
BNE ADDW ; IF NOT DONE, ADD NEXT ENTRY
  
```

The 8080 program may seem much longer than the 6800 program, but most of its instructions occupy a single word of memory and execute quickly. At standard clock rates, the actual time and memory requirements for the 8080 loop (the statements from label ADDW on) are 27.5 μ s, 12 bytes. The 6800 loop requires 20 μ s and 11 bytes.

Sometimes a program doesn't have to use the extra words unless the first words cannot settle the problem. For example, in finding a multiword maximum, the less significant words do not matter unless the more significant words are all the same. (It's like looking up a name in a telephone book—you don't have to look at the next letter of the name unless the first letters are identical.) You can find the multiword maximum with these programs:

For the 8080

```

LDA COUNT ; GET COUNTER
MOV B, A
LXI H, START ; POINTER = START OF ARRAY
NEWMX: MOV D, M ; MSBs OF NEW MAXIMUM
INX H
NEWM1: MOV E, M ; LSBs OF NEW MAXIMUM
NEXTX: DCR B ; COUNTER = COUNTER - 1
JNZ DONE
INX H ; POINTER = POINTER + 1
MOV A, M ; GET MSBs OF ENTRY
CMP D ; ARE MSBs OF MAXIMUM EQUAL?
JZ LSIG ; YES, MUST LOOK AT LSBs
JNC NEWMX ; IF MSBs OF MAXIMUM LESS, REPLACE
; OTHERWISE, KEEP LOOKING
LSIG: INX H
JMP NEXTX
INX H
MOV A, M ; GET LSBs OF ENTRY
CMP E ; ARE LSBs OF MAXIMUM LARGER?
JC NEXTX ; YES, KEEP LOOKING
JMP NEWM1 ; NO, REPLACE LSBs OF MAXIMUM
DONE: HLT
  
```

For the 6800

```

LDAA COUNT GET COUNTER
STAA TCTR
LDX #START POINTER = START OF ARRAY
LDAA X ; MSBs OF NEW MAXIMUM
NEWMX: LDAB 1, X ; LSBs OF NEW MAXIMUM
INX H
INX H
  
```

	DEC	TCTR	COUNTER = COUNTER - 1
	BNE	DONE	
	CMPA	X	ARE MSBs OF ENTRY EQUAL?
	BEQ	LSIG	YES, MUST LOOK AT LSBs
	BCS	NEWMX	IF MSBs OF MAXIMUM LESS, REPLACE
LSIG	BRA	NEXTE	OTHERWISE, KEEP LOOKING
	CMPB	1, X	ARE LSBs OF ENTRY LARGER?
	BCS	NEWM1	YES, REPLACE LSBs OF MAXIMUM
DONE	BRA	NEXTE	NO, KEEP LOOKING
	WAI		

If the processing uses all registers, each program must keep the pointer and counter in memory. Once again, the steps are as follows:
Step 1: Initialize the pointer and counter

For the 8080

```
LXI H, START
SHLD PTR ; (PTR) = START
LDA COUNT
STA TCTR ; (TCTR) = (COUNT)
```

For the 6800

```
LDX #START
STX PTR (PTR) = START
LDAA COUNT
STAA TCTR (TCTR) = (COUNT)
```

As before, the addresses are 16 bits long and occupy two 8-bit words of memory (PTR and PTR + 1). Data words are 8 bits long.

Step 2: Fetch data from array

For the 8080

```
LHLD PTR
MOV A, M ; GET ((PTR))
```

For the 6800

```
LDX PTR
LDAA X GET ((PTR))
```

Step 3: Update pointer and counter

For the 8080

```
LHLD PTR
INX H ; (PTR) = (PTR) + 1
SHLD PTR
LXI H, TCTR
DCR M ; (TCTR) = (TCTR) - 1
```

For the 6800

```
LDX PTR
INX PTR (PTR) = (PTR) + 1
STX TCTR
DEC TCTR (TCTR) = (TCTR) - 1
```

Although the 8080 cannot operate directly on memory locations, it has more general-purpose registers than the 6800.

Put arrays to good use

An example of more complex processing is the moving "news panel" display, on which the message appears to move to the right. Assume displays are being multiplexed as shown in Fig. 9. The number of displays is NDSPLY, the message starts in memory location MESSG and ends with

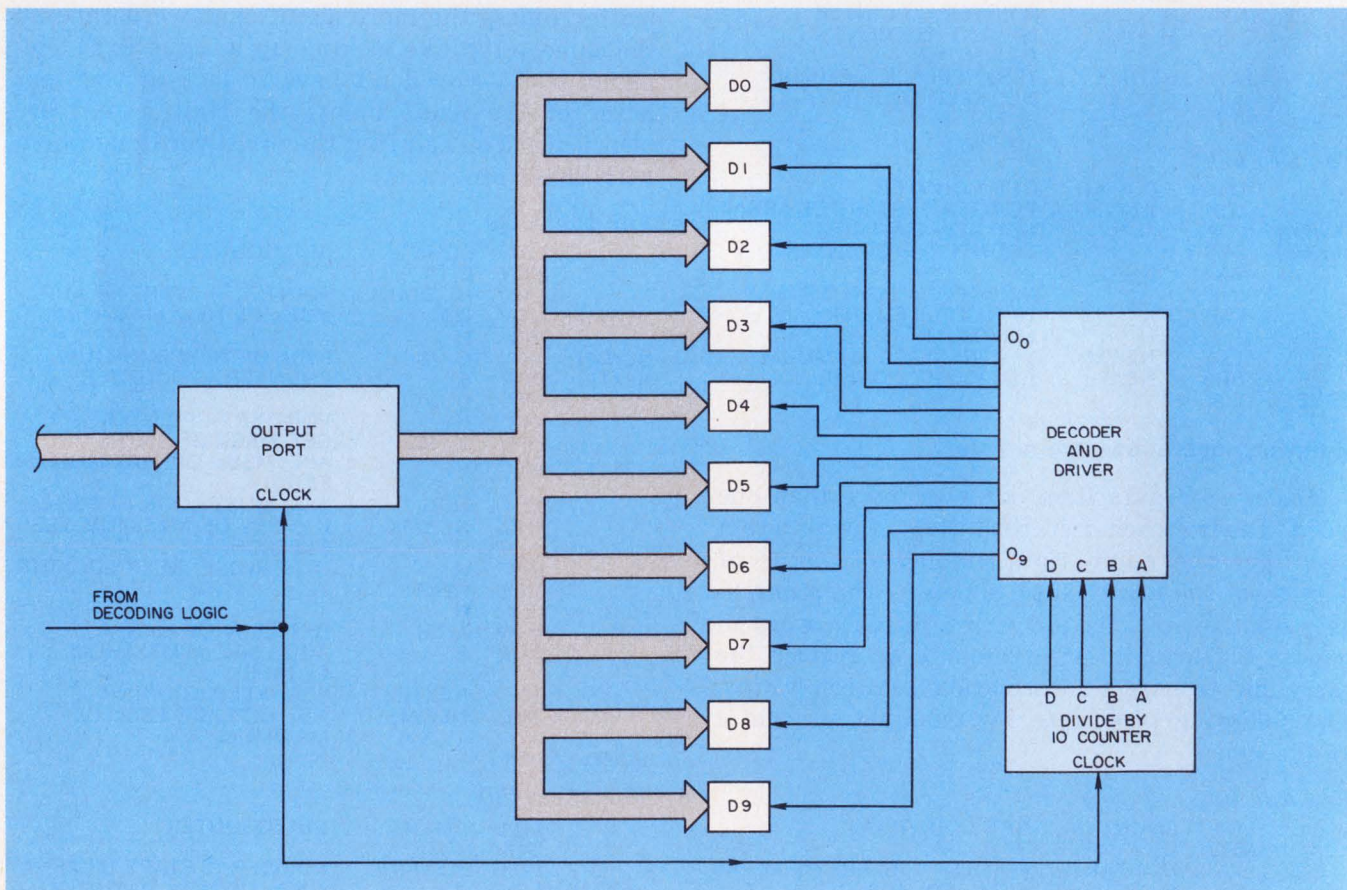

9. Making a moving-character display requires a counter to multiplex the decoder and driver. The counter, in

turn, is controlled by the microprocessor, which increments it each time a scan is finished.

NDSPLY blank characters so that the actual message traverses the display. The message (not counting the ending blanks) is NMESS characters long. For this example, assume also that subroutine SEND sends the data to the display and provides the appropriate code conversion and pulse length.

The decoder and driver activate one of the 10 displays according to the state of the decade counter, which counts output operations. Of course, the message doesn't really move to the right. The starting point in memory of the characters to be displayed moves to the "left." Two pointers are necessary:

- PTR contains the address of the first character the program will send to the displays during a particular iteration.

- DPTR traverses the characters to be displayed during each iteration.

Likewise, two counters are necessary:

- CTR counts the number of display iterations.

- DCTR counts the number of displays handled during a particular iteration.

The flow chart for this example is shown in Fig. 10 and the programs are as follows:

For the 8080

DSTRT: LXI H, MESSG ; PTR, DPTR = START OF MESSAGE

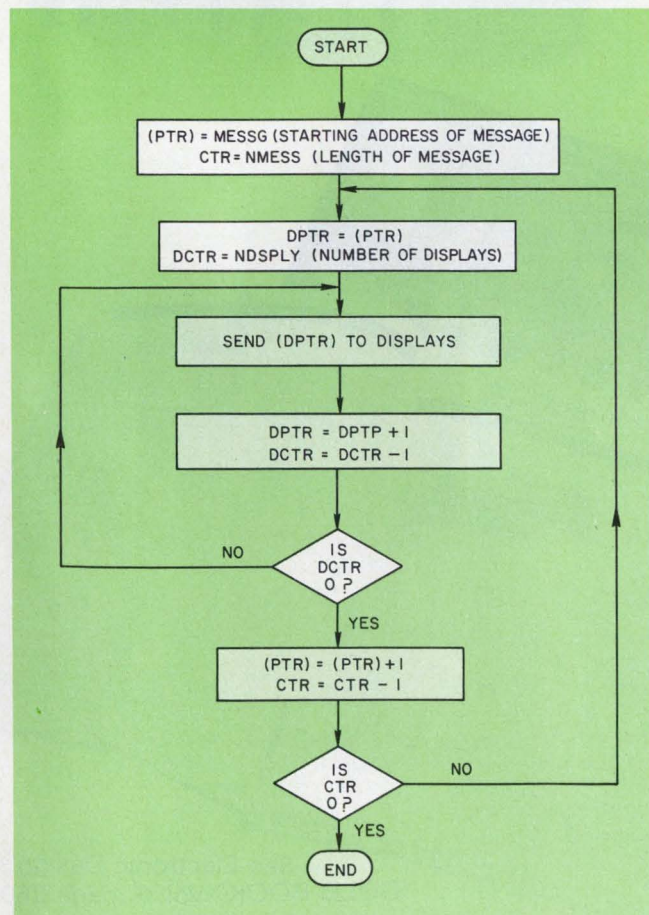

10. Several special registers are required to keep characters in the display moving.

```

DRUN: MVI A, NMESS ; CTR = LENGTH OF MESSAGE
      SHLD PTR ; SAVE STARTING POINTER
      STA CTR ; SAVE RUN COUNTER
      MVI B, NDSPLY ; DCTR = NUMBER OF DISPLAYS
DSPLY: MOV A, M ; GET A CHARACTER FROM ARRAY
      CALL SEND ; SEND CHARACTER TO DISPLAYS
      INX H ; DPTR = DPTR + 1
      DCR B ; DCTR = DCTR - 1
      JNZ DSPLY ; SEND NDSPLY CHARACTERS

      LHLD PTR
      INX H ; UPDATE PTR TO START AT NEXT CHARACTER

      LDA CTR
      DCR A ; COUNTDOWN NUMBER OF DISPLAY RUNS

      JNZ DRUN
      HLT
  
```

For the 6800

```

DSTRT LDX #MESSG PTR, DPTR = START OF MESSAGE
DRUN LDAA #NMESS CTR = LENGTH OF MESSAGE
      STX PTR SAVE STARTING POINTER
      STA CTR SAVE RUN COUNTER
      LDAB #NDSPLY DCTR = NUMBER OF DISPLAYS
DSPLY LDAA X GET A CHARACTER FROM ARRAY
      JSR SEND SEND CHARACTER TO DISPLAYS
      INX DPTR = DPTR + 1
      DCR B DCTR = DCTR - 1
      BNE DSPLY SEND NDSPLY CHARACTERS
      LDX PTR UPDATE PTR TO START AT NEXT CHARACTER
      LDAA CTR COUNTDOWN NUMBER OF DISPLAY RUNS
      DECA
      WAI
  
```

Starting or repeating the moving display simply requires a jump to DSTRT.

One question remains: How is memory space set aside for the arrays? Most assemblers have a special feature (sometimes called reserve), which allocates RAM locations and allows you to name the first or last entry. Note that the array must be assigned to RAM, and you can't place any initial values in the locations. Thus, the program will run properly when started from an on-off switch or power-on reset; no initial values will have to be loaded from permanent storage into volatile RAM.

The Reserve feature is called DS (define storage) in the standard 8080 assembler from Intel and RMB (reserve memory bytes) in the standard 6800 assembler from Motorola. Assigning 100 locations starting at memory address 5000 can be done with these programs:

For the 8080			For the 6800		
RAMST	EQU	5000H	RAMST	EQU	5000H
	ORG	RAMST		ORG	RAMST
	DS	100		RMB	100 ■■

References

1. Leventhal, L. A., "Put Microprocessor Software to Work," *Electronic Design*, Aug. 2, 1976, pp. 58-64.
2. Nichols, A. J. and McKenzie, K., "Build a Compact Microcomputer," *Electronic Design*, May 10, 1976, pp. 84-92.
3. Mazur, T., "Put Together a Complete Microcomputer," *Electronic Design*, July 19, 1976, pp. 66-77.

Datel's 8080 A/D-D/A Advantage

SINETRAC 800

- 32 channel A/D - D/A input card slides directly into Intel's MDS-800 or SBC-80/10/20 Microcomputers.
- Only 2 cards needed for 80 single-ended or 64 differential A/D channels!
- Super-software supplied on paper tape with full listings in manuals.
- On-board channel counters and scan-timers reduce CPU housekeeping for fastest speed: True 40 kHz total I/O rate using DMA.
- Expandable in increments of 48 A/D or 8 D/A channels up to 256 channels each.

COVERED BY GSA CONTRACT

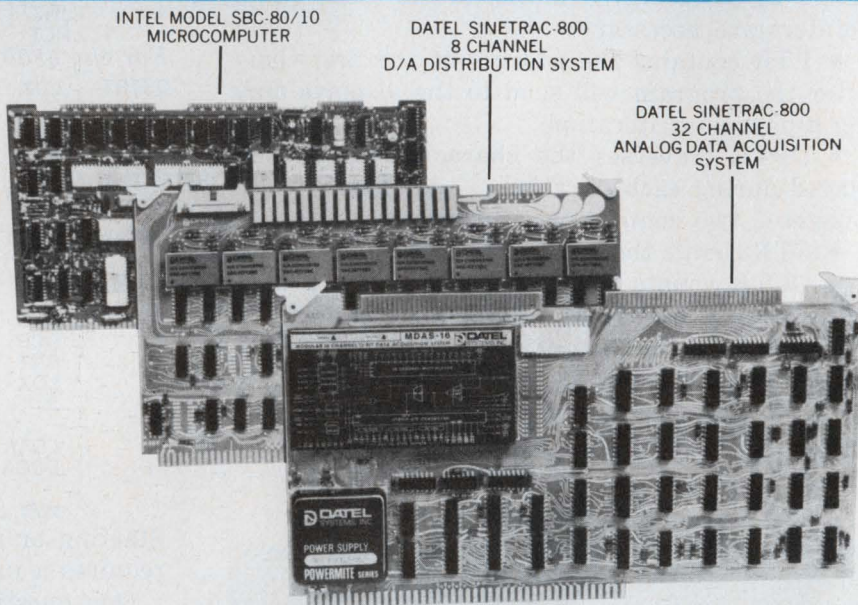

You'll find complete specifications on this product and more than 300 data conversion circuits and systems in Gold Book.

Just check Gold Book's Volume 3. That's Datel's complete Engineering Product Handbook, in its own separate volume. More than 290 pages of D/A & A/D Converters, Multiplexers, Sample-Holds, Op Amps, Power Supplies, Digital Panel Meters, and Printers, Digital Panel Instruments, Data Loggers, Digital Cassette Recorders, and Data Acquisition Systems. Each fully detailed on individual data sheets.

And it's available to you in Gold Book.

D **DATEL**
SYSTEMS, INC.

1020 Turnpike St., Canton, MA 02021
Phone: (617) 828-8000

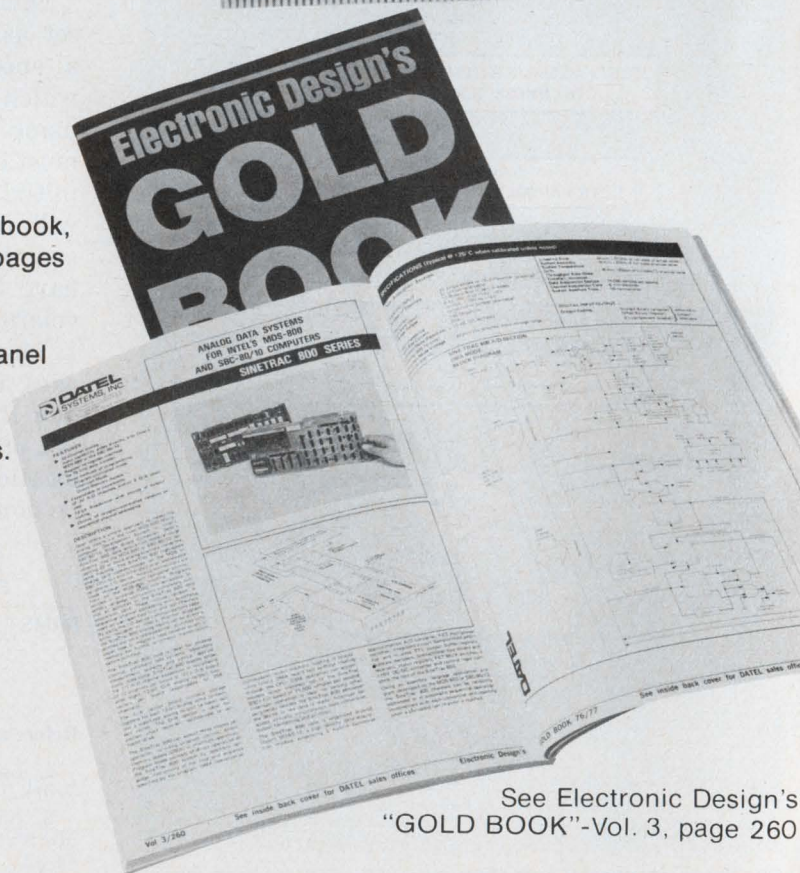

See Electronic Design's
"GOLD BOOK"-Vol. 3, page 260

• Santa Ana, CA (714) 835-2751, (L.A. Exchange) (213) 933-7256 • Sunnyvale, CA (408) 733-2424 • Gaithersburg, MD (301) 840-9490

CIRCLE NUMBER 55



INTRODUCING A BRAND NEW IDEA IN PROM PROGRAMMING: THE DATA I/O MODEL 7.

Now — for the first time ever — you can program all commercially available PROMs on a low cost, high performance, universal programmer; a programmer that you can expand to meet your future programming requirements.

The Data I/O Model 7 is the only programmer you can add all these capabilities to, as you need them:

Insert/Delete, Data Editing. You can replace the front panel and gain a hex keypad, address and data display, and editing.

Input/Output Versatility. Add interfaces and you can communicate in a variety of interchangeable data formats, with computers, teletypes, CRT terminals and other peripherals.

Programmers from \$1095.00.

ROM Emulation. Allows you to completely develop and debug PROM software without using PROMs. This saves you time and money, and eliminates PROM waste.

Calibration. Helps you reach maximum programming yields, and gives you full confidence in PROM reliability.

For complete details, circle reader service number or contact Data I/O Corporation, P.O. Box 308, Issaquah, WA 98027. Phone: 206/455-3990.

DATA I/O

THE PROM PROGRAMMER PEOPLE.

For more information, Circle No. 180.

Ceramics, ceramoplastics and glasses

often perform well where plastics fail. To select the right insulators, learn their relative advantages.

For applications requiring materials that can maintain good dimensional stability under high-temperature stress, ceramics, ceramoplastics and glasses are superior to plastics. Ceramics are good electrical insulators and usually have better thermal conductivity than plastics; this unusual combination of characteristics makes ceramics useful for electrically-insulated heat sinks.

Although ceramics are harder than plastics and more brittle, they can be fabricated and assembled with comparative ease. Furthermore, they can be metalized or coated for specific applications.

Ceramics are widely used as substrates for thick and thin-film circuits, and for hermetically sealed IC packages. In addition, certain ceramics, such as barium titanate, are useful for capacitors because their dielectric constant can be controlled over a wide range.

In this article, the properties of ceramics are covered in more detail than those for ceramoplastics and glasses because ceramics are more commonly encountered in electronic applications.

A listing of the basic ceramics, along with their primary characteristics and typical uses, is provided in Table 1. Typical properties of basic ceramics are given in Table 2. The most important electronic-design properties to be considered in design use of ceramics are their thermal and electrical properties. Whenever possible, an attempt has been made to present important data over the useful range of important variables, instead of merely presenting point data, to better aid designers in predicting performance trends.

Consider the thermal properties of ceramics

The thermal expansion of various ceramics and other materials frequently used in the construction of electronic devices is shown in Fig. 1. These data will be useful in analyzing a system

Charles A. Harper, Systems Development Div., Westinghouse Electric Corp., Baltimore, MD 21203. (This article includes material from the Handbook of Thick Film Microelectronics and the Handbook of Electronic Packaging, edited by Charles A. Harper and published by McGraw-Hill.)

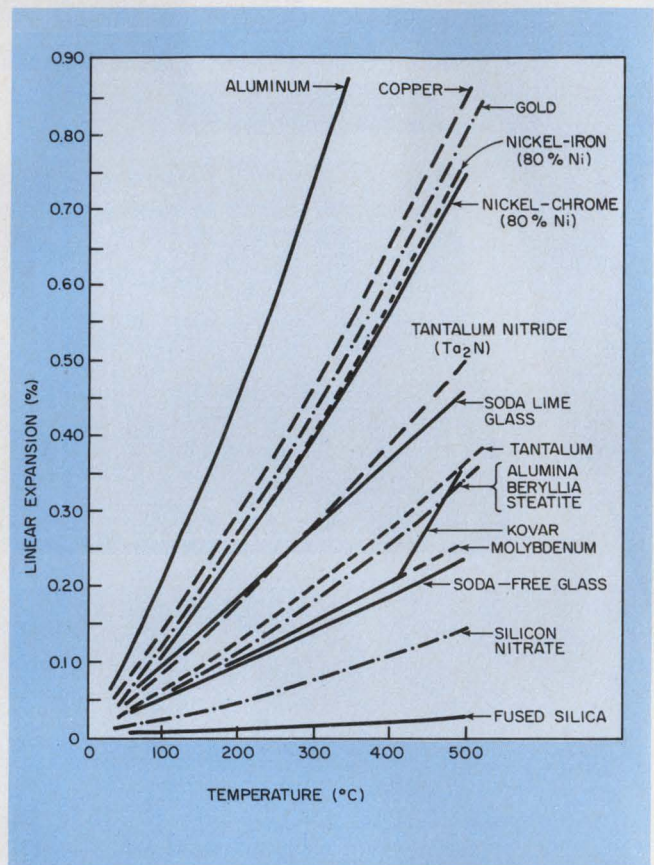

1. Ceramics offer considerably lower thermal expansion values than the metals, adhesives, encapsulants and plastics used in electronic assemblies.

for thermal-expansion differentials—usually the most important consideration in thermal-force problems. Note that these thermal-expansion values are appreciably lower than those for adhesives, encapsulants, and other plastic materials.

Thermal conductivity is one of the most useful characteristics of ceramics; frequently designs call for maximum heat dissipation from an electronic component. Fig. 2 shows the thermal conductivity of various high-density ceramics and Table 3 shows the relative thermal conductivities of several groups of materials compared to copper. As would be expected, porosity, or reduced density, will lower the thermal conductivity for a ceramic material. This is shown in Table 4 as

Table 1. Primary characteristics and typical uses of ceramics

Ceramic	Primary Characteristics	Typical Uses
Alumina	Harder, stronger, and more resistant to wear than most other ceramics. They make better electrical insulators, too, especially at higher temperatures and higher frequencies.	Substrates, dielectric laminates.
Beryllia	Beryllium oxide is a material that insulates electrically as a ceramic does, but conducts heat like a metal. Its thermal conductivity is 62% that of copper, compared to aluminum's 55% and steatite's 0.9%. A component insulated with beryllia, therefore, is isolated electrically, although thermally it is the same as though the component were grounded. Beryllia is unique among practical insulators in this respect, although diamonds do exhibit the same combination of properties.	Substrates, tube envelopes and parts, missile and space devices, microwave windows.
Steatite	Easier to manufacture into final product form than the aluminas, and therefore generally more economical. The thermal shock characteristics are relatively poor.	Insulators, resistor tubes.
Forsterite	Serves well where the primary requirement is for very-low-loss insulators. It is somewhat difficult to form and frequently requires grinding to meet close dimensional requirements. The high coefficient of expansion matches that of several metals, but at a sacrifice in thermal shock resistance.	Insulators for ceramic-to-metal seals.
Titania	High mechanical strength and great hardness. Normally an excellent electrical insulator, titania can be processed to become a partial conductor to assist in control of static electricity.	Capacitance devices
Cordierite	Low coefficient of expansion and excellent resistance to heat shock. It is used mostly in the extruded form for insulators in products such as heating elements and thermocouples.	Resistors, thermocouple insulators.
Lava	A mined natural mineral (aluminum silicate or magnesium silicate), which can be machined and then kiln-fired with little change in size. It has good electrical properties and good heat resistance. Lava is often used in prototypes, or where small quantities of a technical ceramic are needed.	Prototypes and ceramic Parts not requiring precise control of electrical characteristics
Boron nitride	Excellent thermal conductivity and high-voltage resistance properties. This material is used in wafers for thermal conductivity mountings, coil forms, waveguide windings, etc. Since there are variations in the moisture absorption of boron nitride materials, the appropriate grade for a given design objective should be chosen.	Dielectric heat sinks, and mountings or jackets for high-heat-dissipating electrical parts.

a function of the alumina content of an alumina ceramic material.

Beryllia is noted for having a higher thermal conductivity than other substrate materials, as shown in Fig. 2 and Table 3. As with alumina, the density, purity and porosity of the beryllia substrate can have a significant effect on its thermal conductivity.

Glazed ceramics are sometimes used in electronic-circuit devices; however, a glazed surface increases thermal impedance. For example, the thermal resistance of 1 mil of glass is equivalent to that of 30 mils of alumina or 190 mils of beryllia. Glazing beryllia, therefore, almost entirely negates any thermal advantage the material

might otherwise offer. Typical data for a glaze material are included in Table 5.

Reviewing electrical properties of ceramics

A comparison of **volume resistivity** for various ceramics is shown in Fig. 3. Note that all resistivity values decrease sharply with increased temperature. This also happens with most other insulating materials, including plastics—though usually at a much lower temperature, of course.

The **dielectric strength** of ceramics, like that of most insulating materials, varies considerably with changes in temperature, frequency, material thickness, density, porosity, purity and other

Table 2. Typical properties of ceramics

Property	Steatite MgO·SiO ₂ Alsimag 665 L-533	Forsterite 2MgO·SiO ₂ Alsimag 243 L-723	Cordierite 2MgO·2Al ₂ O ₃ · 5SiO ₂ Alsimag 701	Lava (natural stone) grade A, aluminum silicate	Alumina Al ₂ O ₃ Alsimag 753 L-724	Beryllia BeO Alsimag 754 L-623
Water absorption (%)	0	0	0.02-1	2-3	0	0
Specific gravity	2.7	2.8	2.3	2.3	3.85	2.88
Safe temperature at continuous heat	1000 C	1000 C	1200 C	1100 C	1650 C	1600 C
Hardness (Moh's scale)	7.5	7.5	8	6	9	9
Thermal expansion (25-300 C)	6.9×10^{-6}	10×10^{-6}	2.4×10^{-6}	3.3×10^{-6}	7.1×10^{-6}	6×10^{-6}
Thermal conductivity ⁽¹⁾ (300 C)	0.006	0.008	0.008	0.005	—	0.28
Dielectric strength (60-Hz ac, V/mil)	230	240	225	80	230	240
Volume resistivity (Ω /cm) (at 25 C) (at 100 C)	$> 10^{14}$ 1.0×10^{14}	$> 10^{14}$ 5×10^{13}	1.0×10^{14} 2.5×10^{11}	$> 10^{14}$ 6×10^{11}	$> 10^{14}$ $> 10^{14}$	$> 10^{14}$ $> 10^{14}$
Dielectric constant ⁽²⁾ (1 MHz, 25 C)	6.3	6.2	5.3	5.3	9.4	6.4
Dissipation factor ⁽²⁾ (1 MHz, 25 C)	0.0008	0.0004	0.0047	0.010	0.0001	0.0001
Loss factor ⁽²⁾ (1 MHz, 25 C)	0.0050	0.002	0.025	0.053	0.0009	0.0006

(1) Conversion factor figures are in cal/(cm) (s) (m²), one of which equals 2902 Btu/(in.) (h) (ft²) (°F)
 (2) Alsimag 243, 475 and 665 measured wet at 1 MHz, after immersion in water for 48 h. (MIL-I-10A).
 Courtesy American Lava Corporation, 3M Company

Table 3. Relative thermal conductivity of several kinds of material

Material	Percent of thermal conductivity of copper
Silver	105
Copper	100
High-purity beryllia, BeO	62
Aluminum	55
Beryllium	39
Molybdenum	39
Steel	9.1
High-purity alumina, Al ₂ O ₃	7.7
Steatite	0.9
Mica	0.18
Phenolics, epoxies	0.13
Fluorocarbons	0.05

Table 4. Effect of alumina content on thermal conductivity of substrates

Alumina (%)	Thermal conductivity, [cal/(s)(cm ²) (°C/cm)]	Change in thermal conductivity (%)
99	0.070	
98	0.061	-13
96	0.043	-39
85	0.035	-50

variables. To electronic engineers, the first three causes of variation are, perhaps, the most significant.

Table 6 compares the room-temperature dielectric strength of various insulating materials at several frequencies, ranging from 60 Hz to 100 MHz. The dielectric strengths of alumina, beryllia, and steatite, as a function of test-piece thickness, are shown in Fig. 4.

Another important electrical property of insulating materials is **dielectric constant**. Usually the key variables are temperature and frequency. While dielectric constant increases with temperature, the change is generally not drastic over the operating temperature ranges of electrical components. Composition and purity are the factors of greatest influence.

Fig. 5 shows the dielectric constant of several ceramic materials. Note that the range of variation with purity level for alumina is greater than the variation for any single composition up to 200 C—well beyond the operating temperature for most applications. The dielectric constant of several ceramics as a function of frequency is shown in Table 7.

Dissipation factor is a measure of the electrical-loss characteristics of an insulating material, and is usually of greatest importance at higher frequencies. The most important variables for this characteristic are temperature and frequency. Ceramics are more stable than most plastic materials in these areas. The dissipation-factor data

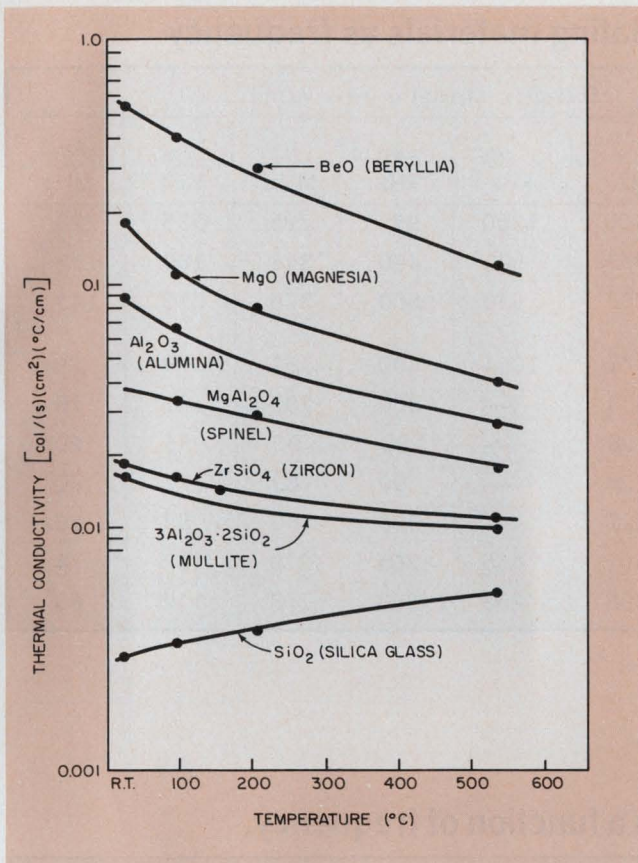

2. Beryllia possesses the highest thermal conduction of the various substrate materials.

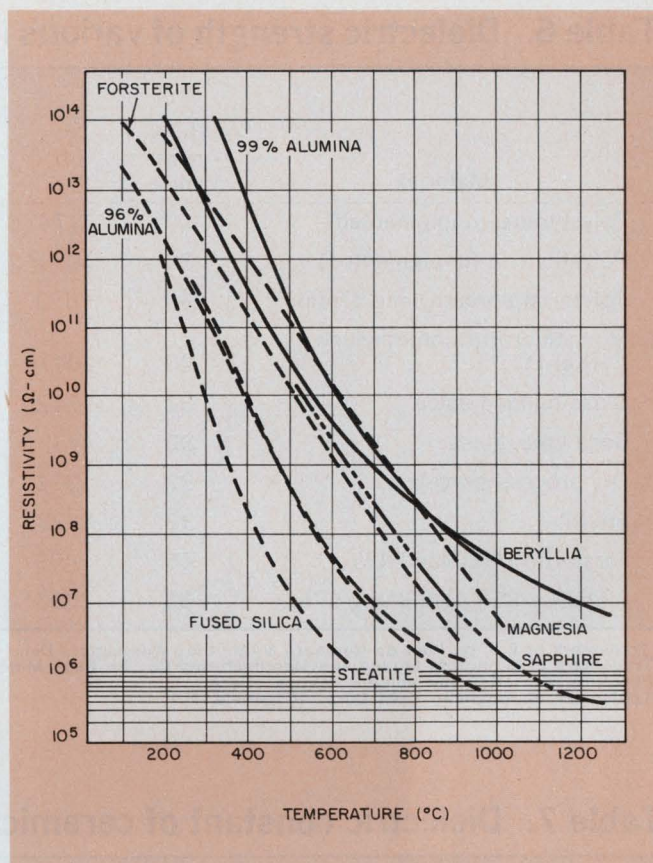

3. The volume resistivity for various ceramic materials drops sharply as temperature is raised.

Table 5. Properties of ceramic substrates and glazes

Material	Tensile strength (lb/in ²)	Expansion coefficient [μ in./in)(°C)]	Coefficient of heat transfer (W)(in.)/(in ²)(°C)	Dielectric properties (at 1 MHz and 25 C)		Volume resistivity at 150 C, (pΩ-cm)
				Relative dielectric constant	Dissipation factor (%)	
Alumina	25,000	6.4	~0.89	9.2	0.03	> 100
Beryllia	15,000	6.0	5.8	6.4	0.01	> 100
Corning 7059 glass	~10,000	4.6	~0.03	5.8	0.1	> 100
Modified B ₂ TiO ₃	4,000	9.1	0.007	6,500	1.8	0.2
Modified TiO ₂	7,500	8.3	0.017	80	0.03	0.5
Glaze for alumina: 2.5% sodium oxide	~10,000	5.5	~0.03	6.3	0.16	> 100
Alkali-metal-free	~10,000	5.3	~0.03	7	0.2	> 100

for several ceramics, including three alumina compositions, are shown in Table 8.

Ceramoplastics can be molded like plastics

Ceramoplastics are inorganic materials that can be molded or processed like plastics, but which have properties more closely resembling those of ceramics. The useful temperatures for ceramoplastics lie between those of plastics and

those of ceramics.

The most common form of ceramoplastic is glass-bonded mica. It consists of finely powdered natural or synthetic mica, bonded with special glasses. To achieve particular properties, ceramics, glasses, and inorganic fibers or fillers may be combined.

Glass-bonded mica parts are molded at relatively high temperatures, commonly in the 1000 to 1500 F range. Close dimensional tolerances can be

Table 6. Dielectric strength of various insulating materials vs frequency

Material	Thick-ness, mils	Dielectric strength, (rms V/mil)						
		60 Hz	1 kHz	38 kHz	180 kHz	2 MHz	18 MHz	100 MHz
Polystyrene (unpigmented)	30	3174	2400	1250	977	725	335	220
Polyethylene (unpigmented)	30	1091	965	500	460	343	180	132
Polytetrafluoroethylene (Teflon)*	30	850	808	540	500	375	210	143
Monochlorotrifluoroethylene (Kel-F)†	20	2007	1478	1054	600	354	129	29‡
Glass-bonded mica	32	712	643	—	360	207	121	76
Soda-lime glass	32	1532	1158	—	230	90	55	20‡
Dry-process porcelain	32	232	226	—	90	83	71	60‡
Steatite	32	523	427	—	300	80	58	56‡
Forsterite (AlSiMag-243)	65	499	461	455	365	210	112	74
Alumina, 85% (AlSiMag-576§)	55	298	298	253	253	178	112	69

*Trademark of E. I. du Pont de Nemours & Co., Inc., Wilmington, Del.
 †Trademark of Minnesota Mining and Manufacturing Co., St. Paul, Minn.
 ‡Puncture with attendant volume heating effect.
 §Trademark of American Lava Corp., Ridgefield, N.J.

Table 7. Dielectric constant of ceramics as a function of frequency.

Ceramic	1 MHz		1 GHz		10 GHz		25 GHz	
	25 C	500 C	25 C	500 C	25 C	500 C	25 C	500 C
Fused silica	3.78	3.78	3.78	3.78	3.78	3.78	3.78	3.78
Steatite	5.7	6.7	5.5	6.5	5.2	6.0	5.2	
Forsterite	6.2		5.9		5.8	6.3	5.8	
Beryllia (99%)	6.4	6.9			6.1	6.3	6.0	6.3
Alumina (96%)	9.0	10.8		9.5	8.9	9.4	8.7	9.0
Alumina (99%)	9.2	11.1	9.1	9.88	9.0	9.86	8.9	9.85

Table 8. Dissipation factor of ceramics vs temperature and frequency

Temp. °C	Alumina			Beryllia, 99%	Forsterite	Steatite	Fused silica
	85%	96%	99%				
1 MHz							
25	0.0004	0.0003	0.0002	0.0001	0.0004	0.002	0.0002
300	0.002	0.003	0.0006	0.0001		0.006	
500	0.009	0.013	0.002	0.0004		0.06	
800	0.06	0.09	0.005	0.003			
1 GHz							
25	0.001	0.0003	0.0002	0.0002	0.0005	0.0015	0.0001
300	0.002	0.0007	0.0003	0.0003		0.004	
500	0.004	0.0015	0.0015	0.0006		0.015	
10 GHz							
25	0.0015	0.0006	0.0001	0.0001	0.0009	0.003	0.0001
300	0.002	0.001	0.0001	0.0001	0.001	0.004	0.00008
500	0.003	0.002	0.0002	0.0001	0.0013	0.005	0.00009
800		0.006	0.0005	0.0005			

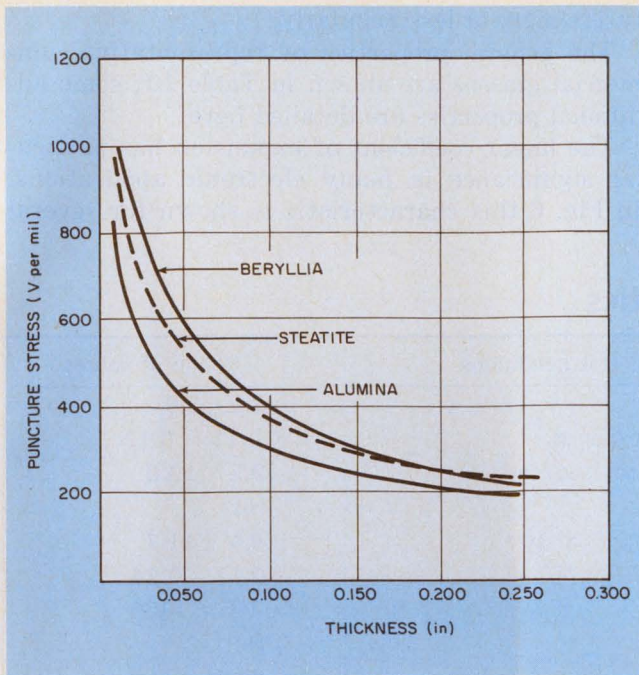

4. For a given thickness, beryllia offers the highest dielectric strength among ceramic materials.

held, however, even in complex shapes or with inserts. Glass-bonded mica is available in custom-molded shapes, or in sheet or bar stock.

The typical properties of ceramoplastics are shown in Table 9. The outstanding features of ceramoplastics are as follows:

- High thermal endurance.
- High arc resistance.
- High radiation resistance.
- Low thermal expansion.
- Moldability, with delicate insert inclusion and true hermetic seal.
- Excellent electrical characteristics.
- Machinability that is better than for ceramics, with no need for firing after machining.
- Corona resistance (in finished parts).
- Good dimensional stability.

A particularly useful property of glass-bonded micas is their relatively low linear coefficient of thermal expansion (especially among moldable products).

There are various electrical grades of glass-bonded micas, some with relatively stable dielectric constants and dissipation factors, up to frequencies of 8500 MHz or higher, and up to 250 or 350 C. Their resistivity, like that of plastics, decreases with temperature.

In glasses, current flows by ion migration

Glasses are produced from inorganic oxides, and one of the most important ingredients is usually silica or sand. Some chemical compounds, notably oxides of silicon, boron, and phosphorous, are capable of being processed into glass products. Glasses are usually not single-chemical com-

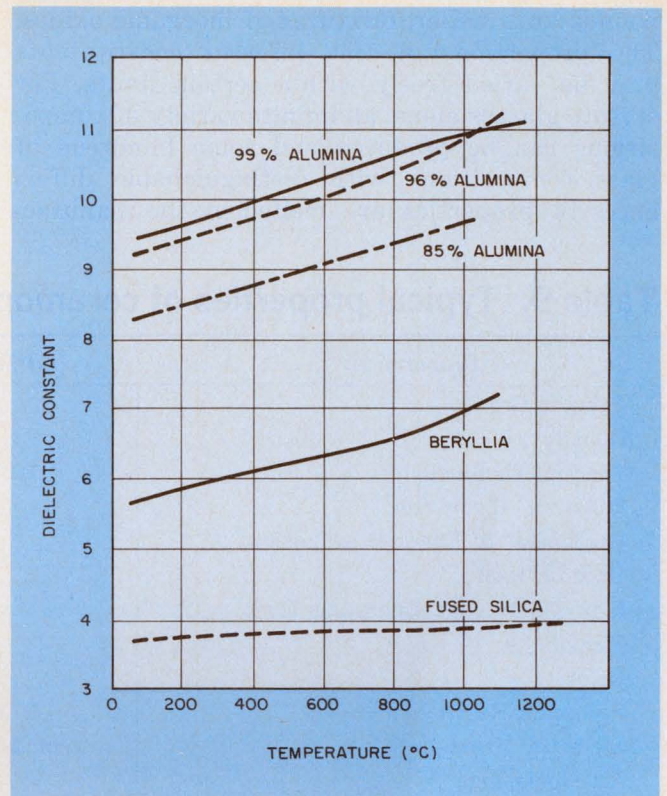

5. At 4 GHz, the dielectric constant of various alumina compositions is higher than that of beryllia and fused silica. Values increase with temperature.

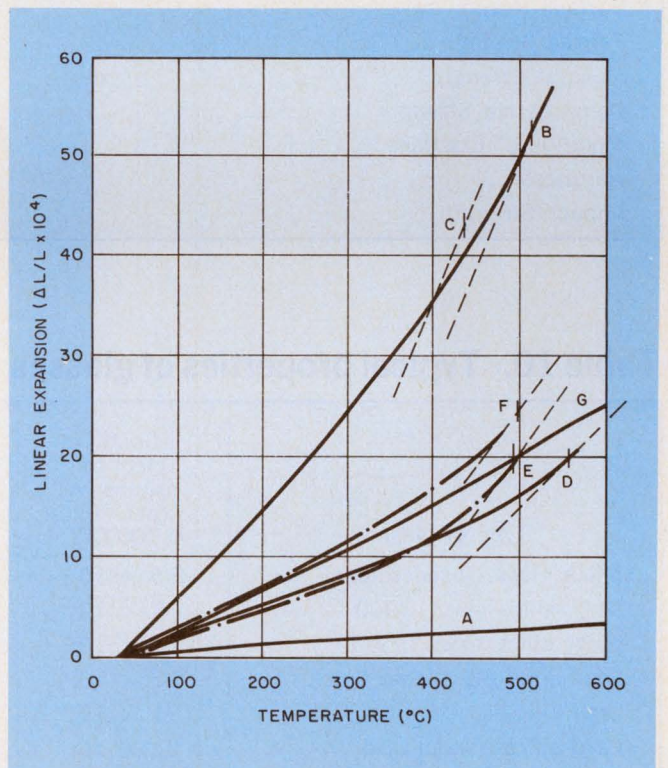

6. Glass expansion is almost linear as temperature is increased. The light broken lines indicate increased rates of expansion at annealing points. A represents 96% silica glass, B soda-lime bulk glass, C medium-lead electrical, D borosilicate low-expansion, E borosilicate low electrical loss, F borosilicate tungsten sealing, and G aluminosilicate.

pounds but, rather, mixtures of inorganic oxides. The proportions of the different constituents may be varied freely within certain limits. For silicate glasses alone, an infinite variety of compositions can be produced and some hundreds of glass compositions with distinguishable differences in properties are melted by the manufac-

turers more or less regularly.

The general properties of representative commercial glasses are shown in Table 10; some additional properties are detailed here.

The linear coefficient of expansion has particular significance in many electronic applications. In Fig. 6 this characteristic is shown for several

Table 9. Typical properties of ceramoplastics

Property	Units and test conditions	Range of values
Specific Gravity		3.2 - 3.9
Density	lb/cu. in.	0.11 - 0.13
Thermal Conductivity	10^{-4} cal cm/sec/cm ² /°C	9.5 - 13.0
Moisture Absorption		Nil
Coefficient of Thermal expansion	in/in/°C $\times 10^{-6}$	9.4 - 11.7
Specific Heat	cal/gm/°C	0.11 - 0.24
Max. Continuous Operating Temp.	°F	740 - 1300
Flamability		Nil
Color		White - Gray
Radiation Resistance	3×10^{10} rads - cobalt	Good - Excellent
Dielectric Strength	V/m, 1/4 in. thick, (ASTM-D149)	320 - 385
Arc Resistance	seconds	400 - 460
Dielectric Constant	1 MHz (ASTM-D150)	7.1 - 9.0
Loss Factor	1 MHz	0.015 - 0.0100
Surface Resistivity	Dry, Ω -cm (70 F)	10^{15} - 10^{16}
Volume Resistivity	Dry, Ω -cm (70 F)	10^{12} - 10^{14}
Surface Resistivity	Wet, Ω -cm (70 F)	10^6 - 10^{11}
Tensile Strength	lb/in. ²	7000 - 9000
Flexural Strength	lb/in. ²	9900 - 21,000
Compressive Strength	lb/in. ²	27,000 - 36,000
Modulus of Elasticity	lb/in. ²	6×10^6 - 10×10^6
Hardness	Rockwell H	90
Impact Strength	Izod	0.6 - 1.8

Table 10. Typical properties of glasses

Type of glass	Coeffi- cient of expansion (per °C, 0-300 C)	Density (g/cm ³)	Electrical properties			
			Log ¹⁰ vol. res., Ω -cm		Dielectric properties (1 MHz, 20 C)	
			250 C	350 C	Power factor	Dielectric constant
Silica glass (fused silica)	5.5×10^{-7}	2.20	12.0	9.7	0.0002	3.78
96% silica glass, 7900	8×10^{-7}	2.18	9.7	8.1	0.0005	3.8
96% silica glass, 7911	8×10^{-7}	2.18	11.7	9.6	0.0002	3.8
Soda-lime, elect lamp bulbs	92×10^{-7}	2.47	6.4	5.1	0.009	7.2
Lead silicate, electrical	91×10^{-7}	2.85	8.9	7.0	0.0016	6.6
Lead silicate, high lead	91×10^{-7}	4.28	11.8	9.7	0.0009	9.5
Aluminoborosilicate, apparatus	49×10^{-7}	2.36	6.9	5.6	0.010	5.6
Borosilicate, low expansion	32×10^{-7}	2.23	8.1	6.6	0.0046	4.6
Borosilicate, low electrical loss	32×10^{-7}	2.13	11.2	9.1	0.0006	4.0
Borosilicate, tungsten seal	46×10^{-7}	2.25	8.8	7.2	0.0033	4.9
Aluminosilicate	42×10^{-7}	2.53	11.4	9.4	0.0037	6.3

*Courtesy Corning Glass Works

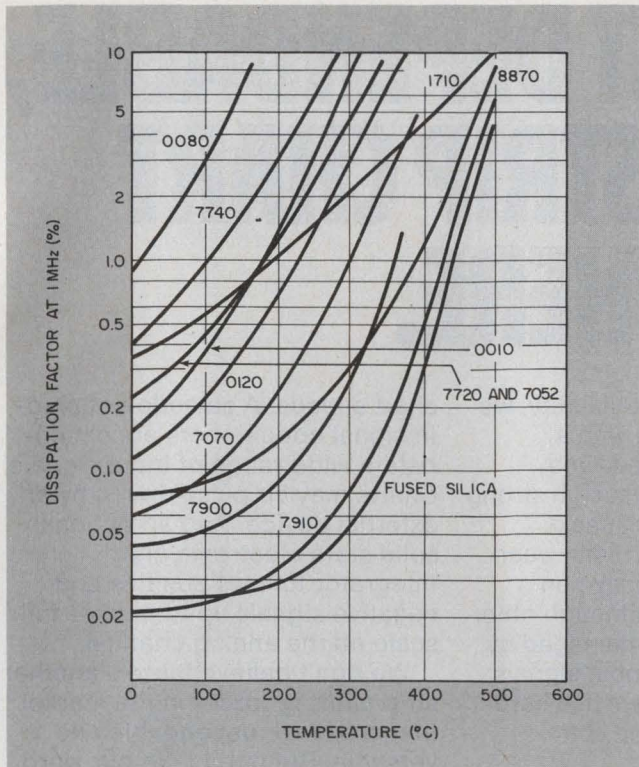

7. The dissipation factor of commercial glasses at 1 MHz rises rapidly as temperature is increased.

types of glass as a function of temperature.

Glass has mechanical properties corresponding to those of crystalline solids. It has elastic properties and strength so that it returns to its original shape after the release of applied forces that deform it. Glass does not exhibit the property of plastic flow, common to metals, and consequently has no yield point. Fracture occurs before there is any permanent deformation, and failure is always in tension.

The electrical properties of glass are, of course, of prime importance to electronic engineers. In glasses, current is carried by the migration of ions (as in electrolytes) rather than by free electrons (as is the case for metals). For this reason, mobile ions—such as sodium ion—have a significant influence on the conductivity or resistivity of a glass. Conductivity tends to increase, and resistivity tends to decrease as the amount of soda in a particular glass is increased.

Resistivity is also affected by temperature, as are nearly all dielectrics. Other important electrical properties of glasses, such as dissipation factor and dielectric constant, are also affected by temperature (Figs. 7, 8). ■■

Bibliography

1. Harper, C. A., *Handbook of Thick Film Hybrid Microelectronics*, McGraw-Hill Book Co., 1974.
2. Harper, C. A., *Handbook of Electronic Packaging*, McGraw-Hill, 1969.

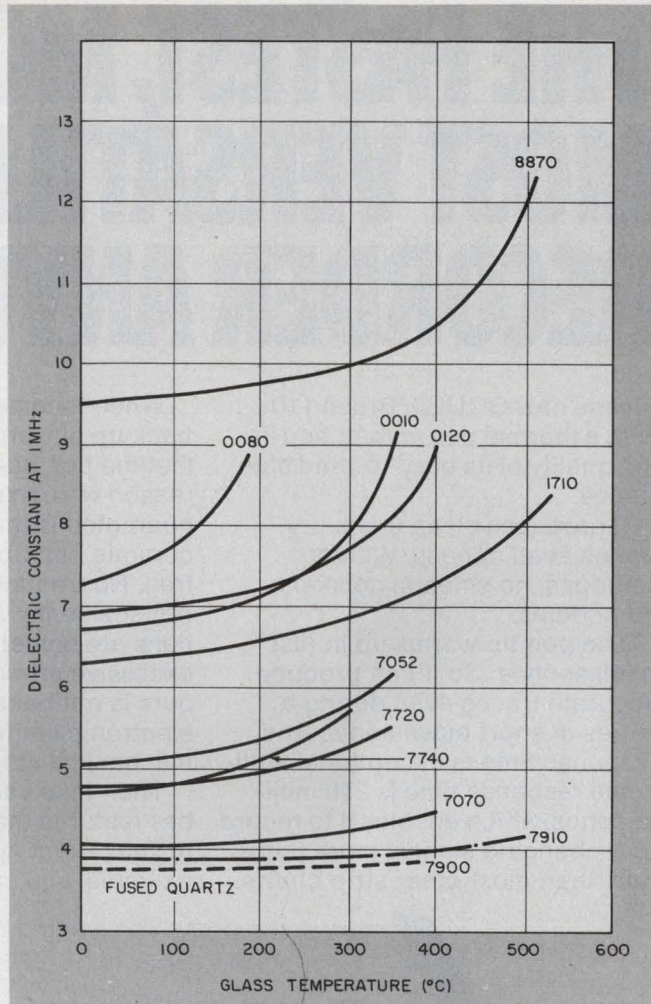

8. The dielectric constant of commercial glasses at 1 MHz increases as temperature is elevated.

3. Harper, C. A., *Handbook of Materials and Processes for Electronics*, McGraw-Hill Book Co., 1971.
4. Coors Porcelain Company: *Coors Technical Data Book on Ceramics Properties*.
5. Lynch, J. F., et al: *Engineering Properties of Ceramics*, U.S. Dept., Comm. Bull. AD803-765.
6. Hessinger, P. S.: "How Good are Beryllia Ceramics?" *Electronics*, October 18, 1963.
7. National Beryllia Corporation: *National Beryllia Technical Bulletin on Berlox BeO*.
8. Martin, J. H.: "The Manufacture of Ceramic-Based Microcircuits," *Sprague Tech. Pap. TP-66-10*, Sprague Electric Company.
9. Comeforo, J. E.: "Properties of Ceramics for Electronic Applications," *Electron. Eng.*, April 1967.
10. Frisco, L. J.: "Frequency Dependence of Electric Strength," *Electro-Technology*, vol. 68, pp. 110-117, August 1961.
11. American Lava Corporation: *Alsimag Tech. Bull.* 691 and 652.
12. Mykroy Ceramic Corporation, *Technical Data Book on Mykroy Ceramoplastics*.
13. Shand, E. B., *Glass Engineering Handbook*, McGraw-Hill, New York, NY and Corning Glass Works, Corning, NY.
14. Harper, C. A., "Select the Proper Insulating Material," *Electronic Design*, May 24, 1976, pp. 72-76.
15. Harper, C. A., "Insulate with Plastics and Elastomers," *Electronic Design*, June 21, 1976, pp. 86-94.

THE FASTEST, MOST DEPENDABLE, MOST VERSATILE STRIP CHART RECORDER ANYWHERE.

It's the new GOULD/Brush 110 with a thermal pen unmatched in the quality of its easy-to-read blue traces.

It produces clear, crisp, dry traces at all speeds. With no smudges, no smears, no skips, no puddles.

The pen tip warms up in just milliseconds. So it can produce accurate traces even during a series of short movements. And response time is exceptional. Full-scale response time is 250 milliseconds, which enables it to record fast-changing signals more faithfully than most other strip charts.

When it comes to reliability, we back up our promise with a lifetime pen guarantee. One reason we can make such a strong guarantee is that the special ceramic pen tip is virtually wear-free. No frequent, costly pen replacements. And although other pens are sometimes damaged by excessive off-scale input signals, ours is not because we use hard-electronic limiters and soft mechanical stops.

Then take versatility. The 110 has features that let you tailor it to your exact application. For example, you can choose from ten

chart speeds. A selection of plug-in signal conditioners accommodate a wide range of input signals. Charts may be pulse-driven by an external device. And an optional solid state electronic chart integrator follows positive and negative signals up to 4 times full scale on the analog channel.

We don't believe there's another strip chart recorder in the market that is as fast, dependable and versatile. But don't take our word for it. We'll be happy to give you a demonstration anytime, anywhere. Once you see it, we think you'll believe it too.

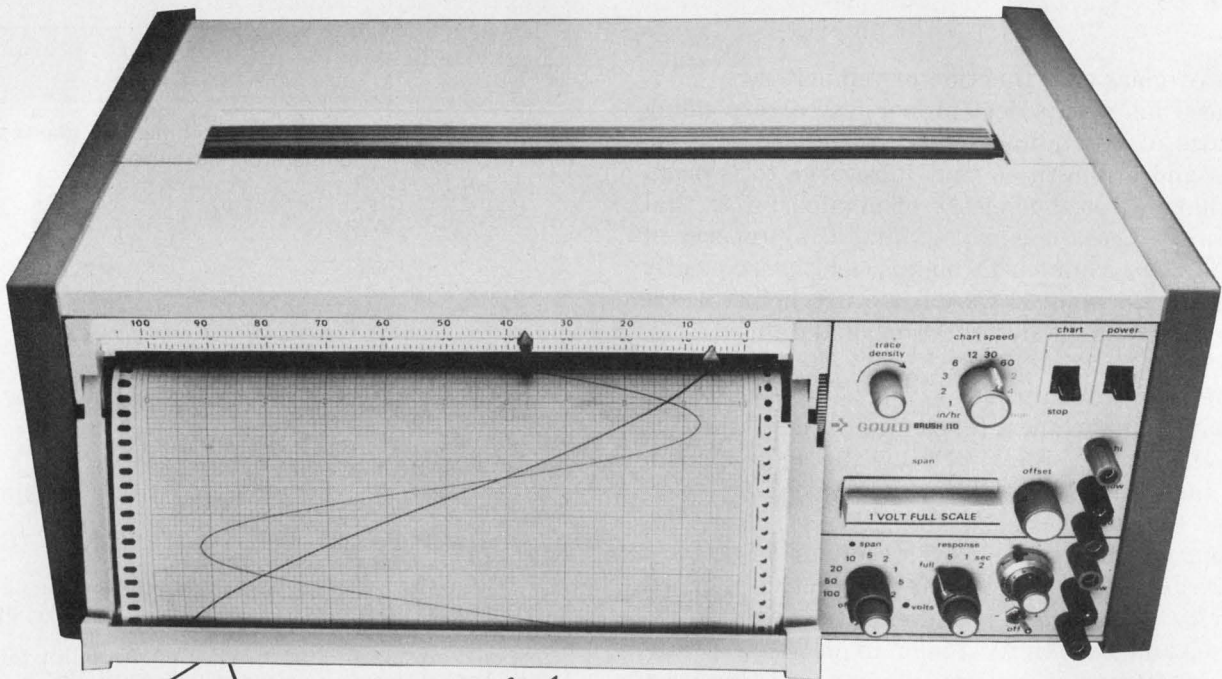

For brochure
call toll free at
(800) 325-6400
Extension 77
In Missouri:
(800) 342-6600

The GOULD/Brush
thermal pen with
a lifetime guarantee.

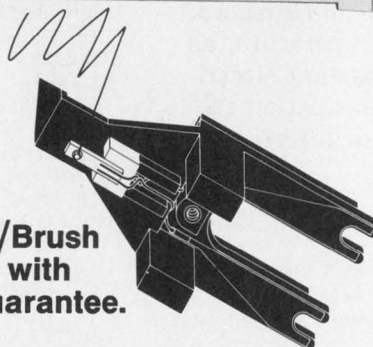

Call your nearest Gould Sales Engineer for a demonstration. Or write Gould, Inc., Instrument Systems Division, 3631 Perkins Avenue, Cleveland, Ohio 44114. Or Gould Allco S.A., 57 rue St. Sauveur, 91160 Ballainvilliers, France.



How fast can you measure rise time, fall time and pulse width?

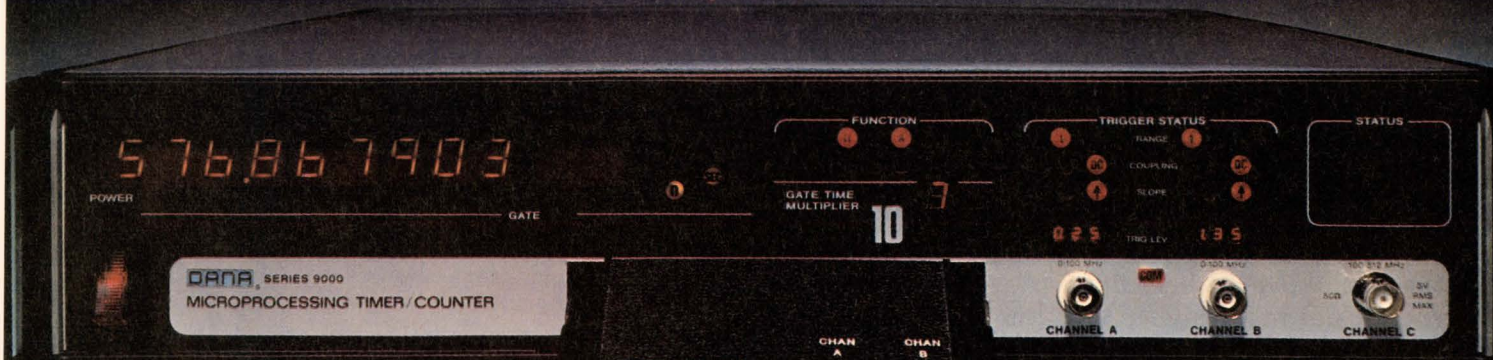
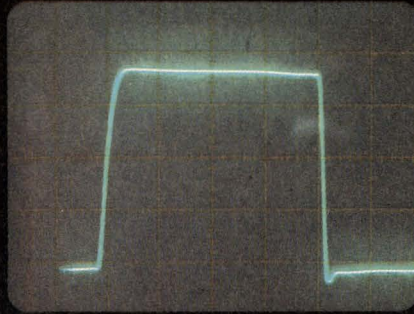

Your way.

(About 5 minutes.)

1. Connect signal to scope.
2. Adjust trace intensity.
3. Adjust focus.
4. Select VOLTS/DIV range.
5. Select TIME/DIV range.
6. Adjust vertical gain to fill screen for location of 10% & 90% points.
7. Locate 10% point.
8. Locate 90% point.
9. Determine horizontal displacement between 10% & 90% points.
10. Multiply displacement by horizontal scale factor.

That's RISE TIME. Only 9 more steps and you've got PULSE WIDTH and FALL TIME.

For Product Demonstration Circle # 282

Our way.

(About 5 seconds.)

1. Connect signal.
2. Push button for RISE TIME.
3. Push button for PULSE WIDTH.
4. Push button for FALL TIME.

The rest is automatic.

Your move.

Give us a call and we'll tell you how the Dana 9000 Microprocessing Timer/Counter can solve your measurement problem the easy way.

DANA[®]
Others measure by us.

Dana Laboratories, Inc., 2401 Campus Drive, Irvine, CA 92715
Phone: 714/833-1234

See us at Electro '77 Booths 1219, 1221 and 1223.

For Literature Only Circle # 283

Use a pulse-width-modulated switcher

for your low-voltage, high-current dc supply. You gain efficiency and can get rid of the input-line transformer.

Look to a pulse-width-modulated (PWM) supply for hundreds of watts of regulated low-voltage dc when efficiency, size and weight are important. With PWM, you boost efficiency by combining dc/dc conversion and regulation in the same circuit. The alternative, a switching regulator cascaded with a dc/dc converter, is not as efficient because the dissipation of each section adds, in the series combination. Of course, when it comes to efficiency, linear regulators aren't even in the same ball park with switchers.

Besides the size and weight saving that comes from higher efficiency (less heat sinking) PWMs needn't use an input power transformer, which, of course, has to be a monster at high power levels. PWM supplies can operate directly from the rectified input line. Because a PWM inverter operates at much higher than the line frequency, you get transformer isolation of the output from the rectified input line with smaller and lighter magnetic components.

Operating at a fixed frequency, a PWM supply converts power from the rectified input line to variable-width pulses, which, when filtered, are the dc output. By varying pulse width, the output is maintained within a specified voltage range in the face of line-and-load variations (regulation).

The circuitry used in a PWM supply is shown as functional blocks in Fig. 1. The major components of the PWM supply are

- Line rectifiers, which convert the input ac-line voltage to dc.
- An inverter power stage, which passes the PWM dc to the output filter. The half-bridge connection cuts by half the power semiconductors needed and simplifies the required base-drive circuitry.
- A 40-kHz clock, which times the P-W modulator.
- A P-W modulator, which delivers drive to the base-drive converter.
- A comparator, composed of an op amp and zener, which develops an error voltage to control

J. H. O'Neal, Applications Engineer, Solitron Devices, 1177 Blue Heron Blvd., Riviera Beach, FL 33404.

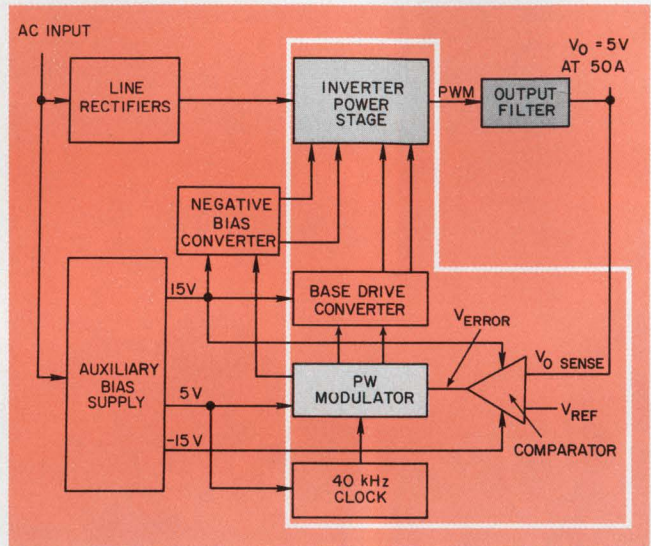

1. Constant-frequency, variable-width power pulses pass from the rectified input line to the output filter. Regulation is achieved by pulse-width control.

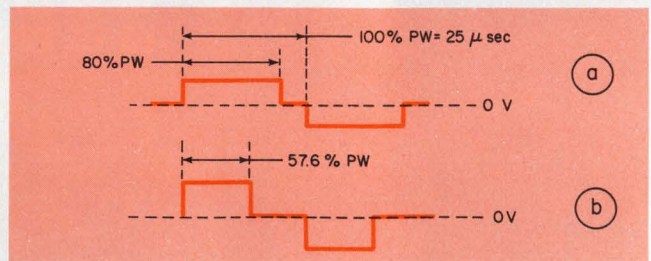

2. A practical operating point is 80% of pulse width for a 20-kHz system at low-line voltage (a). For high-line voltage (b), the pulse width drops to 57.6%.

Table 1. Shottky diode characteristics

Series No.	Pack-age	I _F Rating	V _{BR} range	V _F at I _F	I surge*
MS 8000	DO-35	to 100 mA	5-70	0.4 at 1 mA	—
MS 9000	DO-7	to 500 mA	5-70	0.5 at 100 mA	—
SSP 300	DO-4	3.0 A	5-70	0.56 at 3.0 A	100 A
SSP 800	DO-4	8.0 A	5-70	0.56 at 8.0 A	450 A
SSP 2000	DO-4	20 A	5-70	0.56 at 20 A	650 A
SSP 3000	DO-5	30 A	5-50	0.56 at 30 A	800 A
SSP 6000	DO-5	60 A	5-50	0.56 at 60 A	1200 A
SSP 12500	DO-5	125 A	5-40	0.56 at 125 A	2000 A

*8.3 ms sine wave pulse under simulated load conditions

the timing of the P-W modulator.

- A base-drive converter, which accepts the P-W signals from the modulator and drives the power transistors.

- A negative-bias converter and auxiliary-bias supply, which provide internal operating voltages throughout the supply.

Astable clock times the system

Timing for the entire power supply is derived from the system clock, a 40-kHz astable multivibrator powered from +5 V. This includes timing for the pulse-width modulator.

The pulse-width modulator (Fig. 3), consisting of a monostable multivibrator, flip-flop, and two NAND gates, accepts a clock signal and an error voltage from the comparator. Then the modulator generates push-pull 20-kHz drive for the base-drive converter, as well as a 20-kHz square-wave drive for the negative-bias converter.

The base-drive converter accepts 20-kHz, push-pull, TTL signals from the pulse-width modulator and converts them to a power level that can drive the bases of the bridge transistors. Input signals are negative-going to take advantage of the modulator's 16-mA sinking capability.

Voltage regulation for the system is provided by the comparator consisting of a 741 op amp combined with a 9-V reference zener. The reference supplies 4.5 V to the 741, and so permits you to adjust the +5-V output. The error voltage developed by the 741 controls the mono's timing, and thereby determines the system pulse width.

Use the half-bridge connection of Fig. 4 rather than a full-wave bridge when your output power is in the range of hundreds of watts. You need only half the power semiconductors, and base-drive circuitry is simplified.

In Fig. 4, Q_1 and Q_7 are bridge transistors, while Q_4 and Q_8 are base-clamping transistors. Biasing of Q_4 and Q_8 is arranged so that, at the end of the pulse-width interval, they conduct to remove base charges from their respective bridge transistors by clamping the base to a negative voltage from the negative-bias converter.

The junction of capacitors C_9 and C_{10} in the

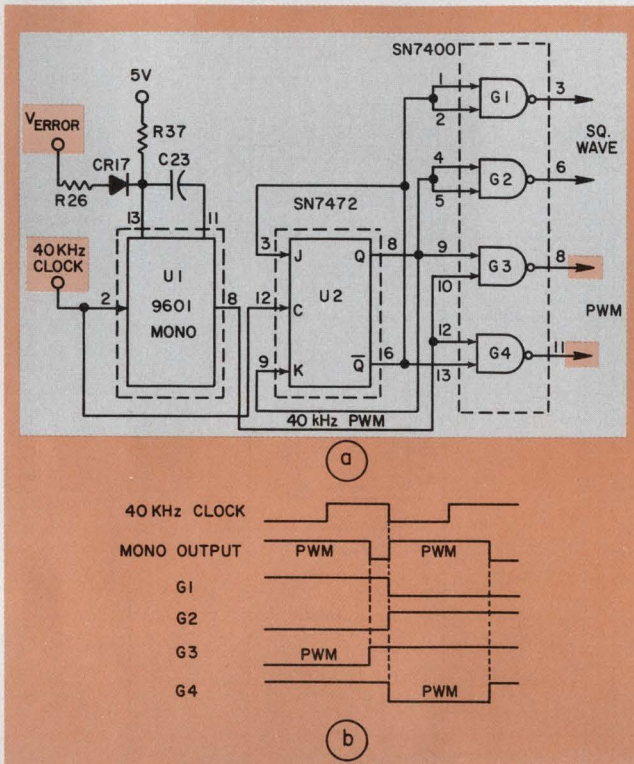

3. Pulse-width-modulation signals are developed from the clock and the comparator's error voltage. The 40-kHz clock is halved for the 20-kHz system frequency.

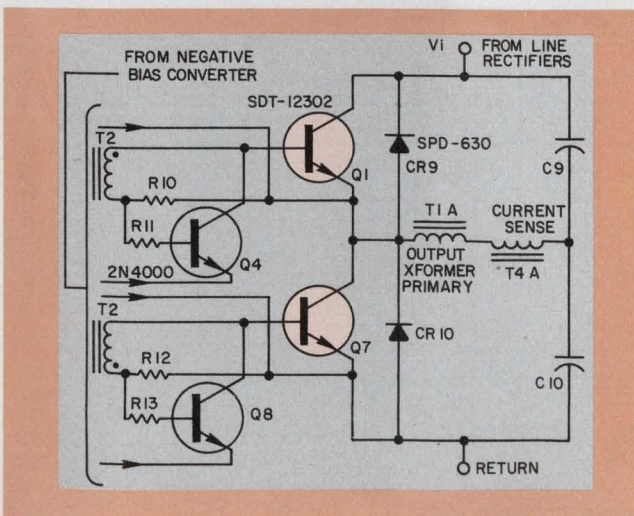

4. Cut your power semiconductors by half and make the base drive for the power transistors simpler than with a full-bridge inverter by using the half bridge.

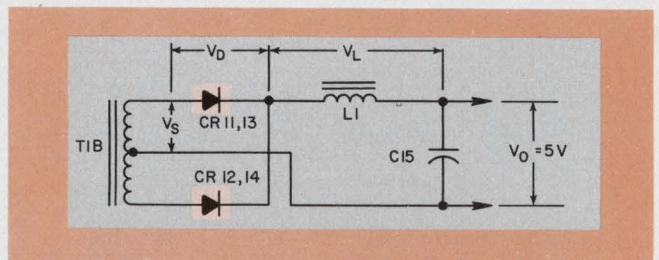

5. Forward drops of 0.56 V at 60 A, coupled with fast switching, make Schottky power rectifiers well suited for high-current, low-voltage supplies. But PIVs are low.

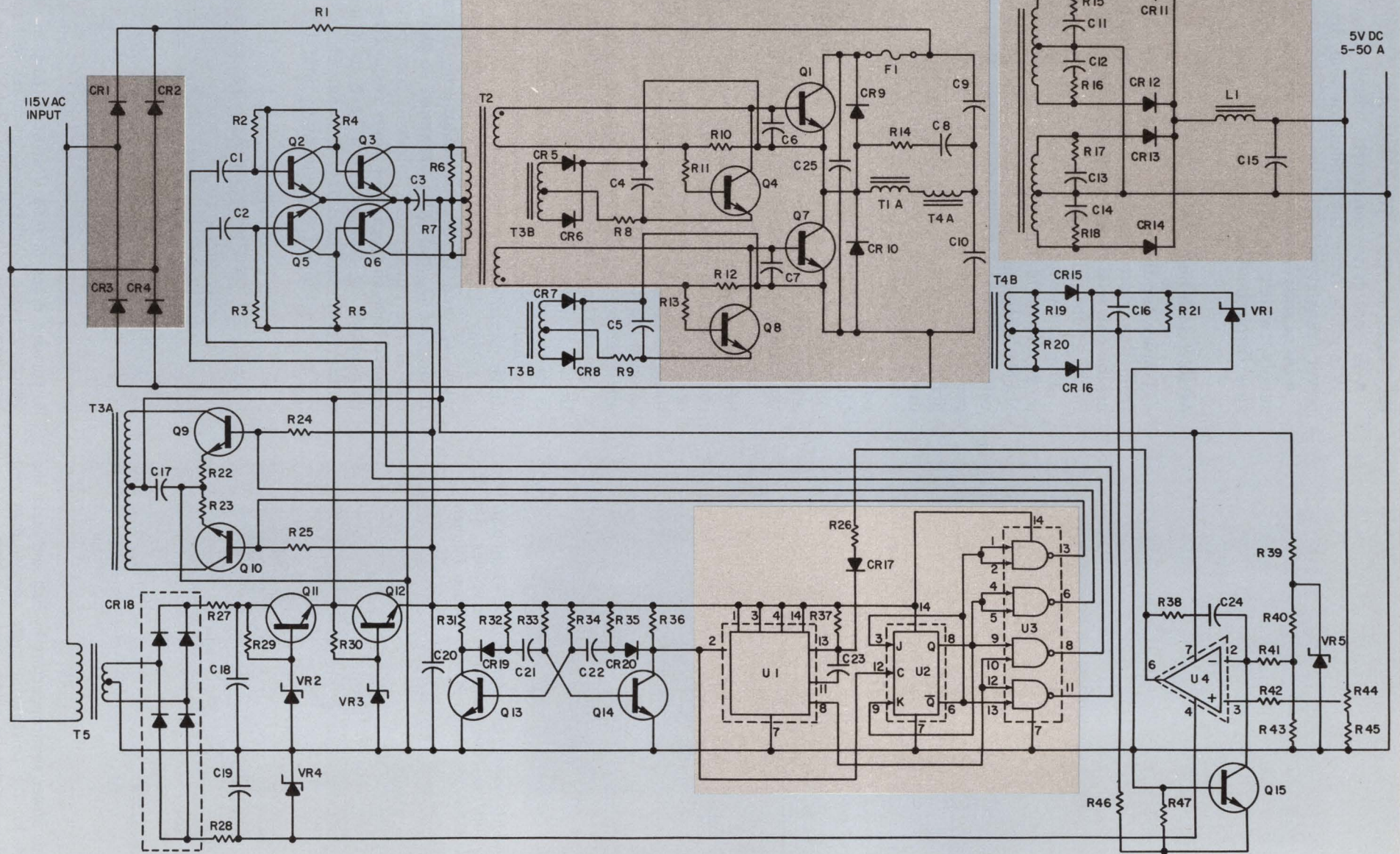

6. Eliminate bulky input-line transformers with supplies whose inverters operate directly from the rectified input line. Transformer isolation of the output with smaller

and lighter magnetic components is a feature of the pulse-width-modulated, fixed-frequency system. Efficiency results from switching power in one circuit only.

List of magnetics to build

Output Transformer (T1)

CORE: Ferroxcube 400T750-3C8 Ferrite Toroid
 BUILD: Primary Winding (N1) = 36T #12HF
 Continuous-wound 360°
 Secondary windings (N2) = 2 x 5T #12HF
 Bifilar-wound 120° Sectors
 Use tape on core between N1 and N2

Base Drive Converter Transformer (T2)

CORE: Magnetics, Inc. 50033-1F Tape Toroid
 BUILD: Primary Winding (N1) = 36T #26HF
 Bifilar-wound 360°
 Secondary Winding (N2 and N3) = 11T #22HF
 Bifilar-wound Close-spaced Sector
 Use tape between N1 and N2

Negative Bias Converter Transformer (T3)

CORE: Magnetics, Inc. 50033-1F Tape Toroid

BUILD: Primary Winding (N1) = 27T #26HF
 Bifilar-wound 360°
 Secondary Windings (N2 and N3) 8T #22HF
 Bifilar-wound Close-spaced Sector
 Use tape between N1 and N2

Current Sense Transformer (T4)

CORE: Magnetics, Inc. 55117-A2 Powder Toroid
 BUILD: Secondary Winding (N2) = 46T #28HF
 Bifilar-wound 360° on core
 Primary Winding (N1) Formed by passing T1 primary lead through core

Output Filter Inductor (L1)

CORE: Magnetics, Inc. 55436-A2 Powder Toroid
 BUILD: 2 x 3 T #12AWG bifilar stranded hookup wire
 VALUE: 4.17 μH

Electrical parts list: (Ref: Fig. 7, schematic)

Ref. Designation	Description		
C1, C2, C11, C12, C13, C14	0.47 μF, 100 V	R6, R7	150 Ω, 2W, 5%
C3, C17, C19	47 μF, 35 V	R8, R9	1.8 Ω, 2W
C4, C5	56 μF, 6 V	R10, R12	6 Ω, 10W
C6, C7	0.005 μF, 1000 V	R11, R13	39 Ω, 1/2W, 5%
C8	0.047 μF, 200 V	R14	330 Ω, 25W
C9, C10	3300 μF, 200 V	R15, R16, R17, R18	15 Ω 5W
C15	47,000 μF, 7.5 V	R21	10 kΩ, 1/2W, 5%
C16	39 μF, 10 V	R22, R23	1 Ω, 1/2W, 5%
C18	2100 μF, 40 V	R26	910 Ω, 1/2W, 5%
C20, C24	0.1 μF, 100 V, (CK06)	R27	1 Ω, 10W
C21, C22	0.001 μF, 200 V, (CK05)	R28	330 Ω, 1/2W, 5%
C23	0.0015 μF, 100 V, (CK05)	R29	390 Ω, 1/2W, 5%
C25	15 μF, 200 V	R31, R36, R39	820 Ω, 1/2W, 5%
CR1, CR2, CR3, CR4	1N1204A	R32, R35	1.2 kΩ, 1/2W, 5%
CR5, CR6, CR7, CR8	Diode, F.R.R., Semtech Type S2F	R33, R34	20 kΩ, 1/2W, 5%
CR9, CR10	Diode, F.R.R., Solitron Type SPD-630	R37	Select in range of 39 kΩ to 47 kΩ to give 80% maximum pulse width
CR11, CR12, CR13, CR14	60 A, 30 V Schottky Rect., Solitron Type SSP6030	R38, R42	2.7 kΩ, 1/2W, 5%
CR15, CR16, CR17, CR19, CR20	1N4148	R40, R43	1.5 kΩ, 1%
CR18	Bridge Rectifier, Semtech SCBH1	R41	15 kΩ, 1/2W, 5%
F1	10 A Fast-blow Fuse	R44	1 kΩ Trimpot
Q1, Q7	SDT-12302, NPN Solitron	R45	3.3 kΩ, 1%
Q2, Q5, Q9, Q10, Q13, Q14, Q15	2N2222A	R47	82 Ω, 1/2W, 5%
Q3, Q4, Q6, Q8	2N4000	T5	Filament Transformer, 115 V/35VCT, 1.5A
Q11, Q12	2N3771	U1	9601DC Retriggerable one-shot
R1	0.1 Ω, 10W	U2	SN7472J J-K Flip-flop
R2, R3, R24, R25, R30, R46	680 Ω, 1/2W, 5%	U3	SN7400J Quad 2-Input NAND Gate
R4, R5, R19, R20	150 Ω, 1/2W, 5%	U4	LM741CN Op. Amp.
		VR1	LVA62A Avalanche Zener, 6.2 V
		VR2	1N4963, 16 V, 1W Zener
		VR3	1N753A, 6.2 V, 0.4W Zener
		VR4	1N965B, 15 V, 0.4W Zener

bridge serves as a tie point of constant potential for one end of the transformer primary. These capacitors also filter the input line.

Start with the operating point

At the outset of designing a PWM dc/dc converter, you must make two fundamental design decisions. First, fix the operating point of the modulator. Second, determine the turns ratio of the output transformer.

The operating point is the percentage of pulse width at the lowest input voltage and, of course, the maximum width used. Select the operating point to be as close to 100 percent as is practical, and you can reduce the peak inverse voltage (PIV) required of the output rectifiers. The approximation is limited by circuit-propagation delays relative to the operating frequency.

Delay is primarily affected by the rise and fall times of the power waveforms at the operating frequency. For example, in a 20-kHz system a half period of 100% PW equals 25 μ s. If circuit delays amount to 5 μ s, the maximum pulse width must be less than 25 - 5, or 20 μ s. This result corresponds to an operating point of 80%.

From the operating point you can determine the operating range. The only additional information you need is the input-voltage range over which the supply must regulate. Thus, if the 115-V input ac ranges from 103 to 132 V and, after being rectified and filtered, from 126 to 175 V dc, the 126-V-dc point must be the 80% operating point.

PWM supplies regulate their outputs by holding the product of voltage and time constant over the operating range. The pulse-width percentage at the maximum input voltage is thus given by the following equation:

$$\frac{126}{175} \times 80\% = 57.6\%$$

So the operating range is from 57.6 to 80% of the half period at 20 kHz, as shown in Figs. 2a and 2b.

The turns ratio follows

Now that you have the operating point of the system, select the turns ratio of the output transformers. This ratio determines that the operating point of 80% will occur at the minimum input voltage, $V_{i(\min)}$ when the system is operating closed-loop. Calculate the ratio, starting with the load, and go toward the transformer primary.

In the output circuit of Fig. 5, the secondary voltage, V_s , is the sum of V_D , V_L and V_o . Also, the PIV of the rectifiers is equal to $2V_s$. Make a design tradeoff at this point to minimize the PIV requirement, yet allow a sufficient drop across inductor L_1 , so that your circuit component is practical.

Accomplishing all this may be a problem at a high current and a low-output voltage. So for a 20-kHz system, let V_L equal 2.5 V and V_D equal 0.6 V. The duty cycle at $V_{i(\min)}$ is 80%. Therefore, the effective secondary terminal voltage is determined in the following equation:

$$V_s = V_D + \frac{V_L}{0.8} = 8.725 \text{ V.}$$

For a primary voltage at $V_{i(\min)}$ of 126 V, the transformer's turns ratio for the full-wave bridge becomes

$$\begin{aligned} \frac{N_1}{N_2} &= \frac{126}{8.725} \\ &= 14.44. \end{aligned}$$

Because the half bridge transforms half the supply voltage and twice the current, the half-bridge ratio is 7.22.

Allow a ± 0.5 -V adjustment to V_o while keeping the same V_L . The 80% operating point then corresponds to $V_o = 5.5$ V, and the secondary voltage is 9.225 V at $V_{i(\min)}$. The new half-bridge turns ratio is 6.83.

Now you can design the transformer through the usual process of selecting the core and finding the number of primary and secondary turns. Core materials can include linear ferrites and 80% nickel steels. Trade names for some of the steels are Supermalloy and Round Permalloy.

Having designed your output transformer, select the output rectifiers. Of all power rectifiers you'll find Schottkys most suitable.

Schottkys shine at output

Schottky power rectifiers feature very low forward drops, and fast switching times at currents up to 125 A. These properties relate very well to the design of low-voltage high-current switching supplies. For example, the forward drop of the SSP6000-series device used in this supply is 0.56 V at 60 A.

Use paralleled Schottky rectifiers. In a current-sharing mode, they are thermally stable especially when mounted on the same heat sink. Also, the reduced size of the transformer's secondary wire—the result of using paralleled secondaries—makes the transformer easy to build.

Generally, the Schottky rectifiers carry low PIV ratings. But, fortunately, in rectifiers for a 5-V supply, PIV is not a great problem. The SSP-6000 series has ratings up to 50 V. Lower current devices are available up to 70 V. In Table 1, you can find Schottky power-rectifier series that span forward-current ranges from 100 mA to 125 A.

Determine the PIV your rectifiers require by applying the high-line condition as follows:

$$\begin{aligned} \text{PIV} &= \frac{V_{i(\max)}}{V_{i(\min)}} (2 V_s) \\ &= 24.24 \text{ V.} \end{aligned}$$

For safety, select rectifiers with at least a 30-V PIV rating. Ringing oscillations caused by junction and distributed winding capacitances and leakage inductance of the toroidal magnetics can produce spikes that exceed the PIV rating. But they are effectively suppressed in this system with simple R-C snubber networks in both the primary and secondary circuits.

Filter the 40-kHz pulse-width waveform from the Schottky rectifiers with an L-C section. Determine the inductance of the filter as a multiple of critical value to minimize the peak current to be switched by the Schottky rectifiers and bridge transistors.¹ Choose the output capacitor so it has a low, equivalent series resistance and ac impedance at the ripple frequency of 40 kHz. With this approach, output ripple becomes approximately the product of the current change, ΔI , through the capacitor's inductor and equivalent series resistance.

Calculate the required inductance for L_1 by plugging in the standard switching-regulator equation,¹ where V_1 is the secondary-terminal voltage of the transformer minus the forward drop of the Schottky rectifiers. For 2.5 V across the inductor, a ripple frequency of 40 kHz and an output current of 50 A, the critical inductance is

$$L_c = \frac{V_o}{2 I_o f} \left(1 - \frac{V_o}{V_i} \right) \\ = \frac{5}{2 (50) (40) (10^3)} \left(1 - \frac{5}{7.5} \right) \\ = 0.417 \mu\text{H}.$$

For a load range of 5 to 50 A, $(50/5) (0.417 \mu\text{H}) = 4.17 \mu\text{H}$, which requires three turns on a Magnetics 55436-A2 power-permalloy-toroid core.

Sense overcurrent in the primary circuit of the output transformer, where you work with 8 A, not in the 50-A secondary. Develop a voltage proportional to primary current with a resistively loaded current transformer (T_1) in series with the output-transformer primary. Rectify the resulting waveform and apply it to the current-limit transistor, which pulls the 741 reference input toward ground during an overcurrent condition.

To be effective, this method requires that you power the 741 from ± 15 V instead of +15 V, since the 741 output cannot be determined when inputs are within a volt or so of the -V terminal.

Effective, sharp current limiting (Fig. 6) is best obtained with a low-voltage avalanche zener rather than a standard 1N type. Avalanche devices produce sharp knees and flat pedestals. ■■

Reference

1. "A Clocked Switching Regulator," Solitron Application Note No. 1, 1177 Blue Heron Blvd., Riviera Beach, FL.

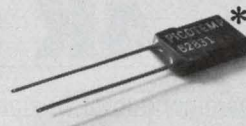

Small Wonder

* It's PICOTEMP® thermal cutoff
New from Micro Devices
(Actual Size)

PICOTEMP® thermal cutoffs. Fit tight spaces — and limited budgets. Same accuracy and similar capabilities as the widely used MICROTEMP® safety thermal cutoffs...but smaller in size. Weighs just 1/48th of an ounce. Installed costs are less, too.

Use PICOTEMP thermal cutoffs when installation or space restrictions rule out MICROTEMP. At present, motors and transformers are two leading applications.

But, wherever you use PICOTEMP thermal cutoffs, you're assured of positive, low cost protection against overheating caused by malfunctions in electrical circuits and components.

The PICOTEMP thermal cutoff is completely sealed

against atmosphere. Because of its unique design and construction, it won't derate. And it is unaffected by age or extended use.

Here are some other things you'll want to know:

- current capacity—to 5 amps. at 120 VAC. Will hold this rating up to and including 240 VAC.
- temperature tolerance +0° C.—3.3° C.
- temperature ratings—63° C.—150° C. (146° to 300° F.)
- leads are 26 gauge silver plated wire.

Recognized under the Component Program of Underwriters' Laboratories, Inc. UL File #E40667A. MITI approved.



MICRO DEVICES



DIVISION OF EMERSON ELECTRIC CO.
1881 SOUTHTOWN BLVD.
DAYTON OH 45439 513-294-0581

MEMORY AT WORK

The First Family of 4K Static RAMs

In the semiconductor business, there are more promises than products. Not at EMM SEMI. Others promised you a family of 4K static RAMs. We delivered. In volume. Military and commercial. We've been delivering for over two years. The first 18-pin 5-volt 4K static memory components (SEMI 4801, 4804). The only 150 ns, 8080-compatible 4K static components (SEMI 4104, 4200). The only 80 ns 4K static component in production (SEMI 4200C). The only 4K static device with enough speed and power dissipation for megabyte applications. (SEMI 4402). Others talked. We delivered the First Family of 4K static RAM components. One of them will fit your need. See your local EMM SEMI distributor or call us today.

EMM SEMI
a subsidiary of

Electronic Memories & Magnetics Corporation
3883 North 28th Avenue, Phoenix, Arizona 85017
(602) 263-0202

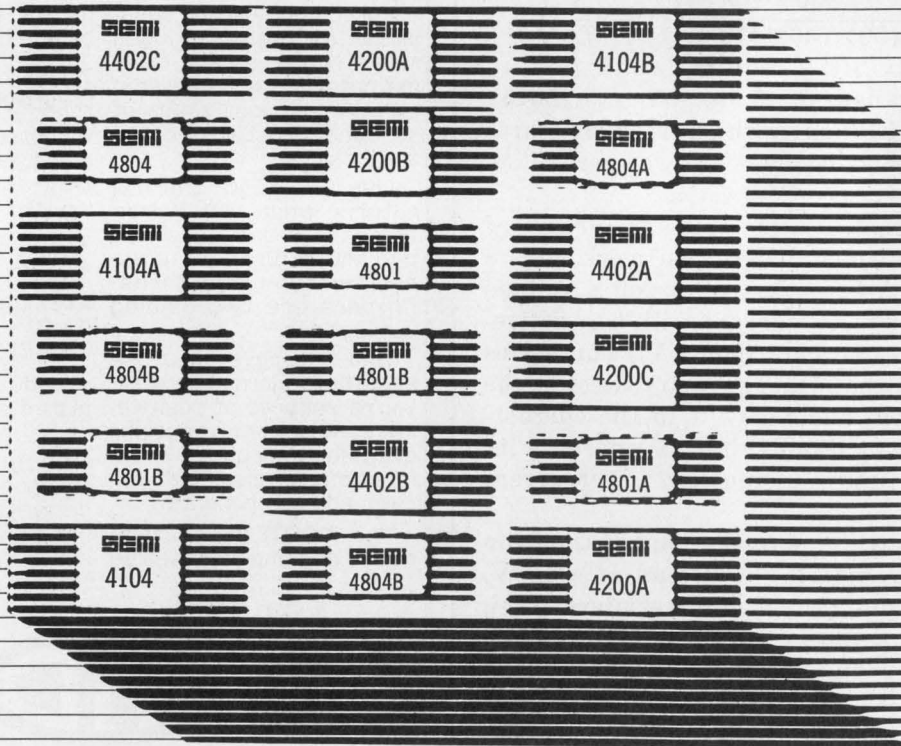

ARROW ELECTRONICS: Woburn, MA; Hamden, CT; Poughkeepsie, NY; Farmingdale, NY; Saddle Brook, NJ; Moorestown, NJ; Baltimore, MD; Fort Lauderdale, FL; Dayton, OH; Cleveland, OH; New Berlin, WI; Bloomington, MN. **CENTURY ELECTRONICS:** Denver, CO; Albuquerque, NM; Salt Lake City, UT. **SEMICOMP:** Newport Beach, CA; Sunnyvale, CA. **STERLING ELECTRONICS:** Watertown, MA; Amboy, NJ; Metairie, LA; Dallas, TX; Houston, TX; Albuquerque, NM; Phoenix, AZ; San Diego, CA; San Carlos, CA; Seattle, WA.





Increase Reliability and Performance with Custom Quartz Crystals.

MCCoy Electronics offers a larger variety of Quartz Crystals than any other supplier. With a frequency range of 700 Hz to 250 MHz and a variety of housings available such as solder seal, glass, and cold weld, MCCoy crystals have found broad uses in commercial, industrial, military, and high reliability applications.

MCCoy specializes in applications where strict control of motional parameters is dictated, tight stabilities are needed, or in any program requiring experienced technological resources.

In addition, MCCoy crystals are proven to be economical for the buyer in terms of consistent performance and high quality, thereby eliminating the costly burden of replacement.

We invite your use of MCCoy's expert engineering and marketing staffs in developing specifications for custom crystals individually tailored to meet your needs.

Please write for our free catalog.

 **MCCOY**
ELECTRONICS COMPANY

a subsidiary of **OAK Industries Inc.**

MT. HOLLY SPRINGS, PA. 17065 • 717-486-3411 - TWX: 510-650-3548

CIRCLE NUMBER 47

Break loose from fixed IC regulators.

With adjustable three-terminal power monolithics you get top performance along with versatility.

Adjustable three-terminal monolithic regulators like the LM117 family overcome the design restrictions that older IC regulators have imposed. Their adjustability paves the way for IC use in applications formerly restricted to higher-priced modules or cumbersome discrete designs.

Variable-output power supplies, precise on-card voltage regulation, two-terminal current regulators, tracking preregulators and logic-controlled shutdown are among the more apparent uses for these adjustable regulators. In some more unique applications, the LM117 ICs, available from several sources, ease the design of battery chargers and high-efficiency adjustable switching regulators.

Like fixed-voltage monolithic regulators, the more adaptable variable regulators are low cost and feature improved specifications and improved on-chip overload protection. These units add the welcome plus to any design of ten-times better regulation than the fixed-output standards. The LM117 family gives you 0.01%/V line regulation and 0.1% load regulation. Further, with only three terminals, standard heat sinks can be used, like with TO-3 power transistors.

The circuit need not be grounded

Eliminating ground operation, the LM117 can be understood by referring to the simplified equivalent circuit of Fig. 1. An op amp, connected as a unity-gain buffer, drives a power Darlington. Op amp and biasing circuitry are arranged so that all quiescent current is delivered to the regulator's output rather than ground. So a separate ground terminal isn't needed. Furthermore all the internal circuitry operates over the full 2-V to 40-V input-to-output differential of the regulator.

A 1.2-V reference appears inserted between the noninverting input of the op amp and the adjustment terminal. About 50 μ A of bias current is needed to bias the reference and appears at the

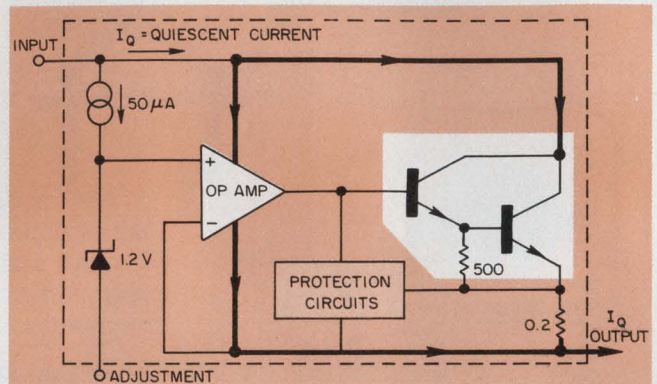

1. All quiescent current but 50 μ A passes to the output of the LM117 rather than to ground. A separate ground terminal is thus unnecessary. The op amp, a unity-gain buffer, drives the power output Darlington.

adjustment terminal. The output is the voltage of the adjustment terminal plus 1.2 V. If the adjustment terminal is grounded, the device acts as a 1.2-V regulator.

For higher than 1.2-V outputs, a divider, R_1 and R_2 , is connected from the output to ground as shown in Fig. 2. The 1.2-V reference across resistor R_1 forces 5 mA to flow. This 5 mA then flows through R_2 , which increases the voltage at the adjustment terminal and thus the output voltage. The output voltage is given by the following equation:

$$V_{out} = 1.2 V \left(1 + \frac{R_2}{R_1} \right) + 50 \mu A R_2 \quad (1)$$

The 50 μ A biasing current is small enough compared to 5 mA to cause only a small output-voltage error. In addition, the reference bias is extremely well regulated against changes in line voltage or load current so it contributes virtually no error to dynamic regulation. Of course, programming currents other than 5 mA can be used, depending on the application.

Since the regulator is floating, all the quiescent current must be absorbed by the load. Too light a load impairs regulation. Usually the 5-mA programming current is sufficient; however, worst-case for commercial-grade parts requires a minimum load of 10 mA.

To protect against short circuits, the LM117

Robert C. Dobkin, Director of Advanced Circuit Development, National Semiconductor Corp., Santa Clara, CA 95051

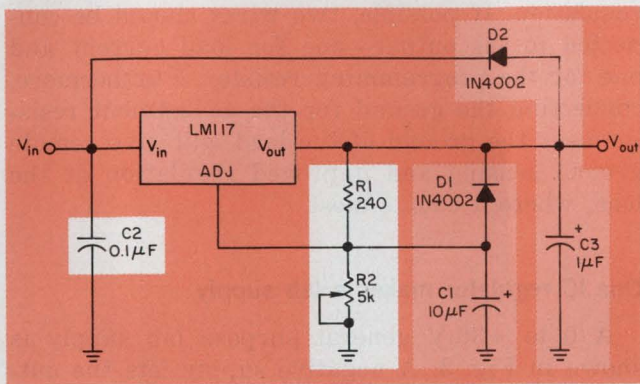

2. Two resistors and an input capacitor are needed for the basic regulator. The two optional capacitors improve ripple rejection and improve transient response. The diodes protect the IC.

has improved current-limiting circuitry. Internally, the current limit is set at about 2.2 A and remains constant with temperature.

Overload protection boosts reliability

Other devices such as the 309 or 7800 regulators use the turn-on of an emitter-base junction to set the current limit. This causes the typical current limit to change by a factor of two from -55°C to $+150^{\circ}\text{C}$. And to ensure adequate output current at 150°C , the current limit in older regulators is relatively high at 25°C . As a result, short circuits may not hurt the regulator but can severely overload the input supply.

Also included is safe-area protection for the pass transistor to decrease the current-limit as input-to-output voltage differential increases. The safe-area protection circuit allows full output current at up to a 12-V input-output differential. And unlike older regulators, the current limit is held above zero at high input-to-output differential voltages, eliminating start-up problems with high input voltages.

Further, to prevent damage from excessive power dissipation, on-chip thermal overload protection limits the die temperature to about 170°C . Where the thermal-limit circuitry found in older regulators requires more than 7 V to operate,

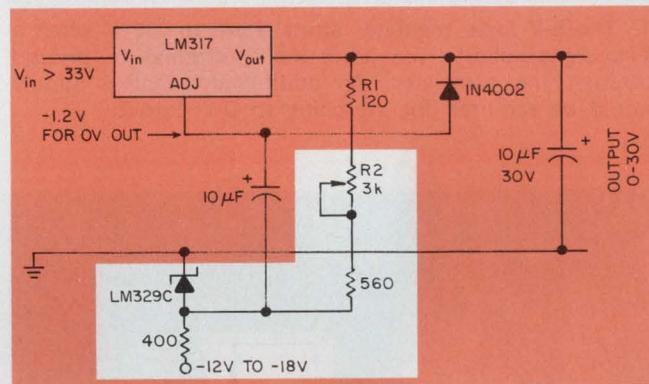

3. To deliver true-zero output the adjustment terminal of the LM317 must be 1.2 V below ground. Operation down to 0 V thus requires a negative supply, to feed the zener and resistor reference for the adjustment pin.

the LM117 uses a new design which can operate down to about 2 V. Moreover, the thermal and current-limit circuitry still works even when the adjustment terminal is accidentally disconnected.

In operation, the basic regulator, as shown in Fig. 2, requires only the addition of two resistors and a standard input-bypass capacitor. Resistor R_2 sets the output voltage while R_1 provides a programming current of 5 mA. The two capacitors on the adjustment and output terminals are optional for improved performance.

Bypassing the adjustment terminal to ground improves ripple rejection. This bypass capacitor prevents ripple from being amplified as the output voltage is increased. With a $10\text{-}\mu\text{F}$ bypass capacitor, 80 dB of ripple rejection at any output level is obtainable.

Although the LM117 is stable with no output capacitors, like any feedback circuit, certain values of external capacitance can cause excessive ringing. This occurs with values between 500 and 5000 pF. A $1\text{-}\mu\text{F}$ solid-tantalum (or $25\text{-}\mu\text{F}$ aluminum-electrolytic) capacitor on the output swamps this effect and ensures stability.

IC regulators need protection diodes

When external capacitors are used with any regulator, protection diodes are needed to pre-

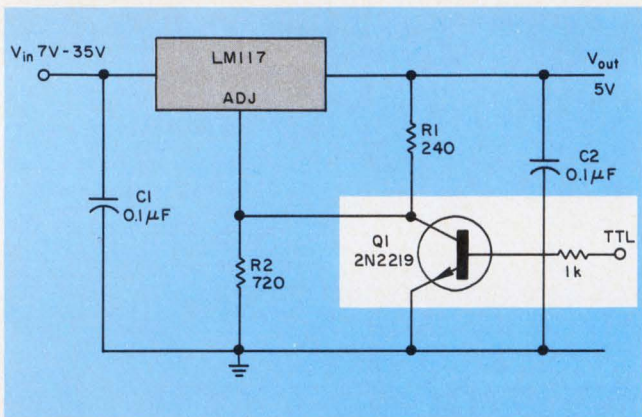

4. The 5-V logic regulator shuts down to 1.2 V when a TTL signal shorts the adjustment terminal to ground through the transistor. An additional negative supply would be required for switching to 0-V output.

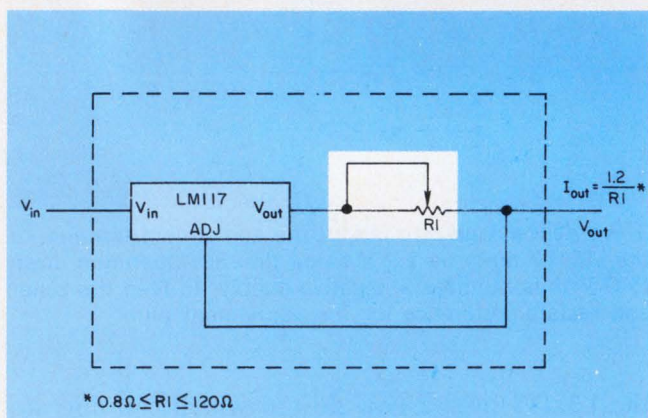

5. A true two-terminal current source uses the adjustable regulator with only one external resistor.

vent the capacitors from discharging through low-current junctions in the IC. When shorted, most 10- μ F capacitors have an internal resistance low enough to deliver 20-A spikes. Although brief, the surge can contain enough energy to damage the IC.

If a regulator's input is shorted, the output capacitor discharges into the regulator's output terminal. The magnitude of the discharge current, depends on the size of the capacitor, the output voltage of the regulator, and the rate of decrease of the input voltage. In the LM117, this discharge path (through the output terminal) can withstand a 20-A surge. This is not true of other positive regulators. So with an adjustable regulator that is used with output capacitors of up to 25 μ F, it is not necessary to use diodes.

The bypass capacitor on the adjustment terminal can discharge through a junction with low-current capability. Discharge occurs when *either* the input or output is shorted. Internal to the IC is a 50- Ω resistor that limits the peak discharge current. No protection is needed for outputs less than 25 V or capacitances less than 10 μ F. Pro-

tection diodes, however, must be included for outputs greater than 25 V or output capacitances larger than 25 μ F.

A diode from output to input protects the regulator from the output capacitor's discharge. Another diode from the output to the adjustment terminal protects the IC from the adjustment-bypass capacitor's discharge.

It is necessary to minimize series resistance between the regulator's output terminal and the programming resistor. Any voltage drop due to load current through a series resistance acts as a change in the reference voltage and degrades regulation. If possible, two wires should be connected to the output—one for load current and one for the programming resistor. Furthermore, connecting the ground for the adjustment resistor near the ground of the load will give remote ground sensing and improved regulation at the load, where it counts most.

One IC regulator makes a lab supply

A 0 to +30-V general purpose lab supply is shown in Fig. 3. A negative supply lets the output voltage go down to 0 V since the adjustment terminal can be driven to the required -1.2 V. An LM329, 6.9-V reference, provides a regulated 1.2 V to the bottom of adjustment pot R_2 . The LM329 is an IC zener with exceptionally low dynamic impedance, so the negative supply needn't be well regulated. Note the use of a 10-mA programming current, which ensures regulation when the supply is used with no-load. The LM317 regulator is adequate for this application. It operates over the narrowest junction-temperature range in the family (0 to +125 C).

The 1.2-V minimum output of the LM117 makes it easy to design power supplies with electrical shut-down: At 1.2 V, most circuits draw only a small fraction of their normal operating current. In Fig. 4, a TTL input signal causes Q_1 to ground the adjustment terminal and decrease the output to 1.2 V. If true-zero output is desired, the adjustment can be driven to -1.2 V; however, this requires a separate negative supply.

In multisystems with fixed-output, on-card regulators, the $\pm 5\%$ tolerance between regulators can cause a 10% difference in the operating voltage between cards. The consequences can be differences in speed for digital circuitry, problems in interfacing or decreased noise margins.

A single-point adjustment scheme¹ cuts the work needed to set up systems with multiple on-card regulators. If the adjustment terminals of all the regulators are tied together they can be controlled from a single divider. Moreover, all outputs will track to within ± 100 mV. To minimize the effect of each regulator's 50- μ A biasing current, set the programming current at 10 mA.

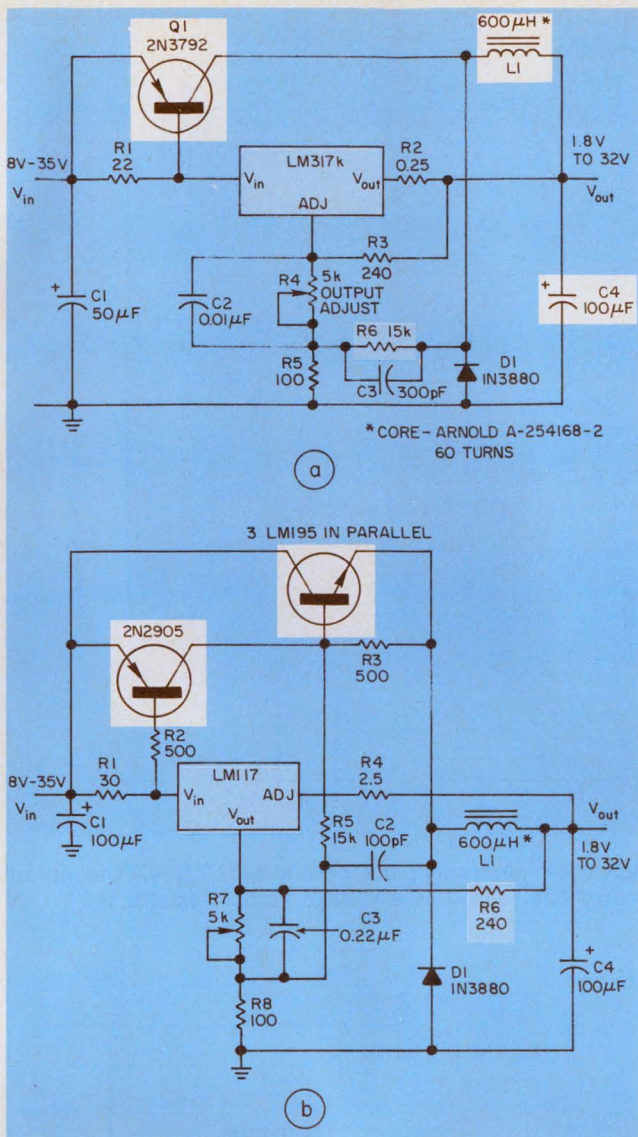

6. A power pnp switch drives the L-C filter in the 3-A switching regulator (a). The pnp-npn combination in (b) delivers up to 4 A with overload protection. Positive feedback to the three-terminal adjustable control element is through the resistor R_6 in both circuits.

If a large number of regulators are used, an even higher program current is necessary.

The same three-terminal device that works so well as a voltage regulator can be turned into a two-terminal current regulator. It is only necessary to insert a resistor between the regulator's output and adjustment terminals as shown in Fig. 5. The value of the resistance that gives an output current of 10 mA to 1.5 A is between 0.8 and 120 Ω . The output current is equal to 1.2 V divided by the resistance. This current source provides 0.01%/V of current regulation even at low currents—since the quiescent current does not cause an error. Current sources made with fixer regulators work poorly because the higher working voltages (7 V) and higher quiescent currents (10 mA) of the fixed-voltage units limit their over-all accuracy. And since the operating

voltage is less than 4 V the current regulator is also usable as a current limiter for protection of circuitry in series with the regulator.

Even switchers can be adjustable

Low cost adjustable switching regulators can be made with an LM317 as the control element. Fig. 6a shows the simplest configuration. A power pnp functions as a switch to drive an L-C filter. Positive feedback for hysteresis is applied to the LM317 through R_6 . When the pnp switches, a small square wave is generated across R_5 . This wave is level-shifted and applied to the adjustment terminal of the regulator by R_4 and C_2 , which causes the regulator to switch on or off. Feedback taken from the output through R_3 makes the circuit oscillate. Capacitor C_3 increases switching speed, while R_2 limits the peak drive current to Q_1 .

However, the circuit in Fig. 6a provides no protection for Q_1 in case of an overload: A blow-out-proof switching regulator is shown in Fig. 6b. The pnp transistor has been replaced by a pnp-npn combination with LM395s used as the npn transistors. The LM395 is an IC acting as an npn transistor with overload protection. Since the acting npn transistor has current limiting, safe-area protection and thermal-overload protection, it is virtually immune to any type of overload.

Efficiency for the regulators ranges from 65 to 85%, depending on output voltage. Efficiency is at its lowest at low output voltages since fixed power losses constitute a greater percentage of the total output power. Operating frequency is about 30 kHz and ripple about 150 mV, depending on input voltage. Load regulation is about 50 mV and line regulation about 1% for a 10-V input change.

One of the more interesting applications for these switching regulators is as a tracking pre-regulator. The only dc connection to ground on either regulator is through the 100- Ω resistor (R_5 or R_6) that sets the hysteresis. Instead of tying this resistor to ground, it can be connected to the output of a linear regulator so that the switching regulator maintains a constant input-to-output differential on the linear regulator.

Get a charge from an IC regulator

Battery charging is especially suited to the LM117. Since battery voltage depends on electrochemical reactions, the charger must be designed specifically for the battery type and number of cells. Ni-Cds are easily charged by constant current sources shown earlier. For float charges on lead-acid type batteries, the output of the LM117 is set at the float voltage and connected directly

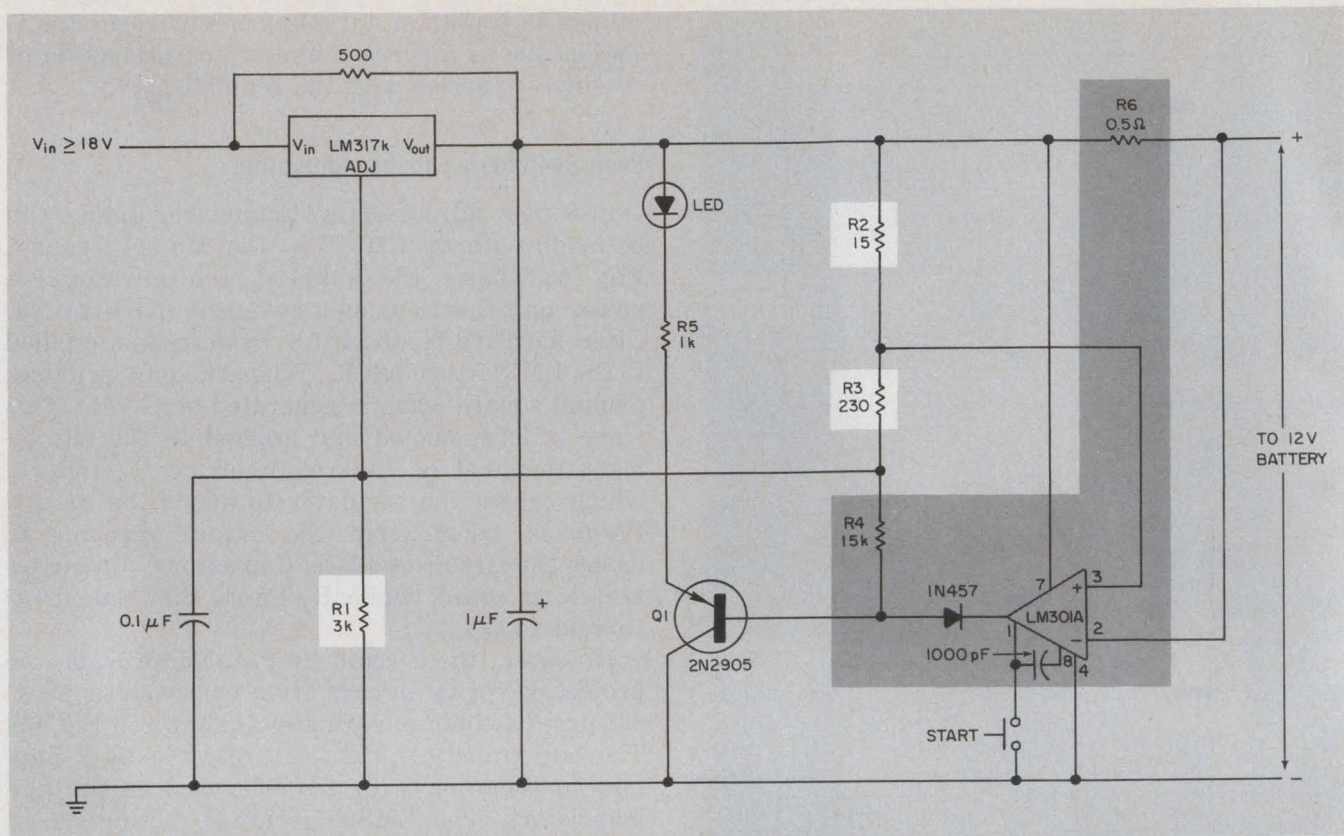

7. Initially the battery charger's output is 14.5 V as set by R_1 , R_2 and R_3 . To end the charging phase, LM301

goes low decreasing the output to 12.5 V. The output current is sensed as a voltage across resistor R_6 .

across the battery terminals.

An adjustable regulator is mandatory since long battery life calls for precise control of the float voltage. The output voltage temperature coefficient can be matched to the battery by inserting diodes in series with the regulator's adjustment resistor and coupling the diodes to the battery so that they track thermally.

A high-performance charger for gelled-electrolyte lead-acid batteries is shown in Fig. 7. This charger is designed to recharge a battery quickly and shut off at full charge. Initially, the charging current is limited to 2 A by the internal current limit of the IC regulator. As the battery voltage rises, current to the battery decreases. When the current has decreased to 150 mA, the charger switches to a lower float voltage and prevents overcharge.

A discharged battery doesn't need a start switch because the charger can start by itself. The switch is included, however, to allow even slightly discharged batteries to be topped off.

When the start switch is pushed, the output of the charger goes to 14.5 V which is set by R_1 , R_2 and R_3 . Output current, sensed across R_6 , is compared to a fraction of the 1.2-V reference (across R_2) by an LM301A op amp. As the voltage across R_6 decreases below the voltage across R_2 , the output of the LM301A goes low, shunting R_1 with R_4 . The resulting lower resistance reduces the

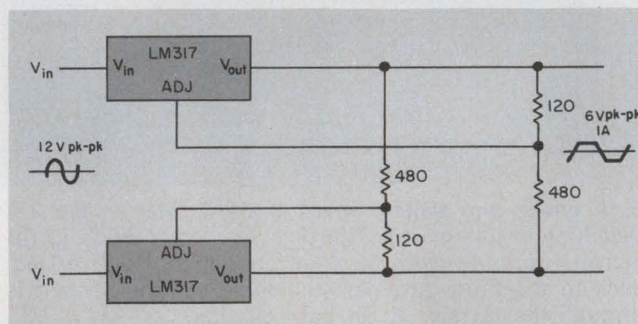

8. Two regulators are used to limit ac voltage. Each regulator peak-clips on one polarity of the ac input.

output voltage from 14.5 V to about 12.5 V and terminates the charging. Transistor Q_1 then lights the LED to indicate a full charge.

To further appreciate this regulator's versatility, examine a peak-clipping ac voltage regulator shown in Fig. 8. Two regulators are used, one for each polarity of the input. Internal to the LM117 is a diode from input-to-output that conducts the current around the device when the opposite regulator is active. Since each regulator is operating independently, the positive and negative peaks must be set separately even when you want a symmetrical output waveshape. ■■

Reference

1. *Linear Data Book*, National Semiconductor Corp., Santa Clara, CA, 1976, Sect. 1.

Guildline Introduces the only 14 Million Count DVM on the Market Today



Guildline's radical 7-1/2 digit precision digital voltmeter, Model 9577 features standards laboratory accuracy and stability. The 9577 is equally at home on the work bench or in a system application via programmable BCD or IEEE Standard 488.

FEATURES:

- Capability — DC volts, AC (rms) volts, ohms, and ratio
- 0.0004% DC accuracy • Resolution — $1 \mu\text{v}$ on 10 volt range
- 20ppm per year stability
- Self-Check via front panel or system mode
- 500 readings per second
- $> 1000\text{G}\Omega$ input resistance • Digital Filtering



ELECTRO 77: BOOTH 1531



Guildline Instruments, Inc.

1997 PALMER AVE., LARCHMONT, NEW YORK 10538 (914) 834-8100



S-D's new dual channel $\pm 18\text{v}$ pulse generator

THE LOGICAL CHOICE

Attention all of you working with 2 and 4-phase logic systems, bipolar logic, radar testing and simulation, and with complex waveforms of all types: the new S-D 110D dual-channel pulse generator is for you.

In one compact instrument, Model 110D contains two complete pulse generators with all pulse parameters separately controllable for each channel. You can also *mix* the channels to produce complex waveforms and *delay* one channel from another.

That's why you can produce a true 2-phase system (4-phase with two slaved 110D's) as well as double and triple pulse pairs and controllable pulse trains for data simulation. For

sheer variety of pulses, nothing today touches Model 110D.

Model 110D is the latest member of a growing family of S-D pulse generators whose distinguished ancestors — Data-pulse Models 110B, 110A, and 110—set the industry standards in their time.

Key 110D data:
Amplitude, $\pm 18\text{v}$
into 50 ohms • DC
offset to $\pm 18\text{v}$ • rise/fall
time variable from 5 ns to
500 millisecc • repetition
rate 50 MHz • Price \$2,250
(U.S. only). Get the facts
on the first modern-day

2-channel pulser.

Contact Scientific Devices or Systron-Donner at 10 Systron Drive, Concord, California 94518, Phone (415) 676-5000.

SYSTRON  DONNER

See us at ELECTRO 77 Show Booth 1527-30

CIRCLE NUMBER 50



The Small Computer

Twenty-five years ago a computer as powerful as the new Processor Technology Sol-20 priced out at a cool million.

Now for only \$995 in kit form or \$1495 fully assembled and tested you can have your own small computer with perhaps even more power. It comes in a package about the size of a typewriter. And there's nothing like it on the market today. Not from IBM, Burroughs, DEC, HP or anybody else!

It fills a new role

If you're an engineer, scientist or businessman, the Sol-20 can help you solve many or all of your design problems, help you quantify research, and handle the books too. For not much more than the price of a good calculator, you can have high level computer power.

Use it in the office, lab, plant or home

Sol-20 is a smart terminal for distributed processing. Sol-20 is a stand alone computer for data collection, handling and analysis. Sol-20 is a text editor. In fact, Sol-20 is the key element of a full fledged computer system including hardware, software and peripheral gear. It's a computer system with a keyboard, extra memory, I/O interfaces, factory backup, service notes, users group.

It's a computer you can take home after hours to play or create sophisticated games, do your personal books and taxes, and a whole host of other tasks.

Those of you who are familiar with small computers will recognize what an advance the Sol-20 is.

Sol-20 offers all these features as standard:

8080 microprocessor — 1024 character video display circuitry — control PROM memory — 1024 words of static low-power RAM — 1024 words of preprogrammed PROM — built-in cassette interface capable of controlling two recorders at 1200 bits per second — both parallel and serial standardized interface connectors — a complete power supply including ultra quiet fan — a beautiful case with solid walnut sides — software which includes a preprogrammed PROM personality module and a data cassette with BASIC-5 language plus two sophisticated computer video games — the ability to work with all S-100 bus products.

Full expansion capability

Tailor the Sol-20 system to your applications with our complete line of peripheral products. These include the video monitor, audio cassette and digital tape systems, dual floppy disc system, expansion memories, and interfaces.

Write for our new 22 page catalog.

Get all the details.

Processor Technology, Box S, 6200 Hollis St., Emeryville, CA 94608. (415) 652-8080.



Verify transistor ratings the right way and avoid erroneous results or even damage. A clamped switching circuit gives safe, accurate results.

Verifying a transistor's voltage rating by operating the transistor in breakdown is wrong. Such a test subjects the transistor to stresses not implied by the rating. To verify any of the blocking voltage ratings—such as V_{CBO} or V_{CEX} —without the "sus" subscript, apply the specified voltage and measure the resultant current. If the current is less than the specified value, the transistor meets its rating.

To verify a voltage rating satisfactorily at the high currents used in the sustaining tests (sus subscript), use a clamped switching circuit. That way only transistors below the rating actually draw the test current while in breakdown.

Actually, unless the specification indicates otherwise, a clamp is recommended for all rating verifications. In the following circuits, a clamp circuit is shown where applicable.

To actually measure breakdown voltages, the transistor must handle the specified test current while in breakdown. To measure the blocking voltages, drive the collector from a current source. Sometimes you must use a pulse technique to keep junction heating low (which minimizes reading errors and the possibility of transistor damage). Sustaining voltages are measured in a switching circuit, without using a clamp diode.

Two basic techniques are available

The myriad test circuits in use can be classified in two broad categories: collector-drive and base-drive. In the collector-drive circuit (curve tracers are a common example), the base-emitter circuit is determined by the specification, and the applied voltage source is connected to the collector. Collector-drive circuits must apply sufficient voltage to cause breakdown and achieve the test current specified.

Note that before they can reach the sustaining region and the test condition, these circuits not only must switch from the high-voltage area but also pass through the negative-resistance region.

Bill Roehr, Applications Engineer, Motorola Semiconductor Products, 5005 E. McDowell Rd., Phoenix, AZ 85008.

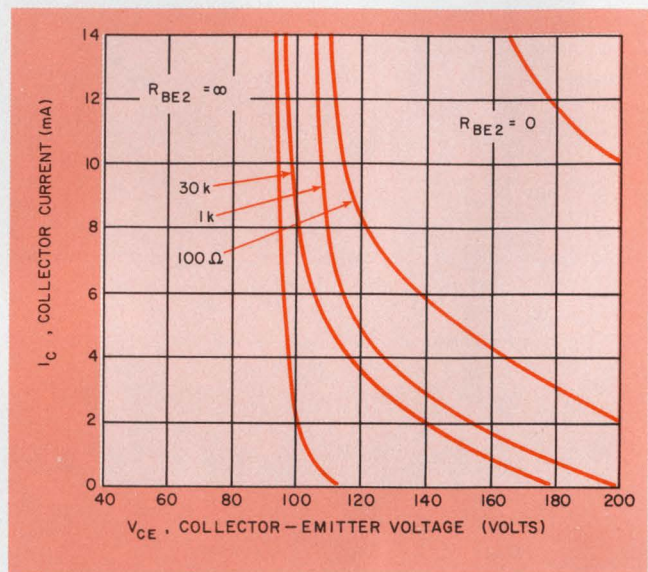

1. Typical transistor-breakdown characteristics show dependence on current and base-emitter resistance.

For this reason, a clamp diode is useless, and the collector-drive circuit is unsuitable for rating verification.

What's more, switching through the negative-resistance region often generates spurious oscillations prior to readout, which often cause erroneous readings and damage transistors. Use of ferrite beads on the collector lead and a small ($0.01 \mu\text{F}$) bypass capacitor at the socket often cures the problem. However, there's a risk of some measurement inaccuracy traceable to capacitor current. But these problems are alleviated by using base-drive circuits instead.

Base-drive circuits apply a signal to the base which alternately turns the device on and off. The base circuit for the on state places the operating point in the saturation region at the collector-current level specified for the voltage rating test. The base circuit for the off state is as specified for the voltage rating test. Because the collector is connected to a current source or an inductor, the operating point moves nearly horizontally from the saturation region to the breakdown region.

In this manner, the negative resistance region

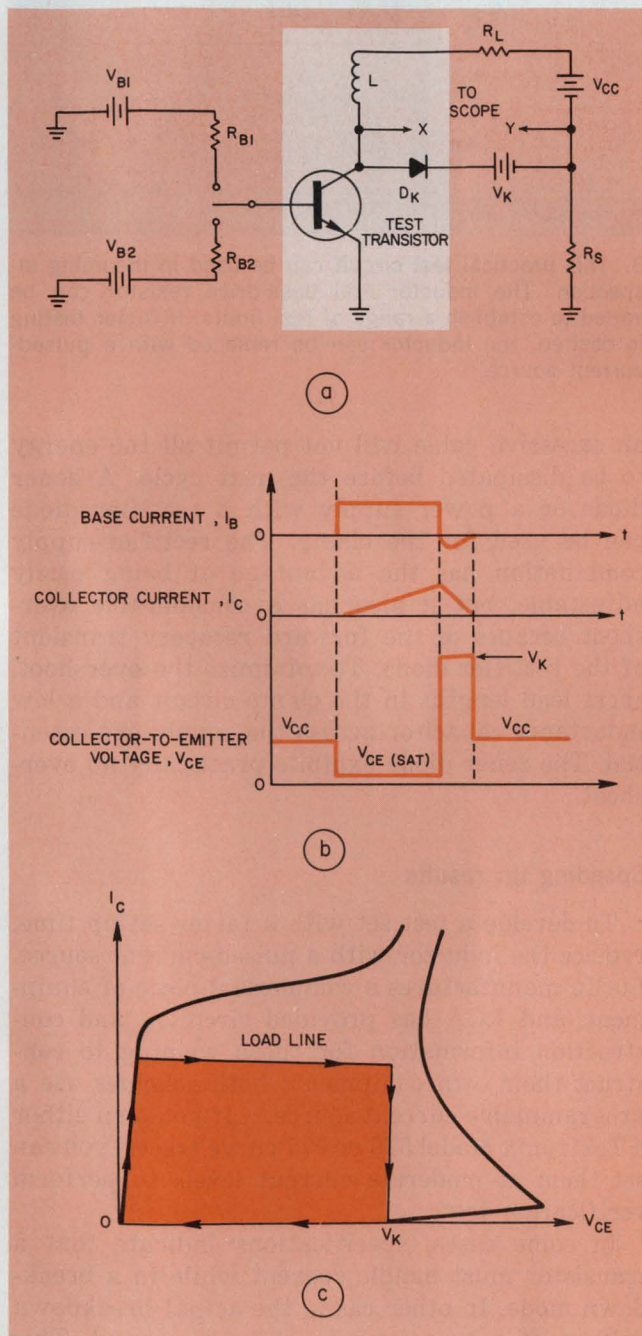

2. Basic inductive sweep, base-drive circuit (a) recommended for verifying transistor ratings and circuit waveforms (b). In the load-line curve appropriate for a BV_{CEX} test, when V_K exceeds BV_{CEX} , the load line intersects and follows the transistor-breakdown curve (c).

Definitions of transistor breakdown

Test	Base circuit values	
	R_{B2}	V_{B2}
BV_{CBO}^*	0	0
BV_{CEO}	∞	0
BV_{CER}	R_{B2}	0
BV_{CES}	0	0
BV_{CEX}	R_{B2}	V_{B2}

R_{B2} and V_{B2} , when used, are set to specified values.
*Open emitter

is avoided until after readout, and more reproducible and accurate readings result. When rating verification is the test objective, not voltage measurement, use a clamp diode to avoid overstressing the transistor.

Two breakdown voltages are fundamental: the collector-base diode breakdown (BV_{CBO}) and the infinite-gain locus, which is the boundary between the normal active operating region and the avalanche region, and is measured by a $V_{CEO(sus)}$ test. But there are also special definitions of breakdown voltage, each having some form of circuit between base and emitter (see table).

Avoiding an avalanche

Fig. 1 shows typical breakdown characteristics for a representative low-voltage, low-frequency, npn power transistor with various values of resistance between base and emitter. Note that the breakdown voltage for any base-emitter termination is a function of current. To avoid operating in the avalanche-breakdown region, most transistor specifications include a $V_{CEO(sus)}$ test at a current that produces the lowest voltage reading in the sustaining region. Every other base-circuit termination causes a reverse base current to flow, so the measured voltage is higher than $V_{CEO(sus)}$.

The significance of these tests is often not appreciated. For example, a transistor with a $V_{CEO(sus)}$ specification of 30 V and a BV_{CER} specification of 40 V (where R is 100 Ω) is often misinterpreted to mean that when the base driving-source impedance is 100 Ω or less, the tran-

sistor can handle voltage excursions of 40 V in an amplifier application.

All transistors are bounded by voltage-current characteristics similar to that of Fig. 1. Nothing can change the boundary of avalanche region $V_{CEO(SUS)}$, which is 30 V in this example and is the upper voltage limit for linear operation. The BV_{CEER} specification means that the transistor can block 40 V if the resistance between base and emitter is 100 Ω or less (and the temperature is equal to or less than the specified value).

The transistor may also be able to switch from an on state to an off state of 40 V, but generally the collector load line will have to be controlled to avoid the operating point's ending, or "latching," at a stable condition on one of the avalanche breakdown curves. A switching test on the transistor specification is required to guarantee switching to voltages above $V_{CEO(SUS)}$ —the test is generally a high-current $V_{CEX(SUS)}$ test.

Theoretical and practical circuits

A popular and recommended test circuit of the base-drive type is shown in simplified form in Fig. 2. An inductor generates a high-voltage pulse. Resistor R_s is a small value used for viewing the current, and R_L is a small resistor representing the coil resistance. Supply V_{CC} provides the collector current, and V_K and the diode D_K act as a clamp. Both V_{B1} and R_{B1} are chosen to place the transistor in saturation; V_{B2} and R_{B2} are chosen in accordance with the required breakdown-voltage test conditions.

When the switch is connected to R_{B1} , base current is applied to drive the transistor into saturation and cause a collector current, I_C , to build up at a rate determined by the inductor. The peak value of I_C is determined by the pulse width of the base current and the collector-supply voltage.

During the turn-off phase, as collector current starts to fall, the resulting di/dt in the inductor generates a high-voltage pulse that is clamped by the network designed for that purpose (or the transistor, if its breakdown voltage is below the clamp level). When the inductive energy is dissipated, the collector voltage falls to the supply level.

A practical implementation of the basic circuit is shown in Figure 3. (This circuit is used by Motorola Quality Assurance for lot sampling.) The mercury relay in the base circuit not only permits fast switching, but also provides low impedance levels. What's more, a provision to switch-in different values of the inductor and base-drive resistor, R_{B1} , permits you to test transistors over a wide range of currents.

The inductor must be large enough to generate enough voltage to reach the clamp level, although

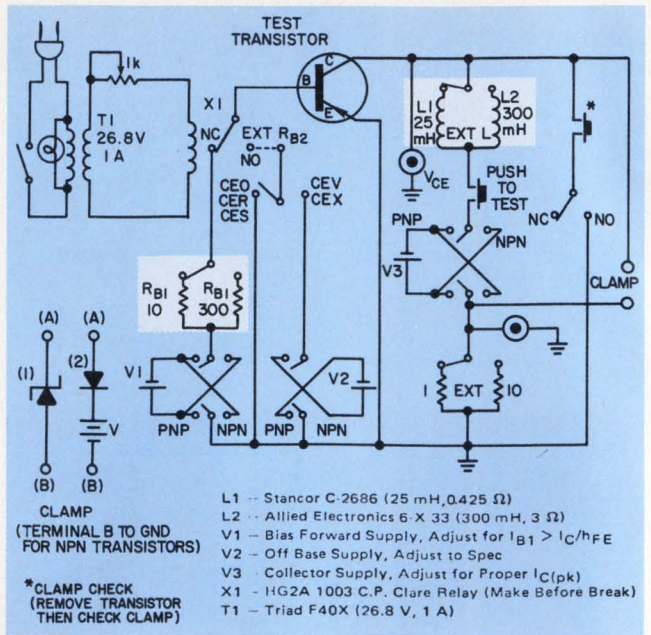

3. This practical test circuit can be used in incoming inspection. The inductor and base-drive resistor can be varied to establish a range of test limits. If faster testing is desired, the inductor can be replaced with a pulsed-current source.

an excessive value will not permit all the energy to be dissipated before the next cycle. A zener diode or a power supply with a rectifier diode can be used for the clamp. The rectifier-supply combination has the advantage of being easily adjustable, but it also has a considerable overshoot because of the forward recovery transient of the rectifier diode. To minimize the overshoot, short lead lengths in the clamp circuit and a low inductance capacitor across the supply are essential. The zener diode exhibits practically no overshoot.

Speeding up results

To develop a test set with a faster set-up time, replace the inductor with a pulsed-current source. Lorlin manufactures a commercial piece of equipment, and RCA has provided circuitry and construction information for those wishing to construct their own equipment; both schemes use a programmable current source.^{1,2} If you own either a Tektronix Model 576 or 577 curve tracer, you can set them at moderate current levels to perform verification tests.

In some cases, specifications indicate that a transistor must handle current while in a breakdown mode. In other cases, the actual breakdown voltage of a transistor must be measured. This test is more properly thought of as an energy (often called $E_{S/N}$) test.

The correct circuit for achieving accurate voltage measurements uses a pulsed current source

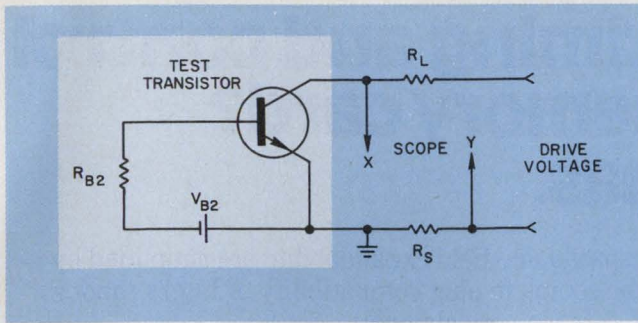

4. **Conventional curve tracers**, like the basic collector-drive circuit shown here, can be used to determine the breakdown level. The circuit isn't recommended, however, for general testing.

for the collector load. The inductive sweep circuit can also be used, with the clamp removed; however, the coil must be chosen carefully. Its value must be large enough (depending on transistor-switching speed) to achieve the breakdown voltage, yet if the coil is too large the transistor may damage itself by absorbing the inductive stored energy. With some transistors, the range of acceptable inductance values is unrealistically low.

When the clamp circuit isn't used, the Tektronix 576 and 577—set up for the pulse technique—can also make measurements. Although not recommended, a conventional curve-tracer set-up is sometimes used to measure breakdown voltages; it is basically a collector-drive circuit, as shown in Figure 4. By choosing the base-circuit components properly, as indicated in the table, you can set up conditions to test for any breakdown specification.

Scope displays transistor curve

Resistor R_L should be fairly large to approximate a current source. To display the transistor characteristic, connect an X-Y scope to the points indicated. The drive voltage is derived from the ac line through a half-wave or full-wave rectifier circuit; however, this voltage is suitable only when the power dissipation resulting from the test is a small fraction of the transistor rating. Transistor heating or damage (due to excessive energy) will produce inaccurate readings.

Instead of a rectified sine wave, use a pulse to alleviate such thermal and energy problems. The X-Y scope is not particularly useful here and can be replaced with either an ordinary scope or a sample-and-hold metering system. ■■

References

1. Falk, A. L., "Accurate Measurement of Sustaining Voltage of Power Transistors—A Pulse Breakdown Test Set," Application Note AN-6281, RCA, Solid-State Div., Somerville, NJ 08876.
2. "Impact 100 Discrete Component Test System," Lorin Industries, Inc., Danbury, CT.

STAMP OUT "almost right" Trimmer Capacitors

—specify all-sapphire
units that never vary!

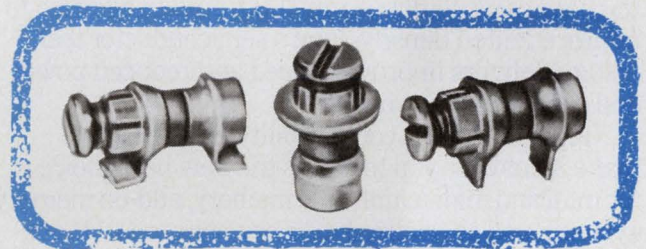

When you need superior performance at microwave frequencies, Voltronics' new precision sapphire dielectric trimmer capacitor is the only answer. You can't settle for a unit that's "almost right" or even "almost" all sapphire.

Only the Voltronics unit achieves the *entire* capacitance with a sapphire dielectric—the best dielectric material known! (Other, so-called sapphire units achieve almost one-fourth of the capacitance with mica—producing a non-linear curve.)

What's more, you can count on this new unit to give unvarying, reliable long life. The dielectric constant of the Voltronics sapphire does not vary with frequency, and its loss tangent is constant and below 0.0003, out to 10 GHz. It's chemically inert, totally moisture resistant, and one of the strongest materials known!

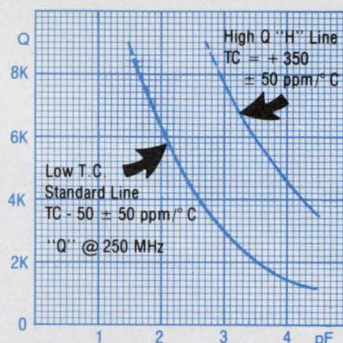

Other Voltronics advantages include metalized electrode bands fired into the sapphire, for lowest loss and no chance of slippage; and positive stops at each end to prevent disassembly or breakage.

Two types are available—a high-Q and a standard line (see curves at left).

Cost? \$5 to \$3 in quantities of 50 to 1,000. Designer kits are available at reduced prices. For complete information, use the Reader Service Card, or write to us at Dept. ED-3.



Voltronics

West Street, East Hanover, N.J. 07936
telephone: 201-887-1517 twx: 710-986-8253

Could you simplify system design with 128K bytes, ECC, timing and control all on a single memory card? Intel has.

Introducing Intel's versatile new MOS-RAM memory card, mu-3000. It gives you your choice of 16K, 32K or 64K by 16 to 22 bits. That's up to 128K bytes on a single card. Plus the added advantages of on-board error correction coding, system interfaces, timing and control.

Imagine the design economies and efficiencies that makes possible. You can replace up to four conventional single board semiconductor and core memory cards with one mu-3000. And in addition to unprecedented density, Intel's semiconductor technology delivers improved speed and reduced power and cooling requirements.

The mu-3000 is compatibility-engineered to make it easy for you to use as the new best choice for mini and midi mainframe memory, add-on memory systems and specialized memory packages. Or use to upgrade existing single board semiconductor and core memory systems.

When you design with mu-3000, memory capacity starts where competing memory cards leave off. Go from 16,384 words up to 65,536 words. Variable

capacity and field expandability are simplified by the complete plug compatibility of Intel's random access memory elements.

ECC provides 10 to 25 times higher data reliability than typical memory systems. Six check bits are added to each word during write operations. Then, during read-out, single bit errors are detected and automatically corrected. And the host processor is notified of any multi-bit errors.

To accomplish longer word lengths and larger system capacity, up to four mu-3000 cards can be combined in a single 5¼" high system chassis. The chassis provides room for Intel's microprogrammable self test card and a custom interface card, too.

Clip the coupon to get detailed data on the mu-3000. Or, if you would like an Intel system specialist to show you how mu-3000 can improve your package, give us a call.

Intel Memory Systems, 1302 N. Mathilda Avenue, Sunnyvale, California 94086. Phone (408) 734-8102.

In Europe call Intel International in Brussels (02) 6603010.

intel® delivers.

CIRCLE NUMBER 43

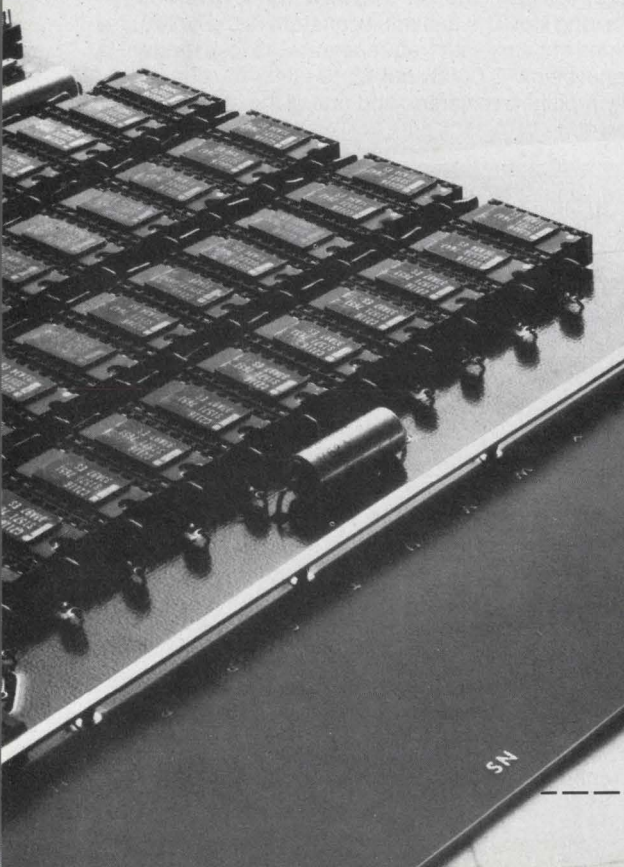

Intel Memory Systems
1302 N. Mathilda Avenue
Sunnyvale, California 94086

Please send me more information on the mu-3000 memory system.

Please have an Intel system specialist call me.

Name/Title _____

Company _____ Mail Station _____

Address _____ Phone _____

City/State/Zip _____

POWER MINI'S FOR LOGIC OR OP AMPS



Terminal strip input/output connections on these miniature power modules eliminate the need for sockets or soldering. They mount in an area only 3.5" x 2.5". Ratings: 5 volt models to 2.5 amps, 15 volts to 5 amps. Other models from 1 to 75 volts, all with 3-day shipment guaranteed.

NEED A POWER SYSTEM?



Order multiple output power systems without searching through a catalog, preparing mechanical layouts, item-by-item pricing and detailed purchase requisitions. Instead, call Acopian. We'll listen to your needs, quote a firm price, and then ship your built-to-order system, fully wired and tested, in just 9 days.

POWER FOR YOUR μ PROCESSOR



Single, dual, and triple output power supplies in a broad selection of output voltage combinations. Output current ratings from 30 ma to 60 amps. Various package styles suitable for virtually every application. Any module you select will be shipped within 3 days; rack mounting models, within 9 days.

MATCHED OR DISSIMILAR DUAL OUTPUT



Select the combination of matched or dissimilar outputs that you require. Hundreds of ratings available, from 1.5 to 150 volts. Outputs are isolated, and may be used in the same or opposite polarities. Acopian's 3-day shipment promise applies for any combination.

HIGHLY ISOLATED POWER

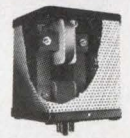

For applications requiring a power supply with unusually high isolation, such as for powering strain gage or other transducer circuits, Acopian offers models with ratings from 5 to 36 volts. Input-output isolation: 10,000 megohms minimum, 1 pF maximum. Guaranteed 3-day shipment.

POWER FOR RELAYS AND DISPLAYS



Drive relays, lamps, small motors and similar loads with low-cost Acopian unregulated power modules. Built-in fusing protects against overloads or shorts. Series U models use terminal strip connections. Plug-in modules mount in standard octal sockets; many have adjustable outputs. Guaranteed 3-day shipment.

RACK MOUNT POWER ...TO 60 AMPS

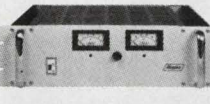

Designed for mounting in standard 19" RETMA cabinet racks, these power supplies are available in 76 different output ratings from 1 to 50 volts, and from 5 to 60 amps. Regulation: $\pm 0.05\%$ or better; ripple: 1 mV rms or better. Options include metering and overvoltage protection. Shipment, 9 days after receipt of your order.

REDUNDANT POWER SYSTEMS

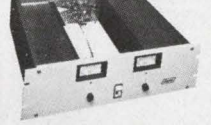

Output reliability is maximized by including two power modules for each voltage. If either fails, the other will continue to provide an uninterrupted output. Ratings from 3.6 to 28 volts, to 32 amps. Shipment, 9 days after receipt of your order.

5V OR $\pm 15V$ POWER FOR PCB'S



Mount these mini power modules, as small as 2.3" x 1.8" x 1.0", directly on printed circuit boards to save space and simplify wiring. Ratings at 5 volts from 250 to 2.5 amps; at ± 15 volts from 0.25 to 5 amps. Short circuit protected. Prices start at \$24. Guaranteed 3-day shipment.

GENERAL PURPOSE POWER

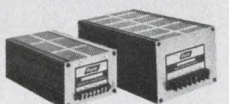

Series A offers premium performance, with regulation to $\pm 0.005\%$ ripple of 0.25 mV maximum and electronic current limiting. Series B supplies provide a lower-cost approach, with regulation typically $\pm 0.1\%$. Ratings to 200 volts, to 32 amps. Guaranteed 3-day shipment.

SINGLE, DUAL PLUG-IN POWER

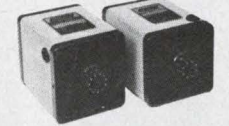

A plug-in power module can be installed in seconds. Simply plug it into a standard octal-type socket. Single output models from 1 to 200 volts. Duals combining two matched or dissimilar outputs in one case available in over 10,000 combinations. Warranty: 5 years. Shipment: 3 days.

ACOPIAN

POWER SUPPLY CATALOG



SOLDER TERMINAL MODULES

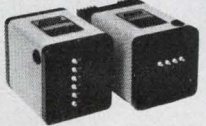

For applications where hard wiring is desired, Acopian offers modules with solder terminals. Included are single output models (regulated and unregulated) duals with two like or dissimilar voltages and high isolation supplies. Guaranteed 3-day shipment.

MULTIPLE VOLTAGES FOR PCB'S



Simplify pc board layout with multiple output power mini's. Duals supply two isolated like or dissimilar outputs, 1 to 28 volts each. Op amp supplies provide ± 12 or ± 15 volts. Triples have two balanced, tracking outputs, a third for powering other circuits. Guaranteed 3-day shipment.

MIL-TESTED PLUG-IN POWER

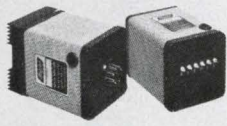

MIL-tested power supplies withstand unusually severe environmental conditions. These extended-temperature plug-in modules exceed MIL specs for humidity, altitude, vibration and shock. Hundreds of single output models, thousands of dual output combinations, all guaranteed for 3-day shipment.

BENCHTOP POWER ...FROM \$99



Reliable yet low-cost power supplies for circuit development and component evaluation. Single, dual and triple output models. Ratings from 0.7 to 0.50 volts. All have adjustable current limiting, coarse and fine voltage adjustments and two meters. They may be stacked to conserve bench space. Regulation: $\pm 0.01\%$ or 2 mV. Ripple: 0.25 mV rms.

SUPPLIES THAT FIT IN THIN SPACES



Measuring only 1.68" high, Acopian narrow-profile power supplies fit where many others cannot. Available in a wide range of ratings from 1 to 150 volts, to 4 amps. Regulation to $\pm 0.005\%$. Tracking dual output models for op amps also available. Guaranteed 3-day shipment.

Write for your copy of the Acopian 48-page catalog



Corp., Easton, Pennsylvania 18042 • Telephone (215) 258-5441

CIRCLE NUMBER 241

Allen-Bradley Trimmers:

**We have what
you need.**

**Our distributors have
them when your
need is now.**



CERMET TRIMMERS



Type A: 1/4" diameter, single turn, 10 ohms to 2 megs $\pm 10\%$, 0.5W at 85°C, immersion sealed, 3 terminal options, Publication 5238. **1000 piece price \$1.12 to 1.68.**



Type S: 3/8" dia., single turn, 50 ohms to 1 meg $\pm 10\%$, 0.5W at 85°C, immersion sealed, top or side adjust, Publication 5208. **1000 piece price \$1.15 or 1.40.**



Type E: 3/8" square, single turn, 10 ohms to 2 megs $\pm 10\%$, 0.5W at 70°C, immersion sealed, 13 terminal options, Publication 5219. **1000 piece price \$0.49.**



Type D: 3/8" diameter, single turn, 10 ohms to 2 megs $\pm 20\%$, 0.5W at 70°C, dust cover, 6 terminal options, Publication 5240. **1000 piece price \$0.42.**



Type 90: Approx. 7/16" square, single turn, 100 ohms to 2 megs $\pm 20\%$, 0.5W at 70°C, open frame, 2 terminal options, Publication 5242. **1000 piece price \$0.55.**



Type MT: 3/8" square, 20 turn, 10 ohms to 2 megs $\pm 10\%$, 0.5W at 70°C, immersion sealed, 3 terminal options, Publication 5241. **1000 piece price \$1.18.**



Type RT: 3/4" long, 20 turn, 10 ohms to 2 megs $\pm 10\%$, 0.75W at 70°C, immersion sealed, 3 terminal options, Publication 5237. **1000 piece price \$0.65 or 0.93.**

CARBON COMPOSITION TRIMMERS



Type Y: 1/2" dia., single turn, 100 ohms to 5 megs $\pm 10\%$ or 20%, 0.25W at 50°C, dust/splash resistant, 5 styles, non-linear tapers, Pub. 5209. **1000 piece price \$0.90 to 1.59.**



Type F: 1/2" dia., single turn, 100 ohms to 5 megs $\pm 10\%$ or 20%, 0.25W at 70°C, immersion sealed, 6 styles, non-linear tapers, Pub. 5234. **1000 piece price \$1.00 to 1.62.**



Type O: 1/2" dia., single turn, 100 ohms to 5 megs $\pm 10\%$ or 20%, 0.40W at 70°C, immersion sealed, 4 styles, non-linear tapers, Pub. 5235. **1000 piece price \$1.20 to 1.58.**



Type FD: 1/2" dia., 2 sec., 1 turn, 100 ohms to 5 megs $\pm 10\%$ or 20%, 0.25W at 70°C, immersion sealed, 4 styles, 5 tapers, 2 atten. Pub. 5231. **1000 piece price \$2.65 to 4.10.**



Type BT: 1/2" dia., 2 section, 1 turn, for 75 ohm Bridged-T pad applications, dust/splash resistant, side and top adjust versions. Pub. 5236. **1000 piece price \$2.49.**



Type N: 1 1/4" long, 25 turn, 100 ohms to 2.5 megs $\pm 10\%$ or 20%, 0.33W at 50°C, immersion sealed, Publication 5206. **1000 piece price \$2.50 or 2.65.**



Type R: 1 1/4" long, 25 turn, 100 ohms to 2.5 megs $\pm 10\%$ or 20%, 0.25W at 70°C, immersion sealed, bushing mount option, Pub. 5205. **1000 piece price \$2.87 to 3.73.**

Quality in the best tradition.



ALLEN-BRADLEY

Milwaukee, Wisconsin 53204

CIRCLE NUMBER 242

EC120

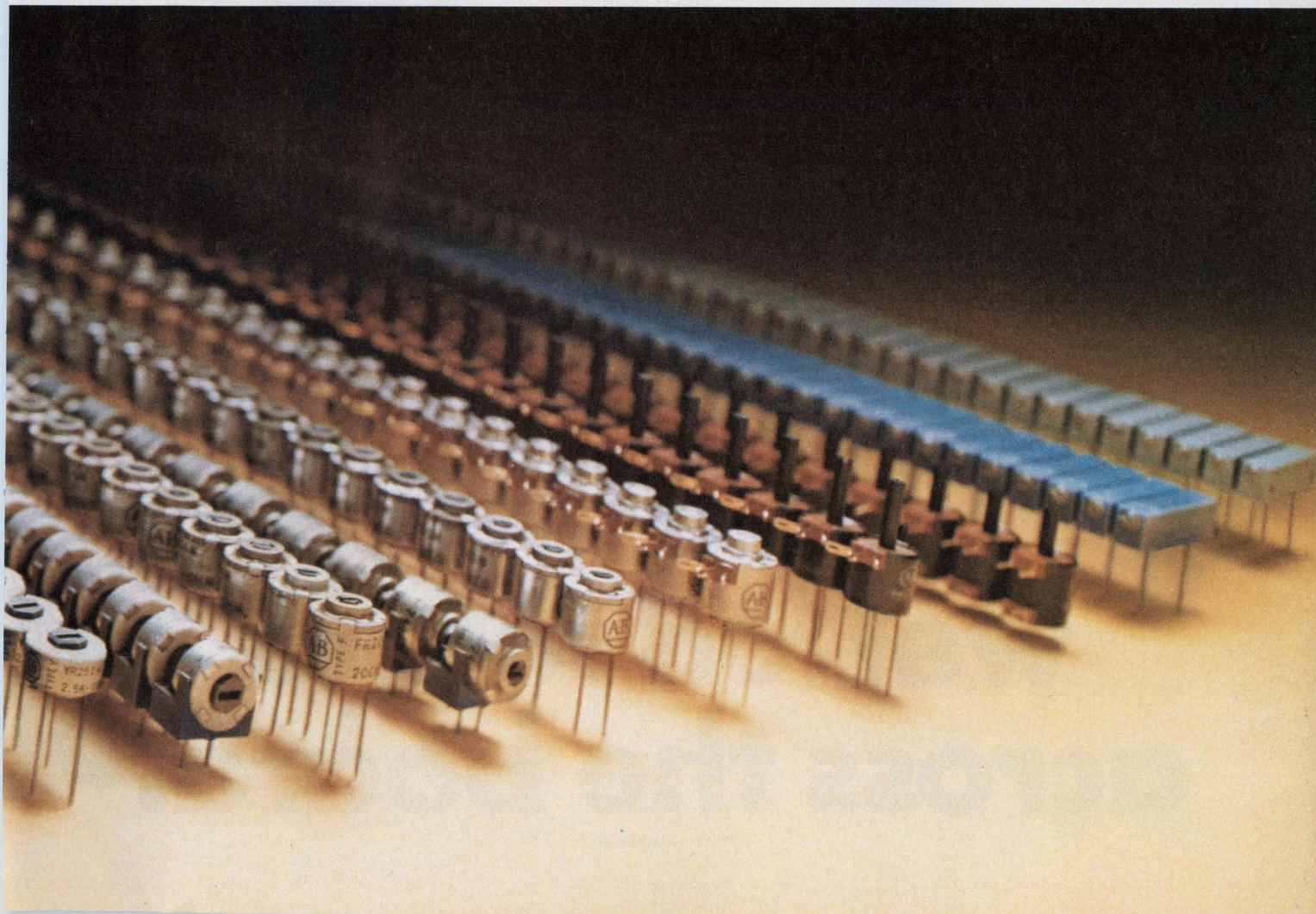

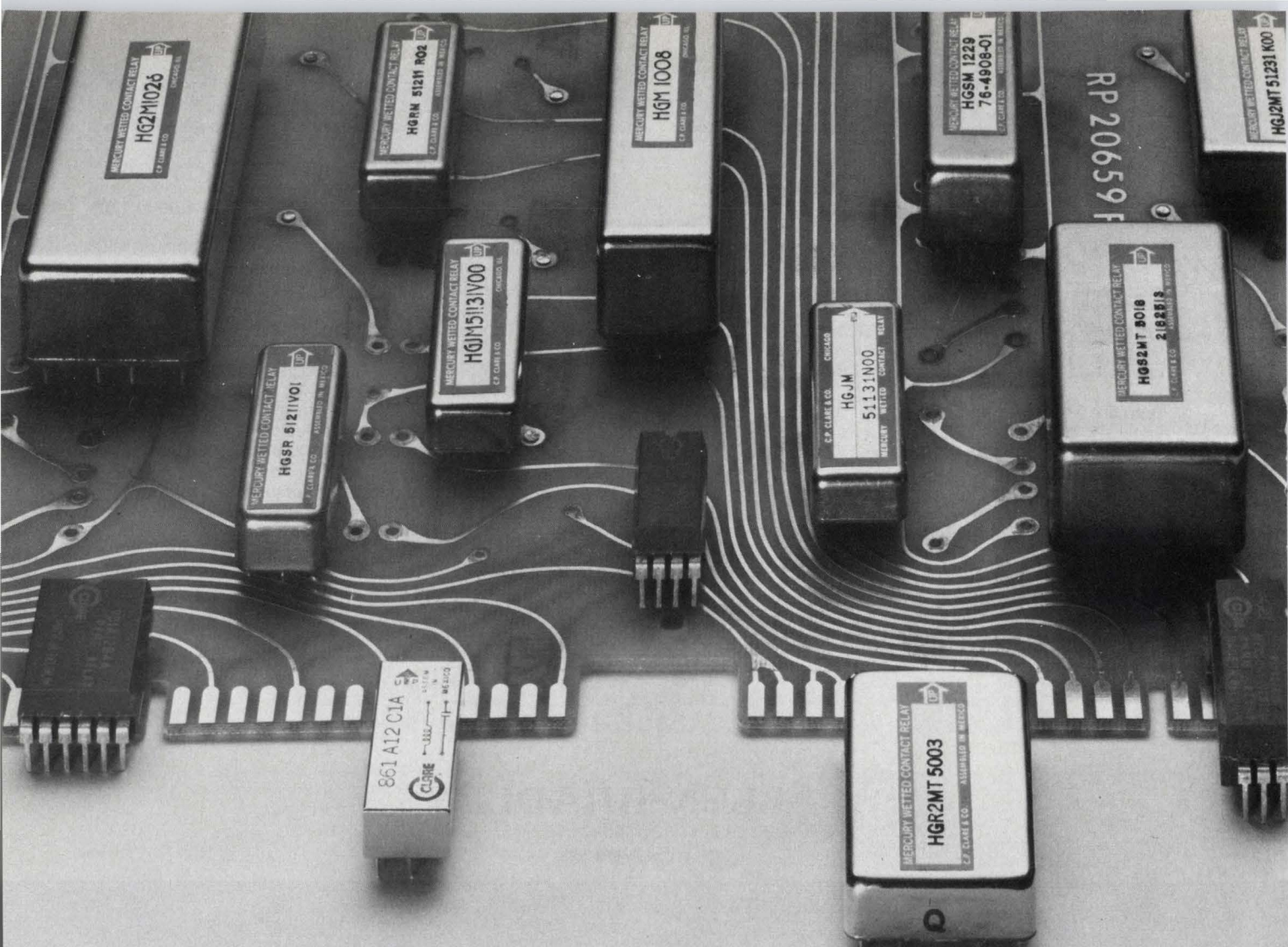

There's a CLARE MERCURY-WETTED RELAY for every PCB application.

From microvolt to 500 volt levels. Nanoamperes to 2 amps. DC to megahertz frequencies. Clare can supply a reliable mercury-wetted relay to enhance operations for process control, data logging/acquisition, automatic component/system testing, telecommunications, whatever.

Every Clare mercury-wetted relay is designed to lead a long and productive life. Billions of operations. Constant ON, OFF impedances—every operation. No contact wear, no contact bounce.

Just call your Clare Representative, or contact C. P. Clare & Company, 3101 W. Pratt Avenue, Chicago, Illinois 60645. Phone (312) 262-7700.

QUALITY, SERVICE, RELIABILITY

**C. P. CLARE & COMPANY
GENERAL INSTRUMENT CORPORATION**



Use CLARE mercury wetted relays across the board.

CIRCLE NUMBER 243

You Don't Have To Beg, Borrow Or Buy...

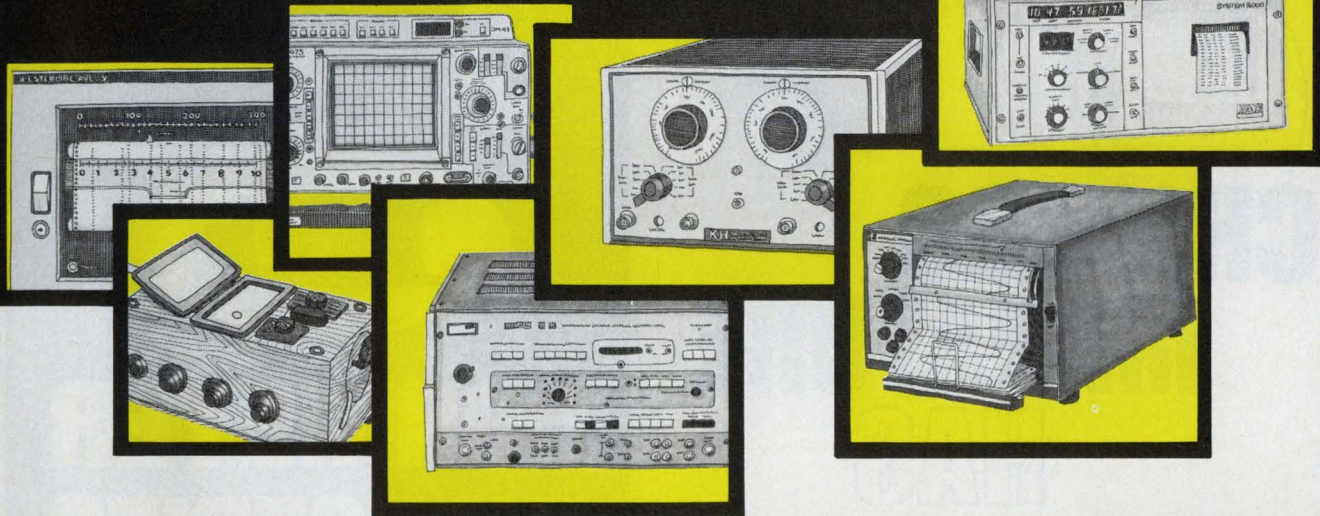
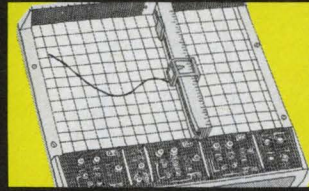

Rent'em From GE

Short or long-term instrument rentals give you flexibility and economy.

GE has over 9,000 instruments available for immediate shipment: □ Tek Scopes □ Biddle Megger Insulation Testers □ H-P Signal Generators □ Honeywell Oscillographs □ Complete Data Systems □ Esterline Angus Recorders □ GE Chart Recorders □ Modems □ Communication Terminals . . . all calibrated to the manufacturer's specs.

We have over 100 Sales/Service Centers,

and one of them is near you. In addition to maintaining our Rental Inventory, they can also repair and calibrate your own equipment.

Don't borrow someone else's GE Rental Catalog. **Call collect (518) 372-9900** or your nearest Sales/Service Center.

**Quick-rental[®]
instruments**

ALA. BIRMINGHAM (205) 925-3101 • ARIZ. PHOENIX (602) 278-8515 or 8516, TUCSON (602) 294-3139 • CAL. LOS ANGELES (213) 642-5350, SAN FRANCISCO (415) 436-9260 • COL. DENVER (303) 371-1260 • CONN. SOUTHINGTON (203) 621-4059 • FLA. JACKSONVILLE (904) 751-0610 • GA. ATLANTA (404) 457-5563 • ILL. CHICAGO (219) 933-4500 • IND. INDIANAPOLIS (317) 639-1565 • KY. LOUISVILLE (502) 452-3311 • LA. NEW ORLEANS (504) 367-6528 • MD. BALTIMORE (301) 332-4700 • MASS. BOSTON (617) 396-9600 Ext. 160, SPRINGFIELD (413) 781-1111 • MICH. DETROIT (313) 285-6700 Ext. 208 • MINN. MINNEAPOLIS (612) 522-4396 • MO. KANSAS CITY (816) 231-4377, ST. LOUIS (314) 965-7115 • N.J. CLIFTON (201) 471-6556 • N.Y. BUFFALO (716) 876-1200, SCHENECTADY (518) 385-2195 • N.Y.C. CLIFTON, N.J. (201) 471-6556 • N.C. CHARLOTTE (704) 525-0311 • OH. CINCINNATI (513) 874-8512, CLEVELAND (216) 523-6382, TOLEDO (419) 691-3501 • OR. PORTLAND (503) 221-5101 • PA. PHILADELPHIA (609) 424-4450, PITTSBURGH (412) 462-7400 • TEX. DALLAS (214) 357-7341, HOUSTON (713) 672-3570 • VA. RICHMOND (804) 232-6733 • WASH. SEATTLE (206) 854-0211 • W.V. CHARLESTON (304) 345-0920 • WISC. MILWAUKEE (414) 744-0110 • PUERTO RICO PONCE (809) 843-4225.

GENERAL  ELECTRIC

asking about
SUBMINIATURE LAMPS?

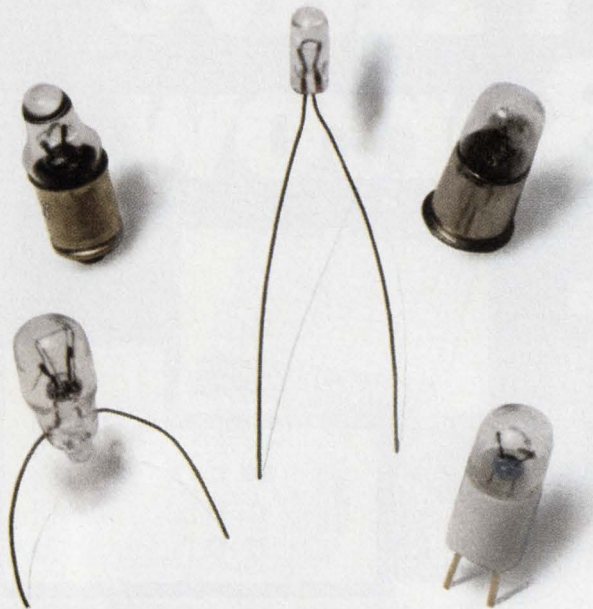

**CHICAGO
MINIATURE
HAS
THE ANSWER!**

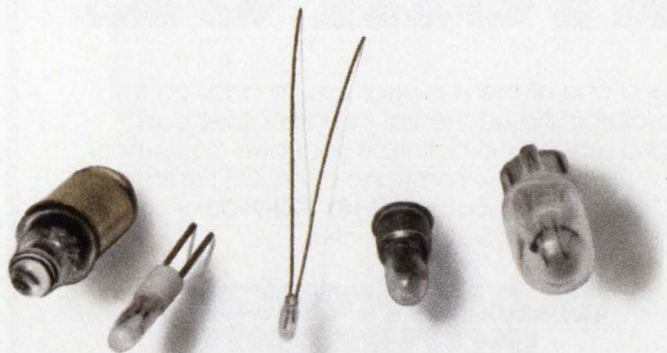

Chicago Miniature has the answer for every subminiature application. All base configurations or wire terminal . . . all colors . . . standard products and specials . . . whatever you need with high quality at competitive prices. There's off-the-shelf delivery on most items from your distributor. For more information, or expert design help, contact Chicago Miniature Lamp Works, 4433 N. Ravenswood Avenue, Chicago, Illinois 60640. Phone (312) 784-1020.

CHICAGO MINIATURE LAMP WORKS

GENERAL INSTRUMENT CORPORATION

SEE US AT ELECTRO '77—BOOTH # 2215-2217

CIRCLE NUMBER 245



130F

CONVERTER CHARGERS

Are big business with us

STANDARDS FROM STOCK
SPECIALS TO ORDER

We have the engineering know how and high production facilities to assure safety and dependability at minimum cost. Our units meet new Underwriters' toy standards.

For dependability, complete follow through and satisfaction — call on:

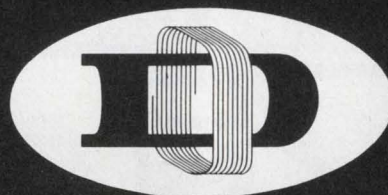

DORMEYER INDUSTRIES

A Division Of A. F. Dormeyer Mfg. Co., Inc.

3414 N. Milwaukee Ave., Chicago, Ill. 60641

Telephone: 312/283-4000

TWX: 910/221-3831

Other Factories in Kentland and Rockville, Ind.



*Request Bulletin No. CC-74A for
general information*



**SOLENOIDS
TRANSFORMERS
CONVERTER/CHARGERS
COILS**

AMERICAN MADE
ELECTROMECHANICAL PRODUCTS SINCE 1946

CIRCLE NUMBER 246

CIRCLE NUMBER 247 ►



Before you buy indicator lights, check these facts:

- LITTELITES** include Cartridge Lamps and Lampholders, Subminiature and Miniature Lampholders, and Snap-Mount Plastic Lites. We offer a wider selection among these four product groups than any other single manufacturer.
- LITTELITES** are made with all new tools and molds. This plus total in-house production capabilities make Littelites the finest quality lights on the market today.
- LITTELITES** are all U.L. Recognized or Listed and Certified by C.S.A.
- LITTELITES** Snap-Mount Plastic Lites feature unique flex arms to ensure positive retention and protection against shock and vibration. Absolutely no additional mounting hardware required.
- LITTELITES** are available off-the-shelf from a nationwide network of Littelites distributors. For large volume requirements, you can depend on a fast turn-around on orders.
- Our **LITTELITES** team of R & D and sales engineers is ready to assist you at any time with standard or special applications.

Then check the source... Littelfuse

Send for your Littelites Product Guide today!

LITTELFUSE

Subsidiary of Tracor

800 E. Northwest Highway • (312) 824-1188 • Des Plaines, Illinois 60016

*iii*impressive figures:

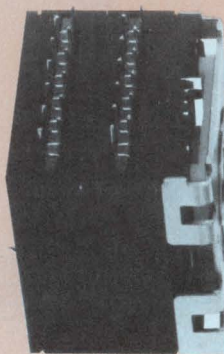

**Noble
Potentiometers**



If you think there's little difference between one pot and the next, *iii* has some numbers to impress you.

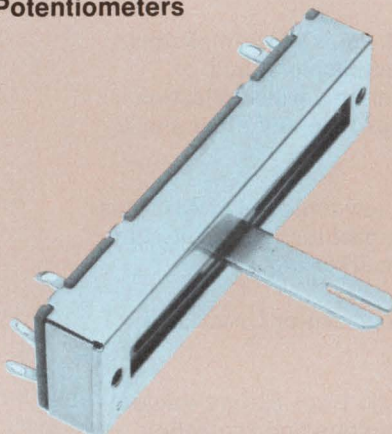

Like the vital statistics on our Noble potentiometers. They're so well built, of such high-quality material, that they offer longer life and greater safety in virtually any application.

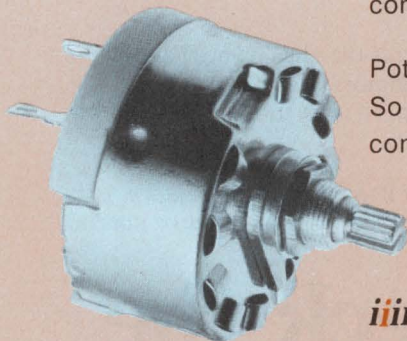

We're telling you about our Noble potentiometer line because, in our opinion, they're the best you can buy. The same is true of *iii* resistors, capacitors, mikes, speakers, switches, connectors and every other component we offer.

Pots are important, but just a start. So when can we start filling your component needs?

*iii*inquiries *iii*nvited



2244 South Western, Chicago 60608 (312) 847-6363

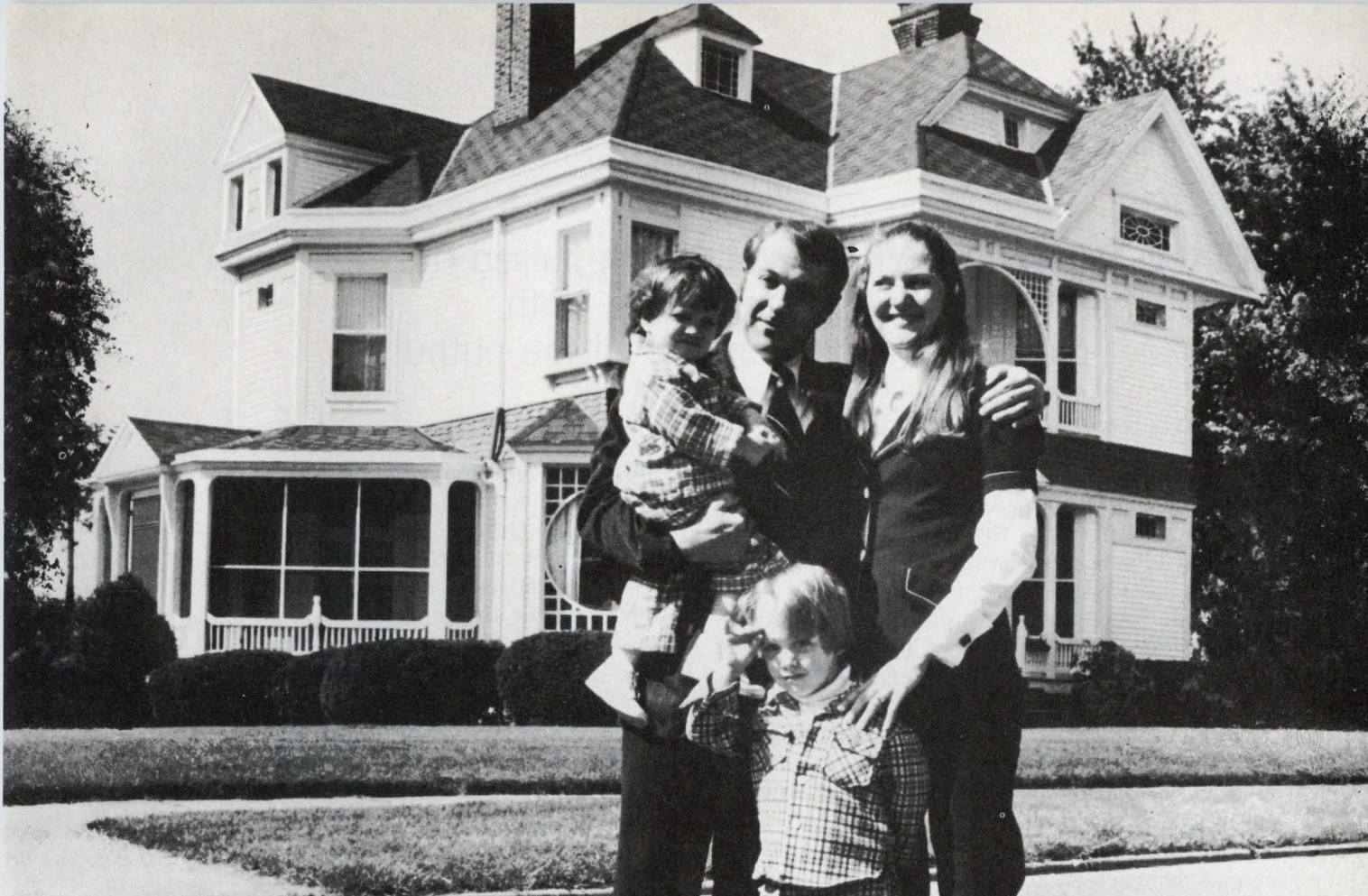

Tom and Barbara Herrold just bought their spacious Wabash, Indiana home for \$31,500.

What do you think relays are going for around here?

ten rooms, 8 fireplaces, 6 porches, 11 foot ceilings, oak paneling, choice neighborhood, mint condition—all for \$31,500. That's Wabash value. And that's why our relays are in such demand. They are made right here—switches and all—to rigid specifications in a hospital-clean environment where heat, humidity and dust are controlled so quality can be assured. Just to be certain, 3 billion test cycles are run every day.

When you purchase Wabash relays you get the kind of quality the Herrold's got in their home. And at a price that gets you the kind of value the Herrold's got. We've got over 6,000 variations of dry reed relays for sale. Contact us. When you see the asking price, you will know you found a new home for your relay requirements.



The Econo-Miser. The most automatically manufactured dry reed relay available. 1 and 2 pole standard types. Less than one dollar in quantity.

Coils, Relays & Transformers

wabash

of
Wabash, Indiana

and Huntington, Indiana; Farmington, Missouri;
Tipton, Iowa and South Boston, Virginia

For information and quotes write or call:
Wabash, Inc., Dept. RA-6, 810 N. Cass St., Wabash, Ind. 46992 Tel: 219/563-2191 TWX 810-290-2722

CIRCLE NUMBER 54

Excite your SAW device with pulsed rf to learn the time-domain performance. With the correct pulse width, you can see all the outputs.

Because a surface-acoustic-wave (SAW) device is physically designed in the time domain, an oscilloscope display of the SAW's response to pulsed rf yields the best visual information about performance. If the input pulse is made short enough and has sufficient amplitude, you can observe and measure the ratio of undesired to desired outputs readily. Electromagnetic feedthrough, bulk acoustic waves, crystal-end reflections, and triple-transit echo comprise the more important interference signals.

The physical placement of the interleaved electrodes in a SAW transducer is often varied or weighted to produce a desired amplitude or time-response characteristic. Amplitudes are usually weighted by varying the overlap of the adjacent, opposite-polarity electrodes. Time is weighted by varying the periodic spacing of the electrodes along the transducer.

Since length is proportional to propagation time (the product of time and velocity of the surface wave), the time-domain response to a single pulse is essentially a replica of the geometry of the electrodes. Each pair of opposite-polarity electrodes in the transducer array samples energy after a delay that corresponds to its position and at a strength corresponding to its overlap.

Relating the two domains

A Fourier transform relates the time-domain operation of a surface-wave device to the frequency domain. For example, a transducer with a constant aperture (identical overlap of all electrodes) and periodic time weighting (all electrodes equally spaced with centers one-half wavelength apart) will have a constant amplitude response in the time domain extending for a duration, T , which is equivalent to the length of the transducer. That is, the time-domain response to a single-pulse input will be a rectangular pulse of width T .

In the frequency domain, the response is a

$\sin x/x$ amplitude variation, with a 4-dB-down bandwidth equal to $1/T$. The frequency responses of input (injection) and output (detection) transducers in a SAW are multiplied (that is, their decibel responses are added) to produce the device's over-all response. So if both transducers are identical, the $1/T$ bandwidth would be measured at $4 \text{ dB} + 4 \text{ dB} = 8 \text{ dB}$.

Fig. 1 is a scope display of the output of a surface-wave device, in which desirable as well as undesirable signals can be identified. The scope trace is generated with the test setup shown in Fig. 2. Here the pulse generator gates a pulse of continuous-wave rf into the SAW device under test.

The repetition rate of the pulse generator is set low enough so the interval between pulses is much longer than the device's time delay. Thus, any reflected signals, as well as the initially transmitted signals, can be displayed. Since the electromagnetic feedthrough signal is much faster than the others, it can be said to occur instantaneously and thus can be used as the time reference $t = 0$.

Triple-transit echo (TTE) interference occurs when a signal reflected from the output travels

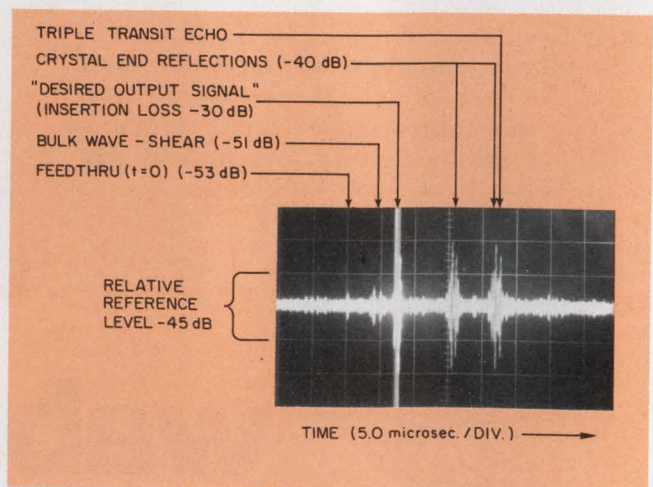

1. Scope photo shows desired signal at SAW-device output, as well as several unwanted interfering signals. The outputs are the response to a pulsed rf signal applied at the device's input.

Phil Snow, Design Engineer, Tektronix Inc., P.O. Box 500, Beaverton, OR 97077.

back to the input, is reflected again, and returns to the output. This echo is easily identified on the display because it occurs at three times the device's time delay, or two time delays after the desired output.

Catching echoes

You can measure the TTE level relative to the desired surface-wave output by adjusting the vertical input setting and the attenuator to obtain a peak-to-peak display of the TTE at some convenient reference level. Add attenuation until the desirable output is reduced to the same peak-to-peak level.

The ratio of the TTE signal to the desired output, then, is the difference between the final and initial attenuator settings. This technique can be used to measure the levels of other interference signals relative to the desired output.

Extraneous output signals may also occur because of the reflection of surface waves from the ends of the crystal substrate. These waves will appear on the display after the desired output pulse at twice the equivalent time delay between the transducer and the crystal end. This is true for reflections from either end.

To determine which end reflection is which on the display (especially when the transducers are nearly equidistant from the ends of the crystal), push a cotton swab soaked with acetone lightly along one end to disturb the displayed signal.

Crystal-end reflections are determined largely by the cutting and polishing of the crystal; ends should be rounded to minimize reflections. When reflections cannot be adequately reduced by cutting and polishing, try an alternate procedure during testing: a solution of silicone rubber adhesive (GE's RTV-102) and trichlorethylene

(TCE) painted on the ends. You must apply a fresh, well-mixed TCE/RTV solution (3:1 by volume) to create a thin layer of film on the crystal's surface and around the edges.

In addition to surface-acoustic waves, interdigital transducers generate bulk acoustic waves, which travel through the bulk of the material and serve as another source of interference. The shear bulk wave is generally the most troublesome. Since the propagation velocity is approximately twice that of the surface wave, the time delay is about half that of the desired surface-wave output.

Measuring bulk effects

Normally a function of transducer design, the strength of the bulk wave can be suppressed significantly by incorporating a multistrip coupler in the device design or with other techniques. But, unlike end reflections, bulk-wave levels cannot be altered at the test bench. Since surface wave devices are often used as delay lines, the time delay is usually important and is often measured with a cancellation scheme (Fig. 3).

In Fig. 3, a signal from the pulse generator gates a pulse of continuous-wave (CW) radio frequency into the SAW device under test. The SAW signal is fed to channel B of the scope, and the device-output signal to channel A. The two amplitudes are first equalized by adjusting the attenuator at channel B's input.

The oscilloscope is set so that channel B is subtracted from channel A. When the repetition rate of the pulse generator equals the inverse of the device's time delay, the two signals will cancel and leave no net signal display. The rate of pulse repetition is monitored by the frequency counter so that its value at cancellation can be accurately

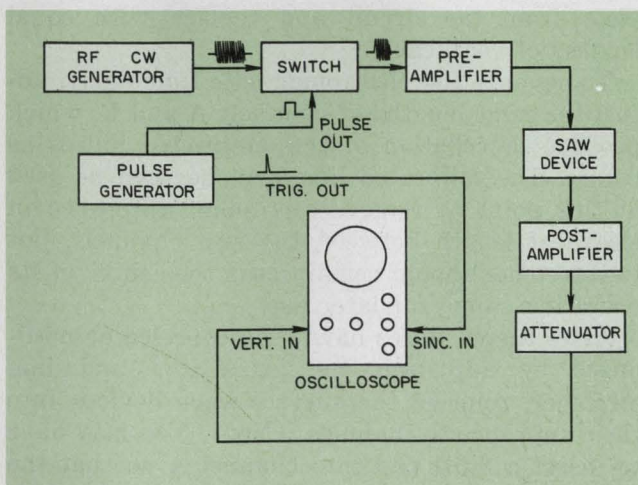

2. Test setup displays the time-domain signals appearing at the output transducer of a surface-wave device. The scope provides identification of the various output signals plus measurement of relative levels.

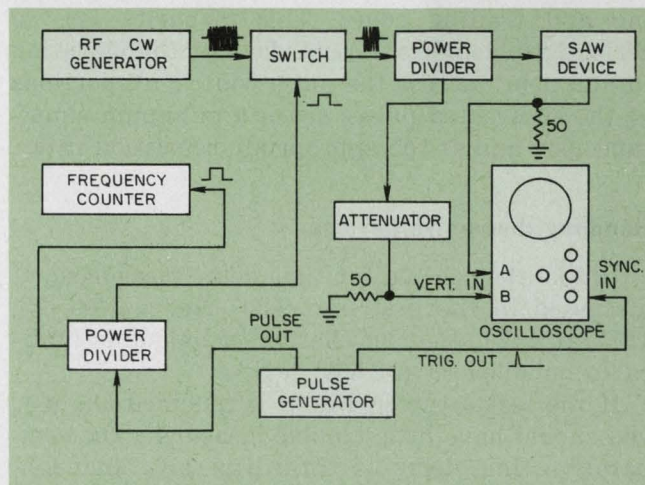

3. To measure time delay in a SAW device, the test circuit is arranged in a cancellation scheme. The arrangement also measures the device's time-delay stability under shock and vibration.

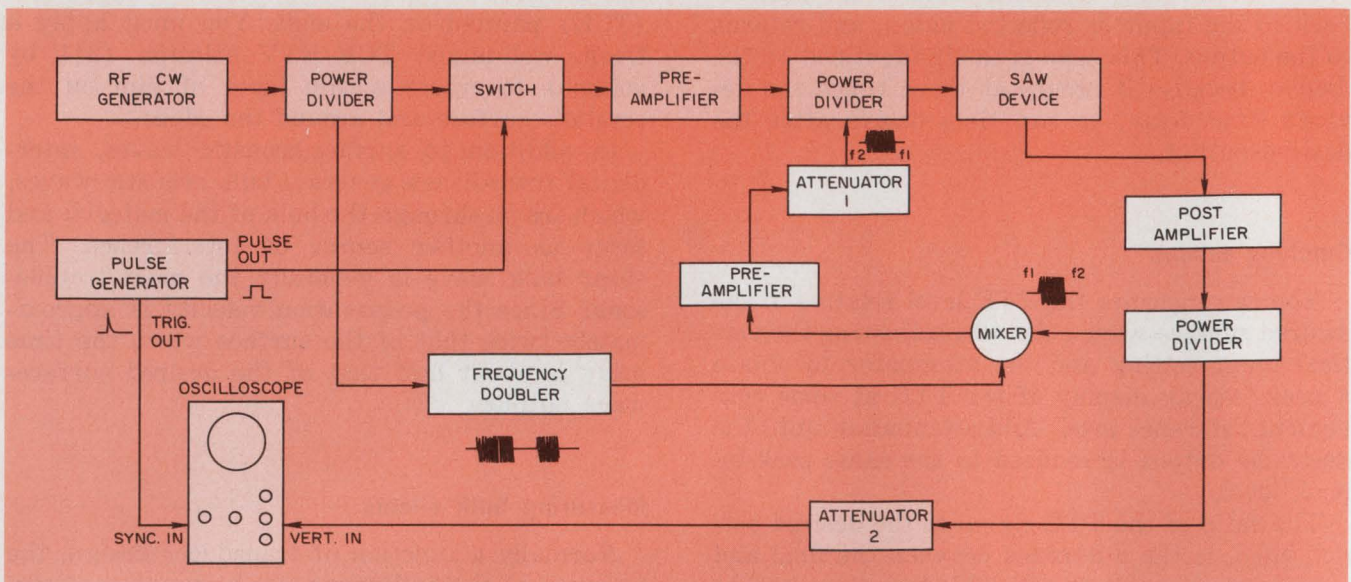

4. With dispersive SAW filters, both expansion and compression pulses must be measured. A spectral-inversion

technique is used here, in which frequencies are translated from low band to high band, and vice versa.

determined. The scope used must be a high-frequency, dual-channel instrument able to subtract signals. The rf generator is set to the center frequency of the bandwidth of the device under test.

To avoid introducing errors, the electromagnetic time delay of the two channels from the power divider to the scope must be equalized beforehand. One way is to bypass the SAW device initially and adjust the relative time delays with an adjustable, lumped-element phase shifter, a variable line stretcher, or various lengths of coaxial cable. To achieve a good null, a second electromagnetic adjustment of the time delay may be necessary after the attenuator has been adjusted.

Since the surface-wave delay lines are band-pass-limited, the output pulses will be shaped differently from the input, and cancellation will be better at the center of the pulses than at the leading and trailing edges. This disparity isn't a serious problem since, regardless of the variation in null depth across the pulse widths, all portions of the subtracted pulses reach a minimum simultaneously and at the appropriate repetition rate.

Handling dispersive devices

Unlike the scheme for time delay measurement discussed in the first part (ED No. 4, Feb. 15, 1977, p. 112), the cancellation technique is limited to nondispersive SAW devices.

If the test setup in Fig. 3 is modified slightly, you should have little trouble measuring the comparative time delay of both dispersive and nondispersive delay lines. Place a reference-delay line in series with the attenuator in channel B, and insert a calibrated variable line stretcher (phase shifter) in series with the device under

test in channel A. The reference-delay line must be identical to the device under test, that is, fabricated with the same transducer patterns on the same type of substrate material, and must have been previously calibrated for time delay.

In such a variation of the test procedure, the pulse generator's repetition rate isn't altered after its initial adjustment. Rather, the time delay of the SAW device is indicated by the phase shift that must be added to its channel (A) to make its signal cancel another signal with a known time delay.

The test procedure is simple. Set the pulse generator to a repetition rate equal to the reciprocal of the time delay of the calibrated reference delay line. Adjust the width of the generator pulse to equal the inverse of the device's bandwidth, and provide maximum amplitude for minimum pulse width. Then remove both surface-wave devices from the circuit and replace with equal lengths of coax cable.

To equalize the electromagnetic time delay, adjust the cable lengths of channels A and B, which produce cancellation of the subtracted pulses as before. The calibrated line stretcher can be used at this point to remove any small difference in electrical length between the two channels, but the stretcher should remain near the center of its operating range for later use.

After the rf pulses have been canceled or minimized by adjusting the attenuator and line stretcher, reinsert the surface-wave devices into their appropriate channels. (Note: You may have to insert a 3-dB pad into channel A so that the attenuator in channel B has enough range to cancel any differences between the insertion losses of the two SAW devices.)

To produce cancellation again, readjust the

calibrated line stretcher. The change in line-stretcher length indirectly indicates the differences in time delay between the device under test and the calibrated reference delay time. If the length is increased, the device under test is shorter than the reference-delay line. If the change represents a decrease, the device under test is longer than the reference.

Vibration affects phase

Another important measurement involves shock and vibration, under which crystal substrates experience dimensional changes that can momentarily alter or periodically modulate the time-delay or phase characteristics of the surface-wave delay line. Thus, package structures for these devices must be tested for their ability to shield the crystal from such disturbances.

You will have a hard time building a sensitive test setup to adequately measure the electrical effects of shock and vibration. However, with careful implementation, a continuous-wave cancellation scheme can detect phase changes of less than 0.1 degree. The test can be done with another modification of the setup in Fig. 3.

To modify the setup, remove the pulse generator and frequency counter from the circuit. Connect the rf generator to bypass the switch and drive the power divider directly. Also, feed the vertical output of the oscilloscope, which represents the difference between channel A and channel B, into a storage-scope/spectrum-analyzer system (such as the Tektronix 7613/7L13).

Adjust the two channels to cancel the CW signal by varying the attenuators and phase shifters in the channels. A cancellation greater than 70 dB can be achieved. Attenuators and phase shifters must be carefully selected; make sure they are continuously variable, with fine control.

Any change between maximum cancellation and the level of cancellation occurring during shock and vibration will be detected on the log scale of the storage-scope display. The cancellation change in decibels is mathematically related to the shift in time delay or phase because the crystal is deformed along its propagation axis. Note that the larger the separation between transducers, the greater the variation for a given amount of shock and vibration.

Dispersive filters have a nonconstant time-delay-versus-frequency characteristic, which may be linear or nonlinear and increase or decrease with frequency. In chirped-radar systems, such a dispersive characteristic is often used to expand the transmitted pulse and recompress it when it returns to the receiver. Such radar is called "chirped" because the expanded pulse changes continuously in frequency, which in the audio-frequency range sounds like a chirp.

To evaluate dispersive devices properly, test their ability to both expand and compress pulses. An expanded pulse may be generated by exciting the dispersive filter with a pulse whose width is equal to the reciprocal of the device bandwidth. The expanded pulse has less amplitude than the excitation pulse, but its pulse width is increased. The width will be equal to the time delay of the dispersive transducer or transducers in the device.

An expanded pulse that is properly generated from a dispersive filter should have a constant amplitude and be free of holes or large ripples. Holes are caused by open or missing transducer electrodes, while ripples are created by acoustic reflections.

You can use an expansion filter as a compression filter or vice versa, depending on the system requirements. Recompressing an expanded pulse requires only that the recompression filter have a delay-versus-frequency slope complementary to that used to expand the pulse.

Obviously, if a dispersive filter complementary to the one under test is available, you can simply generate an expanded pulse to test the filter's recompression capabilities. If a complementary filter is not available, spectrum inversion can be used (Fig. 4). The setup allows a single device to be tested by itself.

Using spectral inversion

Spectral inversion translates the frequencies at the low end of the band to the high end, and vice versa. This is accomplished by subtracting the expanded pulse from twice the input frequency. The spectrally inverted pulse is then fed back to the SAW device, which compresses it.

Attenuator No. 2 in Fig. 4 is useful for measuring the relative levels of the expanded pulse, the compressed pulse and the corresponding sidelobes. The same technique, used before to measure the relative levels of triple-transit echo and desired output, may be used here.

The recompressed pulse will have a $\sin x/x$ shape with a 4-dB pulse width equal to the reciprocal of the device's bandwidth. The first sidelobes of the recompressed pulse should be 13 dB down from the peak level. If the sidelobes are larger, recompression is not perfect. If the level of suppression is greater than 13 dB, there is probably bandpass limiting, and the recompressed pulse will be broader than expected—that is, the pulse width at 4 dB down will be larger than the reciprocal of the device bandwidth.

In chirp-radar systems, weighting filters (filters with prescribed bandpass limiting) are used to suppress the first sidelobes at the expense of broadening the pulse width. Thus, there is a tradeoff between pulse broadening and sidelobe level for optimum resolution. ■■

Behind every successful Microprocessor there's an Ugly™ Driver.

Ugly™ and Super Tough. Who cares! Elexon modular dc power supplies aren't made to be shown. They're made to perform. Reliably. With a cost-effectiveness that can't be beat!

They'll take all you can give. Overloads. High temperature stress. You name it. They'll take it. Time and again. We know because we test them 100%. Under the worst-case line conditions you could ever expect.

Each one is right. And there's a right one for you. Right voltage. Right current. The right specification. Whatever features you need in a microprocessor dc supply, you've got with Elexon, 99% of the time. Off the shelf. In your hands. In record time.

Need it custom. We've got that, too. A sophisticated computer design as it estimates cost. Result? Estimate and design in 30 minutes flat.

That's not ugly. That's beautiful.

If you're specifying dc supplies for your microprocessors, get the Ugly™ drivers. Elexon. The beauty's inside, where performance counts!

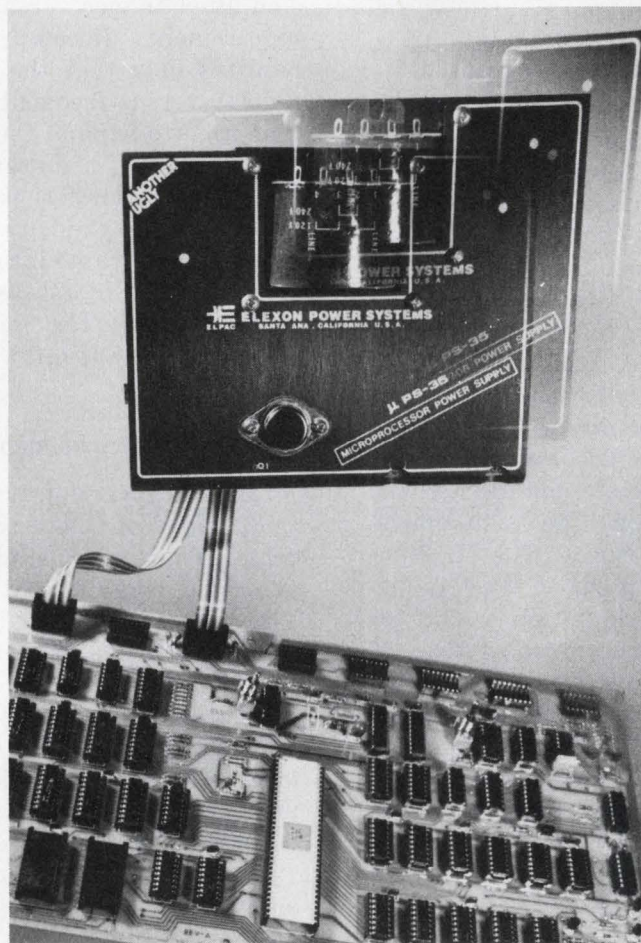

Microprocessor, TEC-9900-SS, TECHNICO, Inc. Columbia, Md.
Visit our Booth #2442 at Electro '77.



© ELPAC Electronics, Inc.

Elexon Power Systems
3131 S. Standard Ave.
Santa Ana, Calif. 92705
(714) 979-4440,
TWX 910-595-1513

Another Ugly™ from Elexon Power Systems.

Get Ugly™ Nationally at: **Cramer, Newark.**

Get Ugly™ Regionally at: **MIL-COMM**, Los Angeles, Ca.,

GPL Electronics, Waltham, Ma., **UTRONICS**, Fairfield, Conn.,

SHAP Electronics, Huntington Valley, Pa., **TECHNICO**, Columbia,

Md., **CLASSIC** Components, Northbrook, Ill., **HAMMOND**

Electronics, Greenville, S.C., **TRANSDUCTION, LTD.**, Canada.

VISIT OUR BOOTH 2442 ELECTRO '77

CIRCLE NUMBER 53

There's a Simpson DPM that's right for your application

All Simpson DPM's feature:

- 0.1% accuracy
- 3-1/2 digit readout
- Automatic zero and polarity
- Dependable LSI circuitry
- Choice of 120/240 V AC or 5 V DC operation
- Panel cutout 1.682" x 3.622". Adaptors available for IEC/DIN and other domestic cutouts
- Input/output edge connector included
- Full 200 hour burn-in
- Backed by the Simpson one-year warranty



Model 2860

The Dedicated DPM

New Series 2860—high performance at a low price

\$46*
from

- 9 stock ranges available
- Bright 0.43" LED readout

The Systems DPM

Deluxe Series 2850—printer/computer interfacing capability and options for custom applications

\$92*

- 9 stock ranges
- Specials available including AC ranges
- Choice of 0.43" LED or 0.55" planar gas discharge display
- BCD output standard

*100-lot OEM prices

Available From
Electronic Distributors
Everywhere

Write for Bulletin P612
containing complete
technical specifications.



Model 2850



Model 2852

SIMPSON ELECTRIC COMPANY

853 Dundee Avenue, Elgin, Illinois 60120

(312) 697-2260 • Cable SIMELCO • Telex 72-2416

IN CANADA: Bach-Simpson, Ltd., London, Ontario

IN ENGLAND: Bach-Simpson (U.K.) Ltd., Wadebridge, Cornwall

IN INDIA: Ruttonsha-Simpson Private, Ltd., Vikhroli, Bombay

CIRCLE NUMBER 56

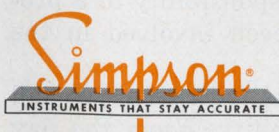

KATY INDUSTRIES



INDUSTRIAL
EQUIPMENT
GROUP

Stan Kukawka of Allen-Bradley

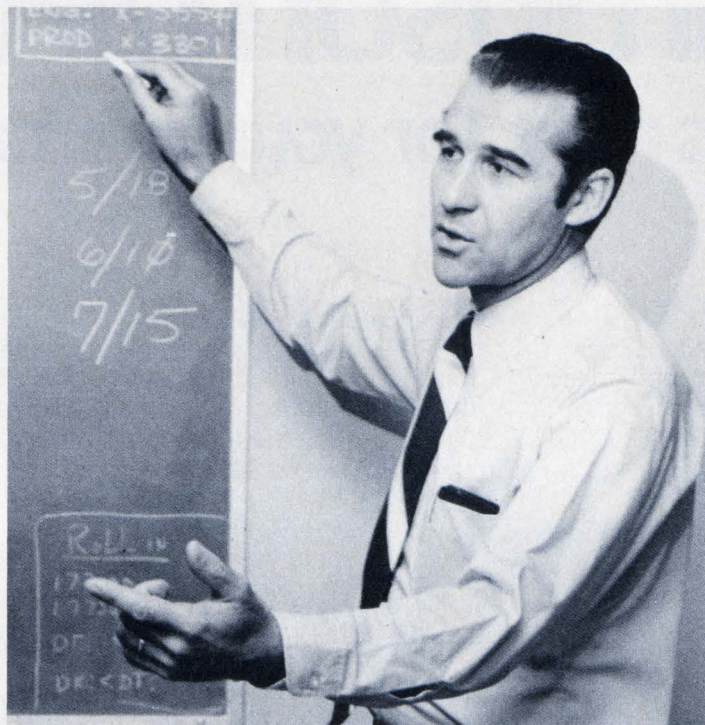

Speaks On

Getting the Small-Company Spirit In a Large Engineering Organization

If it's well managed, a small company can generally run rings around a big one in many ways. Like a light-weight boxer, it can respond faster to external stimuli, so it can bring products to market more quickly. And because a small-company engineer is allowed to shoulder more responsibility than his counterpart in a large company, he has fewer communications problems.

Further because there can be a more intimate relationship between top management and the individual engineers, there can be high morale to generate greater enthusiasm, more devoted effort and a beneficial entrepreneurial spirit.

But large is good, too. In fact, most small companies want to become big ones.

Fortunately, the large company can organize itself to use almost every advantage that we normally associate with the small one.

To achieve the small-company spirit and agility at Allen-Bradley, we break our engineering organization down into smaller product groups. The leader of each group, the project engineer, serves as an entrepreneur. He runs the entire project from design through prototype qualification to pilot production. Once it gets to the pilot phase in production (which can involve thousands of units), he lets go—but not completely. He turns over most of his responsibility to a production engineer who has been involved in the project from the start.

The project engineer starts with what we call the big R, the big responsibility. From the day

he puts his first line on a piece of paper, he interfaces with several other people. He works with a production engineer, a quality-control man and a marketer. Throughout the early stages these people discuss and work out the trade-offs they must make. And throughout the entire process—up to pilot production—that project engineer, to all intents and purposes, runs his own business. The other people serve as his consultants or assistants, but he retains the big R.

When he finally turns the project over to production, he isn't really finished with it; he simply changes his role. He takes what we call the small r, or support responsibility, and moves on to acquire a big R in a new project. At any given time, the project engineer is likely to have a big R for one major product—his current one—and many small r's for products developed in the past.

We can't keep the project engineer in intimate touch with his product after it gets into production. Even a small company can't do that for long because that man is needed for the next project. Sure, he will lend an occasional hand with the product, especially if there's a problem, but he can't keep his whole arm and body in it.

But the project is not new to the production engineer who takes over. He's been involved with the project from the start. In the early days, he had a small r with relation to the product. When it moves into pilot production, he accepts the big R that the project engineer gives up.

When he's running a major project, the project engineer acts like an entrepreneur. He takes the kind of risks an entrepreneur would take. And he does other things that even small companies might hesitate at.

We can't wait to have the product developed sequentially where each step is proved out before we go to the next. It would take us three years from drawing board to marketplace. So we're prepared to take prudent risks. For example, we're willing to start building tooling long before the design is finalized.

We know we'll make mistakes and some tooling will have to be rebuilt or re-worked. But we know, too, that the extra revenue we can develop by bringing a product to market sooner can more than pay the cost of these risks.

The cost we incur in re-working tooling is likely to be very small compared to the revenue we might lose by coming to the market two years

later. Because of lead times, we have to make commitments for tooling at least six months ahead of time, so we want the project engineer to make his tooling commitments early in his design cycle.

Now this is difficult because the engineer tends to be conservative and cautious. He likes to be certain of what he's done before he moves to the next step. He likes to test everything out sequentially, but that takes a long time. So risk-taking calls for courage. The man needs confidence that he's moving in the right direction.

How do we stimulate that courage? First, we don't create a negative environment by kicking the engineer when he makes a mistake. We let him know we're delighted if he has a high batting average. We don't expect 1000 and he knows it. He knows we want him to take prudent risks and this will entail some errors. He also knows that any problems that may occur will be fully resolved before the product is released.

Next, we involve him in objective setting right from the beginning. We ask him how quickly he can meet the objective and later his own pride comes into play. He sets himself tough objectives and then becomes self-motivated. He develops the attitude that's common in small companies that are well run: "I said I could do it in 12 months, and boy, am I going to be a hero if I can do it in 11."

Our objective is to bring a relatively uncomplicated product like a trimmer or potentiometer to market in 12 months. We say to the engineer: "Here are the ground rules. How long will it take you to develop this and what will it cost?"

He does the estimating and then makes a commitment. He wants to meet or beat that commitment because his professional reputation is on the line that he can do the job in a certain period of time for a certain sum of dollars. Before he makes his commitment, the sales people will have provided a sales forecast, so he'll know how many pieces he'll have to produce during the product's lifetime. This will determine the type of tooling and how rapidly he can amortize the tooling.

At the same time, the quality-control guy will tell him how much it's going to cost to get the parts tested. He'll let him know how much the inspection and test equipment will cost and how much labor will be involved in testing. And the production engineer will tell him how much it's going to cost to assemble the part and what the equipment will cost. All these things come together with high credibility by these people being in the same entrepreneurial boat from the start.

Nobody can cop out later and say, "Oh, that was an engineering estimate." The engineers didn't pull the numbers out of the air. They developed the numbers with other people.

When we get the schedule and the costs of developing and manufacturing a part, we can pull all the facts together in a product plan. Then we can do the usual financial calculations like return on investment, cash flow and all that sort of thing. And we can follow with a go or no-go judgment. If we have a go project, we already have the parameters that will form the objective of the team. We hand it to the project engineer because he has the big R.

Now that's a big responsibility, so we want to measure performance all along the way. But it's easy because there are benchmarks at defined intervals from start to finish. Part of the product plan requires setting benchmarks in which the engineer says: "At such a time, I'll have this much ready." He might say, for example, that six weeks after the project is approved he'll have all the parts drawings completed.

He might add that within six weeks after the drawings are done, he'll have prototype parts from soft tooling and will be able to do some preliminary testing. Six months after the project starts he may have prototype parts from hard production tooling. And then, perhaps at the eight-months point, all the tooling will be debugged. At that point he may have a fair quantity of production parts and some hard tooling for a pilot run and extensive qualification tests.

At this point we will usually start showing parts to customers, but we may also do that earlier with prototype parts. We may want to show parts to customers relatively early because we can't come out with a new component, show it to customers, then wait a year while the market develops. We're ready to run volume production when the product is introduced to the field.

Now there's another factor that tends to distinguish the large company from the small one. In a big company, you generally need 20 guys to sign off an approval for a project.

When you're running a small company, you, yourself, may be those 20 guys, so there's no problem. But when you're running a large company this can really slow you down. And yet we must have an approvals procedure.

In a company like Allen-Bradley we might have 30 projects going on at the same time, so we can't

Who is Stan Kukawka?

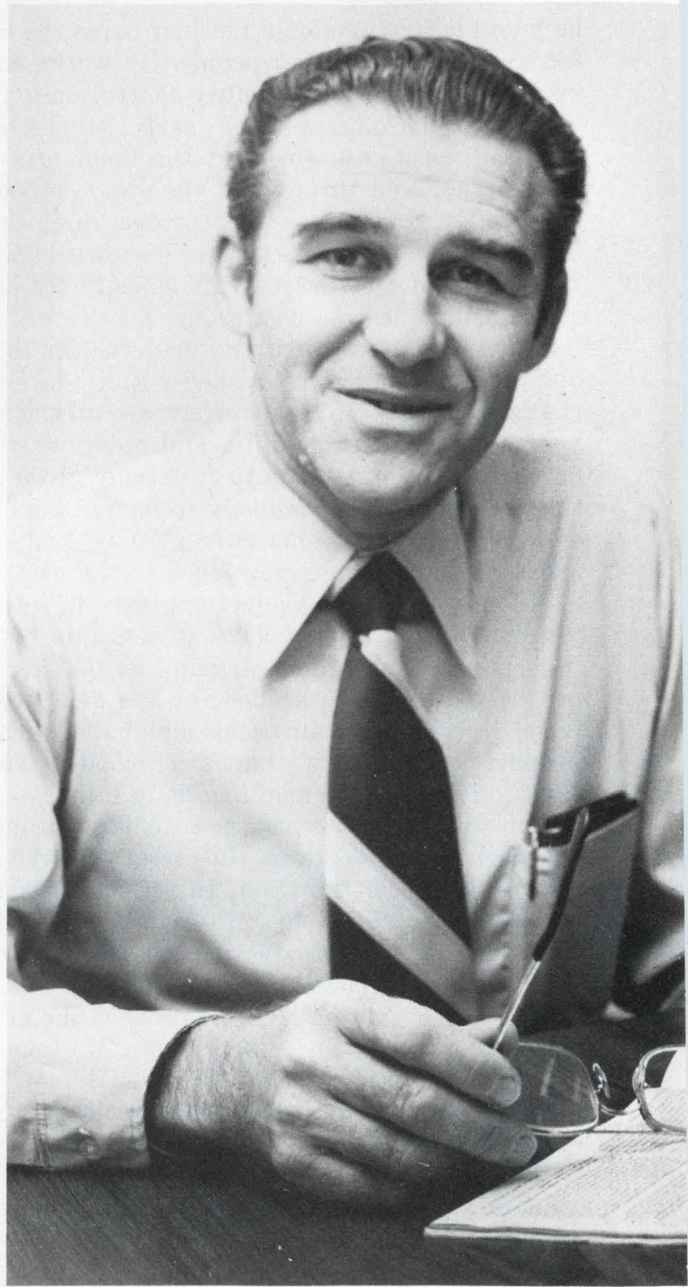

have all these people running off by themselves. We need to know what's going on. We must have some sort of approvals procedure. But we try to minimize the paperwork.

We try to strike a happy medium between the paperwork requirements of the enormous multinational corporation, with thousands of engineers all over the world, and the requirements of the garage shop, with two engineers.

We try to take as many short-cuts as we can and really try to minimize paperwork. We have

Armed with a brand new BS in mechanical engineering from Detroit's Lawrence Institute of Technology, 22-year-old Stanley J. Kukawka took his first professional job with Ethyl Corp. in 1953. When Ethyl transferred him from Detroit to its road-test facility in San Bernardino, CA, Stan started studying electronics at San Bernardino Valley College.

In 1957, when Ethyl wanted him back in Detroit, Kukawka had already been spoiled by California, he says, so he joined Bourns in Riverside. He stayed more than 15 years, then left his position as vice-president and general manager of the Trimpot Div. to accept a similar position with the Electronics Div. of Allen-Bradley in Milwaukee. A-B, a nonpublic company reputed to enjoy annual sales of \$300 million, is often regarded as the world's largest manufacturer of resistors.

Kukawka has lots of hobbies. He particularly enjoys photography, woodworking (especially with driftwood) and playing the banjo, the auto-harp and the fiddle—an instrument he describes as a violin employed otherwise. He's very fond of music, especially folk music, where the fiddle plays an important role.

As active and practicing Christians, Stan and his wife, the former Nancy Sprague, are counselors to the Methodist Youth Fellowship at their church and serve on the Board of Missions. The Kukawkas and their two teenagers, Jeff, 16, and Steve, 13, enjoy hiking, lots of water skiing and lots of traveling. Last summer they traveled through Oregon where they visited fish hatcheries and woolens mills.

"It's amazing," he says, "how much you can learn from completely unrelated industries. Go through a paper mill, a lumber mill or cheese factory and you'll see dozens of techniques you'll never find in the electronics business." He frequently comes away with a thought: "Why can't we do something like that in making resistors?" His pet peeve is that "Many engineers in the electronics industry feel they have the corner on all the good ideas. That's just not true."

hierarchies of approvals. Up to a certain dollar level of expenditures we require the approval of only one man—the project engineer. At a higher level we need the approval of only two men. In all cases other than a major capital investment, all we need are four signatures. And for those major investments we need only two more.

We can get away with such a small number of signatures because of that big-R concept. I know that when that piece of paper comes to me with the project engineer's signature, he had checked

with everybody involved before he signed. He's not going to stick his neck out by himself. If he says he wants to spend this money, I know these other team members are in the boat with him.

Obviously, there's the possibility that Jack feels, "Well, Joe signed it so I may as well sign, too, because he generally knows what he's doing."

When you have a fellow in charge of a group there's a tendency for his subordinates to go along with anything he signs. There's an assumption that the group head knows what he's doing.

But the concept of the responsibility changing is a check and balance. The production manager knows, for example, that at some point Joe is going to give him the big R. He can't say, later, "Hey, this was great in engineering, but it's bombing out in production." The other guys on the team are participating. They are not simply accepting the judgment of the engineer leading the team.

Here again we avoid a common problem. It happens in many companies that engineering hands a project over to production and, at that point, production's hands are clean. If anything goes wrong, it's extremely easy for production to say, "It's not our fault. Engineering screwed up. The engineers should have talked to us. We could have told them how to do it right."

I never want to see a situation where engineering hands me something on a platter and says: "Here it is. We've done all the testing, all the qualifications, all the documentation. Now you build it." That almost never works. That's the way to polarize your groups so that they'll work against each other. Unless those guys are working together from Day One you've got problems.

So where does top management come into the picture? Most important, we don't kick a man when he makes a mistake and we encourage him to take prudent risks and develop a pride of accomplishment. Beyond that, I feel it's not my job or the job of the director of engineering to review every single thing a project engineer is doing, though we follow the benchmarks closely.

My major function is to make that project engineer successful by taking road blocks out of his way. If he gets hung up because he doesn't have the authority to get something done, management should be ready to remove obstacles so that he can run.

We want to make it easy for him to stay on schedule and on budget. We encourage him to come back and yell when he's in trouble. If a man knows that management is working for him and, in a sense, is part of his team, he can really move. And he will. ■■

Complete Control.



Introducing IMSAI 8048 Single Board Control Computer.

Complete Control System

Intel developed the world's first single chip microcomputer. IMSAI has built the system to put it to work. Instantly!

Presenting the IMSAI Single Board Control Computer. A complete program-mable computer and hardware control system on an 8½" x 10" board.

Just plug in the power source (a 5V power supply or a 6V battery will do), connect the equipment you want to regulate, and you're up and running.

In complete control.

The Chip Designed for Control

Intel designed the 8048/8748 single chip microcomputer with one thought in mind. Complete control. Everything you need is there: CPU, RAM, 1K ROM/EROM, I/O, timer/counter, interrupts . . .

The works.

The Board That Implements It Instantly

You can be running hardware configurations today. Without adding a single component.

The IMSAI Control Computer is RS232 compatible, which means you can interface just about any peripheral available. There are 12 quasi-bidirectional I/O lines with handshaking, and 14 more regular I/O

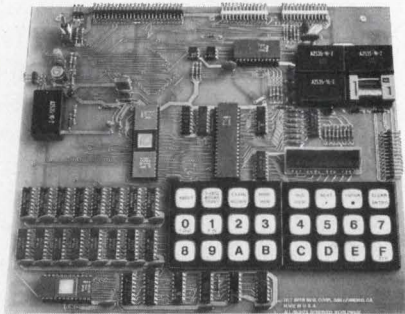

lines, 5 heavy duty relays, and Teletype and audio cassette interfaces. Plus, a 24 pad hexadecimal keyboard and a 9-digit LED hex display. All on one board.

There's already an extra 1K of RAM on board, plus sockets for another 1K of RAM and 2K of ROM/EROM. Still need more memory? The IMSAI 8048 allows expansion up to 64K of RAM off board.

In short, everything you need to make tomorrow's designs today's reality. On one board!

Now, that's control.

For instant control, use the coupon provided.

GENTLEMEN:

I want instant control!

- Send ROM Computer Kit \$249*
- Send EROM Computer Kit \$399
- Send assembled ROM Computer \$299*
- Send assembled EROM Computer \$499
- Send 5V power supply \$99

*June delivery.

Check/MO enclosed. Amt. \$ _____

Charge my: BAC M/C

_____ Exp. Date _____

Sig. _____

Send more information. Have salesman call.

Name _____

Company _____ Title _____

Address _____

City _____

State/Zip _____

IMSAI[®]

IMSAI Manufacturing Corporation
14860 Wicks Blvd.
San Leandro, CA 94577
(415) 483-2093 TWX 910-366-7287

LET FAIRCHILD PUT YOU ON THE BUS

A HYPOTHETICAL CASE

Assume for a moment that you're building an ATE system for in-house use to be controlled by a programmable calculator via an IEEE 488 (HP-IB) bus. You have an instrument pool that you can draw upon. Good instruments. Expensive instruments. Exactly what you need. But the frequency synthesizers, pulse generators, counters and DVMs are several years old and not equipped with a 488 interface.

WHAT CAN YOU DO?

You can spend \$100,000 or more

on new 488 compatible instruments, or you can spend hundreds of man hours designing a custom interface, or you can spend about \$800 each for a few Fairchild interface couplers and put these older instruments back to work.

FAIRCHILD TO THE RESCUE

Fairchild's new microprocessor-based interface couplers will link virtually any programmable instrument to the popular IEEE 488 bus, even though their input and output requirements and the bus itself are not compatible. It's that simple.

AND THERE'S MORE TO THE LINE

Fairchild also offers other instruments that do wondrous things like the 6600 that takes paper tape input and interfaces to CRTs, modems or remote CPUs. And the 1700 that takes BCD output and interfaces with TTYs, CPUs, modems and paper tape punches. They're all detailed in our new brochures. Write: Fairchild Instrumentation, a division of Fairchild Camera and Instrument Corp., 1725 Technology Drive, San Jose, CA 95110. Phone: (408) 275-6600 or (408) 998-0123.

FAIRCHILD



FAIRCHILD

MODEL 4880 INSTRUMENT COUPLER

POWER READY TALKING LISTENING

POWER RESET LOCAL/
REMOTE



Generate nonlinear sweep functions across a capacitor with a feedback circuit

Nonlinear sweep and repetitive waveform generators find extensive use in instrumentation and measurement systems. A versatile way of generating such waveforms makes use of feedback through a suitable nonlinear element, such as a multifunction converter, to provide a controlled current, I , whose value is a nonlinear function of the capacitor voltage, V (Fig. 1).

For example, a parabolic ramp,

$$V = \frac{k^2}{4C^2} \cdot t^2,$$

can be generated with the capacitor, C , initially uncharged by the circuit (Fig. 2a). The factor, k , is a scaling constant determined by the nonlinear element, a Burr-Brown 4302 multifunction module.

The output voltage of the module drives a unity-gain inverter, A_1 , and a voltage-to-current converter, A_2 . A CA3130 FET-input op amp provides voltage-to-current conversion, and allows very low current levels to be used to obtain slow ramp rates. Scale factor k is determined by the ratio, V_R/R_7 ; therefore,

$$V = \frac{V_R^2}{4R_7^2 C^2} \cdot t^2.$$

The scale factor may be adjusted by varying R_7 . Resistors R_2 and R_3 determine the exponent of t .

For the values shown, V is $t^2/775$, where t is in seconds and V is in volts. Fig. 2b shows measurements obtained on an X-Y recorder. Deviation

from the theoretical square-law relationship is less than 0.25% of the full-scale sweep of 10 V.

Such a waveform generator is useful in instrumentation systems such as used for magnetic-cooling experiments. A large variety of complex waveforms can be synthesized by the choice of an appropriate nonlinear function in the feedback loop.

S. Ashok, School of Engineering, Rensselaer Polytechnic Institute, Troy, NY 12181.

CIRCLE NO. 311

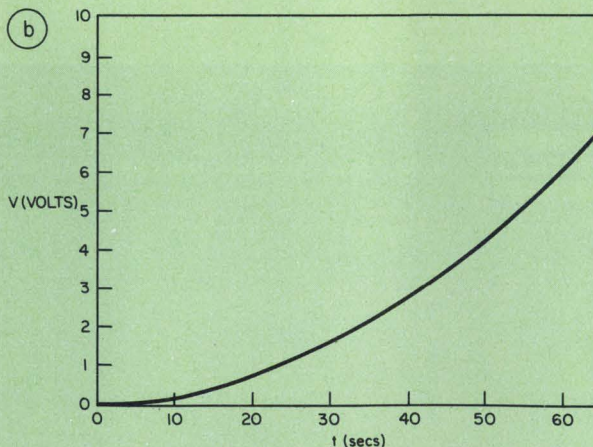
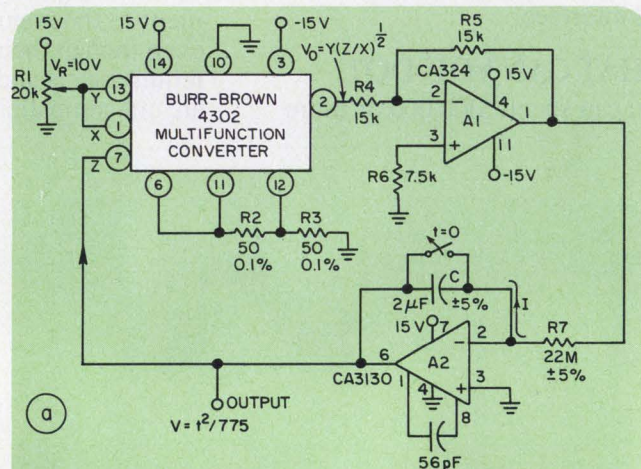

2. The parabolic ramp generated with this feedback circuit is accurate to 0.25%. Amplifier A_1 provides signal inversion, A_2 acts as a voltage-to-current converter, and a multifunction module serves as the nonlinear element.

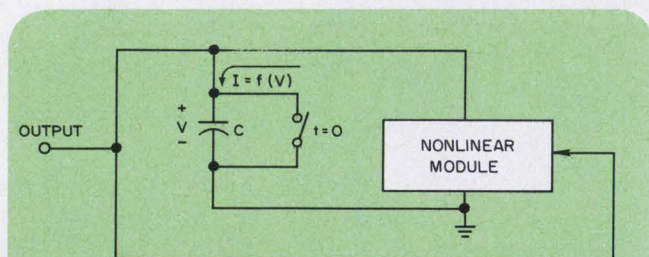

1. A nonlinear module in a feedback circuit is a good way to generate a nonlinear ramp. Because the signal is produced across a capacitor, noise is suppressed and the shape of the output can be changed without discontinuity.

BEST COST/PERFORMANCE

resin-coated SOLID-TANTALUM

CAPACITORS

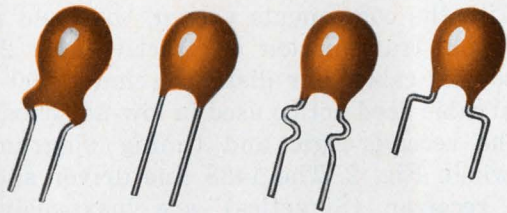

New Sprague Type 199D Capacitors Give You the Most for Your Money

LOWEST COST, YET IMPROVED PERFORMANCE. Prices competitive with any other capacitors of this type, domestic or offshore. Max. impedance in ohms @ 10 kHz guaranteed for every capacitor. Lower d-c leakage currents, lower dissipation factor.

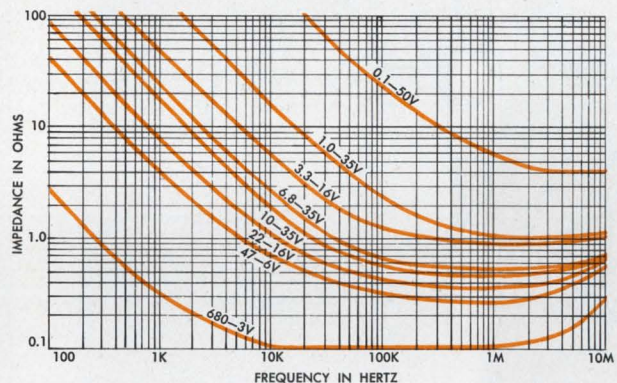

Plus these additional advantages . . .

SUPERIOR EPOXY ENCAPSULANT

Flame-retardant, moisture-resistant resin will not crack or chip under temperature extremes.

CHOICE OF LEAD CONFIGURATIONS

Straight (2 configurations), hockeystick, or lock-in crimp with .100", .200", .250" lead spacing.

STANDARD TOLERANCES: $\pm 20\%$, $\pm 10\%$

$\pm 5\%$ available on special order.

PROVEN CAPACITOR TECHNOLOGY

From the pioneer in solid-electrolyte tantalum capacitors.

RAPID DELIVERY

Up to 999 pieces off-the-shelf from Sprague Industrial Distributors. Larger quantities 4 to 8 weeks ARO.

For price and availability information call your Sprague district office or sales representative. For complete technical data, write for Engineering Bulletin 3547B to: Technical Literature Service, Sprague Electric Company, 347 Marshall Street, North Adams, Mass. 01247.

THE BROAD-LINE PRODUCER OF ELECTRONIC PARTS

CIRCLE NUMBER 59



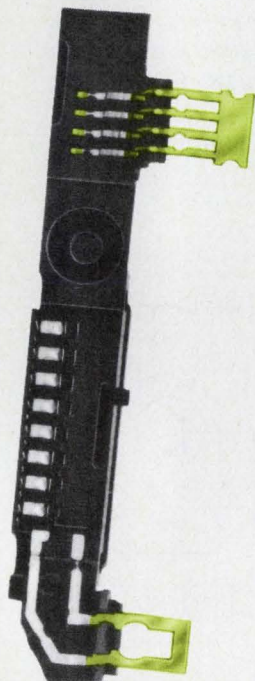
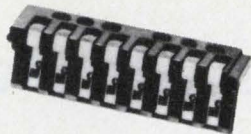

SPRING ASSEMBLIES

**Instrument Specialties
assumes all the headaches
and guarantees quality!**

Until recently, Instrument Specialties was known only for the superb quality and performance of our beryllium copper springs and spring contacts. Customers bought the springs, and frequently assembled them into molded blocks in their own plants—with varying degrees of success.

Now, Instrument Specialties can eliminate this divided responsibility. We can supply your contact springs attached to molded bases, and *guarantee to meet the specifications of the entire assembly!* We'll take complete responsibility for producing the plastic block, manufacturing the springs to exact specifications, and then assembling the parts through heat staking, press fitting, or ultrasonic welding. We can also weld or solder springs to other metal components.

Of course, this eliminates a lot of your procurement and assembly headaches. But most important, your assemblies fit and work the way you specified—Instrument Specialties guarantees it!

We'll be happy to discuss your specific needs—just phone. Or, for a free catalog, write today to Dept. ED-84.



INSTRUMENT SPECIALTIES CO., INC.

Little Falls, New Jersey 07424

telephone: 201-256-3500 twx: 710-988-5732

Specialists in beryllium copper since 1938

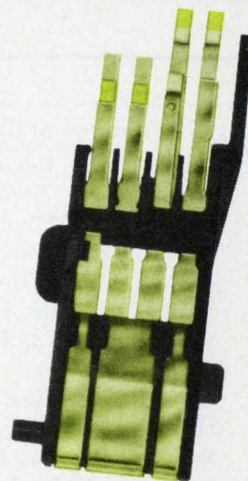
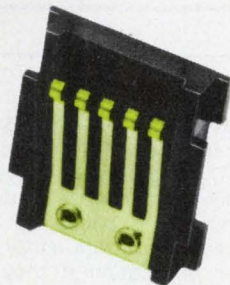

A programming controller for the 2708 EPROM copies data in-circuit

The circuit in the figure is a programming circuit for the popular 2708, 1-k × 8-bit, EPROM (erasable programmable read-only memory). With a simple 8080 subroutine, the circuit can be used to copy a program from a RAM or another PROM into the EPROM (see table). The program will also work with the new Z80 processor.

The signal labeled /ROMSELECT is the same signal that normally would be connected to the chip select (CS) of the EPROM. Setting the 7474 flip-flop puts the circuit into the programming mode by raising CS to 12 V.

When not in the program mode, /ROMSELECT allows the EPROM to be read. The mode-select flip-flop can be set by any desired signal in the system—usually an input/output bit.

In the program mode, /ROMSELECT activates the 74123 programming timer, A, which pro-

vides time for the address and data to settle. Programming timer B, thereafter, turns on the programming signal, P, on the 2708. Both programming timers create the hold request signal, labeled /WAIT, to the processor via the 7408 gate, which temporarily inhibits the address and data bus and lengthens the normal memory cycle.

Terry Dollhoff, Dir. of Computer Science, Acuity Systems, Reston, VA 22090, and Jim Ferry, President, Ross Corp., 9218 Brian Dr., Vienna, VA 22180.

CIRCLE No. 313

Program-copying subroutine for an 8080

```

;
; PROGRAMMING CONTROLLER
; (H,L) = START ADDRESS (of source area)
; ADDRESS OF EPROM IS 0000-03FFH
PROG  SHLD  TEMP  ; SAVE START
      MVI  B,255  ; B=REPEAT COUNT
PROG1  LXI  D,0    ; (D,E)=START OF EPROM
      LHL  TEMP  ; RESET (H,L)
PROG2  MOV  A,M    ; GET NEXT BYTE
      STAX D      ; PROGRAM IT
      INX  H      ; ADVANCE COUNTERS
      INX  D
      MOV  A,D    ; TEST END
      CPI  4
      JNE  PROG2
      DCR  B      ; CHECK LOOP COUNT
      JNE  PROG1
      RET
TEMP   DS  2      ; TEMPORARY
    
```

Note: To meet worst-case programming specifications, copy data 255 times.

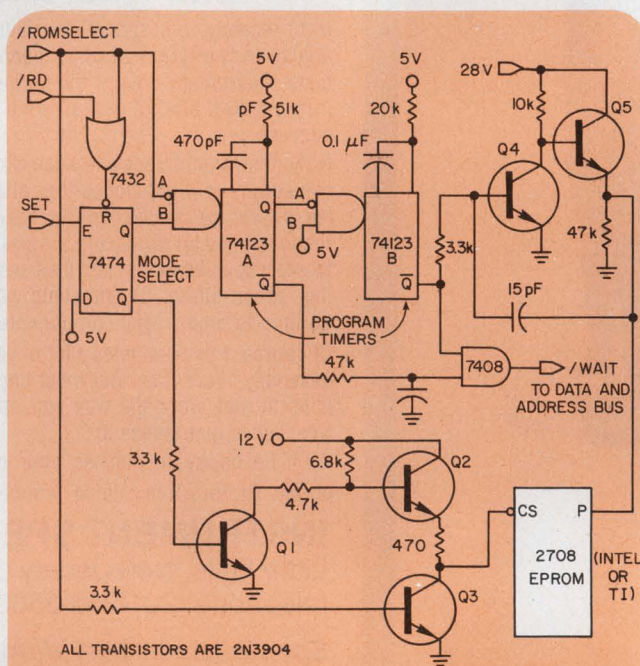

When set to the programming mode, this circuit allows easy in-circuit programming for the popular 2708 EPROM.

IFD Winner of December 6, 1976

Roger H. Lescelius, Electronic Engineer, Branch of Electromagnetism and Geomagnetism, U.S. Geological Survey, U. S. Dept. of the Interior, Box 25046, MS-964, Denver Federal Center, Denver, CO 80225. His idea "Simple Circuit Interfaces TTL to CMOS with Use of Only a Single 12-V Supply" has been voted the Most Valuable of Issue Award.

Vote for the Best Idea in this issue by circling the number of your selection on the Reader Service Card at the back of this issue.

SEND US YOUR IDEAS FOR DESIGN. You may win a grand total of \$1050 (cash)! Here's how. Submit your IFD describing a new or important circuit or design technique, the clever use of a new component or test equipment, packaging tips, cost-saving ideas to our Ideas for Design editor. Ideas can only be considered for publication if they are submitted exclusively to ELECTRONIC DESIGN. You will receive \$20 for each published idea, \$30 more if it is voted best of issue by our readers. The best-of-issue winners become eligible for the Idea of the Year award of \$1000.

SOME STABILITY PROBLEMS ARE EASIER TO CURE THAN YOU MIGHT THINK.

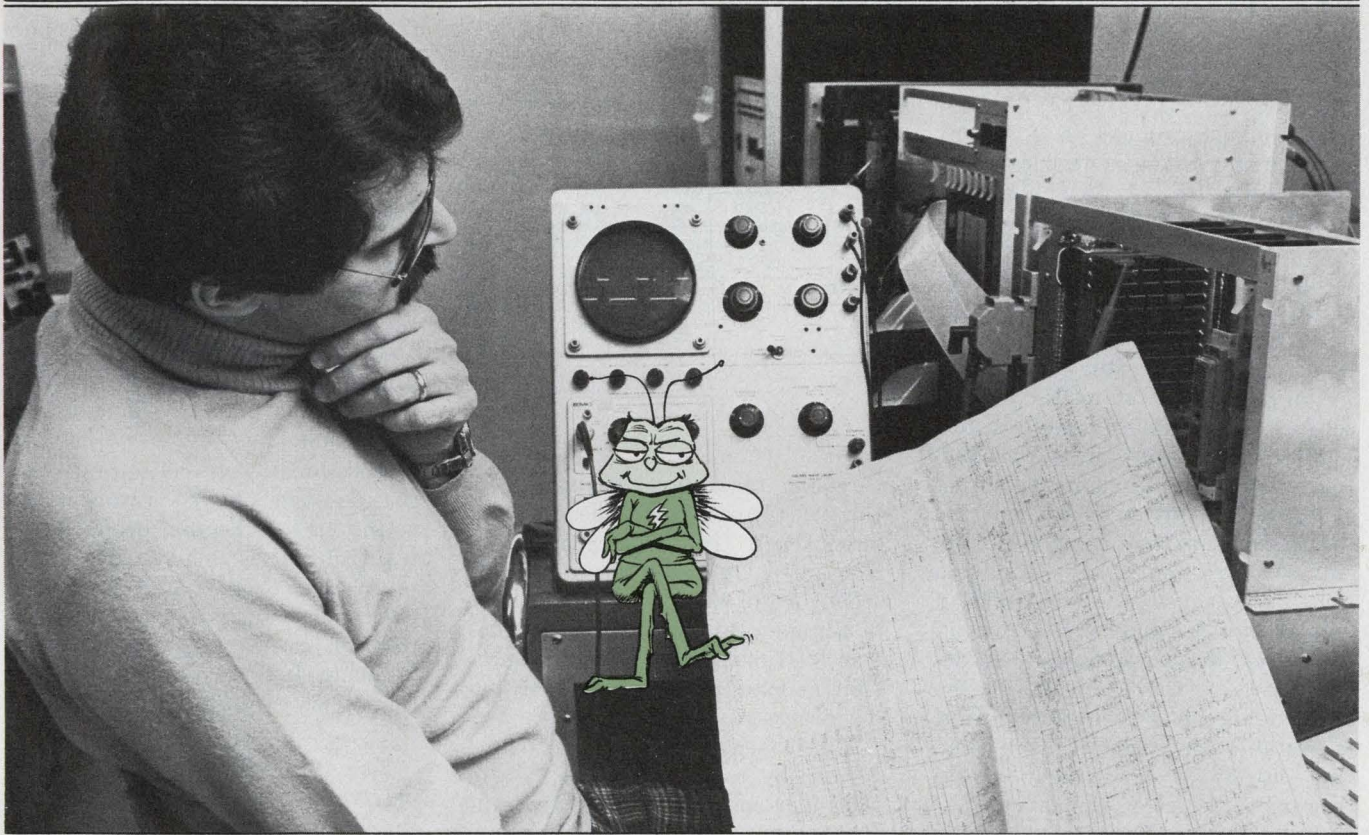

Possibly you have become so accustomed (and inured) to a slight instability or drift in your equipment that you no longer regard the problem as soluble. You've learned to live with it.

But have your customers? They're still waiting for a solution. And if you can't provide one, someone else may.

There are so many stability problems directly traceable to resistive devices that skimping on the quality of a few critical resistors, resistive networks, or trimming potentiometers is simply bad design—and poor business.

Of course not every resistance application calls for the ultra precision and stability of a Vishay Bulk Metal® component. But in those circuits that are causing you trouble, you just may cure your customers' field-adjustment and MTBF problems with

a few well-placed Vishay resistors or trimmers.

Sure, they cost more. But the extra initial cost for Vishay precision often pays for itself in reduced compensating circuitry or temperature-controlling systems. And, too, the resulting higher reliability and better overall system performance prove you've got a good design—and that's good business.

Now a word, please, about the real meaning of precision in resistors. If you're paying for a tolerance of, say, $\pm 0.05\%$ and after a few hundred hours it's loosened to $\pm 1\%$, you haven't gotten what you paid for. Vishay treats you much better than that. One of our unique contributions to your peace of mind is long-term load-life stability (within 0.05% for 2,000 hours under full rated power at 125°C as standard).

In fact, only from Vishay can you get the complete set of top performance characteristics (see below), a combination which will most often free your equipment from that tormenting bug.

Would you like to learn—in a half-day seminar in or near your plant—how to *make your own* custom bulk-metal resistors from Vishay chips, for breadboarding, prototype, or even production use in your products? Call us or write for information. Vishay Resistive Systems Group, 63 Lincoln Highway, Malvern, PA 19355; phone (215) 644-1300; TWX 510-688-8944.



Only Vishay resistors give you all six top performance specs.



TCR
to 0-1ppm/°C



TOLERANCE
to .001%



As low as 1-ns
RISE TIME—
NO INDUCTANCE



TRACKING
to 1/2 ppm/°C



STABILITY
to 5 ppm/yr



NO NOISE

©Vishay

#6843

CIRCLE NUMBER 61

Digital output produced by magnetic field sensor

A novel magnetic field sensor that can produce a digital rather than an analog output is a bipolar semiconductor device fabricated at the University of Southampton, England. It has a mobile domain of carrier current that rotates around a circular path. The rate of rotation is proportional to a magnetic field applied at right angles to the planar structure.

Unlike Hall-effect magnetic field sensors, this carrier-domain device (CDD) doesn't rely on the production of an equilibrium state, because no restoring forces operate to prevent further carrier deflection. What's more, the output is unusual because it is neither a voltage nor a current, but a train of pulses whose frequency is determined by the strength of the applied magnetic field. Because it is suitable for serial transmission, this output is particularly useful in remote sensing applications.

The CDD consists of a number of concentric annular sections (see Fig. 1). There are 10 bonding pads (not shown)—four for angle read-out and two to each emitter. The

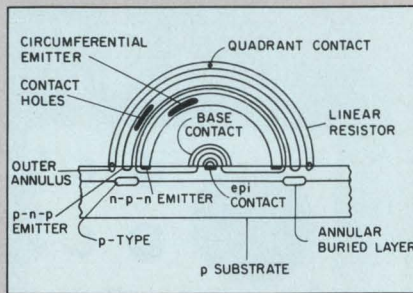

n-type epitaxial layer has two functions: It forms the collector of a planar npn transistor and is the base of a lateral pnp transistor. About 5 μm thick, the n-type layer is bounded by a conventional isolation diffusion. An ohmic connection is made to the center of the disc.

The base of the npn transistor, formed by boron diffusions, is also the inner collector of the pnp transistor. An inner p-type annulus, contacted along its length, forms the emitter of the pnp transistor, and an outer annulus forms a second collector for the pnp transistor.

This annulus also acts as a resistive current divider and is contacted at four points along its length. The emitter ring of the npn transistor is formed by a phosphorus diffusion.

In operation, both emitters are driven by 1-to-10-mA currents of equal magnitude. All collectors are reverse-biased by a few volts. But under these conditions, the system is unstable, and thermal noise or any other imbalance causes a regenerative bunching of carriers. In a magnetic field, all carriers are subject to Lorentz forces that cause rotation when the field is perpendicular to the plane of the semiconductor.

Additional pnp collectors sense the passage of the rotating domain, each collector producing a train of pulses. The frequency of rotation is proportional to the applied perpendicular field. Domain rotation ceases below a threshold of about 0.3 T. Above this value the device exhibits a typical sensitivity of 14 kHz/T.

The prototype devices unfortunately have a high magnetic-field threshold. But when suitably biased, they show a good sensitivity to incremental field changes. Emitter current and chip temperature also affect the output frequency.

High bit density RAM put in CCD memory

Existing CCD memories offer high bit densities, but only at the expense of being able to access individual cells at random. And the densest MOS memories available have single-transistor memory cells. But the bit density of such RAMs is limited by damping the stored signal during the read cycle. Now, however, the advantages of both approaches have been combined in a continuously charge-coupled random-access memory (C³ RAM) based on single-transistor cells. Developed at Siemens Labo-

ratories in West Germany, the cells are all linked to a common bit line that is built like a MOS-transmission line. The bit line is connected to a read/write amplifier.

Applying different voltages to the line creates a drift field in the semiconductor. If a charge from a single-transistor memory cell is injected into the line, it runs with the field over the silicon surface to the read/write amplifier.

Results to date have shown that for a 300- μm MOS-transmission line, running times of about 250 μs can be obtained. Theoretically, at least, these results foretell 32-k memories with a cycle time of 1 μs .

Warning system monitors congestion on autobahn

An automatic computer-controlled traffic congestion warning system has been placed in service along a portion of the well-travelled Stuttgart-Munich autobahn in West Germany.

Designed by Siemens AG, the system consists of 15 signal gantries spaced along an 8-km section of the highway. The gantries carry fiber-optic displays which indicate any one of three recommended speeds to motorists in each lane, and also warn of impending traffic congestion.

WANTED

3MHz to 2350MHz



The VS90 SWEEP GENERATOR

DESCRIPTION

- Wide Frequency Range-3MHz to 2350MHz
- High Output Level-0.7v RMS into 50 ohm
- Wide Sweep Width-100kHz to 1100 MHz
- High Stability-Less than 20kHz residual fm
- Flat Output-Leveling Int Ext. 0.5dB

Price \$ **2695⁰⁰**

Delivery Stock

Texscan

Texscan Corporation 2446 North Shadeland Ave. • Indianapolis, In. 46219 (317)357-8781

Same great name. Same great color.

And now a neat new way to definitive display performance.

DOT MATRIX

Consider the new Noritake-Ise dot-matrix line-up—
9, 10, 16, 20 and 40-character line displays.
Variety aimed at giving you more design potential.
Or consider our unique 400-dot graphics display
with 17m/m depth and low 35V drive rating.
It's aimed at helping you think low voltage,
portability and economy all at the same time.

In short, consider Noritake-Ise period
for dot matrix (or segmental) displays.
Itrons always help you design more competitively.

itron®



DC209A2

Dimension: 41(H)×208(W)×10.5(D)mm Character Size: 9.0(H)×6.3(W)mm

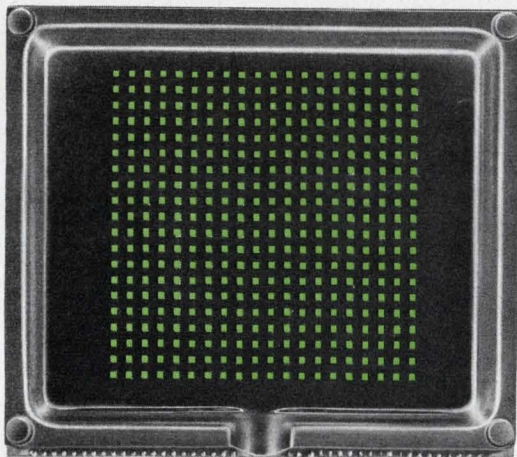

FG400DA1

Dimension: 114(H)×130(W)×17(D)mm

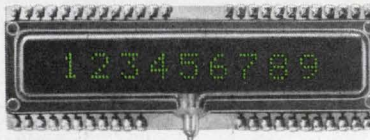

DC95A2

Dimension:
24(H)×75(W)×7.2(D)mm
Character Size:
5.05(H)×3.55(W)mm



FG48D6

Dimension:
25.5(H)×56.5(W)×7(D)mm
Character Size:
8.0(H)×4.2(W)mm

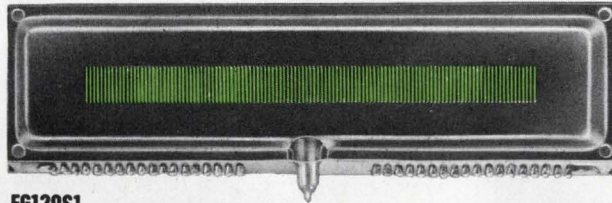

FG120S1

Dimension: 39(H)×138(W)×12.5(D)mm



FG209M2

Dimension: 41(H)×208(W)×10.5(D)mm Character Size: 9.0(H)×5.4(W)mm

NORITAKE CO., LTD.

Electronics Division
1-1, Noritake-Shinmachi, Nishi-ku,
Nagoya-Shi, Japan
Phone: NAGOYA (052) 561-7111
Telex: J59738 NORITAKE

Electronics Office (U.S.A.)
22410 Hawthorne Blvd.
Torrance California 90505, U.S.A.
Phone: (213) 373-6704
Telex: 230674910

F.R. Germany
NEUMULLER GmbH 8 München 2.
Karlstrasse 55, F.R. Germany
Phone: 592-421
Telex: 522106

U.K.
ITT Component Service
Refuge House, River Front,
Enfield, Middx, England
Phone: 01-363 7459
Telex: 21637

Hong Kong
Room 1403 Shing Loon Bldg.
24-26 Stanley Street, Hong Kong
Phone: 5-232420 Telex: HX83151
Taipei
72-9 SEC 2, JEN AI RD., Taipei
Phone: 351-0293 Telex: 11176

Manufacturer:
ISE ELECTRONICS CORP.
P.O. Box 46, Ise-shi,
Mie-Pref., Japan
Phone: (05963) 5-2121 to 4
Telex: 4969523

Reliability test results:

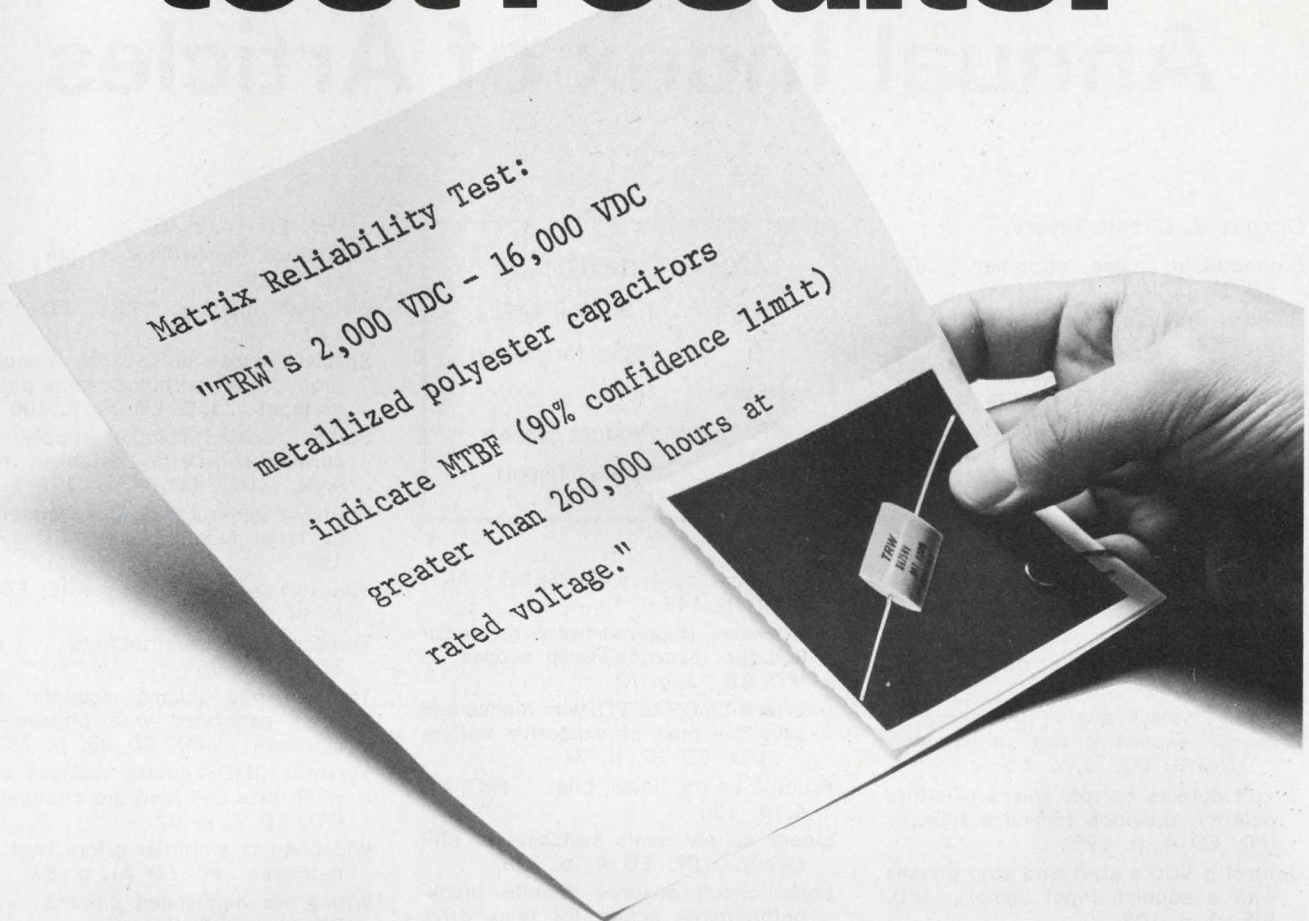

TRW's X675HV series is designed to meet the requirements of voltage multipliers and high voltage filters in high density, high voltage power supplies, instrumentation, data displays, pulse modulators and copiers.

They're smaller, lighter, self-healing and eliminate wet components which can bleed, crack and wreck a board.

The standard design is metallized polyester with axial leads, tape wrap and epoxy endfill case. Insulation resistance is 30,000 megohms x MFD and the dissipation factor is less than 1% at 1000 Hz.

The X675HV series can replace traditional dielectrics in many applications with substantial savings in size at comparable lower costs. *On quantity orders, modifications can be made to your specifications.*

Want to know more? Use the coupon for complete specs on the X675HV series — or information on any dielectric you require.

TRW Capacitors

An Electronic Components Division of TRW, Inc.
301 West "O" Street,
Ogallala, Nebraska 69153.

- Please send me specs on your new X675HV capacitors.
- I'd also like a copy of the matrix test results.
- Please have someone contact me.

Name

Firm Name

Address

City

State

Zip

TRW CAPACITORS

ANOTHER PRODUCT OF A COMPANY CALLED TRW

CIRCLE NUMBER 64

Electronic Design 1976 Annual Index of Articles

Circuits & Circuit Theory

- Bidirectional pulse stretcher...ART, ED 22, p. 180
- Blend a wideband PLL...ART, ED 14, p. 46
- Build a voltage-controlled oscillator with only one TTL-inverter package...IFD, ED 19, p. 126
- CMOS analog switches can precisely control an op-amp gain...IFD, ED 10, p. 106
- CMOS frequency-to-voltage converter is highly linear over wide frequency range...IFD, ED 13, p. 116
- CMOS in chopper designs...ART, ED 4, p. 164
- Cancel 60 Hz and other noise...ART, ED 20, p. 74
- Carefully select analog interfaces to reduce expensive external circuitry...NEWS, ED 13, p. 55
- Circuit detects narrow spikes of either polarity, provides 150-ns output...IFD, ED 4, p. 176
- Control a VCO's start and stop phases with a squelch input signal...IFD, ED 10, p. 108
- Control an LP-filter's cutoff frequency...ART, ED 21, p. 62
- Current-controlled bandpass filter can be built with only one IC...IFD, ED 11, p. 96
- Design flyback converters...ART, ED 26, p. 66
- Design single-section delay equalizers...ART, ED 19, p. 82
- Design transistor oscillators...ART, ED 8, p. 98
- Designers are looking closely at new monolithic DACs and ADCs...NEWS, ED 13, p. 28
- Digital frequency doubler works to 100 kHz...IFD, ED 7, p. 94
- FETs provide current limiting for protection against shorts...IFD, ED 12, p. 160
- Get around op amp limitations...ART, ED 19, p. 104
- High-frequency zero-crossing detector operates beyond 50 MHz...IFD, ED 7, p. 96
- High-voltage pulse generator offers variable delay and only 3-ns jitter...IFD, ED 9, p. 86

Department Key

ART	Technical Article
IFD	Ideas for Design
NEWS	News
PF	Product Feature
SR	Special Report

- Hold noise down with JFETs...ART, ED 4, p. 147
- Inexpensive triggered-sweep generator updates recurring-sweep scopes...IFD, ED 23, p. 72
- Interface CMOS to TTL with diodes and save the cost of expensive buffers...IFD, ED 23, p. 74
- It could be the 'ideal' filter...ART, ED 4, p. 156
- Linear supply rivals switchers in efficiency...PF, ED 4, p. 179
- Logic circuit ensures definite break-before-make action for relay drive...IFD, ED 16, p. 80
- Need an adjustable crystal oscillator...ART, ED 7, p. 88
- Parallel-coupled microstrip-line...ART, ED 11, p. 78
- Phase-locked-loop circuit multiplies frequencies by 2 to 256...IFD, ED 11, p. 94
- Power ramp generator delivers an easily adjustable 1-A output...IFD, ED 5, p. 66
- Power-supply regulator simplified with Norton op amps...IFD, ED 6, p. 106
- Prevent emitter-follower oscillation...ART, ED 13, p. 110
- Reduce the noise output...ART, ED 20, p. 82
- Schmitt-trigger circuit controls firing angle of SCR or triac power systems...IFD, ED 9, p. 84
- Select mixer frequencies painlessly...ART, ED 8, p. 104
- Self-adjusting trigger level featured in monostable photocell circuit...IFD, ED 13, p. 120
- Simple regulator circuits provide tracking bipolar reference voltage...

- IFD, ED 14, p. 62
- 'Simplified' notch-filter design...ART, ED 23, p. 68
- Slew-rate filtering...ART, ED 19, p. 110
- Special-purpose pulse-width modulator produces an output of same polarity as input...IFD, ED 20, p. 100
- Stable constant-voltage supply uses current source to establish reference...IFD, ED 24, p. 176
- Staircase generator divides frequencies by large factors...IFD, ED 17, p. 102
- The average efficiency...ART, ED 14, p. 52
- Transconductance amplifiers...ART, ED 19, p. 98
- Transient-free pulsed acoustic sinusoids generated with phased-array speakers...IFD, ED 26, p. 78
- Versatile CMOS circuit changes mode when bias and load are changed...IFD, ED 7, p. 92
- Wideband rf amplifier offers best gain flatness...PF, ED 21, p. 87
- Wiring for high-speed circuits...ART, ED 11, p. 84
- Zero-crossover tone-burst circuit delivers integral number of sine waves...IFD, ED 25, p. 110
- 90-degree phase-difference networks are simply...ART, ED 19, p. 90
- 555 one-shot circuit features negative output with positive triggering...IFD, ED 17, p. 98

Communications, Microwaves & Lasers

- AT&T system switches 150 calls per second...NEWS, ED 4, p. 37
- Amplifier delivers flat output from 0.15 to 300 MHz...PF, ED 10, p. 138
- Bell plans digital system to use occupied channels...NEWS, ED 16, p. 22
- Cable TV firm installs first fiber-optic cable...NEWS, ED 16, p. 22
- Circuit monitors blinking phone lights and provides soft but commanding tone...IFD, ED 22, p. 194
- Consider low-cost lasers...ART, ED 2, p. 68

Desert laser system detects earth tremors... NEWS, ED 2, p. 22

Extending man's voice by wire and radio... SR, ED 4, p. 78

FCC swamped with complaints as sources of RFI/EMI increase... NEWS, ED 20, p. 24

Fiber-optic telephone link to be field tested... NEWS, ED 1, p. 21

FOCUS on passive microwave components... SR, ED 2, p. 58

GM laser crystals make better pollution monitors... NEWS, ED 19, p. 21

Give priority to first phone lifted in parallel-connected phone systems... IFD, ED 18, p. 110

I-f/rf building blocks now in hybrid form... PF, ED 1, p. 160

Improvements continue in digital and analog communications devices... SR, ED 8, p. 50

Innovations abound in amateur radio equipment and techniques... SR, ED 10, p. 72

Japan's 2-way CATV uses fiber optic cables... NEWS, ED 23, p. 15

Largest graphite-epoxy antennas set for Mariner... NEWS, ED 12, p. 46

Microprocessors help to communicate by voice and bit stream... SR, ED 8, p. 58

Microwave receiver gets better images at 90 GHz... NEWS, ED 3, p. 13

More nations scheduled to receive own domestic satellite systems... SR, ED 18, p. 51

Optical modulator developed for high-

power IR lasers... NEWS, ED 25, p. 36

Powerful laser will be used in space test... NEWS, ED 5, p. 16

Preselector/mixer alignment circuit uses receiver's balanced mixer as a load... IFD, ED 20, p. 96

Programmable SAW delay line developed for data communications... NEWS, ED 25, p. 38

RCA's Satcom looks for new kinds of customers... NEWS, ED 1, p. 22

Race is on to convert 23-channel CBs to 40... NEWS, ED 19, p. 22

'Recombination' laser readied for space use... NEWS, ED 26, p. 20

SAW devices go into commercial production... NEWS, ED 23, p. 15

Satellite antennas boost message capacity... NEWS, ED 12, p. 46

Satellite boosts marine communications... NEWS, ED 4, p. 38

Satellite-borne microwave sensors may improve weather forecasts... NEWS, ED 14, p. 22

Solar μ wave repeater saves power and money... NEWS, ED 26, p. 19

Sonar transmit-receive switch is compatible with most logic levels... IFD, ED 4, p. 172

Spectrum squeeze eased by solid-state microwave oscillator advances... SR, ED 8, p. 74

Undersea communicator sharpens speech clarity... NEWS, ED 26, p. 19

Use an IC voltage reference to control

crystal-oven temperature accurately... IFD, ED 19, p. 124

Use optical fibers for long-range... ART, ED 8, p. 90

Harold Wheeler: An innovator in the world of communications... SR, ED 8, p. 80

X-ray-laser development put back on the beam... NEWS, ED 21, p. 20

μ C-based switchboard helps cut phone bills... NEWS, ED 24, p. 21

Components

Age reference zeners to achieve stable long-term performance... IFD, ED 19, p. 120

Avoid failure of PC board components... ART, ED 21, p. 68

'Common' fuse has been redesigned... NEWS, ED 13, p. 24

Compact storage battery operates for 10,000 hrs... NEWS, ED 21, p. 20

Components conference will focus on new hybrid uses... NEWS, ED 6, p. 19

Connector mass terminates flat-conductor, flat cable... PF, ED 26, p. 89

Consider solid-state photodetectors... ART, ED 21, p. 52

Cost cuts in flat-keyboard encourage new applications... PF, ED 22, p. 208

Digital circuit detects frequency-modulated signals... IFD, ED 8, p. 126

Digital high/low-pass filter features voltage-adjustable cut-off points... IFD, ED 8, p. 124

FOCUS on crystals for frequency control... SR, ED 14, p. 40

FOCUS on diodes and rectifiers... SR, ED 5, p. 40

FOCUS on keyboards... SR, ED 22, p. 122

FOCUS on rf connectors... SR, ED 11, p. 60

FOCUS on solid-state relays... SR, ED 26, p. 48

Gate-turn-off SCRs... ART, ED 26, p. 60

High efficiency achieved with organic photocells... NEWS, ED 20, p. 22

Improve inductor design accuracy... ART, ED 3, p. 58

Mini-Pak: A successor to the conventional DIP... NEWS, ED 11, p. 21

Multiturn glass trimmer caps offer good specs at low cost... PF, ED 5, p. 87

New process advances uniformity of thermistor... NEWS, ED 15, p. 22

Optical transistor doubles as amplifier or switch... NEWS, ED 25, p. 21

PLA: a 'different kind' of ROM... ART, ED 1, p. 78

Programmable divide-by-n counter provides symmetrical outputs for all divisors... IFD, ED 2, p. 82

Quartz-crystal timing accuracy... ART, ED 2, p. 74

Subject Listing

Circuits & Circuit Theory	Industrial Electronics
Communications, Microwaves & Lasers	Management
Components	Materials & Packaging
Computers & Data Processing	Medical Electronics
Consumer Electronics	Microprocessors
Displays & Electro-Optics	Military & Aerospace
General Industry	Semiconductors
	Test & Measuring

ANNUAL INDEX

- SOT-23 packaged components...ART, ED 16, p. 66
- Select more-reliable switches...ART, ED 13, p. 98
- Simple hex VCOs constructed from CMOS inverter and Schmitt trigger...IFD, ED 3, p. 74
- Solar cells power carts at nation's summer fete...NEWS, ED 17, p. 22
- Solderless breadboards easily handle 600-mil DIPs...PF, ED 24, p. 221
- Specify hybrid components properly...ART, ED 3, p. 52
- Stronger battery powers electric car...NEWS, ED 20, p. 21
- Super toroids with 'zero' external field made with regressive windings...IFD, ED 18, p. 110
- The drive motor of a servo...ART, ED 15, p. 110
- Thick-film resistors give precision tempco at low cost...PF, ED 9, p. 138
- Underwater connectors mate with the power on...PF, ED 19, p. 170
- While sodium-sulfur battery stores 10 MWh...NEWS, ED 19, p. 21
- Wideband autotransformers...ART, ED 3, p. 64
- ## Computers & Data Processing
- Accumulate and trap data in counters while their outputs remain constant...IFD, ED 11, p. 100
- Advantages of CCDs and magnetic bubbles cited for main memories...SR, ED 12, p. 60
- Airborne computer may cut consumption of fuel...NEWS, ED 6, p. 20
- Bipolar controllers—they're fast, cheap and easy to use...SR, ED 22, p. 106
- Build a PROM programmer...ART, ED 22, p. 172
- CCD technology invades the digital domain...NEWS, ED 13, p. 24
- CCDs beware: Here come the bubbles...NEWS, ED 21, p. 19
- Calculator remembers—even when turned off...NEWS, ED 16, p. 21
- Choosing among 4-k MOS RAMs...ART, ED 12, p. 138
- Circuit detects incoming data to turn on teletypewriter...IFD, ED 8, p. 122
- Computer microfilm standard proposed...NEWS, ED 3, p. 14
- Computer net concept shown by Sperry Univac...NEWS, ED 25, p. 21
- Computer sound effects generated with only four ICs...IFD, ED 14, p. 64
- Computer updating is needed by domestic ATC system...NEWS, ED 12, p. 45
- Computers on a board...SR, ED 12, p. 86
- Convert keyboard or computer signals to serial pulses for automatic phone dialling...IFD, ED 5, p. 68
- DEC introduces new mainframe computer...NEWS, ED 2, p. 22
- Data General's μ P-based mini extends its Nova line...NEWS, ED 7, p. 21
- Data terminal features low-cost, programmable character set...PF, ED 10, p. 113
- Digital encoder/decoders enhance audio system sound...PF, ED 19, p. 138
- Digital plotter talks back to terminal...PF, ED 12, p. 163
- Distinction between minis and micros continues to narrow...SR, ED 18, p. 46
- Drive lines and discriminate pulses at 50-MHz data rates...PF, ED 7, p. 108
- Dynamic RAMs reach 16-k density—and touch off a memory battle...NEWS, ED 7, p. 26
- Expand a system's memory capacity without mounting hardware and board space...IFD, ED 21, p. 120
- Fastest monolithic 10-bit a/d device has 200-ns conversion time...NEWS, ED 5, p. 20
- Floppy-disc control & format circuit comes on single chip...PF, ED 19, p. 162
- Floppy-disc recorder has more storage capacity...NEWS, ED 11, p. 22
- FOCUS on data converters...SR, ED 19, p. 68
- For sequential control, FPLAs...ART, ED 22, p. 164
- Get on the IEC bus...ART, ED 24, p. 124
- Go from flow chart to hardware...ART, ED 18, p. 90
- HP adopts TI's 4-k, 18-pin RAM...NEWS, ED 10, p. 27
- Hardware and software advances are spurred on by microprocessor invasion...SR, ED 12, p. 76
- High-density RAM board has a good memory...NEWS, ED 24, p. 22
- High-speed FFT chip set under development...NEWS, ED 17, p. 21
- IEEE 488 bus plays a major role in programmable instrument systems...SR, ED 24, p. 76
- Impedance converters buffer signals without loading...PF, ED 8, p. 131
- Inexpensive digital storage media...ART, ED 25, p. 86
- Interactive terminal prints and mates with any protocol...PF, ED 18, p. 134
- Inverter circuit handles bidirectional signal flow without latching up...IFD, ED 24, p. 168
- LSI family reduces size of high-speed systems...NEWS, ED 10, p. 28
- LSI reference voltage source is introduced...NEWS, ED 21, p. 19
- Latent fingerprints matched to databank...NEWS, ED 8, p. 20
- Level-6 mini family announced by Honeywell...NEWS, ED 4, p. 38
- Line drivers made from 555 timers provide inverted or noninverted outputs...IFD, ED 2, p. 86
- Logic analyzers: a new force in digital troubleshooting...NEWS, ED 3, p. 16
- Mag tape systems plug into IEEE 488 bus...NEWS, ED 24, p. 21
- Microcomputer needn't take many ICs...ART, ED 12, p. 126
- Mini-assisted weather net planned by 1981...NEWS, ED 5, p. 15
- Mini features high density memory...NEWS, ED 20, p. 21
- Mini manufacturer warns, 'Beware the microcomputer'...NEWS, ED 8, p. 31
- Miniature open-frame supplies rival potted modules in size and price...PF, ED 9, p. 115
- Minicomputer memories pushing for 32 k of memory—and more...NEWS, ED 1, p. 36
- Minicomputer system to be the first OEM for IBM...NEWS, ED 26, p. 20
- Minicomputer terminal is 'totally flexible'...NEWS, ED 5, p. 16
- Minicomputer that thinks like a mainframe...NEWS, ED 25, p. 22
- Minicomputers offer fast microprogramming...NEWS, ED 22, p. 26
- Model your ROM with NAND gates...ART, ED 20, p. 88
- Multiprocessor control systems...ART, ED 12, p. 132
- Multiprocessor system claims to be 'fail safe'...NEWS, ED 1, p. 21
- N-channel SC/MP-II doubles speed but cuts power by four times...PF, ED 26, p. 39
- Patching a program into a ROM...ART, ED 18, p. 98
- Plug a programmable calculator...ART, ED 6, p. 82
- Power-down circuits allow three-state operation with some CMOS drivers...IFD, ED 15, p. 118
- Programmable erasable PROMs on the board...ART, ED 12, p. 148
- Programmable calculator announced for consumers...NEWS, ED 2, p. 21
- Programmable logic arrays...ART, ED 15, p. 98
- Programming bottlenecks limit widespread use, but the outlook is bright...SR, ED 12, p. 104
- Progress in gigabit logic reported for super-fast switching uses...NEWS, ED 15, p. 34
- Progress seen in CCD memories, bipolar RAMs and I²L logic...SR, ED 18, p. 49
- Remotely control a pocket calculator with a simple CMOS interface circuit...IFD, ED 23, p. 74
- SC/MP-based kit can expand to complete system...PF, ED 12, p. 124
- Should MOS RAMs be 'TTL-compatible'...ART, ED 12, p. 144
- Simple circuit detects data edges...IFD, ED 22, p. 192
- Simple circuit interfaces TTL to CMOS

with use of only a single 12-V supply... IFD, ED 25, p. 112

Software links a/d's to computers... ART, ED 1, p. 102

State diagrams for a 555 timer aid development of new applications... IFD, ED 17, p. 100

Switched digital-data network is dual mode... NEWS, ED 9, p. 15

Systems designers face bewildering array of hardware-software tools... SR, ED 10, p. 68

Telephone-oriented LSI finds tough going despite reported advances... NEWS, ED 7, p. 36

Thermal printhead plus μ P equals greatly simplified circuitry... NEWS, ED 11, p. 32

They are becoming even less expensive as mini and micro prices plunge... SR, ED 12, p. 98

Time-sharing desk-top calculator accepts inputs while driving peripherals... PF, ED 3, p. 76

UV PROM doubles size and adds I/O ports... NEWS, ED 23, p. 15

Univac system employs distributed CPU complex... NEWS, ED 14, p. 18

Use defensive interfacing... ART, ED 13, p. 104

Video system has high program-store capacity... NEWS, ED 6, p. 19

Wang introduces a mini, drum plotter and printer... NEWS, ED 8, p. 19

Wang introduces family of CRT word processors... NEWS, ED 14, p. 18

16-k bit RAM has the same speed and lower dissipation/bit vs 4-k versions... PF, ED 7, p. 101

Consumer Electronics

Automotive charging regulator gives overvoltage and undervoltage warnings... IFD, ED 6, p. 104

Computer-on-a-wrist also tells time and date... NEWS, ED 1, p. 21

Consumer electronics show highlights television games... NEWS, ED 15, p. 21

Delay circuits keep headlights on when needed; turn them off if you forget... IFD, ED 18, p. 114

Digital devices abound at New York boat show... NEWS, ED 3, p. 26

Digital time-delay device greatly enhances living room acoustics... NEWS, ED 16, p. 30

Electronic linesman decides where the tennis ball bounces... NEWS, ED 9, p. 20

GM develops a/d circuit for auto applications... NEWS, ED 9, p. 15

Getting electricity to work for man... SR, ED 4, p. 78

Home TV to double as terminal, information and game center... NEWS, ED 2, p. 26

Improve conventional ignition systems with a transistor-assisted approach... IFD, ED 13, p. 118

'Intelligent' turntable contains μ P and LED in playback assembly... NEWS, ED 16, p. 28

Microwave oven contains a calculator chip... NEWS, ED 17, p. 22

Personal computing—the next consumer boom... NEWS, ED 18, p. 22

Prompting calculator and \$19.95 watch from TI... NEWS, ED 3, p. 13

Simple battery charger for gel cells detects full charge and switches to float... IFD, ED 15, p. 120

Switch to digital accelerates in radios, phones and satellites... SR, ED 26, p. 24

μ C-controlled pinball machine diagnoses its own troubles... NEWS, ED 23, p. 22

30-second diagnostic test developed for cars... NEWS, ED 8, p. 20

1977 automobile to conserve fuel with a μ P-based ignition system... NEWS, ED 19, p. 53

Displays & Electro-Optics

Bar-graph display driver contains all necessary circuitry... PF, ED 9, p. 113

Cathodochromic CRT stores image indefinitely, erases easily... NEWS, ED 2, p. 30

Color LEDs gain in brightness, reliability... NEWS, ED 9, p. 16

Color-TV picture tube is better and cheaper... NEWS, ED 7, p. 22

Corning introduces 200-MHz optical cable... NEWS, ED 18, p. 22

Device emits all colors with applied voltage... NEWS, ED 24, p. 22

Display-blanking circuit saves power, improves readability... IFD, ED 22, p. 188

Display letters and symbols on a 7-segment numerical display... IFD, ED 25, p. 108

Enhance LED visibility... ART, ED 17, p. 62

Ensure uniform LED-display brightness with these simple design tips... IFD, ED 17, p. 96

First flight tests planned of full fiber-optic interface... NEWS, ED 2, p. 34

Flexible CRT terminals have many data handling features... PF, ED 19, p. 152

FOCUS on photodetectors... SR, ED 6, p. 60

Graphic display to compete with costly refresh systems... NEWS, ED 10, p. 27

Holographic ROM stores 200 Mb on microfiche... NEWS, ED 19, p. 22

Pace of new laser developments quickens both in and out of the lab... NEWS, ED 21, p. 24

Pay attention to LED temperatures... ART, ED 9, p. 74

Photodiode and control IC come in transparent DIP... PF, ED 12, p. 176

Photodiode preamp available in small packages... NEWS, ED 21, p. 30

Photoresistor provides automatic dimming of electronic display systems... IFD, ED 11, p. 98

Portable color TV camera's size, power drain halved... NEWS, ED 6, p. 34

Promising optical fibers developed by Corning... NEWS, ED 20, p. 22

Prototype optical telephone link being tested by Bell Laboratories... NEWS, ED 18, p. 32

Speech/hearing aid uses infrared light transmitter... NEWS, ED 18, p. 34

Stabilize optical-sensing systems... ART, ED 26, p. 72

Telephone and data transmission via fiber optics is being pushed... SR, ED 8, p. 42

Where is Natalia Marakova's tutu? It was there a minute ago... NEWS, ED 16, p. 32

Whether the input is analog or digital, in displays the CRT is still No. 1... NEWS, ED 17, p. 26

Your own message is screened onto this gas-discharge display unit... PF, ED 5, p. 86

General Industry

Antenna tracks a key to learning star formation... NEWS, ED 22, p. 26

Biggest Wescon show since 1970 is expected... NEWS, ED 15, p. 22

Cheap sun power by '85 is Government's aim... NEWS, ED 2, p. 21

Compressing the world of electronics... SR, ED 4, p. 118

Deluge of LSI circuits may cause log-jams in systems designs... NEWS, ED 1, p. 26

Jay Forrester: A computer pioneer predicts society's future... SR, ED 12, p. 112

Fuel-cell power plant to generate 27 MW... NEWS, ED 19, p. 21

Largest solar-energy plant to be built... NEWS, ED 8, p. 20

Pentagon C³ investment will rise by FY1982... NEWS, ED 22, p. 25

Photovoltaic applications studied by NASA and ERDA... NEWS, ED 16, p. 21

Reduce circuit manufacturing costs... ART, ED 15, p. 104

Sun, water combination seen as energy source... NEWS, ED 11, p. 22

Taking the crucial step for modern technology... SR, ED 4, p. 98

Understanding that nature obeys rules, too... SR, ED 4, p. 66

Industrial Electronics

Acoustical die monitor will warn of faults... NEWS, ED 18, p. 21

Analog servo system puts live actors in mini sets... NEWS, ED 11, p. 30

Circuit converts voltages to 4-20 mA for industrial current-control loops... IFD, ED 1, p. 116

ANNUAL INDEX

Computerized system to unspool Rio's traffic... NEWS, ED 1, p. 22

Computers are everywhere—in cars, trucks, trains and even taxi meters... SR, ED 22, p. 66

Efficient switching controller drives low-power dc servo motor... IFD, ED 10, p. 110

Electronic fingerprints compete with ID cards for access control... NEWS, ED 19, p. 30

FOCUS on high voltage power supplies... SR, ED 13, p. 68

In all areas, the hardware is becoming ever more intelligent... SR, ED 22, p. 60

Nontracking solar concentrator developed... NEWS, ED 9, p. 16

Party-line intercom system needs only three wires... IFD, ED 16, p. 76

Quartz xtal oscillator charts urban pollutants... NEWS, ED 12, p. 45

Small dictation machine has electronic controls... NEWS, ED 13, p. 24

Smart industrial robot sees whatever it's supposed to do... NEWS, ED 26, p. 30

Time-shared network will aid research on nuclear fusion... NEWS, ED 13, p. 23

Wanted: a robot that thinks for itself... SR, ED 12, p. 67

27 geophones protect miners from rock bursts... NEWS, ED 18, p. 21

Management

Al Cookson of ITT Speaks On Boosting R&D Output... ART, ED 25, p. 100

Bern Dibner of Burndy Speaks on Our Technological Heritage... SR, ED 4, p. 130

Teitaro Hiraga of TDK Speaks On Creating the Creative Atmosphere... ART, ED 9, p. 80

Orion Hoch of AMS Speaks On Making Your Engineers Responsible... ART, ED 21, p. 72

Grace Hopper: 'It's rewarding trying to do things in a new way'... SR, ED 22, p. 82

Taro Kuninobu of Matsushita Speaks On Managing by the Managed... ART, ED 11, p. 88

Floyd Kvamme of National Semiconductor Speaks on Stimulating Your Engineers... ART, ED 19, p. 114

Tadashi Nakamura of ISE Electronics Speaks On Developing Your Engineers... ART, ED 6, p. 96

Ulrich Rohde of Rohde & Schwarz Speaks On European and American Engineers... SR, ED 24, p. 96

Isao Someya of Nippon Electric Speaks On Educating Engineers... ART, ED 16, p. 72

Nick Tagaris of Datel Speaks On How to Get The Most Out of A Small Engineering Force... SR, ED 12, p. 152

Howard Vollum, Bill Peek and Wim Velsink of Tektronix Speak on The Future of the Scope... SR, ED 24, p. 68

Shozo Yokogawa of Yokogawa Electric Speaks on Interfacing Engineers with others... ART, ED 1, p. 110

Materials & Packaging

Compare electrical insulators... ART, ED 11, p. 72

Conductive elastomers... ART, ED 23, p. 60

Conversion efficiency up for CdS-CuS solar cell... NEWS, ED 23, p. 15

Edge-board connector protection is discussed... NEWS, ED 6, p. 20

High voltage encapsulant triples voltage ratings... NEWS, ED 10, p. 28

FOCUS on adhesives and coatings... SR, ED 23, p. 40

Insulate with plastics and elastomers... ART, ED 13, p. 86

Keep modular supplies going... ART, ED 13, p. 78

Laser rods better than neodymium YAG... NEWS, ED 23, p. 16

Listen to the sound: the part is corrodng... NEWS, ED 7, p. 21

Plastic-blade stripper handles multi-wire cables... PF, ED 7, p. 104

Prototype CRT enclosures use plastic for low cost... PF, ED 25, p. 144

Rf-tight enclosures... ART, ED 6, p. 90

Solderless interconnect system shown by Augat... NEWS, ED 26, p. 19

Technique controls atomic layers of crystal... NEWS, ED 21, p. 20

Thin films raise solar collector efficiency... NEWS, ED 10, p. 27

Medical Electronics

Acoustic holography gets sharper pictures of organs in human body... NEWS, ED 13, p. 38

Computerized X-ray systems provide 3-D view of whole body... NEWS, ED 11, p. 26

Everest climbers to carry medical data sensors... NEWS, ED 15, p. 22

Heart-beat monitoring circuit provides steady output and a missed-beat alarm... IFD, ED 26, p. 82

High accuracy scale measures body-weight... NEWS, ED 12, p. 46

Measure pulse-rate ratios... ART, ED 24, p. 136

Pocket calculator can provide bio-rhythm data... NEWS, ED 3, p. 13

Two systems under study to peer inside arteries... NEWS, ED 4, p. 37

Microprocessors

Action is in interfacing and testing μ Ps and microprocessor systems... SR, ED 18, p. 54

Base your IC tester on a μ P... ART, ED 1, p. 88

Benchmark testing of μ Ps is still popular despite its limitations... SR, ED 12, p. 92

Bipolar bit-slice μ Ps shrink the size and cost of minis and controllers... NEWS, ED 10, p. 34

Boost μ P bit-manipulation capability... ART, ED 5, p. 56

Bring up your μ P... ART, ED 15, p. 80

Build a compact microcomputer... ART, ED 10, p. 84

Built a glitchless microprocessor clock with only a two-chip divider... IFD, ED 6, p. 102

CMOS microprocessor for temperature and noise immunity... NEWS, ED 15, p. 53

Consider the 6100 CMOS microprocessor... ART, ED 23, p. 50

Control logic for μ P enables single-cycle operation... IFD, ED 21, p. 78

Control the data rate of a μ P system with software instructions... IFD, ED 24, p. 172

Convert all your synchro channels... ART, ED 25, p. 78

Current crop of 8-bit μ Ps draws ire of a system designer... NEWS, ED 9, p. 39

Custom LSI or μ Ps? That is often the question... NEWS, ED 15, p. 26

Design a μ P analyzer... ART, ED 18, p. 82

Digital controls and μ Ps to infiltrate all areas of consumer electronics... NEWS, ED 1, p. 38

Displays don't trouble 8-bit μ Ps... ART, ED 7, p. 68

Dual μ Ps simplify interactive terminal operation... NEWS, ED 26, p. 40

ECL bit-slice processor arrives, setting top speed for bipolar μ Ps... PF, ED 10, p. 53

Enhanced 8080 cuts component count while new support circuits add flexibility... PF, ED 25, p. 53

FOCUS on microprocessors... SR, ED 7, p. 58

Fortran compiler offered for μ P design system... NEWS, ED 20, p. 21

From data to process systems, μ Ps are reshaping designs... NEWS, ED 1, p. 42

Getting to know the Cosmac... ART, ED 22, p. 136

High-level languages, more throughput expected for next generation of μ Ps... NEWS, ED 12, p. 117

Incorporate a calculator chip... ART, ED 1, p. 96

Instrument analyzes μ P systems in both data and time domains... PF, ED 20, p. 51

Introduction to microprocessors... ART, ED 9, p. 59

Just getting into microprocessors? Odds are you'll end up with a kit... NEWS, ED 1, p. 46

Keep the PACE up and running... ART, ED 25, p. 64

Lack of standards slows progress of analog interfacing for μ P systems... NEWS, ED 7, p. 30

GET FETs

FOR
RF,
AUDIO,
VIDEO,
MIXERS,

SIGNAL SWITCHING,
CURRENT SOURCES,
HIGH VOLTAGE

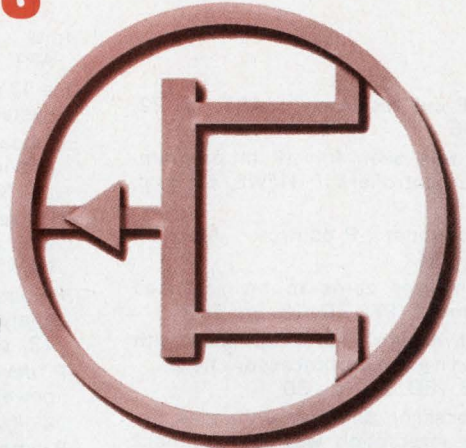
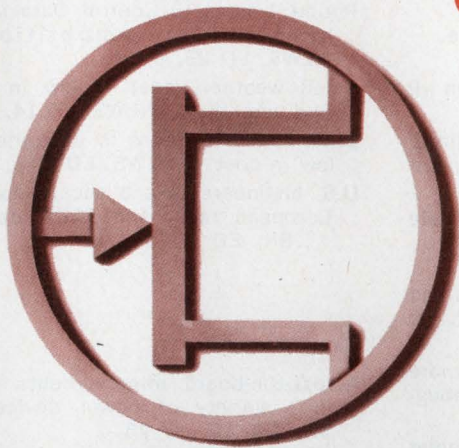

Dial **(415) 968-9241** for samples or design help

It's that simple. Just ask for Walter Wong. He'll be glad to help you decide which of our broad FET line will meet your need and how to use it best. Or drop him a line on your company letterhead. He'll send your sample by return mail.

FETs for all applications. Whatever you're designing—if it's a function FETs can handle—you can be sure we'll have a FET with the precise characteristics to meet your need. You can be sure, too, that the performance of production orders will be consistent with the samples you test.

Profit by our experience. We've been making

FETs longer than anyone else. We have a longer reliability history (ask about our involvement in Hi Rel programs, for instance). We lead the industry in high voltage FETs; in monolithic duals for matched performance. And we're price-competitive across the board.

Ask for applications help. If you'd like design assistance in the best use of FETs for your specific application, just ask. If your need is more general, our FET Application Data Book is just off the press. It, too, is yours for the asking. So dial our number today and ask.

 **TELEDYNE SEMICONDUCTOR**

1300 Terra Bella Avenue, Mountain View, California 94043 Tel: (415) 968-9241 TWX: 910-379-6494 Telex: 34-8416
SALES OFFICES:
DOMESTIC: Salem, N.H. (603) 893-9551; Stony Brook, N.Y. (516) 751-5640; Des Plaines, IL (312) 299-6196;
Los Angeles, CA (213) 826-6639; Mountain View, CA (415) 968-9241 • INTERNATIONAL: Hounslow,
Middlesex, England (44) 01-897-2503; Tiengen, West Germany 7741-5066; Kowloon, Hong Kong 3-240122;
Tokyo, Japan 03-405-5738.

ANNUAL INDEX

- Let a μ P cut test time... ART, ED 22, p. 156
- Limited role seen for μ P in programmable controllers... NEWS, ED 5, p. 15
- Log data under μ P control... ART, ED 10, p. 94
- Logic analyzer zeros in on μ P-based systems... PF, ED 18, p. 131
- Low-cost design aids keep pace with growing microprocessor field... NEWS, ED 25, p. 30
- Microprocessor analyzer enhances operator interaction with development systems... PF, ED 17, p. 51
- Microprocessor analyzer rearranges captured data into unusual displays... PF, ED 17, p. 129
- Microprocessor analyzer untangles knots in both software and hardware... PF, ED 14, p. 75
- Microprocessors continue to improve instruments and testing concepts... SR, ED 10, p. 71
- Micros help automate weather sensing for U.S. Air Force... NEWS, ED 18, p. 35
- PLAs or μ Ps? At times they compete, and at other times they cooperate... NEWS, ED 18, p. 24
- Pedal exerciser with built-in μ P quickly reveals your fitness level... NEWS, ED 17, p. 38
- Performance of military systems monitored by μ Ps... NEWS, ED 18, p. 21
- Popular μ P bit slice has an even better twin... NEWS, ED 26, p. 19
- Put microprocessor software to work... ART, ED 16, p. 58
- Put together a complete microcomputer... ART ED 15, p. 66
- R/d converter handles 8 channels under μ P control... PF, ED 12, p. 172
- Second generation CMOS microprocessors rival performance of n or p-channel units... NEWS, ED 6, p. 47
- Second generation microcomputer takes on multiprocessing applications... PF, ED 18, p. 63
- Separate I/O instructions for μ Ps will disappear in future systems... ART, ED 23, p. 35
- Simplified 16-bit microprocessor is easier to use... PF, ED 21, p. 42
- Simultaneous analog outputs... ART, ED 15, p. 88
- Starting μ P software... ART, ED 25, p. 74
- Thanks to μ Ps, the trend is to lower cost and improved performance... SR, ED 22, p. 52
- There is still a lot of guesswork attached to microprocessor testing... NEWS, ED 22, p. 115
- Three microprocessors can be better than one... NEWS, ED 22, p. 25
- Three μ Ps share memory and drive machine tools... NEWS, ED 15, p. 21
- Unite μ P hardware and software... ART, ED 7, p. 74
- Use TTY or CRT interchangeably on μ P system... IFD, ED 24, p. 174
- μ C board sizes will be standardized, provided that customers demand it... NEWS, ED 16, p. 43
- μ P-based desk-top computers compete with minis and graphic terminals... NEWS, ED 5, p. 29
- μ P computers keep bowling scores and analyze weather patterns... SR, ED 12, p. 62
- μ P development systems need more power to speed up software debugging... NEWS, ED 21, p. 41
- μ P improves accuracy of data-tablet digitizer... NEWS, ED 16, p. 44
- μ P in radio scanner finds 12,000 frequencies... NEWS, ED 13, p. 23
- μ Ps in minicomputer systems... ART, ED 22, p. 148
- 16-bit microprocessors speed things up in high precision computing... ART, ED 14, p. 35
- 16-bit μ Ps increase in speed and density... NEWS, ED 6, p. 20
- 2650 microprocessor... ART, ED 18, p. 70
- ## Military & Aerospace
- Air Force forms library of software abstracts... NEWS, ED 10, p. 28
- Air Force looks at LCs for cockpit display... NEWS, ED 3, p. 14
- Approaching the age of space exploration... SR, ED 4, p. 108
- Army computer system a super problem solver... NEWS, ED 24, p. 22
- Army opens \$40-million missile flight simulator... NEWS, ED 4, p. 22
- B-1 has first radiation-hardened digital avionics... NEWS, ED 4, p. 37
- Calculator-timer makes life easier for light-aircraft pilots... NEWS, ED 23, p. 24
- F-16 radar system to contain high-level digital processing... NEWS, ED 11, p. 21
- In avionics, distributed processing has become a way of life... SR, ED 22, p. 74
- JEDEC package outlines are now available... NEWS, ED 24, p. 21
- Marines test ground-unit concept before buying... NEWS, ED 15, p. 21
- NASA tests solar cell for home and industry... NEWS, ED 10, p. 28
- Navy builds compact MJ energy storage system... NEWS, ED 2, p. 22
- Navy radar antenna does two jobs... NEWS, ED 13, p. 24
- Old and new techniques guided Viking to Mars... NEWS, ED 17, p. 21
- Pulse-compression antenna converts milliwatts to watts... NEWS, ED 14, p. 26
- RPVs get millimeter-wave radar... NEWS, ED 15, p. 42
- Round 1 goes to Control Data in airborne-computer competition... NEWS, ED 23, p. 26
- Small weather radar is low in cost, and versatile... NEWS, ED 14, p. 21
- Strap-down navigator is accurate and low in cost... NEWS, ED 9, p. 16
- U.S. engineers take a second look at European radar and ECCM designs... SR, ED 10, p. 78
- ## Semiconductors
- Across-the-board improvements made in a variety of power devices... SR, ED 10, p. 75
- Bipolar technologies to compete with CMOS and ECL... NEWS, ED 5, p. 18
- CCDs reach practical stage for analog signal processing... NEWS, ED 7, p. 34
- Charge transfer technology used in sonic imager and signal correlator... NEWS, ED 19, p. 22
- Consider CCDs for a wide range of uses... ART, ED 6, p. 70
- Electron-beam IC technology goes commercial in 1977... NEWS, ED 23, p. 20
- Electron Devices Meeting to discuss V MOS progress... NEWS, ED 21, p. 19
- Eliminate static damage to circuits... ART, ED 7, p. 80
- FETs to switch high currents... ART, ED 9, p. 66
- Major solar-cell programs strive to lower cost, improve efficiency... NEWS, ED 6, p. 24
- MOS technology continues to replace bipolar devices in most areas... SR, ED 12, p. 78
- Pick the right p-i-n diode... ART, ED 17, p. 82
- Semis invade medical transducers; μ Ps monitor EKG and blood pressure... NEWS, ED 19, p. 28
- Superconducting diode mixer gives par-amp noise figure... NEWS, ED 15, p. 42
- Test diodes for recovered charge... ART, ED 5, p. 50
- Turn-off gains of 1000 possible with GTO SCRs... PF, ED 5, p. 80
- 10 & 15-A transistors switch fast and have high gain... PF, ED 7, p. 112
- 12-bit MDAC boasts MIL rating in 18-pin DIP... PF, ED 12, p. 174
- 150-V Schottky power diodes developed at GE... NEWS, ED 8, p. 19
- ## Test & Measuring
- Ac source regulates output as both line and load change... PF, ED 10, p. 160

AM detector deflutters analog-signal tape outputs with only three IC packages...IFD, ED 22, p. 186

Angle-position indicator shrinks in size but not performance...PF, ED 18, p. 126

Battery monitor operates on only a few microamperes...IFD, ED 22, p. 188

Brainy instruments take top honors with computer power that boggles the mind...SR, ED 24, p. 52

Build a simple fire alarm with metal-oxide temperature sensors...IFD, ED 9, p. 88

Build precision reference sources...ART, ED 14, p. 56

Burn-in system tickles ICs with programmable patterns...PF, ED 12, p. 180

Calibration devices are better because the basic standards are more precise...SR, ED 24, p. 104

Chopper amplifier for thermocouples has long-term drift of only 0.5 μ V/yr...IFD, ED 16, p. 78

Combined instrument often provides capabilities that exceed the sum of its parts...SR, ED 24, p. 88

Compact high-voltage supply stands tall in performance...PF, ED 16, p. 100

Compact 12-bit s/d converter cuts size, weight by 50%...PF, ED 24, p. 209

Companding d/a converters give 72-dB dynamic range with 8-bit inputs...PF, ED 9, p. 111

Consider v/f converters...ART, ED 24, p. 160

Control a switching power supply with a single LSI circuit...PF, ED 13, p. 125

Cut size, weight and cost with hybrid s/d converters...PF, ED 19, p. 140

DPM building blocks make 93 different instruments...PF, ED 24, p. 183

Data-acquisition modules keep costs low and performance high...PF, ED 6, p. 134

Digital probe shows voltage, duty cycle and signal quality...IFD, ED 2, p. 84

Diodes act as a temperature sensor in remote temperature-measuring circuit...IFD, ED 26, p. 81

Display formatter brings new power to logic troubleshooting...PF, ED 18, p. 121

Divide frequencies by nonintegers...ART, ED 18, p. 104

Don't sweat with thermocouple thermometers...ART, ED 24, p. 146

Electron-beam pictures reveal hidden defects in LSI chips...NEWS, ED 14, p. 20

Fastest pulse generator blazes at 1-GHz rep rate...PF, ED 15, p. 161

FOCUS on digital voltmeters...SR, ED 20, p. 62

FOCUS on IC testers...SR, ED 9, p. 48

We've got

R D Q

Reliability Dependability Quality

Servo-Tek's reputation for superiority in the control and measurement field is based on our ability to produce products of matchless reliability, dependability and quality at truly economical prices. We are known for our efficient, modern production methods and innovative engineering programs.

Our complete line of instrument-type dc generators, dc servomotors, adjustable-speed drives, Bi-Mode servos, analog and digital speed indicating systems, control meter relays and low ripple generators are produced under rigid quality control.

Our repeat list of customers, the nation's top industrial and commercial manufacturers, know they can rely on Servo-Tek's RDQ.

FREE CATALOG of rotating components available.

SERVO-TEK

PRODUCTS COMPANY

1086 Goffle Road
Hawthorne, NJ 07506
201-427-3100

Servo-Tek of California, Inc.
8155 Van Nuys Boulevard
Van Nuys, CA 91402
213-786-0690

SERVO-TEK
ALL AMERICAN
ENGINEERED

ANNUAL INDEX

FOCUS on network analyzers...SR, ED 16, p. 50

Function generator plays dual role as fast amplifier...PF, ED 18, p. 125

Handle 100-V analog signals with 10-V ICs by using a divide/multiply technique...IFD, ED 19, p. 122

Head off dc/dc-converter problems...ART, ED 17, p. 72

Hybrid isolation amplifier avoids transformers but maintains isolation...PF, ED 2, p. 91

IC tester offers 1000 programs by phone...NEWS, ED 11, p. 22

Improved Schottky diode tests for ozone...NEWS, ED 7, p. 22

Inductosyn/digital converter modules offer top resolution...PF, ED 16, p. 85

Instruments designed with safety in mind may be hazardous to your health...SR, ED 24, p. 114

12 L design cuts down DPM's component count...NEWS, ED 22, p. 26

Keep your power flowing...ART, ED 5, p. 62

Lab power supply adjusts itself for constant power...PF, ED 15, p. 144

Logarithmic amplifier's range is extended down to 1 pA...IFD, ED 14, p. 66

Logic probe built from IC timer is compatible with TTL, HTL and CMOS...IFD, ED 12, p. 156

Low-cost DPM carries impressive spec sheet...PF, ED 5, p. 76

Low-cost data-acquisition systems...ART, ED 24, p. 152

Measure signal peaks accurately...ART, ED 17, p. 90

Measure small capacitance at the end of a long cable...IFD, ED 4, p. 170

Measure the characteristic impedance...ART, ED 24, p. 136

Measuring capacitor loss...ART, ED 24, p. 130

Midget d/a delivers 18-bit performance...NEWS, ED 25, p. 22

Mum's the word for electrothermal relay...NEWS, ED 22, p. 26

Ocean seismic device smaller, uses less power...NEWS, ED 17, p. 22

Opto-isolator in fuse monitor keeps indicators at ground potential...IFD, ED 12, p. 158

Portable instruments: The specs are fine, but their batteries are still short-lived...SR, ED 24, p. 60

Power-supply voltage changed 2:1 with SPDT switch arrangement...IFD, ED 4, p. 174

Precise voltage division without precision parts...IFD, ED 21, p. 80

Precision instrumentation amplifier built with general-purpose op amps...IFD, ED 3, p. 72

Precision voltage-to-frequency converter uses only single supply voltage

...IFD, ED 21, p. 82

Pressure transducer to sell for less than \$20...NEWS, ED 5, p. 16

RCA introduces biMOS op amp to replace 741...NEWS, ED 12, p. 45

Rf and microwave test equipment getting more automatic and smarter...SR, ED 8, p. 64

Sampling head measures electro-optic pulses...NEWS, ED 16, p. 22

Say goodbye to 'traditional' as instruments change in 3 ways...NEWS, ED 1, p. 32

Scope built in FM tuner monitors quality of audio and rf reception...NEWS, ED 16, p. 26

Scope combines fast storage and real-time operation...PF, ED 23, p. 79

Shutterbugs bait 'Nessie' in search for fabled monster...NEWS, ED 14, p. 17

Simple transistor circuits speed power-supply testing...IFD, ED 3, p. 75

Smart DVM stays on the job while its plug-in reference is calibrated...PF, ED 17, p. 105

Spectrometer system uses a minicomputer...NEWS, ED 3, p. 14

Speed up your linear circuits...ART, ED 25, p. 92

Standard clears up DMM/DVM accuracy specs...NEWS, ED 20, p. 21

Telemetry link to home will control power loads...NEWS, ED 1, p. 22

Temperature-measuring bridge uses constant-current FET circuits...IFD, ED 20, p. 98

Test modules with LEDs check out PC connects...NEWS, ED 8, p. 19

Three-digit DVM chip requires only 30 mW...PF, ED 10, p. 132

Timer chip becomes meter that detects capacitance changes of 1 part in 10^6 ...IFD, ED 5, p. 70

Transient testing is spreading to systems designers...NEWS, ED 10, p. 42

Ultrasonics shows flaws in solids in 3-D...NEWS, ED 23, p. 16

Uninterruptible power supply delivers five output voltages...PF, ED 9, p. 117

Unusual heterodyne system capable of detecting huge Doppler shifts...NEWS, ED 9, p. 24

Versatile analog multiplier/divider built with three standard ICs...IFD, ED 1, p. 118

Voltage-controlled oscillator provides symmetrical triangular and square waveforms...IFD, ED 24, p. 170

Voltage-to-current converter built with few components...IFD, ED 15, p. 116

Wideband rms-to-dc module has high accuracy, low cost...PF, ED 13, p. 148

μ W generator produces most power pulses...NEWS, ED 14, p. 17

40-MHz function generator grabs top-frequency honors...PF, ED 5, p. 75

50-MHz portable oscilloscope lets you compare four signals...PF, ED 6, p. 111

Reader Service Index

The Cannon Microminiature Connectors



If the insert to the right has been removed circle **Reader Service Card No. 101** and one will be sent to you.

For complete information on Cannon[®] microminiature connectors and interconnect systems please circle **Reader Service Card No. 103.**

ITT Cannon Electric,
666 East Dyer Rd.,
Santa Ana, Ca. 92702.
Toll-free 24-hrs.
(800) 854-3573;
In California, (800)
432-7063. (And be sure to check EEM for all your Cannon connector needs.)

Six decades on the leading edge of interconnect technology

CANNON ITT

When you need small
connectors, and dense
packaging, who can solve
your biggest problems?



Cannon can!

Six decades on the leading edge of interconnect technology

CANNON ITT

Cannon's Small World

PRODUCT OFFERING

CANNON'S GOT IT

CANNON'S TWIST PIN CONTACTS* SYSTEM IS COMMON TO ALL CONNECTORS IN THE MICROMINIATURE SERIES.

Heart of the Twist Pin Contacts system, from ITT Cannon Electric, is a multi-element male twist pin recessed within an insulating housing. The rugged, cylindrical sockets are mounted in the exposed half of the connector. When connector halves are mated, the chamfered sockets guide the twist pins into proper and positive alignment, even under worst case tolerance conditions.

The multiple twist pin spring elements, then under compression, form a multi-point contact of high mechanical and electrical integrity. This tried and true system is designed for fail-safe reliability over thousands of cycles of unplugging. We've made millions of Twist Pin contacts, and have seen them go many places ... like the moon.

THE BASIC SYSTEM INTERCONNECTION.

The system interconnections shown below are common elements in complete system assembly; a few examples of such system intercon-



Seeing is believing

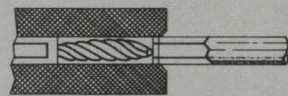

Ideal mating configuration

*Licensed by New Twist

nections are seen on the page to the right. These interconnection systems offer virtually unlimited flexibility in connector system harnessing and encompass printed circuit boards, flex circuitry and standard wire and cable.

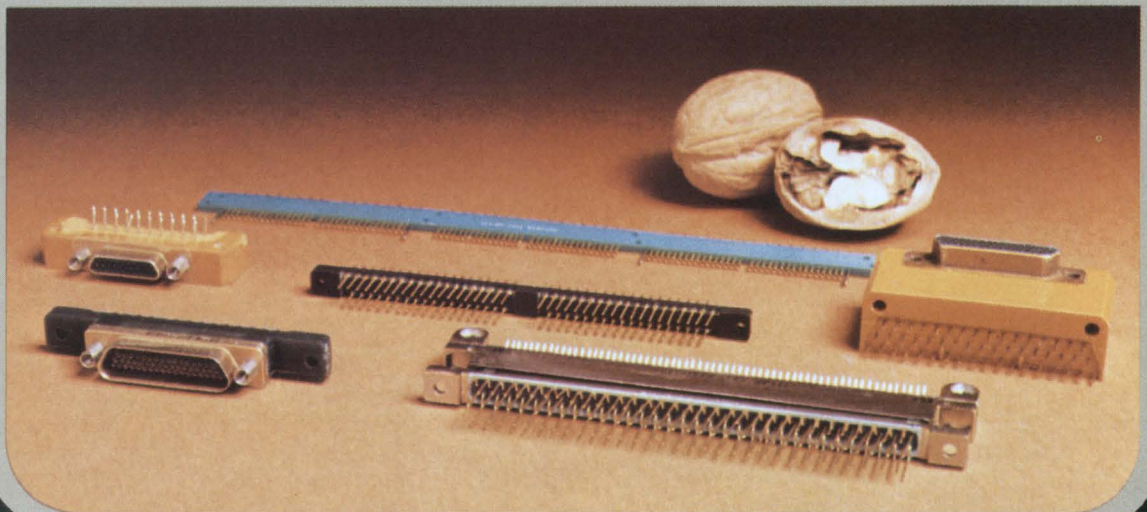

ALWAYS INNOVATIVE
CANNON'S GOT IT

COMPLETE SYSTEM INTERCONNECTION

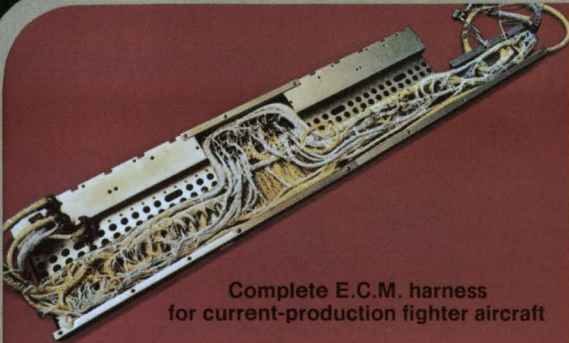

Complete E.C.M. harness
for current-production fighter aircraft

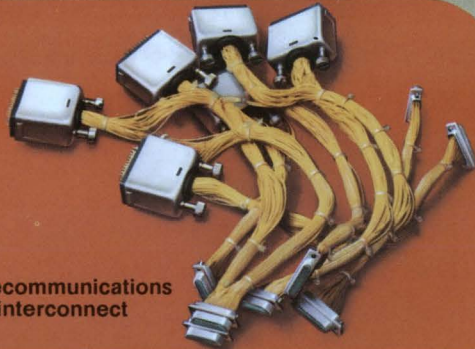

Telecommunications
interconnect

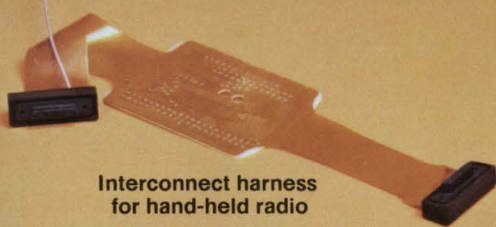

Interconnect harness
for hand-held radio

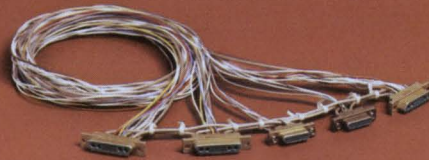

Black box interconnect harness

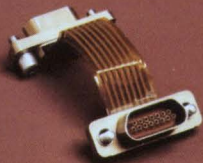

Space saver harness
with flex circuitry



Terminal interconnect,
PCB maintainability

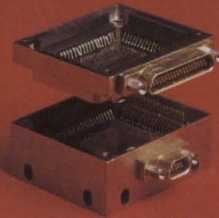

Modular stacking interconnection devices



Interconnect harness for inertial navigation platform

ALWAYS INNOVATIVE

CANNON'S GOT IT

CIRCULAR CONNECTORS



Threaded coupling plastic circulars (MIK) for use in space saving requirements where severe environmental conditions do not prevail. These micro connectors provide twice the number of contacts in shell sizes similar to our miniature circular connectors.

Threaded coupling metal shell circulars (MIKM) for use in rugged,



hostile environments where space is at a premium and high reliability is a must.



Quick disconnect metal shell circulars (MIKQ) for use where space & physical volume are at a premium. And where there is a high frequency of connect/disconnects with minimum effort required, as in medical instrumentation.

All miniature circular connectors are designed to meet MIL-C-38999.

NANO CONNECTORS

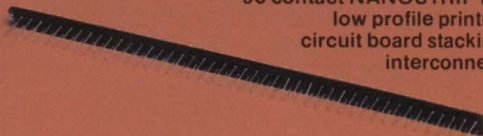

90 contact NANOSTRIP for low profile printed circuit board stacking interconnect.



Center jack screw inline plugs and receptacles on .025" centers used in inertial navigation systems and medical electronics implants (May be polarized to prevent cross-mating).



NANOSTRIP and metal shell connectors on .025" centers.



72 contact circular center jack screw inline configuration.

In these pages we've shown you a few examples of components and systems from over 40,000 microminiature interconnect configurations available, including complete lines of standard MICRO-D's, 50 MIL STRIP, CENTI-STRIP, Double Density D, plus custom designs.

QUICK ACTION GETS YOU ALL THIS...

Send today for our new total line micro products catalog and a Cannon Quick Action card. It contains an application sketch form that lets you show us your particular needs. Once you've completed the Quick Action card and returned it to us, we'll send you a free, old-fashioned apothecary jar filled with Cannon candy. ITT Cannon Electric, 666 E. Dyer Rd., Santa Ana, CA 92702. Toll-free, 24-hr. (800) 854-3573; in CA, (800) 432-7063. (And be sure to check the EEM Directory for all your Cannon Connector needs.)

Cannon can!

Six decades on the leading edge of interconnect technology.

CANNON ITT

Electronic Design Announces "Top Ten" Winners.



On the following pages you will see the advertisements from the January 4th issue of *Electronic Design* which won this year's "Top Ten" contest. In 1977, as in the past, thousands of *Electronic Design* subscribers around the world tried to match wits with our Reader Recall survey in picking the winners. The highest percent "Recall Seen" scores determined the winners. Look at the following pages and find out how well you rated. You may be a winner, perhaps of the Grand Prize — a week's vacation for two on a windjammer cruise in the Caribbean and \$1,000 in cash.

As you will see, the winning advertisements combine well-written copy with superior design to achieve impact and memorability. Here are the winners:

1. Dale Electronics, Inc.
 2. Cherry Electrical Products, Inc.
 3. Harris Semiconductor
 4. Hewlett-Packard
 5. Garry Manufacturing Co.
National Semiconductor Corp.
TRW/IRC Resistors (Electrical Components Div.)
 6. AMP, Inc.
 7. Robinson Nugent, Inc.
 8. Guardian Electric Mfg. Co.
- 

Dale makes your basics better.



More muscle in your resistors

Wirewound, metal film, carbon film, tin oxide... Dale's resistor line is stronger than ever. To match expanded capacity, we've installed a network of computer terminals to speed shipments and aid you in production planning. In addition, we've upgraded our quality assurance programs so that one out of every 10 Dale employees is directly involved with quality control. As a result, the Dale resistors you order are the best we've ever made...and the most efficient for you to buy.

CIRCLE NO. 351

More stretch in your connectors

Don't let the costs of tooling a special connector scrap your design. Dale's innovative ED line gives you dual readout .050" and .100" edgeboards that expand in length and number of contacts without tooling charges. This "stretchability" is also available in a line of digital display connectors. In addition, Dale can provide a variety of .156" edgeboards plus dip solder and rack and panel models. To find out more about the advantages of Dale connectors, circle the reply number or call 605-665-9301 today.

CIRCLE NO. 352

More punch in your trimmers

A trimmer's power rating should give you leeway to derate for assured long-term stability. Dale trimmers do. Our low profile 700 Series provides 1 watt at 70°C in both wirewound and cermet models and cermet models give you 1% CRV in the bargain. In single-turn square trimmers Dale's 3/8" 100 Series gives you a half watt clear up to 85°C in a choice of 5 top adjust and 3 side adjust models. Compare. We're the new source you've been looking for.

CIRCLE NO. 353



Higher Q in your inductors

Dale is steadily growing as a source for a wide range of inductors including: Flame retardant coated chokes with performance and durability comparable to molded models at a much lower price; filter inductors with a wide selection of Q vs frequency; trigger transformers interchangeable with 11Z types. In addition, we offer a versatile line of transformers including low power, converter and pulse models. Get complete price and delivery information by calling 605-665-9301 today.

CIRCLE NO. 354

More versatility in your networks

Dual-in-line, single-in-line standard or special circuits... Dale has what you need in thick film resistor networks. For custom circuits our SDP and SSP Series offer two ceramics with space for up to 28 resistors. New low profile SIP models and machine insertable DIP's solve packaging problems. We were the first to qualify to MIL-R-83401 and now offer 10 models meeting this spec. For network help, call 402-371-0080 today.

CIRCLE NO. 355



*Your man
from Dale
has a lot of
ways to help you
...call him today.*

DALE ELECTRONICS, INC.
1300 28th Avenue,
Columbus, Nebraska 68601
A subsidiary of The Lionel Corporation
In Canada: Dale Electronics Canada Ltd.
In Europe: Dale Electronics GmbH,
8 Munchen 60, Falkweg 51, West Germany

Our complete product line can be found in Electronic Design's GOLD BOOK.

CHERRY

and keep on working.

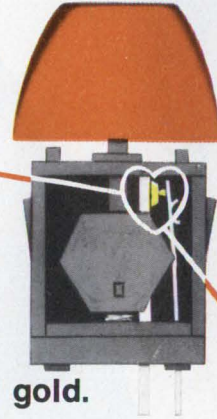
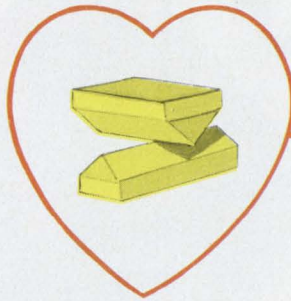

RELIABLE
because they have a heart of gold.

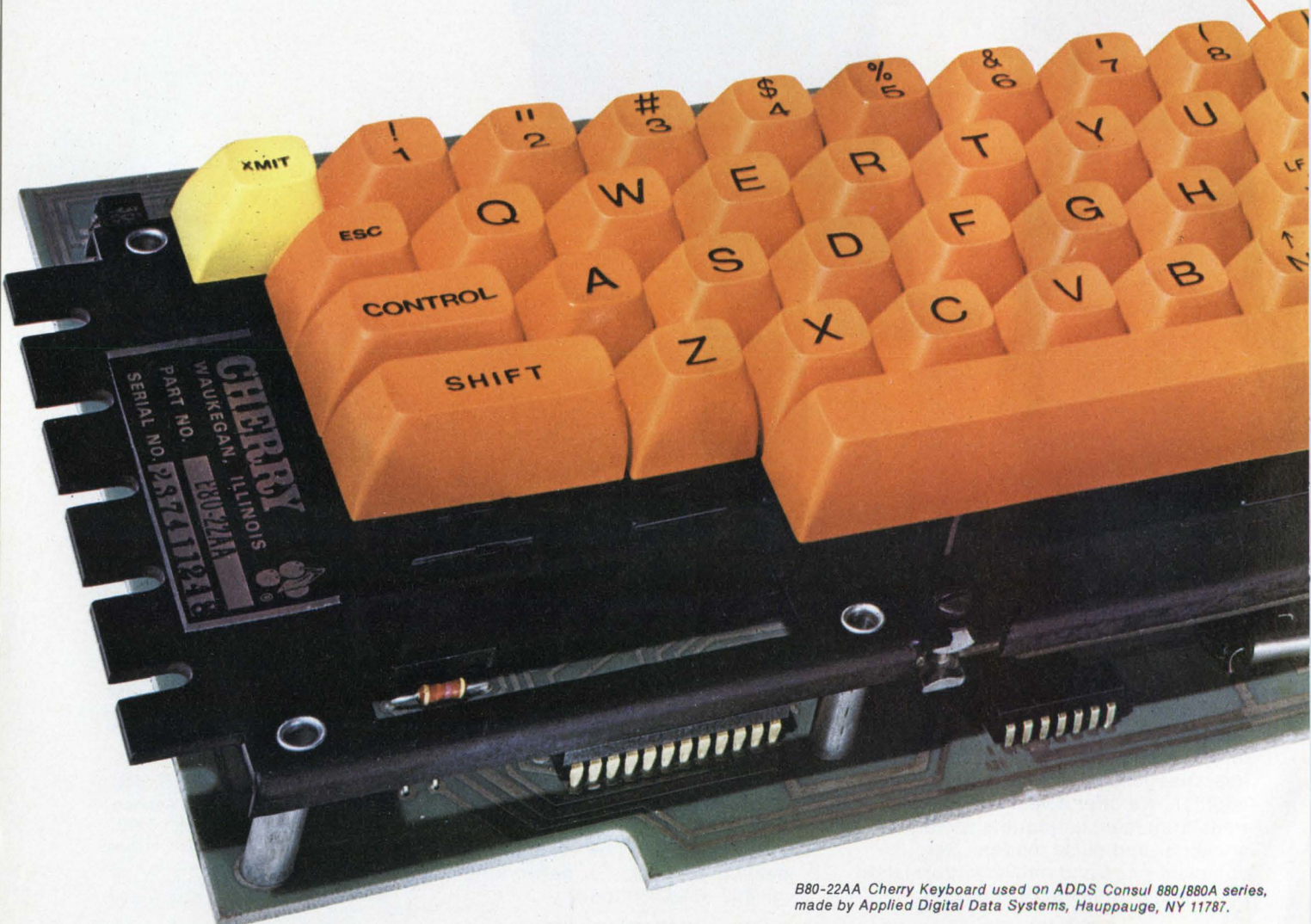

B80-22AA Cherry Keyboard used on ADDS Consul 880/880A series, made by Applied Digital Data Systems, Hauppauge, NY 11787.

keyboards work year...after year...after year.

Why are Cherry keyboards so reliable? One reason is that the gold crosspoint contacts at the heart of the keyswitches *just can't fail*. The knife-edge contact area is so small (9 millionths of a square inch) . . . the contact force so great (approximately 5,000 psi) . . . and the gold alloy so pure and film-free . . . you're absolutely assured of positive contact every time.

Another reason for Cherry keyboard dependability is our uniquely simple design that combines the most advanced technology with a minimum of component parts. This yields a product whose susceptibility to field failure is inherently low. A fact substantiated by the remarkable record Cherry keyboards have achieved in all kinds of environments and demanding applications—like remote terminals, data com-

munications and point of sale equipment.

Still another reason for this excellent field performance is that we build our keyboards from scratch. We start with raw materials and go all the way to the two-shot molded keycaps right in our own plant. Even the printed circuit board is a product of our in-house design and fabrication. Painstakingly bonded to this are the gold crosspoint contact key modules, TTL and other electronic components with all connections 100% wave soldered. Finally, a sturdy frame protects against shock.

Cherry's keyboards draw low power—both quiescent and in use—and generate clean IC logic signals. They are not temperature or humidity sensitive and can be designed to meet your specific requirement at surprisingly low cost.



PUT OUR "KEY MEN" TO WORK ON YOUR APPLICATION

Phone 312/689-7741 to talk directly with our Keyboard Group specialists. Or, get started with the help of these exclusive keyboard aids . . . free! Keyboard Designers' Specification Sheet Keycap Workbook Complete Keyboard and Switch Catalog.



SWITCHES and KEYBOARDS

Available locally from authorized distributors.

CHERRY



CHERRY ELECTRICAL PRODUCTS CORPORATION
3609 Sunset Avenue—Waukegan, IL 60085

CIRCLE NUMBER 67

Now AMP's most versatile interconnection system is even more so.

We've added a whole family of pin headers.



Top performance in a tiny space. AMPMODU posts, receptacles and headers make your packaging designs as tight as necessary.

We've also made it easier to place pins on a board. Forget about positioning pins one at a time. Forget costly front-end insertion equipment. Because AMP engineering ability shows up in our recently introduced AMPMODU pin headers.

Pins are fully protected. Headers are polarized and have self-retention locking latches. Headers fit everywhere on a board, including board center.

Ten basic header styles offer several thousand possible variations. You can approach mass termination with AMPMODU headers. Up to 80 positions.

These headers now complement the AMPMODU interconnection system, which features dual cantilever spring beams in the receptacle, five basic contact types and board to board or board to wire versatility. The forgiving nature of the receptacle design also ensures a uniform, positive electrical contact with the mating posts, everytime.

At AMP our application, service and sales engineers are located throughout the world, and are ready to help you with prototyping as well as providing a complete after-sale service.

For more facts about AMPMODU headers, write or call Customer Service. (717) 564-0100. AMP Incorporated, Harrisburg, PA 17105.

AMP

INCORPORATED

CIRCLE NUMBER 68

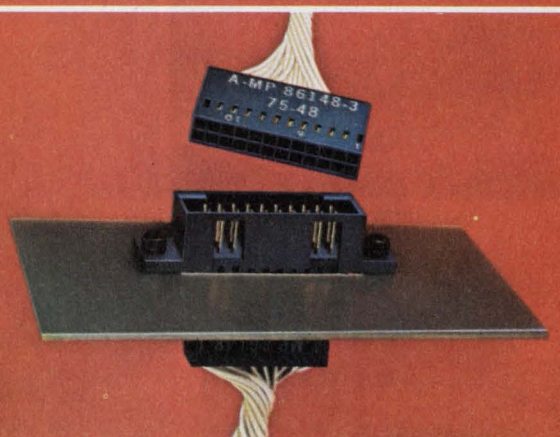
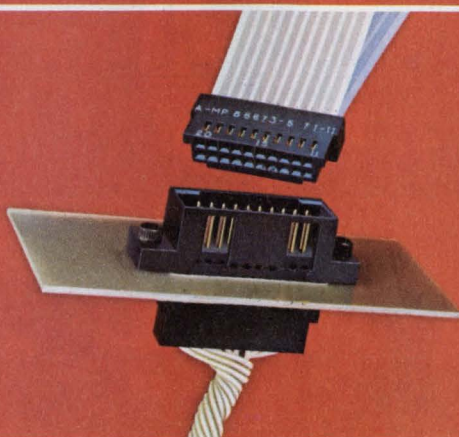
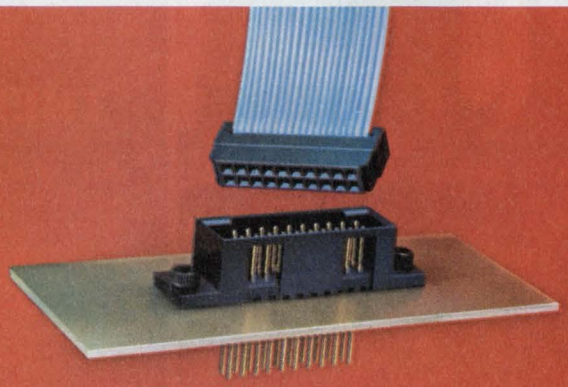
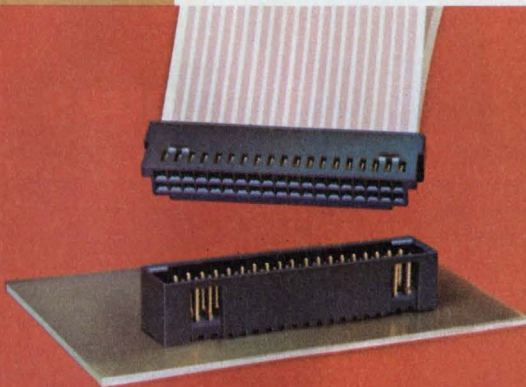

UNRETOUCHED

MICROPHOTOS



Arrows indicate scars and abrasions made by rough edge of lead frame.

22X magnification, unretouched.

THEIRS

An ordinary edge-bearing socket contact after 5 insertions of DIP lead frame. Contact has been spread apart to show inside faces of contact. Notice how the contact has scars and abrasions from rough, irregular edge of IC lead frame. Electrical contact is degraded and resistance is increased. Reliability is obviously reduced.

Lead frame in place in an ordinary edge-bearing contact.

Arrows indicate contact surface still smooth, clean, free from abrasions.

22X magnification, unretouched.

OURS

ROBINSON-NUGENT "side-wipe" socket contact after 5 insertions of DIP lead frame. Contact has been spread apart to show inside faces of contact. See how the RN contact—because it mates with the smooth, flat side of the IC lead frame—retains its surface integrity. This 100% greater lead frame contact results in continued high reliability.

Lead frame in place in RN "side-wipe" contact.

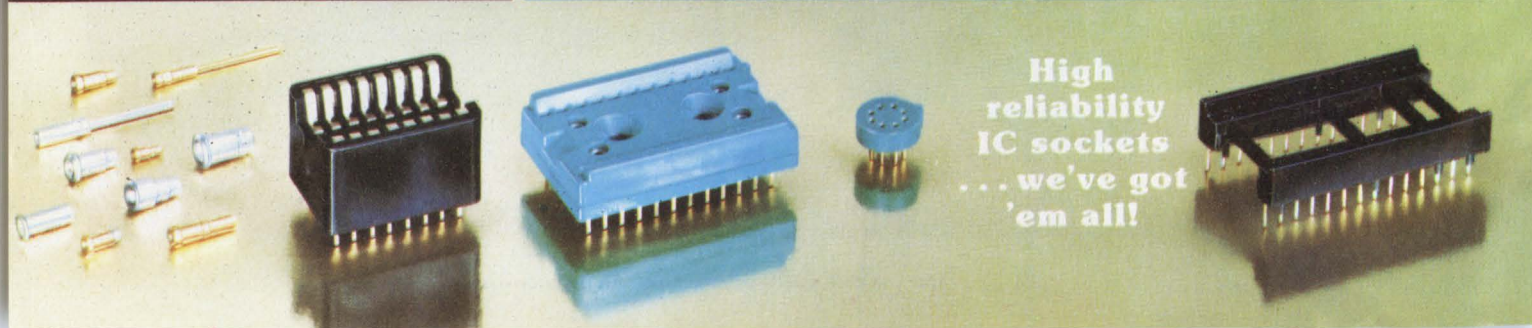

expose 'junk' socket problems

Secret of RN high reliability 'side-wipe' DIP sockets revealed by microphotos

Here's microscopic proof that high reliability Robinson-Nugent "side-wipe" DIP sockets make 100% greater contact than any edge-bearing socket on the market. This advance design provides constant low contact resistance, long term dependability—trouble-free IC interconnects. Yet RN high reliability DIP sockets cost no more than ordinary sockets!

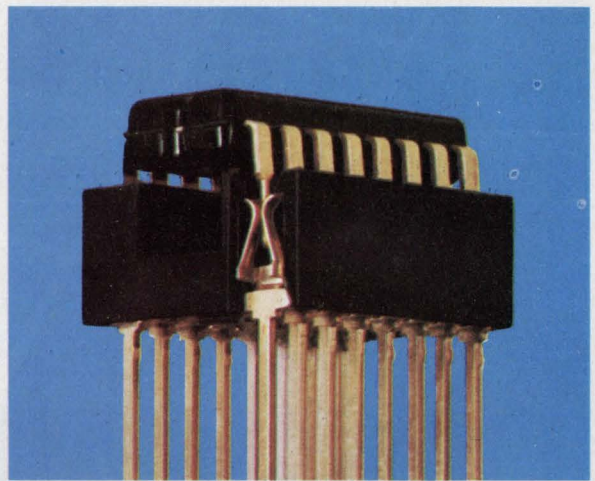

Get the high reliability that eliminates trouble. RN "side-wipe" DIP sockets make contact with the wide, flat sides of your IC leads. You get 100% greater surface contact for positive, trouble-free electrical connection.

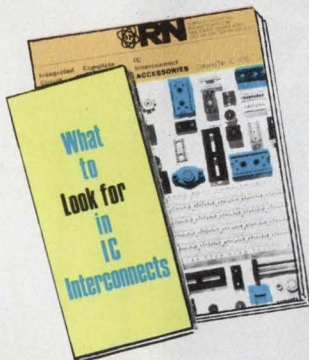

WRITE TODAY

for catalog and informative book "What to Look for in IC Interconnects." Free

from Robinson-Nugent—the people who make more kinds of high reliability IC sockets than anyone.

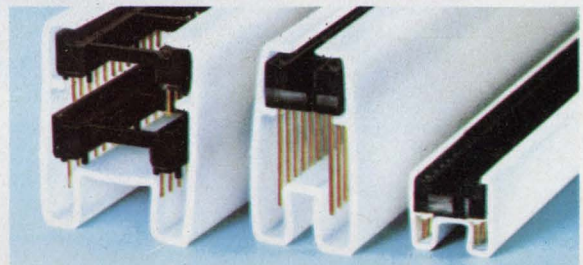

They're even packaged for high reliability. "Protecto-pak"® packaging delivers consistently perfect RN sockets to your production line—for automated or manual assembly.

RN **ROBINSON NUGENT, INC.**

800 East Eighth Street, New Albany, Indiana 47150 • Phone: (812) 945-0211

CALL ME, I'M INTERESTED CIRCLE #178

SEND PRODUCT INFORMATION CIRCLE #269

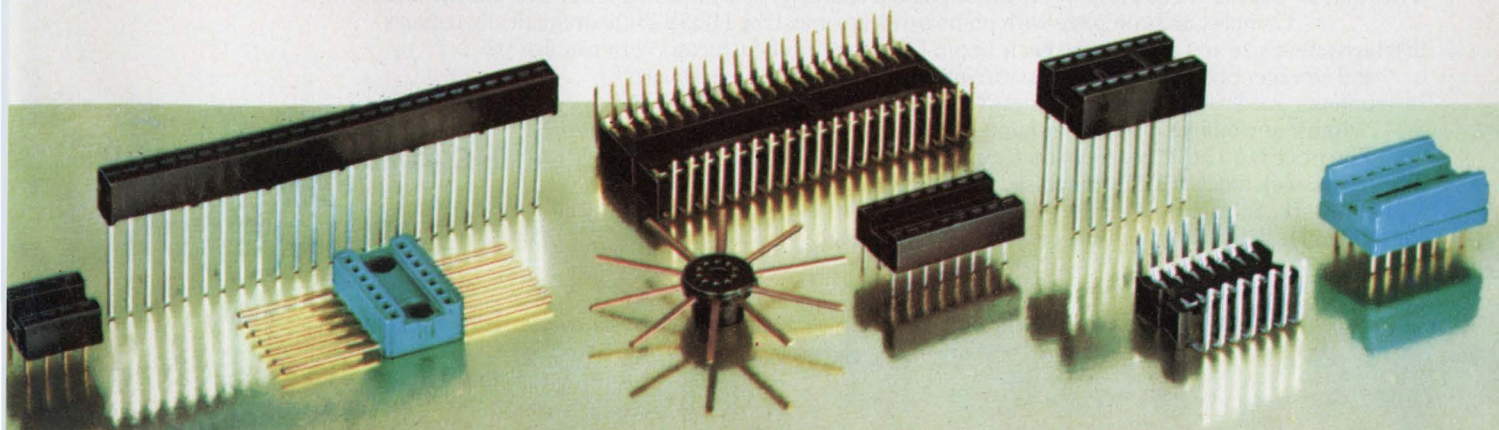

SURPRISE!



Our New Display Can Say A Lot For You

Our new HDSP-2000 Alphanumeric Display can spell it out for you in bright, crisp LED characters. The full 5x7 dot matrix can display ASCII or custom character sets including lower case and symbols.

Compact and complete with on-board electronics, the HDSP-2000 dramatically reduces display system size and complexity. Each 12 pin DIP contains 4 characters with row drivers and storage. End stackable and easy to interface, they're ideal for "smart" instruments, medical systems or business terminals, military applications, and almost any mobile, portable or hand-held device.

The price is \$47.00* per 4-character cluster in quantities of 125 clusters. They're in stock today at HP's franchised distributors. In the U.S. contact Hall-Mark, Schweber, Wilshire or the Wyle Distribution Group (Liberty/Elmar) for immediate delivery. In Canada, contact Zentronics, Ltd. *U.S. Domestic price only.

HEWLETT  **PACKARD**

Sales and service from 172 offices in 65 countries.
1507 Page Mill Road, Palo Alto, California 94304

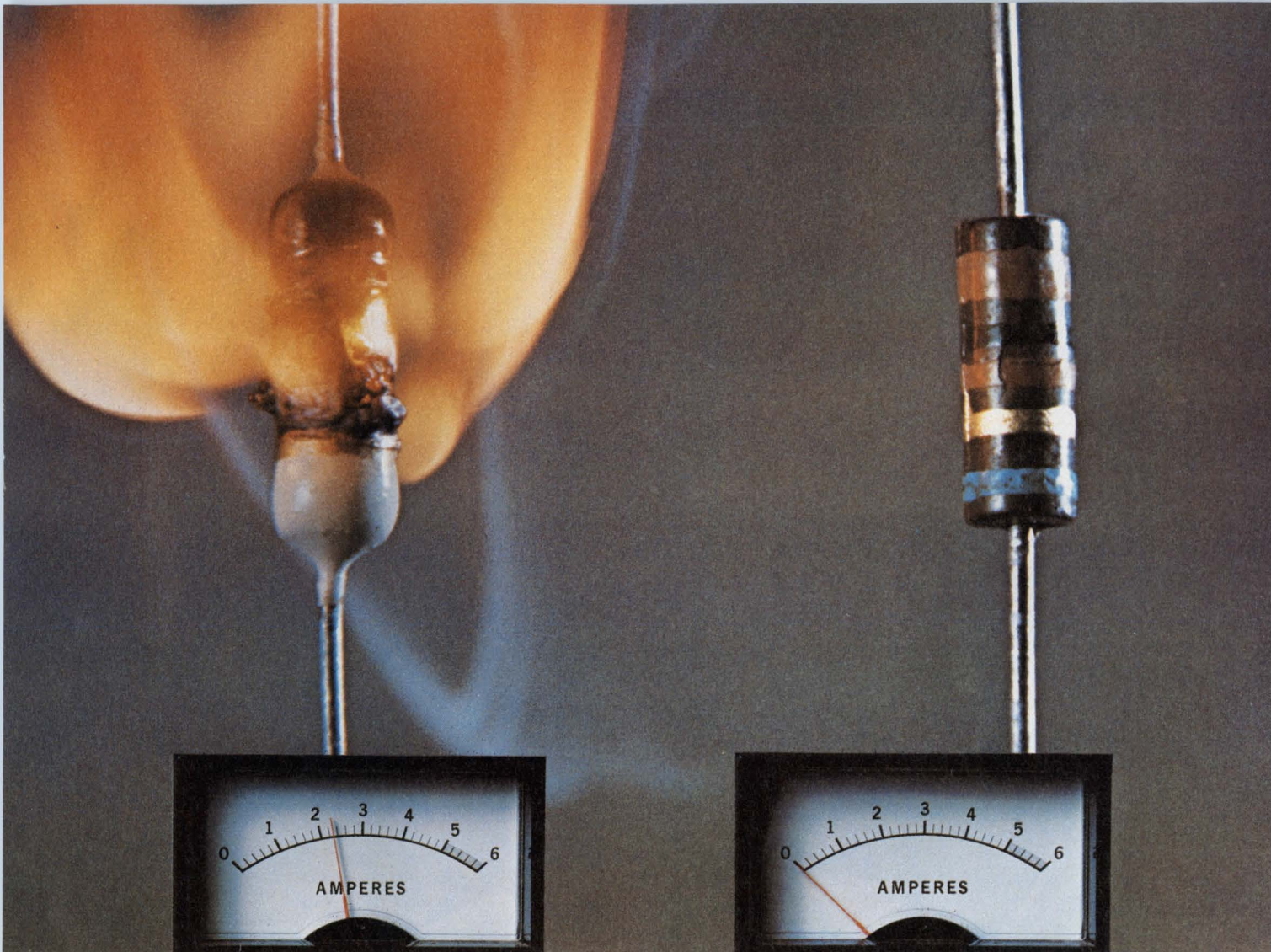

The failure. A 16 W overload causes this 1/2 W carbon film resistor to burst into flame. The initial failure mode is a short circuit, causing even more current to be drawn as shown on the meter.

The successful failure. The TRW 1 W rated BW-20F (1/2 W size) stays cool and fuses quickly and safely under identical power surge conditions. The failure mode, as shown, is an open circuit.

A failure your circuit can live with.

Failsafe, Fusible, Wirewounds Offer Built-In Circuit Protection.

Cool wirewounds like our BW failsafe series have a dual personality.

They provide stable resistance to normal operating current. But at specific overloads, they open circuit like a good fuse. So, as shown above, they'll protect your circuit from excess heat and fire in places where severe fault conditions are encountered.

The BW failsafe series, UL listed per Document 492.2, can save cost by eliminating the need for both resistor

and fuse. Save space, too, because they're about half the size of standard 1 and 2 W devices.

Depending on your specific circuit parameters, other TRW film and wirewound resistors can be engineered to meet your requirements.

For more information on resistors your circuit can live with, contact TRW/IRC Resistors, an Electronic Components Division of TRW, Inc., 401 N. Broad St., Phila., Pa. 19108. Tel. 215-922-8900. Telex: 710-670-2286.

TRW IRC RESISTORS
ANOTHER PRODUCT OF A COMPANY CALLED TRW
CIRCLE NUMBER 70

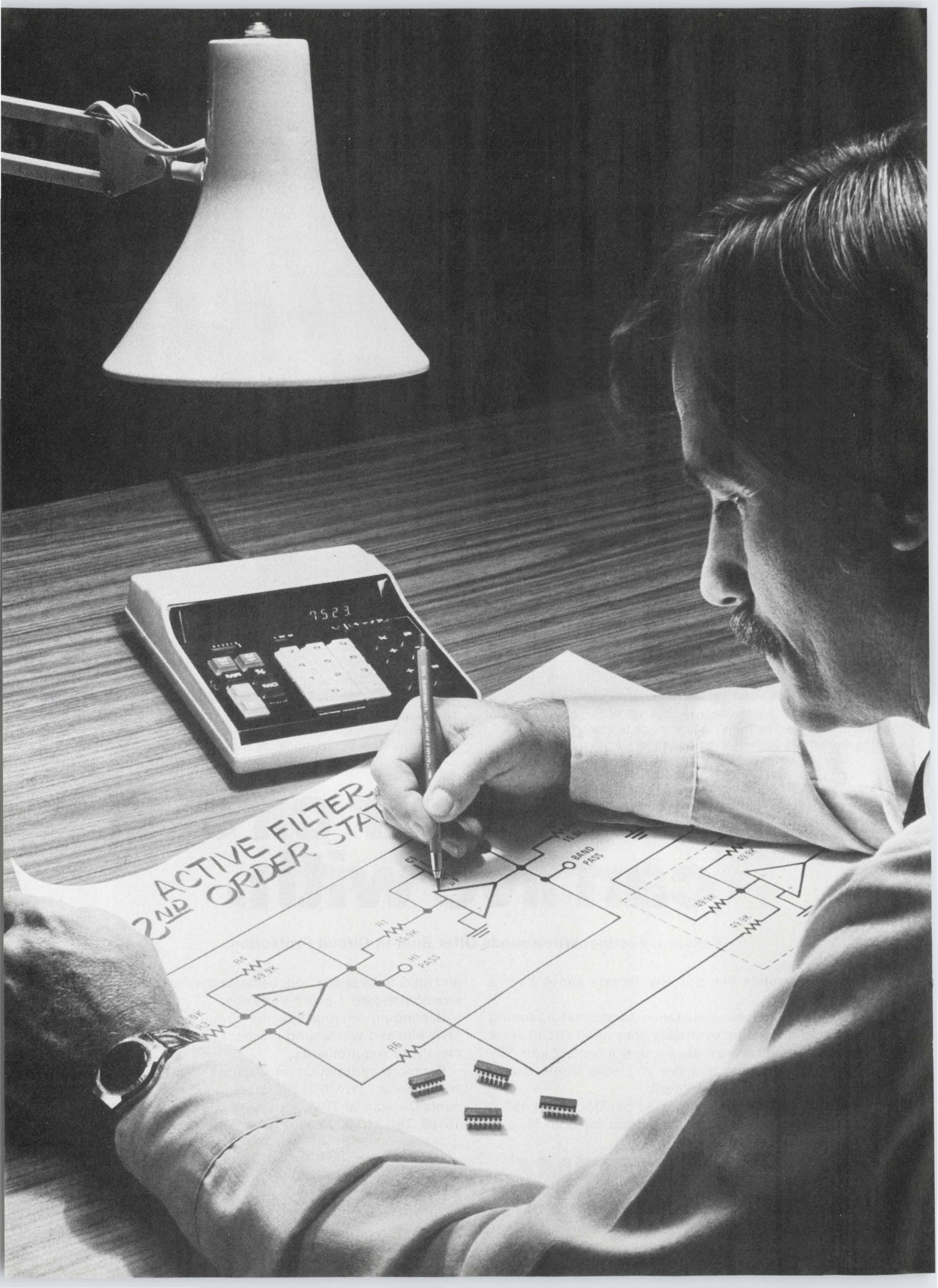

ACTIVE FILTER 2ND ORDER STATE

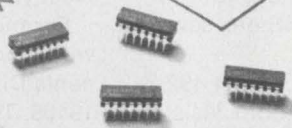
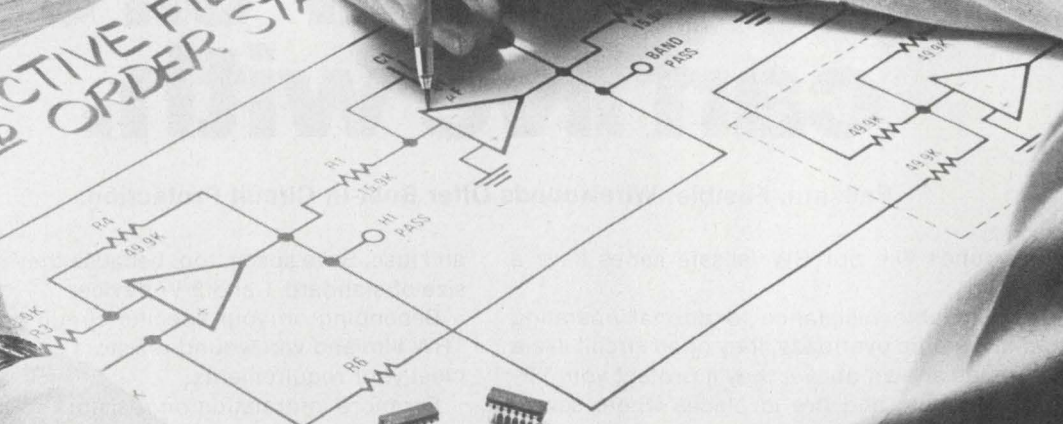

7523

Introducing The Most Advanced Quad OP Amps Ever Made. Nothing Performs Quite Like Them.

The HA 4602/4622 high performance quad operational amplifiers are keys to a whole new concept in amplifier design. They're unique in that they have bipolar, CMOS, and dielectric isolation all in one chip. So they give you a full measure of confidence like you've never known before in general purpose amplifiers.

For example:

- Eight times the slew rate and bandwidth of the 741 at only three-fifths quiescent power.
- High accuracy and stability, even at high gains, over the specified temperature ranges.
- Monolithic construction to provide optimum parameter matching and temperature tracking.
- High performance and a quad structure which is ideal for active filter applications.

STANDARD FEATURES. Both Harris high performance quad amps have standard features you won't find in any other quad amps. The 4602 typically offers a slew rate of $4V/\mu\text{sec}$, unity gain bandwidth of 8MHz, input noise voltage of $8\text{NV}/\sqrt{\text{Hz}}$ and input offset voltage of 0.3mV. The 4622 is uncompensated and provides stability at $A_v=10V/V$, gain bandwidth of 70MHz and a slew rate of $25V/\mu\text{sec}$.

PERFORMANCE/PRICE.

Impressed with this high performance? You'll be just as impressed by the price. For military use the HA 4622-2 and HA 4602-2 cost \$9.90. For commercial, the HA 4625-5 and the HA 4605-5 cost \$4.95 (100 up prices).

ECONOMY TOO. For those of you more inclined to go the economy route, there's our very popular HA 4741 quad op amp. With its superior typical bandwidth of 3.5 MHz, slew rate of $1.6V/\mu\text{sec}$ and input voltage noise of $9\text{NV}/\sqrt{\text{Hz}}$, it offers

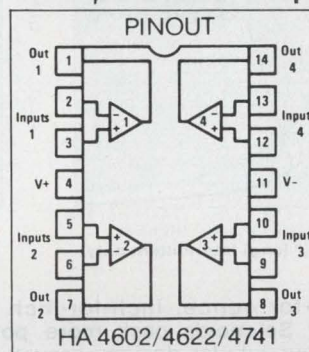

you a lot of amp for not a lot of money. For instance, the HA 4741 for military usage costs just \$4.60, while the HA 4741-5 for commercial is just \$2.48.

AND FAST DELIVERY... Right now we have a full inventory of our new quad op amps. So whether you prefer high performance, or economy, rest assured your order can be honored immediately.



HARRIS
SEMICONDUCTOR
A DIVISION OF HARRIS CORPORATION

P.O. Box 883, Melbourne, Florida 32901 (305) 724-7412

OEM SALES OFFICES: CALIFORNIA: Long Beach (213) 426-7687; Palo Alto (415) 964-6443 FLORIDA: Fort Lauderdale (305) 971-3200; Melbourne (305) 724-7430 ILLINOIS: Hinsdale (312) 325-4242 MASSACHUSETTS: Wellesley Hills (617) 237-5430 MINNESOTA: Minneapolis (612) 835-2505 NEW YORK: Endwell (607) 754-5464; Melville, L.I. (615) 249-4500 OHIO: Dayton (513) 226-0636 PENNSYLVANIA: Wayne (215) 687-6680 TEXAS: Richardson (214) 231-9031

SALES REPRESENTATIVES: ALABAMA: Huntsville (205) 533-6640 ARIZONA: Scottsdale (602) 948-5590 CALIFORNIA: Los Angeles (213) 870-9191; Mountain View (415) 961-8121; San Diego (714) 565-9444 COLORADO: Denver (303) 773-0666 CONNECTICUT: East Norwalk (203) 838-1493 FLORIDA: Boca Raton (305) 395-6108; Oviedo (305) 365-3283; Tampa (813) 933-1759 ILLINOIS: Elk Grove Village (312) 640-1850 INDIANA: Indianapolis (317) 849-6454 IOWA: Cedar Rapids (319) 377-8275 KANSAS: Wichita (316) 943-6221 MARYLAND: Lanham (301) 459-1556 MASSACHUSETTS: Burlington (617) 273-1313 MICHIGAN: Farmington (313) 476-2446 MISSOURI: Hazelwood (314) 371-5799; Independence (816) 737-1100 NEW JERSEY: Keasbey (516) 567-5900; West Caldwell (516) 567-5900 NEW MEXICO: Albuquerque (505) 265-5655 NEW YORK: Albany (518) 489-7408 or 4777; Huntington Station (516) 567-5900 NORTH CAROLINA: Winston Salem (919) 722-5151 OHIO: Cleveland (216) 831-8292; Dayton (513) 890-2150 OREGON: Beaverton (503) 643-1644 PENNSYLVANIA: Allison Park (412) 487-4300; King of Prussia (215) 265-0634 SOUTH CAROLINA: Greenville (803) 268-1125 TEXAS: Dallas (214) 691-4592; Houston (713) 661-3007 VIRGINIA: Charlottesville (804) 973-6672 WASHINGTON: Bellevue (206) 454-0300 CANADA: Mississauga, Toronto (416) 676-1042; Montreal (514) 626-6723; Ottawa (613) 749-0740.

NATIONAL DISTRIBUTORS: Hamilton/Avnet; The Harvey Group, Inc.; Schweber Electronics R.V. Weatherford Company CANADA: Prelco Electronics Ltd.

MORE PULL in a smaller package?

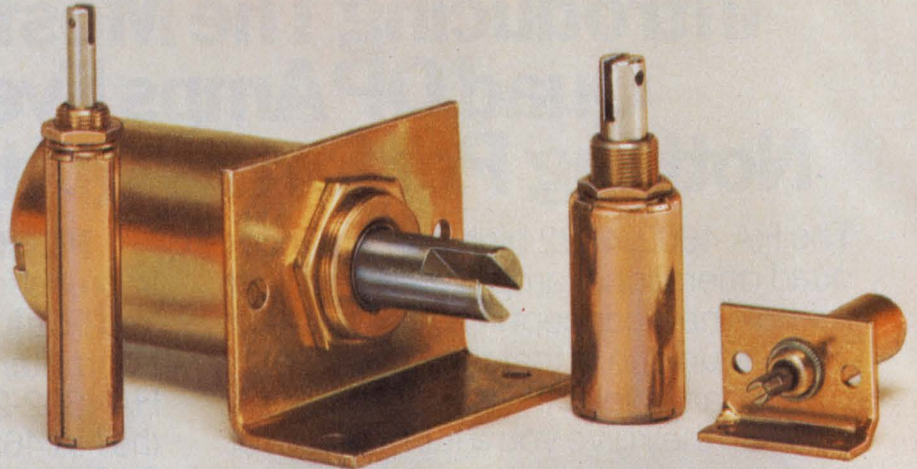

Check these curves.

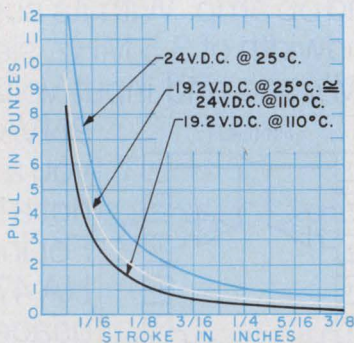

T-4 (7/8" long) Intermittent duty

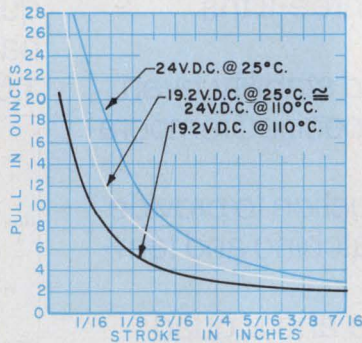

T-8 (1 1/4" long) Continuous Duty

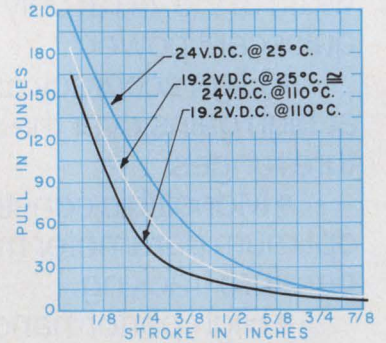

T-12 (1 1/2" long) Intermittent Duty

Ounce-for ounce, inch-for-inch Guardian Tubular Solenoids pack more power... because our tubular designs assure total magnetic field enclosure and result in efficient, powerful operation. More efficient than other DC solenoids. They give you more power in less space, plus U/L and CSA recognition.

Easy to design-in. Easy to install. By design. Guardian Tubulars work in any position. Close tolerance between plunger and bobbin means no possibility of double seating. So they work in your product just the way you want them to work.

Mount them directly into panel by inserting threaded bushing thru installation hole and tightening nut on lock washer. Or, mount with standard bracket.

Either way, Guardian Tubulars install without damage to the solenoid. Look how the

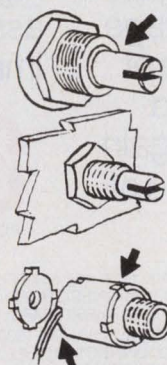

notched tube-steel shell mates with notched end plate. Result? A stronger assembly that takes more torque when installing...with no chance of damage. The leads emerge thru a notch in the steel shell, so they will not, can not be sheared by rotation during installation.

Once you put a Guardian Tubular in your product...forget it. Typical mechanical life is 20 million. That's probably longer than your product's life expectancy...due primarily to the unique Valox® 420 molded bobbin.

Variations and specials? Guardian's got 'em. Any DC voltage from 6 to 240. Push type or pull type operation. Return springs, silencers, termination variations, special mountings... you name it and we'll deliver it with the high quality craftsmanship and low prices that have made Guardian Number 1 in Solenoids—and that keeps us here on top.

Let the Guardian Angel reveal all the pull charts and curves in full size. Send for your free copy of our 72 page catalog.



This mark indicates recognition under the component program of Underwriters Laboratories, Inc.



GUARDIAN®

GUARDIAN ELECTRIC MANUFACTURING CO. 1572 West Carroll Avenue—Chicago, Illinois 60607 • 312/243-1100

CIRCLE NUMBER 72

NATIONAL ANTHEM



A Review of New Products and Literature from

National Semiconductor • No. 5, Oct. 1976

Bi-FET™ Line-Up Continues to Grow

By this time we hope you know about our proprietary process that lets us marry JFET and bipolar technologies on a single, monolithic chip. We call this technique Bi-FET™ technology,

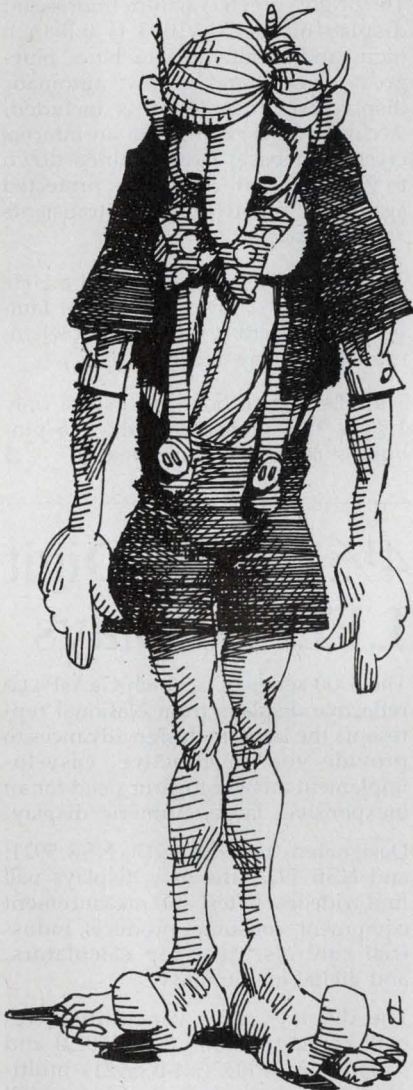

and to date each circuit built with this technology has set new standards of performance for the industry to match.

In fact, we introduced the industry's first Bi-FET products, our LF156 op amp series, almost a year ago. The available specs on these parts— I_B , I_{OS} , V_{OS} , V_{OS} drift, slew rate, and settling time—make the 156 series about the most advanced op amps in the world. And if you've heard otherwise, we'd like to

New Keyboard for SC/MP Kit Replaces Teletype™

National's new Keyboard Kit now gives SC/MP Kit users a low-cost input/output capability. The Keyboard and SC/MP Kits together form an inexpensive learning and development tool for anyone without access to a Teletype™ machine. The new kit replaces the Teletype previously required by the SC/MP Kit, yet still allows you to evaluate the SC/MP CPU and to develop a variety of application software.

The heart of the Keyboard Kit is a 512-byte ROM firmware package called SCMPKB, which replaces the 'Kit Bug' ROM supplied with the SC/MP Kit. SCMPKB lets you use the hex keyboard display to execute programs, examine or modify the contents of memory and the SC/MP registers, and monitor program performance.

The Keyboard Kit comes complete with a manual, all required ICs and

resistors, a keyboard cable-connector assembly, pre-cut wires, and wire-wrap connectors; we even supply a hand-held wire-wrap tool.

The SC/MP PC card already has a hole pattern for additional ICs. Simple instructions in the Keyboard Kit manual tell you how to add the extra circuits to the SC/MP card, replace the 'Kit Bug' ROM with the new SCMPKB ROM, and connect the preassembled keyboard cable-connector to the card. With these steps done, you're ready to go.

The Keyboard Kit is another step in the tradition of simple, cost-effective solutions to your microprocessor needs. For Keyboard Kit specifics, call your local National distributor and ask for information on the ISP-8K/400. ■

Bi-FET™ n-Channel Analog Switches

Our new family of analog switches combines n-channel JFETs and bipolar transistors on a single chip for the first time—a technique made possible by our Bi-FET™ technology. And the switches built this way provide the industry's only low ON-resistance, high-speed, monolithic, n-channel, JFET analog switches.

The new switches are ideal for A/D and D/A converters, data acquisition, signal multiplexers, sample-and-holds, video switchers, and so on.

At 25°C, the Series AM181 switches (for -55° to +125°C operation) feature a 30-Ω maximum ON-resistance,

matched to 2 Ω (typical); this resistance is constant for signals to ±10 V. Switching times are 105-ns turn-on/95-ns turn-off (typ.) for a break-before-make action. Isolation and cross-talk are down 60 dB (typ.)

Four versions of Series AM181 switches are available: dual driver, SPST; dual driver, DPST; single driver, SPST; and dual driver, SPDT. Series AM181 switches are pin-for-pin, spec-for-spec compatible with the Siliconix Series DG181 hybrid parts.

The Series AM281 switches—dual driver, SPDT—are intended for operation between -20° and +85°C, and have slightly relaxed specifications. ■

point out that National does indeed supply a plastic minidip version; just ask about our LF356N—it's been around for several months now.

We've also got the LF13741 op amp, which replaces the 741 wherever you need extremely-low input current; the LF13331 family of analog switches, which has no latch-up or static blow-out problems; the LF352 instrumentation amplifier, which combines low

input-current demand and excellent linearity; and the new LF198/398 sample-and-holds with short acquisition times, high accuracies, and low droop rates.

Of course, more Bi-FET parts are on their way. But we suggest that you find out what the unique specs of our already available Bi-FET parts can do for you now. We're sure you'll be pleasantly surprised. ■

Programmer, Frequency Synthesizers for CB Use

National announces a new family of phase-locked-loop circuits for 40-channel frequency synthesizer applications in CB transceivers.

The MM55104, MM55114, MM55106, and MM55116 are for use in single- or double-I.F. systems, and operate from a single power supply (either +5 V or +8 V, depending on the type number). Each circuit contains a reference oscillator, an oscillator divider chain (10-kHz or 5-kHz outputs), a binary-input programmable divider for channel selection, and a phase detector. A 5.12-MHz or 10.24-MHz crystal determines the reference frequency.

The MM55104/114 provide a 2ⁿ-1 division of the input frequency, while the MM55106/116 provide a 2ⁿ-1 division. These latter two synthesizers also have 5.12-MHz outputs, which may be tripled for use as a reference oscillator frequency in two-crystal systems.

Division of the input frequency is controlled by standard binary signals, which may be set up by mechanical switches or by an external electronic programmer.

National has such a programmer. It's called the MM57150, and it generates the binary codes necessary to control 40-channel PLL synthesizers. Our space here precludes a full description of the host of features available on the MM57150, so we'll simply list a number of its more important ones:

- Initial power-up on Channel 19
- Direct, calculator-style keyboard entry of channel number is available.
- Two-speed, up/down slewing
- Direct access to Channel 9, the emergency channel, via a single contact closure
- Programmable memory bank for scanning up to ten channels in any sequence of your choosing
- Rollover on Channels 1 and 40 (i.e., . . . 38, 39, 40, 1, 2, 3 . . .)
- Scan rate of four channels/second
- Two-channel, alternating channel capability via a single push button
- Automatic monitoring of a preselected channel for 0.25 second every 10-15 seconds while active on another channel; squelch/lock capability on the monitored channel
- Adjustable squelch
- Illegal channel entry prohibited
- Transmit key locks programmer on channel (scanning stops) 

Super Savings on Super-Strong TO-126 Types

We now second-source fifty of the most popular types of TO-126 packaged power transistors. Our TO-126 products are encapsulated in National's tough Epoxy B—so strong that you'll strip the 4-40 screw mountings before you'll damage the package.

Added to our TO-126's toughness is a large cost savings. National can save you 25 percent, typically, over the competition's pricing.

We're stocking our distributors' shelves right now. And in November our distributors will advise their customers, by mail, of the new TO-126 types from National. If you're not already on such a list, call your local National distributor now to make sure you get the information on these hot new ones from National Semiconductor Corp. 

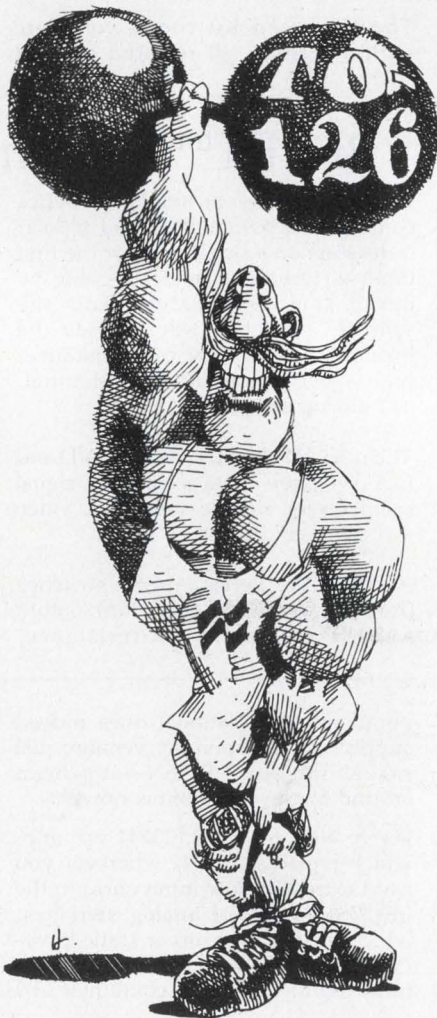

Clock Module Designed for Instrumentation, Automotive Uses

The MA1003 is a self-contained time-keeping module for a host of 12-Vdc applications; just add switches and a lens, and it's ready-to-go in bench and battery-powered instruments, CB base stations, aircraft/marine/auto clocks, and so on.

The bright, green, vacuum fluorescent display of the MA1003 is 0.3-inch high, and is filterable to blue, blue-green, green, and yellow; automatic display-brightness logic is included. Accurate timekeeping, via an internal crystal timebase, is maintained down to 9 Vdc, and all circuitry is protected against automotive supply transients and reversals.

Timesetting controls operate at a 1-Hz rate with no rollover; to prevent tampering, timesetting is locked out whenever the display is blanked.

The MA1003 PC board measures only 1.75 x 3.05-inches overall; a 6-pin, built-in connector is optional. 

4 1/2- and 5-Digit LED Displays

The 5900-series of 0.5-inch GaAsP LED reflective displays from National represents the latest in design advances to provide you an effective, easy-to-implement answer to your need for an inexpensive, large, numeric display.

Designated the NSB 5917, NSB 5921, and NSB 5922, the new displays will find wide use in test and measurement equipment, consumer products, industrial controls, desk-top calculators, and digital instruments.

The displays offer versatility, with both common-anode (NSB 5922) and common-cathode (NSB 5921) multiplexed versions available for five full digits, and an optional direct-drive overflow/polarity indication with four digits in a common-anode multiplexed format (NSB 5917). Electrical connection is by PCB-type terminals on the edges of the display.

The optical design of this series assures a distinct, easy-to-read display with a wide viewing angle (120° total), and excellent on-off contrast and segment-to-segment uniformity. 

APPLICATIONS CORNER

High Performance, Low Power Memories from Inexpensive Parts

You can use standard, inexpensive, bipolar PROMS to build high-performance memories of low power dissipation. The secret is to power-down the chip when it is not being accessed.

The technique illustrated here results in a power savings beyond that possible with bipolar PROMS having on-chip power-down, and the cost is much less than that of CMOS PROMS of the same capacity. In fact, because the access time of the circuit shown here is less than 80 ns, the power savings can be greater than 10 to 1 if the circuit is cycled every microsecond. Longer cycle times, or decoding of the power switching to multiple packages, yields even more impressive ratios.

National's PROMS are well behaved in this application. With power removed, our Tri-State® parts revert quickly to their third state (a high-impedance open). Because there are no clamp diodes from the outputs to V_{CC} , the powered-down device presents only leakage to the output bus.

Note that in a CMOS system, passive pull-ups are desirable to establish the CMOS input level at V_{CC} when the PROM is powered down. If the CMOS input is more than a threshold away from both supply rails, the input stage of the

CMOS device may draw supply current, which will increase system power dissipation. Here it is desirable to clock the PROM outputs directly into a CMOS holding register to reduce the time that the PROM must be powered up. Also, the pnp core driver pass elements can be driven directly by an MM74C42 1-of-10 decoder output without pull-up or current limiting resistors, with some increase in effective access time.

The MM74C42 would replace the 74LS04 shown here.

In any system that switches a device's supply lead to conserve power, the power supply bypassing must be performed on the supply side of the power switch; that is, at the pnp emitter. Any capacitance at the collector of the pnp will increase both system power dissipation and access time. ■

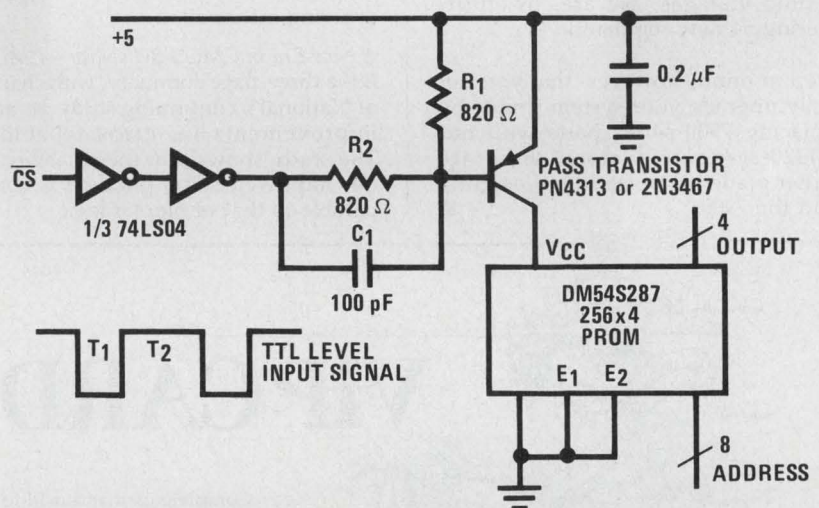

True RMS-to-DC Converter

Our LH0091 will compute the rms value of virtually any combination of ac or dc input signals from dc to 2 MHz. At frequencies below 70 kHz the accuracy is 0.05 percent; the crest factor rating is 10.

The LH0091 is thus ideal for DVMS, DMMS, for measuring audio and noise signals (or both in combination), for vibration and harmonic analysis, etc.

An extra, uncommitted, internal op amp is available, which you can use as a summing amplifier, to buffer the input or the output, to adjust the gain, or whatever.

The LH0091 also is available as the LH0091CD for commercial temperature range uses, and as the LH0091D for the military range—all at prices you cannot walk away from. ■

16,384-Bit Si-Gate n-Channel ROM

National's MM5246 static read-only memory is organized in a 2048-word x 8-bit format. It uses n-channel enhancement and depletion mode silicon-gate technology, which, boiled down, means that it's DTLTTL-compatible and needs only a single, +5.0-V supply.

Very useful in microprogramming, control logic, and table look-up applications, and in random-logic synthesis, the MM5246 provides expandable memory through its three programmable Chip Select inputs, which control its Tri-State® outputs. The MM5246 has a maximum access time of 450 ns, and is fully decoded.

And look for still another 16k ROM that will soon be coming along. Designated the MM5247, it's organized 4kx4; all other specifications are identical to the MM5246. ■

National Announces Oxide-Isolated RAMs

The DM93415/DM93415A (open-collector) and the DM93425/DM93425A (Tri-State®) are 1024-word x 1-bit random-access, read/write memories—the first of our family of oxide-isolated, bipolar memory products.

Designed for buffer control storage and high-performance main memory applications, the DM93415/425 offer maximum access times of 70 ns, while the suffix 'A' versions offer a 45-ns access.

Other features include full on-chip decoding, separate Data In and Data Out lines, and an active LOW Chip Select and Write Enable. Fully DTL/TTL-compatible, the DM93415/415A/425/425A have a 16-mA drive capability, and dissipate 0.5 mW/bit. ■



7900-Series Regulators from National

National Semiconductor now second-sources the popular 7900-Series three-terminal voltage regulators. In particular, we now offer the 7900MK/MH/CK/CH/CT and the 79M00CP.

Since each of these parts is available in nine voltages, we are, in effect, offering 54 new regulators.

Keep in mind, however, that you can easily upgrade your system simply by replacing 7900-series parts with our LM320-series regulators; these are higher grade parts spec'd more tightly than the 7900s. 

New CMOS Guides Now Available

National's new four-page *CMOS Status/Cross Reference Guide* is a concise, handy guide to 90 CD4000-series and 70 MM74C-series parts. Each part is briefly described functionally, and its production status and 38510 status at National are noted; RCA, Motorola, Fairchild, Harris, and SSS equivalent designations are listed. The guide ends with a tabulation of complete ordering information.

A New Era in CMOS Reliability—CMOS II is a three-page summary, with charts, of National's continuing study of, and improvements in, CMOS reliability. The study shows that the reliability of our improved CMOS products is comparable to that of bipolar logic. 

Saturating-Output Display Drivers

We have introduced a series of saturating-output display drivers to interface MOS calculator chips with common-cathode LED displays. The series consists of the DS8871 (an 8-digit driver), the DS8872 (9-digit), the DS8873 (9-digit, with low-battery indicator), and the DS8977 (7-digit, with low-battery indicator).

You can operate these drivers in calculator systems with a supply voltage range of 4.5 V to 9.0 V. In a 9-V system you can use the low-battery feature of the DS8873 and DS8977 to turn on the decimal point of the digit '9' when the supply voltage falls below 6.5 V. This alerts the user that the battery should be replaced, even though the calculator will still function for awhile yet.

Each driver can sink 40 mA, and is designed for multiplexed operation. The saturating-output feature permits operation with power supply voltages lower than possible in Darlington-type output display drivers, and also results in lower power dissipation in the LED driver; standby power consumption is zero. Input and output pins are located to make wiring easy.

The new series is functionally and pin-for-pin equivalent to our DS8855, DS8864, DS8865, and DS8866 family of LED display drivers. 



ED14

VIP CARD

Complete card and mail to
NATIONAL SEMICONDUCTOR
 Attn: Marketing Services
 2900 Semiconductor Drive
 Santa Clara, CA 95051

INDEX

Please send me the information that I have checked:

<input type="checkbox"/> Bi-FET Line-Up, Pg. A, Col. 1	<input type="checkbox"/> 4½/5-Digit Displays, Pg. B, Col. 3
<input type="checkbox"/> 5C/MP Keyboard Kit, Pg. A, Col. 2	<input type="checkbox"/> RMS/dc Converter, Pg. C, Col. 1
<input type="checkbox"/> AM181/AM281 Switches, Pg. A, Col. 2	<input type="checkbox"/> MM5246 16-K ROM, Pg. C, Col. 2
<input type="checkbox"/> CB Freq. Synthesizers, Pg. B, Col. 1	<input type="checkbox"/> DM93415/425 RAMs, Pg. C, Col. 3
<input type="checkbox"/> CB Channel Programmer, Pg. B, Col. 1	<input type="checkbox"/> CMOS Status Guide, Pg. D, Col. 2
<input type="checkbox"/> TO-126 Power Types, Pg. B, Col. 2	<input type="checkbox"/> CMOS-II REL Guide, Pg. D, Col. 2
<input type="checkbox"/> MA1003 Clock Module, Pg. B, Col. 3	<input type="checkbox"/> LED Display Drivers, Pg. D, Col. 3

Please send me the literature that I have checked:

<input type="checkbox"/> AN-163 Mate SC/MP w/Cassette Recorder	<input type="checkbox"/> AN-165 3½ Digit DVM w/CMOS Interface
<input type="checkbox"/> AN-164 A Data Concentrator Using PACE	<input type="checkbox"/> AN-167 DM8678 Bipolar Character Gen.

Your End Product or Application: _____

Have Salesman Call YES NO

Please print clearly; this information will be used for our mailing list.

NAME _____ TITLE _____

COMPANY _____

ADDRESS _____

CITY _____ STATE _____ ZIP _____



WIRE-WRAPPABLE PACKAGING ASSEMBLY ACCEPTS INTEL 8080 AND 8080A MICROPROCESSORS

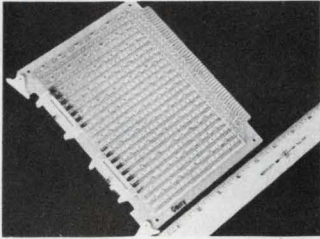

NEW BRUNSWICK, N.J. —A wire-wrappable packaging assembly for interfacing with Intel 8080 and 8080A microprocessors is now available from Garry Manufacturing Co., of New Brunswick, N.J. This new board fits the standard Intel processor rack. It is UL ap-

proved and includes two Input/Output connectors to mate with flat conductor cable wiring.

The new packaging assembly has wide application in computerized automation equipment for the machine tool industry and it will be useful in developing special or custom CPU's with associated RAM and PROM chips.

Garry also manufactures boards to interface with microprocessors made by National Semiconductor, Data General, Texas Instrument, and Digital Equipment Corporation.

For complete information, use the Reader Service Card, or contact: Garry Manufacturing Co., 1010 Jersey Avenue, New Brunswick, N.J. 08902; telephone: 201-545-2424.

SERIES OF MODULAR IC PLUGGABLE PACKAGING ASSEMBLIES

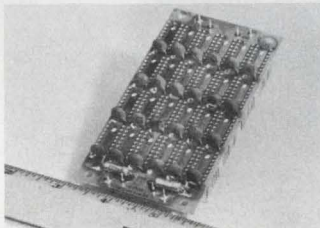

NEW BRUNSWICK, N.J. —A full range of Modular IC Pluggable Packaging Assemblies is now available from Garry Manufacturing Co., of New Brunswick, N.J.

These new packaging assemblies are available with both committed and non-committed power and

ground places. All come equipped with low-frequency tantalum capacitors as standard, and with options of 0.01 uf ceramic capacitors adjacent to each IC position.

The boards are UL approved and are manufactured with one, three, or six groups of either 20 or 24 IC positions, for 14- or 16-pin ICs. One-, two-, or three-level wire-wrappable posts are available, as are a variety of platings including various thicknesses of gold or tin over nickel.

For complete information, use the Reader Service Card, or contact: Garry Manufacturing Co., 1010 Jersey Avenue New Brunswick, N.J. 08902; telephone: 201-545-2424.

PACKAGING SOCKETS FOR TO-5 ICs NOW AVAILABLE IN VARIOUS STYLES

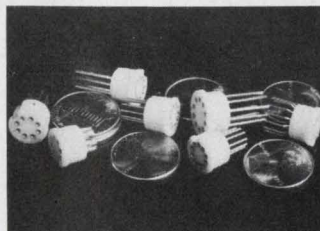

NEW BRUNSWICK, N.J. —Packaging sockets that will permit TO-5 case size IC to plug into a variety of circuits are now available from Garry Manufacturing Co. of New Brunswick, N.J. The new sockets come with 6, 8, 10, and 12 contacts, in standard pin circles They

accept leads from 0.016 to 0.019 in. diameter.

The sockets are available with terminals for most applications: printed circuit, turret, solder pot, and wire-wrappable. Bodies of the sockets are resilient Teflon for snug push fit into circuit-board mounting holes. Terminal sleeves are brass, contacts are beryllium copper, plating is gold over nickel. Sockets are also available with recessed contacts, for "hot case" applications.

For complete information, use the Reader Service Card, or contact: Garry Manufacturing Co., 1010 Jersey Avenue New Brunswick, N.J. 08902; telephone: 201-545-2424.

Joan Borst is doing 5 to 10 on a bum wrap.

Joan should've talked to Garry. Instead of condemning her to a faulty Wire Wrap*, we would've given her a wrap that worked. With pin squareness that's exactly .025 inch. A precision beryllium spring clip that has the most consistent IC insertion/withdrawal rate in the industry. And the widest line in the industry.

In short, we would've given her a good wrap. Backed up by a complete IC packaging facility (boards, headers, wrapping, racks), as well as dependable service, good prices and fast delivery.

Ask us about it. We won't pin a bum wrap on you. Garry Manufacturing, 1010 Jersey Avenue, New Brunswick, New Jersey 08902. (201) 545-2424.

*Registered trademark of Gardner-Denver Co.

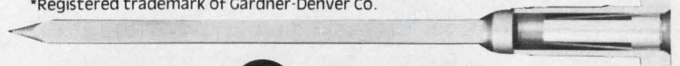

Garry

Manufacturing Co.

We won't pin a bum wrap on you.

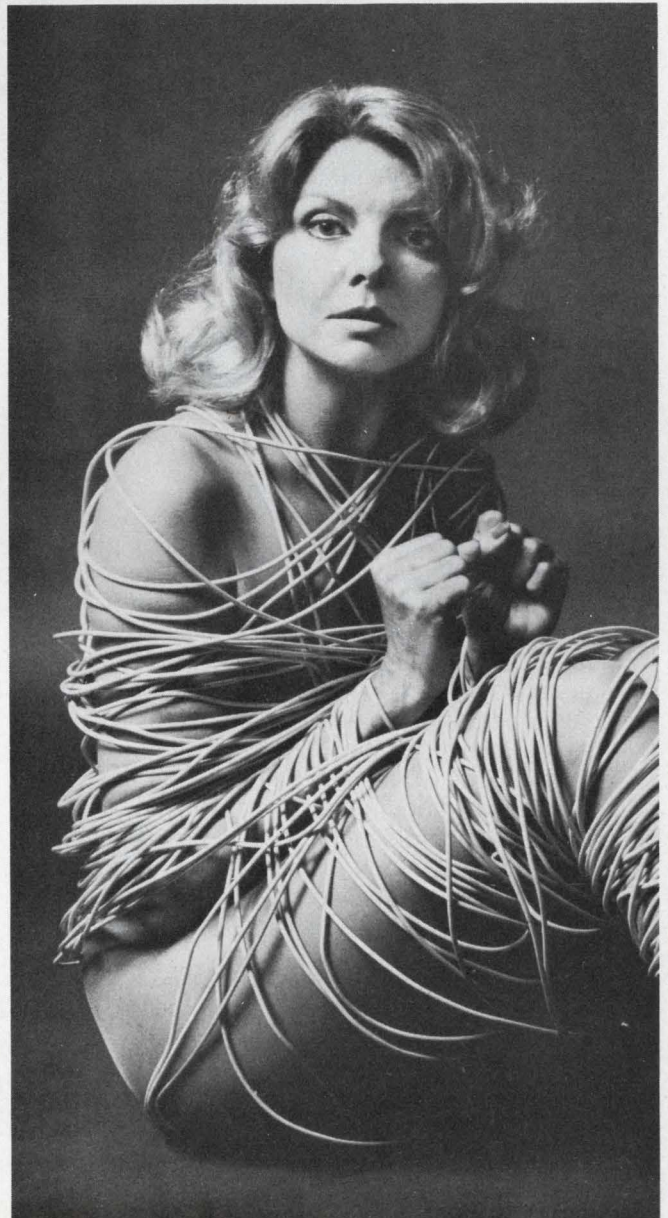

Arrow-M Amber Relays

solve PC board cleaning problems.



Arrow-M's leak-free Amber Relays are N₂ gas-filled and sealed in plastic so they're simple to clean with most degreasers and detergent cleaners, without affecting the maximum contact reliability of the relays.

And, Arrow-M can help you substantially reduce your labor costs! Just use Arrow-M Amber Relays on your PC board in conjunction with automatic wave soldering, instead of costly hand soldering.

The total savings are even greater when you use Arrow-M Amber Relays. Arrow-M Amber

Relay prices are right in line with standard non-seal types.

Arrow-M Amber Relays.

When you want maximum reliability and maximum savings. And only Arrow-M makes them.

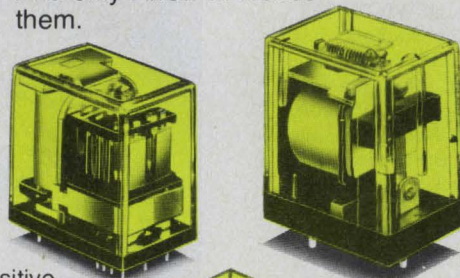

KE—Sensitive—
Long Life—10⁸ mech.

NFE—
New Low Profile—
High Sensitivity

HCE—
Miniature
Power
Type.

For more information on exact specifications, write or call your nearest Arrow-M office.

Arrow-M Corporation
250 Sheffield Street
Mountainside, N.J. 07092
(201) 232-4260

Western Office:
22010 South Wilmington Ave.
Suites 300 & 301
Carson, California 90745
(213) 775-3512

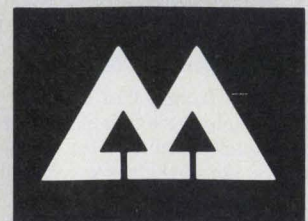

Arrow-M

Member of Matsushita Group

New Products

60-GHz spectrum analyzer resolves down to 30 Hz

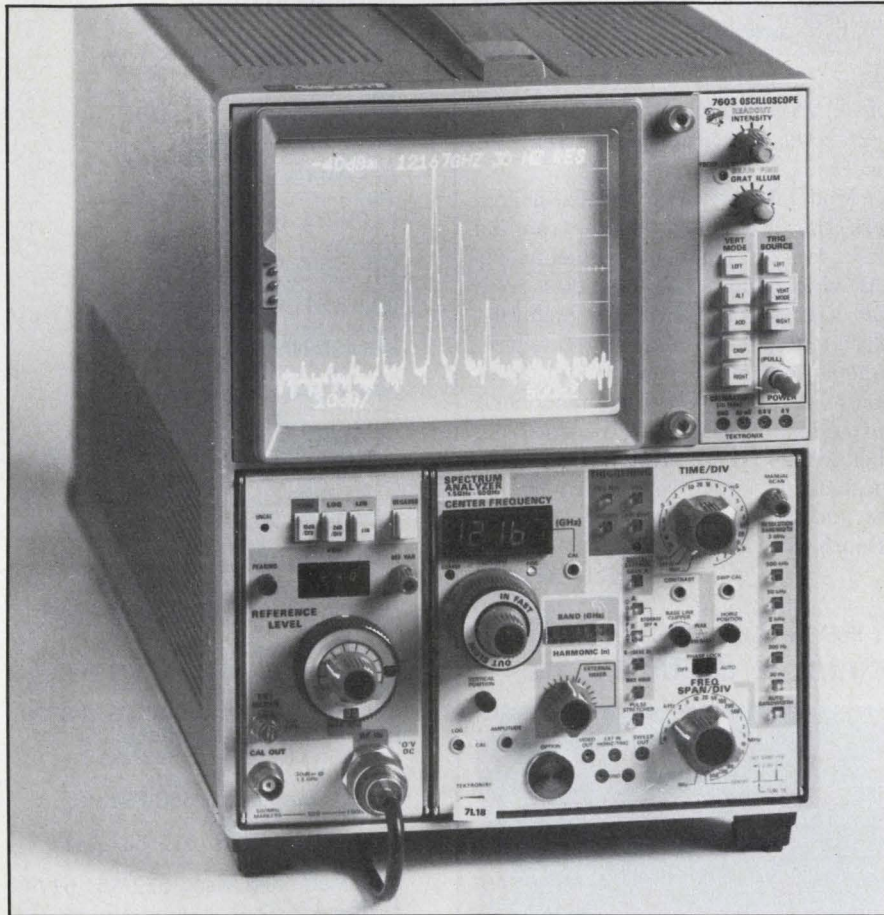

Tektronix, Box 500, Beaverton, OR 97077. (503) 644-0161. P&A: See text.

With a resolution bandwidth of 30 Hz to 12 GHz and a top input frequency of 60 GHz, the Tektronix 7L18 spectrum analyzer outpaces all competition by at least 3.3:1 in bandwidth and 50% in operating frequency. The closest competitor is Hewlett-Packard's 8500 family, long a favorite and probably the best selling microwave analyzer.

Along with its narrow bandwidth, the 7L18—a three-wide plug-in for the company's 7000-Series scopes—offers digital storage and averaging, and microprocessor control of frequency span, speed, bandwidth and other parameters. Included in the 7L18 are the rf/i-f sections and a preselector.

By contrast, the HP analyzer is a modular family, with the major sections sold separately. The competing HP product consists of the 141T variable-persistence display, the 8555A tuning section, the 8552B high-resolution i-f section and the 8445B tracking preselector. To work beyond 18 GHz, both the Tek and HP units require external waveguide mixers.

Three other 40-GHz analyzers—the Systron-Donner 4809A, Ailtech 707 and Polarad/Nelson-Ross 640—occupy rear positions with worse resolutions than the Tek and HP units.

Narrow bandwidth resolutions, of course, let you resolve closely spaced frequencies or low-level sidebands—but only if an analyzer's residual FM, stability and oth-

er specs are commensurate with the bw. A related spec is an analyzer's i-f filter shape factor, the ratio of the filter's 60-dB to 3-dB bandwidths. The working resolution also depends on this factor, which defines the sharpness of the filter's skirts. The sharper the skirts, the better is the resolution of two closely spaced signals of widely different amplitudes.

The 7L18's residual FM doesn't exceed 10 Hz pk-pk to 4.5 GHz, a figure that's 10 times better than the HP residual spec, which is good to 6 GHz. The former's frequency drift stays under ± 2 kHz/hour while the latter's tuning section shows a typical "long-term" drift of ± 3 kHz/10 min.

Note that residual (or incidental) FM and drift are given for fundamental conversion and for the phase-locked or stabilized tuning modes. Furthermore, the drift specs depend on a warmup period—2 h for the HP unit at a fixed center frequency, and 20 min. for the Tektronix.

In other crucial analyzer areas, notably residual and spurious responses and noise levels, the competing units seem almost equal. But comparing noise and distortion specs is almost as nerve-racking as filling out your tax returns. In both tasks, you run into so many qualifiers, you don't feel absolutely comfortable about the number on the bottom line.

Noise level, for instance, depends on the bandwidth, the frequency range (mixing mode), whether internal or external mixing is used, and other factors. Spurious responses can change with the power on the mixer or with the frequency, and can be slashed or eliminated with a video filter or preselector.

With that in mind, Tektronix specifies the sensitivity of the 7L18 as an equivalent input noise of -127 dBm at the 30-Hz setting. HP's sensitivity is identical, but at the 8555A's 100-Hz minimum bw. Both numbers are best sensitivities and hold for internal fundamental mixing.

Shape factor also varies with bandwidth. For the HP 8552B, the high-resolution i-f section, the best 60-dB/3-dB ratio is under 11:1 at bandwidths ranging from 100 to 300 Hz. For the Tektronix 7L18,

(continued on page 184)

INSTRUMENTATION

(continued from page 183)

the factor is 12:1 at 30 Hz—but Tek uses a 60/6-dB ratio, not the 60/3 so the two factors can't be directly computed.

In other key areas—frequency span, flatness, dynamic range and amplitude accuracy—the 7L18's narrowest frequency span goes down to 200 Hz/div to 12 GHz. While this span clearly beats the 8555A by a factor of 10, it's not quite so clear how the units stack up in the other areas.

The 7L18's over-all flatness (with the built-in preselector) is ± 1.5 dB at fundamental mixing and with the unit's peaking control adjusted for maximum flatness. HP doesn't state flatness directly, but supplies a graph of insertion loss versus frequency with each preselector (the loss is about 6 dB ± 1 dB). So here you can't compare directly, either. And whereas the flatness of Tektronix' high-performance waveguide mixers is stated as ± 3 dB over the entire range of 18 to 60.5 GHz (covered by three mixers), HP's isn't specified.

Nor can you easily size up the competing units for either dynamic range or absolute amplitude accuracy. No defining standard exists for either parameter, and—as with noise and distortion—the tendency is to specify so the unit looks as good as possible. Measurement set-up and technique can also make a big difference, especially with accuracy, which is affected by many factors.

Thus, you might squeeze out an over-all amplitude accuracy of ± 1.6 dB with the HP analyzer (again, for fundamental mixing). And you *might* do as well with the Tektronix.

To find out for yourself, the Tek 7L18 will cost you \$12,000, the 7603 mainframe another \$1850. The HP 8555A/8552B/141T/8445B costs \$16,625. Add another \$670 for digital-frequency readout, \$80 for manual preselector controls.

Tektronix	CIRCLE NO. 303
Ailtech	CIRCLE NO. 304
Hewlett-Packard	CIRCLE NO. 305
Polarad/Nelson-Ross	CIRCLE NO. 306
Systron-Donner	CIRCLE NO. 307

Sweeper spans 50 kHz to 1.2 GHz



Kay Elemetrics Corp., 12 Maple Ave., Pine Brook, NJ 07058. (201) 227-2000. \$4950 with counter; 3-4 weeks.

Model 1520 sweep generator covers the frequency range from 50 kHz to 1200 MHz without plug-ins. At video and i-f frequencies from 50 kHz to 100 MHz, a variable-frequency pulse marker offers frequency counter readout and accuracy. A low-frequency video band provides CW or full sweep from below 50 kHz to 10 MHz. A second, scaled-up, video range provides 1 to 300 MHz, full sweep or CW.

Booth No. 1335, 1337

Circle No. 308

Two 4-1/2-digit DMMs count to 30,000

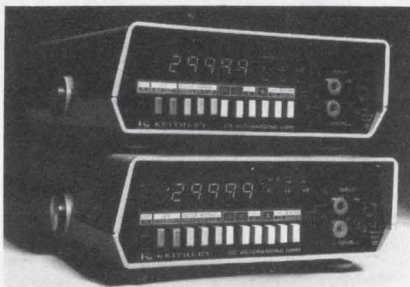

Keithley Instruments, 28775 Aurora, Rd., Cleveland, OH 44139. (216) 248-0400. 172, \$525; 173, \$625; 30 days.

Features offered by Models 172 and 173 DMMs are a 30,000-count display, half-inch digits, automatic or manual range selection, high/low ohms and 2 or 4-terminal resistance measurements. Both units measure dc voltages from 10 μ V per digit to 1200 V, ac voltages from 10 μ V to 1000 V rms and resistance from 10 m Ω per digit to 300 M Ω . The units differ only in current measuring capability. The 172 handles 10 μ A/digit to 2 A, and the 173 10 nA/digit to 3 A.

Booth No. 1436-1438

Circle No. 309

Call your nearest ISC sales representative.

ALABAMA: Huntsville
Col-Ins-Co. 800/327-6600
ARIZONA: Phoenix
Thorson Co. 602/956-5300
CALIFORNIA: Goleta
Thorson Co. 805/964-8751
CALIFORNIA: Los Angeles
Thorson Co. 213/476-1241
CALIFORNIA: Mountain View
Thorson Co. 415/964-9300
CALIFORNIA: San Diego
Thorson Co. 714/298-8385
CALIFORNIA: Tustin
Thorson Co. 714/544-5121
COLORADO: Denver
Thorson Co. 303/759-0809
FLORIDA: Orlando
Col-Ins-Co. 800/432-4480
GEORGIA: Clarkston
Col-Ins-Co. 800/327-6600
ILLINOIS: Arlington Hts.
Future Systems 312/640-6091
LOUISIANA: Baton Rouge
Col-Ins-Co. 800/327-6600
MARYLAND: Bethesda
Bartlett Assoc. 301/656-3061
MASSACHUSETTS: Framingham
Bartlett Assoc. 617/879-7530
MICHIGAN: Madison Hts.
WKM Associates 313/588-2300
NEW MEXICO: Albuquerque
Thorson Co. 505/265-5655
NEW YORK: White Plains
Bartlett Assoc. 914/949-6476
NORTH CAROLINA: Winston-Salem
Col-Ins-Co. 800/327-6600
OHIO: Cleveland
WKM Associates 216/267-0445
OKLAHOMA: Norman
Data Marketing Assoc. 405/364-8320
PENNSYLVANIA: Pittsburgh
WKM Associates 412/892-2953
PENNSYLVANIA: Wayne
Bartlett Assoc. 215/688-7325
TENNESSEE: Knoxville
McCoin Elec. Equip. 615/584-8411
TEXAS: Austin
Data Marketing Assoc. 512/451-5174
TEXAS: Dallas
Data Marketing Assoc. 214/661-0300
TEXAS: Houston
Data Marketing Assoc. 713/780-2511
TEXAS: San Antonio
Data Marketing Assoc. 512/828-0937
WASHINGTON: Bellevue
Thorson Co. 206/455-9180
AUSTRALIA: Mt. Waverly, Victoria
Anderson Digital Elec. 03-543-2077
CANADA: Montreal
Cantec Rep. 514/620-3121
CANADA: Ottawa
Cantec Rep. 613/225-0363
CANADA: Toronto
Cantec Rep. 416/624-9696
EUROPE: England
Techex, Ltd. 0202-293-115
EUROPE: France
Peritex 749-40-37
EUROPE: Switzerland
Interest, AG 031-224481
JAPAN: Tokyo
Munzig International 586-2701

Intelligent Systems Corp.



What's the big difference between the Intecolor 8051 Desk Top Computer and the IBM 5100?

The price tag, for openers.

\$3995*
Intecolor 8051

We've developed a very unique sales philosophy with the Intecolor 8051. We're simply out to give you more desk top computer for less money than anybody in the world. Just compare the capabilities and price of the Intecolor Desk Top Computer with any unit on the market, and you'll see.

Take the Intecolor 8051 versus the IBM 5100, for example. You get the same high-level BASIC Language with both units. But the Intecolor 8051 gives you 8 colors to work with instead of the antiquated, black and white IBM format. Study after study has proven that color means more efficient man-machine interaction, a reduction in operator fatigue, and better use of operator time. And we all know what time is. Money.

Now compare screen sizes. The Intecolor 8051's got a big, 19" diagonal screen that can display up to 3,840 characters—in color. On the other hand the IBM 5100 screen measures a meager 5"x6"! But that's not bad if you've got 10/10 vision. And don't forget memory. Sure you can expand both units to 64K, but the Intecolor comes stock with 26K of memory compared to the IBM's 16K. And graphics? The IBM 5100 can't touch the graphics capabilities of the Intecolor 8051. Not by a long shot. But that's understandable, because not many computers can.

And here's the real zinger. Compare prices. The Intecolor 8051 Desk Top Computer retails for a modest \$3995, while the IBM 5100 starts at a whopping \$8500. That's a lot to pay for a name, especially when you can get a better unit for less than half the price.

The Intecolor 8051 Desk Top Computer. It's selling now for just \$3995. And at that price you can probably afford two. Call us today with your order and we'll prove it to you.

*Domestic USA Prices



Intelligent Systems Corporation®

5965 Peachtree Corners East
Norcross, Georgia 30071
Telephone (404) 449-5880

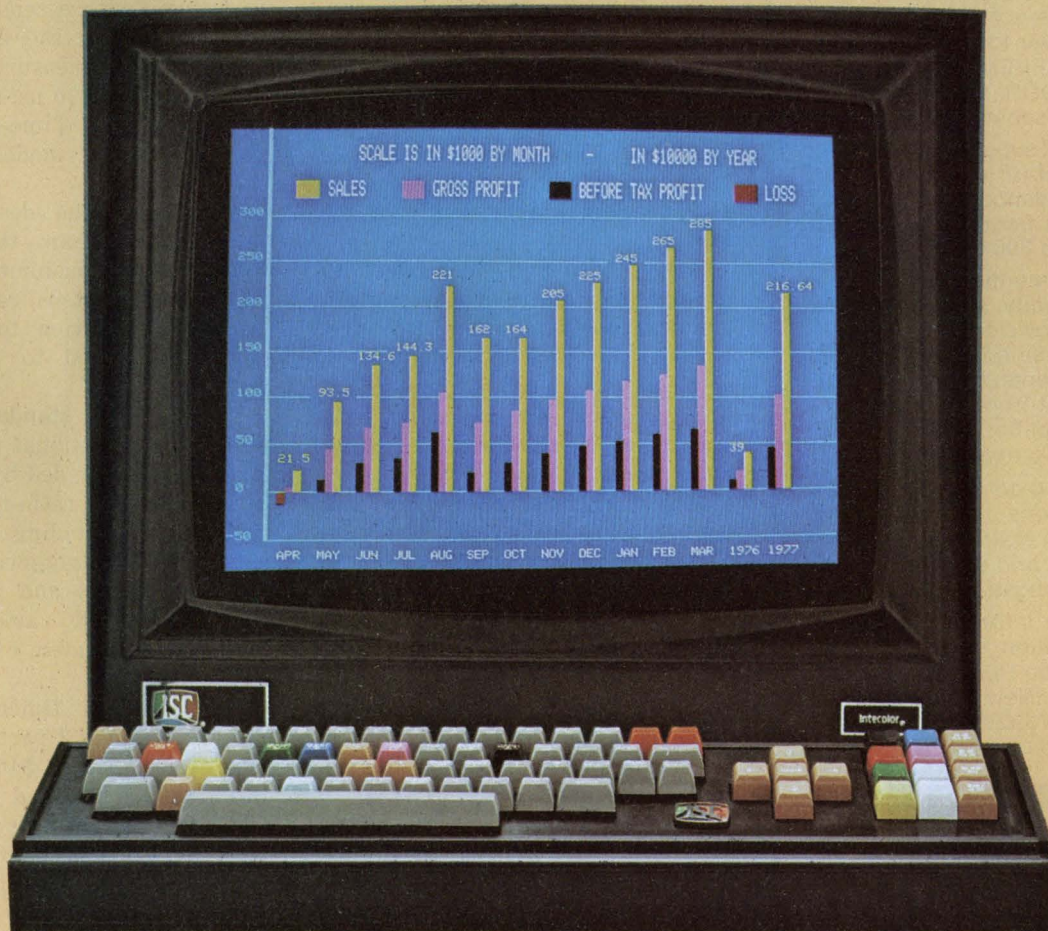

Unretouched photograph of screen.

RF Power Amplifiers?

One unit may be all you'll ever need.

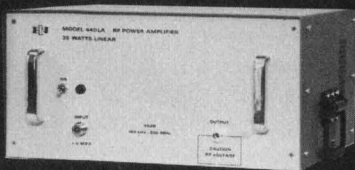

If you have the ENI Model 440LA ultra-wideband solid state power amplifier, all you need is a laboratory signal generator and you've got the ultimate in linear power for such applications as RFI/EMI testing, NMR/ENDOR, RF transmission, ultrasonics and more.

Capable of supplying more than 40 watts of RF power into any load impedance, the 440LA covers the frequency range of 150 kHz to 300 MHz.

We could mention unconditional stability, instantaneous failsafe provisions and absolute protection from overloads and transients, but that's what you expect from any ENI power amplifier, and the 440LA is no exception!

Our catalog contains complete specifications on the 440LA as well as the entire line of ENI amplifiers, and is available without obligation, of course.

For further information or a demonstration, contact ENI, 3000 Winton Road South, Rochester, New York 14623. Call 716-473-6900, or Telex 97-8283 ENI ROC.

ENI

The World's Leader
in Power Amplifiers

CIRCLE NUMBER 76

INSTRUMENTATION

Don't rub your eyes—it's the first dual-display counter



Systron-Donner, 1 Systron Dr., Concord, CA 94518. (415) 676-5000. P&A: See text.

Yes, you are seeing double when you look at Systron-Donner's new 100-MHz universal counter/timer, the 6361A. The unit is the first to give two displays, with each display reading independently of the other.

Armed with two independent input channels and readouts, you can simultaneously measure two frequencies or periods. Even better, you can mix functions and measure, say, both the repetition rate and the pulse width of an incoming pulse train.

The dual feature provides still another mode, called the "alternate period," which is unlike any other found in conventional counter/timers. Because of the way most counters work, the period mode actually measures the length of every other cycle or event. But because of its duality, the 6361A can fill in the alternate periods missed by conventional units.

The only limitation of the alternate-period mode is that the signal frequency must remain below 500 Hz. Other dual applications and combinations depend only on your imagination.

In performance, the Systron instrument can go down to "dc" in frequency, with a sensitivity of 10 mV rms across the entire range. Periods can be measured with resolutions down to 10 ns, and frequencies to 0.1 Hz. Time-interval and alternate-period modes share the same specs.

You select the desired resolution—rather than the timebase interval—with pushbuttons arranged in decade steps ranging from the best resolution to 10 μ s for period/time, and to 100 Hz for frequency.

Most of the standard features found in conventional timer/counters are also provided by the 6361A. Included are a ratio-measurement mode, ac/dc coupling, positive or negative-slope triggering, a trigger-level control and a three-step (X1, X10, X100) attenuator. All these are duplicated, of course, for each channel.

The standard timebase of the 6361A ages at ± 2 parts in 10^6 per year. Tack another \$100 on to the unit's \$895 price, and you can get a TCXO that ages at ± 1 part in 10^6 per year. For even better stability, a proportional oven is available. Delivery takes 60 days.

Booth No. 1527-1530

Circle No. 301

AUGAT ANNOUNCES THE PC BREAKTHRU OF THE DECADE

The card you're looking at is an ordinary printed wiring board with an extraordinary difference. There's not a solder joint anywhere. Every component is plugged into place.

It's this simple: Augat has invented a way to turn plated-through holes into plug-in sockets.

Think what that means: all the benefits of component



plugability with no need for sockets or the headaches of soldering. You get socketed components with card spacing as low as .400"!

And the cost? Less than the total soldered cost of typical inexpensive sockets.

Intriguing, yes? So is the way it works. At the heart of our new method, (which we call the Augat Holtite™ system), is a special adaptation of the long-proven, beryllium copper precision contact that we've turned out by the billions over the past decade for reliable component lead interconnections.

You simply insert the contacts into your plated-through holes, press them into place...



and just like that you've got a component "socket" built right into your board. It's that simple.

Another thing you'll like: switching to our new Holtite system is totally painless. You continue to use the same artwork, drill tapes and process specs. Simply drill the holes to the recommended diameter.

As to mass loading the contacts into your boards, that's easy too. We lease you a machine that does it automatically at a rate of 30,000 con-

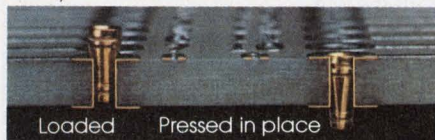

tacts an hour, which includes pressing them into place using a standard hydraulic press.

We're confident our Holtite system is going to revolutionize PC component socketing,

and we invite you to be a part of it.

To get started, order one of our Holtite prototyping kits (for \$94.50) from your Augat distributor, or from us. It has everything you need (1,200 contacts, tools, instructions and test report) to try out our idea firsthand on your own boards. Give it a whirl—this week!



Order Kit No.
398-HK-001

Augat Inc., 33 Perry Avenue,
P.O. Box 779, Attleboro, Mass.
02703. Tel. (617) 222-2202.

AUGAT®

Augat interconnection products,
Isofronic microcircuit packaging,
and Alco subminiature switches.

Bliley

first name in frequency control

We have a reputation that can mean as much to you as it does to us. Here's why.

By manufacturing our own crystals and growing and sweeping our own quartz, we control product quality from raw material to finished unit.

Next, we specialize in the design and production of units whose level of precision is difficult—if not impossible—to find elsewhere.

Finally, our total commitment to quality makes us the preferred supplier to the more sophisticated levels of electronics.

If that's *your* level, you've found your peer in Bliley. Tell us about your present requirements or, simply request our catalog of complete product information and call later when you need us.

QUARTZ CRYSTALS • CRYSTAL OSCILLATORS • CRYSTAL FILTERS

BLILEY ELECTRIC COMPANY
2545 West Grandview Boulevard,
P.O. Box 3428, Erie, PA. 16508
Tel. (814) 838-3571 TWX 510-696-6886



CIRCLE NUMBER 78

MICROPROCESSOR POWER SUPPLIES

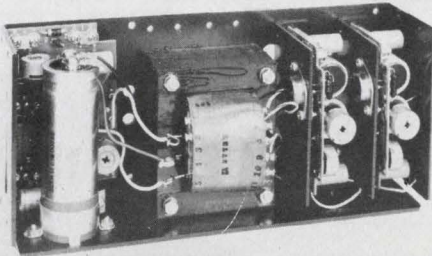

Featuring . . . High Reliability and Low Cost

Now Power/Mate introduces a series of triple output, open frame power supplies designed specifically for microprocessor users.

Based on a rugged, field proven design, the ETR series of microprocessor power supplies features Dual AC Input, remote sensing, adjustable current limiting and plug-in IC regulation throughout the line.

Built to the same rigid quality standards that have made Power/Mate the industry leader, they offer a very impressive 100,000 hour MTBF.

Best of all, the ETR series is economical and in stock. Call or write for our free brochure.

PMIC
POWER/MATE CORP.

World's largest manufacturer of quality power supplies.

514 South River Street/Hackensack, N.J. 07601/Phone (201) 343-6294 TWX 710-990-5023

CIRCLE NUMBER 79

INSTRUMENTATION

5-1/2-digit DMM also measures frequency

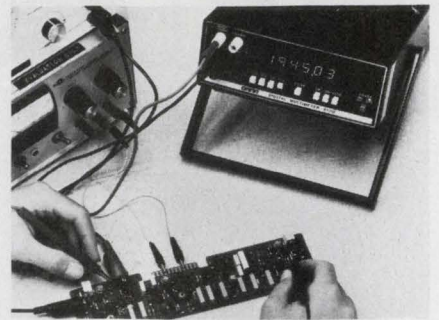

Dana Laboratories, 2401 Campus Dr., Irvine, CA 92715. (714) 833-1234. \$1146; 12 weeks.

The 5100 5-1/2-digit DVM measures ac V, dc V and ohms and also features a built-in 10-Hz-to-20-MHz frequency counter. Readout is 0.43-in. yellow LEDs for reduced eye fatigue. A switchable filter provides inherent noise rejection at multiples of 10 Hz. The dc settling time (filter out) is 30 ms. An averaging ac converter is standard.

Booth No. 1219, 1221

Circle No. 310

Rf wattmeter offers four ranges

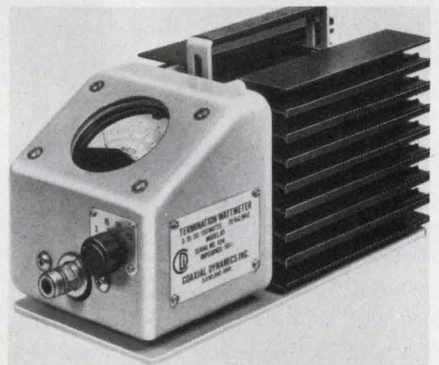

Coaxial Dynamics Inc., 13110 Enterprise Ave., Cleveland OH 44135. (216) 267-2233. \$295; stock.

Model 85 four-range, termination wattmeter covers 20 to 512 MHz and can service anything from hand-held portable and mobile transmitters to 150-W base-station installations. The four power ranges are changed with a front-panel rotary switch. Measurements can be made down to 100 mW on the 3-W scale. The unit safely dissipates levels up to 200 W in overload.

Booth No. 1323

Circle No. 320

ELECTRONIC DESIGN 8, April 12, 1977



**Your
Hi-Rel
Hero
ZAD3214**

**Your Speed Ace
ZAD8014**

**Your
Wild
Card
ZAD3014**

THE ZELTEX A/D ACES

**three NEW high performance
14-bit A/D converters**

ZAD3214—Designed, qualified and screened to 883B. When you want a hard-nosed, battle-tested converter, the 3214 can make you a hero. You get military quality, conversion rates of 100 μ sec or less and 14-bit resolution from 0 to 10V. Fully encapsulated and sealed in a rugged metal case, the 3214 is ready for the most rigid hi-rel assignments. Full military qualifications available on request. Just circle the number.

CIRCLE NUMBER 80

ZAD8014—Analog to Digital in 10 μ sec or less with 14-bit resolution. When you want to overtake high speed analog data and peg it with pinpoint precision, plug-in the 8014. Armed with four pin-selectable input ranges (+10V, +5V, 0 to 5V or 0 to 10V) and unipolar binary, offset binary or 2's complement output codes, the 8014 gives you complete maneuverability. The electrically shielded 2" \times 4" \times 0.4" metal case is streamlined to save board space. Circle the number and we'll hit you with full data.

CIRCLE NUMBER 81

ZAD3014—A general purpose, high-performance, low cost converter. Use it as your wild card, especially when you need superior performance at minimum cost. The ZAD3014 delivers 14-bit resolution at conversion times of less than 100 μ sec. Four input ranges (+10V, +5V, 0 to 10V and 0 to 5V) and three output codes (unipolar binary, offset binary and 2's complement) give you all the flexibility you need in a space-saving 3.5 cu. in. case. This Ace is yours at a deuce price... only \$300.00. Ask for more—we'll send it.

CIRCLE NUMBER 82

The Conversion Product Specialists
940 Detroit Avenue, Concord, CA 94518 (415) 686-6660

Zeltek INC.

ALONE AGAIN

in low cost 1-watt
Zener Diodes

SCHAUER

"Z" SERIES ZENERS

DO-41 epoxy
molded case

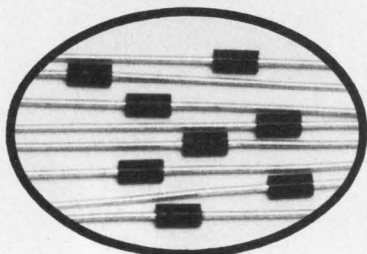

ANY VOLTAGE
2.6 to 34.0

ANY TOLERANCE
1% 2% 5% 10%
At Any Test Current

**Compare These Prices
On 1% Tolerance Diodes**

Quantity	Price each
1-99	91¢
100-499	83¢
500-999	77¢
1000 up	73¢

**LARGE STOCK
GOOD DELIVERIES**

Send for complete rating data
and other tolerance prices.

Semiconductor Division

SCHAUER

MANUFACTURING CORP.

4511 Alpine Ave., Cincinnati, OH 45242
Telephone 513-791-3030 Telex 21-4576

INSTRUMENTATION

Compact ohmmeter resolves 1 $\mu\Omega$

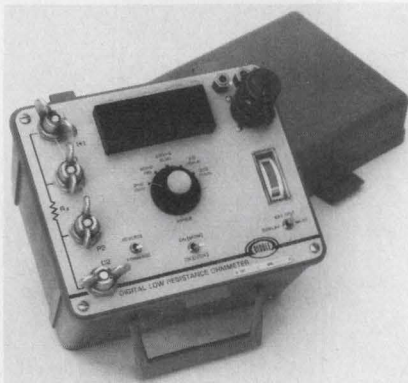

James G. Biddle Co., Plymouth Meeting, PA 19462. (215) 646-9200. \$1300; stock.

A new four-terminal, direct-reading, low-resistance ohmmeter with a 4-digit LED readout offers a ratio circuit to assure accurate readings independent of battery voltage and lead resistance. The unit measures from 1 $\mu\Omega$ to 20 Ω in 5 ranges with a resolution to 1 $\mu\Omega$. Offered are a choice of three different power sources, including rechargeable batteries, plus six different types of test leads.

Booth No. 1721 Circle No. 321

Tumbling DMM prices continue with \$130 unit

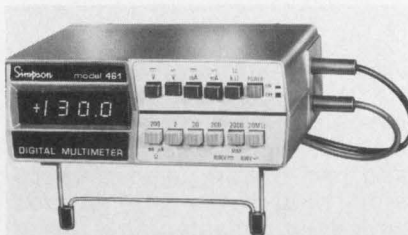

Simpson Electric Co., 853 Dundee, Elgin, IL 60120. (312) 697-2260.

Model 461 3-1/2-digit DMM sells for just \$130, thanks mainly to a single LSI chip containing all a/d conversion circuitry. Accuracy is 0.5% on the dc V ranges. Functions include dc and ac V and current, and resistance. Input impedance is 10 M Ω . Other features include automatic polarity and zeroing. Price includes NiCd batteries, charger/adaptor and test leads.

Booth No. 1620-22

Circle No. 322

Linear tester works with high accuracy

Lorlin Industries Inc., Precision Rd., Danbury, CT 06810. (203) 744-0096. \$75,000 to \$150,000; 90 days.

The LTS/5 system is designed to test linear ICs, including op amps, interface devices, consumer circuits, comparators and voltage regulators; and it can also test diodes, discrete transistors, multi-device packages, a/d and d/a converters and electronic modules. A primary feature of the system is accuracy. Power sources are full V/I programmable as constant voltage or constant current with forcing accuracy of 0.1%, and 0.05% measurement accuracy—said to be an order of magnitude better than linear-device test systems currently on the market.

Booth No. 1303, 1305, 1307

Circle No. 323

Dialable cal source works from batteries



General Resistance, 74 Haven Ave., Mount Vernon, NY 10553. (914) 699-8010. \$1050 to \$1400.

Ten models of the Dial-A-Source Series are now offered in rechargeable battery operated versions providing 8-h operation with total line isolation. Low-battery condition is indicated by the flashing of the LED power lamp. Included are 8 models with full-scale output range of ± 1 and 10 V dc, resolutions to 0.1 μV , and accuracies to $\pm 0.0015\%$ of setting. Two other models supply full-scale outputs of ± 1 , 10 and 100 V dc with resolutions to 1 μV and accuracies to $\pm 0.0025\%$ of setting. Load current capability is 30 mA.

Booth No. 1737

Circle No. 324

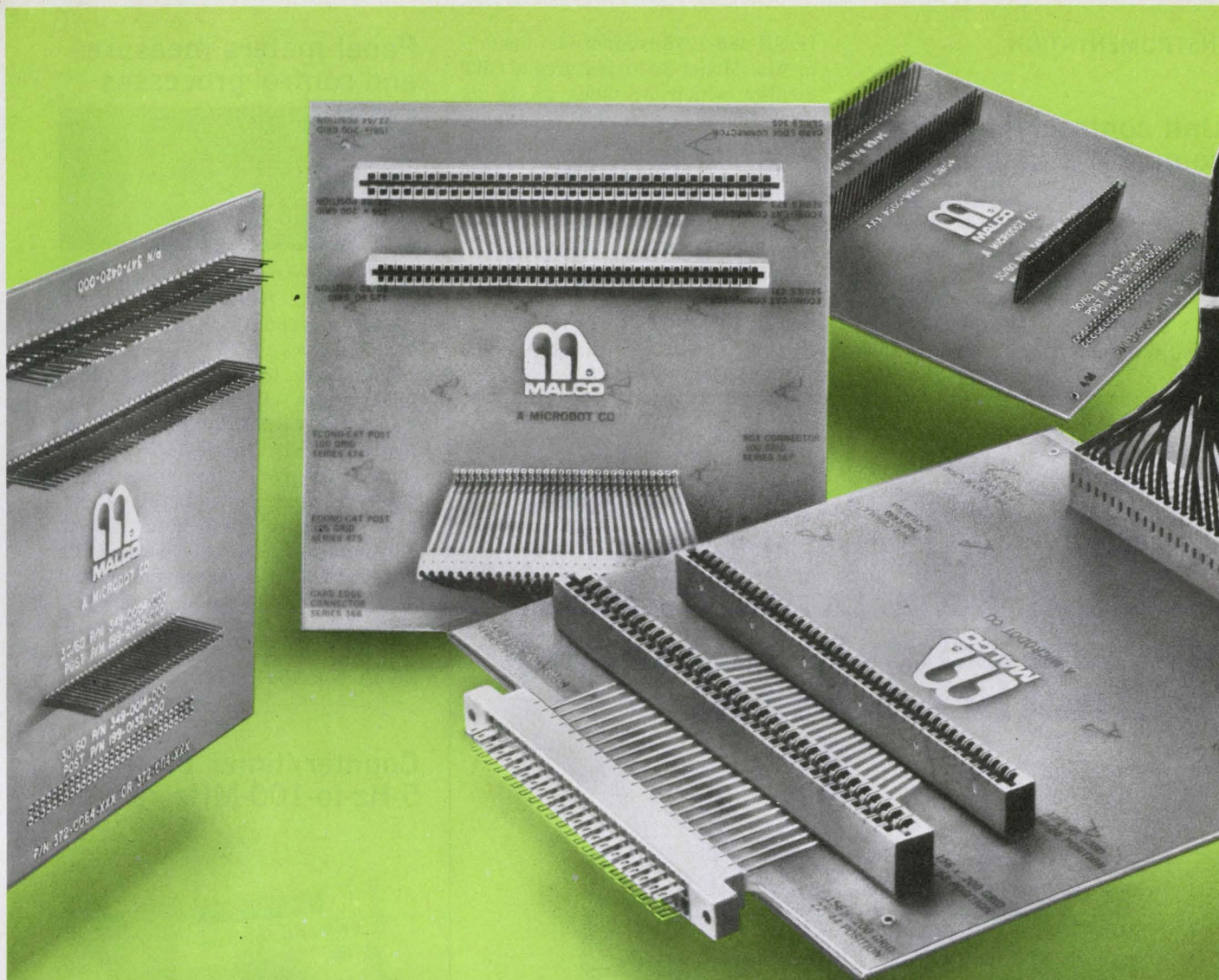

Introducing our new press fit interconnect system. We call it Econ-A-Cat. You'll call it reliable, economical and electrically sound.

Econ-A-Cat is a hybrid packaging technique that utilizes the best of two backpanel approaches—etched circuitry and wire wrapping. It's available as a complete rigid epoxy assembly, built to your drawings and specifications. It's also available in component form for assembly in your plant with Malco supplied tooling. Or else ship Malco your boards and we'll do the assembly for you.

Econ-A-Cat is available in grid patterns of .125" x .125", .100" x .200" and .156" x .200" for card edge and on .100" and .125" centers for (.025)² Post and Box applications.

The end product is the reliable press fit interconnect system that eliminates the heat shock associated with soldering and requires less inspection time. Available for a wide variety of applications.

The price is right too!

Discuss your particular application with your local Malco representative or write or call Malco, 12 Progress Drive, Montgomeryville, PA 18936 (215) 628-9800.

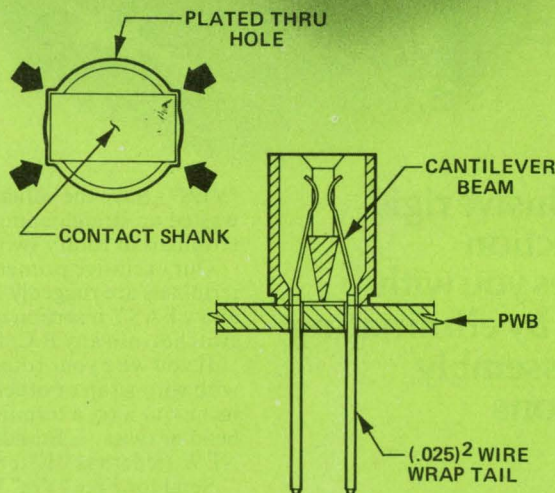

MALCO
A Microdot Company

INSTRUMENTATION

Unit controls IEEE-488 compatible instruments

Systron-Donner Corp., Data Products Division, 935 Detroit Avenue, Concord, CA 94518. (415) 798-9900. \$5995.

Model 3530 microcomputer-operated instrumentation controller is specifically designed to control

IEEE-488-1975-compatible instruments. Model 3530 features a CRT display which provides up to 24 lines for programming, debugging or data formatting. The controller includes a tape-cartridge drive, microcomputer, 24 kbytes of memory, monitor ROM and IEEE 488, TTY and RS232C interfaces. Software is interactive BASIC language.

Booth No. 1527-30

Circle No. 325

Panel meters measure and control processes

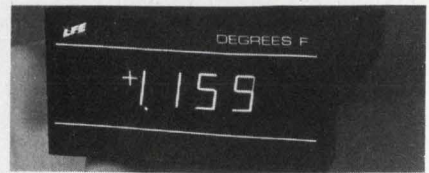

LFE Process Control Div., 1601 Trapelo Rd., Waltham, MA 02154. (617) 890-2000. Prices start at \$135; 6-8 wks.

This new line of digital panel instruments (DPI) offers conversion (signal conditioning) and control capability for measuring and controlling process parameters such as temperature, ac voltage and current, pressure and motor speed. The control function can be integral with the measurement and display in one package, or the set-point function can be mounted remotely.

Booth No. 1634, 1636

Circle No. 326

yes Standard Grigsby's rotary switches have printed circuit and solderless terminals that will not bend or twist

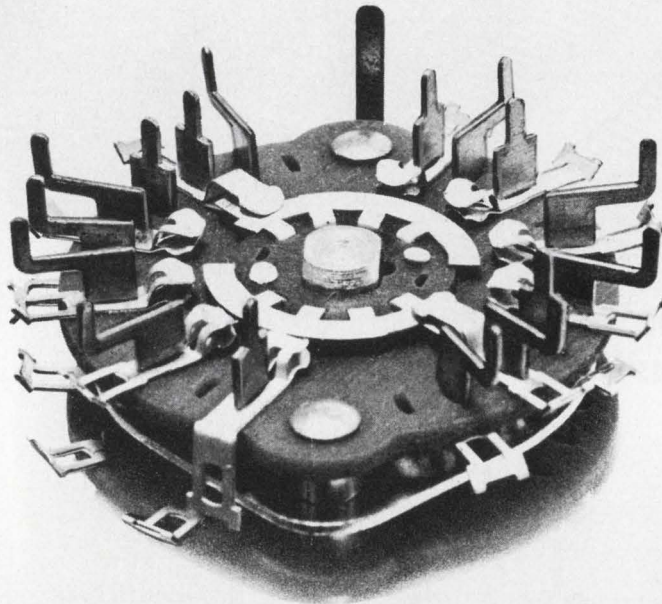

our exclusive rigid construction provides you with savings by eliminating costly assembly operations

"YES" - Save the valuable time wasted on straightening the P.C. terminals of rotary switches!

Our exclusive printed circuit "T" terminals are ruggedly designed to allow EASY insertion of our rotary switches into any P.C. board pattern.

If you wire your rotary switches with wire-wrap or other solderless techniques, try a terminal that won't bend or twist... Standard Grigsby's NEW solderless "T" terminal.

Send for Free "Yes" button and literature.



standard grigsby, inc.

920 Rathbone Avenue • Aurora, Illinois 60507
(312) 844-4300

CIRCLE NUMBER 85

Counter/timer covers 5-Hz-to-100-MHz range



Tabor Electronics, Haifa, Israel, Shemen Industrial Zone, P.O. Box 901. In U. S. Call Arrow International, New York. (516) 643-4500. \$265.

The 424A seven-digit counter/timer measures frequencies from 5 Hz to 100 MHz over the manually selected gate time of 10 ms, 100 ms, 1 s or 10 s. Sensitivity is 25 mV rms typical. The unit measures periods from 1 μ s to 10⁴ s. The clock frequencies (1 kHz to 1 MHz), derived from the internal 1-MHz crystal timebase, are switched in decade steps. Multiple period measurements of the input range from 1 μ s to 10 s and are averaged over the 1 to 1000 periods. Drift is 2 ppm per month while temperature stability is better than 0.5 ppm/ $^{\circ}$ C.

Circle No. 327

Gates introduces the future in energy cells.



There's now a new energy source that's a superb alternative: Rechargeable, sealed lead-acid batteries from Gates.

We call these batteries the future in energy cells. And for good reason.

They have all the product advantages you need plus economic advantages that may well give a new dimension to your product pricing.

Advantages: Gates Energy Cells are as compact as nickel cadmium or gelled type cells. And they are completely sealed, so that no acid vapor can leak out (they also include a self-sealing vent for extra safety). Gates Energy Cells provide low internal impedance for high discharge rates (more than 100 amps from the D cell and 200 amps from our X cell for short periods of time). And can be operated or stored in any position.

Gates Energy Cells offer great packag-

ing flexibility. In fact, our individual cell availability allows you to choose your own specific voltage (in 2-volt increments) and current, as well as configuration.

Just as important as what Gates Energy Cells have to offer is what they don't have to offer. Like outgassing problems. Or cell reversal. Or "memory" problems.

Because Gates Energy Cells are made from low-cost materials that are readily available, they're very high in watt-hr. per dollar value. Which means that if you specify them, you'll probably save your company more than a few dollars. And make yourself into something of a hero in the bargain.

To find out more about the future in energy cells, circle our reader service number or write us. We'll send you *free* literature containing features, application information, ratings and specifications. George Sahl, Gates Energy Products, Inc., 1050 S. Broadway, Denver, CO 80217.



Energy Products

**Where the
energy future is now**

NEW 3½ Digit Multimeter from B&K-PRECISION



B&K-PRECISION
MODEL 283—\$170

...you'll want it for its features
...but its the price that will sell you!

- High intensity LED display is easily read from at least 6 feet in the brightest room
- Measures AC and DC voltage, AC and DC current and resistance.
- 0.5% DC accuracy
- 100% overrange (1000 scale reads to 1999).
- Automatic polarity
- Automatic decimal point
- Flashing overrange indication on display
- Four voltage ranges to 1000V
- Four current ranges to 1000mA.
- Six resistance ranges to 10 meg.
- In-circuit resistance measurements at voltage levels below conduction threshold of semiconductors.
- Overload protection on all ranges

Complete new circuitry makes the Model 283 the most dependable and versatile 3½ digit multimeter you can buy. The extra-bright display allows you to use it where other units would cause reading problems. The selectable "low ohms" function permits accurate measurement of semiconductor shunted resistors.

An optional, internal battery pack (BP-83, \$50.00) provides 8 hours of continuous use on one overnight charging and charges when the Model 283 is in use on 115/230 VAC. Your B&K-PRECISION distributor has the Model 283 in stock and will be glad to demonstrate its features to you. Call him, or write for additional information.

B&K PRECISION
PRODUCTS OF DYNASCAN
6460 W. Cortland Avenue
Chicago, IL 60635 312/889-8870
In Canada: Atlas Electronics, Toronto

CIRCLE NUMBER 87

PACKAGING & MATERIALS

Breadboards route clean power right up to your DIPs

Vector Electronic Co., 12460 Gladstone Ave., Sylmar, CA 91342. (213) 365-9661. P&A: See text.

Two breadboards—one with 72 edge contacts, the other with 44—are designed to bring locally regulated power to DIPs, regardless of their number of pins or their width.

The boards—types 4493 and 4494—can accept from 5 to 44 DIP packages ranging in size from 14 to 64 pins. And no matter how wide the device, no pin is ever more than a quarter-inch away from power.

A special busing arrangement creates 340 pF of capacitance between the lines by routing power and ground together. This routing also helps keep noise down.

The power supply is regulated on the boards and directed to wherever it is needed. The cards' unregulated inputs connect to a TO-220-size regulator, which is referenced to ground and automatically distributed around the cards. Mount-

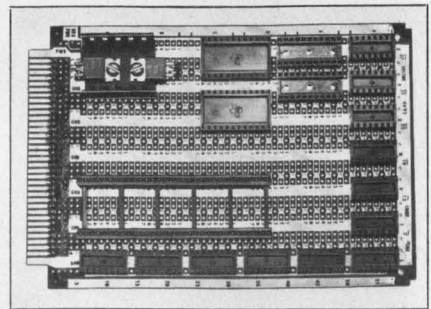

ing hardware, a common sink and even holes are provided.

A second heat-sink slot, left uncommitted, is available for mounting a power transistor, another regulator, or other discrete components.

The 4493 has 72 edge contacts—36 on each side, spaced on 0.1-in. centers. The 4494 has 44 contacts—22 on each side on 0.156-in. centers. Both boards are 6.5 × 4.5 in. Prices vary with quantity between \$10 and \$15 each; delivery is from stock.

Booth No. 2405 Circle No. 302

New twist, color added to flat-cable line

Alpha Wire Corp., 711 Lidgerwood Ave., Elizabeth, NJ 07207. (201) 925-8000.

Alpha's flat-cable line was expanded to include color-coding, a larger number of conductors (10 to 60), and a twisted version to reduce crosstalk. All three lines are compatible with any major brand of insulation-displacement connectors on 0.05-in. centers. A standard color-code sequence is followed with the sequence being repeated for every 10 conductors. The conductors are stranded, tinned copper with 0.01-in. nominal thickness of colored PVC insulation, bonded together to form a flat ribbon. Temperature rating is up to 80 C and maximum voltage rating is 300 V. Color-coded twisted-pair ribbon cable can be used in many applications to replace ground-plane cable, which is difficult to terminate.

Booth No. 2206-08 Circle No. 328

Solder ultrasonically with assorted tips

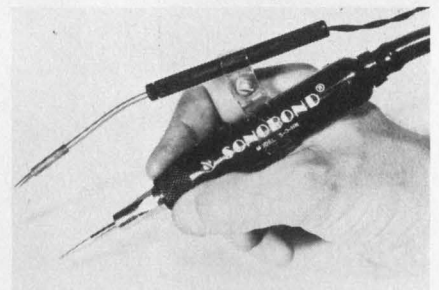

Sonosolder Corp., West Chester, PA 19380. Jim Finley (215) 696-4710.

"Sonosolder" ultrasonic soldering equipment is now available with replaceable tips in various geometric designs and sizes. The ultrasonic production tool permits soldering or coating a variety of nonferrous metals without flux. The resulting joints are free of contamination, eliminating the need for cleaning. Sonosolder also permits soldering of silicon and aluminum.

Circle No. 329

If you're considering a LOGIC ANALYZER or DATA GENERATOR, see the one that's both

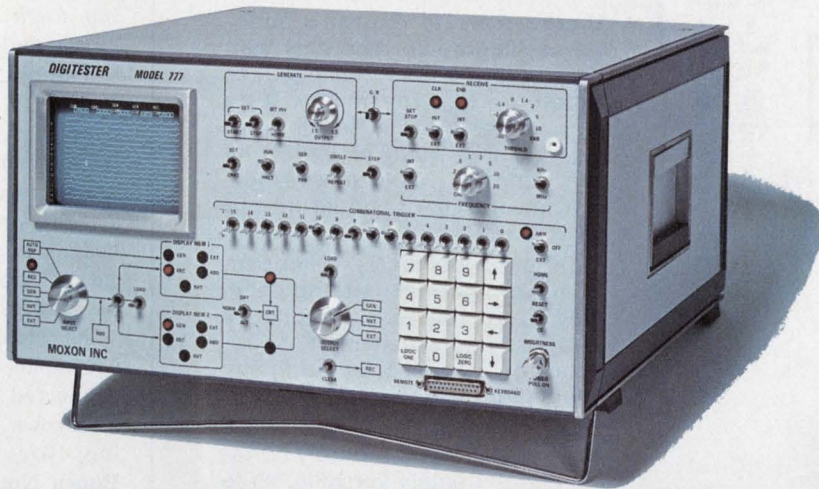

It's a DIGITESTER...3 digital test instruments in 1.

Here are 3 ways you can use a DIGITESTER to reduce your digital logic design costs

INITIAL DESIGN... It's a DATA/WORD GENERATOR

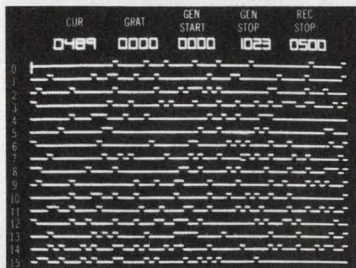

Generate 1024 serial bits to help you develop your communication products.

TROUBLESHOOTING... It's a LOGIC ANALYZER

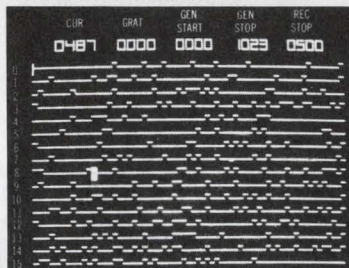

Serial look forward-look back lets you see up to 1023 bits on either side of Trigger Point.

TEST/RECEIVING INSPECTION... It's a DATA COMPARATOR

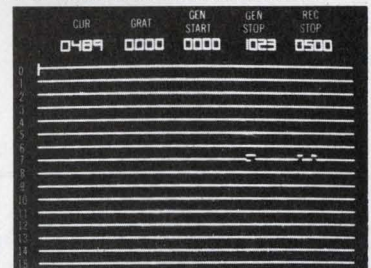

Compare serial response with known program in memory and see disagreement appear.



Generate up to 64, 16 bit words parallel so you can test your interfaces.

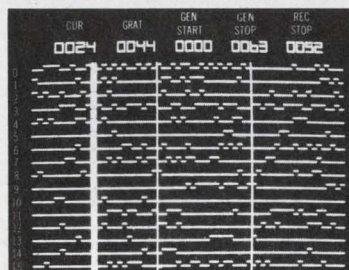

Parallel look forward-look back. Check "fault" symptoms on both sides of selected pattern.

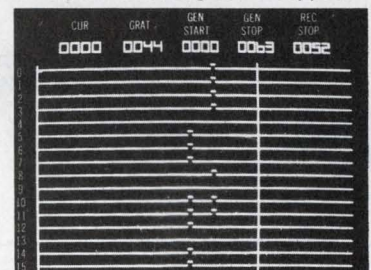

Compare input data with expected pattern in memory and see errors as difference bits.

The DIGITESTER Model 777 is the most valuable test instrument you can get for developing or testing digital logic products...including microprocessors.

To begin with, no other test instrument is quite like the DIGITESTER. It offers you unequalled flexibility for simultaneous or independent logic generating, logic receiving/analysis or comparison. Programs are stored in 1 of 4 internal memories, ready for transfer at variable data rates up to 20 MHz, internally or externally controlled.

You can generate any program with any number of "1" or "0" bits, by using the integral scratch pad keyboard...or an external source if you prefer.

Data is displayed jitter-free, on a 5" CRT. Cursor, graticule, generator start, generate stop and receive stop positions are numerically displayed on the CRT.

Of course the DIGITESTER has all front panel controls needed to make digital development and test work fast, easy and accurate.

You get 3 precision instruments in 1 with exceptional versatility for \$9495.00.

Contact the factory or your local Moxon sales engineer to find out about all the DIGITESTER'S capabilities and discover the savings you'll accrue compared to home-built pattern generators... plus you'll have the added savings of a logic scope. The DIGITESTER can pay for itself in a year. So be sure you see the DIGITESTER...it's the only one that's both a Logic Analyzer and Data Generator.



MOXON INC. • 2222 Michelson Drive • Irvine, California 92715 • Phone: (714) 833-2000 • TWX: 910-596-1362

CIRCLE NUMBER 88

GULTON'S thermal writing portable recorders

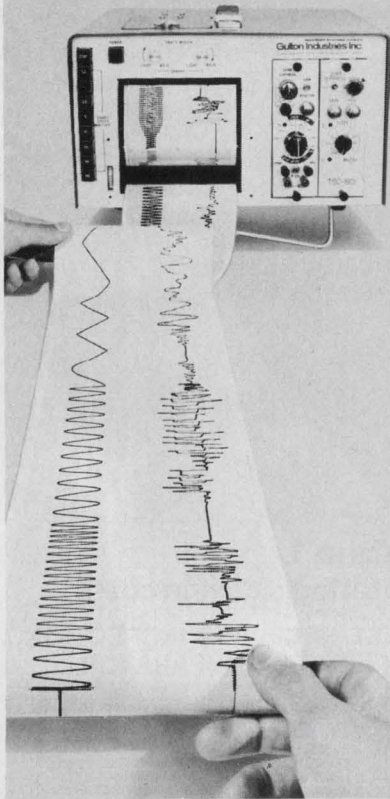

There's more to Gulton's portable oscillographic recorders than clear, easy-to-read tracings. For example, our thermal writing styli eliminate the need for priming, refilling and changing of pen cartridges. And there's never a smear, skip or puddle on your chart.

Light and perfectly balanced, Gulton's thermal writing styli provide up to 125 Hz frequency response and excellent shock resistance. They also record in any orientation.

You'll find that our 2, 4, 6 and 8 channel recorders are truly portable and extremely versatile. Write or call today for 12 page portables catalog.

gulton[®]

Measurement & Control Systems Division
Gulton Industries Inc., East Greenwich, Rhode Island 02818
401-884-6800 • TWX 710-387-1500

CIRCLE NUMBER 89

**SPRAGUE
GOODMAN**

TRIMMER CAPACITORS Our only business!

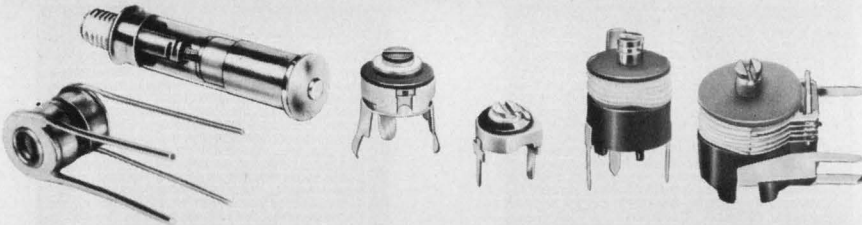

PISTONCAP[®] Multi-Turn Tubular

- Low-Loss, Glass or Quartz
- High Stability/High Reliability
- Simple, Long-Life Adjust Mechanism
- Professional / Military Applications, MIL Approved

CERAMIC Single-Turn

- Compact, Conserves Board Space
- Variety of Mounting Configurations
- Low Cost for Commercial/Industrial Applications

FILMTRIM* Single-Turn Film

- PTFE, Polypropylene, Polycarbonate
- Most Stable Trimmer for Size
- Very Wide Capacitance Ranges
- Low Cost for Commercial/Industrial Applications

*Trade Mark

Tired of broken delivery promises and poor quality? Deal with the trimmer capacitor specialist, for quality products delivered on schedule! Call on us for custom designs too, we deliver!

TRIMMER CAPACITORS — OUR ONLY BUSINESS!

Sprague-Goodman Electronics, Inc.

(An Affiliate of the Sprague Electric Company)

134 FULTON AVE., GARDEN CITY PARK, N.Y. 11040 • 516-746-1385 • TLX: 14-4533

VISIT OUR BOOTH 2531 AT ELECTRO 77.

CIRCLE NUMBER 90

PACKAGING & MATERIALS

Captive nylon mount is tied to standoff

Weckesser Co., Inc., 4444 W. Irving Park Rd., Chicago, IL 60641. (312) 282-8626.

The nylon captive standoff is designed to simplify mounting of a wide variety of electrical and electronic components and parts. The spacer is especially suited for separating or stacking printed-circuit boards and for any type of application that requires components to be rigidly mounted and at the same time electrically isolated. The spacer and nut are physically connected, and either nylon or metal screws may be used for mounting. Sizes range from 1/4 to 1 in. **Booth No. 2532** **Circle No. 330**

LED-display sockets have 8 to 40 pins

Aries Electronics, Inc., P.O. Box 231, Frenchtown, NJ 08825. (201) 996-4096. \$1.50 to \$4.

LED-display sockets, with 8 to 40 pins, allow ganging of multiple displays. The Vertisocket accepts a 1/2-in. high display with 0.6-in. spacing on plug-in pins and has Aries bifurcated contacts. The socket body is 30% glass-filled nylon.

Booth No. 2543 **Circle No. 331**

Pre-insulated terminal reduces labor cost

Hollingsworth Solderless Terminal Co., Nutt and French Creek Rds., Phoenixville, PA 19460. William Shields (215) 933-8947.

The fully pre-insulated flag slip-on terminals are designed to eliminate costly post-insulation procedures. They consist of a right-angle noninsulated quick-disconnect terminal contained within an insulation housing of molded vinyl. Crimping is performed directly through the insulating material. The terminals are available for two wire ranges, 22-18 AWG and 16-14 AWG, fitting NEMA tab size 0.032 x 0.250 in. They are rated at 600-V continuous use and have a maximum working temperature of 105 C.

Booth No. 2439-41 **Circle No. 332**

E-Z-PROBES XP AND XPL ■ TEST LEADS AND JUMPERS ■ ADAPTORS

OUR NEW MICRO TROUBLE SHOOTER SOLVES YOUR IC TESTING PROBLEMS

The XM Micro Hook is designed for difficult IC test connections. Light weight (less than 1 gram) and Finger-eze Hypo Action permit direct hookup to delicate wires where weight and leverage may damage component. Fully insulated to a single contact point for true readings.

Construction: One-Piece Beryllium Copper, Gold-Plated Conductor and Hook, made for connections over leads up to .025" diameter. Durable Heat and Chemical Resistant Nylon Body. Stainless Steel Spring. Available preconnected to a wide variety of interface connectors.

Colors Red, Black, Blue, Green, Orange, Yellow, White, Brown, Violet and Gray.

EXCLUSIVE FIELD SERVICING FEATURE

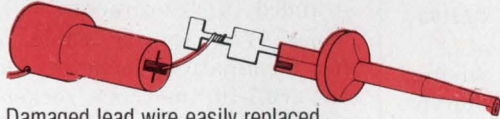

Damaged lead wire easily replaced.

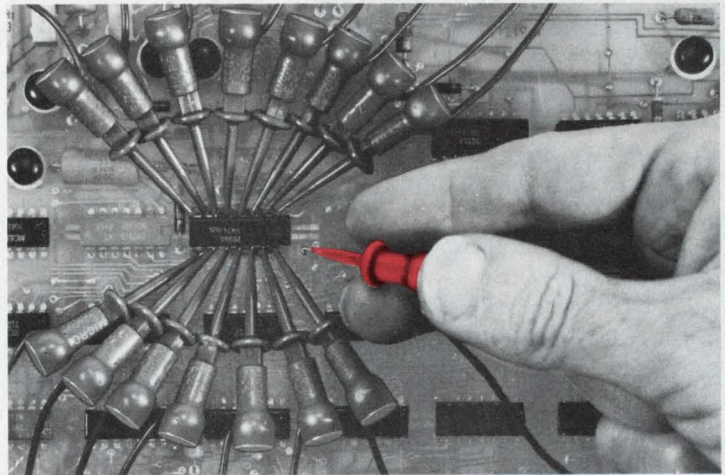

MODEL XM SHOWN ACTUAL SIZE WITH HOOK EXTENDED.

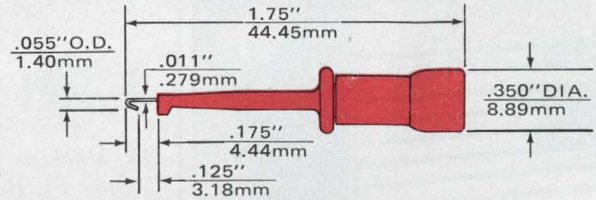

SEND FOR COMPLETE NEW CATALOG AND PRICE LIST

EZ-HOOK
A DIVISION OF TEKTEST, INC.

114 EAST SAINT JOSEPH STREET
ARCADIA, CALIFORNIA 91006
(213) 446-6175 / TWX 910 582 1614

CIRCLE NUMBER 91

PATCH CORDS ■ COAXIAL JUMPERS ■ E-Z-HOOK CLIP 61-1 AND 61-2

new from Hayden!

"... well-organized, extremely well written ... highly recommended for practicing engineers..."
IEEE Transactions

DIGITAL SIGNAL ANALYSIS

Samuel D. Stearns

This is an ideal master handbook on today's signal processing procedures and systems, containing recent advances, new design material, and a comparison between continual and digital systems that's extremely helpful to newcomers to the field. Featuring a foreword by Richard Hamming, the book contains a review of linear analysis; sample-data systems; analog-to-digital and digital-to-analog conversion; the discrete Fourier transform and the fast Fourier transform algorithm; spectral computations; non-recursive and recursive digital systems; computer simulation of continual systems; analog and digital filter designs, and more. 288 pages

"Jacobi's book is great ... a new, original, readable, usable book on writing for business and professional people. ..."

Jim Lufkin, Mgr. Professional Publications, Honeywell.

WRITING AT WORK:

Dos, Dont's, and How Tos

Ernst Jacobi, Xerox Corporation.

This guide to better writing follows its own principles by being lively, informative, and easy to read. More than a collection of pat rules and formulas, the book is a storehouse of practical advice for business and professional people to make their writing sharper, more interesting, and more informative. It shows you how to overcome procrastination and change your entire attitude toward writing, making it easier and more enjoyable for you! 208 pages.

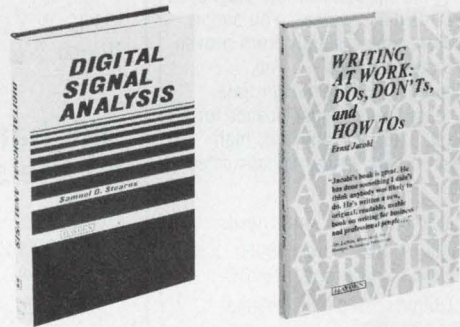

HAYDEN BOOK COMPANY, INC.
50 Essex Street, Rochelle Park, New Jersey 07662

Order today—15-day examination!

Please send me the following book(s) to read and use FREE for 15 days. At the end of that time, I'll either send the amount indicated, plus postage and handling, or return the book(s) with no obligation.

- DIGITAL SIGNAL ANALYSIS, #5828-4, \$19.95
- WRITING AT WORK, #5730-X, \$10.95

Name _____

Company/Institution _____

Address _____

City/State/Zip _____

SAVE MONEY! Payment Enclosed. Publisher will pay all shipping and handling charges. Same 15-day return privilege and full refund if not satisfied.

BUILDING YOUR OWN POWER SUPPLY?

Think Twice!



Think "DESIGN-AS-YOU- ORDER"

Think of the expense and time involved in designing and building your own power supply, and how those resources can be applied to designing and building other components.

Now think about the exclusive Arnold Magnetics "Design-As-You-Order" system. You simply order your **custom** power supply from proven "off-the-shelf" sub-modules . . . no engineering charges, no lost design time. Just fill in our "easy-to-use" specification form, we'll do the rest. Your miniaturized, high efficiency power supply arrives encapsulated and pre-tested.

See if these parameters meet your needs:

- Inputs: Single or dual; 60Hz, 400Hz, 12VDC, 28VDC, 48VDC and 115VDC.
- Regulated Outputs: single or isolated multiple; 5 to 300VDC.
- Line and load regulation to 0.1%.
- Power: 3—160 watts (up to 3.9 watts/in³).
- Other catalog power supplies with outputs to 5000VDC and power to 200 watts.
- Capability to design and build to your special needs.

Send for a free "Design-As-You-Order"
Power Supply Kit today!



ARNOLD MAGNETICS CORPORATION

11520 W. Jefferson Blvd.
Culver City, Ca. 90230 • (213) 870-7014

CIRCLE NUMBER 93

PACKAGING & MATERIALS

Save time & money with wrapped-wiring kit

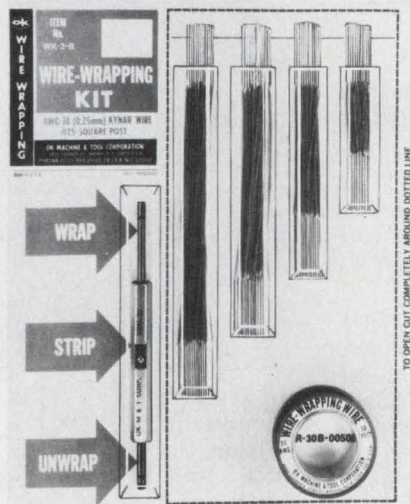

OK Machine and Tool Corp., 3455
Conner St. Bronx, NY 10475. Judy
Camen (212) 994-6600. \$11.95;
stock.

Kit WK-2, for wrapped wiring, contains all you need for prototype wiring. It includes a unique wrapping tool, a roll of wrapping wire, and pre-stripped wire in four popular lengths. The tool, Model WSU-30, wraps, unwraps and strips 30 AWG (0.25-mm) wire on square pins (0.025 in.). You can choose from four wire colors: blue (Model WK-2B), white (WK-2W), yellow (WK-WY), and red (WK-2R).

Booth No. 2712 Circle No. 333

DIP handler gets on the stick

Daymarc, 301 2nd Ave., Waltham,
MA 02154. Ed Martin (617) 890-
2345. From \$12,500; 12-14 wks.

The Model 1152 DIP Handler provides automatic DIP-test handling, stick to stick, for 6-to-42 pin DIPs with three-or-five-output categories. All load boards of any size with any socket location can be used. The Model 1152 can handle existing load boards directly, without modification. The test rate is 6000/h with 100-ms test time. Operation continues during stick change. Tested devices are stored on the output track during stick change. Conversion to different stick types or IC-body dimensions is easily accomplished by the operator in seconds.

Booth No. 2515 Circle No. 334

Tap into IC sockets & PCs the easy way

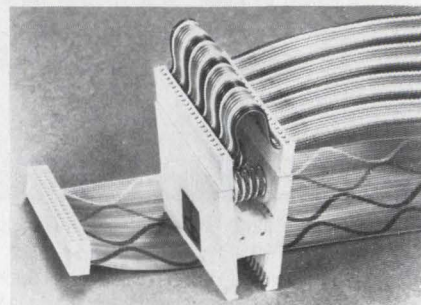

AP Products Inc., Box 110, 72 Corwin
Dr., Painesville, OH 44077.
(800) 321-9668. \$13.88 (1-10);
stock-3 wks.

Now there's a faster and easier way to interconnect directly from an IC package to, say, a logic analyzer. The Test Clip Jumper assembly connects a tandem pair of single-row 20-contact female connectors to any of several 28-AWG stranded 40-contact ribbon cables. You specify cable length and termination, including double-row (0.1-in. matrix) socket connector, card-edge connectors, PC connectors, DIP plug connectors, and daisy-chained connectors.

Booth No. 2138-41 Circle No. 335

Plastic instrument box has sloping panel

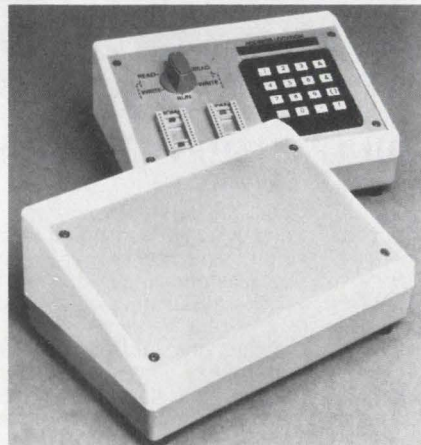

Electronics Inc., 171 Bridge Rd.,
Hauppauge, NY 11787. (516) 234-
0400. \$6.56 (1); stock.

Verobox 75-1798K is a versatile instrument case molded of high-impact ABS with a light-gray upper section and a dark-gray base. A clear-anodized aluminum front panel (0.05-in. thick) is supplied with each box. The base measurements are 6.73 × 4.76 × 2.95 in., sloping to 1.48 in.

CIRCLE NO. 336

Circular connectors take 50-g shock

Viking Industries Inc., 21001 Nordhoff St., Chatsworth, CA 91311. (213) 341-4330. \$1/pair (10,000); 4 wks.

The new Thorkon series of low cost, high quality, miniature, rugged, thermoplastic, circular connectors offers corrosion-resistance and quick-connect/disconnect capabilities, and withstands vibration and up to 50 G's of shock while providing high-density contact arrangements. Thorkon connectors are available for panel mounting, or as part of a molded-cable assembly under the name Vikord.

Booth No. 2815-17 Circle No. 337

Slam latch simplifies installation

Richardson, Thomas & Bushman, Inc., Highland Office Center, 550 Pinetown Rd., Fort Washington, PA 19034. Thomas A. Grant (215) 643-2220.

The No. 88 slam latch snaps shut automatically when a door or panel is closed. A quarter-turn opens the latch, which consists of a stud, jam nut, and spacers with a slotted or knob-style screw, and a receptacle into which the stud nose latches. Easily mounted through a single hole in the door for the stud assembly, and three holes in the frame for the receptacle, it is designed to handle a range of door-frame thicknesses. Other variants are available.

Booth No. 2624-26 Circle No. 338

Well-stacked connector eliminates motherboard

AMP Inc., Harrisburg, PA 17105. (717) 564-0100.

Designed to interconnect without a backplane or motherboard in bus-oriented systems, the new zero-insertion-force stacking connectors require only a mounting width of 0.5 in. These new connectors have post contacts to mate with each other, or with several standard varieties of connectors that accept discrete wires, multiple coax, or flat cable on a grid of 0.1 in. The gold-plated replaceable contacts are held in housings molded from glass-filled nylon.

CIRCLE NO. 339

Digital filtering is old hat



You can now replace ten-bit A/D and D/A converters plus a digital filter module with a single integrated circuit.

Our standard product line already includes devices for audio and video delays, time-base correctors, transversal and real time adaptive filters, convolvers and correlators, and could well be the answer to many of your analog processing needs.

Our SAD-1024 is the industry standard in audio and musical effects; our TAD-32, tapped analog delay, is one of the hottest tools in sophisticated circuit design. We have built mask programmed chirp, linear phase, low pass and band pass filters which are the equivalent of a 14 pole filter in a single DIP.

If this doesn't do it, we can put your 19-inch rack into a DIP or two. Just remember, it is cheaper to quantize only in time than in time and amplitude... and we know how to do it. We have the tools from "old fashioned" silicon gate MOS to the latest n-channel BBD and CCD technologies.

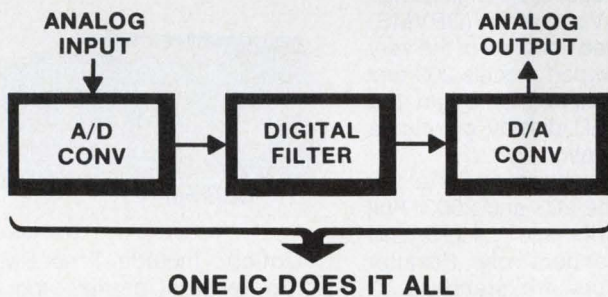

For further information, write or call:

RETICON®

AN EG&G COMPANY

910 Benicia Ave. • Sunnyvale, Ca. 94086 • (408) 738-4266

CIRCLE NUMBER 94

POWER SOURCES

Efficient switcher packs lots of watts

RO Associate, 3705 Haven Ave., Menlo Park, CA 94025. R. O. Okada (415) 322-5321. \$650 (1-99 qty); stock.

Without paralleling power transistors, the Model 712 delivers 5 V at 120 A. The 20-kHz switcher

boasts 75% efficiency within its $3.5 \times 8 \times 13$ in. The standard unit operates from 115/230-V, 47-to-50-Hz input power; 208-V and 400-Hz operation are also available. All units have current-limiting short-circuit protection and over-voltage protection. A thermostat allows full output (no derating) until the case reaches 80 ± 2.8 C. Brownout protection is also included.

Booth No. 1431 Circle No. 340

Unit swallows surges from 400-Hz supplies

Polyphase Instrument, E. 4th St., Bridgeport, PA 19405. R. Simmons (212) 279-4660. \$75 (1-4); stock.

Volt-Check is a 400-Hz line voltage regulator intended for airborne electronic equipment operating from MIL-STD-704-A power sources. The unit is said to suppress voltage transients to a safe peak value with minimal voltage drop.

CIRCLE NO. 341

The most DPVM you can get today for \$69.



Model 203A Price \$69/100 units

THE MOST POPULAR DPVMS BECOME EVEN MORE ATTRACTIVE

Newport's model 203A (3½ digits) and 2003A (4½ digits) Digital Panel Voltmeters (DPVMS) are upgraded versions of the very popular Newport models 203 and 2003. Available with bright red 0.5 inch LED display or orange LED digits optionally.

The pin connections are the same as the 203 and 2003. Full scale counts are ± 1999 and ± 19999 respectively. Parallel BCD outputs are standard. A choice of four voltage ranges. The standard case is high impact plastic with DIN cut out dimensions or NEMA dimensions optional. One adjustment behind the lens sets full scale. Automatic zeroing of the input is performed on each conversion.

Average value, dual slope integration prevents ambiguous

readings of small signals superimposed on noise. Ratio capability is standard.



Model 2003A Price \$129/100 units

Options include True RMS, screw terminal barrier strip for signal and power, and 5 volt DC power instead of normal AC line power. The 2003A has an option for buffered, isolated, gated and latched BCD outputs. Available from distributors and stocking reps world wide. Ask us about our mod centers and high volume custom engineering for your application.

Newport Labs
630 East Young Street
Santa Ana, California 92705
Phone (714) 540-4914
In Europe-Tele Amsterdam 20-452052

NEWPORT

CIRCLE NUMBER 95

Bench supplies let you vary all three outputs

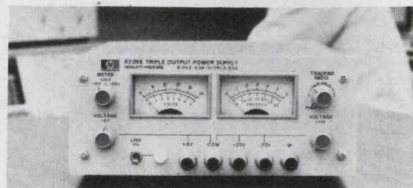

Hewlett-Packard, 1501 Page Mill Rd., Palo Alto, CA 94304. \$345; 2 wks.

Two dc power supplies each provide three adjustable output voltages. You get outputs of 0 to 6 V at up to 2.5 A from Model HP-6236B and 0 to 18 V at up to 1 A from Model HP 6237B. Both bench supplies also have plus and minus outputs of 0 to 20 V at 0.5 A and they track within 1%. With the tracking-ratio control, you can set any negative output voltage between 5 to 95% of the positive output. As the ± 20 -V control is adjusted, the negative output will be proportionately less than the positive output as determined by the tracking ratio setting. For a single 0-to-40-V output at 0.5 A, use the -20 -V and ± 20 -V terminals. Both instruments feature regulation of 0.1% +2 mV, with ripple and noise of 0.35-mV rms or 1.5-mV pk-pk. The supplies accept nominal 100-V, 120-V, 220-V or 240-V, 47-to-63-Hz input power. Both the 6-V (or 18-V) and ± 20 -V outputs are protected from overloads by fixed current-limiting circuits. In the 6-V model, the fold-back current limiter reduces the available current from 2.5 A at the 6-V setting to 1 A at the zero setting. The current limit for the 18-V model is fixed at 1 A for all settings. The ± 20 -V outputs are limited to 0.5 A for all overload conditions. The supplies weigh 9.5 lb and are $3.25 \times 8.5 \times 12.5$ in.

CIRCLE NO. 342

Performance, reliability and economy have been combined in ACDC's OEM Series power supplies to create a product line with exceptional performance specifications and low price. These value-engineered supplies come in a range of outputs from 5 volts at 3 amps to 32 volts at 8.1 amps in the single-output versions, ± 12 and ± 15 volts in the duals, and 5, ± 12 and 5, ± 15 in the triple output units. More than 70 OEM models are available, all recognized under the Component Program of Underwriters' Laboratories, Inc.

ACDC MEETS YOUR HIGH-VOLUME APPLICATION NEEDS WITH ITS LINE OF

OEM SUPPLIES

- 0.1% REGULATION
- SINGLE, DUAL AND TRIPLE OUTPUT VERSIONS AVAILABLE
- UL RECOGNIZED*
- VERSATILE MOUNTING
- OFF-THE-SHELF DELIVERY

*Recognized under the Component Program of Underwriters' Laboratories, Inc. (file number E48765).

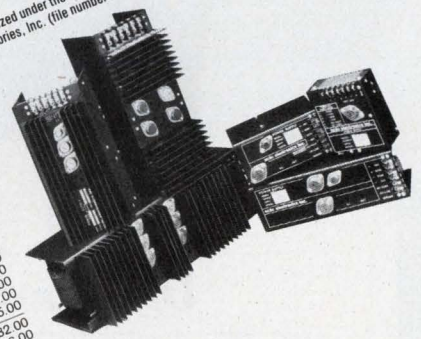

SINGLE OUTPUT POWER SUPPLIES			
Nominal Output Voltage	Max. Current (amps)	Model Number (Add -1 for DVP)	Price
			1 10 50
5v.	3.0	OEM5N3	\$ 55.00 42.00 40.00
	5.7	OEM5N5.7	100.00 78.00 76.00
	10.0	OEM5N10	110.00 94.00 90.00
	17.0	OEM5N17	150.00 137.00 132.00
	35.0	OEM5N35	200.00 190.00 183.00
6v.	2.7	OEM6N2.7	55.00 42.00 40.00
	5.2	OEM6N5.2	100.00 78.00 76.00
	9.5	OEM6N9.5	110.00 94.00 90.00
	15.0	OEM6N15	150.00 137.00 132.00
	30.7	OEM6N30.7	200.00 190.00 183.00
10v.	3.5	OEM10N3.5	105.00 89.00 82.00
	6.5	OEM10N6.5	120.00 105.00 96.00
	10.2	OEM10N10.2	170.00 147.00 135.00
	14.9	OEM10N14.9	210.00 201.00 185.00
	21.0	OEM10N21.0	255.00 245.00 225.00
12v.	1.7	OEM12N1.7	55.00 42.00 40.00
	3.2	OEM12N3.2	100.00 78.00 76.00
	5.8	OEM12N5.8	110.00 94.00 90.00
	9.5	OEM12N9.5	150.00 137.00 132.00
	18.5	OEM12N18.5	200.00 190.00 183.00
14v.	2.8	OEM14N2.8	105.00 89.00 82.00
	5.2	OEM14N5.2	120.00 105.00 96.00
	8.7	OEM14N8.7	170.00 147.00 135.00
	12.0	OEM14N12.0	210.00 201.00 185.00
	16.7	OEM14N16.7	255.00 245.00 225.00
15v.	1.5	OEM15N1.5	55.00 42.00 40.00
	2.7	OEM15N2.7	100.00 78.00 76.00
	5.0	OEM15N5	110.00 94.00 90.00
	8.2	OEM15N8.2	150.00 137.00 132.00
	15.8	OEM15N15.8	200.00 190.00 183.00
16v.	2.6	OEM16N2.6	105.00 89.00 82.00
	4.7	OEM16N4.7	120.00 105.00 96.00
	8.7	OEM16N8.7	170.00 147.00 135.00
	11.2	OEM16N11.2	210.00 201.00 185.00
	15.8	OEM16N15.8	255.00 245.00 225.00
20v.	2.1	OEM20N2.1	105.00 89.00 82.00
	3.8	OEM20N3.8	120.00 105.00 96.00
	6.7	OEM20N6.7	170.00 147.00 135.00
	8.2	OEM20N8.2	210.00 201.00 185.00
	12.2	OEM20N12.2	255.00 245.00 225.00
24v.	1.0	OEM24N1	55.00 42.00 40.00
	1.8	OEM24N1.8	100.00 78.00 76.00
	3.3	OEM24N3.3	110.00 94.00 90.00
	5.4	OEM24N5.4	150.00 137.00 132.00
	10.8	OEM24N10.8	200.00 190.00 183.00

DUAL OUTPUT POWER SUPPLIES			
Nominal Output Voltage	Max. Current (amps)	Model Number (Add -1 for DVP)	Price
			1 10 50
± 12	1.5	OEM12D1.5	\$120.00 \$107.00 \$102.00
	2.7	OEM12D2.7	132.00 119.00 113.00
± 15	1.3	OEM15D1.3	120.00 107.00 102.00
	2.4	OEM15D2.4	132.00 119.00 113.00

TRIPLE OUTPUT POWER SUPPLIES			
Nominal Output Voltage	Max. Current (amps)	Model Number (Add -1 for DVP)	Price
			1 10 50
5v.	3.0	TR101	\$134.00 \$118.00 \$113.00
	0.75		
± 12	3.0	TR102	170.00 153.00 147.00
	0.64		
5v.	5.0	TR201	170.00 153.00 147.00
	1.0		
± 15	5.0	TR202	199.00 182.00 175.00
	0.85		
5v.	10.0	TR301	199.00 182.00 175.00
	1.0		
± 15	10.0	TR302	
	0.95		

acdc electronics
 401 Jones Road, Oceanside, California 92054, (714) 757-1880, TWX: 910-322-1470
 524 South Avenue East, Cranford, New Jersey 07016, (201) 272-3377



makes your life easier

NICS DISTRIBUTOR DIRECTORIES EVER PUBLISHED

BOTH ALPHA AND GEO ACCESS

Looking for a distributor near you? The Geo directory tells you quickly. Need more information . . . just check the Alpha pages.

NAME, ADDRESS & PHONE

Repeated in GEO DIRECTORY to save you time.

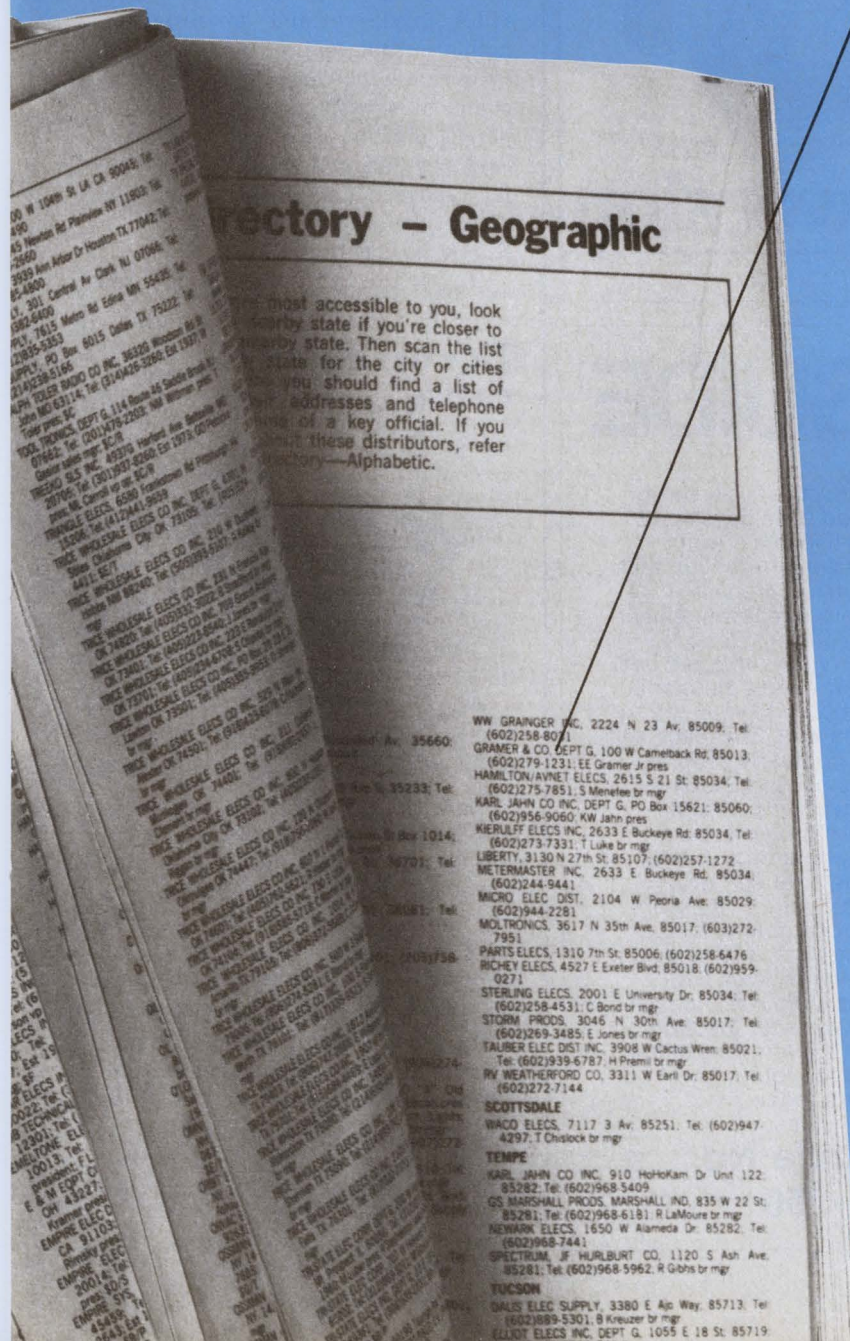

KNOW A TRADE NAME BUT NOT ITS MANUFACTURER?

Here's the place to find it. 7,812 trade names are listed from Abacus to Zyglo. EEM has discontinued its separate Trade Names Directory. The GOLD BOOK's has grown each year.

LOOKING FOR A DISTRIBUTOR NEAR YOU?

LOOK **FIRST** in Electronic Design's

GOLD BOOK

WW GRAINGER INC. 2224 N 23 Av. 85009. Tel: (602)258-8071
 GRAMER & CO DEPT G, 100 W Camelback Rd. 85013. (602)279-1231; EE Gramer Jr pres
 HAMILTON AVNET ELECS, 2615 S 21 St. 85034. Tel: (602)275-7851; S Manoles br mgr
 KARL JAHN CO INC, DEPT G, PO Box 15621. 85060. (602)956-9060; KW Jahn pres
 KIERULFF ELECS INC, 2633 E Buckeye Rd. 85034. Tel: (602)273-7331; T Luke br mgr
 LIBERTY, 3130 N 27th St. 85107. (602)257-1272
 METERMASTER INC, 2633 E Buckeye Rd. 85034. (602)244-9441
 MICRO ELEC DIST, 2104 W Peoria Ave. 85029. (602)944-2281
 MOLTRONICS, 3617 N 35th Ave. 85017. (603)272-7951
 PARTS ELECS, 1310 7th St. 85006. (602)258-6476
 RICHEY ELECS, 4527 E Exeter Blvd. 85018. (602)959-0271
 STERLING ELECS, 2001 E University Dr. 85034. Tel: (602)258-4531; C Bond br mgr
 STORM PRODS, 3046 N 30th Ave. 85017. Tel: (602)269-3485; E Jones br mgr
 TAUBER ELEC DIST INC, 3908 W Cactus Wren. 85021. Tel: (602)939-6787; H Premi br mgr
 WV WEATHERFORD CO, 3311 W Earl Dr. 85017. Tel: (602)272-7144
 SCOTTSDALE
 WACO ELECS, 7117 3 Av. 85251. Tel: (602)947-4297; T Ostock br mgr
 TEMPE
 KARL JAHN CO INC, 910 Hohokam Dr Unit 122. 85282. Tel: (602)968-5409
 GS MARSHALL PRODS, MARSHALL IND, 835 W 22 St. 85281. Tel: (602)968-6181; R LaMoure br mgr
 NEWARK ELECS, 1650 W Alameda Dr. 85282. Tel: (602)968-7441
 SPECTRUM, JF HURLBURT CO, 1120 S Ash Ave. 85281. Tel: (602)968-5962; R Gibbs br mgr
 TUCSON
 DALUS ELEC SUPPLY, 3380 E Alo Way. 85713. Tel: (602)889-5301; B Kreuzer br mgr
 ELIOT ELECS INC, DEPT G, 1055 E 18 St. 85719

ETERNACELL®

The only complete line of Lithium Primary Batteries

There's a new technology in primary batteries. It's called the Eternacell Lithium Battery. Or Eternacell for short.

- Operating voltage 2.8 volts per cell
- -65°F to 160°F performance
- Up to 10 years shelf life
- Highest energy and volume density of any battery system
- 1/2 to 30 ampere-hour cell sizes in production quantities
- Stable voltage output

Reliable, proven in memory standby, communications, underwater power, instrumentation, alarm systems ... to name a few. Delivery, stock to 4 weeks.

Eternacell. The highest energy, longest life battery. For information write: Power Conversion, Inc., 70 MacQuesten P'kway South, Mt. Vernon, N.Y. 10550. Or call (914) 699-7333.



Power Conversion

CIRCLE NUMBER 104

POWER SOURCES

Three- ϕ source spans wide frequency range

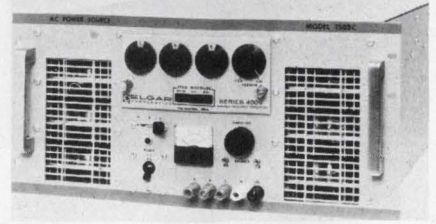

Elgar, 8225 Mercury Ct., San Diego, CA 92111. J. Waterman (714) 565-1155. \$3100; 4 wks.

The 1503C, a three-phase power source, delivers up to 1.5 kVA of 120/208-V output at 15 Hz to 10 kHz. The 105-lb unit accepts either 120/208-V, 60-Hz or 220/380-V, 50-Hz input power and provides fixed, variable or programmable output voltage and frequency over a wide range. The supply is compatible with many of the company's plug-in oscillators. Line and load regulation is 0.25% with 10- μ s response and output harmonic distortion is less than 0.5%.

Booth No. 1420-1422

Circle No. 343

AUTHOR'S GUIDE

writing
for
Electronic Design

An
**Author's
Guide**

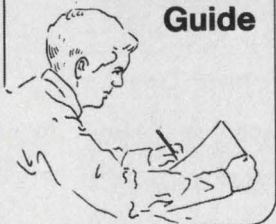

If you've solved a tricky design problem, if you have developed special expertise in a specific area, if you have information that will aid the design process ... share it with your fellow engineer-readers of *Electronic Design*.

Articles you have authored not only raise your own professional status, but help build your company image as well. The readers benefit, your company benefits.

To help you prepare material that meets *Electronic Design's* high editorial standards, our editors have prepared a special author's guide entitled "Writing for *Electronic Design*." It covers criteria for acceptability, form, length, writing tips, illustrations, and payment for articles published. It's available without cost.

It's easy to write for *Electronic Design*, but it's often hard to get started. Send for your copy of our Author's Guide today.

**Circle No.
250**

Tiny dc/dc offers choice of outputs

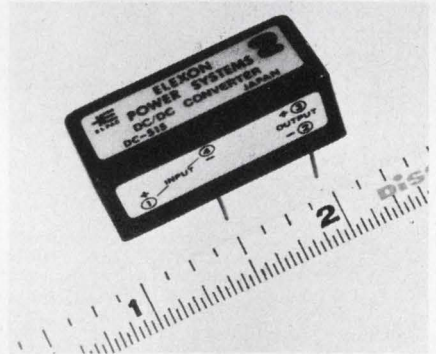

Elexon Power Systems, 3131 S. Standard Ave., Santa Ana, CA 92705. E. Blackman (714) 979-4440. \$3.95 (1000 qty); stock.

Available in four models, with +12, -12, +15 and -15-V outputs, the DC-500 series of dc/dc converters occupies 0.33 in³. Operating from 3-to-7-V input, all models provide 0.5% typical regulation, 300-mW drive capability and 60 to 70% typical efficiency. The PC-board mountable units deliver full power from 0 to 50 C and operate derated up to 70 C.

Booth No. 2442

Circle No. 344

Small, low-cost dc/dc makes displays glow

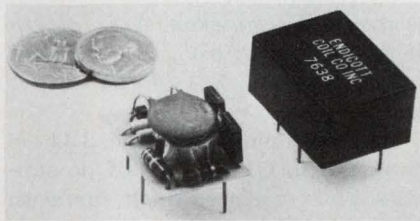

Endicott Coil, 24 Charlotte St., Binghamton, NY 13905. (607) 797-1263. See text; 6-8 wks.

In 1000-unit quantities the E500-series dc/dc converter provides 3 W of unregulated output for under \$5.00. This converter delivers performance comparable to other models priced above \$10.00. The unit converts 5, 9, 12 or 15 V dc to the nominal 200 V required to activate gas-discharge numerical readouts, or for other applications which demand a noninterruptible power source. The PC-board mountable module measures 1 × 1.38 × 0.7 in.

Booth No. 2344 Circle No. 345

Three units added to make a UPS line

Franklin Electric, 995 Benicia Ave., Sunnyvale, CA 94036. E. Addeo (498) 245-8900. \$28,000-\$42,000; 90 days.

Three solid-state frequency converters with power capacities of 50, 100 and 125 kVA to meet 400, 415 and 441-Hz requirements for computer and military/aviation systems join the company's system 475—a 975-kVA, 415-Hz unit. The new arrivals are designated system 450, 4100 and 4125. Each system is available either as a frequency converter or as an Uninterruptible Power Supply (UPS). They require no bolting down to concrete slabs and can operate next to your mainframe. Max. noise level at 5 ft is typically 60 dB. The systems convert 208 or 380-V, 50 or 60-Hz, power to regulated, transient-free 415-Hz output. When supplied as a UPS, the system also provides frequency conversion at up to 89% efficiency. The systems can be paralleled. Standard features include output of 120/208-V ±1%, automatic line-drop compensation, transient voltage of 5% max., harmonic distortion of 2% max.

CIRCLE NO. 346

VICTOREEN WRAPS HIGH VOLTAGE PERFORMANCE IN SLIM-MOX PACKAGES.

Victoreen's SLIM-MOX is the small, flat substrate, high voltage resistor that saves you space with no sacrifice in performance.

That's because small size is only one of many SLIM-MOX features.

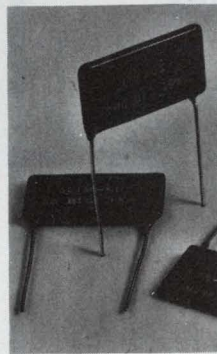

Designed into your high voltage circuits, SLIM-MOX will deliver better long term stability. You will appreciate its small temperature co-

efficients over a wide temperature range.

Switch to SLIM-MOX, the rugged and highly stable resistor now available in an expanded resistance range — 1 to 5,000 M. Tolerances to 1%.

Standard values are available from stock. And at any value, Victoreen quality is a built-in SLIM-MOX virtue. Find out for yourself by using SLIM-MOX wherever you need to save space in high voltage circuitry. Wherever stability and reliability are key performance characteristics.

Victoreen Instrument Division,
Sheller-Globe Corporation,



SHELLER-GLOBE CORPORATION

10101
Woodland
Avenue,
Cleveland,
Ohio 44104

RESISTOR SPECIFICATIONS			
Model	SLIM-MOX 204	SLIM-MOX 208	SLIM-MOX 308
Resistance Range	1M-5,000M	2M-5,000M	5M-5,000M
Critical Resistance	50M	56.25M	64.8M
Power Rating at 70° C	2W	4W	5W
Maximum Operating Volts	10,000V	15,000V	18,000V
Available Tolerance	1% 5% 15%	1% 5% 15%	1% 5% 15%
Max. Surface Temp.	150°C	150°C	150°C

*Applicable above critical resistance

MAXIMUM DIMENSIONS (inches)			
Model	204	208	308
A	1.08	2.08	2.08
B	.59	.59	.89
C	.145	.145	.145
D	.860	1.885	1.885

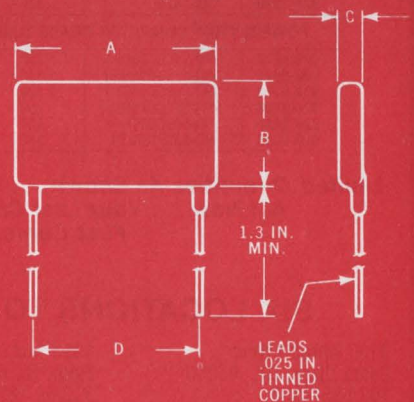

POWER SOURCES

Small module delivers 10 W of high voltage

Spellman High Voltage Electronics, 7 Fairchild Ave., Plainview, NY 11803. D. Galluzzo (516) 822-2203. \$295; 10 wks.

From a 2 × 4 × 0.8 in. module, the Model RVF5-10 provides an

output voltage that is adjustable from 2 to 5 kV at 0 to 2 mA. The supply operates from -55 to +100 C. It features 2% no-load to full-load regulation, 0.1% line regulation and 0.2% ripple. Both output terminals can float so you can get complete input-to-output isolation. Input to the unit is 25 to 30 V dc at 650 mA. The device is protected from short circuits and arc-overs, also it is self-restoring.

CIRCLE NO. 347

Open dc supplies fit into tight spots

Deltron, Wissahickon Ave., North Wales, PA 19454. J. Phillips (215) 699-9261. \$21.50 (250 qty); stock.

For easy mounting, the 2.44 × 4 × 4.5 in. QPS series of dc supplies gives you two flush surfaces. Output ratings for the three models in the series are: 5 V at 3 A or 6 V at 2.5 A, 12 V at 1.5 A or 15 V at 1.2 A, and 24 V at 1 A. Specifications include 0.1% regulation and 1-mV rms ripple and noise. The supplies are UL 478 recognized.

CIRCLE NO. 348

Closeout Sale!

Save Over 66% on Closeouts of Sprague Capacitors!
Quantities As Shown . . . First Come, First Served

ORANGE DROP® DIPPED TUBULARS

Stock No.	Mfr's Type	MFD	WVDC	Quantity Available	Was	Sale Price EACH
926-6859	2PS-P10	.1	200	10,285	.35	.12
926-6864	2PS-P50	.5	200	473	1.08	.36
926-6869	4PS-P10	.1	400	9,971	.51	.17
926-6873	4PS-S10	.01	400	2,252	.30	.10
926-6879	6PS-D10	.001	600	1,812	.30	.10
926-6881	6PS-D20	.002	600	2,519	.30	.10
926-6887	6PS-S20	.02	600	16,470	.33	.11
926-6898	6PS-S22	.022	600	2,436	.33	.11
926-6904	6PS-S56	.056	600	3,291	.51	.17
926-6904	6PS-P10	.1	600	23,497	.54	.18
926-6993	6PS-P22	.22	600	1,254	1.08	.36
926-6895	6PS-S10	.01	600	4,987	.33	.11

HYPERCON® CERAMIC DISCS

926-0730	HY-360	.1	12	2,312	.21	.07
926-0731	HY-370	.22	12	24,520	.33	.11
926-0745	HY-420	.01	16	3,080	.15	.05
926-0749	HY-425	.022	16	2,046	.15	.05
926-0758	HY-435	.047	16	1,156	.15	.05
926-0766	HY-450	.1	16	3,875	.18	.06
926-0812	HY-550	.1	25	4,780	.18	.06

ATOM® TUBULAR ELECTROLYTICS WITH AXIAL LEADS

926-1622	TVA-1104	1,000	6	737	1.47	.49
926-1657	TVA-1162	500	16	281	1.17	.39
926-1699	TVA-1213.5	2,500	25	503	3.03	1.01
926-1784	TVA-1420	100	150	131	1.68	.56
926-1789	TVA-1425	300	150	1,414	2.94	.98

POWERLYTIC® COMPUTER GRADE TUBULAR ELECTROLYTICS WITH AXIAL LEADS

926-5674	39D-118G030GP4	1,100	30	1,934	2.46	.82
926-5675	39D-118G050HP4	1,100	50	603	2.78	.93
926-5779	39D-258G015GP4	2,500	15	306	2.46	.82
926-5795	39D-357G040HE4	350	40	279	2.50	.83
926-5820	39D-507G025HE4	500	25	887	2.14	.71
926-5833	39D-537F150JT4	530	150	152	3.70	1.23

Limited Quantities As Shown . . . No More When These Are Gone . . .
Act Now . . . Your Last Chance for Huge Savings . . .
First Come, First Served

SIX LOCATIONS TO BETTER SERVE YOU

3160 Alfred Street
Santa Clara, CA. 95050
408/985-2323

1355 McLean Boulevard
Elgin, IL. 60120
312/697-8200

845 Woburn Street
Wilmington, MA. 01887
617/942-0150

12311 Industry Street
Garden Grove, CA. 92641
714/894-7581

401 East 8th Street
Fort Worth, TX. 76102
817/336-5401

3705 West Street
Landover, MD. 20785
301/773-6556

Write FORT WORTH Location for FREE 1977 Engineering Manual and Purchasing Guide

ALLIED ELECTRONICS
A DIVISION OF TANDY CORPORATION

CIRCLE NUMBER 107

High-current cells offer many ratings



Exide Power Systems Div., Rising Sun & Adams Ave., Philadelphia, PA 19120. W. Williams (215) 342-8000. \$95/cell; 12-13 wks.

Type EX lead-acid cells are designed for high-current, short-discharge uses as in UPS systems. The cell is particularly well suited for discharges ranging from 5 to 30 min. Units are supplied in a choice of 14 different cell ratings, with individual cell weights ranging from 65 to 200 lb. The largest cell, a 33 plater, supplies 2.264 kW to 1.75 V/cell or 2.642 kW to 1.67 V/cell over 15 minutes and 2.848 kW to 1.57 V/cell at the one-minute rate.

CIRCLE NO. 349

It doesn't look like ceramic, glass or mica. Looks are deceiving.

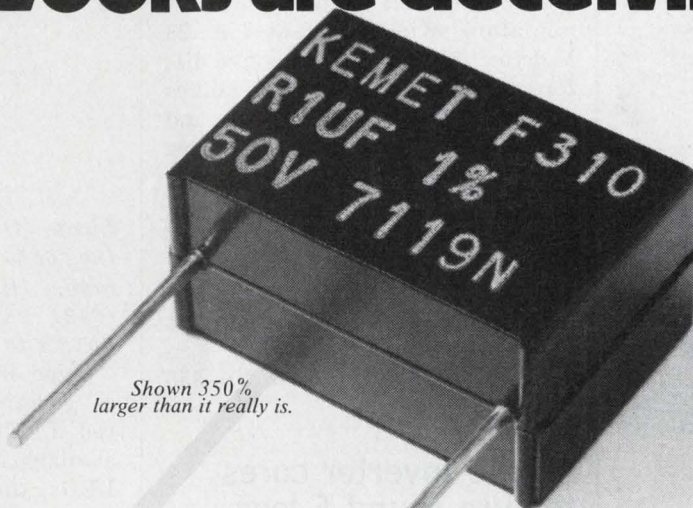

Shown 350% larger than it really is.

The KEMET® Flat-Kap capacitor is made with Parylene film. Which acts in many respects like more expensive materials, to give you more for your money.

Hence, the KEMET Flat-Kap capacitor offers the same insulation resistance as glass. The same dissipation factor as ceramic, mica, glass, and polystyrene, superior to that of polycarbonate and polyester. And dielectric absorption comparable with polystyrene, significantly better than ceramic, mica, glass, or other film dielectrics.

The KEMET Flat-Kap offers a temperature coefficient equal to or better than ceramic, glass, mica, or other film dielectrics. It's smaller than anything else you can buy. It comes with your choice of radial

or axial leads. It's available to $\pm 0.5\%$ capacitance tolerance at prices below any other dielectric.

Now you want proof of all that? Check our comparison chart below. And learn. How to get something you rarely see nowadays.

Your money's worth.

PARYLENE VS. VARIOUS DIELECTRIC MATERIALS							
Characteristic	KEMET® Parylene	Poly-styrene	Polycarbonate	Poly-ester	Mica	NPO Ceramic	Glass
* SIZE (P.C. Board Volume)	.0175 in ³	.143 in ³	.044 in ³	.044 in ³	.141 in ³	.0625 in ³	.082 in ³
STABILITY (Temperature Coefficient in PPM/°C)	Characteristic A - 200 ± 30 B 0 ± 100 C 0 ± 50	-120 ± 30	Varies to ± 350	+1150	Characteristic C ± 200 D ± 100 F - 0 to + 70	0 ± 30	+180
ELECTRICAL							
Dissipation Factor - % at +25°C	0.10	0.10	0.30	0.40	0.10	0.10	0.10
Insulation Resistance Megohm at +25°C	1 x 10 ⁷	1 x 10 ⁶	1 x 10 ⁵	1 x 10 ⁵	5 x 10 ⁴	1 x 10 ⁵	1 x 10 ⁷
Dielectric Absorption	0.03	0.02	0.25	0.25	4.80	0.29	5.10

* Per applicable military specification. Parylene Flat-Kap capacitors are described in Mil-C-55514 for a .01 uF capacitor.

Write for complete information and catalog. Components Department, Union Carbide Corporation, Box 5928, Greenville, S.C. 29606; phone: (803) 963-6300; TWX: 810-287-2536; Telex: 57-0496.



COMPONENTS DEPARTMENT

In Europe: Union Carbide Europe, S.A. 5, Rue Pedro-Meylan, Geneva 17, Switzerland Phone: 022/47-4411 Telex: 845-222-53

KEMET is a registered trademark of Union Carbide Corporation



**now you have
a choice!**

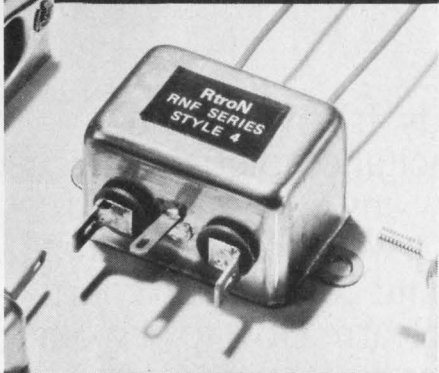

RFI/EMI FILTERS

**For Data Processing,
Industrial Control and
Instrument Application**

Rtron's RNF Type Filters represent three series of the most widely used, low cost filters available. Over 100 combinations of current and case style to choose from. "L" Series - low cost for general applications to combat line to ground noise. "P" Series - for suppression of line to line as well as line to ground interference. "T" Series - most effective for low impedance load applications. All types are U.L. Recognized and meet C.S.A. requirements. Rated at 115/250 VAC. Low leakage current insures safety.

*For complete catalog and
details, write*

Rtron corporation

P.O. Box 743, Skokie, Illinois 60076
(312) 679-7180

CIRCLE NUMBER 109

COMPONENTS

Snap-action switches fit ultraminiature class

Otto Controls, 36 Main St., Carpentersville, IL 60110. Ronald Sparks (312) 428-7171. \$1.93 (100 up); stock to 6 wks.

The B2 Series snap-action ultraminiature switch rated at 7 A, 28 V dc or 115 V ac features five different terminal styles, qualifies under M8805/4 (MS24547) and comes also in commercial versions. The switch measures 0.5-in. long \times 0.2-in. wide. Important specifications include a movement differential to 0.005 in., an operate force of 5 oz max and silver or gold contacts for low-level or dry-circuit requirements.

Booth 2534-2536 Circle No. 356

Ferrite inverter cores feature round E legs

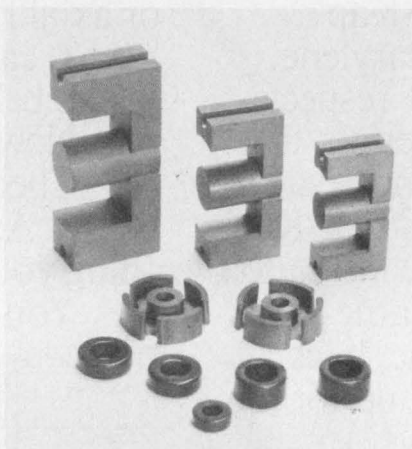

Indiana General Electronic Products, Crow Mill Rd., Keasbey, NJ 08832. (201) 826-5100. \$0.25/pr: IR8535-1, 35-mm core (OEM qty); stock to 6 wks.

Inverter-rated ferrites, series IR8535/8635/8735, now include the round-leg E core that maintains high efficiency with both reduced copper loss and leakage inductance. This new shape, as well as the complete inverter-rated line, is tested specifically for high-frequency inverter characteristics. They are the only ferrites that provide maximum inverter efficiency at your choice of three operating temperatures, 50, 75 or 125 C, according to the manufacturer.

Booth No. 2714 Circle No. 357

LEDs and PB switches combined in DIPs

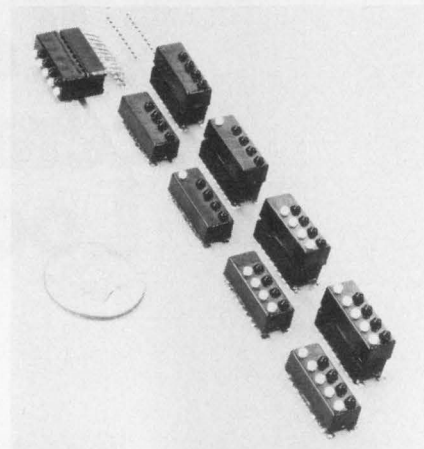

Licon, Div. Illinois Tool Works Inc., 6615 W. Irving Park Rd., Chicago, IL 60634. Rich Francke (312) 282-4040. \$3 to \$4 (1000 up); 8 to 10 wks.

Type 43 DIP pushbutton switches combined with miniature T-1 red LEDs for PC mounting are available with as many as four LEDs and five SPST switches. The assemblies are very useful as aids in diagnostic testing, the programming of microprocessor systems, establishing the status of circuits and for many other purposes. The switch/LED units can be soldered directly to the PC board, or they can be inserted in an 18-pin IC socket.

Booth No. 2443-2445

Circle No. 358

Transformers couple to telephone lines

Microtran Co., Inc., 145 E. Mineola Ave., P.O. Box 236, Valley Stream, NY 11582. (516) LO 1-6050. \$3.15 to \$14 (100 up); stock.

Telephone-coupling transformers for use in FCC-registered equipment for interconnect to the nationwide telephone network meet the leakage-current and longitudinal-balance requirements of FCC Part 68. With them, customer-supplied terminal equipment may be directly connected to the voice-grade telephone network without protective-coupling devices leased from the telephone company. The 15 transformers in this revised series are of open-frame PC construction and weigh from 0.4 to 9.5 oz. Sizes range from approximately 5/8 to 1-1/2-in. cubed.

Booth No. 2119 Circle No. 359

One source of ROMs overshadows all others

If you want 8K and 16K ROMs from the most skilled volume producer in the world, there's just one place to go.

Electronic Arrays pioneered the technology of MOS ROMs seven years ago. Introduced the world's first big 16K ROM over three years ago. Has now delivered 22 billion bits of ROM with over 1800 different mask programs to more than 400 customers worldwide. And every month we deliver another billion bits or more—in 18 different models including the popular 8316E ROM and the 2708 EPROM.

At other semiconductor companies, ROMs are only one of dozens of diverse products competing for attention. At EA, ROMs are the very heart of our business. So your order for ROMs receives the highest priority. You can expect very rapid delivery. And very low prices—because we've learned to fine-tune our production process to a peak of efficiency.

Price and delivery are excellent for another reason too. We make everything from the mask to the final package in house. There are no subcontractors to boost the cost or delay delivery.

So next time you need ROMs come to ROM COUNTRY: Electronic Arrays, 550 East Middlefield Road, Mountain View, Calif. 94043. Phone us on our toll-free WATS line (800) 227-9962 or our regular line (415) 964-4321.

In Europe you can reach us at Aalsmeer, The Netherlands 02977-23722. In the Far East, at Tokyo (03) 591-5241.

ROM COUNTRY



**electronic
arrays, inc.**

CIRCLE NUMBER 110



Pulse Engineering broadens its Delay Lines Series

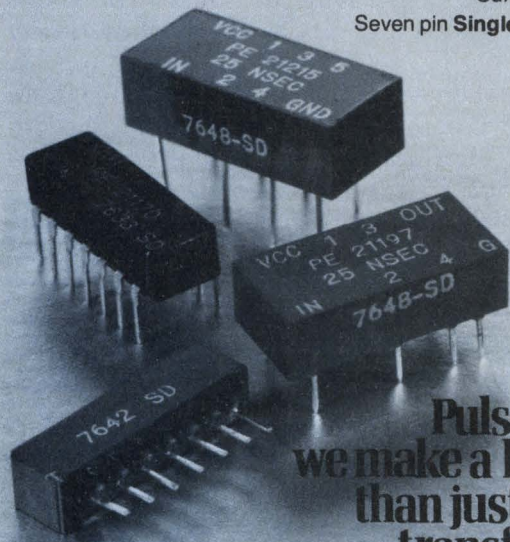

Current additions to our catalog stock —
 Seven pin **Single Inline Series** .195" W X .250" H*
 5ns to 100ns delay

Low Profile DIP Series .220" H*
 10 ns to 500 ns delay
 inline and criss-cross termination

Low Attenuation and Distortion
 DIP Series .250" H*
 50 ns to 300 ns delay

Low Profile Digital Delay Modules
 14 pin configuration .275" H*
 16 pin configuration .300" H*
 25 ns to 250 ns delay

*Height from the board
 for complete specifications
 write for catalog 772

**Pulse Engineering--
 we make a lot more
 than just pulse
 transformers**

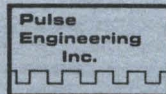

A Varian Subsidiary

P.O. Box 12235, San Diego, California 92112. Phone (714) 279-5900

CIRCLE NUMBER 111



THE 25MHz "NOW" SCOPE with 5sec-1µsec DELAYED SWEEP DUAL TRACE/DUAL CHANNEL

- Built-in delay circuitry, continuously variable, from 1µsec to 5sec... plus 5mV/Div sensitivity.
- Selectable synchronization — automatic, normal, single trace and reset modes with H-F rejection.
- X10 magnification; ±3% overall accuracy, both chan's.
- Displays leading edge of pulse or pulse train for quick functional determination.
- 20,000:1 delay jitter — X-Y phase difference below 3° @ 100KHz.
- External Sweep Sensitivity: (X-Y) 5mV/Div to 2V/Div, 10 steps. \$1395. with accessories

LEADER
 Instruments Corp.

Tests More... Tests Better... for Less!

151 Dupont Street, Plainview, N.Y. 11803 (516) 822-9300
 West Coast: 7733 Densmore Ave., Van Nuys, Calif. 91406 (213) 989-2760 In Canada: Omnitrond Ltd., Montreal, Quebec

CIRCLE NUMBER 112

COMPONENTS

Lighted PB switches wipe gold contacts

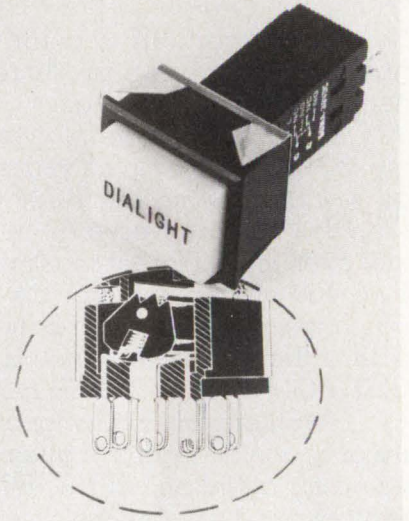

Dialight, 203 Harrison Pl., Brooklyn, NY 11237. (212) 497-7600. \$1.65 (1000 up); 2 to 3 wks.

Low-cost, computer-grade illuminated pushbutton switches with a modular design provide a wide variety of options in a standard format. This newest addition to Dialight's 554 Series provides a wiping-action mechanism with gold contacts for reliable switching at low levels. Applications are typically from 1-to-100-mA resistive switched current at 1 to 30 V dc. For higher power-level application, snap-action versions are available. Booth No. 2130-2132

Circle No. 360

Trimmer capacitors mount vertically

Johanson Manufacturing Corp., 400 Rockaway Valley Rd., Boonton, NJ 07005. Eric Fagerlund (201) 334-2676. \$1 to \$4 (1000 up); stock to 3 wks.

Vertical-mount trimmer capacitors meet the need for adjustments after a PC board is assembled and encapsulated. Furthermore, this style saves space over horizontally mounted units and yet has a low enough profile to allow boards to be mounted on 1/2-in. centers. The capacitors are available in several ranges from 1 to 8 pF up to 1.5 to 30.0 pF with Q values greater than 5000.

Booth No. 2107 Circle No. 361

TRY ONE ON GOULD AND YOU DECIDE.

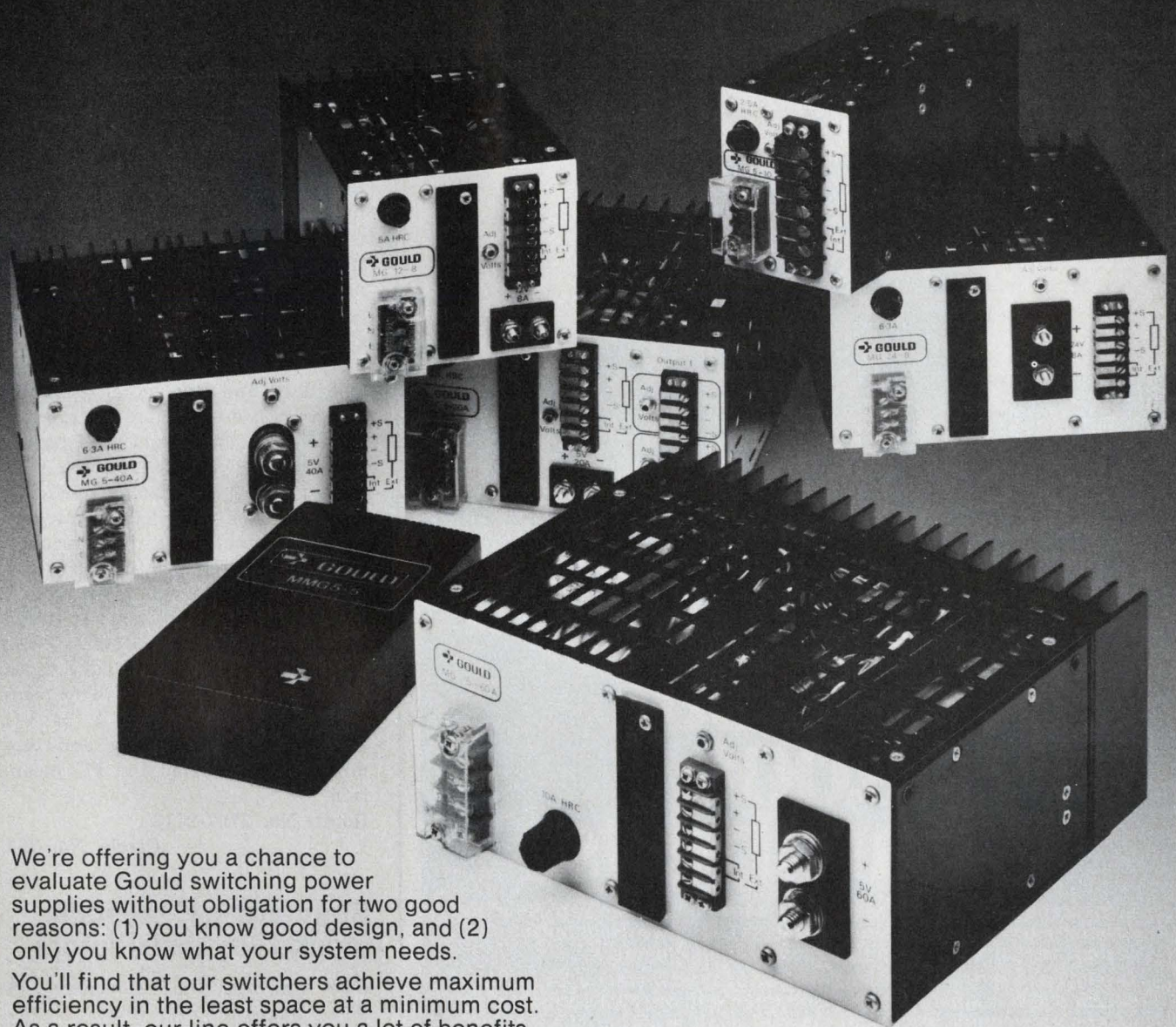

We're offering you a chance to evaluate Gould switching power supplies without obligation for two good reasons: (1) you know good design, and (2) only you know what your system needs.

You'll find that our switchers achieve maximum efficiency in the least space at a minimum cost. As a result, our line offers you a lot of benefits for your system:

- off-the-shelf delivery
- 36,000 hours MTBF
- switching at 33 kHz
- 5 year warranty
- 28 m/sec hold-up time
- 0.1% line/load regulation
- full output at 50°C ambient
- remote sensing and voltage programming
- less than 50 mV peak to peak ripple

But the truth is, you really have to test one of our switching power supplies yourself to appreciate how well our switcher works with your design.

So tell us what you need to fully evaluate our capabilities. Our salesman will deliver the appropriate unit from stock without any obligation to buy.

For information contact Gould Inc., Power Supply Dept., 3631 Perkins Ave., Cleveland, Ohio 44114.

For brochure call toll free at (800) 325-6400 Extension 77

In Missouri: (800) 342-6600

 **GOULD**

CIRCLE NUMBER 113

COMPONENTS

Recessed-rocker switch seals for cleaning

Grayhill Inc., 561 Hillgrove Ave., La Grange, IL 50525. (312) 354-1040. \$2.46: 10 station (500 up).

A recessed-rocker DIP switch allows tape to be used as a seal for the top of the switch during the solder-cleaning operation. The recessed rocker also prevents acci-

dental operation of the switch. Height of the DIP switch above the PC board is only 0.275 in. The switch is available with SPST circuitry in 2-to-10 stations. A spring-loaded sliding ball provides wiping action and positive positioning of the actuator that is less susceptible to shock and vibration than conventional designs. The contacts are gold plated and have a 50,000 operation life with logic-level loads.

CIRCLE NO. 362

Rotary switch provides 60 positions

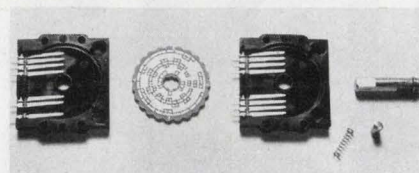

Oak Industries Inc., Crystal Lake, IL 60014. (800) 435-6106. \$2.30: single section, \$3.60: two-section (100 up); limited production.

A rotary switch capable of up to 60 positions—featuring a patent-applied-for rotor design for long-term contact registry and integrity—designated the Communicator-Series switch has several design innovations. Contacts wiping across the rotor surface pass from electrically dead metal to live metal, never touching the laminate, as in conventional designs. Thus particles can't be scraped onto the live metal to create intermittent opens. The dead and live metal areas on the rotor are separated by grooves that clean each contact as it passes over them, which helps the contacts avoid accumulating particles. Moreover, the rotor has an integral cam that functions as the precision detent, which eliminates functional backlash because of loose rotors and tolerance problems. A single section can accommodate two 7-bar readouts or two 8-bit binary codes with separate commons. The plastic materials used have a 94 VO UL flammability listing and terminals are designed for PC insertion.

Booth No. 2707-2713

Circle No. 363

Standard μ P crystals stocked by distributors

CTS Knights, Inc., 400 Reimann Ave., Sandwich, IL 60548. (815) 786-8411. \$4.95: 18-MHz range, \$9.80: 1-MHz range (10 up); stock.

CTS offers a full line of off-the-shelf crystals for μ Ps and related-clock ICs in 17 standard frequencies through their distributors. The crystals feature low start-up resistance and reliability because of MIL-approved manufacturing processes. The final frequency-calibration process guarantees long-term stability.

Booth No. 2511

Circle No. 364

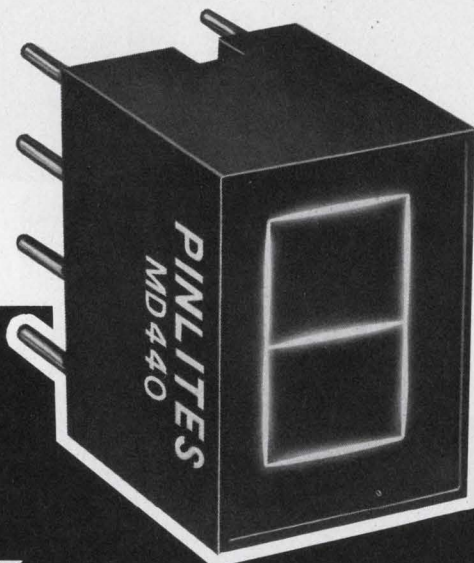

You may not need our 9,000 ft. Lamberts.

Some applications don't require the unusual brightness of a Pinlites directly-viewed incandescent display. But when brightness is important to you, there's no finer choice than Pinlites.

The low power 1/4" model MD-440, above, for instance, produces a dazzling 9000 ft.-lamberts. That, coupled with our 80:1 contrast ratio, means characters are clearly visible even in direct sunlight. And with simple voltage reduction they can be dimmed for night use.

Pinlites numeric and alphanumeric displays offer a 120° viewing angle and are filterable to a wide range of colors. They are available in character heights ranging from 3/16" to 5/8". And provide an average life of over 100,000 hours per segment.

Popular applications include aircraft cockpits, marine navigation, computer peripheral equipment, taxi meters and gas pump readouts.

For a quick answer to your questions, give us a call. We promise a display of brilliance.



REFAC electronics corporation

P.O. BOX 809 • WINSTED, CONN. 06098 • 203-379-2731

CIRCLE NUMBER 114

When battery life is critical, there's nothing even close to a TRW LVA zener

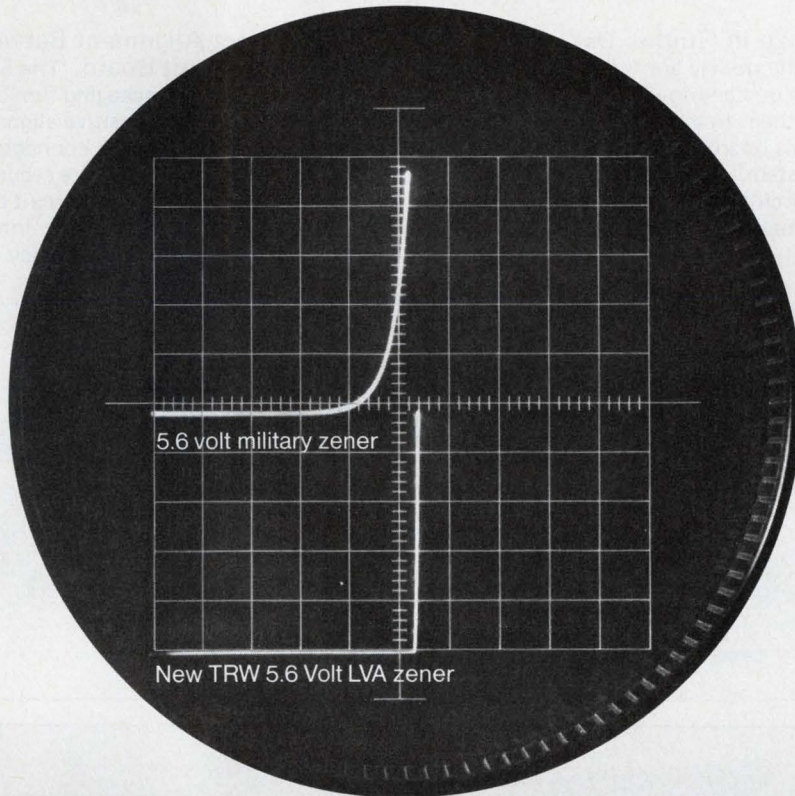

**The sharpest knee below 10 volts
for up to 10 times the battery life.**

In medical equipment, testing devices, watches, pocket pagers—wherever battery life is critical—no other zener can approach a TRW LVA.

TRW's Low Voltage Avalanche zeners are also ideal for instrumentation and logic circuitry where as highly stable zeners they provide extremely constant reference voltage yet draw as little as 50 microamps. True, they cost more. But where battery life is more important than a dollar or so, or when you have to load in transistors and resistors to minimize battery drain, it pays to use TRW LVA's. For your convenience, they're available in several package configurations and chips.

For immediate action and applications assistance, call John Power (213) 679-4561.

TRW Power Semiconductors,

An Electronic Components Division of TRW, Inc.,
14520 Aviation Boulevard, Lawndale, California 90260

Please send me data sheets on TRW's LVA zeners.

Please send samples of _____ devices.
(Voltage)

Name _____

Company Name _____

Address _____

City _____

State _____

Zip _____

ED

TRW POWER SEMICONDUCTORS

ANOTHER PRODUCT OF A COMPANY CALLED TRW

CIRCLE NUMBER 115

**"BET YOU CAN'T
BEAT THE
SYSTEM!"**

AND HERE ARE FOUR REASONS WHY:

Bud's Modular Electronic Packaging System gives you options. Options to use circuit boards; to use full-enclosed modules, to use all of one, or a combination of both to develop an electronic package for a variety of applications. Equally important, the Bud System gives you the flexibility to alter your original circuit board/module arrangement for subsequent applications. The options are yours.

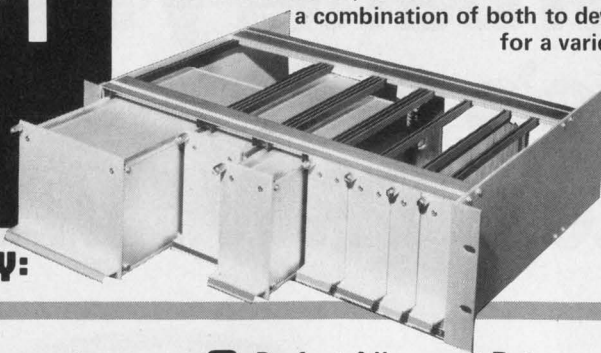

1 Movable Snap-in Guides. One reason for the System's flexibility are full-length, impact-resistant guides. You can move them, snap them in and out -- adjust them to a basic pitch of 0.2" to accommodate circuit boards and modules -- without dismantling the System's outer frame. The System will house up to 42 circuit boards; however, even when densely packed, maximum ventilation is assured.

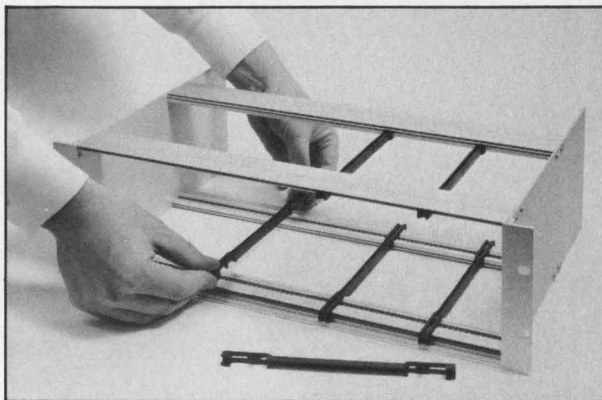

2 Perfect Alignment Between Connector and Circuit Board. The System's distortion-free guides offer packaging flexibility, and also provide the means for positive alignment. All edge connectors, plus panel-type connectors mounted to socket-mounting panels are securely attached at the rear of the guides. Insert circuit boards into the System and they slip directly into the edge connectors. Slide in larger modules and they make perfect contact with the panel-type connectors.

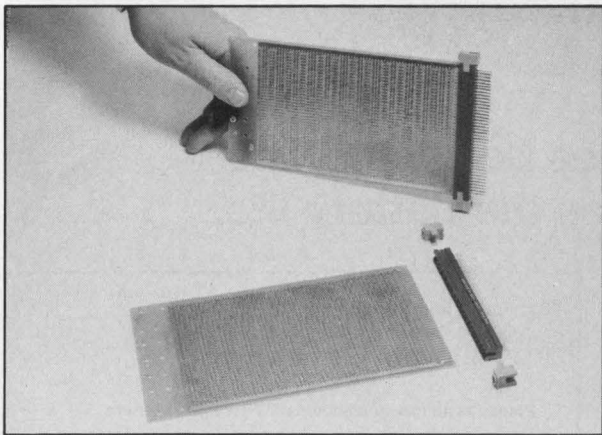
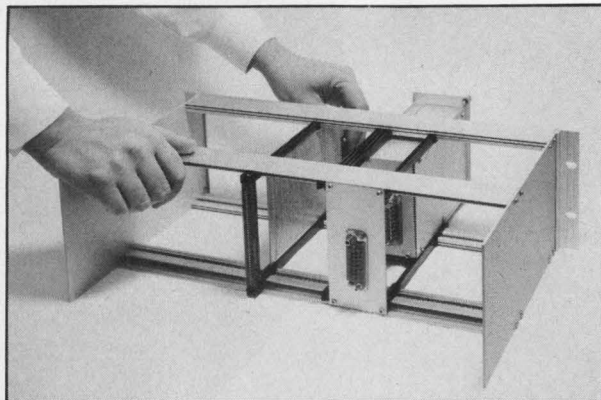

3 Board Profiling is Eliminated. A uniquely designed end foot, easily attached at the end of each guide, not only "leads" circuit boards into edge connectors, but also positions edge connectors so they will accept the full height of the boards. This eliminates board profiling and, in turn, results in maximum contact. Keep in mind the Bud System is designed to utilize a wide universe of circuit boards and edge connectors to give you maximum flexibility.

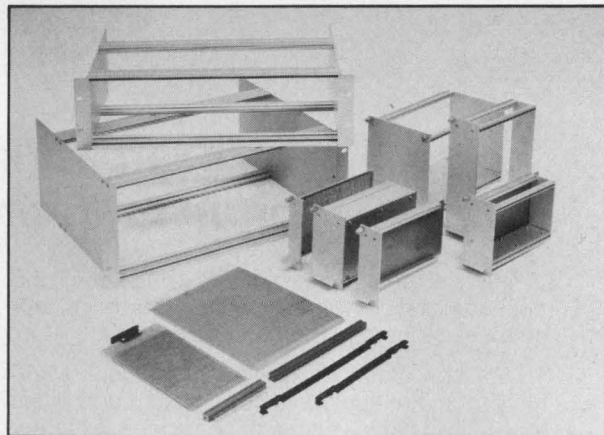

4 A Choice of Components. Regardless of what type electronic package is required for your present or future applications, Bud has the components to develop that package: eight sub-racks (outer frames), 20 sub-units (enclosed modules), six printed board units, eight circuit boards, plus single and double row edge connectors. All are fabricated to exacting tolerances. All are easily assembled. All are in stock -- immediately available.

Your Bud distributor will give you complete data on the Modular Electronic Packaging System. Better yet, he has a demonstration unit. See it. Work with it -- the packaging system that gives you options.

BUD

BUD INDUSTRIES, INC.
4605 East 355th Street
Willoughby, Ohio 44094

"WE'VE GOT THE SYSTEM!"

IT'S IN STOCK AT YOUR LOCAL BUD DISTRIBUTOR.

ALABAMA
Birmingham
James W. Clary Co.
205-322-2486

ARIZONA
Phoenix
Dalis Electronic
Supply
602-254-8471

ARKANSAS
Little Rock
Carlton Bates Co.
501-562-9100

CALIFORNIA
Chatsworth
Westates Electronics Corp.
213-341-4411
Los Angeles
RPS Electronics, Inc.
213-748-1271
Mountainview
Elmar Electronics, Inc.
415-961-3511
Riverside
Electronic Supply
714-787-9220

COLORADO
Denver
Electronic Parts Co.
303-744-1992
Newark Electronics
303-757-3351

FLORIDA
Orlando
Hammond Electronics, Inc.
305-849-6060

GEORGIA
Atlanta
Lykes Electronics
404-449-9400

ILLINOIS
Chicago
Newark Electronics
312-638-4411

Indiana
Palatine
Ohm Electronics
312-359-5500
Peoria
Klaus Radio, Inc.
309-691-4840

INDIANA
Indianapolis
Graham Electronics
Supply, Inc.
317-634-8202
Ra-Dis-Co., Inc.
317-637-5571

KANSAS
Wichita
Radio Supply Co., Inc.
316-267-5213

LOUISIANA
Lafayette
Ralphs of Lafayette, Inc.
318-234-4507

MARYLAND
Gaithersburg
Pioneer/Washington
Electronics, Inc.
301-948-0710
Rockville
Capitol Radio
Wholesalers, Inc.
301-881-2270

MASSACHUSETTS
Dedham
Gerber Electronics, Inc.
617-329-2400
West Newton
A. W. Mayer Co.
617-965-1111

MICHIGAN
Ann Arbor
Wedemeyer
Electronic Supply
313-665-8611
Livonia
Pioneer/Michigan
313-525-1800
RS Electronics
313-525-1155

MINNESOTA
St. Paul
Gopher Electronics Co.
612-645-0241

MISSOURI
Kansas City
Walters Radio Supply, Inc.
816-531-7015

NEW MEXICO
Albuquerque
Walker Radio Co.
505-247-2288

NEW YORK
Binghamton
Harvey Electronics
of Binghamton
607-748-8211
E. Farmingdale
Harrison Electronics
516-293-7990
Lynbrook, L.I.
Peerless Radio Corp.
516-593-2121

NORTH CAROLINA
Winston-Salem
Kirkman Electronics, Inc.
919-722-9131

OHIO
Cleveland
Pioneer/Cleveland
216-587-3600
Radio & Electronic
Parts Corp.
216-248-8900

Cincinnati
Hughes-Peters, Inc.
513-351-2000
Columbus
Hughes-Peters, Inc.
614-294-5351
Dayton
Pioneer/Dayton
513-236-9900

OKLAHOMA
Tulsa
Oil Capitol
Electronics Corp.
918-622-8520

PENNSYLVANIA
Allentown
A. A. Peters, Inc.
215-434-5237
Montgomeryville
Pyttronic Industries, Inc.
215-242-6700

Philadelphia
Almo Electronics Corp.
215-698-4000
Pittsburgh
CAM/RPC Electronics
412-782-3770
Pioneer/Pittsburgh
412-782-2300

SOUTH CAROLINA
Columbia
Dixie Radio
Supply Co., Inc.
803-779-5332

TENNESSEE
Memphis
Bluff City Electronics
901-523-9500
Nashville
Electra Distributing Co.
615-329-3971

TEXAS
Dallas
Wholesale
Electronic Supply
214-824-3001
Ft. Worth
Swieco, Inc.
817-335-6521

Garland
Newark Electronics
214-271-2511
Houston
Harrison Equipment Co.
713-652-4700
San Antonio
Sherman Electronics
Supply, Inc.
512-224-1001

UTAH
Salt Lake City
Standard Supply Co., Inc.
801-486-3371

VIRGINIA
Charlottesville
Virginia Radio
Supply Co., Inc.
804-296-4184

WASHINGTON
Seattle
Almac/Strum
Electronics, Inc.
206-763-2300

COMPONENTS

Tiny snap-action switch mounts on PC boards

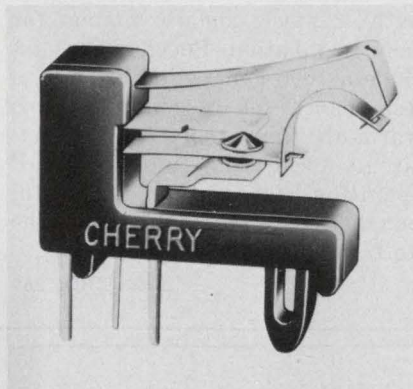

Cherry Electrical Products Corp., 3600 Sunset Ave., Waukegan, IL 60085. Frank Amendola (312) 689-7704.

Subminiature snap-action switches, the S38-20H, mount easily on PC boards. A flexible front-mounting peg allows you to simply plug the switch into the board. No additional hardware is necessary. The unit measures just 0.658-in. high \times 0.768 in. long \times 0.228-in. wide. And when mounted on a PC board, the top of the switch is less than 1/2-in. above the board surface. Switches available with gold cross-point contacts for low energy application are designated S39-20H. Samples can be obtained at the Electro 77 booth.

Booth No. 2302-2308

Circle No. 365

Toroidal power Xformers available as standards

Avel-Lindberg Ltd., South Ockendon, Essex RM15 5TD, England. 04 025-3444. \$9.45 to \$17.12 (50-99); stock.

Toroidal power transformer, previously available only on custom orders, now can be selected from a standard range of 50 secondary voltages from 6 to 40 V in 11 steps, with series, parallel or independent coils. Five nominal-load ratings cover 15 to 130 VA with dual 115 or 230-V primary windings for parallel or series operation. Toroids are said to have 50% less weight and volume, a lower height profile, higher electrical efficiency, a 1/8-lower radiated interference field and less acoustical noise than comparable power transformers.

Booth No. 2113 Circle No. 366

Molded reed relays immersible in solvents

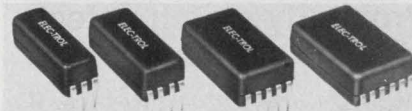

Elec-Trol, Inc., 26477 N. Golden Valley Rd., Saugus, CA 91350. Ken Doriot (213) 788-7292. \$1.10: 500 Ω 5 V, 1 pole (1000 up); 6 to 8 wks (1 and 2 pole), September (4 pole).

Molded-line reed relays made by Elec-Trol are said to cost one-third less than the price of most standard sealed reed relays. Totally molded in epoxy, these new units can withstand complete immersing in cleaning solvents and unusually rough handling. They come with 1 through 4-form-A hermetically sealed contacts and employ pretested dry-reed switches that can carry a 10-W load. Optional features include magnetic shielding, electrostatic shielding, and contact run-in for one million operations.

Booth No. 2338-2340

Circle No. 367

Small thumbwheel is pushbutton actuated

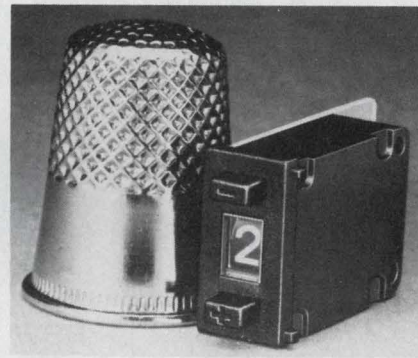

Alco Electronic Products Inc., 1551 Osgood St., North Andover, MA 01845. Tom Clark (617) 685-4371. \$4.52: BCD code (50-99); 4 to 6 wks.

New subminiature bidirectional code switches occupy a panel space of only 0.6 \times 0.3 in. per decade, and the over-all depth from front of panel is less than 1 in. This PICO Series mounts from the front and is available with BCD or BCD-complement four-line output codes. Separate positive-action pushbuttons provide control for numerical increases or decreases, and 0.125-in. numerals are viewed through a polycarbonate window.

Booth No. 2214 Circle No. 368

COMPONENTS

Proximity switch detects steel or aluminum

ELDEC Corp., 16700 13th Ave. W., Lynnwood, WA 98036. (206) 743-1313. \$135 (unit qty); stock to 30 days.

A proximity switch for harsh industrial environments, the ELDEC switch Model 8-274, has a sensing range of 3/4 in. to steel and 1/2-in. to aluminum. Environ-

mentally sealed, the switch is impervious to fluids, cutting oils and corrosive atmospheres. Temperature variations have minimal effect on operation. It is equipped with a steel conduit fitting for easy installation. Specifications include a 1000 cpm switching rate, a less than 2 ms response time, no warm-up time, momentary short-circuit protection, a -40-to-80-F operating temperature range. Input voltage is 13 to 17 V dc. The unit weighs 0.39 lb.

CIRCLE NO. 369

Gas-discharge display readable in bright sun

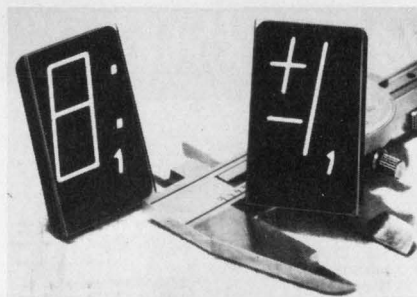

Beckman, 2500 Harbor Blvd., Fullerton, CA 92634. (714) 871-4848. \$5.75 (1000 up); stock to 15 days.

Two 1-in. high, 7-segment, gas-discharge displays, Model SP-101/102, are readable as far as 60 ft within a 130-degree viewing angle under all lighting conditions. Displays are orange (filterable to red). Brightness is rated at 225 ft-L with nominal current. Life expectancy exceeds 10 years. A keep-alive cathode provides an internal ion source that reduces ionization time to less than 30 μ s, allows zero suppression, and improves operation of the display in dark environments and at low temperatures. Power requirement is 160 V dc at 700 μ A per segment.

CIRCLE NO. 370

Here are the latest additions to the Par.Metal line of modern electronic housings!



new... sectional wall cabinets

WC SERIES

Made of 3 sections —

- Wall mounted rear unit — 4" deep
- Center body section — 12" deep
- Front door — 2" deep

new... low silhouette console cabinets

MODEL FS-21

Designed for any control requirement

- Provides unobstructed views
- Modular units for grouping
- 21" wide x 44" high x 24" deep

new... mod-cab welded desk cabinets

DC SERIES

- Panel heights from 3 1/2" to 21"
- Two panel widths 9 1/2" and 19"
- Three depths — 12", 18" and 22"
- Choice of 10 colors with walnut or black vinyl aluminum trim

See us at Booths 2134-36
ELECTRO '77 IN N.Y.C.
APRIL 19, 20, 21

and Booth 219 at
NEPCON '77 EAST
IN PHILA. MAY 17, 18, 19

SEND FOR COMPLETE LITERATURE OF PAR-METAL'S PACKAGING SYSTEMS

Par.Metal
PRODUCTS, INC.

1260 Atlantic Ave., Brooklyn, N.Y. 11216
(212) 772-5800

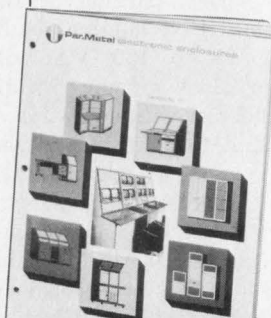

CIRCLE NUMBER 118

Solenoid actuators offered in 3 duty cycles



IMC Magnetics Corp., 570 Main St., Westbury, NY 11591. Don Cronan (516) 334-7195. \$3.45 (1000-up); stock to 8 wks.

Pull solenoids, available in three duty cycles—continuous, 25 and 50%—answer a wide range of applications. The units measure 1/2 in. dia. by 1-in. long, are of tubular construction and feature a female clevis-plunger design. They are designed for 105-C operation and typically up to 10-million operations. For long life, the plunger is restricted from bottoming out in the plunger cavity.

CIRCLE NO. 371

Everyone's going cassettes!



PORTABLE AN/UNH-16A
2 channel audio recorder/reproducer, Mil Spec the way.



LABORATORY Model IDC-IIA
4 channels - 6 speeds, records up to 4 hours per side, direct or FM - Great for voice logging too.

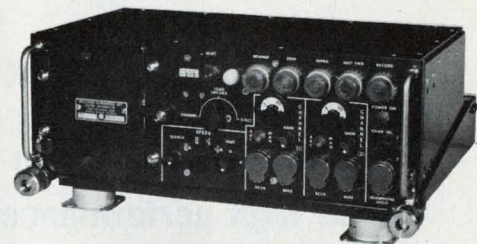

VEHICULAR AN/UNH-17A
Rugged 2 channels - variable speeds, remote controls & transcription features.

**But, if you prefer
reel to reel,
We've got that, too!**

12-1/4
inches
panel
space

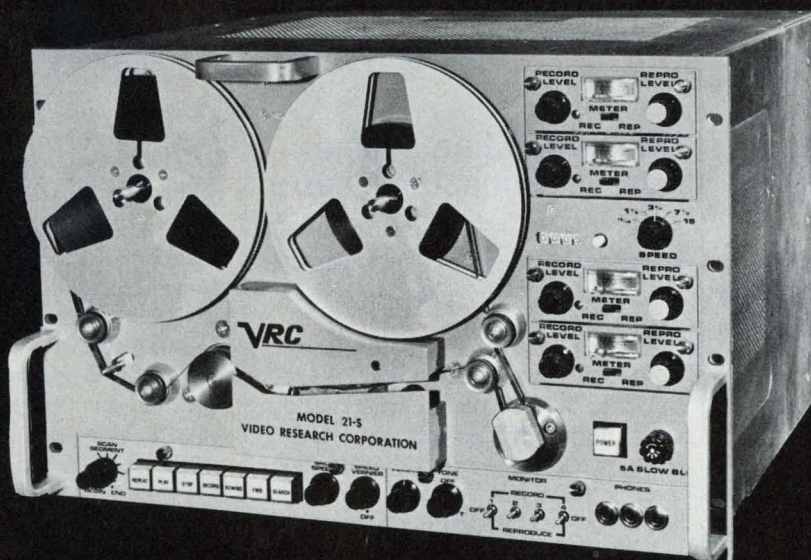

INSTRUMENTATION

Model 21-S

4 channels - 5 speeds linear flux response to 64 KHz and a full spectrum of transcription features for audio surveillance or analog data recording & reproduction

VRC

VIDEO RESEARCH CORPORATION

INTERSTATE INDUSTRIAL PARK RIVIERA BEACH, FLORIDA 33404 PHONE 305-842-2867

Write for our catalog of
Magnetic Tape Recorders
for Professional, Military &
Aerospace applications.

Looking for fast, sure relief from circuit stability problems?

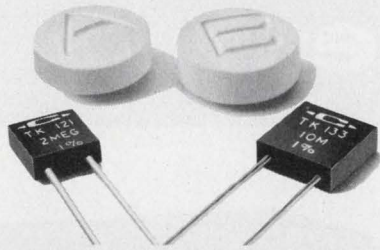

Only Caddock's Type TK Temp-Stable Precision Film Resistors have all seven high performance advantages:

1 Ultra-Low Temperature Coefficients.

Tetrinox™ resistance films provide either 10 ppm/°C or 5 ppm/°C from -55°C to +125°C.

2 Extended Resistance Range.

Better than ±0.05% per 2000 hours!

3 Exceptional Long-Term Stability.

Up to 10 Megohms in a CK 06 case.

4 Big Power in a Small Size.

.3 watts in the .250" square case. .4 watts in the .300" square case.

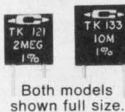

Both models shown full size.

5 Precision Tolerances.

±1% is standard, ±0.01% available.

6 Rugged Construction.

Caddock's T-System™ resistance films are fired onto solid ceramic substrates and molded in a silicone case for the ultimate in stability.

7 Non-Inductive Performance.

Provides wide bandwidth, higher pulse fidelity.

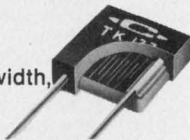

Our budget-pleasing quantity prices and 6-to-8 week 'always-on-time' deliveries can cure your inventory scheduling headaches, too!

For complete information on the only resistors that can give long-lasting, seven-way relief, there's only one company to call:

CADDOCK
ELECTRONICS, INCORPORATED

3127 Chicago Ave., Riverside, Calif. 92507
Tel: (714) 683-5361, TWX: 910-332-6108

CIRCLE NUMBER 120

COMPONENTS

Pushbutton switches are oil tight

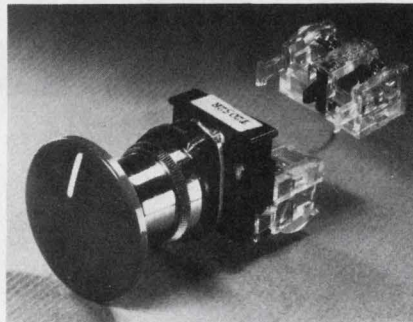

Alco Electronic Products, Inc., 1551 Osgood St., North Andover, MA 01845. Clemens J. Czapinski (617) 685-4371. From \$5.60 (unit qty); 4 to 6 wks.

A new family of oil-tight pushbutton control units mount in 7/8-in. panel holes. They are offered in a wide choice of colors and styles, including momentary and maintained models. Panel mounting is simplified, requiring only the use of a screwdriver. Patented Snap-Bloc contact blocks provide simplified assembly: no tools are required. Ratings are UL and CSA of 10 A at 300 V ac nominal (3600 VA make, 360 VA break). Virtually any combination of NO and NC contact blocks are available including screw terminals, Faston types and even a 600-V-ac series.

CIRCLE NO. 372

DIP-switch line sealed into thermosetting case

SMK Electronics Corp. of America, 118 E. Savarona Way, Carson, CA 90746. (213) 770-8915. \$1.71: 4 position (100 up).

A complete line of DIP switches, from 1-to-10 positions, the JS-8722 Series, features sealed construction in a thermosetting plastic material that prevents flux contamination during wave soldering. A clip-type wiper design assures positive two-sided contact and resistance to shock and vibration. Available in SPST configuration, the switches are rated for 500 mA at 50 V dc, nonswitching and 300 mA at 24 V dc, switching of resistive loads, and they operate from -20 to 60 C.

CIRCLE NO. 373

Small PC-board relays are only 0.4-in. high

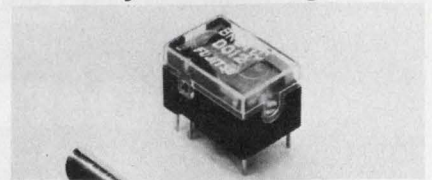

Impact Electrical Products Inc., 7 Westchester Plaza, Elmsford, NY 10523. (914) 592-2880. \$1.08 (1000 up).

A new relay, only 0.4-in. high, with a weight of less than 1/6 oz has a contact rating of up to 3 A at 24 V dc. Coil ratings available range from 1.5 to 24 V dc. The relays are PC-board mountable and come SPDT with four contact variations to suit custom applications. DIP terminals fit 0.1-in. grid spacing. Special construction protects the relays from environmental and solder-flux contamination. The electrical operation life of the new relays is over 1/2 million.

CIRCLE NO. 374

Solid-state totalizer displays large LEDs



Veeder-Root, 70 Sargeant St., Hartford, CT 06102. (203) 527-7201. \$85: 5-decade units.

A miniature solid-state totalizer with 3/8-in. LED-display is readable in all ambient lighting conditions. Housed in a case only 1-in. high by 2-in. wide, this compact counter features a splash and dust-resistant front panel. Instant reset and sustained speeds to 5000 counts per minute are featured. Also, the units have remote or power-interrupt reset. Models with five or four decades are available with or without manual pushbutton reset. All models operate on 12 to 15 V dc at 200 mA and use 3 W. They accept switch contact input signals, and some standard models also accept pulse inputs and include LED-test and battery-standby circuits.

CIRCLE NO. 375

Introducing Robert Bosch Mini-Giants

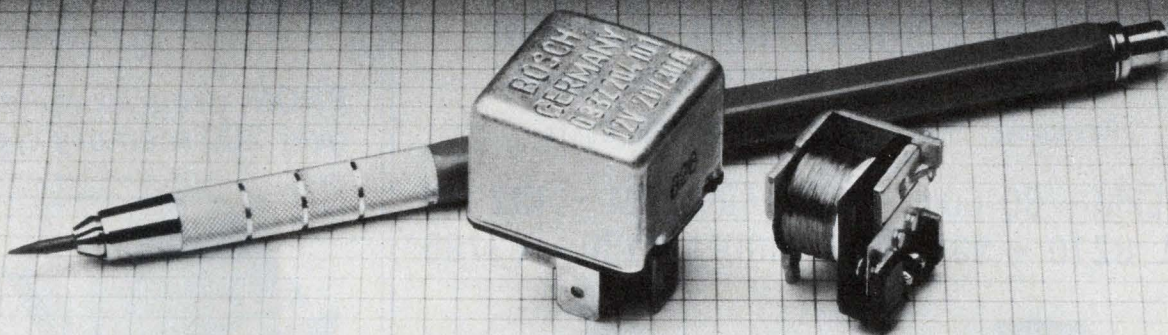

30-amp relays with a quarter-million cycles: smallest for the price

We invite you to compare the high technology advantages of Bosch Mini-Giants to the relays you're now using. We're confident you'll find Mini-Giants hard to beat on all the important criteria.

Versatility. Bosch has engineered the Mini-Giants to be at home in any 12- or 24-volt application—remote controls, generators, automotive systems, construction machinery, marine applications, agricultural equipment, hospitals, storage systems and more.

The same Mini-Giant that can switch the low current of an alarm can also control the high 30-amp load of a heating system.

Size. Bosch technologists have designed a PC board type relay that is 1" x .8" x .7" or just over half (.56) a cubic inch. The plug-in type (not including the plug prongs) is 1" x 1" x .8," still less than a cubic inch.

Capacity. Bosch plug-in Mini-Giants cover the entire power range up to 30 amps, with a peak current capacity of 60 amps. Even the standard 15-amp PC type is available in a 30-amp version on special order.

With one group of relays covering such a range of applications, you can cut down substantially on part numbers and simplify your stocking operations.

Reliability. All Mini-Giants are good for a minimum of 250,000 cycles at the rated current. This compares with 100,000 cycles in many comparable relays from other manufacturers.

And Bosch uses the finest materials for long life (at least 10 million cycles at no load). For example, we build the leaf springs of our plug-in relays from high-grade silver and bronze.

Cost. Bosch Mini-Giants give you all these benefits combined at

a surprisingly low price. You really should compare.

For more information. Fill out the coupon below and we will contact you to discuss your specific needs and answer your questions. Or call (312) 865-5200 and ask about relays. Either way, do it now.

Robert Bosch Corporation,
Department O/ESL
2800 South 25th Avenue,
Broadview, Illinois 60153

Name _____

Address _____

City, State, ZIP _____

Telephone _____

ED/4/77

MINI-GIANTS
ROBERT BOSCH

DATA PROCESSING

Microcomputer kit based on 16-bit microprocessor

Cramer Electronics, 85 Wells Ave., Newton, MA 02159. (617) 969-7700. See text; stock.

The first complete single-chip, 16-bit microcomputer kit, which will sell for \$595, is designed

around the Texas Instruments TMS 9900 μ P. It features double precision addition and subtraction and is the only kit on the market with a hardware multiply and divide capability. The kit comes with sixteen 1024 \times 1 static RAMs, two 1024 \times 8 erasable PROMs, 128 bits of I/O, an RS-232 or 20 mA interface and an on-board EPROM programmer.

Booth No. 2233 Circle No. 376

Two floppy-disc heads are better than one

Applied Magnetics Corp., 75 Robin Hill Rd., Goleta, CA 93017. Ray Freeman (805) 964-4881. See text.

Prototype magnetic heads for double-sided floppy disc drives are now available, increasing storage capacity of a drive to 500,000 bytes of information. The Models 623100 (side 0) and 623101 (side 1) each contain a ferrite/ceramic single-track magnetic head with a read/write section and a tunnel erase section. The catamaran-type head bearing surface is highly polished. Read/write track width is 13 mils and the two adjacent erase track widths are 6 mils each. Maximum packing density is 3268 bits per in., and radial density is 48 tracks per in. Prototypes are priced at \$50 each and are normally ordered in sets of two.

CIRCLE NO. 377

STOP

WAITING ON OUTPUT FROM YOUR MINI

You Are Wasting More In Dollars For Human Resources Than This LINE PRINTER Costs

2400 LPM - 80 COL.
MODEL 8210 - \$3000*

1400 LPM - 132 COL.
MODEL 8230 - \$3785*



FOR ORDERING INFORMATION CALL OR WRITE:

houston instrument

DIVISION OF BAUSCH & LOMB

ONE HOUSTON SQUARE (at 8500 Cameron Road) AUSTIN, TEXAS 78753
(512) 837-2820 TWX 910-874-2022 cable HOINCO

TELECOPIER EUROPEAN OFFICE: Rochestraan 6 8240 Gistel Belgium
Phone 059/277445 Telex Bausch 19399

"the recorder company"

* Domestic USA Prices, Qty 1, End User

CIRCLE NUMBER 122

PROM programmers do over 200 memory types

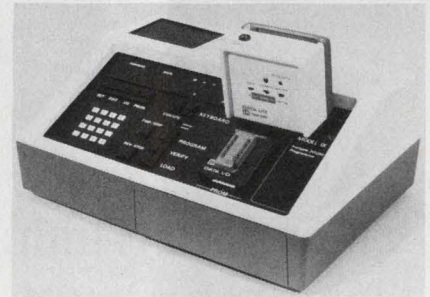

Data I/O Corp., 1297 Northwest Mall, Issaquah, WA 98027. Molly DeGrazia (206) 455-3990. From \$1975; 45 days.

The Model 9 software-based PROM programmer can handle more than 200 different PROM configurations. It features insert/delete data editing capabilities and can program entire generic PROM families using a single personality module. Included in the Model 9 are a hexadecimal keyboard and display controlled by a microprocessor. The programmer is simple to operate and software-based serial and parallel I/O interfaces allow for data communication in key-selectable data translation formats. Data polarity controls are provided, and built-in error checking routines assure the accuracy of all data transfers.

Booth No. 1913, 1915

Circle No. 378

The big three in electronics.



Elektronik

The leading German magazine covering applied electronics and data processing. Enjoys eminent editorial status and a circulation from 32,000 copies monthly. The contact-card reader-service assures your advertisements of greater success.

Funkschau

The big publication in the field of radio, tv, hi-fi and electronics, 26 issues published yearly, with a circulation of 120,000 which includes over 13,000 copies outside Germany. These are the guarantee for your successful advertising campaign.

FRANZIS-VERLAG GMBH
Karlstrasse 41, D-8000 Muenchen 2
phone: (0 89)-5 11 72 77
telex: 5 22 301 frzis d

Germany's leading publishinghouse
for electronics

ELO

The new magazine covering electronics in practice and as a hobby. 30,000 circulation at the start in 75, increasing to 122,000 copies in only one and a half years. Published monthly. It is especially conceived for the interested amateur and all people interested in hi-fi and electronics as a hobby.

USA: INTA Advertising, Inc.
1560 Broadway, New York, N. Y. 10036
phone: (212) 575-92 92

USA: Elmatex International
7742 Redlands Street
Suite H 3021
Playa Del Rey, CA 90291

United Kingdom: Publicitas Limited
525/527 Fulham Road, London SW 6 1 HF
phone: 01 - 3 85 77 23,
telex: 919 223 Almilon

Switzerland: Exportwerbung AG
Neptunstrasse 20, CH-8032 Zürich
phone: 01-47 46 90, telex: 53 327

Japan: International Media Ltd.
1, Shiba-Kotohiracho, Minatoku,
Tokyo, phone: 5 02-06 56, telex: J 22 633

Korea: International Marketing Corp.
C. P. O. Box 6533, Seoul, Korea
phone: 74. 75 35

Single board expands mini I/O capabilities

MDB Systems, Inc., 1995 N. Batavia St., Orange, CA 92665. Gene Sylvester (714) 998-6900. See text; stock to 2 wks.

Two serial asynchronous communication line controllers and a real-time clock controller, housed on a single board, are physically compatible with the Nova chassis as well as the MDB Systems' Nova Expansion Chassis. The serial interfaces are compatible with the DG-4010 teletypewriter controller. The user-defined interface can be current-loop, RS-232C, or long line driver/receiver. The price of the Nova M10B controller for a single teletypewriter is \$300, with the second TTY operation for \$200. The real-time clock option is \$200, and the DG4029 modem control option is \$75 per TTY controller.

CIRCLE NO. 379

Fast 15-column printer offers 54-character set



Sheldon-Sodeco, 4 Westchester Plaza, Elmsford, NY 10523. (914) 592-4400.

Capable of printing at speeds up to 3 lines/s for numeric, and 1.5 lines/s for alphanumeric data, the new Series-PR1500 impact printers offer a full 54 character set and multicopy printing capability. Characters for every three of a maximum of 15 columns are formed by unique "spanning hammers." This reduces the number of moving parts. The printer uses inexpensive standard paper and a snap-in two-color ribbon. Options include special drum-type fonts, single or multiline printing, combination ticket/tape printing and special voltages.

CIRCLE NO. 380

Position controllers handle four axes

Anorad Corp., 115 Plant Ave., Smithtown, NY 11787. Tom DeRenzo (516) 234-1824. From \$5000; 10 wks.

Controllers capable of positioning up to four axes, the Anomatic series, provide combinations of linear and circular motions. The controllers use a microprocessor to keep track of all position inputs. A 12-V CMOS bus interconnects the 6800 microprocessor to all input and output devices, yet the processor PROM and ROM are TTL. All the TTL circuits are located in only one section of one of the circuit cards; thus a noise immunity of 4.8 V is available. The system can be controlled by internal memory, paper tape, cassettes or magnetic cards, and a built-in PROM programmer provides non-volatile memory. The Anomatic Controller has full editing capabilities for stored programs. Either CRT or LED displays are available.

Booth No. 1434 Circle No. 381

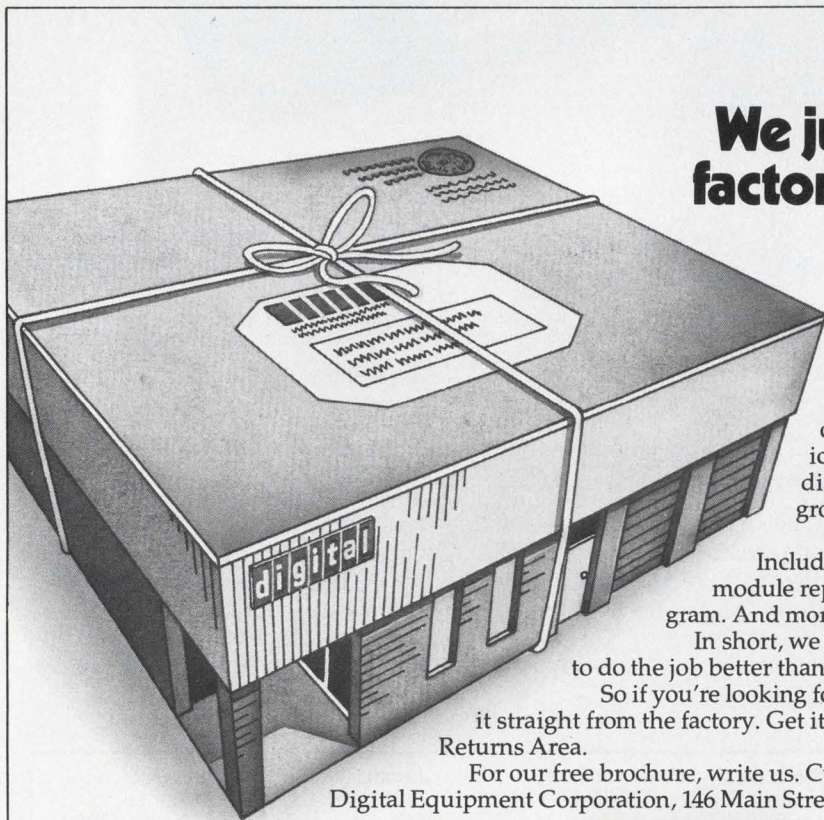

We just brought Digital factory service one step closer to the field.

Announcing the Customer Returns Area. The major off-site repair center for Digital Equipment Corporation.

The Customer Returns Area offers all our customers direct access to factory service. We have our own parts inventory, diagnostic and test center, and engineering group.

We also have a number of service plans.

Including subassembly contracts, individual module repair, our unique Module Mailer™ program. And more.

In short, we have everything it takes to do the job better than anyone else.

So if you're looking for off-site service, get it straight from the factory. Get it from the Customer Returns Area.

For our free brochure, write us. Customer Returns Area, Digital Equipment Corporation, 146 Main Street, Maynard, MA 01754.

digital

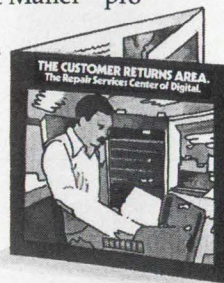

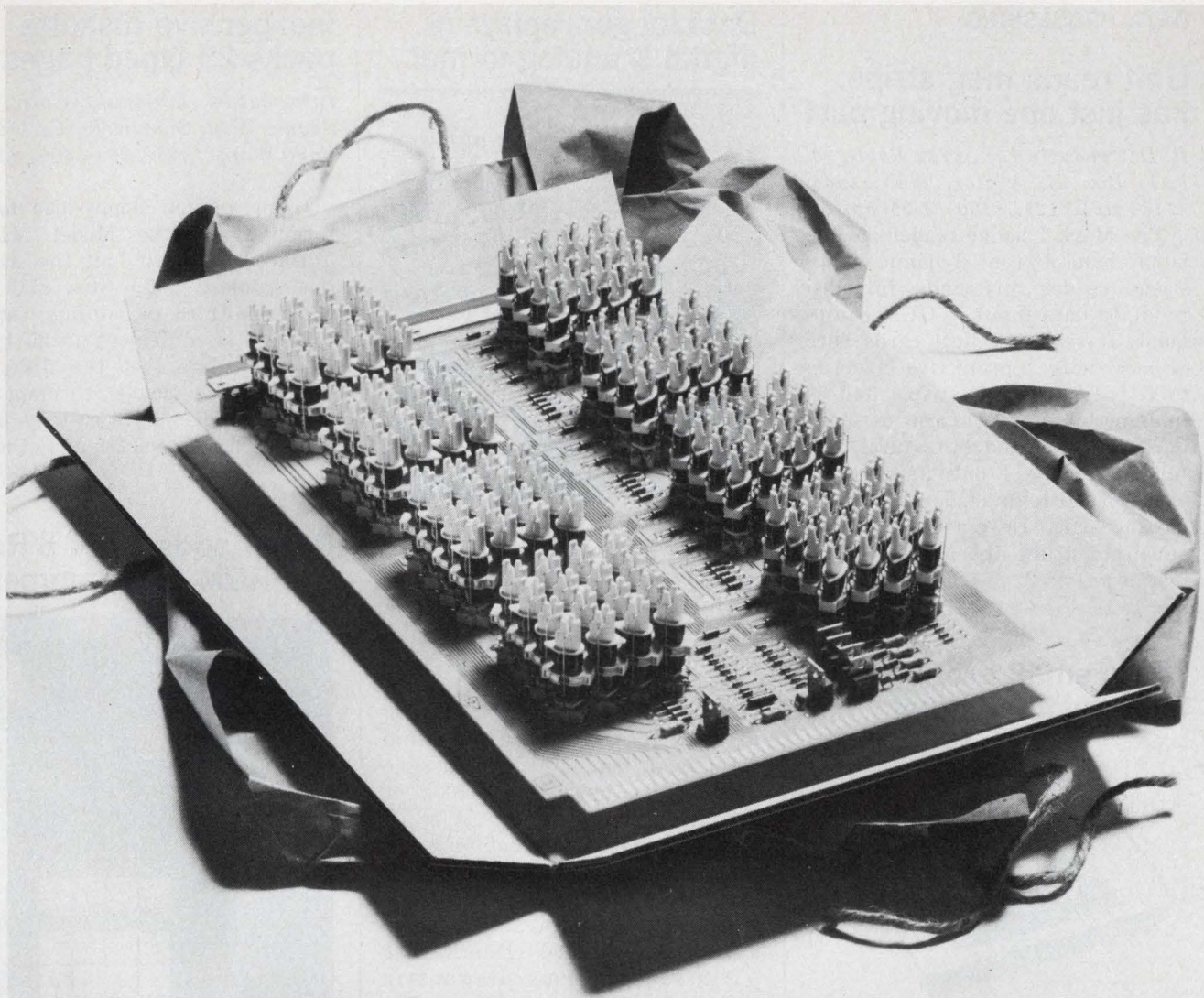

Hot signal switching to go.

Here's a shortcut to your next state-of-the-art voice and data switching system. Our standard matrices and high-rise Correeds.

They help you design your system without long lead time or a big budget. And because they're standard items, you get the components you need fast.

Many matrix configurations are available, with either magnetically latched or electrically held crosspoints. You can create single- and multi-stage networks of any size by connecting two or more matrices together. Or, just buy our Correed crosspoints and build your own matrices, if you wish.

Correeds make the most of any matrix design. They give you high-density packaging. Millisecond switching speed. Very low insertion loss, noise and crosstalk. And millions of

trouble-free operations.

Why start from scratch? Start at THE SOURCE: GTE Automatic Electric.

For more information on matrices or Correeds, send the coupon below. Or call John Ashby at (312) 562-7100, ext. 250.

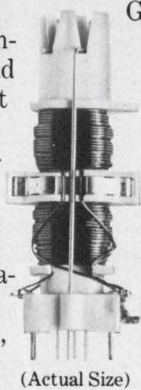

(Actual Size)

Please send more information on Correeds and matrices.

on _____ of _____
(Quantity) (Product)

Name _____ Title _____

Company _____

Address _____

City _____ State _____ Zip _____

Telephone _____

Mail to: Mr. J.D. Ashby, B-4, GTE Automatic Electric,
 Northlake, Illinois 60164

GTE AUTOMATIC ELECTRIC

DATA PROCESSING

Unit reads mag stripe, has just one moving part

R. D. Products Inc., 6132 Route 96, P.O. Box E, Victor, NY 14564. (716) 924-7121. \$100 (1-25 units).

The Mark I badge-reader module is a hand-driven dynamic mag-stripe reader, primarily intended for fixed data input in OEM equipment. It reads 12-digit cards (dec or hex) with a protective layer up to 5 mils over the stripe, and is immune to deformed cards or speed variation. The module features buffered TTL level outputs, a fully enclosed card guide, and only one moving part. Designed for front-panel mounting, the Mark I measures 3-1/2 x 2 x 3.85 in. (depth).

CIRCLE NO. 382

TTY's small brother is light, fast and quiet

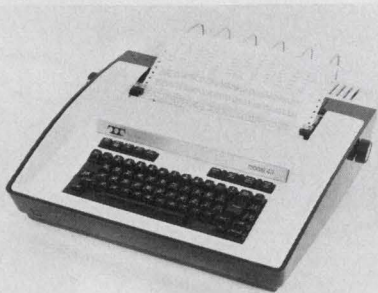

Teletype Corp., 5555 Touhy Ave., Skokie, IL 50076. Tom Race (312) 982-3134. Under \$1000.

No longer is TTY synonymous with the familiar Model 33. A new, low-cost matrix teleprinter with 30 character-per-second throughput, upper/lower case and 132 columns on 11-in.-wide fanfold paper has joined the family. The Model 43 features a nine-wire impact printhead mechanism with superior service life and print quality. Advanced MOS technology, low weight (30 lb), and quiet operation make it attractive for a variety of uses. The Model 43 teleprinter is compatible with systems that support Model 33 terminals. The terminal includes controls for 10 or 30 char/s, half or full-duplex, parity on/off and printer test. The terminal contains five pluggable major components and can be disassembled in a few minutes. Built-in self-diagnostics simplify troubleshooting.

CIRCLE NO. 383

Data logger replays in digital & analog format

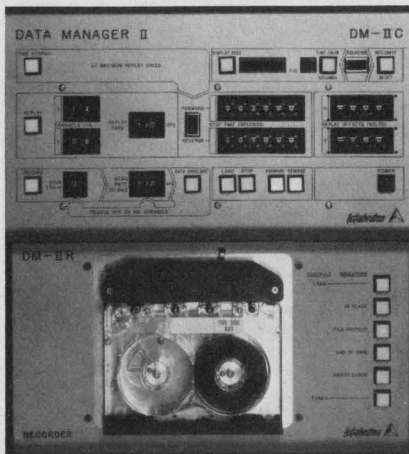

Tetrahedron Associates, Inc., 7605 Convoy Court, San Diego, CA 92111. (714) 277-2820. \$9300.

If you want to have your test data in both analog and digital form, use the Data Manager III to collect them. The DM III auto-ranges up to 14 channels of analog data. The data are stored in digital form by a magnetic tape cassette and can be output in analog or digital format. The DM III's μ P checks each sample point for parity, resulting in low error rates. Recalled data may be expanded or rescaled, and played against time or any other recorded channel. The μ P also performs diagnostic troubleshooting.

CIRCLE NO. 384

Inexpensive terminal plugs into RS-232 port

Micon Industries, 252 Oak St., Oakland, CA 94607. P. Conover (415) 763-6033. \$400; stock to 4 wks.

The Model KDM/1 terminal has a built-in display allowing two-way computer data communication with any RS-232 interface device. The terminal works with computer systems, computer-controlled test equipment, and special purpose devices such as bar-code readers, OCR scanners, and microprocessor development systems. Each unit combines a full ASCII keyboard, 32-character alphanumeric LED display, ac power supply and RS-232 interface. The KDM/1 terminal is available to OEMs with quantity discounts, but is also distributed through retail computer stores and by mail order.

CIRCLE NO. 385

Inexpensive diskette packs 25 typed pages

Information Terminals Corp., 323 Soquel Way, Sunnyvale, CA 94086. Paul Ward (408) 245-4400. \$5.25; stock.

Using proven floppy-disc media formulations, the Model MD525 μ diskette is about half the size of the standard floppy disc and provides one-third the storage capacity. This is equivalent to 25 typed pages of data, yet the diskette's compact size makes it compatible with small disc-drive systems made by Shugart Associates and others.

CIRCLE NO. 386

Buffer adds 1 k x 8 RAM to PROM programmer

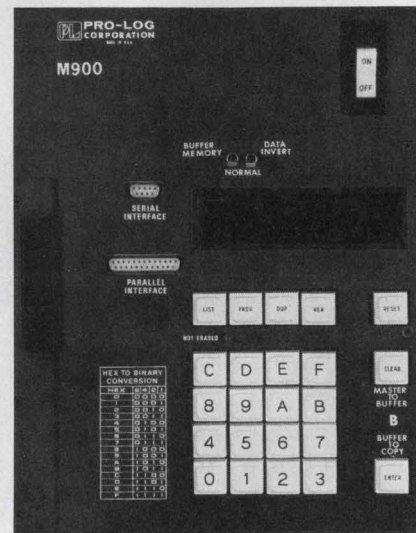

Pro-Log Corp., 2411A Garden Rd., Monterey, CA 93940. (408) 372-4593. \$300; stock.

The 9107-1 CMOS RAM buffer option provides a 1024 x 8 workspace in the Series 90 PROM programmer. The buffer can be loaded from the Series 90 keyboard or from a master PROM. The copy PROM can then be programmed directly from any portion of the buffer. The 9107 also features "data displacement"—during buffer input and output operations. Code can be inserted, deleted, moved, and changed. Power can be switched off for up to 60 seconds without losing buffer data. The option is factory retrofitable in all Series 90 programmers and includes control program, internal circuitry and documentation.

Booth No. 1724, 1726

CIRCLE NO. 387

How to get a lot more into a lot less.

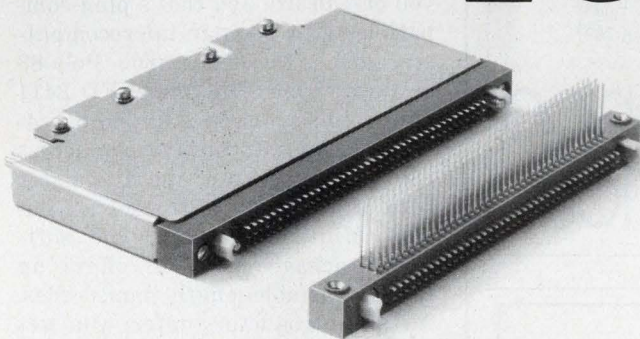
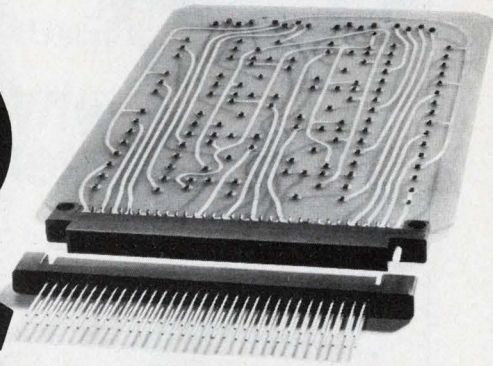

First, with 3 rows of contacts on .100 centers, Viking's unique Nordic 2-piece P/C board connectors and I/O I.C. panel plugs get a lot more contacts into a lot less space.

Second, our unusual polarizing system lets you key each mating pair to prevent cross mating with adjacent connectors of the same type. You can stack a series of Nordic connectors next to one another in cramped space and not worry that they might be cross mated.

Our full line includes 64 and 82 contact models as well as the 120. Contacts on I/O connectors are crimp, snap-in, removable, gold plated and use MIL-T- 22520 tools.

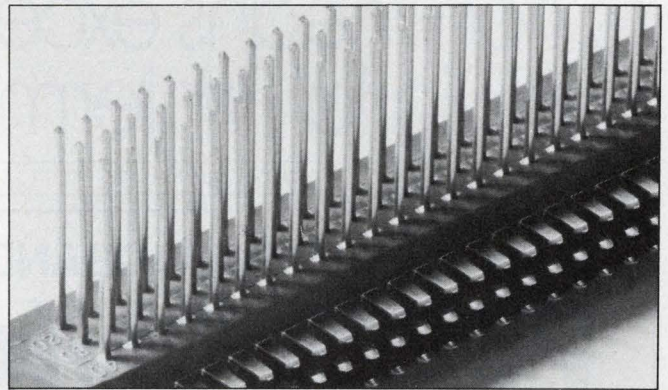

Diallyl Phthalate is the insulator in most models. And all connectors are designed to meet conditions of MIL-C-55302.

If you need them right now, our distributors have most models in stock. For details, use the coupon and get our latest catalog.

O.K. Send me: Your latest catalog with details on the two-piece PC connectors ... and your nearest rep. I have some questions for him.

Name: _____

Position: _____

Company: _____

Address: _____

City: _____ State: _____ Zip: _____

 **Viking**
CONNECTORS

Viking Industries, Inc., 21001 Nordhoff Street, Chatsworth, CA 91311



7 reasons why our Dot Matrix Impact Printers are best buys.

- 40-column capacity (at 12 characters/inch); multi-copy; roll or ticket; 3 1/8" print line capacity; 1.25 lines/sec.
- Flexible symbol-generating capabilities
- Easy electronic interfacing
- Simplicity of design, insures high reliability
- Lowest initial cost—Lowest maintenance cost

• Developed and manufactured by LRC, Inc., Riverton, Wyoming, U.S.A.

• Represented and backed by C. Itoh Electronics, Inc.—part of the 117-year C. Itoh & Co., Ltd. world-wide trading organization.



C. Itoh Electronics, Inc.

East: 280 Park Ave., New York, NY 10017
Call 212-682-0420. Telex WUD 125059

West: 5301 Beethoven St., Los Angeles, CA 90066
Call 213-390-7778. Telex WU 65-2451

C. Itoh means excellence in Digital Printermatics.

CIRCLE NUMBER 126

ULTRA-BROADBAND Power Divider

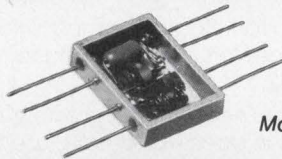

Model DS-313*

10-2000 MHz
(in-phase, 2-way)

Insertion Loss	0.6 dB (typ. midband)
Isolation	28 dB (typ. midband)
VSWR	1.3:1 max.
Matched Power Rating	100 mW max.

Rugged, Low Profile Flatpack is designed to meet MIL-E-5400 specifications. \$65.00

*One of more than 26 2-way and N-way power dividers in the latest ANZAC Full Line Catalog — ALL AVAILABLE FROM STOCK



39 Green Street • Waltham, MA 02154 • Tel. (617) 899-1900 • TWX 710 324-6484

CIRCLE NUMBER 127

DATA PROCESSING

Inexpensive diskette plugs into popular μ Cs

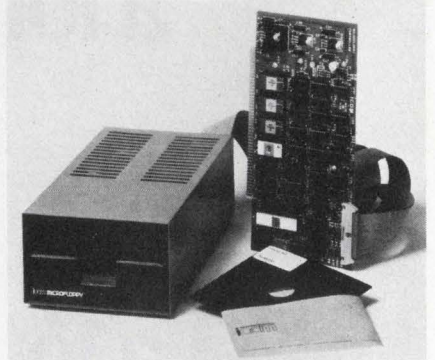

Pertec Computer Corp., iCom Div., 6741 Variel Ave., Canoga Park, CA 91301. Terry Zimmerman. (213) 348-1391. \$1095; see text.

The Microfloppy is a disc system you can afford, and that's plug-compatible with popular microcomputers, such as the Altair 8800, Poly 88 or Imsai 8080. The Model FD 2411 stores 10-kbytes on a single 5-1/4-in. diskette with an average access time of under 0.5 s, and a transfer rate of 125-kbits/s. It uses a Shugart Minifloppy drive. The software package FDOS-M offers up to 175 variable-length named files. As an introductory offer, you get an 8-k Basic software package at no additional charge. The FD 2411 is distributed through computer stores, and will be available in kit form later this year.

CIRCLE NO. 388

Circuit board saves slots and money

Custom Systems, 2415 Annapolis Lane, Minneapolis, MN 55441. (612) 553-1112. See text; 6 wks.

Measuring 15-in. square, the Slot Saver contains interface controllers for low-speed peripheral devices commonly used with Data General's Nova and Eclipse. A maximum configuration consists of controllers for CRTs or TTYs (2), a real-time clock, a paper-tape punch and a line printer. Because the Slot Saver requires only one slot, it frequently permits the use of a computer with a smaller chassis. The Slot Saver is fully compatible with the Data General instruction sets including the peripheral drivers of the assembler or real-time disc operating system.

CIRCLE NO. 389

Diode matrix provides instant firmware

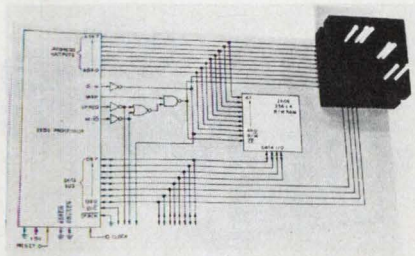

Sealectro Corp., Mamaroneck, NY 10543. (914) 698-5600.

A 10×10 diode matrix permits manual programming of 8-bit or 16-bit words through the simple insertion of diode pins into the bused matrix board. Scanning circuitry is not supplied. The matrix operates at 5 to 15 V dc.

CIRCLE NO. 390

Desktop computer has wide ranging talents



Hewlett-Packard, 1501 Page Mill Rd., Palo Alto, CA 94304. J. Peter Nelson (415) 493-1501. \$7200.

A new 26-lb desktop computer, the Model HP 9831A, can be used as a stand-alone Basic language computer, or linked with peripherals to form systems. It also serves as the heart of the new HP 9896 business information management system. The Model HP 9831 comes with 8kbytes of memory, expandable to 32-kbytes. Commands for string variables, input/output (for peripheral control), and Advanced Programming II operations in Basic are built in. Optional matrix/plotter flexible disc ROMs are also available. The desktop computer can work with flexible-disc drives, plotters, thermal and character-impact printers, and the CRT terminals. It features a built-in, high performance bidirectional tape drive with an average access time of 6 s. The 32-character LED display provides upper and lower-case alphanumeric readout and covers the full ASCII character set.

CIRCLE NO. 391

CIRCLE NUMBER 128 ►

ATE? GO DDS!



Model 5100: Manual/Automatic Programming

Direct Digital Synthesis for Glitchless Switching, Constant Resolution, Smooth Sweeping, Spectral Purity, and Phase Continuity.

For automatic test systems, and a host of other manual and computer-programmed frequency-generating applications in the 0-3MHz range, our Model 5100 Direct Digital Synthesizer (U.S. Patent No. 3,735,269) provides optimum performance at remarkably low cost. Optimum? Read on . . .

DDS, unlike all other methods of frequency synthesis, does *not* use either heterodyning or phase locking. Therefore, it provides *much lower* phase noise (-70 dB spurious, -55 dB harmonic), extremely high and constant resolution (0.001Hz, over the entire range), and stability entirely determined by its reference (internal or external) . . . sync it to an atomic standard, if you wish, for ultimate stability.

But the greatest advantages of DDS are revealed when you start *switching* frequencies. There's just *no* switching transient . . . amplitude and phase are *continually maintained* between frequencies. And the switching speed of the Model 5100 is *orders of magnitude faster* than is theoretically possible in an indirect synthesizer (1.5 microsecond programming delay, 625 nanosecond update rate). Frequency sweeping, under remote digital programming control, is smoother than ever before — and the frequency/time

curve can be either linear, or exponentially "shaped" for best response display.

Finally, DDS allows you to control the phase of the output signal, asynchronously, for any period. Only DDS, for example, will generate sinusoidal *bursts* with each burst starting at *exactly* zero phase.

The Model 5100 provides both manual (10-dial) and remote digital programming (binary or BCD) by computer, programmer, or contact closures. The blank-front-panel Model 5110 is digitally programmable only — for OEM systems, at OEM prices.

HOW & WHY DDS is your best bet for almost every application is explained in this *free* engineering data file. Request it today — use the inquiry number below, call, or write:



Rockland Systems Corporation
230 W. Nyack Road
W. Nyack, N.Y. 10994
TEL: (914) 623-6666
TWX: 710-575-2631

ADVANCED SIGNAL TECHNOLOGY
ROCKLAND
SYNTHESIS • PROCESSING • ANALYSIS
Our Second Decade of Leadership

Subminiature trimmers are built on sapphire

Voltronics, West St., East Hanover, NJ 07936. R. Newman (201) 887-1517. \$5 (50 units); stock-4 wks.

Designated the Picotrim M-series, a line of subminiature precision trimmer capacitors uses sapphire dielectrics for optimum microwave performance. Up to 12 GHz, the loss tangent is below 0.0003, and Q at max capacitance exceeds 1000 (measured at 250 MHz) with a temperature coefficient of 0 to 100 ppm/°C. Designer kits of 12 to 36 pieces with different lead and mounting styles are also available.

CIRCLE NO. 392

Expanded C-band source plugs into synthesizer

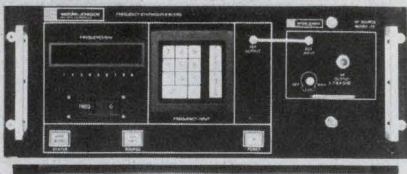

Watkins-Johnson Co., 3333 Hillview Ave., Palo Alto, CA 94304. (415) 493-4141. \$6810.

To cover communications bands fully, the Model 1251-13 plug-in expands C-band coverage of the Model 1250 or 1255 synthesizer to 3.7 to 8.4 GHz, with 7-mW output. Harmonics are at least 20 dB down, and other spurious signals are 60 dB min below the carrier. Depending on the mainframe, the plug-in achieves a frequency resolution of 100 Hz or 100 kHz min.

CIRCLE NO. 393

40-GHz oscillators boast powerful Gunns

Alpha Industries, Inc., 20 Sylvan Rd., Woburn, MA 01801. (617) 935-5150.

The TRG 9200 Gunn oscillator series covers a frequency range of 26.5 to 40 GHz, with 400 mW of output up to 35 GHz. The units are mechanically tunable within ±100 MHz, and operate from -10 to 55 C. Heat-sinking surfaces come with the units.

CIRCLE NO. 394

Motorized attenuator stops on a dime

Waveline, Inc., P.O. Box 718, Caldwell, NJ 07006. Robert H. Koenig (201) 226-9100. \$575; stock-6 wks.

If you must change attenuation at a remote spot, the Model 9026-3 motorized attenuator provides a solution. It spans the 2-to-12.4-GHz range with 1.3 max VSWR. The motor cranks through the 20-dB attenuation range in a minute, and stops within ±0.1 dB.

CIRCLE NO. 395

Fiber-optic cable can save you a bundle



Valtec Corp., West Boylston, MA 01583. Richard A. Cerny (617) 835-6082. 75¢ to \$2 per thousand; 10 days.

Economical communications via fiber-optic cable are now a reality. The Valtec cable offers a large bundle diameter of 0.045 in., less than 400 dB/km attenuation, and a numerical aperture of 0.56. The rugged, crust-resistant cable is available in lengths up to 1 km.

CIRCLE NO. 396

Heavyweight amplifiers debut in L band

Microwave Semiconductor Corp., 100 School House Rd., Somerset, NJ 08873. Richard B. Moffett (201) 469-3311. \$600 to \$750 (100 units); 12 to 25 wks.

Solid-state amplifiers are moving into the heavyweight class with the introduction of the MSC 9000 family. It comprises 35 models at various power levels and bandwidths. Available frequencies range from 0.57 to 2.7 GHz, and power levels reach 20 W. Bandwidths can be as high as 300 MHz, and efficiencies range to 30%. The 9000 series uses power transistors in cascaded chains, interconnected by thin and thick-film microstrip circuits. Custom options include narrowband optimization, MIL-spec performance and special packaging.

CIRCLE NO. 397

Tiny GaAs FET units amplify 4 to 12 GHz

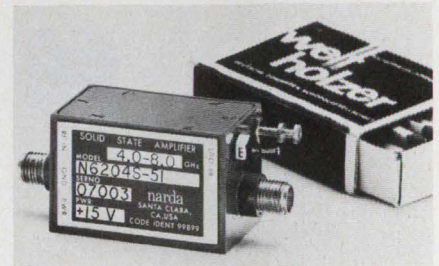

Narda Microwave Corp., Plainview, LI, NY 11803. J. P. Schindler (516) 433-9000. From \$1200; 4 wks.

The 6200 series of ruggedized GaAs FET amplifiers provides frequency coverage from 4 to 12 GHz for radar, communications and electronic warfare applications. The miniature amplifiers exhibit ultra-low noise, a wide dynamic range, and are optimized for maximum power. The communications units are specially tuned to reduce intermodulation products, gain slope, group delay, AM/PM conversion and VSWR.

CIRCLE NO. 398

Bipolar transistors give low NF, high gain

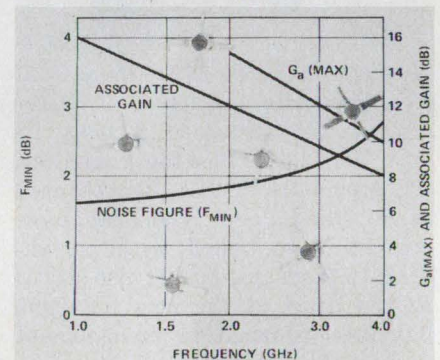

Hewlett-Packard, 1501 Page Mill Rd., Palo Alto, CA 94304. (415) 493-1501. \$55/\$120 (1-9); stock.

HP has announced a new line of silicon bipolar transistors with typical noise figure of 1.8 dB and associated gain of 12 dB at 2 GHz. The Model HXTR-5103 (\$55) is suited to replace the Fairchild FMT4005, and has a 2.2-dB max noise figure at 2 GHz with associated gain of 11 dB min. Model HXTR-6104 (\$120) is specified with a 1.6-dB max noise figure at 1.5 GHz and 13-dB min associated gain. Both come in the hermetically sealed HPAC-100 meal-ceramic package.

CIRCLE NO. 399

now there is one... in signal processing

IF and Microwave Components From One Source.

Where others cut-off at 1 GHz, and still others begin at 1 GHz, Merrimac does it all from DC-18 GHz with lumped elements, stripline or ferrites. For years Merrimac has been a leader in IF while quietly manufacturing components for microwave systems. Now, we have two complete Signal Processing lines with IF, RF, microwave components and subsystems where we can meet your particular needs from over 700 standard off-the-shelf devices.

SPORTS ILLUSTRATIONS SUITABLE FOR FRAMING.



Football, Basketball, Soccer and Hockey,
Two Color reproductions FREE on request.

Circle the Reader Service Number 237

SINGLE AND DOUBLE BALANCED MICROWAVE STRIPLINE MIXERS

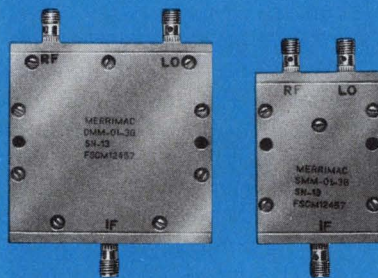

1.7-18 GHz

Check our minimum performance characteristics and see for yourself why Merrimac has the winning combination for you...

SINGLE BALANCED MICROWAVE STRIPLINE MIXERS

MODEL SMM-01-	RF & LO FREQ. (GHz)	IF BW (MHz)	ISOLAT'N dB (MIN)	NOISE FIG. dB (MAX)	CONV. LOSS dB (MAX)
2.95 G	1.7-4.2	DC-400	6	8.0	6.5
3 G	2.0-4.0	DC-400	8	7.5	6.5
3.90 G	2.6-5.2	DC-400	7	7.5	6.5
6 G	4.0-8.0	DC-400	6	8.0	7.0
10 G	8.0-12.4	DC-1000	6	8.5	7.5
15 G	12.4-18	DC-1500	6	9.0	8.0

DOUBLE BALANCED MICROWAVE STRIPLINE MIXERS

MODEL DMM-01-	RF & LO FREQ. (GHz)	IF BW (MHz)	ISOLAT'N dB (MIN)	NOISE FIG. dB (MAX)	CONV. LOSS dB (MAX)
2.95 G	1.7-4.2	DC-400	20	8.5	7.5
3 G	2.0-4.0	DC-400	20	8.0	7.0
3.90 G	2.6-5.2	DC-400	20	8.5	7.5
6 G	4.0-8.0	DC-400	20	9.0	8.0
8 G	6.0-12.4	DC-400	16	9.5	8.5
10 G	8.0-12.4	DC-700	18	9.0	8.0
15 G	12.4-18	DC-1000	15	10.0	9.0

send for our
**NEW '77 MICROWAVE
CATALOG.**

Circle the Reader Service Number 238

DOUBLE BALANCED MIXERS

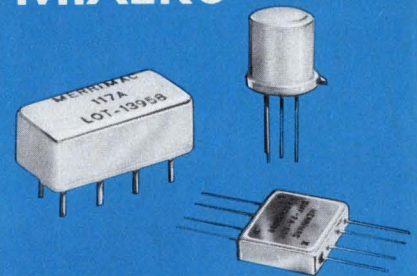

DC to 1 GHz — in TO-5, Flat Pack or Relay Header

Check our minimum performance characteristics and see for yourself why Merrimac has the winning combination for you...

DC-500 MHz MODELS				
PACKAGE	MODEL NO'S	PRICE	CONVERSION LOSS	ISOLATION (DB-MIN)
RELAY HEADER	117A	\$ 9.45	5.5 dB Typ. 8.0 dB Max.	L-R 40-30 L-X 35-20
FLAT PACK	DMF-2A-250	\$29.00	7.0 dB Typ. 8.0 dB Max.	L-R 40-35 L-X 30-20
TO-5 (0.3" HIGH)	M-109	\$25.00	6.0 dB Typ. 8.5 dB Max.	L-R 40-25 L-X 30-18
DC-1000 MHz MODELS				
RELAY HEADER	M-119	\$15.00	7.0 dB Typ. 8.0 dB Max.	L-R 30-20 L-X 25-15
FLAT PACK	DMF-2A-505	\$26.00	7.5 dB Typ. 8.0 dB Max.	L-R 35-25 L-X 30-20
TO-5 (0.3" HIGH)	M-122	\$39.00	6.5 dB Typ. 9.5 dB Max.	L-R 40-25 L-X 30-20

LO POWER (ALL MODELS) +7 DBM NOMINAL

Send for complete data on the above Mixers and we will also include free MTBF data and information on our complete line of DC-3GHz "Connectorized" Single and Double Balanced Mixers.

send for our
**NEW '77 CATALOG
OF IF SIGNAL PROCESSING
COMPONENTS**

Circle the Reader Service Number 239

now there is one...in signal processing

Merrimac
INDUSTRIES, INCORPORATED
POST OFFICE BOX 986, 41 FAIRFIELD PL., W. CALDWELL, N.J. 07006
• 201 575-1300 • TWX 710-734-4314

WHAM!

Now a bendable
2-row
high-barrier
strip;
the size
of 15A
strips,
rated
at 20A.

The interconnection company that
innovates to serve you better.

BEAU

 Beau Products Division
Vernitron Corporation
P.O. Box 10, Laconia, N.H. 03246
N.H. tel.: 524-5101
CALL TOLL FREE: (800)258-0370

CIRCLE NUMBER 130

WELD!

Now a closed-back
20A barrier strip
without eyelets.
Welded-in screw
terminals never
pull out.

The interconnection company that
innovates to serve you better.

BEAU

 Beau Products Division
Vernitron Corporation
P.O. Box 10, Laconia, N.H. 03246
N.H. tel.: 524-5101
CALL TOLL FREE: (800)258-0370

CIRCLE NUMBER 131

MODULES & SUBASSEMBLIES

Multiplying d/a offers 12-bit linearity

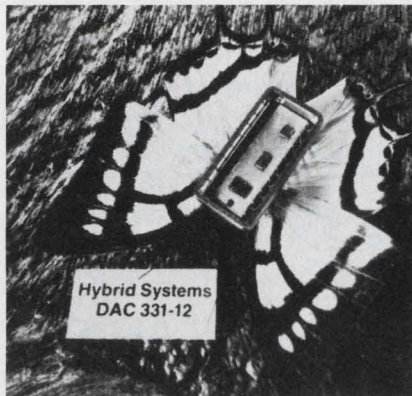

Hybrid Systems, Crosby Dr., Bedford Research Park, Bedford, MA 01730. B. Smith (617) 275-1570. \$49 (unit qty); stock to 4 wks.

Full 12-bit linearity, instead of the usual 10 bits, is the feature of the DAC 331-12, a four-quadrant multiplying d/a converter. The converter accepts dc or ac references and requires one external output op amp. Packaged in an 18-pin DIP, the unit maintains a linearity error of 1/2 LSB over -55 to $+125$ C. The input reference range is ± 10 V and the output settling time is $1.5 \mu\text{s}$. Models are available to meet MIL-STD-883A. Booth No. 2444 Circle No. 400

Optically coupled amp has linear gain

Burr-Brown, International Airport Industrial Park, Tucson, AZ 85734. N. Shah (602) 294-1431. \$47.50 (100 qty); stock.

If gain nonlinearity has kept you from using optically coupled isolation amplifiers, the 3650KG, boasting a maximum nonlinearity of $\pm 0.05\%$, may be just what your system needs. The gain stability of the unit is held to $\pm 0.005\%/^{\circ}\text{C}$; input offset voltage is ± 0.5 mV max; and input offset voltage drift is $\pm 5 \mu\text{V}/^{\circ}\text{C}$ max. Other key parameters include: isolation voltage of 2-kV min, dc-isolation-mode rejection of 140 dB, leakage current (240 V at 60 Hz) of $0.25\text{-}\mu\text{A}$ max; and bandwidth (± 3 dB) of 15 kHz. The 0-to-85-C device comes in a ceramic package measuring $1.75 \times 0.9 \times 0.22$ in. Power-supply requirements are ± 8 to ± 18 V. Booth No. 2824-26 Circle No. 401

Small counters either add or add-subtract

Kessler-Ellis Products, Atlantic Highlands, NJ 07715. R. Laird (800) 631-2165. From \$90; stock.

The 1.0×2.0 in. series L06 is either an add-only or add-subtract counter. Either a bright-type six-digit or a high-efficiency-orange four-digit LED display is available. The counter takes 12 or 24-V-dc power and responds to inputs within the 3-to-30-V-dc range. Inputs from dry switch-closures are also acceptable. The units count at up to 2 MHz. Battery standby circuitry is included. Logic-level-zero and multiplexed-BCD outputs are options.

CIRCLE NO. 402

Oscillators offer smaller error

Motorola Communications, 1301 Algonquin Rd., Schaumburg, IL 60196. C. Chopp (312) 721-4183. From \$40.50 (1-4); stock.

Hybrid clock oscillators of the K1100A series now offer tighter than ever frequency tolerances of ± 25 and ± 50 ppm. Tolerances include the effects of calibration, operating temperature range (0 to 70 C), and load and voltage changes. Frequency range is 250 kHz to 25 MHz on ± 50 -ppm units and 4 to 25 MHz on the ± 25 -ppm units.

Booth No. 2535 Circle No. 403

Fast op amp offers high precision

Teledyne Philbrick, Allied Dr. at Rt. 128, Dedham, MA 02026. (617) 329-1600. \$127 (unit qty); stock.

The DIP-packaged 1435 video op amp boasts a 1-GHz gain-bandwidth product, a 75-ns settling time to 0.01% for 10-V output step and a 60-dB CMRR at 1 MHz. Overshoot is less than 1% of the output. Applications for the unit include: 20-to-40-dB gain differential video mixers with 0.1%-gain stability; peak detectors (sample and hold) that can capture 25-ns pulses with 1% accuracy and 75-ns pulses with 0.01% accuracy; video converters; and sub- μs precision comparators.

Booth No. 1419-21 Circle No. 404

NEW BURROUGHS' 480-CHARACTER GAS PLASMA DISPLAY:

It's a space saver!
It's a weight saver!
It's a cost saver!

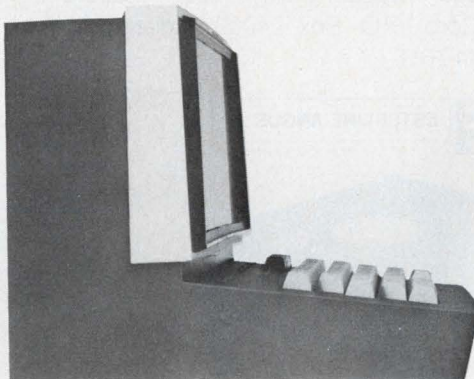

Burroughs low-cost 40, 240 and 480 character SELF-SCAN® II panel displays can help you reduce the size and weight of your data terminals by more than 50%. You'll reduce costs as well. And, at the same time, obtain excellent display readability under all operating conditions — indoors or out, day or night. Characters are uniformly bright, free of jitter and flicker with no fuzziness, distortion or loss of linearity at the display's edges. Character-to-background contrast is better than ever. And, the SELF-SCAN II panel's 40-character



line is compatible with popular software.

Other significant advantages include direct digital address, easy interface to microprocessors, thin cross-section and rugged construction for long service life under all operating conditions.

Give your data terminals a bright new outlook; call or write for complete information.

Burroughs Corporation,
Electronic Components Division, P.O.
Box 1226, Plainfield, New Jersey 07061.
Telephone (201) 757-5000. SELF-SCAN®
displays are available nationwide through our
distributors, Hamilton/Avnet and Cramer Electronics.

On display at Electro '77, Booth Number 2643.

You can **see** the difference

Burroughs



Design better equipment

OEM servo recorder

Esterline Angus original equipment Miniservo® recorder gives more design freedom. The basic unit lists at just \$320, with generous quantity discounts available. Your customers benefit from reliable simplicity, easy use, and state-of-the-art. Nationwide repair network backs every unit.

Short specifications: 100 mm-wide Z-fold or rolled servo chart recorder with 100 MVDC (10 MV optional) and 4 chart drive choices, 0.5 sec. response, ±0.5% accuracy, disposable ink/pen cartridge. Request Bulletin F612. Esterline Angus Instrument Corp., P.O. Box 24000, Indianapolis, IN 46224, Tel. 317-244-7611.

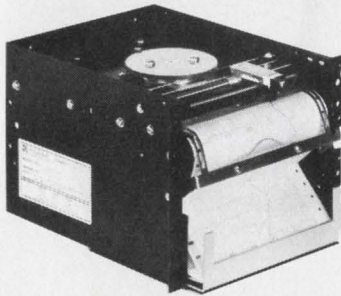

CIRCLE NUMBER 136

DO YOU NEED A RUGGED CONTROL SYSTEM SHAFT ENCODER?



BEI HAS IT!

BEI Series 3700 optical shaft, incremental encoders will meet machine tool specifications. . .

- rugged- 3.5" dia. construction, sealed and protected against severe environments.
 - rugged- industrial grade solid state light source.
 - rugged- high shaft loads, 40 lbs.
- . . . plus dual inch/metric resolutions...plus direction sensed counts to 12,700 per revolution...plus noise immune, low impedance TTL line driver outputs.

For best performance, best reliability in your digital control system phone or write BEI today.

EXCLUSIVE MANUFACTURERS OF THE BALDWIN® ENCODER



BEI Electronics, Inc.

CONTROL AND INSTRUMENTS DIVISION
1101 McAlmont Street, Little Rock, Ark. 72203
Telephone: 501-372-7351 TWX: 910-722-7384

CIRCLE NUMBER 133

LOW NOISE MODULAR DESIGN Switching Power Supplies!

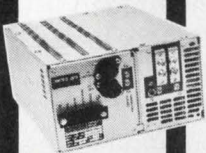
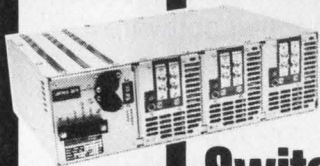

A new line of compact, modular-design switchers that simplify design for 300-600 watt applications and sell for less than 90¢ per watt! End users benefit from low EMI noise levels and highly reliable operation plus easy add-on and maintenance features. Get everything you need to know to evaluate this high quality, money-saving line from:

Jim Daly
phone (612) 830-5800
TWX 910 576 2978
or write: 7801
Computer Ave. So.
Minneapolis, MN 55435.



CIRCLE NUMBER 132

New DIP Switch Line from SMK

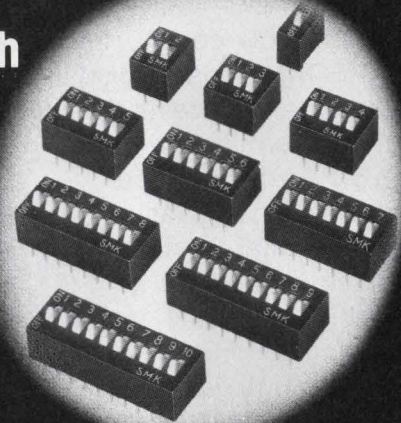

The JS-8722 Series is a complete line of DIP Switches, from 1 to 10 positions, featuring sealed construction to prevent flux contamination during wave soldering. A clip-type wiper design assures positive 2-sided contact to provide excellent shock and vibration characteristics.

Available in SPST configuration, the switches are rated at 24V DC at 300mA switching, resistive load, and will operate from -20°C to +60°C.

Typical price for a 4 position DIP Switch in 100 piece quantity would be \$1.71 each.



SMK Electronics Corporation of America

118 East Savarona Way Carson, California 90746
Tel: (213) 770-8915

CIRCLE NUMBER 134

MODULES & SUBASSEMBLIES

Fast a/d squeezed into a DIP

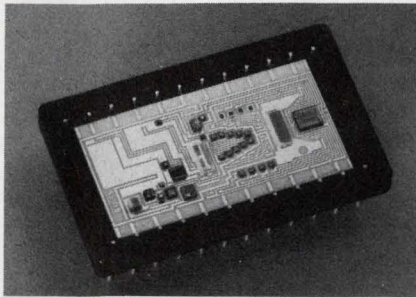

Micro Networks, 324 Clark St., Worcester, MA 01606. J. Munn (617) 852-5400. \$234 (unit qty); stock to 4 wks.

You get an eight-bit conversion in only 900 ns with the DIP-packaged MN 5101 a/d. Conversion can be truncated to six bits in 650 ns or four bits in 400 ns. The converter features better than $\pm 1/2$ LSB linearity and ± 2 LSB accuracy from 0 to 70 C, while accuracy is within ± 1 LSB at 25 C. An H model provides these characteristics from -55 to $+85$ C at a premium price. The laser-trimmed unit is adjustment free.

Booth No. 2511 Circle No. 407

Unit monitors humidity, gives linear output

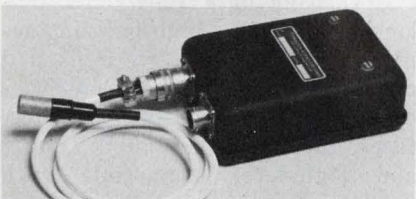

Thunder Scientific, 623 Wyoming S.E., Albuquerque, NM 87123. (505) 265-8701. \$740; 30 days.

Model 4021L monitoring system senses relative humidity from 0 to 100% and provides a linear output signal of 0-to-1-V-dc differential. Linearity is $\pm 2\%$ over the entire range. Accuracy is $\pm 4\%$ of relative humidity at temperatures from 0 to 50 C. The unit uses an open circuit-board construction. The board is sealed within an anodized aluminum case. Bendix connectors attach the 6-ft power/signal cable and 3-ft sensor cable. Model 4021L and the BR-101B sensing element operate on unregulated power of 8 to 28 V dc and draw less than 10 mA.

CIRCLE NO. 408

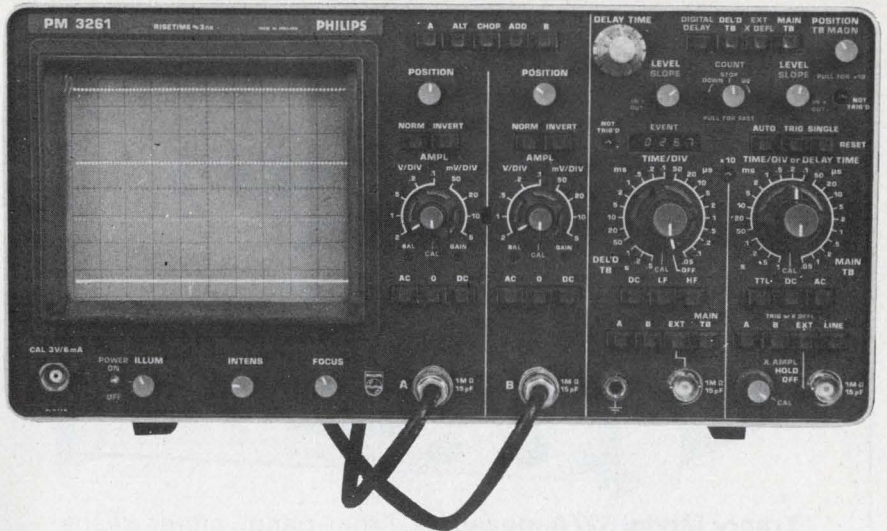

DISPLAY THE 267th BIT
and be sure it's not the 268th or 269th...

Finding the 267th bit takes quite a while, and then you're not sure you have the right one. The solution is programmed digital delay. On the Philips PM 3261, you can program the delayed timebase to start on the nth bit. By means of an internal variable-speed clock, the events counter can be preset from 1 to 99,999 events, with complete trigger level setting control.

Another addition to the Philips family of HF portable oscilloscopes, the 120 MHz PM 3261 adds easily programmable digital delay to the already completely separate delayed timebase control section found on its predecessors.

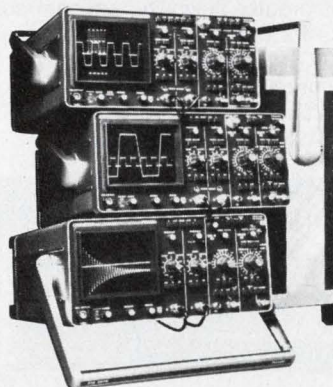

*U. S. domestic price only

Special TTL triggering selection allows the PM 3261 to react just as logic does - a TTL level window prevents false triggering on rising or falling edges.

The PM 3261 list price is only \$2595.00*

For further information contact, Philips Test & Measuring Instruments, Inc.

Utilize our toll-free HOT LINE number 800 631-7172

New Jersey residents call (201) 529-3800 collect.

In the United States
85 McKee Drive
Mahwah, N. J. 07430
(201) 529-3800

In Canada
6 Leswyn Road
Toronto, Ontario Canada M6A 1K2
(416) 789-7188



PHILIPS

CIRCLE NUMBER 137

NEW! INSTANT FREQUENCY DIFFERENCE!



Tracor Model 527A measures frequency difference instantly, precisely. For precisely \$2,950. Front-panel meter reads directly to parts per 10¹¹. Allows adjustment of two oscillators to the same frequency, adjustment to a specific offset, determination of offset—all instantly. Plus both short-term and long-term stability analysis. Internal oscilloscope extends precision to 1 x 10⁻¹². Reference and signal frequencies need not be the same. Write or call for full technical and application information.

Tracor Industrial Instruments

6500 Tracor Lane • Austin, Texas 78721 • AC 512/926-2800

CIRCLE NUMBER 138

The Cimron DMM52. New concepts of accuracy and flexibility where it counts

We invite you to compare "ours" to "theirs." This comparison will show that you would spend almost twice our price to get better accuracy.

The Cimron® Model DMM 52 long term accuracy specifications are made possible by autozeroing the entire conversion circuitry. This includes the input buffer, integrator, comparator and even the reference amplifier. The DC input impedance remains 10,000 megohms all the way to ±20 volts.

The standard true 4-wire ohms converter is conceptually different than all past ohms converters. What other true 4-wire ohms converter is protected to 1000 volts and will settle in 1 second to 20 megohms with the filter activated?

For greater flexibility, optional accessories include TRMS AC or Averaging type AC converters, 4 wire — 4 quadrant ratio, parallel remote control/print output or 8 bit microprocessor controlled GPIB, IEEE 488-1975.



California Instruments,
5150 Convoy Street, San Diego, California 92111
Phone: (714) 279-8620 Telex: 695047
See EEM Pg. 1507

CIRCLE NUMBER 139

Aiken Industries
California Instruments
Division

MODULES & SUBASSEMBLIES

Tiny delay lines fit in TO-5 packages

Allen Avionics Inc., 224 E. 2nd St., Mineola, NY 11501. (516) 248-8080. \$20 (unit qty); stock.

A series of lumped-constant completely passive delay lines housed in a commercial TO-5 package provides delays ranging from 10 to 100 ns. They are stocked in 10-ns increments. Delay to rise time ratios of 5 to 1 are achieved with impedances of 50 and 100 Ω and 5% standard delay tolerances.

CIRCLE NO. 405

Tie your μP to 16 analog channels

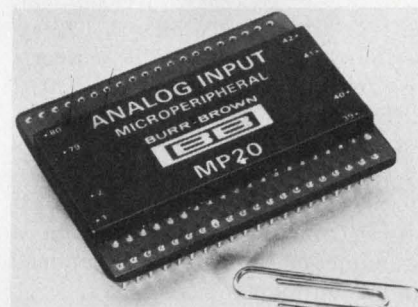

Burr-Brown, International Airport Industrial Park, Tucson, AZ 85734. C. Teeple (602) 294-1431. \$140 (100 qty); 2 wks.

Consisting of a 16-channel analog multiplexer, a high-gain instrumentation amplifier, an 8-bit a/d converter, plus all necessary address, data and control-bus interfaces, the hybrid MP20 is timing and logic-level compatible with 8080A and 8008 μPs. No external logic is needed. Gain and offset are internally laser-trimmed, eliminating the need for external adjustments while providing accuracy better than ±0.4% (1 LSB) on the ±5-V or 0 to +5-V ranges. Low-level signals such as thermocouple outputs can also be handled directly with reduced accuracy. The unit's instrumentation amplifier can be programmed with a single external resistor to provide full-scale input signal ranges as low as ±10 mV. The unit can either be accessed as a memory location or interfaced as an I/O device. The 0-to-70-C system's quad-in-line ceramic package measures 1.7 × 2.1 × 0.15 in. Power requirements are ±15 and +5 V dc.

Booth No. 2824-26 Circle No. 406

More than just the ABC's...

Now we give you the nitty-gritty on design for eight of the currently popular micro's!

Microprocessor Basics

Edited by
Michael S. Elphick

Two unique features make it different from the rest:

1. Unlike most books which either talk in general terms or cover only a single type of microprocessor, this book provides detailed coverage of these important models: 8080, 6800, F8, PACE, IMP, 2650, 1802, and 6100.
2. The first three sections of the book offer the beginner a foundation and the experienced designer a useful review of the general information that applies to all microprocessors.

For each microprocessor:

- The major advantages are highlighted to speed selection for a specific application.
- A detailed analysis of hardware and software features, support circuits, and design aids are given.
- All instructions are tabulated so you can easily follow the application examples and move rapidly to writing your own assembly language programs.

#5763-6, 224 pages,
paper, \$9.95

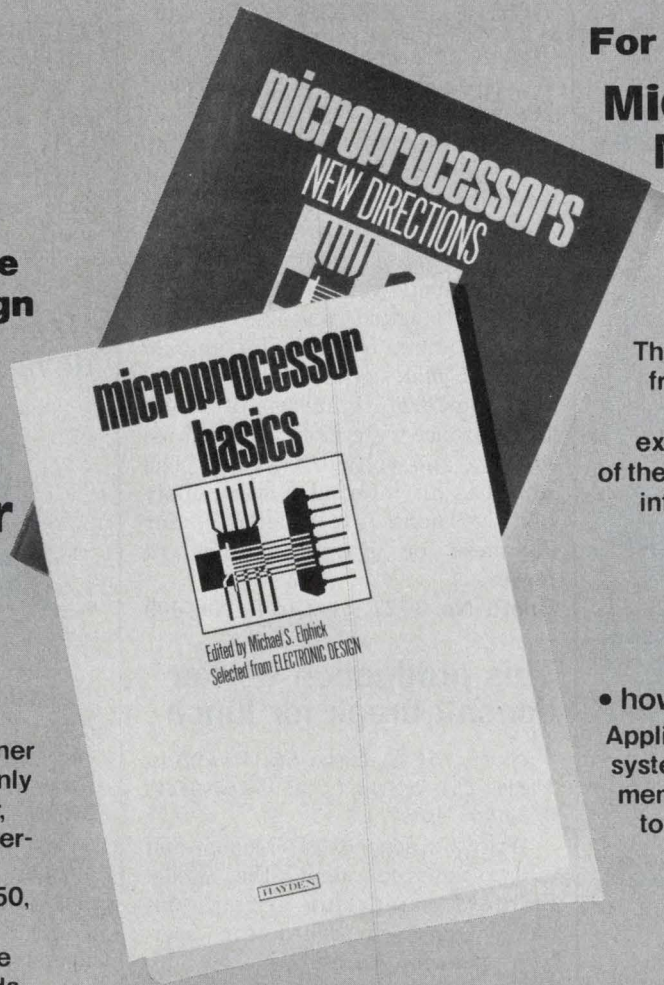

For a good overview...

Microprocessors: New Directions for Designers

Edited by Edward A. Torrero

This popular collection of articles from recent issues of *Electronic Design* magazine provides an exceptionally well-rounded view of the micro world. It offers practical information, data, and advice on:

- how to select circuits
 - how to interpret their capabilities
 - how to extend their useful range
 - how to apply them effectively
- Applications run from traffic control systems to small accounting equipment and from computer terminals to industrial-process controllers.

#5777-6, 144 pages,
paper, \$10.95

**SEND NO MONEY!
EXAMINE FREE FOR 15 DAYS!**



Hayden Book Company, Inc.

50 Essex Street, Rochelle Park, N.J. 07662

Please send me the book(s) checked below on 15-day exam. At the end of that time I will remit payment, plus postage and handling, or return the book(s) and owe nothing. Prices subject to change without notice. Offer good in U.S.A. and Canada only.

- Microprocessor Basics #5763-0 . . . \$9.95**
 Microprocessors #5777-6 10.95

NAME _____

FIRM _____

ADDRESS _____

CITY/STATE/ZIP _____

I want to save money! Payment enclosed. Publisher pays postage. Same 15-day return guarantee.

**For more versatility
in micro design—turn to Hayden Book Co.!**

YOU ASKED FOR IT!!

"The
Pluggable-Planar
System"

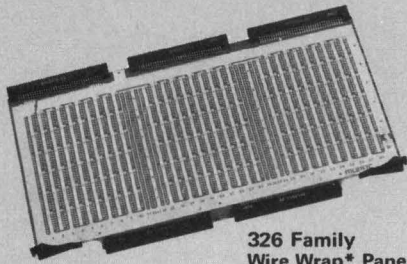

326 Family
Wire Wrap* Panel
*Gardner Denver
Trade Mark

- ★ High IC Density
 - up to 192 ICs
- ★ High Input-Output
 - up to 540 (I/O) pins
- ★ MSI/LSI Compatible
 - 14/16/18/22/24/28/40/42

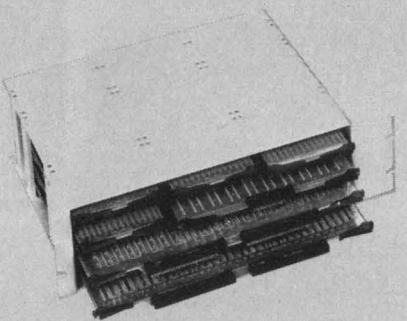

- ★ Total System Hardware
 - rack assemblies, frames
- ★ Multiple Voltage Planes
 - panels and backplanes
- ★ OEM Format
 - horizontal panel packaging



"The Innovative Name in
Microelectronic Packaging Systems"

646 SUMMER ST.
BROCKTON, MA. 02402
(617) 588-6110

CIRCLE NUMBER 141

MODULES & SUBASSEMBLIES

Industrial v/f converter offers isolation

Dynamic Measurements, 6 Lowell Ave., Winchester, MA 01809. (617) 729-7870. From \$195.

In addition to accuracies of up to 13 bits, the 8530/8540 series of Isolation Voltage/Frequency Converters (IVFC) provides a 60-Hz CMR of higher than 120 dB and common-mode voltage ratings up to 4 kV. Standard features include $\pm 0.01\%$ max nonlinearity and 20 ppm/ $^{\circ}\text{C}$ max gain drift. The devices perform signal conditioning, interference rejection, data transmission and voltage isolation. The unit has an internal power supply and versions are available for Japanese or European standard power.

Booth No. 1727 Circle No. 409

This production worker doesn't break for lunch

Vicarm, 154 E. Dana St., Mountain View, CA 94041. (415) 965-0557. \$48,000; stock.

With six degrees of freedom and a two-fingered hand, the Model Stanford manipulator arm is completely servo-controlled for position, velocity, and torque at any joint. Position is sensed through potentiometers or optical encoders. Tachometers provide the velocity signals, with torque computed by the monitoring of the permanent-magnet dc-motor currents. The arm will work at speeds beyond those attainable by humans, and is intended to replace special-purpose assembly machinery. The servo system is driven by a data-acquisition and command-interface unit with 32 channels of a/d conversion and eight d/a converters controlled and instructed by DEC's LSI-11 μC . Included are 20-k words of memory, serial and parallel I/O, and a keyboard terminal. The system uses its own high-level language, compatible with PDP-11 series computers. All components may be hand-carried, and the system sets up in minutes. Manipulator load capability is 4 kg, and working volume is a 2-meter-diameter sphere. Most motions are completed in 2 s. Touch-and-force-sensing capabilities are optional.

CIRCLE NO. 410

FET op amp slews like a rocket

Optical Electronics, P.O. Box 11140, Tucson, AZ 85734. (502) 624-8358. \$79 (10 qty); stock.

Featuring a minimum slewing rate of $\pm 3000 \text{ V}/\mu\text{s}$, the Model 9740 FET op amp has differential inputs and a uniform 6-dB per octave roll-off rate for open-loop gain.

CIRCLE NO. 411

D/a converters dovetail with μPs

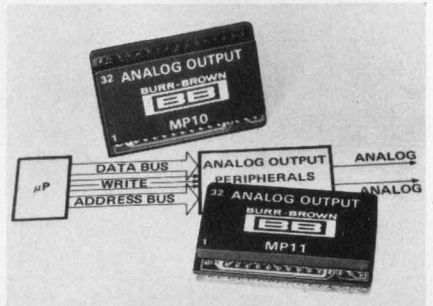

Burr-Brown, International Airport Industrial Park, P.O. Box 11400, Tucson, AZ 85734. G. Athey (602) 294-1431. \$99 (100 qty); stock.

The MP10 and MP11 are analog-output circuits that mate with most popular microprocessors. These 32-pin triple-wide DIPs are compatible with 8008, 8080A, 6800 and many other μPs for voltage level, loading, timing, logic and software. Each unit gives you two channels with $\pm 10\text{-V}$ output. Throughput accuracy is better than $\pm 0.4\%$ of full-scale range. Both modules contain two internally trimmed 8-bit d/a converters plus all necessary interface, timing, and address-decoding logic. The MP10 is bus-compatible with both the 8008 and 8080, requiring no external components. The unit can also be used with the SC/MP by adding pull-up resistors to the address bus, and with the F-8 and Z-80 by observing simple timing considerations. The MP11 is directly compatible with 6800, 650X and 9002 type microprocessors. Programming is simpler than with nondedicated devices since you treat either unit as memory. One 8-bit memory location is required for each channel. A single instruction is all that's required to output data to both channels of either device.

CIRCLE NO. 412

Frequency Measurements Got You Down?

Let our spectrum analyzer tag team wrestle your problems

Princeton Applied Research offers you a choice . . .

The Model 4513: Unique 2048

spectral line display lets you separate closely spaced spectra with unprecedented frequency resolution—Eleven frequency ranges from dc-10Hz to dc-20 kHz.

OR

The Model 4512 (512 lines): Superfast computation time lets you analyze data more often, so important data is not thrown away—that's what real time is all about. Twelve frequency ranges from dc-10 Hz to dc-40 kHz.

Both FFT analyzers provide all digital processing, cursor-controlled digital display of data, transient capture, spectral averaging, and computer compatibility.

Real and Imaginary outputs are optional! Best of all—our team won't come down hard on your budget.

The M4512 is only \$6900 and the M4513 is \$8150. Call or write for our new literature to:

Princeton Applied Research Corporation
P. O. Box 2565, Princeton, New Jersey 08540
Phone: 609/452-2111 Telex: 84-3409

See us at Booth #1729 - Electro 77

CIRCLE NUMBER 142

WHO MAKES WHAT & WHERE TO FIND IT

Volume 1 of **Electronic Design's GOLD BOOK** tells all. And, when you look up an item in its **PRODUCT DIRECTORY** you'll find each manufacturer listed **COMPLETE WITH STREET ADDRESS, CITY, STATE, ZIP AND PHONE.** Save time. There's no need to refer elsewhere to find missing information.

**IT'S ALL THERE
in
Electronic Design
GOLD BOOK**

CIRCLE NUMBER 143 ▶

MS-190 Removes Flux Fast



SAFELY! EFFICIENTLY! ECONOMICALLY!

MS-190 and MS-190HD (Heavy Duty) flux removers clean up flux quickly, completely, without harm to components. Used with patented Cobra Solvent Spray Brush (illustrated), the aerosol solvent is converted into an accurately directed, metered spray combined with scrubbing action of the brush for maximum cleaning with minimum waste. Risk of contamination (as in "dip" method) is eliminated. Nonflammable.

Thousands of electronics firms use these highly effective products routinely. You will too, once you've tried them.

SEND \$5 FOR TRIAL PACK

One 16 oz. can MS-190; one Cobra Solvent Spray Brush. Money back if not satisfied.

ms miller-stephenson
chemical co., inc.
Danbury, Connecticut 06810 (203) 743-4447

- Enclosed is my check for \$5. Please send Trial Pack.
 Please send me data and prices on MS-190, MS-190HD and MS-226 (Cobra Solvent Spray Brush).

Intended Use _____
Name _____ Title/Dept. _____
Company _____
Address _____
City _____ State _____ Zip _____

ED-4V

Since our products are For Industrial Use Only, government labeling regulations prevent our sending these trial units to your home address.

LOS ANGELES • CHICAGO • DANBURY, CONN • TORONTO

The way to say quality relay... BABCOCK

On the Qualified Parts List (QPL) MS27400 4PDT 10 amp, MS27401 2PDT 10 amp, M5757/9 2PDT 2 amp.

Call Mike Altman, Virgil Simpson, or write for data sheet.

Available from stock at Hamilton-Avnet.

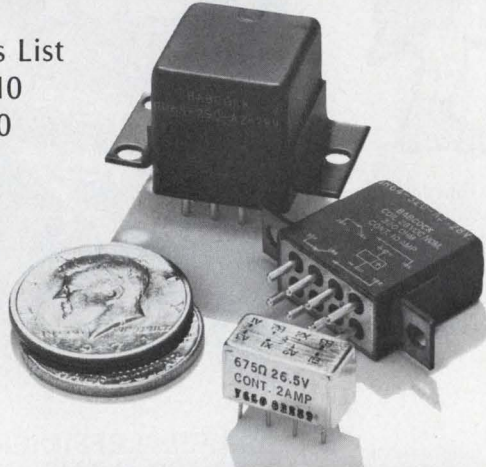

MIL-SPEC
RELAYS

E ESTERLINE ELECTRONICS
AN ESTERLINE COMPANY
3501 Harbor Blvd., Costa Mesa, California 92626
(714) 540-1234 TWX 910-595-1517

CIRCLE NUMBER 145

CRITICAL CRYSTALS

come from M-tron

M-Tron specializes in providing quality crystals and design assistance with maximum economy. Complete facilities for production of AT Cut crystals for commercial and military applications from 800 KHz to 200 MHz. Computer-aided design program speeds sample delivery for all types of precision, industrial and commercial applications.

Phone 800-843-6842 or write

M-tron INDUSTRIES, INC.

Box 630, Yankton, South Dakota 57078 A Div. of Lynch Corp.

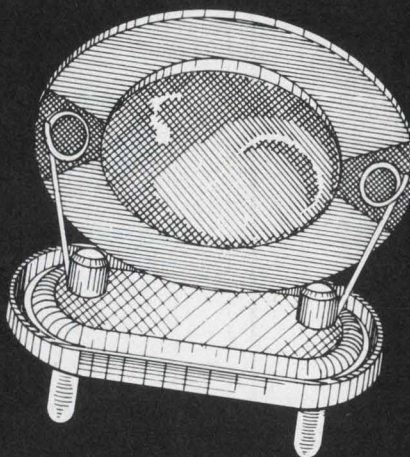

CIRCLE NUMBER 146

INTEGRATED CIRCUITS

CMOS static RAM uses only 1 mW in standby

Synertek, 3050 Coronado Dr., Santa Clara, CA 95051. (408) 241-4300. \$15.45 (100-up); stock.

The SY5102, a 1 k × 1 CMOS static RAM, is a pin-replacement for the SY2102. It dissipates only 1 mW in the standby mode at full 5-V power conditions and will maintain data at 2 V. The SY5102-3 has an access time of 650 ns and comes in a 16-pin ceramic DIP.

CIRCLE NO. 413

Analog switch family maintains constant R

National Semiconductor, 2900 Semiconductor Dr., Santa Clara, CA 95051. Mike Turner (408) 737-5000. From \$2.85 (100-up); stock.

Designated the LF11331, LF11332, LF11333, LF11201, and LF11202, a series of analog switches is designed to operate from minimum TTL input levels. The switches have a break-before-make switching action, a constant ON resistance for signals up to +10 V and 100 kHz, open-switch isolation at 1 MHz of 50 dB, off-state leakage of less than 1 nA, and can handle small level analog signals up to 50 MHz. All units operate from +15-V supplies and switch a +10-V signal. The LF11331 contains four normally open switches with a common disable pin that opens all of the switches in the package. The LF11332 contains four normally closed switches with a common disable. The LF11333 contains two normally closed switches and two normally open switches with a common disable. The LF11201 has four normally closed switches, and the LF11202 has four normally open switches. Three operating ranges are available: The LF11331, 2 and 3 operate over -55 to +125 C and are available in 16-pin ceramic DIPs. The LF11201 and 2 operate over the -25 to +85 C range and come in either a 16-pin ceramic or epoxy DIPs. The LF13331, 2 and 3 series is a commercial grade version which operates over 0 to 70 C and comes in epoxy DIPs.

CIRCLE NO. 414



PHOTO AND NON-PHOTO CARDS
Mag Stripes, OCR, Bar Code
COMPUTERIZED ID SYSTEMS
DATA CAPTURE TERMINALS
ELECTRONIC EQUIPMENT

BADGE READER MODULE

R.D. Products' Badge Reader Module* is a hand driven dynamic mag stripe card reader. Primary application is as a fixed data entry subsystem in OEM equipment.

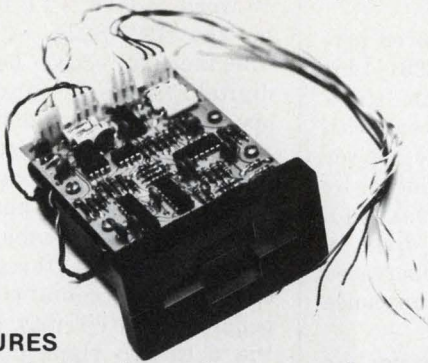

FEATURES

- Uses photo and non-photo mag stripe cards
- TTL clock and data outputs
- Front panel mounting
- Tolerates industrial environments

APPLICATIONS

- Access authorization equipment
- Timekeeping systems
- Inventory control systems
- POS terminals

*U.S. PAT. 3,946,206

R.D. PRODUCTS, INC.

MAIN PLANT • 6132 RT. 96, VICTOR, N.Y. 14564 • TEL (716) 924-7121 • TWX (510) 254-0512
AMSEC ELECTRONICS DIV. • 1675 W 9TH ST., LONG BEACH, CA. 90813 • TEL (213) 432-6544

CIRCLE NUMBER 147

How do you resolve two signals spaced 1 Hz apart at 2 MHz?

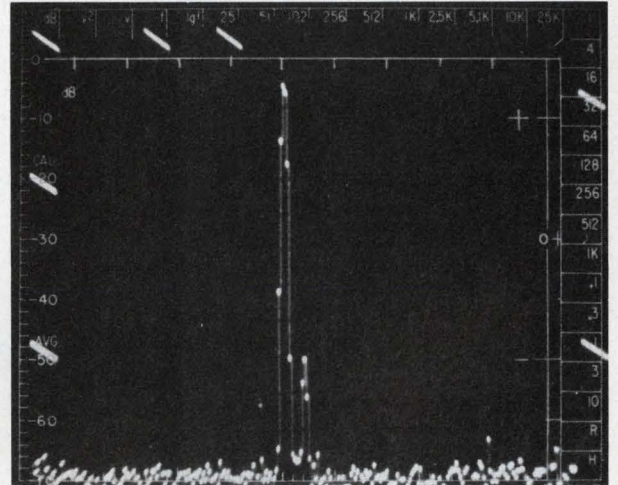

With an EMR Model 1510 Digital Real-Time Spectrum Analyzer and EMR Model 1520 Digital Spectrum Translator. Simply add the optional EMR Model 1521 Range Extension Module to the 1520 Translator, and you have real-time spectrum analysis at frequencies up to 2 MHz!

The CRT photograph illustrates the result. The input signal consisted of two discrete frequencies spaced 1.0 Hz apart, with a 50 dB difference in amplitude. The frequency range covered is 25.6 Hz centered about 1.990000 MHz, and the frequency resolution is 0.1 Hz!



Only EMR offers that much resolution at frequencies up to 2 MHz in real time.

So if you have an analysis problem requiring high-resolution/high-frequency real-time spectrum analysis, contact EMR... we will arrange for a demonstration or detailed information.

Sangamo Weston, EMR Telemetry Division
P.O. Box 3041, Sarasota, FL 33578
813-371-0811

SANGAMO WESTON

Schlumberger



Two pens X-Y, T Recorder
Model D-72BP

**Multi-pens
X-Y, T Recorder....**



Three pens X-Y, T Recorder
Model D-73BP

SPECIFICATIONS

Model	D-73BP	D-72BP
Input Sensitivities	X, Y ₁₋₃ 2mV~100V, 11 ranges	X, Y ₁ , Y ₂ 2mV~100V, 11 ranges
Response speed	X...1.2sec. Full span Y ₁₋₃ ...1sec. Full span	X...1sec. Full span Y ₁ , Y ₂ ...0.7sec. Full span
Chart speed	75mm/hr~480mm/min 10 steps	75mm/hr~480mm/min 10 steps

• For further information, please contact:

Riken Denshi Co., Ltd.

5-5-2, Yutenji, Meguro-ku, Tokyo, Japan. TELEX: 0246-8107

CIRCLE NUMBER 148

ELECTRONIC DESIGN 8, April 12, 1977

CIRCLE NUMBER 149

Designers Choice In Low-Cost 8-Bit A/Ds

3 New Series In Dual In-Line Packages

Provide choice of

- Input ranges
+10V, -10V, $\pm 5V$, $\pm 10V$
- Power supplies
 $\pm 12V$ or $\pm 15V$
- Conversion time
2.5 or 6 μsec max.
- Operating temperature
-0° to 70°C
-55° to +125°C
- Mil-Std 883
processing

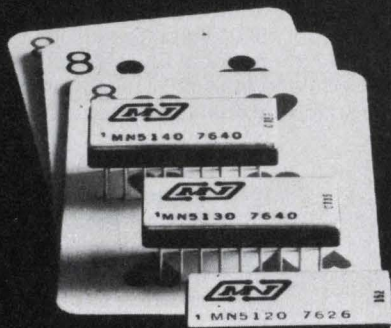

MN 5120 *\$49

($\pm 15V$ 6 μsec)

MN 5130 *\$59

($\pm 15V$ 2.5 μsec)

MN 5140 *\$59

($\pm 12V$ 2.5 μsec)

* (1 to 24 units)



Micro Networks Corporation
324 Clark Street, Worcester, MA 01601
(617) 852-5400 TWX 710-340-0064

CIRCLE NUMBER 161

INTEGRATED CIRCUITS

Improved bit-slice cycles in 75 ns

Advanced Micro Devices, 901 Thompson Pl., Sunnyvale, CA 94086. (408) 732-2400. \$14.70 (100-up); stock.

The Am2901A, an improved performance version of the 2901 4-bit processor, offers read/write times of 75 ns maximum compared with 105 ns for the 2901. And, power dissipation has been reduced by more than 30% at the maximum temperature extreme. The drive on the "Y" outputs has been increased from 0.7 to 0.8 V for better noise immunity.

CIRCLE NO. 415

Analog and digital chips form 12-bit a/d

National Semiconductor, 2900 Semiconductor Dr., Santa Clara, CA 95051. Dave Whetstone (408) 737-5000. 100-up prices: \$6.65 (13300), \$5.50 (1200P); stock.

An a/d converter building block, the LF13300, uses an integrating technique from which a 12-bit plus sign converter can be built. It operates with a companion digital controller chip, the ADB1200P. Contained in an 18-pin DIP, the commercial version of the LF13300 features a 570-mW power dissipation, a ± 5 to ± 18 -V power supply range, as well as a ± 11 -V analog range (with ± 15 -V supplies). Other features include automatic offset correction and compatibility with both CMOS and TTL. The input impedance of the LF13300 is greater than 1000 M Ω . The ADB1200P is the digital controller for the LF13300, and provides all the necessary control functions plus such features as auto zeroing, polarity and overrange indication and continuous conversion. Other features include either serial or three-state parallel outputs, and 100% overrange capability. Contained in a 28-pin DIP, the ADB1200P requires +5 and -15-V supplies and can operate at clock frequencies up to 500 kHz. Together, the LF13300 and the ADB1200P perform a conversion every 30 to 40 ms (with a clock frequency of 250 kHz).

CIRCLE NO. 416

FIFO memory handles 10-MHz data rate

Texas Instruments, P.O. Box 5012, Dallas, TX 75222. Gerald McGee (214) 238-2011. From \$4.50 (100-up); stock.

A universal Schottky-clamped 16-word \times 5-bit TTL buffer memory, the SN74S225, is intended to interface directly between two digital systems, or subsystems, that operate at different data rates. The static bipolar first-in/first-out memory has independent synchronous inputs and outputs, can handle dc-to-10-MHz input or output data rates, has three-state data outputs and contains two independent clock circuits. Once stored, the data are rippled through the memory by on-chip control logic. The on-chip logic provides status lines to indicate when the memory is full and when the output is ready. Also provided is a clock output, which, along with a single enable control for all three-state data outputs, permits the easy expansion to 16N words by 5N bits. The SN74S225 is supplied in a high-density 20-pin plastic or ceramic DIP with pin rows on 300-mil centers and is rated for the 0-to-70-C range.

CIRCLE NO. 417

Dual op amp boosts bandwidth of 1558's

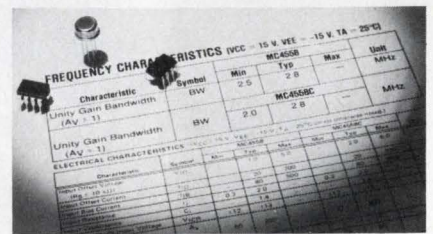

Motorola, P.O. Box 20912, Phoenix, AZ 85036. (602) 244-6900. From \$0.80 (100-up); stock.

A dual op amp, the MC4558, offers the characteristics and package options compatible with the MC1558/MC1458, but with nearly three times its unity-gain bandwidth. The 4558 plugs directly into sockets of existing 1558/1458 designs and expands the unity-gain bandwidth of the circuits from 1 to 2.8 MHz without affecting other characteristics. There are five package/temperature-range versions available in either plastic or ceramic mini-DIPs or in an 8-pin metal can.

CIRCLE NO. 418

Environmental Control?

We've been doing it for 44 years with...

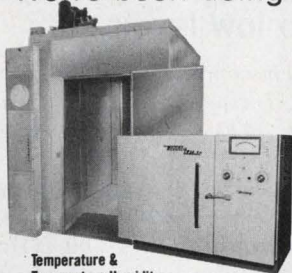

Temperature & Temperature Humidity Bench-top to walk-in.

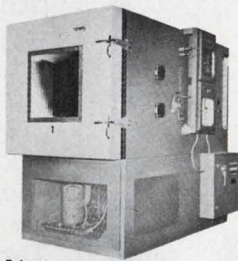

TenneyZphere Temperature, humidity, vacuum.

DIRECT LEASING

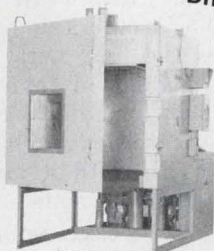

AGREE



Thermal Shock 2 or 3 chamber

Write or call for further information on any of your environmental testing requirements.



Tenney
ENGINEERING, INC.

1090 Springfield Rd., Union, N. J. 07083 (201) 686-7870

Oldest and largest manufacturer of Environmental Equipment

742A

VISIT OUR BOOTH #2346 AT ELECTRO '77
CIRCLE NUMBER 162

Join the IMC Book Club*

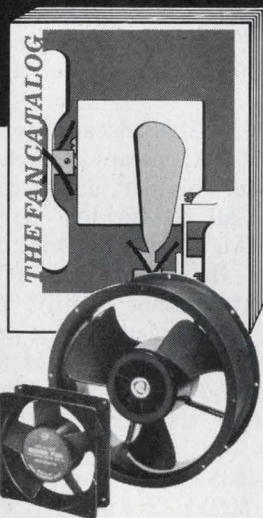

Free 92 page Catalog features specialty propeller and tubeaxial fans.

This catalog shows more than 100 standard designs, including 60 HZ, 400 HZ, multi HZ and DC versions plus a description of IMC's IMCool® and Boxer® models. Information regarding the full line of accessories to fit the Boxer® fan is included.

For immediate service please call Gene Egan, V.P. Sales 516/334-7070.

*Product Literature Broadside and request card will be sent to you along with this catalog.

SERVING INDUSTRY OVER 25 YEARS

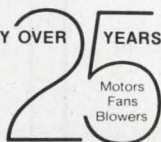

IMC MAGNETICS CORP.

EASTERN DIVISION

570 MAIN STREET, WESTBURY, NEW YORK 11590

CIRCLE NUMBER 163

ELECTRONIC DESIGN 8, April 12, 1977

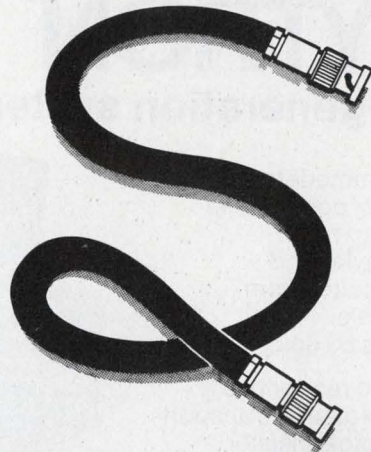

VITEK's Filter Cable* can solve your VHF & UHF filtering & interconnecting problems INEXPENSIVELY!

- Looks like coaxial cable —
- Pliable like coaxial cable —
- Has the longevity of coaxial cable —
- Can be fitted with connectors or solder-joined like coaxial cable —

But there's one major difference —
IT'S A FIRST-RATE FILTER!

For any filtering and interconnecting problem up to 1 GHz, neither price nor the physical viability of the filter has to be a determining factor in the solution. Vitek's innovative filter cable is priced way below any comparable filter on the market.

So the other thing our cable looks like is SAVINGS... with a Capital S.

For further information regarding our filter cable or for assistance with your filtering and interconnecting problems, call or write to:
VITEK ELECTRONICS, INC., 200 Wood Avenue, Middlesex, N.J. 08846, Tel: (201) 469-9400



ELECTRONICS, INC.

*Patent Pending

CIRCLE NUMBER 164

ROYTRON™

tape regeneration system

Punch accommodates almost all varieties of commercial tape including mylar, metallized mylar and mylar composites from 5 to 8 channels. Punch rate is 60 cps.

Photoelectric reader has a stepping motor tape transport and LED phototransistor tape-sensing system for reliable operation.

Other models for direct connection to on-line systems are also available. All made in U.S.A.

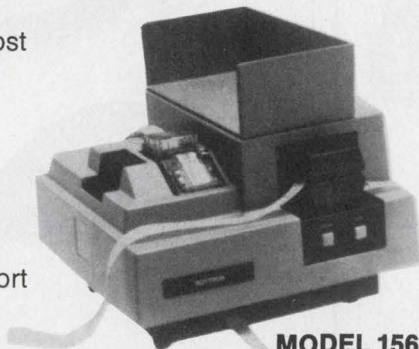

**MODEL 1560-R
Reader/Punch**

High speed, compact, with self-contained power supply and electronics, complete in attractive, noise-dampening housing. Dimensions: 16" x 16" x 10½" Weight: 42 lbs.

for full details, write or call
SWEDA INTERNATIONAL
Litton OEM Products

34 Maple Avenue, Pine Brook, N.J. 07058/(201) 575-8100

IN U.K. — ADLER BUS. SYSTEMS/OEM PRODS., Airport House, Purley Way, Croyden, Surrey, England

IN FRANCE — SWEDA INTERNATIONAL/OEM, 103-107 Rue de Tocqueville, 75017 Paris, France

CIRCLE NUMBER 165

NEW

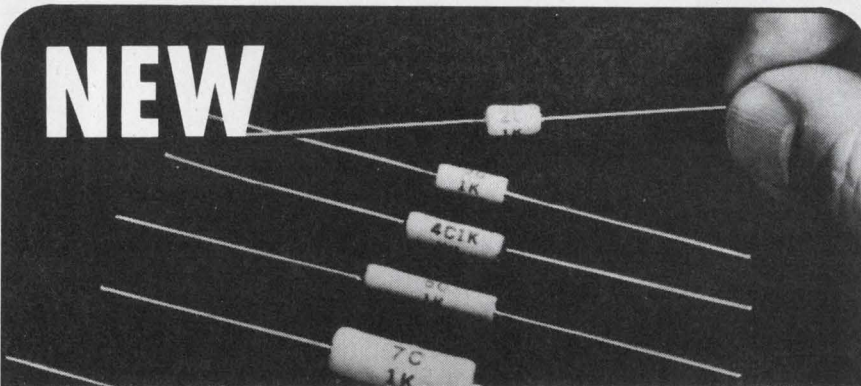

centohm resistors... the penny-savers

They're Ward Leonard's new cement coated power resistors . . . miniature in size, low in cost and flame-proof. They retain the quality features of higher priced vitreous enamel resistors . . . features like precision dimensioned cores, tinned axial leads, solvent resistant markings, etc.

In sizes from 2 to 12.5 watts, Centohms have a wide range of resistance values with $\pm 5\%$ standard tolerance. Options include: non-inductive windings, closer tolerances and reel-packing.

Send for data sheet Series 46 or contact your Ward Leonard district office, rep or distributor today.

Visit Booth 2111 ELECTRO '77 • N.Y. Coliseum April 19-21



WARD LEONARD ELECTRIC CO., INC.

31 South St., Mount Vernon, New York 10550
Tel. 914 664-1000, TWX — 710 562-0144

7.2

MOTOR CONTROLS • CONTACTORS • RELAYS • RHEOSTATS • RESISTORS

CIRCLE NUMBER 166

INTEGRATED CIRCUITS

Wideband op amp keeps noise to low levels

Plessey Semiconductors, 1674 McGaw Ave., Irvine, CA 92714. Dennis Chant (714) 540-9945. \$8.40 (100-up); stock.

Keeping noise figures to less than 2 dB, the SL560 IC amplifier has a bandwidth of over 300 MHz. The amplifier also has gains of up to 40 dB and can operate from 2-to-15-V supplies. Housed in an eight-lead TO-5 metal can, the SL560 provides the user with access to a large number of internal circuit nodes, allowing system performance to be optimized for gain, noise or bandwidth with a minimum of outboard components.

CIRCLE NO. 419

Decade timer needs just Xtal and LED display

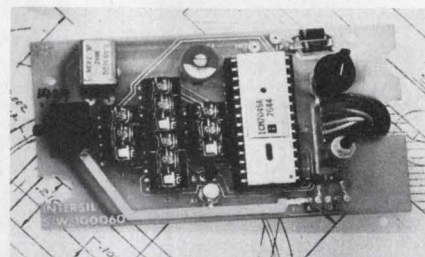

Intersil, 10900 N. Tantau Ave., Cupertino, CA 95014. John Torok (408) 996-5000. \$19.85 (100-up); stock.

A precision CMOS decade timer, the ICM 7045A, comes complete with oscillator, divider, and decoder drivers all integrated on a single chip. An upgraded device derived from the company's ICM 7045 stopwatch timer family, the ICM 7045A is intended for use as a decimal timer. The selection of the oscillator frequency alone determines whether the timer is used for seconds (1.31072 MHz); minutes (2.184533 MHz) or hours (3.640889 MHz) counting. The timer operates with a supply voltage of 3.6 V and is guaranteed to operate over a 2.5-to-4.5-V range. Output current drive is rated at 18-mA peak segment current, with a 12.5% duty cycle. The timer circuit will count to a total of 2399999. The 7045A operates over the industrial-grade temperature range of -20 to 70 C and comes in a 28-pin epoxy DIP.

CIRCLE NO. 420

CODI-SCI

VISIT US AT ELECTRO '77
BOOTH 2143

CODI

HIGH RELIABILITY:

- VVC's
- REFERENCE DIODES
- ZENER DIODES
- NOISE DIODES
- PRECISION VOLTAGE STANDARDS

SCIENTIFIC
COMPONENTS
INC.

HIGH VOLTAGE RECTIFIERS FOR:

- X-RAY
- VIDEO DISPLAY
- POWER SUPPLIES
- INSTRUMENTATION
- ELECTRO-STATIC COPIERS

CERTA-CELL™

SOLID STATE STANDARD CELL

 **CODI CORP.**, Pollitt Drive South
Fair Lawn, N.J. 07410 (201) 797-3900

Scientific Components Inc.,
350 Hurst Street, Linden, N.J. 07036 (201) 791-9500
TWX (710) 988-2241

CIRCLE NUMBER 221

Noise sensitivity problems go away— we guarantee it!

Topaz Ultra-Isolation Transformers provide an inexpensive and reliable way to supply clean, noise-free AC power to sensitive equipment such as computers, instrumentation, communication and process control equipment.

Ultra-Isolation Transformers offer the industry's best noise attenuation:

- Common-mode noise rejection greater than 145 dB.
- Transverse-mode noise rejection greater than 125 dB at 1 kHz.
- Standard models 125 VA to 130 kVA.
- Priced from \$64.

Our guarantee: A Topaz Ultra-Isolation Transformer will solve your noise sensitivity problems to your complete satisfaction or we'll take it back—no questions asked.



TOPAZ SOLUTIONS TO
ELECTRONICS POWER PROBLEMS

3855 RUFFIN ROAD, SAN DIEGO, CA. 92123 • (714)279-0831 • TWX (910)335-1526

CIRCLE NUMBER 222

ELECTRONIC DESIGN 8, April 12, 1977

LOW COST MAGNETIC SENSORS



... for your speed/position input requirements!

Electro has developed a new competitively priced line of molded plastic magnetic sensors for use in producing input signals for the control of speed and position.

Consider the reliability and economy offered by Electro magnetic sensors proven in these applications:

- Engine timing (position and synchronization)
- Closed-loop motor speed control
- Mixer/blender speed sensing
- Conveyor speed monitoring
- Anti-skid control sensing systems
- Turbine RPM monitoring and control.

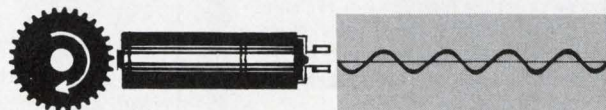

Electro magnetic sensors provide many advantages including: non-contact sensing of any ferrous metal object; trouble-free operation under all conditions such as dust, dirt, oil and other adverse environments; -65°F to +300°F operating range.

Send us your system input sensing specifications. We will provide you with the most economical solution!

 **ELECTRO
CORPORATION**

1845 57TH STREET

P.O. BOX 3049, SARASOTA, FLORIDA 33578
AREA CODE (813) 355-8411 • TELEX 5-2683

CIRCLE NUMBER 223

MONOLITHIC CRYSTAL FILTERS

the
state
of the
Art

FIVE THINGS TO DO WITH VHF MONOLITHIC FILTERS ON A RAINY DAY

- 1) Make a paging receiver or other single-channel receiver, (models 2133F & 4171F).
- 2) Reduce IM and front-end overloading in a VHF mobile or base station receiver, (models 2131-33 VBP and 4131-33 VBB).
- 3) Make an up-conversion HF receiver or exciter (custom models).
- 4) Clean up the spectrum in your frequency synthesizer, (custom models).
- 5) Make a 900 MHz mobile receiver (Models 4371F & 2372F, 45 MHz first IF filters).

If one of these projects turns you on, or if you've got a project of your own, don't wait for a rainy day — turn us on right now. Just call or write. We offer a rain barrel full of monolithic crystal filters — from 5 MHz to 180 MHz, including over 60 stock models at 10.7 and 21.4 MHz.

NEW KID ON THE BLOCK...

45 MHz is a popular first I-F for the new 900 MHz mobile radio band. We've got the filters for it — two poles (Model 2372F) and four poles (Model 4371F). And they're in stock. Just write or call for data sheets and quantity pricing.

Pi

Piezo Technology Inc.

2525 Shader Road, Orlando, FL 32804
(305) 298-2000

The standard in
monolithic crystal filters.

CIRCLE NUMBER 167

DISCRETE SEMICONDUCTORS

35-A SCRs stabilized with glass passivation

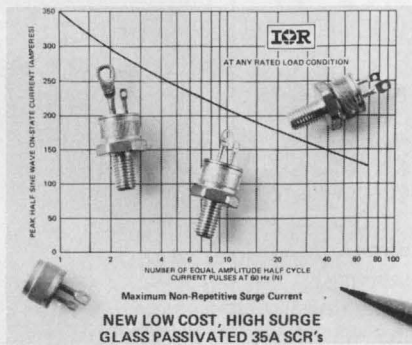

International Rectifier, 233 Kansas St., El Segundo, CA 90245. (213) 322-3331. \$1.58: IR20RA5 (100 up); stock.

SCRs, series IR 20RA, 22RA, 2N3870 and 2N3896, are glass passivated for low leakage and parameter stability over the entire operating range. The units are rated for operation at 35 A rms for voltages through 800-V peak-repetitive off-state voltage. The units, available in TO-48 and TO-203AA cases, handle one-cycle surge currents to 350 A. Off-state voltage rate of rise (dv/dt) for the SCRs is typically 200 V/ μ s at 125-C case temperature.

CIRCLE NO. 421

Fast recovery rectifiers handle 1 A to 600 PIV

Solid State Devices Inc., 14830 Valley View Ave., La Mirada, CA 90638. (213) 921-9660. \$0.25 to \$0.60 (1000 up); stock.

A series of 1-A fast-recovery rectifiers, SPD05F through SPD6F, has a double-stud construction and a low thermal impedance that allows operation with no heat sinking at ambient temperatures from -65 to 55 C. With a heat sink or moderate derating, the units have an operating range from -65 to 175 C. The units have PIVs of 50, 100, 200, 400 and 600 V, and exhibit reverse-recovery times of 100 ns. Average forward drop is 0.85 V. Peak repetitive forward current is 6 A and peak surge current is 25 A. Reverse leakage current is 1 μ A. The devices are hermetically sealed in a D041 glass package

CIRCLE NO. 422

Darlington series replaces many types

Texas Instruments, P.O. Box 5012, Dallas, TX 75222. (214) 238-2481. \$0.75 to \$1.06 (1000 up); stock.

A new series of six Darlington transistors, TIP1000 through TIP107, features an 8-A capability in a small TO220AB plastic package. The units are said to provide improved static forward-current transfer ratio, collector-emitter saturation voltage and collector-cutoff current characteristics. The series is offered in npn and pnp complementary devices. They are designed to replace 2N6045, 2N6388, MJE6045, SE9302, RCA122, 2N6042, SE9402, MJE6042, RCA8203B, and RCA126 series.

CIRCLE NO. 423

Npn/pnp Xistor pair provides high gain

Semicoa, 333 McCormick Ave., Costa Mesa, CA 92626. R.L. Boughan (714) 979-1900.

Two new transistors, the SCA13720 (npn) and the SCA13719 (pnp), are designed for high-reliability applications, such as heart pacers and flight systems. The transistors have a minimum gain of 100 at 1 μ A. They are available in chip form or in a TO-46 package. Burn-in data for 1000 h are available for these low-noise, low-leakage devices.

CIRCLE NO. 424

Dual opto-isolators use low input current

Hewlett-Packard, 1501 Page Mill Rd., Palo Alto, CA 94304. (415) 493-1501. \$5.05/\$6.30 (1-99); stock.

Two dual optically coupled isolators, HCPL-2730/31, for low input-current applications, feature minimum current transfer ratios of 400 and 300%, respectively. Input current requirements are only 1.6 and 0.5 mA, and performance is guaranteed over the temperature range of 0 to 70 C. High common-mode rejection and data rates to 200 kb/s make them especially suitable for low input-current line receivers, μ P system isolation and digital-logic ground isolation.

CIRCLE NO. 425

BRUTE POWER SUPPLIES...

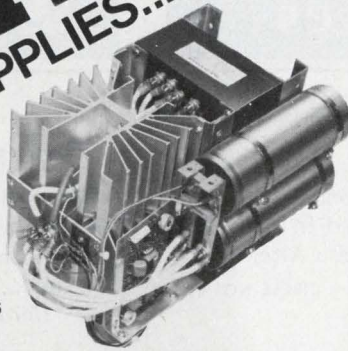

For the versatility you need at 300, 600, and 1200 watts

- Adjustable over either 2 to 25 or 5 to 50 volt range.
- Constant current or constant voltage operation.
- $\pm 0.1\%$ regulation; remote sensing.
- Adjustable damping for inductive loads.
- High efficiency; low cost per watt.

Use for supplying high power to semiconductor circuitry... for charging batteries... for driving relays, solenoids, motors.

Write or call for facts and specifications.

TELE-DYNAMICS

DIVISION OF **AMBAC**

525 Virginia Drive, Fort Washington, Pa. 19034 • 215-643-3900

A STEP AHEAD IN QUALITY

CIRCLE NUMBER 168

ALUMINUM KNOBS



Don't just take our beautiful KNURLED KNOBS for granted! They are completely machined, including the knurl and then carefully anodized. This takes a little more time and effort, but we think it's worth it. We're sure you'll agree too, when you see the luster and high quality.

Call or write today for a catalog, sample and price information.

CIRCLE NUMBER 169

1/2" ROTARY SWITCH



Rugged, Compact and Dependable describes Alco's new rotary switch series. Featuring adjustable stops and molded-in terminals. Available in a choice of 1, 2, 3 or 4 poles and up to 10 positions with either 30° or 36° detent action. Available with PC or wired terminals, or waterproof feature optional. Equipped with 1/8" diameter shaft, with or without black phenolic knob.

CIRCLE NUMBER 170

ALCO ELECTRONIC PRODUCTS, INC.
1551 OSGOOD STREET, NORTH ANDOVER, MA. 01845 U.S.A.

Tel: (617) 685-4371

TWX: 710 342-0552

A SUBSIDIARY OF

AUGAT INC.

ELECTRONIC DESIGN 8, April 12, 1977

NEW FROM INDUSTRIAL TIMER



SERIES 2400
Digital Clocks
12, 24 or 100 hours



SERIES 2320
Industrial Counters
Unidirectional 3-6 digit



SERIES 2500
Comparators
Parallel BCD tracking



SERIES 2600
Stopwatches
Microseconds to minutes



SERIES 3500
D.C. Voltmeters
5999 count full-scale



SERIES 9500
Thermometers
Thermocouple indicators

DIGITAL PANEL INSTRUMENTS

Designed and built to highest laboratory standards for Testing Procedures and Systems.

Our new line of Digital Panel Instruments consists of: Clocks, Counters, Comparators, Stopwatches, Voltmeters and Thermometers. Their solid state design and construction reflect the ultimate in engineering sophistication and physical excellence.

For testing procedures and systems they supply the utmost reliability and accuracy attainable with large LED displays, rugged compact size, binary code decimal (BCD) outputs, remote control option and solid aluminum enclosures.

Now you can buy them all from one source. Let us send you our 1977 catalog. For special information call us at 201-887-2200. Ask for Tom ReCasino and your nearest Digital Instrument Rep.



INDUSTRIAL TIMER

AN ESTERLINE COMPANY

Industrial Timer Corporation, U.S. Highway 287, Parsippany, N.J. 07054
CIRCLE NUMBER 171

where weight
and space are
critical...
like this magnetron...

Redesign with Alnico 8 and 9 MAGNETS

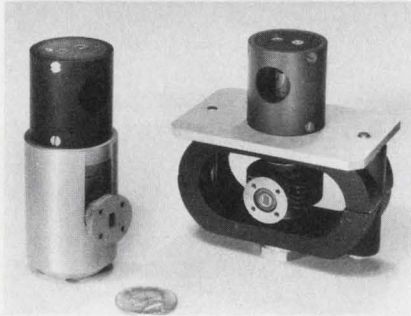

New Alnico 9
Design

Previous Alnico 5
Design

For minimum space and weight, maximum power efficiency and consistent performance, design your unit around T & S high performance magnetic alloys... Alnicos 8C, 8HC, 8HE, and 9Nb. You can get up to twice the energy product, permitting the use of smaller pieces and assemblies, with less weight and at a lower unit cost. The high coercive force of these magnetic alloys... up to four times that of Alnico 5... reduces stray fields and allows lower leakage factors, permitting more efficient structures for replacing Alnico 5 designs. And these alloys have low temperature coefficients and extreme magnetic stability... are easy to magnetize and stabilize.

APPLICATIONS

Alnico 8 and 9 alloys are ideally suited for: Meters • Motors • Microwave Tubes • Generators • Alternators • Tachometers • Latching Relays • Stepping Motors • Medium hp Precision Motors and Torquers • D'Arsonval Type Movement Systems.

Improve your products magnetically... Come to the Magneticians!

Take advantage of our long years of experience in the development, refinement and successful production of these high performance magnet materials. T & S was the original manufacturer, and has been the only continuous manufacturer of Alnico 9 for over ten years. And we have produced Alnico 8 alloys since 1960.

BEFORE YOU DESIGN... Send for Bulletin M-304 CR which gives details on all T & S metallic alloy permanent magnets. Or better yet, call on T & S experts to help solve your magnet design problems... large or small... unique or ordinary.

Thomas & Skinner, Inc.



MAGNETICIANS

P.O. BOX 150-B, 1120 EAST 23RD ST.
INDIANAPOLIS, IND. 46206
PHONE: (317) 923-2501

CIRCLE NUMBER 172

Application Notes

Printer/plotters

Various applications of printer/plotters are described in a 28-page brochure. Varian, Palo Alto, CA

CIRCLE NO. 426

IR crystals

A 12-page "Crystal Selection Guide" covers the transmission range, chemical properties and physical characteristics of crystals used as transmission windows. Barnes Engineering, Stamford, CT

CIRCLE NO. 427

Surge testing

State of the art of surge testing is discussed in an eight-page application note. KeyTek Instrument, Waltham, MA

CIRCLE NO. 428

Integrating a/d converters

"Repetitive Mode Operation for Models 4109/4111 Integrating a/d Converters" discusses two schemes for obtaining trouble-free repetitive-mode operation. Teledyne Philbrick, Dedham, MA

CIRCLE NO. 429

Memory testing

Extended testing for the DR 12/25 memory board that uses board error mapping and provides a combination of high throughput and automatic error detection is described in an application note. Adar Associates, Burlington, MA

CIRCLE NO. 430

Attenuation calibrator

Various applications of the PRD 915-B attenuation calibrator are illustrated in a 12-page note. It describes theory, design concept and error analysis of parallel i-f attenuation measurements. PRD Electronics, Harris Corp., Syosset, NY

CIRCLE NO. 431

Evaluation Samples

535 op amps

The 535 op amp features 15 V/ μ s slew rate and improved input parameters over the 741: $V_{os} = 5$ -mV max, $I_{os} = 40$ -mA max and $I_b = 150$ -mA max. Signetics.

CIRCLE NO. 432

Cable tie mounts

The LPMM-S2 and LPMM-S5 low-profile cable-tie mounts are used with miniature cross-section cable ties and have #2 (3/32-in. dia.) and #5 size screw holes, respectively. The LPMS-S8 mount has a #8 size screw hole and can be used with miniature, intermediate and standard cross-section cable ties. They are made of natural nylon. Panduit Corp.

CIRCLE NO. 433

Heat sinks

Heat sinks, with 1/2 to 1-1/4 in. height, for TO-3 and TO-66 devices allow semiconductors to be mounted with the existing hardware. Aavid Engineering.

CIRCLE NO. 434

Variable arrays

A six-page brochure includes an order form to receive a free sample of a variable array. RCA Solid State Div.

CIRCLE NO. 435

Flexible circuit substrates

An 8 × 10-in. sheet of R/flex 2411 flexible circuit substrate (1-oz copper, 1 side), R/flex 2412 (1-oz copper, 2 sides), and R/flex 2421 (2-oz copper, 1 side), together with product specifications and test data, make up a sample kit. For your samples, write on company letterhead to Rogers Corp., Rogers, CT 06263.

INQUIRE DIRECT

have a gripe?



let us know about it!

We'll help you put pressure on any company that makes promises in its ads . . . then fails to deliver.

Electronic Design refuses to run advertisements deemed to be misleading or fraudulent.

ACCURACY is everybody's business. So if you have a gripe about a misstatement or inaccuracy in either editorial or advertising material in *Electronic Design* . . . tell us about it. We'll do everything we can to find out what happened and see that it's corrected. Notify . . .

George Rostky

Editor-in-Chief

Electronic Design

50 Essex Street
Rochelle Park, New Jersey 07662

Low cost, high performance
3A SPDT relay
really saves
PC board space

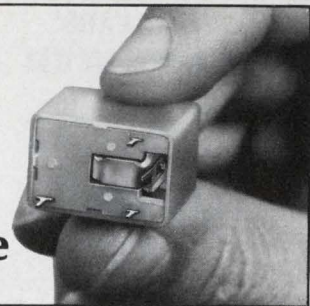

Mounts on .69" centers . . .
satisfies thousands of application needs

Where size and space are important, the Series 27 relay can be just the low cost answer you've been looking for. It provides 3 amps of switching in a 0.526" cube and mounts on .69" centers, assuring high density PC board mounting. The cost is \$1.05 each in 1,000 piece lots for 3, 6 and 12V dc units . . . slightly higher for 24V dc.

You'll find the Series 27 relay suitable for hundreds of control applications. For instance: timing controls; gas pilot light controls; anti-theft devices for CB radios; automotive controls; emergency lighting equipment; and medical equipment, to name a few.

The relay has a 450 mW pick-up sensitivity (180 mW available). Contact rating is 3A res @ 28V dc. 120V ac. Contact resistance is 0.10 ohm.

Write for information today!

NORTH AMERICAN PHILIPS CONTROLS CORP.

Frederick, Md. 21701 • (301) 663-5141

CIRCLE NUMBER 174

EDMUND SCIENTIFIC CO. MONEY BACK GUARANTEE
300 EDSCORP BLDG. BARRINGTON, NEW JERSEY 08007
ORDER BY STOCK NUMBER - ADD \$1 HANDLING CHARGE - SEND CHECK OR MONEY ORDER

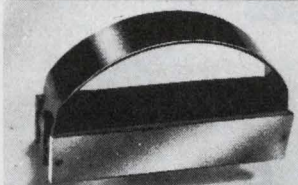

GIANT MAGNET, LITTLE PRICE!
"Fish" with this powerful 1 lb. ceramic magnet. Lifts over 150 pounds, only costs \$11.95. Tie a line to its stainless steel handle, drop it overboard and your first treasure haul (anchors, tackle, ferrous metal valuables?) can pay more than its cost. 4 ceramic magnets, in series, between 4 steel plates; develops fascinating strength. Great for "fishing", for scrap metal and tool recovery, too! No. 42,318 . . . (1 x 1 1/4 x 4 3/4") . . . \$11.95 Ppd.

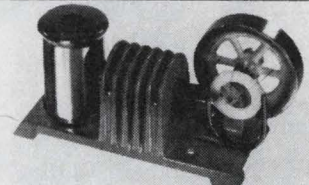

STIRLING ENGINE MODEL WORKS!
New working model of famed Hot Air External Combustion Engine. Ability to use wide fuel variety, low emission & noise level potential of great interest to Ford, GM. Based solely on thermodynamics. Alternate heating & cooling of air in enclosed cylinder makes piston move! Fine crafted aluminum model condensed to simplest form. Uses wood alcohol (safe; no smoke, odor). Adapts to erector set assemblies, etc. Great demo. 24-pg. bklt. Assembled. No. 72,223 . . . (3 1/2 x 8 1/2 x 4 1/4") . . . \$89.95 Ppd.

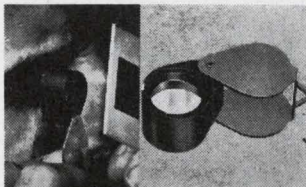

HASTINGS TRIPLET MAGNIFIER
10X, terrific buy — sells elsewhere at twice the price. Best pocket magnifier made. Genuine 3-element type with completely color-corrected, flat field cemented lens system. No distortion, no color fringes! No need for compensation. Sturdily mounted in black anodized aluminum cell. Swings into chrome-plated pocket case for protection. Clear lens dia. 1/2"; field of view 9 1/16". Chain loop. Used in gemology, engraving, photography, etc. to detect flaws. No. 30,344 . . . (Closes to 1 1/4") . . . \$11.95 Ppd.



GIANT FREE CATALOG
Brand new 1977 edition 164 pages. Hundreds of unique new items! Hard-to-get surplus bargains. Ingenious scientific tools. 1000's of components; lenses, prisms, wedges, mirrors, mounts, all types of accessories. 100's of instruments, lasers, comparators, magnifiers, telescopes, projectors, microscopes, binoculars, photo-attachments, black-light equipment and the world's largest, selection of unique lighting equipment. Fully illustrated. Great buys! Write for Catalog "DA".

SCIENCE · OPTICS · ELECTRONICS
ONOSOAC & HARD TO FIND BARGAINS
NEW PRODUCTS · NEW MATERIALS · NEW METHODS

CIRCLE NUMBER 175

TRIO LABS' MAXI-POWER® 682



A 750 watt (5VDC at 150a) Switching Power Supply that has so many features it surpasses comparison.

- Input 208VAC nominal (115VAC-Model 683).
- Low Line -30% (146VAC).
- High Line +10% (229VAC).
- Ride through 35ms @ nominal.
- Efficiency up to 85%.
- Output 2-48VDC standard.
- Power Out up to 800w (750w @ 5VDC out).
- Output voltage adjust.
- Overcurrent protection foldback (standard) or constant current.
- Overvoltage protection crowbar SCR.
- Self Cooling
- Parallelable.
- U.L. recognized (approved).
- 5x8x11"
- Up to 2 watts/in³.
- As low as 63¢/watt.

TRIO LABS The Switcher Source®
80 Dupont St. Plainview NY (516)681-0400

CIRCLE NUMBER 176

FREE



the new HEATHKIT CATALOG

Provides accurate, detailed descriptions of nearly 400 fun-to-build, money-saving products—all designed to prove you can build better electronics than you can buy. Famous Heathkit assembly manuals assure fun and success with simple step-by-step instructions that leave nothing to chance, even for beginners. Choose from the newest and best in stereo components, computerized color TV, digital clocks and weather instruments, home security, fishing, marine, automotive and hobby electronics and much more. Remember: "We won't let you fail".

Send for your **FREE** Heathkit Catalog today!

HEATH
Schlumberger Heath Company, Dept. 511-280
Benton Harbor, Michigan 49022

Please send me my Catalog. **FREE**
I am not on your mailing list.

Name _____
Address _____
City _____ State _____
CL-626 Zip _____

CIRCLE NUMBER 177

New Literature

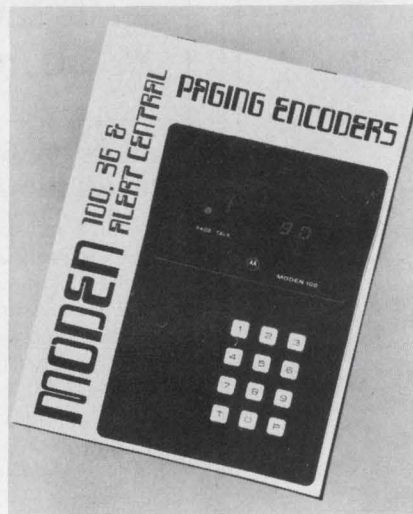

Paging encoders

Small, desktop manual paging encoders are shown in an eight-page brochure. Features, operation and installation information are included. Motorola Communications, Schaumburg, IL

CIRCLE NO. 436

Modular switches

Pushbutton switches—latching, key-lockable and self-return—are described in a catalog. Ledex, Dayton, OH

CIRCLE NO. 437

CAD program

ISPICE, a comprehensive circuit simulation and analysis system, is described in a six-page foldout. National CSS, Norwalk, CT

CIRCLE NO. 438

Memories

A six-page brochure describes the company's add-on, add-in memories for DEC PDP-11 computers. Fabri-Tek, Minneapolis, MN

CIRCLE NO. 439

Digital thermometer

A high-accuracy, digital contact thermometer with platinum sensor is described in a six-page brochure. Barnes Engineering, Stamford, CT

CIRCLE NO. 440

Clutches and brakes

Electric clutches and brakes are described in a 36-page catalog. The catalog has index tabs for easy referencing. Facet Enterprises, Elmira, NY

CIRCLE NO. 441

Amplifiers

TWT and solid-state power amplifiers are described in an eight-page catalog. The catalog includes a selection chart, specifications and drawings. Hughes Electron Dynamics, Torrance, CA

CIRCLE NO. 442

Digital displays

Specifications, dimensions, pin configurations and ordering information for seven-segment digital displays are provided in a bulletin. Refac Electronics, Winsted, CT

CIRCLE NO. 443

PM motors

Features, applications, outline dimensions and electrical-performance tables of PM motors, motor tachometers and motor encoders are found in a bulletin. Clifton Precision, Clifton Heights, PA

CIRCLE NO. 444

Semiconductor testers

Discrete-semiconductor test instruments for laboratory, industry, maintenance and service are featured in a six-page brochure. B&K-Precision, Chicago, IL

CIRCLE NO. 445

Panel meters

"Pick the Right Panel Meter Every Time," a six-page guide, discusses reliability, suspension-types, scales, size, shape, style and special features. General Electric, Schenectady, NY

CIRCLE NO. 446

Interconnect systems

Planar-interconnect systems are illustrated and described in a six-page brochure. Spectra-Strip, Garden Grove, CA

CIRCLE NO. 447

Converters Chargers Power Supplies

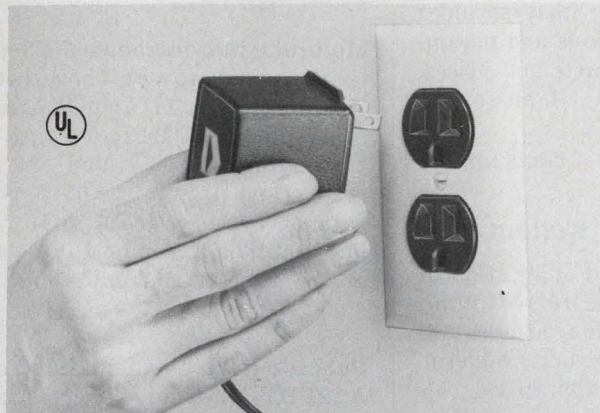

Highest quality units made in the USA for OEM use by the world's largest manufacturer of these products. Standard Units... UL listed... wall plug-in or desk-top types. Custom designs available for large runs. Send for catalog with complete specifications and outline drawings.

Dynamic Instrument Corp.

933 Motor Pkwy., Hauppauge, NY 11787.
Tel: (516) 234-2900.
Cable: "DYNINST" Hauppauge, NY



CIRCLE NUMBER 211

economy model

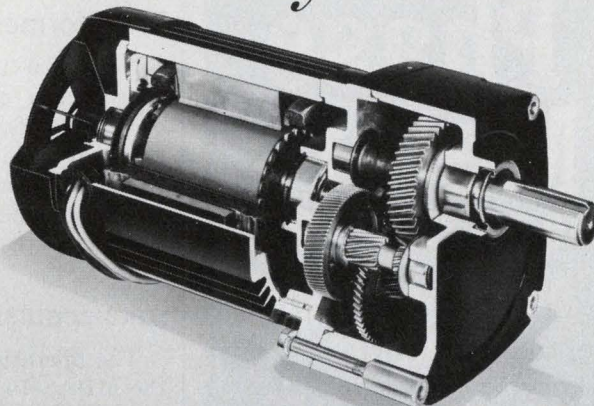

Bodine makes quality fhp motors and drive systems. Some may cost a little more. Initially. But, in the long run they cost less to use.

After Delivery Economies (ADE) are the reason. You get fewer rejects. Consistent quality, motor to motor, lot to lot. Less profit robbing service and downtime problems. Bodine motors perform. Reliably. Run stronger and last longer. Help protect your reputation and profit.

If you're concerned about today's bottom line costs and tomorrow's repeat sales, take a close look at Bodine. (1/2000 thru 1/4 Hp.)

ADE (After Delivery Economies)
make Bodine a better fhp buy

**BODINE
ELECTRIC
COMPANY**

Bodine Electric Company, 2528 W. Bradley Place, Chicago, IL 60618

CIRCLE NUMBER 213

WE KNOW A LOT ABOUT A LITTLE.

**Photoetched parts. Lead frames
and magnetic head frets, for instance.**

For openers, we're big enough to take on any photoetch job, regardless of quantity. And we have the expertise to etch all standard materials. In short, we're a one-stop shop, geared to save you time and money. We compound, melt and roll our own metal alloys. So if you call for a special composition or thickness, we have the capability—in house—to meet your exacting specs. Need artwork? We do that, too. Want your magnetic head frets stacked and bonded? Our process will give you absolute uniformity and precise thickness batch after batch. Put us to the test—send your drawings and let us quote. Write Magnetics, Components Division, Butler PA 16001.

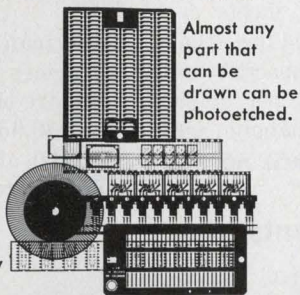

Almost any part that can be drawn can be photoetched.

**Very special
specialists
in photoetched parts.**

MAGNETICS
A DIVISION OF SPANG INDUSTRIES INC.

CIRCLE NUMBER 212

ELECTRONIC DESIGN 8, April 12, 1977

The fabulous **Phi-Deck**® family of 5 cassette transports under \$100 in quantities of 10

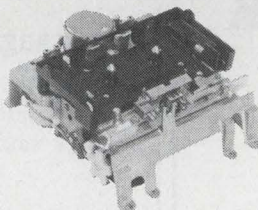

Featuring:

- Die-cast frames
- Remote controllable
- Precise, fast head engage/disengage
- Quick braking
- Search FF/rewind 120 ips
- Speed ranges from .4 to 20 ips

Electronic packages and mag heads for most applications

For application in:

- | | |
|-----------------------------------|---------------------------------------|
| 1. Micro processing | 7. Security/automatic warning systems |
| 2. Data recording/logging/storage | 8. Test applications |
| 3. Programming | 9. Audio visual/education |
| 4. Instrumentation | 10. Telephone interconnect |
| 5. Industrial Control | 11. Hi-Fi |
| 6. RS232 Data storage | 12. Point of sale |



Type I A Division of the Economy Co.

4605 N. Stiles P.O. Box 25308
Oklahoma City, Oklahoma 73125 (405) 521-9000

- I am interested in application no. _____
 Have Representative call Send application notes

Name _____ Title _____
Company Name _____
Address _____
City _____ State _____ Zip _____
Phone Number _____

CIRCLE NUMBER 214

High-Accuracy
**Phase
Meters**
0.5 Hz to 2 MHz
Digital or meter
readouts
As low as \$1150



930 E. Meadow Dr. • Palo Alto, CA 94303
(415) 494-6666

CIRCLE NUMBER 215

KEEP

Electronic Design's

GOLD BOOK

HANDY

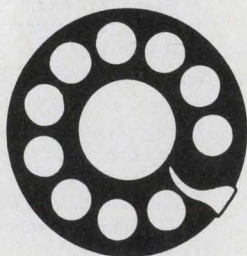

When You Call

Save time when you contact suppliers. Check their catalog pages first in *Electronic Design's* GOLD BOOK. Maybe the information you need is right at your fingertips.

NEW LITERATURE

Transformers

Over 800 transformers are detailed in a catalog that includes electrical specifications and parameters, dimension charts and prices. Abbott Transistor, Transformer Div., Burbank, CA

CIRCLE NO. 448

Data-acquisition system

The operation and application of the MDAS-16 and MDAS-8D miniature data-acquisition modules are highlighted in a six-page bulletin. Datel Systems, Canton, MA

CIRCLE NO. 449

Thin-film ladder networks

Schematic diagrams of thin-film ladder networks and tables of performance specifications are provided in a four-page bulletin. Beckman Instruments, Fullerton, CA

CIRCLE NO. 450

Thermostat

Dimensional drawings, alternative mounting arrangements and specifications of the Series 5100 immersion-type hermetically sealed thermostat are given in a bulletin. Protective Controls, Frederick, MD

CIRCLE NO. 451

IC packaging products

Detailed information on IC packaging products is contained in a 28-page catalog. Scanbe, El Monte, CA

CIRCLE NO. 452

Disc storage modules

Two eight-page data sheets describe disc-storage modules that provide mass-storage capacities of 40, 80, 150 or 300-Mbit per drive. General Automation, Anaheim, CA

CIRCLE NO. 453

Microwave components

A 110-page microwave components catalog and reference handbook lists more than 4000 passive components. Systron-Donner, Microwave Div., Van Nuys, CA

CIRCLE NO. 454

**Bulletin
Board**

Motorola has introduced 20 plastic-packaged power transistors that duplicate TI and RCA-registered devices. Included are six Darlington devices and 14 discrete transistors in the 65-W power category. Prices are 5 to 10% below published competitive prices at the time of introduction.

CIRCLE NO. 455

Babcock Relays has qualified a 10-A, 2PDT, all-welded, hermetically sealed, circuit-breaker-compatible relay to MIL-SPEC-27401.

CIRCLE NO. 456

Plessey Semiconductors introduced its SP 10,000 series of digital circuits as a pin-for-pin second-source replacement of the Motorola MECL 10,000 series. Initially, devices include single and multiple gates, drivers, receivers, decoders, arithmetic units and RAMs with capacities up to 1024 bits.

CIRCLE NO. 457

Texas Instruments is second-sourcing National Semiconductor's three-state line drivers, the DS-7831/DS8831/DS8832. They can be used as either quadruple single-ended line drivers or in a dual differential mode.

CIRCLE NO. 458

Digital Equipment has announced a 24% reduction in the service rate for LA36 DECwriter II terminals. The new rate is \$19 per month, down from \$25.

CIRCLE NO. 459

American Microsystems has slashed prices on three of its EPROMs by more than 50%. The new prices are \$9.95 for the S5204A and S6834-1 circuits and \$10.95 for the S6834 circuit, all in quantities of 100-999.

CIRCLE NO. 460

Intersil has announced across-the-board reductions on its line of watch and clock circuits averaging 21%.

CIRCLE NO. 461

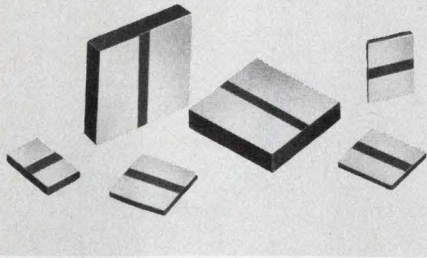

CERAMIC CHIP CAPACITORS. SPLIT-CHIP, is a new concept in ceramic chip capacitor technology. These new units have two broad electrodes on one face and eliminate conventional wrap-around end terminations. This new concept provides lower cost and easier assembly. SPLIT-CHIPS are available in five standard sizes from .040" x .030" to .130" x .090" and .015" thick and in all popular dielectrics and capacitance ranges. JOHANSON DIELECTRICS, INC., Box 6456, Burbank, Ca. 91510 213-848-4465

CERAMIC CHIP CAPACITORS 181

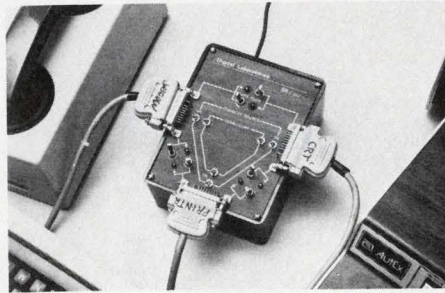

UNIVERSAL JUNCTION UNIT . . . for three devices, RS232C or current loop.

. . . Six switches provide all 63 interconnects that are possible between three I-O devices. LED's indicate data flow. . . . Designed to provide circuit compatibility and easy data routing between different manufacturer's devices. . . . \$350 (1-4) from DIGITAL LABORATORIES, 600 Pleasant St., Watertown, MA 02172 (617) 924-1680

3 PORT RS232 & 20 MA LOOP 184

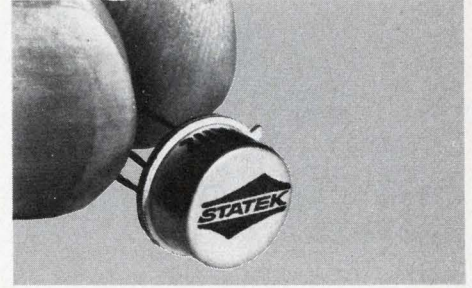

Don't count down. Use SX-1 10 kHz - 300 kHz Quartz Crystals * 18 stock frequencies * 0.185" high TO-5 * 1000g shock * \$2.00 ea. in 1000 qty. (\pm 0.01% accuracy) * Details in Gold Book & EEM * STATEK CORP. * 1233 Alvarez Ave. * Orange, Calif. 92668 * (714) 639-7810 * Telex 67 8394

QUARTZ CRYSTALS 187

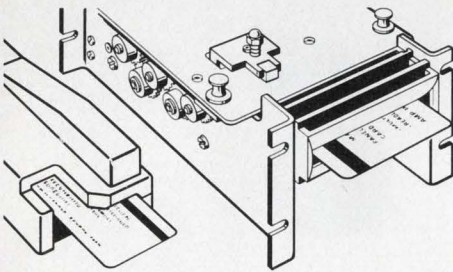

AMP MAGNETIC CARD READERS MAKE EVERY BIT COUNT. The low-profile "75" reads ABA track at 75 bits/inch, up to 250 bits across the card. Ideal for point of sale, access control, personnel identification. The "210/211" reads and writes at 210 bits/inch—as many as 650 bits in one card pass. Also handles bent cards. Captures stolen or expired cards. Call (717) 367-1105, or write AMP Incorporated, Capitron Division, Elizabethtown, PA 17022. AMP is a trademark of AMP Incorporated.

MAGNETIC CARD READERS 182

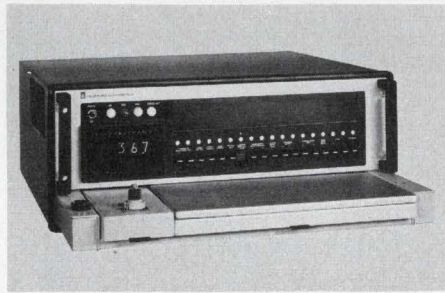

The Cost-Effective Solution to Linear-IC Testing. GenRad's 1730 Linear Circuit Tester tests op amps, comparators, voltage followers and regulators, and other common linear IC's. Up to 18 parameters can be automatically tested in a GO/NO-GO or measurement mode at the push of a button in under 2 seconds. Easily reset memory panel sets test conditions and limits. Broad selection of device-adaptor modules. GenRad, 300 Baker Ave., Concord, MA 01742, (617) 369-8770.

LINEAR IC TESTER 185

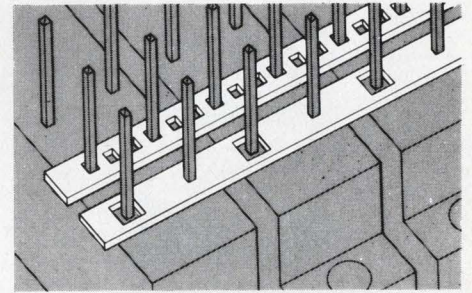

STRIP/BUS BY ROGERS. Low Cost Bussing Systems; easy installation, reliable solder joints; greater pin exposure. Write or call for details. Rogers Corporation, Chandler, AZ 85224. Phone (602) 963-4584. (EUROPE: Mektron NV, Ghent, Belgium; JAPAN: Nippon Mektron, Tokyo)

STRIP/BUS 188



BROAD RANGE FLUXMETERS Analyze magnetic circuits; measure residual, stray, absolute and differential fields, and plot field uniformity. Very low Drift for DC measurement, High Frequency Response for AC measurement. Flexible scale to read Flux or Flux density in kilomaxwells or kilogauss. Complete linearity assured. Not sensitive to vibrations or positioning. Model MF-3A Analog display. Model MF-3D Digital display. Write Walker Scientific, Inc., Rockdale St., Worcester, MA 01606/ (617) 852-3674.

MF 3A/D FLUXMETERS 183

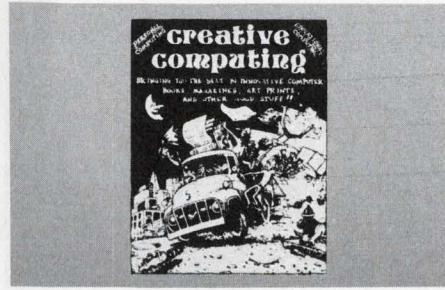

CREATIVE COMPUTER, hobby computing's #1 software and applications magazine, has it all . . . from putting a system together to maximizing its potential . . . equipment profiles, programming, games, puzzles, reviews, and more—even fiction! Subscription rate: \$8.00 one year/6 issues. Circle the Info Retrieval Number to start your subscription immediately. We'll bill you. Or send payment now and receive FREE one additional issue. **CREATIVE COMPUTING**, P.O. Box 789-M, Morristown, NJ 07960

186

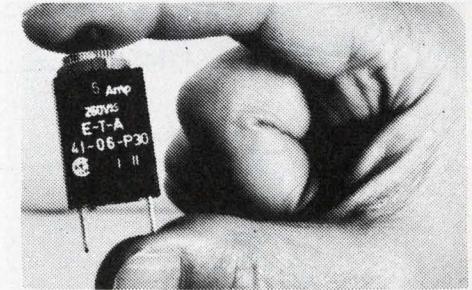

Overcurrent Protector, manual reset eliminates fuse replacement. Convenient panel mounting. 19 fractional ratings from 0.1 to 5 amp. Other models up to 400 amp. Trip-free and fool-proof, UL and CSA approved. High quality, low cost \$1.39 ea. in 1000 lots. E-T-A Products Co. of America, 7400 N. Croname Rd., Chicago, Ill. 60648. Tel: (312) 647-8303. Telex: 253780.

CIRCUIT BREAKER 189

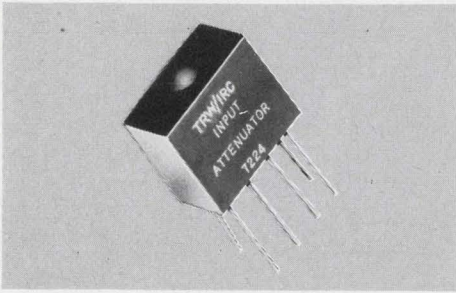

AR Ultra-Precision Resistor Networks from TRW provide maximum environmental protection. They feature lower effective cost, high density packaging, and all-welded construction. And, the AR Matched Resistor Sets provide ultra-precision performance at the lowest possible cost. TRW/IRC Resistors, an operation of TRW Electronic Components, 401 N. Broad St., Phila., Pa. 19108. (215) 922-8900.

AR MODULES

190



MAY I HELP SPEED LEAD BENDING OPERATIONS? Cut costs by 50%! Fast, exact, thumbwheel control adjusts to precise measurements. Match pointers with eyelet holes in circuit boards by adjusting knurled wheel with thumb, automatically spacing bends for insertion of component into boards. All axial lead components accommodated. From 1/2" x 1 1/2" long with max. distance between inside of bends of 1.725". Harwil Co., 1548 17th Street, Santa Monica, CA. 90404. (213) 829-2310

COMPONENT LEAD BENDER

193

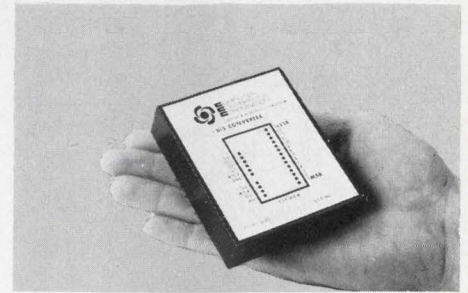

DIGITAL TO SYNCHRO CONVERTERS— 14, 12 or 10 bit input, 11.8/90V, 400 or 60Hz transformer isolated output, accuracy ± 4 , ± 15 or ± 30 min. Driving 1VA, 2VA (2.6" x 3.1" x 82"H module) or 5 VA loads (4 1/2" x 9 1/4" PC card). Price from \$350 in qty. Other CCC products are Synchro to Digital or DC, and DC to Synchro Converters, Solid State C.T.'s or CDX's, and Absolute Encoders. Send for Free Catalog & Application Notes. Computer Conversions Corp., East Northport, N.Y. 11731 (516) 261-3300.

DIGITAL TO SYNCHRO

196

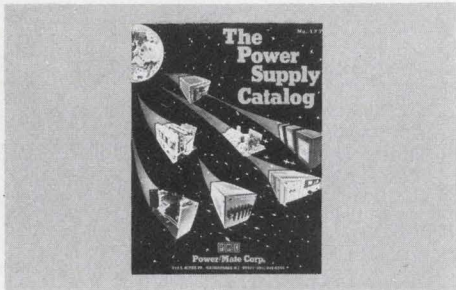

Free New '77 catalog contains over 34,500 quality power supplies from the world's largest manufacturer, Power/Mate Corp. Power Supplies for every application including submodulars, open frame, varigated, encapsulated, laboratory & system. All units UL approved and meet most military and commercial specs for industrial and computer uses. Power/Mate Corp., 514 S. River St., Hackensack, NJ 07601 (201) 343-6294

POWER SUPPLIES

191

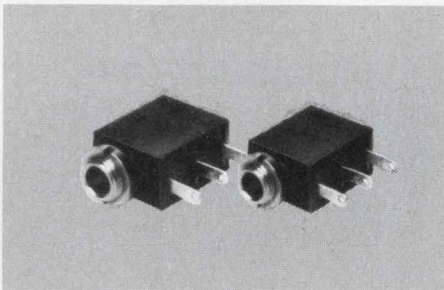

HI-QUALITY SPRING PRESSED RESILIENT TERMINAL JACKS. FEATURES: • Dust-Proof Mechanism Allows Perfect Contact with Each Insertion • Quick Connect Solder Terminals • Contact is Designed and Oriented in the Plastic Body to Generate Maximum Contact Pressure • Reliable - 100,000 Heavy Duty Test Insertions Without Breakdown. IMTRONICS INDUSTRIES, LTD., 813 2nd St., Ronkonkoma, N.Y. 11779 (516) 981-3434

TERMINAL JACKS

194

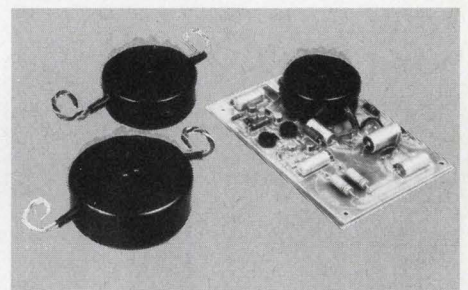

AVEL-LINDBERG toroidal transformer offers many electrical and mechanical advantages combined in attractive, uniform presentation in the range of standard power transformers. Toroids also have 50% less weight and volume; a lower height profile for slimline electronics and an incredible 8:1 lower radiated interference field. See Avel-Lindberg at Electro 77 Booth 2113 or circle distributor list.

VISIT OUR BOOTH #2113 AT IEE

197

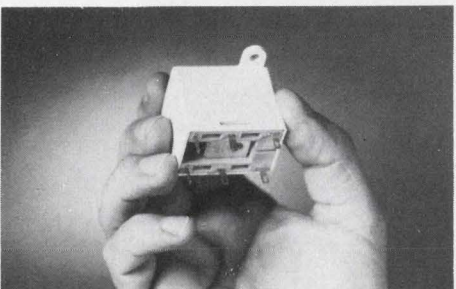

LOW COST 10 AMP MINI RELAY. 2 pole. Only 1.61" x 1.09" x 1.38" high. DPNO, DPNC OR DPDT contacts. DPNO is U/L recognized. 10 amp 0.8PF inductive 125V ac 60 Hz or 28V dc resistive. 470 mw sensitivity. 1/4" surface spacing between terminals inhibits arcing in high humidity areas. For refrigerators, TV, radio and similar equipment. A quality relay, reasonably priced. Series 39. North American Philips Controls Corp., Frederick, Md. 21701. (301) 663-5141.

2 POLE GP RELAY

192



NEW MOTOR CONTROLS COST LESS! KBGE AC Voltage Controls for motors, heaters and lamp loads. KBGE modules use high reliability triacs. Phase-controlled circuitry is rugged and compact (3" x 2" x 1"). Versatile for power on voltage control; many features. Samples: 120 VAC, \$18.; 240 VAC, \$20. Free data sheet D-162. KB ELECTRONICS, INC., 5801 Foster Ave., Brooklyn, N.Y. 11234 (212) 968-8000.

MOTOR CONTROLS

195

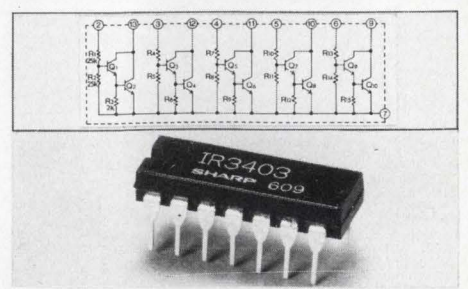

DUAL IN-LINE HIGH CURRENT DRIVER BLOCK • Special driver for Seiko 310, extra versatile. • 5 Darlingtons with 350 mA output current each. • 26V supply voltage. • 14 pins. • Off-the-shelf sales. • 45 cents each for 50K FOB Japan. Contact: Sharp Corporation, Semiconductor Div., 2613-1 Ichinomoto, Tenri City, Nara 632, Japan. Phone: (07436) 5-1321. Tel-ex: 5522364 SHAPEL J

DARLINGTON ICs

198

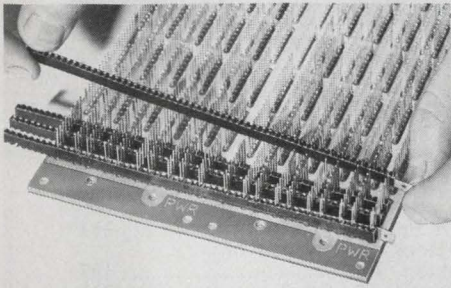

QUIK/STRIP BY ROGERS. Fast, low-cost system for connecting in-line pins on DIP socket boards and connector arrays. Shock and vibration resistant. 18 gauge current capacity. Can be used on pin densities as high as .100" x .100" and be stacked two or more high. Write or call for details. Rogers Corporation, Chandler, AZ 85224. Phone: (602) 963-4584. (EUROPE: Mektron NV, Gent, Belgium; JAPAN: Nippon Mektron, Tokyo.)

QUIK/STRIP

199

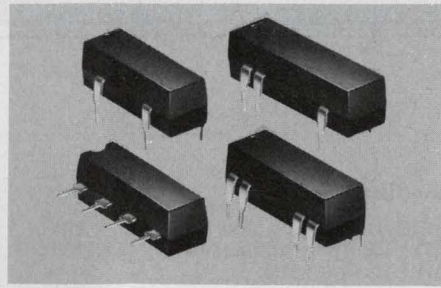

MOLDED-EPOXY DIP REED RELAYS. Industry's widest selection, offering six basic series with 4, 6 and 8-pin standard and single-in-line versions. Contact Forms A, B and C. 1 and 2 poles available in Form A. Dry reed (Forms A, B, C), high-voltage (Form A) and mercury-wetted (Forms A, C) versions. All designs compatible with auto-insertion equipment. Logic compatibility and environmental immunity are prime features. Request Bulletin RR407: Gordos Corp., 250 Glenwood Ave., Bloomfield, N.J. 07003; (201) 743-6800.

DIP REED RELAYS

202

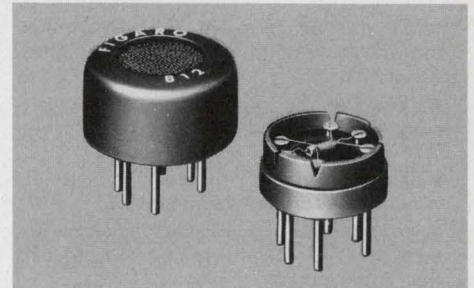

FIGARO GAS SENSOR TGS is a gas sensitive semiconductor. When combustible gas is absorbed on the sensor surface, a marked decrease of electrical resistance occurs. Major features of the sensor include high sensitivity, long term reliability and low cost. The applications are: GAS LEAK ALARM, AUTOMATIC FAN CONTROL, FIRE ALARM, ALCOHOL DETECTOR, etc. Figaro Engineering Inc., North America Office-3303 Harbor Boulevard, Suite D-8, Costa Mesa, Calif. 92626 Tel: (714) 751-4103 Telex: 678396

GAS SENSOR

205

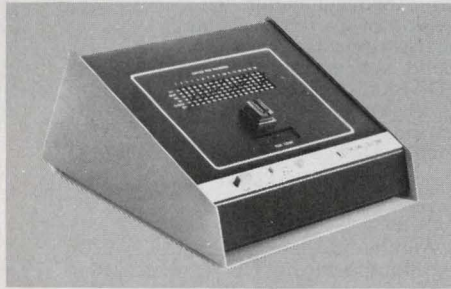

Inexpensive DIGITAL IC TESTER performs 2²⁰ inspections per test in 1-5 secs. Covers 14/16-pin TTL, DTL and CMOS @ 5V. Employs fixed pattern functional test, requiring no "good" IC for comparison. 4-digit display gives absolute results. Can also check continuity of resistor network. Model 1248: \$725. Electro Scientific Industries, 13900 N.W. Science Park Dr., Portland, Oregon 97229. Sister instrument tests at two added voltages and also covers HTL and offers automatic handler interface.

DIGITAL IC TESTER

200



Modular Tone Detectors require no assembly or adjustments. Model 550-1 and 550-2 Tone Detectors detect the standard Bell System Touch Tones. Non-ambiguous detection of 40 ms on/off DTMF tone bursts is provided for input tone amplitudes from -30 dBm to 0 dBm with twists of up to 15 dB. Rejects Dial Tones, Trunk Tones, and adjacent Band Tones. Outputs are open collector logic for interface with CMOS/TTL. Frequency Devices, Inc., 25 Locust St., Haverhill MA 01830 (617) 374-0751 TWX 710 347-0314.

TONE DETECTORS

203

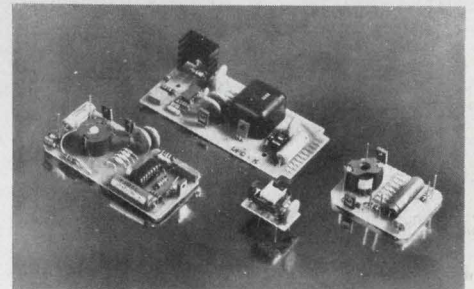

Activate gas discharge readouts! Custom designed and produced DC-to-DC power supplies to activate gas discharge displays, or for other applications. Regulation I/O options, packaging (encapsulated, aluminum shell or open frame), size and configuration, heat dissipation, mounting (PC board pins, edge connectors), etc., can be tailored to meet individual specifications. Price and delivery discussed after specifications are submitted. Endicott Coil Co., Inc., 31 Charlotte Street, Binghamton, N.Y. 13905 (607) 797-1263.

CUSTOM DESIGNED POWER SUPPLIES 206



HANDSOME, RUGGED ENCLOSURES Custom-crafted laminated Formica®-Mahogany-Formica® construction, internally reinforced corners, rich wood grain or solid color exteriors. Superb workmanship, competitive prices, any quantity. W. A. Miller Co., Inc., 307 Mingo Loop, Oquossoc, Maine 04964. Phone: 207/864-3344

ENCLOSURES

201

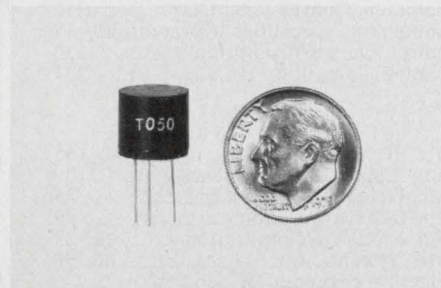

THE ULTIMATE IN MINIATURIZATION New Lumped Constant, completely passive, Delay Lines housed in commercial T05 package (.385 dia. x .330 high). Units compatible with semiconductor and logic assemblies where space is limited. Stocked in delays from 10 to 100 nanoseconds. Write for Delay Lines and L-C Filters Catalogs. See us Electro/77, Booth 2432. Allen Avionics, Inc., 224 E. 2nd St., Mineola, N.Y. 11501, (516) 248-8080.

SEE US ELECTRO/77, BOOTH 2432

204

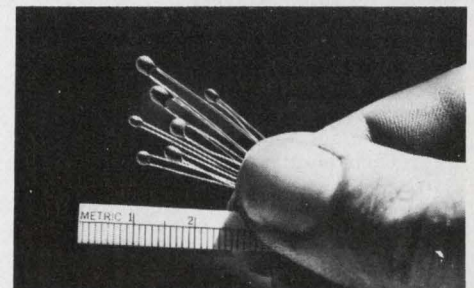

Chip Thermistors with leads and coating are highly reliable, exceptionally predictable, low cost components with small and miniature dimensions more compatible with modern circuit design. R @ 25°C 30 ohms to 3 meg ohms, tolerances ± 10% to ± 1%. Curved matched interchangeable ± 1°C to ± .3°C. Point matched interchangeable for temperature control R, to ± 1%. WESTERN THERMISTOR Corporation, 403 Via El Centro, Oceanside, CA 92054. (714) 433-4484.

THERMISTORS

207

Electronic Design

ELECTRONIC DESIGN's function is:

- To aid progress in the electronics manufacturing industry by promoting good design.
- To give the electronic design engineer concepts and ideas that make his job easier and more productive.
- To provide a central source of timely electronics information.
- To promote communication among members of the electronics engineering community.

Want a subscription? ELECTRONIC DESIGN is sent free to qualified engineers and engineering managers doing design work, supervising design or setting standards in the United States and Western Europe. For a free subscription, use the application form bound in the magazine. If none is included, write to us direct for an application form.

If you do not qualify, paid subscription rates are as follows: \$30.00 per year (26 issues) U.S., \$40.00 per year (26 issues) all other countries. Single copies are \$2.00 U.S., \$3.00 all other countries. The Gold Book (27th issue) may be purchased for \$30.00 U.S. and \$40.00 all other countries.

If you change your address, send us an old mailing label and your new address; there is generally a postcard for this bound in the magazine. You will have to requalify to continue receiving ELECTRONIC DESIGN free.

The accuracy policy of ELECTRONIC DESIGN is:

- To make diligent efforts to ensure the accuracy of editorial matter.
- To publish prompt corrections whenever inaccuracies are brought to our attention. Corrections appear in "Across the Desk."
- To encourage our readers as responsible members of our business community to report to us misleading or fraudulent advertising.
- To refuse any advertisement deemed to be misleading or fraudulent.

Microfilm copies are available of complete volumes of ELECTRONIC DESIGN at \$19 per volume, beginning with Volume 1, 1952 through Volume 20. Reprints of individual articles may be obtained for \$3.00 each, prepaid (\$.50 for each additional copy of the same article) no matter how long the article. For further details and to place orders, contact the Customer Services Department, University Microfilms, 300 North Zeeb Road, Ann Arbor, Michigan 48106 telephone (313) 761-4700.

Want to contact us? If you have any comments or wish to submit a manuscript or article outline, address your correspondence to:

Editor
ELECTRONIC DESIGN
50 Essex Street
Rochelle Park, N.J. 07662

Advertiser's Index

Advertiser	Page	Advertiser	Page
ACDC Electronics, Inc.	201	E-T-A Products Co. of America.....	251
AMP, Incorporated.....	30, 31, 168, 169	E-Z Hook, A Division of Tektest, Inc.	197
AMP, Incorporated, Capitron Division	251	Edmund Scientific Company	247
Acopian Corp.	130A	Electro Corporation	243
Advanced Micro Devices	4, 5	Electro Scientific Industries	253
Aiken Industries	234	Electronic Arrays, Inc.	209
Alco Electronic Products, Inc.	245	Electronic Design	204, 247, 258
Allen Avionics, Inc.	253	Electronic Navigation Industries	186
Allen Bradley Co.....	130B-C	Elektronik	221
Allen Avionics, Inc.	253	Elexon Power Systems	136
Allied Chemical, Metglas Products....	77	Endicott Coil Co., Inc.	253
Allied Electronics, Division of Tandy Corp.	206	Esterline Angus Instrument Corporation	232
Amperex Electronics Corporation.....	27	Esterline Electronics, an Esterline Company	238
Anzac Electronics	226	Fairchild Semiconductor, A Division of Fairchild Camera and Instrument Corporation	42, 43
Arnold Magnetics Corp.	198	Fairchild Systems Technology, A Division of Fairchild Camera and Instrument Corporation	143
Arrow-M Corp.	182	Figaro Engineering, Inc.	253
Augat, Inc.	187	Frequency Devices, Inc.	253
Avel-Lindberg	252	GTE Automatic Electric	223
B & K Products of Dynascan Corporation	194	Garry Manufacturing Co.	181
BEI Electronics Inc.	232	Gates Energy Products, Inc.	193
Beau Products Division, Vernitron Corporation	230	GenRad	19, 251
Bendix Corporation, The, Electrical Components Division	44, 45	General Electric Company, Instrument Rental	130E
Bliley Electric Co.	188	Gold Book, The	202, 203, *214, *215, 237, 250
Bodine Co., The	249	Gordos Corporation	253
Bosch Corporation, Robert	219	Gould, Inc.	79, 108, 211
Bourns, Inc., Trimpot Products	Cover II	Guardian Electric Manufacturing Company	176
Bud Industries, Inc.	214, 215	Guidline Instruments Inc.	123
Bunker Ramo Connector Division....	37	Gulton Measurement & Control Systems Division	196
Burroughs Corporation	231	Harris Semiconductor, A Division of Harris Corporation	174, 175
CODI Corporation	243	Harwil Co.	252
CTS Corporation	67	Hayden Book Company, Inc.	197, 235, 257
Caddock Electronics	218	Heath Company	248
Centralab, The Electronics Division of Globe-Union, Inc.....	48	Heinemann Electric Company	38, 39
Cherry Electrical Products Corp.	166, 167	Hewlett-Packard.....	9 thru 18, 172
Chicago Miniature Lamp Works...130F		Houston Instrument, A Division of Bausch & Lomb	220
Clare & Co., C. P.	130D	ILC Data Devices, Inc.	83
Computer Conversions Corp.	252	IMC Magnetics Corporation	241
Continental Specialties Corporation..	52	IMSAI Manufacturing Corporation..	142
Control Data Corporation	232	ISE Electronics Corporation	152
Creative Computing	251	ISS Sperry Univac	78
Dale Electronics, Inc.	164, 165	ITT Cannon, A Division of International Telephone and Telegraph Corporation	162, 162A-B-C-D
Dana Laboratories, Inc.	109	Illuminated Products Co.	7
Data General Corporation	35	Imtronics Industries, Inc.	252
Data I/O Corporation	99	Industrial Timer, A Unit of Esterline Corporation	245
Data Precision Corporation	22, 23	Intel Corporation	21, 46, 47
Datel Systems, Inc.	86, 98	ECD Corporation	89
Delco Electronics, Division of General Motors Corporation	83	*EMI SE Labs	223
Digital Equipment Corporation....	65, 222	EMM Semi, a subsidiary of Electronic Memories & Magnetics Corporation	116
Digital Laboratories	251		
Dormeyer Industries, Inc.	130F		
Dynamic Instrument Corp.	249		

Advertising Sales Staff

Tom W. Carr, Sales Director
Jean Bunfield, Sales Coordinator

Rochelle Park, NJ 07662

Robert W. Gascoigne
Daniel J. Rowland
Thomas P. Barth
50 Essex St.
(201) 843-0550
TWX: 710-990-5071
(HAYDENPUB ROPK)

Philadelphia

Thomas P. Barth
(201) 843-0550

Boston 02178

Gene Pritchard
P.O. Box 379
Belmont, MA 02178
(617) 489-2340

Chicago 60611

Thomas P. Kavooras
Berry Conner, Jr.
200 East Ontario
(312) 337-0588

Cleveland

Thomas P. Kavooras
(312) 337-0588

Los Angeles 90045

Stanley I. Ehrenclou
Burt Underwood
Neil Canavin
8939 Sepulveda Blvd.
(213) 641-6544

Texas

Burt Underwood
(213) 641-6544

San Francisco

Robert A. Lukas
3579 Cambridge Lane
Mountain View, CA 94040
(415) 965-2636

England

Constance McKinley
50 Essex St.
Rochelle Park, NJ 07662
Phone: (201) 843-0550

Europe

Sanders, W. J. M.
Raadhuisstraat 24
Graft-De Ryp, Holland
Phone: 02997-1303
Telegrams: Euradteam-Amster-
dam

Telex: 13039-SIPAS

G. Nebut

Promotion Presse Internationale
7 ter Cour des Petites Ecuries
75010 Paris, France
Telephone: 5231917, 1918, 1919

Dieter Wollenberg
D-8011 Baldham/Muenchen
Erikastrasse 8
Germany
Telephone: 0 8106/4541

Tokyo

Haruki Hirayama
Electronic Media Service
5th Floor, Lila Bldg.,
4-9-8 Roppongi
Minato-ku, Tokyo, Japan
Phone: 402-4556
Cable: Electronicmedia, Tokyo



Advertiser	Page
Intel Memory Systems	130
Intelligent Systems, Inc.	184, 185
International Importers, Inc.	130H
Instrument Specialties Company.....	147
Itoh Electronics Inc., C.	226
Johanson Dielectrics, Inc.	251
Johanson Manufacturing Corp.	6
KB Electronics, Inc.	252
Leader Instruments Corp.	210
Littelfuse, Subsidiary of Tracor.....	130G
M-Tron Industries, Inc.	238
Magnetics, Inc.	249
Malco, A Microdot Company	191
McCoy Electronics Company	117
Merrimac Industries, Incorporated....	229
Micro Devices Corp.	115
Micro Networks Corporation	240
Miller Co., Inc., W. A.	253
Miller-Stephenson Chemical Co., The	237
Mini-Circuits Laboratory, A Division of Scientific Components Corporation	2
Moxon/SRC Division	195
Mupac Corporation	236
National Semiconductor Cor- poration	28, 29, 177, 178, 179, 180
Newport Laboratories, Inc.	200
Nichicon America Corporation	88
North American Philips Controls Corp.	247, 252
Par-Metal Products, Inc.	216
*Philips Ana-Log	35
Philips Test & Measuring Instruments, Inc.	233
Piezo Technology, Inc.	244
Potter & Brumfield, Division of AMF, Incorporated	41
Power Conversion, Inc.	204
Power/Mate Corp.	188, 252
Precision Monolithics, Incorporated	20
Princeton Applied Research Corp.....	237
Processor Technology Corporation....	125
Pulse Engineering, Inc.	210
RCA Solid State	Cover IV
RCL Electronics, Inc.	40
RD Products Inc.	239
Refac Electronics Corporation	212
Reticon	199
Riken Denshi Co., Ltd.	239
Robinson Nugent, Incorporated	170, 171
Rockland Systems Corporation	227
Rogan Corporation	69
Rogers Corporation	251, 253
Rtron Corporation	208
SMK Electronics Corporation of America	232

Advertiser	Page
Sangamo Weston, EMR Telemetry Division	239
Schauer Manufacturing Corp.	190
Schweber Electronics	81
Servo-Tek Products Company	161
Sharp Electronics Corporation	252
Signal Transformer Co., Inc.....	Cover III
Simpson Electric Company	137
Sprague Electric Company	145
Sprague-Goodman Electronics, Inc.....	196
Standard Grigsby, Inc.	192
Statek Corp.	251
Stanford Applied Engineering, Inc.....	24
Sweda International OEM Products....	242
Systron-Donner	75, 124
TRW Capacitors, an Electronic Components Division of TRW, Inc.	153
TRW/IRC Resistors, an Electronic Components Division of TRW, Inc.	173, 252
TRW Power Semiconductors, an Electronic Components Division of TRW, Inc.	213
Tektronix, Inc.	51, 53
Teledyne Semiconductor	159
Tele-Dynamics, Division of Ambac....	245
Teletype Corporation	72
Tenney Engineering, Inc.	241
Texas Instruments, Incorporated....	70, 71
Texscan Corporation	151
Thomas & Skinner, Inc.	246
Topaz Electronics	243
Tracor Industrial Instruments	234
Trio Laboratories, Inc.	248
Triple I, A Division of the Economy Co.	249
Unimax Switch Corporation	85
Union Carbide, Components Department	207
Victoreen Instrument Division, Shellar-Globe Corporation	205
Video Research Corporation	217
Viking Industries, Inc.	225
Vitek Electronics Inc.	241
Vishay Resistive Systems Group	149
Voltronics Corporation	129
Wabash Inc.	131
Walker Scientific, Inc.	251
Ward-Leonard Electric Company	242
Wavetek San Diego, Inc.	1
Western Thermistor Corporation	253
Wiltron Company	250
Zeltex, Inc.	189

*Advertisers in non-U.S. edition

Product Index

Information Retrieval Service. New Products, Evaluation Samples (ES), Design Aids (DA), Application Notes (AN), and New Literature (NL) in this issue are listed here with page and Reader Service numbers. Reader requests will be promptly processed by computer and mailed to the manufacturer within three days.

Category	Page	RSN	Category	Page	RSN	Category	Page	RSN
Components			transformers, phone-line	208	359	DVM	188	310
capacitors	6	4	trimmer capacitor	129	52	DVMs	123	49
capacitors	145	59	Data Processing			digital panel instru-	245	171
capacitors	153	64	CAD program (NL)	248	438	ments		
capacitors	206	107	cassette transports	249	214	digital thermometer	248	440
capacitors, electrolytic	88	41	catalog (NL)	222	124	(NL)		
capacitors, trimmer	210	361	computer desktop	227	391	function/pulse generator	1	2
cermet trimmers	67	29	controller board	222	379	instrument coupler	143	58
circuit breakers	41	20	controller, position	222	381	instrumentation con-		
clutches and brakes			data logger	224	384	troller	75	33
(NL)	248	441	data terminal	224	385	linear tester	190	323
coils, relays and trans-			data storage module			memory testing (NL)	246	430
formers	131	54	(NL)	250	453	meter	234	138
components	237	143	diskette system	226	388	micro-ohmmeter	190	321
crystals	212	364	firmware	227	390	oscilloscope	51	25
crystals	238	146	floppy disc head	220	377	oscilloscope	210	112
digital displays (NL)	248	443	graphics system guide	65	28	panel meters (NL)	248	446
display, gas-discharge	216	370	I/O card	226	389	portable recorders	196	89
displays	172	69	impact printers	226	127	power divider	226	126
ferrite cores	208	357	kit, microcomputer	220	376	pulse generator	124	50
gas plasma display	231	132	line printer	220	122	RLC tester	19	6
IMC book club	241	163	mag-card reader	224	382	recorder, strip-chart	108	44
IR crystals (AN)	246	427	magnetic tape recorders	217	119	semiconductor testers		
incandescent display	212	114	memories (NL)	248	439	(NL)	248	445
keyboards	167	67	memory, programmer	224	387	spectrum analyzer	237	142
magnetic sensors	243	169	memory system	21	8	spectrum analyzer	239	149
micro DIP switch	81	37	miniature floppy disc	224	386	surge testing (AN)	246	428
modular switches (NL)	248	437	printer, alphanum.	222	380	sweeper	184	308
motors and drive sys-			printer/plotters (AN)	246	426	test chambers	241	162
tems	249	213	programmers, PROM	220	378	wattmeter, rf	188	320
PM motors (NL)	248	444	reader module	239	147	Integrated Circuits		
potentiometers	11	262	recorders	239	148	amplifier, dual	240	418
proximity switch	216	369	tape regeneration sys-			amplifier, wideband	242	419
quartz crystals	117	47	tem	242	165	converter, a/d	240	416
relays	182	74	teleprinter	224	383	EPROM, 16-k	47	23
relays	218	374	Discrete Semiconductors			memory, FIFO	240	415
relays	238	145	Darlington	98	42	op amps, quad	175	71
relays	247	173	Darlington	244	423	processor, bit-slice	240	415
relays, reed	215	367	FETs	159	65	RAM, CMOS	238	413
resistor	205	106	opto-isolators	244	425	RAMs, 4-k static	116	46
resistors	165	351	rectifiers, fast recovery	244	422	switches, analog	238	414
resistors	173	70	SCRs	244	421	timer, decade	242	420
resistors	242	166	transistors	IV	264	variable arrays (ES)	246	435
rotary switches	192	85	transistors, comple-			535 op amp (ES)	246	432
rotary switches	245	170	ments	244	424	Microprocessor Design		
solenoids	216	371	transistors, pnp	27	13	assemblers, cross	80	506
solenoids, tubular	176	72	zener	213	115	board, processor	84	510
switch, DIP	212	362	zeners	190	83	board, prototype	73	501
switch, DIP	218	373	Instrumentation			CPU card, Z-80	80	504
switch, PC mounting	215	365	analyzer	183	303	card, μ P memory	84	509
switch, rotary	212	363	brush recorders	79	36	interface, peripheral	80	505
switch, thumbwheel	215	368	calibration source	190	324	software, resident	76	503
switches	40	19	catalog (NL)	248	177	system, microcomputer	82	507
switches	85	39	controller	192	325	system, μ P development	74	502
switches, DIP	232	134	counter	186	301	Microwave & Lasers		
switches & LEDs	208	358	counter/timer	192	327	amplifier, 4-12 GHz	228	398
switches, PB illuminated	210	360	DMM	184	309	attenuation calibrator		
switches, pushbutton	218	372	DMM	190	322	(AN)	246	431
switches, snap-action	208	356	DMM, 3-1/2-digit	194	87	attenuator, motorized	228	394
thermostat (NL)	250	451	DMMs	234	139	capacitor, trimmer	228	392
thin-film ladder networks			DPMs	137	56	fiber-optic cable	228	395
(NL)	250	450	DPMs	192	326	low-noise Xistor	228	399
totalizer	218	375	DPVMs	200	95			
transformers	215	366						
transformers	243	168						
transformers (NL)	250	448						

Step-by-step coverage of defense radar system design . . .

INTRODUCTION TO DEFENSE RADAR SYSTEMS ENGINEERING

James N. Constant

This all-inclusive handbook covers virtually every facet of radar technology that must be mastered in order to design a complete defense radar system. In fact, it concludes with a *step-by-step procedure for specifying and designing a complete radar system for a given application*. Separate chapters cover target characteristics; radar detection; radar receivers; radar system error model; flight of a ballistic missile; ballistic reentry trajectories; trajectory prediction; radar data processing; reflector antennas; and array antennas. Order your 15-day examination copy today! #9194, 344 pages, cloth, illustrated, \$22.95



15-DAY FREE EXAMINATION!



Hayden Book Company, Inc.
50 Essex Street
Rochelle Park, N.J. 07662

- Please send me my copy of INTRODUCTION TO DEFENSE RADAR SYSTEMS ENGINEERING to read and use for 15 days. At the end of that time, I'll send a check or money order for \$22.95, plus postage and handling, or return the book and owe absolutely nothing.
- I want to save money! I have enclosed full amount. Publisher pays postage and handling. I get a complete 15-day money-back guarantee.

Name _____
Firm _____
Address _____
City/State/Zip _____

Category	Page	RSN
microwave components (NL)	250	454
power amplifier	228	397
synthesizer source	228	393
Modules & Subassemblies		
amp, instrumentation	230	401
amplifiers	248	442
converter, a/d	230	400
converter, d/a	233	407
converter, v/f	236	409
converters, a/d	189	80
converters, a/d	240	161
correeds and matrices	223	125
counter module	230	402
crystal filters	244	167
d/a	236	412
data acquisition	234	406
data-acquisition system (NL)	250	449
delay lines	234	405
filters, RFI, EMI	208	109
generators, servomotors, drives	161	66
humidity sensor	233	408
integrating a/d converters (AN)	246	429
op amp	236	411
op amp, high-speed	230	404
oscillators	230	403
paging encoders (NL)	248	436
rf power amplifiers	186	76
robot industrial	236	410
servo recorder	232	133
Packing & Materials		
aluminum knobs	245	169
barrier strips	230	130
barrier strips	230	131
breadboards, DIP	194	302
cable	247	175
cable-tie mounts (ES)	246	433
connector	199	337
connectors	31	14
contacts	225	125
DIP sockets	171	269
door/panel latch	199	338
electronic housings	216	118
flat cables	194	328
flux solvent	237	144
heat sinks (ES)	246	434
IC packaging products (NL)	250	452
instrument case	198	336
interconnect system	191	84
interconnect systems (NL)	248	447
interconnection system	169	68
LED socket	196	331
magnetic shielding	77	34
magnets	246	172
manual wire-wrap	198	333
PCB mounting	196	330
packaging systems	236	141
packing	181	73
photoetch parts	249	212

Category	Page	RSN
production equipment	198	334
soldering tool	194	329
solderless breadboarding	52	26
stacking connectors	199	339
terminal	196	332
test-clip, DIP	198	335
Power Sources		
batteries	193	86
battery, lead-acid	206	349
converter, dc/dc	204	344
converter, dc/dc	205	345
power source, 3-phase	204	343
power supplies	188	79
power supplies	198	93
power supplies	201	96
power supplies	232	132
power supplies	245	168
power supplies	248	176
power supplies	249	211
power supplies, dc	200	342
power supply, dc	200	340
power supply, dc	206	348
power supply, HV	206	347
power supply, μ Ps	205	346
switching power supplies	211	113
voltage regulator	200	341

new literature

CAD program	248	438
clutches and brakes	248	441
digital displays	248	443
digital thermometer	248	440
disc-storage module	250	453
IC packaging products	250	452
interconnect systems	248	447
memories	248	439
microwave components	250	454
modular switches	248	437
PM motors	248	444
paging encoders	248	436
panel meters	248	446
semiconductor testers	248	445
thermostat	250	451
thin-film ladder networks	250	450
transformers	250	448

application notes

attenuation calibrator	246	431
integrating a/d converters	246	429
IR crystals	246	427
memory testing	246	430
printer/plotters	246	426
surge testing	246	428

evaluation samples

cable mounts	264	433
heat sinks	246	434
535 op amp	246	432

COMING IN



ROUND AND RACK/PANEL MULTIPIN CONNECTORS

The sixth installment of *Electronic Design's* 1977 FOCUS series will appear in the June 21 issue. The topic: Multipin Connectors.

Connectors are as crucial to a successful electronic system as the more exotic components. Associate editor Morris Grossman takes an in-depth look at round and rectangular multipin units, including rack/panel types. The report examines zero-insertion-force (ZIF) connectors, mass-termination connectors, and multiple-lead fiber-optic connectors.

As with all FOCUS reports, emphasis is placed on the significant specs readers should watch for and how to avoid pitfalls in connector selection and use. More than 61,000 *Electronic Design* subscribers specify or authorize purchase of connectors. If you're one of them... mark June 21 on your calendar. It's a report you'll want to keep for months to come.

FOCUS ON MULTIPIN CONNECTORS

**ANOTHER REASON ELECTRONIC DESIGN IS THE BEST
READ ELECTRONICS PUBLICATION IN THE WORLD!**

At signal, we transform custom problems into off-the-shelf solutions.

Next time your needs dictate a transformer design that looks like a sure candidate for a time-consuming, budget-busting "special," contact Signal. Chances are we make something very close if not exactly what you're looking for.

And if we catalog it, we stock it. And if we don't catalog it, we'll make it—and ship it pronto, too.

Signal's unique record of having transformers ready for designers when they need them is no accident. Our R&D department goes to great length to keep pace with new design trends so we can anticipate the needs of circuit designers and packagers.

Take our Flathead, for example.

We were first in the industry to develop a "flat" power transformer for high density PC board packaging problems. Our 6 VA units are less than 0.85" high, while our 12 VA units require just 1.06" of headroom.

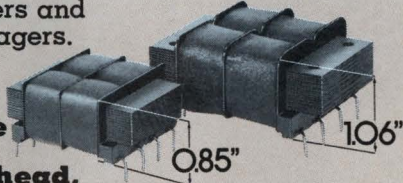

Need another example? How about 50% savings in weight, size and cost?

Our 2-4-1 series of small power transformers are unbeatable for applications from 2.4 to 100 VA. They use bobbin instead of layer winding to save 40-50% in winding space, and a special "split" bobbin we developed at Signal to eliminate inter-winding insulation and crossover of primary and secondary leads.

For further savings, we made the core out of grain-oriented steel instead of ordinary silicon steel. Result, 40% reduction in the number of required turns and additional weight and cost savings. Not bad.

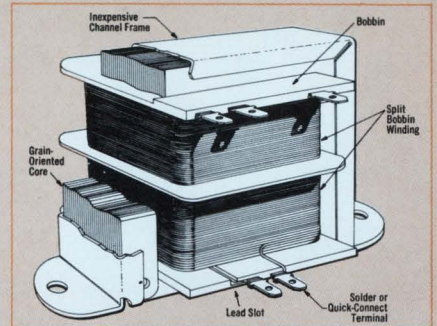

The biggest line, the fastest delivery.

Our complete catalog includes over 1,000 standard transformers and chokes, from 1 to 10,000 VA. All available from stock, with guaranteed shipment of at least four pieces within 48 hours. (Last year we had a 100% record of honoring that guarantee on more than 8,000 orders.)

And all at low, factory direct prices that are made even lower by our enormous volume.

We've moved and doubled the size of our plant and catalog, ask for your new copy today.

Signal Transformer Co., Inc.,
500 Bayview Ave., Inwood, N.Y.
11696, Tel. 516-239-7200

CIRCLE NUMBER 263

signal

TRANSFORMER

STOCK ROOM



ANOTHER PRONTO SHIPMENT FROM SIGNAL

New option from the Powerhouse ...

RCA 2N3055.

Now pay less and still get more.

RCA gives you a new choice in Power Transistors. The 2N3055H is the industry's original hometaxial workhorse. It still offers unique RCA features. And it still sports the ultimate in SOA characterization.

The 2N3055 is our new epitaxial version of the hometaxial "H". It lets you trade in a little SOA for a lower price. Without having to trade in all the features that made RCA the leading choice in 2N3055's in the first place.

The RCA epitaxial version still offers you more than other similarly priced 2N3055's.

What extras do you get? Rugged steel headers (they give you aluminum). Clip-lead connectors (they give you wire bonds). Plus real-time process controls.

The RCA epitaxial - hometaxial option is available in three voltages. And if your choice is epitaxial you can have complementary pairs at all three levels.

They're all available now from your local

Buy as much SOA as you need.

NPN	PNP	V _{ceo}	SOA	Beta	1K Price
RCS617	RCS618	80	2.87A@40V	20-70@5A	0.88
2N3055	MJ2955	60	2.87A@40V	20-70@4A	0.55
2N6569	2N6594	40	2.87A@40V	15-200@4A	0.50
2N6254		80	1.87A@80V	20-70@5A	1.20
2N3055H		60	1.95A@60V	20-70@4A	0.95
2N6253		45	2.55A@45V	20-150@3A	0.55

*Optional distribution resale price. U.S. only.

RCA Distributor or Representative. Or send for complete data.

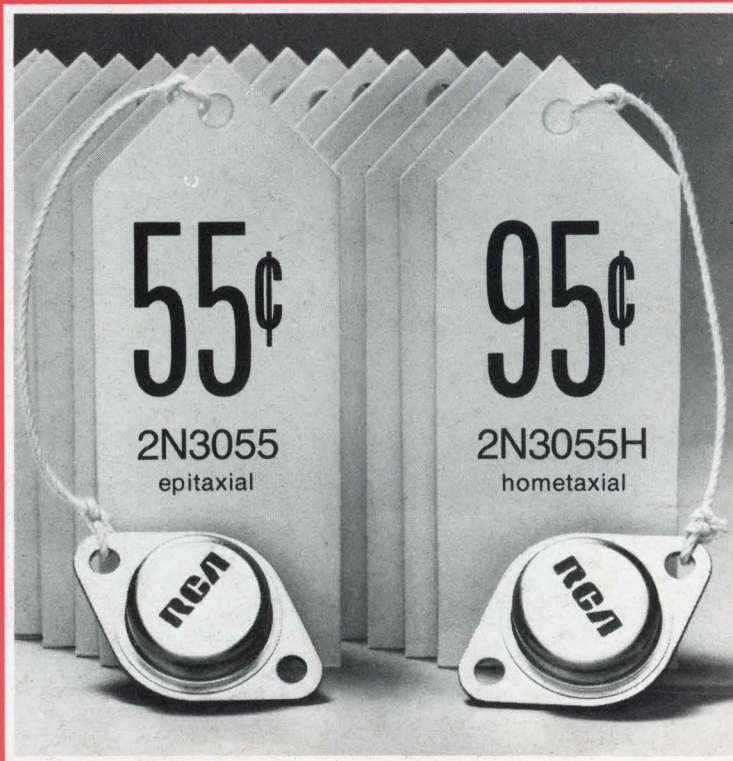

Write: RCA Solid State, Box 3200, Somerville, NJ 08876; Sunbury-on-Thames, Middlesex TW16 7HW, England; Ste.-Anne-de-Belleuve, Quebec, Canada; Fuji Bldg., Tokyo, Japan.

RCA Power experience is working for you.

RCA