

# Electronic Design<sup>®</sup> 11

VOL. 25 NO.

FOR ENGINEERS AND ENGINEERING MANAGERS

MAY 24, 1977

Counters are so good, you tend to take their readings on faith. But no counter is error-free: Time bases still wander, triggers still go off target. Misleading specs

keep accuracy in the shadows or hide instability behind a wall of numbers. Often, you're not told about sensitivity holes across the frequency range. More on p. 54



**RENEW NOW!**  
SEE CARD  
INSIDE  
COVER



# The \$2 Pot with the \$5 Linearity...

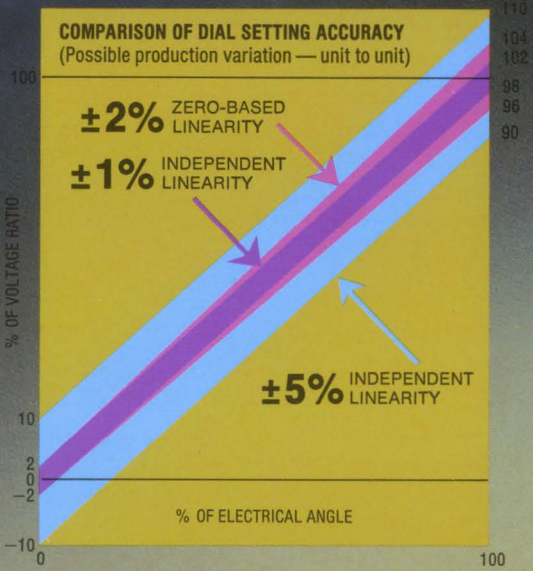
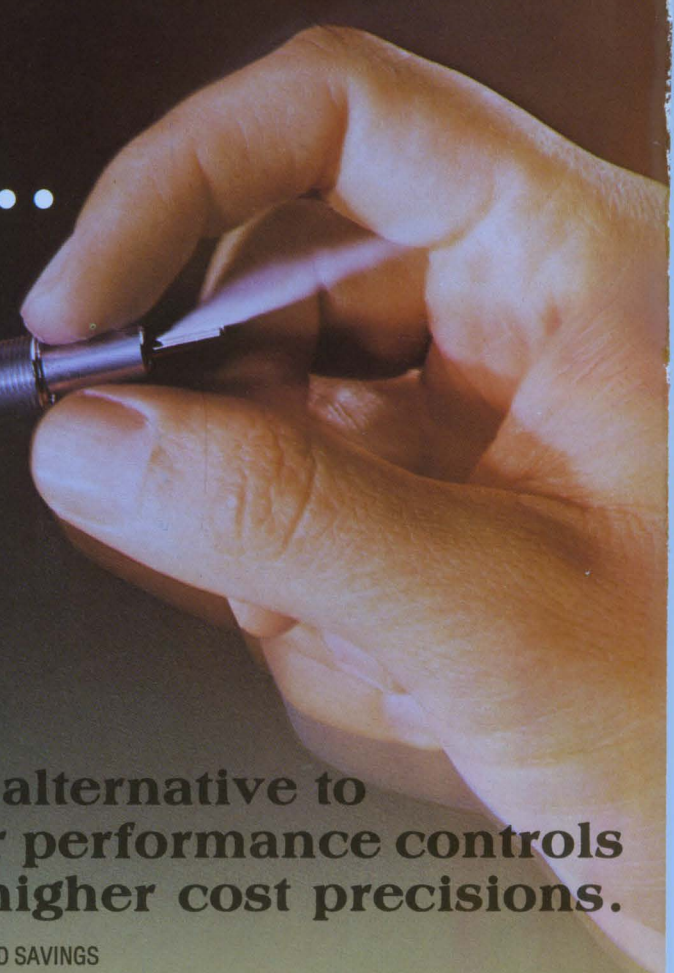

**Your alternative to lower performance controls and higher cost precisions.**

**LASER-TRIMMED SAVINGS**

Now, for about \$2\*, the Bourns® Model 87/88 semi-precision, single-turn potentiometer delivers  $\pm 2\%$  zero-based linearity. Compare the accuracy to the \$5 precision pot with  $\pm 1\%$  independent linearity that you're buying now . . . especially the performance at the low end setting, where dial setting accuracy is most critical. Laser trimming and advanced element design† deliver performance and savings in a  $\frac{5}{8}$ " square modular package.

**MOVE UP FROM INDUSTRIAL GRADE CONTROLS**

Again, for about \$2, the Model 87/88 offers 200-300% greater panel setting accuracy over industrial grade controls. They're perfect for applications requiring close, consistent calibration of output-to-panel setting and versatility of design.

**MODEL 87/88 — THE ALTERNATIVE**

Don't compromise your application with lower performance controls or pay a premium for precision pots. Specify the alternative — Bourns Model 87/88. Write or call today for complete technical information.

**\$2 SEMI-PRECISION MODULAR POTS . . . BEAUTIFUL!**

**TRIMPOT PRODUCTS DIVISION, BOURNS, INC., 1200 Columbia Avenue, Riverside, California 92507, Telephone (714) 781-5122 — TWX 910 332-1252.**

PERFORMANCE/COST COMPARISON			
Type	Element	Linearity	Approx. Cost
HIGHER COST PRECISION POTS	Conductive Plastic	$\pm 1\%$ Independent	\$5.00
BOURNS 87/88 SEMI-PRECISION POTENTIOMETERS	Conductive Plastic	$\pm 2\%$ Zero-Based	\$2.00
	Cermet	$\pm 2.5\%$ Zero-Based	
LOWER COST CONTROLS	Conductive Plastic/Cermet	$\pm 5 - 10\%$ Independent	\$1.00



\* Production quantities, Domestic U.S.A. price, Single cup unit only.  
† Patent Pending



International Marketing Offices: European Headquarters — Switzerland 042/23 22 42 • Belgium 02/218 2005 • France 01/2039633 • Germany 0711/24 29 36 • Italy 02/32 56 88 • Netherlands 70/87 44 00 • United Kingdom 01/572 6531 • Norway 2/71 18 72 • Sweden 764/20 110 • Japan 075/921 9111 • Australia 02/55-0411 03/95-9566 • Israel 77 71 15/6/7



# SURPRISE!

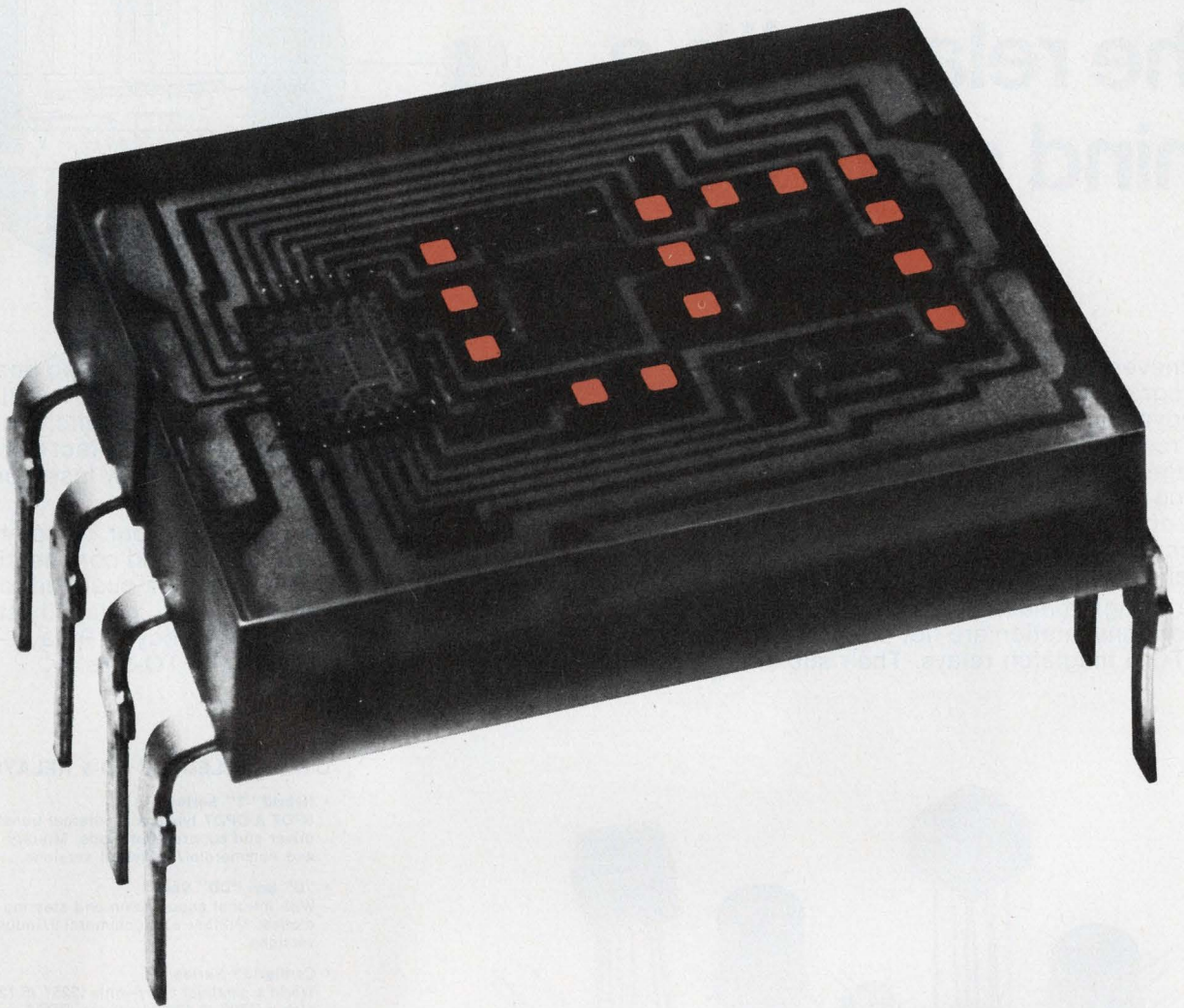

## We built in the decoder/driver so you don't have to.

Not only the decoder driver but memory too!

HP's family of integrated displays was designed with an on-board IC to save you time and up to 50% of the space required by conventional LED display systems. These bright 0.29 inch high, shaped character displays are completely TTL compatible. All you do is address them directly with four-line BCD input.

HP's 5082-7300 series displays include numeric displays with right- or left-hand decimal points, a hexadecimal display (0-9, A-F), and a "±1" polarity/overflow indicator.

For immediate delivery of any quantities you need, call Hall-Mark, Schweber, Wilshire, or the Wyle Distribution Group (Liberty/Elmar) today.

01329A

HEWLETT  PACKARD

Sales, service and support in 172 centers in 65 countries.  
Palo Alto, California 94304. Offices in principal cities throughout the U.S.

CIRCLE NUMBER 2



## TO-5 RELAY UPDATE

# Maglatch TO-5: the relay with a mind of its own.

Whenever critical switching circuits call for reprogrammable non-destructible memory, choose Teledyne's magnetic latching TO-5 — the relay that remembers. Once set with a short pulse of coil voltage, it will retain its state until reset or reprogrammed — even if system power fails or is shut off. And you get the added advantage of reduced system power demands, since conventional relay holding power is not required.

But reprogrammable memory capability and low power consumption are not the only advantages of our TO-5 maglatch relays. Their subminiature

size makes them ideal for high density pc board packaging, and they're available in SPDT, DPDT and 4PST contact forms. And for RF switching, their low intercontact capacitance and contact circuit losses provide high isolation and low insertion loss up through UHF.

Our magnetic latching as well as our complete line of TO-5 relays includes military and commercial/industrial types with MIL versions qualified to "L" and "M" levels of established reliability specs. For complete data, contact Teledyne Relays — the people who originated the TO-5 relay.

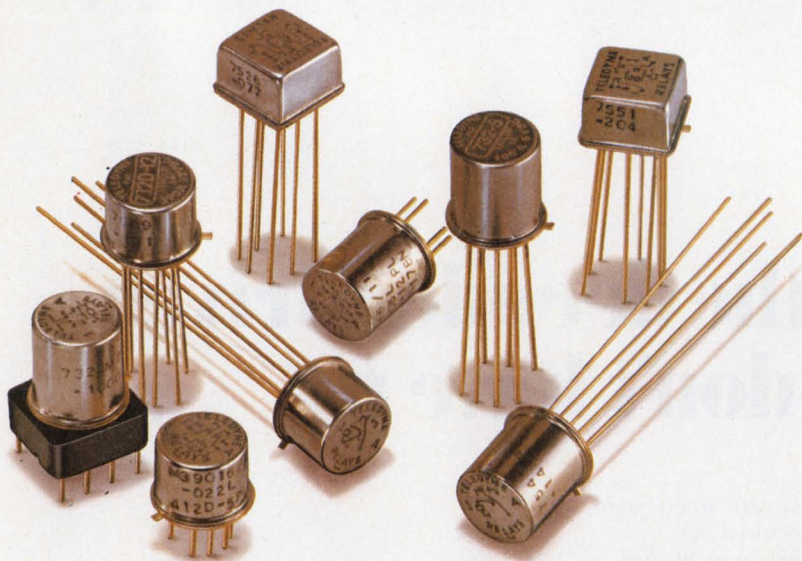
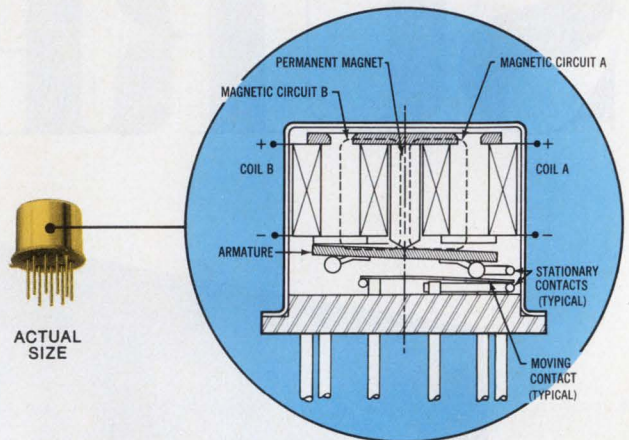

### OTHER TELEDYNE TO-5 RELAYS

- **Hybrid "T" Series**  
SPDT & DPDT types with internal transistor driver and suppression diode. Military and commercial/industrial versions.
- **"D" and "DD" Series**  
With internal suppression and steering diodes. Military and commercial/industrial versions.
- **Centigrad® Series**  
World's smallest relay—only .225" (5.72mm) high x .370" (9.40mm) square. DPDT, with optional internal suppression and steering diodes.
- **Hi-Rel Series**  
Screened versions for space flight applications (NASA qualified).
- **High Environment Series**  
Hi-temperature, Hi-shock, and Hi-vibration types.

 **TELEDYNE RELAYS**

3155 West El Segundo Boulevard, Hawthorne, California 90250  
Telephone (213) 973-4545

CIRCLE NUMBER 3



---

## NEWS

- 21 **News Scope**
- 28 **Next year, the Federal Communications Commission will select a standard** for stereo broadcasting on AM radio.
- 36 **Largest and heaviest oil rig** to monitor wind speed, direction of waves and its own stability.
- 45 **Washington Report**

---

## TECHNOLOGY

- 54 **FOCUS on electronic counters:** Although the counter has made remarkable advances, the manner of specifying one hasn't. Sensitivity and time-base specs are particularly troublesome. This report tells why.
- 162 **Matched filters boost receiver gain** by improving the signal-to-noise ratio. The resulting 'processing' gain can be vital in satellite systems.
- 172 **Slew rate important for audio amps?** Electrical and listening tests show that slew rate is a sensitive predictor of high-quality audio performance.
- 178 **Optimize transducer/computer interfaces** with these six easy steps and get the quality of data and number of useful bits needed for the computer input.
- 186 **Snare those elusive aliasing errors.** When you can't sample fast enough, use input filters to make sampled-data-acquisition systems more accurate.
- 194 **Keys to quality intercom design:** Speaker characteristics, impedance matching and balanced circuit loops assure interference-free response.
- 202 **Restore dc to your filtered channel** with an active clamp. You get practically ideal performance plus adjustability with this single-chip circuit.
- 206 **Dave Methvin of Computer Automation** speaks on getting your engineers to do engineering.
- 212 **Ideas for Design:**  
Control the ac input to a power supply and reduce variations by 40 dB.  
Measure relay-operate and release times automatically with digital timers.  
Use a remote-base biased SCR to make a simple HV logic translator.  
Double exposure lets you take good spectrum-analyzer photographs.
- 223 **International Technology**

---

## PRODUCTS

- 227 **ICs & Semiconductors:** Op amps jump ahead with less drift and more drive.
- 234 **Micro/Mini Computing:** Single-board minis deliver performance at low cost.
- 252 **Components:** Small low-cost solid-state relays handle the 50-to-40-A load range.
- 245 **Packaging & Materials**
- 250 **Power Sources**
- 255 **Modules & Subassemblies**
- 258 **Instrumentation**

---

## DEPARTMENTS

- 51 **Editorial:** Dear deer,
- 7 **Across the Desk**
- 262 **Design Aids**
- 262 **Application Notes**
- 262 **Bulletin Board**
- 263 **New Literature**
- 270 **Advertisers' Index**
- 272 **Product Index**
- 272 **Information Retrieval Card**

**Cover:** Cover photos courtesy of B & K Precision, Ballantine Laboratories, Dana, Data Precision, Data Tech, Digitec/United Systems, John Fluke Manufacturing Co., Hewlett-Packard, Philips Test and Measuring Instruments, Simpson Electric, Systron-Donner and Tektronix.

---

ELECTRONIC DESIGN is published biweekly except 3 issues in July by Hayden Publishing Company, Inc., 50 Essex St., Rochelle Park, NJ 07662. James S. Mulholland, Jr., President. Printed at Brown Printing Co., Waseca, MN. Controlled circulation postage paid at Waseca, MN and New York, NY, postage pending Rochelle Park, NJ, Atlanta, GA. Copyright© 1977. Hayden Publishing Company, Inc. All rights reserved. POSTMASTER: Please send form 3579 to ELECTRONIC DESIGN, P.O. Box 13803, Philadelphia, PA 19101.



# The 2900 Family: Two years later.

1975. Advanced Micro Devices introduces the world's best 4-bit microprocessor slice, the Am2901, along with a few support circuits.

1977. It's a whole new family. Now there's an Am2901A just like the Am2901, only better. Now there are 18 support circuits, two or three second sources and all the software you'd ever want. The 2900 family has become the family of the future. Here's why:

## **The first family.**

The Am2900 family is the first group of products designed specifically for microprogrammed machines. Microprogramming is rapidly becoming the most popular way to design medium- and high-performance systems, to reduce development time, make changes easily, and conveniently add new features.

## **Less weight, less size.**

With the Am2900 family, it's not uncommon for entire boards to be eliminated. You'll shrink system size and weight, increase

overall reliability and reduce manufacturing costs.

## **Time goes by, price goes down.**

In July 1975, we told you we'd reduce the cost of the Am2901 by 30% per year. We've done it twice. Once in April 1976 and once in March 1977. The Am2900 family gets less and less expensive all the time.

## **We're so popular, we're the industry standard.**

The Am2900 family is the most widely used Bipolar LSI family in:

- Minicomputers: For emulators, high-performance CPU's and add-ons by eight out of the top ten U.S. manufacturers.
- High-performance controllers: For discs, tapes, floppy discs and universal controllers.
- Communications: For PBX systems, central exchanges, multiplexers and modems.
- Military: For radar processors, display systems and the Navy's new standard avionic computer, the AN/AYK-14.



### The Family:

CPU Slice (ALU and general registers)	Am2901A, 2902, 2903*, 2904*
Microprogram Control Units	Am2909, 2910*, 2911
Branch and Instruction Control for Microprogram Sequencers	Am29803, 29811
LSI Bus Interface Devices	Am2905, 2906, 2907, 2915A, 2916A, 2917A
Priority Interrupt Control	Am2913, 2914
Main Program Control	Am2930*, 2931*, 2932*
New More Powerful MSI functions	Am2918, 2919, 2920, 2921, 2922

\*In Development

### Plus:

Schottky and low-power Schottky MSI, MOS static and dynamic RAM's and all the devices you need to build your high-performance microcomputer.

### We don't sell and run.

Advanced Micro Devices offers learning aids to help speed up designs and keep your engineers up-to-date on the very latest microprogramming techniques. Learning aids and application materials like these perennial favorites:

- A 16-Bit Microprogrammed Computer
- The Am2900K1 Learning and Evaluation Kit
- The Microprogramming Handbook

- A High Performance Microprogrammed Disc Controller  
In development:
- Vertically Microprogrammed State Machines
- An emulation of the Am9080A/8224/8228 using the Am2900 family

### And two terrific design aids:

#### AMDASM

Our powerful, easy-to-use microprogram assembler offering software support through the worldwide INFONET time-sharing division of Computer Science Corporation. (It supports user-defined mnemonics for producing microinstructions up to 128 bits wide, and includes formatting and default features as well as tape generation for PROM programmers. If you've got the other guy's MDS system, ask for AMDASM/80. It comes on a floppy disk and runs under their operating system.)

#### AMDS

Beginning this fall, we'll be offering hardware support with the Advanced Microprogram Development System. (It's the first prototyping system especially designed for microprogramming systems.) It'll help speed up construction of prototype systems and generation and de-bug of microcode. Resident AMDASM, of course!

### The Am2900 family.

It's today's product family for tomorrow's high-performance machines. Am2900. Remember that number. You're going to be hearing it a lot.

# Advanced Micro Devices

Bipolar LSI. N-channel, silicon gate MOS. Low-power Schottky.  
Multiple technologies. One product: excellence.





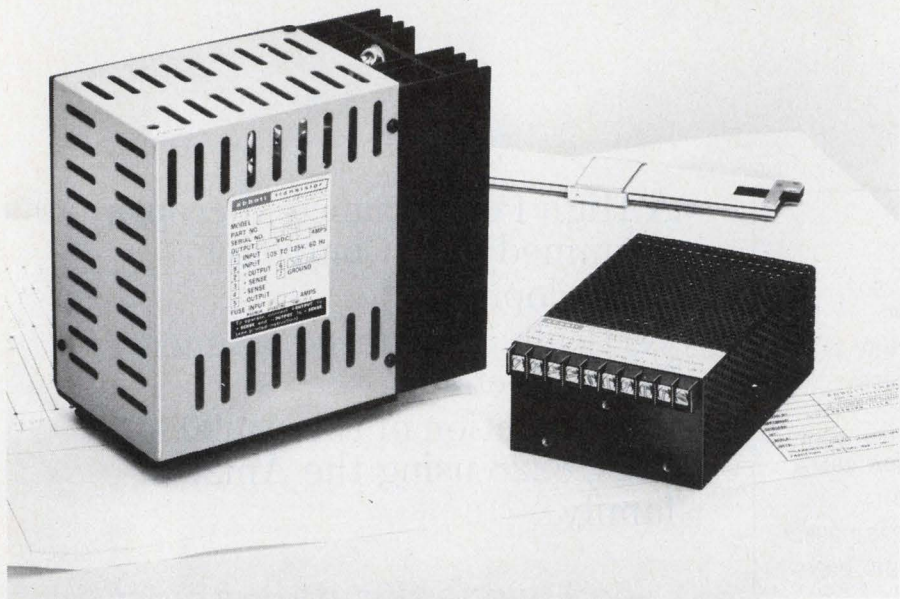

## Reduce Your Power Supply Size and Weight By 70%

A new way has been found to substantially reduce power supply size and weight. Consider the large power supply shown at left in the above photo — it uses an input transformer, into a bridge rectifier, to convert 60 Hz to 5 volts DC at 5 amperes. This unit measures 6½" x 4" x 7½" and weighs 13 pounds. Abbott's new model Z5T10, shown at right, provides the same performance with 70% less weight and volume. It measures only 2½" x 4" x 6" and weighs just 3 pounds.

This size reduction in the Model Z5T10 is primarily accomplished by eliminating the large input transformer and instead using high voltage, high efficiency, DC to DC conversion circuits. Abbott engineers have been able to control the output ripple to less than 0.02% RMS or 50 millivolts peak-to-peak

maximum. This design approach also allows the unit to operate from 100 to 132 Volts RMS and 47 to 440 Hertz. Close regulation of 0.15% and a typical temperature coefficient of 0.01% per degree Celsius are some of its many outstanding features. This new Model "Z" series is available in output voltages of 2.7 to 31 VDC in 12 days from receipt of order.

Abbott also manufactures 3,000 other models of power supplies with output voltages from 5 to 740 VDC and with output currents from 2 milliamps to 20 amps. They are all listed with prices in the new Abbott catalog with various inputs:

60  $\text{A}$  to DC  
400  $\text{A}$  to DC  
28 VDC to DC  
28 VDC to 400  $\text{A}$   
12-28 VDC to 60  $\text{A}$

Please see pages 1836-1848 of your 1976-77 EEM (ELECTRONIC ENGINEERS MASTER Catalog) or pages 676-682 Volume 2 of your 1976-77 GOLD BOOK for information on Abbott Modules.

Send for our new 60 page FREE catalog.

**abbott transistor**  
LABORATORIES, INCORPORATED

GENERAL OFFICES  
5200 W. Jefferson Blvd.  
Los Angeles, CA 90016  
(213) 936-8185  
Telex 69-1398

EASTERN OFFICES  
1224 Anderson Ave.  
Fort Lee, NJ 07024  
(201) 224-6900  
Telex 13-5332

CIRCLE NUMBER 4

### Sr. Vice President, Publisher

Peter Coley

### Editors

Editorial Offices  
50 Essex St.  
Rochelle Park, NJ 07662  
(201) 843-0550  
TWX: 710-990-5071  
(HAYDENPUB ROPK)  
Cable: Haydenpubs Rochellepark

Editor-in-Chief George Rostky

### Managing Editors:

Ralph Dobriner  
Michael Elphick

### Senior Associate Editor

Stanley Runyon

### Associate Editors:

Sid Adlerstein  
Dave Bursky  
Morris Grossman  
John F. Mason  
Andy Santoni  
Max Schindler

### Contributing Editors:

Peter N. Budzilovich, Jules H. Gilder,  
John Kessler, Alberto Socolovsky,  
Nathan Sussman

### Editorial Field Offices

#### East

Jim McDermott, Eastern Editor  
P.O. Box 272  
Easthampton, MA 01027  
(413) 527-3632

#### West

Dick Hackmeister, Western Editor  
8939 S. Sepulveda Blvd., Suite 414  
Los Angeles, CA 90045  
(213) 641-6544  
TWX: 1-910-328-7240

Dave Barnes  
844 Duncardine Way  
Sunnyvale, CA 94087  
(408) 736-6667

### Editorial Production

Marjorie A. Duffy, Production Editor  
James Keane, Copy Editor

### Art

Art Director, William Kelly  
Richard Luce, Anthony J. Fischetto

### Production

Manager, Dollie S. Viebig  
Helen De Polo, Nancy Hurey

### Circulation

Director, Barbara Freundlich

### Information Retrieval

Paula Greenleaf

### Advertising Promotion

Susan G. Apolant

### Reprints

Maxine Correal



# Across the desk

## Back in the 1950s

In "Software for Microprocessors: Part 1" (Ed No. 1, Jan. 4, 1977, p. 90), the author states: "It takes a string of 24 binary digits to spell 'GO!' to your computer. You certainly cannot write a whole program that way." I disagree. You certainly *can* write a whole program that way. As a matter of fact, in the early 1950s that was the only way you could write a program because there were no assemblers, compilers, or any other language processor. In those days all programming had to be done in machine language using absolute memory addresses.

*John W. Meyers*

8808 Peabody St.  
Manassas, VA 22110

## Watch that bracket

Regarding your article on microprocessor software (ED No. 1, Jan. 4, 1977, p. 90), I discovered an error on p. 95, where the following statement is made: "Thus [addr] means 'Contents of the memory location addressed by addr.' According to the definitions made in that same paragraph, this statement is not true unless the order of the enclosing symbols is reversed to read ([addr])."

Despite the inaccuracy (probably "corrected" by a diligent proofreader conforming to proper bracketing rules), I thoroughly enjoyed the article and hope to see more of the same.

*Fulton Smith, Jr.*

*Product Design Engineer  
Advanced Engine Engineering*

Ford Motor Co.  
Allen Park, MI 48101

*Ed. Note: Yes, Mr. Smith is absolutely right, the order is reversed. No, the source was not a proofreader, but an editor rushing to make the deadline.*

## What's in a name...

The volume on receivers in the MIT Radiation Laboratory series mentions the "Yehudi circuit." Would any of your readers know what this is? It certainly has an interesting name, but seems to appear nowhere else.

*I. Borditch*

4007 Rosecrest Ave.  
Baltimore, MD 21215

## Misplaced Caption Dept.

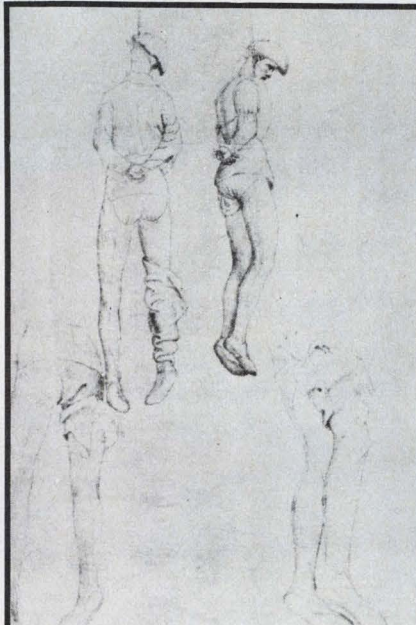

We know there were a few customer complaints about reliability, but basically the design was sound.

Sorry. That's Antonio Pisanello's "Studies of Men Hanging on the Gallows," which hangs in the Frick Collection, New York City.

*(continued on page 11)*

Electronic Design welcomes the opinions of its readers on the issues raised in the magazine's editorial columns. Address letters to Managing Editor, Electronic Design, 50 Essex St., Rochelle Park, NJ 07662. Try to keep letters under 200 words. Letters must be signed. Names will be withheld upon request.



## OPTRON REFLECTIVE TRANSDUCERS

NEW OPB 704 OFFERS  
MAXIMUM RELIABILITY  
IN A SINGLE  
HERMETIC PACKAGE

OPTRON's new, low cost OPB 704 reflective transducer assures maximum reliability by combining a high efficiency solution grown LED with a silicon phototransistor in a single miniature hermetic package.

The hermetically sealed glass-metal-ceramic package offers extremely high reliability and stable performance at a cost competitive with that of plastic encapsulated devices. And, the OPB 704 has a usable continuous operating life of more than five years when operated at an average LED device current of 20 mA.

The OPB 704's phototransistor senses radiation from the LED only when a reflective object is within its field of view. With an LED input current of 50 mA, the output of the phototransistor is typically 0.5 mA when the unit is positioned 0.100 inch from a 90% reflective surface. With no reflective surface within the phototransistor's field of view, maximum output is 10  $\mu$ A with a LED input of 50 mA and  $V_{CE}$  of 5 volts.

Ideal applications for the OPB 704 reflective transducer include EOT/BOT sensing, mark sensing, detection of edge of paper or cards and proximity detection.

The OPB 704 and other low cost, high reliability OPTRON reflective transducers are immediately available. Custom designed versions for special applications are available on request.

Detailed information on the OPB 704 reflective transducer and other OPTRON optoelectronic products... chips, discrete components, limit switches, isolators and interrupter assemblies... is available from your nearest OPTRON sales representative or the factory direct.



**OPTRON, INC.**

1201 Tappan Circle  
Carrollton, Texas 75006, U.S.A.  
TWX-910-860-5958  
214/242-6571



# Designing microprocessor

Get a system overview with this memory map. The 1600S shows how your memory is being utilized in an operating program. Knowing how your memory is organized, you can see at a glance what your program is doing and the relative time being spent in any one memory location. This helps you spot unwanted program sequences or parts of your program that aren't being implemented.

Base page data storage

I/O ports

Stack storage

Executive, interrupt and subroutine program

Interrupt vector address

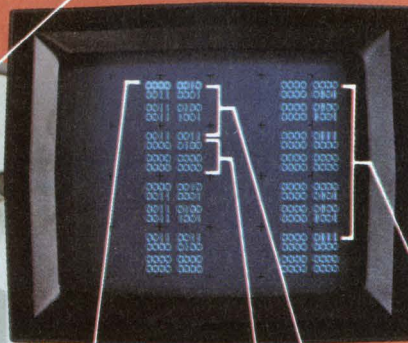
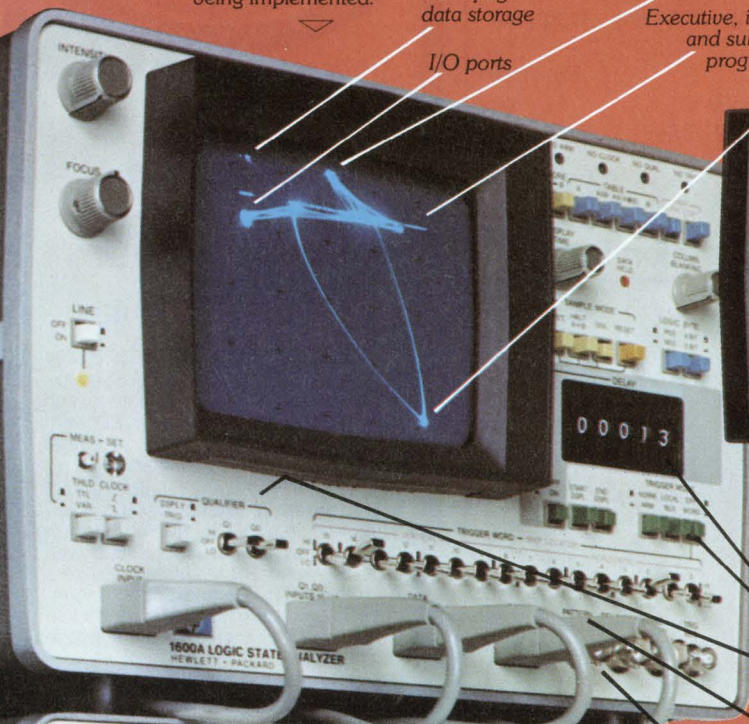

Monitor a serial data stream and compare new data with that previously stored. This display shows software conversion of BCD data at a 7-segment display to an ASCII format. Column blanking simplifies display by showing only 8 of 16 bits available.

Intensified bits are those that have changed since start-up.

Preamble

Postamble

ASCII of displayed data

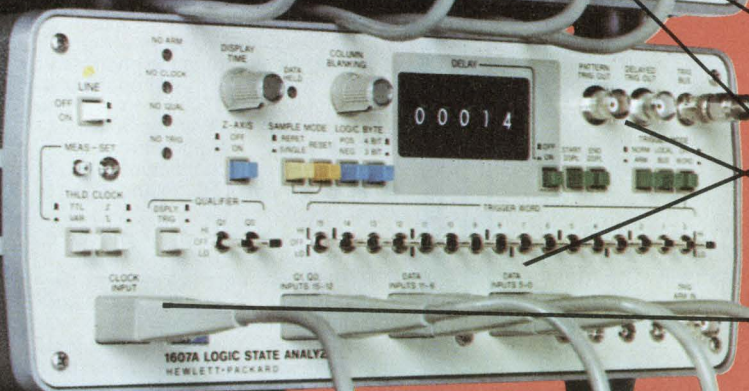

**Qualifiers**, digital delay and various local or bus-triggering modes give you pinpoint selection of data flow for effective program tracing.

**Up to 32 channels** let you see all the action on the microprocessor address and data buses plus the I/O, peripherals or any other logic section of your microprocessor system.

**Output triggers** drive your scope—at the right instant—for making electrical measurements in the time domain.

**Dual clock** means you can easily relate bus activity to events occurring elsewhere at a different clock rate.

**Serial-to-Parallel Converter** (HP's 10254A) lets you directly view serial data in relation to parallel data on the system bus.

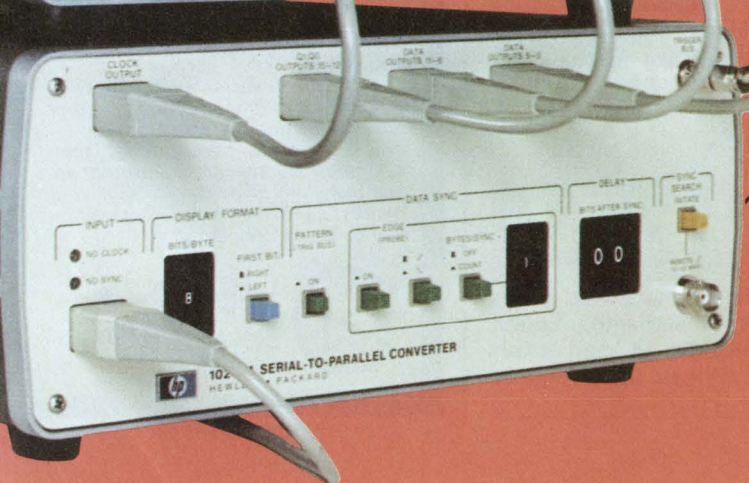

## FREE DATA DOMAIN SEMINAR

Find out for yourself how HP Logic State Analyzers can broaden your view of the data domain and speed digital design and debugging of your microprocessor-based system.

Seminars are scheduled in a number of cities throughout the country. Ask your HP field engineer about specific details on seminars in your area.







# When you need to get the most out of tin-contact pc connectors, you need AMP's bifurcated leaf design.

Because true bifurcated design gives you the extra reliability of full contact redundancy. And computer design yields optimum, predetermined contact forces for a dependable tin/tin interface. Firm wiping action with board pads for intimate electrical contact. In short, all the cost economy of tin without losing high conductivity and reliability.

These U.L. recognized AMP connectors have housings made of 94V-O flame retardant thermoplastic that can withstand temperatures as high as 120°C. There are board-to-board and wire-to-board types for single-sided boards, and a wide variety of accessories including locking levers, locking plugs, card guides and keying plugs. Contacts handle a wire range of #30 to #18 AWG and a current range of 1 to 5 amps.

You'll gain many more advantages with these economical connectors, including one of the most important. AMP backup. You can count on it to make sure our products deliver the kind of performance you expect.

For more information on AMP Bifurcated Leaf connectors, call Customer Service at (717) 564-0100. Or write AMP Incorporated, Harrisburg, PA 17105.

AMP has a better way.

# AMP

INCORPORATED

CIRCLE NUMBER 7

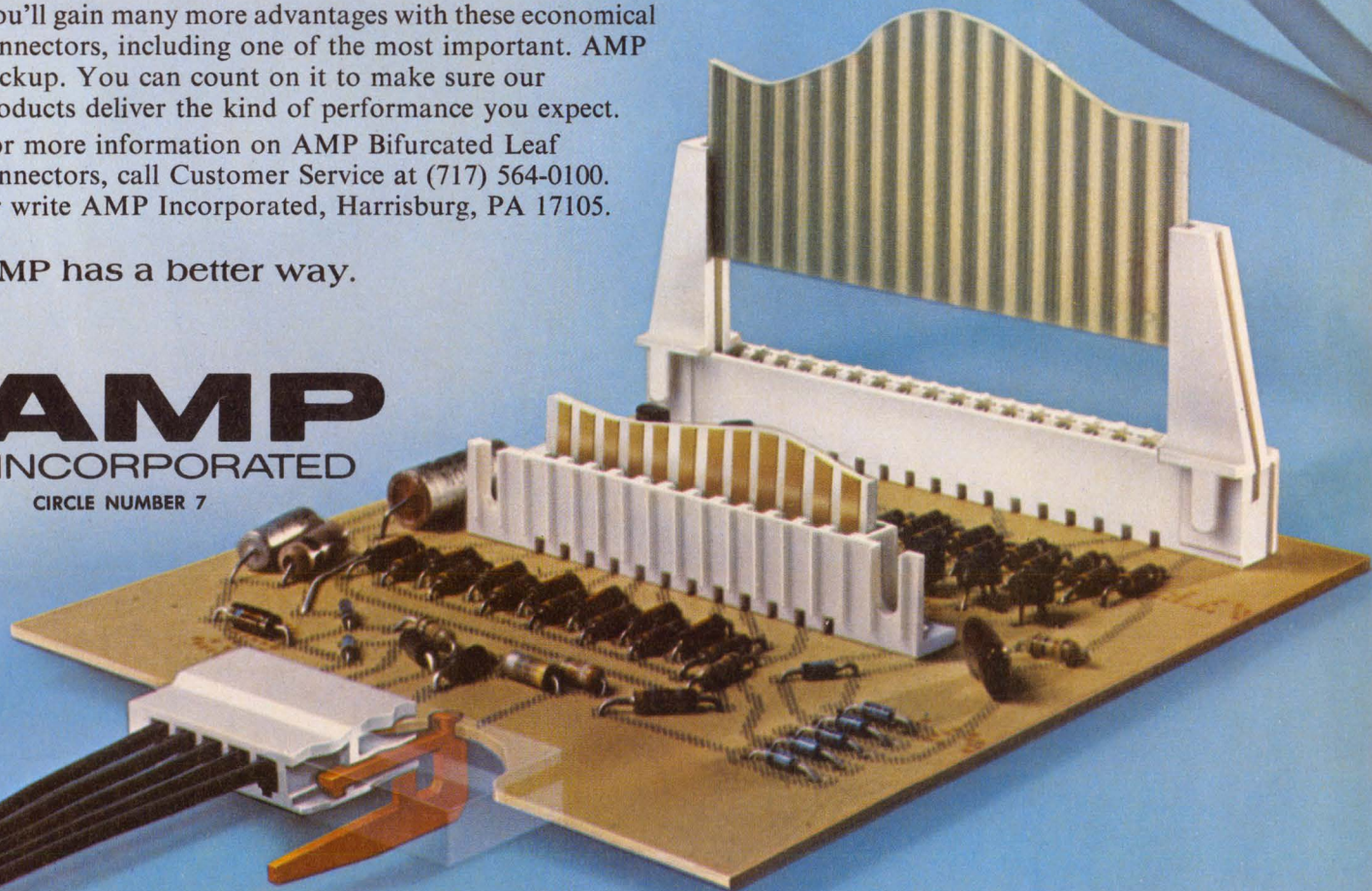



## AMP EUROPE

**Austria** — AMP Austria. Branch of AMP Deutschland GmbH. Markgraf-Ruediger Str. 6-8, 1150 Vienna. Phone: 924191/92

**Belgium** — AMP Belgium. Branch of AMP-Holland B.V., Rue de Brabant 62-66, Brussels. Phone: 322.17.55.17

**Finland** — AMP Finland OY  
Postilokero 3, 00401 Helsinki 40  
Phone: 90/584122

**France** — AMP of France, 29 Chaussée Jules-César, Boite Postale No. 39, 95301 Pontoise France. Phone: 030 82 20, 030 92 30

**Germany** — AMP Deutschland GmbH. Ampèrestrasse 7-11, 607 Langen, B. FFM., West Germany. Phone: (06103) 7091

**Great Britain** — AMP of Great Britain Limited, Terminal House, Stanmore, Middlesex, England. Phone: 01-954-2356

**Holland** — AMP Holland B.V., Papierstraat 2-4 's-Hertogenbosch, Holland. Phone: (04100) 25221

**Italy** — AMP Italia S.p.A., Via Fratelli Cervi 15, 10093 Collegno (Torino), Italy. Phone: 785-656

**Spain** — AMP Española, S.A., Apartado 5294, Pedro IV, 491, 495, Barcelona 5, Spain. Phone: 307-75-50

**Sweden** — AMP Scandinavia AB, Datavägen 5, 17500 Jakobsberg, Sweden, Mailing Address: Fack S-175 20 JARFALLA 1, Sweden. Phone: 0758/10400

**Switzerland** — AMP AG, Haldenstrasse 11, 6006 Luzern, Switzerland. Phone: (414) 235421, 235422, 235423

## AMP NORTH AMERICA

**Canada** — AMP OF CANADA LTD., 20 Esna Park Drive, Markham, Ontario, Ph: 416-499-1251

**Mexico** — AMP de Mexico, S.A., Apartado Postal 179, Naucalpan de Juarez, Edo, de Mexico, Phone: Mexico City 576-41-55

**Puerto Rico** — AMP OF CANADA LTD., 677 Calé de Diego, Rio Piedras, Puerto Rico 00924, Phone: (809) 766-2346

**United States** — AMP Incorporated, Harrisburg, Pa. 17105, Phone: 717-564-0100

## AMP SOUTH AMERICA

**Argentina** — AMP S.A. Argentina 4 de Febrero, 76 Villa Zagla — SAN MARTIN, Buenos Aires, Argentina, Phone: 752-4612

**Brazil** — AMP do Brasil Ltda., AV Comendador Martinelli 185, Lapa, Sao Paulo, Phone: 262-4353

## AMP PACIFIC

**Australia** — Australian AMP Pty. Limited, 155 Briens Road, Northmead, N.S.W. 2152 Australia, Mailing Address: P.O. Box 194, Baulkham Hills, N.S.W. 2153 Aus. Ph: 630-7377

**Japan** — AMP (Japan), Ltd., No. 15-14, 7-Chome, Roppongi Minato-Ku, Tokyo, Japan, Ph: 404-7171

Products and services for many specialized industries are provided by the AMPLIVERSAL Division. In the United States, this division is known as AMP Special Industries.

For Amp products and services in other countries, write: AMP International Division, Harrisburg, PA 17105, USA.



## Across the desk

### 'Resolving' an oversight

In our March 1 story on Guildline Instruments' 7-½-digit voltmeter (ED No. 5, p. 18), we said that the highest-resolution DVM available in the United States was the 6-½-digit Dana/Keithley 6900. Dave Komoroff, a sales representative at Julie Research Laboratories Inc. in New York City, reminds us that his firm also makes a 6-½-digit voltmeter, the Model DM-1000.

### Have a little more

Thank you for publishing my article, "Starting the  $\mu$ P Software" (ED No. 25, Dec. 6, 1976, p. 74). The following was left out and I think that it will help readers understand the last section of the article:

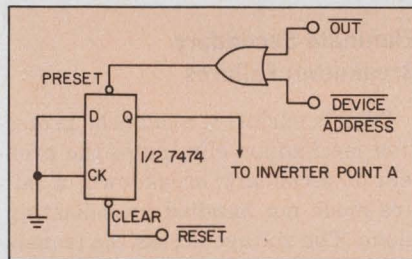

"You can also use an output-device select pulse to remove the reset from the 7498 counter. Since the output pulse lasts for only one 8080 clock period, or 500 ns at 2 MHz, use the other half of the 7474 flip-flop. The additional circuitry is shown in the figure. Only four IC packages are needed, along with the switches and input ports."

Jonathan A. Titus

Tychon, Inc.  
P.O. Box 242  
Blacksburg, VA 24060

### Two important points weren't featured

I just read the April 12th cover story feature of Tektronix's new spectrum analyzer and must confess that I was surprised that two very significant elements were omitted from the story.

First of all, there is no mention of product availability. Second, nothing whatsoever was said about the fact

that the Tek analyzer only measures down to 1.5 GHz, whereas every other analyzer listed in the story measures down to 10 MHz or less. We think that most people interested in microwave spectrum analyzers would deem the 10 MHz to 1.5-GHz gap in coverage as important as many of the other features and specs that were mentioned.

Dean Abramson

Hewlett-Packard  
Santa Rosa Div.  
1400 Fountain Grove Parkway  
Santa Rosa, CA 95404

*Ed. Note: Both elements are indeed important and should have been included. The quoted delivery of the Tektronix analyzer is 16 to 18 weeks.*

### Me an editor?

Maybe. If you would enjoy interviewing industry authorities, and writing and editing articles on the latest technological developments, you might enjoy being an editor.

We have openings at our home office in New Jersey. Write to Mike Elphick, Managing Editor, Electronic Design, 50 Essex St., Rochelle Park, NJ 07662.

### A matter of definition

Two of the software definitions you have on page 24 of the January 18 issue may be misleading. You define a compiler as a program to translate an assembled program into a machine-code listing. To some of us, an assembled program is the output of an assembler, and a compiler outputs much more than a listing. As I'm sure you know, the function of a compiler is to fully translate some high-level programming language into machine code that can be executed at some later time. The subroutine library and loading functions may also be included as part of the compiling process.

In another definition, you describe the function of a disassembler correctly; therefore, it is the reverse process of an assembler, not a compiler (otherwise we would have to call it a discompiler).

Gerald Cahill

System Programmer, USAF

2550 East Ave. I  
Space 90  
Lancaster, CA 93534



# Common RF Transistor Failures—that shouldn't happen

Most RF circuits are plagued with semiconductor failures that are costly to you as an Original Equipment Manufacturer in terms of reworks, lost customers and lost profits. These are failures that just shouldn't happen. With TRW RF Semiconductors' technological advances, there's no reason for you—or your circuits—to suffer from these annoying failures any longer.

## Eliminate Costly Mismatch Failures

TRW's RF Transistors are guaranteed to withstand all mismatch conditions (any magnitude, any phase angle). This guarantee eliminates costly failures due to inadvertent mismatches in your laboratory, on your production line or in the field. TRW's RF devices are 100% on-line tested for VSWR to assure you die-mount integrity and overall ruggedness.

## Eliminate Ballast Resistor Failures

TRW's unique diffused ballast resistors eliminate peeling and micro-cracking—two of the primary causes

of failures associated with thin-film, metal ballast resistors (see Point 1 in illustration below). Since TRW's ballast resistors are diffused directly into the silicon die (see Point 1a), resistance values from  $25\Omega$  to  $100\Omega$  are achieved. The practical limit with thin-film ballasting is only  $8\Omega$  to  $10\Omega$ . These higher ballast levels provide near-perfect finger-to-finger and cell-to-cell current sharing thereby eliminating deadly "hot-spotting" by equalizing temperature distribution.

## Eliminate Secondary Breakdown Failures

TRW's exclusive avalanche protection mechanism eliminates the problem of secondary breakdown, a failure mode not handled by ballasting alone. The voltage across the transistor junction is never allowed to reach breakdown. The P-N diode of the ballast resistor is diffused to avalanche several volts less than the transistor junction. Under severe mismatch conditions when voltages in excess of breakdown occur, the diode conducts the full avalanche cur-

rent, thus protecting the transistor junction. True "full circle" VSWR protection of your RF devices is achieved.

## Eliminate Metal Migration And Crowding Failures

Another primary wear-out mechanism in RF transistors—metal migration—is prevented because of TRW's exclusive etchless gold die metallization process. The etchless process (see Point 2) prevents finger scalloping, characteristic of all etching processes and eliminates resultant current crowding where metal fingers are necked down (see Point 2A). The gold metallization system not only capitalizes on the vast improvement in electromigration properties of gold over aluminum, but also assures you that the metal lifetime design criteria are retained in the manufacturing process.

## Eliminate Failures From Intermetallic Formations

Intermetallic formations and resultant failures you find with other

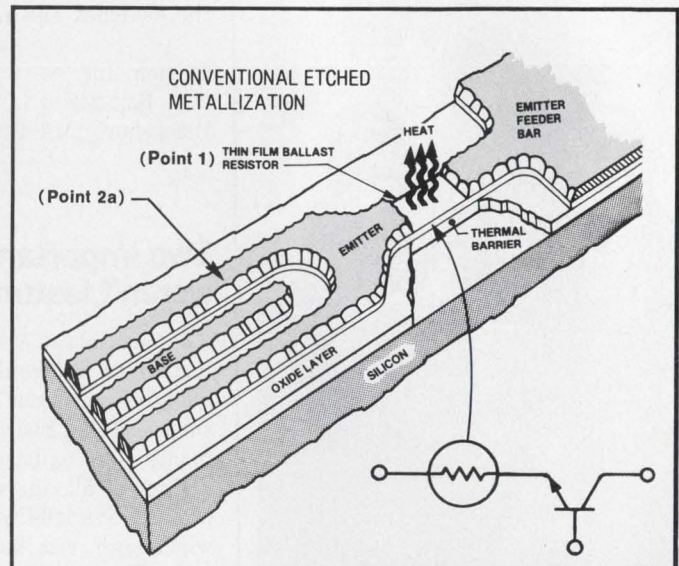
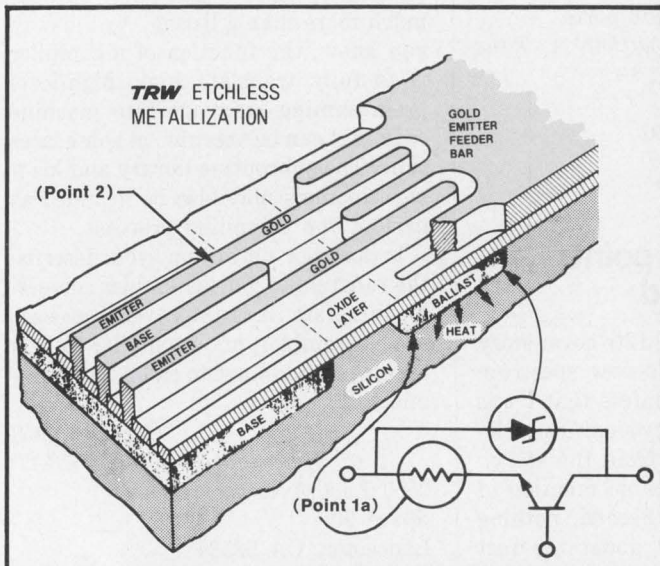



RF devices are prevented by TRW's use of gold metallized die, gold wire bonds and gold package metal. Gold wire bonding does not work-harden and is thousands of times more resistant to fatigue than is the more

brittle aluminum wire alternative. TRW's gold thermal-compression bonding technique provides you with bond-to-pad mechanical integrity, not possible with aluminum or ultrasonic bonding systems.

### Performance And Reliability

Take advantage of TRW Semiconductors' performance and reliability in your next circuit design. Check our chart. We have RF devices for every circuit requirement. More details are available in our Product Selection Guide.

## RF POWER TRANSISTORS & HYBRIDS—BUILT-IN RELIABILITY

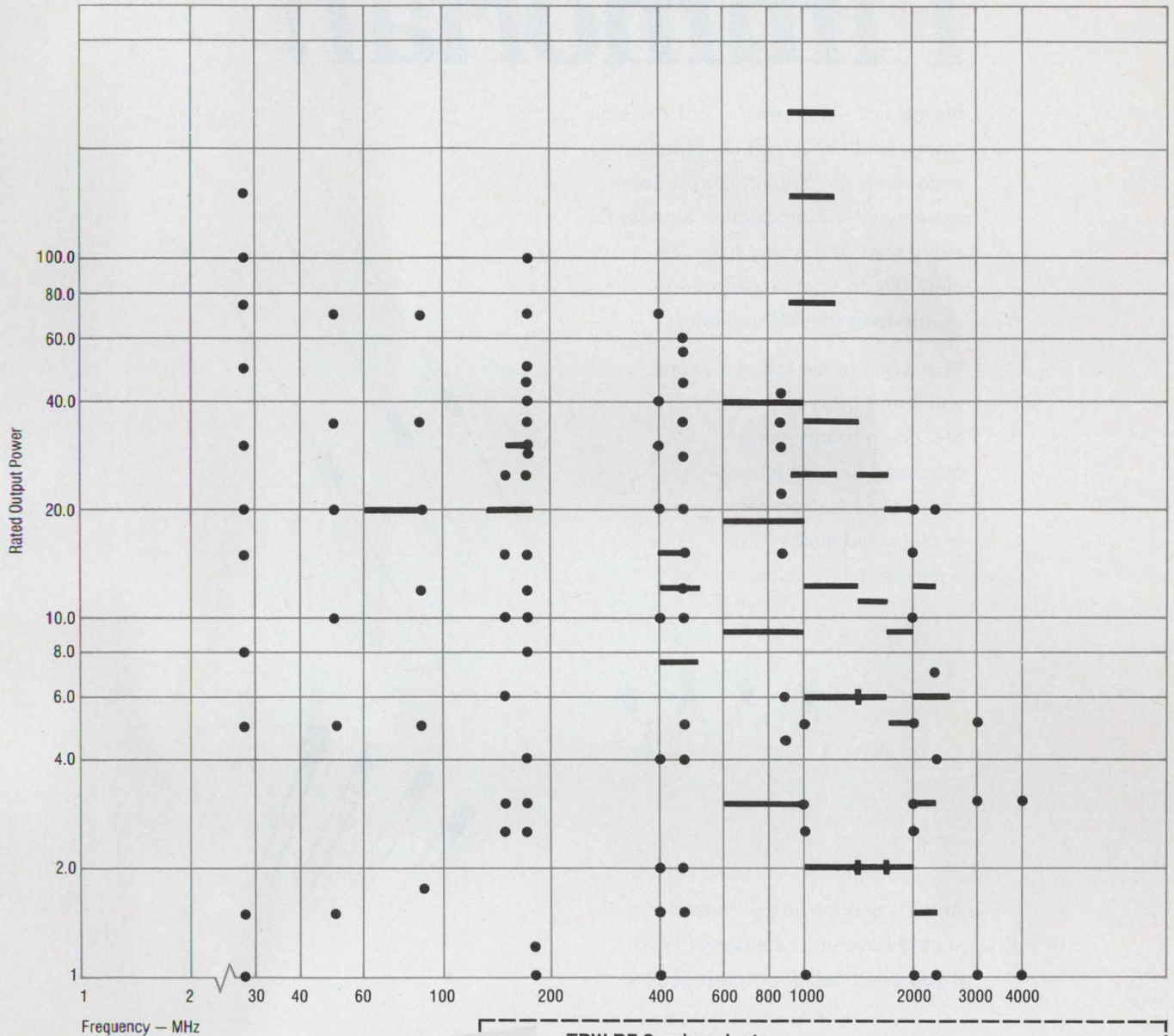

### Aren't they worth checking out?

Use this coupon, or call Warren Gould at (213) 679-4561 for complete specs and samples of TRW RF discretes and hybrids—milliwatts to kilowatts, 1MHz to 4GHz. When it comes to RF semiconductors, we're ready to help.



#### TRW RF Semiconductors

An Electronic Components Division of TRW Inc.  
14520 Aviation Blvd., Lawndale, California 90260

Please send me your new RF Product Selection Guide.

Please have an applications engineer contact me: \_\_\_\_\_ (PHONE)

NAME \_\_\_\_\_

POSITION \_\_\_\_\_

COMPANY NAME \_\_\_\_\_

ADDRESS \_\_\_\_\_

CITY \_\_\_\_\_ STATE \_\_\_\_\_ ZIP \_\_\_\_\_ ED \_\_\_\_\_

# TRW RF SEMICONDUCTORS

ANOTHER PRODUCT OF A COMPANY CALLED TRW

CIRCLE NUMBER 8



# iiimmortal?

Maybe not iiimmortal . . . but certainly "long-iiife"! Our Hitachi-tantalum capacitors are manufactured under extremely tight production standards, every step of the way from raw materials to final inspection, to assure long reliable service.

That's one of the major reasons you'll find them in a variety of leading brand-name products, from small economical consumer items to major industrial equipment.

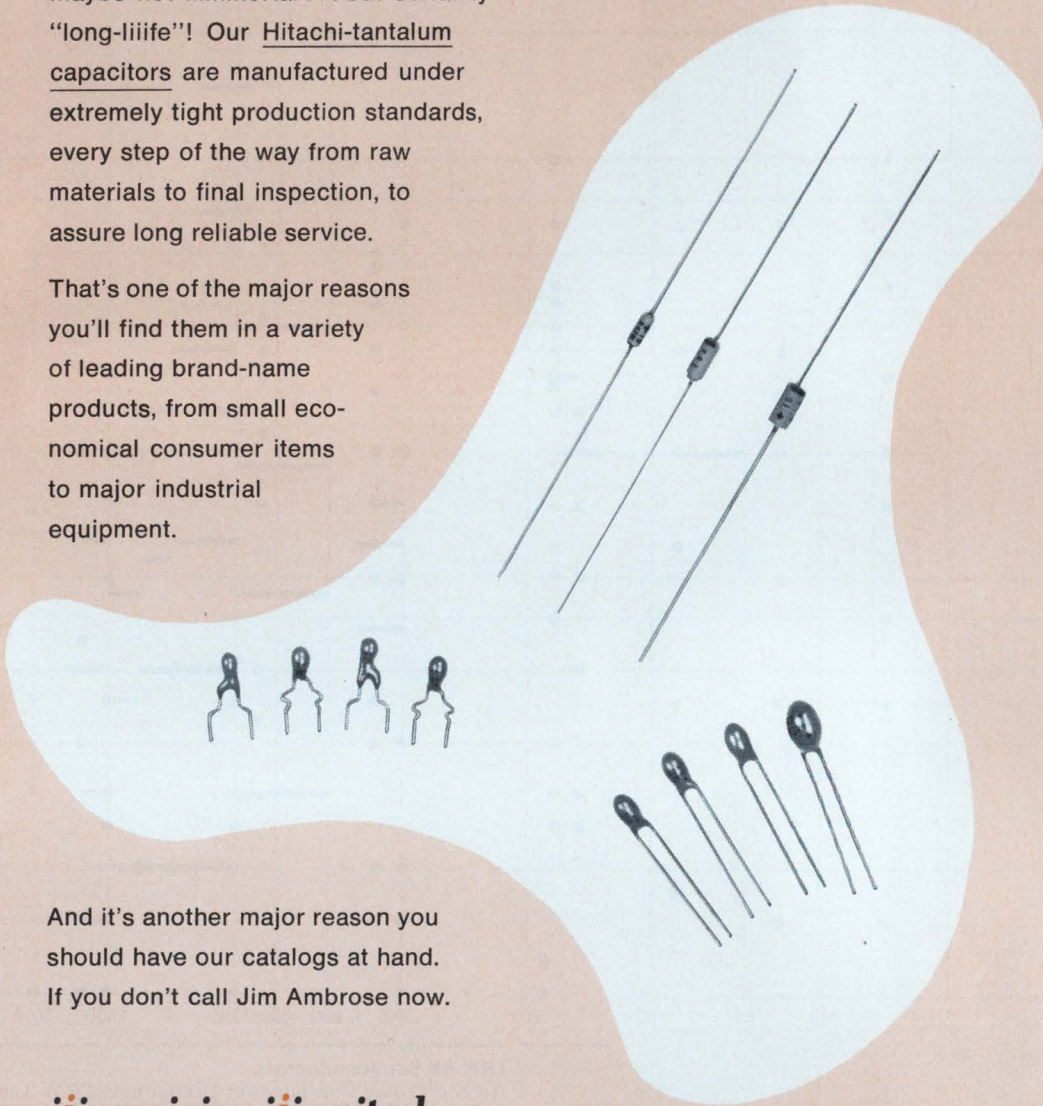

And it's another major reason you should have our catalogs at hand. If you don't call Jim Ambrose now.

**iiinquiries iiinvited**



2244 S. Western, Chicago, IL 60608 • (312) 254-4252



# What this country needs is a good \$39 DPM.

And we've got it.

The AD2026 from Analog Devices. Priced at \$39 in hundreds\*, it's the first real alternative to the measurement grade analog panel meter. And the first to give you all the advantages of a DPM at a practical price. Advantages like visual appeal, accuracy, resolution, small size and reliability.

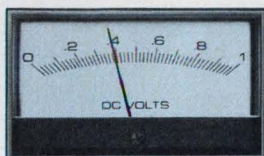

The AD2026 is a three digit, logic powered DPM that measures and displays voltages from  $-99\text{mV}$  to  $+999\text{mV}$  on 0.5" LEDs. It consumes only  $\frac{3}{4}$  Watts of 5V power. And because the AD2026 can be scaled with a simple resistive divider on its input pins, you can get direct readout in any engineering unit with equal or better resolution than APMs.

With an accuracy of 0.1% of reading  $\pm 1$  digit, the AD2026 is again far superior to conventional APMs, where their inherent inaccuracy usually limits the total performance of the instrument.



The AD2026 conserves on space, too. Its small front panel size of 3.4" x 2.0" and only 0.64" needed behind the panel makes it smaller than  $3\frac{1}{2}$ " scale APMs. But its performance outclasses  $4\frac{1}{2}$ " APMs.

When it comes to reliability, the AD2026 is unsurpassed. Its I<sup>2</sup>L technology combines most of the active analog and digital circuitry on *one* chip. The AD2026 has only 14 components and a MTBF of 250,000 hours at 25°C. In a 24-hour-a-day application, you shouldn't expect a failure for 28 years.

A new commercial tester automatically tests all AD2026's for defects such as bad components and solder shorts. It also fully tests both the LSI chip and the complete DPM. Following 168 hours of failure free burn-in, the units are again 100% tested.

The AD2026. Its low price (\$39/100s), small size, superior performance, and remarkable reliability make it the only sensible alternative to APMs. Which is just what this country needed.

Check it out. Return the coupon with your check or money order today to order an evaluation sample at the low 1-9 quantity price of \$62. And when you receive your evaluation samples you will also receive a Credit Certificate for \$23 redeemable when you place your order for the first hundred or more AD2026's.

**ANALOG DEVICES**

The real DPM company.

Box 280, Norwood, MA 02062  
 Telephone: East Coast: (617) 329-4700,  
 Midwest: (312) 894-3300,  
 West Coast: (213) 595-1783,  
 Texas: (214) 231-5094.



Please send me \_\_\_\_\_ AD2026 for testing and evaluation at the low (1-9) price of \$62. (Enclose check or money order.)

Enclosed is my purchase order for 100 AD2026 DPMs at the unbelievably low price of \$39 in 100s.

I'm not ready to order my AD2026 DPM for testing and evaluation, but I would like to receive all available technical information.

ED 5/24

P.O. # \_\_\_\_\_

Name \_\_\_\_\_

Company \_\_\_\_\_

Telephone \_\_\_\_\_

Address \_\_\_\_\_

City \_\_\_\_\_

State \_\_\_\_\_

Zip \_\_\_\_\_

\*Substantial quantity discounts available.



# The CRADLE that'll ROCK the industry

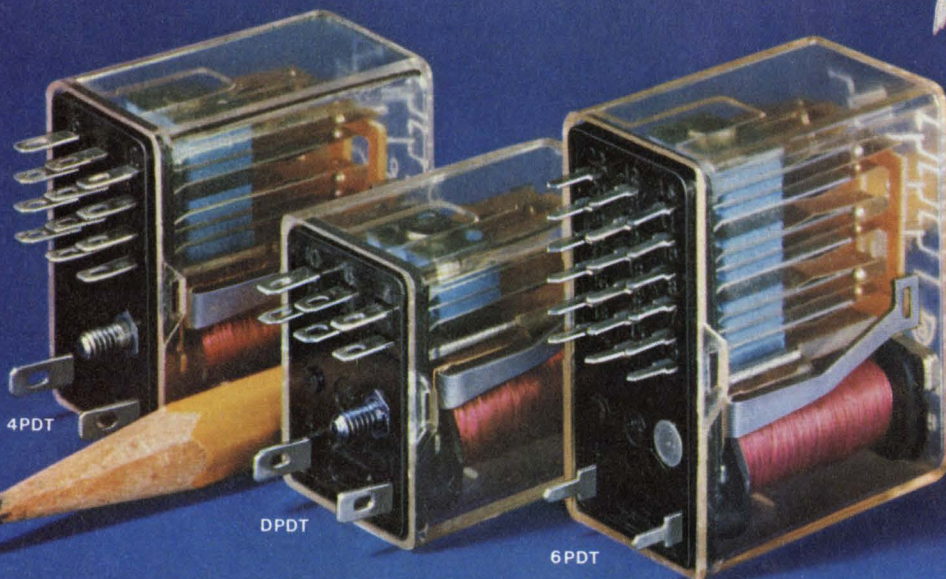

## At last: Guardian's high quality in telephone type relays...at Guardian's low price.

Interchangeable with most miniature, enclosed cradle type relays you are now using . . . will handle dry circuit to 5 amp DC loads.

Interchangeable because they have the same form. The same fit. The same function.

Interchangeable, but **better**: With a one piece core and yoke for improved magnetic efficiency and stability. With one piece bobbin and terminal assemblies for rigid, built-to-take-it coil terminations. With polycarbonate insulation to virtually eliminate moisture absorption and insure stability of spring-set adjustment.

 Recognized under the component program of Underwriters Laboratories, Inc.

What else do you get besides sensible basic design and superb efficiency? You get a choice of PC or solder lug terminals. A choice of contact material. A choice of mating sockets and mounting hardware.

That's why your choice should bear the Guardian name. And why **you** should join the swing to the cradle that's rocking the industry.

Your Guardian Angel has a free technical application bulletin waiting for you. Send for your 1555 Series data today.



# GUARDIAN®

GUARDIAN ELECTRIC MANUFACTURING CO. • 1572 W. Carroll Ave. • Chicago, IL 60607 • 312/243-1100

CIRCLE NUMBER 11





# See, we sell all the parts together. Or all the parts apart.

If you are looking for complete telephones to use as part of a system, or if you need telephone parts to build into your product, GTE Automatic Electric is the logical source.

Why? Because we are the largest U.S. manufacturer of telephones and telephone subassemblies outside the Bell System.

So, if you are an OEM and you have quantity requirements for telephones or telephone components, we'll usually have what you are looking for. Telephones in a large variety of styles and colors. And components ranging from handsets and hookswitches to housings and hardware. If it goes into a telephone system, we probably make it.

Use the coupon for a complete catalog. Or, if you are in a real hurry, call John Ashby at (312) 562-7100, Ext. 250.

When it comes to quality components, call **THE SOURCE: GTE AUTOMATIC ELECTRIC.**

Please send your catalog of communications components.

Please send more information and prices on \_\_\_\_\_ of \_\_\_\_\_.  
(Quantity) (Product)

Name \_\_\_\_\_

Title \_\_\_\_\_ Phone \_\_\_\_\_

Company \_\_\_\_\_

Address \_\_\_\_\_

City \_\_\_\_\_ State \_\_\_\_\_ Zip \_\_\_\_\_

Mail to: Mr. J. D. Ashby, B-4,  
GTE Automatic Electric, Northlake, Ill. 60164

**GTE AUTOMATIC ELECTRIC**



# Interested in network variety? Select from a spectrum of 540 standards.

Allen-Bradley has the popular configurations you need. Pull-ups, Pull-downs. Line Terminators. Networks to complement Core Memory Sense Amplifiers. TTL to ECL Translators. O-Pad Attenuators. All styles available from your Allen-Bradley *Electronic Distributor*. Call for specs or check your EEM Catalog. If you need specials, contact your local Allen-Bradley district office for fast turn-around. Ask for Publication 5840. A-B is an experienced twin-film manufacturer, i.e. precision thin film and thick film.

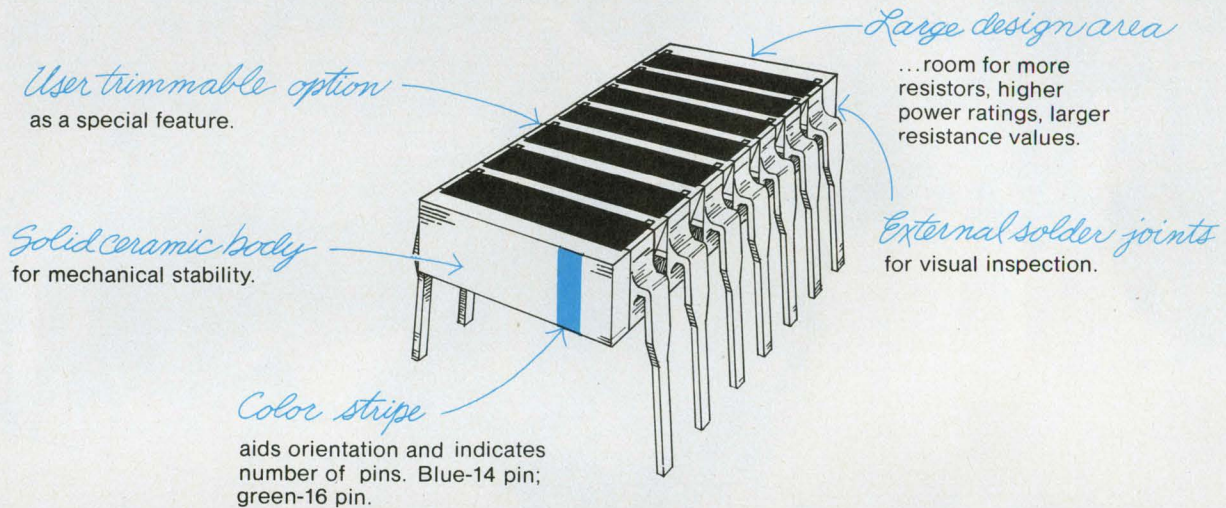

0540

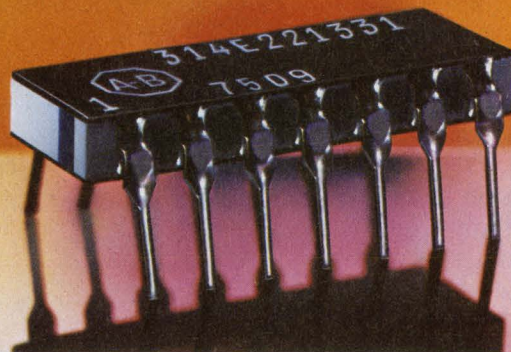

## Quality in the best tradition.



**ALLEN-BRADLEY**

Electronics Division  
Milwaukee, Wisconsin 53204



# TAKE A CLOSE LOOK AT THESE BURROUGHS PLASMA DISPLAY BREAKTHROUGHS.

Easier to read

Greater brightness

Improved contrast

Larger matrix dot

Broader horizontal  
viewing angle

Lower power  
requirements

Cost effective  
design

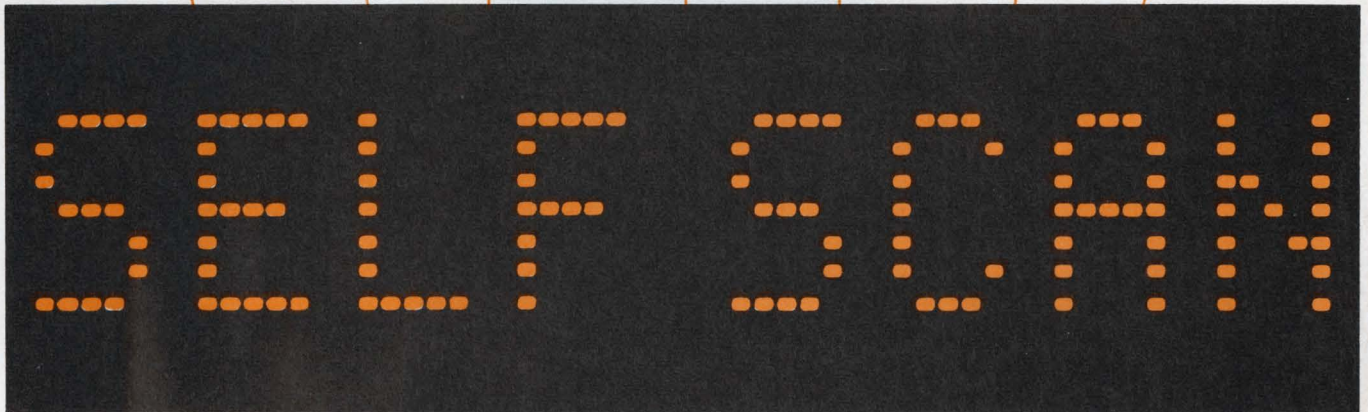

The new Burroughs SELF-SCAN® II single register gas plasma panels are breakthroughs in visibility and readability, making them ideal for all types of applications — from audience information displays to instrumentation applications. They are digitally addressed to interface easily with microprocessors and computers.

Only 15 connections are required. These new units complement Burroughs' standard line of single register 16 and 32 character plasma displays.

The Burroughs SELF-SCAN II 1 x 20 and 1 x 40 displays. Certainly worth looking into.

Burroughs Corporation, Electronic Components Division, P.O. Box 1226, Plainfield, New Jersey 07061. Telephone (201) 757-5000. SELF-SCAN displays are available nationwide through our distributors, Hamilton/Avnet and Cramer Electronics.

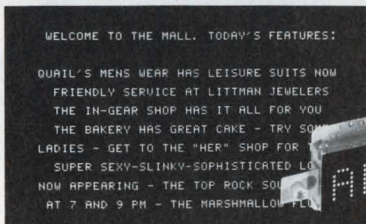

New 1 x 20 panel can be stacked and butted together to give a contiguous large audience information display of any number of characters.

New 1 x 40 panel for instrumentation, data terminals, computers and hundreds of other applications.



You can **see** the difference

## Burroughs



SELF-SCAN is a registered trademark of Burroughs Corporation.



# Siemens new line of ultra high-speed DIP Handlers helps you test faster-easier.

What's new about it? It's all new; the products, the design, the performance. Now you can turn to Siemens DIP Handlers to increase your throughput at ambient, hot or cold temperatures. And, since they are modular in design, you can start with a basic ambient handler and, should the need arise, you can simply upgrade to hot or cold or both.

Also, field retrofit kits are available for rapid track-width changeover. This flexibility assures that you buy only what you require and yet have the option to expand as your test needs increase.

The Siemens handlers are backed by our applications engineers who are thoroughly knowl-

edgeable in all phases of IC handling and testing. They are trained and available to assist you in getting the highest throughput for your test dollar. That can include developing a "turn-key" interface between tester and handler and also involve our accepting complete systems responsibility.

Come see for yourself at Semicon West on May 24, 25, & 26. But for full information right now, write or call: Cliff Small, Siemens Corporation, Measurement Systems Division, 3 Computer Drive, Cherry Hill, New Jersey 08034, (609) 424-2400.

The DIP Handlers are manufactured by Precision Engineered Products and marketed by Siemens.

# SIEMENS

CIRCLE NUMBER 16

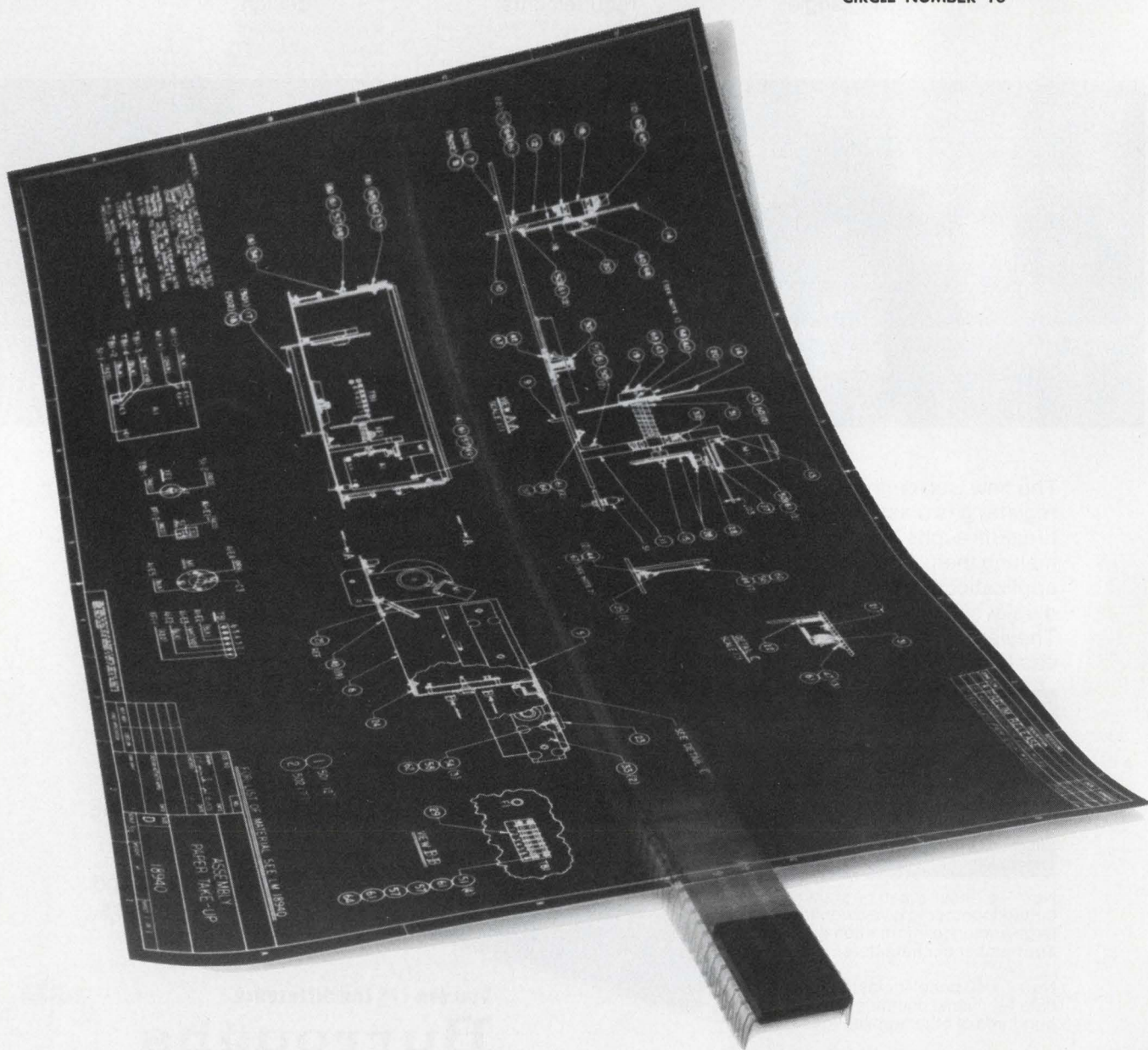



## Fiber-optic links go into telephone nets

After years of testing laser/fiber-optic telephone links in laboratories, three communications giants have independently inaugurated operational systems that will eventually become part of commercial networks:

■ A 1-1/2-mile fiber-optic cable from AT&T, being laid under the streets of Chicago, will be ready for tests by mid-summer.

■ A 9-km (6-mile) underground cable duct, in England, built jointly by four European subsidiaries of ITT, was demonstrated in late April.

■ A 5.6-mile fiber-optic link by General Telephone & Electronics is operating successfully in California.

ITT's fibers are made from graded-index silica, and contained in a cable 7 mm (1/4 in.) in diameter. The fibers carry nearly 2000 simultaneous conversations or two color-TV transmissions. Two repeaters are spaced at 3-km intervals in manholes along the 9-km route. Each repeater point is equipped with two regenerators, one for each direction of transmission. In all, six gallium-aluminum-arsenide lasers are used in the system.

The optical cable consists of working fibers, a spare fiber, and four metal conductors (two carry the power to the repeaters and two are "order wires" used by technicians). A filler fiber is also in the cable. These eight cores are sheathed in polyethylene.

The cable system works with standard multichannel digital multiplex equipment, and the bit rate is 140 Mbit/s. The joint developers are Standard Telecommunications Laboratories in Harlow, England, Standard Telephone and Cables in London, Bell Telephone Manufacturing Co. in Antwerp, Belgium, and Fabbrica Apparecchiature Per Comunicazioni Elettriche Standard in Milan, Italy.

GT&E's 5.6-mile system uses optical components and circuitry as well as standard multiplexing equipment to provide a 24-channel route at 1.554 Mbit/s. The optical-fiber cable makes

six 90-degree turns and passes through 58 manholes.

The six graded-index optical fibers are contained in the cable and encapsulated in a flat plastic tape. Two strands are assigned to public-telephone traffic, two are held as spares, and two are dedicated to various testing programs. Attenuation averages 8 to 9 dB/km.

The light sources are high-radiance Burrus-type LEDs described as small-area, multilayer gallium-aluminum-arsenide heterostructures that emit light signals at 815 nm.

With a multiple 100-V potential to permit avalanching, commercial silicon-avalanche photo detector diodes provide light-pulse detection and conversion to electronic signals for further processing. These devices are sensitive to better than .6 nW of the 815-nm infrared light pulses.

Light pulses transmitted through the two optical fibers are regenerated at each of the two repeaters, which are 2.3 miles apart.

The AT&T system, which will be tested by Bell Laboratories, Holmdel, NJ, contains a single half-inch-diameter cable carrying 24 lightguides. The cable will be installed in standard telephone company ducts.

A single pair of lightguides will be able to carry 576 simultaneous conversations or an equivalent mix of voice and data signals. Separate pairs of lightguides will be used to carry Bell Telephone's Picturephone video signals. And no amplifiers will be needed to boost signals along the route, according to AT&T.

Each lightguide in the Chicago system will be connected at one end to a transmitter module that includes either a solid-state laser or a LED source. A modulator circuit will provide 44.7 Mbits of digital information per second.

The other end of the lightguides will be connected to a receiver module. A photodetector in the module will con-

vert the light pulses to signals compatible with those transmitted within the nationwide AT&T telecommunications network.

Since the average signal loss in the encabled fibers is expected to be 10 dB per mile, laser-light pulses may be transmitted for four miles before needing regeneration.

## \$500 computer system talks over IEEE 488 bus

The lowest-cost computer system by far will have a 6502 microprocessor-based CPU, a 9-in. CRT screen, a keyboard, a data-storage cassette drive—and be able to communicate with peripherals over an IEEE-488 standard instrument-interface bus. Though aimed primarily at personal computing, the \$500 system will also act as an instrument-system controller, and handle data-processing and educational applications.

Prototypes of the Personal Electronic Transactor (Pet) Model 2001 have been built by Commodore Business Machines, Inc., Palo Alto, CA (see ED No. 4, Feb. 15, 1977, p. 50). Production should begin this fall, says Commodore marketer Arnie Karush.

The extremely low price results from

■ Commodore's vertical integration—it builds almost all the parts that go into the Pet, including microprocessors and memory, which come from its MOS Technology subsidiary in Valley Forge, PA.

■ Commodore's marketing hopes—it expects to sell hundreds of thousands of Pets to consumers through mass merchants such as department stores.

Commodore, which manufactures pocket calculators, "won't even consider a marketplace unless they can sell several hundred thousand," says Will Mathyes, microprocessor applications manager at MOS Technology. Mathyes notes that Commodore, which is also handling sales of MOS Technology's KIM-1 microcomputer and is applying cost-cutting techniques to that product as well, has overseas facilities to manufacture consumer electronic products in high volume, and already deals with retailers such as Sears.

With the IEEE-488 bus, however, the Pet can also tie into commercial automatic test systems, as well as interface with a line of peripherals such as a printer and a floppy-disc drive that Commodore will be introducing over the next year. The bus is used because it can handle large amounts of



data on relatively few lines, says Karush. In addition, it contains an information protocol and is readily available as a printed document.

The Pet's memory includes 12 kbytes of ROM, 4 kbytes for the computer's operating system and 8 kbytes for a Basic interpreter. The standard user memory is 4 kbytes of static RAM, expandable to 32 kbytes.

The video-display unit includes a black-and-white CRT that measures 9 in. diagonally. The screen can handle up to 1000 8 × 8 dot-matrix characters in 25 lines of 40 characters, with a black on white or white on black field.

The 73-button keyboard consists of all 64 ASCII symbols and a numeric pad. In addition, 64 graphic and reverse-field characters can be accessed with a shift key; other keys clear and erase the screen as well as insert and delete characters.

## Graphite to improve more connector contacts

A graphite bonding technique used for gold-finish flat-surface connector-contacts can now be applied to a variety of other finishes and contact geometries.

The technique—bonding a permanent graphite film to a connector-contact surface—was developed by AMP Inc., Harrisburg, PA, more than five years ago and two years later applied commercially to its Dualatch connector line. The graphite doubled the number of mating cycles to more than 20,000, reduced mating/unmating forces and had a negligible effect on contact resistance. The company, however, felt the technique could be applied only over gold finishes and only on flat surfaces—like those in Dualatch.

But after additional research and life testing, AMP is prepared to offer graphite bonding for pin-and-socket contacts as well and for a variety of finishes, including silver and palladium.

Although this bond tends to raise contact cost about 7 or 8% initially, it actually lowers cost because this permanent lubrication extends contact life and makes it possible to use a thinner coating of precious metal. For example, a contact that would have required 150 microinches of gold may now be able to use just 50 microinches to provide the same contact life.

Useful over a range of -40 C to 100 C, the bonding technique reduces wear and prevents asperity welds. It also

cuts down noise and insertion/withdrawal forces, and has a negligible effect on contact resistance.

Circle No. 319

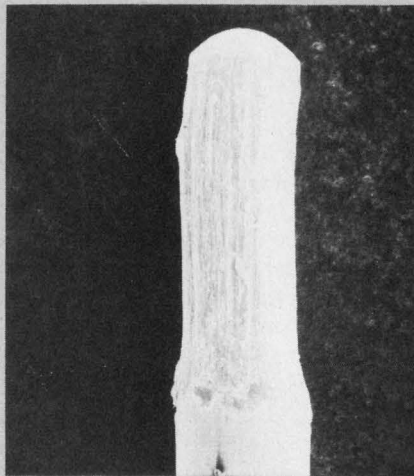

ELECTRON IMAGE

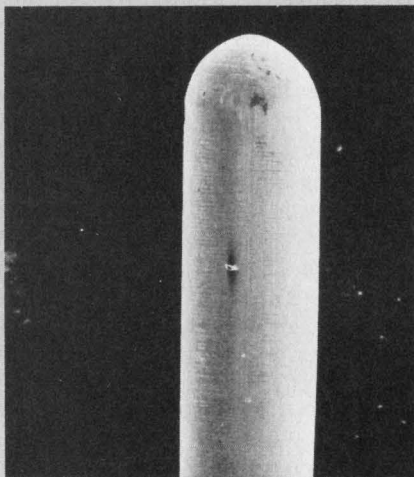

ELECTRON IMAGE

After 2000 mating cycles, a typical 22-gage pin contact looks like the one in the upper photo, while a contact lubricated with a permanent graphite film looks like the one in the lower photo.

## News Brief

**Analog Devices opened up its first manufacturing plant in Limerick, Ireland** on May 13. The facility—the first IC plant in Ireland—will assemble and test IC chips produced in Analog Devices' U.S. plants.

**A ten-day seminar on "How to Design with Microcomputers"** will be conducted by Osborne & Associates, of Berkeley, CA. It will be held July 11 through July 22 at the Holiday Inn, Sunnyside Blvd. and Fairchild Ave., Plainview, NY. For details call or write Microcomputer Development Services,

## Point-contact diode spans dc to infrared

By minimizing the junction area and thus the capacitance of a point-contact diode, researchers at the University of California at Berkeley have broadened its bandwidth by orders of magnitude over previously available devices. The metal-oxide-metal device can handle frequencies from dc through infrared and almost to visible wavelengths.

Capable of handling applications such as mixing infrared laser signals, the diodes have contact areas of  $10^{-10}$  cm<sup>2</sup>—about 100 Å wide and 1 micron long. The contacts are nickel, and are separated by a nickel-oxide layer.

To make the narrow contact, a 100-Å layer of nickel is deposited on a quartz insulating substrate. A second quartz insulator is then applied over the contact to form a sandwich. Etching away one edge of the sandwich leaves a thin, bare nickel strip. The sandwich is then mounted perpendicular to the second contact surface, which consists of an oxide layer over a 2000-Å nickel base.

Such a diode, however, is "five to ten years away from market, closer to ten years," says Shihyuan Wang, a graduate student at Berkeley who will present a paper on the development at the Conference on Laser Engineering and Applications in Washington DC next week.

Even if the metal-oxide-metal (MOM) diodes can be produced in volume, "I'm not really sure you need all that bandwidth," says Wang. Yet Berkeley researcher's investigations of the technique continue: "Extension of the principle raises the possibility of a transistor structure that might result in the first amplifier with a response band from dc to optional frequencies," says Wang.

41 E. 19 St., New York, NY 10003; (212) 924-5451. The price of \$650 includes luncheon and books.

**IBM researchers have upped the efficiency of gallium-arsenide solar cells to 22%**—close to the theoretical maximum of 27%. Previously, the highest efficiency reported for GaAs solar cells was 18%.

**A new entrant into the citizen's band radio market**, Texas Instruments has introduced high-priced mobile and base-station rigs that employ microprocessors and charge-coupled devices.





SIMULATED DEMONSTRATION.

# One of ours outshines twenty-five of theirs.

We couldn't think of a better way to demonstrate our brightness story on the printed page. And although it may seem a little unbelievable at first, it's true.

One of our Brite-Lite® LED lamps outshines twenty-five of most competitive LED lamps (50 mcd vs. 2 mcd). This comparison isn't just a figment of our imagination. The facts have been tested time and time again. On the bench and on the job.

**Light before bright.** We know brightness is only part of the story, though. The lamps must turn on to begin with. No problem. We offer traditional incandescent-type brightness with proven solid-state reliability. Reliability that amounts to at least 100,000 hours per lamp. In most cases, that's more than 10x the life of standard incandescent lamps.

**Brite-Lites® come through.** Our brightness story means that Brite-Lites® come shining through repeatedly in those panel and printed circuit board applications where lamp visibility is critical. In your choice of red, green or amber.

**The best combinations going.** In addition to outshining the competition lamps down, we offer the most complete selection of packages. From convenient snap-ins to space saving T<sup>2</sup> Lites, which enable you to design panel lamps right onto your PC boards. And, there are a number of current/voltage combinations you can specify. From 1.6 to 28 volts — 10 to 35 milliamps. Complete with current-limiting resistors.

**We shine on delivery.** Feature for feature, Data Display Products outperform as well as outshine the competition. Best of all, we don't keep you waiting. After all, delivery is as important as performance!

**The best and the brightest.** We don't really expect any of you to use twenty-five lamps where one will do. We do hope you'll let us shine up your project at the early design stages. Call or write, today. We'll give you a lot more than twenty-five outstanding reasons to make you look our way. Because when it comes to LED lamps, the brightest also happens to be the best.

**"The brightest LED lamps in the business."**

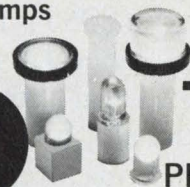
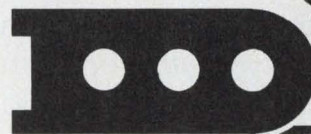

**DATA  
DISPLAY  
PRODUCTS**

5428 W. 104TH ST., LOS ANGELES, CA. 90045 (213) 641-1232

CIRCLE NUMBER 17



# Intel delivers a unique the 8085. It's like the

Introducing the 8085, a unique new microcomputer that is part of a new Intel® microcomputer system—the MCS-85.™

The 8085 is both software and bus compatible with the 8080. So you can take full advantage of the wealth of software, peripherals and development tools that have helped make the 8080 the industry standard.

Yet the 8085 is 50% faster than the 8080. So your 8085-based products will enjoy a new level of performance at even lower cost.

All components in the MCS-85 system have higher level integration, making it possible to replace a 10-chip 8080 system with three MCS-85 chips. Components of the MCS-85 system include the 8085 CPU, the 8155 256-byte RAM with I/O and timer, and the 8755 16K EPROM with I/O and interchangeable 8355 ROM with I/O. All these components, including the 8755 EPROM, operate from a single +5V TTL supply enabling you to go from prototype to production without board or power supply changes.

It all adds up to faster, easier, more economical—and better—system design.

The 8085 is more than a faster, more efficient microcomputer. It's the newest example of Intel's total system commitment. Here's what that means for existing 8080 users and new microcomputer users.

Because the 8085 is fully compatible with 8080 software and 8200 series peripheral components, it protects your investment in existing designs and allows you to implement new designs without starting the development cycle all over again.

And now you can design your 8085 and 8080 systems around four new advanced peripheral controllers: the 8271 Floppy Disc Controller, the 8273 Synchronous Data Link Controller, the 8275 CRT Controller and the 8279 Keyboard/Display Interface. Like the other 8200 series peripherals, these new devices are fully programmable, single chip solutions to system interface requirements.

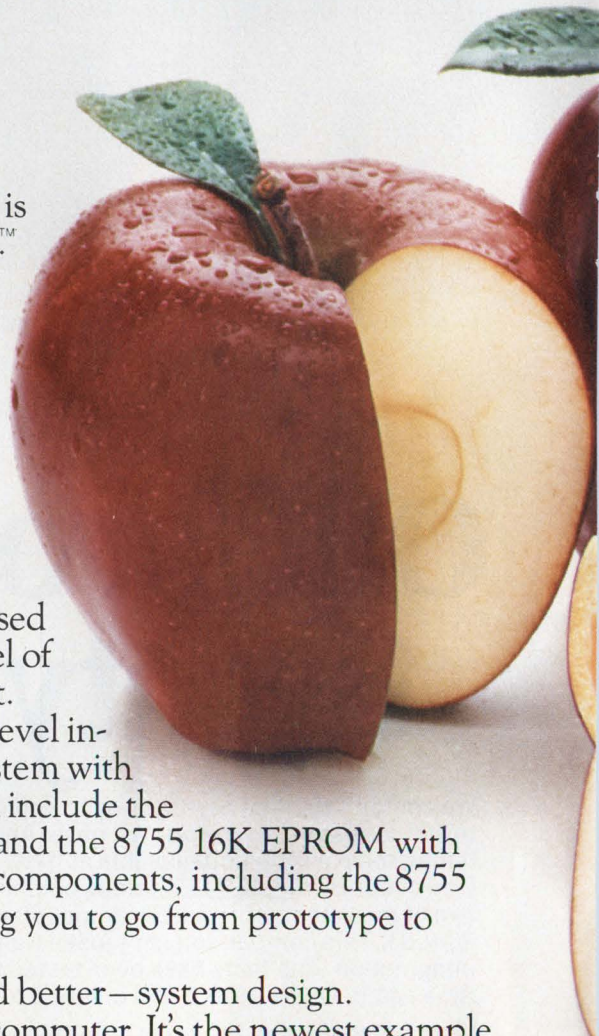



# new microcomputer, 8080. Only better.



Intel's total system commitment means that the MCS-85 is being introduced as a fully supported, complete system. All the support that has helped 8080 users get

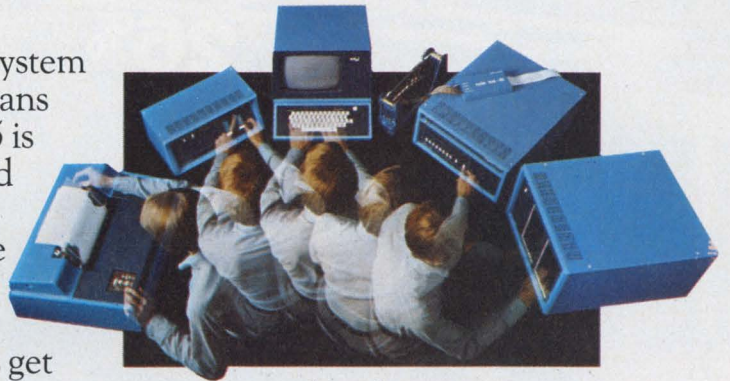

to market sooner now gives 8085 users a head start too.

To speed programming we provide PL/M, the high level programming language for microcomputers that can cut months off software development. The Intellec® microcomputer development system, with ICE-85™ in-circuit emulation and symbolic debugging, helps reduce system integration and debug time. Then there's application assistance worldwide. Training classes and seminars to help you get the most from the MCS-85 system. And a comprehensive development software library at your disposal.

Total system commitment. It protects your investment. And gives you the jump in a competitive world. Because MCS-85 is a complete and fully supported system, comparing Intel with any other microcomputer supplier becomes an apples to oranges comparison.

The fastest way to get started is to order MCS-85 products from your local Intel distributor. Almac/Stroum, Component Specialties, Cramer, Elmar, Hamilton/Avnet, Harvey Electronics, Industrial Components, Liberty, Pioneer, Sheridan, L.A. Varah, or Zentronics.

Or, for our detailed MCS-85 brochure, use the reader service card or write us directly. Intel Corporation, 3065 Bowers Avenue, Santa Clara, California 95051.

**intel® delivers.**



# .150" PROFILE

high density DIP sockets from R-N  
ICL SERIES

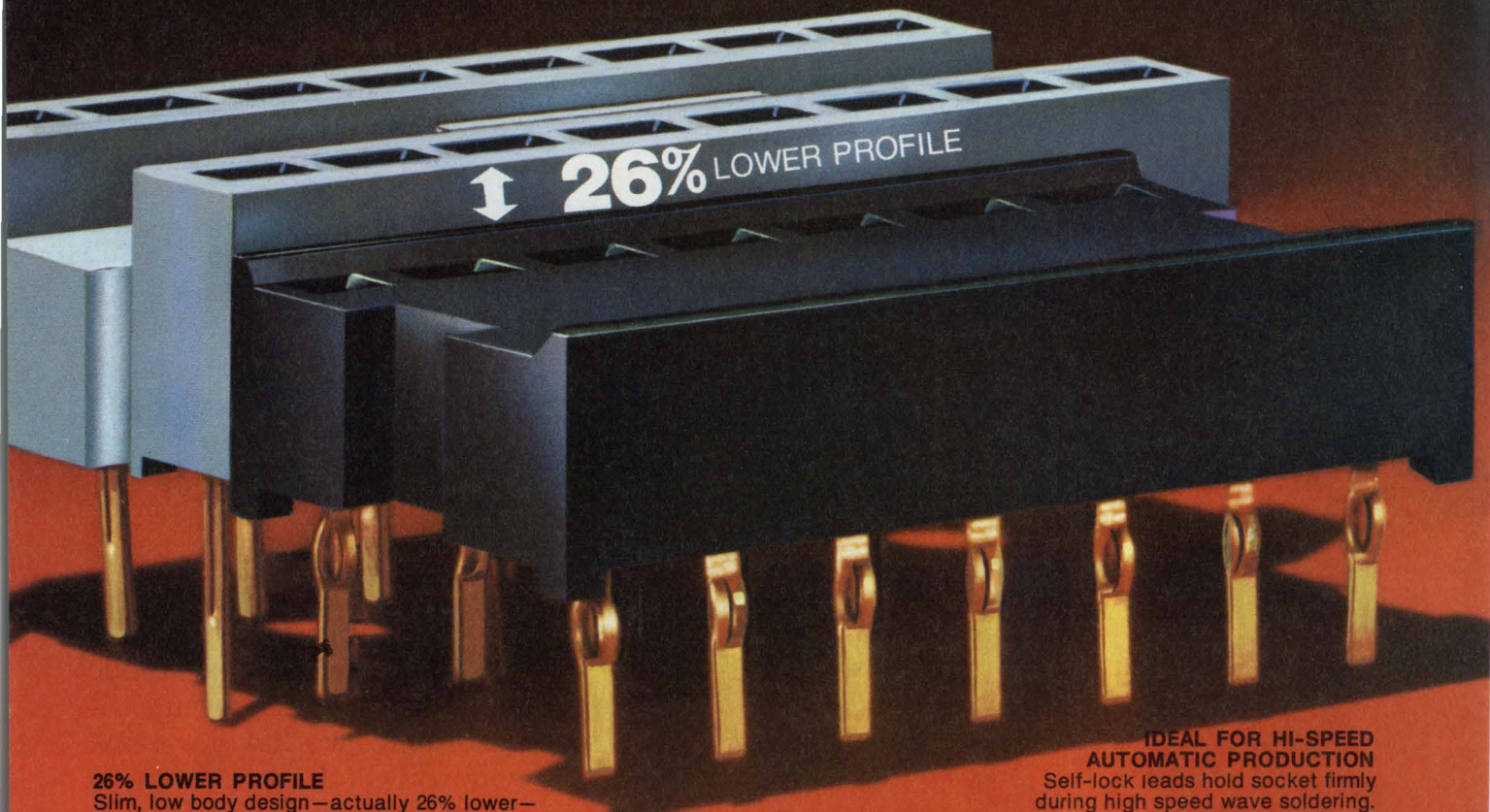

#### 26% LOWER PROFILE

Slim, low body design—actually 26% lower—cuts packaging space needs drastically.

#### .100" PROGRESSION

of socket leads permit maximum board density in either end-to-end or side-by-side arrangement. Cuts PC board drilling costs as well.

#### IDEAL FOR HI-SPEED AUTOMATIC PRODUCTION

Self-lock leads hold socket firmly during high speed wave soldering.

#### MAXIMUM VIBRATION RESISTANCE

Unique R-N contact design assures that your IC lead maintains solid contact—even in most punishing applications.

## CUT COSTS, SPEED PRODUCTION

with these new ICL low-profile DIP sockets from Robinson-Nugent. Designed for high speed automatic assembly and maximum shock and vibration resistance. Has famous R-N "side-wipe" single leaf contacts, body meets UL94V-0 flammability rating. 8 thru 40 leads available.

Check the advantages of these high density sockets today! Write for complete specifications on this new R-N low-profile ICL DIP socket now.

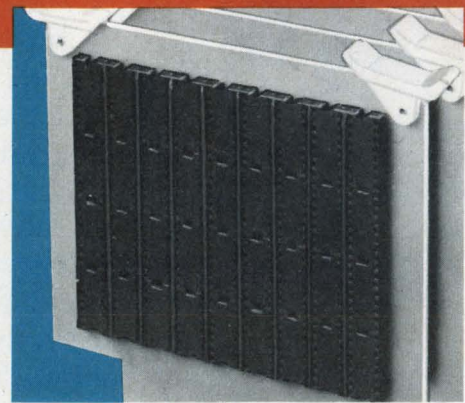

For maximum package density with traditional R-N reliability, specify this new low cost, low-profile ICL DIP socket.

# **RN** ROBINSON NUGENT, INC.

800 East Eighth Street, New Albany, Indiana 47150 • Phone: (812) 945-0211 — TWX: 810-540-4082

CIRCLE NUMBER 19



# Here's why REI can rent you what you want when you want it.

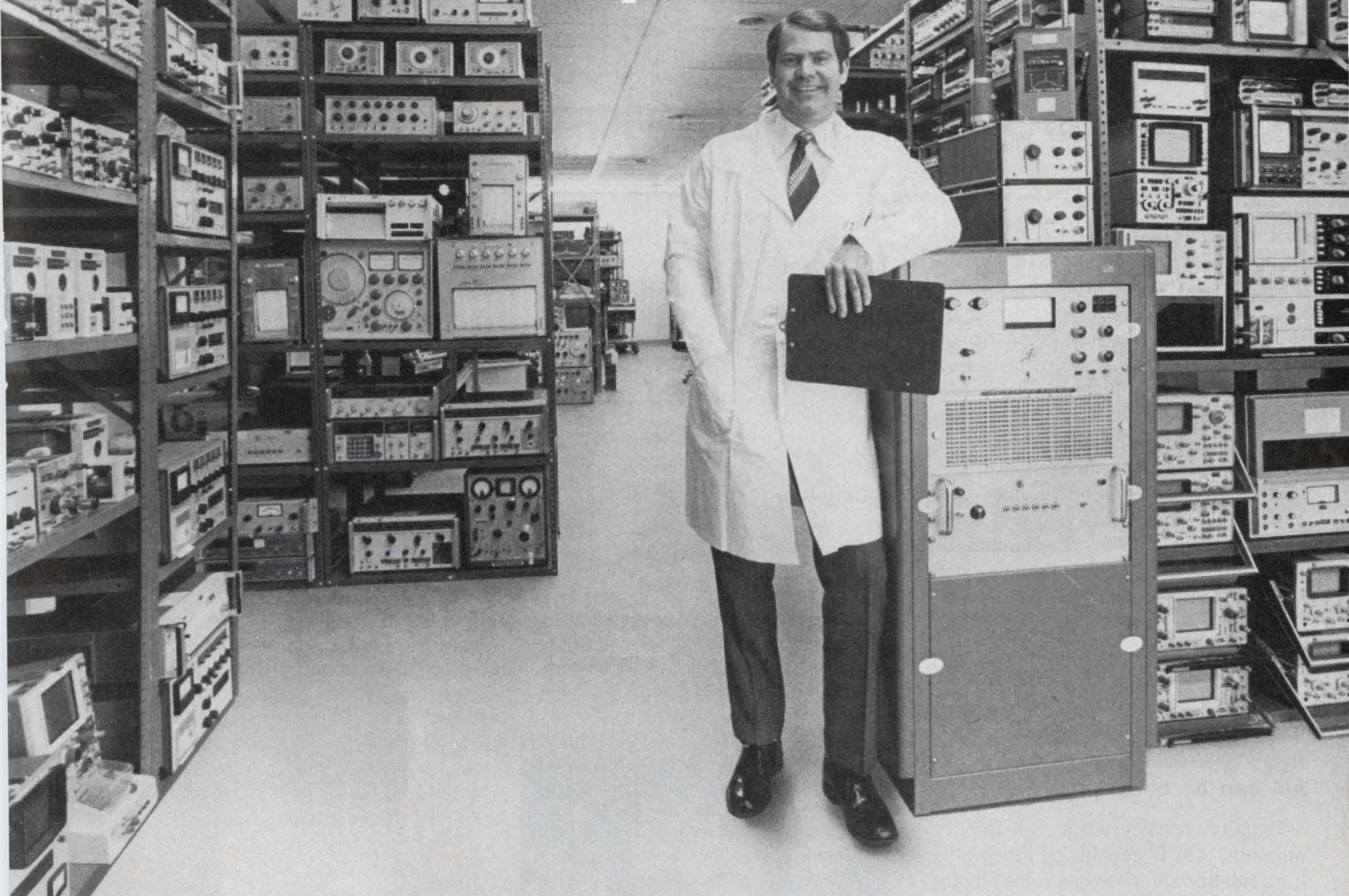

Our inventory. It's the biggest in the industry, with over 8,000 items of electronic test equipment in stock and ready to go. And it's getting better all the time, because we add more state-of-the-art equipment every month. This means we can deliver one special instrument... or a dozen... within hours of the time you place your order.

Now, more than ever, renting makes sense... to stretch your equipment budget, to fill temporary needs, and to avoid the long delivery lead times associated with purchasing. And renting from REI makes even more sense... because we're better equipped to fill your needs than any other rental company.

Send for our catalog today for a description of our rental, rental/purchase and leasing plans, and for our low rental prices. Or call the instant inventory center nearest you for immediate assistance.

Rental Electronics, Inc.,  
99 Hartwell Avenue, Lexington, Mass. 02173.  
Please send me your free instrument rental catalog:

Name \_\_\_\_\_ Title \_\_\_\_\_

Company \_\_\_\_\_

Address \_\_\_\_\_

City \_\_\_\_\_ State \_\_\_\_\_ Zip \_\_\_\_\_

Tel. Number \_\_\_\_\_

## Rental Electronics, Inc.

Burlington, MA (617) 273-2770 • Gaithersburg, MD (301) 948-0620 • Oakland, NJ (201) 337-3757 • Ft. Lauderdale, FL (305) 771-3500  
Des Plaines, IL (312) 827-6670 • Dallas, TX (214) 661-8082 • Mountain View, CA (415) 968-8845 • Anaheim, CA (714) 879-0561  
Rexdale, Ontario (416) 677-7513

CIRCLE NUMBER 20



## FCC to select a standard for stereo broadcasting on AM

New circuits for AM radios and transmission equipment will have to be designed next year after the Federal Communications Commission gives the go-ahead to stereophonic broadcasts on the AM band. Precisely how those circuits will have to operate depends on which of five AM stereo-transmission techniques proposed to the FCC emerges as a standard.

Once AM stereo is on the air—perhaps by the end of this year and likely by the middle of 1978—the demand for high sound quality at the transmitting and receiving ends is likely to grow. Circuits will have to be designed to increase the bandwidth and cut the distortion, as well as to encode and decode the stereo information, in AM transmitters and receivers.

### AM can be better

Usually considered a low-fidelity medium, AM is capable of acceptable high fidelity and even has some advantages over FM. Although the FCC requires that the frequency response of an AM transmitter be checked only from 100 to 7500 Hz, many AM stations transmit with flat response to 10 kHz, and some even to 15 kHz. With proper equipment, and without interference from nearby stations, an AM station can offer flat frequency response from 50 Hz to 10 kHz, which is more than sufficient to satisfy most listeners' needs for high fidelity.

While a response beyond 10 kHz would satisfy an audio buff, it would be wasted in the location that is most important to broadcasters—automobiles. Especially valuable—and profitable—are morning and evening rush hours.

High-frequency response and extreme stereo separation in a car is unnecessary because wind and road

**Andy Santoni**  
Associate Editor

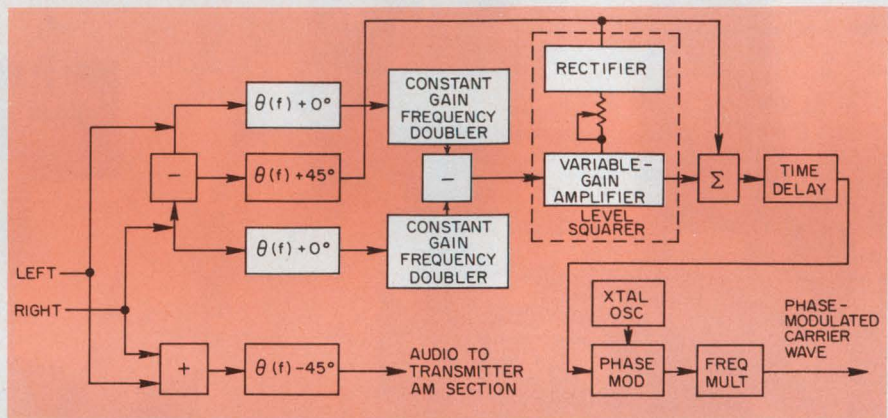

1. To increase stereo separation to more than 30 dB, Kahn-system transmitters shift the left and right signals by  $-45^\circ$  from the L-R signal, then double the frequencies, subtract, and square. The result is a second-order component.



"Cousin Bruce" Morrow could be on AM in stereo by next year.

noise mask high-frequency sound, and stereo speakers are generally close to each other. The systems proposed for AM stereo can provide more than adequate performance in frequency response and separation.

In fact, AM can provide better performance than FM in a car. As a car

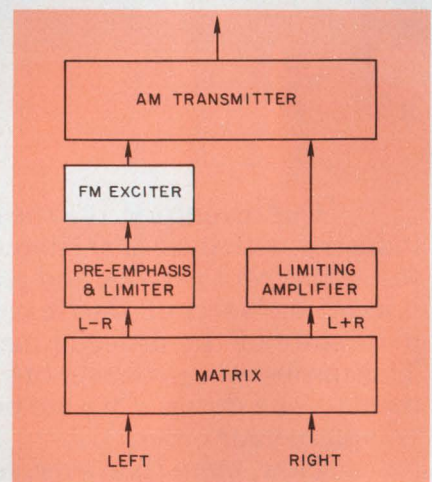

2. Adding FM to AM is an alternate approach to stereo AM. In RCA-system transmitters, an L-R signal frequency-modulates and L+R amplitude-modulates the carrier.

moves past buildings and other obstructions, FM multipath patterns change, and the stereo image shifts. This "picket fence" problem doesn't exist in AM.

The range of AM broadcast is also substantially larger than that of FM, whose broadcast frequency limits re-



# Introducing the intelligent LED display.

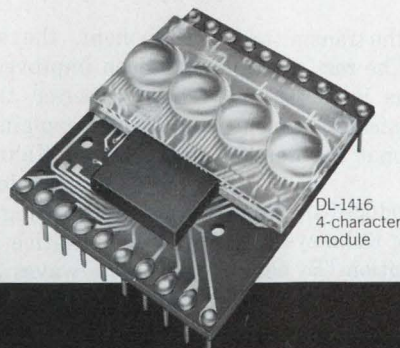

I I N T E R F A C E J U S T L I K E A R A M

Photograph of display actual size

## Alphanumerics at the lowest cost ever.

This newest Litronix Alphanumeric display has built-in ASCII decoder, multiplexer, memory and LED drivers. That means it needs only the inputs you'd feed a RAM. Operates directly off a microprocessor bus. Creates all 64 ASCII characters 0.16" high — shown in actual size above.

No alphanumeric display has ever been so simple to use. Actuated entirely by TTL logic levels. Needs only a +5v supply.

And it's by far the most economical way to create alphanumeric displays as long as 80 characters. Because you don't need to supply all that built-in circuitry externally.

The DL-1416 4-character modules can be butted end-to-end to make displays of any length with equal spacing between all characters.

### I'm in favor of intelligence. Tell me more.

For DL-1416 data phone (408) 257-7910 or send coupon.

NAME \_\_\_\_\_ TITLE \_\_\_\_\_  
ORGANIZATION \_\_\_\_\_  
ADDRESS \_\_\_\_\_  
ZIP \_\_\_\_\_ PHONE \_\_\_\_\_

Mail to Litronix, Dept. D, 19000 Homestead Road,  
Cupertino, CA 95014. Phone (408) 257-7910.

# litronix

CIRCLE NUMBER 21



ception to line of sight from the transmitter, or no better than 60 to 80 miles. Because of ionospheric refraction, AM broadcasts can travel hundreds of miles, especially at night, and some stations can be heard anywhere in the country.

Another advantage of AM stereo is its relatively easy demodulation. Simple, inexpensive ICs can effectively demodulate the stereo signals that would be generated with any of the AM stereo systems under consideration.

But before anything more permanent than an experimental AM stereo broadcast gets on the air, the FCC will have to choose which system to employ. While all the techniques have great similarities they also have distinct differences.

### Choosing a system

Four systems have already been proposed to the FCC and are now being investigated. A fifth system is still being developed, and should be proposed later this year.

The system that has undergone the most extensive on-the-air testing to date was developed more than 15 years ago by Kahn Communications Inc. of Freeport, NY. In the Kahn system (Fig. 1), the L+R wave is produced by adding left and right channel signals and feeding the sum signal through a constant phase-difference, constant amplitude-response network. This wave, which is identical to the wave that would be produced in a monophonic broadcast, is connected to the audio input of the associated transmitter and modulates the carrier. In addition, the envelope modulation in the Kahn system, as in all proposed systems, is compatible with current monophonic receivers.

The left and right channel signals also feed a difference circuit, and the output of the difference circuit feeds a second constant phase-shift network that displaces the phase of the audio wave by 90° from the phase of the L+R component. The signal passes through a summation circuit, then a variable time delay that compensates for the difference in timing between the L+R and L-R signals.

The output of the time delay feeds a phase modulator. Since the modulator produces relatively small amounts of phase modulation, a frequency multiplier is added to the chain.

The phase-modulated output wave shifts to the carrier frequency of the station, then feeds the transmitter. The exciter has an output power level

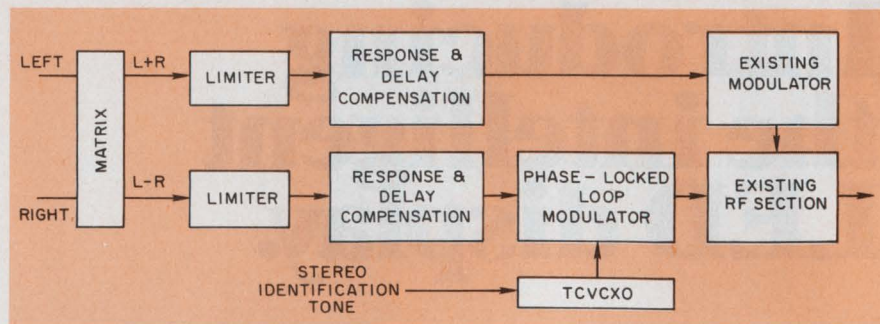

3. The listener knows it's in stereo when the indicator responds to a 5-Hz identification tone, a feature of this Magnavox system.

of about 2 W, and feeds the transmitter at a low power stage. The rest of the transmitter operates as it would in transmitting monophonically, which simplifies the installation of the stereo exciter.

The stereo signal produced by this simplified version of the Kahn system has limited stereo separation. "By adding a second-order phase-modulation

component, the sideband separation has been improved so that separation slightly better than 30 dB can be achieved," explains Leonard R. Kahn, president of Kahn Communications.

The second-order component is generated by shifting the L and R signals by -45° relative to the L-R component. The waves are first fed to frequency doublers, then to a circuit that

## Looking back

Thoughts about transmitting stereo information on an AM broadcast band may be a live issue, but the subject is far from new. In fact, the first AM stereo transmissions date back more than 50 years, to 1925, when WPAJ in New Haven, CT, experimented with stereo broadcasting via two transmitters.

Many patents on AM stereo-transmission techniques have been issued over the years, and many broadcast demonstrations of AM stereo conducted. But interest shifted to FM stereo in the 1950s, largely because the Federal Communications Commission wanted to foster the development of the economically weaker medium. When the FCC was petitioned with AM-stereo proposals in the late 1950s and early 1960s from Philco Corp., RCA, and Kahn Research, it denied them. Lack of "public need" and "industry desire" for such service was the prime reason given.

Nonetheless, AM-stereo experiments continued. In 1970, XETRA, a 50-kW station broadcasting on 690 kHz from Tijuana, Mexico, put Kahn stereo equipment to work. The station uses a directional antenna to aim its English-language transmissions at the Los Angeles/San Diego area, where KMPC

operates at 710 kHz. The proximity of KMPC provides a good test of the spectral cleanliness of the AM stereo signal, says Kahn, adding that the tests "confirm the lack of increased interference of XETRA during the three-year period of experimental stereo operation." This despite reports that XETRA has a powerful enough beam to be received clearly as far north as Alaska.

More recent tests, again with Kahn equipment, have taken place in Baltimore over WFBR. "No complaints of interference or air product deterioration were received by the station from any source," says a January, 1976, report from WFBR to the FCC. "Stereo separation was excellent as transmitted," according to the report.

The most recent on-air AM stereo tests took place with experimental Motorola gear, in December, 1976, over WKDC. There was no increased interference or degradation in signal quality, says Frank Blotter, president of the station.

Today, the inroads made by FM stations into markets formerly dominated by AM stations has changed the broadcasters' attitudes toward stereo broadcasting, and the FCC has again been called upon to study the matter.



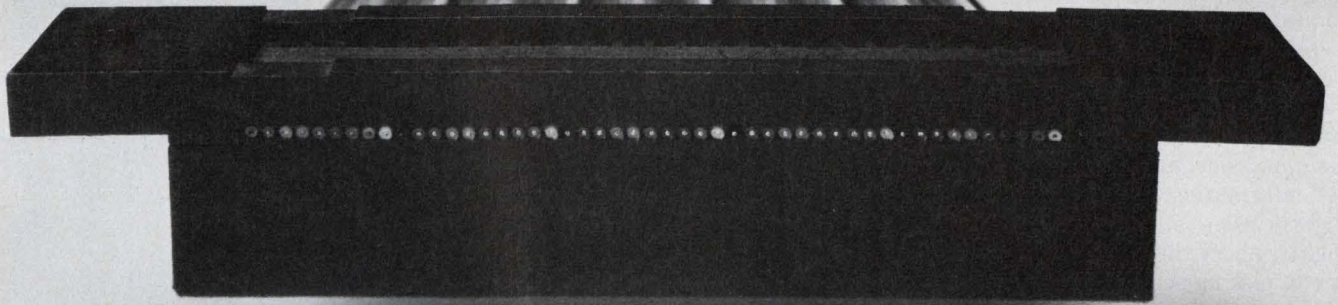

# MULTI-TERM: HAPPY ENDING

Putting together a system that uses flat flexible cable? Watch out for these five key factors.

## 1. Cable Contacts

Insulation displacement requires a sharp edge. Any roughness or irregularity can nick the conductor and weaken it. Only SAE uses precision coining to produce a perfect contact surface.

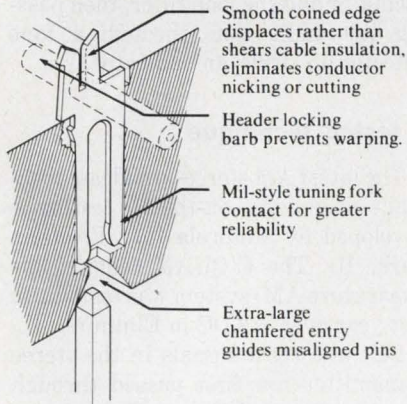

## 2. Mating Contacts

A lot of systems use a beam-type contact. SAE uses a military-type tuning fork configuration. It grabs the pin and produces maximum electrical reliability.

## 3. Header Security

Only MULTI-TERM™ contacts have locking barbs that bite into the header at every conductor position. Built-in pre-retention keeps header, contact and conductor securely mated. Vibration resistance is superior, and headers won't warp or bow.

## 4. Cable Quality

The best termination system in the world can't overcome irregular cable. Specify SAE ribbon cable as part of your system and you'll get more than just economy. You'll get dimensional stability.

## 5. Production Tooling

MULTI-TERM tooling speeds

production. Alignment is automatic, cuts and terminations are square, and the final result is as pleasing to the eye as it is effective and reliable.

SAE manufactures all the parts. PC connectors, header connectors, I/O headers, 14 and 16 pin DIP connectors and socket connectors. Tooling. Fixtures. Cable. You can buy any component you need.

Better yet, call SAE during your design phase. Let our engineers help work out a complete MULTI-TERM System for your flat cable runs. Your project, and your cable, will have a happy ending.



The OEM Connection

Stanford Applied Engineering, 340 Martin Avenue, Santa Clara, CA 95050. (408) 243-9200. TWX 910-338-0132



takes the difference, and finally to a level-squaring network.

## Two-set reception

A major advantage of this system, says Kahn, is that "many listeners will be able to use radio sets now in their homes, at no additional expense, for stereo reception on the first day their local AM station initiates stereo-casting." Because the lower sideband carries left-channel information and the upper sideband carries right-channel information, one receiver tuned slightly below and one receiver tuned slightly above the AM carrier frequency can pick up separate left and right-channel signals. "The sets do not have to be matched, and even tiny portable sets can be used to provide creditable stereo performance," Kahn adds.

According to a report of on-the-air performance submitted to the FCC by station WFBR in Baltimore, the Kahn system will provide more than the minimum 8 dB required to produce a stereo effect: "Receiver bandpass, care in tuning, and adjacent channel interference will influence the stereo separation, but in most cases 9 dB to 12 dB is achieved."

The low-cost, immediate transition to AM stereo that the Kahn system would provide "avoids the chicken-and-egg problem for broadcasters and set manufacturers that plagued the color-television industry for many years," says Kahn. "The broadcaster is assured of a sizable stereo audience, [and] set manufacturers will be certain of an immediate market for AM stereo receivers."

Another feature of the Kahn system is a stereo-indicator lamp on the receiver, which tells the listener when a station is broadcasting in stereo.

## Combining AM and FM

An alternative to the Kahn system comes from RCA Corp., which dropped its support of the technique when it ceased producing radios last year. However, the system is being supported by Belar Electronics Laboratory Inc. of Devon, PA, a studio-equipment manufacturer that had manufactured much of the RCA stereo-transmission gear.

Like the Kahn system, RCA's approach to AM stereo is compatible with present monophonic receivers, can make use of existing transmission equipment, and dates back to the 1950s (see box, page 30).

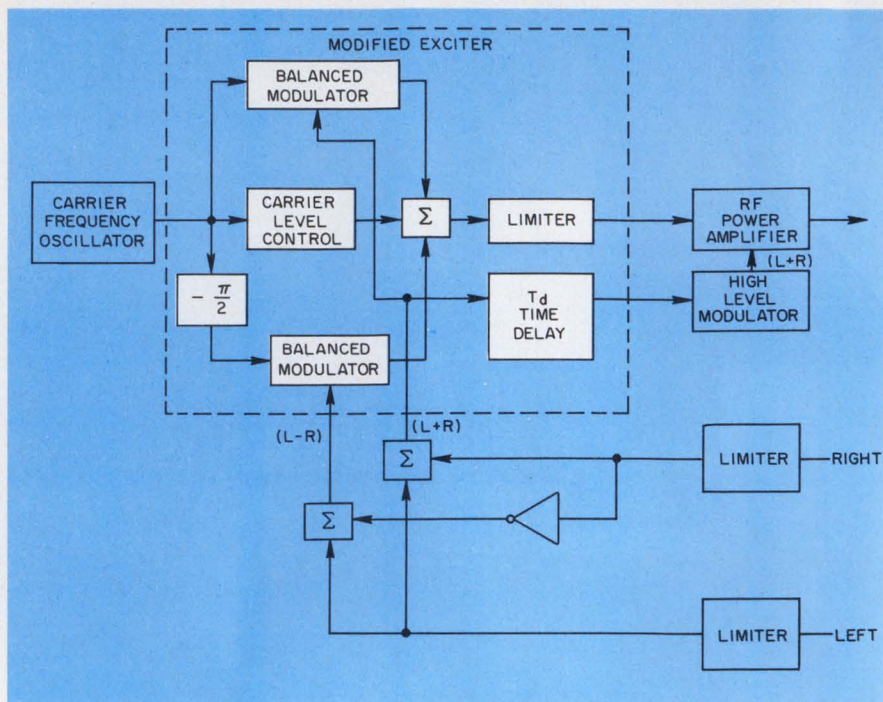

4. A modified exciter adds a second channel to AM broadcasts with a variation of quadrature transmission developed by Motorola.

The carrier in the RCA/Belar system (Fig. 2) is frequency-modulated with an L-R signal and amplitude-modulated with an L+R signal. The receiver has a conventional mixer and a single i-f amplifier. The amplifier drives an AM detector and a balanced-discriminator FM detector. Matrix circuits encode and decode between the left and right-channel signals and the L+R and L-R signals that are transmitted over the air.

## Changing phase

A system similar to RCA's has been proposed by Magnavox Consumer Electronics Group, Fort Wayne, IN. The Magnavox system (Fig. 3) combines amplitude modulation for the L+R signal with phase modulation for the L-R signal. The phase deviation is 1 radian, peak.

In addition, the Magnavox system has a 5-Hz subaudible tone that is frequency-modulated onto the carrier with a deviation of about 20 Hz. This tone can be decoded to light a stereo indicator—like the Kahn system's—and modulated to transmit slow-speed digital data such as station call letters, time, or temperature.

The transmitter in the Magnavox system employs virtually all the existing parts of a standard AM transmitter, without modification. And because the station carrier, which is modulated with the 5-Hz tone, is generated

at broadcast frequency, neither multiplying nor mixing is needed. This carrier signal is a reference for a wideband phase-locked loop, which delivers an on-frequency signal phase-modulated with an L-R signal. The resulting signal is amplitude-modulated with the L+R audio signal.

The receiver configuration is one of the main advantages of the AM/PM system, says Magnavox. The receiver has a single i-f and a standard envelope detector for the AM channel. Phase-modulation information is recovered by sampling the i-f signal, limiting it, and detecting it with a phase-locked loop circuit.

A stereo-identification tone is regenerated by recovering the audio tone between the main voltage-controlled oscillator and the loop filter, then passing the audio tone through a tone detector to drive an indicator.

## A tested technique

The latest AM stereo-broadcast technique to undergo on-the-air testing is developed by Motorola Inc., Franklin Park, IL. The C-QUAM (compatible quadrature AM) system was tested late last year over WKDC in Elmhurst, IL.

Left and right signals in the stereo transmitter are first passed through program limiters (Fig. 4). The left signal is supplied to two summing devices. The right signal is supplied to one of these circuits to form L+R signals. To



# S-D VALUPOWER!



VP, 1400 watts

VPH, 400 watts

VPL, 2800 watts

You have the slot.  
Here's the sensible way to fill it  
with quiet, dependable DC power.

Why pay the price for a general purpose power supply when Systron-Donner can satisfy your DC power needs with an economical and efficient VALUPOWER supply? Shown here are but three of many VALUPOWER models for OEM and system applications, all based on highly successful Trygon designs. Waste not power, waste not money. Use VALUPOWER.

- **Six slot-range** voltages, 5 to 48 volts DC. Others available.
- **High current** supplies with 20,000 hours MTBF.
- **Overload** and **overvoltage** protection.
- **Low noise**, low cost per watt.
- **Remote** sensing and programming.

Doesn't it make good sense to use the most efficient power supply? For literature, contact Scientific Devices or Systron-Donner at 10 Systron Drive, Concord, CA 94518. Phone (415) 676-5000.

SYSTRON  DONNER

Put our power to work for you.



provide L-R signals, the phase of the right signal is reversed and combined with a left signal in the second summing device.

To provide L+R sidebands, the carrier frequency is supplied to a balanced modulator with the L+R signals. An adjustable level carrier in phase with L+R is added to the L+R sidebands to provide an AM signal with the appropriate degree of modulation.

A second balanced modulator is fed by the L-R signal and the phase-shifted carrier-frequency oscillator signal to provide the quadrature signal at the output of the carrier-frequency summing device.

In the Motorola receiver (Fig. 5), the output of the i-f amplifier is applied to the carrier-level modulator and the limiter. The voltage-controlled oscillator (VCO), which is locked in phase quadrature with the i-f carrier, is used with the limiter output to provide input signals to a phase-detector circuit. The phase detector and low-pass filter provide the control signal that keeps the VCO locked in phase-quadrature with the i-f carrier. To provide a signal that is in phase with the i-f carrier, the VCO output is shifted 90°.

When the phase-shifted VCO signal and the signal from the limiter are fed to the phase detector, a signal is derived that can supply the carrier-level modulator. The left and right signals can be demodulated by a pair of synchronous detectors.

### Overseas interest in AM stereo

Other proposals for AM stereo systems will be submitted to the FCC from other manufacturers, including Sansui Corp. of Japan. Sansui had submitted

a proposal already, but withdrew it because the company felt it was not up to the technical standards of some of the other methods being proposed. A different technique, now being developed, should be submitted later this year, after testing in Japan.

The Sansui tests will be performed in accordance with procedures developed by the National AM Stereophonic Radio Committee, which is advising the FCC. The committee plans to begin testing the RCA/Belar, Magnavox, and Motorola systems over radio stations WBZ in Boston and WGMS and WTOP in Washington, DC, this month. These tests should be completed in about two months, and a report submitted to the FCC before Labor Day, according to Harold Kassens, a consultant with A. D. Ring & Associates in DC and NAMSRC chairman. Sansui test data might be included in that report.

Kahn Communications, however, has bypassed the group testing and submitted its system directly to the FCC. Kahn calls the cost of joining the committee and its subcommittees "prohibitive for a small company," and questions the advisability of a group "composed of cooperating, putative commercial competitors who represent neither the public nor the broadcasters."

According to Kahn, whose petition to the FCC to adopt the Kahn system was filed last June, "Small organizations have not been well represented on such committees because of the high cost of participation and their lack of bargaining muscle." In addition, he says, joint decisions by competitors raise anti-trust questions.

In opposing the Kahn petition, the

NAMSRC states, "We believe that comprehensive, carefully controlled tests of possible systems should be performed in a uniform manner to complement analytical information developed on a common basis. This work should represent the cooperative effort of suitable numbers of technical people so that diverse points of view are considered."

"Only by this method of true field testing can the FCC be sure that the information it eventually uses to choose an AM stereophonic broadcasting system is suitable and sufficient," adds the NAMSRC.

The public interest would be better served, the committee suggests, if the Kahn system were submitted to the committee for analysis and testing, and NAMSRC's Kassens says, "We wish Leonard would come in." But Kahn maintains his system has undergone sufficient scrutiny, adding, "Why should I do it over again?"

### An economic boon

Whatever the FCC eventually decides, the result will be "a boon to the economy," says Frank Blotter, president of WKDC in Elmhurst, IL, a Chicago suburb. In the automotive market alone, he points out, a \$50 additional charge for adding stereo to optional AM radios would mean a market of \$300-million. The cost of new station equipment and new AM radios for the home will generate additional millions in sales. In fact AM-radio sales may just boom as FM-set sales did 15 years ago, when a second channel was added.

Operators of AM radio stations, too, are looking forward to being able to broadcast in stereo. The AM band has suffered a loss in market share and advertising revenue over the past few years as consumers switched to FM listening, first at home and then in their cars. Despite critics who call stereo broadcasting a gimmick, AM broadcasters are convinced that two-channel transmissions, along with improved sound quality, will bring back much of the audience that was won over to FM in the last decade. The talk and sports-show formats that fill most of the AM band are likely to be replaced with music of all types.

If only 20% of the existing AM stations went stereo, muses WKDC's Blotter, there would be more stereo stations on the AM band than on the FM band. A 20% crossover could happen by next year. ■■

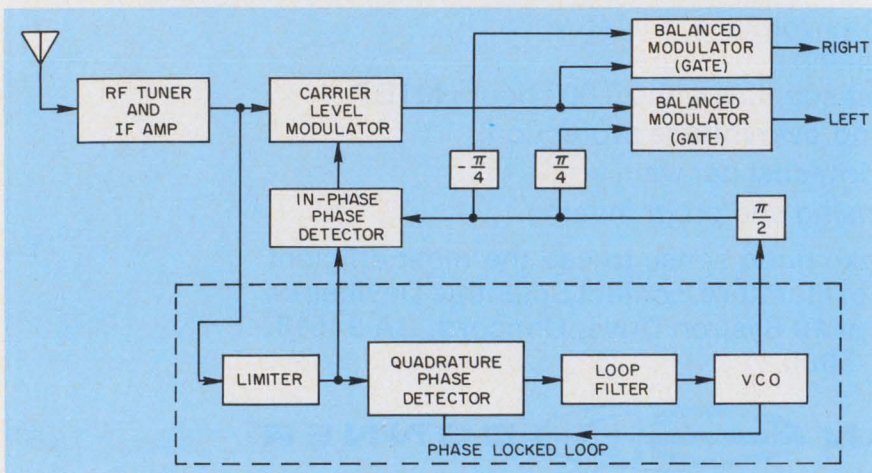

5. Balanced modulators convert quadrature signals into separate left and right channels in Motorola-system receivers.



# Amphenol® 17-Series rear-release connectors, contacts, and crimpers.

A family that  
works together  
to save  
together.

**Cut your assembly costs with a total termination systems approach.** Our 17 Series has everything you need for rear-release, input/output connections for data transmission. You get the lowest possible installed cost.

**First, the connectors: 50% less costly to assemble.** These rear-release connectors permit fingertip contact insertion. Without insertion tools. You can snap several of our crimp Poke-Home® contacts in place in the time normally required for a single contact inserted with a tool. So you can cut labor costs in half—at least. And no special skills or training are needed either.

**Some important electrical improvements, too.** Our 17 Series connectors have a shrouded rear-release insert to prevent shorting and arc-over. No potting or sleeving is required. These connectors meet EIA Standard RS-232C for data-communication input/output connectors and have an insulation resistance greater than 5000 megohms, per MIL-STD-202A, Method 302.

**Second, the contacts: big savings for volume users.** With our 15,000-contact capacity reels, you can save a bundle over loose contacts.

**Finally, the crimpers: high-speed for lowered costs.** Our new hand crimp tool makes accurate, identical crimps—time after time. And our semi-automatic crimping machine can turn out up to 2000 terminations per hour.

**Get them all—connectors, reeled contacts, crimpers. And get them now.** Five basic contact configurations in 17 Series connectors are now available. So is all termination equipment, backshells, and accessories. For more details, call: Bob Ashley, (312) 986-3763 or write: Amphenol North America Division, Bunker Ramo Corporation, Dept. C57B, 900 Commerce Drive, Oak Brook, Illinois 60521.

The right idea  
at the  
right time.

# AMPHENOL

**BUNKER  
RAMO**®

Hand crimpers  
and semi-automatic  
crimping machine.



CIRCLE NUMBER 24



## Huge North Sea oil platform will monitor its own movements

As the world's largest oil platform settles into the seabed of the North Sea's Ninian oil field this summer, a minicomputer-based data-acquisition and reporting system will record its movements. This rig, built by an Anglo-French consortium, is taller than the Washington Monument and over half a million tons with a base diameter 1-1/2 times the length of a football field. Its bottom deck is 100 ft above the water line.

By reporting movement trends, the monitoring system, developed and built by Interstate Electronics Corp., Anaheim, CA, will help rig operations ward off trouble before it starts. "Because of the costliness of drilling for oil," explains Bob Kendall, Interstate's project leader, "saving a single day of downtime on the job often can justify the entire cost of a system like this."

The 136-channel Adaptive Recording System (ADRS) will monitor the bending and flexing of the submerged tower and the causes—wind speed and direction, waves and tides. In addition, the force of the structure on the seabed itself will be gauged, as well as any lateral motion the rig may experience. However, it is expected (and hoped) that this last parameter will "never register more than a few inches," says Kendall. "The rig's operators would be very concerned if the accelerometers ever did."

### Over the threshold means trouble

Designed as a simple-to-operate "turnkey" system, the ADRS accepts input to its DEC PDP-8 minicomputer from a variety of environmental sensors and compares the magnitude of each parameter with their operator-defined thresholds. If any threshold is exceeded, the system activates an

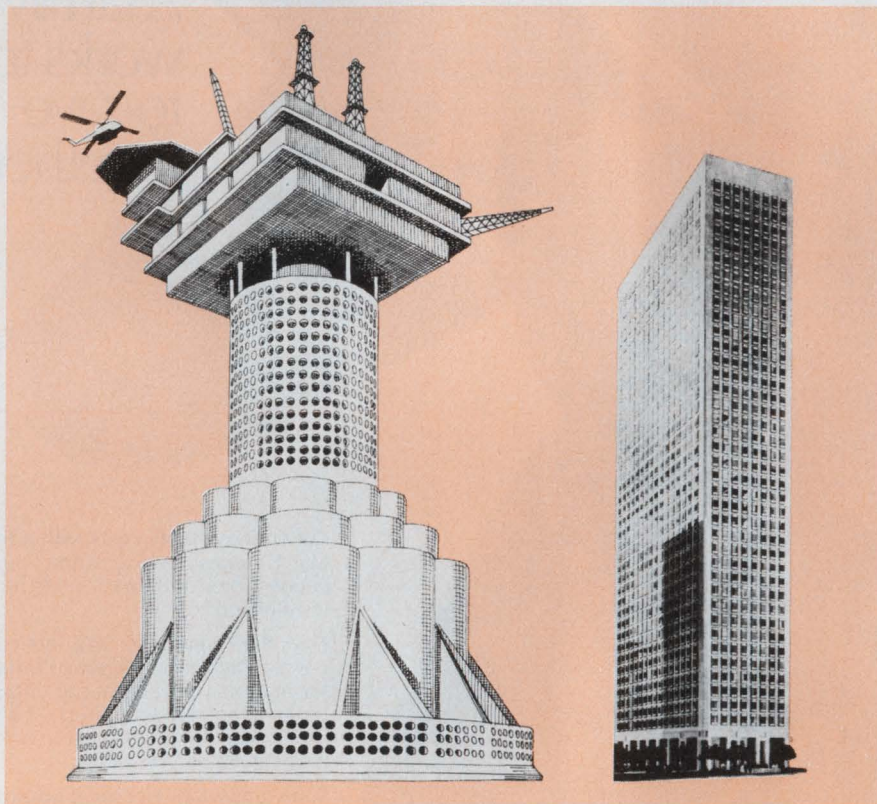

This drilling platform, as tall as a 39-story office building, will be towed 450 miles from Scotland to the Ninian oil field in the North Sea. En route, it will be the largest floating man-made object. After placement, a computerized data-acquisition and reporting system will monitor sea and air pressures and the rig's structural stresses. Holes at the waterline and at the base will help reduce the effect of tides and currents.

alarm, displays a warning message and records raw data on the offending parameter.

Under normal conditions, statistical data on all parameters are outputted periodically to floppy disc for analysis. "Thirty-two seconds after initial power is applied, the first summary will be outputted to disc," says Kendall. All sensors are scanned every half second, except for the cathodic protection monitors that are sampled on a daily basis. Should conditions worsen, multiple thresholds provided by the ADRS firmware enable data to be recorded in increasing volume.

The minicomputer keeps a running average of 64 samples in time, and, with these data, calculates other parameters like wave energy, height, direction and speed, mean-tide level, and the tower's degree of tilt. With input from the accelerometers, the computer can locate the structure's position by deduced (dead) reckoning. It constructs histograms of the parameters, too.

### Helicopters need help to land

The only access to the isolated Ninian Field is through the air via heli-

Dick Hackmeister  
Western Editor



# ✓ Check your system's output.

*If it's anything like one of these, investigate the HP display that makes your system look its best.*

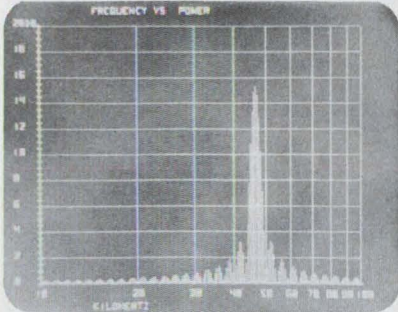

Spectrum Analysis

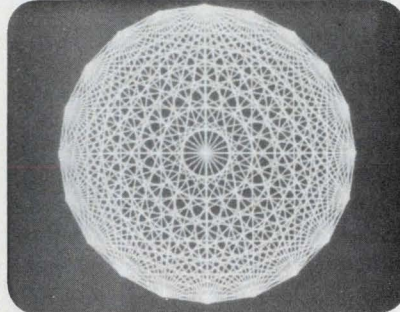

Computer Graphics

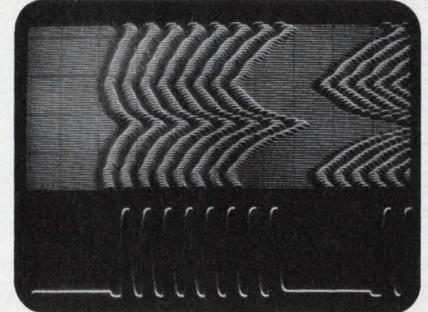

Vibration Analysis

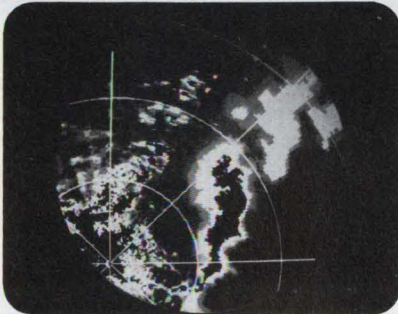

Weather Radar

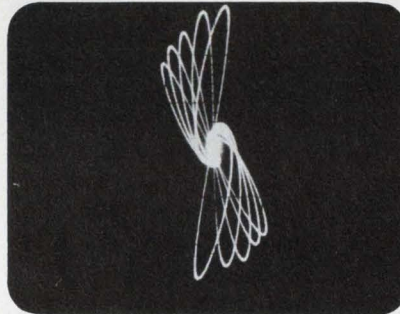

Non-destructive Metal Testing

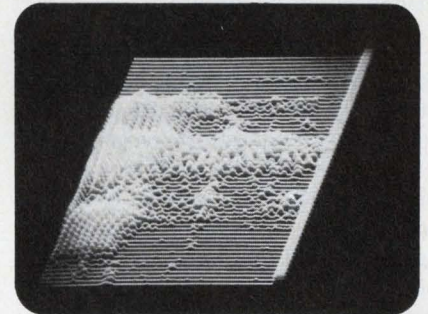

Frequency/Amplitude/Time Analysis of Speech

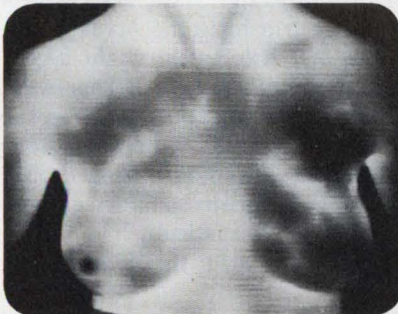

Medical Thermography

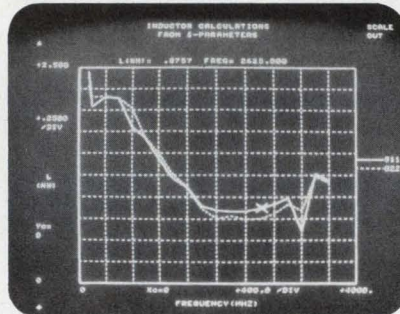

Automatic Test Systems

Mine is different, try this

Check your system's output. Then clip your business card or other identification to this ad and mail to Hewlett-Packard. We'll send display data pertinent to your OEM system needs...large screen or small. HP's displays, with a variety of CRT and electronic options, can meet your need for U.L. listings, fast writing speed, storage, variable persistence, high resolution, and more. And HP provides worldwide after-sales support tailored to your needs. Mail this ad today, or call your local HP field engineer.

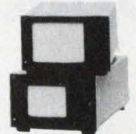
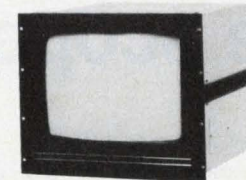
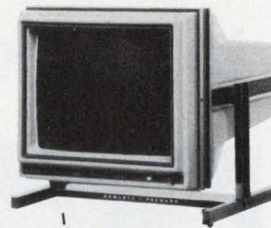

HEWLETT **hp** PACKARD

Box 2197, Colorado Springs, CO 80901, Dept. 233

For assistance call: Washington (301) 948-6370, Chicago (312) 255-9800, Atlanta (404) 955-1500, Los Angeles (213) 877-1282



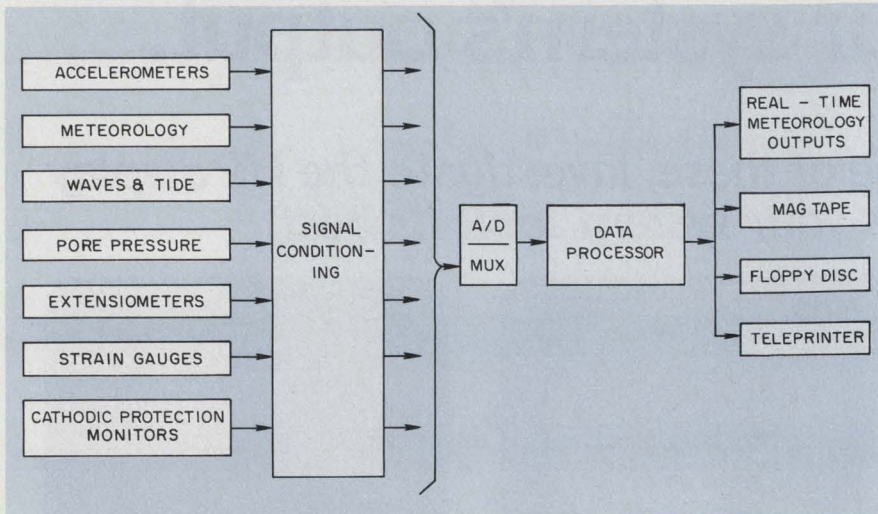

**A real-time environmental monitoring and reporting system** samples 56 strain gauges, 32 vibrating-wire extensimeters, 24 pore pressure transducers, 12 linear accelerometers, three wave staffs, one real-time meteorological package, and four cathodic protection monitors, each in half a second. A minicomputer delivers two-minute summaries, calculates small shifts in the tower's position, and generates histograms.



copters. Armed with ADRS's meteorological data—wind speed and direction, air temperature, barometric pressure and sea temperature—they will be able to land safely. Besides being included in the two-minute summaries to disc, these weather data are repeated on a cluster of strip-chart recorders and direct-reading meters in a room on the rig's fourth deck, below the landing pad. They provide Automatic Terminal Information Service.

There are many other sensing elements in the monitoring system, including 56 strain gauges, 32 vibrating wire-extensimeters, 24 pore-pressure (weight-of-the-structure) analog transducers, 12 linear accelerometers, and three wave staffs.

Two wave staffs determine wave height and direction, respectively,

while the third is a tide sensor. Only their software integrating limits differ. Manufactured in-house by Interstate, all three staffs are TTL-compatible, water-operated rheostats, 40 m (131 ft) long, according to Kendall. The other sensors are available on the OEM market.

All 24 analog transducers are inputted to rack-mounted signal conditioning (filtering and gaining) modules, which are digitized, multiplexed and inputted to the minicomputer.

#### Little intervention needed

Because the ADRS is a "turnkey" system, operator intervention is minimal. The only thing on the programmer's panel is the minicomputer's On/Off switch. All the sensing equip-

ment is housed in five bays on the rig's first level—the most sensitive of the units are hermetically sealed with heat exchangers as a safeguard against the corrosive salt air.

Microprocessors may get into the oil act as well—several spare channels are being held aside to accommodate a  $\mu$ P-controlled riser pipe—a 20-in. pipe in which the drill rotates, and drilling "mud" is pumped down (at 150 ft/s), and back up again. "With existing technology, a drill bit could break at the bottom of a hole and it might be difficult to detect," says Dick Thomason, project leader of an Interstate group investigating this complementary product line. "Adding a 'smart' riser pipe could make any drilling rig more efficient by acoustically monitoring the goings-on down there." ■■

## Space scope to seek X-ray sources

A powerful X-ray telescope will map the sky for thousands of new X-ray sources, including neutron stars, black holes, quasars, radio galaxies, clusters of galaxies and very hot gas that may permeate the universe. The telescope is scheduled to be launched into earth orbit this June.

One of four experiments that make up the payload of the High-Energy

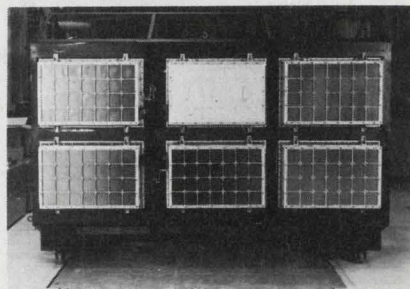

Astronomy Observatory, the Large Area X-ray Survey Array—developed by the Naval Research Laboratory—will be the largest space experiment ever flown in a satellite. It weighs almost 1000 lb, is 20 times larger than any of its predecessors, and is 100 times more sensitive than previous X-ray detectors, says Dr. Herbert Friedman, head of NRL's Space Science Div. ■■





Who  
checks you in and out  
of the best hotels in New York,  
Paris, Honolulu, and Las Vegas?  
We.



SYSTEM INSTALLATIONS IN:  
Aladdin Hotel & Casino • Cerromar  
Beach Hotel • Dorado Beach Hotel •  
Hotel Inter-Continental Maui • Hotel  
Inter-Continental Paris • Hyatt House Orlando  
• Hyatt Regency Waikiki • Innisbrook Resort & Golf  
Club • MGM Grand Hotel • Sea Pines Plantation • Sheraton-  
Boston Hotel • Sheraton-Four Seasons Hotel • Sheraton  
New York Hotel • Sheraton Waikiki • Princess Kaiulani  
Hotel • Royal Hawaiian Hotel • Tamarron

The computer system that takes your reservation, registers you, continuously updates your guest folio from hotel points of sale, and prints out your final bill is almost certainly our EECO Hotel System. Because we dominate the field you'll find it unobtrusively doing its job at a growing number of the world's best hotels and resorts.

We're telling you now because we thought it's time you knew we do more than make thumbwheel switches, tape readers, and packaging hardware.

EECO is part of your life.

**EECO**

1441 E. Chestnut Ave., Santa Ana, California 92701 • Phone 714/835-6000

CIRCLE NUMBER 26



## News

# Multilingual teleprinter types in either direction

Any language that can be written horizontally—including English, Russian, Greek, and Hebrew—can be transmitted between teleprinters that use a microprocessor-controlled dot-matrix printing mechanism. Nine ink jets in the mechanism form characters and symbols and print them from left to right or right to left.

The teleprinter, developed by Koor

Systems of Petah Tikva, Israel, incorporates an 8080-type microprocessor and 32 kbytes or more of memory, depending on the number of type fonts it can handle. Under microprocessor control, characters are formed in a matrix nine dots high and up to 16 dots wide. The appropriate letter or symbol is retrieved from memory and printed when a key is depressed or an incoming

message received.

Print direction and type font are switch-selectable at the transmitting end, and the teleprinter sends a coded control signal to the receiver to adjust for direction, font, and transmission rate.

The electronics for the teleprinter are mounted in a 16-slot card cage. Six slots are used in the simplest version of the device, and up to 13 slots are filled in a machine that can handle multiple fonts. Along with controller and memory cards, there are cards for such circuitry as stepper-motor drivers.

The teleprinter has three separate motors for the print mechanism, a

# One way...

## HP's Universal Counters

satisfy the needs for most electronic counter measurements up to 1300 MHz, and do it without breaking your budget. Two distinctly different models are loaded with features, and a wide variety of options are available.

**One way is the 5328A** for high performance frequency, period and time interval measurements in a modular 8 or 9-digit unit for systems or bench use. Start with the basic 100 MHz/100 ns unit for just \$1300\*. Modules expand its capabilities to 512 or 1300 MHz for frequency, 10 ns for time interval and add 10 $\mu$ v to 1000v, digital voltage measurements. Other options include ultra-stable time base, and full HP Interface Bus operation. Standard at no extra cost are burst frequency measurement and time interval averaging to

10 ps resolution...matched input amplifiers make this resolution meaningful.

**The other way is the 5300B/5308A System** for lower cost yet highly versatile 8-digit frequency, period and time interval measurements in a modular portable package that also can be rack mounted. In just 30 seconds, snap on any of 10 other modules including: a full capability DMM, battery pack and 1300 MHz and HP Interface Bus modules. The 5300B/5308A's low \$910\* price even includes time interval averaging for resolution to 1 ns!

Use the 10855A Preamplifier for higher sensitivity with any model: 22 dB gain, 2 to 1300 MHz for just \$225\*.

**To do it your way** contact your nearest HP field engineer for full data, or write.

\*Domestic U.S. prices only.



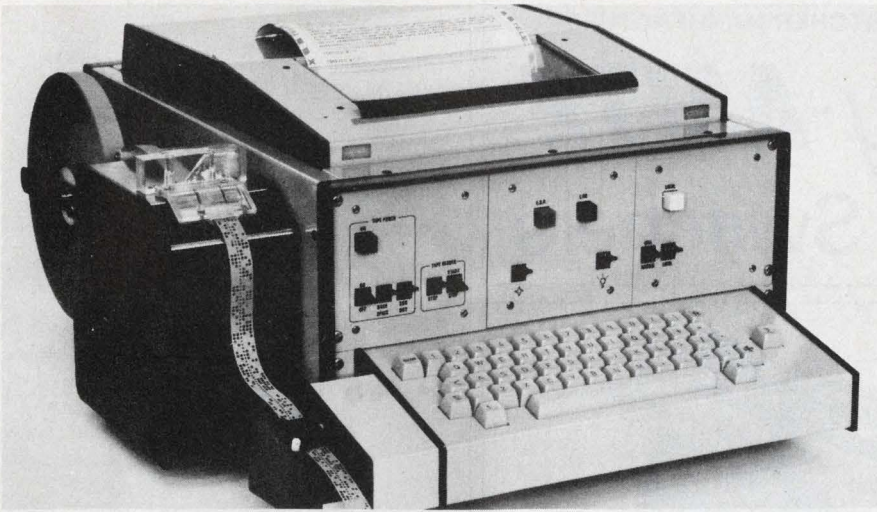

Two-way printing and a dot-matrix head made this teleprinter multilingual.

paper tape punch, and a paper tape reader. This arrangement is more reliable than the system of belts driven by a single motor that is found in most teleprinters, explains Noah Horowitz, designer of the teleprinter and general manager of Koor Systems.

"The teleprinter serves as an advantage to all business organizations, especially to those heavily involved in international trade and communications," says Solcoor Inc., New York, which markets Koor Systems' products in the United States. "It represents a savings to those organizations that would make use of more than one machine (to handle different languages)," it adds. A single-font teleprinter is \$4000 in unit quantities. ■■

# or the other,

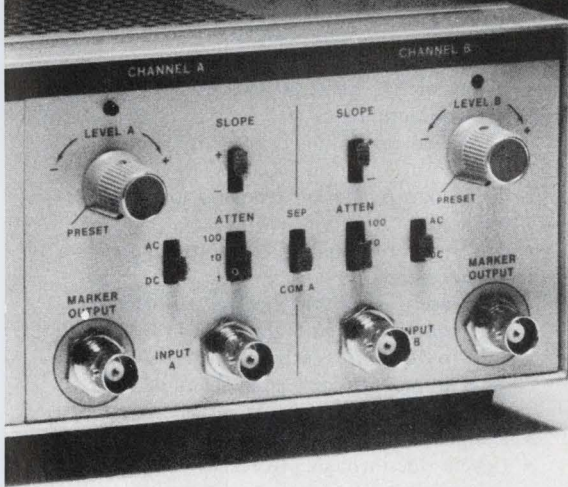

# the right performance at the right price.

HEWLETT  PACKARD

1507 Page Mill Road, Palo Alto, California 94304

For assistance call: Washington (301) 948-6370, Chicago (312) 255-9800, Atlanta (404) 955-1500, Los Angeles (213) 877-1282

CIRCLE NUMBER 27



FROM THE WORLD'S LARGEST SWITCHER MANUFACTURER . . .

# NEW *Tiny-MITE* Open-Frame Switchers

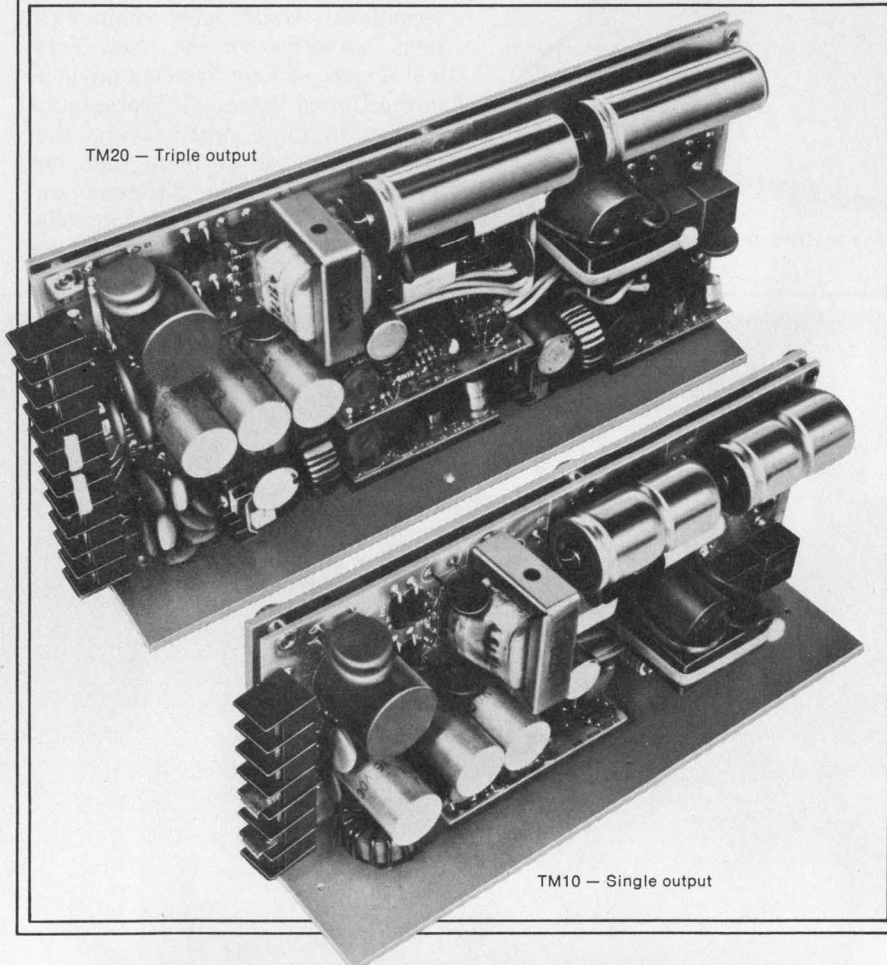

## Single- and multiple-output switchers for OEM computers and terminal systems.

### Power density of 1w/in.<sup>3</sup>

With LH's Tiny-MITE switchers you get power density of 1 watt/in.<sup>3</sup> in small, open-frame packages offering up to 75-percent efficiency — at a price much lower than switchers usually sell for.

The single-output TM10 packs 100 watts in a package that's only 9.5 in. L x 4.0 in. W x 2.5 in. H and weighs only 3 lbs. The triple-output TM20 produces 150 watts in a package that's 12.0 in. L x 5.0 in. W x 2.8 in. H and weighs less than 4 lbs.

### Single- and triple-output units

TM10's single-output voltage is 5 volts adjustable  $\pm 5$  percent at 100 watts; other

outputs are available including 12, 15, 18, 24, and 28 volts standard. The TM20's primary output is 5 volts adjustable  $\pm 5$  percent at 20 amperes with second and third outputs in any of the following combinations: 5 volts at 5 amps, 12 volts at 5 amps, 15 volts at 5 amps, 18 volts at 3 amps, 24 volts at 2 amps, or 28 volts at 2 amps. (Combined power outputs may not exceed 150 watts.)

### More power, less space

TM10 and TM20 are perfect choices for OEM computer and terminal system applications. Why? Because the new Tiny-MITE switchers were specifically designed

for high volume, low cost production and to pack more power in less space. This high power density is especially important when circuit redesign demands more power and there is no more space in your package.

Technology used in the new TM Series was developed by LH and has been proven in over 30,000 switchers now in the field. And to further assure reliability, every LH switcher is tested and burned-in before shipment.

### Advanced circuitry = versatile specs

- Wide input variation standard — 92-130 VAC and 180-260 VAC, 47-450 Hz.
- 50 mv or 1% peak-to-peak ripple and noise on output.
- 0.4% line regulation over entire input range.
- 0.4% load regulation from no load to full load.
- Power failure signal and remote on/off control standard.
- Response time of 200  $\mu$ sec to 1% after 25% load change at 5 amps/ $\mu$ sec.
- 0°C to 50°C operating temperature range in natural convection. Derated to 50% load at 70°C.
- Designed to meet UL 478.
- 1-cycle ride-through (16 msec) before power fail is signaled.
- Fold-back current limit on outputs.
- Overvoltage protection standard (on main output) — factory-set at 125%  $\pm 5$ %.
- Remote sense (main output only) compensating for load cable loss up to 250 mv.
- — and a whole lot more.

Call or write today to learn how LH's Tiny-MITE Series will fit your needs.



LH RESEARCH, INC., 1821 Langley Avenue, Irvine, CA 92714 (714) 546-5279 • TWX 910-595-2540

CIRCLE NUMBER 28



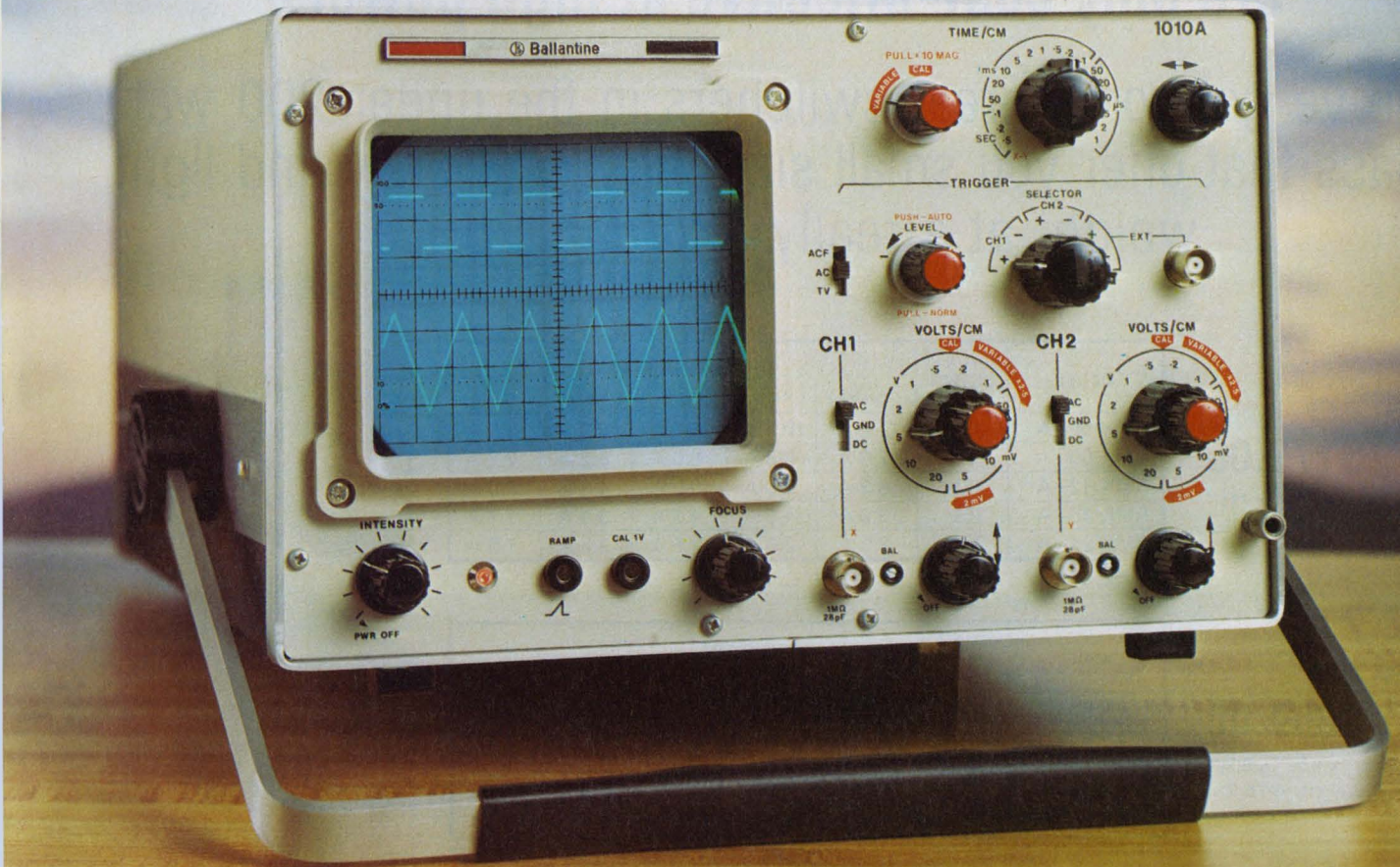

# A SCOPE FOR ALL REASONS

Finally a professional oscilloscope to fit your basic needs.  
 High quality, easy to maintain, and easy to use.  
 Ideal for production, design laboratories, field service and schools.

## Ballantine Model 1010A Dual Channel and X-Y oscilloscope

- FREQUENCY:** DC to 15 MHz each channel  
24 nanosecond rise time. 15 MHz full scan
- SENSITIVITY:** 2 mV/cm to 20 Volts/cm  
Continuously variable gain.
- TIME BASE:** 100 ns/cm to 1.25 s/cm  
X10 Magnifier, Trigger beyond 20 MHz
- PORTABILITY:** Only 7 Kg. (15 pounds)
- DISPLAY:** 8 x 10 cm CRT with 3600 volts
- ECONOMY:** \$ 595

# Ballantine

Available on GSA Contract GS-00S-04619, Stock Number 6625-00-472-9910.

Ballantine Laboratories, Inc., Boonton, New Jersey 07005 USA

CIRCLE NUMBER 29



# who says- switch-mode (25 kHz) power supplies are only cost-effective at high power?

we've got some great switchers in the under 200 watt class that offer you small size, high efficiency and light weight at a really affordable price!

size **A**  
\$179.00

2 7/16" x 5 1/8" x 7 1/2"  
Weight: 3 lbs.

MODEL	NOMINAL OUTPUT VOLTAGE*	OUTPUT CURRENT				
		30°C	40°C	50°C	60°C	71°C
RMK 05-A	5V	12.0 A	10.8 A	10.0 A	8.3 A	5.0 A
RMK 09-A	9V	7.6 A	6.8 A	6.0 A	5.2 A	2.7 A
RMK 12-A	12V	6.3 A	5.6 A	5.0 A	4.3 A	2.0 A
RMK 15-A	15V	5.0 A	4.5 A	4.0 A	3.4 A	1.7 A
RMK 24-A	24V	3.2 A	2.8 A	2.5 A	2.2 A	1.0 A

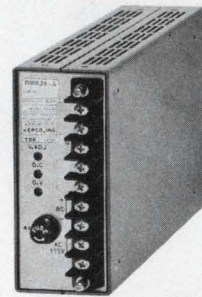

size **B**  
\$259.00

3 7/32" x 5 1/8" x 8 3/4"  
Weight: 4.75 lbs.

MODEL	NOMINAL OUTPUT VOLTAGE*	OUTPUT CURRENT				
		30°C	40°C	50°C	60°C	71°C
RMK 05-B	5V	36.0 A	34.0 A	26.0 A	17.0 A	9.0 A
RMK 09-B	9V	20.0 A	17.0 A	15.0 A	10.0 A	5.2 A
RMK 12-B	12V	16.6 A	15.0 A	12.0 A	8.0 A	4.2 A
RMK 15-B	15V	13.3 A	13.3 A	10.2 A	6.2 A	3.3 A
RMK 24-B	24V	8.5 A	8.5 A	7.5 A	4.7 A	2.3 A

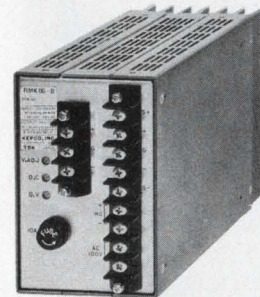

size **C**  
\$299.00

4 1/16" x 5 1/8" x 8 3/4"  
Weight: 5.25 lbs.

MODEL	NOMINAL OUTPUT VOLTAGE*	OUTPUT CURRENT				
		30°C	40°C	50°C	60°C	71°C
RMK 05-C	5V	40.0 A	38.0 A	30.0 A	21.5 A	14.0 A
RMK 09-C	9V	22.0 A	22.0 A	17.2 A	12.5 A	7.7 A
RMK 12-C	12V	17.0 A	17.0 A	14.6 A	10.5 A	5.8 A
RMK 15-C	15V	14.0 A	14.0 A	12.3 A	8.3 A	4.7 A
RMK 24-C	24V	9.0 A	9.0 A	8.0 A	5.5 A	3.0 A

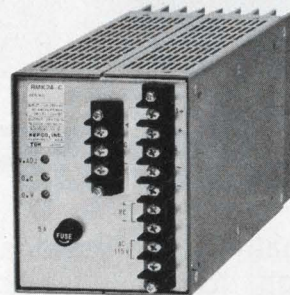

\*Adjustable ±10%, you may order them to be factory-set anywhere in the range -30% to +10% of the nominal.

**KEPCO series RMK** are the product of a KEPCO/TDK joint venture. They employ advanced digital signal processing for a low parts population (enhancing reliability) and advanced TDK ferrites for efficiency and low noise. RMK are burned in for 48 hours at +55°C to insure delivery to you of a reliable, trouble-free power supply. We back that with a 5-year Warranty! . . . the same warranty offered on our fine linear and ferroresonant models. Call Kepco collect : (212) 461-7000 and arrange for a demo right in your own shop!



**KEPCO**

For complete specifications, write Dept. BTF-05

KEPCO, INC. • 131-38 SANFORD AVENUE • FLUSHING, N.Y. 11352 U.S.A. • (212) 461-7000 • TWX # 710-582-2631 • Cable: KEPCOPOWER NEWYORK

CIRCLE NUMBER 30



# Washington report

---

## Defense-service contractors face business loss

Defense-support-services contractors face a dry spell until next spring unless they can persuade the Senate to knock out a moratorium on additional contracting-out imposed by the House in section 809 of defense-authorization bill HR 5970.

The moratorium, which would last until March 15, 1978, is supported by government employees' unions pressing to block planned cutbacks in civilian employment and opposed by industry groups claiming that it restricts competition.

Secretary of Defense Harold Brown has urged the Senate Armed Services Committee to delete Section 809 from the defense-authorization bill because it conflicts with earlier legislation requiring the Defense Department to reduce manpower costs. The Pentagon has been criticized by the General Accounting Office for not contracting out enough support services to industry. A recent GAO survey of 24 military bases revealed that the military services are keeping 77% of some \$2-billion in support services in-house—which conflicts with Office of Management and Budget Circular A-76, requiring maximum contracting-out.

## Nuclear aircraft re-emerge in Navy studies

Nuclear-powered aircraft—a research blind alley in the 1960s—have resurfaced in conceptual studies just completed for the Navy.

A nuclear-powered ocean patroler that can remain airborne for 15 days is one of three concepts studied by Lockheed-Georgia Co., Marietta, GA, under contract from the Navy's Office of Advanced Vehicle Studies. The aircraft would weigh 1.25-million lb—twice the weight of a 747 jumbo jet—and would send recoverable remotely piloted vehicles (RPVs) down to the ocean's surface in search of enemy vessels.

The patroler is strictly on paper—however, the Defense Department has been studying a successor to the Lockheed P-3C Orion patrol aircraft in its Large Multimission Naval Aircraft (LMNA) program, which is nicknamed "Big Mother." That aircraft would be about the size of a 707 jetliner and would carry RPVs and other weapons.

A huge amphibious aircraft and a wing-in-ground-effect logistics aircraft weighing 1.4-million lb were also studied by Lockheed.

## Air Force, Navy testing LEDs for airborne use

The Air Force and Navy are cosponsoring 5000-hour life tests on 240 light emitting diodes to evaluate their life expectancy in airborne fiber-optic digital flight-control systems and other military applications. The tests, which began



last December at the Air Force's Arnold Engineering Development Center, Tullahoma, TN, are due to reach the 5000-hour mark in mid-June.

An electrical signal is supplied to each LED, and the output is monitored by a fiber-optics bundle terminating in a photodetector. One trend has emerged from the tests to date, according to ARO Inc., the Air Force contractor that operates the Arnold center. Diode failure appears directly related to temperature, with high failure rates experienced at high temperatures. The LEDs were apportioned into four groups of 60 each and installed in chambers maintained at -60 C, 20 C, 90 C and 120 C.

The naval participant in the tests is the Naval Ocean Systems Center (formerly Naval Electronics Laboratory Center).

## Thinner solar cells eyed for space power use

Solar cells thinner than this page are being developed to increase the power-to-weight ratio of solar arrays in space and perhaps achieve megawatt levels for beaming energy back to earth. Measuring 40 to 50  $\mu$  thick, the cells are already achieving energy-conversion efficiencies of around 11%—vs 12 to 13% for the conventional 300-micron-thick cells currently used, according to the National Aeronautics and Space Administration (NASA), which is sponsoring the work by two contractors, Solarex Corp., Rockville, MD, and Spectrolab Inc., Sylmar, CA. The thin cells are being developed in 4-cm-square panels by Solarex. Cells as large as 38 cm square will be developed by Spectrolab.

## FAA cuts traffic control channel spacing to 25 kHz

The Federal Aviation Administration has begun reducing the channel spacing from 50 kHz to 25 kHz for very-high-frequency (vhf) air-traffic-control communications for aircraft operating above 18,000 feet. The change, which affects the upper end of the aeronautical mobile service band's air-traffic-control portion, is intended to make more vhf channels available to relieve congestion and provide for future communications growth.

The new spacing is already in effect in four high-altitude traffic-control sectors. Eight more are due to be added by October. Next year, FAA plans to reduce the channel spacing for the rest of the country's 240 high altitude sectors on a case-by-case basis.

**Capital Capsules:** The People's Republic of China is expected to request American assistance in developing an air-traffic-control system, once diplomatic relations with the U.S. are restored, according to the Federal Aviation Administration. FAA is currently helping to set up such systems in Iran, Oman, Kuwait, Korea, Venezuela and the Republic of China (Taiwan). . . .A hydrometeorological telemetering system will be supplied to the Philippine government by Systron-Donner Corp. to monitor flood levels at 14 points in the Laguna de Bay Basin near Manila. . . .An ultrasonic calorimeter measures beam power up to a few watts from ultrasonic transducers. Developed by the National Bureau of Standards, the twin-vessel, series-flow comparator operates in the 1 to 15-MHz frequency range.



# You design the system. We'll display your solutions.

**Together we make each other look better than ever.** Because our specialty is taking your system's output and displaying it as concepts that any user quickly understands.

Tektronix has made graphics desirable and affordable

worldwide. Our components can give your system the same universal acceptance and versatility. Our capabilities complement your needs: including graphic and alphanumeric terminals and monitors. Plotters. Hard copiers. Combined refresh and storage technology.

**We'll work as your partners.** We'll provide modular display components you can stake your reputation on, with prices and quantity

discounts that put it all together. You've got high standards for your OEM suppliers: we stack up to them. Give us a call soon.

Tektronix  
Information Display Group  
OEM Components  
P.O. Box 500  
Beaverton, Oregon 97077

**Tektronix  
OEM components:  
the perfect fit.**

CIRCLE NUMBER 31

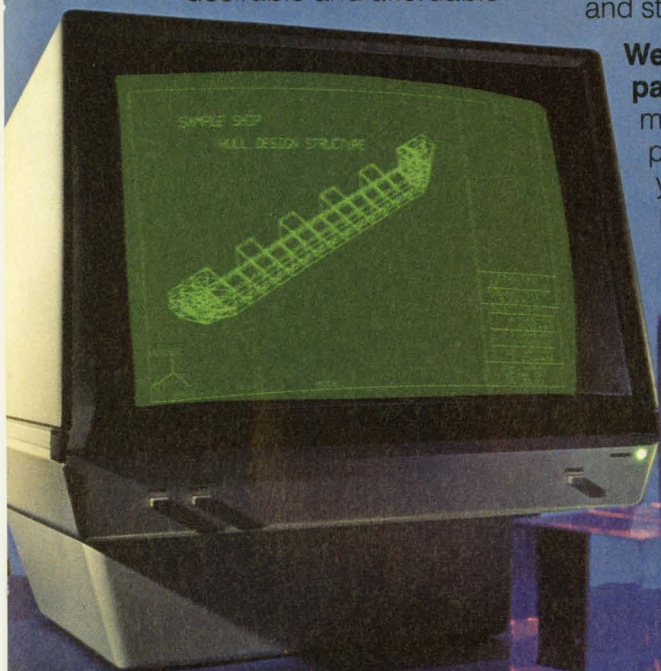

**Tektronix**  
COMMITTED TO EXCELLENCE

copyright © 1977, Tektronix, Inc. All rights reserved



# Solderless bus connector

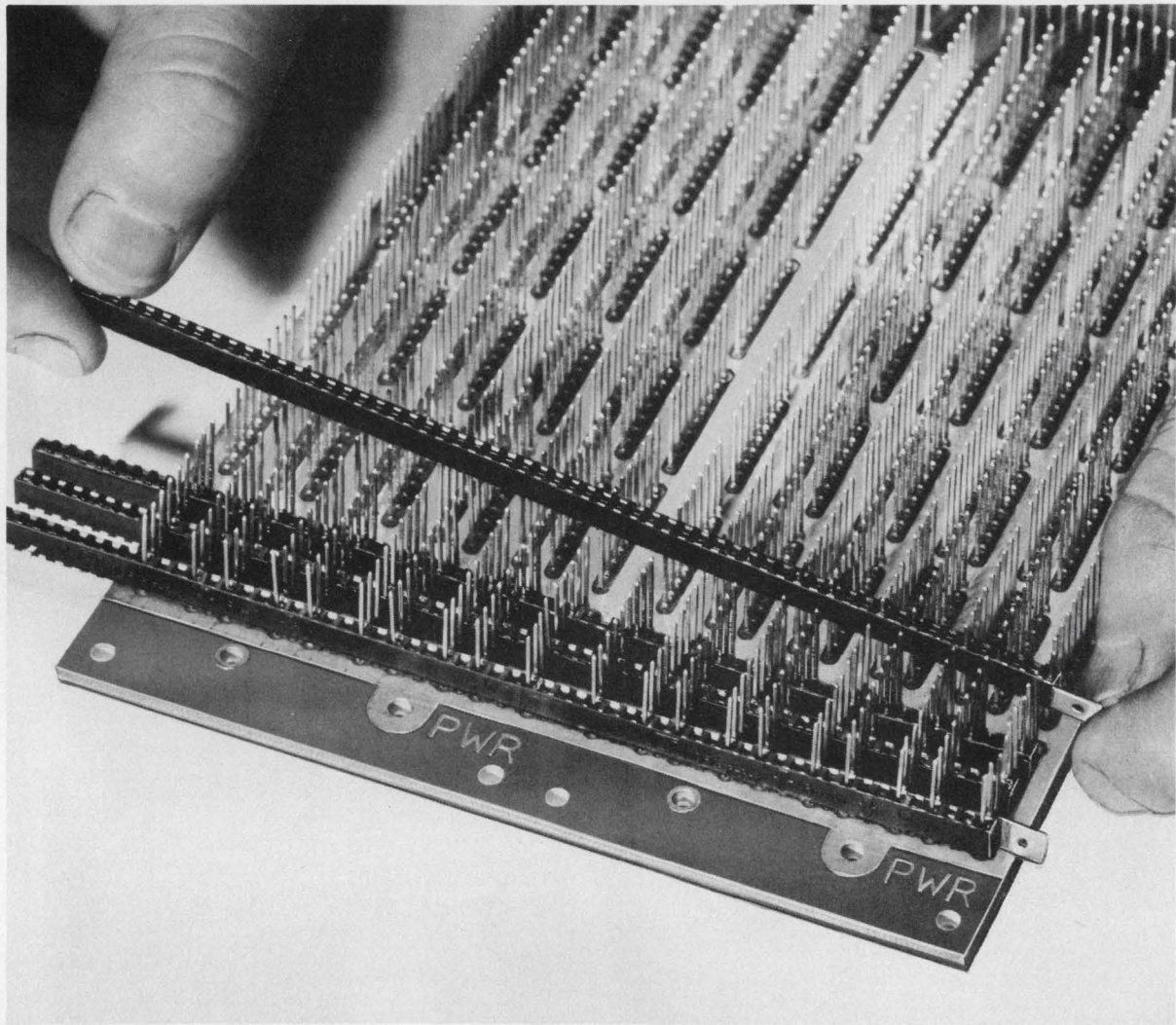

## QUIK/STRIP

The new, fast, low cost method of connecting in-line pins on DIP socket boards and connector arrays.

- low installed cost\*
- 18 gauge current capacity
- contacts fully insulated and protected in glass filled nylon housing
- extremely reliable — shock and vibration resistant
- can be used on pin densities as high as  $.100'' \times .100''$
- two or more strips stacked for higher capacity

\* Installed cost runs between 2.5¢ and 11¢ per connection.

For a free sample, write on company letterhead; for more information, contact product specialist.



**Rogers Corporation** Chandler, AZ 85224 Phone: (602) 963-4584  
EUROPE: Mektron NV, Ghent, Belgium. JAPAN: Nippon Mektron, Tokyo.

CIRCLE NUMBER 32



# Here's how Data General's microNOVA system stacks up against the competition.

## microNOVA Processor:

Fully packaged 9-slot micro-computer, 16K words MOS memory, 2.4-microsecond arithmetic operations, hardware stack facility, multiply/divide, DMA capability. Includes RTC, PF/AR and APL. Supports up to 32K words RAM/PROM memory.

## Dual-diskette subsystem:

Integral DMA controller, compact 630KB capacity.

## Cabinet:

37 inches high, holds all rack mounted components.

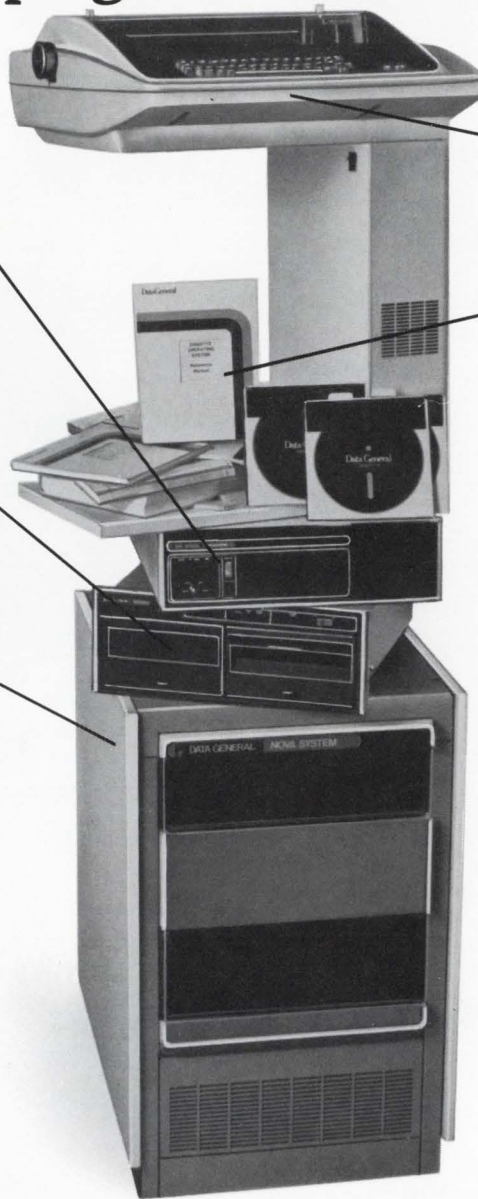

**DASHER**  
terminal printer:  
30 cps, 132-columns, typewriter  
keyboard, upper/lower case.

**Systems Software:**  
Multitasking Disc Operating  
System, Real-Time Operating  
System, FORTRAN IV,  
Extended BASIC, Macro Assem-  
bler, Utilities.

**\$10,970**  
List\*

The facts speak for themselves. For \$10,970, Data General's new microNOVA gives you more system, software availability and support than any other comparable computer. And we deliver in 60 days.

Any way you look at it, it all stacks up in your favor. For more information and our brochure, call our toll free number, 800-225-9497, or, fill out and return the coupon.

\*Additional software fees apply to first system only.  
Quantity and OEM discounts available.

Data General, Westboro, MA 01581  
Sounds like smart business. Send me more information.

NAME \_\_\_\_\_  
TITLE \_\_\_\_\_  
COMPANY \_\_\_\_\_  
ADDRESS \_\_\_\_\_ TEL. \_\_\_\_\_  
CITY \_\_\_\_\_ STATE \_\_\_\_\_ ZIP \_\_\_\_\_  
NOVA is a registered trademark of Data General Corporation.  
DASHER is a trademark of Data General Corporation. ED 5/24



**Data General**  
It's smart business.

Data General, Westboro, MA 01581, (617) 485-9100. Data General (Canada) Ltd., Ontario. Data General Europe, 15 Rue Le Sueur, Paris 75116 France. Data General Australia, Melbourne (03) 82-1361.

CIRCLE NUMBER 121



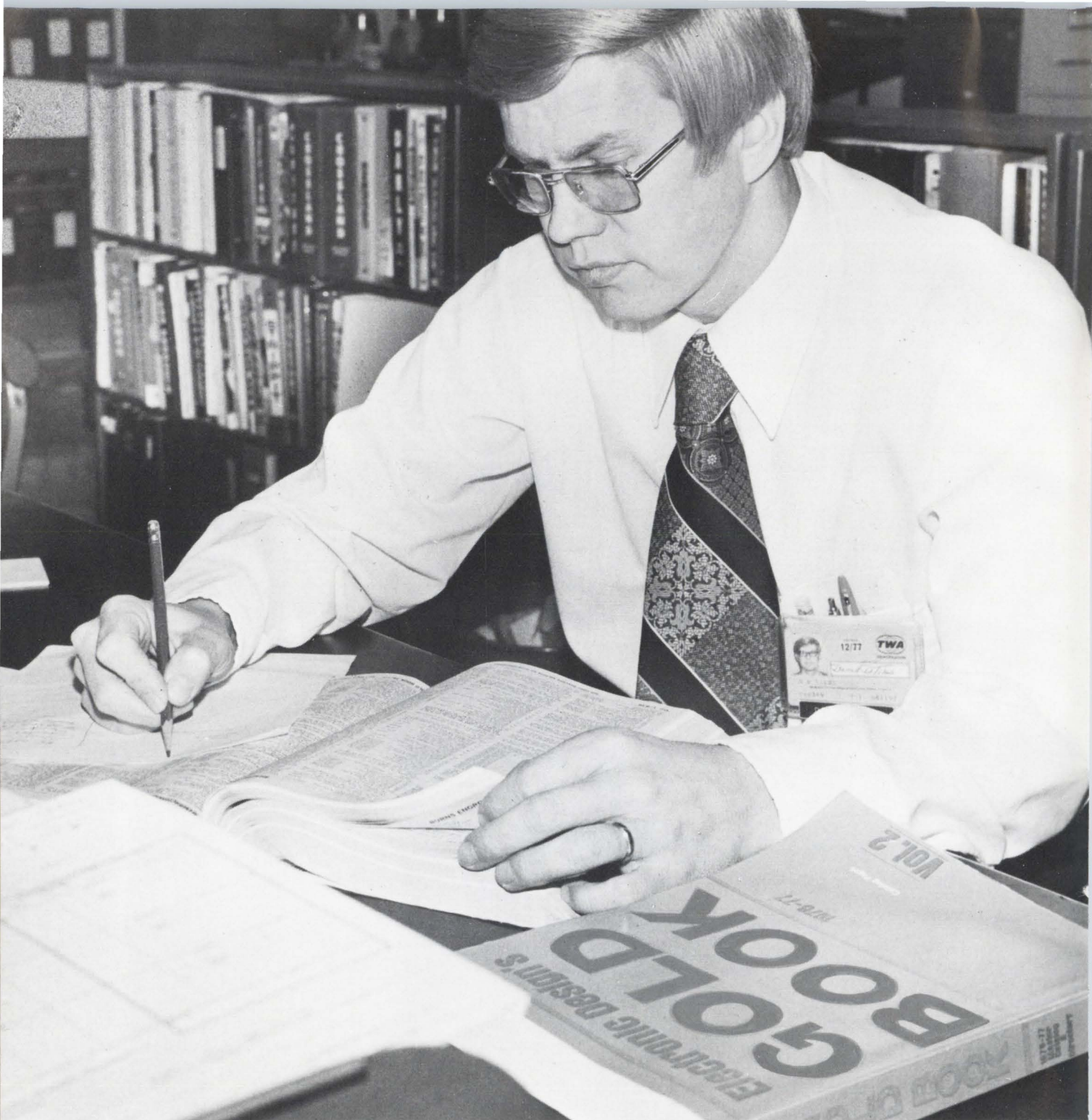

## **“I BELIEVE THE GOLD BOOK IS ONE OF THE MOST IMPORTANT BOOKS ON MY SHELF.”**

Darrell D. Tilus is Master Engineer at TWA, Kansas City. He's in charge of design and/or purchase of equipment used to test aircraft "black boxes," and specifies the needed equipment and components. His directory? *Electronic Design's* GOLD BOOK.

Mr. Tilus estimates that he used the GOLD BOOK two or three times a week during the past year, rates it "extremely useful" and has purchased over \$10,000 worth of test equipment, components and devices through its pages.

**"I can count on the GOLD BOOK to give me and my fellow engineers the address and phone of all the electronic/electrical companies I need to contact. I think it's far superior to the others (especially the EEM) in the directory pages."**

If you're looking for electronic products — do what Mr. Tilus does — look *first* in the GOLD BOOK.

**IF IT'S ELECTRONIC...IT'S IN THE GOLD BOOK**



# When you need LEDs or more than LEDs...



Dialight is the first place to look. We can help you do more with LEDs... because we've done more with them.

Discrete LEDs come in a variety of sizes, shapes, colors (red, yellow, green in clear or diffused), with or without built-in resistors.

Low cost logic state fault indicators for trouble shooting complex circuits. Designed for close density PC board mounting.

High-brightness bi-color LEDs (red/green) suitable for go/no-go situations. Designed with unique

lenses for the extra visibility you'll want for your most critical applications.

Snap-in mounting LED indicators reduce labor cost. Available in red, yellow or green with or without built-in resistors.

Whatever you need in LEDs, Dialight's probably got it already. For your free 60-page selector guide and listing of our nationwide stocking distributors, contact us today.

**DIALIGHT**  
A North American Philips Company

## Dialight meets your needs.

Dialight, 203 Harrison Place, Brooklyn, N.Y. 11237 (212) 497-7600

CIRCLE NUMBER 33



# This plant specializes in advanced IC technology.

It takes a lot of research, development, design, and production know-how to turn out a good line of semiconductor devices . . . it also takes a lot of sophisticated equipment . . . plus a lot of specially-educated and skillfully-trained people mutually striving for product excellence.

At Sprague Electric's Semiconductor Division, we have accumulated over fifteen years of intensive experience in the manufacture of *innovative* semiconductor devices . . . devices making special contributions to technology . . . devices manufactured under the most exacting QAR program . . . devices that assure total customer satisfaction.

We have built the kind of operation it takes to produce semiconductors compatible with today's as well as tomorrow's requirements.

We proudly invite customers and prospects to tour our plant, the nation's finest semiconductor facility of its type. Here you will see the magnitude of effort that goes into properly designed and manufactured devices. You'll be pleasantly surprised!

Write or call George Tully or Bob Milewski to arrange a visit. You can reach them at the Semiconductor Division, Sprague Electric Co., 115 Northeast Cutoff, Worcester, Mass. 01606. Tel. 617/853-5000.



#### FOR FAST INFORMATION, CALL YOUR NEAREST SPRAGUE SALES OFFICE:

ALABAMA, Sprague Electric Co., 205-883-0520 • ARIZONA, Sprague Electric Co., 602-279-5435 • CALIFORNIA, Sprague Electric Co., 213-649-2600; Wm. J. Purdy Co., 415-347-7701; KCE Corp., 714-278-7640 • COLORADO, Wm. J. Purdy Co., 303-777-1411 • CONNECTICUT, Sprague Electric Co., 203-261-2551 • DIST. OF COLUMBIA, Sprague Electric Co. (Govt. sales only), 202-244-6006 • FLORIDA, Sprague Electric Co., 305-831-3636 • ILLINOIS, Sprague Electric Co., 312-678-2262 • INDIANA, Sprague Electric Co., 317-253-4247 • MASSACHUSETTS, Sprague Electric Co., 617-899-9100; Sprague Electric Co., 413-664-4411 • MICHIGAN, Sprague Electric Co., 517-787-3934 • MINNESOTA, HMR Inc., 612-920-8200 • MISSOURI, Sprague Electric Co., 314-781-2420 • NEW JERSEY, Sprague Electric Co., 201-696-8200; Sprague Electric Co., 609-795-2299; Trinkle Sales Inc., 609-795-4200 • NEW MEXICO, Wm. J. Purdy Co., 505-266-7959 • NEW YORK, Sprague Electric Co., 516-549-4141; Wm. Rutt Inc., 914-698-8600; Sprague Electric Co., 315-437-7311; Mar-Com Associates, 315-437-2843 • NORTH CAROLINA, Electronic Marketing Associates, 919-722-5151 • OHIO, Electronic Salesmasters Inc., 800-362-2616; Sprague Electric Co., 513-278-0781 • PENNSYLVANIA, Sprague Electric Co., 215-467-5252; Trinkle Sales Inc., 215-922-2080 • TEXAS, Sprague Electric Co., 214-235-1256 • VERMONT, Ray Perron & Co. Inc., 617-762-8114 • VIRGINIA, Sprague Electric Co., 703-463-9161 • WASHINGTON, Sprague Electric Co., 206-632-7761 • CANADA (Ontario), Sprague Electric of Canada Ltd., 416-766-6123 • CANADA (Quebec), Sprague Electric of Canada Ltd., 514-683-9220

**SPRAGUE**  
THE MARK OF RELIABILITY

... and you thought we  
only make great capacitors.

CIRCLE NUMBER 34



## Dear deer,

My secretary assures me that deer can read. To prove this, she points to the fact that, during most of the year, you can find herds of deer almost anyplace in the forest—particularly near signs warning hunters of severe penalties for shooting deer out of season.

But on the day the hunting season opens, the deer disappear—except near roads, where it's illegal to shoot them. The exceptional one that is seen, or even shot at, is merely proof that an occasional deer is illiterate.

I must confess I was skeptical when Elaine called this to my attention. I felt the phenomenon was merely an example of the law of nature that causes taxicabs to disappear when it rains, or policemen to vanish when you want one. Well, knowing that we engineering types are more logical than those secretarial types, I began to show Elaine the flaw in her logic. Just because two things happen at the same time, I was going to say, that doesn't prove that one caused the other.

Then I remembered some engineering logic that was just as credible as Elaine's: "Our line is extremely reliable; we tested one part for 10,000 hours." "Our design is superb; our backlog doubled last month." "Our product is much better than our competitor's; our specs are always conservative." "Our design is fantastic; our chief engineer is a genius." "It must be better than anybody else's; we've been selling it all over the world." "It must be superior; the Navy uses it." "It's terrific; we spent three years developing it." "Of course we have the best performance; we're using a brand new technology." "Our performance is best; we're using a tried and proven technology." "We give you better service; we're much bigger so we have a vast service organization." "We give you better service; we're much smaller so we have to pay more attention to you." "That job can't be done by one man; it once took two." "It can't be done; I tried it." And so on.

I'm pleased to say that you'll never hear such logic from me. Well. . .hardly ever. Now, about those deer I was writing to.



*George Rostky*

GEORGE ROSTKY  
Editor-in-Chief



How do you squeeze  
7000 feet of reliability  
into a fighting  
package?

Ask Hughes.







## Total interconnection technology.

When it's a complex fighting machine like the Navy's A-6E and its TRAM target-sensing system's highly sophisticated avionics, you connect with Hughes capability. Hughes, because of our deep involvement in high-technology military and aerospace programs: Phoenix, Maverick, Lance, Minuteman, AWACS, F-14, F-15, Space Shuttle, Viking, Sonobuoy, F-4, A-7, Condor, Standard Missile, F-8, Trident, Hobo, Sprint, and many more.

With all that experience, we've developed not only the hardware and the circuitry, but also the concepts and design capability to solve the toughest interconnection problem. And the techniques to make it work. Aside from our design-to-system advanced packaging, we also offer umbilical and special connectors and off-the-shelf connectors.

**Umbilical and other special connectors.** Our umbilical on the new laser-guided Maverick is typical of our specials; we also have connectors on many of the country's airborne missiles where sure-fire operation is critical to national defense. Meeting your requirements is the challenge to us. We give priority to your special-connector problems. Solutions are just part of what we offer.

**Off-the-shelf connectors.** The new C-21 (MIL-C-85028) is another typical example of Hughes hi-rel technology. For high-altitude applications the C-21 has individual seals for up to 250 psi on the contacts, preventing altitude breathing and consequent contamination. It's a Hughes exclusive.

Our standard line also features subminiature rectangulars, standard size, subminiature circulars, and miniature rectangulars—better because they're super hi-density connectors. Our exclusive PolarHex™

Center Jackscrew coupling device makes it all possible. Another Hughes first is our HAC PAK™ connector (MIL-C-28804), the simplest way to connect round to flat cables.

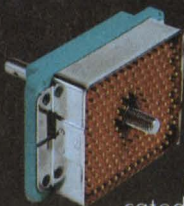

**Ask Hughes.** Squeezing reliability into any sophisticated machine is no problem

for you. Just ask Hughes Connecting Devices, 17150 Von Karman Avenue, Irvine, CA 92714, or call (714) 549-5701.



# HUGHES

HUGHES AIRCRAFT COMPANY  
CONNECTING DEVICES

## Total interconnection technology: the hardware, the circuitry, and the concepts.

CIRCLE NUMBER 296



# FOCUS

on  
Electronic  
Counters

Counters may be better than ever, with sensitivities soaring, frequencies vaulting to new highs, and prices tumbling.

But if you're looking for the right counter, you still must pace the same, time-worn specifying ruts: ephemeral accuracy specs, spotty sensitivity figures, uncertain triggering levels. And climbing out of the ruts isn't easy.

**Stanley Runyon**  
Senior Associate Editor

Hardly any counter manufacturer specifies absolute accuracy. Too many error sources are involved, and the spec is a moving target—vary the measurement, change the test set-up, let calibration slide, and accuracy can crumble. The familiar  $\pm 1$  count  $\pm$  time-base stability is undependable as well. Accuracy can get worse—much worse—than that number implies.

The key to accuracy is the time base, which is really

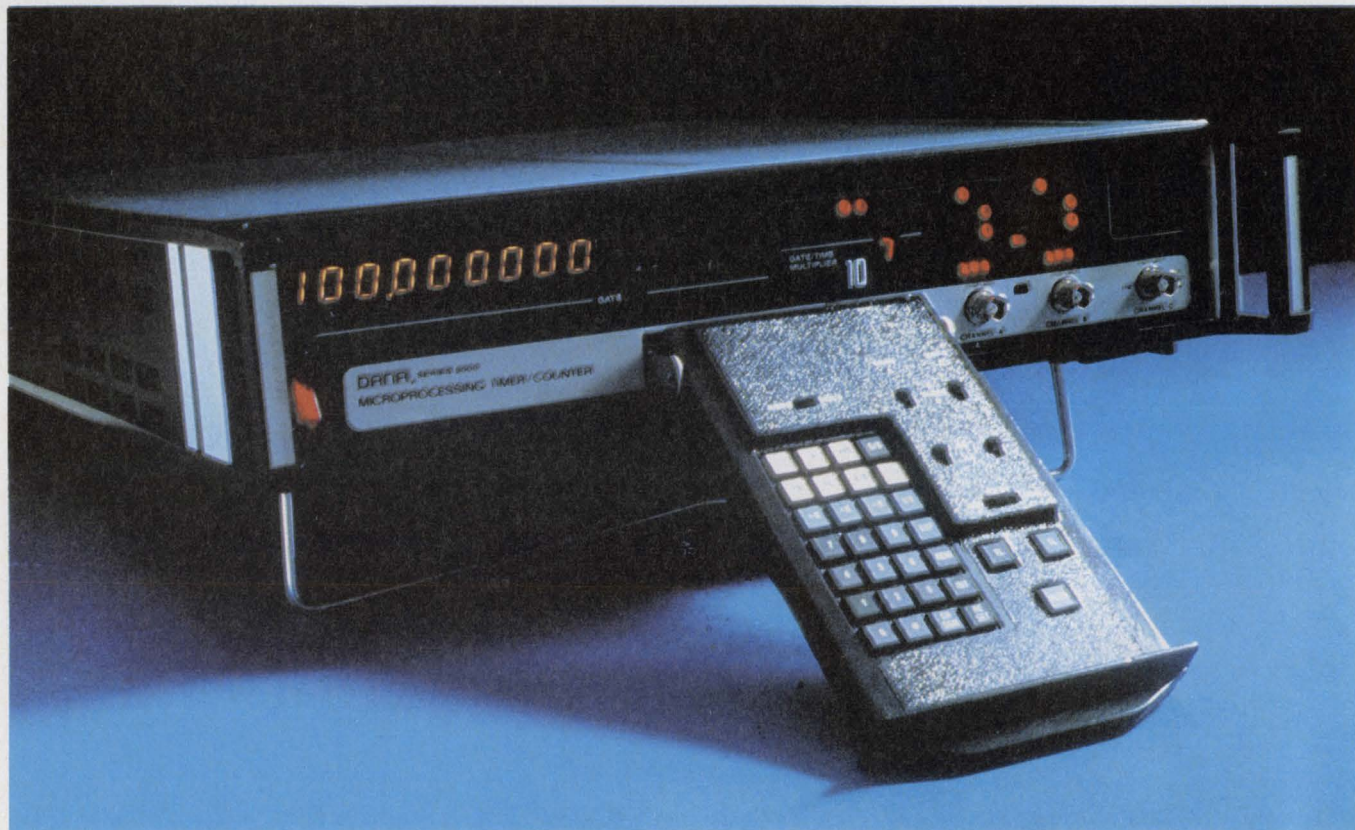

Slip the calculatorlike keyboard out of its front-panel drawer, and you can measure pulse parameters at the

touch of a button. Dana's 9000 microprocessing timer/counter does all the calculations.



just a clock—with all the shortcomings of any clock.

No clock keeps perfect time, of course. It runs either slow or fast and eventually must be reset. A counter's time base is no different, except that it's also sensitive to changes in temperature or line voltage. More than a few spec sheets neglect to say so. Some sheets "generously" list all factors, but leave it up to you somehow to assemble the various drifts into one accuracy number. You might add all the drifts arithmetically. Or you might merge them statistically. Neither way is completely satisfactory for a number of reasons.

Right off, you encounter the problem of temperature instability, probably the largest error source in uncompensated crystal oscillators. If tempco isn't missing from the data, it may be given for only a narrow temperature range. You then have to extrapolate to cover your expected operating extremes.



You usually need all the help you can get to set accurate trigger levels. Hewlett-Packard's 5328A UCT gives it to you with a built-in DVM and trigger lights.

But you can't. Tempco isn't linear, even for temperature-compensated oscillators (TCXOs).

You can't be sure which temperature the vendor means, either—is it the external-ambient, the internal-equipment or the oscillator temperature? Perhaps the best solution is to plot time-base frequency versus temperature. Few, if any, vendors provide that.

Oven-controlled crystal oscillators offer improved temperature stability. But these have their own problems. Thermostatic, on-off ovens produce temperature cycling, which can be undesirable. Either a proportional oven or an oven within an oven is the steadiest, but both types boost costs considerably.

Oven units may require longer warm-up times—30 days isn't unheard of—and all ovens must be kept plugged in. You can't just move most oven-controlled counters from place to place and still get the specified stability.

Oddly enough, warm-up time isn't always given

with counter data. But a rarer spec—retrace error—tells an even more revealing story: Many standards don't return to the original frequency after an off period. In some instances, retrace error exceeds a year's aging.

### Avoiding lumped-figure lumps

Besides temperature instability, you've got to worry about errors caused by both crystal aging and by power-line variations. Don't assume that the vendor has relieved you of this concern when he lists one accuracy figure—say, in ppm. You can't be sure of what's included in that figure. Even if all effects are somehow lumped in, how valid is the number under your expected operating conditions?

Finding out how much and how fast an oscillator ages can be quite a hassle. Long-term aging causes

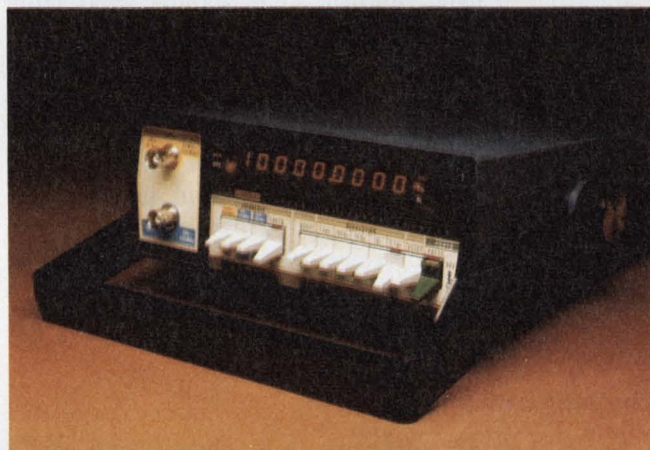

Designed for telecommunications work, the Fluke 1920A frequency counter works to 520 MHz, measures rf bursts and travels—with an optional battery.

a slow, cumulative drift in frequency. The drift rate isn't constant, but tends to shrink with time. Yet almost to a man, counter vendors warn against "ambiguous, ambivalent and abysmal" drift specs. (With this unanimity, you may wonder who the offenders are.)

For quite some time, both vendors and users have been chasing time-base stability, and considerable time and effort are still being spent to shave a few more ppm off the specs. As a result, vendors often end up giving you greater stability—at least on paper.

One way of misleading: The vendor says his time base is "settable" to an impressive 1 ppm. What does this actually mean? It means you need sophisticated frequency standards and practices, trained personnel, patience and time. Then you might need a miracle, since there's no guarantee the oscillator will keep the setting.

Inexpensive or poor designs—those with crystals that aren't pre-aged, those with poor power-supply



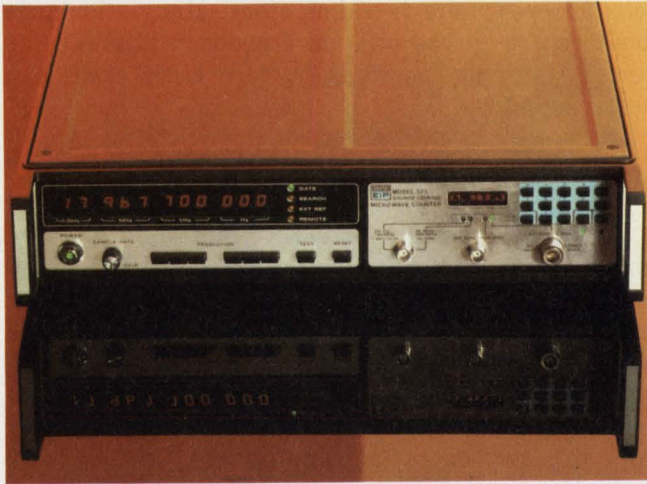

**Microwave counters are a different breed.** The Dana/EIP 371 does double duty as an automatic 18-GHz counter and as a "lock box." You can phase-lock an external source to the 371's internal clock.

regulation or loose tempcos—can wander away from the setting by more than you'd like in just one hour. And, of course, even the best counters are affected to some degree by time, temperature and line variations.

Long-term drift and settability are important for determining calibration intervals and initial time-base accuracy. Naturally, the greater the long-term drift, the shorter the re-cal interval needed to maintain a desired accuracy. But what's "long"? What's "short"? It depends on who's talking.

### The long and short of it

Look over six different data sheets, and you'll probably find six different definitions of "long-term." The most prevalent are one-month and 24-hour periods, the former usually attached to room-temperature and compensated crystals, the latter to oven-controlled types. The reasoning is that in room-temperature oscillators, a one-degree change can alter frequency much more than a day's aging, and vice versa in oven oscillators. While this may be so, the lack of standardization makes it hard to compare competing products. One man's parts-per-month figure isn't necessarily another man's parts-per-year number divided by 12. And many aging specs say "after a period of continuous use." How long is "period"?

The emphasis on aging is more than matched by the dearth of short-term stability figures. The absence of the spec may convince you that a time base doesn't generate any random frequencies or phase fluctuations along with the desired frequency. But all oscillators do.

The undesirable components can be thought of as fractional deviations in frequency ( $\Delta f/f$ ), which can contribute errors during a measurement. The less time the measurement takes, the greater the uncertainty.



**The first dual UCT**, the 6361A from Systron-Donner, takes advantage of recent LSI advances to package two independent channels, each with its own display, under one roof. The 100-MHz unit sells for \$895.

To be meaningful, therefore, a short-term spec should be stated for the most frequently used measurement periods, about 1 s or less. Longer and unrealistic periods—like 10 min.—should be suspected immediately. Given enough time, the deviations will average out to a pleasingly petite quantity.

With room temperature and TCXO types, the data sheet may argue that short-term specs aren't needed because temperature swamps out all the other drifts. But then, if a measurement lasts just 1 s, or less, how much will the temperature change in that time interval?

It is also suggested sometimes that since the  $\pm 1$ -count error will probably dominate the inaccuracy of short measurements ( $< 1$  s), why bother specifying short-term stability? If the instability is insignificant compared to the  $\pm 1$  count, fine. But if the spec isn't given, can you safely ignore instability? Perhaps. Perhaps not.

### Don't get short-changed

Similarly, if the effect on frequency of a 10% line-voltage change isn't given, don't be lulled into a false sense of security. Power-supply regulation may be good enough to filter out line variations in some counters—but not in all. And if your line isn't too clean, but suffers from noise, random pulses, drop-outs and other problems that exceed the 10% swing, what happens then? You're rarely told.

One way to get around ambiguous and missing clock specs is to ignore them—and use an external house standard. With stringent requirements ( $< 3 \times 10^{-9}$ ), or for longer recal intervals, you may have no choice but to do so. A standard may add to the cost, but it can be made traceable to NBS.

Hopefully, clock specs will one day be standardized. One vendor's suggestion: Give the worst clocking error for 10 s, 90 days, six months and one year. List each





**The new look in UCTs:** compact, more features, 1-GHz operation, and portability from either an internal or

external battery. The Philips 6620 series lets you configure from seven options to match your job.

spec for continuous operation and for 20-min. and 72-h warm-ups. Finally, specify each spec for the entire operating ranges of temperature, vibration, shock, and line voltage.

Meanwhile, take nothing for granted. Don't assume that a nine-digit counter is always 10 times more accurate than an eight-digit rival. Don't buy lots of digits only to find out later that the time base is so bad, you can't "count" on the accuracy of the last digit. Don't expect seven-figure accuracy with a 1-MHz time base. And don't automatically assume that all time bases are crystal-based—some are derived from the line frequency.

You may need more digits, if not for more accuracy, then for better resolution—that is, to detect incremental changes in the input frequency. How many more? If you'd like to read the counter's top frequency to 1 Hz—without overflow—you'll need nine digits in a 100-MHz counter, 11 in an 18-GHz box.

With, say, an eight-digit, 250-MHz unit, you can resolve just 10 Hz unless you spill digits off to the left by going to a longer time base. With automatic test equipment, you may not want to do so. Or you may not want to lose the digits.

In any case, remember: Neither the number of digits nor an overflow feature guarantees that you'll realize the best resolution.

Resolution and accuracy take on added significance

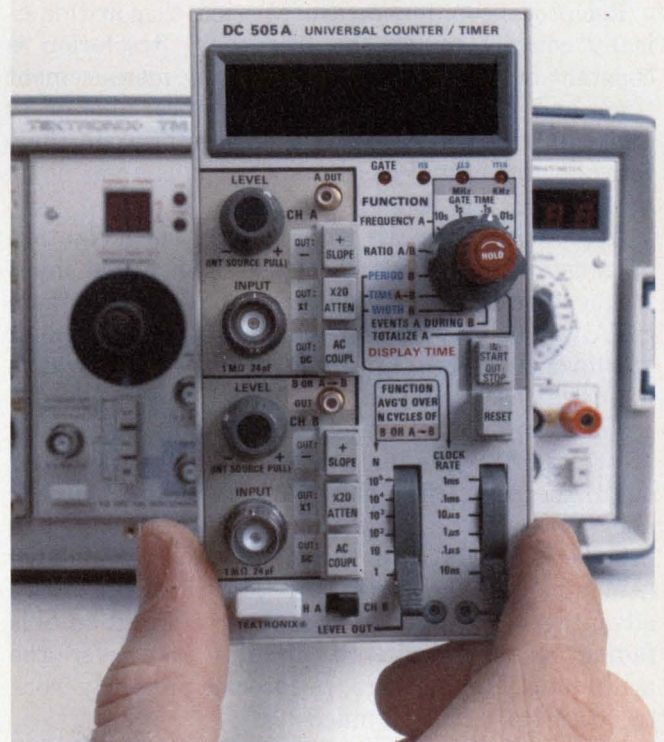

**Combine a counter and an oscilloscope** and you can make otherwise difficult measurements. The Tektronix DC505A UCT can read out a selected portion of the waveform displayed on the scope.



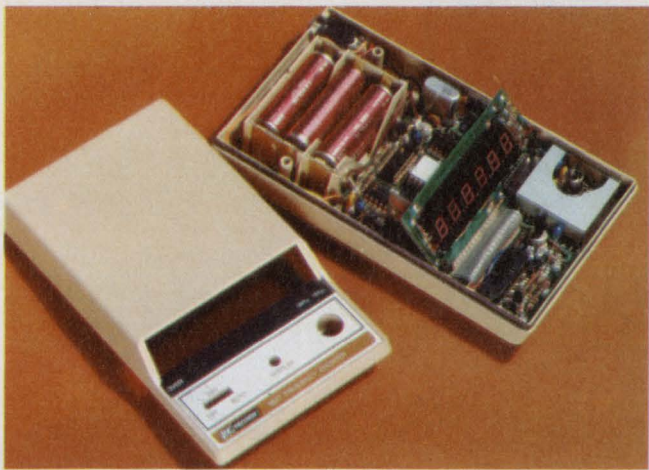

**Hand-held, battery-operated frequency counters**, like this one from B&K Precision, are a growing trend. The 1827 autoranges and sells for just \$120.

in the measurement of low frequencies ( $< 100$  Hz) or time intervals. Time intervals are especially troublesome, and you must look beyond clock stability for new sources of error.

#### Low frequencies got you down?

In conventional counters, resolution drops with input frequency if the gate period is held constant. With low frequencies, absurdly long measurement times would be needed to keep resolution—and accuracy. Of the various ways to get around the problem, the most notable are reciprocal counters or counters using phase-locked-loops (PLLs).

Reciprocal counters measure period, then arithmetically convert to get the frequency. Resolution is constant over the input range for any measurement time, and you can resolve, for instance, nine or 10 digits in only 1 s. Accuracy is also improved—theoretically, at least. Phase-locked loops can get down to, say, 0.01 Hz in 1 s.

Approach reciprocals with caution. The advantage of constant resolution disappears when the input frequency exceeds the reciprocal unit's clock frequency. A vendor may not tell you. He may quickly point you towards his unit's top input of 50 MHz. But what's his clock frequency? Just 10 MHz.

Phase-locked-loop units can also have their share of problems. While it's true that the PLL can filter out higher-frequency noise (at about 20 dB/decade above 10 kHz), the loop can lock on subharmonics and behave strangely with narrow pulses or modulated (AM and FM) inputs. In addition, the PLLs' price advantage over the more complex reciprocal units is fading as  $\mu$ Ps and LSI circuits take over the arithmetic. Furthermore, reciprocals presently work to 500 MHz, PLLs to much less.

Reciprocal units usually average a number of periods when measuring frequency. The idea is to minimize not only the  $\pm 1$ -count ambiguity error, but also the noise susceptibility suffered by almost all period

and time-interval meters, reciprocal or not. With true averaging, accuracy or resolution can be improved—the error is divided by the square root of the number of averaged cycles. Many conventional counter-timers also offer a period averaging mode.

Of course, if you're not measuring a repetitive signal, if what you want are transition times or an interval between two events or a single pulse width, then you can't average. But errors will crop up, and you'll certainly wish to know what they are. More than a few vendors wish you wouldn't ask.

#### The essence of time

When you measure time intervals between two events—periods, too—you must add several error terms to the time-base error and  $\pm 1$ -count ambiguity. Whether the terms are significant depends on the instrument, the purity of your signal, the kind of measurement and the desired accuracy.

In period or interval measurements, the noise at, and the setting resolution of, the trigger point can be major factors in determining accuracy. Signals with slow rise and fall times or low amplitudes are especially troublesome. In pulse-width or other time measurements, hysteresis in the counter's Schmitt trigger can further aggravate the situation.

On top of everything else, you can't depend on a  $\pm 1$ -count ambiguity—it might get much worse if a sluggish main gate opens or closes too slowly and so adds an appreciable error.

Consequently, even though a time base is accurate to one part in  $10^9$ , it's difficult to measure time to better than 0.1%—or even 1% in many cases. Even more difficult is uncovering all the error contributions in a given instrument.

Hysteresis isn't often spelled out, nor are gating errors. Be suspicious if the  $\pm 1$ -count spec is missing—the vendor may hope you'll assume it applies, when



**Prices of counters are tumbling:** \$295 buys a 225-MHz, direct-count unit with three functions. The Ballantine 5725B's plastic case is metallically coated.





**Dc-coupling to 500 MHz with 20-mV rms sensitivity:** The top-of-the line Hewlett-Packard 5345A is the only counter that can claim those specs.

$\pm 20$  counts is closer to the truth.

The stability of the trigger-point setting is often "overlooked." But what good is the ability to dial-in a trigger to four or five places when the setting wanders away—often, it seems, as soon as your hand leaves the knob? What good is it if the trigger level is affected by the input-signal amplitude, waveshape or duty cycle?

Some counter-timers compensate for hysteresis automatically by shifting the upper and lower trigger points to the desired level. Other units provide a range of features to help set triggers: built-in DVMs, trigger-level outputs, trigger-status lights, markers, and the like. None should take the place of missing trigger specs.

In some cases, the data sheets seem bent on making up for missing specs. Trigger levels are called out, or time-interval capabilities clearly given. The only problem is, your model can't do any of those things. Since it isn't dc-coupled, you can't measure nonrepetitive or asymmetric signals or signals with variable duty cycles. And since that model doesn't have two channels, you can't measure time intervals. What can you do? Look for another counter, perhaps.

Remember, the time-interval mode always uses two channels, one for start and one for stop. The channels should be closely matched in bandwidth and other characteristics to avoid gross errors in high-frequency measurements.

Remember also to consider the three minimums of interval measurements: time interval, dead time and pulse width. The first specifies the least time interval a counter will recognize between a start and stop pulse; the second, the least interval between a stop and the next start trigger; the third, the least width of a start or stop pulse that the counter will accept.

To be truly universal, a counter-timer should have both ac and dc coupling, as well as slope controls, trigger-level adjusts, and attenuators or sensitivity controls (not to be confused with trigger-level controls). And both channels should be identical.

Many a purchaser has been stung on that last requirement. Spec-sheet headlines blare out high frequencies and sensitivities, but too late you learn that the numbers apply to only one channel. Or that the top frequency doesn't apply to all functions. Or that one channel does less than the other. . .

But to some observers, the art of misleading without actually lying is raised to its highest level in the specification of sensitivity.

### Allergic to sensitivity specs?

It's an unusual counter indeed that can boast a flat sensitivity across its entire frequency range. Sensitivity usually falls off at the extremes, and often you'll find local peaks or dips along the way. Temperature can also affect sensitivity.

Under the rationalization of "competitive pressures" or "smart marketing," you're given the best news in a towering headline, the worst news in a microscopic footnote. Sometimes even the fine print doesn't quite reveal the true performance. You've got to work it out from vague formulas loosely sprinkled about the data sheets.

You're also left on your own to find out that the specified sensitivity may apply only to a sinusoid. Pulses may need several times greater magnitude to be measurable.

Ironically, high sensitivity can be a two-edged sword. The greater the sensitivity, the smaller the signal that can trigger the counter—but low-level noise can do the same, and the counter can't tell the signal from the noise. By the same token, the greater the bandwidth, the greater the susceptibility to noise.

Signal-to-noise discrimination specs are rarely given. Instead, you'll find switchable low or high-pass filters on some counters, attenuators and variable-gain controls on most others. Some have both filters and controls. Automatic gain control (AGC) is also offered.

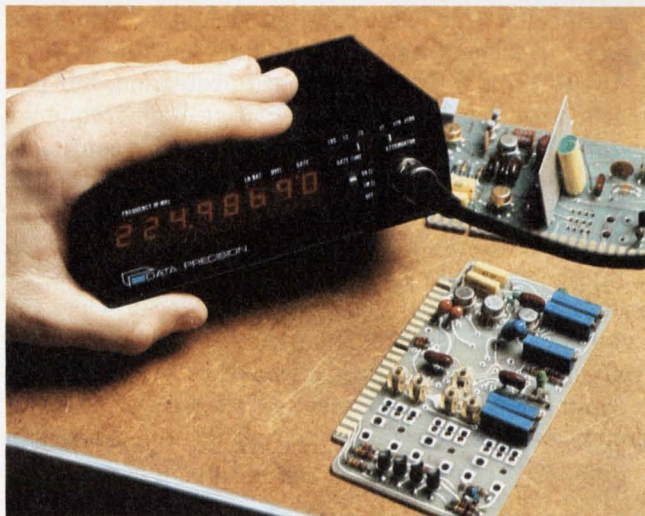

**The 585 portable frequency counter** marks Data Precision's first entry into the field. The eight-digit, 250-MHz unit works from NiCd batteries.





**Automatics are catching on fast** in low-priced counters. Four autorangers, the 380 series from Hickok, range up

to 512 MHz in frequency and down to \$295 in price. Fast update is a feature of all four.

The idea behind all such controls is to combat noise by either manually or automatically adjusting a unit's sensitivity to the signal level being measured.

But if your S/N ratio is poor, adjustments may not work. False counts will result. With low-frequency noise, a sine-wave S/N of 40 dB is often mentioned. With that ratio, a single-period measurement will have a worst-case trigger error of 0.3%.

AGC circuits can simplify adjustments for unskilled personnel. But while AGC is good for low frequencies with high-frequency noise, it's not so good in the other direction. And AGC circuits may not like AM signals too much, so errors may occur.

High sensitivity brings another possible danger: It may not take much input voltage to blow up a counter's front end. Adequate protection must be built in. The challenge: Determine what is meant by "adequate."

#### That lowly fuse

If nothing else, any counter should be protected against overloads, especially against the line voltage. Both 50- $\Omega$  and 1-M $\Omega$  inputs need protection, but pay special attention to the more sensitive, high-frequency channel. Here, protection may be stated in a confusing manner or perhaps at just one frequency where the protection is greatest—and nowhere else.

Often, rf fuses or relays are placed behind the 50- $\Omega$  input jack. Ask: Can the fuse or relay act quickly enough to stop a fast transient in its tracks? Does the fuse cause VSWR problems—thus, errors—at high frequencies? Is there any high-speed backup circuitry?

Input VSWR at high frequencies isn't often mentioned. Nor is the fact that input impedance can change with frequency or amplitude and so cause loading or reflections. Ask.

Other questions you are certain to ask in your search for the right counter: What are the trends in counters? How does the latest equipment stack up? Which

vendor should I choose? With over 30 vendors and hundreds of models, and with advances coming almost every day, the answers aren't pat.

But obviously all models aren't competitive, and after you've narrowed down your needs, the culling becomes a bit easier.

The busiest new-products activity today centers around low-cost, single-function (frequency-only) counters, pulsed-rf and microwave counters, and smart counters. In addition, prices are tumbling in the more traditional areas—frequency counters and counter-timers for communications—while performance and features are on the rise.

Electronic panel meters are becoming more important as the older mechanical or electromechanical models yield to new LSI and display advances. And counters are showing up increasingly in special equipment, like CB testers, and as part of other instruments, like DMMs and scopes.

New vendors arrive seemingly each day, with high hopes of capturing a segment of the market—now almost half owned by Hewlett-Packard, long the dominant counter force.

In the low-cost (under \$500), limited-function (usually frequency-only) category, you'll find products like Ballantine's 5725B, a six-digit, 225-MHz counter that sells for just \$295 and also totalizes and measures ratio. Data Tech offers a number of models with varying frequency coverage and digits, but all feature metal enclosures, rather than plastic, and 10-mV sensitivity across the entire range.

HP's frequency-only, low-priced line includes the 80-MHz 5381A (\$295) and the 225-MHz, eight-digit 5382A (\$495). Both count directly, unlike units that prescale the input and slow down the reading. Hickok's frequency counters, the 380 series, are autorangers with one-button operation.

With the introduction of a full line of 11 units last year, Philips gave notice that it is a serious contender



in the counter arena. The only control on both the Philips 80-MHz PM 6661 (\$325) and 520-MHz PM 6664 (\$625) is an on-off switch. Sensitivity, range and decimal point are all automatic. Sencore's brand new frequency counter, the FC45, covers audio through vhf with 1 ppm performance for only \$395.

Just \$150 gets you Simpson's 710, a six-digit, 60-MHz box that measures a wee  $2 \times 5.6 \times 4.6$  in. A switchable low-pass filter is included. Covering the same frequency range as the 710 is the WD-752A, from VIZ Test Instruments group. At a dealer-optional price of \$255, the 752A gives you a built-in 1-kHz side tone for modulating SSB equipment, plus a selectable sensitivity of 10 or 100 mV. Gee viz!

A bunch of miniature frequency-only counters has gone portable. For example, the 1827 from B&K Precision (Dynascan Corp.) isn't much larger than a calculator. Yet the six-digit 1827 works from AA or NiCd batteries, and gives 30-MHz operation, auto-ranging and automatic decimal—all for \$120.

Data Precision's 2-month-old 585 is also battery-powered. The pint-sized ( $5\text{-}1/2 \times 1\text{-}3/4 \times 3\text{-}1/2$  in.) 585 offers big performance: a 250-MHz top frequency and 10-mV sensitivity (to 10 MHz). A battery-operated newcomer, the FC-200 from Aero Marine, uses the same package as the 585, and adds an analog signal meter to the front panel. The "D" version covers 6 Hz to 200 MHz.

Still another battery-operated, calculator look-alike comes from Logic Technology. The Pocket Counter III reads 10 MHz to seven digits and claims 0.001% accuracy. Cost: \$189. The Non-Linear Systems FM-7 also goes anywhere. At \$195, the tiny ( $2.7 \times 1.9 \times 4$  in.) FM-7 monitors frequencies to 60 MHz, with seven-digit resolution. Add the SC-5 prescaler for \$89, and you can go to 512 MHz.

Getting power from an external battery, such as a car's, is another way to go "portable." One unit that goes this route is the EC-175, a 175-MHz, six-digit counter from Regency Electronics. The 175 works from ac, too, and keeps its crystal in an oven. Data Tech's Model 115 520-MHz frequency counter offers a battery pack, as does the TC21 10-MHz timer-counter from Gould Advance. Other units with batteries include Fluke's 1920A and the Philips 6620 series, which can work with internal or external batteries.

### Filling communications needs

When requirements become more stringent, as is often the case in communications, instruments crop up for every need. Frequency counters worth looking into include the Anadex CF710 (50 Hz to 1 GHz), Dana's 7500 series, DigiTec's 8720 and 8730, Fluke's 1920A and the Gould Advance TC312. Hewlett-Packard offers more than a dozen choices in its 5300 series, including counter-timers. And don't overlook the Marconi TF 2432 or either the Philips 6600 series or the Systron-Donner 6240 series.

By far the largest segment of the counter market is held by the so-called "universal" counter-timer

(UCT)—sometimes called a multifunction counter or just plain counter-timer. UCTs are popular for systems and bench use. But since there's no commonly accepted definition of "universal," watch out. All UCTs are not alike.

Companies active in counter-timers include Ballantine, Dana, Data Tech, DigiTec, Fluke, Gould Advance, Hewlett-Packard, Krell Electronics, Philips and Systron-Donner. Krell's DT-400 can measure time up to one year. A newcomer is Tabor Electronics, an Israeli firm marketing the 424A 100-MHz UCT through Arrow International. The import sells for just \$265.

When you switch a range or function, an automatic reset on Fluke's two UCTs, the 1952B and 1953A, gives you correct readings the first time. All Fluke units offer leading-zero suppression, too.

Features in the top-of-the-line HP 5345A illustrate the advances being made today. The reciprocal-taking 5345A is the first counter-timer with a 500-MHz clock: it can resolve one-shot time measurements to 2 ns, and randomly dither its clock frequency (time base) to provide true averaging of inputs that are close to the harmonics of the internal clock. And with gate openings as brief as 20 ns, the 5345A can measure the frequency of a single 100-ns pulse or measure a pulse's frequency profile.

Another first of its kind comes with Systron-Donner's freshly unwrapped 6361A dual UCT: two identical channels with two independent displays. With the 6361A, you can measure two frequencies or periods simultaneously. Or you can mix functions and measure frequency and period together.

When a  $\mu$ P and counter get together, an unusual instrument is sure to result—one that pushes counter capabilities toward the realm of computers.

Dana's 9000 is the first such intelligent instrument. A sampling of what it can do: set trigger levels automatically, perform arithmetic, measure pulse rise and fall times, read out all control settings, and select a pulse from a train for analysis.

Orbit Controls, an English vendor, uses a micro-

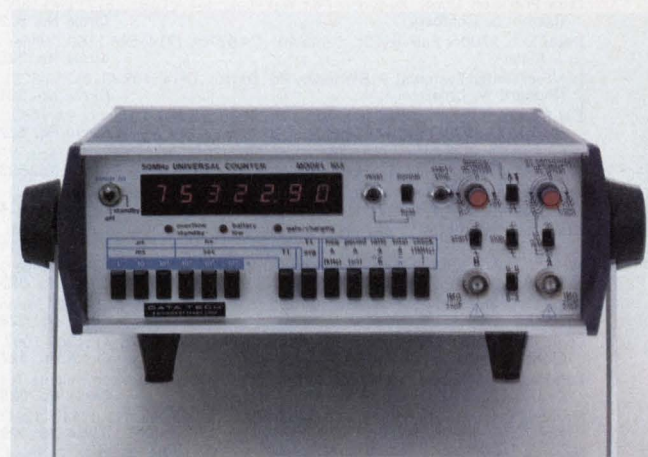

**What LSI hath wrought:** A 50-MHz, portable UCT—the Data Tech 103—keeps its crystal oven always hot with a built-in battery pack (optional).



processing technique to take reciprocals, among other things, in its 75 series of time-interval-conversion counters. While the 75C501 computes one sample, it measures another sample and so holds down update time. Ballantine's 5500B UCT can also be called smart: Choose your resolution, and an internal ROM and logic do the rest.

Counters don't have to get smart to be able to do more or better. Another way is to design the counter to work with other instruments—in the same case or through external connections. The Tektronix counters are a case in point.

Designed as plug-ins for the Tektronix TM500 line of test equipment, or for the company's 7000-series oscilloscopes, the Tek counters can help improve measurements. For example, you can plug in an accurate, high-resolution DMM alongside the counter to set trigger levels more accurately. Or, with a counter/scope, you can boost sensitivity to 1 mV rms or measure the stability of a portion of a burst.

Similarly, the E-H Research Laboratories 8243 is a counter plug-in to the company's 8200 integrated measurement system. With the combination, you can pin down single-shot intervals to 10 ps, count to 100 MHz with 13 decades of accumulation, and set gate widths up to 100 s.

Combined DMM-counters are also available from California Instruments, Dana and Hewlett-Packard.

Of all counter types, the one at the peak of technology (and price) is usually the microwave unit. Because direct counting beyond about 500 MHz isn't yet economically feasible, special techniques must be used to reach stratospheric regions up to 23 GHz.

### Working at the top

Both automatic and manual microwave counters are being offered, with a trend today toward the automatic. Heterodyne and transfer oscillators form the major methods of down conversion.

As with any piece of equipment, there are tradeoffs to be made in microwave counters. Both methods have advantages and disadvantages relating to ease of use, sensitivity, FM and AM tolerance, ability to measure pulsed rf, noise, acquisition time and other areas. Only your application can tell you which method is best.

Vendors of microwave units are scarce. Here, too, Hewlett-Packard is the most prominent, with products like the 5340A (18 GHz) and 5341A (4.5 GHz). Dana/EIP has pioneered many microwave-counter advances and now offers its 451 automatic pulse counter, the 351D 18-GHz unit, and the brand new

## Need more information?

The products cited in this report don't represent the manufacturers' full lines. For additional details, circle the appropriate number on the Reader Service Card. For data sheets and more vendors, consult ELECTRONIC DESIGN'S GOLD BOOK.

### Standard counters and counter-timers

- Aero Marine Electronics, Unit 1, 1819 Underwood Blvd., Delran, NJ 08075. (609) 764-9000. (Jackson Taylor) **Circle No. 507**
- Anadex, 9825 De Soto Ave., Chatsworth, CA 91311. (213) 998-8010. (Ken Mathews) **Circle No. 508**
- Ballantine Laboratories, Inc., P.O. Box 97, Boonton, NJ 07005. (201) 335-0900. (Fred L. Katzmann) **Circle No. 515**
- B&K Precision, Dynascan Corp., 6460 W. Cortland Ave., Chicago, IL 60635. (312) 889-9087. (Myron Bond) **Circle No. 516**
- California Instruments, 5150 Convoy St., San Diego, CA 92111. (714) 279-8620. (P. Muller) **Circle No. 517**
- Dana Laboratories, 2401 Campus Dr., Irvine, CA 92715. (Norbert Laengrich) **Circle No. 518**
- Data Precision Corp., Audubon Rd., Wakefield, MA 01880. (617) 246-1600. (Harold S. Goldberg) **Circle No. 519**
- Data Tech, 2700 S. Fairview St., Santa Ana, CA 92704. (714) 546-7160. (William J. Miller) **Circle No. 520**
- DigiTec (United Systems), 918 Woodley Rd., Dayton, OH 45403. (513) 254-6251. (Richard W. Dale) **Circle No. 521**
- E-H Research Laboratories, Inc., 515 11th St., Box 1289, Oakland, CA 94604. (415) 834-3030. (Earl M. Olsen) **Circle No. 522**
- John Fluke Manufacturing Co., Inc., P.O. Box 43210, Mountlake Terrace, WA 98043. (206) 774-2211. (Randy Davison) **Circle No. 523**
- Gould Advance (Distributed by Electroplan Ltd.), P.O. Box 19, Orchard Rd., Royston, Herts SG8 5HH, Great Britain. (John Acres) **Circle No. 524**
- Hewlett-Packard, 1501 Page Mill Rd., Palo Alto, CA 94304. (415) 493-1501. **Circle No. 514**
- Hickok, 10514 Dupont Ave., Cleveland, OH 44108. (216) 541-8060. (Gregory M. Morris) **Circle No. 525**
- Krell Electronics, 64 Sylvan Ave., Clifton, NJ 07011. (201) 773-6902. (Gene Juall) **Circle No. 526**
- Logic Technology, 2525 Charleston, Mountain View, CA 94043. (415) 967-1007. (John Rowan) **Circle No. 527**
- Luff Research Associates (scaling probes), P.O. Box 449, Jackson Heights, NY 11372. (212) 429-5900. (Anne M. Christopher) **Circle No. 528**
- Marconi Electronics Inc., 100 Stonehurst Ct., Northvale, NJ 07647. (201) 767-7250. (Keith Elkins) **Circle No. 529**
- Marconi Instruments Ltd., Longacres St., Albans, Herts, AL40JN, England. **Circle No. 530**
- Matsushita Communication Industrial Co., Ltd., Tsunashima-higashi, Kohoku, Yokohama 223, Japan. (H. Kawai) **Circle No. 531**

- Non-Linear Systems, Inc., 533 Stevens Ave., Solana Beach, CA 92075. (714) 755-1134. (Ben W. Fisher) **Circle No. 532**
- Orbit Controls Ltd., Lansdown Industrial Estate, Cheltenham Glos GL51 8PL. (P. Vlcek) **Circle No. 533**
- Phillips Test & Measuring Instruments, Inc., 85 McKee Dr., Mahwah, NJ 07430. (201) 529-3800. (Stu Rauch) **Circle No. 534**
- Regency Electronics Inc., 7707 Records St., Indianapolis, IN 46226. (317) 545-4281. (Wayne Ayers) **Circle No. 535**
- Sencore, 3200 Sencore Dr., Sioux Falls, SD 57107. (605) 339-0100. (Bob Hoffman) **Circle No. 509**
- Simpson Electric Co., 853 Dundee, Elgin, IL 60120. (312) 697-2260. (Irv Linker) **Circle No. 536**
- Systron-Donner, 10 Systron Dr., Concord, CA 94518. (415) 676-5000. (Gail M. Dishong) **Circle No. 537**
- Tabor Electronics, Youth City Bldg., P.O. Box 901, Haifa, Israel (Joseph Kahona) [marketed through Arrow International (516) 643-4500.] **Circle No. 510**
- Tektronix, Inc., P.O. Box 500, Beaverton, OR 97077. (503) 644-0161. (Robert L. Down) **Circle No. 538**
- VIZ Test Instruments, 335 E. Price St., Philadelphia, PA 19144. (215) 844-2626. (Bob Liska) **Circle No. 539**

### Microwave counters

- Dana/EIP Inc., 3230 Scott Blvd., Santa Clara, CA 95051. (408) 244-7975. (Richard A. Bush) **Circle No. 540**
- Eldorado Instruments Co., 2495 Estand Way, Pleasant Hill, CA 94523. (415) 682-2100. (Richard Swift) **Circle No. 541**
- Hewlett-Packard, 1501 Page Mill Rd., Palo Alto, CA 94304. (415) 493-1501. **Circle No. 542**
- Systron-Donner, 10 Systron Dr., Concord, CA 94518. (415) 676-5000. (Gail M. Dishong) **Circle No. 543**

### Panel-meter and other counters

- Aitek Corp., 2150 Industrial Parkway, Silver Spring, MD 20904. (301) 622-3906. **Circle No. 544**
- Anadex, 9825 De Soto Ave., Chatsworth, CA 91311. (213) 998-8010. (Ken Mathews) **Circle No. 511**
- Bowmar Instrument Corp., 8000 Bluffton Rd., Fort Wayne, IN 46809. (219) 747-3121. (Thomas McCreery) **Circle No. 545**
- Centronic, King Henry's Dr., New Addington Croydon CR9 0BG, England. (M.J. Davies) **Circle No. 546**
- Colstar Limited, 233/243, Wimbledon Park Rd., London, S.W.18. (A. Balabanovic) **Circle No. 547**
- Curtis Instruments, Inc., 200 Kisco Ave., Mount Kisco, NY 10549. (914) 666-2971. (Eugene A. Sands) **Circle No. 548**
- Datel Systems, Inc., 1020 Turnpike St., Canton, MA 02021. (617) 828-8000. (Lawrence D. Copeland) **Circle No. 549**



371, a unit that lets you phase-lock an external source to the 371's internal oscillator for identical accuracy and stability.

Eldorado Instruments has been in the nanosecond/microwave field for 20 years (off and on) and takes credit for many innovative techniques. Two new instruments from Eldorado are the Model 797 100-ps time-interval counter and the 989G 18-GHz pulsed microwave counter. Systron-Donner also offers automatics, the 24-GHz 6054B and 18-GHz "C".

For those who wish to get deeper into microwave or pulsed measurements, both HP and Dana/EIP offer excellent application notes. The headaches of time-interval measurements are "aptly" described in yet another note from HP.

If you're really ambitious, try building your own counter. Start with counter ICs from Ferranti, Intersil, Mostek, Plessey and others. Some are virtually complete "systems" on a chip.

If you already have a counter, and would like to extend its range, Avantek, Santa Clara, CA, has an app note that shows you how to build a prescaler. With the prescaler, you can go from your present 250 MHz to 1 GHz. Or you can buy a ready-made frequency-scaling probe for \$425 from Luff Research Associates, and do the same. ■■

## How do you resolve two signals spaced 1 Hz apart at 2 MHz?

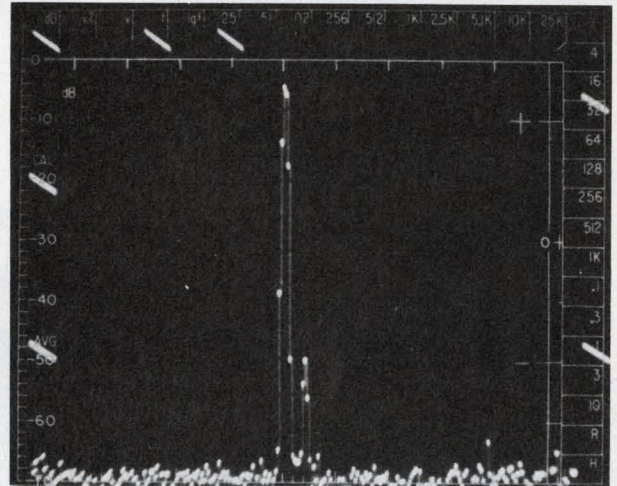

With an EMR Model 1510 Digital Real-Time Spectrum Analyzer and EMR Model 1520 Digital Spectrum Translator. Simply add the optional EMR Model 1521 Range Extension Module to the 1520 Translator, and you have real-time spectrum analysis at frequencies up to 2 MHz!

The CRT photograph illustrates the result. The input signal consisted of two discrete frequencies spaced 1.0 Hz apart, with a 50 dB difference in amplitude. The frequency range covered is 25.6 Hz centered about 1.990000 MHz, and the frequency resolution is 0.1 Hz!



Only EMR offers that much resolution at frequencies up to 2 MHz in real time.

So if you have an analysis problem requiring high-resolution/high-frequency real-time spectrum analysis, contact EMR... we will arrange for a demonstration or detailed information.

Sangamo Weston, EMR Telemetry Division  
P.O. Box 3041, Sarasota, FL 33578  
813-371-0811

SANGAMO WESTON

Schlumberger

CIRCLE NUMBER 36

- DigiTec (United Systems), 918 Woodley Rd., Dayton, OH 45403. (513) 254-6251. (Richard W. Dale) **Circle No. 550**
- Durant Digital Instruments, 901 S. 12 St., Watertown, WI 53094. (414) 261-4070. (Thomas P. Ackerman) **Circle No. 551**
- Eagle Signal Div., Gulf & Western Manufacturing Co., 736 Federal St., Davenport, IA 52803. (319) 326-8111. (Jimmy Schwartz) **Circle No. 552**
- ESE, 505 1/2 Centinela Ave., Inglewood, CA 90302. (213) 674-3021. **Circle No. 553**
- Flo-tech, Inc., 403 S. Washington Blvd., Mundelein, IL 60060. (312) 566-9120. (L.E. Bartling) **Circle No. 554**
- Haydon Switch and Instrument, Inc., 1500 Meriden Rd., Waterbury, CT 06705. (203) 756-7441. (Silvio Conte) **Circle No. 555**
- Hecon Corp., 31-45 Park Rd., Tinton Falls, NJ 07724. (201) 542-9200. (W. Fuellemann) **Circle No. 552**
- J. Hengstler K. G., Zahlerfabrik, D-7209 Aldingen, Postfach 100. (Hans-Jürgen Peter) **Circle No. 558**
- International Microtronics Corp., 4016 E. Tennessee St., Tucson, AZ 85714. (602) 748-7900. (Otto Fest) **Circle No. 556**
- IVO Industries, Inc., P.O. Box 36, Neptune, NJ 07753. (201) 922-3600. (Hon Becker) **Circle No. 557**
- Kessler-Ellis Products Co., Atlantic Highlands, NJ 07716. (201) 291-0500. (Richard K. Laird) **Circle No. 559**
- Newport Laboratories, Inc., 630 East Young St., Santa Ana, CA 92705. (714) 540-4914. **Circle No. 560**
- Scanning Devices Company, 226 Broadway, Cambridge, MA 02139. (617) 354-7226. (Louis Goldenberg) **Circle No. 561**
- Sodeco, 4 Westchester Plaza, Elmsford, NY 10523. (914) 592-4400. (Peter M. Engstrom) **Circle No. 562**
- Square D Co., Executive Plaza, Park Ridge, IL 60068. (312) 774-9200. (R. Wiczorek) **Circle No. 563**
- Veeder-Root, Hartford, CT 06102. (203) 527-7201. (Philip E. Worley) **Circle No. 564**
- Weston Instruments, 614 Frelinghuysen Ave., Newark, NJ 07114. (201) 242-2600. (Bob Bilby) **Circle No. 513**

### IC counters

- Ferranti Electric, Inc., East Bethpage Rd., Plainview, NY 11803. (516) 293-8383. (Bron Kutny) **Circle No. 565**
- Intersil, 10900 N. Tantau Ave., Cupertino, CA 95014. (408) 996-5000. (John R. Torok) **Circle No. 566**
- LSI Computer Systems, Inc., 1235 Walt Whitman Rd., Melville, NY 11746. (516) 271-0400. (Alvin Kaplan) **Circle No. 567**
- Mostek Corp., P.O. Box 169, 1215 West Brosby Rd., Carrollton, TX 75006. (214) 242-0444. (Jim Garrett) **Circle No. 568**
- Plessey Semiconductors, Cheney Manor, Swindon, Wiltshire SN2 20W. (Jeff Salter) **Circle No. 569**
- SGS-ATES Semiconductor Corp., 435 Newtonville Ave., Newtonville, MA 02160. (617) 969-1610. (Bill Strachon) **Circle No. 570**



# You'll like what printer designers like about the 82900 logic stepper motor.

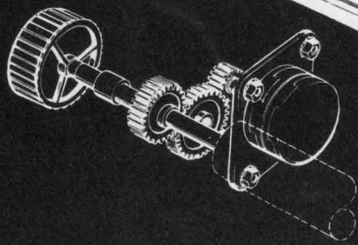

Schematic showing motor drive arrangement. A pinion mounted on the motor shaft engages a spur gear that drives the carriage platen.

## Take low price...top quality...compactness and 23 oz-in torque as starters.

The new 82900 stepper motor is built to do yeoman's service not only in impact and non-impact printers, but in small X-Y plotters, chart drives and computer peripherals. Yes, even medical instrumentation, where its reliability really pays off. Compact size, efficiency, low cost and 23 oz-in torque @ 200 PPS all combine to offer design advantages unobtainable in larger, bulkier and more expensive steppers.

A case in point. A high-speed impact terminal printer. Initially a mechanical linkage, actuated by a solenoid, was used to advance the carriage platen and paper automatically on command. This design proved to be somewhat cumbersome in making adjustments during assembly and required excessive downtime during servicing. After careful investigation, the 82900 stepper was adopted as a more vi-

able alternative. In addition to meeting the load requirements of the application, the 82900 proved capable of providing the necessary torque output, the required step angle and a minimum of 5000 hours operating time. Equally important, the motor met price parameters.

Consider the 82900 stepper in your own design. It's bidirectional. It has a nominal power rating of 12.38 w @ 5 vdc. And it is efficient, operating at lower than average temperatures. Standard construction provides 2-phase operation (requiring simplified drive circuitry) a 7.5° step angle and roller bearings. A 15° step angle, 4-phase operation or sleeve bearings in any combination desired can also be provided as options.

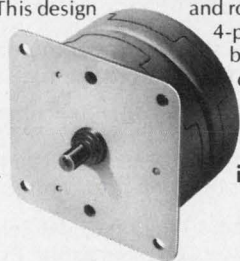

Send for  
information now!

**NORTH AMERICAN PHILIPS CONTROLS CORP.**

Cheshire, Conn. 06410 • (203) 272-0301

CIRCLE NUMBER 37

If the  
**Mini-Circuits'  
Mixer  
Applications  
Handbook**  
to the right has  
been removed,  
**Circle Reader-  
Service No. 100**  
to receive your  
personal copy.

### MIXER APPLICATIONS HANDBOOK

- Specifier's guide to mixer package performance 1-1
- Selecting the proper mixer 1-2
- Get the most from mixers 1-3
- How to measure mixer performance 1-4
- Chances are your IM measurements are inaccurate 1-5
- Mixer application notes 1-6
- Definition of mixer terms 1-7
- Reliability and environmental considerations 1-8
- Specifications and performance curves 1-9

**Mini-Circuits**

637 841 01th Avenue, Brooklyn, NY 11222  
1210 1th Avenue, 1st Floor, Bldg. 10  
DC 20014-2048

Contents of this 96-page  
handbook include:

- Specifier's guide
- How to select the proper mixer
- How to measure mixer performance
- Mixer application notes
- Definition of mixer terms
- Specifications and performance curves



semiconductor (MOS)<sup>7, 8</sup> with a multiphase clocking scheme acting as the energy-propagating mechanism (see box). Charge-transfer devices (CTD) currently permit signal processing and filtering in the 100-Hz-to-30-MHz range.

The CTD family includes charge-coupled devices, which transfer a bidirectional flow of electric charge along the surface of the semiconductor, and the bucket-brigade device, which transfers the charge through transistor action.<sup>9, 11</sup>

A newer family member, the peristaltic charge-coupled device, overcomes some of the carrier diffusion and transport-drift problems by storing the active charges in a region well below the semiconductor surface.<sup>12</sup>

With clock frequencies under 3 MHz, charge-transfer losses of less than 0.01% are typical. At 10 MHz, charge-transfer losses of surface CTDs rise to 0.1% while those of peristaltic CTDs remain at 0.01%. For transversal filter applications, CTDs are capable of providing amplitude weighting ( $W_n$ ), while phase

weighting ( $\phi_n$ ) must be accomplished with external circuitry.

Both the SAW and the CTD technologies can accomplish a wide variety of filter and pre-processor functions<sup>13, 14</sup>, offer programmability or adaptability, and are in many respects complementary. CTDs typically operate at frequencies below 10 MHz, and SAW devices typically operate above 2 MHz for materials like PZT, and above 10 MHz with materials like quartz and lithium niobate.

### In satellites, brain beats brawn

Because of the high cost of satellite transmitter power, a satellite navigation system is an excellent candidate for matched-filter techniques. Such a system (Fig. 2) transmits uhf signals to various types of users, and its signals might have an rf bandwidth of 1.0 MHz, with a transmitter peak-power of less than 40 W.

In a satellite navigation system, the signal's arrival

## What is a matched filter?

Conceptually, a matched filter is simply a linear network that minimizes the mean square error in determining the presence of a signal immersed in gaussian noise. The matched filter maximizes the signal-to-noise ratio prior to detection by shaping the received waveform  $S_i(t)$  as shown. The resulting output signal  $S_o(t)$  is a product of the convolution of  $S_i(t)$  with the matched-filter time-domain response,  $h(t)$ :

$$S_o(t) = S_i(t) * h(t) = \frac{1}{2\pi} \int_{-\infty}^{\infty} F_i(\omega) H(\omega) e^{j\omega t} d\omega,$$

where  $F_i(\omega)$  and  $H(\omega)$  describe the frequency-domain spectrum of the input signal and the matched filter, respectively. In the frequency domain, the matched filter can be described as a delayed reproduction of the input waveform. In the time domain, the impulse response  $h(t)$  of the matched filter is identical to the input waveform, but reversed in time.

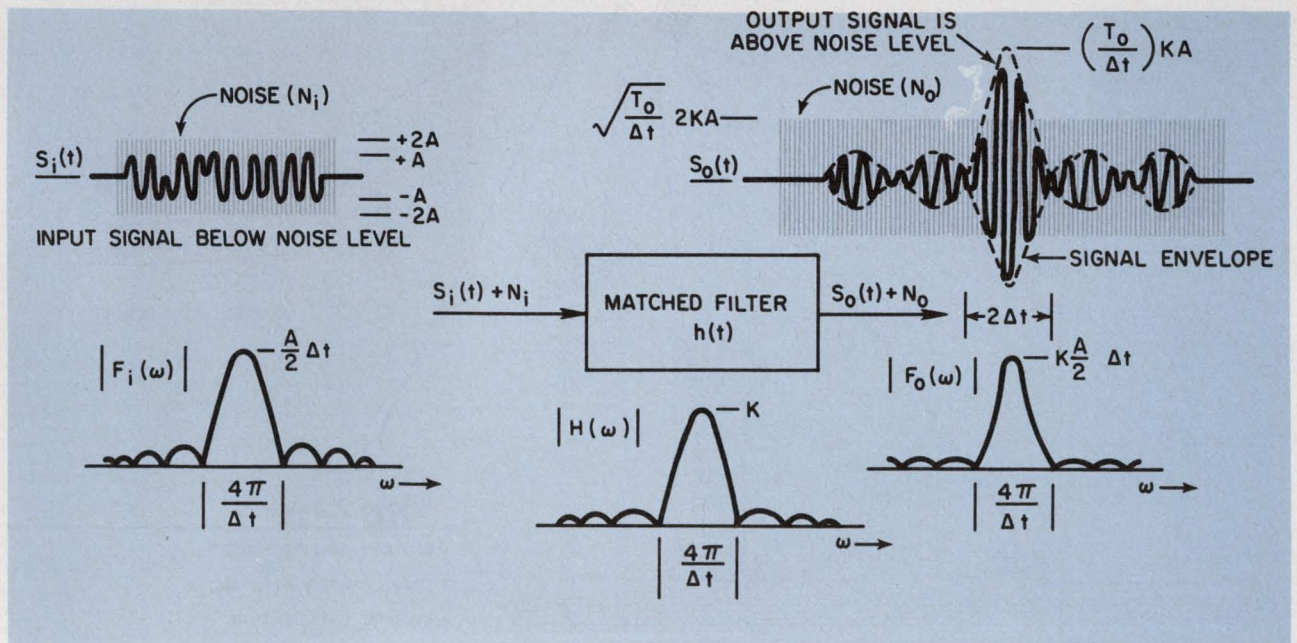



## What is a charge-transfer device?

The basic CTD delay line provides a unidirectional transfer of charge from one charge-storage cell to an adjacent charge-storage cell. Charge-transfer devices operate by transferring charge between potential wells created at semiconductor/oxide interfaces. The operation is based on storing and transferring minority carriers between closely spaced MOS capacitors pulsed into a deep depletion mode by a multiple clock voltage.<sup>9</sup> The propagation velocity,  $v_s$ , of the CTD device is determined by the multiphase clock frequency,  $f_c$ . During the charge transfer, part of the signal charge is lost by trapping at the oxide/semiconductor interface by free carrier diffusion and charge-transport drift.

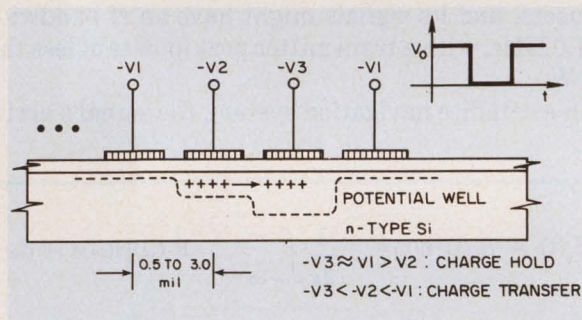

## What is a SAW device?

An electro-acoustic device employs phonon propagation, i.e., vibrations associated with a material's crystal lattice structure, as the energy-transport mechanism.<sup>10</sup> Metallized transducers convert electrical energy into acoustic energy via the material's piezoelectric properties. Most of the energy is confined to a region within one wavelength of the surface of the substrate so that it can be easily manipulated. Although numerous propagating modes are possible, the most commonly used is the surface-acoustic wave. The propagation velocity,  $v_s$ , of this mode is approximately 95% of the bulk shear-wave velocity  $v_b$ , or approximately  $3.16 \times 10^5$  cm/s for quartz, and  $3.48 \times 10^5$  cm/s for lithium niobate.

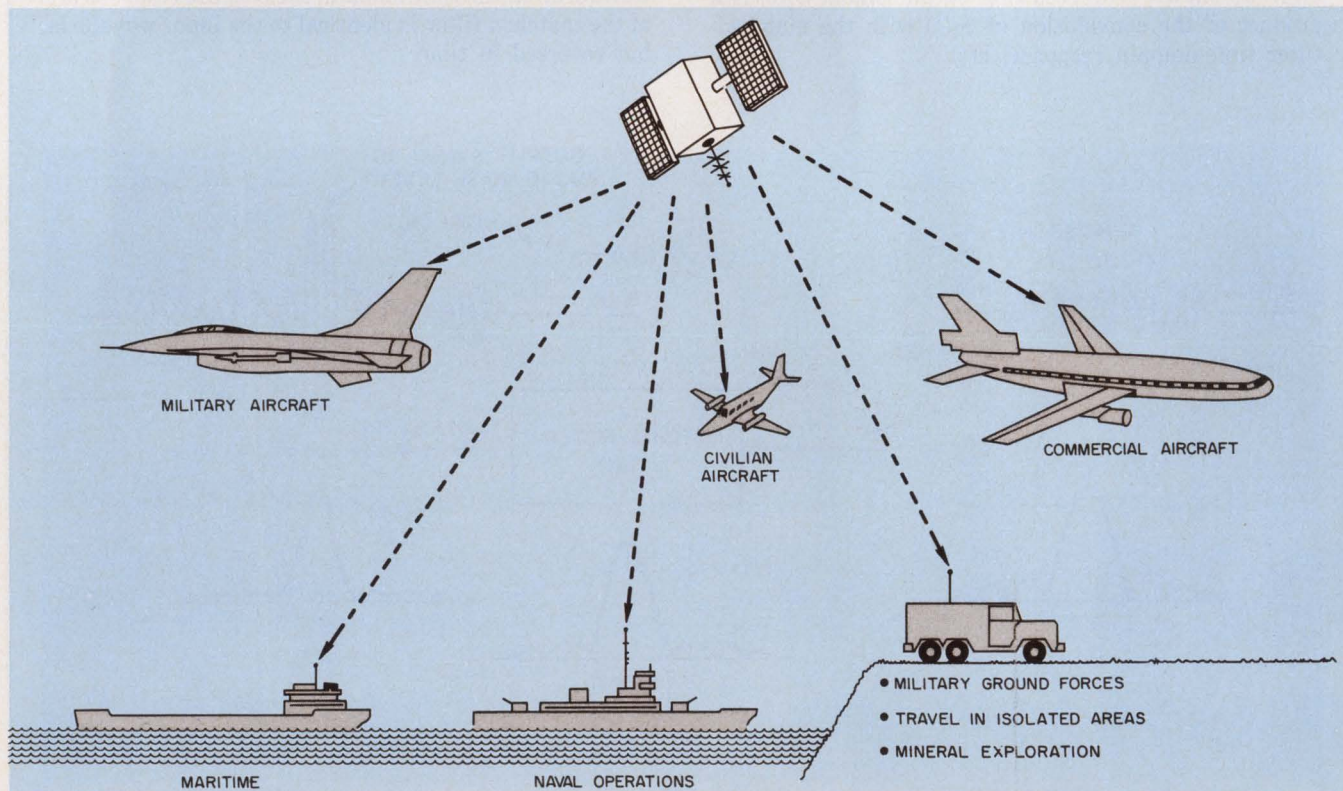
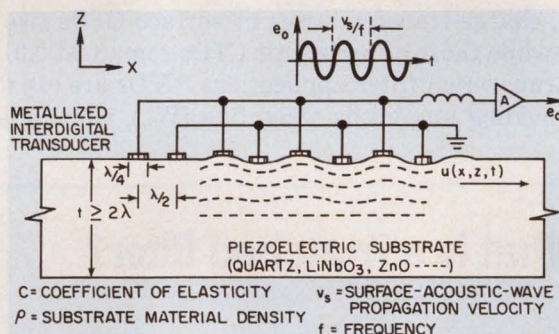

2. The users of a navigation satellite can get as much as 15 dB additional system gain through matched filters.



time, transmitted from the satellite, must be determined very accurately by a navigation receiver. Very often, adverse conditions exist, such as low signal level, high levels of atmospheric and man-made interference,<sup>15</sup> and degradation of the satellite circuitry.

The received power,  $P_R$  for an earth, or near-earth-based navigation receiver can be calculated as follows:

$$P_R = \frac{(P_T) (G_{AS}) (G_{AR}) (T_D/\Delta t)}{(L_{CS}) (L_{PR}) (L_{ST}) (L_{CR}) (L_P)} \quad (1)$$

where  $T_D/\Delta t$  = signal-to-noise improvement (commonly called processing gain) provided by the matched filter,  $P_T$  = the satellite transmitter's peak output power,  $G_{AS}$  = the satellite antenna gain,  $G_{AR}$  = the receiver-antenna gain,  $L_{CS}$  = the satellite antenna coupling loss,  $L_{PR}$  = the propagation path loss,  $L_{ST}$  = the link statistical losses (ionospheric fade, pointing loss, rain),  $L_{CR}$  = the receiver antenna coupling losses, and  $L_P$  = the polarization loss. Converting Eq. 1 to logarithmic form and inserting typical values in the sequence of Eq. 1, you obtain the following, for the received power:

$$P_R \text{ (dBm)} = \begin{matrix} 46 & + & 12 & + & 2 & + & 10 \log (T_D/\Delta t) \\ -1.5 & - & 182 & - & 5.5 & - & 1 & - & 0.8 \end{matrix}$$

Depending on the satellite transmitter's actual output power, and setting aside the processing gain for the moment, the received power will be less than, or equal to,  $-131.8$  dBm.

Assuming a receiver noise figure of 3.7 dB, an antenna noise temperature of 120 K and an rf/i-f bandwidth of 1.0 MHz, you find that the effective noise level at the receiver input is approximately  $-110$  dBm. Even if you ignore the additional signal-to-noise degradation in the receiver, the noise level at the receiver is 21.8 dB higher than the signal level. Relatively error-free detection requires an 8 dB S/N ratio. Considering noise level, signal level and detection requirements, your received signal level is deficient by approximately 30 dB.

### SAW or CTD, that is the question

You may want to overcome the 30-dB deficiency completely by matched-filter processing gain. However, this much processing gain would require a transversal filter with 1 ms of delay time—highly impractical for SAW devices due to the physical size, temperature drift, and excessive losses. A 30-dB processing gain would also tax the capabilities of the CTD, because of thermal constraints on dynamic range and storage time, clock frequency limitations, nonuniformities, and charge-transfer losses.

You will find it more practical to provide a matched-filter processing gain of 15 dB, and make up for the other 15 dB by either using noncoherent pulse integration or providing more receiver-antenna gain. Pulse-integration gain requires high processing time for the

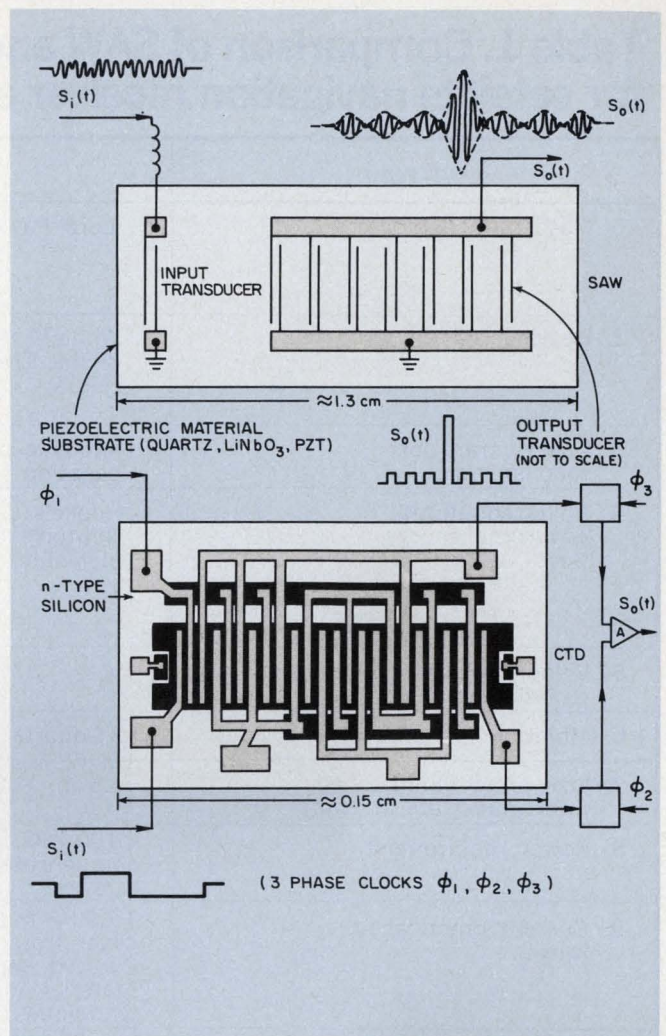

3. The physical realization of matched filters includes SAW devices (top) and CTD circuits (bottom). The latter are much smaller, but their frequency range is limited.

incoming data, while antenna gain can be achieved at the expense of coverage. Table 1 compares the capability of SAW and CTD matched filters to achieve a 15-dB processing gain at 1-MHz bandwidth.

The physical realization of the filter of Fig. 1 with the two solid-state technologies is given in Fig. 3. (The two solutions aren't drawn to scale.) But even though the SAW device is 10 times larger than the CTD filter, it can work at much higher frequencies. So, which of the two solutions should you choose? SAW devices offer high frequency and wide bandwidth, but have limited delay time because of the limited size of the piezoelectric crystal substrates. CTDs can provide milliseconds of delay, but with standard silicon MOS technology they are currently limited somewhat by frequency and bandwidth.

As Table 1 shows, the SAW filter can do with only one i-f stage and needs no clock, and at present the SAW approach may deserve your first consideration. But depending on your application and future developments, this decision may change.

Apparently, SAW technology will evolve toward



**Table 1. Comparison of SAW and CTD matched filters for satellite navigation receiver applications**

ITEM	SAW	CTD
1. Mathematical origins	Lord Rayleigh (1885)	Poisson's Equation, Energy band model for surface states and Fermi-Dirac function
2. Device origins	White & Voltmer Interdigital Transducer (1965)	Sangster—bucket brigade device (1969), Bell Labs—surface charge device (1970)
3. Energy transport mechanism	Acoustic phonon propagation	Electrical charge transfer
4. Basic equations governing energy flow	Hooke's Law, Newton's Second Law of Motion	Fermi-Dirac statistics energy band theory, density of states, space charge density, Poisson's Equation Continuity Equation
5. Velocity of propagation	$v_s = \sqrt{C/\rho}$	$V_c = 1/f_c$
6. Material medium	ST-quartz	Silicon
7. Size of 15 dB matched filter (substrate or chip)	4.5 in. × 0.3 in.	<80 mil × 40 mil
8. Power requirement	<100 mW, amplifier to compensate for insertion loss	<60 mW, for peripheral circuitry
9. Current practical i-f range	15 MHz to 120 MHz (can cover from 3 MHz to 2.5 GHz depending on material and fabrication techniques)	2 MHz to 5 MHz (can cover from 0.5 kHz to 120 MHz under limited operation)
10. Dynamic range	60 dB to 70 dB	70 dB to 85 dB
11. Radiation hardness	>10 <sup>10</sup> rad	10 <sup>4</sup> to 10 <sup>5</sup> rad
12. Clocking requirement	None	Two or three phase clock required (5 MHz)
13. Receiver i-f requirement	Possibility of only one i-f stage	Double conversion required

specific bandpass filter and matched-filter applications at high frequencies, and with some programmability or adaptability. CTDs will operate in the i-f or video-frequency range in applications requiring long delay or integration times, with a high degree of adaptability. ■■

**References**

1. Kallman, H. E., "Transversal Filters," *Proceedings of the IRE*, July, 1940, pp. 302-310.
2. North, D. O., "An Analysis of the Factors which Determine Signal/Noise Discrimination in Pulsed-carrier Systems," *RCA Technical Report PTR-6C*, June 25, 1943.
3. Bernfeld, M., et al, "Matched Filtering, Pulse Compression and Waveform Design," *Microwave Journal*, October, 1964, pp. 57-64.
4. Turin, G., "An Introduction to Digital Matched Filters," *Proceedings of the IEEE*, July, 1976, pp. 1092-1112.
5. White, R. M., "Surface Elastic Waves," *Proceedings of the IEEE*, August, 1970, pp. 1238-1276.
6. Grasse, C., "Tips on Specifying Acoustic-Wave Devices," *Microwaves*, June, 1975, pp. 48-57.
7. Sequin, C. H., and Tompsett, M. F., *Charge-Transfer Devices*,

- Academic Press, New York, NY, 1975.
8. Kosonocky, W.F., and Sauer, D. J., "The ABCs of CCDs," *Electronic Design*, April 12, 1975, pp. 58-63.
9. Altman, L., "The New Concept For Memory and Imaging: Charge Coupling," *Electronics*, June 21, 1971, pp. 50-59.
10. O'Clock, G. D., Jr., "Acoustic-Wave Filters Improve Radar," *Electronic Design*, July 5, 1973, pp. 56-59.
11. Sangster, F. L. J., "The Bucket-Brigade Delay Line, A Shift Register For Analogue Signals," *Philips Technical Review*, 1970, pp. 97-110.
12. Esser, L. J. M., "The Peristaltic Charge-Coupled Device: A New Type of Charge Transfer Device," *Electronic Letters*, December, 1972, p. 620.
13. Jones, W. S., et al, "Evaluation of Digitally Coded Acoustic Surface-Wave Matched Filters," *IEEE Transaction on Sonics and Ultrasonics*, January, 1971, pp. 21-27.
14. Buss, D. D., et al, "Transversal Filtering Using Charge-Transfer Devices," *IEEE Journal of Solid-State Circuits*, April, 1973, pp. 138-146.
15. Cuccia, C. L., and Davies, R. S., "Operation of Information Satellites in an Interference Environment," *Microwave Journal*, June, 1972, pp. 33-42.
16. O'Clock, G. D., Jr., Gandolfo, D. A., Sunshine, R. A., "16-Bit Switchable Acoustic Surface Wave Sequence Generator/Correlator," *Proceedings of the IEEE L*, June, 1972, p. 732.



# Surprise!

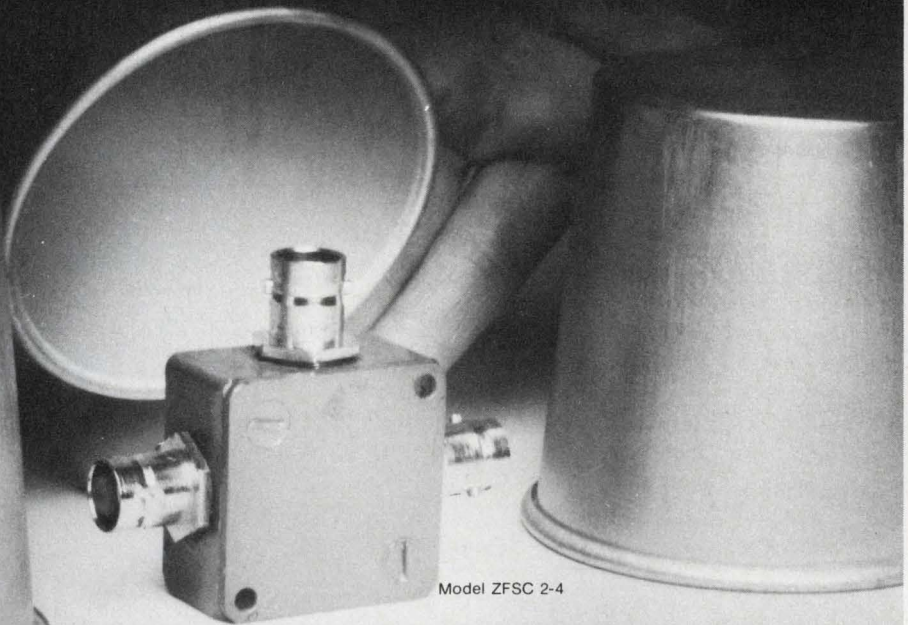

Model ZFSC 2-4

## 200 KHz-1000 MHz Power Splitter/Combiner in a single unit... \$44.<sup>95</sup><sub>(4-24)</sub>

### SPECIFICATIONS FOR ZFSC-2 SERIES

Model No. (Price-Qty)	ZFSC 2-1 (\$31.95 4-24)	ZFSC 2-1W (\$35.95 4-24)	ZFSC 2-2 (\$39.95 4-24)	ZFSC 2-4 (\$44.95 4-24)
Frequency Range (MHz)	5-500	1-750	10-1000	0.2-1000
Isolation (dB)	Typ. Min.	Typ. Min.	Typ. Min.	Typ. Min.
Lower band edge to one decade higher	30 25	30 25	30 20	20 12
Mid range	28 20	28 20	25 20	25 20
Upper band edge to one octave lower	25 20	25 20	23 18	23 18
Insertion Loss (dB) above 3 dB split	Typ. Max.	Typ. Max.	Typ. Max.	Typ. Max.
Lower band edge to one decade higher	0.2 0.5	0.2 0.5	0.2 0.5	0.2 0.5
Mid range	0.3 0.6	0.4 0.8	0.5 1.0	0.5 1.0
Upper band edge to one octave lower	0.6 0.8	0.8 1.0	0.9 1.2	0.9 1.2
Phase Unbalance (deg)	Typ. Max.	Typ. Max.	Typ. Max.	Typ. Max.
Lower band edge to one octave from upper band	0.5 2	0.5 2	0.5 2	0.5 2
Upper band edge to one octave lower	1 4	1 4	1 4	1 4
Amplitude Unbalance (deg)	Typ. Max.	Typ. Max.	Typ. Max.	Typ. Max.
Lower band edge to one octave from upper band	0.05 0.15	0.05 0.15	0.05 0.15	0.05 0.15
Upper band edge to one octave lower	0.1 0.3	0.1 0.3	0.1 0.3	0.1 0.3

Common specifications: Impedance all ports — 50 ohms. VSWR — 1.25 typ. Nominal phase difference — 0. Matched power rating — 1 watt max. Internal load dissipation — 1/8 watt

Yes . . . it's no longer necessary to order several different models of power splitters/combiners if your designs are within the 200 KHz to 1000 MHz region.

Order Mini Circuits new, versatile model ZFSC-2-4 offering these benefits:

- ultra wideband performance, 200 KHz to 1000 MHz
- tighter specs over narrower band range
- lower cost with single-model, high volume purchasing
- fast delivery, one week maximum

For narrower bandwidth applications models in the ZFSC series are available at low prices starting from \$31.95 (see chart)

World's largest manufacturer of Double-Balanced Mixers

**Mini-Circuits**  
Mini-Circuits Laboratory  
A Division Scientific Components Corp.

837-843 Utica Avenue, Brooklyn, NY 11203 (212) 342-2500 Int'l Telex 620156 Domestic Telex 125460

**International Representatives:**  **AUSTRALIA:** General Electronic Services, 99 Alexander Street, New South Wales, Australia 2065.  **ENGLAND:** Dale Electronics, Dale House, Wharf Road, Frimley Green, Camberley Surrey.  **FRANCE:** S.C.I.E. - D.I.M.E.S. 31 Rue George - Sand 91120 Palaiseau, France.  **GERMANY, AUSTRIA, SWITZERLAND:** Industrial Electronics GMBH, Klüberstrasse 14, 6000 Frankfurt/Main, Germany.  **ISRAEL:** Vecronics, Ltd., 69 Gordon Street, Tel-Aviv, Israel.  **JAPAN:** Denso Kaisha, Ltd., Eguchi Building, 8-1 1 Chome Hamamatsucho Minato-ku, Tokyo.  **EASTERN CANADA:** B.D. Hummel, 2224 Maynard Avenue, Utica, NY 13502 (315) 736-7821  **NETHERLANDS, BELGIUM, LUXEMBOURG:** Comex, Veldweg II, Hatterem, Holland.  **NORWAY:** Datamatik AS, Ostensjoveien 62, Oslo 6, Norway.  **AFRICA:** Altira (PTY) Ltd., P.O. 9813, Johannesburg 2000  **SINGAPORE, MALAYSIA:** Electronics Trading Company, 87, Bukit Timah Road, Singapore. 9  **SWEDEN:** Integerad Elektronik, Box 43 S-1, 82 51 Djursholm, Sweden.

**U.S. Distributors:**  **NORTHERN CALIFORNIA:** Cain-White & Co., Foothill Office Center, 105 Fremont Avenue, Los Altos, CA 94022 (415) 948-6533  **SOUTHERN CALIFORNIA, ARIZONA:** Crown Electronics, 11440 Collins Street, No. Hollywood, CA 91601 (213) 877-3550

For complete information and specifications see Microwaves "Product Data Directory", Electronic Designs "Gold Book" or Electronic Products "EEM".

CIRCLE NUMBER 38

20/Rev B



**Of the last 3,102,551 switches  
we shipped to a major appliance manufacturer,  
they rejected 86. Even MICRO SWITCH isn't perfect.**

That's a rejection rate of .00003%. This kind of performance has earned us their Outstanding Vendor classification for 59 months running.

Unusual reliability like this isn't unusual at MICRO SWITCH.

Our people feel quality is everyone's responsibility, not just our inspectors'. So defects aren't simply sought and eliminated. They're prevented from occurring. The result is what we call the Quality Assurance Program.

Naturally, every product is thoroughly tested and evaluated before it ever goes into production.

To further insure that nothing can go wrong, we actually manufacture most of the parts that go into our products.

And even after they've been in production for years, MICRO SWITCH products are being tested to see that their quality manufacturing standards remain constant.

As a result, we have so much

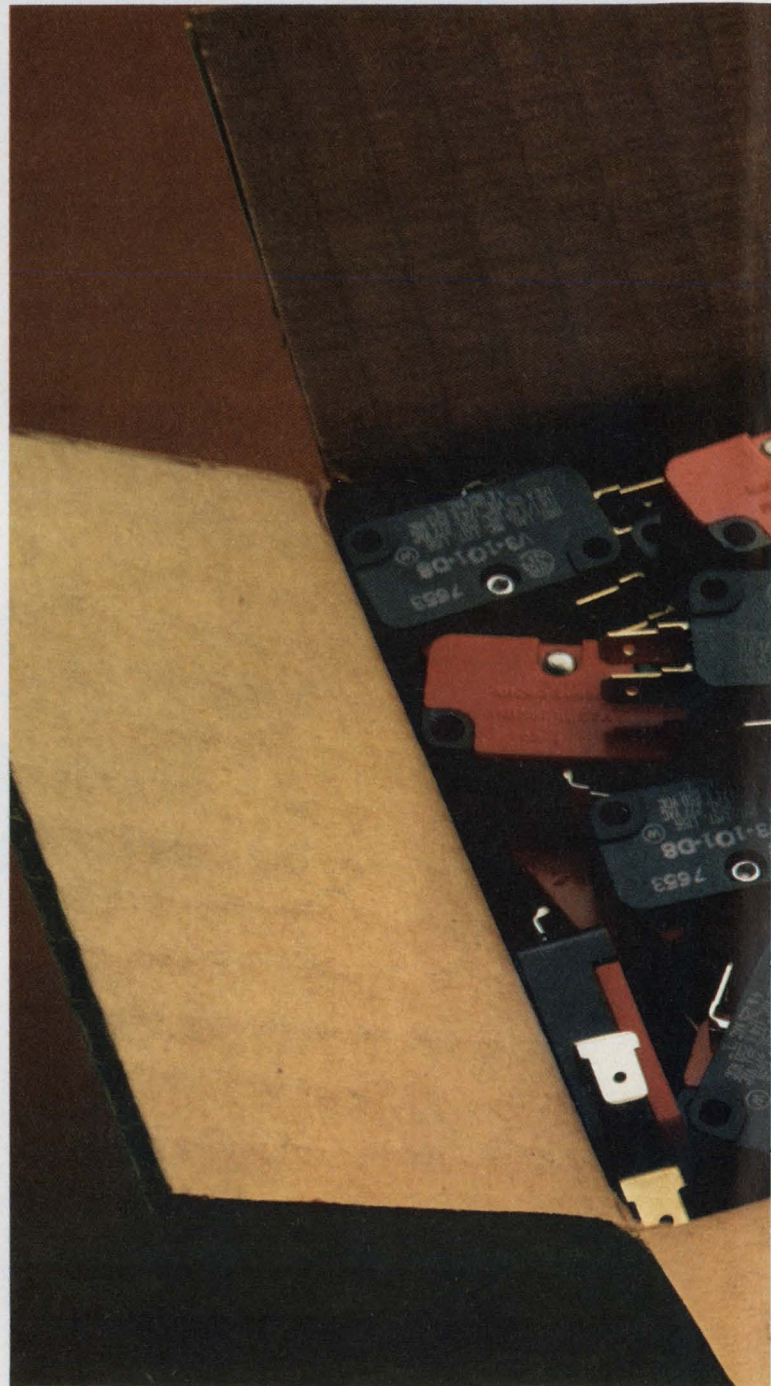

faith in our quality assurance, we guarantee our products a full 18 months—the industry standard is only 12.

You see, when you buy a MICRO SWITCH product, you're buying more than a component. You're buying a company. A company





with capabilities to help solve your problems. Whether through research and development. Innovation. Availability. Reliability. Or Quality Assurance.

MICRO SWITCH. Consider what it would cost to have anything less.

For more information, write for our Quality Assurance booklet.

MICRO SWITCH, Freeport, Illinois 61032. Or call 815/235-6600.

MICRO SWITCH products are available worldwide through Honeywell International.

**MICRO SWITCH**  
**Can you afford anything less?**

CIRCLE NUMBER 40 FOR DATA



# When you're putting bucks into p.c. backpanels, get the single-source advantage of Advanced Circuitry.

Plenty of companies will take your orders for printed circuit backpanels. And that's just what they do . . . take your orders. Then they subcontract one of the most critical parts of your design — the printed circuit board. You see, their backpanel expertise is limited to mechanical assembly of components — boards, pins, and hardware. If you have a problem with your finished backpanels, you may have a real problem in getting someone to take responsibility in a hurry.

Advanced Circuitry takes that responsibility because we are a single-source supplier of printed circuit backpanels. Our State of the Art production methods for single-sided, double-sided, and multilayer boards are second to none. Since much of the interconnect capability is printed, reliability is increased while wire wrap is minimized. Higher levels

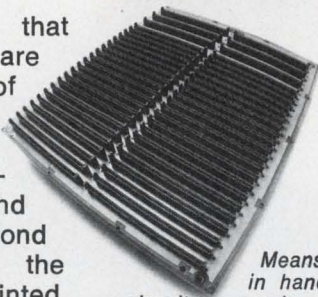

## The State of the Art Company

Means **TOTAL CAPABILITY** in handling all your printed needs — print - and - etch, circuit - double - sided plated - thru - holes, and multilayers. EPA standards have been met through 1980.

of circuit density and signal speed become possible with multilayered interconnections. You can design in all these features plus future versatility at a lower total package cost. Let us show you how.

Our engineers will assist you in optimizing your layout. Then, we will manufacture the entire backpanel right on the premises. With repairable press-fit connectors installed to your specifications, total electrical testing insures you a trouble-free backpanel. Even our shipping containers

are specially designed to protect the backpanels until they reach you.

When you're putting bucks into p.c. backpanels, you need the assurance of single-source responsibility. **AT ADVANCED CIRCUITRY, THE BUCK STOPS HERE!**

Contact Sue Carrol in Sales & Marketing, for your free copy of our "State of the Art" brochure.



### ADVANCED CIRCUITRY

4811 West Kearney  
Springfield, Missouri 65803  
Telephone 417-862-0751  
TWX 910-775-4705

CIRCLE NUMBER 41



# We're now an analog for Analog.

Analog Devices has named  
us the second source for these  
linear CMOS circuits:

The broadest selection of linear CMOS switches, multiplexers and converters used to be available from only one company—Analog Devices. Now you can get identical CMOS components from us.

We've become the second source for Analog Devices for a lot of good reasons. Like specs, functions and package options you can't find anywhere else. And CMOS—our brand of High-Density CMOS—which insures the lowest power dissipation available in linear ICs.

## Multiplexers

- 7501 8 channels
- 7502 4 channels (differential)
- 7503 8 channels (inverted Enable)
- 7506 16 channels (DG506 replacement)
- 7507 8 channels (DG507 replacement)

So let's begin a dialogue about Analog today. Simply circle the R.S. number, and we'll send you more information about the circuits listed here. We'll also give you an opportunity to request detailed data sheets for the specific devices which interest you.

If your need is urgent, contact Linear Marketing at (408) 247-5350.



3100 Alfred Street, Santa Clara CA 95050  
CIRCLE NUMBER 42

## Switches

- 7510DI Quad SPST (protected)
- 7511DI Quad SPST (protected)
- 7512DI Dual SPDT (protected)
- 7513 Dual SPST (DG200 replacement)
- 7516 Quad SPST (CD4016A replacement)
- 7519 Quad SPDT (current steering)

If you've used Analog CMOS in the past, you'll find

it easy to order pin-for-pin replacements from us. Our numerical model numbers are identical, and our OEM prices are comparable. And of course, we offer the same reliability and product performance you've come to expect from Analog.

Check the tables for the linear CMOS you can get from us today. Soon, more unique circuits will join the roster. Whether you're a veteran user of linear CMOS, or just now contemplating its merits, you should know more about our responsive second-source capability.

## Converters

### Digital-to-Analog

- 7520 10-bit, Multiplying
- 7521 12-bit, Multiplying
- 7522 10-bit, Multiplying (buffered)

### Analog-to-Digital

- 7550 13-bit (2's complement)
- 7570 10-bit (successive approximation)



## Slew rate important for audio amps?

Electrical and listening tests show that slew rate is a sensitive predictor of high-quality audio performance.

The slewing-rate specification of an amplifier has far greater importance in high-fidelity audio-amplifier design than has been generally appreciated. Nevertheless, virtually no published material can be found on the details of this distortion-producing mechanism. And data sheets for audio amplifiers rarely include minimum slew rates along with the related total-harmonic-distortion (THD) specs, even though slew rate is a sensitive predictor of audio-amplifier performance.

An amplifier's maximum rate of output-voltage change, or slew rate (SR), is

$$SR = I/C, \quad (1)$$

where I is a limiting maximum available charging current and C is a controlling nodal capacitor somewhere in the circuit. Eq. 1 is a generalized relationship, applicable to any type of amplifier circuit. In IC op amps, C usually represents the value of the compensation capacitor that stabilizes the feedback circuit, and I is the maximum current available at the input-stage collector (or drain).

Such input-stage slew-rate limiting can cause gross departures from linearity—several-percent in many cases. The amplifier operates in a highly nonlinear mode when it is forced by high slew-rate signals to depart from its normally balanced state because of current limiting.

Other current-limiting points in an amplifier circuit, such as in equalizer stages with large-valued frequency-shaping capacitors, also can determine the amplifier's slew-rate limit. In audio power amplifiers, large capacitance loads and limited output-current capability often determine the slew-rate maximum.

Specifications for op amps usually contain both the slew-rate (SR) and a corresponding full-power-frequency capability,  $f_p$ , where

$$f_p = \frac{SR}{2\pi E_o \text{ (peak)}} \quad (2)$$

and  $E_o$  is the peak voltage output. Accordingly, an op amp that can deliver, say, 10 V of peak output should have a slew rate,

$$SR = 1.25 \text{ V}/\mu\text{s},$$

for the accurate reproduction of a 20-kHz audio signal.

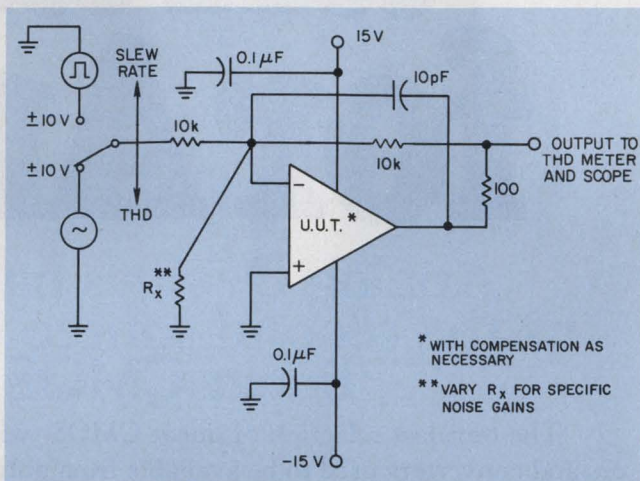

1. Testing for the effects of slew rate on audio amplifiers is best done with the amplifier connected as a unity-gain inverter and compensated accordingly. In this way, you minimize other sources of distortion and obtain the worst-case conditions for slew rate.

The popular 741 has a slew-rate specification of typically only 0.5 V/ $\mu$ s; consequently, its use for wide-band high-quality audio work is not recommended.

But a high slew rate, alone, is not enough: The THD can still easily exceed 1% at the full-power frequency, if the slewing isn't symmetrical with signal polarity. Even at 1/10 to 1/5 of  $f_p$ , significant amounts of THD are produced. Slew-rate dissymmetry also produces intermodulation products. The over-all effect is easily detected by the ear—fractions of a percent of slew-rate induced distortion (SID) are highly audible.

### Testing for SID

Several methods can determine an amplifier's SID; however tests have shown that measurement of THD over a wide frequency range is most effective. To isolate SID as the primary error source and eliminate the effects of common-mode errors, the unit under test (UUT) should be connected as an inverter with a gain of one. Compensation for unity gain produces the lowest SR, and therefore, the greatest SID. And to minimize output-stage nonlinearities, the output-stage loading should be a high impedance—about 10 k $\Omega$  (Fig. 1).

The input of the UUT should sweep from 100 Hz



to 100 kHz and drive the UUT (to  $\pm 10$ -V input for IC op amps) so the output reaches its maximum voltage. And the THD analyzer connected to the output of the UUT should have a frequency resolution capability of 0.002% of full scale for input levels of at least 1 to 7 V rms.

The UUT's slew rate is measured by driving it with a 10-kHz square wave and observing the rise time of the output on a scope. Ideally, the positive and negative-going slew rates should be the same. Check to see if they are: Unsymmetrical slew rates can cause high THD, as previously mentioned. Even though

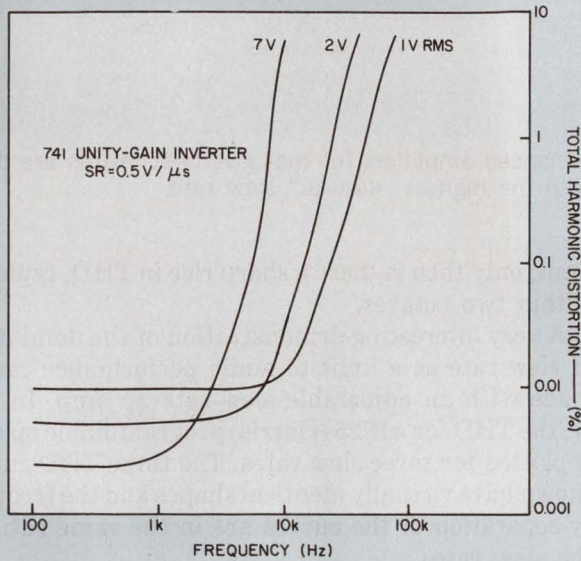

(a)

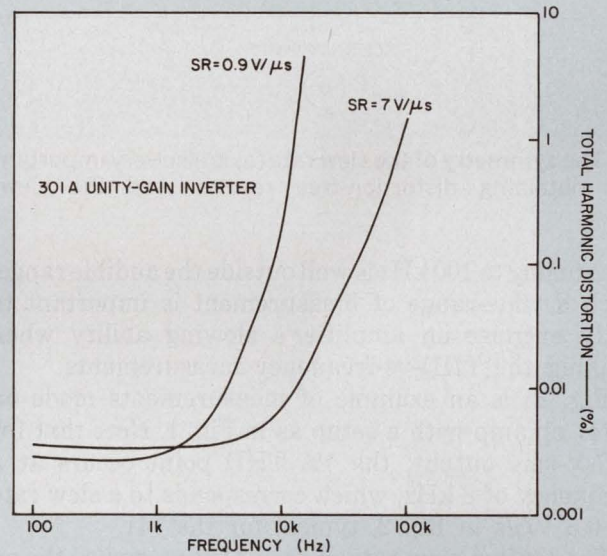

(b)

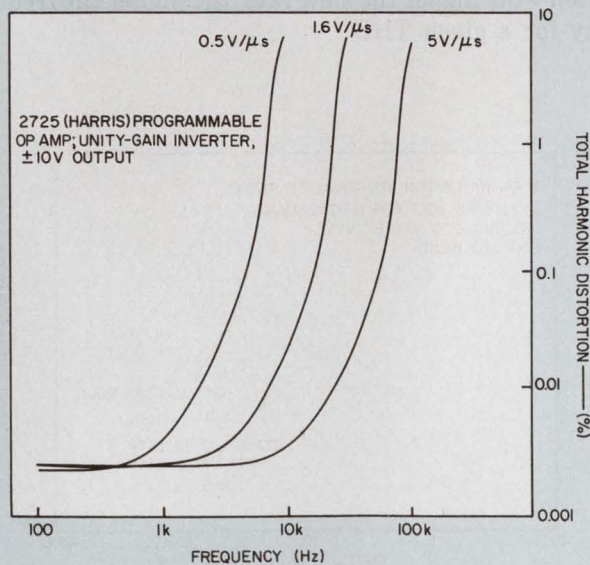

(c)

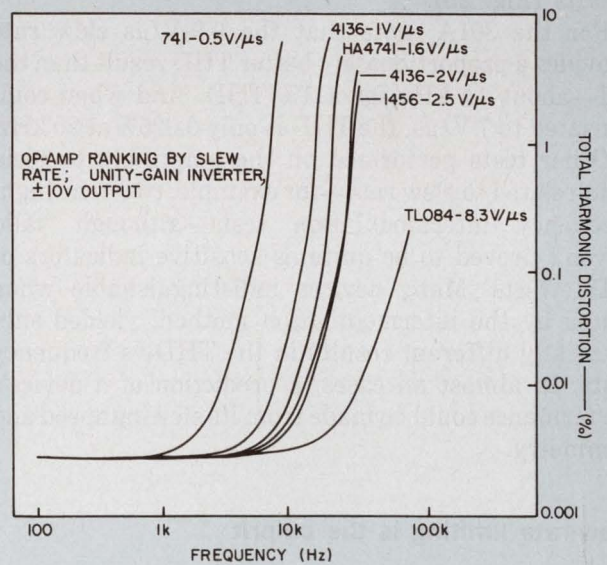

(d)

2. Measurements of total harmonic distortion are directly related to slew rate and the peak output voltage.



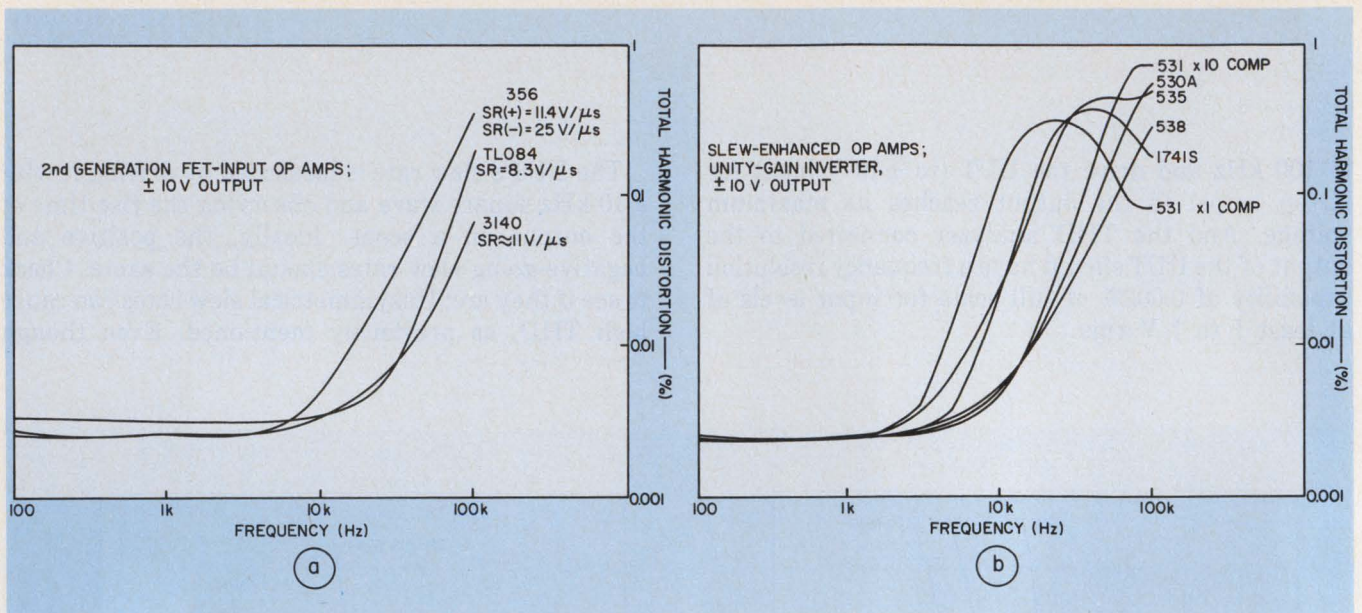

3. **The symmetry of the slew rate** (a) is also very important for obtaining distortion-free results. And the slew-

enhanced amplifiers (b) that give best results are those with the highest "natural" slew rate.

measuring to 100 kHz is well outside the audible range, such a wide-range of measurement is important to fully exercise an amplifier's slewing ability when making the THD-vs-frequency measurements.

Fig. 2a is an example of measurements made on a 741 op amp with a setup as in Fig. 1. Note that for a 7-V-rms output, the 1% THD point occurs at a frequency of 8 kHz, which corresponds to a slew rate of 0.5 V/μs in Eq. 2, typical for the 741.

The limited slew rate of the 741 thus makes the op amp unsuited for high-performance audio work. However, the 301A, which is similar to the 741, but with the capability of being externally compensated to improve the slew rate, shows vastly better THD results (Fig. 2b).

For the 301A, note that the 0.9-V/μs slew rate provides a proportionately better THD result than the 741—about 14 kHz for a 1% THD. And when compensated to 7 V/μs, the THD is only 0.025% at 20 kHz.

Other tests performed on the amplifiers to yield data related to slew rate—for example, two-tone high-frequency intermodulation tests—although valid haven't proved to be quite as sensitive indicators of SID effects. Many devices indistinguishable when tested by the intermodulation method, yielded substantially different results in the THD-vs-frequency tests. In almost all cases, a prediction of a device's performance could be made from its slewing speed and symmetry.

### Slew-rate limiting is the culprit

At low frequencies, where the slew rate does not enter the picture, the THD value is constant and in the vicinity of 0.01% or less. This value derives mostly from noise, not harmonic distortion. As the frequency approaches the  $f_p$  value corresponding to the slew-rate

limit, only then is there a sharp rise in THD, typically within two octaves.

A very interesting demonstration of the dominance of slew rate as a limit to audio performance can be made with an adjustable slew-rate op amp. In Fig. 2c, the THD for a 2725 (Harris) programmable op amp is plotted for three slew rates. The three THD curves shown have virtually identical shapes and the frequency separation of the curves are in the same ratio as the slew rates.

Moreover, Fig. 2d, compares the performance of several op amps under unity-gain conditions. Although the devices are built by different technologies, performance directly follows the slew-rate specification—the higher the slew rate, the higher the frequency for a given THD.

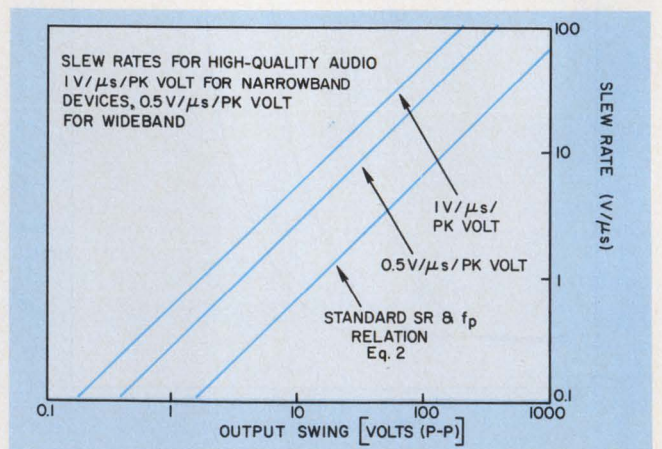

4. **A simple criterion for predicting superior audio-amplifier performance** calls for a symmetrical slew rate between 0.5 and 1 V/μs per peak volt of output. This slew-rate range is more demanding than the usually accepted relationship that relates SR and  $f_p$ .



Of course, slew rate alone can't be used indiscriminately to "grade" the audio performance of an amplifier. Other effects can produce overriding results—for example, the previously mentioned slew-rate symmetry. Fig. 3a shows how symmetrically slewing FET-input amplifiers such as the TL084 (TI) or 3140 (RCA) outperform the FET-input 356 (National); which slews with a built-in asymmetry.

Moreover, amplifiers with slew enhancement, whose input stages operate class AB to attain a wide dynamic range, show an early THD rise and that drops and levels off above 20 kHz (Fig. 3b). Of this group, the best performers are those with the highest "natural" slew rate, such as the 530, and lightly compensated 531 and 538 (Signetics) units.

### High slew-rate amps perform best

Superlative performance as judged by SID is achieved by high slew-rate, wide-band devices such as the dielectrically isolated 2525 and 2625 units (Harris), and also the 301 A and OP-01 (Precision Monolithics), TDA1034 (Signetics), and 318 (National) operated in feed forward. Older FET input units such as the 740 (Fairchild), 8007 (Intersil), NE536 (Signetics) and AD540 (Analog Devices) also are excellent audio performers, although they are considered obsolete by their manufacturers. All these wide-band, high slew-rate amplifiers show a very low THD—close to the noise, or residual, level of the

instruments—and then the THD rises rapidly, only near 100 kHz.

Based upon extensive SID testing, a simple criterion for predicting audio-amplifier performance has been evolved: The amplifier and its circuit (under all loading conditions) should possess a slew rate between 0.5 and 1 V/ $\mu$ s for each volt of peak output (Fig. 4). Therefore, a high-quality audio amplifier that delivers  $\pm 10$  V, or 20-V pk-pk output, should slew at a minimum rate of 5 V/ $\mu$ s.

The lower slew rate of the recommended range is adequate for wide-bandwidth amplifiers—for gain-bandwidth product  $> 3$  MHz—and should increase to the upper 1-V/ $\mu$ s value for narrow-band units. In the recommended slew-rate range, THD resulting from SID will be 0.01% or less at 20 kHz. Controlled listening tests confirm the validity of this slew-rate criterion. ■■

### References

1. Jung, W. G., "Improve Op Amp Audio Circuits," *Electronic Design*, Sept. 27, 1973, pp. 68-73.
2. Jung, W. G., "The Pitfalls of the General Purpose IC Operational Amplifier As Applied to Audio Signal Processing," *Journal of the AES*, Vol. 21, No. 9, November, 1973.
3. Jung, W. G., "IC Op Amp Cookbook," Howard W. Sams & Co., Indianapolis, IN, 1974.

### Acknowledgement

Portions of this article were adapted from an article series, "Slewing-Induced Distortion in Audio Amplifiers," ©Copyright 1977, Walter G. Jung, *Audio Amateur*, January, 1977, pp. 3-20.

Effects of line voltage interruptions... brown-outs... variations in line voltage... fast pulses... short pulses with fast rise times... high energy pulses... static charges... can all be easily detected and corrected in your design. Now with the Schaffner NSG200 Series Line Interference Simulators, you can, for the first time, test reactions to calibrated power line faults inexpensively in your lab... not in the field where it can be costly.

Whether designing an instrument or system... from a power supply to a computer... for yourself or a customer... for total product reliability, rely on the Schaffner Line Interference Simulator.



Write for your 12 page brochure on Line Interference Simulators.

**interference simulator**

Now... Simulate Line Interferences Before They Happen!

Available in the U.S.A. only through

**ROHDE & SCHWARZ SALES CO., (U.S.A.) INC.**

14 Gloria Lane, Fairfield, N.J. 07006 ■ (201) 575-0750 ■ Telex 133310

CIRCLE NUMBER 43



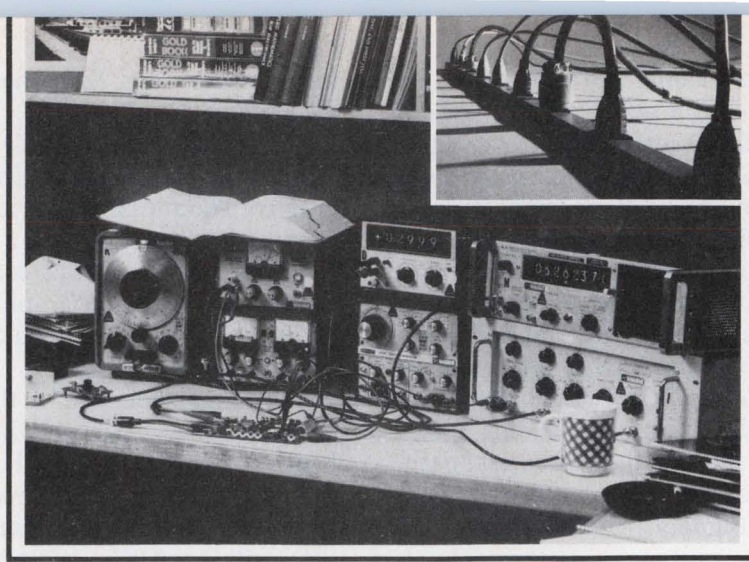

# Here's an idea that could change your thinking about test equipment.

A complete test station doesn't have to be an assortment of special-function instruments. A working workbench doesn't have to be crowded and unhandy. And a truly portable test lab doesn't have to be out of reach.

**TM 500 offers you an alternative:** a modular line of compact, interchangeable plug-ins and mainframes. Multiconfigurable both in packaging and in performance, TEKTRONIX TM 500 is designed around the idea that test equip-

ment which is compatible in every respect can, in fact, cover a broader range of functions and meet a wider variety of measurement situations. To say nothing of its ability to adapt more readily to new challenges.

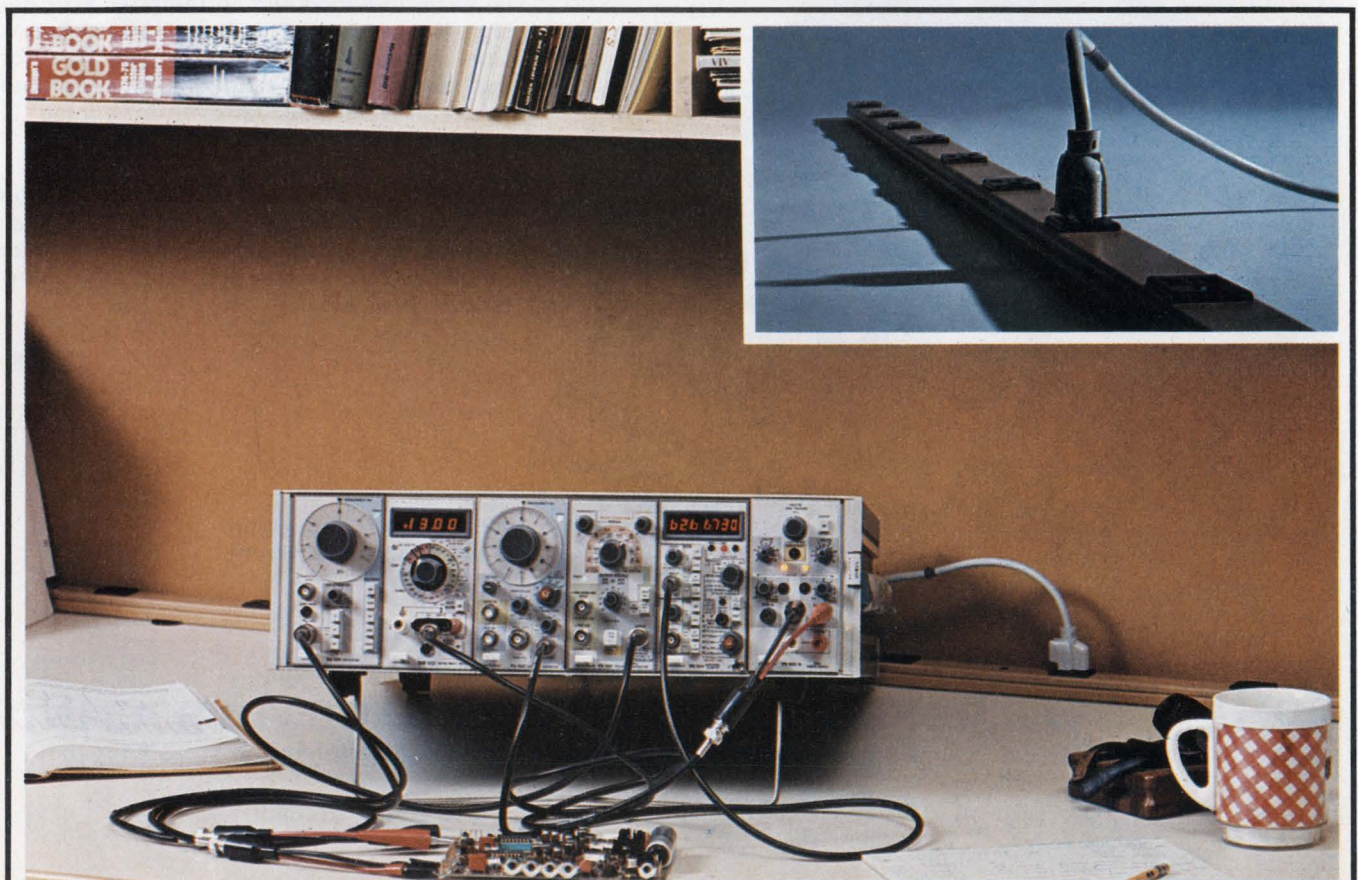



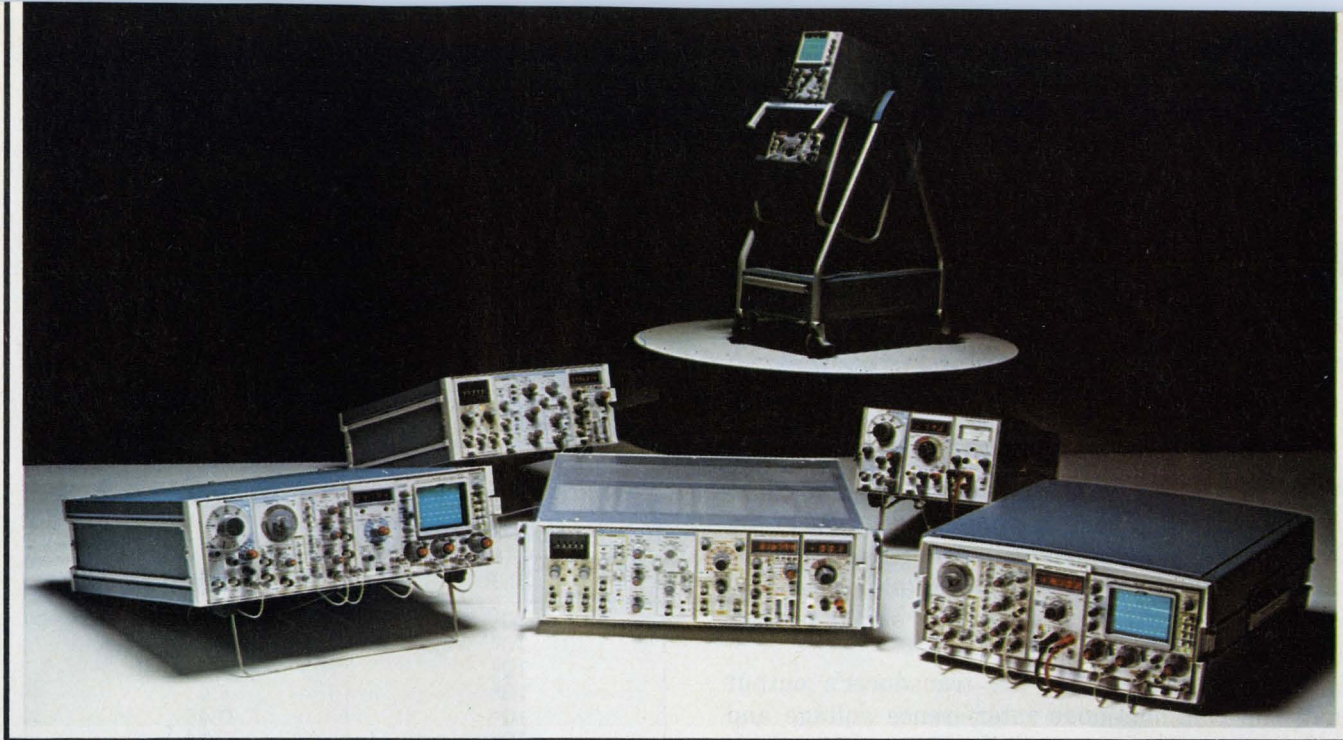

**Modular** DMMs, counters, generators, amplifiers, power supplies, oscilloscopes, logic analyzers, and word recognizers can be interfaced electrically. Signals

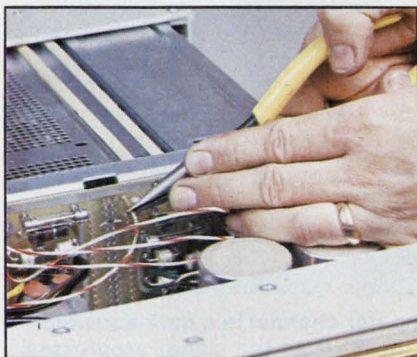

can be routed from one plug-in board to another via the mainframe mother board, thus enabling you to build a test instrument that's more powerful than the sum of its parts.

**The plug-ins can be configured** together in six widths of mainframe and four types of packages, depending on where and how you'll use them. Select the plug-in modules you need just as you would monolithic instruments, and then combine them in the appropriate mainframe for a

convenient, uncluttered bench setup; mount up to 6 functions



side-by-side in a 5¼-inch rack; build a rollabout station that "follows" you around the lab. Or



pack a portable test station in the small-as-a-suitcase TM 515 Traveler Mainframe, which carries up to 5 modules and typically weighs less than 35 pounds, including the modules.

**The result** is a total test system that looks like a unit . . . works as a unit . . . yet is still configurable to new or changing measurement requirements. So the next time you're looking into test instrumentation, specify the one product line that's designed for configurability.

For further information or a demonstration of TM 500 Instrumentation, write or phone: Tektronix, Inc., P.O. Box 500, Beaverton, Oregon 97077, (503) 644-0161 ext. 5283. In Europe: Tektronix Limited, P.O. Box 36, St. Peter Port, Guernsey, Channel Islands.

**Tektronix**<sup>®</sup>  
COMMITTED TO EXCELLENCE

FOR TECHNICAL DATA CIRCLE #131  
FOR DEMONSTRATION CIRCLE #132

**TM 500...designed for configurability.**



## Optimize transducer/computer interfaces

with these six easy steps and get the quality of data and number of useful bits needed for the computer input.

A basic data-acquisition channel between a measurement transducer and computer input generally includes a preamplifier and filtering circuit (Fig. 1). To get the most out of the transducer and provide the computer input with the quality of signal needed, follow these six design steps:

1. Identify the level of the transducer's output signal, the common-mode interference voltage and resultant signal-to-noise ratio (SNR).
2. Determine the required common-mode rejection ratio (CMRR) of the preamplifier, and select components to provide this CMRR.
3. Design the preamplifier to provide enough gain to raise its output SNR  $\geq 100$ .
4. Establish the required quality of the signal input to the computer—the number of significant bits of data per sample—and relate this number to an equivalent SNR.
5. Determine the bandwidth the filter should have and design a filter circuit to provide the needed improvement in signal quality.
6. Determine the optimum sampling rate for the a/d converter.

A good way to explain the steps is to follow along with a practical design (Fig. 2). To start, consider a 1-mV-rms signal coming from a transducer that also provides the relatively high level of 1 V rms of common-mode noise. Also, assume the transducer signal to the preamplifier is classified as "complex-periodic" (Table 3) with a period of 0.5 s. You will make use of this signal classification later.

The input signal-to-noise ratio, therefore, is given by the following equation:

$$\text{Input SNR} = \frac{(\text{rms signal})^2}{(\text{rms noise})^2} = \left( \frac{10^{-3}}{1} \right)^2 = 10^{-6}.$$

A differential-input preamplifier can substantially improve this SNR by means of its common-mode rejection ratio (CMRR). The CMRR is the ratio of its differential-mode gain (DMG) to its common-mode gain (CMG) and the following ratio of SNRs:

**Table 1. SNR vs amplitude error for 1σ (68%) confidence**

SNR	Amplitude
10 <sup>1</sup>	44%
10 <sup>2</sup>	14
10 <sup>3</sup>	4.4
10 <sup>4</sup>	1.4
10 <sup>5</sup>	0.44
10 <sup>6</sup>	0.14
10 <sup>7</sup>	0.044
10 <sup>8</sup>	0.014
10 <sup>9</sup>	0.0044
10 <sup>10</sup>	0.0014
10 <sup>11</sup>	0.00044

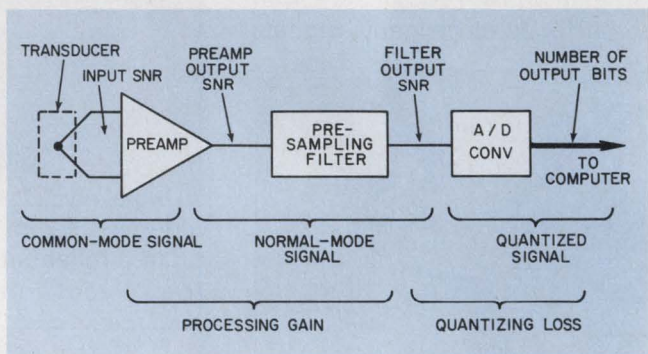

1. A transducer-to-computer channel in a data-acquisition system must upgrade the SNR as the signal progresses to the a/d converter so that all the required bits per sample delivered to the computer are valid data.

$$\begin{aligned} \text{CMRR} &= \frac{\text{DMG}}{\text{CMG}} & (1) \\ &= (\text{Preamp-output SNR}/\text{Input SNR})^{1/2} \\ &= \left( \frac{100}{10^{-6}} \right)^{1/2} = 10^4 \end{aligned}$$

The CMRR of the three-amplifier preamplifier circuit of Fig. 2 is given by the following equation, which implements Eq. 1:

$$\begin{aligned} \text{CMRR} &= \left( \frac{1 + 2R_2/R_1}{\text{CMG}_1} \right) \left( \frac{R_4/R_3}{\text{CMG}_s} \right) & (2) \\ &= \frac{1 + (2)(75k)/5k}{1} \cdot \frac{160k/5k}{0.01} \end{aligned}$$

Patrick Garrett, Chairman of EE Technology, University of Cincinnati, on leave with Environmental Protection Agency, Research Triangle Park, NC 27711.







**Table 2. Quality of the computer input**

Binary bits	Levels	Amplitude error	Filter output SNR
6	64	0.8%	$3.1 \times 10^4$
8	256	0.2	$4.9 \times 10^5$
10	1024	0.05	$7.8 \times 10^6$
12	4096	0.012	$1.3 \times 10^8$
16	65,536	0.00076	$4.0 \times 10^{10}$

**Table 3. Presampling-filter cutoff frequency**

Signal type	Filter cutoff ( $f_c$ )
Dc	1/rate change (Hz)
Sinusoidal	1/period
Complex periodic	20/period
Single events	1/width

**Table 4. Overlap suppression for Butterworth filters**

$f_s$ sample rate	Overlap amplitude	Number of filter poles
3 $f_c$	-28 dB	4.0%
	-36	1.6
4 $f_c$	-36	1.6
	-48	0.4
5 $f_c$	-40	1.0
	-60	0.1

relates input-amplitude error and SNR on a probability-basis, and Table 1 lists solutions of the equation for a confidence limit ( $1\sigma$ ) of 68%.

And according to Table 2, to achieve an 8-bit computer input, the a/d input must have an SNR of about  $10^6$ , which is  $10^2$  more than is provided by the preamplifier output. Consequently, the filter must supply this  $10^2$  improvement.

**Maximizing filter SNR output**

For high-input SNRs ( $> 100$ ), linear filtering methods approach within about 3-dB of the efficiency of correlator-matched filters.<sup>1,2,3</sup> For a preamp output SNR  $\geq 100$ , the relationship between SNR and bandwidth (BW) is

$$\text{Filter SNR processing gain} = \frac{\text{Filter-output SNR}}{\text{Preamp-output SNR}} = \frac{1}{2} \left( \frac{\text{Preamp BW}}{\text{Filter BW}} \right) \quad (3)$$

$$\text{Filter BW} = f_{c1} = \frac{1}{2} \left[ \frac{(\text{Preamp BW})(\text{Preamp-output SNR})}{(\text{Filter-output SNR})} \right] \quad (4)$$

A gain-vs-frequency plot for the L144 op amps used in the preamplifier is given in Fig. 3. Both the first and second sections of the preamplifier have the same frequency characteristics. And since the over-all pre-

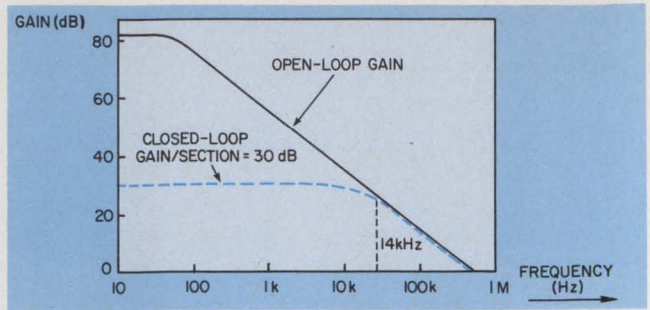

3. Negative feedback flattens the open-loop gain curve of an L144 op amp to the 30-dB line for a passband of about 14 kHz.

amplifier gain of about  $10^3$ , or 60 dB, is distributed approximately equally between the first and second sections, the 30-dB closed-loop gain per section yields a bandwidth of 14 kHz. The over-all preamp BW for  $n = 2$  identical sections is then,

$$\begin{aligned} \text{Preamp BW} &= (\text{Section BW}) \sqrt{2^{1/n} - 1} \\ &= (14) (0.64) \\ &= 9 \text{ kHz.} \end{aligned}$$

Therefore,

$$\begin{aligned} f_{c1} &= (1/2) \left( \frac{9 \times 10^3 \times 10^4}{10^6} \right) \\ &= 45 \text{ Hz,} \end{aligned}$$

which is the suggested cut-off frequency of the filter circuit.

This presampling-filter corner frequency,  $f_c$ , also may be determined from the input-signal's fundamental period. Assuming that the amplitudes of the harmonics decrease approximately as  $1/n$  for complex periodic signals, a filter chosen to pass harmonics of at least 5% amplitude will have a cutoff frequency at about the twentieth harmonic. Therefore,

$$\begin{aligned} f_{c2} &= \frac{20}{\text{input-signal period}} \quad (5) \\ &= \frac{20}{0.5} = 40 \text{ Hz} \end{aligned}$$

for the previously specified complex-periodic input signal whose period is 0.5 s.

For other categories of signals, the filter's suggested cutoff frequency,  $f_{c2}$ , can be selected from Table 3. Since  $f_{c1} > f_{c2}$  in the implementation of Fig. 2, the preamplifier's bandwidth requires no iteration.

Difficulty arises only when the  $f_{c1}$ , required to provide the necessary SNR processing gain is lower than that necessary to adequately pass the input signal's frequency spectrum. When the initial preamplifier design iteration yields an  $f_{c1} < f_{c2}$ , then the  $f_{c1}$  of Eq. 4 must be increased. The preamplifier bandwidth is most easily increased by lead compensation, and many instrumentation amplifiers provide terminals for this. Alternately, the bandwidth can be increased by adding a feedback-network zero near the amplifier's unity-loop-gain cross-over frequency.

If the lower end of the a/d converter's folding



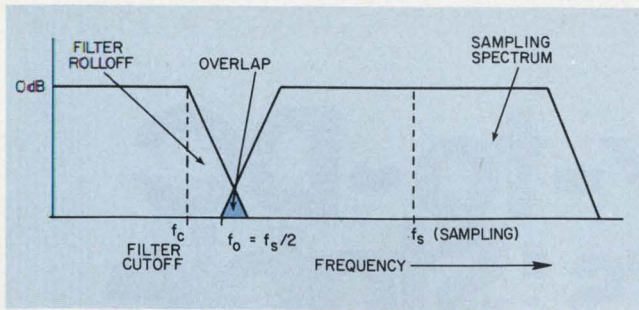

4. The overlap between the filter rolloff and skirt of the sampling spectrum must be minimized to prevent excessive aliasing.

frequency,  $f_0$ , which is equal to half the sampling rate ( $f_s/2$ ), overlaps the filter's cutoff frequency, aliasing errors will result (Fig. 3).<sup>5</sup> The errors are a complicated function of the ratio of the signal and noise in the overlapped region to the signal and noise in the remainder of the spectrum.

#### Reduced overlap reduces aliasing errors

Obviously, overlap is reduced with increasing  $f_s$ . But to avoid excessive sample rates, a steeper rolloff after  $f_c$  with improved filtering also will reduce the overlap. For most applications, an overlap of about 1% of the passband amplitude is a conservative goal.

An active filter can readily provide the needed rolloff steepness. The literature on active filters is

considerable and many filter types can be used, but for the application in Fig. 1 a sharp-cutoff, low-pass network with Butterworth characteristics is the closest thing to an ideal filter (Table 4).

The three-stage active filter shown in Fig. 2 uses a unity-gain configuration for maximum stability. The low-pass networks in the three-stage filter provide six-pole, low-pass Butterworth characteristics and a roll-off of 120 dB/decade. The circuit uses standard-valued resistors, and the nonstandard capacitor values can be made by the paralleling of standard capacitor units. The six-pole circuit achieves adequate overlap suppression for a sample rate of  $4f_c$ , or 160 Hz. ■■

#### References

1. Raemer, H. R., "Statistical Communication Theory and Applications," Prentice Hall, Englewood Cliffs, NJ, 1969, pp. 190, 254-255.
2. Schwartz, M., Bennett, W. R., and Stein, J., "Communications Systems and Techniques," McGraw Hill, New York, NY, 1966, p. 310.
3. Fano, R. M., "Signal to Noise Ratio in Correlation Detectors," MIT Technical Report-186, Feb. 19, 1951.
4. Schwartz, M., "Information Transmission Modulation and Noise," 2nd Edition, McGraw Hill, 1970, p. 155.
5. Gardenshire, L. W., "Selecting Sample Rates," *ISA Journal Reprint*, April, 1964.
6. Sallen, R. P. and Key, E. L., "A Practical Method of Designing RC Active Filters," *IRE Transactions on Circuit Theory*, Vol. CT-2, March, 1955, pp. 74-85.

#### Acknowledgement

Adapted from a forthcoming book, "Analog Systems for Microprocessors and Minicomputers," with permission of the Reston Publishing Co.

# At +125°C you can burn your fingers on some DAC's our 4058 stays cool



Because this new, hybrid 12 bit DAC was specifically designed for the temperature range  $-55$  to  $+125^\circ\text{C}$ . It is not merely a top-end selection of commercial DAC's, where you don't know today what tomorrow's yield will be.

Your application may not need the full temperature range nor the hermetically sealed metal DIP. But for a lot of industrial applications these and other features of the new DAC offer you vital safety factors.

For example, it is produced to MIL Std 883 giving extremely high reliability. It has a very low temperature drift of 5 ppm/ $^\circ\text{C}$  gain, 10 ppm/ $^\circ\text{C}$  max. offset.

And if you want to fly with it, the 4058 is shock, vibration and acceleration tested - its already being used in the new MRCA.

 **TELEDYNE PHILBRICK**

Allied Drive at Route 128  
Dedham, Massachusetts 02026  
Tel: (617) 329-1600

TWX: (710) 348-6726  
Telex: 92-4439  
Cable: TELEPHIL



# Anadex Frequency-to-DC Converters: Stable, Sensitive & Linear.

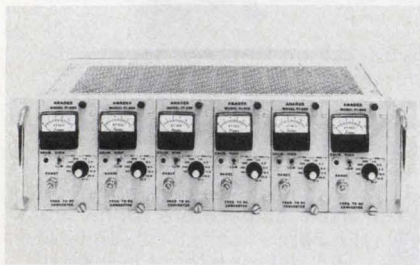

**The PI-608 Series** features  $\pm 0.025\%$  linearity, front panel calibration, 5 Hz to 51.2 KHz frequency range in 10 switchable ranges. Input sensitivity for Sine or Squarewave: 0.01 V RMS from 5 Hz to 51.2 KHz; for Pulse Input: 50 mV pk (10  $\mu$ s minimum width). DC output is 0 to 5 V floating, 20 mA maximum at 5 volts. CMR is 60 db at 60 Hz. Internal power supply accepts 105-125 V RMS, 50-400 Hz.

**The PI-355 & PI-375 Series** features  $\pm 0.03\%$  linearity, full scale frequencies from 100 Hz to 50 KHz with a 2-to-1 full scale adjustment range. Output is 0 to 5 VDC, 5 mA maximum. Units can operate from 22 to 30 VDC power or optionally 105-125 V RMS, 50-400 Hz. PI-355 has 10 mV sensitivity from 5 Hz to 10 KHz; 20 mV to 50 KHz. PI-375 has 1 V RMS sensitivity from 5 Hz to 10 KHz; 2 V RMS to 50 KHz. Size is MIL-T-27 can. Weight is 3 lbs.

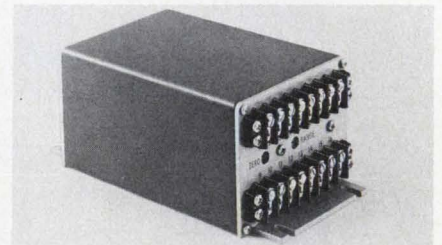
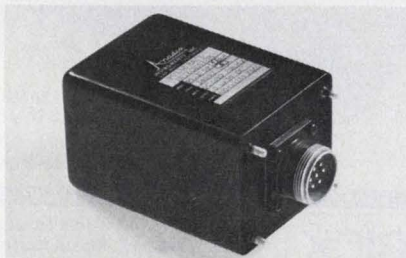

**The PI-600 Series** features  $\pm 0.05\%$  linearity, frequency range of 250 Hz to 3 KHz full scale, sine wave, square wave, or approximations thereof, in three selectable ranges. Multiple outputs for current and voltage range from 0 to 5 VDC, 1 to 5 mA, and 4 to 20 mA selectable by terminal strip jumpers.

 **Anadex**



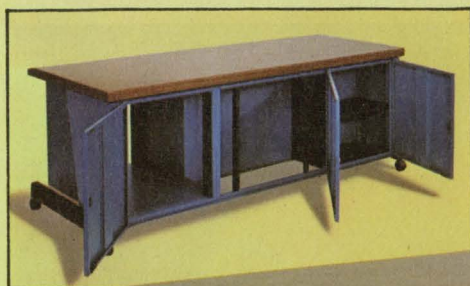

# COMMANDER

## MODULAR WORK STATIONS BY BUD.

Put efficiency on your side -- better yet, at your side -- with the new, modular, contemporary-styled Commander.

One, two and three-bay units, each with a rear compartment, plus a selection of cabinets, three-drawer pedestals, and shelves, give you the options to choose what you require for storage, or housing electronic equipment; the options to develop a self-contained, independent data/terminal station.

The new Commander comes in a choice of 19 colors. Walnut wood-grained Formica® top has a smooth, comfortably beveled front edge.

The new Concorde Series was designed as a companion piece for the Commander work station; designed to provide a contemporary-styled installation, a complete and effective system. Yet, the Concorde, a definite break with traditional racks, will harmonize with and enhance any installation, simple or sophisticated.

Contact Bud for further facts on the Commander and Concorde. Phone Bud toll free: (800) 321-1764; in Ohio, (800) 362-2265.



Front and rear view of one-bay unit with vertical sliding drawer.

Ask us for our 4-color brochure on Bud's new Commander and Concorde Series.

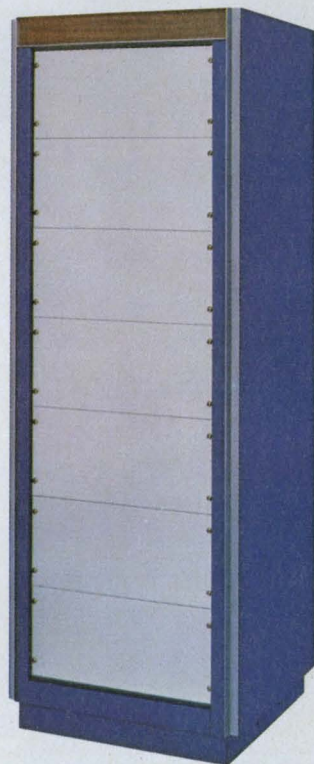

# CONCORDE

# BUD

Bud Industries, Inc.  
4605 East 355th St.  
Willoughby, Ohio 44094

Bud West, Inc.  
3838 North 36th Ave.  
Phoenix, Arizona 85019

CIRCLE NUMBER 47





## Down to earth economy from CTS

Overall cermet resistor network economy is what CTS has been putting into modern systems for well over a decade. For example, Series 760 DIP cermet networks, purchased in quantity, can cost less than 30¢ each.

And on the PC board, they offer still more economy by saving valuable space. Quick, automatic installation lets you cut handling costs and inspection time. You eliminate many separate components. And CTS production methods assure not only the highest quality product, but the fastest delivery, too.

Where one of our more than 210 standard off-the-shelf 14-pin and 16-pin DIP cermet resistor networks won't meet your circuit requirements, we'll custom design the network you need in either

8, 14, 16 or 18 pin package configuration.

CTS Series 760 DIPs' stability and reliability are remarkable. Over 900 million hours of test data on CTS cermet resistor networks prove CTS reliability with an established failure rate of only 0.00051% per 1000 hours @ 95% confidence level — considerably superior to military failure level S of established reliability specs. With failure so low, you enjoy the ultimate in long-range system economy.

See for yourself the many ways CTS reliable, economical DIPs can benefit you. Write for your copy of our reliability report and complete 12-page cermet resistor network catalog. **CTS OF BERNE, INC.**, 406 Parr Road, Berne, Indiana 46711. Phone (219) 589-3111.

**CTS CORPORATION**

Elkhart, Indiana

A world leader in cermet and variable resistor technology



CIRCLE NUMBER 48



**TAKE A 757  
NON-STOP  
TO FIVE-O!**

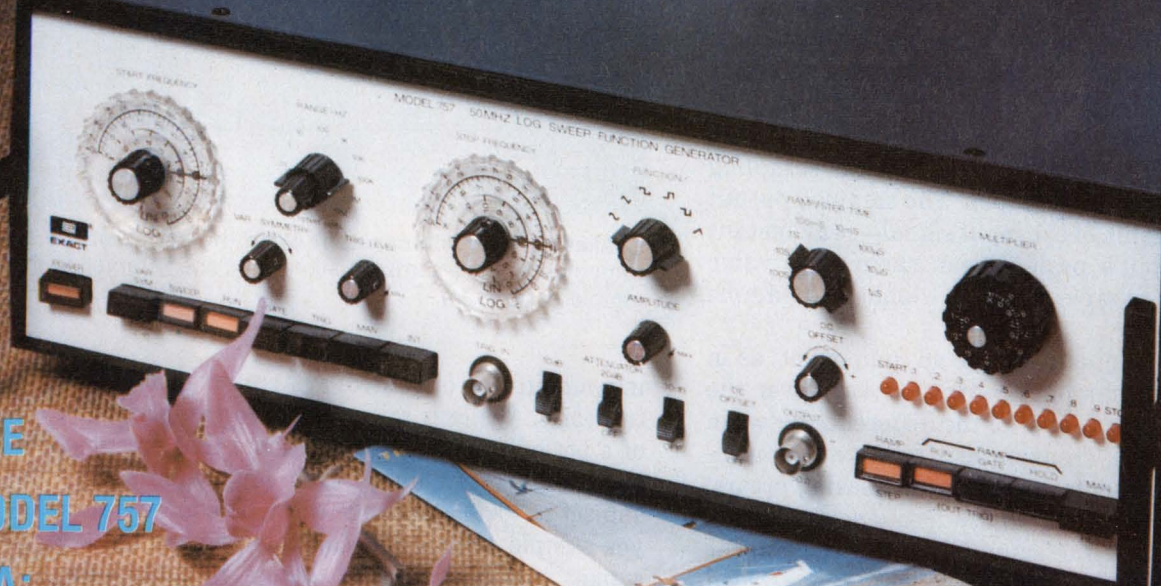

**THE  
MODEL 757  
IS A:**

- 50 MHz FUNCTION GENERATOR
- STEPPED SWEEP GENERATOR
- LINEAR SWEEP GENERATOR
- LOG SWEEP GENERATOR
- PULSE GENERATOR
- AND MORE!!

**PRICE: \$1450 (USA)**

**CIRCLE THE NUMBER BELOW  
AND WE'LL FLY YOU THE WHOLE STORY**

 Box 160 Hillsboro, Oregon  
97123 Tel. (503) 648-6661  
TWX 910-460-8811  
**EXACT electronics, inc.**





# Snare those elusive aliasing errors.

When you can't sample fast enough, use input filters to make sampled-data-acquisition systems more accurate.

Protect sampled-data measurements from aliasing errors with high-speed sampling and input filtering. Now that low-cost, microcomputer-based data acquisition has arrived, sampled-data systems will become even more popular. But before you can design systems free from aliasing errors, you must pin down the sources of these errors.

Signal spectral components, which are symmetric above and below a sampling frequency ( $f_s$ ), are aliases of each other. Aliasing errors occur when you sample a time-varying signal—if the input changes significantly between samples.

An extreme case (Fig. 1) illustrates the characteristic of aliasing errors. A sine wave at the sampling frequency rides on the dc input. The sampled output—the apparent value of the input signal—is a constant value in the input's peak-to-peak range. The value depends on the relative phase of signal and sample frequencies.

Changing the frequency of the ac component, as in Fig. 2, causes the sampler's output to vary over the pk-pk range at a rate equal to the difference between signal and sample frequencies. This variation illustrates a fundamental property of aliasing errors: Input-signal components, whose frequencies are significant fractions of the sampling frequency, appear in the sampler's output as spurious fluctuations folded around half the sampling frequency.

For example, an input-signal component at 0.75 of the sample frequency,  $f_s$ , is indistinguishable at the sampler's output from an equal-amplitude input-signal component at  $0.25 f_s$ , as shown in Fig. 3. That is, signal processing *after* the sampler can't reconstruct the original waveform.

### Filters and speedy sampling cut errors

You must lower the amplitude of input-signal spectral components with frequencies above  $0.5 f_s$ , to keep errors negligible from dc to the highest useful input frequencies. It is essential, therefore, that you provide adequate low-pass signal filtering *before* the sampler. But first select your sampling speed.

Selecting the sampling interval, or rate, to be used

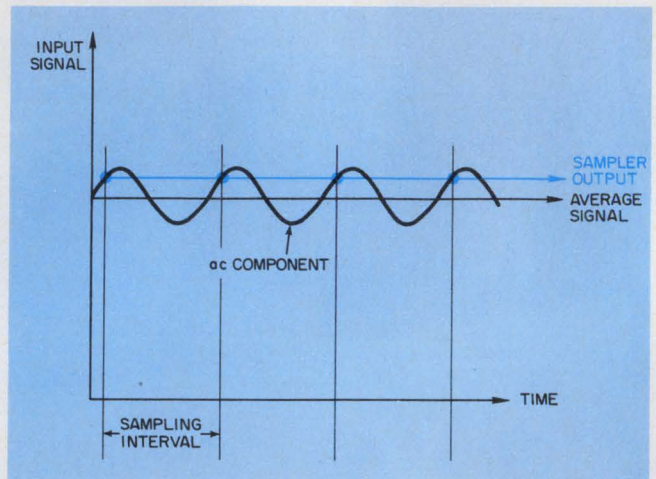

1. Aliasing error is a constant when the period of the ac component of the sampled signal and the interval of the sampler are equal.

in a monitoring or control system invariably involves tradeoffs. While it takes just two samples per cycle of a periodic waveform to indicate that signal's presence, measurements at this low sample rate are subject to 100% amplitude error. The more frequently you sample, the more accurately you can track input signals with high rates of change. But increasing the sampling speed requires faster equipment to process the acquired samples.

Usually, sample rates are selected either to give some desired number of samples per cycle for the highest signal frequency of interest or to limit the quantizing error in tracking the input signal's highest expected rate of change. But bear in mind that the dynamics of some systems cause the sampled signals to change slowly. When sampling rates are high enough so that signal changes between samples are smaller than the desired measurement resolution, no significant aliasing errors occur. In this case, signal prefiltering is unnecessary.

However, even with an encouragingly low signal bandwidth, a wide noise bandwidth can require either a high sampling rate or an input filter before the sampler. For example, suppose the depth of water at a dam is to be measured to a resolution of 0.25 cm. Assume that flow-rate considerations limit the depth's maximum rate of change to 0.25 cm in 90 s. If the



depth transducer responds only to the average water depth, a sampling interval less than 90 s provides immunity from aliasing errors without the complexity and cost of additional filtering.

### Transducers respond to noise

But if the depth transducer responds to the vertical displacement of a relatively small float, it will be sensitive to surface-wave motion. So, to avoid the aliasing errors implicit in Figs. 1 and 2, either increase

the sampling rate or install a low-pass filter between the transducer and the sampler. In addition, of course, you can combine these methods.

Select minimum sampling rates as in Fig. 4. Here the monitored-signal spectrum is related to the sampling frequency. A signal-velocity limit shapes the spectrum in the same manner as a first-order, low-pass filter (6 dB/octave). If the signal is also subject to the acceleration limit shown, the spectrum will be bounded by a second-order function.

The aliasing error for the steady-state signal is greatest where the sampling frequency and the signal-spectrum boundary intersect. The two cases shown in Fig. 4 correspond to possible static errors of 1% and 0.1% of the full-scale signal, respectively. This error component must be added to all other measurement errors, such as drifts in gain and offset, and linearity. Fig. 4 also indicates that increasing transducer noise bandwidth increases aliasing errors.

Sometimes, the highest sampling rate is limited, so that either signal or noise spectral components generate excessive aliasing errors at dc and low frequencies. Then you must use a low-pass filter to attenuate the sampler inputs in the region of  $f_s$  to the desired static-error levels. Such filters can introduce significant gain and phase errors that, at first sight, seem to degrade the system's dynamic response. However, the errors due to filtering occur at the upper end of the useful signal spectrum and so are already implicit in the limited sampling rate. But the filter does reduce aliasing errors at dc and low frequencies.

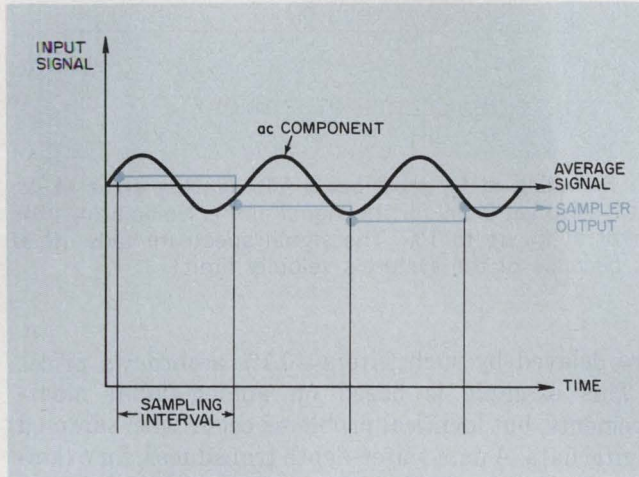

2. Aliasing-error frequency is the difference between signal and sampling frequencies. Error amplitude is the peak-to-peak magnitude of the ac-signal component.

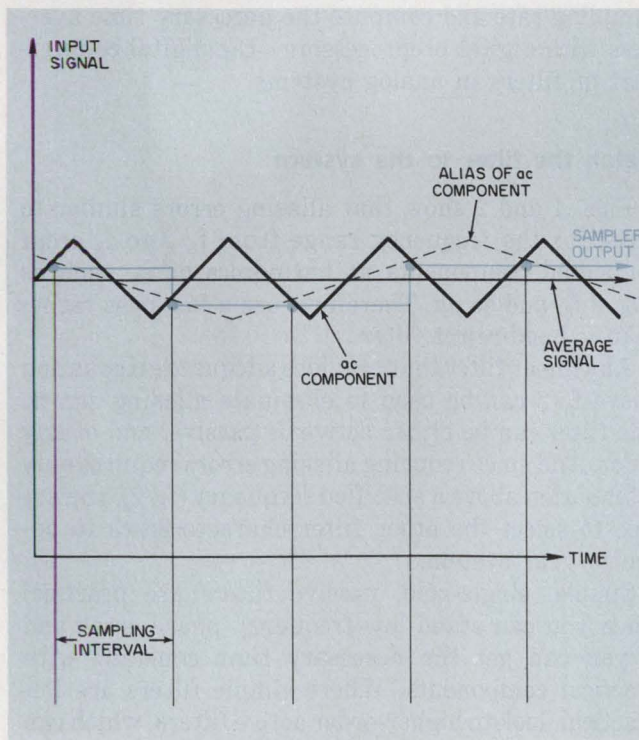

3. Frequencies of aliasing errors fold around half the sampling frequency,  $f_s/2$ . Equal-amplitude input-signal components, whose frequencies fall equally on both sides of the  $f_s/2$  pivot, can't be distinguished from one another after the sampler's output.

### Slow multiplexing causes problems

Now that you know what causes aliasing errors, look at how filtering can improve a practical sampled-data system. Consider a process monitor in which 100 analog variables are sampled sequentially via a relay multiplexer. Relays are used for their high common-mode voltage standoff capability and high signal-transfer accuracy. The multiplexer feeds an a/d converter with a resolution of  $\pm 0.01\%$  of full scale.

Assume that other steady-state errors indicate that a long-term, over-all probable error limit of  $\pm 0.1\%$  of full scale should be achieved. Due to relay speed restrictions, the scan rate is 100 channels per second, with a one-second sample interval for each channel.

If aliasing errors at dc are to be no greater than the total of all other steady-state errors, the peak amplitude at 1 Hz of dynamic signal components at the inputs to the multiplexer must be less than 0.1% of full scale. Without anti-aliasing filters, the input-signal-plus-noise spectrum must be velocity-limited, starting at or below 0.001 Hz (Fig. 4). A signal that changes at a rate above 0.005% of full scale per second is subject to proportional aliasing errors exceeding 0.1% of full scale.

Conversely, accuracy for wideband channels requires filtering. Single-pole filters for this system need a time constant of 1000 s. Of course, the signals

(continued on page 188)



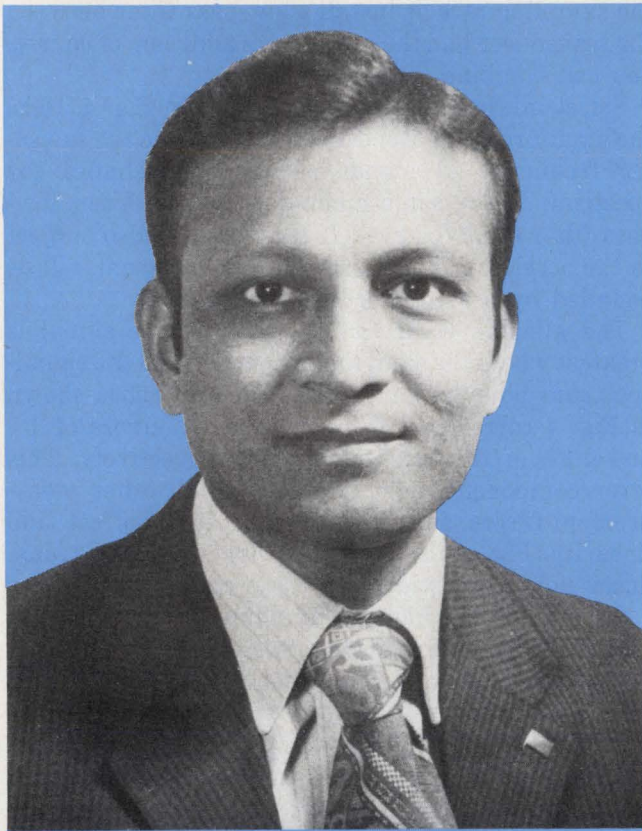

## "The GOLD BOOK is easy to use"

Navnit C. Shah is an engineer with Sequential Information Systems, Inc., Elmsford, N.Y. Sequential makes encoders, motors and limit switches. Shah designs test fixtures and develops improved design for this equipment as well as customer-ordered options. Although he has only been with the company for a short time, he has referred to the GOLD BOOK often, and reports that other engineers in the firm have recently placed \$15,000 in purchases through its use.

**"The GOLD BOOK is very easy to use, handy, versatile. It contains all the information a designer could use . . . information that is very well presented. The GOLD BOOK is very good compared to EEM."**

The GOLD BOOK is working for advertisers because it's working for 90,000 engineering managers, engineers and specifiers — like Mr. Shah. If you're looking for an electronics supplier . . . product . . . trade name . . . sales outlet or distributor . . . look first in the GOLD BOOK.



## IF IT'S ELECTRONIC...IT'S IN THE GOLD BOOK

(continued from page 187)

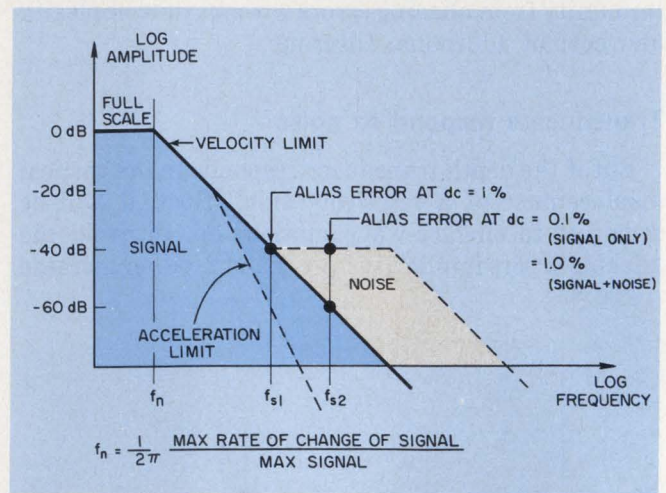

4. Sampling at  $f_{s1}$  produces a 1% aliasing error at dc; at  $f_{s2}$  you get 0.1% for the signal alone. Noise brings the error at  $f_{s2}$  up to 1%. The signal spectrum falls off at  $f_n$  because of the system's velocity limit.

are delayed by such filters—0.1% accuracy's price.

This example is based on analog-signal measurements, but identical problems occur with sampled digital data. A dam water-depth transducer, for example, can generate digital data directly from an optical encoder. Resolution and accuracy can be 0.25 cm in a total range of 25 m. If the output is sampled too slowly, wave motion could produce aliasing errors of 10 cm. To avoid these errors, increase the signal sampling rate and compute the necessary time averages with digital preprocessors—the digital counterpart of filters in analog systems.

### Match the filter to the system

Figs. 1 and 2 show that aliasing errors similar to those for the frequency range from  $f_s/2$  to  $f_s$  occur for signal components at harmonics of  $f_s$ , such as  $2f_s$ ,  $3f_s$ , and so on. Therefore, use a low-pass rather than a band-reject filter.

Any linear filter that provides adequate attenuation above  $f_s/2$  can be used to eliminate aliasing errors. The filter can be either active or passive, and of any order. And since reducing aliasing errors requires only attenuation above a specified frequency ( $f_s/2$ ), you are free to select the other filter characteristics to optimize your system.

Simple, single-pole, passive filters are practical when you can stand low-frequency phase error and if you can get the necessary time constant with practical components. Where simple filters are impractical, look to higher-order active filters, which can reduce low-frequency phase errors. But design the damping coefficients carefully. When using active filters to reduce aliasing errors, take care that the filters do not cause significant gain and offset errors. Don't let the cure become worse than the disease. ■



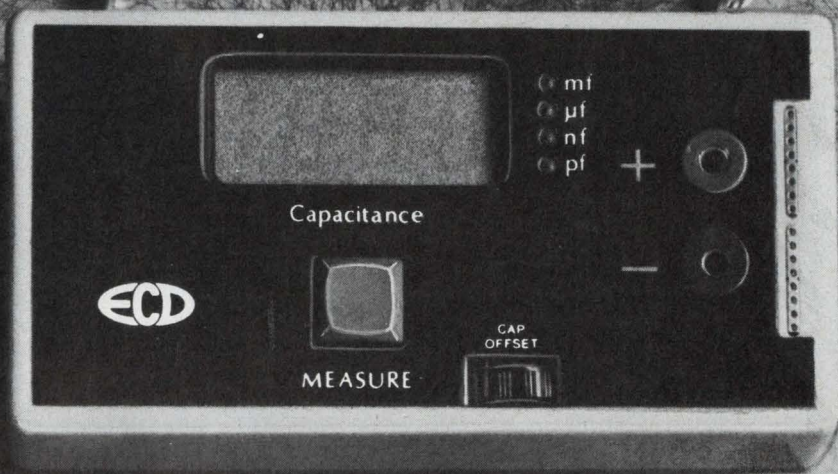

## My shirt, yes...my C-Meter, no.

Test the kind of guy who'll give you the shirt off his back: ask him for his C-Meter.®

He knows that his C-Meter gives him a definite edge. It exposes an obvious efficiency: capacitors are easier to measure than resistors.

No more twiddling and nulling. No need for expensive, tight-tolerance capacitors or tweak pots. With its pushbutton speed, high accuracy (0.1%), small size

and versatility (0.1 pf to 0.2 farads), the C-Meter makes you a more productive engineer.

You owe it to yourself to try one on. It'll cost no more than a fine suit: stocked locally at only \$289.00.

ECD CORP.  
196 Broadway, Cambridge  
Mass. 02139 (617) 661-4400



CIRCLE NUMBER 51

SALES OFFICES: AL, Huntsville (205) 533-5896; AZ, Scottsdale (602) 947-7841; CA, Costa Mesa (714) 540-7160; CA, Sunnyvale (408) 733-8690; CO, Denver (303) 750-1222; FL, Winter Haven (813) 294-5815; GA, Chamblee (404) 457-7117; IL, Elk Grove Vill (312) 593-0282; IN, Indianapolis (317) 293-9827; MD, Silver Spring (301) 622-4200; MA, Burlington (617) 273-0198; MN, Minneapolis (612) 781-1611; MO, Kansas City (816) 358-7272; NJ, Camden (215) 925-8711; NM, Albuquerque (505) 299-7658; NY, Great Neck (516) 482-3500, (212) 895-7177, Syracuse (315) 446-0220; NC, Raleigh (919) 787-5818; OH, Centerville (513) 433-8171; TX, Houston (713) 688-9971; TX, Richardson (214) 231-2573.



# TI introduces the Face Gripper.



TI, the world leader in dual-in-line sockets, brings you a new version of an old idea: Face Grip Sockets. Tin or gold contact surface, extremely reliable, redundant contact points, champhered entry design, low insertion force, high retention, built-in anti-wicking feature, U.L. approved 94V-O insulator material, 8 to 40 position availability, and priced to sell. Which means we now can offer you a full line of dual-in-line wire wrap and solder tail sockets for your next application. For free samples of our new Face Gripper,\* specs and literature, write to Texas Instruments Incorporated, Mail Station W-1, Attleboro, MA 02703. Or call Connector Systems Marketing, (617) 222-2800, Ext. 268 or 269.

\*Patent Pending



**TEXAS INSTRUMENTS**  
INCORPORATED  
CIRCLE NUMBER 52



# Four very small ways to improve on your PC design.

With four types of switches—rockers, pushbuttons, toggles and DIPs—Cutler-Hammer offers one of the industry's broadest and most unique selections of PC subminiatures.

Each of the hundreds of available styles provides the reliability you've come to expect from Cutler-Hammer. With ratings to 6 amps, each conforms to standard circuit board mounting requirements.

PC switches, along with accessories and decorative hardware, are distributor stocked for local availability. And since most are manufactured in the United States, we offer fast reaction time on solder lug and wire wrap terminal variations, as well.

To improve your next design in any number of small ways, contact your Cutler-Hammer Sales Office or Switch Distributor.

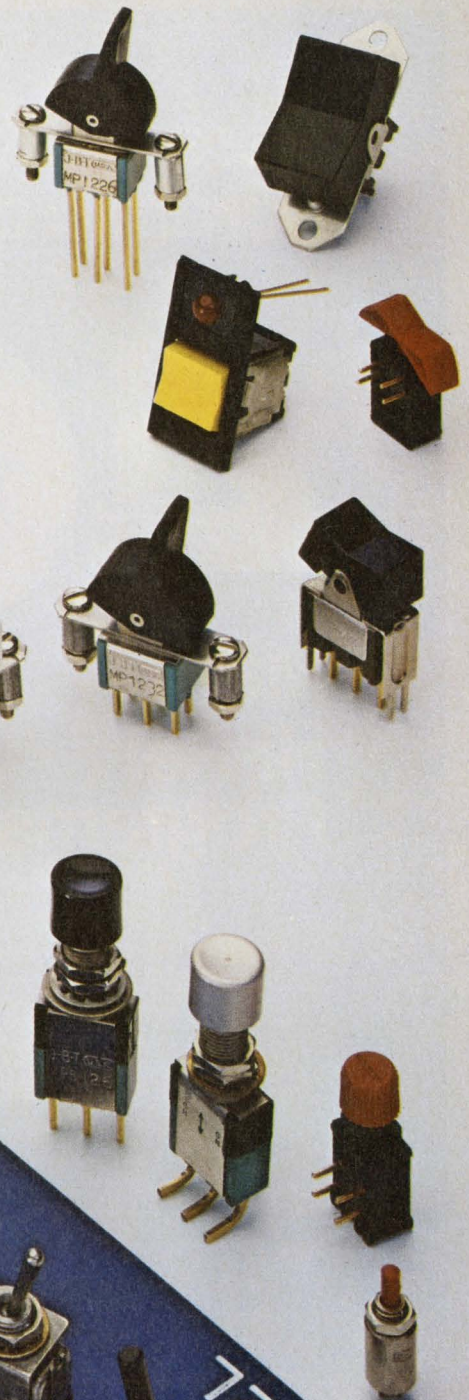

 **Switch to No.1**

  
**CUTLER-HAMMER**  
SPECIALTY PRODUCTS DIVISION, Milwaukee, Wis. 53201  
CIRCLE NUMBER 53



Here are two ways to measure  
ceramic capacitor reliability

40

## Major Hi-Rel Programs

You'll find our ceramic capacitors functioning in some of the toughest environments known to man. Here are just a few of the programs. Space: Surveyor, Mercury, Gemini, Apollo (Command Module, LEM, PLSS). Defense: Minuteman II and III, F-14, F-15 and F-16, Polaris and Poseidon, Sparrow, Hawk and Maverick, F-111 and the B-1 bomber.



15

## Years of Hi-Rel Experience

Founded in 1960 to supply ceramic capacitors for Hi-Rel programs, we were a technology leader almost from the start. We were the first to develop precious metal alloy electrode systems; the first to automate chip production to meet a proven failure rate level of .001% per 1000 hours; the first to perfect the use of base metals in electrodes. Latest — the totally redundant fail-safe feed-thru capacitor.

Unlike many companies, we do not have separate chip lines for Hi-Rel military and commercial MonoKap products. You get the same high quality in both. And, you can buy MonoKaps right off our distributor's shelves.



CENTRALAB/USCC

4561 Colorado Blvd., Los Angeles, CA 90039 (213) 240-4880

CERAMIC CAPACITORS • FILTERS • THICK FILM CIRCUITS • SWITCHES  
TOUCH SWITCHES • POTENTIOMETERS • TRIMMER RESISTORS



# There's a world of difference in Sensors.

The difference is Elmwood. Sensitive fast-response snap-acting thermostats for a world of applications, designed to meet the world's needs.

Difference in design. Models that meet U.L., C.S.A. and European requirements, and conform to DIN norms. Wide or narrow differentials and tolerances that match your high limit or control applications perfectly, while keeping your costs to a minimum.

Difference in performance, with each unit factory pre-set then 100% tested for a lifetime of dependable operation. Choose from ratings to 15 amps, and exposures from  $-65^{\circ}\text{F}$  to  $550^{\circ}\text{F}$  ( $-54^{\circ}\text{C}$  to  $288^{\circ}\text{C}$ ).

Ask for prototypes. See the difference in Sensors for yourself.

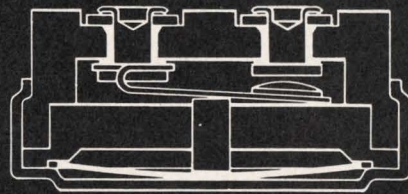

Elmwood Sensors, Inc. 1655 Elmwood Avenue, Cranston, R. I. 02907

Ph 401/781-6500. Twx 710-381-6413

European Div., Elmwood Sensors Ltd., North Shields, Tyne and Wear, NE29 8SA  
England Ph(089) 45-82821. Telex: 53284



**Elmwood Sensors**

*Elmwood makes Sense*

CIRCLE NUMBER 55





# Keys to quality intercom design:

Speaker characteristics, impedance matching and balanced circuit loops assure interference-free response.

For some intercom applications, a \$19.95 squawk box may fill the bill nicely. But, if the intercom is part of the design of a data terminal, or a transmitter and its remote console, or a topside radar, you're going to need a professional job—one that accounts for line losses, microphone output and ambient noise.

And that throws some engineers who have had little experience with audio. Actually the designs are not difficult. There are three keys to success: permanent-magnet speakers, impedance matching and balanced circuit loops.

The heart of the system is the permanent-magnet loudspeaker. You must recognize that this device is bilateral—put electrical energy in and you get sound, apply acoustical energy and you get electrical energy.

Most small radio loudspeakers have an impedance somewhere between 3 to 4  $\Omega$  at 400 Hz. The Electronic Industries Association standard is 3.2  $\Omega$ . For intercom use, however, 3.2  $\Omega$  is too low, because of line loss encountered on long runs and low output voltage.

The most popular impedance is 45  $\Omega$ , which is also available in 3-to-4-in. versions from many suppliers. The 45- $\Omega$  impedance is the best balance between resistive line loss, voltage output and susceptibility to capacitively coupled interference, for these reasons:

- The resistive loss of No. 22 AWG cable is 16.14  $\Omega$  per 1000 feet, so long runs are possible.

- As a microphone, the voltage output of the speaker is approximately 3.7 times that of a similar 3.2- $\Omega$  unit.

- The susceptibility to capacitively coupled interference is proportional to the line impedance, and 45  $\Omega$  is low enough to provide good signal-to-noise ratio.

### Plan for the output level

What output can be expected of a 45- $\Omega$  speaker-microphone? If you are seated at a desk and speak at a conversational level, the loudspeaker input to an open-circuit will be between 20 to 60 mV. The output rises to between 0.1 and 0.3 V for someone shouting a few inches from the cone. The output drops to

between 3 and 8 mV for a soft-spoken person who is 10 feet from the speaker. And with the speaker-microphone matched to an equal input-impedance, these values are halved.

To specify the amplifier, assume a 4-mV input into 100  $\Omega$  and a 4-W audio output into 4  $\Omega$ . This makes the required voltage gain 60 dB (the amplifier output voltage is 4 V and the input voltage 0.004 V). To be conservative, use a maximum gain of 80 dB and establish the operational gain with a master volume control such as  $R_1$  (Fig. 1).

There should also be adequate negative feedback within the amplifier to make the output impedance less than 1  $\Omega$ . To limit amplifier power dissipation, the maximum line load is 4  $\Omega$ .

The amplifier output spec provides sufficient output volume for office use—about 0.3 W—and this power is computed as the ratio of 4 to 45  $\Omega$ . Is 0.3 W really enough? Yes. An average classroom public-address system requires only 0.5 W for each loudspeaker.

There is one more advantage to the output spec: In an "all-call" mode, you can parallel up to 11 remote stations with 45- $\Omega$  speakers without amplifier overload. And there will be negligible volume change at an individual speaker, regardless of the number of speakers (from 1 to 11) on the lines.

Horn speakers can provide more volume for noisy locations with the same 4-W amplifier power. And yet you will not upset the lower sound levels used in office areas. A 4, 8 or 16- $\Omega$  unit will do with some variation in volume— $(4/16) \times 4$  W for a 4- $\Omega$  amplifier driving a 16- $\Omega$  speaker. There is one precaution, however: These re-entrant speakers, when used as microphones, can overdrive the amplifier input, since their energy conversion efficiency is 16%, compared with 2% for cone speakers. The best solution is to add a simple age circuit, with 30-dB range, to the amplifier.

The talk-listen switch,  $S_1$ , is spring returned. A simple toggle switch would work, but if left unintentionally in the talk mode, everything said at the master station would be broadcast to the remote speaker.

The intercom in Fig. 1 is in the listen condition. Remote speaker  $SP_2$  is fed to the amplifier input via selector switch  $S_2$  and the talk-listen switch.

The signal is amplified to a preset level established by  $R_1$ . The amplifier output is fed through the 250- $\Omega$  volume control,  $R_2$ , which adjusts the volume for

---

**Dr. Walton N. Hershfield**, Communications Consultant, Bentley Engineers, 149 New Montgomery St., San Francisco, CA 94105



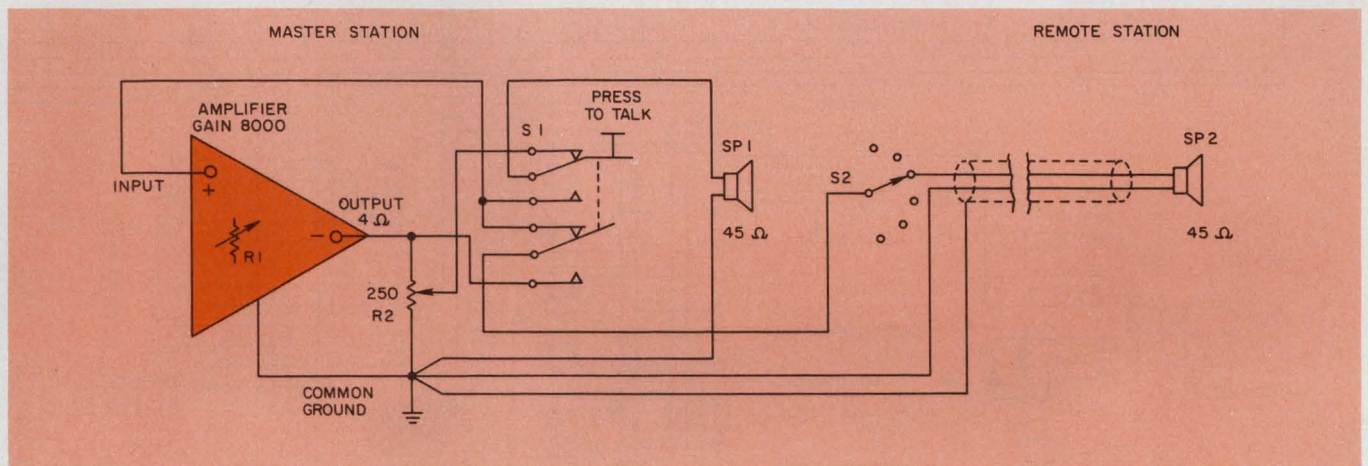

1. **Basic intercom circuit** allows for separate adjustment of listening level and output levels at the master station. An

inverting amplifier prevents positive feedback for this single-input, or unbalanced, system.

the master station speaker, SP<sub>1</sub>.

Depression of the talk-listen switch reverses the speaker-microphone roles—SP<sub>1</sub> acts as the microphone and SP<sub>2</sub> becomes the loudspeaker. The intercom is normally set up in the talk mode with the master volume control set at an optimum level. Should this volume be too loud in the listen mode, R<sub>2</sub> can be set for the best listening level at the master station. In this way you can talk loudly but listen softly.

When S<sub>1</sub> is switched from the listen to the talk position, the intercom input and output are disconnected at some point. And when they are connected again, there is an unpleasant click from the loudspeaker. To avoid clicks, adjust the switch contacts so the audio input is connected before the output. This adjustment is possible with switches like Switchcraft's Lever-Lock 4000 series. The loading afforded by input and output resistors also ameliorates the problem.

One last point: All grounds are made to a common point to avoid unnecessary loops, since ground potential and input-output coupling can be a problem. These intercom's are often referred to as the unbalanced type. And the amplifier should be designed so input and output are out of phase, to render stray capacitive coupling degenerative. Any ground potentials developed will also be degenerative. In addition shielded cable is needed to prevent unwanted in-

terference on the microphone line.

One reason that the public telephone system works as well as it does is because it uses the balanced line. A twisted-cable pair picks up interference and crosstalk and feeds it as an in-phase electrical signal, E<sub>r</sub>, to the windings of a transformer with grounded center tap (Fig. 2). The instantaneous interference, E<sub>r</sub>, is in-phase across the windings and cancels out. But the generator signal, E<sub>s</sub>, is out of phase and appears across the whole secondary winding. With a carefully designed transformer, electrostatic shielding and a balancing potentiometer, noise-voltage rejection to 60 dB (1000:1) is readily achieved.

With IC op amps like the 709, rejection as high as 90 dB is available. Of course, the value far exceeds the balance possible with ordinary twisted-pair wire. And there are unbalances within the intercom and related switch banks. However, transposition of the input bus helps.

The intercom amplifier in Fig. 3 is designed for balanced line operation. Capacitors C<sub>1</sub> and C<sub>2</sub> protect the input in case one side of the line is grounded. Capacitors C<sub>3</sub> and C<sub>4</sub> act as a filter for any stray rf energy pickup. The 500-Ω potentiometer, R<sub>1</sub>, is used to balance the input. Filter elements R<sub>8</sub> and C<sub>8</sub> provide a high-pass characteristic to assure clear and articulate reproduction of voice (200 to 3000 Hz) and to reject the powerful base tones from fans, machinery



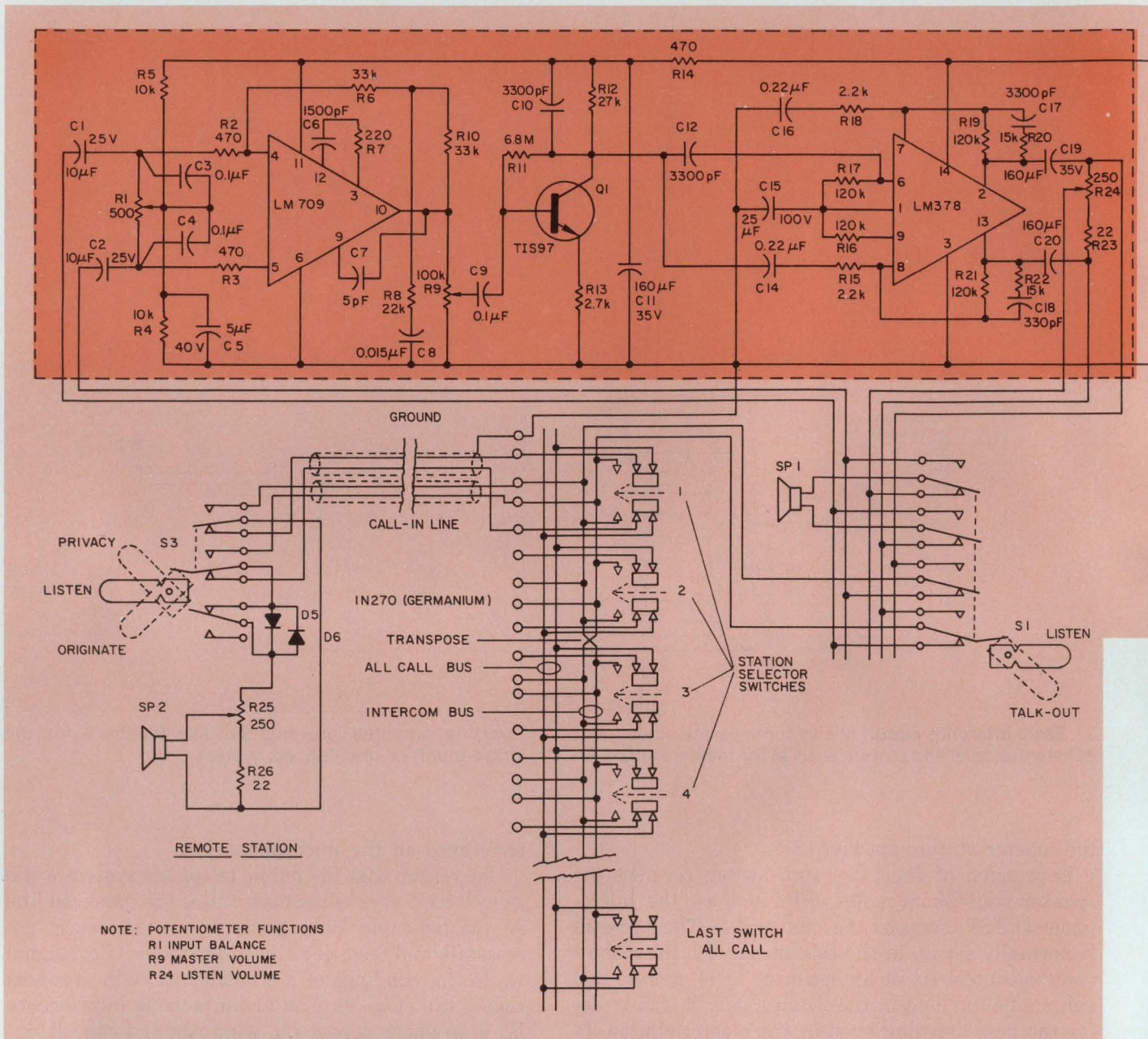

3. A differential input amplifier replaces the transformer for this balanced-line intercom. The entire circuit shown

and other devices. The 100-k $\Omega$  potentiometer, R<sub>9</sub>, sets up the master gain of the system. The LM709 is operated from a single-ended power supply through the voltage divider, R<sub>4</sub> and R<sub>5</sub>. A balanced output is achieved through the use of National Semiconductor's dual 4-W LM378 amplifier. However, any stereo dual-IC power amplifier that can deliver the out-of-phase signal required for a transformerless balanced output will do. This circuit lends itself easily to construction on a single card, which also contains a small power transformer.

The action of the four-pole, double-throw switch, which has a spring return, is identical to that of S<sub>1</sub> in Fig. 1, except that the number of poles has been doubled for balanced-line operation. Resistor R<sub>23</sub> has been added to the volume control so that it cannot

here fits on a single printed-circuit board and delivers 4 W to the output bus that drives remote stations.

be turned all the way down.

The station-selector switches are now shown as double-pole, double-throw push-to-make or push-to-break types. In addition an "all-call" switch has been added to provide the convenience of calling all stations with a single switch.

The remote station of Fig. 3 uses a triple-throw, double-pole switch to originate calls. When depressed, this switch bypasses the master selector switches and connects the remote station directly to the master communications bus.

Privacy at the remote station is achieved with two germanium diodes, D<sub>5</sub> and D<sub>6</sub>, that have relatively low forward conductance (such as the 1N270). In the privacy mode (S<sub>3</sub> up), the diodes offer a high impedance to the voice signals that originate at the



# 19¢<sup>\*</sup>

ea.

An integrated  
bridge rectifier in a  
miniature  
dual in-line package

# DIB

DUAL IN-LINE BRIDGE

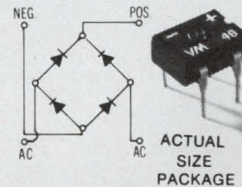

- 4-pin, low-profile DIP
- Leads on standard .10" (2,54 mm) grid
- Compatible with automatic testing, handling and inserting
- 1 Amp at 40°C ( $I_o$ )
- 25V to 1000V ( $V_{RRM}$ )
- 25A Peak One-Half Cycle Surge ( $I_{FSM}$ )
- Two devices will fit into standard 14-pin DIP socket
- Moisture resistant epoxy package
- Call Lee Miller 214/272-4551, Ext. 206 for more information.

\* 100V; 100,000 qty.

Design us in . . . we'll stay there  
**VARO SEMICONDUCTOR, INC.**

P.O. BOX 676, 1000 N. SHILOH, GARLAND, TEX. 75040  
(214) 272-4551 TWX 910-860-5178

EUROPEAN OFFICE: UK: VARO SEMICONDUCTOR INTERNATIONAL, INC.  
Deepdene House, Bellegrave Road, Welling, Kent, England DA163PY, 01-304-6519/0

CIRCLE NUMBER 56

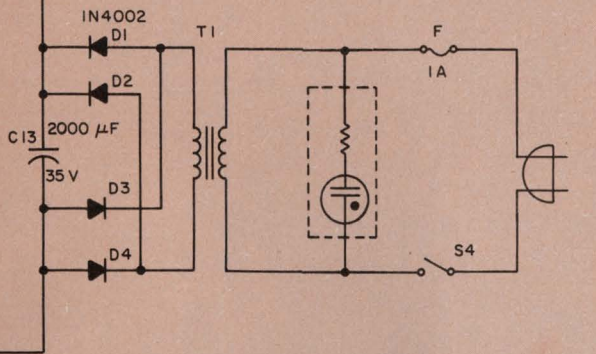

PRIMARY 120V, 50-60 Hz  
SECONDARY 15V CT, .840A  
(TRIAD F152XP)

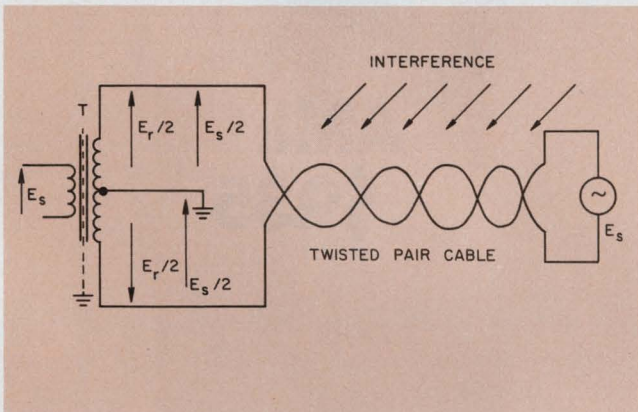

2. **Balanced-line operation** can provide additional noise immunity. Interference energy picked up by the twisted pair contributes no signal at the output.

remote station. But in the loudspeaker mode the diodes' contact potentials break down, and except for minimal crossover distortion, the high-level signal reaches to the remote loudspeaker. Hence in the privacy position the remote station can be called but cannot be monitored. If the switch is in the listen position, diodes  $D_5$  and  $D_6$  are shorted and the unit operates as a normal speaker-microphone.

Agc circuitry can be added at the emitter terminal of  $Q_1$  to handle re-entrant speaker levels. One method is to use a FET as a variable resistor. The FET and a series-blocking capacitor are connected across  $R_{1,3}$  (between emitter and ground). The source-drain resistance of the FET varies with the dc voltage applied to the gate. The dc voltage used is a rectified and filtered version of the amplifier's audio output. ■■



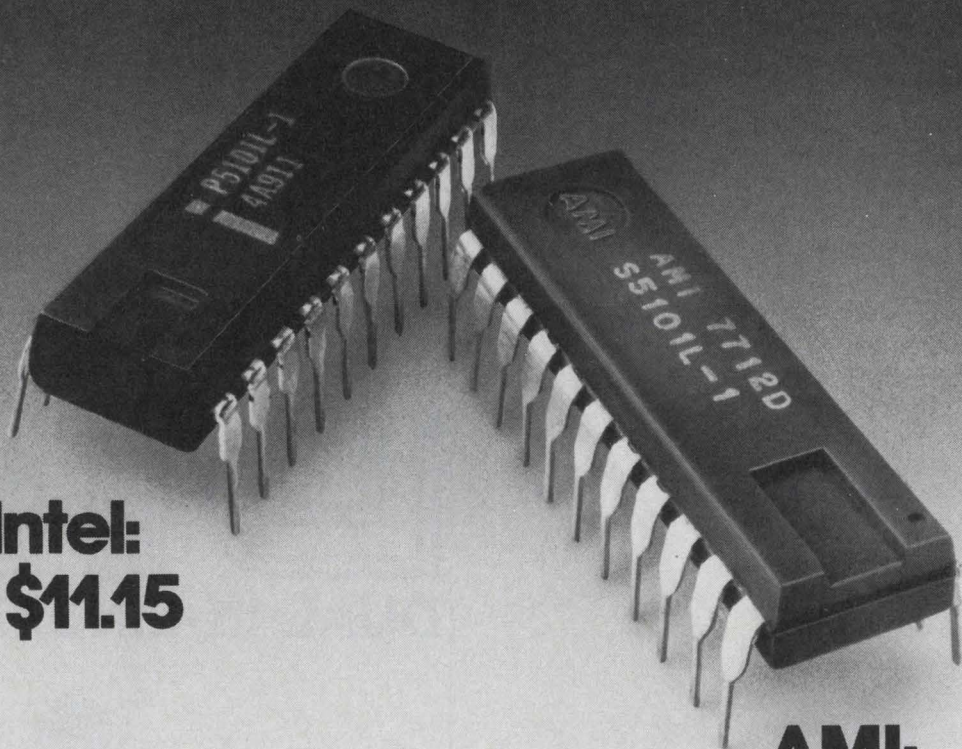

**Intel:**  
**\$11.15**

**AMI:**  
**\$9.35**

## Our CMOS RAM has a lot less going for it.

You can see that our 1K RAM costs less. What you can't see is that it uses less power, too.

Our S5101 takes only 10 milliamps of operating current to give you 650 nanosecond access time. The competition uses almost three times as much. Our standby power is just 10 microamps. And our L version retains data down to 2.0 volts.

With our part, you also have

far less waiting around. Call up an AMI distributor right now, and he'll supply you right off the shelf.

But we can't promise you less of everything. For instance, we have more packages to choose from—plastic, ceramic and cerdip. We have more RAMs, too, with speeds ranging from 450 ns to 800 ns. They all have the L option in case power retention is critical to your

product, and all of them operate over the full military temperature range.

Want to know more? Check with your nearest AMI distributor or sales office. Or contact us at AMI, 3800 Homestead Road, Santa Clara, California 95051. Phone (408) 246-0330. We'll prove that less is really more.

**AMI**  
AMERICAN MICROSYSTEMS, INC.

Prices effective 4/1/77

CIRCLE NUMBER 57



**NOW DELIVERING**

# A Half Million Word Computer



**THE ROLM 1666.** Memory expansion to 576K words. Transparent mapping into 64K blocks for six users. Four-way memory protection. Privileged instructions with I/O allocation & protection.

# A Whole Line of Peripherals & Software



**THE PACKAGE.** Complete selection of peripherals. Both military & commercial specs. Fully integrated & documented. Supported by a wide range of systems software including RMX/RDOS.

## That's Why We're #1 in Mil-Spec Computer Systems

**ROLM**

MIL-SPEC  
Computers

4900 Old Ironsides Drive, Santa Clara, CA 95050. (408) 988-2900. TWX 910-338-7350.

In Europe: 645 Hanau, Muehlstrasse 19, Germany, 06181 15011, TWX 418-4170.

CIRCLE NUMBER 58



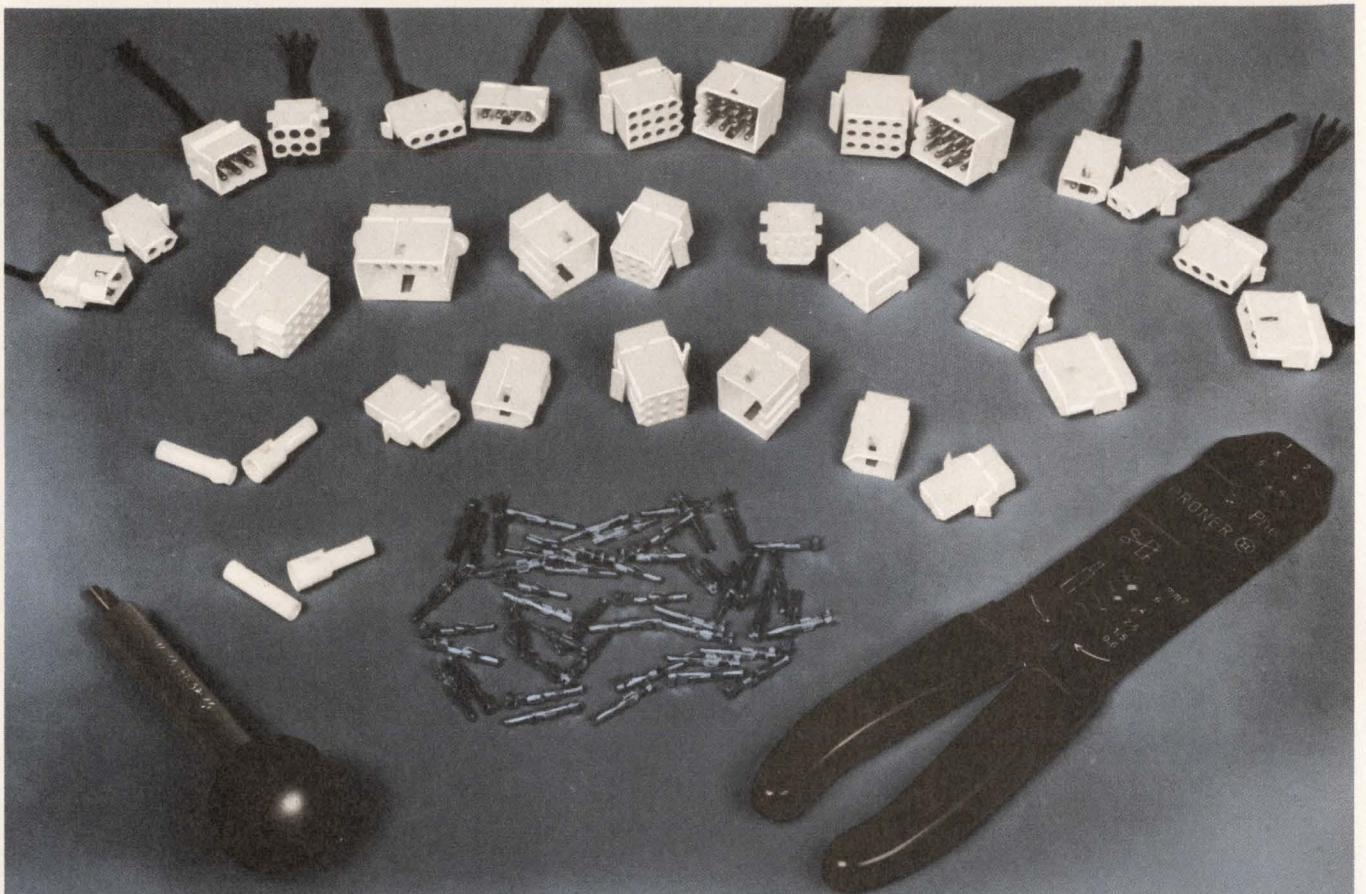

U.L. and C.S.A. approved

## MALCO'S THRIFT-MATE™

...cuts your price  
not your performance

Thrift-Mate is a high-performance, hard-shell plug and receptacle, perfect for low-cost, rapid assembly applications. You can get Thrift-Mate immediately for cable-to-cable, free hanging or panel mount applications. Also in strip form for automatic or semi-automatic crimping of wires to terminals. Thrift-Mate is intermateable/interchangeable with hard shell connectors available from other manufacturers.

Let Malco help you save money without sacrificing performance. Write Malco, 12 Progress Drive, Montgomeryville, Pennsylvania 18936. Phone: (215) 628-9800.

Adjustable for free hanging and panel mount applications.

Available in 1, 2, 3, 4, 6, 9, 12 or 15 contact layouts. Other sizes on request.

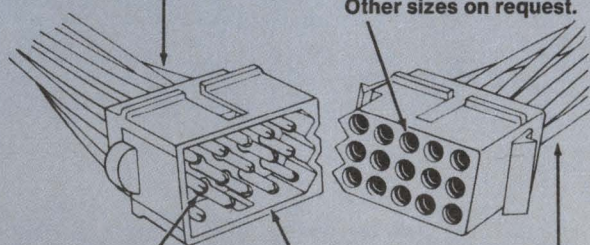

.093" diameter contacts of tin plated brass.

16 to 26 AWG

Contacts can be inserted and removed from insulators easily for changing, repair or replacement.



**MALCO**  
A Microdot Company





# NOW!

## AVAILABLE FROM EECO.

Now you can buy these\* wire wrap panels from us . . . and with improvements, too. Here are a few of the features.

### ● IMPROVED GROUND AND POWER PLANES:

We put more copper into them.

### ● FAMILY DESIGN CONSISTENCY:

The ground plane is always on the wire wrap side.

### ● DISCRETE CAPACITOR PROVISIONS:

Special provisions for mounting tantalum capacitors.

### ● INTERCHANGEABLE WITH OTHER BRANDS:

Complete compatibility with competitive panels.

### ● COMPETITIVELY PRICED.

### ● AVAILABLE FROM STOCK:

Off-the-shelf at your local Marshall Industries distributor.

### ● SINGLE SOURCE RESPONSIBILITY:

Hardware production, assembly, wiring, and computer produced documentation, all available under one roof.

* E8136-UG1	E8136-PG21
E8136-UG6	E8136-PG20
E8136-UG119	E8136-PG190
E8136-PG5	E8136-PG191
E8136-PG13	

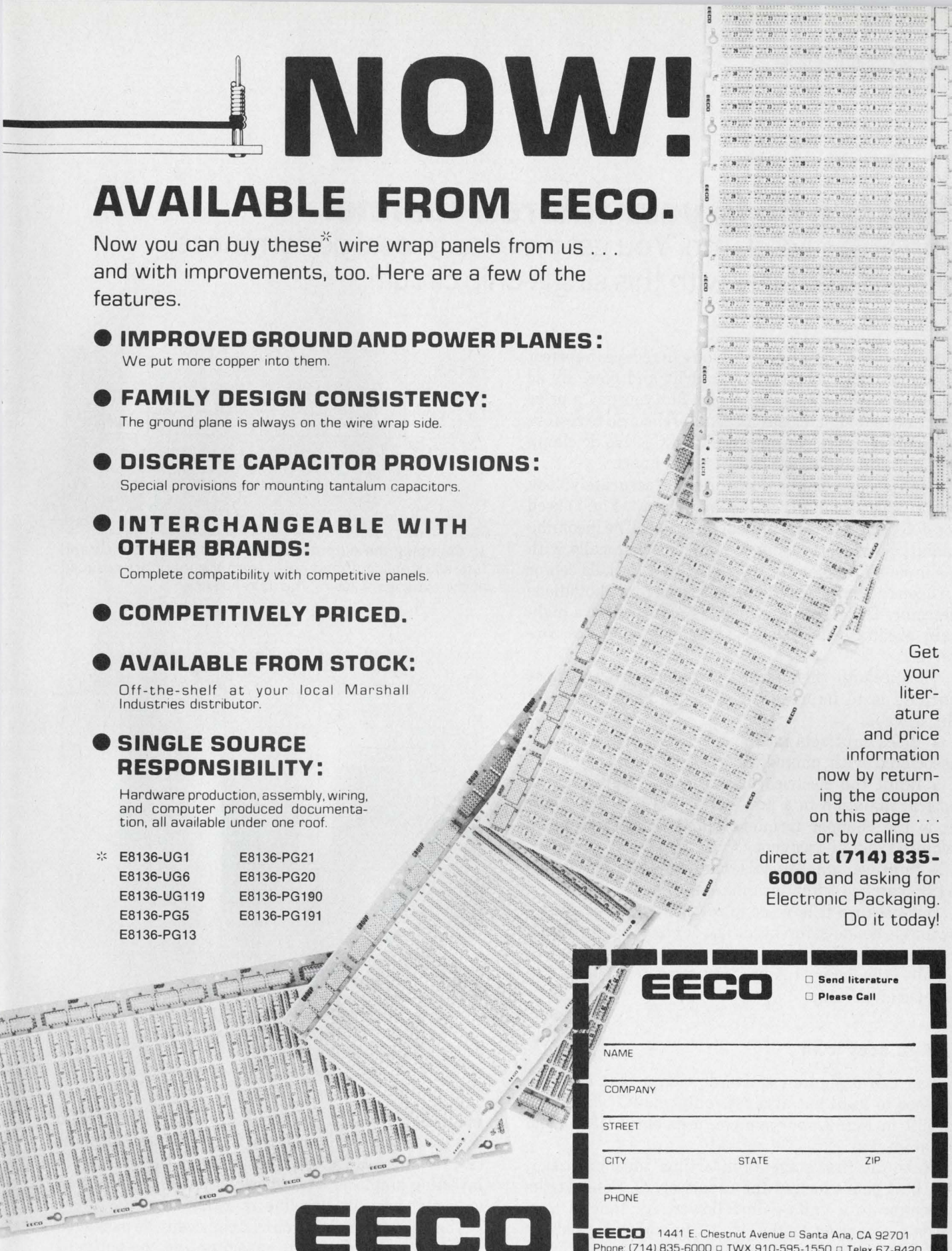

Get your literature and price information now by returning the coupon on this page . . . or by calling us direct at **(714) 835-6000** and asking for Electronic Packaging. Do it today!

## EECO

Send literature  
 Please Call

NAME \_\_\_\_\_

COMPANY \_\_\_\_\_

STREET \_\_\_\_\_

CITY \_\_\_\_\_

STATE \_\_\_\_\_

ZIP \_\_\_\_\_

PHONE \_\_\_\_\_

**EECO** 1441 E. Chestnut Avenue □ Santa Ana, CA 92701  
Phone: (714) 835-6000 □ TWX 910-595-1550 □ Telex 67-8420

## EECO

1441 E. Chestnut Avenue □ Santa Ana, CA 92701

CIRCLE NUMBER 60



## Restore dc to your filtered channel

with an active clamp. You get practically ideal performance plus adjustability with this single-chip circuit.

For low-level amplification you can reduce the effect of major error sources like dc drift and noise by ac coupling and bandpass filtering. But you pay a price—the output signal loses its dc reference. So to restore the dc level at the output, design an active dc clamp that is adjustable, accurate and compact.

For a good example of restoring dc accurately, look at the high-sensitivity photodiode circuit (Fig. 1) used for detecting low-level optical radiation. The incoming radiation, which is chopped either mechanically with a simple shutter or electrically with a Pockels cell or an acoustic-optic modulator, is sensed by a photodiode detector. The detector, in turn, is connected to a high-gain preamp that acts as a current-to-voltage converter.

The preamp then feeds a bandpass filter whose purpose is to improve the system's performance in three ways:

- Block dc offsets and low-frequency drift normally associated with photodiode preamps.
- Limit the electrical bandwidth of the incoming optical radiation to a range of  $F_c$  to  $(F_c + F_s)$ , where  $F_c$  is the chopper frequency, and  $F_s$  is the highest required signal frequency.
- Improve signal-to-noise ratio for detecting signals with matched-filter techniques.

But because it is ac coupled, the bandpass filter's output is not dc-referenced. The dc clamp at the filter's output re-establishes a dc baseline for the signal. Ideally, the dc level is unaffected by the drift in the front-end preamp.

### One IC does it all

You can design an active dc clamp that not only is close to ideal but also uses only one IC. The clamp circuit in Fig. 2, for example, uses one LM324 quad op amp chip.

Make the first stage an inverting "ideal" rectifier,  $A_1$ , that peak-charges the capacitor,  $C$ . Connect the capacitor to a unity-gain follower,  $A_2$ , that in turn feeds a summing amplifier,  $A_3$ . In addition, feed the

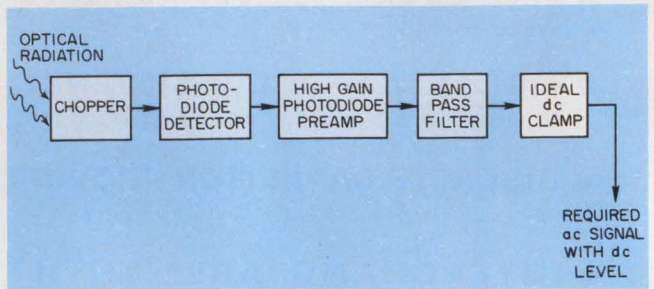

1. Clamping the output restores dc to the amplified and filtered signal. Drift and noise from the input are reduced at the expense of losing the dc reference.

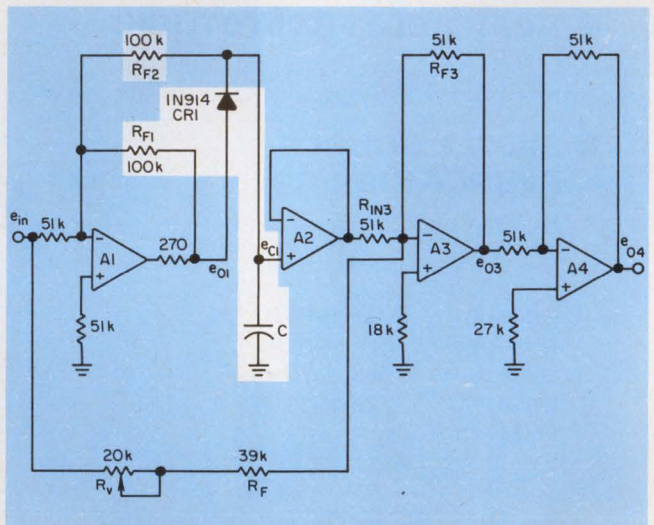

2. Two feedback resistors close  $A_1$ 's loop. The diode in the  $R_{F1}$  loop isolates  $R_{F1}$  after the input passes its negative-peak voltage. Then only  $R_{F2}$  loads  $C$ .

input signal,  $e_{in}$ , to the summing amplifier through the series combination of the fixed ( $R_v$ ), and variable ( $R_v$ ) resistors. Have amplifier  $A_3$  drive the unity-gain inverting amplifier,  $A_4$ , whose output is the required ac signal with its baseline re-established.

The adjustable-clamp circuit can easily be packaged in a 14-pin DIP. Only the capacitor and the pot need be external to the DIP. And even though the circuit is simple and potentially compact, you'll get plenty of performance. When the band-limited signal,  $e_{in}$ ,

**Edmond I. Vinarub**, Senior Member, Technical Staff, Kuras-Altman Corp., 200 Fairfield Rd., Fairfield, NJ 07006.



goes negative,  $e_{01}$ , the output of amplifier  $A_1$ , goes positive and the diode,  $CR_1$ , conducts. Capacitor  $C$  then begins to charge toward the negative peak of the input signal. While  $C$  is charging, resistors  $R_{f1}$  and  $R_{f2}$  are in parallel. Therefore, the effective feedback resistance is  $50\text{ k}\Omega$ .

When  $e_{01}$  drops toward ground,  $CR_1$  is back-biased so that feedback around  $A_1$  takes place only through  $R_{f2}$ . This produces a step change in the gain of  $A_1$ . But since the feedback loop is still closed,  $A_1$  continues to operate in a linear mode.

With this parallel-feedback technique you sidestep saturation and recovery-time problems that often plague active peak detectors that don't contain the second feedback resistor,  $R_{f2}$ . When the input signal goes positive,  $C$  begins to discharge through  $R_{f2}$  toward ground—the summing-point potential of  $A_1$ . You can therefore calculate a value for  $C$  that limits the discharge to, say,  $10\text{ mV}$  in a certain time,  $t$ . Compute  $C$  from the following equation:

$$C = \frac{-t}{10^5 \times \ln \left( 1 - \frac{0.01}{v} \right)}$$

where  $v$  equals the peak voltage toward which  $C$  charges.

For a  $v$  equal to  $1\text{-V}$  pk and a  $t$  equal to  $1\text{ ms}$ ,  $C$  is  $1\text{ }\mu\text{F}$ . For this case, either low-loss polycarbonate or Teflon capacitors will do. If you need capacitors in the  $1000\text{-pF}$ -to- $0.1\text{-}\mu\text{F}$  range, use an additional amplifier between  $A_1$  and  $C$ —and reduce the loading of  $R_{f2}$  by the large capacitor. After you select the value for  $C$ , adjust the gain of  $A_3$  to clamp the final output,  $e_{04}$ , to the dc level of  $e_{in}$ . Make the adjustment with the  $20\text{-k}\Omega$   $R_v$ .

You can compute the essential features of the clamp by separately considering its operation for positive and negative polarity of  $e_{in}$ . For negative  $e_{in}$ :

$$e_{03} = e_{in} \left( \frac{R_{f3}}{R_v + R_f} \right) - e_{C1} \left( \frac{R_{f3}}{R_{in3}} \right)$$

You can set this equation equal to zero and then compute the value of  $R_v$ .

For positive or zero  $e_{in}$ :

$$e_{03} = -e_{C1} - e_{in}$$

where  $e_{C1}$  equals the voltage on  $C$  due to previous charging. Therefore, for a symmetrical input:

$$0 \leq e_{04} \leq 2e_{in} \blacksquare$$

## Design it for safety!

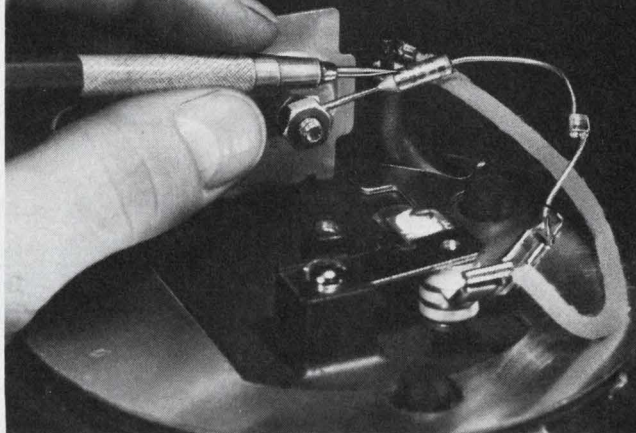

4000 Series MICROTEMP® thermal cutoff in electric fryer

## Guard your products and profits with MICROTEMP® thermal cutoffs

Our 4000 Series MICROTEMP® thermal cutoff protects this fryer, those using it, and those who make and sell it. If the fryer overheats, for any reason, the alert MICROTEMP® opens the circuit to cut off power.

After cutoff, the fault must be corrected and the MICROTEMP® cutoff replaced before the fryer can be used again.

Quick-connect terminals make it easy to replace the cutoff in the field without soldering.

Millions of MICROTEMP® thermal cutoffs are now being used on hundreds of OEM electrical applications. We can provide the right thermal cutoff—temperature ratings from  $136$  to  $468^\circ\text{F}$ , assorted terminations,

mounting packages and insulation—to meet your design and production needs precisely and economically. Write or call us for specific data and test samples.

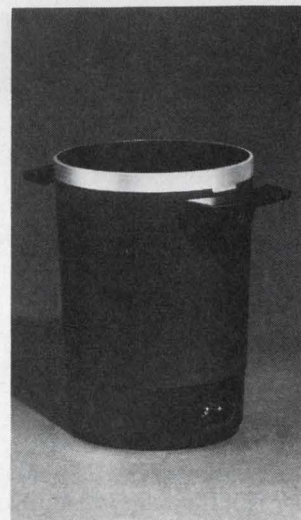

**MICRO DEVICES**



DIVISION OF EMERSON ELECTRIC CO.  
1881 SOUTHTOWN BLVD.  
DAYTON OH 45439 513-294-0581



# PRECISION SIGNALS

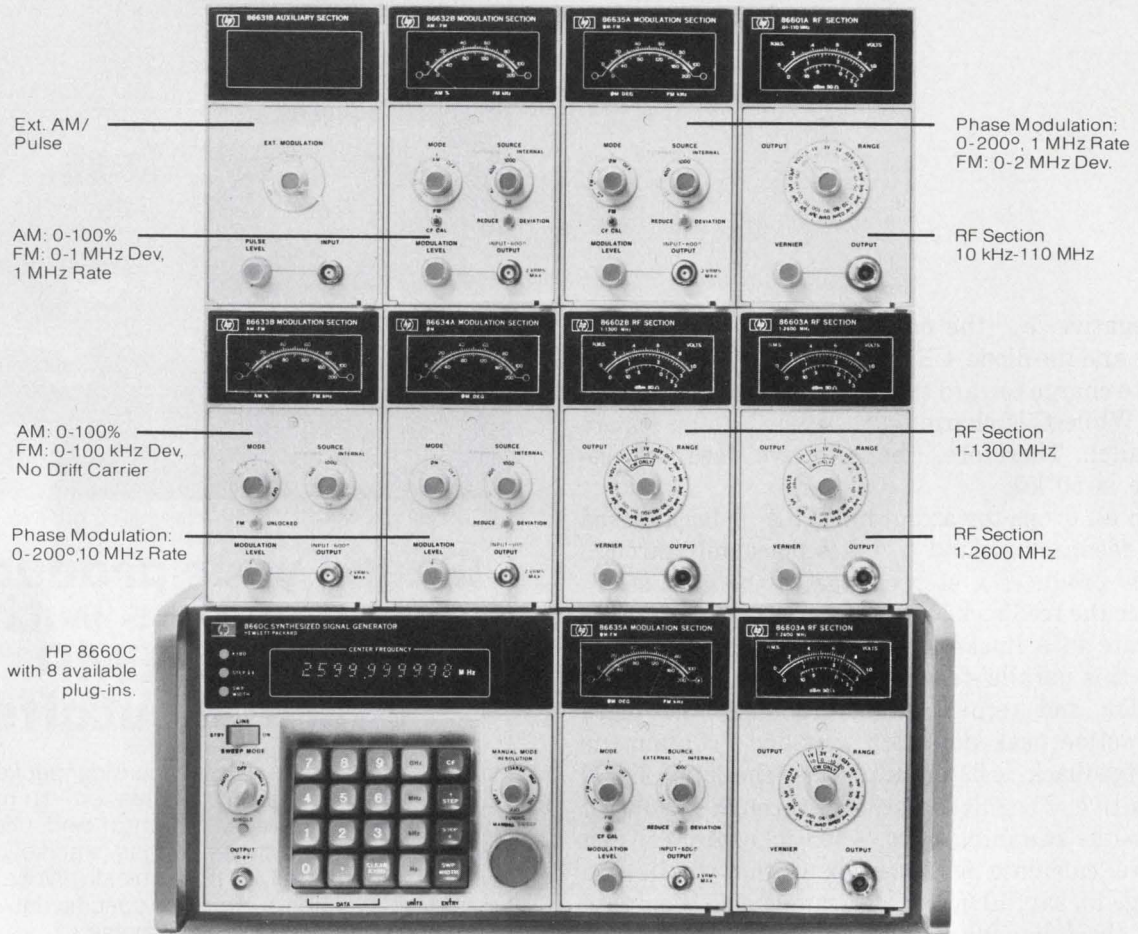

## FROM 10 kHz TO 2600 MHz.

### Your broadest selection of precision signals.

Choose a modulation capability for your exact frequency range. You can get the precise combination for the signals you need. And you won't

find a broader selection of modulation and output capabilities on the synthesizer market.

For manual operation, choose the HP 8660C mainframe. It features keyboard entry, digital readout, 1 or 2 Hz resolution, digital sweep, good signal purity and the operating convenience you need.

For systems operation, the HP 8660A mainframe features thumbswitch entry.

Both mainframes are completely programmable with the HP Interface Bus (IEEE 488) or BCD.

Complete systems start at \$9850\* and a typical keyboard mainframe with 1300 MHz output and AM-FM modulation is \$18,950\*.

For our 20 page brochure describing HP's synthesized signal generator call your nearby HP field sales office, or write.

\*Domestic U.S. prices only.

HEWLETT  PACKARD

1507 Page Mill Road, Palo Alto, California 94304

For assistance call: Washington (301) 948-6370, Chicago (312) 255-9800, Atlanta (404) 955-1500, Los Angeles (213) 877-1282

CIRCLE NUMBER 62



**Need miniature audio transformers  
in most popular configurations  
in any of three sizes?**

**TRW/UTC has a stock answer.**

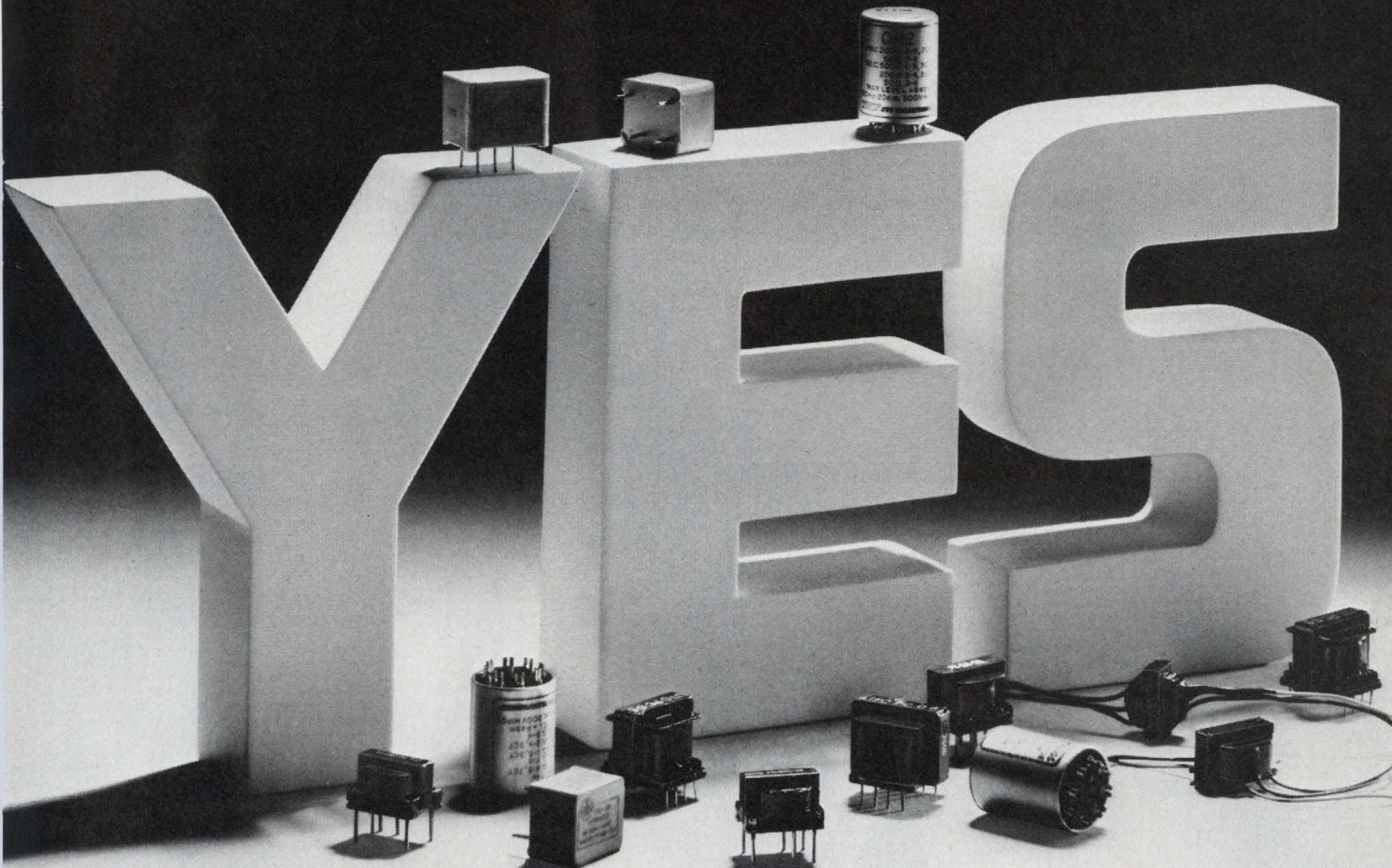

TRW/UTC has a line of miniature industrial audio or signal transformers that come in three wattage ratings. And, they're available in four different configurations.

To find the unit you need, check the table below.

	Ouncer	Subouncer	Sub-Subouncer
P.C. Board Mounting	PC-O Series	PC-SO Series	PC-SSO Series
Flexible Leads		SO Series	SSO Series
Molded		SO#P Series	SSO#P Series
Alarm Housing	O Series		

Because our miniatures come in 4 styles, you have a choice. Now you can design our unit into your circuit in the manner most convenient for you.

For immediate off-the-shelf delivery check your authorized TRW/UTC local distributor. Or for more information on standards that are something special, contact TRW/UTC Transformers, an Operation of TRW Electronic Components, 150 Varick Street, New York, N.Y. 10013. Area Code: 212-255-3500.

CIRCLE NUMBER 63

**TRW UTC TRANSFORMERS**

ANOTHER PRODUCT OF A COMPANY CALLED TRW



CHALLENGES TO THE ENGINEER WHO MANAGES

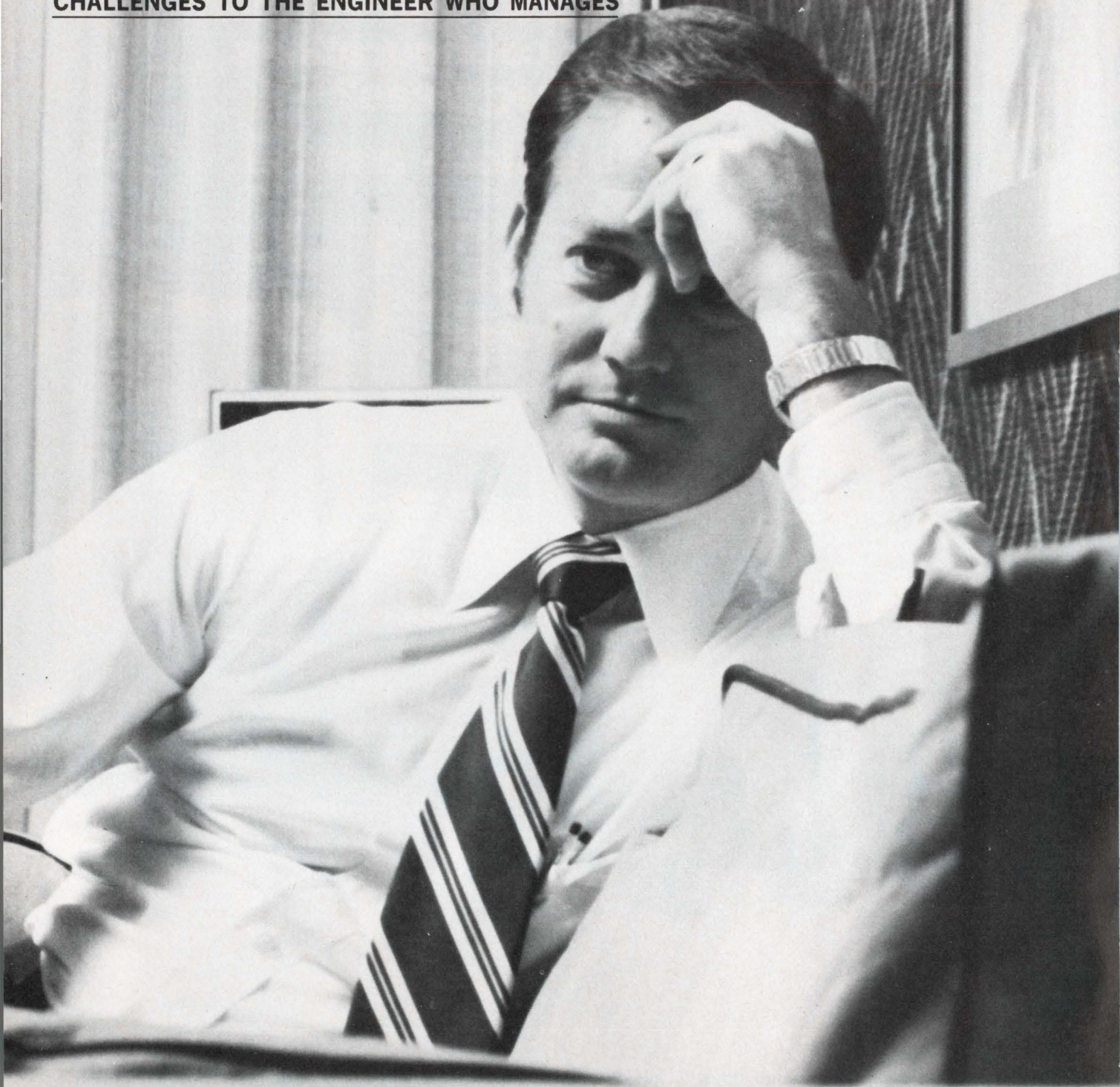

**Dave Methvin of Computer Automation  
Speaks On  
Getting Your Engineers  
To Do Engineering**



It's easy to get engineers to do research—to chase a few nanoseconds out of something. It's not so easy to get them to do engineering—to make something in the most cost-effective way, to make it reliable, and to make it flow through production as quickly and smoothly as possible.

We're in a very technical, very exciting field. When you're designing a computer it's easy to get carried away with all the technical possibilities. You can add all sorts of interesting instructions, for example, or you can push 10 nanoseconds out of access time. You want to do something exciting. You want to puncture the state of the art. Then you can stand up in front of a group of your peers and talk about the techniques you used to design a monument to yourself.

And that's a trap. We want to get away from designing computers for computer designers. We're not in the aerospace business, so we're not pioneering the state of technology. We want to make reliable, inexpensive products. And squeezing out 10 nanoseconds is not the way to achieve reliability or economy.

We want our engineers to design computers that will solve a large portion of the problems our intended customers have—but not 100% of the problems. We don't want them to try to solve every conceivable problem. There are products around that are so overdesigned because of that motivation that you can't really sell them. In fact you can't even explain them. We want our guys to go after the simple solution. That's elegance.

**We want to teach our engineers to stop designing so they can deliver technical papers and concentrate on designing to build a salable product for the marketplace.**

This involves several concepts, one of which I call the 80% rule. You have to realize that some engineers want to design so that nobody can complain. They want a 100% solution. Baloney! You can never get there. I'll really be happy if we can solve 80% of the problems out there. That's a big enough market for me.

This means you have to focus on designing cost out. If you design out all those extra parts and goodies, you stand a chance of getting 80% of that market, especially since you can make the product much less expensive and get to the market much faster. Let some other guy sell those gold-plated, super-militarized products that nobody can afford.

Let me show you how we go about this. When you start designing a computer, creativity starts to flow. All of a sudden somebody wants to do something extra with the cabinetry or machine parts. Or a designer wants a 1-microsecond memory because he already has 1.8 microseconds. Or a software designer wants to add sophisticated instructions. So I try to get across the concept of building the thing out of beer cans.

Our original machine opened like a book, offering instant access to everything. One of the things about front-access drawers is that they have slides. That's 25 bucks a copy. Not only that, but when you get this drawer to slide out, this cable must come out with it. And when you shove the thing in, the cable has to go back, too. So now you need a cable retractor. That's another 25 bucks.

Then you need a special connector that won't break periodically because it has a special cable that's always being flexed. And each cable has to be different because every computer buyer wants different options, so you need a different cable drawing for each computer you ship.

So I started by saying, "Bull manure. Let's start by taking off the slides." Then the machine had a whole bunch of test points. We took those out, too. The console of that early machine cost more than our complete new computers.

**We always run into the engineer who, since he's redesigning, would, like to add this part that costs only two dollars.**

We try to teach him that it costs money to buy the part. You have to specify the part. You have to write a print around it. You have to inspect it. You have to provide power for it. And you have to document everything.

I try to teach them not to keep adding, but to take away. When you take the chassis slides away, for example, you not only save \$25 but, guess what, you don't need a handle, and you don't need this expensive connector, and pretty soon you trim out a lot of cost and a lot of reasons for malfunction. You make the computer better.

We even made a lightweight chassis. Marketing came in screaming: "My God. You can't do that. If you step on it, it will bend." So we said: "That's simple. Don't step on it." Our computers are not made to be stepped on.

I like to draw the analogy of designing a TV set. Say you design a set so that it has everything you want. The sound is perfect and the picture is beautiful. Now you cut out a part and throw it away and see what happens. Then you throw out another part and see what happens. When you finally reach the point where you cut out a part and it hurts your sound or picture, then you put that part back and say, "OK, build it."

Our customer is a very pragmatic guy who wants to know, "Will your machine do my job?" That's a threshold question and the answer should be yes or no. The customer's next question is, "How much is it?" And that's where our answer should be the mark of our engineering.

We want to continue to reduce the cost of products over the years. Well, you can say: "This is so inexpensive now. How can you cut more cost out of it?"



And the answer is that we don't know that yet. That's the task of the Engineering Department.

**Sometimes I send the engineers back to cut cost out of a product and they don't think they can win that battle. But the other battle is with me and they know they'll lose that one.**

I remember the engineers who brought in the first Naked Mini. They were terribly excited about it. They saw no way to improve it. Well, I congratulated them on a terrific achievement, of course. But then I asked: "What could we do if we had to do it all over again?"

And I told them: "For an encore, we're going to cut 50% off the cost." They did. They didn't know how, at first, but that was their challenge. The challenge wasn't to make it twice as fast or to put in twice as many instructions or to make it half as big. The challenge was to make it half as costly. It took two years, but they did it.

Just the other day, walking through the shop, I ran into one of our engineers and said, "Hey George. How's it going?" For 30 minutes he told me how his project was going without once mentioning the technical specs. He'd been piling his life into this thing for several months, but for 30 minutes he told me how he had shaved \$3 out of a PC board by laying it out differently and making the lines and spacings wider so it would be easier to manufacture.

Then he showed me how he had changed the power routing to use fewer bus bars and how he had redesigned the memory stack so it would be cheaper to build. The net effect was that over the thousands of units we expected to make, we would save tens of thousands of dollars. Now that's engineering.

**There's something else that's just as important—the tendency of engineers to want to design out every potential flaw. They don't understand that you can never engineer a product like a computer so there will be no problems.**

I know it's extremely embarrassing to check a product out, and then have the customer call in a month or two and say, "Hey, I found a situation where if I do this, your computer won't work." So the engineer wants to work toward the ideal. He wants his product to be 100% perfect.

We try to teach him that, no matter how long you keep it in the engineering department, no matter how many tests you run, when you put it out in the field and a few hundred customers get at it, they're going to find some problems. If you test for another six months or a year, it doesn't buy you very much.

The customers will find the problems a lot sooner than the design engineer. So we want to get our computers out there very fast and solve as many problems as we can as quickly as we can. But we can't expect or hope to solve every single possible problem. So we stand behind our product. If the customer finds a flaw, we'll satisfy him. But we can't design perfect products every time.

## Who is Dave Methvin?

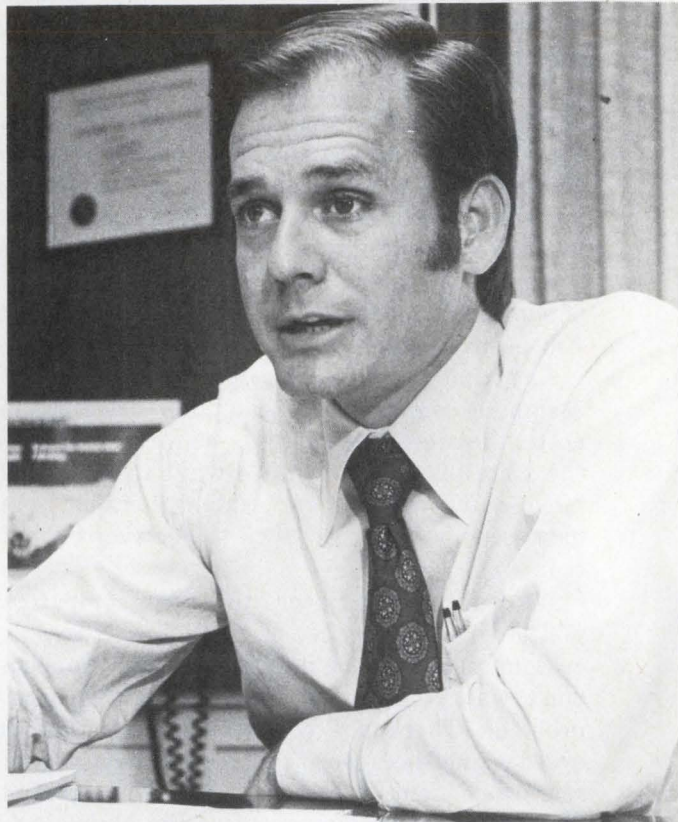

Armed with a BSEE from New Mexico University in 1961, David Methvin went forth to continue the work in satellites that he had begun in college, where he had worked on a subcontract for the Navy at the Applied Physics Lab of Johns Hopkins University. Still pursuing satellites, he worked in Florida and California,

That's difficult for an engineer to swallow. It's a constant fight to pull the product out of the hands of the engineer. We have to convince him that if he hangs onto the product too long, it's going to be obsolete by the time it hits the marketplace. It may work, but people won't buy it.

We try to explain that to our engineers. We try to convince them that worst-case design—where you spend months trying to design so nothing could ever possibly go wrong—is bad news.

Years ago we found a problem with 600 computers we had already shipped. Well, that was embarrassing. But we called them back and repaired every one. Naturally, that caused some disruption in our normal activities. Soon after that I saw a sign on the bench of one of the engineers: "There's never enough time to do it right, but there's always time to do it over."

My first reaction was, "Dammit. I'll kill that guy." But my second reaction was, "He's absolutely right."



then in Hawaii, as manager of a satellite-tracking station.

At the age of 28 he moved into a new career as he joined Decision Control, a manufacturer of logic modules and, later, core-memory systems. He worked for a year designing core-memory systems, then moved into the company's new computer activity, called Data Machines, which was soon purchased by Varian to become Varian Data Machines. Two years after he joined the company, he left the position of manager of computer development to start Computer Automation in 1967, with the philosophy of shaving cost rather than pushing technology.

A year later he was divorced from his wife of 10 years. "I guess I wasn't cut out to be a family man," he says, though he speaks fondly of his three children, Deborah, Dianna and Denise, and his grandchild, Jamie.

As president of Computer Automation, Methvin drives his people hard. He drives himself harder. But he plays hard, too. He owns two airplanes, one for stunt flying and one for going places. In the winter he likes to ski and, anytime, he likes to cook—anything from buttermilk biscuits, which his grandmother taught him back home in Arkansas, to haute cuisine. Right now he's trying to refine his Beef Stroganoff.

He loves fine food and fine wine and points out that the difference between a wine connoisseur and a wino is that one can afford it. He feels that the creation of great food is an outlet for the creative energies that boil in him all the time. But they're not his only outlet. He's also a great admirer of women. On this score, he indicates that there are men who are admirers of lips, eyes, legs and other female segments. "As far as I'm concerned," Methvin confides, "I like everything. I'm a systems man."

That product, the Alpha 16, led the industry. We captured a big chunk of the market by coming out quickly. Now you can look back and say: "Wouldn't it have been nice if we had kept that product in the lab another month and found the problem?" Sure, it would have been. But it might have been here a year before we found the problem and we would have lost the market.

Fortunately, we had enough profit in the product because the engineering cost wasn't huge. How could it be when we didn't have it sitting in engineering for a long time? So we were able to plow back some of our profit to take care of the customers who bought the 600 computers.

Unfortunately, our engineers learned the wrong lesson. They didn't want us to suffer the cost and embarrassment of shipping another computer with a flaw. They were gun-shy. So they ran every conceivable test on the next computer. They ran hot tests

and cold tests and what have you. And in spite of all those tests, the next machine had more engineering changes against it than any other.

**Now an engineering change notice is not a cardinal sin. Lord knows we've made mistakes. We know we're going to make mistakes. And that's why we have engineering change notices.**

In one sense, we force our engineers to make mistakes. We challenge them. We stretch them to see how far they can reach before they trip. We want to let them make mistakes. Otherwise we won't know what they're capable of doing. Through mistakes they get scars and scars are experience. Without scars, if they ever encounter problems, they're lost.

So we want our engineers to realize that they're not going to design perfect products and they won't get killed if they make mistakes. But basically we want our engineers to understand the business implications of what they're doing. Here's what we show them.

If a product sells for one dollar, it costs us, say, 45¢. So we get 55¢ in gross margin. Now our engineering budget calls for, typically, 10¢ of that sales dollar. But for the engineers to get that dime, other things have to happen.

Administration has to get 9¢; we want about 20¢ for pre-tax earnings; and we need at least 16¢ for marketing. There's our 55¢ gross margin.

But let's say the engineers design a product that costs 55¢ out of that dollar instead of 45¢. How are we going to take care of all the other needs? Let's say they want to cut marketing's share from 16¢ to 6¢. Well, you can't cut marketing's share by two thirds or you won't grow. And you can't cut your pre-tax earnings or you won't have enough to invest in your future.

All of a sudden, these young engineers begin to see what makes up a profit-and-loss statement and pretty soon they get a good feel for the financial side of the business.

In fact, we've been pretty successful with this philosophy. In fiscal 1976, on a sales volume of \$30.4 million, we had an after-tax net profit of \$3.1 million. That's more than the net profit of 154 of the companies on the *Fortune* 1000 list.

That success is due to our engineers and the other people in our organization. So we want to let them reap some of the benefits of the contributions they make to the profits of the company. We have stock options, as other companies do. We also have an Employee Stock Ownership Plan that makes it possible for a fellow to wind up with a very substantial net worth.

The employees don't put money into this plan; the company does. The employees contribute their blood, sweat and tears. And since the value of the stock depends very much on the company's earnings, there's a real inducement for the engineer to help the company become as profitable as he can.

As I see it, that's real engineering. ■■



# International Rectifier "Function Fit" Power Transistors will enhance your circuit design and increase its reliability.

It's unlikely that you'll find a Power Transistor line with as many types as ours, or with functional characteristics that fit specific applications so well . . . to improve reliability.

For example, for **Switching Power Supplies**, our 2N6542-2N6547 and IR6002's will switch up to 600V  $V_{CEX(sus)}$  with optimum  $t_f$  and  $E_s/b$ .

For **Display Terminal** horizontal and vertical deflection, you can get up to 900V  $V_{CBO}$  with a sharp breakdown (from hard-glass passivation) for added reliability . . . coupled with low  $V_{CE(s)}$ .

For **Automotive Ignition**, count on higher  $V_{CEO(sus)}$  and higher inductive energy capability with the reliability you need. Clamped or unclamped performance in a TO-3 package, on a chip, or a chip on a Beryllia substrate.

For **High Current Applications** our BUX-20 not only switches 125V and 50A at 20KHz, but does it at commercial prices. Also try our 2N6274-2N6277.

For **Amplifiers**, try our high energy EPI base discretes and Darlington. You'll get the SOA you need plus better frequency response than you'll find in other companies' diffused types.

For **Motor Drives**, our rugged Darlington will provide the inductive energy, high  $V_{CEO(sus)}$ , and high gain needed for reliability in these tough applications.

Whatever your application, chances are good that we have a "Function Fit" Power Transistor that will give you extra-margin reliability without changing your circuit . . . or costs!

Contact your local IR Sales Office or Distributor for data or write to  
*International Rectifier,*  
233 Kansas Street,  
El Segundo, CA 90245  
(213) 322-3331, Telex 67-4464

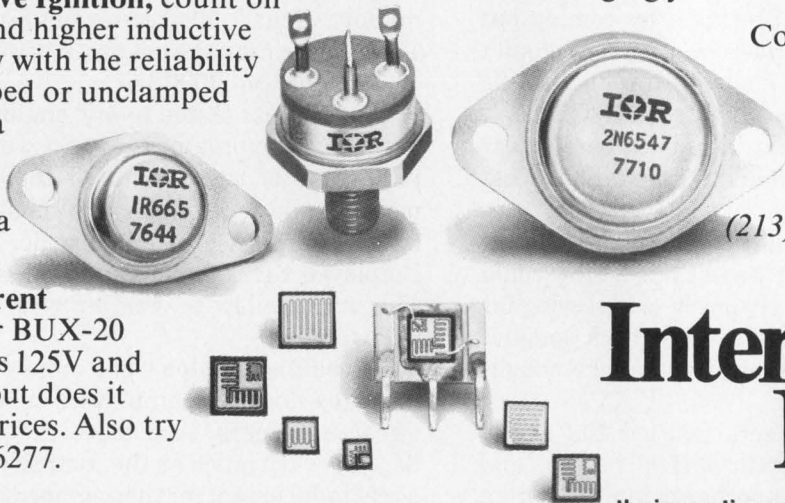

## International Rectifier

... the innovative semiconductor people





# Creeping up on daylight

We've just brought the integrated dc-to-daylight frequency synthesizer a couple of steps closer to reality.

The new Plessey IC's offer a quick and easy way to lower synthesizer costs while increasing loop response and channel spacing all the way from dc through the HF, VHF, UHF and TACAN bands.

Start with one of our IC prescalers. They feature input ports for VHF and UHF, self-biasing clock inputs, TTL/MOS-compatibility and variable input hysteresis for wideband operation.

Then add one of our two-modulus dividers. All of them provide low power consumption, low propagation delay and ECL-compatibility, and most of them are available in commercial and MIL-temp versions.

Finally, to make things even simpler, add the Plessey SP8760 control chip and phase lock your synthesizer to any crystal up to 10 MHz. All the stability you need with none of the usual headaches and hassle.

If it all sounds too good to be true, contact us today for details and application notes.

Once you've seen the data, you'll see the light.



## PLESSEY SEMICONDUCTORS

1674 McGaw Avenue, Irvine, CA 92714  
Tel: (714) 540-9945. TWX: 910-595-1930  
Represented world-wide.

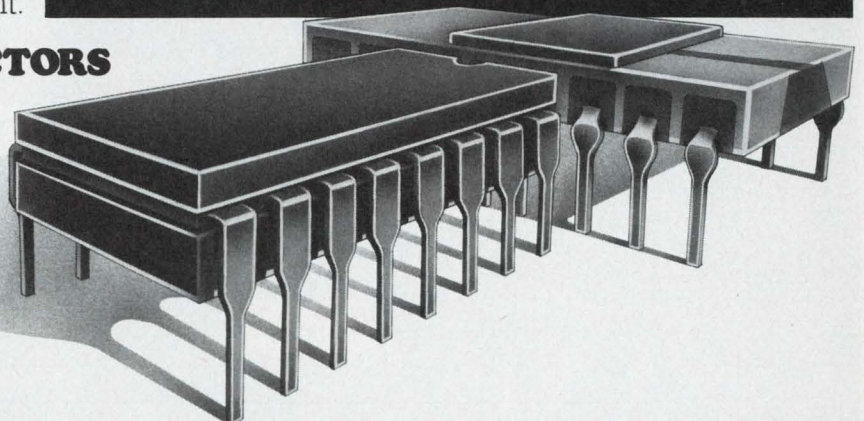
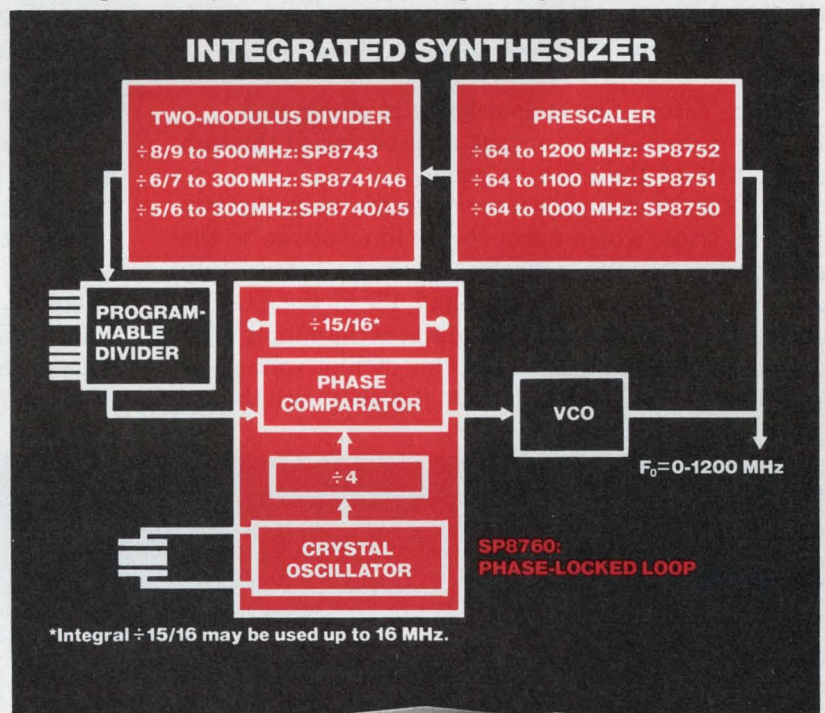

## State-of-the-art brought down to earth

Fixed and programmable dividers □ Linear and digital communications circuits

CIRCLE NUMBER 65



## Control the ac input to a power supply and reduce load and line effects by 40 dB

With the pulse-modulation regulator shown in the figure, you can reduce low-frequency line and load variations of almost any unregulated high-voltage, low-current or medium-voltage, high-current power supply by about 40 dB. The circuit has the following key features:

- Only one chip—an SG3079 zero-crossover detector IC—is used.
- No separate reference or chip power supply is needed.
- Core saturation at low loads is eliminated.
- The power-supply output may be varied through about half of the circuit's range.

An SG3079 zero-crossover detector chip directly drives a triac, which gates the ac line voltage to the supply. The regulator circuit closes the control loop via the on-off inputs (pins 9 and 13) of the SG3079 and  $R_5$  and, in effect, pulse modulates the supply with one or more complete half cycles of line voltage. A sharp-knee LM103-3.3 zener,  $D_3$ , together with the on-

chip supply serves as a reference.

Design details may vary, depending on the type of power supply, and on whether it presents an inductive or capacitive load, but a typical application is shown in the figure. Capacitors  $C_1$ ,  $C_2$  and  $C_3$  eliminate core saturation caused by successive triggering of the triac on the same half-cycle. Resistors  $R_1$  and  $R_2$  prevent squegging at low-output voltages. And the network consisting of  $R_{3A}$ ,  $R_{3B}$  and  $C_4$  shifts the zero-sense input to the SG3079 to compensate for supply-leakage reactance that retards phase reversal across the triac.

The output voltage is varied by potentiometer  $R_4$ . Diode  $D_1$  provides personnel protection, and charging current can be limited through  $D_2$ . Although the on-chip voltage source (pin 2) is unregulated, components  $R_6$ ,  $C_5$  and  $D_3$  convert the voltage into a fine reference.

*B.L. Kortegaard, University of California, Los Alamos Scientific Laboratory, P.O. Box 1663, Los Alamos, NM 87544.*

CIRCLE NO. 311

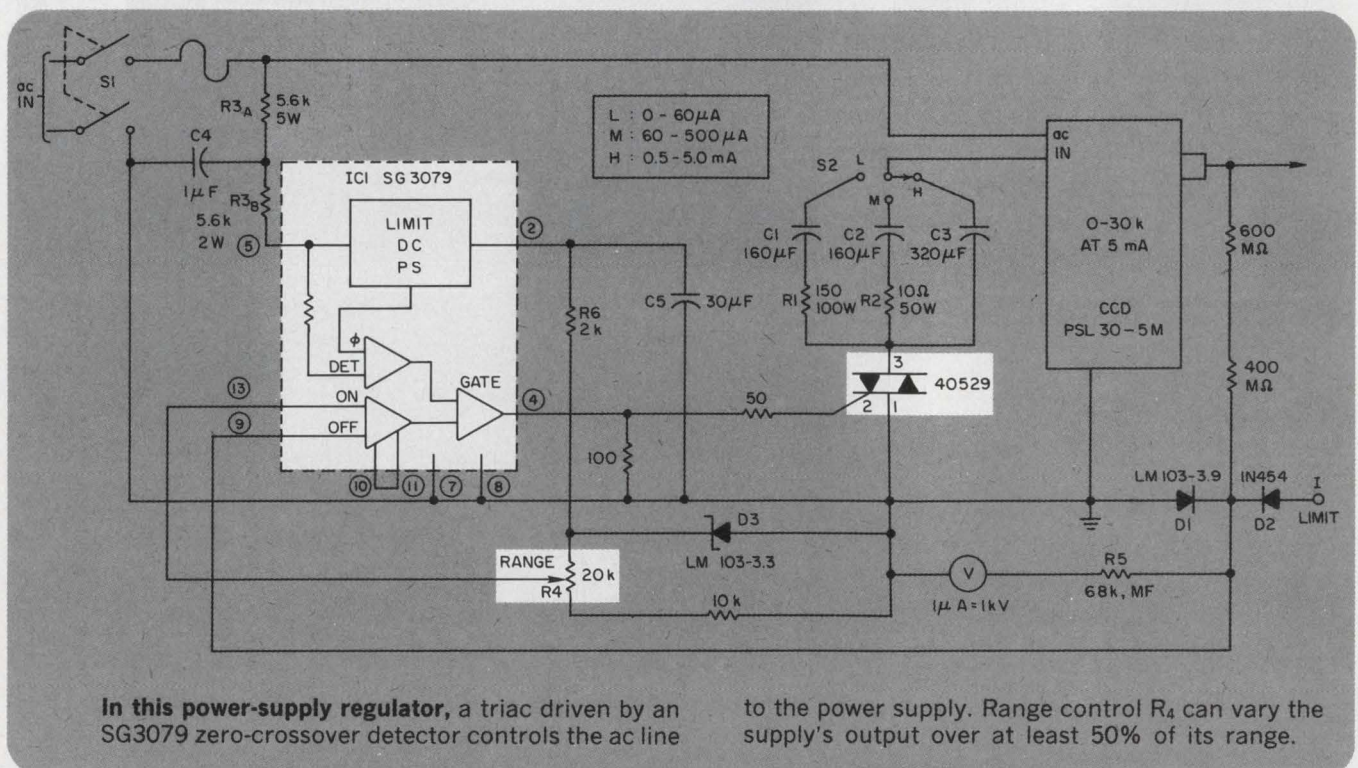



# a New Family of VOMs The Model 60 Series

## MODEL 60

RANGES  
8 DC VOLTS  
4 DC CURRENT  
6 AC VOLTS  
5 OHMS  
5dB

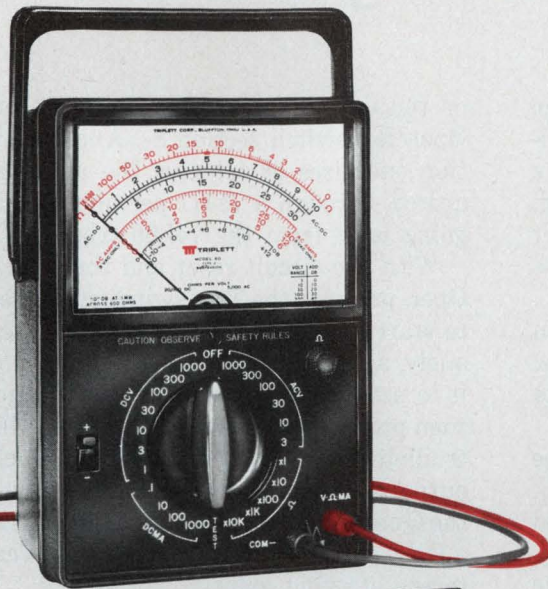

\$99

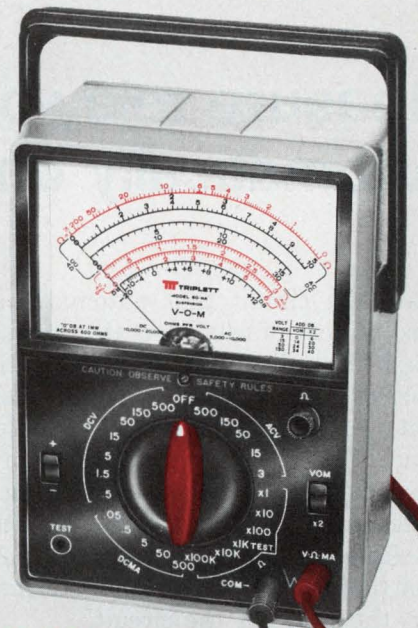

## MODEL 60-NA

16 DC VOLTS, 10 DC CURRENT,  
10 AC VOLTS, 6 OHMS, **\$136**  
AND 8 dB RANGES

The new 60 Series has been designed for the value conscious users in industrial production and maintenance, communications, vocational training and hobbyists, airconditioning, appliance and automotive service, R & D and application engineering . . . anyone who wants to be more productive with the latest in V-O-M technology. The large, "simplified" 4 1/2" scale is an "easy reader". This combined with a single range selector switch minimizes the possibilities of error. Detented handle position, only 2 recessed input jacks and 48" safety engineered test leads are just a few of the many other user benefits of the 60 Series. Compare them with other V-O-Ms and you'll know why the new Triplett family of V-O-M's eliminate over 90% of the costly repairs from V-O-M misuses. Cultivate a profitable habit for selecting Triplett designed products. For more technical data and a demonstration of the Model 60 Series, see your local Triplett distributor or a Triplett sales representative. Triplett Corp., Bluffton, Ohio 45817, (419) 358-5015.

**X'TRA™ RUGGED  
OVERLOAD PROTECTED  
SAFETY DESIGNED FOR YOU**

## MODEL 64

RANGES  
8 DC VOLTS  
8 AC VOLTS  
7 OHMS  
6 Low Power  
JUNCTION  
TEST

\$136

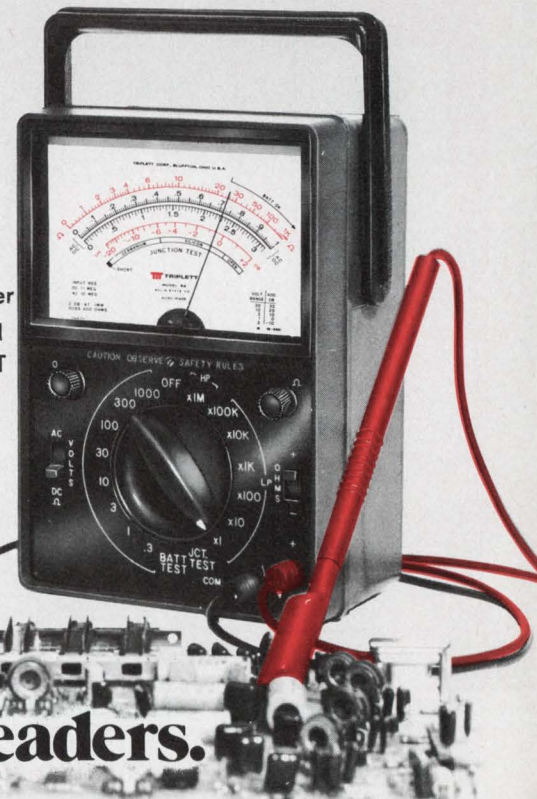

**TTT**® **TRIPLETT**  
BLUFFTON, OHIO 45817

**Triplett. The easy readers.**



# Measure relay-operate and release times automatically on standard digital timers

Here's a circuit that automates and speeds the measurement of relay-operate and release times. Although an oscilloscope may measure these times quite effectively, it requires constant dial twirling and, often, repeated operations to determine contact bounce. And when large quantities of relays must be tested, it's rather tedious and tiring.

The circuit in Fig. 1 converts relay-contact operation into signals that may be used to start and stop a digital timer (not shown). Two 74122 retriggerable one-shots form the heart of the circuit.

The time constants of the one-shots need not be precise. The time constant of the first one-shot, OS<sub>1</sub>, is selected to be just a little longer than the expected contact bounce of the relay under test; the second, OS<sub>2</sub>, must have a time constant somewhat shorter than the total expected closure or release time.

The 74L86 Exclusive-OR gate serves as the input and provides a ZERO output when the relay operates

or releases, in accordance with the position of the Oper/Rel-switch section S<sub>1</sub>. And the switch's S<sub>2</sub> section energizes or releases the relay, as initially required, through a 75471 peripheral driver. A ZERO-going level from the 74L86 triggers OS<sub>1</sub>.

With the circuit reset and the Oper/Rel switch in Oper, pressing the Test switch energizes the relay coil to start a pull-in of the relay under test. Simultaneously, a ONE is applied to the B input of OS<sub>1</sub> causing it to produce a single pulse that triggers OS<sub>2</sub>, which then produces a pulse approximately 100- $\mu$ s long. The trailing edge of OS<sub>2</sub> triggers OS<sub>3</sub>, which produces the output signal labeled Start to the external timer. Also, the  $\bar{Q}$  output of OS<sub>3</sub> resets latch RS<sub>2</sub>, which then places a ONE on the A input of OS<sub>1</sub> and reverses the inputs to the steering gates.

As shown in the timing diagram (Fig. 2), the time between the output's Start and Stop pulses is the operate time of the relay under test. The operate time

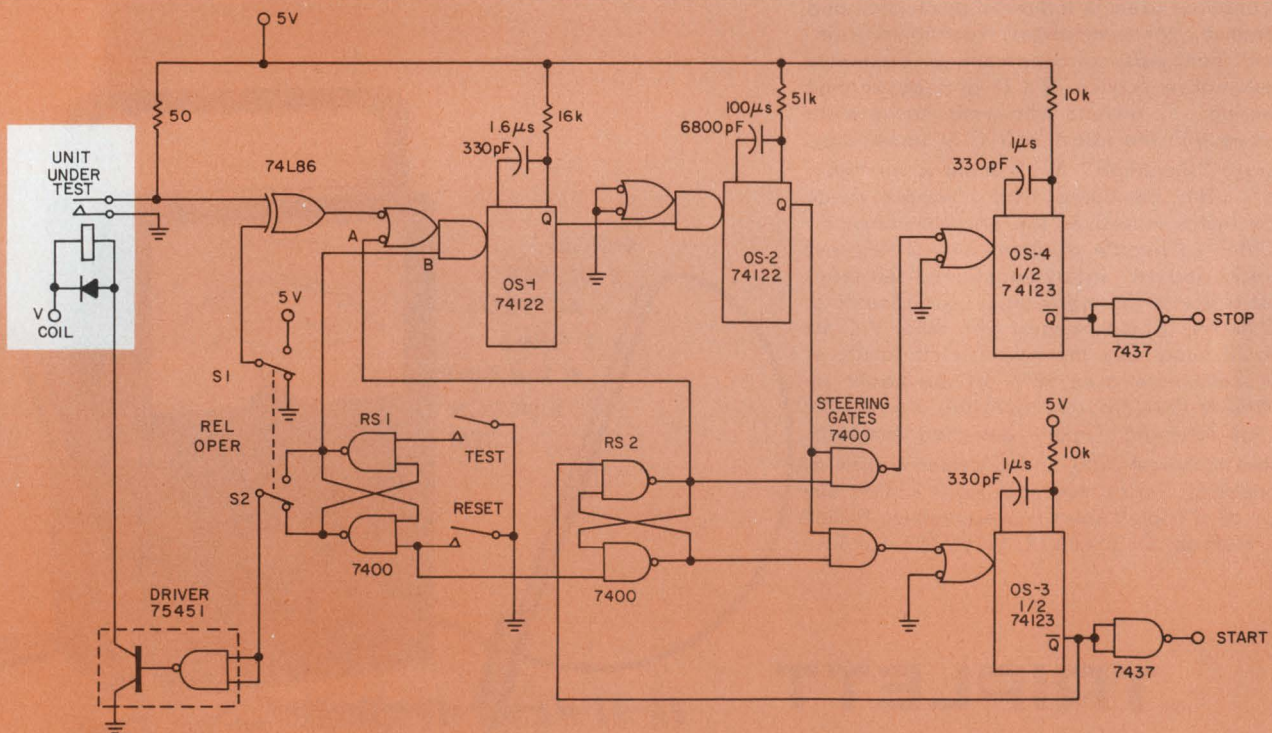

1. The operate or release time of a relay can be measured by using a standard digital timer that is

started and stopped by the output pulses of this circuit and read directly in milliseconds.



# Behind all these pretty faces...

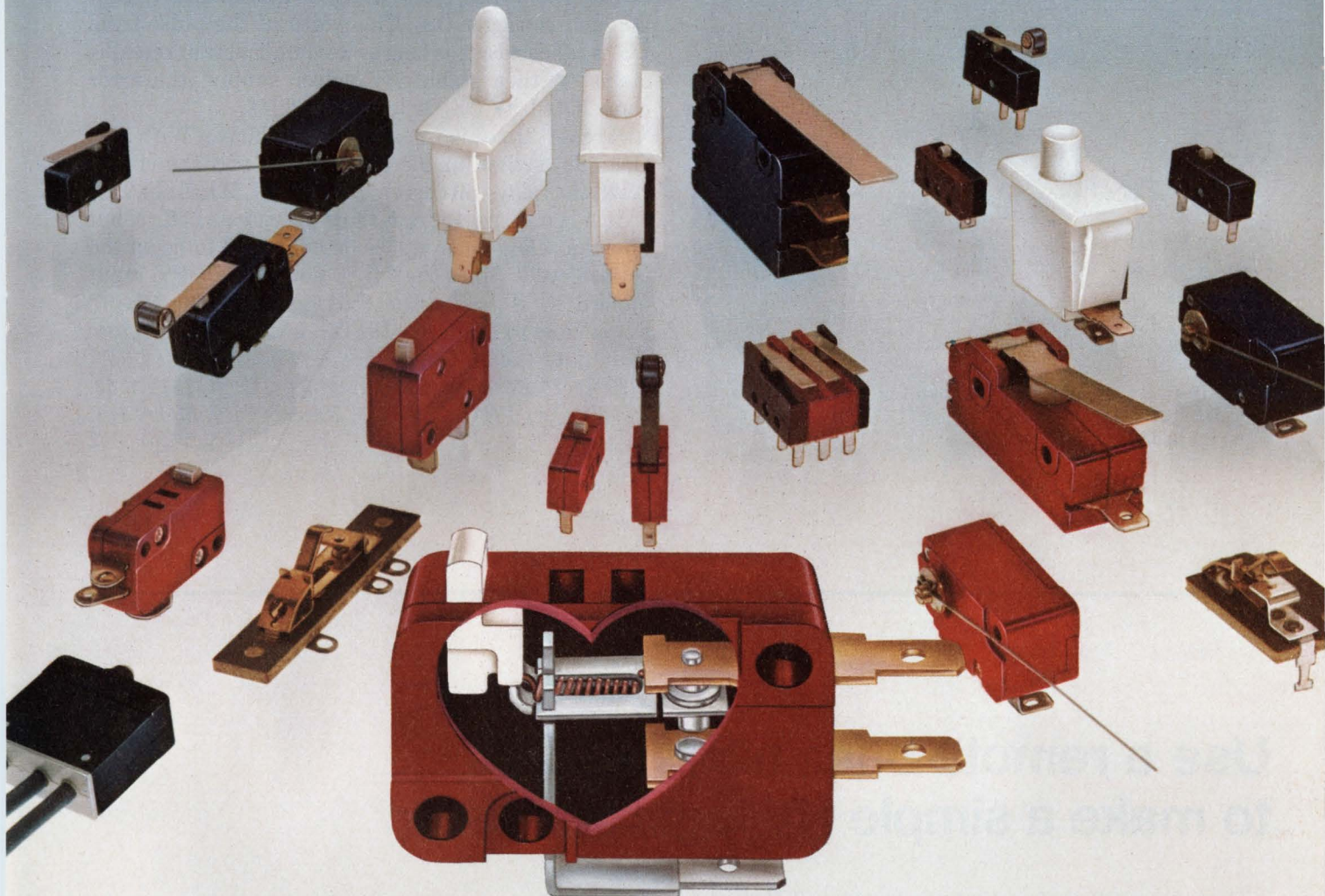

## beats a heart of coiled stainless steel.

No Cherry snap-action switch has ever died of a broken heart. Because there's a coil spring at the heart of every Cherry switch that expands and contracts again and again and never gets tired. Or breaks. Compare *that* to the stamped spring many switch builders use. The kind of spring that gets tired . . . and breaks. (Snap. Drat!)

This stainless steel coil spring mechanism not only insures long life, it provides large overtravel to make our switches quicker, easier to design-in and to install. Which is why more than 300 million of them have been designed-

in and installed. So far.

Cherry snap-action switches are available in gold crosspoint design for low energy switching. In general purpose, miniature and subminiature designs. In low torque. Light force. Open or enclosed. Panel mount pushbutton. And more.

For free catalog of all the Cherry switches, just circle the reader service number below. If you're in a hurry, our direct line number is 312/689-7702 . . . and we'll throw in a switch sample of your choice.

# CHERRY



**CHERRY ELECTRICAL PRODUCTS CORP.**  
3609 Sunset Avenue, Waukegan, Illinois 60085

**SWITCHES and KEYBOARDS — Available locally from authorized distributors.**

CIRCLE NUMBER 67



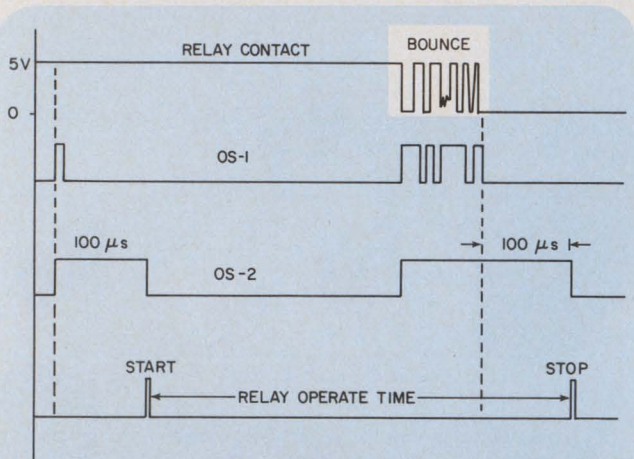

2. The circuit includes the bounce time into the start/stop interval, but the time of OS<sub>2</sub> automatically cancels and isn't included.

includes all relay-contact bounces long enough to switch the 74L86 from ONE to ZERO and trigger OS<sub>1</sub> and retrigger OS<sub>2</sub>. The width of the pulse from OS<sub>2</sub> is canceled out as long as its time constant remains stable. With a stable 5-V power supply, the error contributed by OS<sub>2</sub> is less than 0.5%.

Release time is measured similarly. With the Oper/Rel switch in the Rel position and the circuit reset, the relay-coil current is fully ON. When the Test switch is pressed, the one-shots operate as before, but now the relay under test is de-energized to begin the release cycle. Since the 74L86 now has a ONE input applied by S<sub>1</sub>, when the contacts open the 74L86's output goes to ZERO and the OS<sub>1</sub> is triggered as before to initiate the stop sequence.

Kenneth Benedict, Staff Engineer, Dept. 131 FC 39, Bendix Corp., P.O. Box 1159, Kansas City, MO 64141.  
CIRCLE NO. 312

## Use a remote-base biased SCR to make a simple HV logic translator

Designing an interface that can translate TTL-logic levels to voltages greater than 300 V dc can be an engineer's nightmare. However, a little used non-regenerative mode of an SCR can solve the problem very simply.

The circuit of Fig. 1a is a TTL-to-HV interface that needs only four parts—three resistors and an SCR—to accomplish the translation. With ordinary SCRs having breakdown ratings of 1200 V and higher, ultra-high power levels can be easily controlled by low-power logic and with very few parts.

The nonregenerative mode of an SCR is an often forgotten characteristic of its pnpn structure (Fig. 1b).<sup>1</sup> A so-called remote-base pnp transistor results from this biasing arrangement, and the "transistor's" pseudo-pnp equivalent circuit is shown in Fig. 1c.

The high reverse-breakdown voltage rating of an SCR is retained and the common-emitter current gain,  $h_{FE}$ , can vary from much less than one to well over five. For example, curve tracings of a 2N2329, biased as in Fig. 1b, show a saturation  $h_{FE}$  of 2.5 to 10 for "collector" currents ranging from 0.5 to 2 mA.

### Reference

1. *SCR Manual*, 5th Edition, General Electric, Syracuse, NY, p. 13.

Gordon E. Bloom, Radiation Effects Group Leader, IRT Corp., P.O. Box 80817, San Diego, CA 92138.

CIRCLE NO. 313

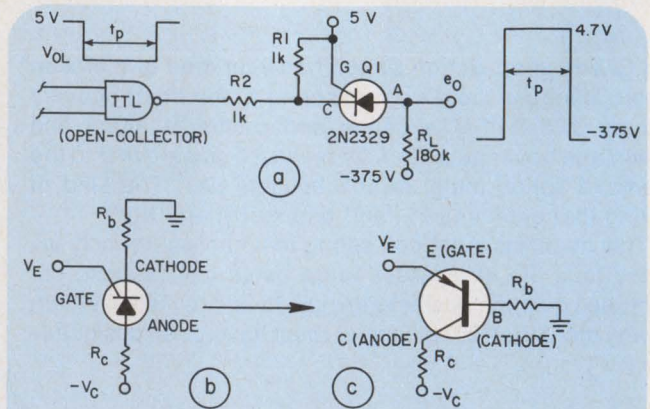

1. TTL to high-voltage interfacing (a) can be done with an ordinary SCR that is "remote-base" biased in a nonregenerative mode (b), so that it behaves as an equivalent transistor circuit (c).



# VACTEC Photodetectors

The Industry's Broadest Line Provides More Semiconductor Detectors for More Design Applications

Vactec serves manufacturers of a wide range of modern electronic products. Pictured are a few examples. All these devices are both made and sold by Vactec, including complete lines of LDR's (photoconductive cells, CdS and CdSe); silicon solar cells, as well as silicon high speed and blue enhanced cells; NPN phototransistors and darlington's; opto-couplers (LED/LDR, lamp/LDR and neon/LDR); selenium photovoltaic cells; silicon photodiodes, blue enhanced and PIN; and custom C-MOS and bi-polar IC's. Write for technical bulletins on the types that suit your requirements. Or send your application, and Vactec will recommend the right cell for the job.

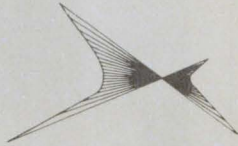

## Vactec, Inc.

2423 Northline Industrial Blvd.  
Maryland Heights, Mo. 63043  
(314) 872-8300

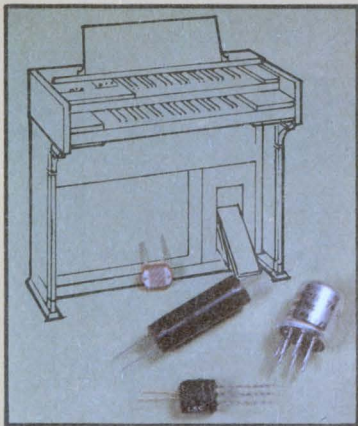

**Electronic Organs**

LED or lamp/LDR Vactrols for audio, and CdS cells for swell pedal controls.

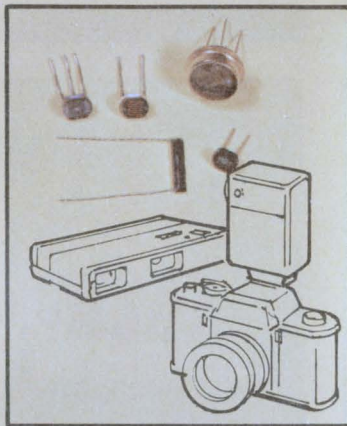

**Cameras and Projectors**

CdS or blue enhanced silicon photodiodes for automatic shutter timing; aperture servo systems for automatic projector focus; and slave flash controls.

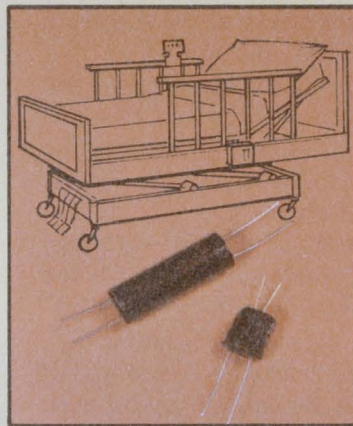

**Triac Motor Controls**

A special Vactrol gates a triac for forward and reverse motor operation as in hospital beds.

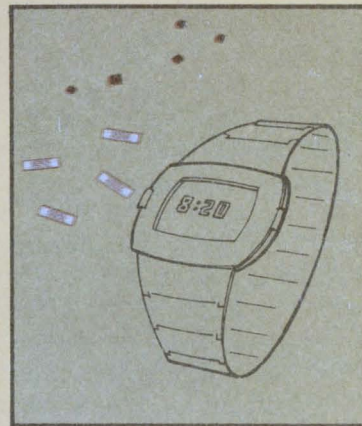

**LED Watches**

Photoconductive or phototransistor chip controls LED brightness.

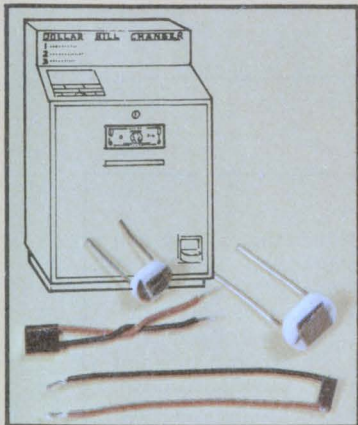

**Dollar Bill Changers**

Silicon photovoltaic cells analyze optical characteristics.

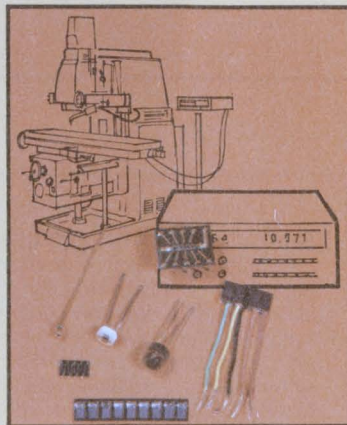

**Machine Tool Controls**

High-speed photovoltaic cells or transistor arrays help computer control repetitive operations, non-contact sensing, and counting and weighing.

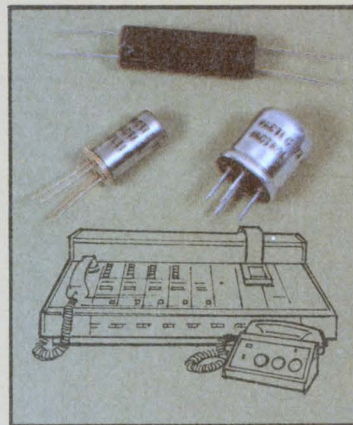

**Telephone Equipment**

Neon/LDR Vactrols sense ringing. Direct a-c coupling, slow LDR response isolates electronics from noise.

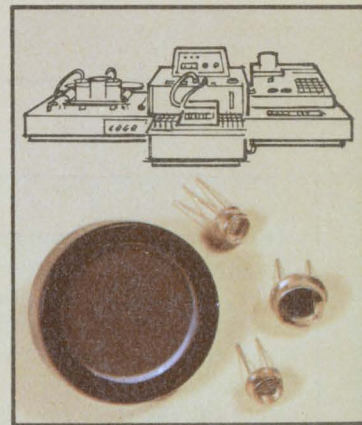

**Scientific Instruments**

Blue enhanced silicon or selenium photovoltaic cells detect solutions densitometrically for precise blood chemistry, and other analyses.



## Ideas for design

# Double-exposure technique lets you take good spectrum-analyzer photographs

If you have tried taking spectrum-analyzer display photographs for permanent records, you've probably been frustrated because the background came out dark and the graticule scale markings didn't show up. Some spectrum analyzers, such as the AIL 727 or HP141T, don't have provisions for illuminating either the graticule or the screen in the stored display mode. So, at best, all you see of the photographed scale markings are the lines where they cross your spectrum display.

However, a simple double-exposure trick can give you a useful picture—a white-spectrum display, a gray background and crisp black scale markings. Follow these four steps to success:

1. Set up the analyzer and camera controls as you would normally. Store a single sweep of the spectrum display, and then snap the lens shutter.
2. Switch the analyzer out of the store mode and erase the display. Adjust the storage controls and leave the analyzer in the single-sweep mode until the screen is a uniform green. Snap the lens shutter again.
3. Remove the film and develop it.
4. Repeat the process with a slightly different storage adjustment, if you aren't satisfied with the photograph. A brighter screen gives a lighter background; a darker screen, a darker background.

This technique works well with the AIL and HP spectrum analyzers and may be equally useful with other spectrum and network analyzers that have storage capability.

*W.M. Rogers, Principal Engineer, Harris Satellite Communications Operations, P.O. Box 1700, Melbourne, FL 32901* CIRCLE NO. 314

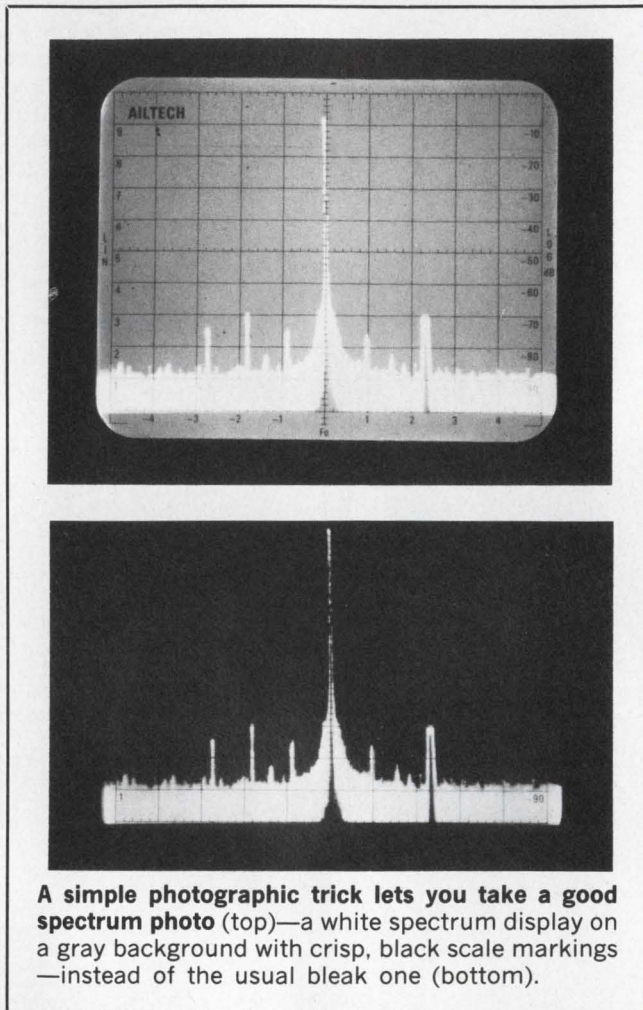

### IFD Winner of January 18, 1977

Dale Hileman, Sphygmetrics, Inc., 6311 J DeSoto Ave., Woodland Hills, CA 91367. His idea "Simple Solid-State Relay Circuit Can Be Built with Few Components" has been voted the Most Valuable of Issue Award.

**Vote for the Best Idea in this issue** by circling the number for your selection on the Reader Service Card at the back of this issue.

**SEND US YOUR IDEAS FOR DESIGN.** You may win a grand total of \$1050 (cash)! Here's how. Submit your IFD describing a new or important circuit or design technique, the clever use of a new component or test equipment, packaging tips, cost-saving ideas to our Ideas for Design editor. Ideas can only be considered for publication if they are submitted exclusively to ELECTRONIC DESIGN. You will receive \$20 for each published idea, \$30 more if it is voted best of issue by our readers. The best-of-issue winners become eligible for the Idea of the Year award of \$1000.



# Analog input...analog output. Now they're both just this simple.

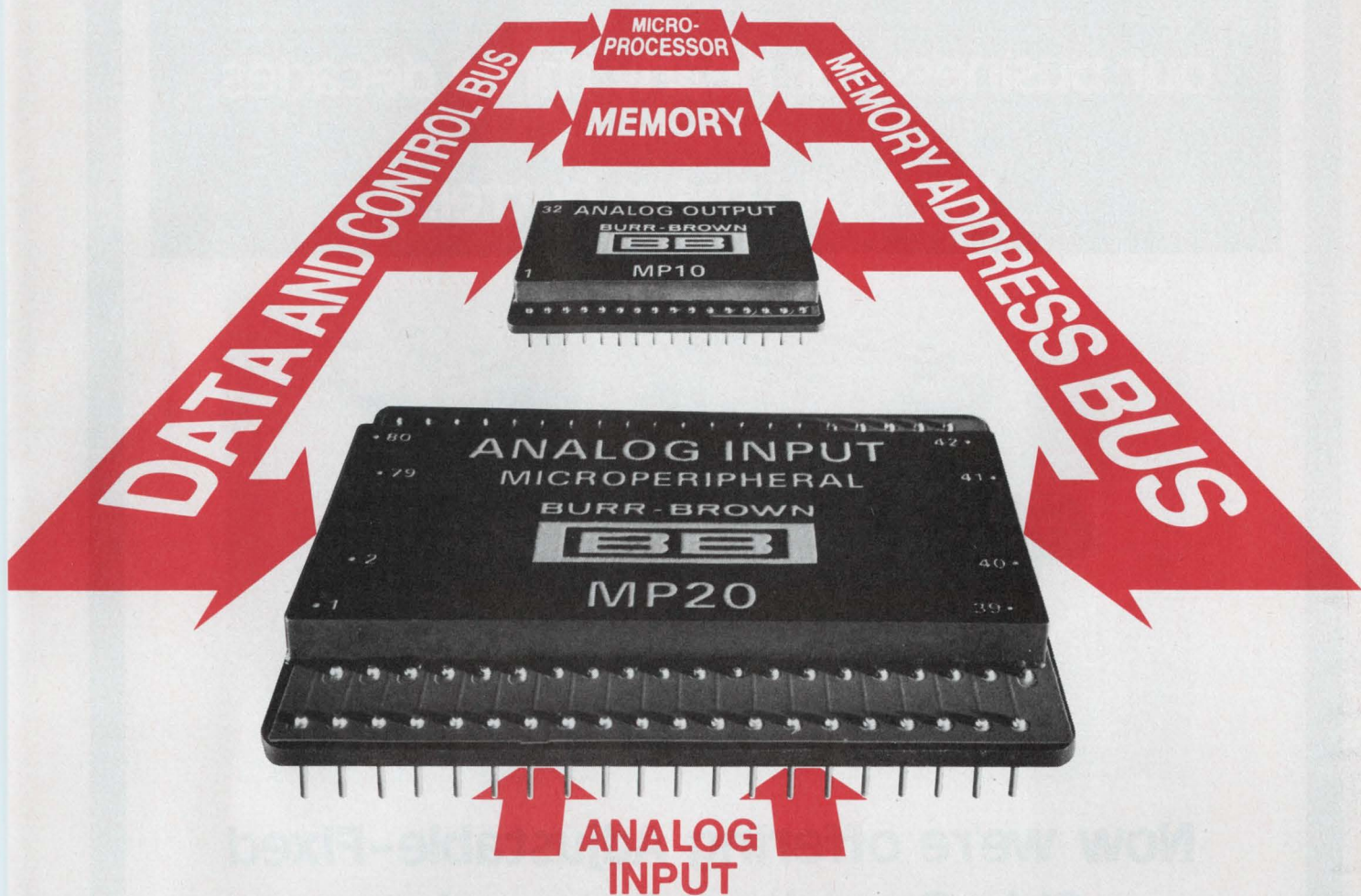

Meet the 16-channel MP20 and MP21 Analog Input Systems. They join our previously introduced MP10 and MP11 Analog Output Systems to give you a complete analog interface solution for your microprocessor based designs.

Now, instead of designing a complete data acquisition system, you simply plug in one of these units as if it were memory. That means big savings in design costs, and faster product introduction too.

For 8080A and SC/MP and Z80 type microprocessors, you need our new MP20. And for 6800, 650X and F-8 types, our MP21. Both of these bus-compatible Analog Input Microperipherals are self contained, requiring no external components.

Since these systems are treated as memory by your CPU, software implementation is simple too. Just assign one 8-bit memory location per channel, and use any

memory reference instruction to access data. For example, one LDA instruction will acquire a channel of information when used with the 8080A. Alternatively, the units can be interfaced as an I/O port or on an interrupt basis.



Both the MP20 and MP21 have resistor programmable input ranges of  $\pm 10\text{mV}$  to  $\pm 5\text{V}$  full scale allowing you to handle low-level signals directly. They provide 8-bit resolution and throughput accuracy better than  $\pm 0.4\%$  of full scale on the  $\pm 5\text{V}$  range.

With a price of just \$140 (100's), it just doesn't make sense to design your own analog input solution. For complete details, write or call Burr-Brown, International Airport Industrial Park, Tucson, Arizona 85734. Phone (602) 294-1431.

CIRCLE NUMBER 69



Leaders in  
microcomputer I/O.





**Monolithic capacitors have been  
our business for nearly three decades.**

**We build them better.**

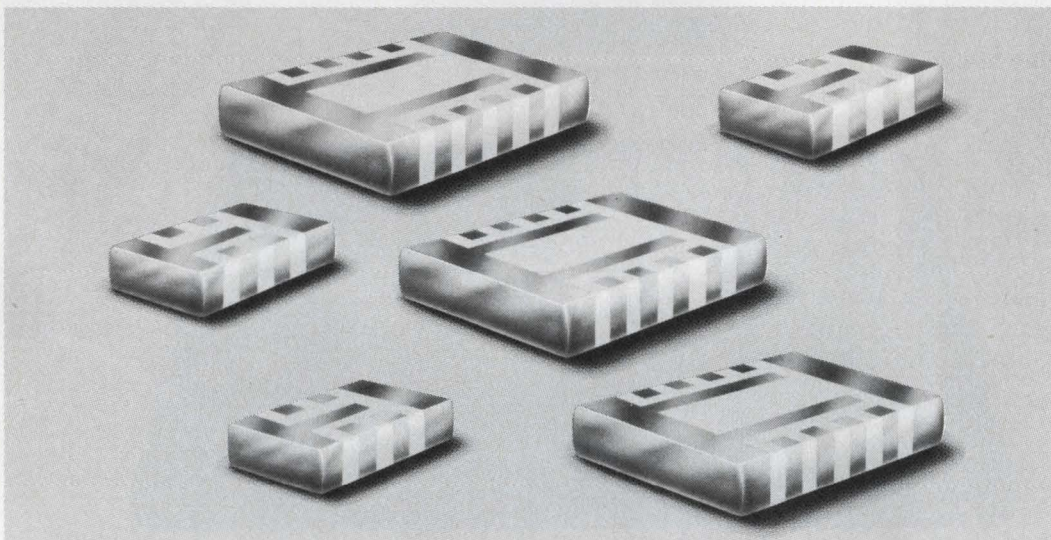

## **Now we're offering Adjustable-Fixed Chip Capacitors in two sizes**

Your interest in our first planar 'VEE CAL' Adjustable Fixed Chip has led us to develop an additional body size — the popular .08" x .05" (2.03 x 1.27mm) package.

Now you can obtain the original VC2A (.12" x .10"/3.05 x 2.55mm) in values 3 to 47 pF — and adjust it within  $\pm .25$  pF of any value.

Or you can select the new VC3A and adjust it within 2-3 pF of any value in its 15 to 32 pF range.

You can adjust (add or subtract) capacitance in or out of circuit on both NPO parts — and arrive at a fixed value each time.

We've also developed a probe card system that allows you to adjust the VC2A to within  $\pm .25$  pF of any value in 30-45 seconds.

Thinking of making some adjustments in your chip capacitor usage? Then think of our 'VEE CAL' Adjustable-Fixed Chip Capacitors. In fact, call us at (203) 268-6261 and ask for your free sample.

A stylized logo consisting of a large, bold letter 'V' with a registered trademark symbol (®) to its upper right.

**Vitramon<sup>®</sup>**

**Vitramon North America  
Division of Vitramon, Incorporated  
Box 544, Bridgeport, Conn. 06601**

**Subsidiaries:** Vitramon Limited (London) • Vitramon GmbH (Stuttgart) • Vitramon France S.A.R.L. (Paris) • Vitramon Pty. Limited (Sydney) • Vitramon Japan Limited (Tokyo)



# TRW power Schottkys.

## Reliability at $T_j$ of $125^\circ\text{C}$

International Exchange of Authenticated Electronic Component Performance Test Data  
**PRODUCT TESTED:** TRW SD-51 Power Schottky Diode

**TEST— High Temperature Reverse Bias**  
**TEST CONDITION—  $V_R = 30\text{ V}$   $T_C = 125^\circ\text{C}$**

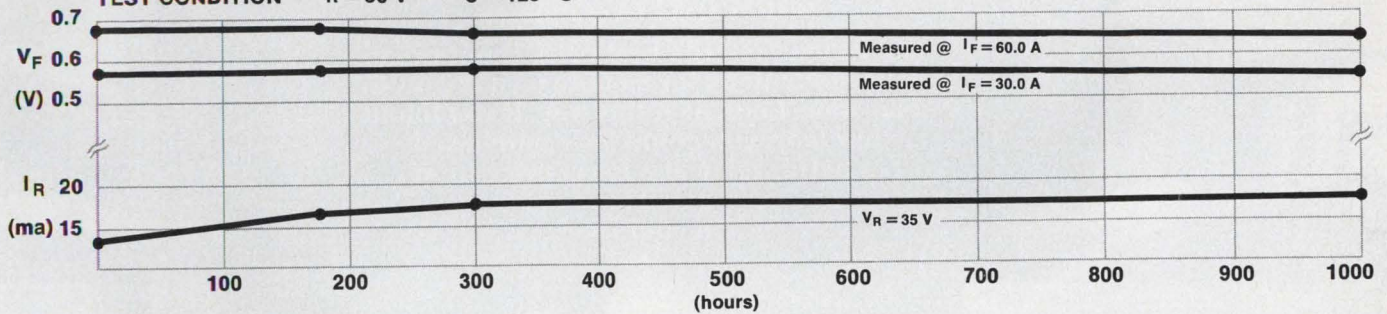

**TEST— Endurance**  
**TEST CONDITION—  $I_F = 30\text{ A}$   $T_C = 125^\circ\text{C}$**

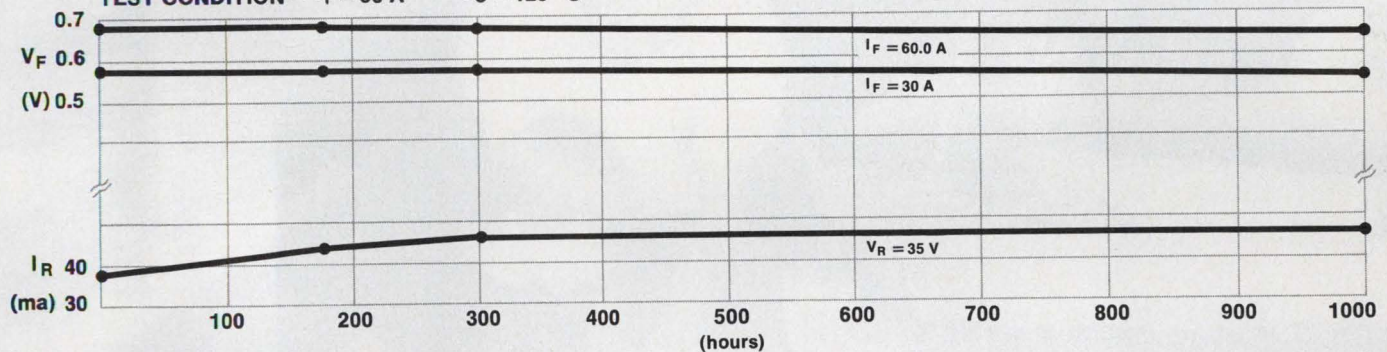

**Proof of reliability? You bet. And proof of stability. You can rely on TRW Schottkys to keep on working as specified.**

If you're into low voltage, high current power supplies, you owe it to your next design to test TRW's reliable SD-51, (in a DO5 package) the fastest switching diodes going! They're great little problem-solvers, they're drop-in, and they're very competitively priced.

What's more, they're JEDEC registered and available for immediate delivery.

If you're into lower currents (30 amps, 45 volts) check out our SD-41 in a DO4 package. For complete specs on either Schottky, use the coupon or call John Power at (213) 679-4561.

### TRW Power Semiconductors

An Electronic Components Division of TRW, Inc.  
 14520 Aviation Boulevard, Lawndale, California 90260

- Please send me data sheets on TRW's power Schottkys.  
 Please send sample.  
 Current requirement \_\_\_\_\_ amps.

NAME \_\_\_\_\_

COMPANY NAME \_\_\_\_\_

POSITION \_\_\_\_\_

ADDRESS \_\_\_\_\_

CITY \_\_\_\_\_

STATE \_\_\_\_\_

ZIP \_\_\_\_\_

ED \_\_\_\_\_

# TRW POWER SEMICONDUCTORS

ANOTHER PRODUCT OF A COMPANY CALLED TRW

CIRCLE NUMBER 71



# Here in Wabash James Pobst can sell his eggs for less because he grows his own feed. We make relays the same way – sort of.

We make our own switches. That not only helps lower the cost of our relays, it does something else that's important.

Since James Pobst knows what's gone into his chickens, he knows what kind of eggs he's going to get. Same way with us. We know what our relays with our switches in them are going to do. And just to make sure – we run over 3 billion test cycles a day.

That's what you get in a Wabash relay – performance you can count on – no matter which of over 6000 variations you select. Of course all meet proposed NARM and EIA standards.

But as we say – the best news is our price. Why not call us for a quote on a dry reed relay now. Look at it this way. If you found out later you could have purchased a better relay at a lower price from us – you'd have egg on your face.

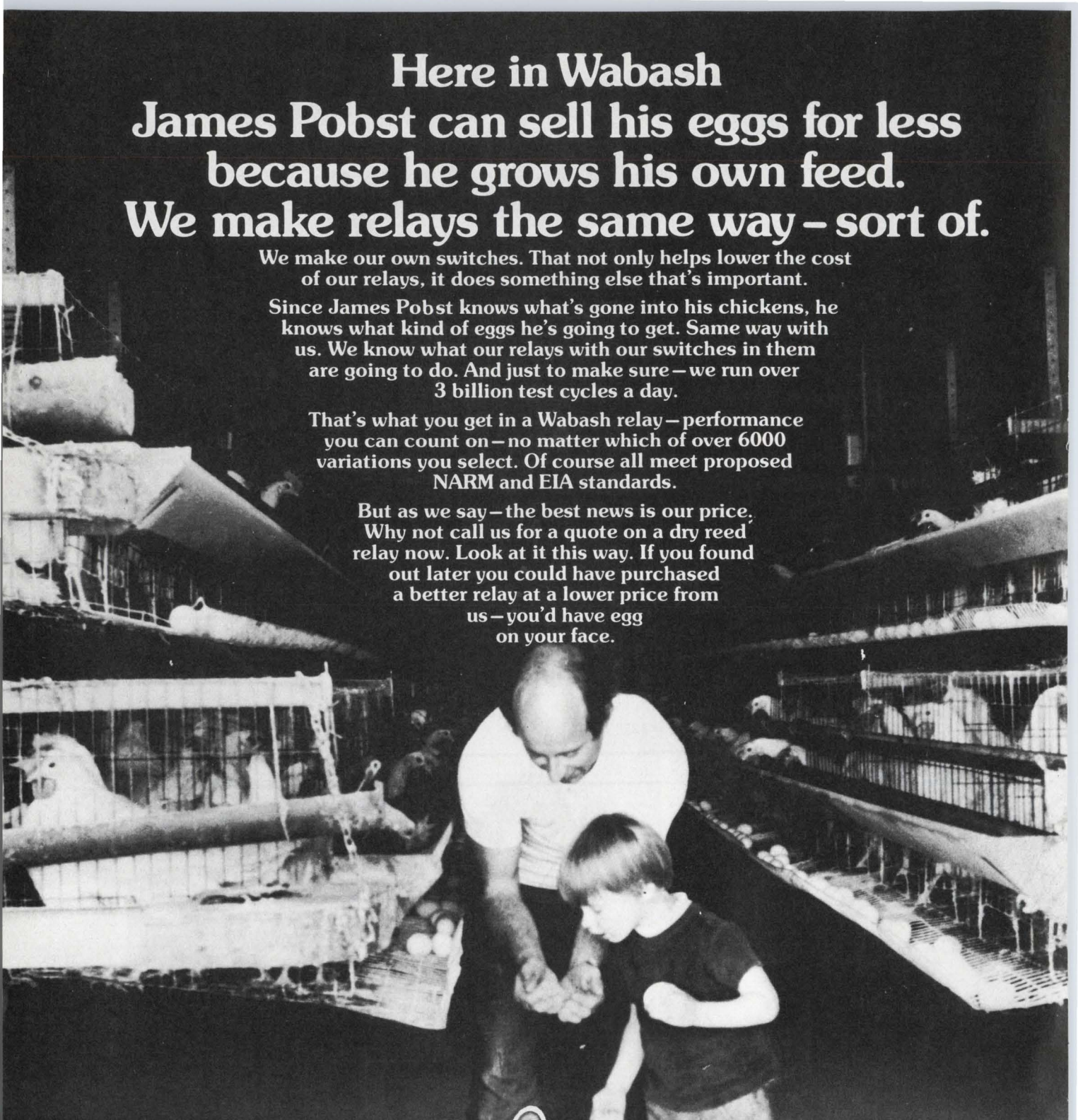

*Coils, Relays & Transformers*  
**wabash**  
of  
**Wabash, Indiana**

and Huntington, Indiana; Farmington, Missouri;  
Tipton, Iowa and South Boston, Virginia

For information and quotes write or call:

Wabash, Inc., Dept. RC-3, 810 N. Cass St., Wabash, Ind. 46992 Tel: 219/563-2191 TWX 810-290-2722

CIRCLE NUMBER 72



The Econo-Miser. The most automatically manufactured dry reed relay available. 1 and 2 pole standard types. Less than one dollar in quantity.



## Solar cell promises 15% efficiency at low cost

A silicon solar cell combines the good points of monocrystalline devices (high efficiency) and thin-film polysilicon cells (low-cost processing), and eliminates their bad points. Monocrystalline silicon cells have efficiencies of more than 15% but their stringent processing requirements are expensive. And while thin-film polysilicon cells can be produced rather inexpensively, their efficiencies are about one-tenth that of the monocrystalline units.

Fabrication of the improved cells, developed at the University of Madrid, starts with a polysilicon rod to obtain high-grade monocrystalline silicon. This rod consists of a monocrystalline-doped core surrounded by five grains of intrinsic silicon. From the rods, a single-pass melting zone produces homogeneously doped silicon with a relatively large grain size—a material that is neither monocrystalline nor truly polycrystalline.

P-type slices of this material, with

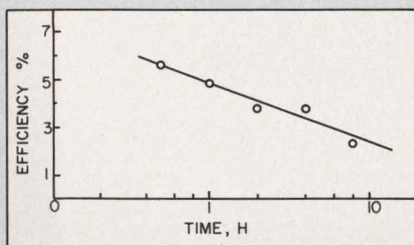

a mean grain size of about  $10^4 \mu\text{m}^2$ , form  $n^+$  and  $p^+$  regions simultaneously by diffusion at 1200 C. Evaporated aluminum contacts are then added. Because the  $n^+$  contacts are semi-transparent with an optical transmission of about 50%, no anti-reflection coating was applied.

While maximum efficiency is about 15%, the combination cell's efficiency varies with diffusion time (see Fig.). A 30-min. diffusion produces 5.0% efficiency, which could be doubled if the aluminum contact were made in an interdigitated form. An antireflection coating further boosts efficiency.

## Vidicons perform better with CdSe targets

Substituting cadmium selenide photoconductive targets for standard antimony trisulfide, lead oxide, or silicon-diode arrays improves the performance of 1-in. and  $\frac{2}{3}$ -in. vidicon tubes. With this target material, Siemens AG of West Germany reports a high sensitivity of  $2670 \mu\text{A}/\text{lumen}$ , referred to a tungsten lamp color temperature of 2856 K. Peak sensitivity is  $0.5 \mu\text{A}/\mu\text{W}$ , with an almost unity quantum efficiency in the optical range and a gamma value between 0.90 and 0.95.

The target electrode is coated with several layers of vapor-deposited cadmium selenide, each layer a few micrometers thick. The CdSe photosurface is also said to be much more stable than existing materials.

After-images can be eliminated with a single voltage adjustment. Dark current is low—between 0.5 and 1 nA.

## New type magnetron tuned electronically

Frequency-agile magnetrons, which operate at one frequency and 50 ns later work at another, can now be electronically tuned. This new approach is in contrast to present slow mechanical methods of changing the magnetron frequency by vacuum bellows and mechanical drive systems.

Frequency tuning is achieved in the new type magnetron, developed by English Electric Valve Co., Chelmsford, England, by applying a 1 to 3-kV rf control voltage to an auxiliary resonant cavity, called the multipactor cavity. This cavity is coupled to the main magnetron anode, and when the rf voltage is applied a controlled electron multipactor discharge occurs. The discharge causes a resonance shift.

Several of these cavities can be fitted to the same anode to increase total frequency shift or to give multiple frequency bands.

## MNOS data retention increased 20 times

The charge-storage properties of MNOS transistors and capacitors have been improved to such an extent at the Institute of Microelectronics in Sofia, Bulgaria, that their expected data-retention time has been increased from the 10 years expected of today's MNOS memories to 200 years.

The storage capability of the conventional thin-oxide MNOS transistors with 20-to-30-Å layers is reduced by direct back-tunneling, which causes the charge to leak through the layers. So the Bulgarian researchers tried thick-oxide MNOS structures with silicon-dioxide layers 40 to 60 Å deep, then reduced the leakage factor by increasing the conductance of the

thick-oxide layers. The oxide is treated with tungsten, which, the researchers believe, strengthens the conductance by producing an additional band in the oxide-band gap.

The Bulgarian MNOS transistors and capacitors are fabricated on n-type (111)-oriented silicon covered by the 40-to-60-Å layer of silicon dioxide. A 2000-Å layer of tungsten is then deposited by dc sputtering. The deposited metal is etched away in the proper pattern and silicon nitride deposited to about 1000 Å. The gate electrodes are made of aluminum.

The greatly increased data retention expected has been achieved with a 35-V write pulse of 50-ms duration. But the write time might be reduced, according to the researchers, by optimizing the tungsten treatment.



# New improved Ceramag<sup>®</sup> 24B gives you more of what you switched to a switcher for.

Bertie was an engineer  
Designing switchers, but this year  
His boss said, "Bertie,  
Cut your power loss by thirty  
Percent, or, I fear,  
I'll have to use some words  
You'd rather just not hear."

Now Bertie saw he was in a hole,  
So he picked up the phone,  
and he called Stackpole,  
And he said, "Hey, guys,  
Have you got my size  
In a 24B core  
That'll use less power than before,  
And save my face  
When in comes the boss  
To ask me questions  
on power loss?"

And Stackpole said, "Alright,  
We've got so many shapes and sizes.  
It shouldn't come as big surprises  
That we've got the one that's wisest  
For your needs.  
So when your boss reads  
How your brain  
Fixed the power drain,  
All we ask is that you cite  
24B as the right  
Ferrite."

If you'd like to see our brochure,  
The procedure's a real sinecure.  
Just fill out the coupon below,  
And we'll wrap one up to go.

## Ceramag 24B.

The right ferrite.

Stackpole Carbon Co.  
Electronic Components Div.  
St. Marys, Pa. 15857



Take a looklet  
at our booklet

name \_\_\_\_\_

game \_\_\_\_\_

company \_\_\_\_\_

address \_\_\_\_\_

city \_\_\_\_\_

state \_\_\_\_\_

zippany \_\_\_\_\_

# Ceramag 24B. The right ferrite.

 **STACKPOLE**

CIRCLE NUMBER 73



# CLIPLITE™

COMBINATION LENS AND  
MOUNTING DEVICE FOR  
T 1 $\frac{3}{4}$  LED

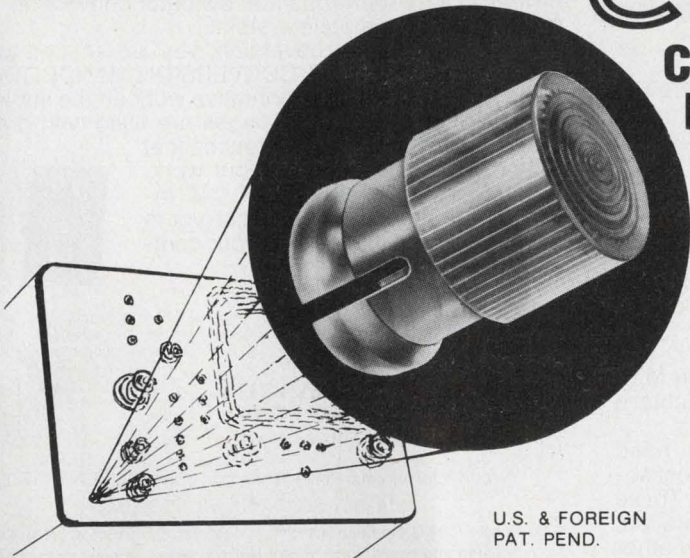

U.S. & FOREIGN  
PAT. PEND.

**REQUIRES  
NO TOOLS  
AND . . .**

**INSTALLS IN 6 SECONDS**

**SIMPLE TWO-STEP INSTALLATION**

**SNAP CLIPLITE**

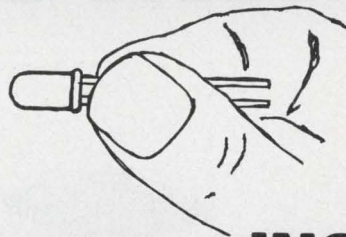
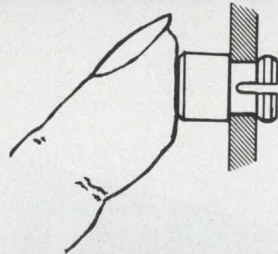

**INSERT LED**

**INSTALLATION** The CLIPLITE requires no tools; just snap it into a  $\frac{1}{4}$ " hole and insert the LED.

**DESIGN** The CLIPLITE design and color have been optimized through the use of selected red, clear, yellow, green, and amber plastics to provide exceptionally high contrast and visibility.

**VISIBILITY** The CLIPLITE permits up to 180 degrees of viewing angle using any standard T 1 $\frac{3}{4}$  LED.

**AESTHETICS** The CLIPLITE gives any display or control panel the finished appearance equal to that of the most expensive indicator light assembly.

**BRIGHTNESS** The CLIPLITE allows the use of the much brighter narrow beam LED. Example: HP 5082-4657, 12 mcd @ 10ma vs. current popular wide beam LED HP 5082-4650, 2 mcd @ 10ma. Correspondingly, the amber and green narrow beam LEDs typically increase brightness by a factor of 4 over the commonly used wide beam LEDs.

**ORDER YOUR TRIAL SAMPLE TODAY**

**Special Pricing for Trial Order Only**

ED-1

**PLEASE SHIP:**  100 CLIPLITES \$10.00  LITERATURE

**NAME** \_\_\_\_\_ **COMPANY** \_\_\_\_\_

**ADDRESS** \_\_\_\_\_

**CITY** \_\_\_\_\_ **STATE** \_\_\_\_\_ **ZIP** \_\_\_\_\_



MINIATURE  
INDICATORS

**VISUAL COMMUNICATIONS COMPANY**

P.O. BOX 986

EL SEGUNDO, CALIFORNIA 90245

(213) 822-4727



## We're the industry's Hi-Rel leader, the pace-setting innovators.

Our position as industry leaders in the Hi-Rel area is due to our unceasing dedication and innovation in synchro conversion technology whether in meeting the precision demands for ruggedness in MIL spec requirements or the high-level needs of designers for tough, enduring industrial applications.

Never content with synchro conversion "as is", we were the first to modularize bulky rack-size equipment, the first to introduce thick-film hybrid synchro converters and the first to apply both thick-and thin-film technology to this, our major area of activity . . . synchro conversion.

The result is the broadest line of high-quality S/D and D/S products available anywhere. Products that use MIL-grade components throughout . . . products that achieve MTBF ratings in the hundreds of thousands of hours.

From our offerings, you can select whatever you need from single-channel, single-speed modules to the most sophisticated multiplexing converters ever developed. These are complemented with a full array of test instrumentation, building blocks, amplifiers, translators and every other

device in high-performance synchro conversion all the way through to complete systems.

If you're into data conversion, you are entitled to a free copy of our SYNCHRO CONVERSION HANDBOOK. This is the most complete, authoritative work on the subject that was ever compiled. Its 96 pages are filled with drawings, tables, illustrations and references that will be invaluable to you in your work. If you don't own a copy of this invaluable reference manual, get yours today. Just drop us a line on your company letterhead!



# DDC

## ILC DATA DEVICE CORPORATION

A wholly owned subsidiary of ILC Industries, Inc.

ILC DOVER is the sole designer and manufacturer of the Apollo, Skylab and Shuttle space suits



Airport International Plaza/Bohemia, Long Island, NY 11716

(516) 567-5600 TWX:510-228-7324

West Coast: 7337 Greenbush Ave., N. Hollywood, CA 91605 • (213) 982-6454

Interested engineers, write or call Harry Lewis or request data sheets.

CIRCLE NUMBER 75

# DDC - world's leader in synchro conversion





# New products

## Op amps jump ahead with less drift and more drive

Operational Amplifier Specifications	Military Types (-55 to 125 C)			Commercial Types (0 to 70 C)		
	108A	OP-08A	OP-08B	308A	OP-08E	OP-08F
Offset voltage, $V_{os}$ (maximum at 25 C)	500 $\mu$ V	150 $\mu$ V	300 $\mu$ V	500 $\mu$ V	150 $\mu$ V	300 $\mu$ V
Offset voltage, $V_{os}$ (maximum over temp. range)	1000 $\mu$ V	350 $\mu$ V	500 $\mu$ V	730 $\mu$ V	260 $\mu$ V	450 $\mu$ V
Temperature coeff of $V_{os}$ (maximum over temp. range)	5 $\mu$ V/ $^{\circ}$ C	2.5 $\mu$ V/ $^{\circ}$ C	3.5 $\mu$ V/ $^{\circ}$ C	5 $\mu$ V/ $^{\circ}$ C	2.5 $\mu$ V/ $^{\circ}$ C	3.5 $\mu$ V/ $^{\circ}$ C
Minimum load resistance (for $\pm$ 10-V output swing)	10 k $\Omega$	5 k $\Omega$	5 k $\Omega$	10 k $\Omega$	2 k $\Omega$	2 k $\Omega$
Min. CMRR = min. PSRR (over temperature range)	96 dB	100 dB	100 dB	96 dB	100 dB	100 dB
Unit price (in 100-up quantities)	\$9.31	\$20.00	\$12.00	\$1.00	\$6.00	\$4.50

Precision Monolithics, Inc., 1500 Space Park Dr., Santa Clara, CA 95050. Shelby Givens (408) 246-9222. P&A: See table; stock (small qty), July, 1977 (large qty).

The OP-08A, a low-power precision operational amplifier, has the same pinout as the "industry standard" 108A. Yet over the full military temperature range (-55 to +125 C), it boasts one-third the voltage offset, half the offset tempco, and twice the output drive capability. But the OP-08A costs more than twice as much as the 108A, and, so far, there is no second source.

In the 0 to 70-C range, the OP-08E version outshines the popular 308A with about a 3:1 improvement in offset and 2:1 in offset tempco. Furthermore, the new unit has five times the output drive of the 308A. And its offset-voltage error over the entire range is half the 308A's guaranteed error at 25 C.

The table compares the top four grades of the OP-08 with the 108A/308A originated by National Semiconductor, Santa Clara, CA, and now made by many other manufacturers.

The OP-08A and B have the same minimum gain (40 V/mV), with a 5-k $\Omega$  load, as the 108A has with 10 k $\Omega$ . Like the 308A, the OP-08E and F have

a minimum gain of 60 V/mV with a 10-k $\Omega$  load. But gain can drop to 25 V/mV when the load is 5 k $\Omega$ .

The key to the OP-08's low tempco is its thermally symmetric chip layout, according to PMI's design engineering manager, George Erdi. The input stage is a quad-connected transistor pair with balanced geometry that inherently cancels the effects of both thermal gradients and diffusion gradients.

Zener-zap trimming is used to null the offset voltage at the wafer-sort production stage. Tests and selection of the packaged units yield the various grades of OP-08s as well as PMI's output of second-source 108As and 308As.

An internally compensated 108 called the 112 is available from National. And PMI's internally compensated OP-08, the OP-12, has the same specs and prices as all four grades of the OP-08. But while PMI offers a premium version of the OP-12, the OP-12A, no one makes an "A" version of National's 112.

The OP-12 die is the same as the OP-08, except that its 30-pF compensating capacitor is metalized. However, since the OP-12 chip is 40% smaller than the 112, its yield may be superior.

CIRCLE NO. 301

## Counter/prescaler runs at 1.5 GHz, needs 600 mW

Plessey Semiconductors, 1674 McGaw Ave., Irvine, CA 92714. Dennis Chant (714) 540-9945. \$36 (100 qty); stock.

Operating at frequencies in excess of 1.5 GHz, the SP8619B, a  $\div$ 4 counter dissipates less than 600 mW, typically. The circuit works over 0 to 70 C and will trigger accurately with a sine wave input from 1.5 GHz down to 150 MHz, or all the way down to dc with inputs whose slew rate is at least 200 V/ $\mu$ s. The SP8619B has a dynamic input range of 0.4 to 1.2 V, two complementary emitter-follower outputs that will drive 100  $\Omega$  lines, and ECL-III compatibility.

CIRCLE NO. 320

## Plastic power transistor series handles 15 A

Texas Instruments, P.O. Box 5012, Dallas, TX 75222. Ken Renard (214) 238-2011. From \$9.70 (1000 qty.); stock.

Designated the TIP73, TIP73A, TIP73B, TIP73C, TIP74, TIP74A, TIP74B and TIP74C, a series of TO-220AB transistors is designed to replace the 2N6488, 2N6491, D44H10, and D44H11 series. The transistors can handle 15 A and have a maximum safe operating region of 40 V at 2 A and a collector cutoff current of 50  $\mu$ A, maximum.

CIRCLE NO. 321

## Avalanche diodes provide voltages of 2.8 to 10 V

Codi Corp., Pollitt Drive, Fair Lawn, NJ 07410. John Halgren (201) 797-3900. 100 to 999 prices: \$2.05 (LNA), \$1.75 (GLA); stock.

The LNA328 to 3100 and GLA28 to 100 low-noise, sharp-breakdown avalanche diodes have characteristics which closely approach those of the theoretical diode. Zener voltages range from 2.8 to 10 V in both series and noise density is controlled to 1  $\mu$ V/ $\sqrt{\text{Hz}}$  for the LNA series and 4  $\mu$ V/ $\sqrt{\text{Hz}}$  for the GLA series. Both series come in DO-7 packages, can dissipate 600 mW and operate over -65 to 175 C.

CIRCLE NO. 322



## Stepper-motor driver made for 4-phase units

North American Philips, Cheshire Ind. Pl., Cheshire, CT 06410. L.J. Torok (203) 272-0301. \$4.75 (100 qty); 6 wks.

Able to drive a four-phase stepper motor, the SAA1027 IC driver can deliver 350 mA per phase. The circuit, housed in a 16-pin DIP, needs no external power stages, can operate from a 12-V supply and is designed for high noise immunity so it can share the supply with the motor.

CIRCLE NO. 323

## Printer control chip has character generator

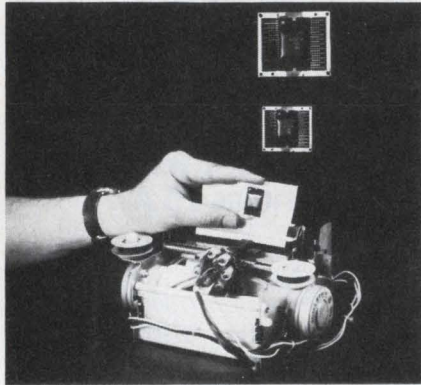

Rockwell International, Microelectronic Device Div., 3310 Miraloma Ave., P.O. Box 3669, Anaheim, CA 92803. (714) 632-2321. \$17.75 (1000 qty.); stock.

An LSI printer controller chip, designed to interface to the dot matrix printer mechanism made by LRC, Inc., Riverton, WY, replaces about 40 TTL packages normally required to control the matrix print mechanism. In addition to interfacing the printer with Rockwell PPS-4 and -8 microprocessor systems, the controller can be used directly with other microcomputers since it is TTL or CMOS compatible. It accepts up to 64 bytes with each byte representing either a character or control code. Requiring a 15-V supply, the controller has a built-in 5 x 7 character generator that can produce single or double width characters. The circuit generates single or multiple paper feeds in forward or reverse directions with each print command and also controls the paper-form hold solenoid, and senses the top of the form, the print head, and paper feed switches for proper operation of the printer.

CIRCLE NO. 324

## Quad comparators make decisions in just 130 ns

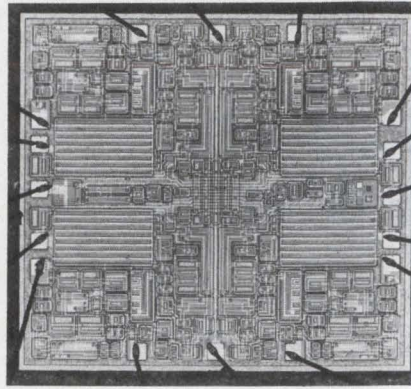

Harris Semiconductor, P.O. Box 883, Melbourne, FL 32901. (305) 724-7407. From \$4.95 (100-qty.); stock.

The HA-4900 and HA-4905 quad comparators offer a response time of 130 ns with 5-mV overdrive and an offset voltage of 2 mV. With an offset current of 10 nA and no channel-to-channel crosstalk, the comparators can sense signals at ground level while being operated from either a single +5-V supply or from dual supplies of up to ±15 V. The output stage of the HA-4900/4905 has its logic levels controlled by two separate logic supply pins so that the output can be made compatible with any logic family. Both devices come in 16-pin ceramic DIPs but the 4900 operates over -55 to 125 C while the 4905 operates over 0 to 75 C.

CIRCLE NO. 325

## 16-k UV PROM requires just 5 V for operation

Intel Corp., 3065 Bowers Ave., Santa Clara, CA 95051. Jim Coe (408) 246-7501. \$112 (100-qty.); stock.

The densest UV PROM, the 16,384-bit 2716, operates from just a +5-V supply for normal read operations. However, in the programming mode, a +26-V supply is also required. And, there is no requirement for externally switching the +26-V supply to obtain the pulsed signal necessary for programming. Access time on the 2716 is 450 ns and power dissipation in the read mode is 525 mW. Another feature not available in any UV EPROM is a standby mode in which the 2716 can be deselected and require just 125 mW. Programming time for all words is about 100 s, while programming time for one word is just 50 ms. The 2716 comes in a 24-pin package that is plug compatible with the 2316E mask-programmable 16-k ROM.

CIRCLE NO. 326

# Call your nearest ISC sales representative.

**ALABAMA:** Huntsville  
W. A. Brown Inst. Inc. 205/539-4411  
**ARIZONA:** Phoenix  
Thorson Co. 602/956-5300  
**CALIFORNIA:** Goleta  
Thorson Co. 805/964-8751  
**CALIFORNIA:** Los Angeles  
Thorson Co. 213/476-1241  
**CALIFORNIA:** Mountain View  
Thorson Co. 415/964-9300  
**CALIFORNIA:** San Diego  
Thorson Co. 714/298-8385  
**CALIFORNIA:** Tustin  
Thorson Co. 714/544-5121  
**COLORADO:** Denver  
Thorson Co. 303/759-0809  
**FLORIDA:** Ft. Lauderdale  
W. A. Brown Inst. Inc. 305/776-4800  
**FLORIDA:** Melbourne  
W. A. Brown Inst. Inc. 305/723-0766  
**FLORIDA:** Orlando  
W. A. Brown Inst. Inc. 305/425-5505  
**FLORIDA:** Valparaiso  
W. A. Brown Inst. Inc. 904/678-7932  
**GEORGIA:** Atlanta  
W. A. Brown Inst. Inc. 404/939-1674  
**ILLINOIS:** Arlington Hts.  
Future Systems 312/640-6091  
**LOUISIANA:** Gretna  
W. A. Brown Inst. Inc. 504/366-5766  
**MARYLAND:** Bethesda  
Bartlett Assoc. 301/656-3061  
**MASSACHUSETTS:** Framingham  
Bartlett Assoc. 617/879-7530  
**MICHIGAN:** Madison Hts.  
WKM Associates 313/588-2300  
**NEW MEXICO:** Albuquerque  
Thorson Co. 505/265-5655  
**NEW YORK:** White Plains  
Bartlett Assoc. 914/949-6476  
**NORTH CAROLINA:** Durham  
W. A. Brown Inst. Inc. 919/682-2383  
**OHIO:** Cleveland  
WKM Associates 216/267-0445  
**OKLAHOMA:** Norman  
Data Marketing Assoc. 405/364-8320  
**PENNSYLVANIA:** Pittsburgh  
WKM Associates 412/892-2953  
**PENNSYLVANIA:** Wayne  
Bartlett Assoc. 215/688-7325  
**SOUTH CAROLINA:** Columbia  
W. A. Brown Inst. Inc. 803/798-3297  
**TENNESSEE:** Knoxville  
McCoin Elec. Equip. 615/584-8411  
**TEXAS:** Austin  
Data Marketing Assoc. 512/451-5174  
**TEXAS:** Dallas  
Data Marketing Assoc. 214/661-0300  
**TEXAS:** Houston  
Data Marketing Assoc. 713/780-2511  
**TEXAS:** San Antonio  
Data Marketing Assoc. 512/828-0937  
**WASHINGTON:** Bellevue  
Thorson Co. 206/455-9180  
**AUSTRALIA:** Mt. Waverly, Victoria  
Anderson Digital Elec. 03-543-2077  
**CANADA:** Montreal  
Cantec Rep. 514/620-3121  
**CANADA:** Ottawa  
Cantec Rep. 613/225-0363  
**CANADA:** Toronto  
Cantec Rep. 416/624-9696  
**EUROPE:** England  
Techex, Ltd. 0202-293-115  
**EUROPE:** France  
Peritex 749-40-37  
**EUROPE:** Switzerland  
Interest, AG 031-224481  
**JAPAN:** Tokyo  
Munzing International 586-2701



**Intelligent Systems Corp.**



# What's the big difference between the Intecolor 8051 Desk Top Computer and the IBM 5100?

## The price tag, for openers.

**\$3995\***  
Intecolor 8051

We've developed a very unique sales philosophy with the Intecolor 8051. We're simply out to give you more desk top computer for less money than anybody in the world. Just compare the capabilities and price of the Intecolor Desk Top Computer with any unit on the market, and you'll see.

Take the Intecolor 8051 versus the IBM 5100, for example. You get the same high-level BASIC Language with both units. But the Intecolor 8051 gives you 8 colors to work with instead of the antiquated, black and white IBM format. Study after study has proven that color means more efficient man-machine interaction, a reduction in operator fatigue, and better use of operator time. And we all know what time is. Money.

Now compare screen sizes. The Intecolor 8051's got a big, 19" diagonal screen that can display up to 3,840 characters — in color. On the other hand the IBM 5100 screen measures a meager 5"x6". But that's not bad if you've got 10/10 vision. And don't forget memory. Sure you can expand both units to 64K, but the Intecolor comes stock with 26K of memory compared to the IBM's 16K. And graphics? The IBM 5100 can't touch the graphics capabilities of the Intecolor 8051. Not by a long shot. But that's understandable, because not many computers can.

And here's the real zinger. Compare prices. The Intecolor 8051 Desk Top Computer retails for a modest \$3995, while the IBM 5100 starts at a whopping \$8500. That's a lot to pay for a name, especially when you can get a better unit for less than half the price.

The Intecolor 8051 Desk Top Computer. It's selling now for just \$3995. And at that price you can probably afford two. Call us today with your order and we'll prove it to you.

\*Domestic USA Prices



**Intelligent Systems Corporation®**

5965 Peachtree Corners East  
Norcross, Georgia 30071  
Telephone (404) 449-5880

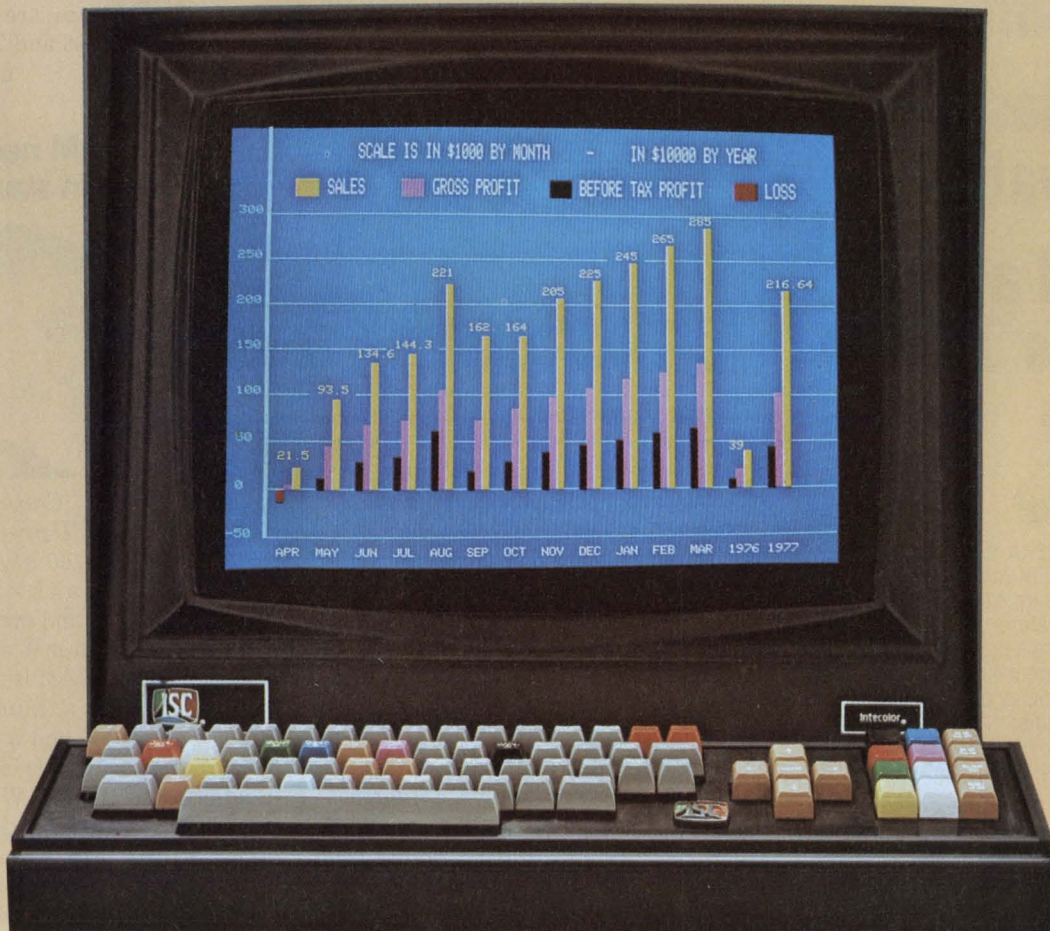

Unretouched photograph of screen.

CIRCLE NUMBER 76



# Now! 25/35 Amp PRESSFIT SCRs...

with any  
gate sensitivity  
you want...

voltages  
to 800V.

unsurpassed  
surge current  
capability...

and glass  
passivation...

priced as low  
as \$1.15!



Type IR30, IR32, 20RA, 21RA, 22RA and 23RA with voltages to 800V and minimum  $I_{GT}$  from 1 to 100 mA. Unsurpassed surge capability and high temperature stability from hard glass passivation to help make them the most reliable pressfits around. Delivery from stock! Call your IR Distributor or Sales Office today. International Rectifier, 233 Kansas, El Segundo, CA 90245. Phone (213) 322-3331, Telex: 66-4464.

## International Rectifier

... the innovative semiconductor people

CIRCLE NUMBER 77

## ICs & SEMICONDUCTORS

### Photodiode/CCD arrays have up to 1728 cells

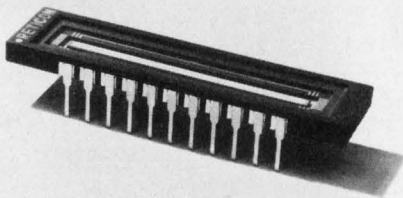

Reticon Corp., 910 Benicia Ave., Sunnyvale, CA 94086. John Rado (408) 738-4266.

Combining both photodiodes and charge-coupled devices in arrays, the CCPD series of solid-state sensors come with 256, 1024 or 1728 elements. All arrays are mounted in optical window ceramic DIPs with up to 22 pins and have the elements diffused on 16  $\mu$  centers. The actual sensing aperture is made from interdigitated photodiodes which transfer their sensed light value into two CCD shift registers that, in turn, feed on-chip output charge-detection circuits. This circuit arrangement has a small output capacitance, and when the CCD outputs are multiplexed off-chip to obtain a full-wave boxcar video output, the fixed pattern noise can be substantially reduced. Dark currents of the CCPD are claimed to be at least an order of magnitude below those available in CCD arrays. The arrays require +12 and -5-V supplies for a total power of 70 mW.

CIRCLE NO. 327

### Power transistors switch fast & handle 400 V

Silicon Transistor Corp., Katrina Rd., Chelmsford, MA 01824. William Schromm (617) 256-3321. 100 qty. prices: \$2.25 (2N6542), \$2.85 (2N6543); stock.

Able to handle 5 A of collector current the 2N6542 and 6543 npn switching transistors have  $V_{CEO}$  sustaining voltages of 300 and 400 V, respectively. The TO-3 housed transistors have a storage time of 4  $\mu$ s and rise and fall times of about 0.8  $\mu$ s, when measured with a collector voltage of 125 V and a current of 3 A. Dc current gain is a minimum of 12 at an  $I_C$  of 1.5 A while the second breakdown energy is 180  $\mu$ J, minimum with an  $I_C$  of 3 A, a  $V_{BE}$  of 4 V and an inductive load of 40  $\mu$ H.

CIRCLE NO. 328

### High voltage transistors come in pnp & npn types

Solid State Devices, 14830 Valley View Ave., LaMirada, CA 90638. Dee Peden (213) 921-9660. From \$11 (100 qty); 30 days.

Two series of pnp and npn power transistors provide a total of 10 devices. There are four pnp units in the 2N5091 series and they have collector-base voltages from 350 to 500 V with a 100  $\mu$ A collector current, collector-emitter voltages from 300 to 450 V with collector currents of 50 mA, and an emitter-base voltage of 6 V. Collector-emitter saturation voltage is 3 V with a 25 mA  $I_C$  and a 2.5 mA base current. Base-emitter voltage is 1 V at an  $I_C$  of 25 mA. The six npn devices in the 2N5092 series offer collector-base voltages from 400 to 800 V with a 100  $\mu$ A  $I_C$ , collector-emitter voltages from 350 to 550 V with an  $I_C$  of 50 mA, and an emitter-base voltage of 6 V. Base-emitter voltage is 1 V with a 25 mA  $I_C$  and 5 V collector-emitter bias. Collector-emitter saturation voltages are 0.5 V with an  $I_C$  of 25 mA and an  $I_B$  of 2.5 mA. Continuous dissipation for both series is 2 W at 100 C with a linear derating factor of 26.7 mW/ $^{\circ}$ C above 100 C. The devices are available in TO-5, TO-46, TO-66 and TO-111 cases.

CIRCLE NO. 329

### 4-k static RAM needs just 27 mW in standby



Mostek, 1215 W. Crosby Rd., Carrollton, TX 75006. Derrell Coker (214) 242-0444. \$18.75 (100 qty); stock.

The MK4104P-3 a 4 k  $\times$  1 static RAM accesses in 200 ns and cycles in 310 ns. Requiring only 165-mW active and 27-mW standby the RAM is directly TTL-compatible with a minimum input "one" level of 2 V and a "zero" of 0.8 V. The output will drive four TTL loads in addition to 100 pF. When the  $V_{CC}$  is reduced, data retention is maintained at less than 0.3  $\mu$ W/bit (typ), allowing a true battery back-up static RAM system. The MK4104 comes in 18-pin ceramic DIPs.

CIRCLE NO. 330



## Four-channel coupler isolates I/O by 1500 V

Hewlett-Packard, 1501 Page Mill Rd., Palo Alto, CA 94304. (415) 493-1501. \$44 (100 qty); stock.

Offering four independent opto-couplers in a 16-pin hermetic DIP, the HPCL-2770 provides up to 1500 V of isolation. Each coupler has a 300% current transfer ratio at an input current of 0.5 mA. Output saturation voltage is 0.1 V typical and the maximum output current is 40 mA/channel. Performance of the circuit is guaranteed over a -55 to 100-C range and operation from 1.8-to-18-V supplies is possible.

CIRCLE NO. 331

## Video game circuit offers seven games

Synertek, 3050 Coronado Dr., Santa Clara, CA 95051. Jack Balletto (408) 984-8900. \$9.00 (5000 qty); stock.

The C10091 video game circuit contains logic for seven video games and the necessary audio visual signal generators. Both horizontal and vertical paddle motion as well as a ball speed select are available. All seven games are displayed in color, with four audio tones to complement each game. Game scores are also displayed. Included in the chip are hockey, table tennis, hand ball, squash, practice hockey/soccer, practice ping-pong/table tennis, practice hand ball/squash, and a target game. The C10091 comes in a 40-pin plastic DIP, requires 12 V at 40 mA and comes in two scan versions—one for U.S. systems and one for PAL receivers.

CIRCLE NO. 332

## Bridge rectifiers get UL recognition

International Rectifier, 233 Kansas St., El Segundo, CA 90245. (213) 322-3331. From \$2.40 (100 qty); stock.

Molded bridge assemblies with operating current ratings ranging from 7.5 to 30 A have been extended recognition by Underwriters Laboratories. The molded units have a complete diode bridge for power rectification in a package 1.12-in. square and 0.85-in. high. Units assigned UL recognition include the 75JB rated for 7.5 A, the 100JB for 10 A, the 150JB for 15 A, the 250JB for 25 A, and the 300JB for 30 A. For each bridge type, voltage ratings are available from 50 to 600 V.

CIRCLE NO. 333

# Our attenuators will always level with you.



### Honest attenuation.

In your equipment or on the bench, Telonic Attenuators provide reliable "specs or better" performance. We make sure, because we use them in our own instruments.

Our thick film resistive elements are made in-house to assure you of top quality. Their operating parameters enable us to guarantee accuracies in some models to  $\pm .02$  dB, frequency coverage to 4GHz and power-handling capabilities up to 25 watts. Here's the selection, in 50- or 75-ohm versions:

#### Variable (Rotary) Types

1, 10, 69, 100, or 110 dB ranges  
0.1, 1.0, and 10 dB steps,

#### Fixed Value Types

3, 6, 10, 20, 30, 40, 50, or 60 dB  
SMA, TNC, BNC, or N connectors.

Telonic also supplies bench-top versions incorporating sequenced rotary models, and special versions to fit your requirements. Call us TOLL

FREE (except in Calif.) for further specs, prices, more information, or our new Attenuator Catalog. Telonic Altair, 2825 Laguna Canyon Road, Box 277, Laguna Beach, CA 92652. Phone: 714/494-9401  
TOLL FREE: 800-854-2436.

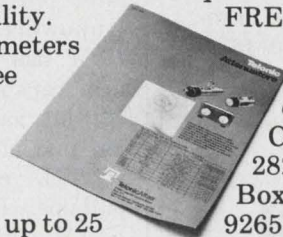

**TelonicAltair**

CIRCLE NUMBER 78



## an investment in capitol buys rugged switch design and long, trouble-free life

For Example!  
Our Extremely Dependable, Multiple-Position Push Button Strip Switches

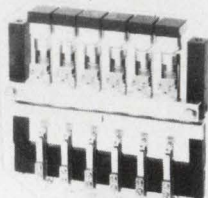

Basic frames are anodized aluminum. Plungers are 5/32" square brass with a nylon actuator molded on them. Hence, they will not bend or warp.

Mechanical linking of all switch positions prevents operation of more than one position at a time. A released button will return to the "up" position before the next button can be actuated. These switches can be illuminated either by an external circuit or directly from the switch. Lamps do not travel when positions are engaged, eliminating shock to the bulb.

Capitol switches are tested with 2 to 3 million operations to assure life-long, trouble-free performance.

Our 28-page catalog will give you all the "specs" on CAPITOL's entire line of quality switches. **CAPITOL SWITCHES are rated at 3 Amps, 110 Volts AC, non-inductive.**



CAPITOL manufactures a complete, high-quality line of push button and lever switches — illuminated if desired — standard and custom designs to fit your every need.

# CAPITOL

The Capitol Machine and Switch Co.  
87 Newtown Road, Danbury, Conn. 06810  
Phone: 203-744-3300

CIRCLE NUMBER 79

## ICs & SEMICONDUCTORS

### Precision reference delivers 2.5 V ± 1%

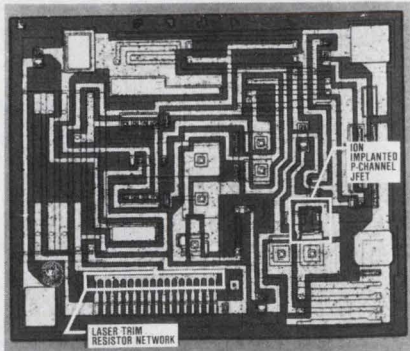

Motorola Semiconductor Products, P.O. Box 20912, Phoenix, AZ 85036. Lothar Stern (602) 244-6900. From \$1.50 to \$12 (100 qty.); stock.

Providing a 2.5-V reference output, the MC1403/1503 monolithic circuit has a maximum output voltage variation of only 1% ( $\pm 25$  mV). The reference has a typical temperature coefficient of ( $\Delta V_o/\Delta T$ ) of 10 ppm/ $^{\circ}$ C. Line regulation of the circuit is 3 mV (max) over an input range of 4.5 to 15 V and 4.5 mV (max) over 15 to 40 V. Load regulation is 10 mV (max) at output currents from 1 to 11 mA. The 1403 is specified for 0-to-70-C operation and has worst-case voltage drifts of 25 or 40 ppm/ $^{\circ}$ C. The 1503 operates over -55 to 125 C and has versions with drifts of 55 or 25 ppm/ $^{\circ}$ C. CIRCLE NO. 334

### Electrically alterable ROM holds 4096 bits

General Instrument, Microelectronics Div., 600 W. John St., Hicksville, NY 11802. Bryan Cayton (516) 733-3107. \$32 (100-up); stock.

Organized as 1024  $\times$  4, the ER-3401 electrically alterable ROM requires only 10 ms for erase and 1 ms for write. And each individual word can be selectively erased and rewritten without any effect on the rest of the memory. Unpowered, the word-alterable ROM has a nonvolatile data storage capability of 10 years. The ER3401 has an access time of 950 ns, maximum, 700 ns typical, and is TTL compatible with resistor pull-ups. Requiring +5, -12 and -30-V supplies, the EAROM consumes about 400 mW and is housed in a 22-pin ceramic DIP. The EAROM has four operating modes, controlled by two input lines: read, write, word erase and bulk erase. CIRCLE NO. 335

### PLL synthesizer delivers frequencies for AM & FM

Signetics, 811 E. Arques Ave., Sunnyvale, CA 94086. (408) 739-7700. \$13.65 (100 qty); stock.

Using digital phase-locked-loop techniques to generate rf signals, the 8X08 synthesizer combines low-power Schottky and emitter-coupled logic on a single chip. The circuit operates with input signals of up to 80 MHz. On board the chip are a reference oscillator, an ECL prescaler, a divider chain, a phase comparator, and a programmable counter chain for channel selection. A VCO and loop filter are all that are required to complete a synthesizer. In the 8X08 the ECL prescaler makes possible programmable channel spacing to 100 kHz for FM-receiver local oscillator generation, when using a 3.6-MHz reference oscillator crystal and an external  $\pm 2$  circuit. Operating features of the circuit include maximum power dissipation of 680 mW and a single 5 V power supply. The 8X08 comes in an 18-pin DIP.

CIRCLE NO. 336

### Npn power transistors switch in just 250 ns

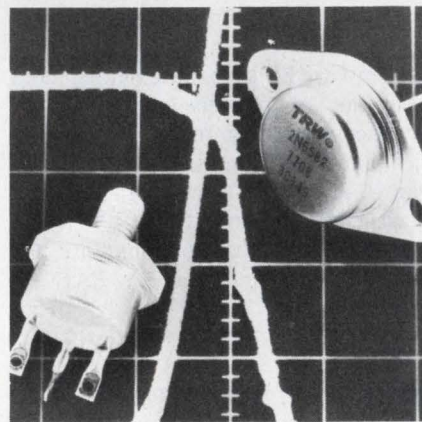

TRW Power Semiconductors, 14520 Aviation Blvd., Lawndale, CA 90260. John Power (213) 679-4561. \$5.40 (100 to 999); stock.

A series of six npn power switching transistors, the 2N6582 series, has switching times of 250 ns. The collector-emitter sustaining voltage for the devices ranges from 350 to 450 V and the continuous collector current is 10 A. For all units the  $V_{CE(sat)}$  is less than 1.5 V at an  $I_C$  of 7 A while dissipation for the devices is 125 W at 25 C. The junction operating and storage temperature range is -65 to 200 C, and the transistors are available in T0-3 or T0-61 (isolated) packages. CIRCLE NO. 337



## Power transistors switch 30 A in less than 4 $\mu$ s

International Rectifier, 233 Kansas St., El Segundo, CA 90245. (213) 322-3331. 100 qty. prices: \$2.70 (3773), \$3.05 (6302); stock.

Handling a peak collector current of 30 A, the IR3773 and 6302 npn power transistors also offer a gain-bandwidth product of 1 MHz. Both units have a rise time of 1.5  $\mu$ s, a storage time of 2  $\mu$ s and fall time of 1.8  $\mu$ s. The IR6302 is rated for a  $V_{CEO}$  of 140 V and IR3773 for 160 V. Maximum dissipation for each type is 200 W at a temperature of 25 C for their TO-3 cases. Saturation voltage for each type is 2 V at 16-A continuous collector current, and the minimum dc current gain is 15 at 8 A and 4 V.

CIRCLE NO. 338

## Zener and LVA diode chips handle up to 1 W

Transistor Specialties, 484 Lowell St., Peabody, MA 01960. Tom Parsons (617) 535-1533. 10 to 99 qty. prices: \$0.80 to \$1.60 (zener), \$1.60 to \$3.20 (LVA); stock.

A series of low voltage avalanche diode (LVA) and zener diode chips come in tolerances of  $\pm 1$ , 5, or 10% and are 100% tested to the electrical parameters specified. Breakdowns in the 4-to-10-V range are available and all chips have a power rating of 1 W. The chips can be mounted to substrates by eutectic techniques or with solder pastes that do not require temperatures above 425 C.

CIRCLE NO. 339

## Npn transistors handle 8 A of collector current

Silicon Transistor Corp., Katrina Rd., Chelmsford, MA 01824. William Schramm (617) 256-3321. 100-qty prices: \$3.75 (6544), \$4.75 (6545); stock.

Able to handle 8 A continuous collector current the 2N6544 and 6545 npn transistors provide  $V_{CEO}$  sustaining voltages of 300 and 400 V, respectively. The transistors can switch resistive loads in under 6  $\mu$ s with a  $V_{CC}$  of 125 V and an  $I_C$  of 5 A. Both units have an  $h_{FE}$  of 12, minimum, at an  $I_C$  of 2.5 A and a  $V_{CE}$  of 3 V. At 5 A the  $h_{FE}$  drops to 7, minimum. Either transistor can dissipate 125 W at 25 C and both have a  $\theta_{JC}$  of 1.4 C/W in their hermetic TO-3 cases.

CIRCLE NO. 340

## Looking for fast, sure relief from circuit stability problems?

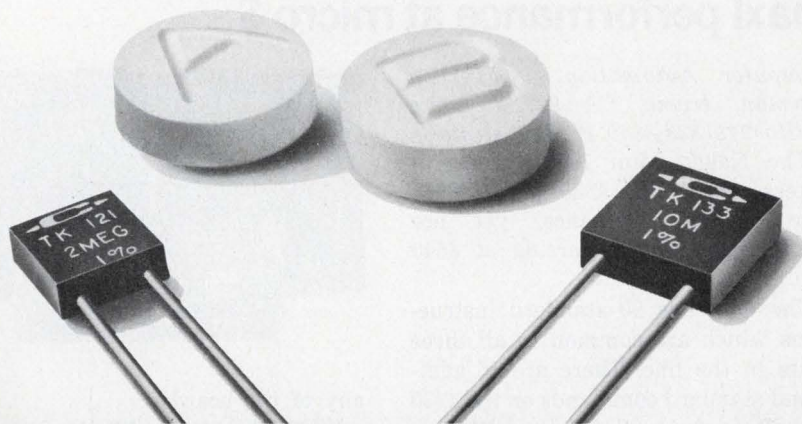

## Only Caddock's Type TK Temp-Stable Precision Film Resistors have all seven high performance advantages:

### 1 Ultra-Low Temperature Coefficients.

Both models can be delivered with TCs of either 10 ppm/ $^{\circ}$ C or 5 ppm/ $^{\circ}$ C over the entire temperature range from  $-55^{\circ}$ C to  $+125^{\circ}$ C!

### 2 Extended Resistance Range.

From 1000 ohms to 10 Megohms in a standard miniature CK 06 rectangular case.

### 3 Exceptional Long-Term Stability.

Better than  $\pm 0.05\%$  per 2000 hours of operation!

### 4 Big Power in a Small Size.

Wattage ratings at  $+125^{\circ}$ C are .3 watts in the .250" square case and .4 watts in the .300" square case.

### 5 Precision Tolerances.

$\pm 1\%$  is standard and tolerances as tight as  $\pm 0.05\%$  are available.

### 6 Rugged Construction.

Ultra-stable Tetrinox<sup>TM</sup> resistance films are fired onto solid ceramic substrates and molded in a silicone case for no-shift performance through extremes of power, temperature and the many environmental conditions of Mil-R-55182/9.

### 7 Non-Inductive Performance.

Caddock's Non-Inductive Design delivers maximum pulse fidelity in all types of wide-band circuitry.

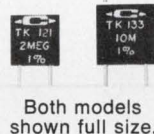

Both models shown full size.



Why is Caddock the only company that delivers all of these advantages? Because only Caddock has over 14 years of experience with the unique complex-oxide technology that has now perfected the Tetrinox<sup>TM</sup> high stability resistance system.

What more can you ask for? Ask for price and delivery information. The moderate prices of Type TK resistors can instantly reduce the pain that accompanies 'profit squeeze,' and Caddock's 6-to-8 week "always-on-time" delivery provides fast, sure relief from both inventory and production scheduling headaches.

So remember, when you need precision resistors that give long-lasting, seven-way relief from circuit stability problems, there's only one resistor company to call:

**CADDOCK**  
ELECTRONICS, INCORPORATED

3127 Chicago Ave., Riverside, Calif. 92507 • Phone: (714) 683-5361 • TWX: 910-332-6108

CIRCLE NUMBER 80



## Single-board minis deliver maxi performance at micro \$

Computer Automation, 18651 Von Karman, Irvine, CA 92713. Larry Lotito (714) 833-8830. P: See text; stock.

The Naked Mini 16-bit minicomputers—the 4/10, 4/30 and 4/90—give high performance, yet are available at prices starting at \$645 in unit quantities.

The 4/10 has 90 standard instructions which are common to all three units in the line. There are 16 additional standard commands on the 4/30 and 29 on the 4/90. Optional instructions are also available: 37 for the 4/10, 24 for the 4/30 and 26 for the 4/90. Execution times average 4  $\mu$ s with the 4/10's custom NMOS processor, 2  $\mu$ s with the 4/30's TTL processor, and 1  $\mu$ s with the 4/90's Schottky-based processor.

For \$645, the 4/10's 7.5  $\times$  15-in. board contains up to 4 kwords of ROM, PROM or static RAM and four I/O channels. The faster minis are both built on 15  $\times$  17-in. boards.

All three computer boards are available in packaged versions. A three-slot cabinet with a 17-A, 5-V supply houses

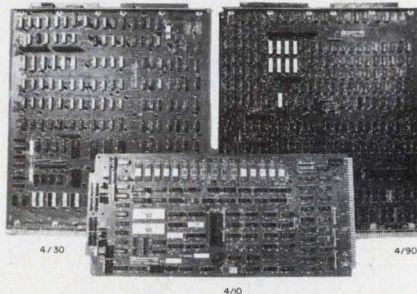

any of the boards.

With cabinet, 4 k of RAM, operator's console and four I/O channels, the 4/10 costs \$995—about the same cost as a fully assembled 8-bit microcomputer. The 4/30 comes with 16 k of RAM and costs \$3495 while the 4/90 includes 64 k of RAM for \$9950.

Available software includes two assemblers, Omega and Macro, which come in three versions; a 4-k, an 8-k with editor, or a 12-k with additional macro features. Also available are loaders, dumps, debuggers and such high-level languages as Basic, Fortran IV, Pascal and Macro.

CIRCLE NO. 310

## Microcomputer system has disc-based programs

Ohio Scientific Instruments, 11679 Hayden St., Hiram, OH 44234. Charity Cheiky (216) 569-7945. \$2599; stock.

A completely integrated microcomputer system, built around the 6502 microprocessor, includes a terminal, floppy disc and Challenger 65 CPU. The basic system includes 16 kbytes of RAM, system monitor and disc bootstrap PROMs, and serial interface. Software included in the system consists of a disc operating system, a disc-based resident assembler/editor, a line editor with general text-editing capability, a debugging and utility package plus an 8-k Basic program and program library. Optional items include a dual-disc drive, two line printers, extra RAM boards, I/O boards, graphics display board and cassette interfaces.

CIRCLE NO. 341

## Diskette-based Basic runs on 8080 or Z80s

iCom Div. of Pertec Computer Corp., 6741 Variel Ave., Canoga Park, CA 91303. (213) 348-1391. \$50; stock.

A version of Basic, dubbed Basic-M, has routines and instructions optimized for microcomputers and floppy-disc operating systems. The software, available on diskette, operates with any microcomputer that is based on the 8080 or Z80  $\mu$ P. Basic-M adds five commands to the standard Basic set for moving data to and from the disc. The commands Input to disc, Open, Close, Read and Write allow "conversation" with the disc to organize and manage files by names rather than by internal addresses. Numerical data can be stored in floating point scientific notation or as whole numbers.

CIRCLE NO. 342

## IEEE-488 bus coupler handles many instruments

Fairchild Camera and Instrument, 1725 Technology Dr., San Jose, CA 95110. Gordon Daggy (408) 998-0123. From \$574 to \$845; stock.

Able to link test and measurement hardware to the popular IEEE-488 bus, the 4880  $\mu$ P-based interface contains the bus drivers, logic and memory needed to convert data to the right code. The 4880 is available in three versions. As a talker, the coupler can be used to output data from any instrument onto the 488 bus. As a listener, the coupler can be used to control programmable devices or to just output parallel data. And, as a talker/listener, the 4880 can take data from a programmable piece of instrumentation hardware, or accept program controls from the system controller and pass them onto the instrumentation. The coupler measures 8.5  $\times$  3  $\times$  10 in. (215.9  $\times$  76.2  $\times$  254 mm) and weighs 7 lb.

CIRCLE NO. 343

## Silent 700 terminals now offer APL characters



Texas Instruments, P. O. Box 1444, M/S 784, Houston, TX 77001. D.B. Fullerton (713) 494-5115. \$175 above terminal cost of \$1395 (743) and \$1995 (745); September.

APL keyboard options on the Silent 700 portable data terminals are available for the 743 and 745 versions. The KSR hard-copy terminals provide 30 character/s print rates and use a 5  $\times$  7 dot matrix. The APL option includes a switch-selectable APL/full ASCII keyboard. When the APL mode is selected in either terminal, the special APL symbols and standard alpha characters are generated using the upper 5  $\times$  5 portion of the 5  $\times$  7 dot matrix printhead. The 5  $\times$  5 matrix permits a true underscore capability which is required in APL terminals.

CIRCLE NO. 344



# Just as you can count on Newton's law,



## you can count on Synchron<sup>®</sup> motors.

The synchronous motor you install in your product is likely to be the most important single component. So everything about that motor should be exactly right for your product. The speed, the torque, the price and the delivery, of course. The performance, the quality and the dependability. But, especially, its rightness for you.

What's exactly right for someone else may be exactly wrong for you. That's why it's almost impossible to find a ready-made synchronous motor



that meets your specs in every way.

We custom-make every Synchron motor. At a competitive price. To fit your needs, not ours. Delivered on time. Designed and built right, to do the job right. That's the only way we do business.

Call or write for our specification sheets and the name and location of our representative in your area.

Choose from five principal styles of Synchron motors—60 or 50 Hz—from one revolution per week to 900 rpm—from 8 thru 98 oz-in torque at 1 rpm—from hundreds of different outputs.



**HANSEN MANUFACTURING CO., INC.**

Princeton, Indiana 47670

a subsidiary of IMC MAGNETICS CORP.

We make every Synchron motor as if our name were on your product



## MICRO/MINI COMPUTING

### Video terminal handles remote or local service



Control Data Corp., Box O, Minneapolis, MN 55440. Kent Nichols (612) 853-4656. From \$1595; 30 days.

Controlled by a  $\mu$ P, the 92456 video terminal offers local or remote data entry and editing capabilities. It can display up to 24 lines of data, each 80 characters long. Data are transmitted asynchronously in half or full-duplex modes at speeds of 110 to 9600 bits per second. A detachable keyboard allows entry of 128 displayable characters, including standard 64 and 96-character, upper and lower-case ASCII sets. Also built into the keyboard is a numeric keypad.

CIRCLE NO. 345

### Fortran compiler fits in 16-kword memory

Motorola Semiconductor Products, P.O. Box 20294, Phoenix, AZ 85036. (602) 244-6454.

By eliminating the need for a large computer system to develop high-level language programs, a resident Fortran compiler from Motorola has enabled the user to slash his microcomputer-development program costs. The compiler package is available on a floppy disc for EXORciser-based  $\mu$ P development systems. The Fortran used on the compiler is a subset of ANSI-standard Fortran IV. All Fortran programs are translated into M6800 machine-level relocatable object modules. Also on the disc is a Fortran library of mathematical subroutines and run-time I/O routines. Only 16 kbytes of memory space in the EXORciser are needed to hold the working program. A floppy-disc driver, such as EXORDisk, is required to load the compiler into RAM. Available for \$500 in disc form, the M68FTNR010D compiler can be ordered from stock.

CIRCLE NO. 346

### Powerful microcomputer cycles in only 250 ns

Cromemco, 2432 Charleston Rd., Mountain View, CA 94043. Joe McCrate (415) 964-7400. \$595 (kit); \$995 (assembled); 30 days.

A complete microcomputer, built around the Z-80 microprocessor, the Z-2 has a cycle time of 250 ns. The Z-2 contains the company's CPU card, a motherboard with 21 card sockets, and a heavy-duty power supply capable of meeting most power needs (8 V at 30 A,  $\pm 18$  V at 15 A), including floppy-disc drives. All cards are compatible with the Altair bus originally developed by MITS and are contained in an all-metal housing designed for either relay-rack or bench-cabinet mounting. Bank-select on available memory boards lets the user have up to eight independent banks of memory, each with a capacity of up to 64 kbytes.

CIRCLE NO. 347

### Mini hard-copy terminal includes mini cassette

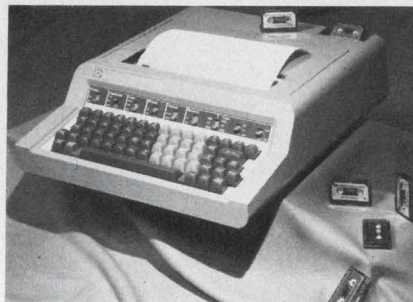

Computer Devices, 25 North Ave., P.O. Box 421, Burlington, MA 01803. K. Stofer (617) 273-1550. \$3385 (purchase) or \$165/month (1 yr. lease); stock.

The Miniterm 1204 hard-copy terminal features both a built-in mini-cassette transport for 68,000 bytes of removable storage and an integral 8-k RAM. The automatic send/receive terminal weighs less than 20 lb, and has simultaneous transmit/receive capability; tape-to-memory, memory-to-tape or either tape or memory-to-line transmission. Transmission rates of 110, 300 or 1200 baud are available and the unit's keyboard has three operator selectable modes: typewriter, TTY or special numeric pad. The printer portion can provide a 35 character per second printing speed, up to 80 characters per line, is fully buffered and is compatible with all units that use an RS-232 interface.

CIRCLE NO. 348

### Moving-head disc drives hold up to 74 Mbytes

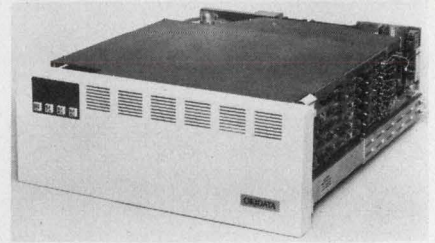

Okidata, 111 Gaither Dr., Mount Laurel, NJ 08054. Jake Powell (609) 235-2600. Unit qty. prices: \$3185 (12 Mbyte), \$4295 (74.4 Mbyte); 60 days.

The 3300 series of disc drives consists of six models of moving-head, fixed-disc units. They range in capacity from 12.4 to 74.4 Mbytes. Two other fixed-head models provide capacities of 2.97 and 5.94 Mbytes. Fixed heads can also be added to moving head models to provide a maximum of 2.2 Mbytes. The fixed head sections have an average access time of 10.1 ms and can be accessed while positioning the moving heads. The drives use a special rotary positioner that permits over 74 Mbytes to be provided in a 7 x 23.5 x 19-in. rack-mountable case. Maximum weight is 65 lb, including power supply. An optional CDC 9760 storage module is also available for \$3405 (100 qty).

CIRCLE NO. 349

### Disc-based Basic made for 8080 microcomputers

Binary Systems, 634 S. Central Expressway, Richardson, TX 75080. David Wilson (214) 231-1096. \$50 (disc), \$10 (manual); stock.

Disk Basic Etc, an interpreter for 8080-based microcomputers, is a general-purpose program suitable for business and scientific applications. Available on a floppy disc, the sector-based program, which works with the iCOM floppy-disc controller, makes available up to three memory buffer files to the user. The software includes six file manipulation commands plus Save, Load and two special integer functions, helpful in keeping track of files. Using the lower 12 kbytes of memory plus 1 kbyte of scratchpad, the program handles up to a 255-character string variable, n-dimensional arrays, variable precision arithmetic and has 19 functions plus user defined functions. Disk Basic Etc is supplied either on a 5.25-in. minifloppy disc, or on an 8-in. regular floppy, along with a comprehensive user's manual.

CIRCLE NO. 350



# This is what counters are supposed to be all about.

## Model 5740, 7-digit, 100 MHz Multifunction Counter/Timer. \$295\*

Quality you can count on. Data Precision's Model 5740 is a 7-digit, 100 MHz Timer/Counter; a superb laboratory quality instrument.

Data Precision built the 5740 to be exceptionally versatile. It measures frequency, period, period average, elapsed time and total events with the kind of accuracy, sensitivity, and upper frequency capability generally found only in higher priced units.

Consider: 10 mV RMS sine-wave to 20 MHz. 50 mV RMS at 100 MHz. That's excellent sensitivity in anyone's book. And this

sensitivity is a minimum specification (not a typical) allowing lock-in measurements from even extremely weak signals. The 100 MHz bandwidth means the 5740 handles everything from sub-audio to VHF. Seven, not six digit resolution, means 0.1 Hertz resolution at 1 MHz, 1 part in 10 million in period measurements, with the decimal point always automatically correct.

Want even more? A low-cost optional BCD output provides printer and/or computer/system compatibility while providing counter status timing and control signals as well as reading and decimal-point data.

## New Portable, 250 MHz Frequency Counter \$345.00\*



We have just introduced a miniature portable frequency counter to give you measurement capability anywhere you need it. Our Model 585 is a full 8 digit, rechargeable battery and line operated precision instrument.

Data Precision Corporation, Audubon Road, Wakefield, MA 01880, USA, (617) 246-1600. TELEX (0650) 949341.

\*Price U.S.A.

**DATA PRECISION**<sup>®</sup>  
*...years ahead*  
 CIRCLE NUMBER 82

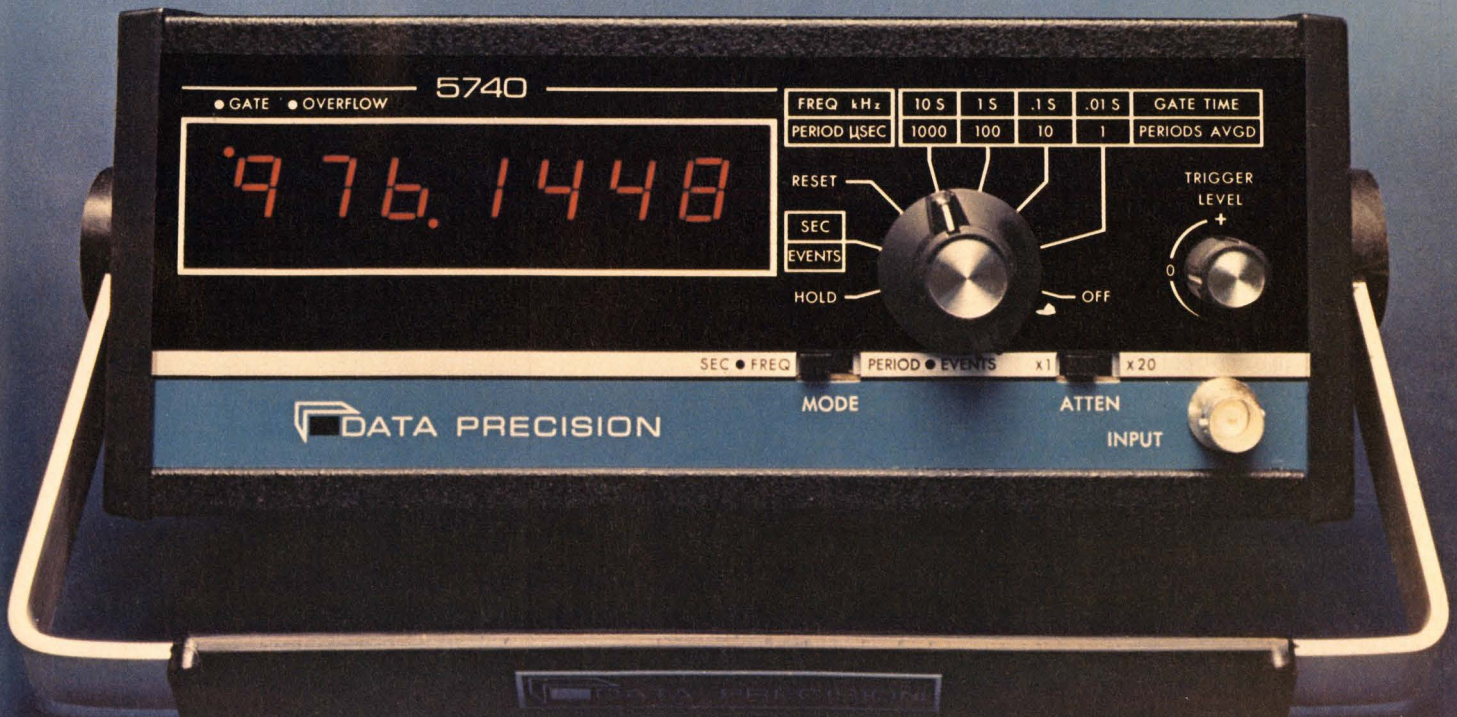



## MICRO/MINI COMPUTING

### Editor/assembler program fits in just 5 k of ROM

Tychon, P.O. Box 242, Blacksburg, VA 24060. Jonathan Titus (703) 951-9030. From \$35 (paper tape); stock.

A coresident editor/assembler program for 8080 systems requires only 5 kbytes of memory (R/W or PROM).

The package, called TEA, is completely I/O independent, relying upon its own I/O software or the I/O routines already available in a user's system. It accepts both octal and hexadecimal values throughout; the program listings may be in either octal or hexadecimal form. The switch between octal and hex is made at any time using keyboard commands. The editor/assembler is relocatable, and is available in 1702A or 2708 PROMs and on paper tape. Listings are also available.

CIRCLE NO. 351

### Video terminal transmits data from 50 to 9600 bps

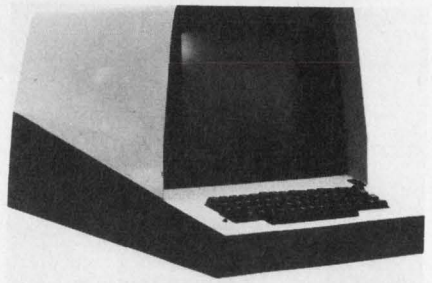

Dataview, 23A Dana St., Malden, MA 02148. John Surette (617) 322-2244. \$1195; stock.

Intended to serve as a teletypewriter replacement, the Marquis video terminal includes TTY current loop and RS-232-C communication capabilities. There are 15 internally generated, switch-selectable transmission speeds from 50 to 9600 bits/s and one externally controlled speed of up to 1800 char/s. Full or half-duplex operation and parity generation are also switch selectable. Display characteristics include the 64 character ASCII set, 80 char/line and 24 lines/display. Each character is made from a 5 x 7 dot matrix. The terminal operates in a scroll mode and displays all data on a 12-in. CRT.

CIRCLE NO. 352

**Q:** Is there a recorder just for spectrum analyzers?

**A:**

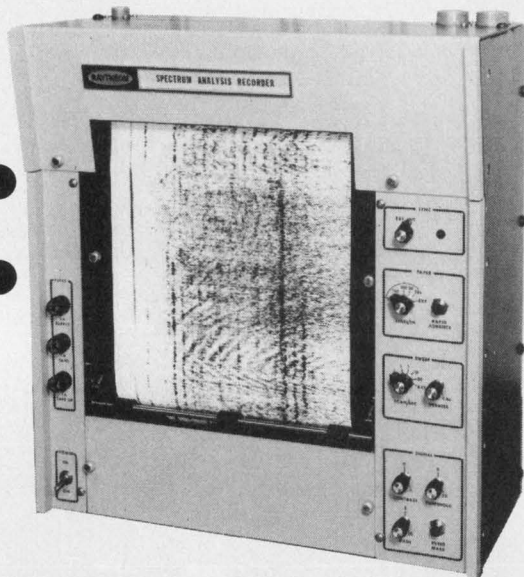

The new 19" rack-mounting SPECTRUM ANALYSIS RECORDER from Raytheon. It's the first dry paper line scanning recorder specifically developed for direct plug-in operation with commercially available spectrum analyzers.

Any new or existing spectrum analyzer equipped with the SAR-097 will have a lot more going for it. Like infinitely variable 100:1 speed range—5 sec/scan to 50 millisc/scan...stylus position encoder... automatic recorder synchronization... computer/analyzer compatibility... high resolution and dynamic range... all-electronic drive. And more.

If you design and build—or buy and use—spectrum analyzers, you don't have to settle for multi-purpose recorders any more. The SAR-097 is here. For full details write the Marketing Manager, Raytheon Company, Ocean Systems Center, Portsmouth, Rhode Island, 02871. U.S.A. (401) 847-8000.

RAYTHEON

CIRCLE NUMBER 83

### Interface card mates printer & desk computer

Hewlett-Packard, 1501 Page Mill Rd., Palo Alto, CA 94304. Inquiries Manager (415) 493-1501. \$8390 (including terminal); \$625 (interface with cable, manual and test cartridge); stock.

An I/O interface card for the company's 9881A high-speed, wide-carriage impact printer subsystem lets it be used with both the HP 9825A and 9831A desktop computers. The 9881 delivers 200 lines per minute regardless of line length and has a full 132-column width. An eight-channel vertical format unit simplifies automatic formfitting and vertical formatting under program control. There are two subsystems, the HP 9881 Option 025 and Option 031, and they include an HP 2607A line printer and the 02607-60348 interface card. Two additional options for the 9825 and 9831, Options 081 and 181, respectively, provide cables, installation manuals and operating notes. Option 081 also includes a test cartridge for the 9825.

CIRCLE NO. 353



## Full ASCII terminal comes only in kit form

Southwest Technical Products, 219 W. Rhapsody, San Antonio, TX 78216. (512) 344-0241. \$325 (less monitor); stock.

Able to display up to 64 characters per line and 16 lines, the CT-64 terminal is available in kit form only. When assembled the stand-alone terminal can operate in either a page or scrolling mode, displaying both upper and lower-case ASCII characters. Either a maximum of 32 or 64 characters per line can be jumper selected; use of a 32 character line permits a modified television receiver to be used instead of a 10-MHz bandwidth video monitor. Various special functions such as screen reversal (black characters on white background), cursor on/off switching, solid/blinking cursor selection and a beeper that sounds whenever 16 lines have been displayed or a CTRL.G is encountered. Circuitry can be jumper programmed for 60-Hz, 525-line or 50-Hz, 625-line monitors. Included in the kit is an RS-232 interface with 110, 150, 300, or 1200 baud rates switch selectable. The complete unit, less monitor, measures 13 x 21 x 5 in.

CIRCLE NO. 354

## Floppy-disc subsystem operates with minis

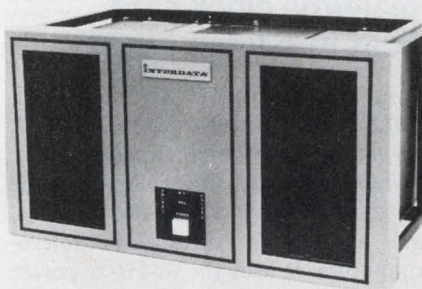

Interdata, Oceanport, NJ 07757. Christopher Hoppin (201) 229-4040. From \$2900 (unit qty); stock.

A floppy-disc subsystem designed for 16-bit processors is IBM format compatible and provides up to 256 kbytes of storage. The FMD-1 is available in single or dual drive configurations with power supply, cables and a controller that can handle four drives. Each drive has a track-to-track positioning time of 6 ms and an average latency of 325 ms. The dual-drive subsystem measures 10.5 x 19 x 14.5 in. and can be mounted in a standard 17-in. rack.

CIRCLE NO. 355

# MEET OUR family of ELECTRONIC TEST ACCESSORIES

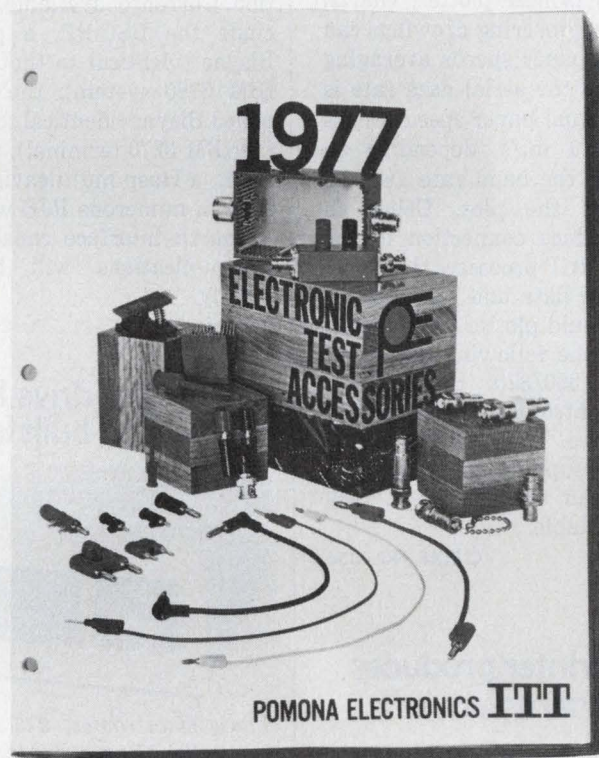

The 1977 edition of our family album of electronic test accessories (illustrated above) is yours for the asking.

Our new general catalog has grown to 82 pages. It describes and illustrates every one of the 600-plus members of the ITT Pomona Electronics family, including 28 new items that have been added for the first time this year.

You'll find this comprehensive catalog will be your best single source for high quality test accessories in every phase of electronic testing. For your free copy, circle the reader service number listed below, or write:

## ITT POMONA ELECTRONICS

1500 East Ninth St., Pomona, Calif. 91766  
Telephone (714) 623-3463. TWX: 910-581-3822



CIRCLE NUMBER 84



## MICRO/MINI COMPUTING

### Graphics processor gives hard copy from terminal

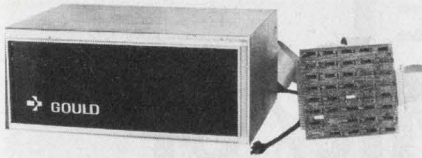

Gould Inc., 3631 Perkins Ave., Cleveland, OH 44114. R.F. Kerzman (216) 361-3315. \$4450 (hardware only); 60 to 90 days.

The RGP processor lets remote terminals generate high-speed graphic hardcopy when coupled with a Gould 5000 series electrostatic printer/plotter. With the RGP unit and a Gould 5000 or 5005 printer/plotter, charts, graphs, and engineering drawings can be printed at paper speeds averaging 0.5 in./s when the serial data rate is 9600 baud. Actual paper speed ranges from 0.04 to 1 in./s, depending on plotter model, the baud rate and the complexity of the plot. Using an RS-232C interface connection to the terminal, the RGP processes the transmitted graphic data and sends raster data to the Gould plotter. Software is available for the following host computers: IBM 360/370, Univac 1100 Series, and Control Data 6000, 7000 or Cyber 70 Series. The microprocessor-based RGP is supplied in an enclosed cabinet, and an optional 19-in. rack mount is available.

CIRCLE NO. 356

### Desktop printer produces up to 60 characters/s

Anderson Jacobson, 521 Charcot Ave., San Jose, CA 95131. Don Estus (408) 263-8520. \$2950; 30 days.

A 60 character per second desktop teleprinter terminal, the AJ 860, uses a nine wire dot-matrix print element. The printer delivers 9 x 5 dot-matrix upper or lower case characters in a 12 x 9 character cell. Included are features such as horizontal and vertical tabulation, reverse line feed, auto pagination, and operator selectable speeds of 10, 30 or 60 cps. A built-in keyboard includes a 17-key numeric pad, n-key rollover and auto repeat capability. The standard AJ 860 also includes self-test diagnostics, dual gate-forms tractor, and 94 printable character operation.

CIRCLE NO. 357

### Synchronous interfaces meld micros with IBM

Adtech, P. O. Box 10415, Honolulu, HI 96816. Mike Gouveia (808) 941-0708. \$1250 (100 qty); stock.

A family of synchronous data communication interfaces for use in micro-computer systems permits simple connection between two industry standard formats—the Altair microcomputer bus and Bisync data communications protocol. The interfaces permit the direct connection of a microcomputer system to IBM hardware and software. Each of the three available interfaces plugs into two card slots on the micro-computer bus and communicates with a remote computer using a Bisync protocol through an RS-232-C connection. Currently available interfaces include the BSC-PP, a point-to-point Bisync (identical to that used by the IBM 3780 system); the BSC-POL, a polled Bisync (identical to that used by the IBM 3270 terminal); and the BSC-HML, a Hasp multileaving Bisync (as used in numerous RJE workstations). A fourth interface capable of SDLC communications will be available shortly.

CIRCLE NO. 358

### Floppy-disc drive has RS-232 link built in



Sykes Datatronics, 375 Orchard St., Rochester, NY 14606. Albert Montevecchio (716) 458-8000. \$1500 (single drive), \$2100 (dual); November.

Comm-Stor, an RS-232 compatible flexible disc system, can interface directly with all asynchronous terminals, printers and modems. The unit offers a random access file management system for hard-copy or CRT terminals. Built around a  $\mu$ P that uses a message (file) oriented directory for flexibility in storing and retrieving data, the Comm-Stor feature automatically handles the label and data conversions (ASCII to EBCDIC) required to let you prepare IBM 3740 (System 3/32, 370) compatible diskettes with an ASCII terminal. Data transfers can occur at up to 9600 baud.

CIRCLE NO. 359

### Mini electrostatic printer does 60 char/s

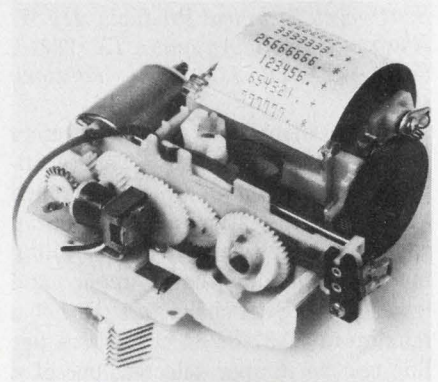

Hycom, Inc., 16841 Armstrong Ave., Irvine CA 92714. Russell Quackenbush (714) 557-5252. \$70 (1 to 9), Paper \$0.80/roll (box of 5); stock.

Providing 12 columns of alphanumeric printout, the DC 31206 electronic discharge printer can deliver five lines per second. Characters are made from a 5 x 7 dot matrix and are printed by current from the electrodes in a print head passing over a 1.4 in. wide roll of aluminum coated paper. Character height is 0.1 in. The printer measures just 3.65 x 3.2 x 1.7 in. and weighs 5.25 oz, less paper. Motor and head-drive requirements are 5.7 V  $\pm$ 10% at 800 mA and 30 V  $\pm$ 10% at 140 mA (all head elements energized), respectively. Operation is possible over a 5 to 50-C range.

CIRCLE NO. 360

### Real-time clock card plugs into Altair buses

Comptek, P.O. Box 516, La Canada, CA 91011. Susan Finster (213) 790-7957. \$98 (kit), \$135 (wired); 2 wks.

The CL2400 real-time clock keeps the present time of day in hours, minutes, and seconds in Altair-bus micro-computers. It uses the 60-Hz-ac power line frequency as a reference. Because it is treated as a peripheral by the CPU, the CL2400 eliminates the memory and execution time overhead inherent with interrupt driven clocks. To read the present time, the CPU merely accesses the six time digits from six adjacent I/O ports. A hold mode and two fast modes are included for setting the present time into the clock. The CL2400 can also provide periodic interrupts to the CPU at any of six programmable rates, from twice each day through once each second. The CL2400 comes with complete documentation, including sample programs in both 8080 assembly language and Basic.

CIRCLE NO. 361



### Resident compiler runs Fortran on 8080 system

Microsoft, 819 Two Park Central Tower, Albuquerque, NM 87108. Paul Allen (505) 256-3600. \$500 including documentation; stock.

A Fortran IV resident compiler for 8080 microprocessor software, called Fortran-80, is available in ANSI standard Fortran with the exception of the double-precision and complex data types. It provides three data types including: logical (one byte), integer (two byte), and real (four byte, floating point). The compiler generates relocatable code and can be held in ROM. Requiring less than 12 kbytes of memory, the one-pass compiler also includes a relocating linking loader. Another part of the package is a relocating assembler and an assembly language debugging program. The assembler produces Fortran-compatible subprograms and the debugging system can debug Fortran or assembly-language programs.

CIRCLE NO. 362

### Microcomputer kit needs external power supply

Motorola HEP/MRO, 705 W. 22nd St., Tempe, AZ 85282. (602) 244-3208. \$169.95 (Educator II), \$29.95 (power supply); stock.

Containing all the makings for an 8-bit microcomputer, the Educator II kit requires just an external power supply. The kit includes the 6800 8-bit  $\mu$ P, a PIA, a 128  $\times$  8-bit static RAM, two TTL 512  $\times$  4-bit ROMs and a TTL clock circuit. The clock frequency is approximately 625 kHz. An executive program, residing in the ROMs, contains routines for examining and modifying memory locations and  $\mu$ P registers, servicing interrupts, transferring programs to and from cassette tapes, searching tapes for specific programs and a routine to test the finished kit. When assembled the Educator II is housed in an aluminum case, with front panel toggle switches and LEDs. Also available is a power-supply kit designed specifically for the Educator II. It delivers 1 A at 5 V dc  $\pm$ 5%. A 60 Hz, real-time clock signal (approximately 5.1 V pk-pk) is also available.

CIRCLE NO. 363

### Monitor program runs on Intel SBC 80/10s

Mini Micro Mart, 1618 James St., Syracuse, NY 13203. Maury Goldberg (315) 422-6666. \$19.95 (paper tape), \$169.95 (PROM); stock.

An operating monitor program, the Monitor 80 SBC, is designed for use with an Intel SBC 80/10 single board computer. The monitor permits the board to be used as a stand-alone development system and permits entering and dumping of listings in both symbolic and octal codes. The user can initiate program execution, set or clear break points, copy a block of memory, or translate a program to a new location. An edit mode is also provided. In addition to the normal monitor software, there are routines for programming PROMS, a checksum routine, and software for loading and dumping to a simple audio cassette recorder interface. The monitor occupies approximately 2.5 k of memory, and starts at the "O" address. It is available complete with source listings and a punched tape in Intel hex loader format.

CIRCLE NO. 364

# Use this versatile frequency counter when accuracy counts.



WD-752A  
\$255.00

See it at your  
VIZ distributor

Exceptional accuracy and sensible features make our new wide-range frequency counter the ideal choice for checking out audio, video, CB, ham radio and other communications equipment.

- Wide range—10Hz to 60MHz
- Precise 10.000MHz crystal-controlled time base for  $\pm$ 0.1ppm stability
- 1KHz audible tone for SSB carrier frequency measurement
- Selectable input sensitivity (for noise rejection)—10 or 100mV
- 6-digit bright LED readout
- Indicators for signal, overflow, and range
- Small and compact; ac operated

**VIZ Test**  
**Instruments Group**  
of VIZ Mfg. Co.

335 E. Price St., Philadelphia, Pa. 19144

© VIZ  
6644

Formerly  
**RCA**  
Instruments



## Amplifier Per Channel

### Series 2500 Data Acquisition System

100 KHz Bandwidth  
130 DB CMRR

\$160 per Amplifier

#### SERIES 2500

It includes a fixed gain amplifier/filter per channel, multiplexer, programmable gain amplifier, sample and hold amplifier and analog-to-digital converters with from 12 to 15 binary bits of resolution. The gain and cutoff frequency of the input amplifier/filter may be changed in the field by replacing plug-in modules.

Amplifier per Channel  
10 Mv-10V Full Scale  
DC Accuracy to 0.01% of Full Scale  
0.5 uv/C° Drift  
12-15 Bit ADC's  
Programmable Gain  
Bessell or Butterworth Active Filters  
Optical Logic Coupling  
64 Channels in on 5 1/4" cabinet  
(expandable to 256)

#### OTHER SYSTEMS

If a more flexible approach is required the Series 2400 System with a programmable gain amplifier on each channel might be a solution to your problem. Fixed or programmable active filters following the amplifiers are optional. If an amplifier per channel is not required, we can measure low level signals very accurately with one of our Series 1540 solid state multiplexer systems.

#### THROUGHPUT RATES

The standard throughput rate of the Series 2500 System is 50 KHz. Throughput rates of 1.0 MHz and 500 KHz for 12 to 15 bit ADC's respectively are available in both the Series 2400 and 2500 Systems. The Series 1540 Systems can be operated up to a throughput rate of 10 KHz.

**TUSTIN**  
ELECTRONICS COMPANY

1431 E. St. Andrews Place  
Santa Ana, California 92705  
(714) 549-0391

CIRCLE NUMBER 86

## MICRO/MINI COMPUTING

### Add-in memory board holds 16 k × 17 bits

National Semiconductor, 2900 Semiconductor Dr., Santa Clara, CA 95051. Doug Felder (408) 737-5000. \$995; stock.

Developed as add-in memory for the HP 21MX minicomputer series, the NS-21 cards have a capacity of 16,000 words of 17 bits each. The boards are completely compatible with the HP system Models 2105, 2108, 2112 and 2113. Additional cards in the NS-11 series will soon be available for the DEC PDP 11 minicomputers.

CIRCLE NO. 365

### Interface boards provide eight 1-A relay outputs

MITS, 2450 Alamo S.E., Albuquerque, NM 87106. (505) 243-7821.

Both the Altair 88 process control interface board and the similarly designed Altair 680b-PCI enable the 8800 or 6800 microcomputers to communicate with electromechanical systems. Each board has eight spst relay outputs that are capable of switching 1 A at 120 V ac. Both boards also have optically isolated inputs, which can be configured to accept a wide range of input signals. Two optically isolated, software-controlled "handshake" lines are also provided for interfacing with external devices. Each board also has a software-controlled interrupt structure.

CIRCLE NO. 366

### Disc operating system works on 8080 micros

Digital Research, P.O. Box 579, Pacific Grove, CA 93950. Dorothy Kildall (408) 373-3403. \$70; stock.

CP/M, a disc operating system, is designed for use with IBM-compatible diskette-based computers that use 8080  $\mu$ Ps. The functions of CP/M include named dynamic files, program editing, assembly, debugging, batch processing, and instantaneous program loading. It is an unbundled software package and can be easily adapted to any 8080 or Z-80 system with at least 16 kbytes of main memory and one or two IBM-compatible disc drives. Although the standard CP/M system operates on an Intel MDS, a field-modification manual tells how to alter CP/M for other hardware configurations.

CIRCLE NO. 367

### Z80-based microcomputer comes with dual discs

Zilog, 10460 Bubb Rd., Cupertino, CA 95014. Dave West (408) 446-4666. From \$5990; stock.

A general-purpose microcomputer, the Z80-MCS, makes full use of all 158 instructions in the  $\mu$ P. The microcomputer is housed in a 9-slot 19-in. chassis and comes with a dual floppy-disc drive capable of storing 600 kbytes. Up to 64 kbytes of RAM can be directly addressed and RS-232 and current loop interfaces are included for terminal connections. The basic Z80-MCS includes the Z80 CPU board, a disc controller, 16 kbytes of dynamic RAM and 3 kbytes of PROM, which contains a system debugger, disc driver, console driver and bootstrap routine. The 2.5-MHz Z80  $\mu$ P is used in the system and a 5-V, 9-A supply is built into the cabinet. Optional software includes Basic for \$200 additional and soon to come is MCS-RIO and MCS-Cobol.

CIRCLE NO. 368

### Get 16, 32 or 65 kbytes of RAM on one board

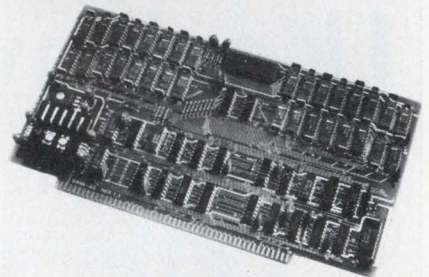

Imsai Manufacturing, 14860 Wicks Blvd., San Leandro, CA 94577. Michael Stone (415) 483-2093. From \$449 (16 RAM kit), from \$299 (controller kit); stock.

The RAM-16, 32 and 65 memory boards offer 16, 32 and 65 kbyte storage capability for Altair, Imsai and other bus compatible microcomputers. With 400-ns access times and hidden refresh, the boards are divided into 16-kbyte blocks that are individually selectable. When used with the company's memory manager board up to 1 Mbyte of memory can be used on the same bus. The controller board uses an 8048  $\mu$ P, an 8155 memory and I/O timer and an 8255 ROM I/O chip to provide 2 kbytes of program control and 320 bytes of data storage.

CIRCLE NO. 369



## Minicomputer system based on LSI-11



RDA Inc., 5012 Herzel Pl., Beltsville, MD 20705. W.R. Davies (301) 937-2215. See text.

The RD11 desk-sized computer is built around the LSI-11 CPU manufactured by Digital Equipment Corp. Either static MOS or core memory is available as well as a direct-memory-access interfaced floppy-disc system. A wide selection of peripherals—cartridge disc, magnetic tape, card reader/punches, paper tape and word processing printers, etc.—are also available. Software offered includes DEC's RT11 operating system, full macro-assembler, Fortran IV, multi-user Basic, Focal and APL. A representative system with 56,000 bytes of MOS RAM, fixed and floating point arithmetic, dual 1.2-Mbyte floppy disc, 24 line video display console, 120-cps line printer, enclosure and RT11 operating system cost \$14,650. Delivery is 30 days.

CIRCLE NO. 370

## Disc subsystem for mini has one or two drivers

Varian Data Machines, 2722 Michelson Dr., P.O. Box C-19504, Irvine, CA 92713. (714) 833-2400. \$5000 (dual drive); 30 days.

Consisting of single or dual-disc drives, a formatter and an interface controller, a floppy-disc system for the V-77 series of minis holds up to 590 kwords (dual drive). A maximum of four drives can work with one controller and up to eight controllers can be supported by Vortex II—the company's operating system for the minis. In foreground-only applications Vortex I (requires 16 or 32 k of main memory) supports the floppy system. And, in foreground/background applications the Vortex II system (requires 64 k of main memory) is needed.

CIRCLE NO. 371

## Controllers for printers mate with PDP-11 & Novas

Riada Electronics, 2535 Via Palma, Anaheim, CA 92801. Les Alberts (714) 995-6552. \$1000 (unit qty.); 30 days.

Line-printer controllers that are software and hardware compatible with PDP-11 computers from Digital Equipment Corp. and Nova computers from Data General can be factory or field configured. The controllers can handle Data Products, Centronics,

Printronix, Tally, or equivalent, line printers. Minimum configuration supplied include the controller (one printer-circuit board that installs in the computer chassis), a 15-ft cable to the selected line printer, a diagnostic routine in paper tape form and an instruction manual. Factory integration of customer-supplied printers, on-site installation or complete systems including a line printer, can be provided.

CIRCLE NO. 372

# CONNECTORS with character .....

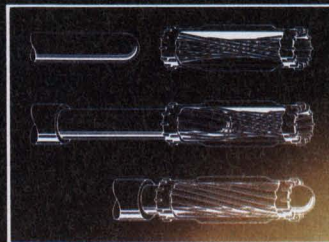

- LOW MATING FORCES
- LOW RESISTANCE
- HIGH DURABILITY
- HIGH INTEGRITY
- RUGGED

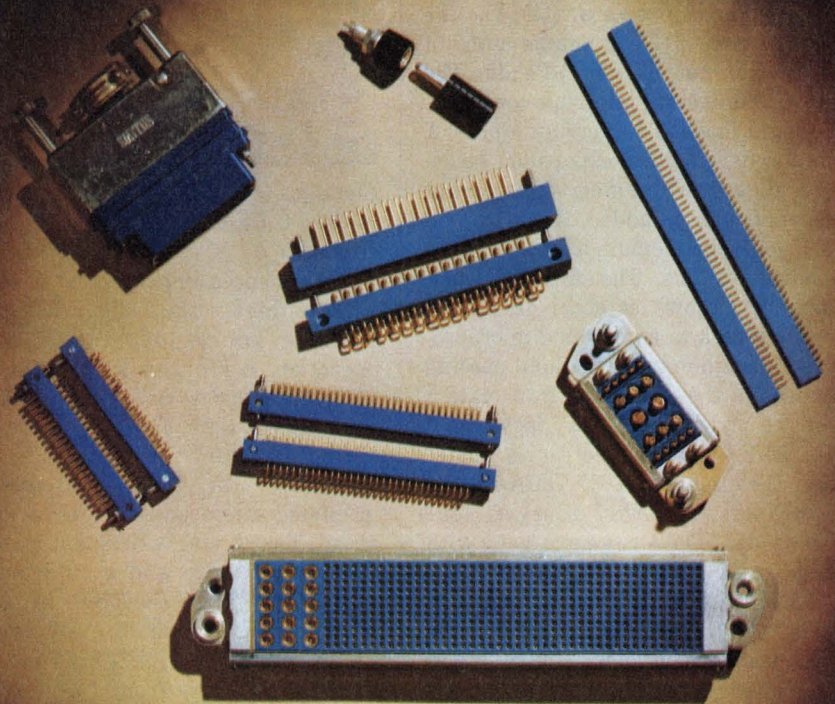

MANUFACTURERS' REPRESENTATIVES INQUIRIES INVITED



SMITHS INDUSTRIES INC.  
CONNECTOR DIVISION

SITAC



CONNECTORS

P.O. Box 5389, Clearwater, Florida 33518 Tel. (813) 531-7781, Telex 52602

CIRCLE NUMBER 87



## MICRO/MINI COMPUTING

### Resident Basic program operates on 6800 $\mu$ Ps

Ryan McFarland, 608 Silver Spur Rd., Rolling Hills Estates, CA 90274. Dave McFarland (213) 377-0491. \$450; stock.

A programming language for 6800 microcomputer users is a complete resident software development system. It includes a compiler, editor, loader debug, and run time support routines. Available in paper-tape, cassette, or diskette form, all that's needed to begin using this system is a 6800 microcomputer with at least 24 kbytes and an input/output device.

CIRCLE NO. 373

### LSI support circuits unbundle $\mu$ P systems

Advanced Micro Devices, 901 Thompson Pl., Sunnyvale, CA 94086. Andrew Allison (408) 732-2400.

Two powerful  $\mu$ P support circuits developed by Advanced Micro Devices can greatly increase the throughput of microcomputer systems—no matter which of today's many  $\mu$ Ps is used. Directed at interrupt handling and direct memory access (DMA), the Am9519 and 9517 can handle many of the tasks that current  $\mu$ Ps do. The Am9519 universal interrupt controller has eight maskable interrupt inputs. A simple daisy-chain expansion structure allows any number of interrupt controllers to be added. All inputs on each controller remain available in expanded systems. The Am9517 DMA controller allows external devices to transfer data to and from a microprocessor's main memory without passing it through the processor. Information can be transferred as fast as 2 Mbytes/s—about three times faster than the proposed 8257 DMA circuit from Intel. The 9517 contains four independent DMA channels, each with separate registers for load control, base address, base word count, current address and current word count. The DMA system may be expanded to any number of channels by cascading additional controller chips. The Am9519 and Am9517 use only a 5-V supply and come in 28 and 40-pin DIPs, respectively. Prices are expected to be \$17.25 and \$20.75, respectively, in 100-unit lots, for versions with an operating range of 0 to 70 C. Both circuits will be available in the latter half of 1977.

CIRCLE NO. 374

### Diskette drives offer hard or soft sectoring

Innovex Corp., 75 Wiggins Ave., Bedford, MA 01730. (617) 275-2110. 100 qty. prices: \$435 (410), \$445 (420); 30 days.

The series 400 diskette drive comes in both a soft sectored, IBM compatible model, the 410, and a hard sectored version, the 420. Unique features of the drive include automatic head-unload and stepper motor timeouts, bidirectional write protect, radial stepping ability, host-power-failure detectors, six LED activity indicators and a 50-line ribbon cable or twisted pair interface. Access time track-to-track is 8 ms, latency is 83 ms average, and storage capacity is  $3.2 \times 10^6$  bits in single density format. Both models provide single and double density recording, require 100 to 132 V ac, 60 Hz at 0.2 A, +5 V at 800 mA, -5 V at 25 mA and 24 V at 1.4 A, and weigh 14 lb.

CIRCLE NO. 375

### Emulation board speeds 8080 operation 9 times

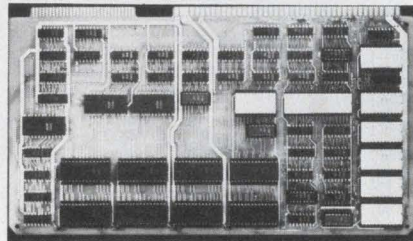

Signetics, 811 E. Arques Ave., Sunnyvale, CA 94086. (408) 739-7700. \$299; stock.

With a speed improvement of up to nine times, the 3000KT8080SK emulator kit can duplicate 8080  $\mu$ P operation. It provides a 150-ns microinstruction cycle time and a 150-ns RAM access time. The kit contains all parts necessary to construct the emulator, including the preprogrammed microcontrol store, printed circuit board, and instruction manual with all schematic and microcode listings. The 3000KT8080SK is fully equivalent in function to systems containing the 8080A, 8228, 8224 and the 8212. Operation is from a 5-V supply and included is a hardware multiply and divide and full vectored interrupt to any location within 64 bytes of memory. The emulator is microprogram expandable, enabling the user to use the 12 unused instruction locations in the 8080 for expanding the instruction set.

CIRCLE NO. 376

### Analog I/O board mates with 6800-based systems

Burr-Brown, International Airport Industrial Park, Tucson, AZ 84734. C.R. Teeple (602) 294-1431. \$198 to \$398 (100 qty); 2 wks.

The MP7400, an analog I/O system, is an 8-bit bus-compatible system for Motorola's series of Micromodules and its EXORciser development system. Each board can be set up to handle up to 64 single-ended or 32 differential input channels and two output channels. A high-gain instrumentation amplifier handles input levels as low as 10 mV full scale. The MP7400 interfaces to the microcomputer as memory, thus allowing it to be used with or without halting the CPU, or in the interrupt mode. The analog input portion of the MP7400 includes an analog multiplexer, an instrumentation amplifier, an 8-bit a/d converter, plus necessary timing, decoding and control logic. The analog output portion consists of two 8-bit d/a converters with input latches and control logic. A dc/dc converter is available to permit operation from just a single power supply. I/O specifications include: an input voltage range of  $\pm 10$  mV to  $\pm 5$  V, input overvoltage protection of  $\pm 15$  V, and input throughput accuracy better than  $\pm 0.4\%$ .

CIRCLE NO. 377

### Simulator/programmer handles ROMs to $1 \text{ k} \times 8$

Electro Design, 7364 Convoy Ct., San Diego, CA 92111. Cliff Griffin (714) 277-2471. From \$1550; 45 days.

Combining ROM simulation, PROM programming and storage in a single self-contained unit, the ED6001 handles most 16 to 24-pin ROMs and PROMs. Data are entered by way of any 8-bit data bus, RS-232 or TTY system as well as from a front-panel hex keyboard. Both the data and the address, also in hex format, are displayed on a front panel LED readout. As an option, the basic simulator system can be expanded to include programming of all standard fusible or UV PROMs. Also available is a read/write cassette transport. The ED6001 is actually a general-purpose  $1 \text{ k} \times 8$  memory that can be made to look like a ROM/PROM or RAM. Capacities to  $1 \text{ k} \times 40$  bits are available in other models.

CIRCLE NO. 378



### Fast-curing solder mask also saves power

3M Co., P.O. Box 33600, St. Paul, MN 55133. (612) 733-9214.

A blue epoxy material that cures in seconds in ultraviolet light is designed for use as a solder mask for conventional PC boards, or as a cover coat for flexible circuits. Formerly available only in green, the new color provides enhanced contrast for board inspection. In addition to significantly faster curing, the material eliminates processing steps and saves up to 90% energy compared to conventional two-part and oven-curing systems. Epoxy 1301 has an extended working life, and shelf-life in the can is one year. The solvent-free UV-cure system permits thicker deposits in one pass, eliminates toxic fumes and provides excellent resolution. A flexible circuit with a 4-mil cover coat of blue epoxy may be creased to 180° without cracking.

CIRCLE NO. 379

### 'Glassy' metal fabric shields magnetic fields

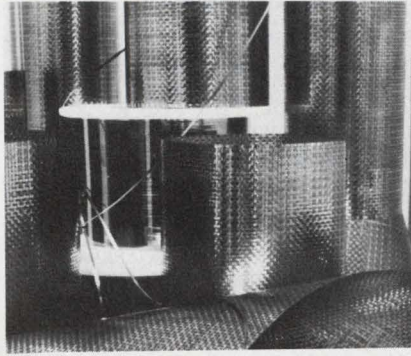

Allied Chemical, P.O. Box 2245R, Morristown, NJ 07960. (201) 455-2301. See text: 1-3 wks.

A different kind of magnetic shielding material, 0.02 in. thick Metshield fabric, is made from a newly developed amorphous metal alloy. It combines magnetic softness with mechanical strength, ductility, hardness, and corrosion resistance. Metglas 2826 alloys require no annealing after cutting, die-stamping and forming. The fabric is available in 7-in. width. Samples (7 × 12 in.) cost \$40, and quantities over 100 ft are \$7/ft.

CIRCLE NO. 380

### Manual unit dispenses ICs

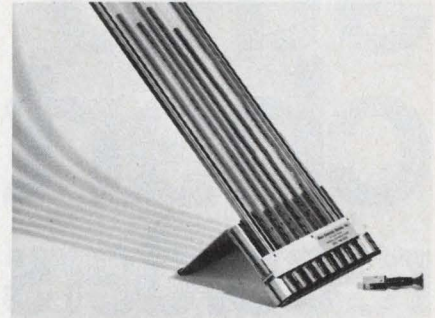

Micro Electronic Systems, 8 Kevin Dr., Danbury, CT 06810. (203) 746-2525. \$35.00.

PIC-A-DIP III, a manual IC dispenser, incorporates the features of earlier systems plus several new ones. Made of all aluminum parts, the III is groundable for MOS applications and features a 10-channel mechanical interface between the dispenser and the manufacturers' DIP sticks, thus eliminating handling of the ICs and possible spillage. Shipping sticks are inserted directly into tube guides, keeping the work area neat and organized for higher output.

CIRCLE NO. 381

# Price & Performance that can't be matched!

DigiTec's full-function Universal Counter/Timers and Frequency Counters supply extended frequency ranges at a ratio of price to performance that can't be matched.

Outstanding features include dual input channels with independent controls, high input sensitivity, oven controlled crystal, and full 9 digit LED display with autoranging.



50 MHz ... Universal Counter ...	8510A ...	\$725
150 MHz ... Frequency Counter ...	8720A ...	625
150 MHz ... Universal Counter ...	8520A ...	850
500 MHz ... Universal Counter ...	8530A ...	995
600 MHz ... Frequency Counter ...	8730A ...	795
1 GHz ... Frequency Counter ...	8740A ...	995
1 GHz ... Universal Counter ...	8540A ...	1295

DigiTec: precision measurements to count on.

These instruments available under GSA contract GS-00S-27741.

**DigiTec** UNITED SYSTEMS CORPORATION

918 Woodley Road, Dayton, Ohio 45403  
(513) 254-6251, TWX (810) 459-1728



# strip chart recorders

- OEM MODULES
- LOW PROFILE
- PACKAGED UNITS
- PORTABLE DC

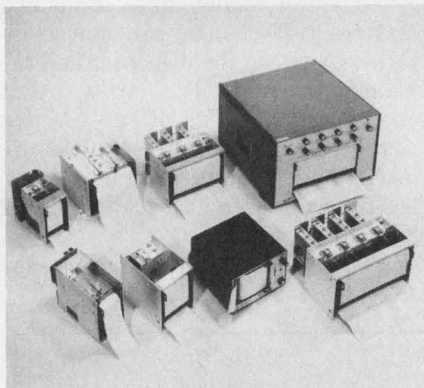

General Scannings thermal writing Strip Chart Recorders are available in a wide range of configurations and performance characteristics to meet virtually every recorder need.

You can select open-loop, velocity feedback or closed-loop operation; continuous roll or fan-feed paper; one to eight channels in channel widths of 20, 40, 50, 80 or 100mm; a variety of chart speeds; and either AC or DC operation.

Recorders can be furnished as modules for use by OEM's or fully packaged.



For complete details, circle readers' service number or write today for our full line Strip Chart Recorder Catalog.



**GS** GENERAL SCANNING INC.  
150 Coolidge Avenue  
Watertown, MA. 02172  
TEL: (617) 924-1010  
CIRCLE NUMBER 89

## PACKAGING & MATERIALS Fix damaged PC boards right on the spot

*Pace Inc., 9329 Fraser St., Silver Spring, MD 20910. Rhoda Deblinger (301) 587-1696. \$65.00; stock.*

How do you repair a damaged circuit board? One way is with the Cir-Kit selector pack. This easy-to-use and totally self-contained kit permits field repair or replacement of lifted, damaged or missing pads and tracks on PC boards. Virtually anyone can quickly and easily repair a damaged board, thereby eliminating the need for discarding it, or waiting while it is repaired at the shop. Cir-Kit includes a wide selection of pre-tinned and scored eyelets, pre-tinned sheets of various-size replacement pads and tracks, an abrasive stick for cleaning both the work area and the pads to be used, plus the necessary tools and accessories for cold-setting the eyelets. The user needs just a soldering iron and solder.

CIRCLE NO. 382

## Enclosures show no hardware



*Optima Div., Scientific Atlanta, 2166 Mountain Industrial Blvd., Tucker, GA 30084. (404) 939-6340. Approx. \$270.*

The Optima Accent Rack includes such features as knocked-down shipment and easy screwdriver assembly; equipment is installed in an open framework, accessible from all sides for cabling and check-out; all exterior parts are fastened to the frame without visible hardware after the equipment is installed. Standard panel heights are 42, 61-1/4, and 70 in., 24 and 30 in. deep.

CIRCLE NO. 383

## Wire-Wrap board accepts variety of components

*Wyle Computer Products, 3200 Magruder Blvd., Hampton, VA 23666. (804) 838-0122. \$65.00.*

The WW-1 Wire-Wrap board is based on the company's standard 44-pin, 3.25 x 4.5-in. microcomputer and digital-logic module configuration. WW-1 contains 14 rows of 20 pins each. The rows are spaced on 0.3-in. centers for direct insertion of any combination of most IC chips, from eight to 40 pins. Power and ground are bused throughout the board for connection to specific pins as dictated by user needs.

CIRCLE NO. 384

## Cool PC-board guide mounts with clips

*Unitrack Div., Calabro Plastics, Inc., 8738 W. Chester Pike, Upper Darby, PA 19082. (214) 789-3820. From 6-1/2¢/in.*

The Unitrack Series 1000 PC-board guide is made from phosphor bronze, beryllium copper or stainless steel. When assembled into a specially designed aluminum heat-sink guide bar (Cat. No. GBH-1000), the Series 1000 offers exceptional heat dissipation. The spring fingers, of the metal-card guide, firmly press one edge of the PC board into contact with the guide bar over its entire length. The large contact area provides good heat sinking for even extremely hot boards. Guide-bar and card-guide assembly can be mounted with mounting clips at each end, or can be epoxied or riveted directly to the chassis.

CIRCLE NO. 385

## Benchtop plating system expedites prototypes

*Proto-Plate, Box 3274, Allentown, PA 18106. (215) 439-0889. From \$899; stock to 4 wks.*

Developed primarily for the fabrication of plated-thru hole PC boards on a limited basis, the benchtop system consists of two plating modules and all required chemicals. A user may choose between a completely electroless process (Model 100), or a combination electroless/electrolytic process (Models 100/101). Both models are completely portable and each occupies less than 2 ft<sup>2</sup> of bench space. Only a water source and 110 V are needed.

CIRCLE NO. 386



## Coating machine works automatically

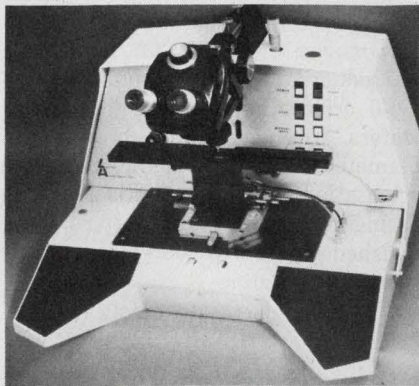

Laurier Associates, Executive Dr., Hudson, NH 03051. (603) 899-8800. \$6200; 8-10 wks.

Model CC-870 is said to be the first automatic conformal coating machine with deposition rates as high as 1800 per hour. Besides metering and dispensing conformal coating materials, the machine handles electrically conductive epoxies, resins, protective junction coatings and thermally conductive materials. All operations with the exception of loading and unloading lead frames into the indexer are fully automatic.

CIRCLE NO. 387

## LSI sockets keep low profile

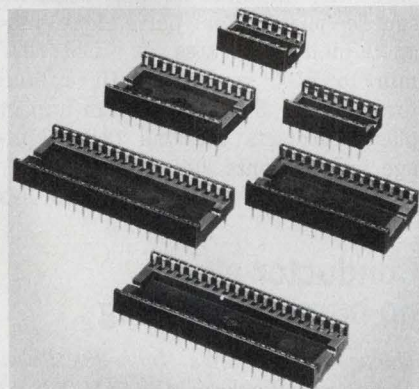

SMK Electronics, 118 E. Savarona Way, Carson, CA 90746. (213) 770-8915. 14 pins, \$0.00311 (100 qty).

The SI-2440 series of LSI sockets includes 14, 16, 24, 28, 40, and 42-pin versions on 0.1-in. centers. The glass-filled nylon bodies (66% nylon) are designed to withstand soldering temperatures to +350 C for 3 s and are available with either tin plating, selective gold contact plating or gold flash. All units are designed to flush mount end-to-end. For example, two 24-pin sockets can be mounted end-to-end to accommodate the latest 48-pin ROM.

CIRCLE NO. 388

## 'Bullet' treats PC board gentler than staking

Sealectro Corp., 225 Hoyt St., Mamaroneck, NY 10543. (914) 698-5600.

Cracks and fissures in PC boards due to staking or swaging of uninsulated terminals are eliminated with a new line of "bullet-nose" terminals. The mounting end of the terminal is hollow and spun closed. When the terminal is inserted into a PC board, a chamfered

portion under the shoulder centers the terminal in the mounting hole, accommodating variations in hole diameter. When the assembly is pressed against a flat tool face, pressure causes the hollow bullet nose to flatten out, forming a "mushroom" on the underside of the PC board that's ideal for wave soldering operations. The resilience of the formed metal compensates for variations in board thickness. A wide range of designs and sizes is available.

CIRCLE NO. 389

# New S-D Communication Counters

## Automatically measure up to 4,500 MHz!

Four new S-D Communications Counters offer the latest technical advances in high speed, precision frequency measurement. They are small and light, but they pack enormous capability.

- **Ranges:** 100 MHz, 512 MHz, 1250 MHz, and 4500 MHz.
- **Sensitivity:** 10mV RMS (Models 6241A, 6242A, 6243A). Model 6244A: 10mV RMS to 500 MHz, -13 dBm above 500 MHz.
- **Overload protection:** Withstands high input signal levels without damage.
- **Display:** 8 LED digits, 0.1 Hz resolution.
- **Tone measurement (opt.):** Example: measure 1020.01 Hz automatically in 1 sec.
- **Meet the whole family:**
  - 100 MHz Model 6241A—\$ 595
  - 512 MHz Model 6242A—\$ 795
  - 1250 MHz Model 6243A—\$ 995
  - 4500 MHz Model 6244A—\$2150

For sales assistance, contact Scientific Devices or Systron-Donner at 10 Systron Drive, Concord, California 94518. Phone (415) 676-5000.

**SYSTRON  DONNER**

CIRCLE NUMBER 90



# FAILURE OF PULSE CAPACITORS GIVING YOU A PAIN IN THE CIRCUIT BOARD?

Here's a straight-from-Europe remedy: the WIMA low-loss FKP1 polypropylene pulse capacitor manufactured by Wilhelm Westermann, a leading producer of special purpose, high performance, high reliability capacitors. The FKP1 combines the self-healing and volumetric efficiency of metallized film design with the current-carrying capabilities of film/foil construction and the inherent dielectric properties of polypropylene. They add up to the most successful type of pulse capacitor available today.

## FKP1 Specifications

<i>Max. Pulse Rise Time</i>	
Rated DC Voltage	V/Microsecond
630	2400
1000	2100
1500	5400
<i>Power Factor at +20°C</i>	
@ 1 KHz: $\tan \delta$	$= 1 \times 10^{-4}$
@ 100 KHz: $\tan \delta$	$\leq 1.5 \times 10^{-3}$
Epoxy cast construction with radial leads for PC board mounting.	

Write us for catalog that gives detailed specifications of the FKP1 and the twenty-five other types of WIMA capacitors.

## The Inter-Technical Group, Inc.

P.O. Box 23 • Irvington, NY 10533  
Tel.: (914) 591-8822 • TWX: 710-564-0802

CIRCLE NUMBER 120

## PACKAGING & MATERIALS

### Magnetic shields boost motor compatibility

*Ad-Vance Magnetics, 226 E. Seventh St., Rochester, IN 46975. (219) 223-3158. \$4 to \$8/unit (qty); 4 wks.*

This "triple action" magnetic shield adds decibels to small-motor compatibility performance by diverting interfering magnetic leakage. In addition, Model SMS-70F provides an electrical and thermal conductivity approximately 90% that of aluminum. Thirdly, production costs are lowered for many motors by reducing the self-shielding case requirements. Construction is high-permeability, flexible 0.010-in. (0.254 mm) AD-MU-78 foil alloy.

CIRCLE NO. 390

### Barbed inserts groove in plastics, laminate

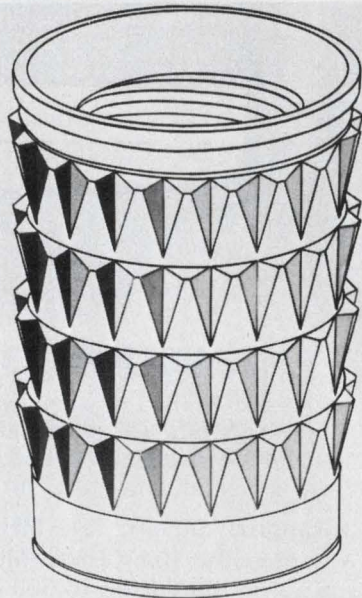

*Groov-Pin Corp., Hendricks Causeway, Ridgefield, NJ 07657. (201) 945-6780.*

High pullout strength, high torque-out resistance and fast installation characterize these barbed inserts for low-strength materials such as plastics, wood and laminates. Ultrasonic and heat methods produce minimum bursting stress on thin plastic walls and bosses. Barb-serts can also be pushed into molded or drilled holes in thermoset plastics, wood or composite materials. Threads range from No. 4 to 1/4 in.

CIRCLE NO. 391

### Large GaAs wafers come in large volumes

*Epidyme, Inc., 12525 Chadron Ave., Hawthorne, CA 90250. (213) 772-4545.*

Production volume quantities of 1-0-0 orientation ingots and circular wafers from 2-1/4 in. to 3 in. in diameter are now available. The 1-0-0 orientation GaAs material is available as ingots, as cut round wafers or as polished wafers with low etch pit densities—5000 or less.

CIRCLE NO. 392

### Wrapped-wire tool weighs only 7 oz

*Vector Electronic Co., Inc., 12460 Gladstone Ave., Sylmar, CA 91342. Floyd Hill (213) 365-9661. \$80 (1).*

The Model P160-4T1 cuts wiring time, eliminates wire stripping, and reduces operator fatigue while allowing continuous wrapping during long production or prototype wiring runs. Weighing only 7 oz, the pistol-gripped tool is considerably lighter than commonly used tools. Two bits are available: the P180 permits daisy-chain wrapping on 0.025 in. square posts without cutting or stripping the wire, and the P160-2A bit is used with conventional 26-AWG to 30-AWG wrapping wire in 0.025-in. and 0.028-in. square posts. The permanent magnet motor operates at 4500 rev/min to 5100 rev/min with a stall torque of 5 in-oz. High-impact plastic protects the tool from damage and prevents electrical shocks.

CIRCLE NO. 393

### Conductor allows no-burnish soldering

*Thick Film Systems, Inc., 324 Palm Ave., Santa Barbara, CA 93101. (805) 963-7757. \$5.85/gram (qty); 10 days.*

Solderability after refiring, difficult to achieve with thick-film platinum-gold conductors, is attained with Conductrox 3106. The conductor can be fired first in a thick-film resistor network and soldered without burnishing after numerous refirings made to accommodate subsequent resistor prints. A high metal content assures low resistivity. Routinely printable to 5-mil lines and spaces, formula 3106 retains the ability to be soldered when fired on dielectric as the top layer in a multilayer circuit.

CIRCLE NO. 394



# COUNT ON US!

## 8 DECADE MULTIPLEXED MOS UP COUNTER

LS7030

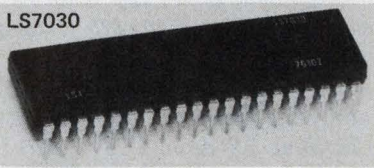

DC to 5MHz Count Frequency  
Multiplexed BCD and 7 Segment Outputs  
Counter Output Latches  
Leading Zero Blanking  
Compatible with CMOS Logic  
Internal Digit Scan Oscillator  
Single Power Supply Operation,  
+5 to +15VDC

\*DC to 5MHz Counting Applications

## 6 DECADE MOS UP COUNTER WITH 8 DECADE LATCH & MULTIPLEXER

LS7031



DC to 5MHz Count Frequency  
Multiplexed BCD Outputs  
Ability to Latch External BCD Data  
in the Two LSD Positions  
Leading Zero Blanking  
Compatible with CMOS Logic  
Single Power Supply Operation,  
+5 to +15VDC

\*5MHz to 500MHz Counting Applications

## DUAL 3 DECADE UP/DOWN COUNTER.

LS7040



DC to 350 KHz Count Frequency at  
+5V Operation  
Fully Synchronous, Cascadable  
Parallel BCD Output Data  
Counter Output Latches  
Power-On-Reset  
Inputs CMOS, TTL and DTL Compatible  
Reset and Count Enable Inputs  
Single Power Supply Operation,  
+5 to +15VDC

\* Multicomparison Applications Where  
Parallel Outputs are Required.

# LSI computer systems, inc.

1235 Walt Whitman Road, Melville, NY 11746 • Tel: (516) 271-0400 • TWX: 510-226-7833

CIRCLE NUMBER 91

## WHO MAKES WHAT & WHERE TO FIND IT

Volume 1 of **Electronic Design's GOLD BOOK** tells all. And, when you look up an item in its **PRODUCT DIRECTORY** you'll find each manufacturer listed **COMPLETE WITH STREET ADDRESS, CITY, STATE, ZIP AND PHONE.** Save time. There's no need to refer elsewhere to find missing information.

**IT'S ALL THERE**  
in  
**Electronic Design  
GOLD BOOK**

ELECTRONIC DESIGN 11, May 24, 1977

## subminiature piezoelectric tuning forks

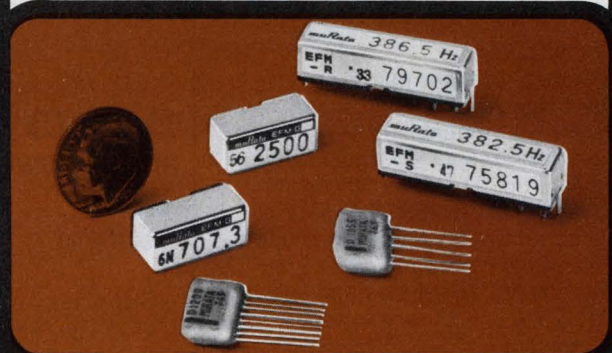

- For coding and decoding • 360 Hz to 2900 Hz and E.I.A. frequencies • Diminutive size —1.26"x.306" in sq. • —20° to 60°C operation
- Extremely stable and reliable

Designed for both consumer and industrial tone signaling and control systems such as paging, traffic signaling, alarms, and remote instrumentation. Write for complete technical data.

**muRata**  
CORPORATION  
OF AMERICA

*First in ceramics*

1148 Franklin Road, S.E.  
Marietta, Georgia 30067  
Tel: 404-422-9777  
Telex: 54-2329  
TWX: 810-763-4723

CIRCLE NUMBER 93

249



# KEEP THE HORSE BEFORE THE CART!

You've probably known design engineers who are half-way through a project before they realize the power supply that could have come from a standard line must all of a sudden be a customized design. And you also know what that means in the way of extra costs. It's the old cart before the horse theory.

Call us when you are in the embryonic stages of your design and we'll work with you in your primary important stages. And not only will you like the fact that our standard lines will both fit your supply and keep you in budget... you'll like the idea of our already field-tested dependability.

Our power supplies are available for OEM computer, point of sale, EDP, bank telling and telecommunications use:

- Switching regulator and linear designs • 11 models — single/multi-output • Voltage ranges, from 2 to 30V • 50 current levels from .01 to 225 amps • Overcurrent/overvoltage protection • Filtering to meet world-wide EMI requirements • Designed and built to UL, CSA and European safety requirements.

*Dependability.* That's a word we define as quality and reliability. It's also what design engineers define as our reputation!

# NCR

NCR POWER SYSTEMS DIVISION

formerly Scott Electronics  
584 S. Lake Emma Road, P.O. Box 898  
Lake Mary, Florida 32746

Telephone (305) 323-9250  
CIRCLE NUMBER 94

## POWER SOURCES

### Efficient supplies power $\mu$ Ps, memories

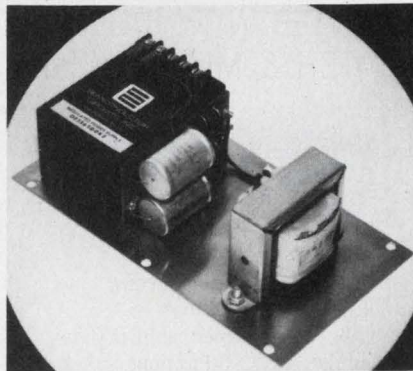

*Semiconductor Circuits, 306 River St., Haverhill, MA 01830. (617) 373-9104. From \$85 (10 qty); stock to 4 wks.*

The OE family of dc power supplies boasts efficiencies to 70% and immunity to input-line transients of 60 dB. For powering  $\mu$ Ps and memories, the outputs, 5 V at 4 or 6.5 A and 12 V at 2 or 3.5 A, are all regulated to within 0.5% for line and load. The supplies operate from ac inputs of either 105 to 125 V or 210 to 250 V, 50 to 440 Hz. Other key specifications include output ripple and noise of 13-mV rms (PAR), output-voltage tolerance of  $\pm 2\%$  (trim-adjustable to zero) and output foldback short-circuit protection. The units deliver full output, from  $-25$  to  $+60$  C. The supplies are mounted on an 8.25  $\times$  4.5-in. plate with a max height above the plate of 3.75 in.

CIRCLE NO. 397

### 120 to 180-V units aren't power fussy

*Datel Systems, 1020 Turnpike St., Canton, MA 02021. (617) 828-8000. \$79 (1-9 qty.)*

Supplies of the BPM series (BPM-120/25, BPM-150/20, and BPM-180/16) offer outputs of  $\pm 120$  V at 25 mA,  $\pm 150$  V at 20 mA, and  $\pm 180$  V at 16 mA, respectively. In addition to the standard input of 115 V ac, 60 to 440 Hz, versions for international use operate from 220 V, 48 to 440 Hz, or 100 V, 48 to 440 Hz. Line regulation is 0.05% max., load regulation is 0.1% max., tempo is 0.02%/°C max and output ripple is 10 mV rms max. Other features include output-current limiting and an operating range of  $-25$  to  $+71$  C. The 24-oz phenolic unit occupies 3.5  $\times$  2.5  $\times$  1.56 in.

CIRCLE NO. 398

### Dual output supplies come in new size

*Abbott Transistor Laboratories, 5200 W. Jefferson Blvd., Los Angeles, CA 90016. (213) 841-2510. \$75 (1-24 qty); stock.*

In a 7  $\times$  4.87  $\times$  2.5-in., "BB" size, NL-family supplies provide dual outputs of  $\pm 12$  V at 1.7 A or  $\pm 15$  V at 1.5 A. Standard input is 115 or 220 V ac, 47 to 440 Hz. Dual primaries are available. The supplies operate at full load up to 50-C ambient and derated to 40% at 71 C. Overvoltage protection is optional. The NL line also includes single, dual and triple-output models with ratings from 15 to 170 W.

CIRCLE NO. 399

### Eight-level regulator also programs

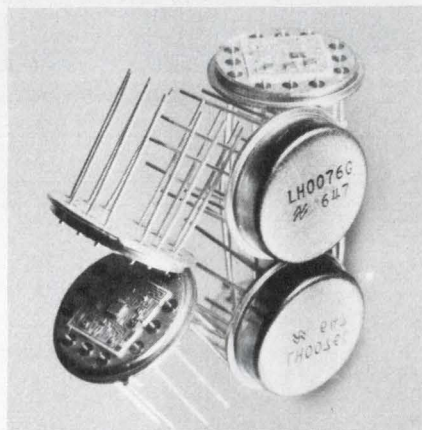

*National Semiconductor, 2900 Semiconductor Dr., Santa Clara, CA 95051. (408) 737-6523. From \$12.95 (100 qty.).*

Without external components, Models LH0075 positive regulator and LH0076 negative regulator offer 3, 5, 6, 8, 9, 12, 15 and 18-V outputs with 0.1% accuracy. Adding just one external resistor programs any output from 0 to 27 V. In addition, two resistors can program an output-current limit between 0 and 200 mA. Line regulation is 0.005%/V typ and 0.02%/V max, load regulation is 0.02% typ and 0.15% max, and ripple rejection is 70 dB typ. Because a constant-current source is used as the reference, remote voltage programming and remote voltage sensing is practical. Both TO-8 hybrid devices can be used for current boosting, electronic shutdown, and as programmable constant-current sources.

CIRCLE NO. 400



## Why did it fail?

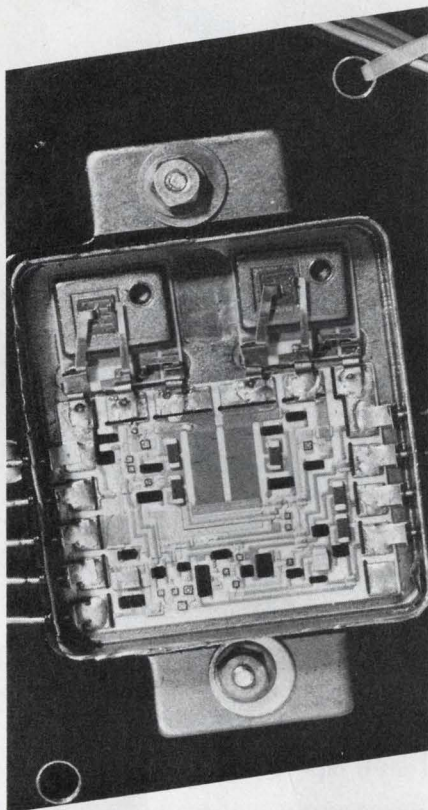

Locating circuit failures has always been a slow, tedious process. If only there were some way to **see** and **measure** the heat patterns created by failed components and connections, you could save much time and effort.

**Now you can.** UTI will show you.

## More power squeezed into switchers

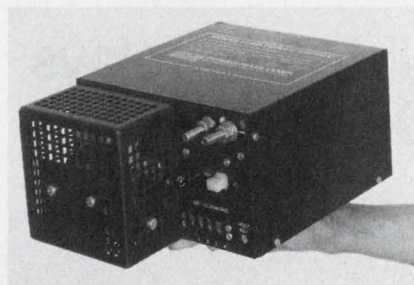

*Power/Mate, 514 S. River St., Hackensack, NJ 07601. (201) 343-6294. From \$750; stock.*

The SW family of switching regulated power supplies delivers 25% more power than previous models, in the same package sizes, with from 2 to 28-V outputs at up to 150 A. Operating at 70 to 80% efficiency they pass up to 1000 W from 440 cubic-inch package. The 14-lb units are 5 × 8 × 11 in. Dual inputs of 85 to 132 V ac and 170 to 264 V ac at 47 to 63 Hz operate the supplies. Regulation is maintained down to 78 V ac and 156 V ac for up to 10 min. Output regulation is maintained for 30 ms after loss of input power. Regulation for both line and load is 0.1% with 25-mV pk-pk ripple.

CIRCLE NO. 401

## Dual-output switcher packs lots of watts

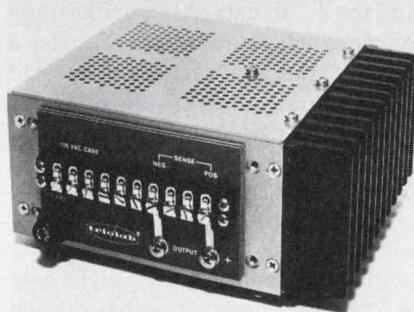

*Trio Labs, 80 Dupont St., Plainview, NY 11803. P. Bauer (516) 681-0400. \$420; stock.*

The dense Model 610, a dual-output switching supply, delivers a total of 125 W in 168 in<sup>3</sup>. The unit produces ±12 V at 5 A or ±15 V at 4 A with an efficiency of up to 87%. The 3.28 × 7.55 × 6.78 in. unit has overload and over-voltage protection plus remote sensing, and delivers full-load from -20 to +40 C. The switcher can be ruggedized to meet MIL specs.

CIRCLE NO. 402

## Thermography tells you instantly!

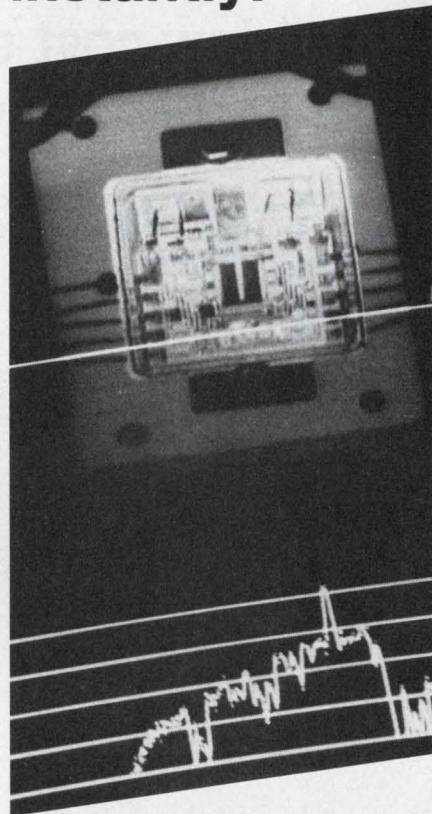

The new UTI-Spectrotherm Thermal Imaging System makes heat patterns visible for quick identification of faults. High-resolution images like this may be viewed on the CRT and recorded on film or tape.

Along with the picture, you get rapid quantitative measurements of temperatures from -27°C to +990°C. You may position the index line anywhere on the image

to produce a graphic profile and readout of temperatures.



*New Model 900 Thermal Imaging System*

Get the facts from UTI. Call 408/738-3301, use inquiry card, or write to 325 N. Mathilda, Sunnyvale, California 94086.

# UTI

CIRCLE NUMBER 96



## Small low-cost solid-state relays handle the 5-to-40-A load range

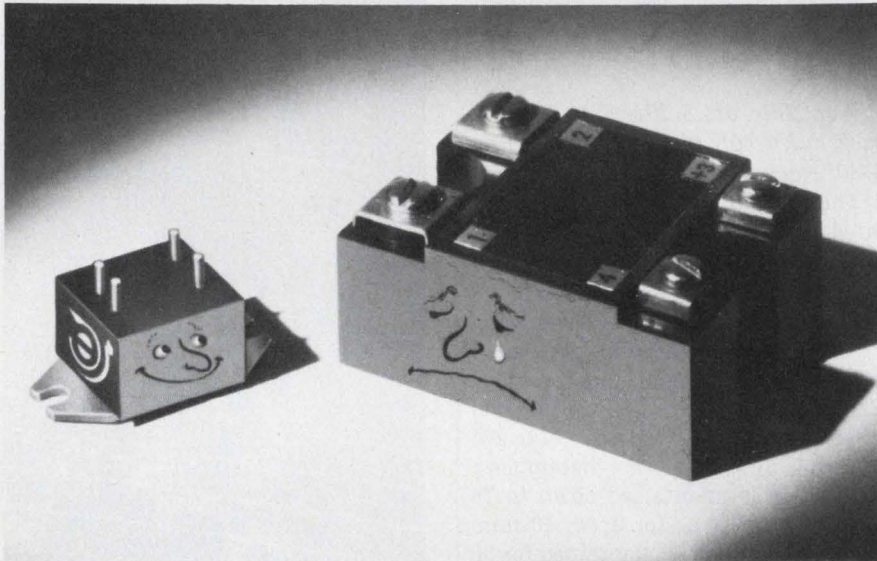

*Theta-J Relays, 1 DeAngelo Dr., Bedford, MA 01730. (617) 275-2575. \$3.75: 5 A, 120 V; \$12: 40 A, 120 V (1000 qty); 6 to 8 wks.*

The J-Tab line of ac miniature solid-state relays are the smallest, lowest-cost units offered to date with load ratings up to 40 A. They occupy less than 1/3 cubic inch, come in two current ranges and are rated for loads to 280 V ac.

The J-Tabs are 30 to 50% lower in cost than the lowest cost conventionally sized "25-A" units—such as the four-screw terminal-block styles, which are nominally 1-3/4 × 2-1/2 × 1 in. These larger relays are made by Opto-22, Crydom, Magnecraft, Electrol, Teledyne, Hamlin and many others.

Control signals for the 5-to-15-A J-Tab model is 5 mA max, and for the 15-to-40-A model, 30 mA max; both models have control voltages of 5, 12 or 120 V. The package, which can be mounted on a T0-3 transistor heat sink, has only two mounting holes on 1.19-in. centers.

Another company, Sigma, offers a solid-state relay, Series 226, with the same connection and case dimensions. But Sigma's unit handles only a maximum of 7 A and costs slightly more

—\$3.85 in production quantities.

All the Theta-J relays employ optical coupling with 1500-V isolation and maximum leakage currents of 1 mA. Connections are via 0.062-in. solid round copper pins—Sigma uses hollow pins, similar to those on vacuum tubes. And the J-Tab data sheet, unlike those for other solid-state relays, includes a table of thermal resistance vs load current to aid in heat-sink selection.

Theta-J expects that the relay's high transient peak-current capability—up to ten times rated load—will find many applications. For example, in 500-to-1000-W computer power supplies, normal line input current might only be 5 to 10 A. However, initial turn-on magnetization current of the power transformer can reach 200 to 300 A. Therefore, a small 25-A J-Tab unit could readily replace a high-current, large mechanical contactor, and require minimal heat sinking.

- |                 |                |
|-----------------|----------------|
| Theta-J         | Circle No. 302 |
| Crydom          | Circle No. 303 |
| Electrol        | Circle No. 304 |
| Hamlin          | Circle No. 305 |
| Magnecraft      | Circle No. 306 |
| Opto-22         | Circle No. 307 |
| Sigma           | Circle No. 308 |
| Teledyne Relays | Circle No. 309 |

## Dc servomotor performance improved

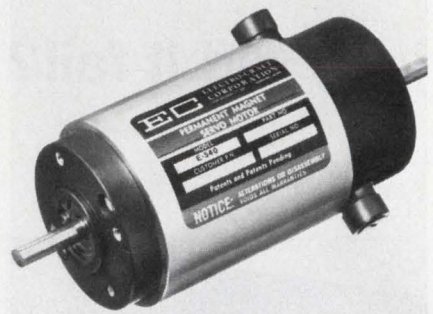

*Electro-Craft Corp., 1600 Second St. S., Hopkins, MN 55343. (612) 935-8226. Typical \$30 (1000 qty); 14 to 16 wks.*

Dc PM servomotors, series E-540 through E-542, are 2-1/4-in. dia and provide increased performance because of an enhanced magnetic circuit. For example, they deliver 50 to 100% more output torque with no increase in the moment of inertia or the motor length, and an increase of only 1/4 in. in the housing diameter over older designs. Therefore, the cost per unit of output torque has decreased by 30%. Motors are rated at 29-to-50 oz-in. continuous torque, 220-to-260 oz-in. peak torque, and inertias of only 0.0038 to 0.0062 oz-in.-sec<sup>2</sup>.

CIRCLE NO. 403

## Dot-matrix displays have up to 400 dots

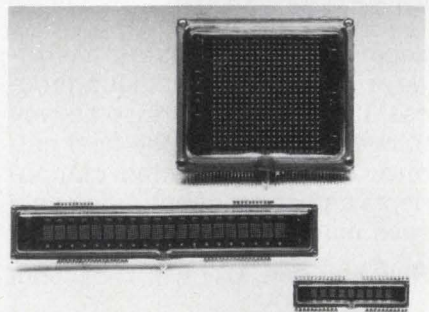

*Noritake Ltd., 22410 Hawthorne Blvd., Torrance, CA 90505. (213) 373-6704.*

The dot-matrix displays can be used to display numbers, letters, and symbols with moderate power consumption. Several different designs meet a wide variety of microprocessor I/O schemes. These include 9, 10, 16, 20, and 40-character displays with 5 × 7 dots, in heights ranging from 5 to 15 mm. For graphic displays as many as 400 (20 × 20) dots are available. The economical Itron dot-matrix displays are driven with 35 V, and are especially suited for portable equipment.

CIRCLE NO. 404



## Bright LEDs display lens legends

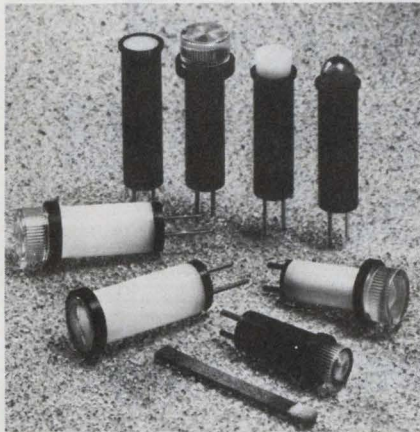

Data Display Products, P.O. Box 91072, Los Angeles, CA 90009. (213) 641-1232. \$1.39 to \$1.60 (1000 to 4999); stock to 6 wks.

Large integral Fresnel lenses rather than separate lens assemblies, and the brightest LEDs available, allow legends printed on the lenses to become practical for the first time. At a drive current of 20 mA, the LEDs put out typically 50 mcd (red), 35 mcd (amber) and 24 mcd (green). The LEDs fit sockets previously occupied by incandescents on a direct replacement basis.

CIRCLE NO. 405

## Subminiature PB rotary saves panel space



Alco Electronic Products, 1551 Osgood St., North Andover, MA 01845. (617) 685-4371. \$4.25 (100 qty); 4 to 6 wks.

The Pico series 10-position subminiature switches occupy less than 0.18 in. of panel space per decade and incorporate bidirectional pushbuttons. Snap-together modules and snap-in panel mounting save time and cut costs. Design engineers may choose either four-line-BCD or BCD-complement output codes. Wiping contacts are heavily gold plated. Lead wires may be soldered directly to card edge tabs, or an available PC connector may be used.

CIRCLE NO. 406

# Bliley

first name in frequency control

We have a reputation that can mean as much to you as it does to us. Here's why.

By manufacturing our own crystals and growing and sweeping our own quartz, we control product quality from raw material to finished unit.

Next, we specialize in the design and production of units whose level of precision is difficult—if not impossible—to find elsewhere.

Finally, our total commitment to quality makes us the preferred supplier to the more sophisticated levels of electronics.

If that's *your* level, you've found your peer in Bliley. Tell us about your present requirements or, simply request our catalog of complete product information and call later when you need us.

QUARTZ CRYSTALS • CRYSTAL OSCILLATORS • CRYSTAL FILTERS

BLILEY ELECTRIC COMPANY  
2545 West Grandview Boulevard,  
P.O. Box 3428, Erie, PA. 16508  
Tel. (814) 838-3571 TWX 510-696-6886

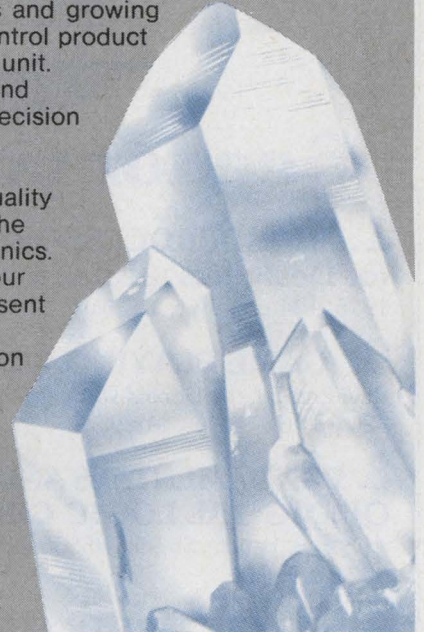

CIRCLE NUMBER 97

## MICROPROCESSOR POWER SUPPLIES

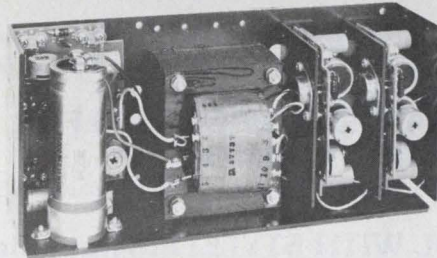

### Featuring . . . High Reliability and Low Cost

Now Power/Mate introduces a series of triple output, open frame power supplies designed specifically for microprocessor users.

Based on a rugged, field proven design, the ETR series of microprocessor power supplies features Dual AC Input, remote sensing, adjustable current limiting and plug-in IC regulation throughout the line.

Built to the same rigid quality standards that have made Power/Mate the industry leader, they offer a very impressive 100,000 hour MTBF.

Best of all, the ETR series is economical and in stock. Call or write for our free brochure.



## POWER/MATE CORP.

World's largest manufacturer of quality power supplies.

514 South River Street/Hackensack, N.J. 07601 / Phone (201) 343-6294 TWX 710-990-5023

CIRCLE NUMBER 98



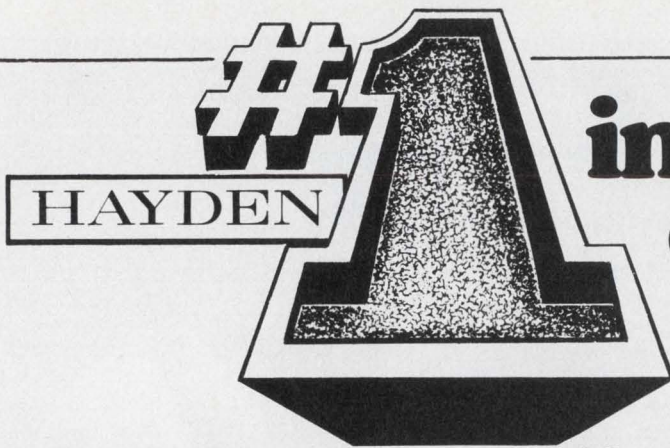

# in personal computing books!

## See for yourself the reasons why:

- 1. MICROPROCESSORS: New Directions for Designers** by Edward A. Torrero, #5777-6, paper, 1975, 144 pp., 8½ x 11, illus., \$10.95.
- 2. GAME PLAYING WITH COMPUTERS** Rev. 2nd Ed., by Donald D. Spencer, #5103-4, cloth, 1976, 320 pp., 6 x 9, illus. \$16.95.
- 3. FUNDAMENTALS AND APPLICATIONS OF DIGITAL LOGIC CIRCUITS** by Sol Libes, #5505-6, paper, (\$6.95), #5506-4, cloth, (\$9.95), 1975, 192 pp., 6 x 9, illus.
- 4. COMPUTERS IN ACTION: How Computers Work** by Donald D. Spencer, #5861-6, paper, 1974, 160 pp., 6 x 9, illus., \$5.50.
- 5. COMPUTERS IN SOCIETY: The Wheres, Whys and Hows of Computer Use** by Donald D. Spencer, #5915-9, paper, (\$5.50), #5916-7, cloth, (\$7.50), 1974, 208 pp., 6 x 9, illus.
- 6. PROGRAMMING PROVERBS** by Henry F. Ledgard, #5522-6, paper, 1975, 144 pp., 6 x 9, illus., \$6.50.
- 7. PROGRAMMING PROVERBS FOR FORTRAN PROGRAMMERS** by Henry F. Ledgard, #5820-9, paper, 1975, 144 pp., 6 x 9, illus., \$6.50.
- 8. COBOL WITH STYLE: Programming Proverbs** by Louis J. Chmura, Jr., and Henry F. Ledgard, #5781-4, paper, 1976, 144 pp., 6 x 9, illus. \$5.45.
- 9. MINICOMPUTERS: Structure and Programming**, by T.G. Lewis and J.W. Doerr, #5642-7, cloth, 1976, 288 pp., 6 x 9, illus., \$12.95.
- 10. PATTERN RECOGNITION** by M. Bongard, #9165, cloth, 1970, 256 pp., 6 x 9 illus., \$14.90.
- 11. DIGITAL SIGNAL ANALYSIS** by Samuel D. Stearns, #5828-4, cloth, 1975, 288 pp., 6 x 9, illus., \$19.95.
- 12. BASIC BASIC: An Introduction to Computer Programming in BASIC LANGUAGE** by James S. Coan, #5872-1, paper, (\$7.95), #5873-X, cloth, (\$9.95), 1970, 256 pp., 6 x 9, illus.
- 13. ADVANCED BASIC: Applications and Problems**, by James S. Coan, #5856-X, cloth, (\$8.95), #5855-1, paper, (\$6.95), 1976, 192 pp., 6 x 9, illus.
- 14. FORTRAN FUNDAMENTALS: A Short Course** by Jack Steingraber, #5860-8, paper, 1975, 96 pp., 6 x 9, illus., \$4.95.
- 15. DIGITAL TROUBLESHOOTING: Practical Digital Theory and Troubleshooting Tips** by Richard E. Gasperini, #5708-3, paper, 1976, 180 pp., 8½ x 11, illus., \$9.95.
- 16. DIGITAL EXPERIMENTS** by Richard E. Gasperini, #5713-X, paper, 1976, 192 pp., 8½ x 11, illus., \$8.95.

### Write for 15-day examination copies of any of these books!

*At the end of 15 days, please remit payment plus postage and handling, or return the books and owe nothing. Prices subject to change without notice. If payment*

*accompanies order, we pay postage and handling. Outside USA, cash must accompany order — include \$2.00 per book for shipping and handling.*



## Hayden Book Company, Inc.

50 Essex Street, Rochelle Park, New Jersey 07662

phone: (201) 843-0550





## MODULES & SUBASSEMBLIES

### Economical 12-bit a/d offers speed, linearity

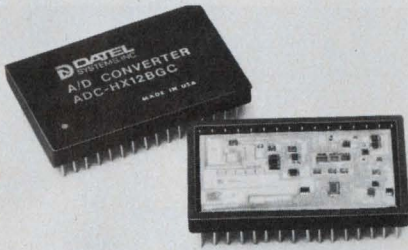

Datel Systems, 1020 Turnpike St., Canton, MA 02021. E. Murphy (617) 838-8000. \$85 (1 to 24 qty.); stock to 4 wks.

The economical Model ADC-HX12BGC a/d converter performs a 12-bit conversion in 20  $\mu$ s max while maintaining  $\pm 1/2$  LSB linearity with a 20 ppm/ $^{\circ}$ C max tempo. Pin-selectable input ranges are 0 to  $\pm 5$ , 0 to  $\pm 10$ ,  $\pm 2.5$ ,  $\pm 5$ , and  $\pm 10$  V. Output coding is binary or offset binary with two's complement coding also selectable in bipolar operation. An internal buffer presents 100-M $\Omega$  input impedance when connected to the successive-approximation converter. In addition the differential-linearity tempo is 2 ppm/ $^{\circ}$ C and no codes are missed over 0 to 70 C.

CIRCLE NO. 407

### Tiny 14-bit a/d needs no adjustments



Micro Networks, 324 Clark St., Worcester, MA 01606. J. Munn (617) 852-5400. \$275 (1-24 qty.); stock to 4 wks.

In less than 2.5 in.<sup>2</sup> the MN5260 gives you a complete 14-bit a/d. Functional laser-trimming eliminates adjustment or calibration. The DIP devices feature linearity of  $\pm 1/2$  LSB from 0 to 70 C, absolute accuracy including all error sources of 0.4% from 0 to 70 C, and power consumption of 230 mW. Conversion time for the full 14 bits is typically 175  $\mu$ s, and the digital inputs and outputs are TTL or CMOS compatible depending on the supply.

CIRCLE NO. 408

### Analog in, 14 bits out in only 10 $\mu$ s

Zeltex, 940 Detroit Ave., Concord, CA 94518. R. Terry (415) 686-6660. \$695 (100 qty); 30 days.

In only 10  $\mu$ s the ZAD 8014 a/d converter resolves signals to 14 bits. Additional features include four pin-selectable input ranges and binary, offset-binary or two's-complement output codes. Differential nonlinearity is  $\pm 1/2$  LSB. The converter operates monotonically from 0 to 70 C.

CIRCLE NO. 409

### Optical scanner sees hair-thin reflections

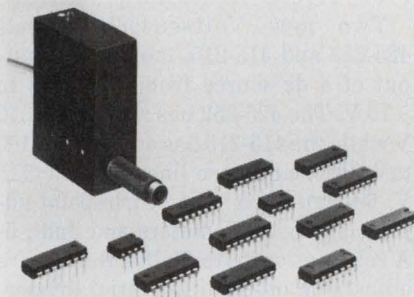

Skan-A-Matic, P.O. Box S or Rt. 5 West, Elbridge, NY 13060. R. Walker (315) 689-3961. \$108.90 (1-9); 6 days.

The C32101 coaxial fiber-optic scanner detects a 0.005-in. mark at 0.1 in. An amplifier in the same package boosts the output of the phototransistor in the reflective scanner. The unit comes in lamp or LED versions. Either requires only 5-V-dc power and contains a 15-turn pot for sensitivity adjustment. A red indicator light signals when the amplifier is energized.

CIRCLE NO. 410

### Peak-detecting a/d stores only digits

Hybrid Systems, Crosby Dr., Bedford Research Park, Bedford, MA 10730. L. Peacock (617) 275-1570. \$104 (1 to 9); stock.

Peak-detecting a/d converters of the PD855 Series digitally track and store the peak value of an analog input signal without degradation or droop. Storage is completely digital and units come with either 3-decade BCD or 12-bit binary coding. The converters can peak detect and read signals from 0 to 10 V at 40 V/ms for the BCD version and 10 V/ms for the binary-coded unit.

CIRCLE NO. 411



## 300 $^{\circ}$ C TEST SOCKETS

TEXTOL's new line of 300 $^{\circ}$ C test sockets offers single source, fast delivery and high temperature test capabilities for almost all industry standard devices.

New TEXTOL standard high temperature test sockets in a wide range of models are immediately available to meet applications requiring device testing or burn-in at 300 $^{\circ}$ C.



The extensive line includes TEXTOL's proven 300 $^{\circ}$ C ZIP DIP (zero insertion pressure) sockets and others capable of high temperature testing of TO-5 packages (3 leads up), flat-packs and DIPs, power devices, as well as axial lead packages and miscellaneous hybrid devices.

In short, with one of the widest lines of 300 $^{\circ}$ C sockets available, TEXTOL offers a high temperature test capability for virtually all industry standard devices.

All new TEXTOL high temperature sockets feature the option of either chassis or P.C. board mounting as required by the application. The socket line is available with Nickel Boron plated BeNi contacts for extended use at highly elevated temperatures.

Detailed information on this new high temperature socket line and other products in a wide choice of materials from TEXTOL . . . IC, MSI and LSI sockets and carriers, power semiconductor test sockets, and custom versions . . . is available from your nearest TEXTOL sales representative or the factory direct.

Ask today for your copy of the new 1977 TEXTOL CONDENSED CATALOG!



PRODUCTS, INC.

1410 W. Pioneer Drive • Irving, Texas 75061  
214/259-2676

CIRCLE NUMBER 101



## MODULES & SUBASSEMBLIES

### Display offers any character you like

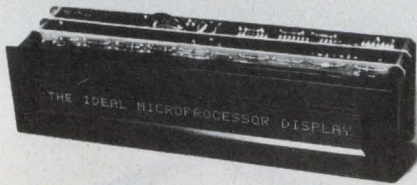

Burroughs, P.O. Box 1226, Plainfield, NJ 07061. J. Pittman (201) 757-5000. \$172 (1000 qty); stock.

The 5 × 7 dot-matrix for each of the 32 characters in a Self-Scan Model SS DO 132-0081 is programmable. Two PROMs contain a repertoire of 64 characters. The PROMs can be repeatedly programmed for any character set. The display repertoire can be extended to 128 characters using a ROM and two PROMs. The gas-discharge panels characters are 0.2 × 0.14 in., readable up to 15 ft. Character-entry rate is 166,000 char/s. ROMs and PROMs are priced separately.

CIRCLE NO. 412

### Units protect circuits from overvoltage

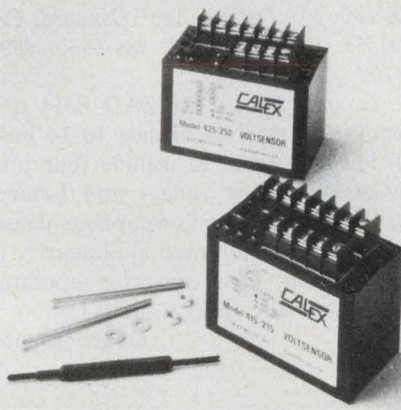

Calex Mfg., 3305 Vincent Rd., Pleasant Hill, CA 94523. R. Kreps (415) 932-3911. From \$118 (1-9); stock.

Two new Voltensors, Models 425-252 and 415-215, monitor the output of a dc source from millivolts to ±10 V. The 425-252 has a range of ±10 V while the 415-215 has a range of ±100 mV. Both units are line operated (115 V, 60 Hz), have built-in trip-point adjustment potentiometers and dpdt, 5-A relays as outputs. Both units feature adjustable on-off differential (hysteresis) and programmable latching.

CIRCLE NO. 413

### High ratio i-f switch covers 30 to 300 MHz

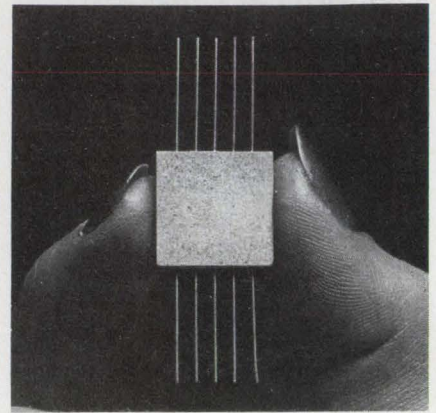

Vari-L, 3883 Monaco Pkwy., Denver, CO 80207. (303) 321-1511. \$97.50 (unit qty); 4 wks.

A balanced i-f processing switch, the SS-80, offers a typical on-off ratio ranging from 85 dB at 30 MHz to 50 dB at 300 MHz. Features include switching time of 5 ns, isolation of 75 dB, insertion loss of 2.5 dB, 3rd-order intercept point (on) of +30 dBm, switching-signal transient of 2 mV and VSWR (on) of 1.3:1. This unit comes in a metal flatpack that is 0.635 × 0.635 × 0.125 in.

CIRCLE NO. 414

## FREE...WALL CHART POWER ROTARY SWITCHES

SELECTOR GUIDE - ROTARY SWITCHES											
NO. OF POLES	NO. OF POSITIONS	NO. OF CONTACTS	NO. OF CONTACTS PER POSITION	NO. OF CONTACTS PER POLE	NO. OF CONTACTS PER POSITION	NO. OF CONTACTS PER POLE	NO. OF CONTACTS PER POSITION	NO. OF CONTACTS PER POLE	NO. OF CONTACTS PER POSITION	NO. OF CONTACTS PER POLE	NO. OF CONTACTS PER POSITION
1	2	2	2	2	2	2	2	2	2	2	2
2	3	3	3	3	3	3	3	3	3	3	3
3	4	4	4	4	4	4	4	4	4	4	4
4	5	5	5	5	5	5	5	5	5	5	5
5	6	6	6	6	6	6	6	6	6	6	6
6	7	7	7	7	7	7	7	7	7	7	7
7	8	8	8	8	8	8	8	8	8	8	8
8	9	9	9	9	9	9	9	9	9	9	9
9	10	10	10	10	10	10	10	10	10	10	10
10	11	11	11	11	11	11	11	11	11	11	11
11	12	12	12	12	12	12	12	12	12	12	12
12	13	13	13	13	13	13	13	13	13	13	13
13	14	14	14	14	14	14	14	14	14	14	14
14	15	15	15	15	15	15	15	15	15	15	15
15	16	16	16	16	16	16	16	16	16	16	16
16	17	17	17	17	17	17	17	17	17	17	17
17	18	18	18	18	18	18	18	18	18	18	18
18	19	19	19	19	19	19	19	19	19	19	19
19	20	20	20	20	20	20	20	20	20	20	20
20	21	21	21	21	21	21	21	21	21	21	21
21	22	22	22	22	22	22	22	22	22	22	22
22	23	23	23	23	23	23	23	23	23	23	23
23	24	24	24	24	24	24	24	24	24	24	24
24	25	25	25	25	25	25	25	25	25	25	25
25	26	26	26	26	26	26	26	26	26	26	26
26	27	27	27	27	27	27	27	27	27	27	27
27	28	28	28	28	28	28	28	28	28	28	28
28	29	29	29	29	29	29	29	29	29	29	29
29	30	30	30	30	30	30	30	30	30	30	30
30	31	31	31	31	31	31	31	31	31	31	31
31	32	32	32	32	32	32	32	32	32	32	32
32	33	33	33	33	33	33	33	33	33	33	33
33	34	34	34	34	34	34	34	34	34	34	34
34	35	35	35	35	35	35	35	35	35	35	35
35	36	36	36	36	36	36	36	36	36	36	36
36	37	37	37	37	37	37	37	37	37	37	37
37	38	38	38	38	38	38	38	38	38	38	38
38	39	39	39	39	39	39	39	39	39	39	39
39	40	40	40	40	40	40	40	40	40	40	40
40	41	41	41	41	41	41	41	41	41	41	41
41	42	42	42	42	42	42	42	42	42	42	42
42	43	43	43	43	43	43	43	43	43	43	43
43	44	44	44	44	44	44	44	44	44	44	44
44	45	45	45	45	45	45	45	45	45	45	45
45	46	46	46	46	46	46	46	46	46	46	46
46	47	47	47	47	47	47	47	47	47	47	47
47	48	48	48	48	48	48	48	48	48	48	48
48	49	49	49	49	49	49	49	49	49	49	49
49	50	50	50	50	50	50	50	50	50	50	50
50	51	51	51	51	51	51	51	51	51	51	51
51	52	52	52	52	52	52	52	52	52	52	52
52	53	53	53	53	53	53	53	53	53	53	53
53	54	54	54	54	54	54	54	54	54	54	54
54	55	55	55	55	55	55	55	55	55	55	55
55	56	56	56	56	56	56	56	56	56	56	56
56	57	57	57	57	57	57	57	57	57	57	57
57	58	58	58	58	58	58	58	58	58	58	58
58	59	59	59	59	59	59	59	59	59	59	59
59	60	60	60	60	60	60	60	60	60	60	60
60	61	61	61	61	61	61	61	61	61	61	61
61	62	62	62	62	62	62	62	62	62	62	62
62	63	63	63	63	63	63	63	63	63	63	63
63	64	64	64	64	64	64	64	64	64	64	64
64	65	65	65	65	65	65	65	65	65	65	65
65	66	66	66	66	66	66	66	66	66	66	66
66	67	67	67	67	67	67	67	67	67	67	67
67	68	68	68	68	68	68	68	68	68	68	68
68	69	69	69	69	69	69	69	69	69	69	69
69	70	70	70	70	70	70	70	70	70	70	70
70	71	71	71	71	71	71	71	71	71	71	71
71	72	72	72	72	72	72	72	72	72	72	72
72	73	73	73	73	73	73	73	73	73	73	73
73	74	74	74	74	74	74	74	74	74	74	74
74	75	75	75	75	75	75	75	75	75	75	75

- Snap-action . . . detent . . . and cam switches
- Ratings from 10A-240V to 200A-600V
- Up to 75 poles
- Many standard & custom options
- Fast deliveries



**ELECTRO SWITCH**  
Weymouth, Massachusetts 02188

Telephone: 617/335/5200 • TWX: 710/388/0377

CIRCLE NUMBER 102

## Sexy Skanners to detect small stuff.

.001 inch and smaller.  
Coaxial fiber optic design puts the phototransistor in the tip away from lamp or LED heat for negligible drift. Response time from skanner to amplifier output in 5 microseconds.

And there's more.  
Widest selection of subminiature photoelectric sensors ever offered. Controls and automation systems to match. 3 day shipments.

SEND FOR COMPLETE CATALOG.

**SKAN-A-MATIC®**  
CORP.  
P.O. BOX 5, ELBRIDGE, N.Y. 13060  
PHONE (315) 689-3961

CIRCLE NUMBER 103

ELECTRONIC DESIGN 11, May 24, 1977



## Low priced v/f's excel at drift linearity

Burr-Brown, International Airport Industrial Park, Tucson, AZ 85734. J. Santen (602) 294-1431. From \$46 (100 qty.); stock.

Two v/f converters, VFC12LD and VFC15LD, feature drift of 10 ppm/°C and linearity of ±0.005%. The VFC12LD offers a 0 to 10-V input range and dc to 10-kHz output. Both units are compatible with systems that have digital resolution of 12 or 13 bits. These modules are 1.5 × 1.5 × 0.4 in. Only ±15-V-dc power is needed. Gain and offset can be adjusted with external pots.

CIRCLE NO. 415

## Counter gets miserly when power fades

Kessler-Ellis Products, Atlantic Highlands, NJ 07716. E. Laird (201) 291-0500. From \$135; stock.

When switched to standby by a power failure, the seven-digit HO-7 Series counters draw only 60 μA. A D-size flashlight battery can operate these counters without the display for up to two years. For short-term interruptions an internal power capacitor extends operation for up to 10 min. When power fails, the 0.2-in. LED display shuts off but all other functions remain active, the display can be switched back on. The units count at up to 500 kHz and mount in panel cutouts of 1 × 2 in. They operate from 5 to 30-V input power and count either switch closures or signals of from 3 to 30 V dc.

CIRCLE NO. 416

## Small v/f converter comes complete

Teledyne Philbrick, Allied Dr. at Rte. 128, Dedham, MA 02026. F. Goodenough (617) 329-1600. \$21 (100 qty.); stock.

The 4723, a 10-kHz v/f converter, requires no external active, passive, timing or trimming components. The device offers 0.01% nonlinearity and 50 ppm/°C full-scale tempco in a 0.4 in. high by 1.3 in.<sup>2</sup> package. Additional features include voltage and current inputs, max preset full-scale error of ±0.5%, initial offset error of 5 mV and open-collector output. With the company's 4722 f/v device, the converter makes a system with 0.02% accuracy.

CIRCLE NO. 417

# MAGNETIC SHIELDING

## MATERIAL

- CO-NETIC AA Alloy High Permeability .002" to .100" thick

## EXCLUSIVE

Perfection Annealed — No further anneal required if severe forming is avoided.

- NETIC S3-6 Alloy — High Saturation Induction. .004" to .095" thick
- Immediate Shipment from Stock

SEND FOR NEW MG-3

Material, Application & Fabrication Guide

MAGNETIC SHIELD DIV.



PERFECTION MICA CO.

740 N. Thomas Dr.  
Bensenville, Ill. 60106  
Ph. (312) 766-7800  
TWX (910) 256-4815

The Preferred Source  
for Magnetic Shielding

CIRCLE NUMBER 104

## SAVES \$ EXTEND YOUR COUNTER'S FREQUENCY RANGE TO 1,000 MHz!

## WITH NEW FREQUENCY SCALING PROBES

- low cost
- outstanding input performance
- miniature size

### DESCRIPTION

The Frequency Scaling Probe is a miniature assembly which attaches directly to any counter and increases frequency range and sensitivity to 1,000 MHz. The probe consists of a high gain amplifier and two division ratios; ÷10 and ÷100. The power to the probe is provided by a wall mounting power unit — input performance comparable to the most costly counters available!

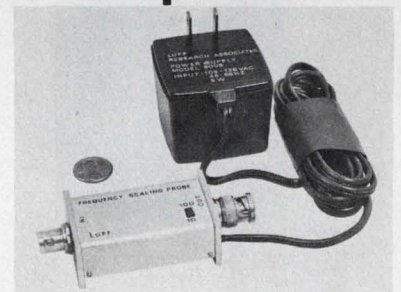

SPECIFICATIONS	MODEL 1000	MODEL 600	MODEL 500
Frequency Range	30 to 1,000 MHz min.	10 to 600 MHz min.	10 to 512 min.
Input Sensitivity	-27 dBm typ.	-37 dBm typ.	-37 dBm typ.
Frequency Scaling Ratios	÷10 and ÷100 all models		
Input	50 ohm nom., A.C. coupled and diode protected to +13 dBm min.		
Output	.5 V p.p. nom. into 50 ohms		
Size	probe: 2.5 × 1.5 × 1 in. power unit: 2.1 × 2.1 × 1.7 in.		
Input Power	115 or 230 Volts A.C., 50-60 Hertz		
Warranty	one year		
Price	\$ 425	\$ 325	\$ 265

**luff RESEARCH**

P.O. Box 449 Jackson Heights N.Y., N.Y. 11372

(212) 429-5900

CIRCLE NUMBER 105



# spill-proof power



for every stand-by emergency need



Our batteries are truly Carefree. They won't spill, never require maintenance, built with dual covers and they're completely rechargeable. We've got practically all sizes, but if you need a unique configuration that isn't on our shelf, we can probably build it for you. Call us. We're prompt and we're Carefree.

**EAGLE P P P ICHER**  
SINCE 1843

EAGLE-PICHER INDUSTRIES, INC.  
Commercial Products Department ED  
P.O. Box 130, Seneca, Mo. 64865  
Telephone (417) 776-2258

CIRCLE NUMBER 106

## INSTRUMENTATION

3-1/2-digit DMM carries \$99.95 price



B & K Precision Dynascan Corp., 6460 W. Cortland Ave., Chicago, IL 60635. (312) 889-9087. \$99.95.

A 3-1/2-digit portable DMM, the 2800, is priced at only \$99.95. The 2800 features 22 ranges that measure as high as 1000 V dc or ac, or up to 40,000 V dc with optional PR-28 probe. Resolution is to 1 mV, 1  $\mu$ A or 0.1 $\Omega$ . Typical dc accuracy is 1% with an input impedance of 10 M $\Omega$ . The 2800 also features auto-zeroing and 100% overrange reading on all ranges.

CIRCLE NO. 418

LED DPM can be seen from 40 feet

Fairchild Instrumentation Unit, 1725 Technology Dr., San Jose, CA 95110. G. Daggy (408) 998-0123. See text; 2 to 4 wks.

Visibility at 40 ft results with the Model 80, a 3-1/2-digit panel meter that uses LEDs with a height of 0.8 in. The meter accepts either voltage (\$98, 1-9 qty) or currents (\$110, 1-9 qty) inputs and makes ratio measurements between two analog signals. Bit-serial, decimal-point selection and external-hold are standard. BCD bit-parallel is optional. All data bits including sign are latched. The meter can power external circuitry with 25 mA of 5 V dc and 15 mA of -8 V dc. The panel housing is 3.58 x 1.645 in.

CIRCLE NO. 419

Digital scope writes at 100 cm/ $\mu$ s

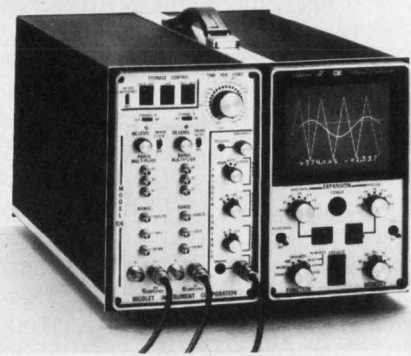

Nicolet Instrument, Oscilloscope Div., 5225 Verona Rd., Madison, WI 53711. (608) 271-3333. \$4200 to \$4500.

EXPLORER II is designed to replace low-frequency analog oscilloscopes, either storage or nonstorage types. It features nonfading high-capacity storage with writing-rate equivalents up to 100 cm/ $\mu$ s, depending on the plug-in unit, and precision of form from 0.4% to 0.025% of full scale. Time resolution is 0.025%. Normalized voltage and time values are displayed for any selected point, either true values with respect to zero or with respect to the time and voltage corresponding to any other selected point.

CIRCLE NO. 420

Processor doubles as DMM and calculator



Electro Design Inc., 7364 Convoy Ct., San Diego, CA 92111. (714) 277-2471. \$2200, base price.

Model ED6773 instrumentation processor combines the functions of a digital multimeter with those of a programmable calculator and offers the ability to specify up to seven analog-to-digital input variables. A choice of a/d converters for dc V, ac V resistance or frequency are offered. In addition, the user can manually or remotely program and store up to 84 algebraic equations and up to 24 constants for performing computations on any two of the input variables at a time. A front-panel keyboard (or remote entry) is provided for equations, constants and instructions.

CIRCLE NO. 421



## 50-MHz pulse gen delivers 20 V



Philips Test & Measuring Instruments,  
85 McKee Dr., Mahwah, NJ 07430. (201)  
529-3800. \$1975; 4 wks.

PM 5716 pulse generator works to 50 MHz, with 20-V maximum pulse amplitude and transition times continuously variable between 6 ns and 100 ms. All controls function independently and do not interact with others, allowing a "once-only" setting per operation. Pulse characteristics are set using independent sliders. A mechanical lock prevents the output pulse from exceeding 20 V max anywhere over the entire -20 to 20-V range. The device under test can be safeguarded by using the built-in limiter. Backmatched 50-Ω outputs absorb reflections.

CIRCLE NO. 422

## Unit tests or simulates IEEE-488 bus devices

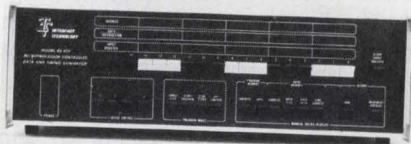

Interface Technology, 852 N. Cummings Rd., Covina, CA 91724. (213)  
966-1718. \$7995; 8-10 wks.

Model RS-432-IB tests, exercises and simulates IEEE STD 488-1975 bus/devices. The programmable unit simulates the bus control function, and can exercise all bus functions and messages. More importantly, it allows the user to control and exercise the end device under test. All testing can be accomplished at full dynamic bus speed or at user programmed rates, with memory provided to store and transmit up to 512 bytes of end-device-dependent message data. A basic IEEE STD 488-1975 exerciser program comes with the RS-432-IB but the user can generate new programs.

CIRCLE NO. 423

# New 20 column full alphanumeric printer

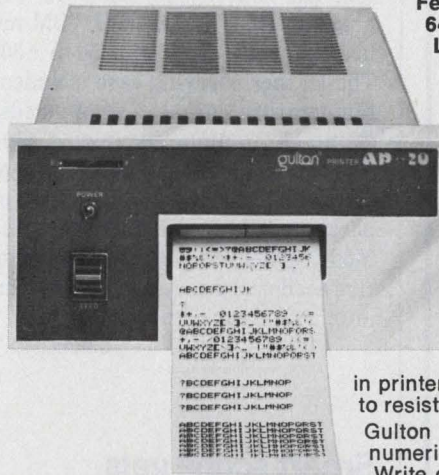

Featuring Quiet Thermal Printing . . .  
64 Characters ASCII Subset . . . 2.5  
Line/Sec. Print Rate . . . Panel  
Mounting . . . Full Electronics . . .  
Simple Paralle! Interface

Alphanumeric printers don't have to use complex mechanical print mechanisms, with their inherent clicking and banging.

Now, Gulton's AP-20 printer gives you a quiet, reliable, non-impact thermal printhead/print mechanism in a handsome unit complete with all electronics including power supply.

It's the most significant advance in printers yet . . . and at a price that's hard to resist.

Gulton offers a full line of alphanumeric, numeric and special character printers. Write or call for detailed catalog.

**gulton**<sup>®</sup>

Measurement & Control Systems Division  
Gulton Industries Inc., East Greenwich, Rhode Island 02818  
401-884-6800 • TWX 710-387-1500

CIRCLE NUMBER 107

## microFORTH<sup>®</sup> The High-Level Language For Microprocessor Development Systems

**microFORTH will Simultaneously:**

**Slash Software Development Time Up to 90%**

Users find that software development time is cut from three to ten times. Save important development time and money beginning today! Write for results of a recently completed study.

**Slash Memory Requirements Up to 90%**

**On development systems** - microFORTH's operating system provides powerful interactive high-level capabilities and runs independently of any other system in less than 8K plus diskette. Compare with Intel's PLM, requiring 64K plus diskette!  
**In production systems** - microFORTH produces programs 50% smaller than assembler code, 60-90% smaller than PLM or other high-level languages!

**Produce Transportable Programs**

High-level microFORTH is processor independent! This gives you a new flexibility in choosing microprocessors; you can change later without extensive re-programming.

**Cut Run Time By 60%**

microFORTH runs several times faster than other high-level languages. This speed difference can be critical in your present or future microcomputer applications.

The microFORTH software price including Primer, Technical Manual and telephone Hot Line consultation is \$2,500.00 plus options.

For further information on microFORTH and applications, call or write:

**FORTH** inc.

815 Manhattan Ave., Manhattan Beach, CA 90266 - (213) 372-8493

CIRCLE NUMBER 108



# Electronic Product Design Engineers

Our High Energy Laser Systems Laboratory has several critical openings for product-design engineers who are analytically oriented and able to interface effectively with manufacturing personnel in their own environment.

Duties include first-order thermal and structural analyses, hybrid microelectronics, conceptual physical design of electronic units to military specifications—including selection of components, materials and processes, coordination with circuit and systems engineers, supervision of designers and draftsmen during detail design, data-package maintenance, and configuration-status accounting to program management.

All of our openings require an accredited degree in either mechanical or electronic engineering and experience in some of the areas indicated above.

Please mail us your resume. It will receive prompt attention. Professional Employment, Hughes Aircraft Company, 11940 West Jefferson Blvd., Culver City, CA 90230.

**HUGHES**

HUGHES AIRCRAFT COMPANY  
AEROSPACE GROUPS

U.S. Citizenship required  
Equal opportunity M/F/HC employer

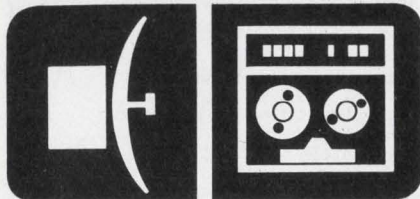
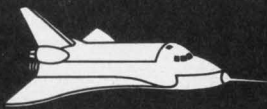

## INSTRUMENTATION

### Pocket VOM tells how hot your part is

Triplet Corp., 286 Harmon Rd., Bluffton, OH 45817. (419) 358-5015. \$120.

Model 100-T hand-sized VOM measures temperature from -50 to +300 F. The leather carrying case includes the temperature probe, VOM leads, a clamp-on ac ammeter, plus a plug-in line separator for current readings on standard line cords. The complete package sells for only \$120. The basic Model 390 shirt pocket VOM includes five ac/dc voltage ranges, four dc milliamper and four ohm ranges.

CIRCLE NO. 424

### Smart scope gets even smarter



Norland Instruments, Norland Dr., Fort Atkins, WI 53538. (414) 563-8456. \$13,400 (mainframe); stock-30 days.

The NI2001A waveform and data-analysis system is an expanded version of the NI2001 programmable digital oscilloscope with the following additional capabilities: Nine additional frequency-domain operators, including Fourier transform, inverse Fourier transform, power spectral density and many more—all through simple keystroke programs; five new transcendental operators including sine, cosine, arctan, natural log, and exponential; a statistics package including linear regression, mean and standard deviation; and 17 additional, directly addressable, operable and displayable floating point registers.

CIRCLE NO. 425

### Instrument combines four functions

Philips Test & Measuring Instruments, 85 Mc Kee Dr., Mahwah, NJ 07430. (201) 529-3800. \$545; 6-8 wks.

This laboratory instrument combines four functions; wideband amplifier, ac/dc converter and impedance conversion. The PM 5171 measuring amplifier covers dc to 1 MHz. Input may be ac or dc coupled, and impedance 1 M $\Omega$  in parallel with 25 pF. Input voltage is a maximum of 100 V pk-pk and output is 0 to 10 V rms into an open circuit. Adjustable gain from 0 to 68 dB in 10-dB steps is accurate to within 0.1 dB at 1 kHz. At maximum gain, distortion is only 0.2%.

CIRCLE NO. 429

### Waveform recorder gives high speed, resolution

Biomation, 10411 Bubb Rd., Cupertino, CA 95014. (408) 255-9500. \$5500; 60 days.

Model 1010 analog waveform recorder operates at 10 MHz with 10-bit resolution. Basic memory capacity is 2050 words (10-bit data samples) and this can be expanded to 4100 words with a plug-in printed-circuit card. Memory partitioning and dual timing functions are included. Partitioning allows half the total basic or expanded memory capacity to be allocated to an initial waveform recording, simplifying the "before and after" tests. With its dual time base, the 1010 can be set up to change sampling rates automatically during a recording sweep.

CIRCLE NO. 430

### Memory tester simulates patterns

Microgamma Systems Inc., 260 N. Rock Rd., Suite 225, Wichita, KS 67206. Start at under \$30,000; 10-12 wks.

MG 3000 semiconductor memory test system is said to be the first to provide a pattern simulator to aid test-pattern generation and verification. A microprocessor-based test-system controller features floppy-disc storage, CRT or teletypewriter I/O, and can control multiple test stations simultaneously. Each test station is a pattern processor capable of 10-MHz test speeds (50-ns cycle time with split cycle timing).

CIRCLE NO. 431



# dip/loc™

## A LOCK-ON CLIP THAT'S THIN-AS-A-DIP

- Lock-on design assures positive contact and prevents accidental disconnects.
- Thin-As-A-Dip profile fits into areas where component density is high.
- Contacts accept square post receptacles, barrier strips guard against shorting.
- Clips for 14 or 16 pin Dips, available from stock.

PATENT APPLIED FOR

**EC**  
**EVERETT CHARLES, INC.**

2806 Metropolitan Place  
Pomona, CA 91767  
PHONE (714) 593-2541

CIRCLE NUMBER 109

## We can take the heat

Nichicon R-2A High-Temperature Capacitors have an operating temperature range of  $-40^{\circ}\text{C}$  through  $+105^{\circ}\text{C}$ . With a capacitance range of  $0.47\ \mu\text{F}$  through  $1,000\ \mu\text{F}$  they meet the stringent specifications of the automotive industry, yet they cost considerably less than tantalum or film-type capacitors. Available in axial and radial lead styles.

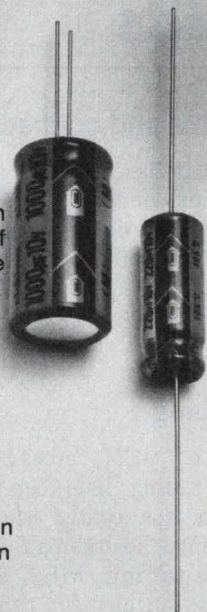

### Free Catalog.

To receive complete catalog information and engineering samples, write to us on your company letterhead.



The pulse of the industry.

**nichicon**

NICHICON (AMERICA) CORPORATION  
6435 N. Proesel Ave. • Chicago, IL 60645 • (312) 679-6530  
Division of NICHICON CAPACITOR LTD., Kyoto, Japan

CIRCLE NUMBER 110

# AUTHOR'S GUIDE

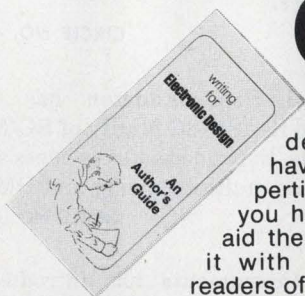

If you've solved a tricky design problem, if you have developed special expertise in a specific area, if you have information that will aid the design process... share it with your fellow engineer-readers of *Electronic Design*.

Articles you have authored not only raise your own professional status, but help build your company image as well. The readers benefit, your company benefits.

To help you prepare material that meets *Electronic Design's* high editorial standards, our editors have prepared a special author's guide entitled "Writing for *Electronic Design*." It covers criteria for acceptability, form, length, writing tips, illustrations, and payment for articles published. It's available without cost.

It's easy to write for *Electronic Design*, but it's often hard to get started. Send for your copy of our Author's Guide today.

Circle No.  
250

## Free!

Power advantage . . . economic advantage. Get full details on the energy future . . . new Gates rechargeable, sealed lead-acid batteries. Send today for our free, informative brochure containing exclusive battery features, application information, ratings and specifications. Find out what this new third-generation energy cell could mean to your design work.

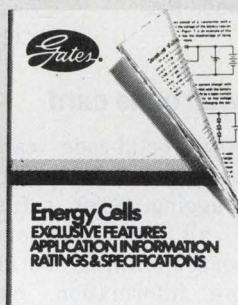

Yes! I would like to know more about these new energy cells. Please send free information.

Name \_\_\_\_\_

Title \_\_\_\_\_

Company \_\_\_\_\_

Address \_\_\_\_\_

City, State, Zip \_\_\_\_\_

Mail to: George Sahl,  
Gates Energy Products, Inc.  
1050 S. Broadway, Denver CO 80217



ED-5

Where the energy future is now

CIRCLE NUMBER 111



# Design aids

## Cable and connectors

Flat flexible cable and mass-termination-connector specs, package dimensions, detailed pin spacing and contact reliability data is all included in a 24 x 34-in. BLUE MACS wall chart. T&B/Ansley

CIRCLE NO. 432

## Tubing

An OEM cross-reference guide on tubing lists competitive equivalents for coated sleeving, extruded tubing, heat-shrink tubings, shrinkable-tubing kits, shrinkable end caps, spirally cut tubings and lacing cords and tapes. Cole-Flex.

CIRCLE NO. 433

## Power semiconductors

A cross-reference guide covers all rectifiers, SCRs, transistors and assemblies currently available from Westinghouse Semiconductor Div. The guide includes more than 10,000 JEDEC, Westinghouse and competitive part numbers. Westinghouse, Youngwood, PA

CIRCLE NO. 434

## 8080 octal code card

An 8080 octal-code card is a slide-rule-like aid for programming and debugging 8080 software. It contains all the mnemonics and their corresponding octal codes. For more information, circle the reader service number. Tychon.

CIRCLE NO. 435

## Flow chart kit

A baseboard and complete line of programming symbols provide tools to create a program flow chart quickly, efficiently and neatly. Use a common ball-point pen. If you need a change, simply peel off the symbol, rub out the flow lines, re-stick the symbol and draw new flow lines. The "Starter Kit" includes 10 legal-size base boards and over 320 symbols. It sells for \$8.95 plus \$1 postage and handling. Fickled, P.O. Box 6064, 990 Enterprise St., Orange, CA

INQUIRE DIRECT

# Application notes

## Oscillographic recorder

"A More Rugged, Cleaner Writing Oscillographic Ink Recorder" discusses the design of the Model 7402A oscillographic recording system with emphasis on its lifetime pens and instant-dry ink system. Hewlett-Packard, Palo Alto, CA

CIRCLE NO. 436

## Plug-in oscilloscopes

How to use an oscilloscope for mechanical measurements is shown in an application note. Included is information on oscilloscope capabilities and uses, transducer selection and installation, and a procedure for balancing rotating machinery. Tektronix, Beaverton, OR

CIRCLE NO. 437

## Process current converter

"3 IC 8-Bit-Binary Digital to Process-Current Converter with 4-20 mA Output" describes a converter that can be constructed for less than \$20 at current (100-qty) prices. Theory of operation is given, followed by calibration procedures and a parts list. Precision Monolithics, Santa Clara, CA

CIRCLE NO. 438

## Diode testing

Several techniques for automatically testing conventional diodes and zener diodes are described in a six-page application note. Examples of these testing techniques are completely defined and illustrated with data derived from the GenRad 2230 component test system. GenRad, Concord, MA

CIRCLE NO. 439

## Analog switches

"Analog Switches and Their Applications" covers theory and practical applications of analog switches in 352 pages. It is offered at \$4 per copy. A second handbook, "High Speed CMOS Analog Switches," is a free, 20-page design catalog on DG300 series CMOS analog switches. Siliconix, 2201 Laurelwood Rd., Santa Clara, CA 95054.

INQUIRE DIRECT

# Bulletin board

Control Data has announced the availability of a nationwide equipment and maintenance program designed for system houses, other computer manufacturers and end-users of minicomputer based systems that incorporate Control Data OEM computer peripheral products.

CIRCLE NO. 440

Electronic Array's Model EA 2708 erasable 8-k ROM offers 450-ns access. It is organized 8 bits x 1024 words and uses standard power supplies of +12, +5 and -5 V. All inputs and outputs are TTL compatible.

CIRCLE NO. 441

Electronic Products Associates has introduced its Data-Catcher option for the MICRO-68 line of 6800  $\mu$ P prototype development systems. The Data-Catcher provides single-step operation of the MICRO-68.

CIRCLE NO. 442

Precision Monolithics has reduced prices up to 50% on all models of the DAC-76 monolithic companding d/a converter.

CIRCLE NO. 443

National Semiconductor has redesigned its ISP-8C family of SC/MP  $\mu$ P cards. Expanded address buses and logic, ease multiprocessing and DMA.

CIRCLE NO. 444

Texas Instruments has introduced two dual optically coupled isolators, designated the TIL122 and TIL 123. They are direct pin-for-pin replacements, both electrically and mechanically, for Monsanto's MCT6 and MCT66.

CIRCLE NO. 445

Wang Laboratories has added three new packages and a data-entry language for building new forms to its line of fully supported applications-software products, and announced major enhancements for six of its current packages.

CIRCLE NO. 446



## New literature



### One-chip microcomputer

TMS-1000 series one-chip MOS microcomputers are described in a 44-page data manual. Texas Instruments, Houston, TX

CIRCLE NO. 447

### Cables

A 60-page catalog details mechanical steel cables and cable assemblies, ranging from sub-miniature sizes up to and including 1/2-in. diameter. Loos & Co., Pomfret, CT

CIRCLE NO. 448

### Dial calculators

Over 60 precision rotary-dial calculators are featured in a 20-page catalog. Most of the units are available in both English and metric versions. Hunter Associates, Bridgewater, NJ

CIRCLE NO. 449

### Broadband rf components

Specifications on hybrids, 2, 4 and 8-way power dividers, quadrature hybrids, double-balanced mixers, phase shifters and transformers, covering 1 to 2000 MHz, are given in a four-page catalog. Baldpate Electronics, Georgetown, MA

CIRCLE NO. 450

### Binary coded switches

Dimensions, available codes, options, specifications, distributor sources and prices of miniature, binary-coded switches are given in a six-page folder. EECO, Santa Ana, CA

CIRCLE NO. 451



electrocube solutions...

## POLYCARB

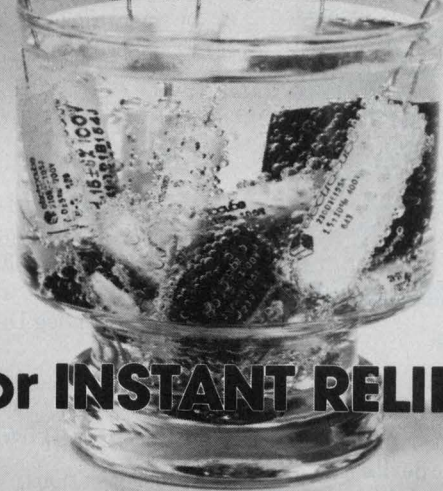

for **INSTANT RELIEF**

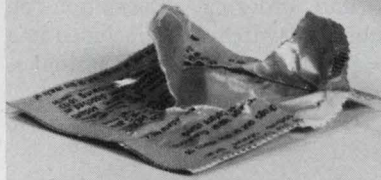

If capacitor performance and delivery are giving you problems, our reliable metallized polycarbonate Series 650 could be the solution. More than the 1100 miniature units, in 6 case styles, rated to 50 mfd and 600 VDC — all extremely stable over a wide temperature range. **And they're available in reel and un-reel packaging.** For instant relief, contact Electrocube, 1710 So. Del Mar Ave., San Gabriel, CA 91776; Tel.: (213) 573-3300.

CIRCLE NUMBER 113

# To The Point

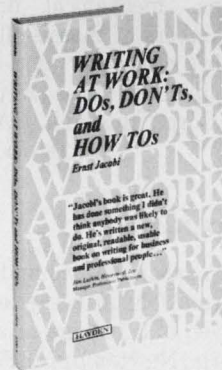

## WRITING AT WORK: DOs, DON'Ts, and HOW TOs

by Ernst Jacobi, Xerox Corporation.

"Jacobi's book is great ...

He's written a new, original, readable, usable book on writing for business and professional people..." Jim Lufkin, Manager, Professional Publications, Honeywell.

*The book on writing for business and professional people!*

#5730-X, cloth,  
208 pp., \$10.95.

Order your  
15-day exam  
copy today!



**Hayden Book Company**

50 Essex Street  
Rochelle Park, N.J. 07662

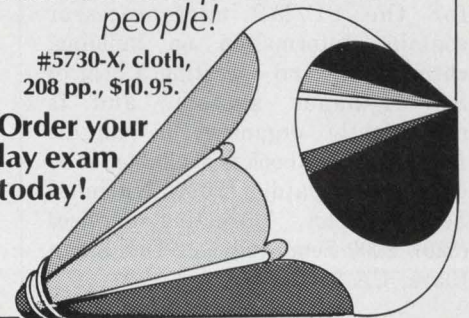



## NEW LITERATURE

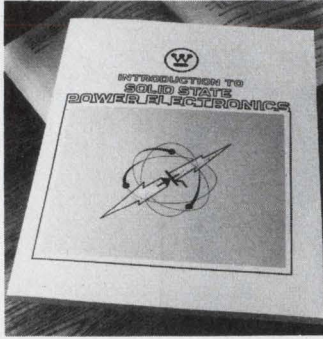

### Power electronics

A 144-page textbook, "Introduction to Solid-State Power Electronics," describes the characteristics of solid-state power electronic devices and their fundamental circuit principles. The book costs \$6. For more information, circle the reader service number. Westinghouse Electric, Youngwood, PA

CIRCLE NO. 467

### Relays

Over 1100 stock relays and accessories are contained in a 40-page catalog. Also included are voltage sensors, special-purpose relays, and a wide choice of relay sockets, both chassis and PC-board mount. List prices are shown for each item. Potter & Brumfield, Princeton, IN

CIRCLE NO. 452

### LCDs

Physical and electrical specifications as needed for application of liquid-crystal displays, magnetically operated reed proximity switches, solid-state relays and magnetic reed switches are included in a catalog. Hamlin, Lake Mills, WI

CIRCLE NO. 453

### SC/MP $\mu$ P handbook

A 150-page applications handbook for the SC/MP microprocessor contains information on building, checking out and operating a host of SC/MP-based systems and is conveniently organized in capsule form. The handbook is available for \$5 each, postpaid, from National Semiconductor, Marketing Services (520), 2900 Semiconductor Dr., Santa Clara, CA 95051.

INQUIRE DIRECT

### $\mu$ C recipe book

A "Microcomputer Recipe Book" covers everything from soup to nuts, to put together your own microcomputer operating system for personal, business, or scientific use. Computer Center, San Francisco, CA

CIRCLE NO. 454

### A/d converters

A 36-page short-form guide provides specifications, application data, and prices for over 300 electronic products for precision measurement and control. Analog Devices, Norwood, MA

CIRCLE NO. 455

### Pushbutton switches

Specifications, dimensional drawings and ordering information on pushbutton switches are included in a 12-page catalog. Centralab Electronics, Milwaukee, WI

CIRCLE NO. 456

### Rf and microwaves

A 129-page Diode and Transistor Designer's Catalog contains specifications and design data for HP's rf and microwave semiconductors. Hewlett-Packard, Palo Alto, CA

CIRCLE NO. 457

### Chassis slides

Specifications, mechanical drawings, model numbers of chassis slides, handles, cable retractors and accessories are included in a 28-page catalog. Zero Corp., Burbank, CA

CIRCLE NO. 458

### Cassette recorders

Descriptions, specifications and application information on cassette recorders are given in a 16-page catalog. Memodyne Corp., Newton Upper Falls, MA

CIRCLE NO. 459

### Transformers

"What You Should Know About TRW/UTC" is a basic reference for purchasing magnetic products. Included are helpful charts that summarize significant characteristics of the company's products. TRW/UTC Transformers, Kinston, NC

CIRCLE NO. 460

### Flat cable

More than 30 flat-cable constructions are described in a 12-page guide. The guide summarizes general properties of both flat-cable types including electrical characteristics, physical properties, and termination techniques. Belden Corp., Geneva, IL

CIRCLE NO. 461

### Freq multiplex system

Audio-tone frequency-multiplex modules, designed for plug-in, pin-to-pin compatibility with equipment previously manufactured by other firms, are described in a catalog. Harris Controls, Melbourne, FL

CIRCLE NO. 462

### Photomultipliers

A 48-page catalog provides information on photomultiplier tubes, auxiliary photomultiplier assemblies, and associated components and accessories. The catalog includes initial tube-selection guides and tabulated data for each device, as well as outline drawings and basing diagrams. RCA Electro-Optics and Devices, Somerville, NJ

CIRCLE NO. 463

### Minicomputers

Software, application examples and support for the NOVA-3 minicomputer family are covered in a 16-page brochure. Data General, Southboro, MA

CIRCLE NO. 464

### Power transistors

A photo and dimensional drawing of a 900-V, 50-W power-transistor package along with maximum range ratings, electrical characteristics and thermal-resistance values are given in a four-page data sheet. International Semiconductor, El Segundo, CA

CIRCLE NO. 465

### Alphanumeric displays

Optical, electrical, physical and environmental characteristics, power requirements, filter information, input connectors, character fonts, installation drawings and ordering information for alphanumeric display subsystems are featured in a 20-page brochure. IEE, Van Nuys, CA

CIRCLE NO. 466



# have a gripe?



# let us know about it!

We'll help you put pressure on any company that makes promises in its ads . . . then fails to deliver.

*Electronic Design* refuses to run advertisements deemed to be misleading or fraudulent.

ACCURACY is everybody's business. So if you have a gripe about a misstatement or inaccuracy in either editorial or advertising material in *Electronic Design* . . . tell us about it. We'll do everything we can to find out what happened and see that it's corrected. Notify . . .

**George Rostky**

*Editor-in-Chief*

## Electronic Design

50 Essex Street  
Rochelle Park, New Jersey 07662

## EMC Engineer

*Come bring your talents and experience to the SAN FRANCISCO PENINSULA.*

At Lockheed, the opportunities are as vast as your own talents and potential. Our professional environment and varied programs will keep your career moving with excitement and plenty of challenge.

Join us now if you have a BSEE and are capable of establishing package and system interface for Electromagnetic Interference (EMI) and RF Hazard Test requirements as well as compatibility analysis. You must have a thorough knowledge of applicable test equipment, testing procedures and be able to direct EMI/RFI/GBS tests and document results.

You'll enjoy the sunny year 'round weather and exceptional activities that are available on the beautiful San Francisco Peninsula. You can also expect a good salary and excellent benefits. For confidential consideration, please send your resume to Professional Employment Office, Dept. ED-1, P.O. Box 504, Sunnyvale, California 94088. An equal opportunity affirmative action employer.

**LOCKHEED**  
MISSILES & SPACE COMPANY

CIRCLE NUMBER 116

## ALCOSWITCH®

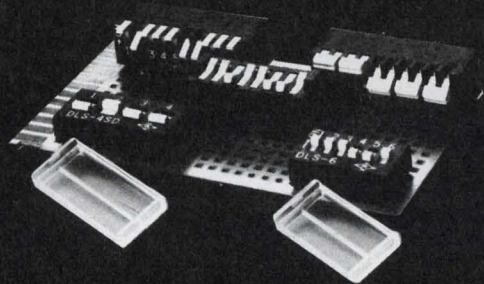

ALCOSWITCH Dual-In-Line switches offer a choice of actuation methods. DSS models have rocker actuators, with locking bars and protective covers available optionally. Low profile DLS types have slide levers and protective covers with actuator lock features as standard. DYS models have piano key levers for right angle operation. DLS and DYS series include SPDT models in addition to SPST types. All have sealed terminals to prevent solder and flux contamination. The positive detent contacts are gold plated to assure dependable service in logic level applications.

Call (617) 685-4371 or write today for more detailed information, prices and specifications.

**ALCO** ELECTRONIC PRODUCTS, INC.  
1551 OSGOOD STREET, NORTH ANDOVER, MA 01845 U.S.A.

Tel: (617) 685-4371

TWX: 710 342-0552

A SUBSIDIARY OF

**AUGAT® INC.**

CIRCLE NUMBER 117



# The GOLD BOOK

## THE MOST COMPREHENSIVE, MOST COMPLETE ELECT

### 7,648

#### MANUFACTURERS ARE LISTED

Want to know more about a company? The **GOLD BOOK** lists almost twice as many as EEM.

#### U.S. DISTRIBUTORS

Local distributors are listed by geographical area under each manufacturer — turn to the separate Directories of Distributors if you need more data.

#### DATASCAN ELEC PRODS

DATASCAN ELEC PRODS, 3550 Middlesex Ave  
Wilmington MA 01887, Tel: (201)478-2800, G  
Moore sales mgr; G Moore adv mgr; SC

**SALES OFFICES & REPRESENTATIVES**

AL Huntsville: Lee Assoc (205)533-5896  
CA Los Altos: Angiot Tech Sls (415)841-8858  
CO Denver: Elec Sls (303)771-6300  
HI Honolulu: Aloha Assoc (808)941-1574  
IL Wilmette: Crest Assoc (312)266-5202  
MA Newton Centre: Danner-Hayes (617)859-4650  
MD Ellicott City: Alo Elics (301)531-6700  
MN Minneapolis: R/I Inc (612)476-9181  
MI Frammington: Anderson Elics (313)922-1425  
NJ Cherry Hill: Williams Assoc (609)424-4110  
NY Fort Lee: Tech Mktg (201)224-8911  
OH Dayton: B Hacker & Assoc (513)398-8638  
PA Pittsburgh: RF Clark (412)42-9500  
TX Houston: LP Spencer (713)337-3751

DATA SIGNAL INC, 2403G Commerce Ln Albany GA  
31707; Tel: (912)883-4703, WQ Sanders pres, 15  
emp; 3 eng, 58

DATA SPECIALTIES INC, 3455G Commercial Av  
Northbrook IL 60062; Tel: (312)564-1800; E  
Kaplan pres; E Kaplan sales mgr; SD ... Vol 2/766

**SALES OFFICES & REPRESENTATIVES**

AL Huntsville: J.L. Highsmith & Co (205)881-3294  
AZ Phoenix: Mountaintek (602)242-5551  
CA Anaheim: Moxon (714)263-7600  
CA Cupertino: Inter-Link Sys (408)257-7165  
CA San Diego: Moxon (714)270-4820  
CO Boulder: Mountaintek (303)444-1738  
CO Evergreen: Mountaintek (303)674-5295  
IL Indianapolis: Pivan Engrg (317)253-1681  
IL Chicago: Pivan Engrg (312)539-4838  
IN Indianapolis: Pivan Engrg (317)253-1681  
KS Shawnee: Mission Pivan Engrg (913)722-1030  
MA Wakefield: Data Engrg Svcs (617)245-6666  
MI Milford: Milford Scientific (313)885-8932  
MN Minneapolis: Pivan Engrs (612)537-4501  
MO St Louis: Pivan Engrs (314)567-3636  
NC Charlotte: J.L. Highsmith & Co (704)333-7743  
NM Albuquerque: Mountaintek (505)246-1491  
NY Roslyn Heights: Tranco Assoc (516)621-3223  
OH Lancaster: Cam & Co (614)654-4800  
CA Amber: Deming (214)381-2855  
TX Dallas: Remtek (713)684-2115  
UT Salt Lake City: Mountaintek (801)276-8911  
VA Richmond: J.L. Highsmith & Co (804)727-5888  
WA Brookfield: Pivan Engrs (414)786-1940  
TX NY New York: Multiquip (212)944-4372  
FR FRANCE: Seivres, Rue Carle-Vernet  
Telex: Arturics 626 02 35

DATA SYNTHESIS INC, DEPT G, 8G Blanchard Rd  
Burlington MA 01803; Tel: (617)935-7960, WF  
Baker pres, 16 emp; 6 eng, 3C

**SALES OFFICES & REPRESENTATIVES**

MA Waltham: Datscom Inc (617)891-4600  
NJ Berkeley Heights: Associated  
Measurement & Controls (201)464-5100

DATA SYS DESIGN, 1122G University Berkeley CA  
94702; Tel: (415)849-1102, 12 emp, 4 eng, 3C

**SALES OFFICES & REPRESENTATIVES**

AZ Mountaintek (602)591-0553  
CA MOJ (714)832-5554  
CA Palo Alto: Ekins Assoc (415)229-7871  
CO Mountaintek (303)444-1738  
IL Pan Data (312)824-0804  
MA Lynnfield: Newmar Assoc Inc (617)245-7940  
MI Miltronics (248)454-8332  
NM Mountaintek (505)724-1981  
NY Pittsford: RJC Assoc (716)385-2770  
NY Tuxedo: Asco Elics (914)779-8119  
TX Dallas: Data Mktg Assoc (714)358-4543  
TX Houston: Data Mktg Assoc Inc (713)686-9627  
UT Mountaintek (801)266-9617  
WA Bellevue: Brennan Assoc (206)454-8332

DATA SYS ENGRG INC, DEPT G, PO Box 44883 1055  
SE St Anapheim CA 92805

DATA TECHNOLOGY INC, 40 Gill St Woburn MA 01801  
Tel: (617)935-8820, Telex 94 9476, JK Livingston  
pres; H Margulius vp ops; DE Skenderian sales mgr,  
61 emp, 4 eng, 5D

**SALES OFFICES & REPRESENTATIVES**

CA San Marino: Data-Dahl Assoc (714)682-3417  
CA Walnut Creek: Data-Dahl Assoc (415)933-9595  
CO Littleton: Delta Data Prod (303)377-8867  
CT Guilford: Whitehead Assoc (203)453-3762  
DE Deerfield: Traco Engrg (302)438-3520  
MA Boston: Whitehead Assoc (617)542-7679  
MD Columbia: Repton Inc (301)455-6433  
MI Troy: Xanpithus Inc (313)471-9012  
MN Minneapolis: Bican Co (612)827-4734  
NJ Atlantic Highlands: R Dalton Assoc (201)291-0500  
NM Albuquerque: Walter Dodge Sls (505)256-0307  
OH Berea: Geotronix Mktg Assoc (216)443-5200  
OH Columbus: Geotronix Mktg Assoc (614)457-8472  
OK Tulsa: JW Elder (918)589-9149  
FR CANADA: Gaskville, Ont: Sandtron  
Auto Ltd (416)827-8230

FR ENGLAND: Kidderminster B  
Heworth & Co Ltd  
FR GERMANY: D 9051 Eching  
Krontron Electronics

FR SPAIN: Madrid: Tectronic  
SWEDEN: Huddinge: LIF Produkter  
AB

DATA-TEK CORP, 1211G Chestnut St Philadelphia PA  
19107; Tel: (215)564-4133, HG Mechals pres, DL  
Stanton vp tech; RP Whittall vp appl; 6 emp, 3C

DATA TEST CORP, 2450G Whitman Rd Concord CA  
94518; Tel: (415)689-3983, FW (910)481-  
9973, J Roberts pres, OD Greenwood mktg, C  
Edmonds reg sales mgr; 49 emp; 5 eng, 5D

**SALES OFFICES & REPRESENTATIVES**

CA Oakland: Advanced Technology (415)452-1401  
CT Middletown: McBar Assoc (203)585-4376  
FL Measurements & Control (305)564-1929  
FL Indiantastic: Assoc Measurements  
& Control (305)723-7474  
GA Atlanta: Assoc Measurements &  
Control (404)452-6808  
IL Chicago: Carter Elics (312)585-9485  
MA Waltham: McBar Assoc (617)890-0233  
MI Detroit: Electro Sls Assoc (313)526-8800  
MN Minneapolis: Carter Elics (612)559-1976  
NJ Panschnack (609)662-3081  
NY Megargel: Himmelmstein Assoc (516)544-8314  
NY Tuxedo: Asco Elics Inc (914)779-8110  
OH Cleveland: Electro Sls Assoc (216)261-5440  
OH Dayton: Electro Sls Assoc (513)426-8520  
OK Norman: Data Mktg Assoc Inc (405)364-8520  
PA Pittsburgh: Electro Sls Assoc (412)571-9449  
TX Dallas: Data Mktg Assoc Inc (214)661-0300  
TX Houston: Data Mktg Assoc Inc (713)686-9627  
TX San Antonio: Data Mktg Assoc Inc (512)824-9757  
VA McLean: Creative Mktg Assoc (703)893-6612  
FR BELGIUM: Brussels, 97 Ave  
de la Woluwe 344-48-53

FR CANADA: Reaxide, Unit 20  
Baywood Rd Unit 1 Applied  
Computer Technology (416)745-6107

FR ENGLAND: Middlesex: Stockley  
Close Intertrade Scientific West Drayton 41528  
FR JAPAN: Tokyo, 100, 1-1  
Jichuanan-Cho 2-Chome: Teijin  
Advanced Prods Corp Tokyo 560-4670-3

FR W GERMANY: D 8 Munich 60;  
Manningerweg 7 Intertrade  
Scientific 089-883657

DATATEX CORP, DEPT G, 10935 S Wilcrest Dr Houston  
TX 77072; Tel: (713)949-3100, AW Epley pres; CW  
Bentley vp mktg; RA McKee mktg mgr; 70 emp, 6  
eng, 5D

**SALES OFFICES & REPRESENTATIVES**

CA LA: PF Wiley Co (213)663-8028  
CA San Carlos: DM Ross Co (415)581-4411  
CO Littleton: Simpson Assoc (303)794-8381  
CT New Canaan: S Pierce Inc (203)966-4630  
IL Rolling Meadows: Sumner Inc (312)394-4900  
MA Norwood: S Pierce Inc (617)762-3164  
MI Ferndale: Haltronics Inc (313)998-5556  
MO St Louis: Lowell-Kangas (314)821-4050  
NY Yonkers: D Sorokin Assoc (914)668-9809  
NY NY Syracuse: LD Allen Inc (315)456-7470  
OH Bracksville: A Nace Co (419)927-2728  
PA Pittsburgh: A Nace Co (412)233-0651  
TX Richardson (214)233-0651

DATA TRANSLATION INC, 109G Concord St  
Frammingham MA 01701; Tel: (617)879-3595;  
Telex: 948474; Cable: CHESBRETT FHM; P Molinari  
pres; 15 emp; 5 eng, 3C

**SALES OFFICES & REPRESENTATIVES**

AZ Tucson: Nakoma (415)965-8858  
CA Mtn View: Repco (916)449-4000  
KS Prairie Village: Engrg Svcs Co Inc (913)651-7774  
MI Madison Heights: WKM Assoc (313)588-2130  
MO St Louis: Engrg Svcs Co Inc (314)957-1515  
NJ Parsippany: E Corp (201)777-6454  
NY Rochester: Scientific Devices-NY Inc (716)334-2445  
OH Cleveland: WKM Assoc (216)267-6500  
OH Dayton: WKM Assoc (513)282-2953  
PA Pittsburgh: WKM Assoc (412)892-3262  
WA Bellevue: Scientific Devices NW (206)454-0900  
FR AUSTRALIA: Stratfield NSW 2135,  
AMPECO Engrg Co (02)747-2731

FR ENGLAND: Billingshurst: Sussex  
Sals Onics & Consulting Technologies Ltd (040 381)3171

FR FINLAND: Helsinki 16: Digilux 650 955

FR FRANCE: 92310 Sevres: Telex: Arturics 626-02-35

FR GERMANY: 80331 Puchheim: Stemmer Elektronik (089)8060612

FR ISRAEL: Tel-Aviv: STG Intl Ltd 53459

FR JAPAN: Tokyo, 102 Takachiko: SWEDEN: Jantalla: Scancopter AB 0758-37440

FR NETHERLANDS: The Hague: CN  
Road BV 99 63-60

FR NORWAY: Oslo 2: Scancopter AS 02 55-11 84-44

FR SWITZERLAND: CH-6300 Zug 2:  
AUDELCO AG 042-21-81-44

DATATRON, 1562G Reynolds Av, Box 11427 Santa Ana  
CA 92711; Tel: (714)540-9330, TW (910)595-  
1589, C J Davis Jr pres; H Weiss mktg mgr; R Orton

#### MANUFACTURERS DIRECTORY

CO Englewood: Davis Assoc  
CA Light Green: Duser/Denver  
CA Woodstock: Saber Assoc  
CA Woodstock: Saber Assoc  
IL Chicago: Whelan Inc  
MD Gaithersburg: Data-Time  
MI Milford: Mike Dyer  
MN Minneapolis: Nyrtek  
MO Raytown: Production Automation  
NM Albuquerque: KLS Assoc  
NY Kings Park: KLS Assoc  
OH Dayton: WKM Assoc  
TX Dallas: Data Marketing Assoc  
TX Dallas: Martin Zienkovic Brown &  
Assoc  
WA Seattle: Avionics Liaison  
FR FRANCE: Genelec  
FR FRANCE: Technology Resources  
FR GERMANY: Gama  
FR ISRAEL: Vetronica  
FR NETHERLANDS: Dita-Benlux  
FR SWEDEN: B Martimsson &  
Nordqvist  
DATATRONIC SYS CORP, DEPT G, PO Box 84320  
Panorama City CA 91402; Tel: (213)862-5290, MW  
Mileprie pres; Clark vp mktg; 150 emp; 13 eng, 80  
DATATYPE CORP, DEPT G, 1050 NW 163 St Miami FL  
33159; Tel: (305)562-8451, TWX (407)404-  
4072, R Higginbotham pres, L Moulton vp mktg, FC  
Rueckel sales mgr; 41 emp; 5 eng, 5D  
DATATYPE CORP, LOCAL DISTRIBUTORS  
NJ E Hanover: AM/Vantiper Div  
FR AUSTRALIA: Melbourne, Victoria:  
AM Intl Inc  
FR AUSTRALIA: Victoria: Crabtree  
& Co Ltd  
FR ENGLAND: London: British Airways  
FR JAPAN: Minato-Ku, Tokyo: Mitui  
& Co Ltd  
DATAVISION VIDEO PRODS MINCOM DIV, 3M  
3M CO, DATAVISION VIDEO PRODS MINCOM DIV  
DEPT G, CORP DEPT G, 7333 E Him St South  
AZ 85262; Tel: (602)948-3280, Telex (310)500-  
1289; NT Holzer pres; DJ Borch sales mgr; 20 emp,  
5 eng, 3C

**SALES OFFICES & REPRESENTATIVES**

CA Cupertino: B McInturff  
HI Honolulu: Sauer Assoc  
KS Leawood: E Shepro  
KS Lynnfield: L Gredy  
MA Nashua: G & P  
MN E Orange: J Friedman  
FR CHINA: Taipei, Taiwan: Intl Elics  
FR ENGLAND: London: G15390  
Mycaltes Instrus Ltd  
FR FRANCE: 92160 Antony: 5 Av  
de la Renaissance  
FR HOLLAND: Rotterdam 3022 Van  
Rietschoten & Huisman  
FR ANDORRA: Les Escaldes: WBS Hindtron  
Computers Private Ltd  
FR ISRAEL: Tel-Aviv 61000; 2 Zevulun  
FR JAPAN: Intl Trading House Ltd  
FR ISRAEL: Setagaya, Tokyo 157,  
7-29-4 Kita-Karasuyama: Nomura  
Electronics  
FR MEXICO 18: Insurgentes Sur N  
933; Informatica National  
FR SPAIN: 3 Madrid 7: Aparado  
FR SWITZERLAND: Zurich: 11  
FR TURKEY: Kavaklar, Ankara: UTE  
Engrg & Trade Co Ltd  
FR USA: Moscow: Codemetric Inc  
FR W GERMANY: Köln: Hohenzollern  
Ring 84; Europav-Deutschland

DATA WORKS INSTRUMENTATION, 97480 Canyon Rd  
Chatsworth CA 91311; Tel: (213)998-8991, GA  
Mercola pres; GE Blair sales mgr; 10 emp; 3 mg 18

**SALES OFFICES & REPRESENTATIVES**

AL Birmingham: E J Routh Inc  
CA Los Altos: Jay Stone & Assoc  
CA Los Angeles: Basic Sys Co  
CA San Diego: Basic Sys Co  
HI Honolulu: Aloha Assoc  
IL Baton Rouge: SESCO  
MI Boston: Newmar Assoc  
MO Bethesda: Powell-Pendergraph  
NY Mercola pres; GE Blair sales mgr; 10 emp; 3 mg 18  
OH Cleveland: ISI  
OH Dayton: ISI  
OH Englewood: DM Inc  
PA Abington: Powell-Pendergraph  
PA Pittsburgh: ISI  
TX Houston: SESCO  
WA Richmond: SESCO  
FR CANADA: Burnaby BC: Megatronix  
FR CANADA: Montreal, Quebec:  
Megatronix  
FR CANADA: Ottawa, Ontario:  
Megatronix  
FR CANADA: West Vancouver:  
Megatronix  
DATA WORKS LOCAL DISTRIBUTORS  
FR CANADA: Downsview, Ontario: Len

#### MANUFACTURERS DIREC

OR Portland: Ingalls Engrg (503)244-1111  
FR NEWTON SQUARE: SWR Assoc (215)851-1111  
CA KEMCO  
EX CA Foster City: Carvill Intl (415)954-1111  
FR CANADA: Calgary 22: Alberta  
Tel: 10544 Farrell RD SE Calgary  
Control  
FR SPAIN: Madrid 16, Enrique Larraga  
31, Payma

DATTEL SYS INC, 1020G Turnpike St  
02021; Tel: (617)828-8000; TWX:  
0135; Telex: 924461; N Tagaris pres;  
915 emp; J Zaros sales mgr; RSCM 5072;  
25 eng, 5D

Vol 1/Last Pg: IBC, Vol 2/IFC, 944  
Comp

**SALES OFFICES & REPRESENTATIVES**

AL Huntsville: Intl Scientific Insts (205)881-3294  
AZ Phoenix: Cleveland Engrs (602)242-5551  
CA Los Angeles: Data Sls Inc (213)862-5290  
CA Santa Ana: Data Sls Inc (714)832-5554  
CA Littleton: Eissler Sls (303)444-1738  
FL Lighthouse Point: Sauer Assoc (305)444-1738  
FL St Petersburg: Sauer Assoc (813)444-1738  
HI Honolulu: Hawaii Data Sys (808)941-1574  
IL Cedar Rapids: Tech Reprs Inc (312)266-5202  
IL Chicago: Carter Elics Inc (312)266-5202  
IL Indianapolis: Carter Elics Inc (317)253-1681  
KS Olathe: Tech Reprs Inc (913)762-3164  
MO Gathersburg: Sauer Assoc (314)661-0300  
MI Troy: GR Peters Assoc (313)998-5556  
MN Minneapolis: Carter Elics Inc (612)559-1976  
MO Hazewind: Sauer Assoc (314)661-0300  
MI Ft Lee: Tech Mktg Assoc (201)266-9617  
NM Albuquerque: Sauer Assoc (505)246-1491  
NY Liverpool: R & D Assoc Inc (516)468-9809  
OH Cleveland: Instrumentation Sys Inc (216)334-2445  
OH Dayton: Instrumentation Sys Inc (513)282-2953  
PA King Of Prussia: Rivco  
Pittsburgh: Instrumentation Sys Inc  
TX Austin: Evans McDowell (512)821-4050  
TX Dallas: Evans McDowell (214)381-2855  
WA Seattle: JB Jolly Inc (206)454-0900  
MI Milwaukee: Carrier Elics Inc (414)786-1940  
FR AUSTRALIA: Artarmon, NSW: 4/29  
Jotham Parade: Digital Electronics  
FR AUSTRALIA: Mervin 3144 Vic. 66  
Mervin  
FR AUSTRALIA: 1120 Vienna 12:  
Medinger Hauptstr 78. Bacher  
Electronics GmbH  
FR BELGIUM: Brussels, Bd du  
Triomphe 148: Simax Elic  
FR CANADA: Mississauga: 505 Ont;  
FR CANADA: Montreal, Que: 480 Port  
Royal St W: Preico Elics  
FR CANADA: Ottawa: Ont: 882 Bank  
St: Preico Elics (613)821-4050  
FR DENMARK: DK-2500 Valby:  
Saxbove 19: Paratron A/S  
FR FINLAND: SF-00100 Helsinki:  
Vuorikatu 16: Havullina Oy  
FR FRANCE: 75013 Paris: 11  
Berdans Bussion Ave: Data  
Systems SARL  
FR ISRAEL: Tel-Aviv, 182 Ben Yehuda  
St: M TI Engrs (05)521-244  
FR ITALY: Milano: Via Perugino 9 Post  
3147932: 3G Elics Srl  
FR JAPAN: Tokyo 150: Kobayashi  
3-26-3 Higashi-Shibuya-Ku: Data  
Kv  
FR NETHERLANDS: Steenwijk:  
Netherlandsw 58: Simac Elic (051)  
FR NEW ZEALAND: Auckland 1: CPO  
Box 2630: 3 S Auburn St  
Auckland 1: Reed (NZ) 27 Ltd  
FR NORWAY: Oslo 5, Kongelieve 3:  
Morgensterne & Co  
FR SPAIN: 40100: Schanberg, PO Box  
31582 Braamfontein: P Jones Elic  
Egpt  
FR SPAIN: Madrid 16, Colombia 34:  
Apoca Elic Sys  
FR SWEDEN: 10272 Stockholm: AB  
9145 Bergsunds Stokk 37, Box  
Nordbyl & Berg  
FR SWITZERLAND: Zurich: 11  
Janatschstrasse: Traco Elec Co Ltd  
FR USA: 75013 Paris: 11  
Hampshire: Sealine House Priestley  
Rd Dale UK Ltd  
FR USA: 75013 Paris: 11  
Gundahst 1: Data Sys GmbH ... 0  
DTEX DIV, CONRAC CORP—See CONR  
DTEX DIV  
DATHAR ACOUSTICS INC, DEPT G, PO Box 1  
NJ 07446  
DATOTEK INC, 13740G Midway Rd Dallas  
TX (214)233-1030, Telex 73-0558; I  
pres, FA Kitch Jr vp mktg; LD Bowlin sales  
mgr; 15 emp; 4 eng, 5D

**SALES OFFICES & REPRESENTATIVES**

FR CANADA: Downsview, Ontario: Len



# Make your life easier

## RONCS MANUFACTURERS DIRECTORY IN THE WORLD!

### CATALOG PAGES AVAILABLE IN SECTION 2

Boldface type and page reference numbers steer you toward the company's catalog pages in Section 2.

### KEY PERSONNEL FINANCIAL DATA

Many companies have included financial data. You can tell the size of the company from dollar volume, number of employees and number of engineers.

### SALES OFFICES & REPS — USA AND FOREIGN

A total of 83,930 sales outlets are listed under manufacturers. Both U.S. and foreign sales offices and reps are included.

### COMPLETE

Company name, street address, city, state, zip and phone. If provided by the company, you'll also find TWX, TELEX, cable address, toll-free numbers, facsimile equip.

### LOOKING FOR ELECTRONICS MANUFACTURERS?

LOOK **FIRST** in Electronic Design's

# GOLD BOOK

#### DAYTON ELECS PRODS CO

DATRONIC ASSOC INC, DEPT G, Rt 4 Flemington NJ 08822; Tel: (201)782-0077; HL Herman pres; 5 Herman sec-treas; 6 emp; 4 eng; 1A  
 DATRON SYS INC, 20716G Plummer St Chalfont PA 19311  
 DATRON SYS INC, ELEC SPECIALTY DIV, DEPT G, 18900 NE Sandy Blv Garland DR 97220; Tel: (503)665-0121; TWX: (910)469-8782; Telex: 36 0453; Fax: (503)665-0127 ext 214 XEROX M-400; F Brodie vp mgr; RS Lidero sales mgr; HS Lidero adv mgr; 475 emp; 20 eng

**SALES OFFICES & REPRESENTATIVES**  
 AZ Scottsdale: Goodreau Assoc (602)994-9909  
 FL Semole: Spartak (813)393-5402  
 GA Smyrna: B-C Elecs (404)436-5169  
 KS Prairie Village: Eng Svc Co (913)641-4005  
 MD Brocton: Fortberg Sls (617)522-6300  
 MN Lutherville: LD Lowery Inc (301)923-2172  
 NY St Paul: Countryman Assoc Co (516)649-9151  
 NY Smithtown: Ye Sls (516)997-1515  
 NY Syracuse: CW Floring & Assoc (315)476-2149  
 PA Broomall: LD Lowery Inc (215)356-5300  
 TX Dallas: Blackburn Assoc Inc (214)525-8885  
 WA Seattle: HS Thorpe (206)784-3333  
 FR ALSTHOM: Moorabin Victoria  
 FR CANADA: Ottawa: Wilson Enter (416)224-9878  
 FR CANADA: Toronto: Wilson Enter (416)935-1266  
 FR GERMANY: Frankfurt: IV Elec (416)756-0510  
 FR JAPAN: Tokyo: Wako Indl Co 03-281-0583  
 FR UK: Crawley: Electric Match Ltd  
 DATRON SYS INC/ELEC SPECIALTY Div LOCAL DISTRIBUTORS  
 FR INDIA: Bombay: Cosmics Electroni  
 Anciliana Private Ltd  
 FR ISRAEL: Tel Aviv: Victorics Ltd  
 DATILO ENTPR INC, 9405G Dorval Ct Louisville KY 40220; Tel: (502)491-6262; DP Dattilo pres; 47 emp; 5 eng; 5D

**SALES OFFICES & REPRESENTATIVES**  
 IN Indianapolis: Reeder Sls (317)255-8056  
 KY Louisville: Custom Component Sls (502)959-4473  
 OH Cleveland: Comp/Insta Corp (216)521-3970  
 DATUM INC, DEPT G, 1363 S State College Blvd Anaheim CA 92806; Tel: (714)533-6333; TWX: (910) 592-1289; Telex: 935-398; WE Riande pres; NL Davies vp mktg; P Sheets mktg svcs; FSCM 31160; 350 emp; 50 eng; 5E

**SALES OFFICES & REPRESENTATIVES**  
 AL Huntsville: Lee Assoc Inc (205)533-5896  
 AZ Scottsdale: BFA Corp (602)946-4215  
 CA San Jose: Datum (408)249-5370  
 CA Sunnyvale: Ward/Davis Assoc (408)245-1700  
 CO Denver: BFA Corp (303)744-3301  
 CT Hartford: P Jenks Assoc Inc (203)281-0810  
 FL Ft Lauderdale: Lee Assoc Inc (305)831-3311  
 FL Longwood: Southern Data Assoc (407)562-1551  
 IL Winter Haven: Lee Assoc Inc (813)294-2815  
 IL Chicago: SEA Inc (312)298-1244  
 IL Hoffman Estates: Datum (312)946-2593  
 CA Carmel: SEA Inc (408)249-5370  
 KS Wichita: Winco Inc (617)246-1550  
 MA Wakefield: P Jenks Assoc Inc (617)899-4300  
 MA Waltham: Digital Sls Assoc (617)899-4300  
 MD Silver Spring: K-G Elecs (617)245-4455  
 MN Minneapolis: SEA Inc (612)432-7818  
 NC Raleigh: Lee Assoc Inc (919)787-5818  
 NJ Woodbridge: GL Williams Assoc (609)949-6860  
 NM Albuquerque: BFA Corp (505)252-1211  
 NM Las Cruces: BFA Corp (505)523-0601  
 NY Great Neck: Krasser Assoc (516)487-0690  
 NY Melville: Astropac Inc (516)483-2766  
 NY NYC: Techntron Inc (212)758-2790  
 NY Aurora: EMA Corp (212)562-104  
 OH Centerville: EMA Corp (513)343-2800  
 PA Ambler: Denco Data Engng Co (215)482-9876  
 TX Arlington: PJ Houston Assoc (817)265-2981  
 TX Dallas: Data Aces Assoc (214)620-1551  
 TX Houston: Data Aces Assoc (713)862-6885  
 UT Richardson: Datum (214)352-7411  
 UT Salt Lake City: BFA Corp (801)466-6522  
 WA Seattle: Compnetics (206)234-4842  
 WI Waukesha: SEA Inc (414)547-8637  
 FR ENGLAND: Harrington  
 Datum Elecs Ltd 01-897-0456

DAVCO MFG CO, 169G Ridgedale Av Morristown NJ 07960; Tel: (201)267-4990; JC Lawless Jr pres; 6 emp; 1 eng; 5B  
**SALES OFFICES & REPRESENTATIVES**  
 FR CANADA: Montreal: PQ Solid State (514)481-3313  
 ENRGA Co  
 DAVEK SYS, 12740G Dean Pl Granada Hills CA 91344; Tel: (213)641-6544; D Keyte pres  
 DAVIDSON ELEC DEVELOPMENT, 2211G Peninsula Dr Erie PA 16506; Tel: (814)833-9818; AR Davidson pres; 10 emp; 2 eng; 5B  
**SALES OFFICES & REPRESENTATIVES**  
 MI Detroit: WKM Assoc (313)892-2500  
 OH Cleveland: WKM Assoc (216)273-2045  
 OH Dayton: WKM Assoc (513)334-7500  
 PA Pittsburgh: WKM Assoc (412)892-2953  
 DAVIDSON OPTRONICS INC, 5593G Danville St, Mount

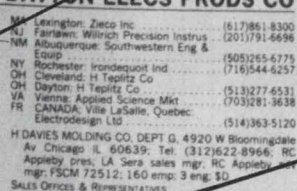

Lexington: Zeco Inc (617)861-8300  
 NJ Fairlawn: Wilrich Precision Instrus (201)791-6696  
 NM Albuquerque: Southwestern Eng & Equip (505)265-6375  
 NY Rochester: Irondequoit Ind (716)544-6257  
 OH Cleveland: H Teplitz Co (513)277-6531  
 OH Dayton: H Teplitz Co (703)281-3638  
 VA Vienna: Applied Science Mkt (703)281-3638  
 CANADA: Ville LaSalle, Quebec: Electrodesign Ltd (514)363-5120  
 H DAVIES MOLDING CO, DEPT G, 4920 W Bloomingdale Av Chicago IL 60639; Tel: (312)622-8966; RC Appleby pres; LA Sera sales mgr; RC Appleby, RC mgr; FSCM 72512; 160 emp; 3 eng; 5D

**SALES OFFICES & REPRESENTATIVES**  
 CA Los Angeles: Littell Western Sls (213)261-0164  
 CT Meriden: PR Sturgeon (203)237-1112  
 FL Fort Lauderdale: W Chester Smith (305)564-1477  
 IA Des Moines: Clancey Co (515)278-1331  
 IL Chicago: Kruse Corp (312)786-8646  
 IN Clermont: CT Clower Co (317)293-3588  
 KS Shawnee Mission: T Clancey Co (913)432-4550  
 MA Babson Park: PR Sturgeon Co (617)231-9506  
 MI Bloomfield Hills: Gittre Co (313)645-1777  
 MO St Louis: Clancey Co (314)431-3633  
 NY Syosset: Rywell Sls (516)364-0888  
 OH Westlake: JJ Foley Co (216)827-8830  
 PA Paoli: WG Walker (610)267-8146  
 TN Memphis: LE Ohlutt Co (901)789-1210  
 TX Dallas: Commercial Plastics & Supply (214)931-8170  
 WA Seattle: Northwest Plastics Ind (206)763-0441  
 WI Milwaukee: Clague Sls (414)272-1951  
 FR CANADA: Toronto: Atlas Elecs Ltd (416)781-6174

DAVIS ELECTRIC CO, DEPT G, PO Box 38 Cape Girardeau MO 63701; Tel: (314)335-5547; BO Davis pres; BO Davis sales mgr; 50 emp; 1 eng; 5C  
**SALES OFFICES & REPRESENTATIVES**  
 CA Los Altos: Schwerin Assoc (415)941-3737  
 IL Northridge: Gianaras Sls Co (312)774-6600  
 MA Scituate: NEAR Inc (617)454-5327  
 MO Kansas City: Automatic Gen Elec Sls (816)332-8206  
 OH Cleveland: Components Inc (216)243-8200  
 OH W Carrollton: Components Inc (513)866-0661  
 PA Radnor: WH Cordray Sls Co (215)878-3339  
 TX Dallas: Stevens Sls Co (214)272-4476  
 WI Cedarburg: TFL Assoc (414)377-7030

DAVIS & HEMPHILL INC, 5710G Furnace Av Elkridge MD 21227; Tel: (301)796-2290; SH Balderson pres; MJ Williams sales mgr  
**SALES OFFICES & REPRESENTATIVES**  
 MD Baltimore: JA Maguire & Co (301)377-0223  
 NC Winston Salem: JA Maguire & Co (919)723-9880  
 NJ Pennsauken: JA Maguire & Co (609)655-6336  
 NJ Plainfield: JA Maguire & Co (201)754-4100  
 DAVIS HW & CO, DEW' G, 9212 Denton Dr Dallas TX 75235; Tel: (214)352-8405; MH Earp pres and chrm; W Hevron ex vp; JM Haerle sales mgr; 42 emp; 1 eng; 5D  
**SALES OFFICES & REPRESENTATIVES**  
 IL Chicago: B Burns & Assoc (312)775-1233  
 KS Overland Park: T Dowell & Assoc (913)236-8200  
 PA Broomall: LD Lowery Inc (610)356-5200  
 TX Dallas: Crockett Sls Co (214)748-8209  
 TX Dallas: Lund & Co (214)358-4335

DAVIS & SANFORD CO INC, 24G Pleasant St New Rochelle NY 10802; Tel: (914)632-1636; Resk pres; EE Resk vp mktg; HE Dunn sales mgr; 35 emp; 1 eng; 5C  
 DAY-LIGHT DISPLAY CORP, 11G Fairfield Pl W Caldwell NJ 07006; Tel: (201)575-1045; D Rovine sales mgr; 12 emp; 4 eng; 5B  
 DAYMARC CORP, 301G Second Av Waltham MA 02154; Tel: (617)890-2345; TWX: (710)324-6469; Cable: DAYMARC; NJ Cedrone pres; 100 emp; 10 eng; 5D  
**SALES OFFICES & REPRESENTATIVES**  
 CA Orange (714)532-1212  
 CA San Jose (408)244-8297  
 FR AUSTRALIA: Greystaines 2145  
 CA San Jose  
 FR BELGIUM: Brussels: CN Road SA 352135  
 FR ENGLAND: Weybridge: Surrey D Newth 51431  
 FR FRANCE: Paris: A Renaud 265-72-62  
 FR GREECE: Athens: Mortek 021 9517341  
 FR INDIA: Ludhiana: J11001: Bharat Sls (Int'l) of Biv 427  
 FR ITALY: Roma: E Ferradino 5915780  
 FR JAPAN: Shibuya-Ku Tokyo: S Peters (03)406-4021  
 FR NETHERLANDS: Gennep: Heijnen Nv 088511956  
 FR SPAIN: Madrid: Atajo Ingenieros SA 2153543  
 FR SWEDEN: Stockholm: Enk Ferner AB 08/802540  
 FR SWITZERLAND: Mutschellen: Stoiz AG (057)54555  
 FR W GERMANY: Munich: P Bette 089/335061  
 DAYTON AIRCRAFT PRODS, DEPT G, PO Box 14070 Ft Lauderdale FL 33302; Tel: (305)463-5451; CD Cline pres; JD Cline vp mktg; JD Chapoletain sales mgr; 100 emp; 5 eng; 5C



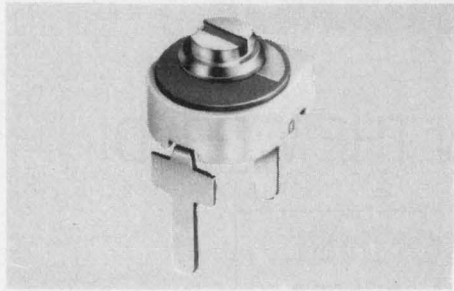

**MINIATURE CERAMIC TRIMMER CAPACITORS** 9371 series of ceramic trimmer capacitors are compact, economical and rugged. They are 50% smaller than other trimmers of this type yet provide high capacitance values. Available in 4 capacitance ranges, 1.5 to 4, 3.0 to 10, 3.5 to 18 and 5.0 to 25 pf with Q's > 300 at 10 MHz. They have an overall diameter of .225" with .215" above board height. **JOHANSON MANUFACTURING CORPORATION**, Rockaway Valley Road, Boonton, N.J. 07005 201-334-2676  
**TRIMMER CAPACITORS 181**

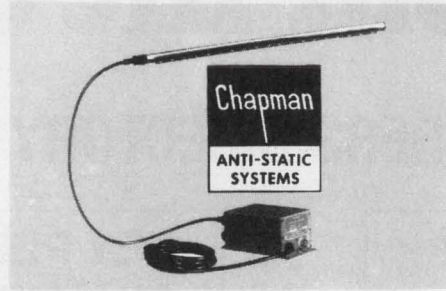

**ANTI-STATIC SYSTEMS FOR PRINTERS, OCR COM and other machines.** Static causes rapidly moving paper and film to jam. . . cause arc tracks on undeveloped film. . . attract and hold dust to photographic negatives causing imperfections on printed circuit boards. Numerous products, of interest to both OEM and user, are detailed in new 32 page catalog to solve these problems quickly, reliably and economically. Chapman Anti-Static Div., Portland Co., 58 Fore St., Bx 427, Portland, ME 04112. (207) 773-4726  
**ANTI-STATIC SYSTEMS 184**

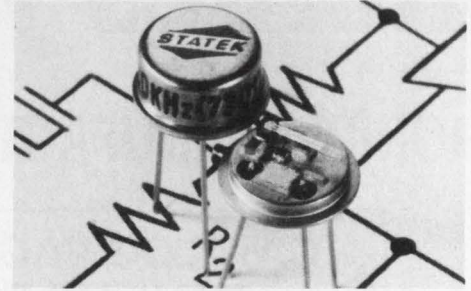

**CMOS Crystal Oscillators in Low profile TO-5.** Frequency range is 10 kHz to 300 kHz (divided outputs to 1 kHz, low as one cycle per month available). Low milliamp current consumption. Accuracy  $\pm 0.01\%$ . Shock 1000 g. Hybrid thick and thin film chip and wire design is rugged and ideally suited for portable equipment. Details in Gold Book & EEM \* **STATEK CORP** \* 512 N. Main, Orange, Ca. 92668 \* (714) 639-7810 \* Telex 67-8394.  
**CRYSTAL OSCILLATOR 187**

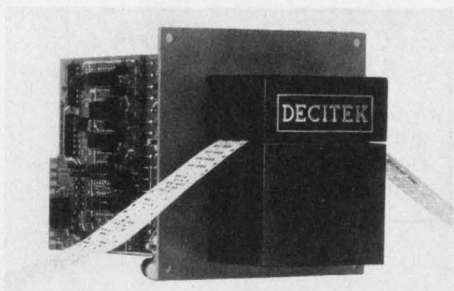

**Low-cost tape reader is fast—up to 300 cps—and quality-built.** Dual sprocket drive, a state-of-the-art fiber optic light source and photo transistor read head. Simplicity of design makes it easy to adapt to specific OEM requirements. Decitek, 250 Chandler Street, Worcester, MA 01602 (617) 798-8731  
**SAM® TAPE READER 182**

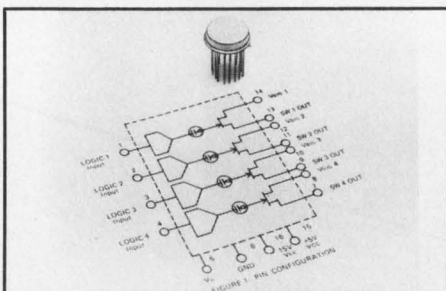

**HIGH REL. QUAD J-FET.** The CAG50T features 4 SPST J-FET analog switches in a rugged TO-8 package. J-FET output devices allow  $\pm 10V$  switching with constant ON-Resistance. Inputs are directly compatible with DTL/TTL logic using standard power supplies. Max. switching times are 500 nsec turn-off and 1.0  $\mu$ sec turn-on. Operation is guaranteed over the full  $-55^{\circ}C$  to  $+125^{\circ}C$  military temp. range. Price: 1-49, \$33.00; 50, \$27.55; 100, \$22.10. Teledyne Crystalonics, 147 Sherman St., Cambridge, MA (617) 491-1670.  
**QUAD J-FET 185**



**MAGNETIC SHIELDING** Take advantage of Eagle's 23-year background in shield design and production. Custom and standard models. Full service includes design, engineering, fabrication, heat treating, finishing, testing. Also wide selection of sheet and foil so you can form your own shields. For helpful design and cost data, request Bulletin E-77. Eagle Magnetic Co., Inc., Box 24283, Indianapolis, IN 46224, 317-297-1030.  
**MAGNETIC SHIELDING 188**



**Analog speed with digital read out.** The 78 Process Monitor combines digital readout with analog and/or digital setpoints. You choose the signal inputs, the number and the type of setpoints, output and power. Easy installation: Slide in and hook up. Order as a tachometer, accumulator, timer, or ratio monitor. For all the facts, write: Airpax, Controls Division, 6801 W. Sunrise Blvd., Fort Lauderdale, Fla. 33313  
**DIGITAL MONITOR 183**

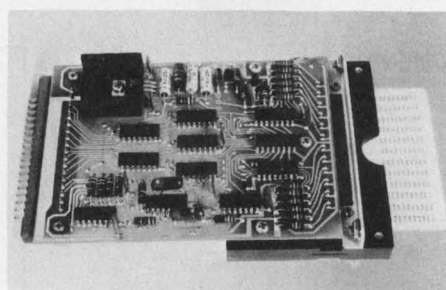

**NEW BADGE/CARD READER, NO MOVING PARTS, SCANS OPTICALLY.** Reads cards/badges of up to 12 rows and 10, 20, 30 or 68 columns. Designed for OEM and systems applications. Error-free readout, long-life, minimum maintenance. Particularly suitable for security and access-control applications. Series H catalog available. **TAURUS CORPORATION, Lambertville, N.J. 08530; Phone (609) 397-2390.**  
**BADGE/CARD READER 186**



**MEMODYNE INCREMENTAL LOW POWER DATA LOGGER Model 2221,** is ideal for remote or unattended collection of sporadic measurements. Features 16 channels, 0 to +10 volt analog input, 12 bit resolution, over 2 megabit capacity per 300 foot cassette. Standby current is less than 50 microamps. Available for line or battery operation. Unit price is \$1670.00. Memodyne Corporation, 385 Elliott Street, Newton Upper Falls, Massachusetts, 02164. (617) 527-6600.  
**LOW POWER DATA LOGGER 189**



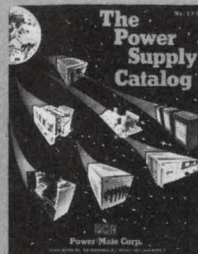

**Free New '77 catalog** contains over 34,500 quality power supplies from the world's largest manufacturer, Power/Mate Corp. Power Supplies for every application including submodulars, open frame, variorated, encapsulated, laboratory & system. All units UL approved and meet most military and commercial specs for industrial and computer uses. Power/Mate Corp., 514 S. River St., Hackensack, NJ 07601 (201) 343-6294

POWER SUPPLIES

190

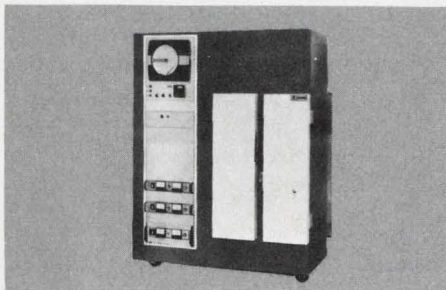

**CRITERIA IV, BURN-IN SYSTEM** for IC's, RAMs, UP's etc. performs dynamic or static screening up to 200°C, is now available for in-house burn-in use. The high temperature dynamic capability is provided by means of a "Exsert Connection" (extending the socket board through the oven wall) and connecting to externally mounted driver cards. For a brochure and a proposal to help you set up an in-house lab, contact Bob Burton, Reliability, Inc., P.O. Box 37409, Houston, Texas 77036. (713) 666-3261

SEMICONDUCTOR BURN-IN SYSTEM 193

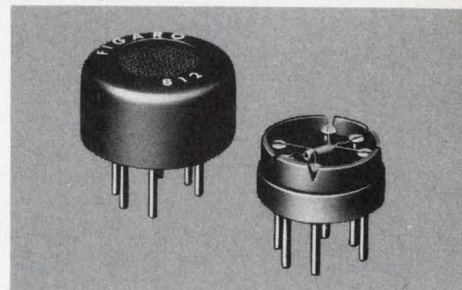

**FIGARO GAS SENSOR TGS** is a gas sensitive semiconductor. When combustible gas is absorbed on the sensor surface, a marked decrease of electrical resistance occurs. Major features of the sensor include high sensitivity, long term reliability and low cost. The applications are: GAS-LEAK ALARM, AUTOMATIC FAN CONTROL, FIRE ALARM, ALCOHOL DETECTOR, etc. Figaro Engineering Inc., North America Office-3303 Harbor Boulevard, Suite D-8, Costa Mesa, Calif. 92626 Tel: (714) 751-4103 Telex: 678396

GAS SENSOR

196

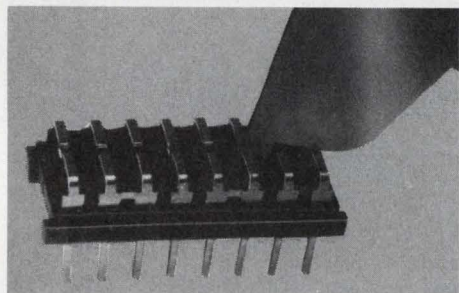

**DIP PROGRAM HEADER (8 - 14 - 16 PIN)** Program within the header itself! Available pre-programmed to your program or you program them with Aries Program Header Tool or needle nose pliers . . . simply by removing interconnection sections between adjacent or opposing pins. Low profile can be marked to identify program. Layout sheets to indicate programming are available. **ARIES ELECTRONICS, INC.**, P.O. Box 231, Frenchtown, N.J. 08825. Telephone (201) 996-4096, TWX 510-235-3391.

DIP PROGRAM HEADER

191

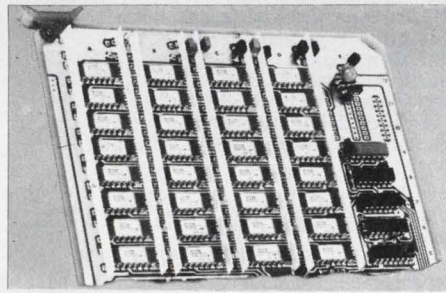

**FOR MOS MEMORY CIRCUITS, Mini/Bus®**, the off-board power distribution system, does things: saves PC board space and eliminates multi-layers; drastically reduces de-coupling capacitors; suppresses, reduces and isolates noise; makes PCB design easier. Full details on how and why Mini/Bus serves so well are in Rogers' Application Note No. 1976. For a copy, write or call Rogers Corporation, Chandler, AZ 85224. Phone: (602) 963-4584. (EUROPE: Mektron NV, Ghent, Belgium; JAPAN: Nippon Mektron, Tokyo)

MEMORY CIRCUIT FILTER BUS

194

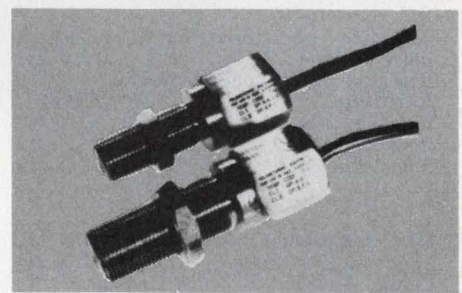

**UL approved magnetic pickups.** Airpax manufactures a broad, standard line of high quality magnetic pickups and digital transducers. So, we can deliver off the shelf. And because our designs are flexible, we can handle unusual applications fast and economically. The pickups shown are Underwriters' Laboratories UL Approved for hazardous locations. For more facts write: Airpax, Controls Division, 6801 W. Sunrise Blvd., Fort Lauderdale, Fla. 33313

MAGNETIC PICKUPS

197

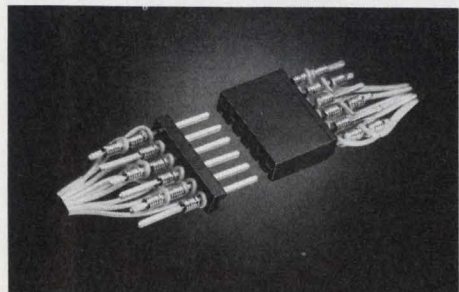

**NEW MINIATURE "HAPPY-WRAPPER" CONNECTORS.** Rugged .045" square pins married to sturdy female contacts to withstand high production wrapping torque. Permit flying lead connections via hand wrap terminations to both male and female elements. Pins available with .156" or .200" centers. Take 8 inch-ozs of torque without distortion. Contacts rated 2.5 amps, 250 VAC. Methode Electronics Corporation, 1700 Hicks Road, Rolling Meadows, IL 60008. (312) 392-3500. **HIGH PRODUCTION "HAPPY WRAPPERS" CONNECTORS**

CONNECTORS

192



**MICRO DIGITAL OHMMETER.** The 1700 series digital ohmmeter offers 4 1/2-digit readout and your choice of plugin ohmmeters ranging from 1 μΩ through 20 MΩ. Resolution below 20 Ω is 1 μΩ; above that 10 μΩ. Auto-ranging. Automatic comparator and test fixture (both shown) optional. Total price equip. shown (low-ohm plugin): \$2155. Electro Scientific Industries, Portland, Oregon 97229

MICRO DIGITAL OHMMETER

195

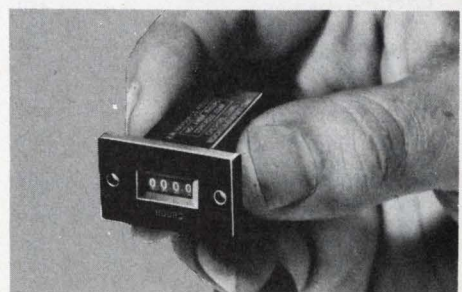

**ELAPSED TIME INDICATOR** Microminiature. Series 49200. One of smallest direct digital ETI's on the market. Only 37/64" sq by 1-1/2" long. 4-digit hourly readout clearly legible. Uses 1W synchronous motor, 115V ac, 60 Hz. Accuracy ± 1% or ± 1 hr., whichever is greater. Where size is important, one of your best buys anywhere. 7 standard mounting styles available. North American Philips Controls Corp., Cheshire, Conn. 06410. (203) 272-0301.

ELAPSED TIME INDICATOR

198



# Advertiser's index

Advertiser	Page	Advertiser	Page	Advertiser	Page
AMP, Incorporated.....	10, 11	Guardian Electric Manufacturing Company.....	16	Philips Industries Electronic Components and Materials Division.....	20
Abbott Transistor Laboratories, Inc.....	6	Gulton Industries, Inc.....	259	Plessey Semiconductors.....	211
Advanced Circuitry Division of Litton.....	170			Portland Co., Inc.....	268
Advanced Micro Devices.....	4, 5	Hansen Manufacturing Co.....	235	Power/Mate Corp.....	253, 269
Airpax Electronics, Controls Division.....	268, 269	Hayden Book Company, Inc.....	*14, 48B, 254, 263, 271	RCA Solid State.....	Cover IV
Alco Electronic Products, Inc.....	265	Hewlett-Packard..	1, 8, 9, 37, 40, 41, 204	Raytheon Company, Ocean Systems Center.....	238
Allen Bradley Co.....	18	Hughes Aircraft Company, Aerospace Groups.....	260	Reader Service Card.....	272A-B
American Microsystems, Inc.....	198	Hughes Aircraft Company, Connecting Devices Division.....	52, 53	Reliability, Inc.....	269
Amphenol North America Division, Bunker Ramo Corporation.....	35			Rental Electronics, Inc.....	27
Anadex.....	182	ILC Data Devices, Inc.....	226	Robinson Nugent, Incorporated.....	26
Analog Devices, Inc.....	15	ITT Pomona Electronics.....	239	Rogers Corporation.....	48, 269
Aries Electronics, Inc.....	269	*Industrial Programming, Inc.....	27	Rohde & Schwarz Sales Co. (USA) Inc.....	175
		Intel Corporation.....	24, 25	Rolm Corporation.....	199
Ballantine Laboratories, Inc.....	43	Intelligent Systems, Inc.....	228, 229		
Bliley Electric Co.....	253	Inter-Technical Group, Inc.....	248	Sangamo Weston, EMR Telemetry Division.....	63
Bourns, Inc., Trimpot Products Division.....	Cover II	International Importers Inc.....	14	Siemens Corporation.....	20
Bud Industries, Inc.....	183	International Rectifier.....	210, 230	Signal Transformer Co., Inc.....	Cover III
Burr-Brown.....	219			Skan-A-Matic Corp.....	256
Burroughs Corporation.....	19	Johanson Manufacturing Corp.....	268	Smiths Industries Inc. Connector Division.....	243
				Sprague Electric Company.....	50
CTS Corporation.....	184	Kepeco, Inc.....	44	Stackpole Carbon Co., Electronic Components Div.....	224
Caddock Electronics.....	233	*Kienzle Apparate GmbH.....	224D-E	Statek Corp.....	268
Capitol Machine & Switch Co., Inc., The.....	232	*Knurr KG, Hans.....	224B	Stanford Applied Engineering, Inc.....	31
Centralab/USCC.....	192			Systron-Donner.....	33, 247
Cherry Electrical Products Corp.....	215	LH Research, Inc.....	42		
Cutler-Hammer, Specialty Products Division.....	191	LSI Computer Systems, Inc.....	249	TRW Power Semiconductors.....	221
		Litronix, Inc.....	29	TRW RF Semiconductors, an Electronic Components Division of TRW, Inc.....	12, 13
Data Display Products.....	23	Lockheed Missiles & Space Company.....	265	TRW/UTC Transformer, an Electronic Components Division of TRW, Inc.....	205
Data General.....	48A	Luff Research.....	257	Taurus Corp.....	268
Data Precision Corporation.....	237			Tektronix, Inc.....	47, 176, 177
Decitek.....	268	Magnetic Shield Division, Perfection Mica Company.....	257	Teledyne Crystalonics.....	268
Dialight, A North American Philips Company.....	49	Malco, A Microdot Company.....	200	Teledyne Philbrick.....	181
		*Matsuo Electric Co. Ltd.....	224F	Teledyne Relays, A Teledyne Company.....	2
ECD Corporation.....	189	*Mektron.....	18	Telonic Altair.....	231
EECO.....	39, 201	Memodyne Corporation.....	268	Texas Instruments, Incorporated.....	190
*EMI SE Labs.....	17	Methode Manufacturing Co.....	269	Textool Products, Inc.....	255
*ENI Power Systems.....	242G	Micro Power Systems.....	171	Triplett Corporation.....	213
Eagle Magnetic Co., Inc.....	268	Micro Devices Corp.....	203	Tustin Electronics Company.....	242
Eagle-Picher Industries, Inc.....	258	Microswitch, A Division of Honeywell.....	168, 169		
Electro Scientific Industries.....	269	Mini-Circuits Laboratory, A Division of Scientific Components Corp.....	64 thru 160, 167	UTI.....	251
Electro Switch Corp.....	256	MuRata Corporation of America.....	249	*U.S. Department of Commerce.....	18
Electrocube Corp.....	263			United Systems Corporation.....	245
Electronic Design.....	*26, 161, 188, 261, 265	NCR Power Systems Division.....	250		
Elmwood Sensors, Inc.....	193	Nichicon Corporation.....	261	VIZ Manufacturing Company.....	241
Everett/Charles, Inc.....	261	North American Philips Controls Corp.....	64, 269	Vactec, Inc.....	217
Exact Electronics, Inc.....	185			Varo Semiconductor, Inc.....	197
		Olympia Sales Company, Inc.....	271	Visual Communications Company.....	225
Figaro Engineering, Inc.....	269	Optron, Inc.....	7	Vitramon North America Division of Vitramon Incorporated.....	220
Forth Inc.....	259	*Oscilloquartz SA.....	224C		
				Wabash, Inc.....	222
GTE Automatic Electric.....	17	*Philips Electronic Components and Materials.....	15	Wandel & Golterman.....	224H
Gates Energy Products, Inc.....	261				
General Scanning, Inc.....	246				
*Germanium Power Devices Corp.....	27				
Gold Book, The.....	*16, 48B, 249, 266, 267, 271				

\*Advertisers in non-U.S. edition



# Electronic Design

## Advertising Sales Staff

Tom W. Carr, Sales Director  
Robert M. Lepore,  
Sales Coordinator

## Rochelle Park, NJ 07662

Robert W. Gascoigne  
Daniel J. Rowland  
Thomas P. Barth  
50 Essex St.  
(201) 843-0550  
TWX: 710-990-5071

## Philadelphia

Thomas P. Barth  
(201) 843-0550

## Boston 02178

Gene Pritchard  
P.O. Box 379  
Belmont, MA 02178  
(617) 489-2340

## Chicago 60611

Thomas P. Kavooras  
Berry Conner, Jr.  
200 East Ontario  
(312) 337-0588

## Cleveland

Thomas P. Kavooras  
(312) 337-0588

## Los Angeles 90045

Stanley I. Ehrenclou  
Burt Underwood  
Neil Canavin  
8939 Sepulveda Blvd.  
(213) 641-6544

## Texas

Burt Underwood  
(213) 641-6544

## San Francisco

Robert A. Lukas  
3579 Cambridge Lane  
Mountain View, CA 94040  
(415) 965-2636

## England

Constance McKinley  
50 Essex St.  
Rochelle Park, N.J. 07662  
Phone: (201) 843-0550

## Europe

Sanders, W. J. M.  
Raadhuisstraat 24  
Graft-De Ryp, Holland  
Phone: 02997-1303  
Telegrams: Euradteam-Amster-  
dam  
Telex: 13039-SIPAS

## G. Nebut

Promotion Presse Internationale  
7 ter Cour des Petites Ecuries  
75010 Paris, France  
Telephone: 5231917, 1918, 1919

## Dieter Wollenberg

Erikastrasse 8  
D-8011 Baldham/Muenchen  
Germany  
Telephone: 0 8106/4541  
Telex: 5215532 auri d

## Tokyo

Haruki Hirayama  
Electronic Media Service  
5th Floor, Lila Bldg.,  
4-9-8 Roppongi  
Minato-ku, Tokyo, Japan  
Phone: 402-4556  
Cable: Electronicmedia, Tokyo



# Electronic Design

ELECTRONIC DESIGN's function is:

- To aid progress in the electronics manufacturing industry by promoting good design.
- To give the electronic design engineer concepts and ideas that make his job easier and more productive.
- To provide a central source of timely electronics information.
- To promote communication among members of the electronics engineering community.

**Want a subscription?** ELECTRONIC DESIGN is sent free to qualified engineers and engineering managers doing design work, supervising design or setting standards in the United States and Western Europe. For a free subscription, use the application form bound in the magazine. If none is included, write to us direct for an application form.

If you do not qualify, paid subscription rates are as follows: \$30.00 per year (26 issues) U.S., \$40.00 per year (26 issues) all other countries. Single copies are \$2.00 U.S., \$3.00 all other countries. The Gold Book (27th issue) may be purchased for \$30.00 U.S. and \$40.00 all other countries.

If you change your address, send us an old mailing label and your new address; there is generally a postcard for this bound in the magazine. You will have to requalify to continue receiving ELECTRONIC DESIGN free.

**The accuracy policy** of ELECTRONIC DESIGN is:

- To make diligent efforts to ensure the accuracy of editorial matter.
- To publish prompt corrections whenever inaccuracies are brought to our attention. Corrections appear in "Across the Desk."
- To encourage our readers as responsible members of our business community to report to us misleading or fraudulent advertising.
- To refuse any advertisement deemed to be misleading or fraudulent.

Microfilm copies are available of complete volumes of ELECTRONIC DESIGN at \$19 per volume, beginning with Volume 1, 1952 through Volume 20. Reprints of individual articles may be obtained for \$3.00 each, prepaid (\$.50 for each additional copy of the same article) no matter how long the article. For further details and to place orders, contact the Customer Services Department, University Microfilms, 300 North Zeeb Road, Ann Arbor, Michigan 48106 telephone (313) 761-4700.

**Want to contact us?** If you have any comments or wish to submit a manuscript or article outline, address your correspondence to:

Editor  
ELECTRONIC DESIGN  
50 Essex Street  
Rochelle Park, N.J. 07662

## Save on Calculators

### Hewlett-Packard

Model	Your Cost	Model	Your Cost
HP 21	\$ 64.00	HP 55 (was \$335.00)	149.00
HP 22	100.00	HP 67	369.00
HP 25	116.00	HP 80	236.00
HP 25 C	160.00	HP 91 Scient. Printer	249.00
HP 27	140.00	HP 97	629.00

Free Reserve Power Pack with purchase of HP 21, -22, -25, -25C and -27 if bought before May 31. We are an H-P franchised dealer. We carry all accessories at a discount.

### Texas Instruments

Model	Your Cost	Model	Your Cost
SR 52	\$177.00	TI 5050M	88.00
PC 100	147.00	TI 5100	47.90
SR 52/PC 100		Little Professor	16.00
Combo Sale	322.00	TI Digital Watch 501	16.00
SR 56	79.00	Money Manager	20.00
SR 51-2	52.00	Libraries for SR 52	23.00 up
SR 40	31.00	TI accessories available	
TI 30SP	20.00		
TI 2050-3	29.00		
Bus. Analyst	31.00		
TI 5040	108.00		



### Specials

Model	Your Cost	Model	Your Cost
Norelco #95	\$149.00	Canon #P 1010 Elec. Printer	89.00
Norelco #185	107.00	Sharp #EL 1052 Elec. Printer	85.00
Norelco #88	255.00	3M Dry Photocopier 051	139.00
Norelco #186	265.00	SCM Elec. Type. with case #2200	229.00
Norelco #97	309.00	Craig Elec. Notebook #2625	149.00
Norelco #98	419.00	Casio CQ1 Comp. Alarm Clock	44.00
Norelco Cassette	2.95	Chrono.-Alarm-Calc. Digital Watches-All kinds!	

Also SCM • Olivetti • Rockwell • Victor • APF • Lloyds • Unitrex • Amana • 3M  
Litton • Sharp • Craig • Canon • Panasonic • Sony • Sanyo • and many more.

Prices FOB L.A. • Goods subject to availability • Please request our famous catalog. We will beat any deal if the competition has the goods on hand • Add \$3.00 for shipping handheld calculators • CA residents, add 6% sales tax.

### OLYMPIC SALES COMPANY, INC.

216 South Oxford Ave. • P.O. Box 74545  
Los Angeles, CA 90004 • (213) 381-3911 • Telex 67-3477

CIRCLE NUMBER 118

## KEEP

Electronic Design's

## GOLD BOOK

## HANDY

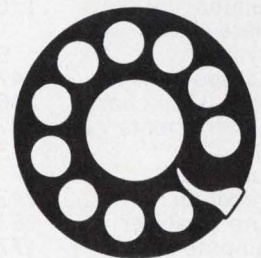

## When You Call

Save time when you contact suppliers. Check their catalog pages first in *Electronic Design's* GOLD BOOK. Maybe the information you need is right at your fingertips.







# The Flathead Transformer

For optimum powering of 1" spaced PC boards—and shipped with the pronto challenge

Here are the first *flat* power transformers for your high density PC board packaging problems—from Signal, the world leader in off-the-shelf transformers and chokes.

**Flat.** LP's deliver 6VA in less than 0.85" height or, you can squeeze 12VA into 1.06" of head room.

**Field-Free:** LP's use Signal's split-bobbin, balanced-coil, hum-bucking construction. This semi-toroidal configuration significantly reduces magnetic field radiation which can cause havoc with sensitive IC's or low-level circuits. And the LP's split-bobbin provides unprecedented insulation and isolation. Minimal electrostatic coupling suppresses line noise and prevents false triggering of digital circuits. Ideal for medical, industrial or other low leakage applications!

**Flexible:** 115/230V 50/60Hz dual primaries are standard. Each of the 22 standard designs

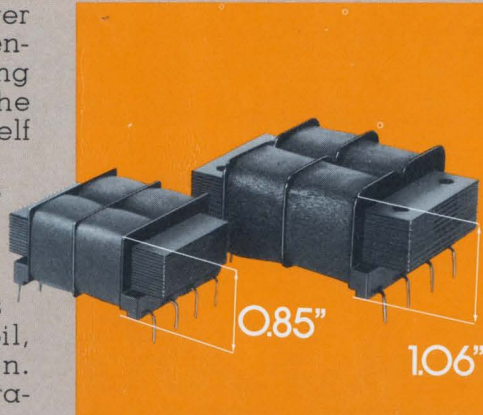

provide dual secondaries for either dual isolated DC outputs, series connected for dual complementary supplies with common return, or paralleled for double current rating.

**The Pronto Challenge:** We ship your prototypes (up to 4 pcs.) in 48 hours or you get Polaroid's new Pronto™ camera, free! But don't get your hopes up too high—we rarely miss! That's why thousands of companies swear by Signal, for quality, value and complete satisfaction.

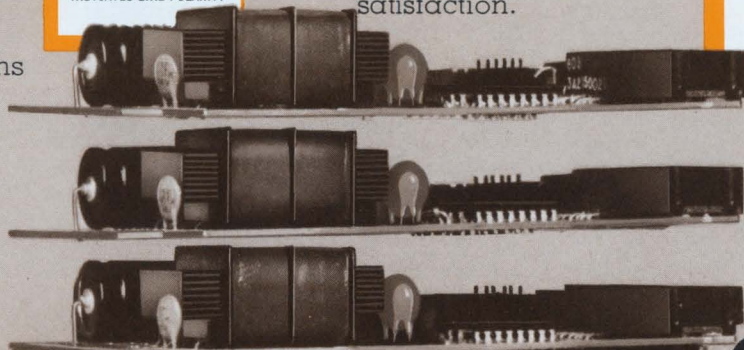
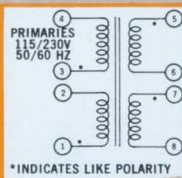

**Free**—Our complete catalog with over 1,000 standard transformers and chokes, from 1 to 10,000 VA. All are available from stock, and all at low, factory-direct prices—prices made even lower by our enormous volume. Contact—Signal Transformer Co., Inc., 500 Bayview Ave., Inwood, N.Y. 11696; (516) 239-7200.

Part No.	L	C	Size	SECONDARY*		USER NET (1-4 pcs.)
				Series	Parallel	
LP-10-600	6		10V CT @ 600 MA	5V @ 1.2 A	\$ 8.20	
LP-10-1200	6		10V CT @ 1200 MA	5V @ 2.4 A	10.00	
LP-12-450	6		12.6V CT @ 450 MA	6.3V @ 900 MA	8.20	
LP-12-900	6		12.6V CT @ 900 MA	6.3V @ 1.8 A	10.00	
LP-16-350	6		16V CT @ 350 MA	8V @ 700 MA	8.20	
LP-16-700	6		16V CT @ 700 MA	8V @ 1.4 A	10.00	
LP-20-300	6		20V CT @ 300 MA	10V @ 600 MA	8.40	
LP-20-600	6		20V CT @ 600 MA	10V @ 1.2 A	10.25	
LP-24-250	6		24V CT @ 250 MA	12V @ 500 MA	8.40	
LP-24-500	6		24V CT @ 500 MA	12V @ 1A	10.25	
LP-34-170	6		34V CT @ 170 MA	17V @ 340 MA	8.40	
LP-34-340	6		34V CT @ 340 MA	17V @ 680 MA	10.25	
LP-40-150	6		40V CT @ 150 MA	20V @ 300 MA	8.40	
LP-40-300	6		40V CT @ 300 MA	20V @ 600 MA	10.50	
LP-56-100	6		56V CT @ 100 MA	28V @ 200 MA	8.60	
LP-56-200	6		56V CT @ 200 MA	28V @ 400 MA	10.50	
LP-88-65	6		88V CT @ 65 MA	44V @ 130 MA	8.60	
LP-88-130	6		88V CT @ 130 MA	44V @ 260 MA	10.75	
LP-120-50	6		120V CT @ 50 MA	60V @ 100 MA	8.60	
LP-120-100	6		120V CT @ 100 MA	60V @ 200 MA	10.75	
LP-230-25	6		230V CT @ 25 MA	115V @ 50 MA	8.60	
LP-230-50	6		230V CT @ 50 MA	115V @ 100 MA	10.75	

\*Regulation of Size 6 units is 30%, i.e., no load-secondary voltage is 30% higher than full load. Regulation of Size 12 units is 20%.

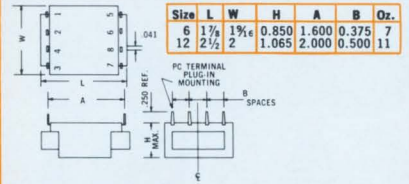

# signal

TRANSFORMER

CIRCLE NUMBER 235

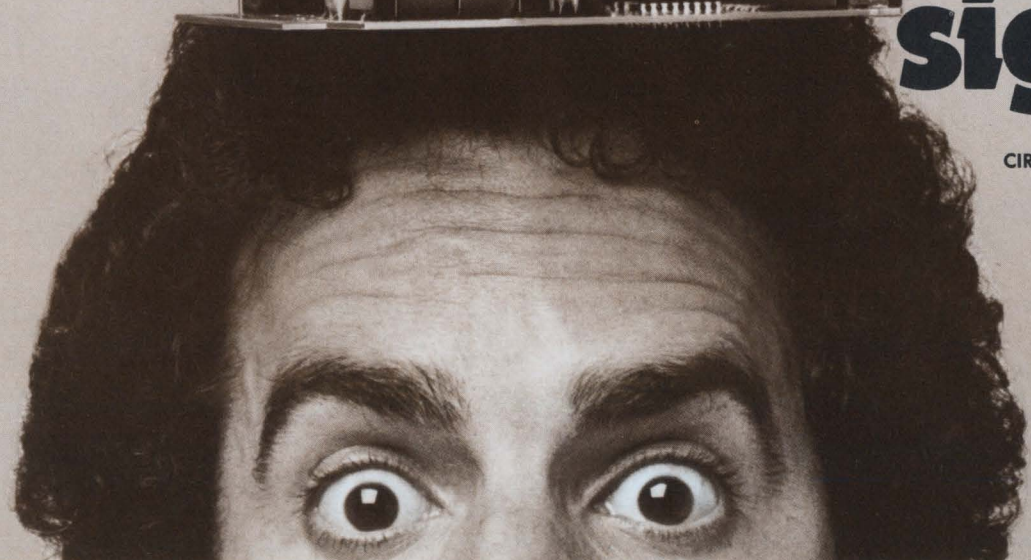



# Designer's guide to the hot numbers in LICs.

**BiMOS Op Amps:**  
they mix technologies  
to match  
circuit needs.



## CA3140

Most useful op amp since the 741. MOS/FET input plus bipolar speed and 4-44 V supply voltage. Does most jobs better than 741 or many premium op amps — at far less cost.

## CA3160 CA3130

Universal op amp, available with compensation (3160) or without (3130). Very low priced, yet with features for general purpose, FET input (1,500,000 M $\Omega$ ), wideband (15 MHz), micropower and high current uses.

## CA3100

Wideband op amp (40 MHz) for both large and small signals. High open-loop gain, slew rate (25 V/ $\mu$  sec) and output current, plus fast settling time.

BiMOS combines the best of Bipolar and MOS in versatile, easy-to-use, low-cost op amps that are simple to manufacture in high volume. It's the op amp technology of today — and tomorrow. Millions of BiMOS devices have been produced and sold. Most are available off the shelf.

CIRCLE NUMBER 271

**Variable Op Amps:**  
as easy to use as  
a transistor.

## CA3080

Programmable op amp: differential voltage input, current output. Variable voltage, power, bandwidth, slew rate, input and output current. \$0.59 @ 1K.

## CA3094

Programmable power switch/amplifier. Adds integral Darlington output to CA3080 circuit to provide 300 mA peak current.

## CA3060

Variable op amp array: 3 variable op amps plus zener bias regulator to use as current control or voltage reference source. All on one chip.

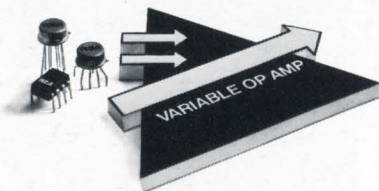

CIRCLE NUMBER 272

**Micro Power Op Amp.**

## CA3078

Delivers up to 6.5 milliamps with standby power as low as 0.7 microwatt. Programmable input terminal for tailoring response and slew rate without sacrificing power.

CIRCLE NUMBER 273

## Gold CHIP

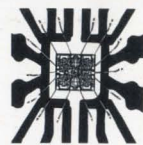

The metalization is gold, and the chip is hermetically sealed with a layer of silicon nitride. The result is corrosion-free, extended life added to the economy of an advanced, rugged plastic package. In short, Gold CHIP (Chip Hermeticity In Plastic) gives you better than standard plastic reliability at the same price as plastic.

There are over 25 Gold CHIP types including these popular numbers: CA301A, CA307, CA311, CA324, CA339, CA555, CA741, CA747, CA748, CA1458, CA3401, CA3724, CA3725.

CIRCLE NUMBER 274

## ARRAYS

RCA amplifier, diode and transistor arrays help you reduce parts cost, save space, cut insertion costs and increase reliability. Choose from 24 different arrays that allow you to create new circuit designs and do the jobs you want done.



RCA Array circuit diagrams and free sample offer

CIRCLE NUMBER 275

For more information, contact your local RCA Solid State distributor.

Or write: RCA Solid State, Box 3200, Somerville, NJ 08876; Sunbury-on-Thames, Middlesex TW16 7HW, England; Ste.-Anne-de-Bellevue, Quebec, Canada; Fuji Bldg., Tokyo, Japan.

**RCA Linear experience  
is working for you.**

# RCA