

# Electronic Design 18

VOL. 25 NO.

FOR ENGINEERS AND ENGINEERING MANAGERS

SEPT. 1, 1977

**'What hath God wrought? . . .'**  
These words sent by Samuel Morse on his telegraph key more than 130 years ago marked the beginning of a new phase in the

history of man. In celebrating its 25th anniversary, Electronic Design salutes the continuing revolution that Morse began. A special report begins on p. 40.





# The First Modular Precision Pot...



... 10 turn precision,  
in a  $\frac{5}{8}$ " square package.

Now custom design precision in your equipment! Bourns modular line of 10-turn wire-wound potentiometers offers virtually infinite selection of standard options, with specs that are unequaled in any other line of modular controls, potentiometers and switches.

**SMALL SIZE**—The  $\frac{5}{8}$ " square design saves up to 35% of panel space compared to standard circular models. Position them closer or in an area simply not possible before now.

**LOW ASSEMBLY COSTS**—Easy and economical mounting on P.C. boards. Only Bourns offers a choice of P.C. pins or solder lugs!

**MANY OPTIONS**—Single shafts of  $\frac{1}{8}$ " or  $\frac{1}{4}$ " diameter are each available in 3 standard lengths, or choose dual concentric shaft options - all with plain or locking bushings. Specify to your application and gang up to two modules.

You'll find these smaller modular precision pots offer the same electrical specs as the larger circular types - such as independent linearity of only  $\pm 0.25\%$ .

**"FEEL-APPEAL"**—As with Bourns other styles of controls and switches, this precision line offers the same smooth, consistent feel. The low rotational torque is still only .3 to 2.0 oz. inch!

**CALL TODAY**—for complete information on this versatile off-the-shelf, modular constructed potentiometer. Find out how to custom design precision in your equipment at standard cost and leadtime.

**MODULAR PRECISION... BEAUTIFUL!**

TRIMPOT PRODUCTS DIVISION, BOURNS, INC., 1200 Columbia Avenue, Riverside, CA 92507, Telephone 714 781-5122—TWX 910 332-1252.

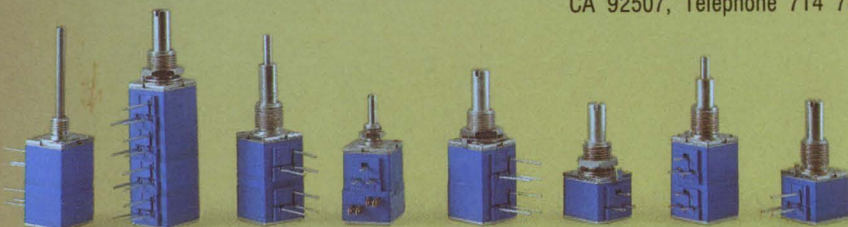

International Marketing Offices: European Headquarters — Switzerland 042/23 22 42 • Belgium 02/218 2005 • France 01/2039633 • Germany 0711/24 29 36 • Italy 02/32 56 88 • Netherlands 70/87 44 00 • United Kingdom 01/572 6531 • Norway 2/71 18 72 • Sweden 764/20 110 • Japan 075/921 9111 • Australia 02/55-0411 03/95-9566 • Israel 77 71 15/6/7

**For Immediate Application — Circle 130**  
**or for Future Application — Circle 230**



Wavetek's just put new life into the function/pulse generator business. Our Model 145 function generator not only doubles as a pulse generator, it does so without sacrificing any features.

The Model 145 is a 20 MHz function generator with sine, square, triangle, and DC output to 30V peak-to-peak.

Turn the function switch to pulse and you have a full-fledged pulse generator

with independent pulse width and delay control, plus single and dual pulse outputs. In addition to the 30V output, you get simultaneous ECL and TTL outputs.

Whether you use it as a pulse generator or a function generator, it offers triggering and gating manually or remotely, and external voltage control of frequency/period for frequency-shift keying and FM operation.

So if you've been coming down with a case of "should I buy a pulse or function generator-it is," the cure is obvious: Wavetek's Model 145. Just \$895. Circle our reader service number for details.

WAVETEK, P.O. Box 651, San Diego, CA 92112. Phone (714) 279-2200, TWX 910-335-2007

**WAVETEK®**

CIRCLE NUMBER 2

**"Doctor, this function generator has a pulse!"**

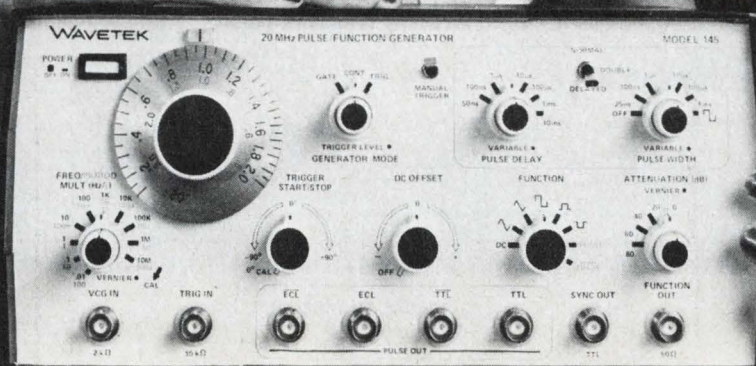



# Surprise!

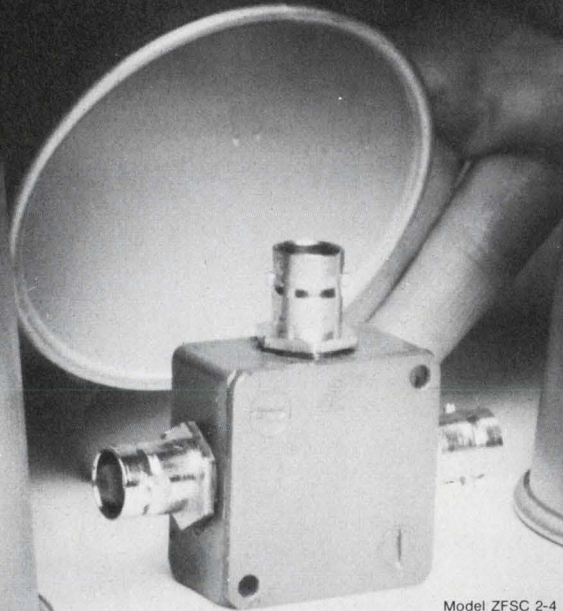

Model ZFSC 2-4

## 200 KHz-1000 MHz Power Splitter/Combiner in a single unit... **\$44.95** (4-24)

### SPECIFICATIONS FOR ZFSC-2 SERIES

Model No. (Price-Qty)	ZFSC 2-1 (\$31.95 4-24)	ZFSC 2-1W (\$35.95 4-24)	ZFSC 2-2 (\$39.95 4-24)	ZFSC 2-4 (\$44.95 4-24)	ZFSC 2-5 (\$49.95 4-24)
Frequency Range (MHz)	5-500	1-750	10-1000	0.2-1000	10-1500
Isolation (dB)	Typ. Min.	Typ. Min.	Typ. Min.	Typ. Min.	Typ. Min.
Lower band edge to one decade higher	30 25	30 25	30 20	20 12	25 15
Mid range	28 20	28 20	25 20	25 20	35 25
Upper band edge to one octave lower	25 20	25 20	23 18	23 18	35 20
Insertion Loss (dB) above 3 dB split	Typ. Max.	Typ. Max.	Typ. Max.	Typ. Max.	Typ. Max.
Lower band edge to one decade higher	0.2 0.5	0.2 0.5	0.2 0.5	0.2 0.5	0.25 0.5
Mid range	0.3 0.6	0.4 0.8	0.5 1.0	0.5 1.0	0.5 0.7
Upper band edge to one octave lower	0.6 0.8	0.8 1.0	0.9 1.2	0.9 1.2	0.8 1.5
Phase Unbalance (deg)	Typ. Max.	Typ. Max.	Typ. Max.	Typ. Max.	Typ. Max.
Lower band edge to one octave from upper band	0.5 2	0.5 2	0.5 2	0.5 2	3 5
Upper band edge to one octave lower	1 4	1 4	1 4	1 4	5 10
Amplitude Unbalance (dB)	Typ. Max.	Typ. Max.	Typ. Max.	Typ. Max.	Typ. Max.
Lower band edge to one octave from upper band	0.05 0.15	0.05 0.15	0.05 0.15	0.05 0.15	0.05 0.2
Upper band edge to one octave lower	0.1 0.3	0.1 0.3	0.1 0.3	0.1 0.3	0.1 0.3

Common specifications: Impedance all ports — 50 ohms. VSWR — 1.25 typ. Nominal phase difference — 0. Matched power rating — 1 watt max. Internal load dissipation — 1/2 watt.

Yes . . . it's no longer necessary to order several different models of power splitters/combiners if your designs are within the 200 KHz to 1500 MHz region.

Order Mini Circuits new, versatile model ZFSC-2-4 offering these benefits:

- ultra wideband performance, 200 KHz to 1000 MHz
- tighter specs over narrower band range
- lower cost with single-model, high volume purchasing
- fast delivery, one week maximum

For narrower bandwidth applications models in the ZFSC series are available at low prices starting from \$31.95 (see chart)

World's largest supplier of Double-Balanced Mixers

## Mini-Circuits

MINI-CIRCUITS LABORATORY

A Division Scientific Components Corp.

2625 EAST 14th STREET  
BROOKLYN, NEW YORK 11235  
(212) 769-0200

OUR NEW ADDRESS  
AND PHONE NO. IS:

DOMESTIC TLX 125460 • INTERNATIONAL TELEX 620156

Israel □ NETHERLANDS, BELGIUM, LUXEMBOURG: Coimex Veldweg 11 Hattem, Holland  
□ NORWAY: Datamatik AS, Ostensjoveien 62, Oslo 6, Norway □ SINGAPORE & MALAYSIA:  
Electronics Trading Co. (PTE) Ltd., 87 Bukit Timah Road, Singapore 9, Malay Peninsula.  
□ SWEDEN: Integerad Elektronik AB, Box 43, S-18251 Djursholm, Sweden

U.S. Distributors: □ NORTHERN CALIFORNIA: Cain-White Co., Foothill Office Center, 105 Fremont Avenue, Los Altos, CA 94022 (415) 948-6533 □ SOUTHERN CALIFORNIA, ARIZONA:  
Crown Electronics, 11440 Collins Street, No. Hollywood, CA 91601 (213) 877-3550

### WE'VE GROWN

Customer acceptance of our products has been so overwhelming, we've been forced to move to larger facilities — THANKS.

International Representatives: □ AFRICA: Afrira (PTY) Ltd, P.O. Box 9813, Johannesburg 2000, S. Africa □ AUSTRALIA: General Electronic Services, 99 Alexander Street, New South Wales, Australia 2065 □ ENGLAND: Dale Electronics, Dale House, Wharf Road, Frimley Green, Camberley, Surrey □ EASTERN CANADA: B. D. Hummel, 2224 Maynard Avenue, Utica, NY 13502 (315) 736-7821 □ FRANCE: SCIE - D I M E S, 31 Rue George - Sand, 91120 Palaiseau, France □ GERMANY, AUSTRIA, SWITZERLAND: Industrial Electronics GMBH, 6000 Frankfurt, Main Klüberstrasse 14, West Germany □ INDIA: Gaekwar Enterprise, Kama Mahal, M.L. Dananagar Marg, Bombay 400 026, India □ ISRAEL: Vectronics Ltd, 69 Gordon Street, Tel-Aviv,



---

## NEWS

- 19 **News Scope**
- 27 **Washington Report**
- 40 **Communications**—A special issue
- 42 **Telephone**—A historical journey from Alexander Graham Bell's first crude telephone designs to today's electronic-switching systems that can interconnect more than 500,000 long-distance calls an hour.
- 58 **Radio**—A biography that covers the growth of the 'wireless' from the electromagnetic-wave experiments by Hertz and Maxwell nearly a hundred years ago to the latest craze in radio—citizen's band.
- 70 **Television**—A lifelong portrait of what is now a global medium, from the 'persistence of vision' papers that were formulated in the 1880s to field-sequential color systems that relayed moon pictures back to earth.
- 86 **Data Communications**—A review of a burgeoning technology, beginning with the electrical telegraphic devices patented by Morse and Wheatstone 137 years ago to today's high-data rate PCM communications systems.
- 98 **Modern Media**—A look at two completely different communications media that have emerged in the last 25 years: satellite and optical communications.
- 112 **An interview with Vladimir Zworykin**—the man who was sure TV would work.
- 
- 120 **Wescon 77**—A special section devoted to this year's big San Francisco show.
- 

## TECHNOLOGY

- 138 **Revised data-interface standards** permit faster data rates and longer cables. New chips, and RS232 adapters, simplify their use.
- 144 **Design active low-pass filters** with stock resistors and capacitors. Six frequency decades can be covered with simple component changes.
- 148 **Ideas for Design:**  
Emulate a seven-segment decoder with a subroutine in a  $\mu$ P control program.  
Time stretcher speeds memory access in Z80  $\mu$ P.  
Two voltage comparators provide null detection for bridge circuits.
- 

## PRODUCTS

- |  |                             |
|--|-----------------------------|
| 157 <b>Instrumentation:</b> Digital-panel thermometer automatically scans input. |                             |
| 158 <b>Instrumentation:</b> Spectrum analyzer boosts accuracy and resolution.    |                             |
| 162 Micro/Mini Computing   | 180 Packaging & Materials   |
| 166 ICs & Semiconductors   | 184 Modules & Subassemblies |
| 172 Microwaves & Lasers  | 190 Power Sources           |
| 174 Components   | 193 Data Processing         |
- 

## DEPARTMENTS

- |   |                                |
|---|--------------------------------|
| 37 <b>Editorial:</b> How fast the years have fled |                                |
| 7 Across the Desk                                 | 202 Bulletin Board             |
| 196 Evaluation Samples                            | 214 Advertisers' Index         |
| 196 Application Notes                             | 216 Product Index              |
| 198 New Literature                                | 216 Information Retrieval Card |

**Cover:** Cover design by Art Director, Bill Kelly. Engraving courtesy of Western Union. Dish photo courtesy of Scientific Atlanta.

---



# BREAKT



**HARRIS HOT LINE!**  
**1-800-528-6050, Ext. 455**

Call toll-free for phone number of your nearby  
Harris sales office, authorized distributor or  
expedited literature service.



# THROUGH!

## Announcing the first all-digital CVSD.

The only Encoder/  
Decoder available  
in a single IC.

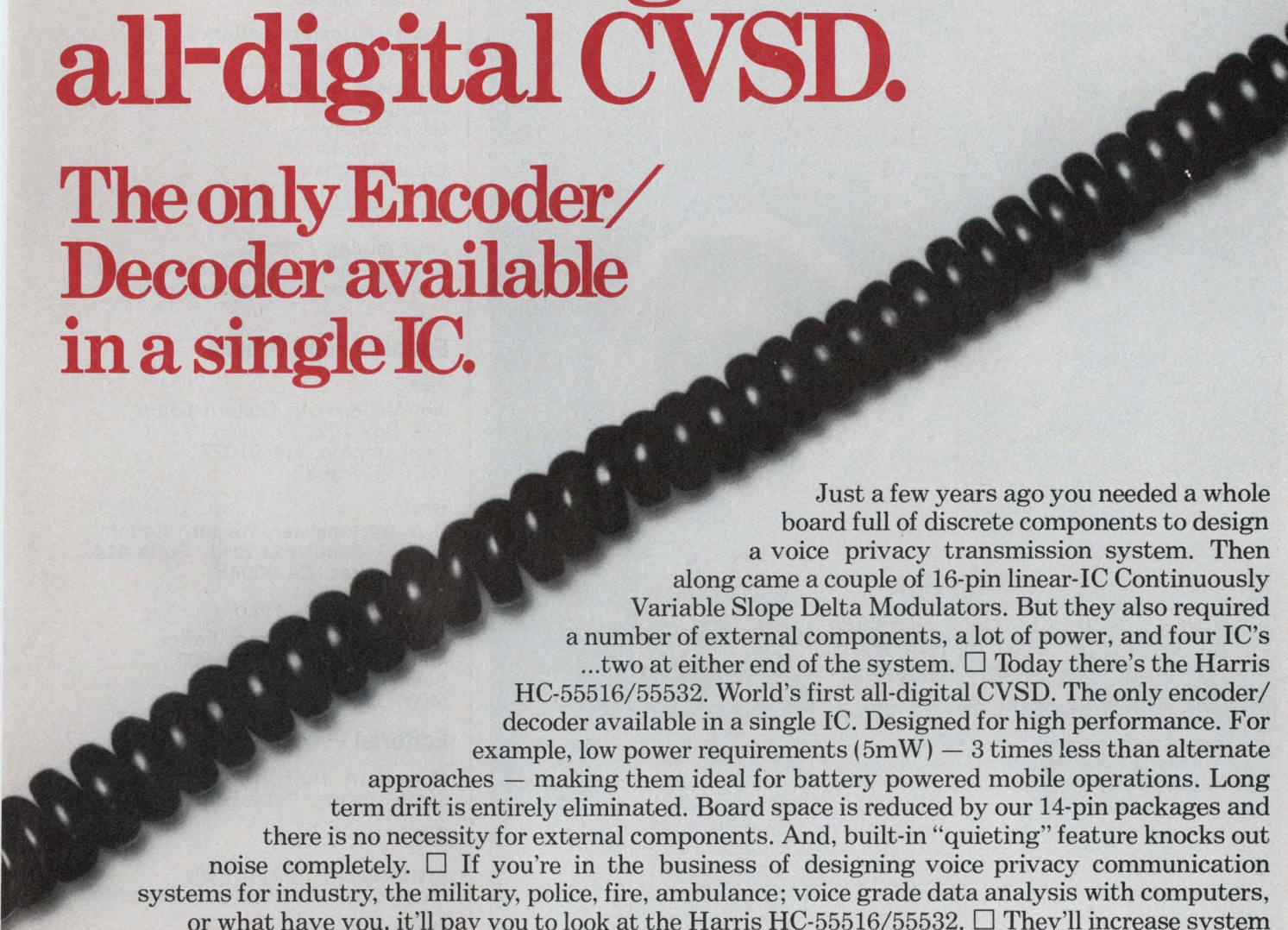

Just a few years ago you needed a whole board full of discrete components to design a voice privacy transmission system. Then along came a couple of 16-pin linear-IC Continuously Variable Slope Delta Modulators. But they also required a number of external components, a lot of power, and four IC's ...two at either end of the system. □ Today there's the Harris HC-55516/55532. World's first all-digital CVSD. The only encoder/decoder available in a single IC. Designed for high performance. For example, low power requirements (5mW) — 3 times less than alternate approaches — making them ideal for battery powered mobile operations. Long term drift is entirely eliminated. Board space is reduced by our 14-pin packages and there is no necessity for external components. And, built-in "quieting" feature knocks out noise completely. □ If you're in the business of designing voice privacy communication systems for industry, the military, police, fire, ambulance; voice grade data analysis with computers, or what have you, it'll pay you to look at the Harris HC-55516/55532. □ They'll increase system performance. They'll save money; cut overall system costs appreciably. They'll provide you with a design flexibility you've never enjoyed before. □ They come in a variety of packages, models and temperature ranges: 14-pin DIP or flat pack, or chips. 16K for lower data bandwidth; 32K for improved fidelity. -40°C to +85°C and -55°C to +125°C. □ For complete information, call your nearby Harris sales location, or write Harris Semiconductor, P. O. Box 883, Melbourne, FL 32901.



**HARRIS**  
**SEMICONDUCTOR**

A DIVISION OF HARRIS CORPORATION

CIRCLE NUMBER 4



# Revolt!



**Break the expensive bonds of hard wire  
— discover new design freedom  
with Repco's RF links.**

Repco's modular RF links are used in hundreds of applications including remote and supervisory control, voice communications, alarm and reporting systems . . . all become more versatile and effective through the use of Repco's rugged, reliable RF transmitters and receivers.

Repco's RF links are packed with performance features: *multiple transmission modes designed to carry tone, voice or low-speed digital data; a wide VHF/UHF frequency range; all units meet FCC and DOC requirements.*

Best of all, Repco's RF links are *economical*. They beat hard wire system costs over the long haul, thus affording you maximum performance at minimum expense. Now is the time for you to link up . . . with Repco's versatile RF links! Write or call today for free specs brochure, application booklet and special evaluation offer.



TX

## Repco Inc.

A subsidiary of Scope, Inc.  
1940 Lockwood Way  
Orlando, FL 32804  
(305) 843-8498

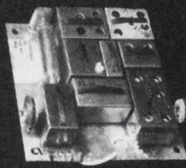

RX

World's leading manufacturer of modular communication products.

**Sr. Vice President, Publisher**  
Peter Coley

### Editors

Editorial Offices  
50 Essex St.  
Rochelle Park, NJ 07662  
(201) 843-0550  
TWX: 710-990-5071  
(HAYDENPUB ROPK)  
Cable: Haydenpubs Rochellepark

**Editor-in-Chief** George Rostky

### Managing Editors:

Ralph Dobriner  
Michael Elphick

### Senior Associate Editor

Stanley Runyon

### Associate Editors:

Sid Adlerstein  
Dave Bursky  
Morris Grossman  
Gene Heftman  
Andy Santoni  
Max Schindler

### Contributing Editors:

Peter N. Budzilovich, Jules H. Gilder,  
John Kessler, Nathan Sussman

### Editorial Field Offices

#### East

Jim McDermott, Eastern Editor  
P.O. Box 272  
Easthampton, MA 01027  
(413) 527-3632

#### West

Dick Hackmeister, Western Editor  
8939 S. Sepulveda Blvd., Suite 414  
Los Angeles, CA 90045  
(213) 641-6544  
TWX: 1-910-328-7240

Dave Barnes, Western Editor  
465 S. Mathilda, Suite 302  
Sunnyvale, CA 94086  
(408) 736-6667

### Editorial Production

Marjorie A. Duffy, Production Editor  
James Keane, Copy Editor

### Art

**Art Director**, William Kelly  
Richard Luce, Anthony J. Fischetto

### Production

**Manager**, Dollie S. Viebig  
Helen De Polo, Nancy Hurey

### Circulation

**Director**, Barbara Freundlich

### Information Retrieval

Paula Greenleaf

### Advertising Promotion

Judith Nappo

### Reprints

Maxine Correal

CIRCLE NUMBER 5

ELECTRONIC DESIGN 18, September 1, 1977



# Across the desk

## Me an editor?

If you'd like to be among the first to know (and write about) what's going on in the electronics industry, you might enjoy being an editor.

We have openings at our home office in Rochelle Park, NJ. Call Mike Elphick at (201) 843-0550.

## Design, not system, determines memory size

Your article, "Should You Use Static or Dynamic RAMs? Only the System Can Say for Sure," (ED No. 6, March 15, 1977, p. 51) has the proper premise, but draws the wrong conclusion. The article argues, correctly, that you can't make a device comparison—a system comparison is needed. However, it goes on to conclude that dynamic memories are better than static memories for large memory systems. The basis for this conclusion is that "large memory systems simply can't justify the power required by an array of static devices."

EMM and IBM have both been building large semiconductor memory systems very successfully using static devices. Since static devices can maintain data at a lower voltage level than dynamic devices, it is possible to reduce the power on the portions of the memory that are on stand-by to about 40% of normal operating power with no loss of memory.

For any memory system, and at any given time, about 99.4% of the devices are on stand-by. The total power required by the system, therefore, is less than a comparable system using dynamic RAMs.

The article concludes by mentioning some new memory chips soon to be introduced by Texas Instruments. We

have been accomplishing the same function as these new chips in our memories for some time now.

We agree that the system is the solution. But the design of the system determines whether the solution is right or wrong.

*Wayne Brumm*

*Product Marketing Manager*

Electronic Memories & Magnetics Corp.

Computer Products Div.  
3216 W. El Segundo Blvd.  
Hawthorne, CA 90250

## Misplaced Caption Dept.



Yes, it's a very small package. . . well, not exactly a TO-3 can. . .

Sorry. That's Andy Warhol's "Tomato Soup Can," which hangs in the Museum of Modern Art in New York City.

*(continued on page 13)*

Electronic Design welcomes the opinions of its readers on the issues raised in the magazine's editorial columns. Address letters to Managing Editor, Electronic Design, 50 Essex St., Rochelle Park, NJ 07662. Try to keep letters under 200 words. Letters must be signed. Names will be withheld upon request.

# RF Power Amplifiers?

# One unit may be all you'll ever need.

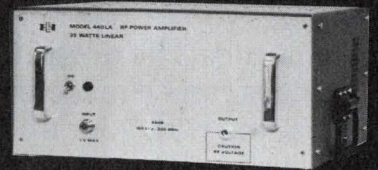

If you have the ENI Model 440LA ultra-wideband solid state power amplifier, all you need is a laboratory signal generator and you've got the ultimate in linear power for such applications as RFI/EMI testing, NMR/ENDOR, RF transmission, ultrasonics and more.

Capable of supplying more than 40 watts of RF power into any load impedance, the 440LA covers the frequency range of 150 kHz to 300 MHz.

We could mention unconditional stability, instantaneous failsafe provisions and absolute protection from overloads and transients, but that's what you expect from any ENI power amplifier, and the 440LA is no exception!

Our catalog contains complete specifications on the 440LA as well as the entire line of ENI amplifiers, and is available without obligation, of course.

For further information or a demonstration, contact ENI, 3000 Winton Road South, Rochester, New York 14623. Call 716-473-6900, or Telex 97-8283 ENI ROC.

# ENI

*The World's Leader  
in Power Amplifiers*

CIRCLE NUMBER 6



# Intel delivers the first with resident EPROM.

Intel's new single chip microcomputer, the 8748, makes it easier than ever to add intelligence to your products. And it enables you to do it at a lower cost than ever before. It's a complete system with powerful central processor, full I/O facilities and, for the first time, resident EPROM program memory. All on a single 40-pin DIP and operating from a single +5V power supply. And you can purchase the 8748 from Intel distributors today.

During product development, the UV-erasable EPROM enables you to load and run your application programs in minutes. The 8748 also speeds debugging. Program changes can be made by erasing the EPROM and reloading with your updated software. This gets your new product out of the lab and onto the market months ahead of the competition, and with reduced development costs.

When you're ready for production, just substitute the fully compatible 8048 microcomputer with your program in low cost, resident masked ROM. If market entry timing has top priority, you can even ship your first production units with the 8748 while you gear up for the switchover to 8048. And by using the 8748 you can respond to non-standard customer requirements without waiting for ROM turn-around.

Intel's advanced MOS/LSI process technology allows a single 8748 or 8048 chip to replace up to 100 or more conventional TTL devices. The 8748/8048 contains an 8-bit general purpose CPU, 1024 bytes of EPROM or ROM program memory, 64 bytes of read/write data memory,

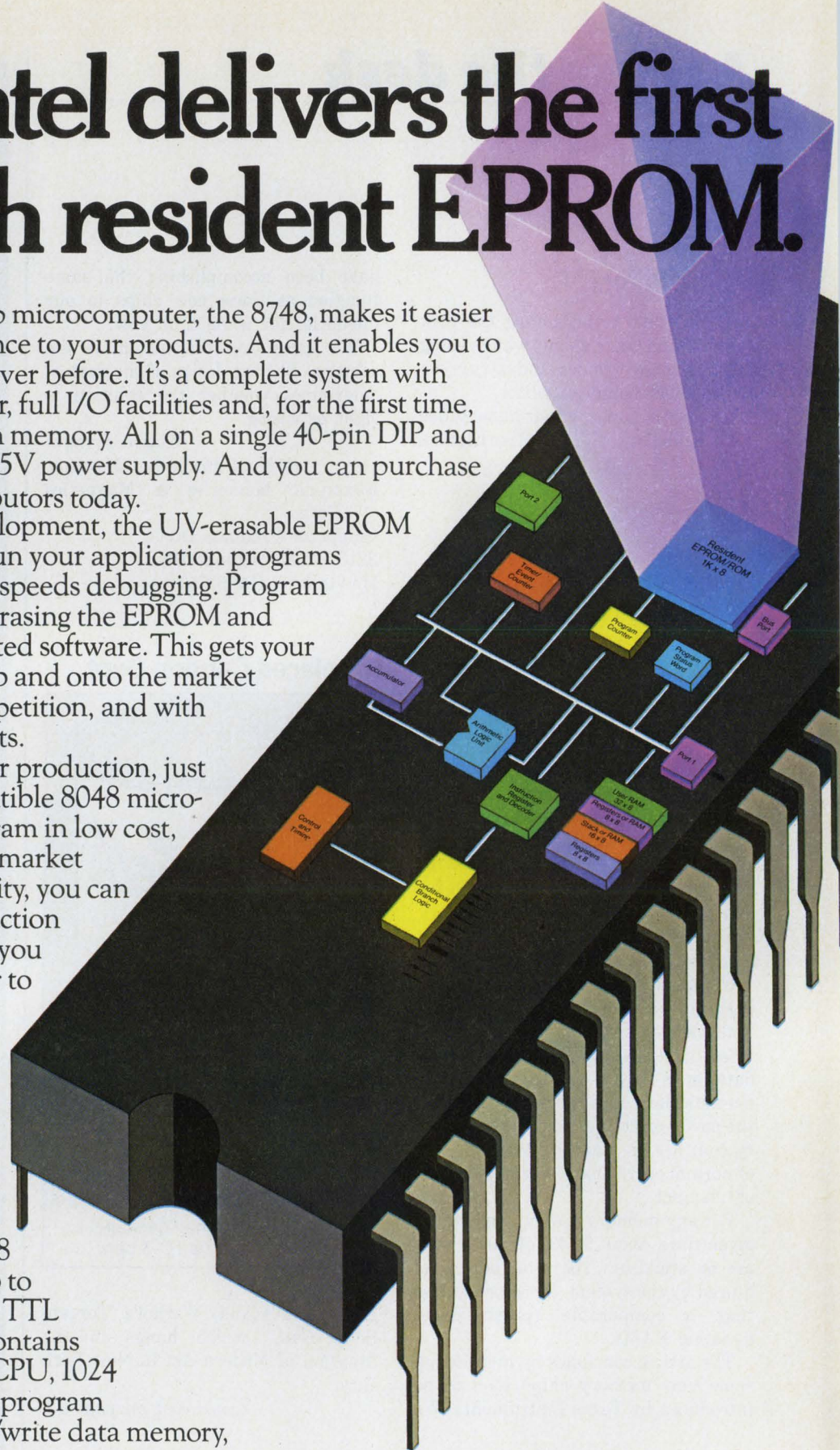



# single chip microcomputer

## The 8748.

three programmable 8-bit I/O ports, 8 additional control/timing lines, programmable interval timer/event counter, priority interrupts, system clock generator and a full set of system controls. It's a single chip solution to a wide variety of applications, yet it's fully expandable by adding compatible MCS-80™/MCS-85™ I/O chips and Intel® standard memories.

There's also a new 8035 micro-computer that is exactly like the 8748/8048 but without resident program memory. It enables you to precisely match system memory size to your needs, using external ROM or EPROM.

The 8748 is the best supported single chip microcomputer you can buy. To speed development there's the Intel® Microcomputer Development System with assembly language programming, symbolic debugging, and full EPROM programming capability. The ICE-48™ In-Circuit Emulation module simplifies hardware/software integration and debugging. And the Intel Prompt-48™ Design Aid is a low cost, stand alone alternative for 8748 programming, simulation and debugging. Intel supports you from prototype to production with development software, documentation, training and application assistance.

The new 8748 will give manufacturers of instruments, terminals, communications equipment, controllers, electronic games, automotive products, home appliances and hundreds of other products the competitive edge. It will help you get better products to market ahead of the competition at lower cost.

The 8748, 8035 and all compatible components can be purchased now from franchised Intel distributors: Almac/Stroum, Components Specialties, Cramer, Elmar, Hamilton/Avnet, Harvey Electronics, Industrial Components, Liberty, Pioneer, Sheridan, L.A. Varah, or Zentronics.

Or, for a copy of our single-chip microcomputer brochure write: Intel Corporation, 3065 Bowers Avenue, Santa Clara, California 95051. Telephone: (408) 246-7501.

Part No.	Description	Availability
<b>MCS-48 Components</b>		
8748	Single chip $\mu$ C with 1K bytes EPROM	NOW
8048	Single chip $\mu$ C with 1K bytes masked ROM	NOW
8035	Single chip $\mu$ C without resident program memory	NOW
8243	I/O Expander with 16 high current drive I/O lines	NOW
8355	ROM, 2K bytes, 16 I/O lines	NOW
8155	RAM, 256 bytes, 22 I/O lines and timer	NOW
<b>Compatible MCS-80/85 Components</b>		
2316E	Standard ROM, 2K $\times$ 8, 450 ns	NOW
2708	Standard EPROM, 1K $\times$ 8, 450 ns, light erasable	NOW
2716	Standard EPROM, 2K $\times$ 8, 450 ns, light erasable	NOW
2111A-4	Standard RAM, 256 $\times$ 4, 450 ns, common I/O	NOW
2101A-4	Standard RAM, 256 $\times$ 4, 450 ns, standard I/O	NOW
5101	Standard RAM, 256 $\times$ 4, 650 ns CMOS	NOW
8256A	Programmable Peripheral Interface	NOW
8251	Programmable Communications Interface	NOW
8214	Priority Interrupt Controller	NOW
8253	Programmable Interval Timer	NOW
8259	Programmable Interrupt Controller	NOW
8279	Programmable Keyboard/Display Controller	NOW



# intel® delivers.



# SABRE X is Here!

## Your ten best reasons for buying it are benefits no other tape recorder/reproducer provides

- 1.** Programmable microprocessor control of tape speeds, operating modes, monitor/alarm and other diagnostic testing functions
- 2.** Tape transport with ten speeds from 240 to 15/32 ips
- 3.** 2<sup>9</sup> time base expansion and/or contraction ratios
- 4.** 10-speed switchable all-band Direct channel electronics
- 5.** 10-speed switchable all-band FM channel electronics
- 6.** 6 megabit digital data processing per track
- 7.** Usable Direct/FM/Digital channel electronics at 240 ips
- 8.** 88.8 hour record time per tape reel — the industry's longest
- 9.** 4.0 MHz/Track direct Record/Reproduce system
- 10.** The same manufacturing excellence that has made Sangamo a leader in tape recorders for over 16 years

IRIG tape recording/reproduction was never like this. But then, that's the whole point of SABRE X: pushing back the horizons of *our* technology to help you push back yours. We know your needs. So we've given you still more features, including serial

and/or parallel high density electronics, vacuum tape tensioning and modular design. We've made it easy to customize the unit with options ranging from coded computer control, data monitoring and a voice/time code to a tape servo and remote control. We've freed you for virtually unlimited applications, including data reduction, deep space, satellite and space networks, mass data storage and security. We've got your number: SABRE X.

For additional information, call or write:

Sangamo Weston, Inc.  
Sangamo Data Recorder Division  
P.O. Box 3347  
Springfield, Illinois 62714  
TEL (217) 544-6411

SANGAMO WESTON

Schlumberger

# SABRE X





# BELDEN IS CELEBRATING ITS 75<sup>th</sup> ANNIVERSARY

## BIG DEAL.

It is a big deal if you consider what's happened in those years. And what we've learned – from you, our customers.

For instance, a long time ago we learned that real service doesn't stop with delivery. It takes an entire organization of dedicated and knowledgeable sales people, engineers, manufacturing, quality control and customer service personnel . . . All working to meet your special needs.

We've also learned to look at wire, cable and cord applications from your point of view. To provide what you actually need – not what we've got. This philosophy has led to some exciting technological breakthroughs, ranging from new insulation and jacketing compounds, shielding methods and packaging concepts to revolutionary testing methods.

On our 75th anniversary we'd like to thank you for your business. And the ways you've challenged us.

Right now, you'll find high quality Belden wire products coming through in the most exciting applications known. And we'll continue to come through for you in the years ahead. With everything we've got.

**BELDEN** 



Protection that adds value . . .

# What's your handle?

We want to make you look good. So we've designed our circuit breakers with the industry's broadest selection of handle styles and colors.

Rather than hiding fuses or cheap thermal breakers, you can put a Heinemann hydraulic-magnetic breaker right on the front panel, where it can double as a power switch...just one more way our products add value to your products.

And one more reason Heinemann is No. 1 in OEM circuit protection for everything from computers to coffee machines. Not just for overcurrent and short circuits, but also for overvoltage, undervoltage, and a surprising variety of switching, calibration, and control functions.

Ask for your Protector Selector—a handy reference chart loaded with specs, capabilities, and dimension drawings for twelve top-selling protector lines (of which our Type J series, shown below, is but a single example). Contact your nearby Heinemann representative (listed in EEM) or Heinemann Electric Company, Trenton, NJ 08602. (609) 882-4800.



Ours is Flip, Rock, Push, Switch, and Color-Me-Red.



another reason Heinemann  
is No. 1 in  
OEM circuit protection.



# HEINEMANN

We keep you out of trouble.

Factories in Trenton, Montreal, Dusseldorf,  
Johannesburg, and Melbourne.

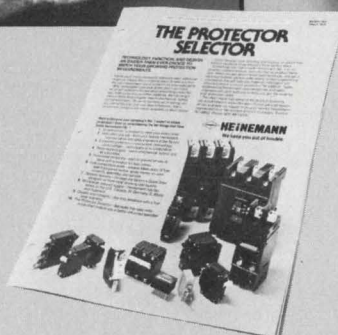



# ...and you can get breakers fast from these Heinemann stocking locations.

## California, Burlingame 94010

G. O. Johnson Co., Inc.  
840 Mahler Road  
(415) 697-2965

## California, Woodland Hills 91367

POCO Sales  
6311-F DeSoto Avenue  
(213) 999-0171  
Telex 69-1603

## Illinois, Chicago 60646

NEDCO Electronics, Inc.  
6232 N. Pulaski Road  
(312) 286-5565

## Maryland, Baltimore area

Automation Industrial Control  
9070 Chevrolet Dr., Box 627  
Ellicott City, MD 21043  
(301) 465-3616

## Michigan, Detroit area

Michigan Lectrols Corp.  
24301 Telegraph Road  
Southfield, MI 48034  
(313) 353-1350  
TWX 810-224-4654

## New Jersey, West Trenton 08628

Automation Controls & Equipment  
210 Scotch Road, P. O. Box 7153  
Toll-free: (800) 792-9738 or  
(800) 257-9085

## North Jersey/New York City area

Power/Electro Supply Co., Inc.  
P. O. Box 306  
Ridgewood, NJ 07451  
(201) 444-6990  
N.Y.C. no: (212) 964-4640

## New York, Binghamton 13902

Harvey Electronics, Inc.  
P. O. Box 1208  
(607) 748-8211

## North Carolina, Charlotte 28204

Joyce Sales Company  
P. O. Box 4245  
(704) 377-1555

## Ohio, Cleveland area

Radio & Electronic Parts Corp.  
6835 Cochran Rd.  
Solon, OH 44139  
(216) 248-8900

## Ohio, Dayton 45401

Duellman Electric Company  
131 Wayne Ave., Box 771  
(513) 461-5010

## Oregon (see Washington area)

## Texas, Dallas 75231

Hall-Mark Electronics Corp.  
9333 Forest Lane  
(214) 231-6111

## Washington, Seattle area

J & A Sales  
7616 S.E. 24th Street  
Mercer Island, WA 98040  
(206) 232-0463  
From Portland: (503) 222-2662

# HEINEMANN

We keep you out of trouble.

© Heinemann

6850

## Across the desk

(continued from page 7)

### Program bugs stamped out

Thanks to the help of Les Birman of Grumman Aircraft, and others, several bugs in the ROMGEN program described in "Model your ROM with NAND Gates" (ED No. 20, Sept. 27, 1976, p. 88) were brought to my attention. The following corrections need to be made to the program:

#### Subroutine Epitgen

1. Add NN=1 after statement 51.
2. Delete NN=1 two statements after statement 59.
3. Change statement 60:  
IFUNC (1025+NN, 18)—IFUNC (1026,18)
4. Change 60—62 two statements after statement 60.
5. Delete statement 61 and the next three statements.
6. Change statement 65:  
IFUNC(5,17)—IFUNC(6,17)
7. Change statement 60:  
IFUNC(3,17)—IFUNC(4,17)

#### Subroutine Cktgen

1. Change statement 29:  
IF (IFUNC(M,2). EQ.1. AND IFUNC (M,3). NE.2) GO TO 13—  
IF (IFUNC (M,1). EQ.-1. AND IFUNC (M,3).NE.2) GO TO 13.

#### Subroutine Nandgn

1. Change LX—LN three statements after statement 911.
2. Change LX—LN two statements after statement 909.
3. Add LN=LN-1 after statement 905.

The dimension statements for arrays IPIT and EPIT should be expanded to 5000. The DO statements that are used in initializing these arrays should be changed to account for the increased array size.

James J. Hanratty  
Electronic Engineer

Naval Air Rework Facility  
Alameda, CA 94501

### We misplaced a processor

Our apologies to readers we confused by listing the Ferranti F100L microprocessor in the wrong place in Table 1 that appeared in ED No. 14, July 5, 1977 on p. 30. Data describing the processor had not arrived at press time and a change in the table resulted in Ferranti being put in the wrong place

Ferranti belongs just after the Fairchild 9440. For those of you who are curious about the F100L's performance, here are the facts that would have appeared in the table:

Process technology: Bipolar  
Word size (data/instruction): 16/16  
Direct-addressing range (words): 32 k  
Number of basic instructions: 28  
Max clock freq (MHz)/phases: 20/1  
Execution time (short/long) in  $\mu$ s: 0.3/1  
TTL-compatible: Yes  
BCD arithmetic: No  
On-chip interrupts/levels: Yes/1  
Internal general-purpose reg: 1  
Number of stack registers: RAM  
On-chip clock: No  
DMA capability: Yes  
Specialized mem & I/O support: Yes  
Prototyping sys avail: Yes  
Package size (pins): 40  
Voltages required: 5 V  
Assembly lang dev syst: Yes  
High-level lang: Yes  
Time-sharing cross soft.: Yes  
Comments: Processor can meet full MIL temp range.

For more information **CIRCLE NO. 319**

### Case of the missing diode

I found a discrepancy in one of your Ideas for Design ("Display Letters and Symbols on a 7-Segment Numerical Display," ED No. 25, Dec. 6, 1976, p. 108). A diode is missing between line d and line 4 in the diode matrix (Fig. 2), thus generating an "E" instead of an "F."

Garnett T. McNeil, EE  
Engineering Service  
Manager

Photovolt Corp.  
1115 Broadway  
New York, NY 10010

### The real unusual feature

There is a slight mistake in your description of our 9440 microprocessor in ED No. 7 March 29, 1977, p. 28. The unusual feature of the 9440 is not a 4-bit accumulator, as mentioned in your article, but a 4-bit-wide ALU. The 9440 is a 16-bit, single-chip bipolar processor, with four general accumulators and four special registers—all 16 bits wide.

Dan Wilnai  
Supervising Engineer  
Processor Design

Fairchild Semiconductor  
Advanced Products  
464 Ellis St.  
Mountain View, CA 94040



# All aerosol cleaners are not alike.

What do we mean by this statement? Simply, that not all industrial cleaners have kept pace with the increasing demands for purity in the electronics industry.

For years now, we've recognized industrial cleaning as a vital link in maintaining component and system purity and reliability. And here's what we've done to make sure Miller-Stephenson aerosol cleaners can help achieve the system integrity you need.

**PURITY COMES FIRST** In laboratory testing, Miller-Stephenson aerosol cleaners have the lowest residual contamination in the industry — some approaching 5-7 parts per million. The general industry range is 50-130 ppm.

We believe the purer *our* product, the better the performance and reliability of *your* product.

**ATTENTION — FILTER AT WORK** We use only the highest grade certified virgin solvents and propellants (all propellants are nonflammable — TWA 1000ppm — the surest, safest propellants available.)

We *double filter* our Freon solvent and propellant, first with a 5 micron filter, then with a Millipore 0.2 absolute filter. The filtered product goes directly into seamless cans, eliminating any possibility of flux contamination from seamed cans. We have complete quality control, from tanker to customer.

**WE'RE FUSSY ABOUT OUR LOADING ENVIRONMENT** Our loading room environment is immaculate, controlled by Clean Room conditions. Each loading line is kept exclusive for an individual product. This avoids the danger of contamination often caused when loading lines are used for multiple products.

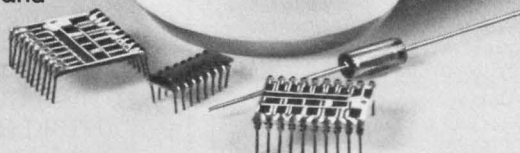

**MS CLEANERS CAN BE SHIPPED WITH SAFETY** Here's an important bonus! Because of our special formulating most Miller-Stephenson aerosol cleaners can be shipped Air Transport. They are exempt from all the federal regulations listed under the heading, "Restricted Articles".

**WHY DO WE TELL YOU ALL THIS?** *Because we believe no other aerosol cleaner now on the market meets these purity standards. And we think the rigid standards we demand of our products will help you meet your own high level of safety and reliability.*

But let us send you a can of MS-180 Freon TF Solvent to try for yourself.

"Freon" is DuPont's registered trademark for its fluorocarbon compounds.

## miller-stephenson

Danbury, Connecticut 06810 (203) 743-4447

ED-9V

- Enclosed is \$2.00, please send trial unit of MS-180 Freon Solvent
- Enclosed is \$5.00, please send trial units of MS-180 and Cobra Brush
- Please send FREE literature and prices on complete line of MS cleaners

Intended Use \_\_\_\_\_

Name \_\_\_\_\_ Dept./Title \_\_\_\_\_

Company \_\_\_\_\_

Address \_\_\_\_\_

Since our products are For Industrial Use Only, government labeling regulations prevent our sending these trial units to your home address.

LOS ANGELES • CHICAGO • DANBURY, CT. • TORONTO

CIRCLE NUMBER 12



Our exclusive Cobra extension brush MS-226 will convert any Miller-Stephenson aerosol cleaner into an efficient metered spray with scrubbing action. Insures maximum cleaning accuracy with minimum solvent waste.



# The one variable the world can standardize on.

Our new Type M conductive plastic variable resistor is hard metric. A 10 mm cube that's tiny, flexible and rugged. The MINI-METRIC is the smallest dual pot available today. Manufactured in the United States, it's dimensioned the way the rest of the world thinks. Allen-Bradley has what you need; or, it can be ordered through our distributors. Ask for Publication 5239.

## *Choices*

single or dual pot or pot/switch combinations

## *100 ohms to 1 megohm*

conductive plastic resistance elements,  $\pm 20\%$  tolerance, standard resistance values conform to IEC.

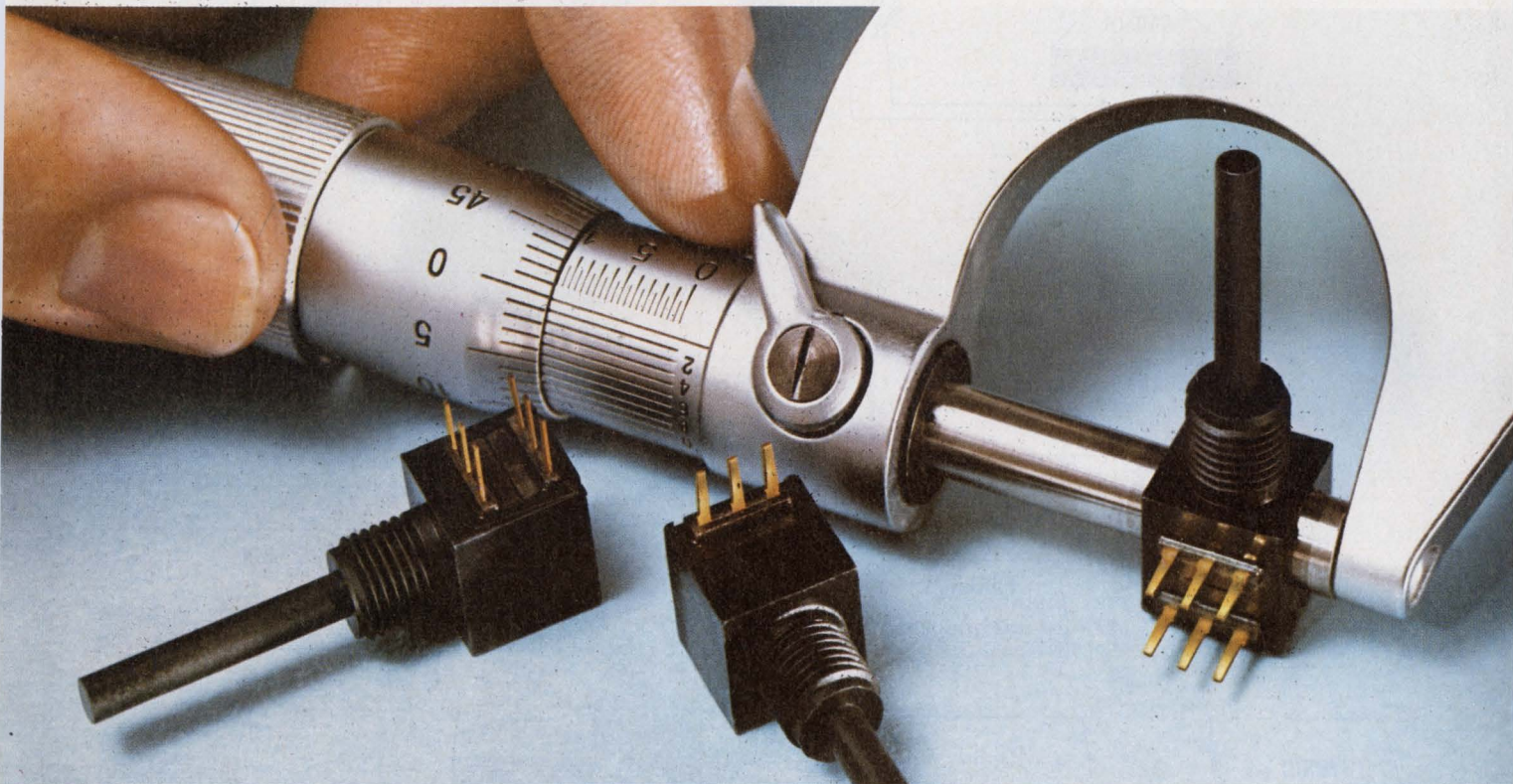
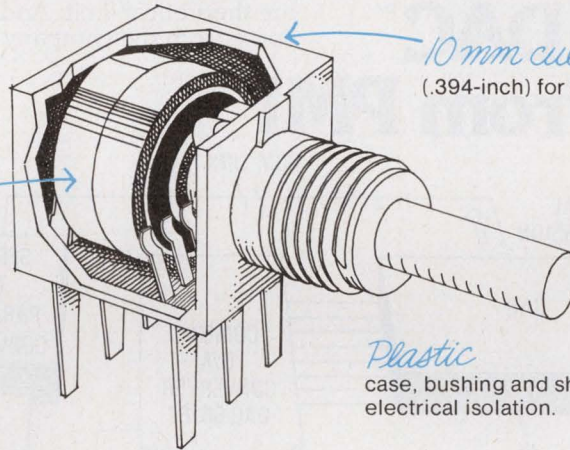

## Quality in the best tradition.



**ALLEN-BRADLEY**  
Milwaukee, Wisconsin 53204

CIRCLE NUMBER 13



Lowest cost per channel.  
 Lowest power per channel.  
 And best performance.

# The eight-channel COMDAC™ codec from PMI

Now you can put together an eight-channel PCM codec using high-quality, low cost PMI parts.

At the heart of this great idea is PMI's COMDAC series—unique companding monolithic DAC's designed to conform with the Bell  $\mu$ -255 Law (DAC-86) and the CCITT "A" Law specifications (DAC-87). The two COMDAC's, in conjunction with our SMP-81, CMP-01, OP-16, REF-02 and MUX-88, provide system performance close to the theoretical limit. And they come from the company with

the greatest experience of all when it comes to monolithic DAC's.

We've been delivering companding DAC's—COMDAC's—since 1975. There are now more than half a million COMDAC's in operational

DAC-86  $\mu$ -255 Law DAC  
 COMDAC™ TRANSFER CHARACTERISTIC

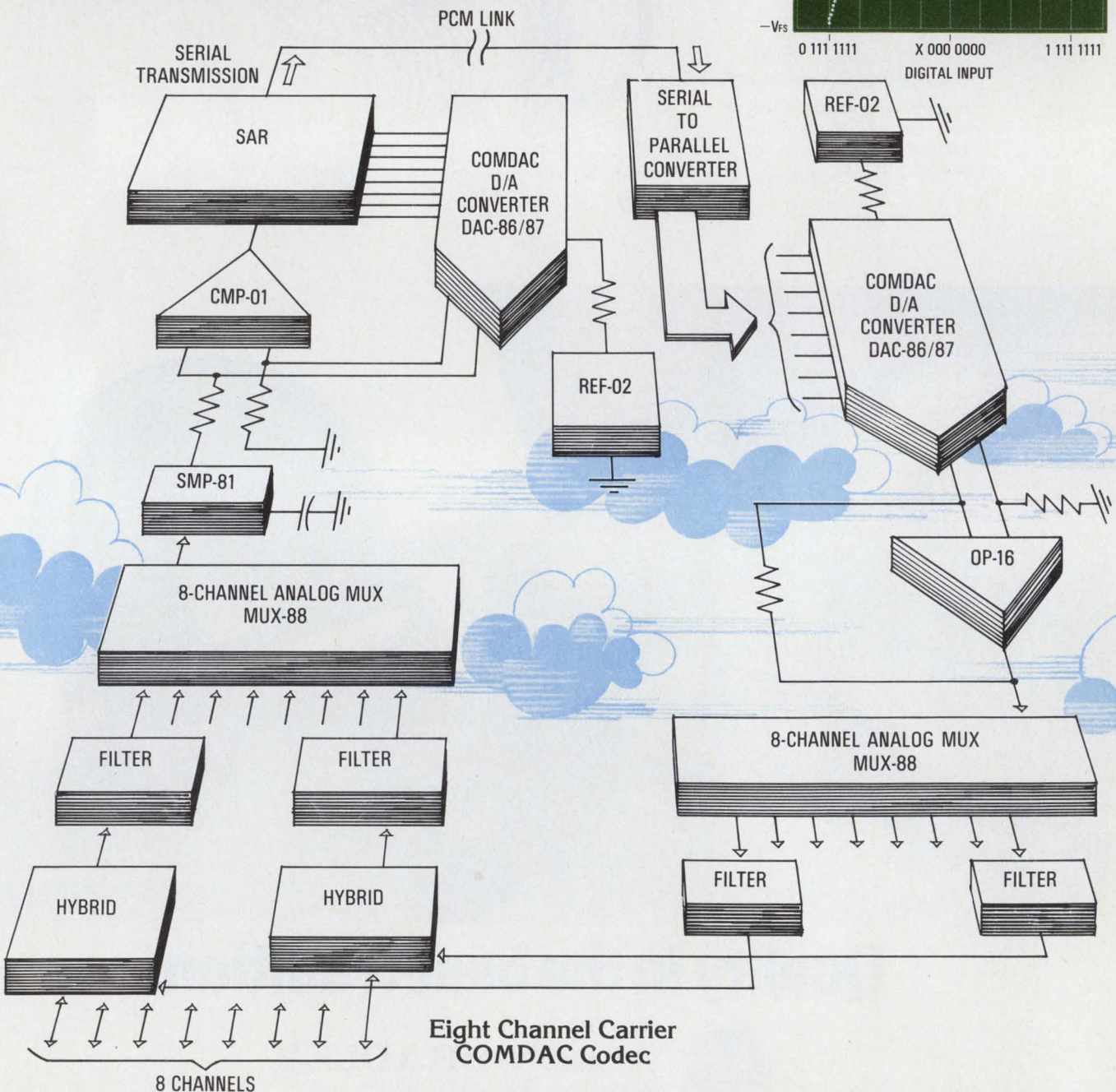
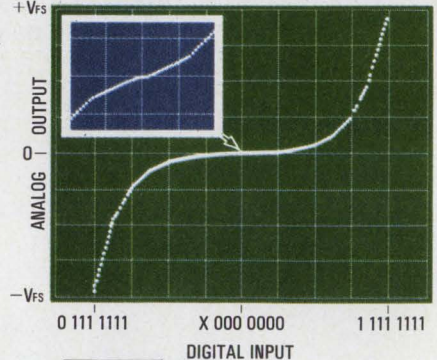

Eight Channel Carrier  
 COMDAC Codec



**DAC-87 CCITT A-Law DAC**  
**COMDAC™ TRANSFER CHARACTERISTIC**

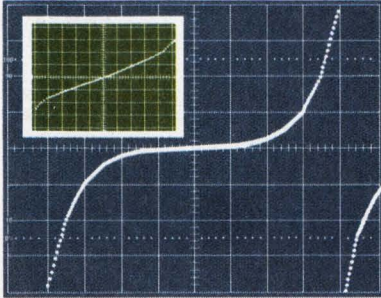

systems carrying traffic. As a result of all this telecommunications experience PMI has a thorough understanding of common codec applications.

**Take the system approach.**

Now take a look at the diagrams. Both are full-blown, eight-channel-multiplexing, PCM codecs. Almost all the solid-state components are now available from PMI. This gives you the advantages of simple ordering, high reliability, and superior performance.

When you compare the total cost of the COMDAC codec with other available approaches, you'll see that the PMI multiplex approach can cut cost substantially.

Another advantage is low power consumption. An examination of the specs will show that the PMI codec uses less power to do the job than other designs. And you know what a watt costs these days.

**One other thing:**

We don't compete with our customers. True, we do know a lot about transmission, digital PBX systems and digital central

offices; we have to. But we're in the IC business only. You'll always get high quality, good delivery, and no competition from us. Please tell us how we can help you better.

**Precision Monolithics Incorporated**  
 1500 Space Park Drive  
 Santa Clara, California 95050  
 (408) 246-9222. TWX: 910-338-0528  
 Cable MONO.

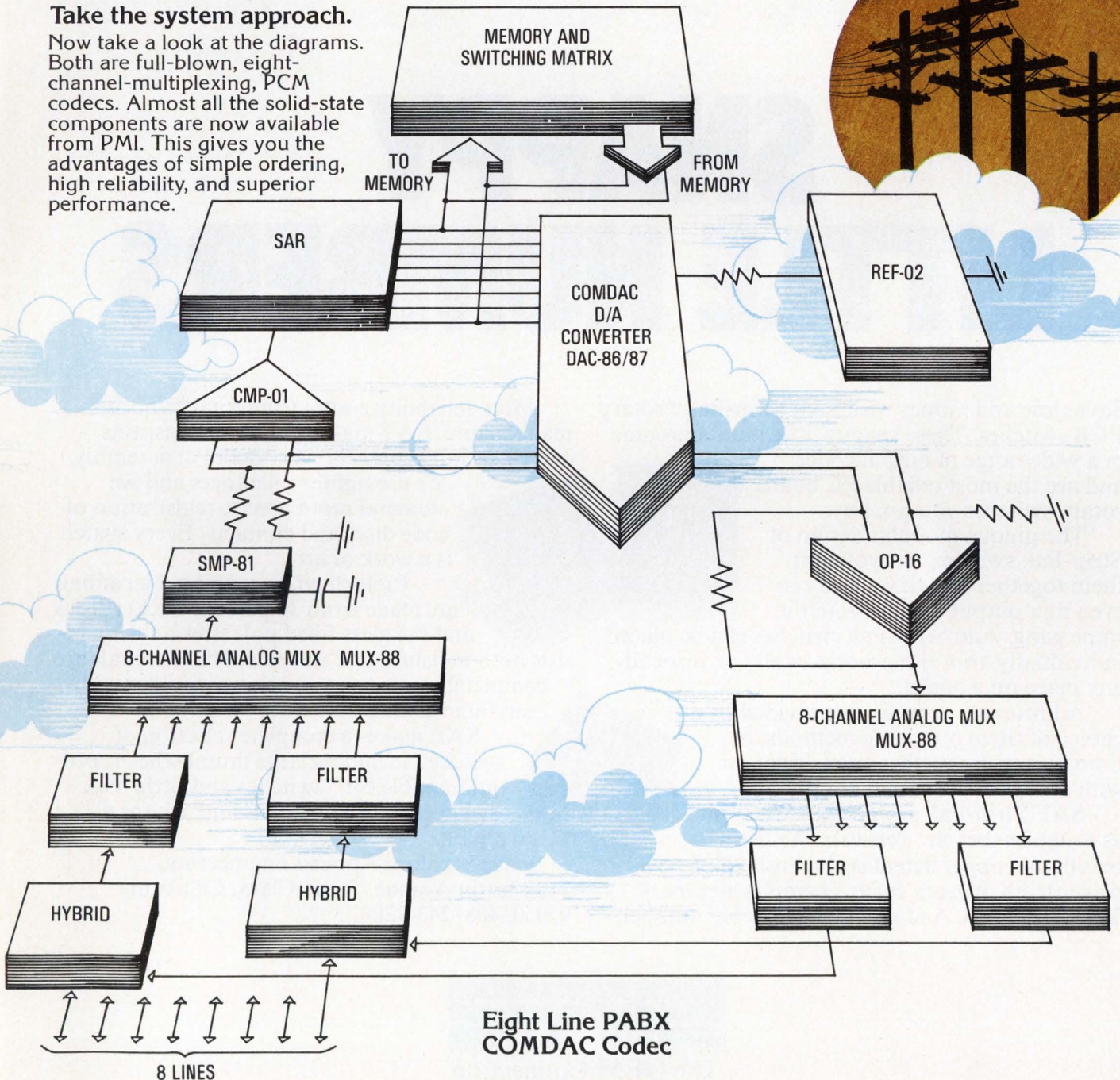

**Eight Line PABX  
 COMDAC Codec**



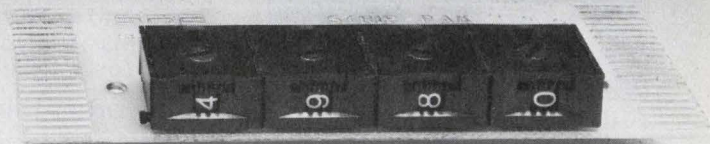
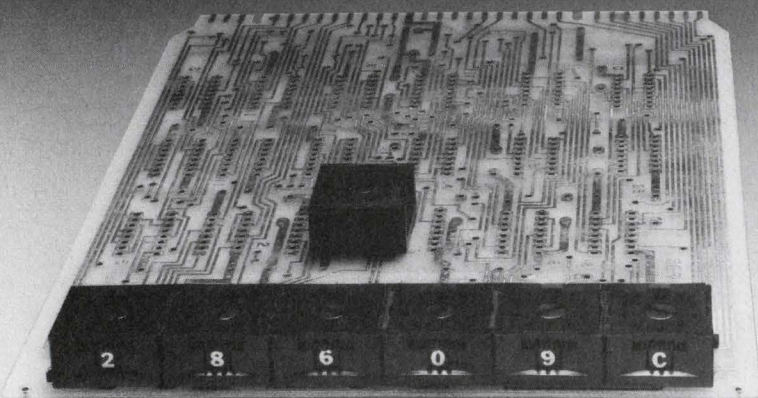

# SNAPPY LITTLE NUMBERS

Save time and money with SAE Strip-Pak™ rotary PCB switches. These snappy little numbers come in a wide range of output codes, and are the most reliable PC board rotary switches you can buy.

The unique modular design of Strip-Pak switches lets you snap them together in strings. You can even mix output codes within the same gang. And Strip-Pak switches can be placed individually, too, either horizontally or vertically, any place on a board.

Additional versatility is provided by a choice of three operating methods: by thumb pressure, with a screwdriver, or with an optional snap-in knob.

SAE Strip-Pak switches are every bit as tough as they are versatile. We use a beryllium copper detent spring instead of plastic teeth or gears, for an operating lifetime of 500,000 detents. And that's a snappy *big* number.

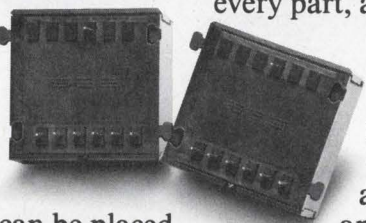

More reliability comes from total in-house manufacture. SAE makes every part, inspects every part, and controls every detail of assembly.

We use tighter tolerances and we demand more precise registration of code discs and contacts. Every switch is a work of art.

Preformed, heat-treated terminals are made from 30 percent thicker stock, and the glass filled polyester housing resists both moisture and solvents. The terminals are completely sealed so you can wavesolder without flux wicking.

SAE makes a complete selection of switches, including large thumbwheels, programmable Bit™ switches and Strip-Pak switches. Write or call us and ask for a catalog.

We're Stanford Applied Engineering,  
340 Martin Avenue, Santa Clara, California  
95050. 408/243-9200.



The OEM Connection

CIRCLE NUMBER 15



## ELF technology saved— Seafarer gets a year

Extremely low-frequency communications—by which a transmitter radiating a mere 2 W in Wisconsin can send messages to submarines deep in the ocean—is still alive. A House-Senate subcommittee has voted \$15-million to continue research on the Navy's Seafarer ELF communications project through fiscal year 1978.

After 20 years of R&D, the Navy's plan to put ELF to work as a submarine communications system has almost come to fruition. But local objections to using part of Michigan's Upper Peninsula as a 76-Hz loop antenna still threaten to put an end to the fledgling technology, whose only application so far is keyed to national defense.

Low-porosity, low-conductivity granite rock is used as a dielectric between the two buried ends of an antenna cable. The dry-rock formation causes the antenna current to form a huge underground loop as deep as 2 km beneath the surface and as long as the distance between the buried ends—14 miles in the case of the Navy's test site at Clam Lake, Wisconsin.

Once propagated, the ELF signals assume a vertical polarization, and are ducted between the Earth's surface and the ionosphere, which can be anywhere from 50 to 250 miles high.

As it passes over the Earth's surface, the vertically polarized E-field develops a downward tilt. When the downward-tilted waves penetrate the surface of water, they propagate downward and become horizontally polarized.

Since the attenuation of radio waves in seawater is proportional to  $\sqrt{f}$ , an ELF signal at 76 Hz can penetrate the ocean 14 times better than conventional VLF signals at 15 kHz. Consequently the Navy wants ELF.

There is another reason. No other

land-based system today can communicate with a nuclear sub at operational depths," notes Cdr. John Hoshko, Public Affairs Officer for Seafarer. Three schemes now exist for shore-to-sub communications, but they all require subs to approach or actually break the ocean surface.

An ELF communications system, however, would enable a nuclear sub fleet to stay at an undetectable depth without losing contact with its base. Nuclear subs reportedly carry half of America's nuclear capability. So keeping in touch with home is extremely important.

But people living on Michigan's Upper Peninsula, the best site for an antenna, want no part of Seafarer. Building the proposed, full-scale antenna system means burying some 2400 miles of cable in an area 68 miles square. Moreover, the disparity between the antenna's electrical length and the transmitted 76-Hz wavelength calls for a very inefficient transmitter—on the order of  $10^{-4}$ —to realize 500 W of output power. Moreover, the antenna grid needs to be driven with over 10 MW.

As a result, these high-power levels and the need to bury 2400 miles of antenna cable have given rise to a fair amount of controversy over Seafarer. The Navy and the Secretary of Defense are on one side; the President and the Governor of Michigan are on the other.

But proposed alternative sites in the Southwestern deserts are too costly and even less efficient, Hoshko insists. And the test site in Wisconsin is unsuitable for a full-scale antenna.

Michigan's Governor Milliken is currently reviewing a scaled-down compromise version of Seafarer's 2400-m, 500-W antenna. So the long-term viability of ELF rests in his hands.

## Low-cost home computer makes a race of it

Trying to capture a major portion of the projected \$1.5-billion home computing market, Radio Shack has just introduced a low-cost Z80-based home computer. The TRS-80, which is the second system aimed at home computing, includes an ASCII keyboard, a video display and a cassette recorder for bulk storage.

Scheduled to be available for delivery by September, the whole system will cost \$599.95. This price includes the Z80 CPU, 4 k of RAM and 4 k of ROM—which contains Basic. The computer alone—without monitor and cassette recorder—costs only \$399.95.

The computer can be internally expanded to 16 k of RAM—which costs \$289—and 12 k of ROM. The additional ROM will be used to hold extended



**The latest home computer, the TRS-80 from Radio Shack, uses a Z-80 micro. It comes assembled and tested with Basic language in ROM for \$599.95.**

Basic and an assembler editor that will be available by the end of the year.

Like the Pet home computer announced by Commodore Business Machines (see ED No. 11, May 24, p. 21), the TRS-80 contains the Basic programming language in ROM and comes completely wired, tested and ready for plug-in and use.

Unlike the Pet, whose IEEE 488 bus interface makes it suitable for industrial applications as well as home computing, the TRS-80 has no standard interface. Instead, a 40-line bus in the Radio Shack unit is brought out to the rear of the computer on PC board fingers, which mate with an edge connector.

Other features of the TRS-80 computer include a 16-line CRT display with 64 characters per line and a computer-controlled cassette-storage system. The format of the CRT display can be changed to display 32 characters



per line by altering the machine language program that controls the output.

By the end of the year several additional options will be available to make the computer more versatile according to Steve Leininger, engineer in charge of the TRS-80 project. These include an expansion unit that will hold an additional 16 k of RAM and interface cards, a mini floppy-disc system based on the Shugart drive, and a printer.

The printer uses a 5 x 7-dot matrix to print upper-case letters only, features 80 characters per line, and can make up to seven copies. To add this hard-copy device to the \$600 computer will require only \$1500 more.

## BBD time delay sets record at 4096 stages

A bucket-brigade device with 4096 stages—four times longer than previous commercial units—can delay audio-frequency signals as much as 205 ms. Geared for audio and musical-instrument amplifiers and medical equipment, the MN3005 from Matsushita Electronics, Japan, will be available in production quantities in October.

Bucket-brigade devices can be used to simulate the time delay in telephone conversations caused by the transmission path from ground to satellite. They can also measure and compensate for reverberation in electroacoustics. And they can help correct stuttering by feeding back delayed conversations.

Each of the 4096 stages consists of a capacitor and a MOS tetrode switch. Each is alternately driven by one of two stages of a clock signal ranging from 10 kHz to 100 kHz,—corresponding to time delays of 205 ms to 20.5 ms.

An earlier Matsushita part has two 512-stage delay lines, each capable of a 25.6-ms delay at a clock frequency of 10 kHz. Reticon Corp. of Sunnyvale, CA, has been marketing a single 1024-stage bucket-brigade device.

But, audio reverberation and echo effects require a time delay of more than 100 ms. While this delay could be achieved by connecting several shorter bucket-brigade circuits in series, signal-to-noise ratio would be sacrificed. Moreover, an amplifier and low-pass filter would have to be connected between stages. Which would result in high cost and complexity.

The long MN3005 uses p-channel silicon-gate processing to achieve low noise—75 dB s/n compared with less

than 55 dB s/n for eight 512-stage Matsushita devices in series. Insertion loss is kept typically at 0 dB by adjusting input and output capacitances to match input and output charge levels and by increasing transfer efficiency between stages to as high as 99.997%. Matsushita would not elaborate on the internal workings of the device.

Matsushita expects to price the MN3005 about four times higher than its dual-512-stage MN3001, which sells for \$8.85 in thousand quantities. Samples should be available in September.

## Liquid-based solar cells: high efficiency, low cost?

Solar cells with a liquid, rather than a solid-state junction have already demonstrated a relatively high efficiency of 7.5%. They may prove to be low-cost as well. The liquid-junction cells are under development at Bell Laboratories in Murray Hill, NJ.

The bell cells look promising because they can use materials less expensive than those used by conventional solid-state-junction cells. Plus, they are easier to make and appear to be long-lived. A three-to-four-year life has been simulated in a prelaboratory experiment.

Liquid-junction cells composed of two electrodes immersed in a water-based sulfide-polysulfide solution have been put together by Bell researchers Adam Heller, Barry Miller and Murray Robbins. One of the electrodes is a semiconducting material. The other may be carbon or any of a number of common metals.

When light falls on the semiconductor electrode, current flows between the two electrodes—much like in a common wet-cell battery. In this case, the p-n junction is formed at the interface between the semiconductor and the liquid.

The cells cost less to make than their solid-state counterparts because no critical processing is required to form the junction. The cells are chemically stable.

In one form of the Bell cell, low-cost polycrystalline cadmium selenide is the semiconductor electrode. This version has an efficiency of 5.1%. In another version the more expensive single-crystal form of cadmium selenide converts 7.5% of light into electricity. The polycrystalline electrode is fabricated with a technique based on pressure

sintering, which is widely used in ceramics. It produces extremely dense cells with high efficiencies and can be adapted to mass production.

## Nuclear pumping may put gas lasers in space

A nuclear-pumped gas laser whose output is 100 times more powerful than that previously attained with electrically pumped gas lasers may turn out to be the means of sending high beams of energy between space stations and from space to earth. In demonstrating nuclear pumping, researchers at the National Aeronautics and Space Administration's Langley Research Center have produced 10 W of power in a volume of 1 cm<sup>3</sup>.

Nuclear-pumped lasers have several advantages over conventional high-power types. For one thing, they eliminate large, costly equipment required by electrically pumped devices, according to Dr. Frank Hohl, head of the Space Technology Branch at the Hampton, VA, Research Center. The nuclear pump is a volume source of energy, Hohl explains. Nuclear energy from fission fragments that bombard a gas in a laser tube is converted directly into laser light.

The laser tubes used in the first Langley experiments were coated with uranium oxide and placed in a source of neutron flux to induce fission in the wall. But helium-isotopes turned out to be a more efficient volume source. Neutrons bombarding the helium-3 ejected an energetic proton and a triton, which produce lasing in noble and other gases—including argon, which lased at a 1.79- $\mu$ m wavelength, and xenon at 2 and 2.7- $\mu$ m wavelengths. Chlorine, krypton and neon also radiated laser energy. So far, the argon has produced the highest power output.

## 8048 is second-sourced

The leading single-chip LSI  $\mu$ C, Intel's 8048, and two related chips, the 8035 and 8243, will be produced by Signetics. As official second-source suppliers for the pioneer 8048, the Sunnyvale, CA, company will use Intel masks to produce devices interchangeable with Intel devices. They will be available in early 1978.



# Our New Dual-Polarity Voltage Regulator replaces two singles for less than a buck.

**Replacing 78M and 79M regulators, this new IC gives you positive and negative regulation at 32% lower cost.**

How many times have you reached for two single-polarity regulators, and wished that the functions of both were handled by a single, low-cost IC?

Wish no more. Signetics dual-polarity voltage regulators are here. And each new model is designed to replace both 78M and 79M devices at a 32% savings.

They cost only 99¢ each in hundred quantity. But low price isn't the only reason to choose our dual-polarity regulators for your next design. They also reduce capacitor costs and increase design flexibility.

**Compare Capacitor Costs.** Almost always, a voltage regulator requires input/output capacitors because it is remotely located from the power supply filter. With the 78M/79M approach, two fixed-composition capacitors (0.1µf and 0.33µf) and two electrolytics (1.0µf and 2.0µf) must be used. But because of a unique design, our dual-polarity ICs use only low-cost, fixed-composition capacitors (0.1µf). Even when components are purchased in large quantity, the dual-polarity approach can save more than 40¢ per regulator in capacitor costs alone, when compared to the 78M/79M requirements.

**Enhance Design Flexibility.** Check the chart below to select from the five fixed-voltage models now available. Continuously adjustable, each model can be balanced/unbalanced simply by using shunt resistors. This feature enhances design flexibility during development or small production runs. Internally current-limited, our dual-polarity regulators are also fully protected against thermal overload. And they come in a choice of packages: either a commercial-grade plastic DIP—or a TO-99 specified over the full military temperature range.

Now's the time to start designing in the Signetics dual-polarity regulators for future cost savings and reduced parts count. And if you're designing a single-polarity power supply, don't forget that we also have a complete line of 3- and 4-terminal, single-polarity regulators. To get complete technical information and a quick response to your specific needs, complete and mail the coupon below.

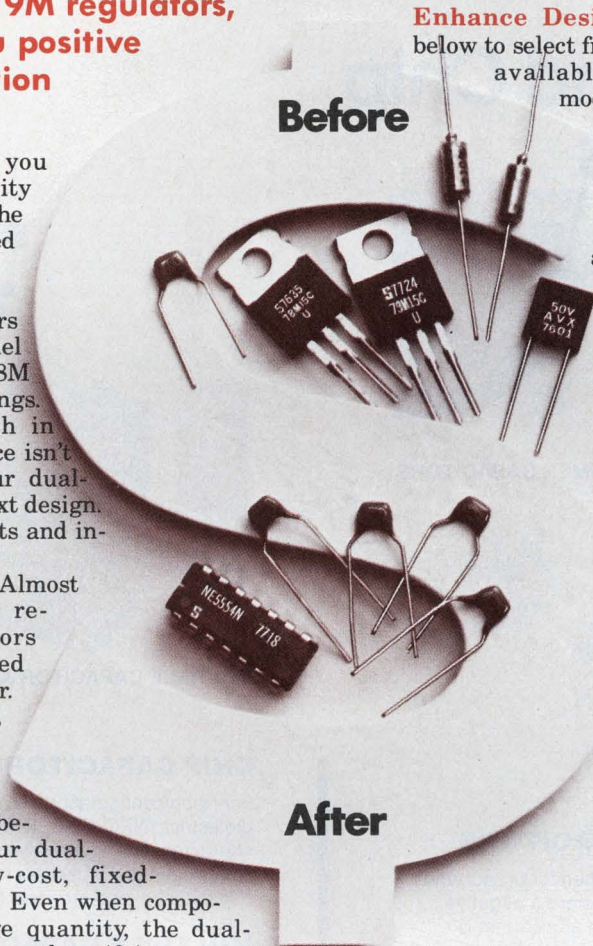

Model	Voltages*
SE/NE5551	±5.0
SE/NE5552	±6.0
SE/NE5553	±12.0
SE/NE5554	±15.0
SE/NE5555	+5/-12

**I<sub>out</sub>:** 300 mA with heat sinking.  
**Regulation:** 1% Line; 0.5% Load.  
**Input Voltage:** Up to ±32V.  
**SE:** TO-99, **NE:** Plastic DIP

\*Continuously adjustable with shunt resistors.

## Signetics

a subsidiary of U.S. Philips Corporation

Signetics Corporation  
 811 East Arques Avenue  
 Sunnyvale, California 94086  
 Telephone 408/739-7700

To: Signetics Information Services, 811 E. Arques Ave.  
 P.O. Box 9052, MS 27, Sunnyvale, CA 94086

Please send data sheet and application note for:

- Dual-Polarity Regulators  
 Single-Polarity Regulators

Name \_\_\_\_\_ Title \_\_\_\_\_

Company \_\_\_\_\_ Division \_\_\_\_\_

Address \_\_\_\_\_ MS \_\_\_\_\_

City \_\_\_\_\_ State \_\_\_\_\_ Zip \_\_\_\_\_

- My need is immediate. Please have your local sales representative provide me with a free sample.

Phone ( ) \_\_\_\_\_ ED91





## Variable and Chip Capacitors

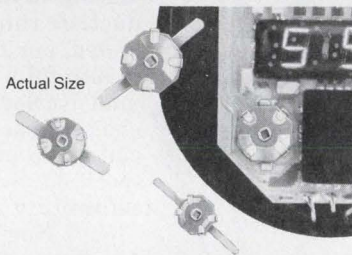

Actual Size  
**CERAMIC TRIMMER CAPACITORS**

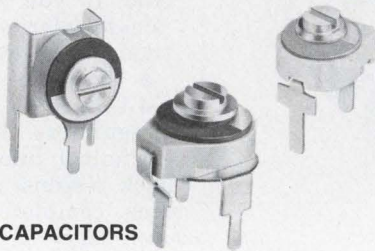

**THIN-TRIM CAPACITORS**

### CERAMIC TRIMMER CAPACITORS

Ceramic trimmer capacitors are designed for broadband applications from audio to 200 MHz, where a negative temperature characteristic and ease of adjustment is important. Typical applications include crystal filters, crystal oscillators, CATV amplifiers, and communications and test equipment. Models are available for top tuning (illustrated), side tuning (illustrated) and bottom tuning.

### THIN-TRIM CAPACITORS

Thin-Trim capacitors are a new development in tiny variable capacitors for demanding applications from quartz crystal watches to phased array MIC's. They provide the hybrid and microwave design engineer a reliable means of adjusting capacitance rather than abrasive trimming of fixed capacitors.

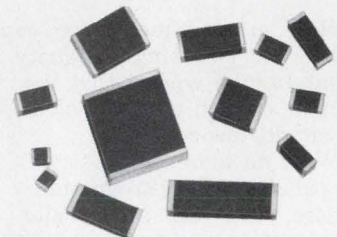

**CHIP CAPACITORS**

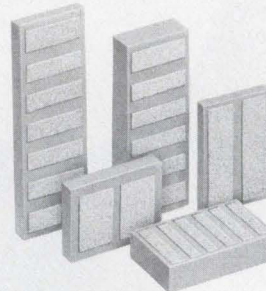

**MULTIPLE CAPACITOR ARRAYS**

### CHIP CAPACITORS

Fourteen configurations are available in four basic dielectrics; NPO/COG, BX/X7R, Z5U and Y5V characteristics, to meet MIL-C-55681A and EIA 198B specifications. Capacitors feature high volume efficiency of capacitance, and are ideal for hybrid circuit applications.

### MULTIPLE CAPACITOR ARRAYS

Capacitor savings are made possible with Johanson Dielectrics' Multiple Capacitor Arrays custom-designed, single-plate, multiple capacitance elements. Rugged, precise, with high mechanical and dielectric strength, these devices are compact capacitance arrays ideally suited for multiple circuit coupling, filtering, by-pass and high-voltage meter multiplier circuits.

Units serve as practical replacements for arrays of individually bonded chips in hybrid circuits. Built in a variety of dielectric characteristics, they are available to meet specific requirements.

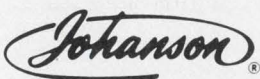

**JOHANSON MANUFACTURING CORPORATION**  
Boonton, New Jersey 07005  
Telephone [201] 334-2676 TWX 710-987-8367

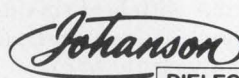

**DIELECTRICS, INC.**

**JOHANSON DIELECTRICS, INC.**  
P.O. Box 6456, Burbank, Calif. 91510  
Telephone [213] 848-4465 TWX 910-498-2735

Engineering opportunities available





Littelfuse

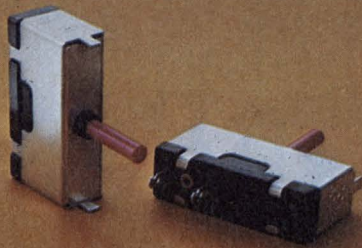

Littelfuse



Littelfuse



Littelfuse

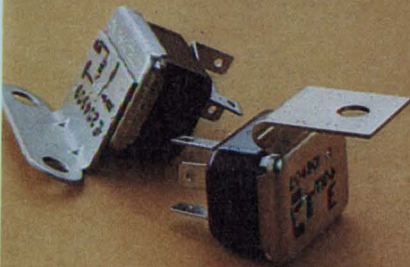

Littelfuse

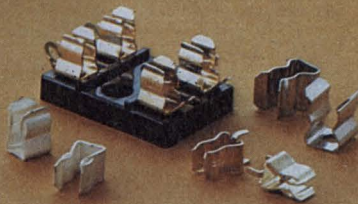

Littelfuse



Littelfuse

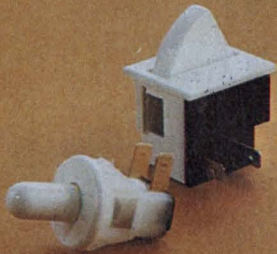

Littelfuse



Littelfuse



Littelfuse



Littelfuse



Littelfuse



Littelfuse

# We're a whole lot more than fuses.

Everybody knows Littelfuse makes fuses...and a complete line of related devices like fuseholders, fuse clips, fuse blocks, and circuit breakers.

But that's only one side of our story. We're switches, relays, and indicator lights, too.

In fact, our Littelite line includes the widest selection of cartridge lamps and lampholders, sub-miniature and miniature lamp-holders, and Snap-mount Plastic Lites you'll find anywhere. And they're available off-the-shelf from a nationwide network of Littelite distributors.

Switches and Relays? We make all shapes and sizes, designed to fit a variety of applications—from appliances to computers.

To find out what our products can do for yours, just give us a call or send for our Catalog No. GL-77. We can show you a whole lot more than fuses.

1927-1977 **50** YEARS

**LITTELFUSE**  
SUBSIDIARY OF  
**Tracor**

800 East Northwest Highway  
Des Plaines, Illinois 60016  
312/824-1188

CIRCLE NUMBER 17



# The truth about resistors:





# THERE IS A DIFFERENCE.

If you use wirewound resistors, you probably specify either silicone or vitreous enamel coatings. Before you buy either coating, make sure you talk to someone who knows both. Because some companies that offer only one type of coating would have you believe that silicone and vitreous enamel work equally well in all applications and are therefore interchangeable.

Don't believe it.

The truth is this: many significant differences—in aging characteristics, resistance to heat, puncture, overloads and mechanical shock—not only can make a critical difference in your product's performance, but in your company's reputation, as well.

Let's look at just one coating characteristic that can make a big difference. Silicone coatings tend to out-gas, giving off silicone vapors. When a silicone-coated resistor is subjected to heavy overloads, the coating can fail catastrophically in a cloud of smoke. But even in

normal operation, silicone coatings can out-gas, contaminating sensitive equipment.

Many telephone equipment manufacturers have found, for example, that silicone deposits can foul relay contact surfaces, causing expensive maintenance and trouble-shooting headaches. So these manufacturers demand vitreous enamel-coated resistors for critical switching equipment.

Now, we're not saying that vitreous enamel is always the answer. Some applications call for vitreous. Some call for silicone. That's why Ohmite offers both. We can show you where one resistor works better and why; explain the options, costs and trade-offs involved. In fact, we can tailor a complete package to your overall resistive product requirements.

Before choosing one coated resistor over another, talk to the people who know resistors best: Ohmite\*.

Ohmite Manufacturing Company, 3601 Howard Street, Skokie, IL 60076; 312-675-2600.

## MAKE UP YOUR OWN MIND

Get a copy of our free brochure, "The truth about resistors:"

It contains a wealth of performance characteristics and application experience covering silicone and vitreous enamel-coated resistors. Circle the reader service number for your copy today.

CIRCLE NUMBER 22

# OHMITE®

makes the difference

*\*After all, who are you going to believe? A company that offers only silicone? Or vitreous enamel? Or a company that offers both?*



Amphenol® 17-Series  
rear-release  
connectors,  
contacts, and  
crimpers.

Now with  
insulation-support  
crimp-contact  
back end.

**You asked for it.** With our 17-Series, you can crimp any conductor size from 22 to 26 AWG and also crimp the insulation up to a maximum of 0.050" OD.

**The connectors are 50% less costly to assemble.** Snap several of our crimp Poke-Home® contacts in place in the time it normally takes for a single contact inserted with a tool. You can cut labor costs in half.

**The contacts mean big savings for volume users.** With our 15,000-contact capacity reels, you can save a bundle over loose contacts.

**Our high-speed crimpers lower costs even more.** Completely eliminate stripping with our stripper-crimper (up to 1500 terminations per hour). Our semi-automatic crimping machines handle up to 2000 terminations per hour. And our new hand crimp tool makes accurate, identical crimps—time after time.

**Get them all — connectors, reeled contacts, crimpers. And get them now.** For more details, call: Bob Ashley, (312) 986-3673 or write: Amphenol North America Division, Bunker Ramo Corporation, Dept. C97A, 900 Commerce Drive, Oak Brook, Illinois 60521.

The right idea  
at the  
right time.

**AMPHENOL**

**BUNKER  
RAMO**®

CIRCLE NUMBER 23

Hand crimpers  
and semi-automatic  
crimping machine.

Visit Us At  
WESCON/77  
Booths 211-214.





# Washington report

---

## FAA eyes Navstar for commercial aircraft use

The Defense Department's Navstar global positioning satellite system is being considered as the logical candidate to succeed the present VCR-DME system for local navigation and nonprecision approaches by business and commercial aircraft.

The present VOR-DME network, which consists of vhf omnidirectional ranging and distance measuring equipment, would be maintained into the mid-1990s, according to S. P. Poritsky, director of the Federal Aviation Administration's Office of Systems Engineering Management, at the annual meeting of the Institute of Navigation in Costa Mesa, CA. The FAA, which is expanding the number of DME channels through 50-kHz spacing, plans to increase the number of area navigation routes. But a satellite-based system like Navstar may be needed to handle future traffic.

However, five qualifiers would have to be satisfied before the FAA accepts the Navstar GPS, according to Poritsky: "If the Defense Department proceeds with GPS, *if* the system is available for civil use, *if* simple avionics and associated equipment come into being, *if* the computer processing needed for GPS is refined onto a simple chip, and *if* the navigation signal is reasonably strong and accurate down to the ground level. "If all these *if*'s become *yes*'s, transition from VOR-DME to a satellite system may be proper in the 1990s," he added.

Although the Air Force is developing Navstar for tactical bombing missions, both the Air Force and Navy still favor inertial navigation for their intercontinental missiles. This preference could make capability in the satellite system available to commercial air traffic.

## Appeals court overturns FCC ruling on Execunet

Independent suppliers of telephone service won a victory when the U.S. Circuit Court of Appeals in Washington overturned an earlier Federal Communications Commission ruling against MCI Communications Inc.'s Execunet service.

The three-judge panel ruled unanimously that the FCC improperly ordered MCI to halt its low-cost message-toll services for businesses which account for about 40% of MCI's revenues. The halt had been sought by AT&T, but the Court of Appeals ruled against the company on grounds that it had no legal monopoly on long-distance telephone service. Message-toll services also accounts for about 40% of Bell System revenues, according to AT&T's reports to the FCC.

The court also admonished the FCC to make sure that any future decisions in this area be based strictly on a determination that "the public interest is best served by whatever course of action the Commission adopts, not on an assumption that one or another carrier has been authorized already to engage in one or another type of business."

## LAMPS ASW helicopter program delayed by DOD

An airframe contractor for the Navy's Light Airborne Multi-Purpose System (LAMPS) Mark III anti-submarine warfare helicopter will not be selected now until Sept. 1. But even then, full-scale engineering development will not begin until Dec. 1 at the earliest.



The Navy was ready to award the development contract on July 26. But Defense Secretary Harold Brown and his staff ordered another program review and a freeze on development funds until a Defense System Acquisition Review Council (DSARC) meeting could be held in late November. The two competitors—Boeing's Vertol Div. and United Technologies Corp.'s Sikorsky Aircraft Div.—were required to prepare new best and final offers covering both a three-month start-up phase and the full-scale development phase. IBM Federal Systems Div. has already been selected the prime contractor and system integrator.

The delays are making the contractors nervous because they see it as a signal that the Carter administration will be increasing its scrutiny of all the new aircraft programs. However, the delays will not affect the planned LAMPS Mark II's initial operational capability (IOC) date of 1983, according to the Navy. In addition, the Navy is reported to be budgeting at least \$100-million for fiscal 1979 to launch a major development effort. The steadily increasing Soviet submarine threat requires a new ASW platform for fleet defense, says the Navy.

### British order Hughes missile, seek closer ties

The British Defense Ministry has chosen the Hughes tube-launched, optically tracked, wire-guided (TOW) missile over the competing HOT missile of Euro-missile, a France-German joint venture. In so doing, the ministry has established stronger ties between Hughes and British Aerospace Corp., which should be subcontracted to do much of the work.

Hughes will handle the initial development work, which is aimed at mounting the missile sight on the roof of British Lynx helicopters. But BAC is expected to receive subcontracts on the TOW and other programs, primarily in the area of optics.

All told, Great Britain will be spending about \$85-million for TOW, half of that amount to procure 8000 missiles from Hughes and the other half for ground-support and helicopter equipment, most of that to be spent with British industry. The arrangement also gives Hughes and its avionics subcontractors an entry into other NATO markets. The Netherlands also uses the British Lynx helicopters and is understood to be interested in a Lynx/TOW combination.

### Capital Capsules

The National Security Agency and Defense Intelligence Agency are seeking a total of \$303.2-million to procure equipment during the fiscal year beginning Oct. 1, according to a partial report released by the Senate Appropriations Committee. **Equipment on DIA's shopping list includes photographic-interpretation equipment, computers, encryption/decryption equipment and photographic laboratory equipment.** NSA is looking for cryptologic, signal-processing, HF-signal-intelligence and machine-processing equipment plus some special equipment for collecting and processing data relayed by communications satellites....**The Army plans to procure three more aircraft for its classified Cefly Lancer signal intelligence (SIGINT) program.** The new aircraft, currently designated only RU-( ), would supplement the present RU-21J Cefly Lancer aircraft and carry new airborne sensors to support tactical operations. Cefly Lancer prime contractor is American Electronic Laboratories....**The Navy is cutting the civilian work force at four of its laboratories by 1074** to meet a Defense Dept. requirement to reduce manpower by 5.7% before the current fiscal year ends. The Naval Surface Weapons Center, Naval Weapons Center and Naval Underwater Systems Center will both lose about 300 and the Naval Air Development Center, about 100....**The Air Force Avionics Laboratory is seeking an industry study of carbon dioxide laser sensors to be used by tactical aircraft.** The purpose is to evaluate CO<sub>2</sub> lasers against microwave and millimeter wave systems for target-acquisition and tracking applications.





## microNOVA keeps on trackin'.

Southern Railway has a long track record of being one of the most profitable rail systems in the country. To help stay on that track, they decided to increase the speed and flexibility of their online distributed communications network. So Southern Railway is now changing dumb terminals into intelligent ones throughout its rail system, using microNOVA microcomputers.

Southern Railway found that only the Data General microNOVA microcomputers could help them cut costs and keep track of some 75,000 freight cars moving over 10,500 miles of track, and do it the way Southern Railway wanted to. Controlling rolling inventory like that takes a lot of flexibility. And that's the big advantage Data General microNOVA microcompu-

ters bring to any application. Whether in a chip, on a board, or as a packaged system.

With the speed, flexibility and software of a minicomputer and the economies of microprocessor technology, microNOVA microcomputers let you do things your way. That's why they're setting track records in all kinds of applications.

Mail to: Data General, Westboro, MA 01581

- Send microNOVA technical literature.  
 Send literature and have your sales representative call.

Name \_\_\_\_\_

Title \_\_\_\_\_

Company \_\_\_\_\_

Address \_\_\_\_\_ Tel. \_\_\_\_\_

City \_\_\_\_\_ State \_\_\_\_\_ Zip \_\_\_\_\_

NOVA is a registered trademark of Data General Corporation  
 ©Data General Corporation, 1977

Data General, Westboro, MA 01581, (617) 366-8911. Data General (Canada) Ltd., Ontario. Data General Europe, 15 Rue Le Sueur, Paris 75116, France, 50-006-06. Data General Australia, Melbourne (03) 82-1361. ED91

**Data General**  
 It's smart business.



# 1976:

## Shugart introduces minifloppy,<sup>®</sup> the first miniature floppy.

# 1977:

## Shugart reduces minifloppy prices by 15%.

Experience pays. When Shugart introduced the first miniature floppy, OEM's and end-users gained floppy access speed and reliability at a cost competitive with cassettes. The value was obvious to OEM's. Wang Laboratories. North Star. ICOM (Pertec). Southwest Technical. Intelligent Systems. All are buying quantities of Shugart minifloppy drives and going after new markets. Now, with minifloppy deliveries approaching 10,000 units, Shugart does it again. High volume production expertise allows the impossible—a 15% reduction in price.

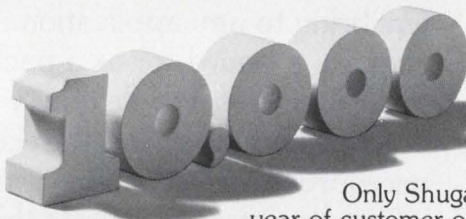

What's coming next from Number 1? Now you can reach data in milliseconds with our field-proven spiral cam actuator. Depend on a reliability of 8000 Power-On-Hours MTBF. Gain a two orders of magnitude improvement in error rate compared to cassettes. And record your data safely with the industry accepted high margin 35 track format.

Only Shugart has it all. Drives proven in one year of customer operation. ministreaker™ controllers that control up to three minifloppy drives. Floppy expertise, comprehensive systems design support, technical service, documentation and applications help. All this, and the best price in the business.



So come to the people who started the minifloppy revolution. Shugart.

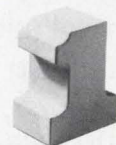
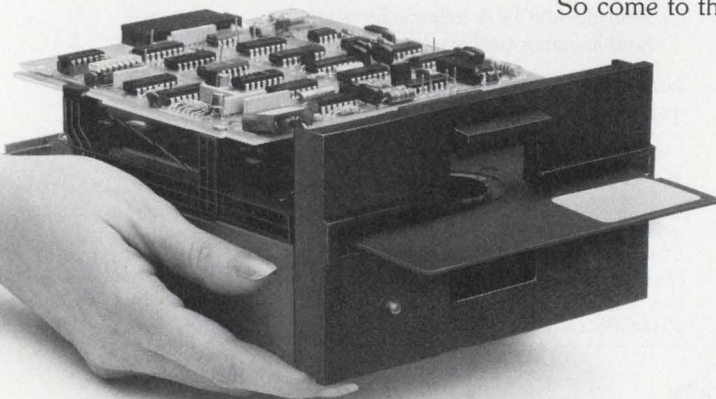

**The Leader  
In Low Cost  
DiskStorage**

 **Shugart Associates**

415 Oakmead Parkway, Sunnyvale, California 94086  
Telephone: (408) 733-0100  
West Coast Sales/Service  
Telephone: (408) 252-6860  
East Coast Sales/Service:  
Telephone (617) 890-0808  
Europe Sales/Service:

3, Place Gustave Eiffel, Silic 311  
94588 Rungis, France Telephone: (1) 686-00-85

™ ministreaker is a Shugart trademark



# CENTRALAB MONOPANEL KEYBOARDS

## The TOUCH Switch System ...

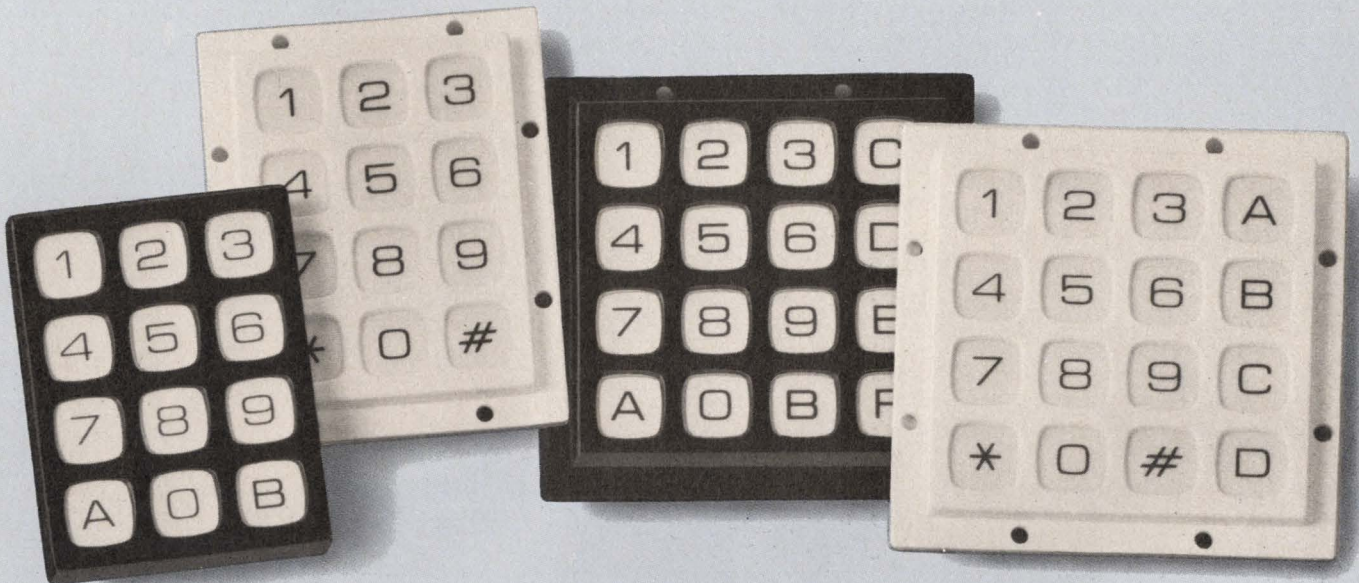

## ...Now available from Centralab Distributors

You'll meet keyboard requirements faster, easier and at surprisingly low cost with MONOPANEL — Centralab's touch-sensitive keyboards. They help solve design problems, simplify and reduce cost in assembly and production and give your product a competitive edge in appearance, design and function. And now, 16 standard keyboards are in stock for immediate delivery from Centralab Distributors.

Don't confuse MONOPANEL with other keyboards. Even though they're priced about the same, MONOPANEL keyboards are superior in construction, reliability, quality and value. First of all, they're backed by Centralab's more than half-century of experience in switch manufacturing. They're 100% tested. They're tough — designed for long, trouble-free life; have no mechanical parts to wear out. And they've been proven in use. The basic Monopanel key switch has undergone more than 70,000,000 switching cycles without failure.

Your Centralab Distributor can furnish 16 standard keyboards. Select from 12 or 16 positions; with alpha-numeric or

telephone format numeric nomenclature; white or black bezel; with or without mounting flange. All units have .025" square terminals that are suitable for solder, wirewrapped or plug-on quick connects. One side common or X-Y switch interconnections are available.

For complete product and price information contact your Centralab Distributor. Or, for the name of your distributor, call Centralab Distributor Products, Milwaukee (414)228-2911.

### Products you need from people who care.

DISTRIBUTOR PRODUCTS



CENTRALAB

Electronics Division

GLOBE-UNION INC.

5757 NORTH GREEN BAY AVENUE  
MILWAUKEE, WISCONSIN 53201

### THIS IS HOW MONOPANEL WORKS

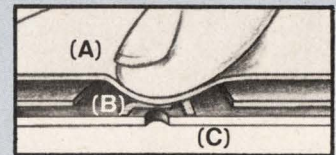

### To Give You Long-Life, Trouble-Free Keyboards.

MONOPANEL is a thin, light, flat, front panel subassembly with micro-motion touch switches already mounted and interconnected. Each MONOPANEL is a multilayer assembly containing (A) a flexible, tough, moisture proof polyester membrane with graphics and flexible conductors screened upon the rear surface; (B) a thin spacer with holes for each switch provides an .007" air-gap; (C) a circuit board with switch circuits on its face, joined by plated through-holes to interconnections on its back.

The basic switch closure is momentary, normally open. Light touch pressure (2 oz. typical) on the smooth, flexible front panel closes the contact. Releasing pressure allows the front panel membrane to return, opening the contact.



A LITTLE IMAGINATION HAS MOLDED MANY DESIGNS

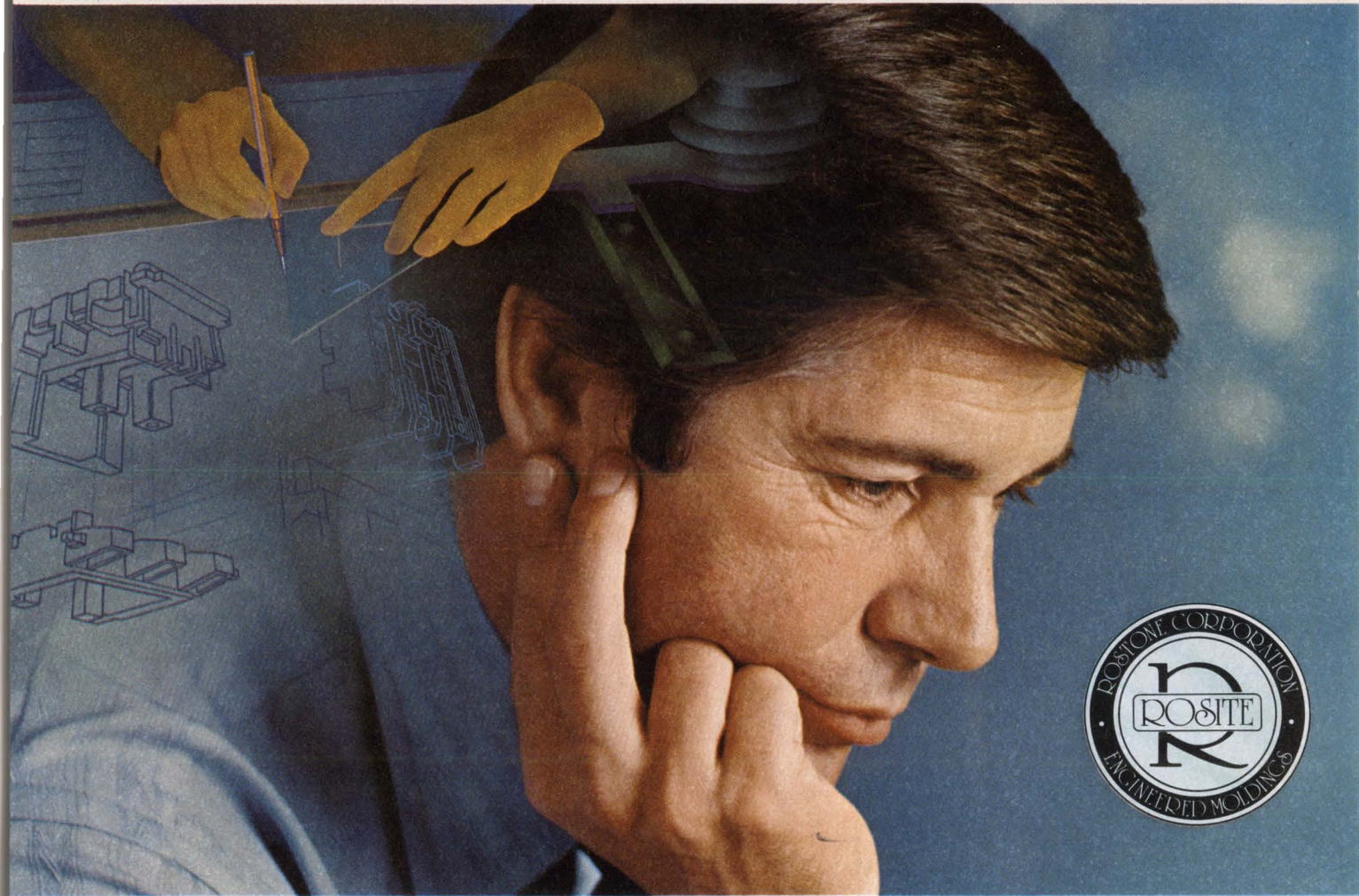

The special properties and characteristics of ROSITE® glass reinforced polyester custom moldings have advanced the application of plastics to many highly engineered products. Continual research, in combination with thousands of customer feasibility studies has resulted in our development of over a hundred thermoset compounds which offer significant benefits to contemporary product designs.

Our hot mold compounds use thermoset polyester resin with mineral fillers and other additives which give our moldings unique and functional properties. The non-tracking property of most ROSITE compounds has a direct relation with the U.L. flammability rating 94 V-O and a gas releasing, arc-quenching ability which adds

to the interruptive capacity of electrical switchgear.

Excellent dimensional stability (creep resistance) combined with other salient features is characteristic of ROSITE moldings. In ROSITE 3550, for example, zero shrinkage with virtually no warpage allows tolerances as close as  $\pm .0005$  in./in. to be achieved. In some special compounds we can produce physical strengths in excess of 100,000 psi, flexural and 40,000 psi, tensile with added benefits of reduced weight and cost.

Plastics in general have better corrosion resistance than metals and ROSITE 3450 replaces stainless steel. Our wear resistant grade compounds approach the qualities of Teflon.

The net effect of using

ROSITE moldings is a superior product design produced at a favorable cost with fewer production complications. A conversation with one of our sales engineers will give you a chance to examine the applicability of ROSITE moldings to your product design. Call us.

Rostone  
Corporation

2450 Sagamore Parkway South  
Lafayette, Indiana 47902  
317/474-2421

**CUSTOM ENGINEERED  
PLASTIC MOLDINGS**



**Dialight**  
**meets your needs**  
**with something**  
**new...**



# Dialight is now your for rockers and toggles.



We've already made quite a name for ourselves in indicator lights, LED readout displays, LED indicators and illuminated switches.

Dialight's success in these areas is built on our ability to see your most important needs . . . and meet them consistently.



# second source to C&K



We see a need for a dependable second source of miniature rockers and toggles, a need we can now meet with these advantages:

Dialight quality. Direct replacement to C&K. Competitive prices. American-made. World-wide distribution.



Now with Dialight you have a choice: of local or national distributors offering off-the-shelf delivery.

Your Dialight distributor is ready right now, with thousands of rockers and toggles for whatever needs you have.

We can prove it right now: just call your local Dialight representative as listed below for immediate

cross reference to C&K products. We'd like to send you a copy of Dialight's new "Meet Your Need" Miniature Rocker and Toggle Switch catalog. Circle the reader card number at the bottom of the page, or contact us directly:

Dialight, a North American Philips Company, 203 Harrison Place, Brooklyn, N. Y. 11237.



**FOR IMMEDIATE CROSS-REFERENCE TO C&K PRODUCTS,  
OR ENGINEERING ASSISTANCE  
CONTACT YOUR LOCAL DIALIGHT REPRESENTATIVE.**

**EASTERN**

**Cartwright & Bean Inc.**  
Memphis, Tenn.  
phone: (901) 276-4442

**Cartwright & Bean Inc.**  
Atlanta, Ga.  
phone: (404) 255-5262

**Cartwright & Bean Inc.**  
Ft. Lauderdale, Florida  
phone: (305) 791-3989

**Cartwright & Bean Inc.**  
Orlando, Florida  
phone: (305) 422-4531

**Cartwright & Bean Inc.**  
Gretna, La.  
phone: (504) 362-4649

**Cartwright & Bean Inc.**  
Raleigh, N.C.  
phone: (919) 781-6560

**Cartwright & Bean Inc.**  
Charlotte, N.C.  
phone: (704) 337-5673

**Cartwright & Bean Inc.**  
Huntsville, Ala.  
phone: (205) 533-3509

**L. D. Lowery, Inc.**  
Broomall, Pa.  
phone: (215) 528-5170

**L. D. Lowery, Inc.**  
Lanham, Md.  
phone: (301) 459-1556

**Precision Sales, Inc.**  
No. Syracuse, N.Y.  
phone: (315) 458-2223

**Mullin Technical Sales Co.,  
Inc.**  
Needham, Mass.  
phone: (617) 444-4780

**Metropolitan NYC**  
Contact Factory

**MID-AMERICA**

**D. Dolin Sales Co.**  
Chicago, Ill.  
phone: (312) 286-6200

**Hilltronics**  
Ferndale, Michigan  
phone: (313) 398-5556

**K W Electronic Sales Inc.**  
Dayton, Ohio  
phone: (513) 890-2150

**K W Electronic Sales Inc.**  
Cleveland, Ohio  
phone: (216) 831-8292

**K W Electronic Sales Inc.**  
Worthington, Ohio  
phone: (614) 888-0483

**K W Electronic Sales Inc.**  
Allison Park, Pa.  
phone: (412) 487-4300

**R. G. Ragon, Inc.**  
St. Paul, Minn.  
phone: (612) 488-0201

**K & M Sales Company**  
Shawnee Mission, Kansas  
phone: (913) 262-1444

**K & M Sales Company**  
St. Louis, Missouri  
phone: (314) 423-2420

**Southern Sales Corp.**  
Indianapolis, Indiana  
phone: (317) 299-2992

**WESTERN**

**Westrep**  
Pico Rivera, Calif.  
phone: (213) 949-2551

**Tesco**  
Dallas, Texas  
phone: (214) 328-5484

**R. G. Bowen Co., Inc.**  
Englewood, Colo.  
phone: (303) 789-1884  
Salt Lake City, Utah  
phone: (801) 363-8801

**Moulthrop Sales Inc.**  
Pleasanton, Calif.  
phone: (415) 846-0550

**Electronic Sources, Inc.**  
Bellevue, Washington  
phone: (206) 453-0800

**Electronic Sources, Inc.**  
Portland, Oregon  
phone: (503) 292-0701

**Stitzer - Dodd Inc.**  
Phoenix, Ariz.  
phone: (602) 944-2237

**EASTERN CANADA**  
**Munro Electronics Comp.  
Ltd.**  
Mississauga, Ont.  
phone: (416) 676-1042

**WESTERN CANADA**  
**Arwin Technical Sales**  
N. Vancouver, B.C.  
phone: (604) 980-4346

**Dialight meets your needs.**

**DIALIGHT**

203 Harrison Place, Brooklyn, N. Y. 11237

(212) 497-7600 TWX #710-584-5487



# Guildline Introduces the only 14 Million Count DVM on the Market Today



Guildline's radical 7-1/2 digit precision digital voltmeter, Model 9577 features standards laboratory accuracy and stability. The 9577 is equally at home on the work bench or in a system application via programmable BCD or IEEE Standard 488.

#### FEATURES:

- Capability — DC volts, AC (rms) volts, ohms, and ratio
- 0.0004% DC accuracy • Resolution — 1  $\mu$ v on 10 volt range
- 20ppm per year stability
- Self-Check via front panel or system mode
- 500 readings per second
- > 1000G $\Omega$  input resistance • Digital Filtering



PRICE \$3995



Guildline Instruments, Inc.  
2 Westchester Plaza., Elmsford, New York 10523 (914) 592-9101



# Designers ... Have It Your Way!

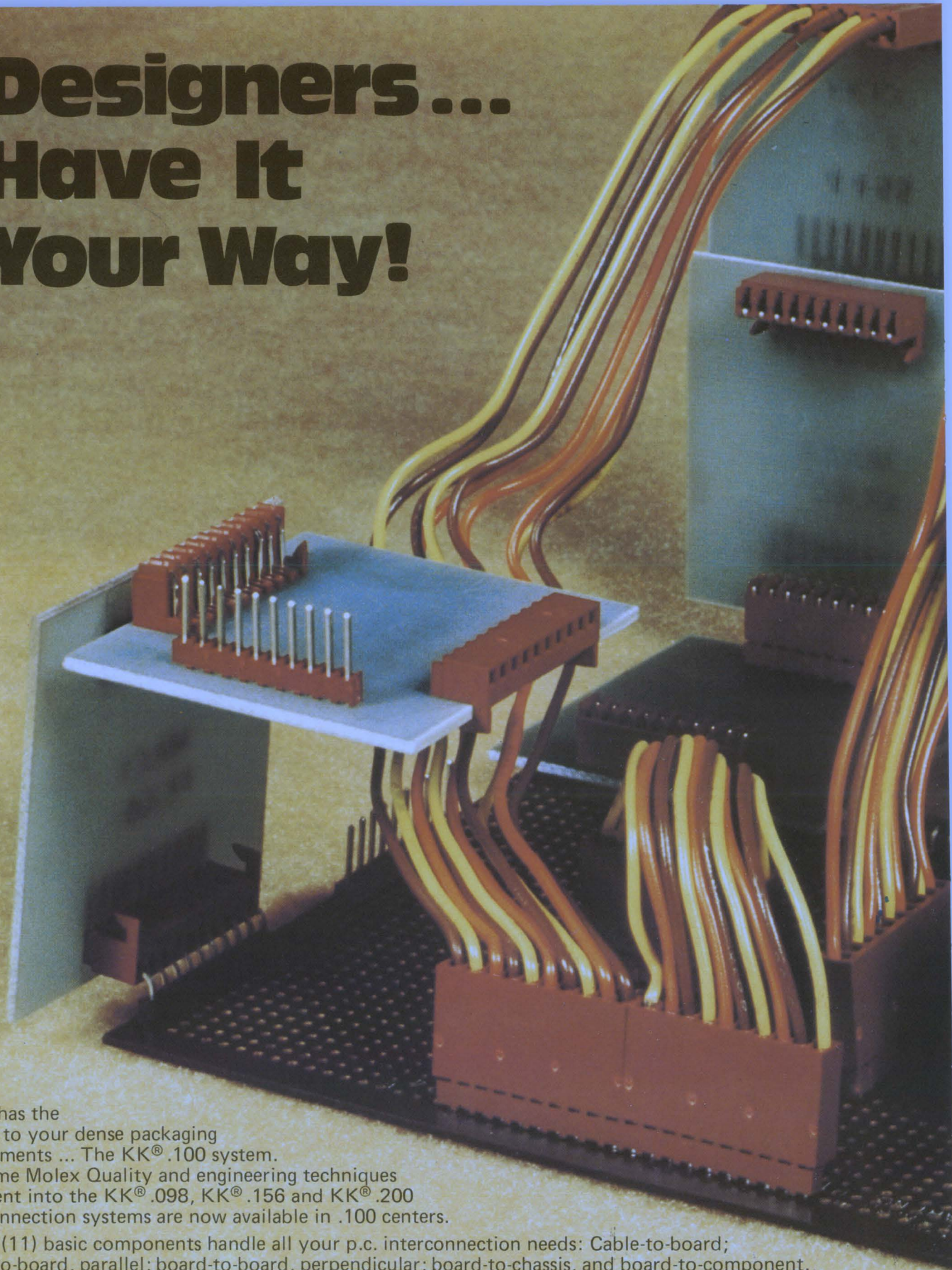

Molex has the answer to your dense packaging requirements ... The KK<sup>®</sup>.100 system. The same Molex Quality and engineering techniques that went into the KK<sup>®</sup>.098, KK<sup>®</sup>.156 and KK<sup>®</sup>.200 interconnection systems are now available in .100 centers.

Eleven (11) basic components handle all your p.c. interconnection needs: Cable-to-board; board-to-board, parallel; board-to-board, perpendicular; board-to-chassis, and board-to-component.

The photo illustrates examples of typical applications, configurations and components. The KK<sup>®</sup>.100 system consists of .025 pins; right angle, straight and polarized wafers; female connector housings, both crimp type and p.c. board mount; polarizing keys; and crimp or solder tail terminals, featuring the Molex patented dual cantilever terminal system. Non-flammable 94V-O material is used in all KK<sup>®</sup>.100 connector housings and wafer bases.

To compliment this system, Molex has developed the most economical and fastest pinsetting equipment in the industry. The patented equipment can offer single or multiple pinsetting capabilities and the unique Molex honeycomb vibratory can set 12,000 pins in 3 minutes! **Now you can really have it your way!!!**



# The New Molex KK<sup>®</sup> 100 Interconnection System

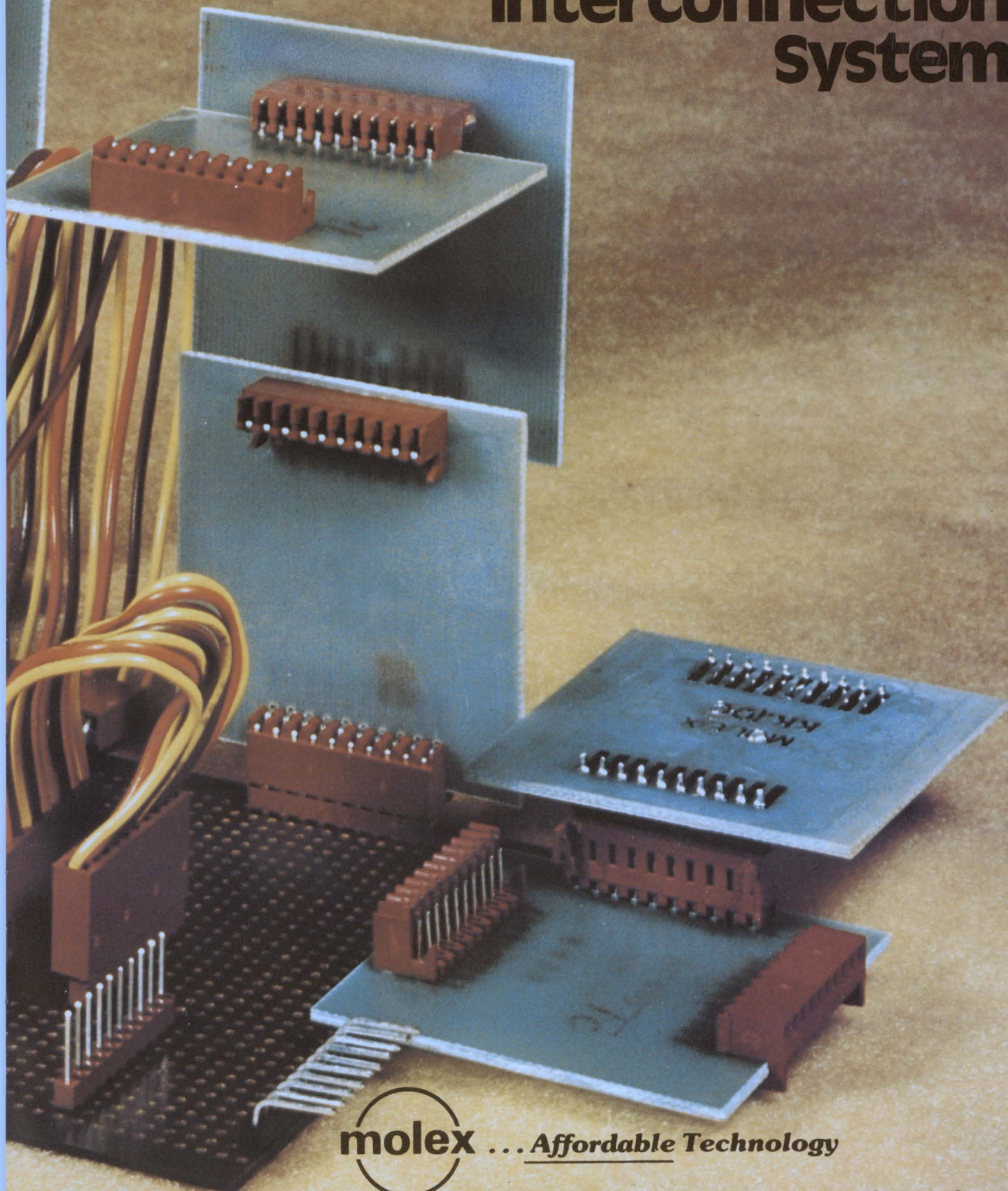

**molex** ... *Affordable Technology*

For complete information on the Molex KK<sup>®</sup>.100, KK<sup>®</sup>.098, KK<sup>®</sup>.156 and KK<sup>®</sup>.200 Interconnection Systems, call or write:

**Molex Incorporated, 2222 Wellington Court, Lisle, Illinois 60532  
(312) 969-4500**

CIRCLE NUMBER 242

Our  
tem which



# FOR RENT...

the two most advanced instruments for on-site structural and vibration analyses, Honeywell's 1858 graphic data acquisition system and their laboratory-quality 5600 magnetic tape recorder.

The 18-channel 1858 is easy-to-set-up and easy-to-use . . . anywhere . . . and it's smaller than a portable TV set. The completely self-contained 1858 packs performance-plus in a tiny (8¾" high and 65-pound) package. It gives you 18 channels (32 with the 1870 amplifier housing), each with dc to 5,000 Hz response. The 1858 also provides a choice of 42 discrete paper speeds, up to 120 inches per second. All you have to do is plug in a power cord, connect signal input cables and start recording wherever—and whatever—you need to record. You can use it in a rack, on a table, on the seat of a car, or on the ground. You don't have to mount any separate cases, nor hook up any interconnect cabling, nor fool around with any powders, inks, chemicals or heaters. Plug it in, and you're in business.

When the quality of your test data is too important to compromise, a 5600 recorder gives lab-quality results on the bench or on the move. Another rugged, take-it-anywhere portable, the 5600 is a perfect partner to the 1858. It gives you big-machine capability in a compact case, and its tricapstan drive tape transport treats your tape so gently you can use ½ mil tape. The 5600 gives you monitor meters for viewing input and output signals in real-time, offers state-of-the-art record and reproduce heads, and has FM flutter compensation and good servo flutter attenuation to minimize unavoidable artifacts. It's an open-ended system allowing easy conversion of tape width, power source and recording formats. It lets you convert from intermediate-band to wideband, from direct to FM recording. The 5600 operates in hostile environments and can withstand the roughest jolts and vibrations. It's available now.



## Rental Electronics, Inc.

Another of the **AMERICAL** companies

More than 11,642  
electronic instruments...  
off-the-shelf, throughout North America.

- Tell me more about the Honeywell 1858 and 5600 now! Call me at \_\_\_\_\_
- Send me a copy of your free illustrated Rental Catalog.
- Send me your Equipment Sales Catalog—I might be interested in buying some of your great "previously owned" equipment on a money-back guarantee.
- I have a pressing need right now for the following: \_\_\_\_\_

Please phone me immediately at \_\_\_\_\_

NAME \_\_\_\_\_  
TITLE \_\_\_\_\_  
COMPANY \_\_\_\_\_  
ADDRESS \_\_\_\_\_  
CITY \_\_\_\_\_  
STATE \_\_\_\_\_ ZIP \_\_\_\_\_  
PHONE NUMBER \_\_\_\_\_  
EXTENSION \_\_\_\_\_

Complete this coupon and return it today to the world's oldest and largest electronic equipment rental firm, REI, 19347 Londelius St., Northridge, California 91324.

GSA #GS-04S-21963 Neg ©1977 Rental Electronics, Inc.

Anaheim, CA (714) 879-0561  
Mountain View, CA (415) 968-8845  
Fort Lauderdale, FL (305) 771-3500  
Des Plaines, IL (312) 827-6670  
Burlington, MA (617) 273-2770  
Gaithersburg, MD (301) 948-0620  
Oakland, NJ (201) 337-3757  
Cleveland, OH (216) 442-8080  
Dallas, TX (214) 661-8082  
Houston, TX (713) 780-7218  
Seattle, WN (206) 641-6444  
Rexdale, Ontario, Canada (416) 675-7513  
Montreal, Quebec, Canada (514) 681-9246  
Northridge, CA (213) 993-RENT (7368)



# SPRAGUE SWITCHING 'LYTICS

Select from this family of capacitors for output filtering in power supplies



### TYPE 672D

- Suitable for parallel stacking
- Plug-in PWB mounting
- Low to medium ripple current capability



### TYPE 673D

- Suitable for parallel stacking
- Plug-in PWB mounting
- Medium ripple current capability



### TYPE 604D

- True 4-terminal isolation
- Low profile PWB mounting
- Medium ripple current capability



### TYPE 622D

- Best ESR in std. construction
- 1st with symmetrical ESR and capacitance tol.
- High ripple current capability



### TYPE 432D

- Lowest available ESR and impedance
- Bus-bar mounting
- Maximum ripple current capability

Construction	Rolled-Section		Rolled-Section		Rolled-Section		Rolled-Section		Stacked-foil	
Terminal Configuration	2 terminals, wire pins		2 terminals, wire pins		4 terminals, wire leads		2 terminals, low or high female threaded		2 terminals, strip-line, female threaded	
Case Size Range (D. x L.)	.400" x .552" to .625" x 1.337"		.750" x 1.125" to 1.000" x 3.625"		.750" x 1.625" to 1.000" x 3.625"		1.375" x 2.125" to 1.375" x 5.625"		1.375" x 2.125" to 3.000" x 5.625"	
Operating Temperature Range	-55°C to +105°C		-55°C to +105°C		-55°C to +105°C		-55°C to +85°C		-40°C to +85°C	
WVDC Range	6.3 to 100		6.3 to 250		5 to 200		5 to 55		6 to 50	
Capacitance (Range (μF))	4.7 to 1,500		15 to 15,000		50 to 16,000		2,800 to 67,000		470 to 100,000	
Capacitance Tolerance	-10, +100%		-10, +100%		thru 50 V: -10, +75% over 50 V: -10, +50%		±20%		-0, +100%	
Max. Inductance	20 nH		20 nH		2 nH		20 nH		2 nH	
Max. ESR (@ 25°C and 120 Hz)	1,500 μF @ 6.3 WVDC	.110 ohm	15,000 μF @ 6.3 WVDC	.014 ohm	16,000 μF @ 5 WVDC	.022 ohm	67,000 μF @ 5 WVDC	.004 ohm	100,000 μF @ 6 WVDC	.0015 ohm
RMS Ripple Current (@ 85°C)		2.61 @ 10 kHz		12.25 @ 10 kHz		7.00 A @ 10 kHz		19.5 A @ 20 kHz		54.6 A @ 1 kHz
Max. Impedance (@ 25°C)		.060Ω @ 100 kHz		.019Ω @ 100 kHz		.017Ω @ 10 kHz		.010Ω @ 20-60 kHz		.001 Ω @ 10 kHz
Engineering Bulletin	3452A		3452A		3458A		3459		3443A	
	Check 281 on Reader Service Card		Check 282 on Reader Service Card		Check 283 on Reader Service Card		Check 284 on Reader Service Card		Check 285 on Reader Service Card	

For complete technical data, write for Engineering Bulletin(s) (see table for bulletin numbers) on the capacitor(s) in which you are interested to: Technical Literature Service, Sprague Electric Company, 347 Marshall St., North Adams, Mass. 01247.

**THE BROAD-LINE PRODUCER OF ELECTRONIC PARTS**





# 24 new Low-Power Schottky ICs available now from the leader, Texas Instruments.

From the innovators of the Low-Power Schottky circuits come 24 new types—new line drivers, transceivers, encoders, shift registers, adders and flip-flops—all with TI performance reliability, speed and economy. And they're available now for a wide range of applications, from TI or your local TI authorized distributor.

## The LS240 Series

Designed to interface with highly capacitive bus-oriented systems, the LS240 Series includes six line drivers and transceivers that can be used with any bus-oriented microprocessor or chip set. Each offers a low-price-per-gate and lower applied costs than conventional 4-bit drivers or discrete components. These octal drivers together with the quad and octal transceivers reduce the package count, increase packaging density, reduce assembly time and the required interconnections. All are designed with hysteresis on the inputs to prevent oscillation and improve noise margins. PNP inputs reduce dc loading on the bus lines. Each guarantees 24 mA sink capability but can deliver far more as indicated in the  $V_{OL}/I_{OL}$  curve below.

### SN54LS/74LS240, LS241, LS244

These octal drivers improve both the performance and density of 3-state memory address drivers, clock drivers and bus-oriented drivers. They feature high fan-out, improved fan-

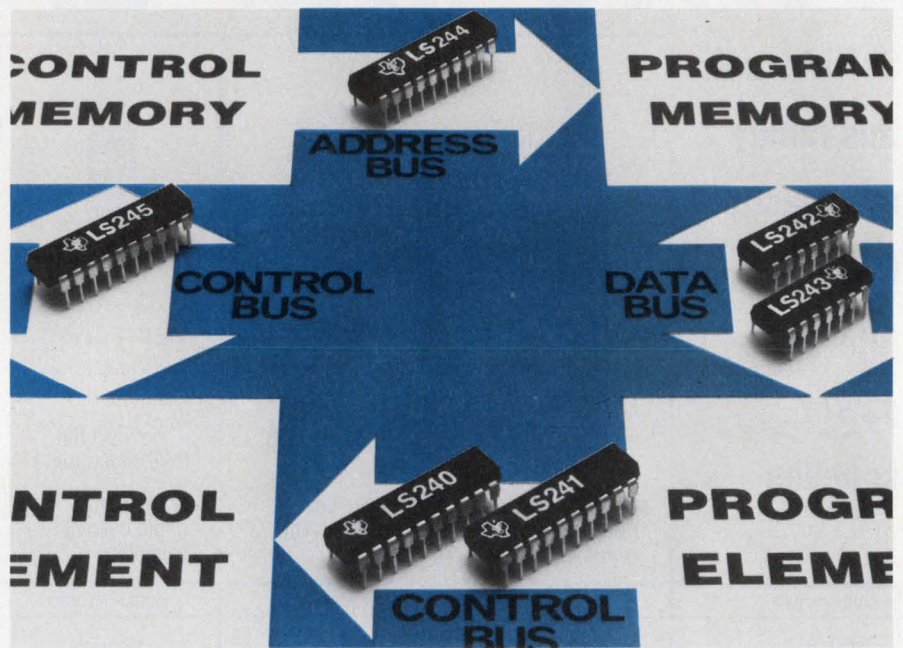

in and 400 mV noise margin. Typical propagation delay times are 9 ns for the LS240, 12 ns for the LS241 and LS244. Power dissipation is typically 130 mW. Each is available in the high density 20 pin package.

### SN54LS/74LS242, LS243

These 4-bit data line transceivers are designed for 2-way asynchronous communications between data bus lines. They require no external components, feature Schmitt-trigger inputs and 24 mA sink capability. They're available in the 14 pin DIP package.

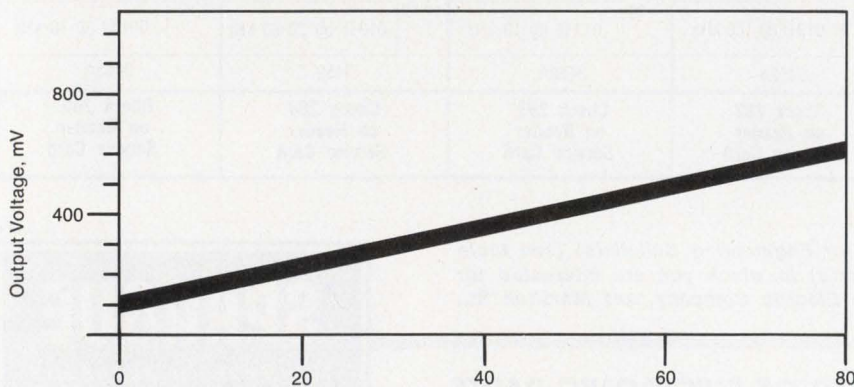

LS240 Series Output Low Sink Capability Over Temperature

### SN54LS/74LS245

The LS245 is an octal bidirectional bus transceiver that can effectively replace four 4-bit drivers. Available in the high density 20 pin package, it offers 3-state outputs to drive bus lines directly. Port-to-port propagation delay times are typically 12 ns. Typical enable/disable times are 17 ns.

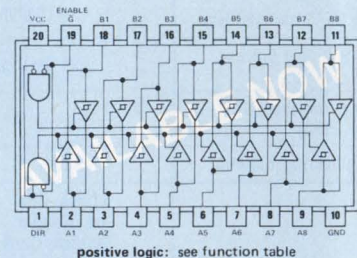

FUNCTION TABLE

ENABLE G	DIRECTION CONTROL DIR	OPERATION
L	L	B data to A bus
L	H	A data to B bus
H	X	Isolation

H = high level, L = low level, X = irrelevant



**SN54LS/74LS147,  
LS148 (TIM9907),  
LS348 (TIM9908)**

These TTL encoders feature priority decoding of the inputs to ensure that only the highest-order data line is encoded. The LS147 encodes 10-line decimal to 4-line BCD while the LS148 and LS348 encode 8 data lines to 3-line BCD. The LS348 offers the features of the LS148 plus 3-state output for direct drive of data bus lines. Cascading circuitry allows octal expansion without external circuitry. Data inputs are buffered to represent one normalized series 54LS/74LS load. Typical data delay for both is 15 ns.

**SN54LS/74LS377, LS378, LS379**

Monolithic, positive edge triggered flip-flops using TTL circuitry to implement D-type flip-flop logic with an enable input. The LS377 and 378 contain 8 and 6 flip-flops, respectively, with single rail outputs. The LS379 has 4 flip-flops with double-rail outputs. Maximum clock frequency is typically 40 MHz and typical power dissipation is 10 mW per flip-flop.

**SN54LS/74 LS668, LS669**

The LS668 and LS669 are synchronous presettable 4-bit up/down counters offering an internal carry look-ahead for cascading in high-speed counting applications. The LS668 is a decade counter while the LS669 is a 4-bit binary counter. Completely new designs featuring 0-ns minimum hold times, all buffered outputs, and reduced input currents. Clock circuits are fully independent.

**SN54LS/74LS275**

The LS275 is a complex Schottky-clamped TTL circuit designed for summation of partial products from binary multipliers such as the LS261. It adds up to 7 bit-slice and 2 carry inputs, resulting in a 4-line sum in 45 ns typically. Outputs are buffered for direct interface with 3-state buses.

**SN54LS/74LS183**

This Low-Power Schottky dual carry-save adder offers a 4-to-1 reduction in power over the H183 with little sacrifice in performance. These dual adders are completely independent and therefore can be used to sum randomly weighted numbers, making the LS183 attractive for summing partial products from multipliers.

**SN54LS/74LS273**

These monolithic positive-edge triggered octal flip-flops feature buffered clock and direct clear inputs, individual data inputs to each flip-flop plus single-rail outputs. They're guaranteed to respond to clock frequencies ranging from 0-30 MHz. Maximum clock frequency is typically 40 MHz. Typical power dissipation is 10 mW per flip-flop with propagation delay times typically 18 ns.

**SN54LS/74LS398, LS399**

These LS devices are monolithic quad 2-input multiplexers with storage that provide essentially the equivalent functional capabilities of 2 separate MSI functions (LS157 and LS175) in a single 16 or 20 pin package. The LS398 features double-rail outputs while the LS399 offers single-rail outputs. Typical power dissipation is 37 mW.

**SN74LS362 (TIM9904)**

The LS362 is a four phase clock generator/driver designed for the TMS9900 and other microprocessors. It consists of a self-contained oscillator that can be crystal or capacitor controlled, high-level 4-phase outputs and complementary TTL 4-phase outputs, corresponding high and low-level output drivers, and a clocked D-type flip-flop with Schmitt-triggered input for reset signal synchronization.

**SN54LS/74LS373, LS374**

These 8-bit functions offer the choice of 8 transparent latches or 8 D-type edge-triggered flip-flops in a single 20 pin package. Each features totem-pole 3-state outputs for driving highly capacitive or relatively low-impedance loads. Schmitt-triggered buffered inputs at the enable/clock lines simplify system design through improved noise rejection, typically 400mV, from input hysteresis. Typical propagation delay time for the LS373 is 14 ns and 16 ns for the LS374.

**SN54LS/74LS396**

An octal storage register organized as two 4-bit bytes of storage. It's ideally suited for n-bit storage files or hex/BCD serial to parallel converters. Clock and strobe lines are fully buffered. Typical propagation delay times are 20 ns with typical power dissipation of 120 mW.

**SN54LS/74LS280**

The LS280 generates or checks either odd or even parity for a 9-bit data line and is cascadable for n-bits. Typical data delay times are 33 ns with power dissipation typically 80 mW.

**FREE  
Low Power Schottky Users Guide  
Application Notes**

Design with maximum confidence with the Low Power Schottky Users Guide and the Application Notes, 24 pages of charts, tables and comparative data to help predict system behavior in environments not defined in the specifications.

Texas Instruments Incorporated  
Inquiry Answering Service  
P. O. Box 5012, M/S 308  
Dallas, Texas 75222.

ED



- ( ) Please send me a free copy of the Low Power Schottky Users Guide and Application Notes.  
( ) Please have a salesman contact me.

Name \_\_\_\_\_ Phone \_\_\_\_\_  
Title \_\_\_\_\_  
Company \_\_\_\_\_  
Address \_\_\_\_\_  
City \_\_\_\_\_ State \_\_\_\_\_ Zip \_\_\_\_\_

**TEXAS INSTRUMENTS**  
INCORPORATED  
CIRCLE NUMBER 30





## Data General. A la carte.

Now, you can buy our DASHER™ terminals, even if you don't own a Data General computer system. Select our fast impact printer and our user-oriented video display. Both are interface-compatible with any standard computer system.

Choose either 60 or 30 cps versions of the DASHER printer, which has a standard typewriter keyboard, u/l case, 132 columns.

DASHER display features a 1920 character screen, u/l case, convenient detached keyboard, programmable function keys, and a monitor that tilts and swivels.

Just as DASHER terminals' features make them easy to use, their attractive appearance makes them

easy to fit into any environment.

And of course they are solidly reliable and easy to maintain, a Data General trademark. For more details call your Data General sales office or nearest independent supplier of Data General terminals. Or send the coupon. Even a bit of Data General in your computer system is better than none.

Send details on  DASHER printers  DASHER displays  
 Have salesman call.

I'm interested in \_\_\_\_\_ / \_\_\_\_\_ terminals.  
 no. type

Name \_\_\_\_\_

Title \_\_\_\_\_

Company \_\_\_\_\_

Address \_\_\_\_\_ Tel. \_\_\_\_\_

City \_\_\_\_\_ State \_\_\_\_\_ Zip \_\_\_\_\_

Mail to: Data General, Westboro, MA 01581

DASHER is a trademark of Data General Corporation

© Data General Corporation, 1977

ED 91

 **Data General**  
 It's smart business

Data General, Westboro, MA 01581, (617) 366-8911. Data General (Canada) Ltd.,  
 Ontario. Data General Europe, 15 Rue Le Sueur, Paris 75116, France. Data General Australia, Melbourne (03) 82-1361.

CIRCLE NUMBER 31

ELECTRONIC DESIGN 18, September 1, 1977



## How fast the years have fled

What an exciting 25 years these have been. How rewarding it has been for us at ELECTRONIC DESIGN to work for the most innovative audience in the world, and to help you do your jobs better—which has been our mission.

How exciting it has been to work for the people who helped make reality out of impossible dreams. You made it possible for people all over the world to talk to each other—and see each other—in an instant. You made it possible for a man to stand on the moon. How astoundingly glorious! You made it possible for man to send his instruments to the far reaches of the solar system, and for him to probe the mysteries of the planets.



Less glorious, but equally dramatic, you made it possible in many ways for men to live better and easier. One single example we all tend to overlook is that a man can carry with him, for less than \$10, a calculator that will perform all his basic arithmetic. And for \$100 or so, you give him calculators that outperform the Univac 1 of a quarter century ago. You take all this for granted.

We know that ELECTRONIC DESIGN has been useful in your achievements for these 25 years. But that's largely because you've been a marvelous audience. Some 20,000 of you subscribed to our first issue in 1952. Today there are more than 93,000 paid and qualified subscribers. To qualify for ELECTRONIC DESIGN, you take the time to fill out an extremely detailed qualification card. We appreciate that.

And how responsive you've been. Since 1952 you've used our reader-service cards to ring up 24-million inquiries. You currently send about 1,500,000 inquiries every year. That's the largest number received by any magazine in the world. You use the cards to keep our editors informed about what you like, dislike or would like. What's more, you tell them about your problems with vendors. Our editors try to rectify these problems and thus help make our industry a better one. They couldn't do that without you. How cooperative you have been in communicating and in helping us communicate better.

And something we're terribly proud of: on independent readership studies, you keep voting for ELECTRONIC DESIGN as the one you read most regularly, the most helpful, and most useful in your work, the magazine you would choose if you could have only one, and the magazine you prefer and believe in.

We are deeply grateful for such faith and responsiveness. You have my word that we will continue to do our very best to continue to earn it.

A handwritten signature in dark ink, reading "James S. Mulholland, Jr." in a cursive style.

JAMES S. MULHOLLAND, Jr.  
President  
Hayden Publishing Company, Inc.



**It's easy to inspect, test and repair  
AMP Latch multi-conductor  
connectors.**

**Even after they're in use.**





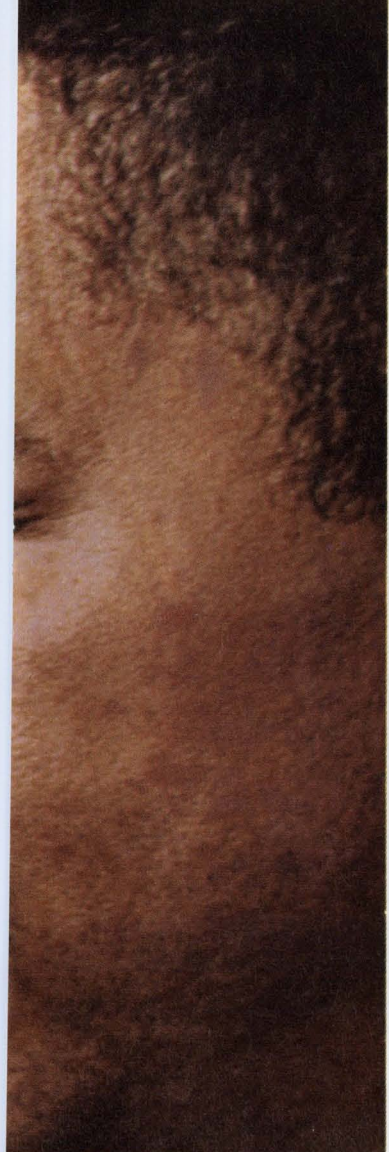

We designed them that way. Because a mass termination connector should help you save time and effort before, during and after assembly.

Their unique folded contact design, with dual camming and latching ears, assures you of four-point electrical contact and mechanical grip for each conductor. And that means superior overall reliability and protection. In addition, these fork-type contacts make it especially easy to visually inspect each termination before the cover is applied.

And even after the cover is on, each contact can still be visually checked for proper locking and latching. Because every AMP Latch cover has a built-in inspection port over each termination. This also permits electrical testing without cover removal, saving additional production time. And if repair ever is necessary, we've made that easier, too, by designing special hand and pen tools.

There are more reasons why you should choose AMP Latch connectors such as quick, easy terminating with the AMP shuttle tool, and the broad variety of pin headers and connectors. You also get AMP backup . . . expert design and production help that's yours for the asking from AMP connector engineers.

Why not contact Customer Service, at (717) 564-0100 for complete details on the AMP Latch connector line? Or write us direct. AMP Incorporated, Harrisburg, PA 17105.

AMP has a better way.

SEE US AT  
WESCON, SAN FRANCISCO

**AMP**  
INCORPORATED  
CIRCLE NUMBER 33

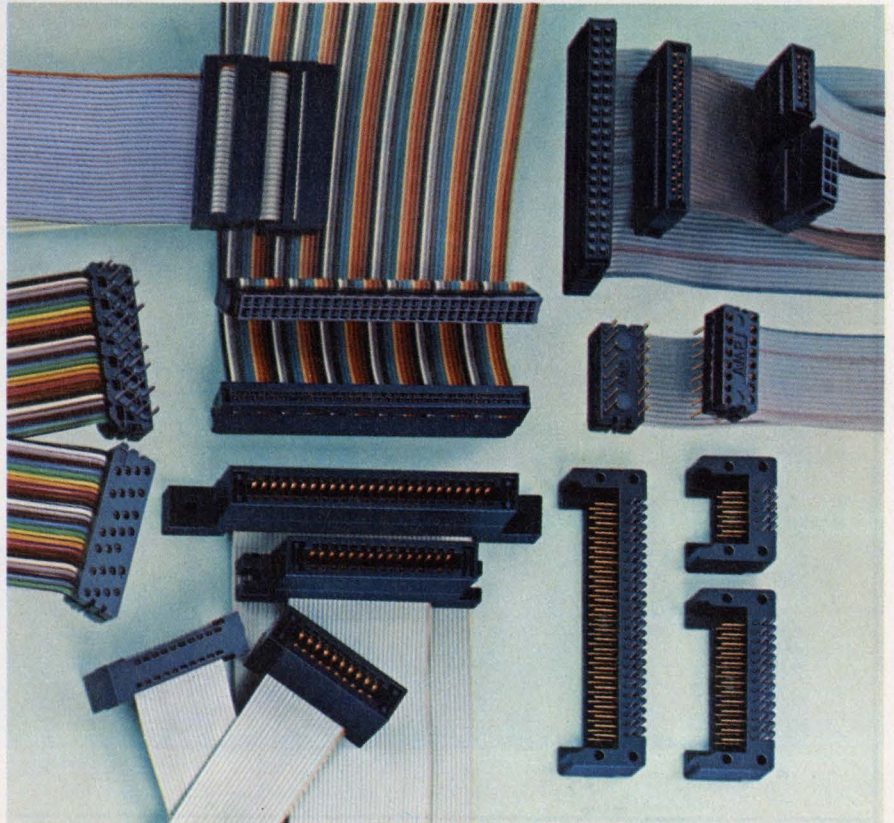
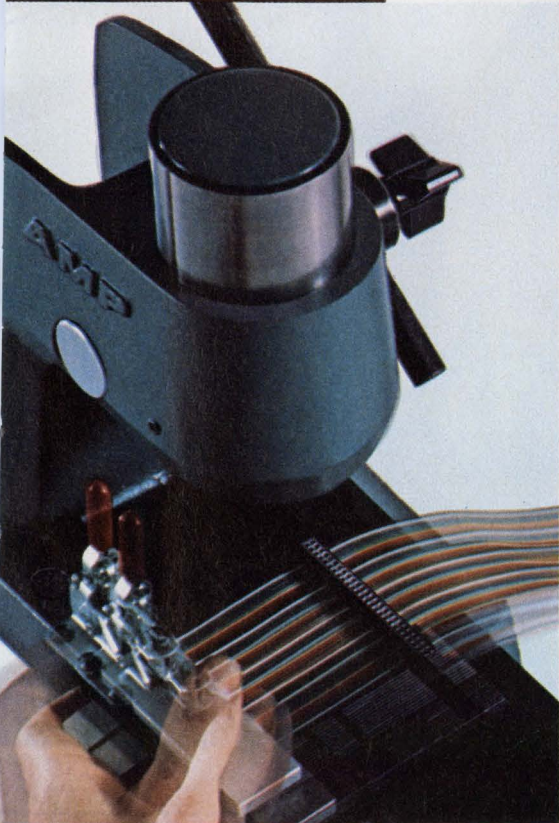

AMP is a trademark of AMP Incorporated.



# COMMUNICATIONS

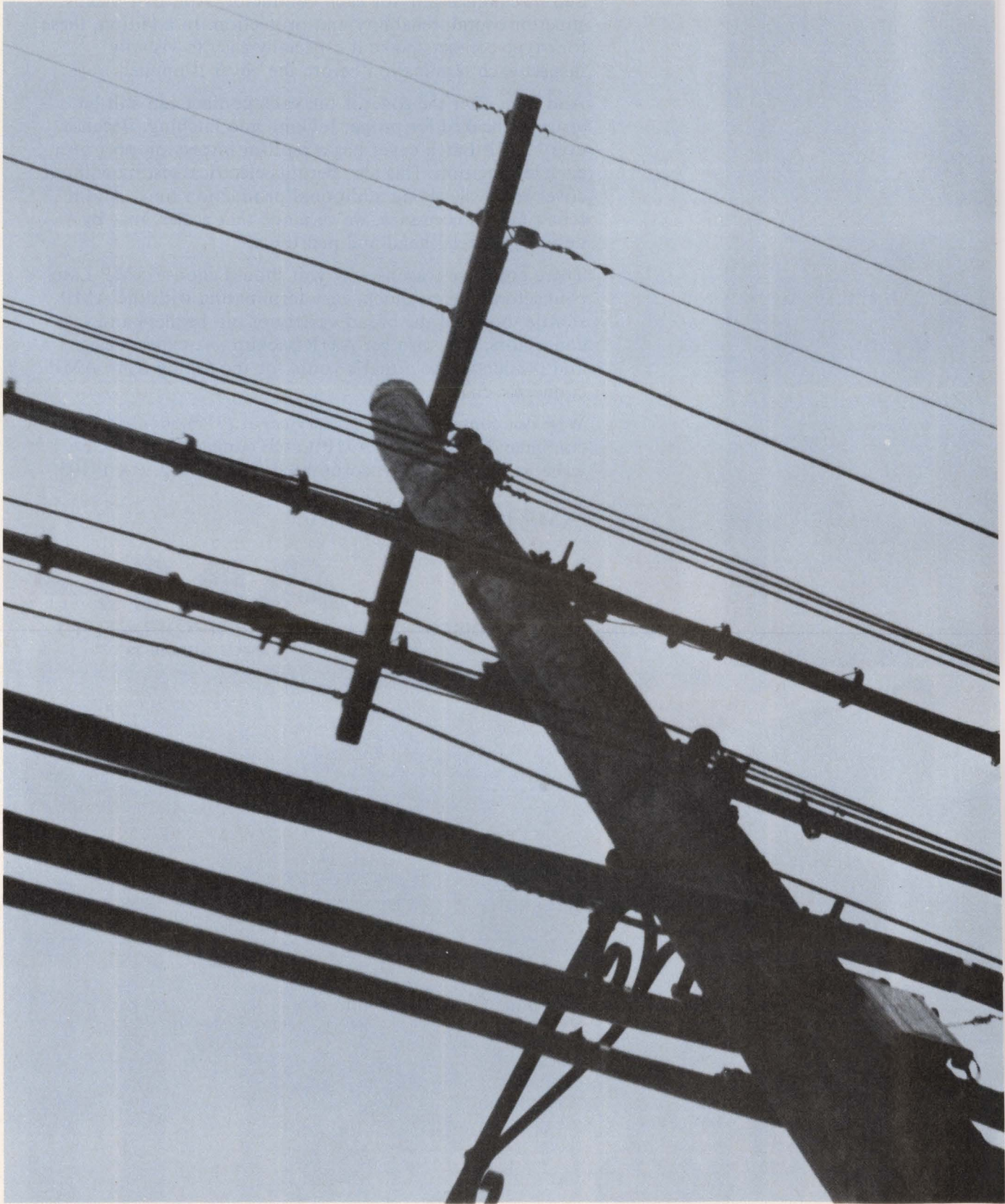



Without communications, we die. Well, maybe not every single man, woman and child. And maybe not immediately. But rather quickly a baby must communicate his need for food. And rather quickly an adult must communicate his need for groceries.

And there begins an enormously complex chain which, at every link, requires communications. Fortunately, probably no other human endeavor has evolved so magnificently over the centuries.

In his luncheon address at Electro, the world-renowned author of more than 180 books of science fact and science fiction, Isaac Asimov, pointed to four landmarks in man's communications: when man learned to speak; when he learned to write; when he learned to print with movable type; and when he began to communicate using electronic media.

The last is most exciting, for we've just begun. A glance at the articles in this issue, particularly those devoted to "early" communications, suggests that we've been at this a long time—more than a hundred years. But in the life of mankind, a hundred years is nothing. Yes, we've learned to talk to each other around the world and, if we can find respondents, across the universe. But we've just begun to take advantage of that capability.

Asimov speculates that someday we'll have enough communications channels for everybody to have one—just as everyone, or almost everyone, now has an individual telephone number. That could bring the world's people a lot closer. Then, perhaps, we could develop a world language.

Once we really develop the knack of communicating, that should lead to energy conservation. We now send humans thousands of miles away to deliver or receive ideas at conferences. Or we send humans far away to carry documents. Why not use closed-circuit-TV conferences to conserve the energy needed for the transportation? That's just one possible application of tomorrow's improved electronic communications.

Those communications won't be successful unless they can reach us as simply as does print. And they must. For we've probably gone as far as we can go with the printed word—which buries us. An engineer with one of our leading electronics companies wryly commented recently that, if future generations of archeologists should unearth his facility, a summary of their reports would probably read: "They made paper." That's not good.

Paper should be our servant, not our master. Communications, whatever the form, should serve man. It is up to electronics engineers to make that happen. They will.

For these engineers and their ancestors have brought us here. They've brought us communications tools that our grandfathers could not conceive in their wildest dreams.

So it's far more than fitting that ELECTRONIC DESIGN, a communications vehicle, should take the occasion of its 25th anniversary to pay tribute to the communications-equipment designers who fulfilled more than yesterday's dreams and who will give us more than we can dream today.

---

<b>The Telephone</b> —A history of the device, beginning with Bell's first crude instrument to today's complex switching systems.....	42
<b>Radio</b> —A report tracing the development of this ubiquitous "box" from Branly's coherer to the latest citizens' band transceiver.....	58
<b>Television</b> —A review of the significant developments beginning with tele-photography more than 100 years ago to 3-D television.....	70
<b>Data Communications</b> —A history delving into the first flag and light systems used in the Middle Ages to current high-speed data networks.....	86
<b>Modern Media</b> —A report that covers two completely different communications media: satellites and optical communications.....	98
<b>An interview with Vladimir Zworykin</b> —The man who was sure TV would work....	112



# The telephone

“If I can make a deaf-mute talk, I can make iron talk,” Alexander Graham Bell vowed in 1874. The stubbornness of this young Scottish speech teacher, untutored in electricity, led him to invent, not one, but two practical telephone designs in 1876.

One was a voice-powered all-magnetic design, and the other used a variable-resistance transmitter that offered significant power gain. To Bell, these were two means to the same end.

Depending on his machinist assistant, Thomas Watson, for practical electrical knowledge, Bell had set down the clear design strategy. He told Watson, “If I can get a mechanism which will make a current of electricity vary in its intensity as the air varies in density when a sound is passing through it, I can telegraph any sound, even the sound of speech.”

True, some properties of simple sound waves had been well known since the 18th century, but complex voice sounds were not even partially understood until the work of Helmholtz (which influenced Bell) was published in 1863.

Amazingly, Bell was “into bio-feedback” 103 years ago. A speech teacher, like his father and grandfather, Bell hoped his deaf students could learn to speak better by comparing their attempts, displayed as visible speech, with a previously recorded pattern. But designing the display was not easy with the instrumentation of the time.

He used both the phonograph and the manometric capsule as “voice oscilloscopes.” The phonograph used a membrane to drive a quill that inscribed sound waves on moving smoked glass, while the manometric device, invented by Koenig, voice-modulated a gas flame that was viewed as a continuous wavering band of light in a revolving mirror.

Dave Barnes  
Western Editor

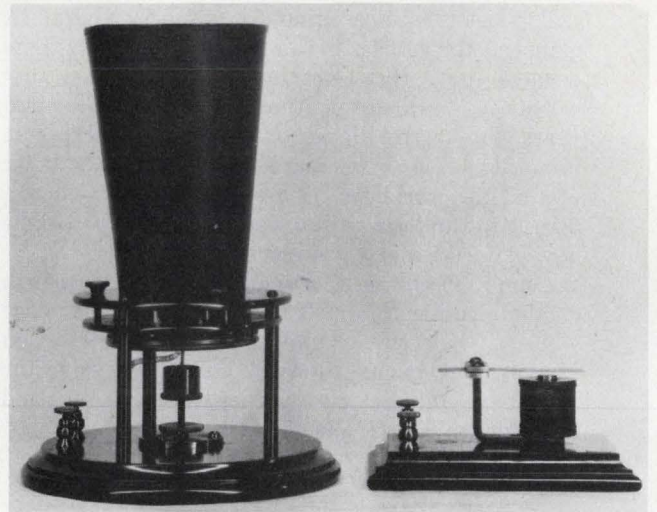

Photo courtesy of Bell Laboratories.

**1876—Liquid transmitter and tuned-reed receiver** were the first ever to carry the human voice. When Bell spilled acid he shouted “Mr. Watson, come here. I want you.”

Unhappy with non-repeatable tracings when seemingly identical sounds were fed to the primitive phonograph, Bell built an improved version that used a human eardrum obtained from the Harvard Medical School.

“It struck me,” Bell wrote in later years, “that the bones of the human ear were very massive, indeed, as compared with the delicate thin membrane that operated them, and the thought occurred that if a membrane so delicate could move bones relatively so massive, why should not a thicker and stouter piece of membrane move my piece of steel. And the telephone was conceived.”

## Messenger boys vs. the telephone

News reporters in England, learning via Cyrus Field’s 10-year-old transatlantic telegraph cable that Bell had invented the telephone in America, asked an official of the British Post Office whether the tele-



phone would be important in England.

"No, sir, they have need of it in the colonies, but in England we have an abundance of messenger boys," the gentleman said.

Bell demonstrated his early telephone at the Centennial Exposition of 1876 in Philadelphia and won a Centennial prize. In his efforts to raise money, Bell

lectured often during the year after the Centennial, delighting audiences with live demonstrations of the telephone over telegraph lines borrowed for each occasion. Transmission distances grew from two to 27 miles during 1877, and audiences heard the words from a single receiver on the stage.

Sometimes Bell had Watson sing from the Boston

**1876**

Bell patents first workable telephone, beating out Elisha Gray's patent by hours.

**1877**

Bell demonstrates telephone in USA and in England.

**1879**

First dual-cord telephone exchanges appear in USA and England.

**1882**

Western Electric becomes official manufacturing arm of Bell organization.

**1884**

First metallic-loop, long-distance telephone line is cut over, between Boston and New York.

**1886**

Edison patents carbon-granule microphone using coal, and vastly improves telephone service.

**1889**

Almon B. Strowger invents switch with line contacts in circular rows inside a cylinder. Motion is controlled by pushbuttons on telephone.

**1892**

The world's first automatic-telephone exchange is placed in service at LaPorte, Indiana, by Strowger's Automatic Electric Co.

**1896**

First dial installations are made in Milwaukee, Wisconsin and Albion, New York.

**1898**

Relays are used for switch control, instead of direct operation of magnets over line wires.

**1900**

Basic trunking principles are established for large exchanges. Bank terminals are molded in plaster of paris.

**1905**

Party lines see first use. First common-battery system appears.

**1908**

Automatic, intermittent ringing is used.

**1910**

Strowger system is introduced in Hawaii and Cuba. Dialing is used over toll lines.

**1915**

First long-distance calls across U.S. travel over wire line with 130,000 telephone poles.

**1919**

Bell System cuts over its first major dial exchange, using Automatic Electric switchgear in Norfolk, VA.

**1920**

Bell System commits itself to the dial systemwide.

**1927**

Bell makes first demonstration of long-distance TV transmission (N.Y. to Washington, DC). (Transmission of color TV is demonstrated in 1929.)

**1927**

Negative-feedback amplifier makes possible transcontinental multi-channel telephone transmission.

**1929**

Coaxial-cable carrier system paves the way for many broadband transmission systems.

**1932**

Automatic Electric develops unattended private automatic branch exchanges.

**1937**

Bell cuts over first common-control crossbar switching system, separating the call setup and talking-path connection functions.

**1939**

First speaker-phone demonstrated, by Automatic Electric.

**1940's**

Information-theory formulation provides a complete mathematical theory of communications—and leads to better design of digital transmission systems.

**1947**

Bell Labs develops transistor, for which John Bardeen, Walter Brattain and William Shockley share the 1956 Nobel Prize in Physics.

**1948**

Bell places first commercial microwave radio-relay system in service between New York and Boston.

**1956**

Bell System opens first cable with underwater amplifiers, connecting North America and Europe.

**1960**

Bell approves Illinois field trial of first electronic switching system central office. (New toll-switching system goes into service in 1976, as 1000th local ESS is installed.)

**1962**

Live transatlantic television and telephone transmission is made via Telstar communications satellite.

**1964**

Picturephone service trial held in Washington, DC, New York City and Chicago.

**1968**

FCC kills phone-attachment rule (by which foreign attachments had to be proved harmless to overall telephone service).

**1974**

Bell Labs evaluates millimeter-waveguide transmission system with capacity of 230,000 simultaneous conversations.

**1976**

An experimental lightwave transmission system, using glass lightguides to carry information as pulses of light from tiny solid-state lasers and light-emitting diodes, is successfully tested in Chicago.



## Did A. Meucci invent the 'Ameche'?

In 1886 The U.S. Supreme Court ruled that Antonio Meucci had the priority as inventor of the telephone. But his patent expired in 1873, three years before Alexander Graham Bell and Elisha Gray both filed their patent "caveats" on February 6, 1876.

Though he developed a primitive phone in 1857, Meucci's many efforts to get financial backing never succeeded, and he ran out of money. Vindicated in court, he died happy in 1889, a candlemaker on Staten Island.

(Despite the similar sound of the names, A. Meucci, born in Florence, Italy, was not related to the Amici's of Ascoli Piceno, Italy, northeast of Rome. But their American grandson, Don Ameche, had the title role in *The Story of Alexander Graham Bell*, a circa-1940 movie that revolved around who really invented the telephone.

(Film critics and newspaper feature writers jokingly identified Ameche with the Bell role. In 1946, when Ameche was type-cast as Hiram Maxim, the inventor of the automatic rifle, the *New York Times* review began, "Don Ameche, who gave us the telephone, turns his inventive genius to. . ." By then, "Ameche" was even a slang word for "telephone".)



Photo courtesy of Stamp Collector magazine.

**1871—Italy still claimed that Antonio Meucci, not Bell, was the inventor of the Telephone.** These 1976 Italian postmark cancellations honor Meucci for his 1871 invention.

In 1976, Bell was honored on telephone-centennial postage stamps of many nations around the world, but Italy, where Meucci was born in 1808, issued no such commemorative.

Back in 1965, when the U.N. asked member nations to issue stamps publicizing the International Telecommunications Union, Italy designed its stamp around a portrait of Meucci. And he'll be on another Italian stamp later in 1977.

end of the line. Even when quality suffered, the pitch came through faithfully, and the audiences, recognizing the tune would think they had understood the words.

Bell's liquid transmitter, included in the Centennial-exhibition demonstration, was the first use of the variable-resistance amplifying principle. A fine wire attached to a diaphragm was partially immersed in a metal cup of "acidulated water." The resistance varied as the voice sounds moved the wire up and down in the acid. Bell used this "spill-prone" version for laboratory demonstrations, but preferred the electromagnetic version for lectures and commercial telephony, improving his electromagnetic transmitter enough to work over distances of about 100 miles.

### Telephones and burglars

In May of 1877, after seeing one of these public demonstrations, E. T. Holmes, proprietor of a burglary and fire-protection service with wire lines to the protected premises, ordered several box-type telephones from Bell and installed them for his burglar-alarm customers. But Holmes' customers could only talk to him, not to each other.

The first "exchange", a New Haven installation with 21 customers who could be interconnected as they desired through a central switchboard, opened January 28, 1878. (See photo.)

The Bell System tempts customers in 1977 with a menu of "extras," from modest coiled cords to opulent

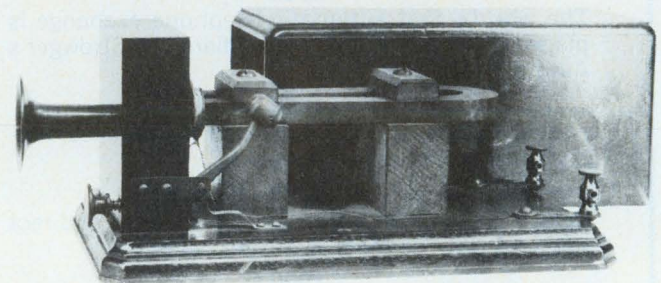

**1877—Long before telephone ringers appeared,** this box-type telephone featured a knob-operated hammer (nicknamed "Watson's thumper") to hit the phone diaphragm. The called party might hear a tinny click.

picture-phone installations. But with the first commercial telephones of 1878, the soundpowered, hand-held kind, the most tempting "extra" was another telephone. A thrifty subscriber got by with one telephone, shuffling it from mouth to ear to mouth as he talked and listened. But the more prosperous subscribers paid for two telephones, and held less chaotic conversations.

Since Bell was trying to improve old telegraph technology when he discovered the telephone, it was natural to offer his invention to the leading telegraph company.

"To Western Union, Bell's telephone at first was a joke," says Joseph C. Goulden in his 1968 book, *Monopoly*.

"A classic example of conventional management



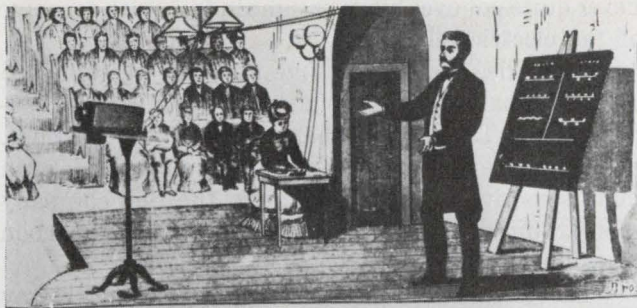

Fig. 218.  
Salem



Fig. 219.  
Boston

Photo courtesy of Bell Laboratories.

**1877—Bell's first public lecture** in Salem, MA, (above) features audible comments from Watson in Boston (below). This demonstration used permanent magnet telephones with metallic diaphragms, and no battery in the 18-mile line.

reaction to any major innovation," roars Marshall McLuhan. He cites the following extract from the minutes of an 1877 Western Union meeting that rejected Bell's offer to sell the telephone idea for \$100,000:

- "1. The telephone is so named by its inventor, A. G. Bell. He believes that one day they will be installed in every residence and place of business.
- "2. Bell's profession is that of a voice teacher. Yet he claims to have discovered an instrument of great practical value in communication which has been overlooked by thousands of workers who have spent years in the field.
- "3. Bell's proposal to place his instrument in almost every home and business place. . . is fantastic. . . The central exchange alone would represent a huge outlay in real estate and buildings, to say nothing of the electrical equipment.
- "4. In conclusion, the committee feels that it must advise against any investment in Bell's scheme. We do not doubt that it will find users in special circumstances, but any development of the kind and scale which Bell so fondly imagines is utterly out of the question."

Bell ignored the scoffing and continued to improve and show his telephone until enough people recognized its value so that stock could be sold.



**1877—A burglar alarm company** made first commercial telephone service available. Subscribers could not talk to each other.

In July 1877, Bell and his financial backers, Sanders and Hubbard, formed a corporation, the Bell Telephone Company. Watson got 10% of the shares.

Two days later, Alexander Graham Bell married Mabel, the deaf daughter of Hubbard, and in August the couple sailed for Europe to remain there more than a year. Watson, the machinist with no scientific training, would carry the technical load in Boston for the next four years, then retire, wealthy.

Now that the telephone was being eagerly accepted by an excited public, Western Union used Edison's transmitter with Gray's receiver to go into the telephone business, with a vigor that belied its original scorn for Bell's idea. There was active competition between Western Union and the Bell company until all the conflicting invention claims were settled.

Berating himself for not inventing the telephone,



## Boys meet girls—and lose

Young boys were the first telephone operators in most cities, but they soon lost out to women. In 1881, the National Telephone Exchange Association heard the informed views of a Mr. Eckert of Cincinnati:

"I would like to say right here, I've been asked by Mr. Savin what our experience has been with young ladies' help; the service is very much superior to that of boys and men. They are steadier, do not drink beer, and are always on hand."

The peremptory "What do you want?" with which boys had answered the calls, was clearly on its way out of style. By 1883 the *Paul Mall Gazette* was commenting about a London exchange:

"The alert dexterity with which, at the signal given by the fall of a small lid about the size of a teaspoon, the lady hitches on the applicant to the number with which he wishes to talk, is pleasant to watch. Here indeed is an occupation to which no 'heavy father' could object; and the result is that a higher class of young woman can be obtained for the secluded career of a telephonist as compared with that which follows the more barmaid-like occupation of a telegraph clerk." Commenting on this boy-girl transition in *Voice Across the Sea*, his history of submarine telegraph and telephone cables, Arthur C. Clarke says: "Perhaps the telephone did almost as much as the typewriter to emancipate women and to give them independence."

Xavier Hollander might agree, but could not be reached for comment; her line was busy.

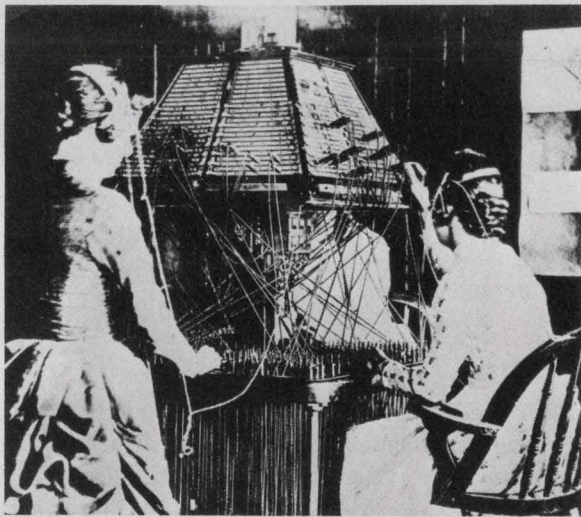

1881—Pyramid-type switchboard suited "higher grade young women."

Photo courtesy of Bell Laboratories.

Thomas Edison had responded to Bell's liquid-transmitter idea with its powerful principle of variable resistance. He systematically tested 2000 different substances and settled on a carbon button, strikingly similar in principle to those used today. Its performance obsoleted Bell's acidulated-water technique. But Edison, who had invented the phonograph in 1876,

never quite got over his oversight in failing to conceive of the electric telephone.

Meanwhile, back at the five-man lab at 141 Pearl St. in Boston that was the ancestor of today's 16,000-person Bell Telephone Laboratories, Emile Berliner, pioneer of the microphone, devised a microphone even more sensitive than Edison's, and the Bell company soon acquired rights to it and to an improved carbon transmitter invented by Francis J. Blake.

When telephone acceptance really got under way in 1878, Tom Watson could no longer build all the telephone equipment for the Bell organization in the Boston telegraph-instrument shop of Charles Williams, Jr. The Bell organization needed more production power. Western Union recognized the strength of the Bell patents and agreed in November 1879 to bow out of the telephone business. One of WU's major suppliers had been the Western Electric Manufacturing Co., of Chicago. By 1882, the American Bell Telephone Company bought controlling interest in Western Electric, and made it the manufacturing unit.

### Bell's many-faceted life

Bell retired from the telephone business at the age of 34, already famous and wealthy. From his mansion in Washington, D.C. or his large estate in Nova Scotia, he campaigned vigorously for the welfare and education of the deaf, and continued experiments of many kinds.

In 1879 Bell proposed echo sounding for determining the depth of water. In 1880 he transmitted speech over a light beam, detected by a selenium cell. He suggested the use of radium for the treatment of cancer, and designed the "vacuum envelop", forerunner of today's "iron lung."

Bell made important contributions to the early development of aircraft, inventing the aileron in 1908. He also developed hydrofoil boats. It was Bell who financed Albert Michaelson's historic determination of the velocity of light.

Just before sunset on August 4, 1922, Alexander Graham Bell went to his last resting place. During the funeral services, all telephone service was suspended for one minute on the entire telephone system of the United States and Canada.

When Bell left the telephone business in 1878, he left it armed with a strong patent position.

Cross-claims by Elisha Gray and Johann Philipp Reis were settled in the early 1880s. A court decision of 1881 ruled that with Reis' apparatus "articulate speech could not be sent and received. . . a century of Reis would never have produced a speaking telephone by mere improvement in construction." Bell was upheld.

Elisha Gray, who coincidentally was one of Bell's judges at the Centennial exposition and by an earlier coincidence had made a patent filing on the telephone the same day as Bell, did no better in court.

The bitter court battles were won on the unshakable



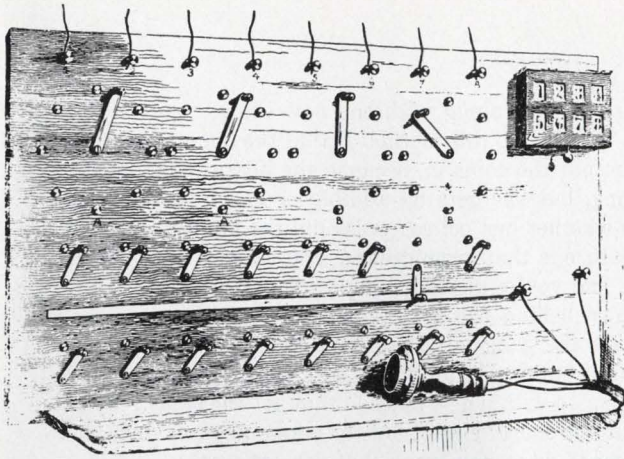

Photo courtesy of Bell Laboratories.

**1878**—The first telephone switchboard served 21 customers over 8 lines (top). Installed in New Haven, CT, in January, it had multiple-contact rotary switches. Magnetic “drop” (top right) showed which line wanted service.

clarity of Bell’s patent, issued three days before the telephone first talked. The six-page patent entitled “Improvement in Telegraphy” concentrates on Bell’s harmonic telephone ideas but mentions that the transmitter can be operated by the human voice, and predicts that “a similar sound to that uttered” will issue from the receiver. The Bell patent, still perhaps the most valuable single patent ever issued, tied up until 1893 all rights to “apparatus for, transmitting vocal or other sounds telegraphically. . . by causing electrical undulations.”

Iron had been used to make telegraph wires, so iron was used to make telephone wires. A single 12-gage wire was all it took—but squeaks, howls and clanks were heard on the phone. They came from the trolleys, the street arc lights, and the telegraph wires running in parallel with the phone wires.

A pair of new twists in the 1880s solved most of these problems: the full metallic circuit, and “alternation.” The use of a wire pair rather than a single wire got rid of the effects of the resistance back through the earth ground. Most inductive effects could be cancelled once experiments proved that the pair should be “twisted.”

Iron still had too high resistance, and it rusted. When copper was first tried for telephone lines, it would stretch and break of its own weight; it was too soft. But by 1877 Thomas B. Doolittle had perfected hard-drawn copper wire. Copper had such a bad reputation that Watson didn’t test Doolittle’s new version until 1881. American Bell bought 500 miles of it in 1883 and in 1884 used it for the first Boston-New York line. Copper eventually replaced iron telephone wire. The change to equal-sized copper dropped the line-resistance loss by a factor of 10.

Brute-force use of copper to minimize line attenuation was the practice through the 1890s. The 900-mile line from New York to Chicago, opened for traffic in 1890, cost \$130,000, and used a pair of copper wires,

LIST OF SUBSCRIBERS.

**New Haven District Telephone Company.**

OFFICE 219 CHAPEL STREET.

February 21, 1878.

<i>Residences.</i>	<i>Stores, Factories, &amp;c.</i>
Rev. JOHN E. TODD.	O. A. DORMAN.
J. B. CARRINGTON.	STONE & CHIDSEY.
H. B. BIGELOW.	NEW HAVEN FLOUR CO. State St.
C. W. SCRANTON.	“ “ “ “ Cong. ave.
GEORGE W. COY.	“ “ “ “ Grand St.
G. L. FERRIS.	“ “ “ “ Fair Haven.
H. P. FROST.	ENGLISH & MERSICK.
M. F. TYLER.	NEW HAVEN FOLDING CHAIR CO.
I. H. BROMLEY.	H. HOOKER & CO.
GEO. E. THOMPSON.	W. A. ENSIGN & SON.
WALTER LEWIS.	H. B. BIGELOW & CO.
	C. COWLES & CO.
	C. S. MERSICK & CO.
<i>Physicians.</i>	SPENCER & MATTHEWS.
Dr. E. L. R. THOMPSON.	PAUL ROESSLER.
Dr. A. E. WINCHELL.	E. S. WHEELER & CO.
Dr. C. S. THOMSON, Fair Haven.	ROLLING MILL CO.
	APOTHECARIES HALL.
<i>Dentists.</i>	E. A. GENNER.
Dr. E. S. GAYLORD.	AMERICAN TEA CO.
Dr. R. F. BURWELL.	
	<i>Meat &amp; Fish Markets.</i>
<i>Miscellaneous.</i>	W. H. HITCHINGS, City Market.
REGISTER PUBLISHING CO.	GEO. E. LUM, “ “
POST OFFICE.	A. FOOTE & CO.
MERCANTILE CLUB.	STRONG, HART & CO.
QUINNIPIAC CLUB.	
F. V. McDONALD, Yale News.	<i>Hook and Boarding Stables.</i>
SMEDLEY BROS. & CO.	CRUTTENDEN & CARTER.
M. F. TYLER, Law Chambers.	BARKER & RANSOM.

Office open from 6 A. M. to 2 A. M.

After March 1st. this Office will be open all night.

**1878**—According to this classified directory, New Haven had 49 telephone subscribers by February but no one needed telephone numbers yet.

each as big as a human finger. Long before any form of “repeater” or amplifier became available, the series loading coil arrived and the puzzling problems of voice transmission, line losses and impedance matching between the instruments and the transmission line began to be understood. Loading coils were invented in 1900 by Michael I. Pupin, a Serbian immigrant who came to America by selling his watch and school books.

**The automatic switch vs. the girl**

The “girl-less, cuss-less, out-of-order-less, wait-less telephone” arrived in the 1890s. That’s how Almon Brown Strowger advertised his automatic-switching system, which let the caller complete his own connections without an operator. This idea, which won him a patent in 1889, had come to Strowger when he got angry about the state of his own telephone service.

Furious because he was losing business when operators failed to complete calls to him, and suspecting collusion between the operators and his competitors, Strowger, a Kansas City undertaker, vowed to put the problem to rest for good.



## Now it can be tolled. . .

It was not a formal design contest, but it was surely an earnest one for two budding engineers determined to produce in one week the most elegant and satisfying design for beating the system—the Bell System.

At the end of a college "beer bust" in the early 1950s a few MIT engineering students remained, griping. The telephone company had just taken out the dormitory pay phones because of repeated shortages of cash from their locked cashboxes. Upperclassmen grandly shared their insights, detailing for neophytes just how the popular "ungrounding" method gave free toll calls.

"Only two wires come into the booth from the phone company. That's your voice circuit, balanced to ground. The ground is picked up locally by a wire to some pipe or radiator. When the operator sends a 'collect' pulse, both wires of the talk circuit carry it, and a solenoid connected between there and ground 'collects' the money; that is, dumps the coins into the cashbox from a little cup inside the upper part of the phone.

"But if your call doesn't go through, she returns the money. She keys a 'return' pulse, negative with respect to ground, and the 'return' solenoid dumps the coins back to you. Each solenoid has a diode in series, so each works with its own polarity," they explained.

To "beat the system" on long-distance calls, a student could unground the booth, disabling both pulses, place the call to California or wherever, deposit all the change the operator asked for, finish the call, and hang up—then reconnect the ground wire, drop in a dime to get dial tone, and hang up again. All the toll-call coins, still waiting in the upper cup, would

be returned along with the new dime.

"The key to this method is that the operator is sure you put the coins in, because she hears them hit the gong, but she gets no audible or other feedback as to whether her 'collect' pulse did the job. But the bad feature is that ground-wire. You can't always get at it, and you're kind of conspicuous struggling with it down behind the booth."

As the gang left the hall, the leaders argued out the groundrules for a contest. Each student would come up with a new method that got the same results but had more "class"; not for personal gain, since the phones were now gone, but for art's sake.

A week later, two of the students brought working units, and the crowd clamored for a look. Marty, showing a breadboard with a rat's-nest of wires, was inverting the pulses with the latest transistors, making the "collect" pulse give him back the money. But the onlookers all talked at once, trying to convince him he'd missed the point. To use his "great solid-state design" you had to break into all three wires, outside the booth. And what if the "return" pulse got inverted?

Bill, the other contestant, smiled and waited for quiet before he removed the handsome wooden cover from his device, revealing some seldom-seen "solid-state hardware"—a nickel gong, a quarter gong, a little brass hammer. No wires at all. "You hold it up to the mouthpiece," he said, and gave each gong a tap.

Bill, like Lincoln after the Gettysburg Address, waited through long seconds of stunned silence. Then cheering broke out and someone led a toast to "the systems approach."

At the start, Strowger, like Bell, lacked technical background, but he soon found partners to develop his simple idea. Electromagnets, energized by electrical pulses received over the telephone line actuated a pawl-and-ratchet mechanism to move a metal finger (now called a wiper) over a bank of contacts, each connected to a different telephone. In the first systems, the calling telephone was permanently connected to its own wiper, and the size of the exchange was limited by the number of the contacts on the Strowger switch.

To call Subscriber 89 before Strowger's engineers had invented the rotary dial, the caller pressed one key eight times and another key nine times. Users made mistakes in counting, however, and the need to eliminate these errors led to the invention of the dial.

Operating essentially like the present-day dial, the first dial was larger and, in the beginning, used flanges instead of finger holes. The Strowger designs evolved rapidly in the 90s. People liked the system, and the dial was a success in most locations.

But in some communities in Wisconsin, populated mainly by German-speaking people, complaints came in about many wrong numbers. At first, Strowger

engineers could not imagine what the trouble could be. Then they discovered the answer. When these people dialed 21, they thought the German equivalent of "one and twenty," or *ein-und-zwanzig*, and dialed the "one" before the "twenty." After a brief orientation of the burghers of Wisconsin, everything worked fine.

(Some customer confusion in such areas may have persisted into the 40s. A James Thurber cartoon caption of that era reads, "Well, if I called a wrong number, why did you answer the phone?")

During these first years, 1892-4, each successive Strowger installation was a "field trial," as the engineers tried various forms of the equipment. By 1895, however, they had settled on the semi-circular contact banks and the "up-and-around" motion of switch shaft and wipers, which are still used today.

The principle of "transfer-trunking" was developed to free the Strowger system from limitations of exchange size. For transfer-trunking, telephones are assigned into "hundreds groups" which are combined, in turn, into "thousand groups." In an exchange of up to 10,000 telephones a calling party could dial four digits to control separate switches successively, extending his connection through switches for the thou-



sands, hundreds, tens and units selections. By the start of the 20th century, the dial system was ready.

Until the 1890's, Bell's patents had kept others from manufacturing telephones and AT&T had concentrated on telephone service for the larger cities. Small towns, after a long and possibly futile wait for telephone service, welcomed the "independent" telephone companies that sprang up across the country. Most of these used manual switchboards just as Bell did, but a few used the new Strowger automatic system.

Strowger and his Automatic Electric Company (now GTE—Automatic Electric) had their first commercial installation in 1892 and a reasonably well engineered dial system by 1900. The Bell contingent, with an entrenched commitment to manual switchboard, tried and eventually abandoned the "village system," an attempt to provide operatorless operations for very small communities by running everyone's phone line to everyone else's house. Each subscriber did his own switching, with a rotary switch.

It worked well until the exchanges exceeded 10 or 20 party lines, and they soon did.

In the early 1900s, farmers and ranchers, feeling the need for telephone service, had built their own telephones and strung iron and steel lines on trees. The typical telephone "central" (each farmer paid one dollar per month), was set up by a farm-cooperative association. It was often difficult to make a telephone call because owner-members used the party lines for socializing, playing gramophone records or even having contests among the old-time fiddlers.

### Batteries go central

In the first years of the 20th century, batteries were taken out of the telephone instruments and replaced by "common battery" installations at each central office; telephones were made smaller, and the desk-type telephone came into vogue. From 1895 to 1920, broadly speaking, "dial" meant Automatic Electric, and Bell stayed with manual switchboards.

"Pay-telephones" were adopted by AE for dial operations; private exchanges were developed that provided dial service both within and between business organizations; dial control was extended over longer distances, and dial-toll networks permitted operators to dial directly to subscribers in distant exchanges.

The Bell System had tried Strowger-type equipment in its smallest exchanges, but remained unconvinced that it was superior to manual exchanges. The problem was that the automatic-dial system made an attendant unnecessary in these tiny towns, but telephone popularity grew so fast that the size of the exchange soon outstripped the capacity of the original automatic system, and manual switchboards again provided a better economic solution.

Before there were vacuum tubes, attenuation on long lines was still limiting the reach of the telephone.

From 1900 on, mighty struggles to obtain repeaters with gain included efforts to make amplifiers from carbon-granule units with power gains of about 100, and from mercury-vapor tubes. These were both successful, and were perfected for transcontinental use. But when that achievement linked the coasts in 1915, they had been put aside in favor of the vacuum tube.

### Enter the vacuum triode

In 1907 Lee deForest invented the Audion, a triode vacuum-tube improvement on Fleming's thermionic diode that could provide amplification and started a revolution that immediately changed radio practice and eventually made telephone repeaters possible. The triode was first used by radio-receiver designers as a detector, not as an amplifying device. (They had been getting by with spark-gap transmitters and passive quartz receivers for their Morse messages.)

For nearly five years, the use of deForest's triode as an audio amplifier was essentially unrecognized, even by deForest. After two more years of development, the Audion found its way into telephone repeaters in 1914.

The vacuum tube helped save copper. "Five telephone conversations are carried on today simultaneously over one toll-line circuit," an AT&T advertisement boasted in 1919. Frequency-division multiplexing (then called wired radio) required many tubes, but the copper savings made it worth while.

"Static will at times cause breaks in the ether circuit," a 1927 AT&T advertisement admitted, when the Bell System began transatlantic telephone service via radio "at certain hours daily." But for 28 more years, radiotelephone service supplied the only voice channels to Europe, until repeater reliability made a voice cable feasible.

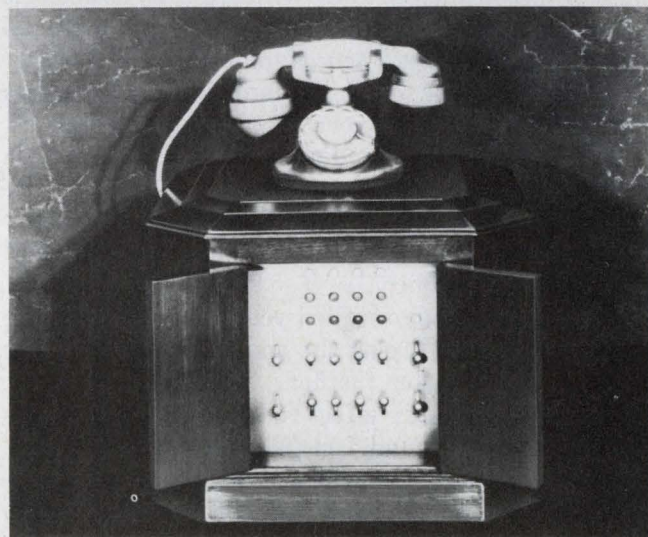

1927—The First PBX from Bell Labs featured a cordless "turret" and factory-wired switch gear to reduce installation costs. First installed in the residence of Edsel Ford, it had a prosperous 1920's look, antique walnut finish and oxidized silver panel and handset.



"You can have any color as long as it's black," said Henry Ford of his famous Model T, which had been in production since 1909. By 1926, 51% of the passenger cars in America were black Model Ts. Those buyers hadn't needed color.

But times were changing. Flappers and flask-toting "swells" liked colors. So Ford offered colors in 1928 and Automatic Electric offered a choice of colors in telephones in 1929. Bell followed suit—25 years later.

### The feedback fundamentalists

Commuting by ferry across the Hudson to Bell's New York City laboratory at 463 West Street one morning in 1927, Harold S. Black was seized by a daring idea for a low-distortion amplifier circuit. After working for years on the problem he hoped his new idea might solve, he made a hasty sketch on his newspaper. The whole idea of negative feedback for correcting errors and distortion in amplifiers was born.

But 20 years of wrestling with the problem of amplifier stability lay ahead. Most designs oscillated and were hard to stabilize "by guess." "The invention of negative feedback had all the initial impact of a blow with a wet needle," one of Black's laboratory assistants later recalled.

Years later, while stability problems still baffled the experts, Harry Nyquist produced the criterion and diagram that defined the conditions required to keep feedback circuits stable. But Nyquist, who accumulated nearly 150 patents during his 37 years at Bell Laboratories, had established what had to be done, rather than how to do it. Designers had to meet the Nyquist requirements under more and more exacting conditions as the capacity of telephone lines—and their length—grew.

Hendrick W. Bode came on the scene long after the early transcontinental lines (with typically 60 decibels of loss on a single channel) had given way to coaxial systems that handled 480 channels with a repeater every five miles or so. This meant that 600 repeaters were needed in series to overcome a loss of 30,000 dB.

Bode's exhaustive studies of automatic-feedback equalizers to compensate for changes in temperature and other variants in transmission lines inevitably faced him with the still unsolved problem of "singing"—amplifier instability.

"At length," Bode recalled years later, "in desperation, I began modifying the amplifier proper rather than trying to tinker further with my equalizer. . . Finally after I had in effect redesigned the complete feedback loop, I found I could obtain a solution."

A physicist and engineer as well as a mathematician, Bode was able to put his theoretical concepts into practice during World War II, working on gunfire control and early missile systems. He was among the first to see and understand the potential for replacing mechanical weapon controls with electronics. Stabilizing one or two servo loops was relatively easy after

winning out over countless equalizers.

Technology was available to develop central-office switching in many different ways, but the economics of the different approaches complicated the problem enormously. The early Strowger switches at Automatic Electric and the Connelly-McTighe single-level electromechanical selectors in the Bell experiments were the 1905 state of the art. The next five decades led through panel, crossbar, and magnetic reed-switch approaches to modern electronic-switching systems in which voice is handled as a digital bit stream and switched by solid-state circuits. Cost factors, service requirements, the available market, and unknowns concerning customer reaction repeatedly changed the

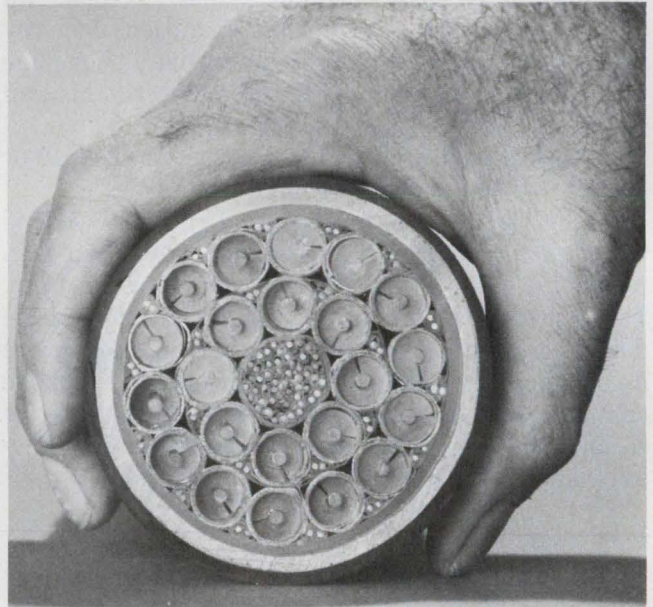

**1968—L-5 transmission system** used 22-tube coaxial cable to carry up to 108,000 two-way voice conversations. Solid-state amplifiers were spaced every mile along the cable length. Regular L-5 service began in 1974.

course of technological thrust for Bell, General Telephone and the independents.

Strowger's direct-control system concept led to three decades of intensive use of the so called "step-by-step" central-office approach in the Bell System. Automatic Electric continued to be an important supplier of this type of equipment to Bell from 1917 through 1936. In a step-by-step system, the switches at each stage in the dialing process are directly responsive to the digits being dialed. This is the system that was used for smaller cities and towns.

For large cities, Bell went with "common-control" equipment. In such systems, the dialed information is stored in centralized equipment before being used to control the switching operations. Over the years, common control has been used with many mechanisms—two dimensional up-and-around switches of the Strowger type. Other types of rotary switches, linear switches of the panel type, cross-point switches,



relays, electronic devices, and of course with digital switching on a time-division basis.

### Progress on many fronts

On July 1, 1948 Bell Telephone Laboratories demonstrated the transistor, "which has several applications in radio where a vacuum tube is ordinarily employed," according to a news dispatch.

Transatlantic-telephone demand was not yet enormous, for, even in the early 50s, only 12 radio-telephone circuits were being used by the Bell System. In 1955 Bell succeeded in opening the first transatlantic wire link between London and New York. Since it would cost an estimated quarter-million dollars to replace a vacuum tube in the ocean-bottom repeater, Bell Labs had sought and achieved a new high in reliability for the design of the 102 three-tube repeater stations in the cables. The transistor hadn't made it yet.

By 1963 the world's longest submarine telephone cable, running more than 9000 miles from Australia to Canada via the Hawaiian Islands, was in service. It cost about 98-million dollars.

Back in the U.S., in 1961, perforated plastic cards "stored" telephone numbers in the first repertory dialer. Magnetic tape was the storage medium in the later Call-a-matic pushbutton dialer, and the 1974 Touch-a-matic from Bell used LSI circuits to remember 31 numbers plus the last number dialed.

On July 10, 1962, Telstar was launched at 4:35 a.m. EDT and used at 7:30 p.m. EDT to transmit to all three major television networks a picture of the American flag and the sound of the Star Spangled Banner.

Innovation in telephone technology of the 1970s has also come from outside Bell's huge establishment, continuing a trend that dates back to Edison and Strowger. In its 1968 "interconnect decisions," the FCC forced Bell and General Telephone to permit attachment of equipment of other manufacturers to telephone lines. Advanced key telephones, private automatic branch exchanges and data-transmission equipment from outside manufacturers proliferated in the new atmosphere of design competition, and perhaps the telephone companies too, ripped their tempo.

The modular concept, stressing connectorization, has spread from the central offices to subscriber locations, and is now making inroads in the "construction and splicing" areas that hook them together.

Behind the scenes, computerized automated repair-service bureaus, toll-service positions, and directory-assistance retrieval systems have more and more telephone people sitting at CRT consoles when they answer a call. A directory-assistance operator taps four letters of a last name, hits a "book" button to choose which city or section to search and, in less than two seconds, gets both a microfilm display of one of 72,000 printed pages and a CRT display of daily updates from disk.



Photo courtesy of Bell Laboratories.

**1977—Maintenance panel of Bell System's new No. 4 electronic-switching system (ESS) checks for correct operations while toll switcher completes long-distance connections at the rate of 550,000 calls an hour.**

A boundless future is seen for the telephone. "Versatility will pervade network services. Voice-storage capabilities in electronic-switching-system (ESS) central offices will allow answer, record, playback, and message-forwarding services without additional equipment on customer premises. Customers may order WATS lines to particular area codes or cities, and visual services will see further development and experimentation. And because of the new high-capacity mobile-telephone system that already can increase availability of mobile service by a factor of 100, the industry may be nearing the next great frontier of communications—the take-along telephone," says *Bell Telephone Magazine*. And a similar idea comes from halfway around the world—from Ceylon, the home of Arthur C. Clarke, author of science fact and fiction, including the book and movie, *2001—A Space Odyssey*:

"It would be an *underestimate* to say that the wristwatch telephone would save tens of thousands of lives a year. Every one of us knows of tragedies—car accidents on lonely highways, lost campers, overturned boats, even old people at home—where some means of communication would have made all the difference between life and death."

In a recent article in *Creative Computing*, Clarke also describes a futuristic home-communications console he calls the "comsole." It would include the CRT display and keyboard of a computer console, plus hi-fi sound, TV, and a TV camera, and would have many functions—from first-class mail delivery to instant interaction with anyone, anywhere on earth. Clarke points to energy savings as well as convenience as benefits of this embodiment of his years-old slogan—"Don't commute—communicate!" ■■



TIME INTERVAL  
SECONDS

3.4168 - 6

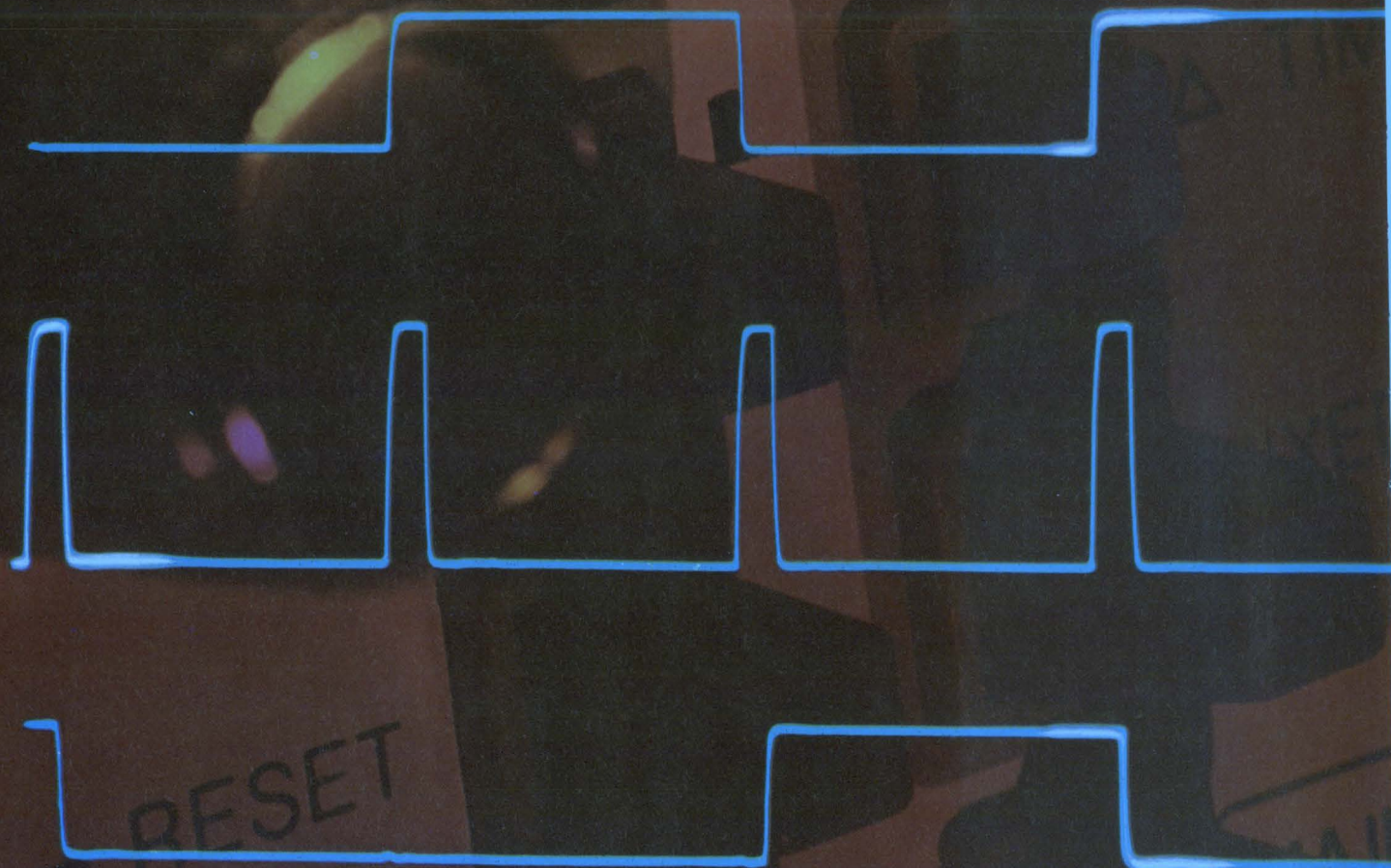



# Announcing a new standard in scope timing measurements.

## For $\Delta$ -time measurements to 0.002% accuracy\* and 100 psec resolution...

### HP's the Answer.

Here's a brand new concept in scopes. HP's revolutionary **1743A**. It has an internal crystal-oscillator time-base reference for high 0.002% accuracy\*... second-generation  $\Delta$ -time capability for added measurement flexibility and convenience...and a 5-digit LED readout for resolution to 1 part in 150,000.

Priced at just \$3300\*\*, this 100 MHz scope provides up to 200 times greater timing accuracy than previous  $\Delta$ -time scopes. And the combination of crystal-oscillator and second-generation  $\Delta$ -time capability means easier timing measurements:

#### **Triggered delay measurements.**

Now,  $\Delta$ -time measurements can be made automatically by positioning markers on the waveform. This means greater speed and convenience in measuring pulse widths and periods. Plus, direct readouts of changing time intervals without touching scope controls.

**Delay functions to zero.** Now you can measure  $\Delta$  time from the first pulse leading edge to any place on screen. That means greater resolution and accuracy, plus easy  $\Delta$ -time measurements with respect to noncyclical pulses such as flags and handshake signals.

**Continuously variable sweep that remains calibrated.** Now you can use the sweep vernier without changing the LED time-display calibration. Make one major division equal to a clock period, compress a long data train to keep it within the display window, or increase readout resolution up to

a factor of three and still read  $\Delta$  time directly and accurately.

**Trigger to channel A and B.** Now you can measure  $\Delta$  time between the trigger signal and events on both channels. This allows you to measure  $\Delta$  time between a flag and the start of a data train, to make phase measurements on dual clocks, or to measure skew between data channels.

And there's much more. Your local HP field engineer has the details.

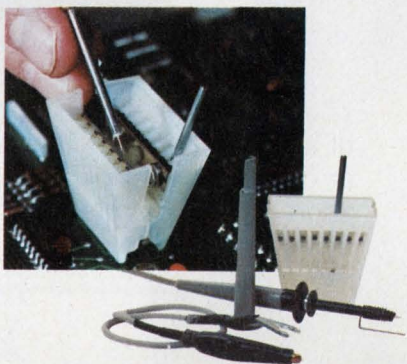

And here's something NEW for scopes. HP's **Easy-IC Probes**. A new idea for probing high-density IC circuits that eliminates shorting hazards, simplifies probe connection to DIP's and generally speeds IC trouble-shooting. The probes are standard equipment with this scope.



\* 15°C to 35°C specification.

\*\* Domestic U.S.A. price only.

087/10

HEWLETT  PACKARD

1507 Page Mill Road, Palo Alto, California 94304

For assistance call: Washington (301) 948-6370, Chicago (312) 255-9800, Atlanta (404) 955-1500, Los Angeles (213) 877-1282

CIRCLE NUMBER 35



# Our LED lamps are brighter by design.



It's no accident that our LED lamps are as bright as incandescents. We designed them that way. We also designed them to last ten times longer. At least ten years at 20 milliamps.

They're designed to use only half the power of an incandescent. To operate either pulsed or continuous without life loss. To respond to short pulses that elude incandescents. We designed them to give you a bright replace-

ment for incandescents. In a proven solid state package. Ready for immediate delivery. From sophisticated computer control panels to simple telephone pushbuttons, our Brite-Lite® LED lamps give you high reliability and longer life. Whatever your size or display requirements, there is a Brite-Lite for you. In red, amber or green. Transparent or translucent. With built-in resistors to handle up to 48 volts. From midget flanged snap-ins to space saving T<sup>2</sup> Lites. Now's the time to switch to our super bright Brite-Lites.

Our LED lamps are the brightest. And, when you are ready to select lamps, don't select them by accident. Give us a call and you'll see why Digital Equipment Corporation, the largest minicomputer manufacturer, has switched to the brightest LED lamps in the business.

"The brightest LED lamps in the business."

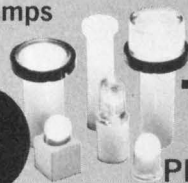

**DATA  
DISPLAY  
PRODUCTS**

303 NORTH OAK STREET, INGLEWOOD, CA 90301  
TELEPHONE (213) 677-6166 • TWX 910-328-7205



# After you look at the specs, look how long they're guaranteed.

The accuracy specs for the Dana 5100 5½ digit multimeter are guaranteed for a full year. Not 90 days. Not 6 months. That means you only have to calibrate it once a year.

All other multimeters have to be calibrated an average of three times a year. At about \$75 a pop. Which makes their \$995 units a lot more expensive to own than the Dana 5100 at \$1145\*.

Instead of sitting in the shop for six weeks over the course of the year, the Dana 5100 will stay right where you are. Measuring AC, DC, Ohms and frequency

(yes, frequency too) with very high accuracy. Just like the specs say. For a year at a time.

When you look at it that way, one thing becomes obvious. The cost of owning a multimeter is a lot more important than the price.

Write Dana Laboratories, Inc., 2401 Campus Dr., Irvine, CA 92715 for all the specs. And take a good look. With specs that good, you'll be glad you only have to give it up once a year.

**DANA**®

**Others measure by us.**

\*U.S. domestic prices.



**Dana 5100.**  
**Ask for a free demonstration**  
**before you consider anything less.**

See us at WESCON Booths 1059-1160-1161

FOR PRODUCT DEMONSTRATION, CIRCLE 251

FOR LITERATURE ONLY, CIRCLE 252



# ZEBRA<sup>®</sup>

## SOLVES YOUR INTERCONNECT PROBLEMS

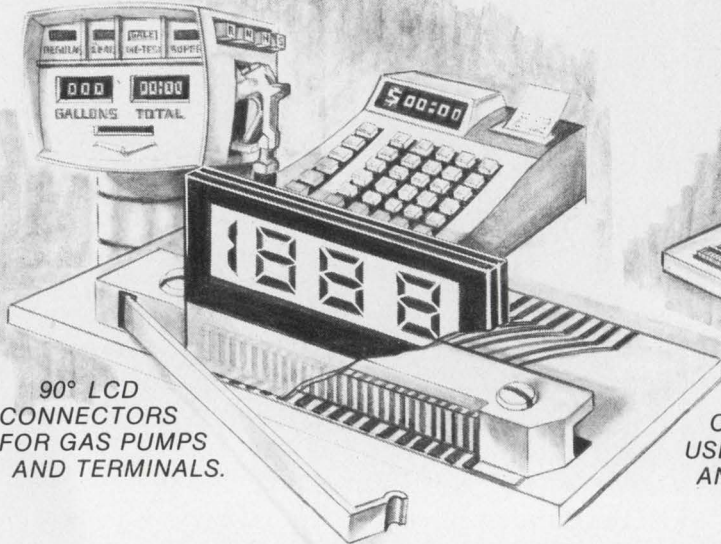

90° LCD CONNECTORS FOR GAS PUMPS AND TERMINALS.

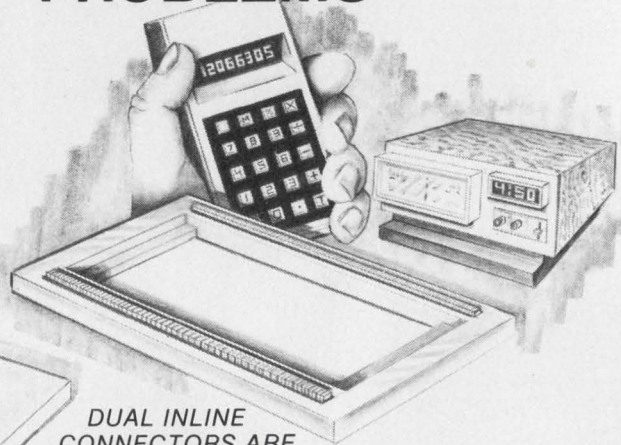

DUAL INLINE CONNECTORS ARE USED IN CLOCKS, DIGITAL METERS AND CALCULATORS.

STACKING CONNECTORS CAN BE MOUNTED TO PROVIDE BOARD-TO-BOARD INTERCONNECTION.

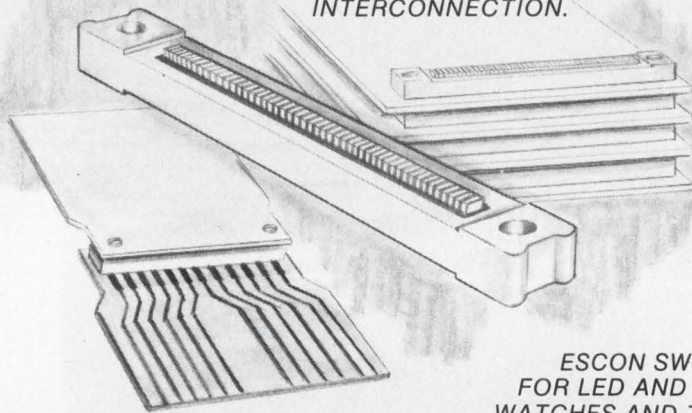

ESCON SWITCHES FOR LED AND LCD WATCHES AND ZEBRA CONNECTORS FOR LCD WATCHES.

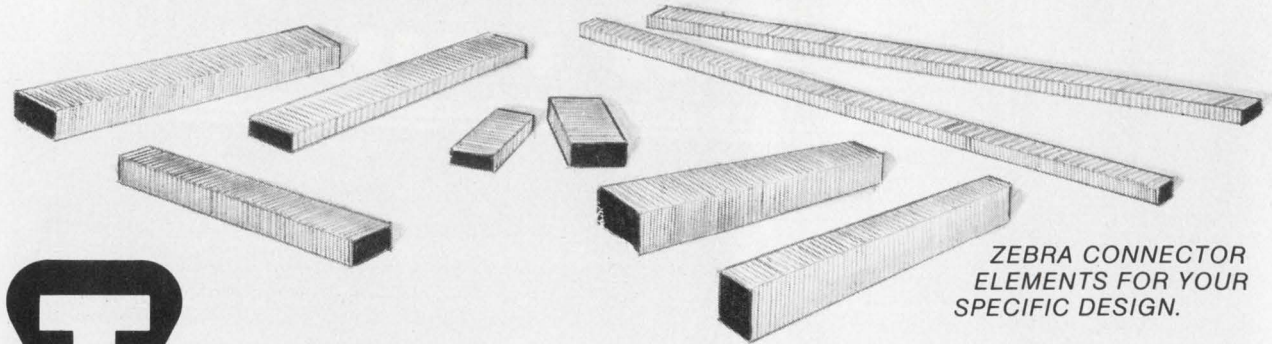

ZEBRA CONNECTOR ELEMENTS FOR YOUR SPECIFIC DESIGN.



*Zebra Connecting Devices Provide a Gas Tight Seal in Harsh Environments and have been proven reliable. Contact Tecknit for a Complete Conductive Elastomeric Connector Catalog.*

129 DERMODY ST., CRANFORD, NJ 07016 (201) 272-5500 / 427 OLIVE ST., SANTA BARBARA, CA 93101 (805) 963-1867

CIRCLE NUMBER 38



# Introducing the 0.38" DIP relay

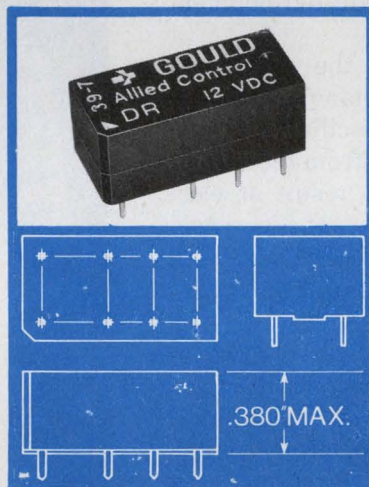

**The most sensitive  
DPDT relay  
costs less than  
two SPDT  
equivalent reeds!**

**Consider these parameters for  
your next PC board:**

Lowest profile—fits well within  
0.5" spacings when mounted  
directly on PC board.

Adaptability—fits standard 16-pin  
I.C. sockets; footprints are interchangeable with similar-but-  
higher e/m DIP relays.

Sensitivity—200 mw max. at pull-in, with 1 amp 28 vdc  
switching and 5 amp carrying capacity.

2 form C configuration.

Life expectancy—10,000,000 cycles low level or mechanical.

Gould/Allied Control has just packaged a lot more per-  
formance into a lot lower relay!

The new miniature Dual-in-line Relay combines the  
compactness of reed relays with the low cost and high  
switching capabilities of electromechanical units.

It's particularly suited to telecommunications and medical  
electronic equipment, but it is already finding widespread  
usage in other areas as well.

Call your Gould/Allied Control distributor for full details  
or write us at Gould Inc., Control and Systems Division,  
Allied Control Operation, 100 Relay Road, Plantsville,  
Conn. 06479

CIRCLE NUMBER 39

**GOULD ALLIED CONTROL**



# Radio

No single scientist, inventor or businessman can be credited with bringing radio from idea to reality. Veritable rosters of scientists, inventors and businessmen contributed to the development of the medium.

Perhaps the most important of the early contributors was Heinrich Hertz, a German physicist. In 1886, he showed that high-frequency oscillations could produce an effect some distance away from the source, and that this phenomenon was the result of electromagnetic waves. His experiments went a long way toward proving the theories of James Clerk Maxwell, who had published a set of wave equations 10 years earlier.

To conduct his experiments, Hertz used a wave-generating apparatus that became the standard for many years—a capacitor discharging through a small spark gap that was the center of a dipole antenna made from short lengths of heavy wire. The receiver was even simpler—a loop of wire with its own small gap. Since a potential of about 300 V was needed to produce a visible spark from such an antenna, Hertz' ability to make any observation at all is extraordinary. Understandably, he didn't seek applications of his discoveries.

Yet by 1892 practical applications of Hertzian waves were being discussed. In the *Fortnightly Review*, a nontechnical journal, William Crookes wrote:

Here is unfolded to us a new and astonishing world, one which is hard to conceive should contain no possibilities of transmitting and receiving intelligence. Here, then, is revealed the bewildering possibility of telegraphy without wires, posts, cables, or any of our present costly appliances.

Crookes went on to list the apparatus needed for practical radio: reliable transmitters; sensitive, tunable receivers; and directional antennas. Advances



1910—The earliest radios were simple affairs, with so little output power that headphones were necessary to hear their static-filled reception. (Photo courtesy James B. Lansing Sound.)

in receivers came first.

The coherer, a detector of Hertzian waves, is based on a principle that had been noticed as early as 1835: The conductivity of a mixture of metal filings is increased when the mixture is subjected to an electrical discharge, and remains relatively high until the mixture is physically disturbed. Professor Eduard Branly, working in Paris between 1890 and 1891, used an insulating tube containing metal filings between two conducting plugs to show that an electric spark occurring at a distance could change the resistance of such a device. In England, G.M. Minchin and Oliver J. Lodge, who named the coherer, recognized that the



response was due to Hertzian waves.

In one demonstration, Lodge substituted an electric bell for the usual meter that signaled reception, and showed that the bell's vibration could reset the receiver and prepare it for the next signal. The use of Hertzian waves in this simple telegraph receiver should have been obvious, but Lodge, in his stilted style, said he "did not realize that there would be any particular practical advantage in thus with difficulty telegraphing across space instead of with ease by the highly developed and simple telegraphic and telephonic methods rendered possible by the use of a connecting wire." Lodge did recognize the need for tuning the transmitter and receiver to the same frequency. He was awarded patents on tuning.

Into the picture stepped an entrepreneur who could put the theory of radio into practice—Guglielmo Marconi from Bologna, Italy. By 1896, Marconi was transmitting Morse code messages nearly two miles. Moving to England, he first demonstrated reception over eight miles, and in 1897 formed the British Marconi Co. On December 12, 1901, using an antenna hung from a kite, Marconi transmitted the Morse letter S from Cornwall to Newfoundland—about 1700 miles.

Instead of trying to compete with transatlantic wire telegraphs, Marconi concentrated on applying wireless devices to ship communications, where there was no practical alternative. In 1909, wireless messages from the S.S. Republic prompted rescue action when that

**1873**

James Clerk Maxwell publishes his theory of electromagnetic radiation.

**1880**

Jacques and Pierre Curie discover the piezoelectric effect, later applied in crystal oscillators to control frequency.

**1882**

Professor Amos E. Dolbear patents a wireless-communications apparatus.

**1886**

German physicist Heinrich Hertz shows that electromagnetic waves can act at a distance.

**1890**

Prof. Edouard Branly develops the coherer in France.

**1895**

Guglielmo Marconi communicates via wireless near Bologna, Italy.

**1897**

Marconi demonstrates a ship-to-shore wireless.

**1900**

Sir Oliver Heaviside and Prof. Arthur E. Kennelly suggest the existence of a reflecting medium for radio waves in the upper levels of the atmosphere. Marconi files for patent on tuned wireless.

Prof. Reginald A. Fessenden first transmits speech by wireless.

William D. Duddel discovers that an arc can produce continuous oscillations.

**1901**

Marconi receives first transatlantic message by wireless.

**1903**

Valdemar Poulsen designs a "singing arc" that produces continuous waves at 100 kHz.

Dr. Ernst F.W. Alexanderson at GE builds the first high-frequency alternator based on Fessenden's specifications.

**1904**

Professor John Ambrose Fleming patents the two-element thermionic valve.

**1906**

Lee De Forest adds a grid to the Fleming valve and produces a triode audion tube.

**1912**

Sinking of Titanic, reported by wireless operator David Sarnoff, sparks public interest in radio.

Edwin Howard Armstrong develops the regenerative-circuit receiver.

**1915**

Sarnoff proposes the development of a "Radio Music Box."

John Carson invents single-sideband transmission.

**1917**

Radios installed on three U.S. warships by AT&T use the carrier principle to allow nine simultaneous transmissions.

**1918**

Armstrong develops the superheterodyne radio receiver.

**1919**

General Electric takes over the American Marconi Co. and founds the Radio Corp. of America.

**1920**

Radio broadcasting begins as WWJ goes on the air in Detroit and KDKA goes on the air in Pittsburgh.

**1921**

Westinghouse joins the Radio Group, and patents are pooled to allow freer development of the medium. L. Alan Hazeltine develops the neutrodyne receiver circuit.

Armstrong develops superregeneration.

**1923**

WEAF in New York and WNAC in Boston are tied together for the first network broadcasts.

**1933**

Armstrong develops frequency-modulation transmission as an answer to static.

Karl Jansky begins studies of astronomical phenomena by radio.

**1939**

Armstrong begins full-power FM broadcasting from Alpine, NJ.

**1954**

Regency introduces the first consumer transistor radio.

**1961**

The Federal Communications Commission approves stereo-FM broadcasting.



ship sank. In 1910, the United States began requiring wireless equipment and a skilled operator on all vessels carrying 50 or more passengers between ports 200 or more miles apart.

### Disaster at sea spurs radio growth

But a far greater impetus to the growth of radio, as it had commonly come to be known by then, occurred in 1912 when the unsinkable Titanic struck an iceberg and sank. In his classic book, *A Night to Remember*, Walter Lord wrote: "The night crackled with signals. Ships out of direct contact got the word from those within range. The news spread in ever-widening circles. On the roof of Wanamaker's department store in New York, a young wireless operator named David Sarnoff caught a faint signal and also passed it on. The whole world was snapping to agonized attention."

Other stations and vessels in the disaster area tried to help, but merely managed to jam the airwaves. President Taft ordered all other stations off the air so that the one at Wanamaker's might better maintain communications. For three days and three nights, without sleep and almost without food, Sarnoff kept in contact with the S.S. Olympic, which was primarily transmitting the names of survivors as they were hauled in from the ocean.

The Titanic disaster changed radio from a scientific curiosity to a necessity in the public mind. The experience, Sarnoff recalled, "brought radio to the front," and, incidentally, Sarnoff along with it. The fame accorded the 21-year-old telegraph operator after his three-day ordeal would follow him over the decades as he advanced first through the American Marconi Co., and then through the Radio Corp. of America.

But radio's growth would not have been possible without the advances of Reginald Fessenden, who had pressed for the replacement of the spark gap by continuous-wave propagation, and Lee De Forest, who had invented the audion vacuum tube in 1906.

Before the vacuum tube, radio transmitters were very much like that of Hertz. A high-voltage source charged a capacitor, and when the voltage reached breakdown the capacitor discharged through the spark gap to set up a damped oscillation in the antenna circuit. The damped signal was highly variable in both magnitude and frequency, and included large amounts of distortion.

Since Hertz had attempted to show that electromagnetic waves follow the laws of optics, he used short dipoles that produced high frequencies, 80 to 100 MHz. Commercial radio, on the other hand, evolved at low frequencies, with long and high antenna systems, because longer waves were more likely to bend around the earth and lengthen communications distances.

Early commercial receivers also had complex antenna systems and coherer-type detectors, which were

as sensitive to static as to signals.

A more-advanced receiver was made possible by the two-element vacuum tube, invented around 1904 by Professor J.A. Fleming of University College in London. At that time, the inventor was working as a consultant to Marconi. The Fleming valve, because it conducted in only one direction, acted as a rectifier of received signals so that the envelope of the wave could be heard. But the rectifying properties of crystals such as carborundum, galena (lead sulphide) and silicon were soon discovered to be superior in detectors. Thereafter, the Fleming valve wasn't used much for such applications.

The audion three-element vacuum tube was De Forest's attempt to produce a detector with the stability of the Fleming valve and the sensitivity of the crystal. For years he concentrated on this application, leaving to others the discovery of many of the audion's more important applications.

Inserted in a receiving circuit in the usual way, De Forest's audion was hardly more sensitive than the Fleming valve and the other detectors preceding it. The slight amplification it provided could not be explained in any scientific way, and many experimenters discarded it as just another detector—more difficult to adjust than the valve.

### The obvious isn't always noticed

One inventor who did not discard the audion was Edwin Howard Armstrong, who understood that the common audion circuit was unsatisfactory. Usually, the audion's grid was connected in a tuned circuit to the receiving antenna, and the plate was connected in a straight telephone circuit with a battery and headphones. The other side of each circuit was connected to the hot filament. Armstrong found that some alternating current was produced in the plate circuit where, theoretically, no ac should be. He tried tuning the plate-to-headphone, or output, circuit—then commonly called the wing circuit—as well as the antenna-



1912—A young radio operator, David Sarnoff, stayed at his post at the John Wanamaker store in New York City for 72 hours to report the Titanic disaster sparking interest in radio. (Photo courtesy RCA.)



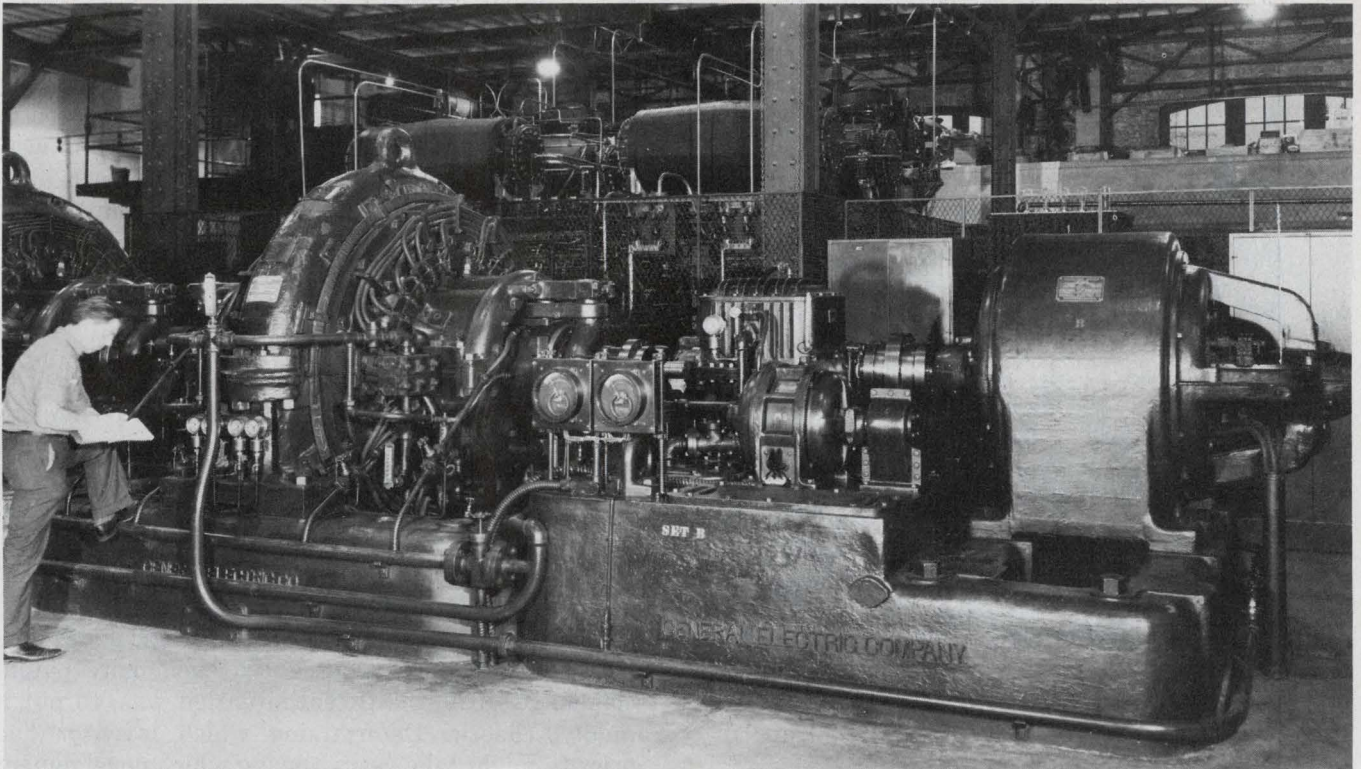

**1922—The first large project of the new Radio Corp. of America** was Radio Central in Rocky Point, Long Island. Alexanderson alternators, shown here, were also used at

RCA stations in California, Massachusetts and Hawaii. They made continuous-wave propagation possible, but were soon made obsolete by higher-power vacuum tubes.

to-grid circuit. Then he fed the output back to the grid. Thus was born the feedback-amplifier circuit, which made reception at long distances possible.

De Forest had noted that when the audion was pressed to higher amplification, it began to hiss. But he had dismissed it as an irritating noise that hindered proper operation. Armstrong, however, noted the same hiss and proved that the audion was, in addition to being a receiver, an oscillator of electromagnetic waves. In so doing, he made the vacuum tube the basis for radio transmission as well as reception.

In 1918, Armstrong invented a second radio receiver, the superheterodyne, while serving as a Major in the U.S. Army Signal Corps in France. A more-sensitive replacement for his earlier regenerative circuit, the superhet used an intermediate-frequency amplifier. The incoming signal is mixed, or heterodyned, with a wave slightly different in frequency, to produce the i-f. The i-f is amplified 3000 or 4000 times, then detected and amplified again at audio frequencies. Armstrong spent much of the decade from 1910 to 1920 hard at work applying vacuum tubes to AM-radio transmission.

The three-element vacuum tube ultimately solved the problems of generating and modulating continuous waves, and completely changed the wireless art that had been developed by Marconi. Continuous waves, unlike spark-gap discharges, have a single frequency and constant level, and can be modulated and demodulated by speech signals. The only problems were to achieve frequencies high enough for radio

propagation and powerful enough for long distances. Prior to the vacuum tube, there were two main means: the rotary alternator, invented by Ernst Alexanderson, the electric arc invented by Valdemar Poulsen.

Over the next few years, about the time of World War I, many experimental broadcasts using vacuum-tube transmitters took place between the United States and Europe, South America, and the Pacific. In one of the more interesting hook-ups, the American Telephone and Telegraph Co. attempted to demonstrate radiotelephony across the Atlantic Ocean. Using the U.S. Navy's antenna in Arlington, VA, to save time and money, AT&T sent both phonograph music and live speech. A new vacuum tube, much larger than its predecessors with an output of 25 to 50 W, had been developed for the transmissions, and some 300 to 550 of these tubes connected in parallel delivered 2 or 3 kW at the antenna with a frequency of around 50 kHz.

The AT&T transmitter employed the van der Bijl modulation technique, which used the audion with suitable bias voltages so that the curve relating output current to grid voltage was parabolic. The receivers also depended heavily on vacuum tubes, with a single stage of rf amplification and two audio stages.

The transmitter's receiving point in Europe was the Eiffel Tower, which the French government could allow the experimenters to use for only a short time each day. World War I was in full swing in Europe, and the tower was a French communications center. In September, 1914, less than a year earlier, the



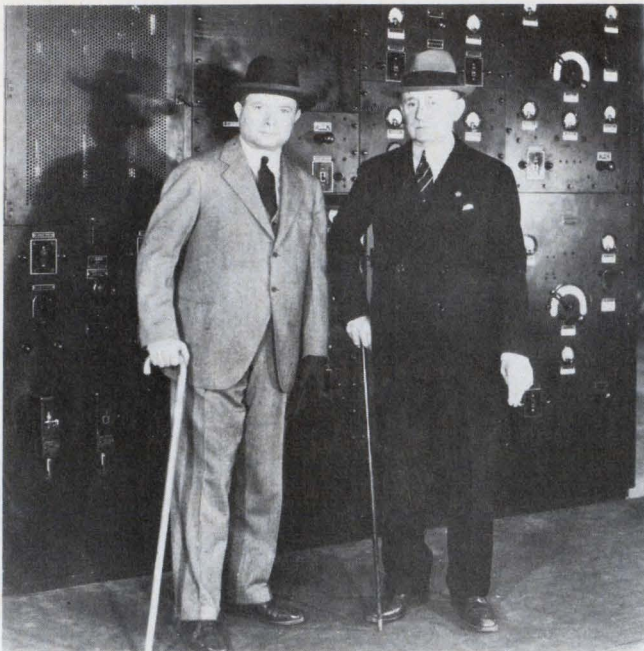

**1933—Guglielmo Marconi visited the United States** and was shown the RCA transmitting center at Riverhead, Long Island, by his former employee, David Sarnoff (left).

German army had been stopped near Paris by reinforcements brought to the front in a fleet of taxicabs.

On August 27, 1915, broadcasts from Arlington were received in Panama. On September 29, speech was received by Mare Island, CA, and on the following day speech was received by Pearl Harbor.

The time available for reception in Paris was understandably limited, but scraps of speech were heard between October 12 and 21. On October 23, a formal demonstration was arranged, and a number of observers in Paris listened to radiotelephone transmissions from Arlington, 3600 miles away.

Indeed, World War I actually encouraged the growth of radio. In 1916, about a year before the United States entered the conflict, the U.S. Navy began working on a system for voice communications between ships at sea and between ships and land headquarters. In April, the Bell System installed a wireless set on the U.S.S. New Hampshire. On May 7, Captain Chandler of the New Hampshire talked to Secretary of the Navy and Mrs. Josephus Daniels and to Mrs. Chandler in Washington, and with naval officers on Mare Island. Broadcast and reception on the East Coast came via the Arlington antenna and telephone land lines—the first time two-way telephony through a wire-telephone network had been extended to a vessel at sea.

Equipment installed on the U.S.S. Pennsylvania, U.S.S. Seattle, and U.S.S. Wyoming in January, 1917, had subcarriers at about 25,000, 35,000, and 45,000 Hz, each of which were modulated by voice before simultaneously modulating the transmitter at 150, 189, and 238. With the ability to handle nine conversations at the same time, this system may have been the first practical use of the carrier principle.

Although American involvement in World War I lasted less than two years, radio managed to overhaul the way the American military communicated. And the greatest impact of the war on radio was probably the demonstration that radio communications were feasible. Many theoretical problems had been overcome with empirical solutions. Theory could be developed later.

### Patent problems hinder radio's growth

The war made clear that one major hurdle remained before radio could proceed as rapidly as technology would allow. Before the war, inventors all over the world had applied for or received patents that were fundamental to the development of the art. Many claims were either conflicting or overlapping. The need to provide wartime equipment was so urgent that companies made their rights available to the government without question. But technological developments during the war produced even more patent claims. By 1920, the patent situation was, to put it mildly, chaotic. Determining which inventor had priority might take years, during which development would come to a standstill for fear of future penalties for unwitting patent violations.

Earlier, the U.S. government, motivated largely by concern for military communications, was contemplating domination of the airwaves. In November, 1916, Congress was considering a plan worked out by an Inter-Departmental Committee on Radio Legislation that would authorize the Navy to operate stations in competition with private firms—even in peacetime. But the plan never went into effect. The armed forces took over radio on a wartime-emergency basis only.

After the war, the government worked to prevent foreign interests from dominating radio. Ironically, the largest wartime supplier by far to the government had been the American Marconi Co., whose majority stockholders were in England. The company's liaison with the American military had been the former Wanamaker wireless operator, David Sarnoff.

Three months after the armistice, representatives of Marconi's company in England came to Schenectady, NY, to negotiate with the General Electric Co. for access to GE's patents on the Alexanderson high-frequency alternator. Sarnoff, after studying all existing methods for sending electromagnetic signals, had reported that the one based on the Alexanderson alternator was "most likely to survive." Marconi wanted this advantage in the race for leadership in radio.

At the request of the U.S. government, however, GE broke off negotiations with Marconi. In return for this financial loss, as well as in recognition of the importance of the Alexanderson patents, the government proposed that GE take the initiative in assembling an all-American firm that would be financially and technically strong enough to bid for both domestic and world primacy in radio communications. At the



time, GE and its chief competitor in manufacturing electrical equipment, the Westinghouse Electric and Manufacturing Co., had little interest in radio except as a market for the equipment they were already producing. The other firm most involved in radio, AT&T, was concerned only with using radio patents in its wire-transmission system. Ironically, again, the one real radio organization in existence was American Marconi.

### The Radio Group coordinates efforts

On December 1, 1919, General Electric acquired majority ownership of American Marconi, and a new corporation came into being. The Radio Corp. of America would handle marketing and communications services. GE would handle all manufacturing of radio equipment. Alexanderson became RCA's chief engineer, and Sarnoff manager of its commercial division.

The patent stalemate was still a major problem, though. In February, 1920, the government had restored the patents commandeered for the war effort. But no one group controlled enough inventions to make a complete ensemble for transmission and reception. The Bell group—AT&T and its manufacturing subsidiary, Western Electric Co.—had been accumulating patents for 10 years. So had Westinghouse, International Radio Telegraph Co., United Fruit Co., and many others.

After GE signed cross-licensing agreements with Bell, Westinghouse concluded a deal with International Radio Telegraph and acquired from Edwin

Armstrong rights and licenses for inventions sorely needed by RCA. Then, in an agreement effective mid-1921, Westinghouse made its patents and licenses accessible to GE and RCA in return for a 40% share in any manufacturing for RCA. In March, 1921, United Fruit—which wanted radio for communications between plantations, warehouses, transport fleets, and the home office—joined the Radio Group.

One of the first projects of this corporation was Radio Central, an array of radio installations that would eventually cover 10 acres of Rocky Point, Long Island. The first segment of the project opened in November, 1921, with one spoke of the final antenna intact and driven by two pairs of 200-kW Alexanderson alternators. When Radio Central was completed just two years later, the massive alternators could be replaced by new vacuum tubes developed by General Electric. The apparatus that had precipitated the formation of RCA became obsolete.

### Broadcasting is a far-out concept

All this time Sarnoff was pressing to develop another of his ideas, one that might be called his consuming passion. He had made his first formal presentation of the concept back on September 30, 1915, in a memo to Edward J. Nally, vice-president and general manager of American Marconi:

I have in mind a plan of development which would make radio a "household utility" in the same sense as the piano or phonograph. The idea is to bring music into the house by wireless.

A radiotelephone transmitter having a range

## Studying static from space

While most radio engineers were searching for ways to eliminate static from their transmissions, others were hard at work looking for static and tracking down its sources in outer space. The earliest studies of radio waves from sources outside our solar system were made in the 1930s by Karl Jansky, a researcher at Bell Laboratories in New Jersey. He found that some of the noise that is always behind a radio broadcast came from beyond the earth's atmosphere.

Intensive investigation of extraterrestrial radio waves had to await the advances in electronics that took place during World War II. Dish antennas designed for radar could then be pressed into service in radio astronomy.

New kinds of astronomical phenomena have been uncovered by radio astronomy's ability to track signals without the distortion to visible light caused by the earth's atmosphere. In 1962, Australian radio astronomers studying a radio source called 3C-273 found its output spectrum to be different from other similar stars. They determined that it was located 1½-billion light-years from earth. And while it was too

small to be a galaxy, it was too bright to be a star. It was the first quasi-stellar object—quasar.

Late in 1967, astronomers at Cambridge University in England discovered an even more interesting phenomenon—pulsars. Graduate student Jocelyn Bell noticed a "regular irregularity" in the output from one point in space. A series of pulses, at first thought to be some form of local noise, was determined to be coming from stellar objects, perhaps neutron stars.

The black-hole theory, which states that a star can collapse enough to form a mass so dense its gravitational pull will keep anything—particles, radio waves, and light included—from escaping, gained some credence in 1970, when the United States launched a satellite and detected X-ray sources in space. One source was identified as a two-star system, one star a visible supergiant and the other invisible but far too massive to be a neutron star.

Black holes may also explain quasars. Enormous black holes might produce enough energy by pulling other matter into themselves to account for the energy emitted by quasars.



of, say, 25 to 50 miles can be installed at a fixed point where instrumental or vocal music or both are produced. All the receivers attuned to the transmitting wavelength should be capable of receiving such music. The receiver can be designed in the form of a simple "Radio Music Box" and arranged for several different wavelengths.

The power of the transmitter can be made 5 kilowatts, if necessary, to cover even a short radius of 25 to 50 miles, thereby giving extra-loud signals in the home if desired. The use of head telephones would be obviated by this method. The development of a small loop antenna to go with each "Radio Music Box" would likewise solve the antenna problem.

Aside from the profit to be derived from this proposition, the possibilities for advertising for the company are tremendous, for its name would ultimately be brought into the household, and wireless would receive national and universal attention.

The concept of commercial broadcasting wasn't new. As far back as 1877, Alexander Graham Bell had transmitted music by wire and had promoted his invention by demonstrating transmissions to an audience assembled in an auditorium. The Bell System had developed and used a loudspeaker for telephones in 1908, and added high-power microphones a few years later to form a primitive public-address system.

On Christmas Eve, 1906, Reginald A. Fessenden spoke from his laboratory at Brant Rock, MA, to shipboard wireless operators off the New England coast. Lee De Forest experimented with broadcasting from New York in 1907, but commercial broadcasting had to wait for improvements in vacuum tubes.

While Sarnoff dreamed of broadcasting, probably the first to broadcast on a regular basis was Frank Conrad, an employee of Westinghouse in Pittsburgh. He transmitted from his home via amateur station 8XK. Westinghouse took over Conrad's activities with a commercial station licensed as KDKA. Service was inaugurated on November 2, 1920, with returns of the Harding-Cox presidential election. Nevertheless some give credit for being the first commercial station to the *Detroit News*, which originally operated under an amateur license, later became WWJ, and began operation on a fairly regular basis some 10 weeks before KDKA.

Meanwhile, AT&T was getting involved in broadcasting. On February 11, 1922, the telephone company announced a new service—"toll broadcasting." AT&T would provide no programs of its own, but would permit anyone to lease its facilities for a fee. The station, WBAY, began operating from the company's long-distance building at 24 Walker Street in New York City on July 25, 1922, on a frequency of 830 kHz. It shared time with 10 other stations on the same frequency. Radiation problems at Walker Street eventually forced AT&T to move the station to the Western Electric Engineering Laboratory at 463 West Street,

where a similar experimental station, WEAFF, had been established.

Network broadcasting began as an experiment on January 4, 1923, when WEAFF and Boston's WNAC, which would later figure in the development of FM, were interconnected by wire to broadcast the same program.

Technical changes were also taking place. In May, 1923, WEAFF began broadcasting on 492 m (610 kHz). In 1924, a crystal-controlled master oscillator was introduced to reduce frequency-drift distortion and improve fidelity in areas where multipath transmission caused signals of poor quality.

AT&T soon decided to leave the broadcasting busi-

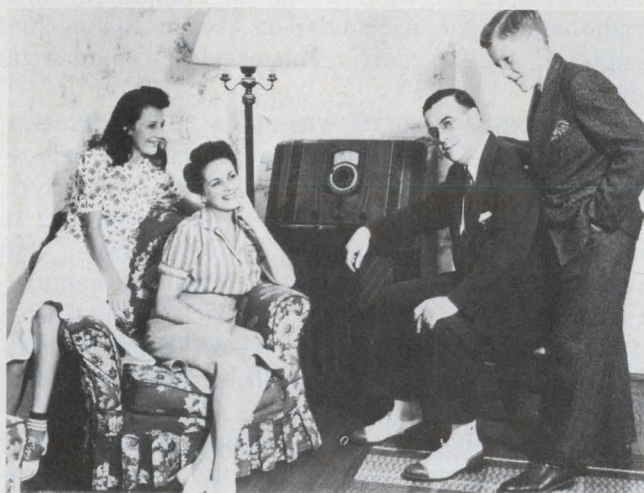

**1930s—Millions gathered 'round their radio sets to hear Franklin Delano Roosevelt's "Fireside chats," presidential addresses that changed the style of political oratory and boosted sales of radios during the Great Depression. The first broadcast took place on March 12, 1933, eight days after FDR's first inauguration.**

ness and concentrate on manufacturing equipment, and sold WEAFF to RCA. In October, 1926, WEAFF became the flagship of RCA's fledgling National Broadcasting Company.

#### **Even more gain is added**

Back in 1921, Armstrong had made another important breakthrough—an extension of the feedback principle that permitted even greater amplification. Battling De Forest over conflicting patent claims on the audion and regeneration, Armstrong one night set up one of his original regenerative circuits in his Columbia University laboratory to bring into court the next day to refute an opposing lawyer's statement. Momentarily, the circuit produced a signal far beyond what Armstrong expected. After weeks of further investigation, Armstrong pinned down the phenomenon he named "superregeneration."

The regenerative circuit was allowed to amplify beyond the point where the tube became an oscillator.



Then a second "quenching" tube cut in to suppress the oscillations. Operating at 20 kHz, the quenching tube was inaudible to the listener, yet allowed the basic circuit to amplify to 100,000 times the original signal. Armstrong's patent on the circuit was granted in July, 1922, and he was to receive more money from this invention than from any of his others.

With all the publicity being given the super-regenerative circuit, RCA was eager to buy the rights and beat back increasing competition. Small companies were introducing receiver improvements so fast that RCA's manufacturing partners, GE and Westinghouse, couldn't keep up.

Earlier, RCA had managed to hold competitors to licenses on regeneration, while moving ahead with the superheterodyne. But a group of independent manufacturers had gone to L. Alan Hazeltine, a professor at Stevens Institute of Technology in Hoboken, NJ. The circuit he developed evaded the RCA patents.

Hazeltine's circuit, the neutrodyne, eliminated the major problem with regenerative circuits—their propensity for falling into oscillation and emitting unpleasant moans and howls. And because it was relatively inexpensive and performed well, the neutrodyne quickly gained in popularity. But RCA hoped Armstrong's new superregeneration circuit would hold off the competition again while the superhet was being developed into the Rolls-Royce of receivers.

In June, 1922, RCA gave Armstrong \$200,000 in cash and 60,000 shares of RCA stock, which made him the largest individual stockholder in the company and eventually netted him far more than his first two inventions combined. Armstrong agreed to let RCA know about any future inventions and to give the company first option. This option was not to be important for nearly 15 years. But then it became *very* important.

As it turned out, superregeneration couldn't live up to the expectations of its many admirers. Despite its spectacular amplification and other virtues, it had one overwhelming drawback: lack of selectivity. It couldn't separate stations close in frequency—and nothing could be done to solve the problem. Superregeneration was used for police radio, ship-to-shore and emergency mobile services, and other applications where a powerful, light receiver could operate on well-spaced high-frequency channels.

Armstrong did, however, put the finishing touches on the superhet, and demonstrated a receiver in David Sarnoff's apartment in New York City early in 1923. Sarnoff's reaction was to cancel millions of dollars in orders for older type sets already placed with GE and Westinghouse, and prepared to miss the 1923 selling season to splash the 1924 market with the new circuit. He was spurred to such drastic measures by rumors that AT&T, still in the broadcast business, was preparing to enter the set-making business as well, with a superhet of its own. With help from Armstrong, RCA solved the superhet's production-engineering problems and hit the stores with it in March, 1924.

The set made more money than any set appearing before 1927, when Westinghouse developed a superhet that could plug into house current.

As a result of his deals with RCA, Armstrong became a millionaire. His RCA stock was worth well over \$3-million. With judicious sales and reinvestment, Armstrong was to realize some \$9-million from his holdings, a modest sum compared with some of the fortunes made in the radio boom, but a phenomenal reward to an engineer and inventor.

### Armstrong takes on a new task

Even though he was at an age—44—when most would gladly rest and take advantage of wealth, Armstrong continued to labor. He received four patents the day after Christmas, 1933, on a completely different radio-signaling system. Filed separately between July, 1930, and January, 1933, the four patents should have left no loopholes for other possible interference proceedings.

Few were paying attention, but the patents incorporated a unique solution to the last basic problem in radio: static. The answer was frequency modulation.

Static had plagued radio from the beginning. Many scientists had tried—and failed—to overcome it. Armstrong, in June, 1914, had tried a "receiving apparatus with arrangements for eliminating static by means of a revolving field caused by the interaction of the incoming signal and a local current of different frequency." It didn't work.

"The biggest problem that I can see is the elimination of static," Armstrong said in 1922. "That is a terrific problem. It is the only one I ever encountered that, approached from any direction, always seems to be a stone wall. I suppose, however, that static will be done away with, sometime."

In 1927, Armstrong presented a paper to the Institute of Radio Engineers proposing a scheme to send out two waves of slightly different frequency in rapid alternation, so that static bursts would tend to interfere with only one or the other. Like other ideas, it was unworkable. Armstrong didn't know it yet, but two years earlier he had come upon the idea that would eventually solve the problem. The effects of static could be overcome only by employing a radio wave different in character from the electrical waves that static produced.

As early as 1915, Armstrong had conducted a series of experiments proving that the bulk of natural electrical disturbances was produced by waves varying in amplitude or power just like the modulated waves of radio. On any standard radio receiver, static could not be eliminated. Any device that passed amplitude variations passed static. Transmission had to depend on a parameter other than amplitude.

Frequency modulation had been tried before. But investigators had treated FM waves like AM waves. Since AM waves propagated most efficiently when



they were held to a narrow band of fixed frequencies, they thought FM waves should do the same. But on FM, narrow-band signals produced nothing but distorted tones, which led experimenters to discard FM as unsuitable for intelligible radio communications.

Here Armstrong achieved his breakthrough. Instead of transmitting waves over a narrow band of frequencies, he allowed them to swing over a very wide band. He found a clarity and lack of distortion and interference unknown in AM.

"The invention of the FM system gave a reduction of interfering noises of hundreds or thousands of times," Armstrong said. "It did so by proceeding in exactly the opposite direction that mathematical theory had demonstrated one ought to go to reduce interference. It widened instead of narrowed the band. And it employed a discarded method of modulation which also, in learned mathematical treatments, had been demonstrated to be totally useless or greatly inferior to amplitude modulation."

The basic concept of FM trades frequency space for signal-to-noise ratio. The power gain of s/n increases as the square of the bandwidth. But developing appropriate hardware was far from simple.

All the original research and development of FM were carried out in basement laboratories of Philosophy Hall at Columbia. Armstrong supplied all funds for equipment and assistants' salaries, and bore all overhead expenses beyond the maintenance of working quarters, power and light.

The problem was to develop a transmitter that sent out a new type of wave, exactly opposite in nature to the wave then in use for radio. Instead of being variable in crest or depth, the FM wave was variable in frequency. Armstrong's solution included a highly stable crystal-controlled oscillator whose waves were modulated by phase shift. The wider the frequency swing of the waves, the less they were affected by natural static, which had a much narrower frequency range.

In another of Armstrong's FM patents, he described the receiver necessary to make the system work. The basis was the superheterodyne, plus two special stages that were the key to FM reception. The first stages of the receiver heterodyned the incoming FM waves to an intermediate frequency. The amplified waves passed through a limiter that clipped off any amplitude variations, including static. A discriminator converted the original frequency variations to amplitude variations, ready for detection and amplification by the usual final stages of a superhet receiver.

Armstrong's system was demonstrated publicly—and unexpectedly—on November 5, 1935, when he presented his classic paper, "A Method of Reducing Disturbances in Radio Signaling by a System of Frequency Modulation," before the IRE in the auditorium of the Engineers Building on 39th Street in New York. The final testing and tuning of the transmitter were completed just half an hour before

the meeting.

But the transmitter burned out while Armstrong was reading his paper. So Armstrong had to conduct an ad lib discussion until he got the signal that all was ready. Then he announced: "Now, suppose we have a little demonstration." The loudspeaker crackled as the receiver tuned near the station, then fell silent. Suddenly the voice of one of Armstrong's aides, Randy Runyon, came through: "This is amateur station W2AG at Yonkers, New York, operating on frequency modulation at two and a half meters."

Waves of 2½ meters, 110 MHz, were considered too short and weak to carry a message across a street, much less nearly 20 miles. And, more important, the signal was so clear and undistorted that water poured from a glass didn't sound like a waterfall, or a crumpling paper like a forest fire, as on AM. The secret lay in a signal-to-noise ratio of 100:1, compared with 30:1 on the best AM stations. Shortly, Armstrong improved FM s/n to 1000:1.

### Struggling to prove a point

Where Armstrong's earlier inventions had been accepted by a new industry eager for improvements, his latest creation faced a long, hard struggle. Established firms wanted no part of a revolutionary concept that threatened existing stations. The "new" radio industry had grown, even through the dark days of the Depression, to a half-billion dollars a year.

Armstrong had already brought FM to RCA's attention as a result of his earlier contract requiring that he disclose any new inventions. RCA, by reason of the large royalties it had collected on radio patents and the large research laboratories these had built, was the logical company to undertake the expensive development of a new invention for the industry. But RCA was wary. In the spring of 1934, Armstrong set up an FM modulator in the Empire State Building with a 2-kW, 44-MHz transmitter, already installed for TV experiments, acting as a power source. The receiver was installed at Westhampton Beach, Long Island, 70 miles away.

In test after test through early summer, static-free reception was recorded through some of the heaviest thunderstorms of the season—storms that made AM broadcasts totally unlistenable. And contrary to theory, FM vhf transmission of signals wasn't limited to the horizon, but showed clear reception over at least three horizons—about 80 miles. On November 24, 1934, Armstrong broadcast two programs from the NBC networks, a facsimile reproduction of the front page of that day's New York Times, and a telegraph message—all on one carrier—to show that an FM system was capable of tying together all types of communications.

For nearly two years, Armstrong had given RCA exclusive information about his invention, and had been left dangling. When he finally made his invention public, RCA responded by announcing it was ready





**1977—Selective calling in the latest citizens' band transceivers**, like this Texas Instruments unit, aims toward eliminating the last handicap of radio transmission—lack of privacy.

to develop electronic television with an initial expenditure of \$1-million. It made no mention of FM, and removed his experimental gear from the Empire State Building.

Armstrong set out to prove FM could work by building an experimental broadcast station in Alpine, NJ, on the palisades opposite New York. Characteristically, Armstrong designed the highest antenna mast he could envision for the new station, designed to meet any future research needs. When completed, the mast rose 400 feet, with three cross arms, and catwalks at the top.

To eliminate even the small noise still remaining in his FM signals, Armstrong employed pre-emphasis and de-emphasis, which boosted highs in transmission and cut them in reception to minimize high-frequency hiss.

One broadcaster who followed these developments was John Shepard III, owner of WNAC in Boston—the pioneer station in network radio—and of the Yankee Network. As Armstrong's antenna went up in Alpine, Shepard built FM transmitters in Mount Asnebumskit, 50 miles west of Boston, and on Mount Washington, NH.

Armstrong finally got the Alpine station on the air with full power early in 1939, and proceeded to show the superiority of FM broadcasting. It had cost the

inventor well over \$300,000 to prove his point.

On July 18, 1939, the Alpine station, W2XMN, began regular scheduled broadcasts. General Electric had been commissioned by Armstrong to build 25 FM receivers at his expense, and then asked Armstrong for a manufacturing license.

But where World War I had spurred the growth of AM, World War II temporarily stunted FM's growth. The FCC ordered FM broadcasters to vacate the 44 to 50-MHz band and move to 88 to 108 MHz by 1944, instantly making all FM transmitters and receivers obsolete. With the coming of peace, public attention turned not to FM, but to television. By 1953, many of the original FM licensees had given up. Armstrong's wealth was gone, spent on experiments and on a drawn out patent fight over FM with RCA.

Shortly after midnight of January 31, 1954, Major Armstrong dressed as if preparing for an evening stroll, and stepped out of the window of his 13th floor apartment overlooking the East River in New York. For him, the battle for FM was over.

On March 6, 1954, W2XMN went off the air after 16 years. But in that same month, the British Broadcasting Co. announced it was building a high-fidelity FM network to cover Great Britain. West Germany was actually in the process of building an FM network of over 100 stations, and in December, 1954, the FM infringement suit brought before the war against RCA was settled by the Armstrong estate.

### FM rebounds vigorously

The FM band began slowly climbing out of its doldrums shortly after Armstrong's death. The FCC augmented this growth, as if to rectify some of its past actions and mistakes, by authorizing FM stereo broadcasting in 1961. Perhaps nothing would have thrilled Armstrong more than the installation, in 1965, of a master antenna capable of transmitting the signals from 17 New York FM stations simultaneously. The antenna stood atop the Empire State Building, where 30 years earlier his test station had been evicted to make room for television.

FM's growth was so rapid that by the 1970s it was pulling ahead, and AM broadcasters were beginning to feel the economic effects of lost listeners. The FCC is now receiving repeated requests for permission to broadcast stereophonic sound on the AM band as a means to achieve some level of equality. A decision should be reached soon.

AM radio, of course, hasn't gone away, and in fact is the medium for the latest craze in radio—citizens' band. With millions of transceivers in consumers' hands, CB is in the vanguard of yet another basic change in radio. With the latest digital circuits putting costs within reach, the day may soon come when a radio user can contact a listener by coded signals that others cannot decipher. This would remove what has always been considered radio's greatest disadvantage—lack of privacy. ■■



**Of the last 3,102,551 switches  
we shipped to a major appliance manufacturer,  
they rejected 86. Even MICRO SWITCH isn't perfect.**

That's a rejection rate of .003%. This kind of performance has earned us their Outstanding Vendor classification for 59 months running.

Unusual reliability like this isn't unusual at MICRO SWITCH.

Our people feel quality is everyone's responsibility, not just our inspectors'. So defects aren't simply sought and eliminated. They're prevented from occurring. The result is what we call the Quality Assurance Program.

Naturally, every product is thoroughly tested and evaluated before it ever goes into production.

To further insure that nothing can go wrong, we actually manufacture most of the parts that go into our products.

And even after they've been in production for years, MICRO SWITCH products are being tested to see that their quality manufacturing standards remain constant.

As a result, we have so much



faith in our quality assurance, we guarantee our products a full 18 months—the industry standard is only 12.

You see, when you buy a MICRO SWITCH product, you're buying more than a component. You're buying a company. A company



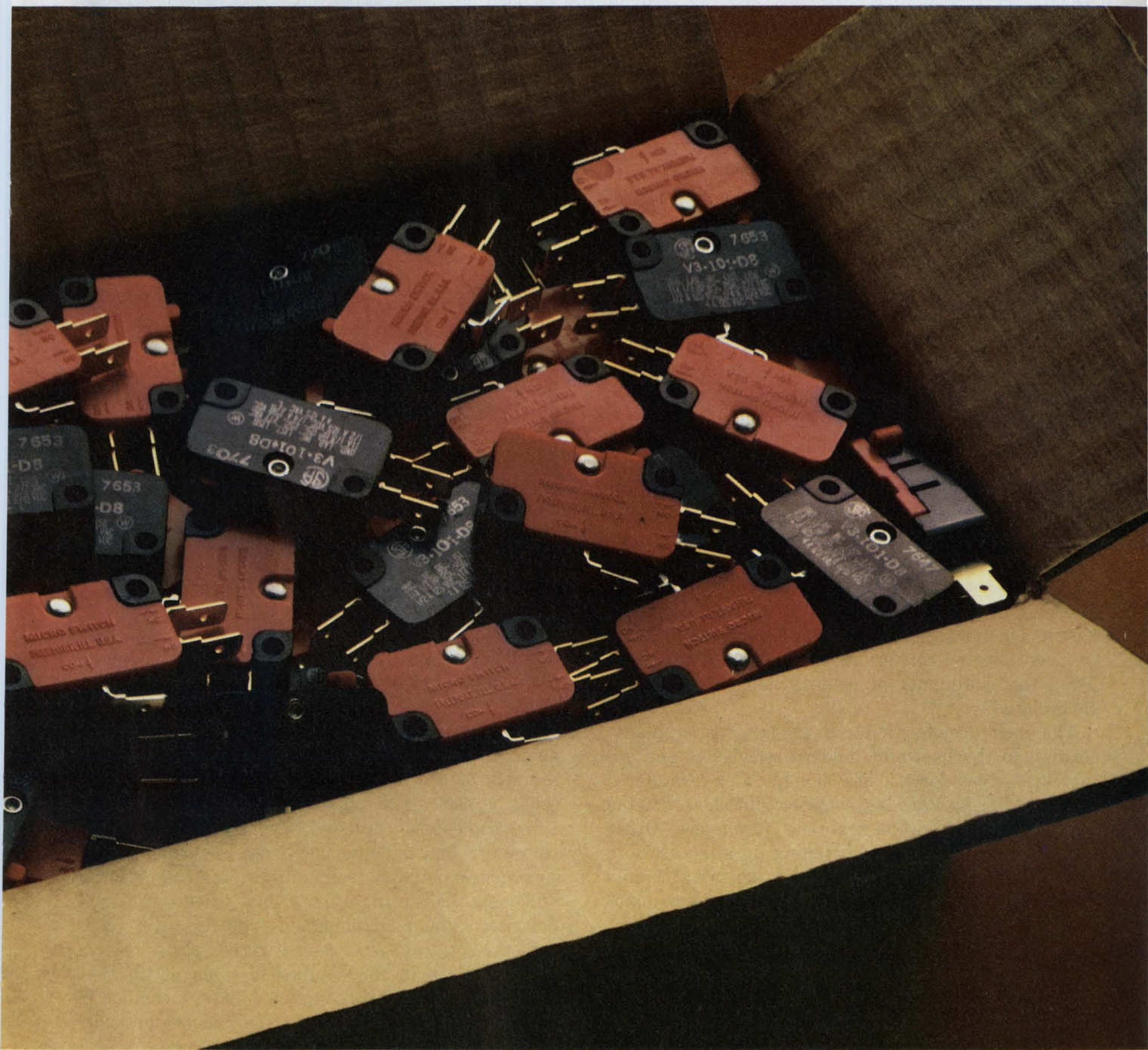

with capabilities to help solve your problems. Whether through research and development. Innovation. Availability. Reliability. Or Quality Assurance.

MICRO SWITCH. Consider what it would cost to have anything less.

For more information, write for our Quality Assurance booklet.

MICRO SWITCH, Freeport, Illinois 61032. Or call 815/235-6600.

MICRO SWITCH products are available worldwide through Honeywell International.

**MICRO SWITCH**  
**Can you afford anything less?**



# Television

**F**ive minutes into "Mary Hartman, Mary Hartman" and a resurrected Roger Bacon surely would return straight to the crypt, perhaps disoriented by the content but marveling at the technical realization of his thirteenth-century notion of "seeing at a distance."

Bacon was dead six centuries before his fantasy began to come true. Two events in the 1870s—the discovery of the light properties of selenium and the invention of the telephone—paved the way.

Talk of "electrical vision," or telectroscopy, came fast and furious after the selenium discovery. Numerous schemes with selenium as the pickup element were proposed over the next 10 years. It was soon suggested that an incandescent element could act as the converse of selenium and convert electrical signals into light. Thus the rudiments of camera and receiver were formulated.

The next decade produced various "paper plans" leading to the basics of modern television. The importance of persistence of vision (an idea formulated much earlier by Faraday) was recognized, as was the need for a minimum scanning frequency. Other "basics" were laid down: breaking up a picture into many elements at the sending end (scanning), transmitting each element individually after conversion to an electrical signal, then reconstituting the picture at the receiving end.

## Telegraphy showed the way

The principles of scanning and synchronism were already well established by the time selenium was proposed. Telegraphy was 30 years old in 1876, and telephotography—the sending of still pictures by wire—was actively practiced.

Sending continuously moving images was another story, however. The basic defects of selenium—slug-

**Stanley Runyon**  
Senior Associate Editor

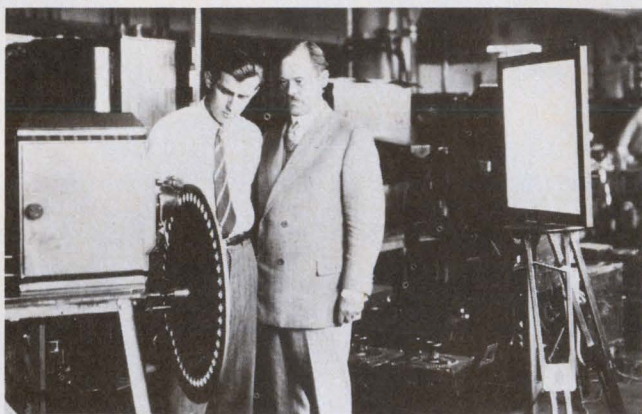

**1927—Mechanical television**, using Nipkow's spinning disc, dominated the early days of TV, starting about 1884. Dr. E.F.W. Alexanderson (right), the brilliant General Electric scientist, was an early pioneer.

gish response and poor sensitivity—thwarted many an experimenter, as did the lack of amplification and the lack of a brilliant light source whose intensity could be easily controlled with a varying voltage.

Experimenters persisted, nevertheless. In 1880, Alexander Bell patented a "visual telegraph" based on a voice-modulated beam of light, instead of wires. Following Bell's lead, activity intensified—on paper. Polarized light, electromagnetic shutters, Kerr cells and other optical systems—all were explored. Scientific American in 1880 published some of the new ideas, including spiral scanning. Indeed, a cartoon in *Punch*, the British humor magazine, had prophetically depicted a wide-screen TV the year before.

Finally, the scattered ideas from experimenters around the world found a home in the work of one man—Paul Nipkow, a German student of natural science, and the grandfather of television.

## The birth of the spinning disc

Like many solutions, Nipkow's system was technically sound, yet simple. He proposed that a scene be



imaged upon a rotating disc having a spiral arrangement of small holes on its surface. Behind the disc, a selenium cell would convert the light coming through the holes into a proportional electrical value.

As the disc rotates, the holes would scan the image, line by line. The cell would "transmit" a series of successive current values corresponding to the intensity of the elements within the imaged scene. Only one pair of wires, or one channel, would be needed between the transmitter and receiver.

At the receiver, Nipkow placed a light source, the intensity of which was varied by the arriving signal, and another disc identical to the one at the transmitting end.

To see the transmitted scene, a viewer would look at the light source through the holes in the disc. With both discs rotating in synchronism—in phase, and at the same speed—an observer would apparently see a reconstructed picture of the original scene, while actually looking at one element at a time. The scanning would be so rapid that the human eye would retain all picture elements until the last element had been transmitted.

For his elegant scheme, Nipkow was awarded a patent in 1885. Amazingly, he had built no actual hardware. And he never did. A short while later, the patent lapsed.

But the idea of television didn't. Over the next 30

## Roses are red, bananas are blue . . .

Color TV was field-tested during the dawn hours of the early 1950s, when the regular broadcast schedule was bedded down for the night. Transmissions were made from the NBC Studios in New York to the RCA Research Laboratories in Princeton, New Jersey.

Consternation reigned one morning when a bowl of fruit didn't have all the proper hues. "We can get the banana right," Princeton told New York, "but then the rest of the fruit is hopelessly off-color." Unknown to Princeton, a prankster had painted the banana blue.

## Whatever happened to channel 1?

Not many people question the absence of Channel 1 from their tuning dials. It hasn't been on American receivers since 1947. In 1937, the FCC established 19 six-MHz channels interspersed with other services in the region of 44 to 294 MHz. Space in the frequency spectrum was hotly contested, however, with proponents of television on one side, those in favor of the new FM on the other. Howard Armstrong, the father of FM, was at the head of those demanding allocation for FM. The FCC, under pressure, finally granted a thin slice—from 44 to 50 MHz—to FM broadcasting. That sliver—no longer used for FM—would have been Channel 1.

**1879**

First attempts at television with light-sensitive selenium cells.

**1884**

Paul Nipkow patents spinning-wheel, mechanical television system.

**1897**

Ferdinand Braun develops the cathode-ray oscilloscope.

**1907**

Boris Rosing proposes a mechanical transmitter combined with the Braun oscilloscope receiver.

**1908**

A. Campbell-Swinton proposes a CRT for both transmitter and receiver.

**1923**

Vladimir Zworykin patents the iconoscope camera tube.

**1925**

Jenkins in the United States and Baird in Great Britain transmit moving images.

**1927**

Live TV images are sent by wire from Washington, DC, to New York City.

**1929**

Zworykin demonstrates the kinescope, the first "modern" picture tube.  
Herbert E. Ives at Bell Labs demonstrates a color system.

**1940**

Dr. Peter Goldmark unveils the CBS field-sequential color system.

**1941**

FCC adopts the first NTSC standards for black-and-white TV.

**1942**

The image-orthicon tube is born.

**1949**

RCA invents the shadow-mask picture tube.

**1950**

The vidicon tube appears.

**1952**

The experimental transistorized TV set debuts.

**1952**

Color standards are adopted by the FCC.

**1953**

CBS invents the curved shadow-mask tube, the standard of today.

**1954**

Commercial color sets emerge.

**1960s**

TV picture tubes grow to 23 and 25 in.  
TV lands on the moon.

**1970s**

TV is used in communications, reconnaissance and weather satellites.  
All-solid-state TV cameras appear.



"All the News That's Fit to Print."

# The New York Times.

VOL. LXXVI, No. 25,276

NEW YORK, FRIDAY, APRIL 8, 1927.

TWO

## FAR-OFF SPEAKERS SEEN AS WELL AS HEARD HERE IN A TEST OF TELEVISION

### LIKE A PHOTO COME TO LIFE

Hoover's Face Plainly Imaged as He Speaks in Washington.

### THE FIRST TIME IN HISTORY

Pictures Are Flashed by Wire and Radio Synchronizing With Speaker's Voice.

### COMMERCIAL USE IN DOUBT

But A. T. & T. Head Sees a New Step in Conquest of Nature After Years of Research.

Herbert Hoover made a speech in Washington yesterday afternoon. An audience in New York heard him, and saw him.

More than 20 miles of space between the speaker and the audience was annihilated by the television apparatus developed by the Bell Laboratories of the American Telephone and Telegraph Company and demonstrated publicly for the first time yesterday.

The apparatus about 200 miles from New York by wire from Washington to New York at the rate of 100,000 miles per second. These wires...

### Voerhis Hopes When He Is 100 To Visit Smith in White House

Hope that he might celebrate his one hundredth birthday with Governor Smith in the White House was expressed yesterday by John R. Voerhis, veteran Grand Sachem of the Tammany Society and President of the Board of Elections. Mr. Voerhis will be ninety-eight years old next July and, if Governor Smith should be nominated for and elected President, his one hundredth birthday would occur in July, 1929, a few months after the inauguration.

"As far as I am concerned, it had as well be nominated," Mr. Voerhis said. "The opposition to him is diminishing, and the general sentiment for him is increasing. So far as I am concerned, it is too late to do anything about it."

Mr. Voerhis, who is still remarkably active, was seen at Tammany Hall. He stopped there on his return from a trip to Honesdale, where he is to inspect quarters now being built for the Board of Elections for the purpose of voting machines.

## \$840,000 FUR STRIKE AUDIT WAS HOPELESS

Accountants at Bribe Inquiry Testily Meagre Data Failed to Show Where Money Went.

## THEFT OF 300 PAPERS ON MEXICO REVEALED BY FORGERY INQUIRY

Secret Military Reports Among Documents Stolen in Wholesale Diplomatic Robberies.

### SOME WERE "DOCTORED"

Callies Turned Them Over to Us When It Became Known That We Knew He Had Them.

### SUBJECT OF MYSTERY NOTE

Many Papers Believed Stolen From Our Embassy in Skillful Plot—Washington Disclaims "Leak."

BY RICHARD V. DELAHAN, Special to The New York Times. WASHINGTON, April 7.—Differing of the United States government's confidential correspondence relating to Mexico has been established through investigation which dovetails with its subject matter of the "mystery note" directed to the Mexican Foreign Office recently by James B. Sheer, the American Ambassador in Mexico City.

This plotting is a conduct, wholesale scale, of nearly one hundred documents belonging to the State Department were stolen. Documents were turned over to the United States and turned them to the State Department. Included in this large "diplomatic papers" was a number of reports of a...

## Caruso Convicted of First Degree Murder; Killed Doctor After Death of Little Son

A jury in the Kings County Court last night brought in a verdict of guilty of murder in the first degree against Frank Caruso for the killing of Dr. Casper S. Pendola at Marpath in February.

Caruso, 26 years old and the father of five children, killed the physician when he found his 9-year-old son, Joseph, who was being treated by Dr. Pendola for diphtheria, had died.

The jury returned to the court room at 11:55 o'clock, after most of those who had listened all day to the trial had left the room. The defendant heard the foreman's announcement with little visible concern. He stood at the call of the clerk, walked a few steps forward and gave his pedigree in an even tone.

Caruso said he had been six years in this country. He was a native of Italy. He lived at 26 Third St. Brooklyn, and had been convicted of a \$100,000 note for a year and a half.

consideration you have given to this case. The verdict will make for law and order. Any other finding would have been a miscarriage of justice."

In summing up George Voss, attorney for Caruso, declared that the defendant was moved to the frenzy that resulted in the killing because Dr. Pendola laughed when he heard that Caruso's son had died following treatment for diphtheria. He told the jury that under the same circumstances they could have felt the urge to kill. He asked them not to convict Caruso with the cold-blooded gangster who murder with deliberation.

## SMITH APPROVES THEATRE PADLOCKS; VETOES GAS CUT-OFF

Governor Declares Majority of the People and Producers of the Stage

## SOVIET RAIDED NOW

Court R...

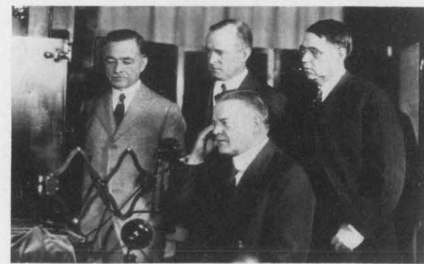

or 40 years, television mechanics developed to their practical limits. Vibrating and rotating discs, wheels and mirrors were experimented with. Refinements were made: faster and more sensitive photoelectric cells, General Electric's neon lamp, whose intensity could be modulated. But not until the 1920s did the first practical transmission of moving images take place.

Two men brought television to this next, crucial stage—C. Francis Jenkins in the United States and John Logie Baird (an underwear salesman turned inventor) in Great Britain. Both men based their work on Nipkow's disc, with Baird placing a glass lens in each hole in the disc, and Jenkins using glass prisms on two discs to scan a light beam across a subject.

### The first transmissions catch on

Baird's whirling discs were lapped up by the British public. A \$22 TV kit offered by Baird became the rage of the day. Never mind that the suitcase-sized kit offered a "peep-show" screen, only 1-in. high by 1/2-in. wide. Never mind that the orange and black images flickered and faded in and out. Never mind the need to stay up after midnight, when London radio went off the air, and the BBC broadcast a video signal on the audio band. The "telly" was a smash.

Other experimenters took up the cause. The Bell

1927—In the first public demonstration of long-distance television in the U.S. Secretary of Commerce Herbert Hoover, in Washington, DC, spoke to AT&T President Walter S. Gifford in New York City. The news electrified the world, but the N.Y. Times noted that the practical use of television was still "uncertain."

System, for one, led by scientists Herbert E. Ives and Frank Gray, developed a system based on the Nipkow disc. By 1927 the system was ready, and the first public demonstration of long-distance television in the United States soon took place.

Herbert Hoover, then Secretary of Commerce, talked from Washington, DC, to AT&T president Walter S. Gifford in New York City. The New York Times headline on April 8 read: "FAR-OFF SPEAKERS SEEN AS WELL AS HEARD HERE IN A TEST OF TELEVISION." A subheadline stated: "COMMERCIAL USE IN DOUBT."

Although the Bell system filled an entire room with equipment, it had one redeeming quality: the postage-stamp receiver gave way to a special neon glow lamp bent back and forth to cover an area of 2 x 2 1/2 ft. Snaking out of the lamp were 2500 wires, each one lighting an individual neon element in sync with the scanning disc. The lamp was a glassblower's nightmare—but the "peep-show" era was over.

Building a working television was not enough. The problems of transmitting a wide-bandwidth signal had to be worked out—a serious difficulty in an era that didn't know of coaxial cables. Harry Nyquist and others at Bell found a way to load and equalize a line to keep it phase-linear over the expected frequency range. The sound and synchronization signals were sent over separate lines. Only two weeks after the 1927





**1928—America's first television star**, a blurry Felix the Cat, whizzed from RCA studios in Manhattan to awe the folks in Kansas, in tests of early pickup devices and primitive 60-line receivers.

demonstration, it was found that the picture and sound could be transmitted together without distortion or cross-modulation.

Just one year later, the General Electric Co.—which was investigating television under the leadership of Dr. E.F.W. Alexanderson—began regular television broadcasting in Schenectady, NY. When Jenkins opened a station in Washington, DC, the floodgates parted. As more stations hit the air waves, more people began to watch. A large-dimension system finally brought outdoor scenes, televised by daylight. And in 1929, colored images—from a three-color, three-channel system—were shown.

### The CRT enters the picture

The cry went up for better pictures, but mechanical TV had no more answers. Indeed, the seeds for an all-electronic system had been planted as far back as 1897, when Ferdinand Braun invented the cathode-ray tube.

Even while mechanical TV was under intensive investigation, the cathode-ray was being explored. A marriage of the Nipkow disc and the CRT was suggested by some. Others saw ahead to all-electronic television. A few—like Baird—expressed no faith in the CRT.

A Scottish-born electrical engineer, Alan Archibald Campbell-Swinton, knew of Braun's work. Campbell-Swinton, who launched Marconi on his career, realized that the CRT could act as a receiver and, in a flash of inspiration, saw that the CRT could work along with pickup photocells to store and convert light to an electrical signal. In 1911, he patented the basis of a television system.

"It is an idea only, and the apparatus has never been

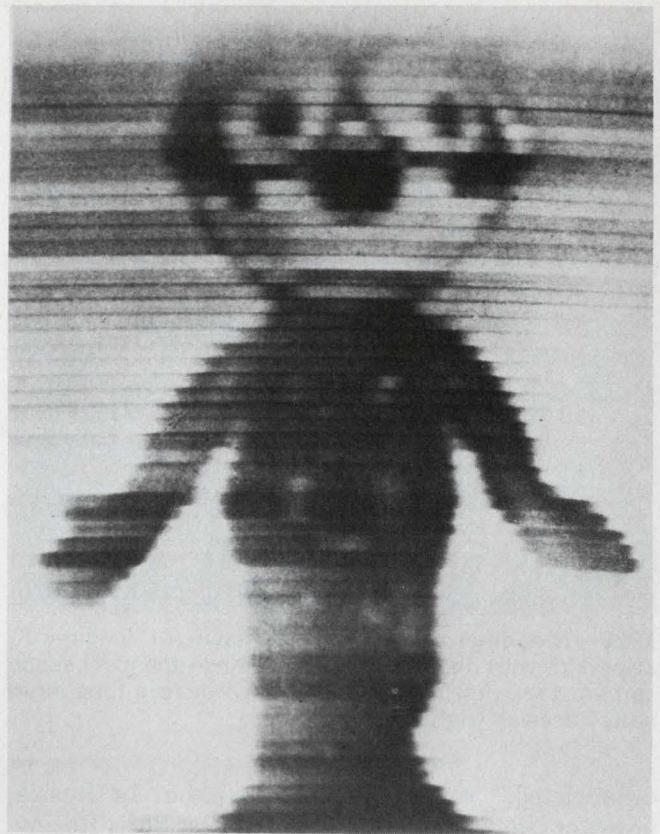

**1928—"And now, station W2XBS presents..."** Experimental broadcasting (over wire) didn't wait for such "unessential" items as pickup and picture tubes, amplifiers, and other electronic circuitry.

### Happy birthday, dear General

One man can be labeled both the guiding light behind the development of television and television broadcasting and its beneficiary: the late David Sarnoff, the legendary "General" of RCA. In 1948, Sarnoff was certain that no existing color system was acceptable and that a fully compatible system had to be invented.

To RCA engineers, Sarnoff's conviction meant that another item would be added to the list of presents—technological innovations "given" to the General on his birthday each Feb. 27. It also meant that the full resources of RCA would be placed behind the effort. And they were—to the tune of about \$130-million.





**1929—The father of electronic television, Dr. Vladimir K. Zworykin, with his two basic inventions—the iconoscope camera tube (left) and the kinescope picture tube in an early receiver (right).**



constructed,” wrote Campbell-Swinton. In Russia, however, someone did build hardware: Boris Rosing, a professor at the Petrograd Technological Institute, designed the CRT into a receiver. Although the primitive system didn’t work well—like Campbell-Swinton, Rosing had poor photocells and no amplifier—the experiment fascinated one of Rosing’s students: Vladimir Zworykin.

The young man’s enthusiasm proved to be a lucky stroke of fate for television. When the Russian Revolution erupted in 1917, Rosing was arrested (he died in exile). Carrying his teacher’s “technology” with him, Zworykin wandered around Russia to avoid arrest. Eventually, he was able to sell an American diplomat on the importance of television, and a visa was granted.

Once in America, Zworykin went to work for Westinghouse. But the company didn’t foresee much of a future for television. Zworykin was advised to find other things to occupy his time. Only after Zworykin left the company (he returned 18 months later) was he free to pursue his experiments. Even then, after he had demonstrated a crude—but working—TV system, Westinghouse remained cool.

Just four years later, in 1923, Zworykin patented the one ingredient needed to complete an all-electronic television system—the iconoscope camera tube. Nipkow’s disc spun no more. The kinescope followed a year later. It was a receiving cathode-ray tube that began its life with most of the principal characteristics of the modern picture tube.

### **RCA becomes TV’s guiding light**

Zworykin’s work wasn’t entirely ignored. David Sarnoff—then a vice president at RCA—was watch-

ing. It wasn’t long before Zworykin moved to Camden, NJ, to direct RCA’s Electronic Research Laboratory. Now Zworykin could concentrate on television. By 1931, Zworykin’s RCA team had greatly improved the sensitivity of the iconoscope.

Between 1930 and 1939, RCA spent more than \$2-million on patents and litigation. Another \$7-million went into development. Television was “digging in,” and not just in the United States. In Great Britain, Isaac Schoenberg and his team were working on CRTs at a company called Electrical and Music Industries. In 1936, the British Broadcasting Corporation began scheduled TV programming.

Others were busy. In America, Philo Farnsworth, a self-taught inventor, patented the ancestor of the modern camera tube—the image dissector. Allen B. DuMont in New Jersey and Baron von Ardenne in Germany also investigated the CRT’s possibilities.

The search for better pickup tubes during the 1930s boiled down to a neck-and-neck contest between young Farnsworth and Zworykin. In Farnsworth’s image-dissector tube, an optical image was focused onto a photoemissive plate to produce an electron “image,” which was then swept across an aperture. In effect, the tube sequentially samples the electron flow from each picture element to obtain a video signal.

Farnsworth’s approach, while brilliant, had one serious shortcoming: Even after signal amplification by an electron multiplier, the dissector was extremely insensitive. Too many electrons were wasted: Only those sampled at one moment by the scanning aperture were collected.

Theoretically, Zworykin’s iconoscope was far more sensitive. It detected, or integrated, the total charge emitted by each element during a 1/30-s scanning period. Light was imaged onto a photoemissive





**1939—The first godfather?** Nope. Chairman J.L. Fly and members of the FCC inspect newly developed, "light-weight portable" field equipment, weighing one-tenth that of the only other available unit.



**1939—Television was a smash** at the New York World's Fair, and crowds lined up to see President Roosevelt on RCA's new sensation. The age of television was dawning.

mosaic, in effect, an array of capacitors on a sheet of mica. The signal formed on a conducting plate on the back of the mica when an electron beam swept across the photoemissive surfaces and consequently discharged the capacitors.

### Better tubes, better broadcasts

But the iconoscope's sensitivity was hindered in practice by unexpected secondary electrons produced by the high-velocity scanning beam. Charge distribution was such that the black level of the transmitted image was nonuniform from center to edges. Nevertheless, Zworykin had helped make it clear that storage was a necessary feature of pickup tubes if normal illumination were to be used.

Interestingly, the image dissector survived, and is still used—in special applications. The iconoscope, used for movie-film pickup until the 1950s, is now obsolete.

The search for improved pickup tubes went on, and 1939 brought the low-velocity orthicon. A few years later, the more stable image orthicon was born. Low-energy electron optics was mastered and made part of almost all subsequent pickup tubes.

Work on the image orthicon was spurred by military

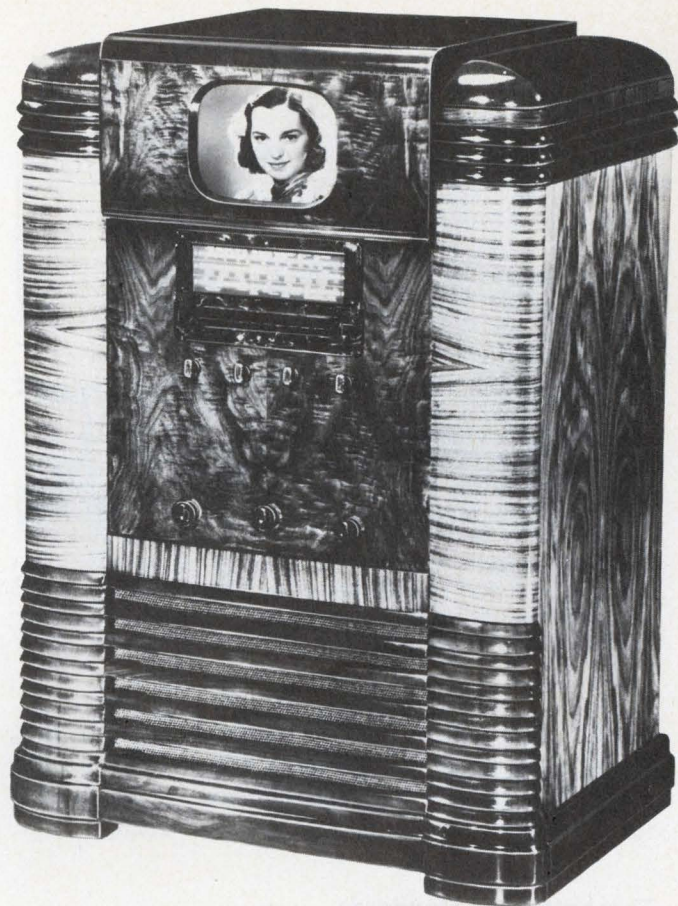

**1939—Compare this set with a modern receiver.** It's RCA Victor's Model TRK-9, a 9-in. model that boasted 12 vacuum tubes and included a three-band, all-wave radio chassis. It cost \$450 in 1939.

concerns. The world exploded into World War II, and television looked promising for reconnaissance and bomb guidance. A miniaturized image orthicon found its way into test bombs guided from an attacking plane. After the war, at a press conference called to announce the image orthicon, Ben Grauer, the renowned announcer for RCA's National Broadcasting Company, labeled the tube "the atom bomb of television."

Despite the lack of sensitive tubes in the 1930s, experimental broadcasting flourished. Farnsworth produced live shows, and NBC had been transmitting from the Empire State Building since 1932. Not to be outdone, fledgling CBS followed suit from the Chrysler Building in New York. CBS ran into an immediate problem—ice falling from its antenna showered unexpected hailstorms on those below.

Another problem was a bit more difficult to solve. The only cameras then available were made by Farnsworth and RCA. Since Farnsworth's needed too much light, CBS had to buy from RCA, already a giant and soon to be CBS' archrival. (CBS was so new, President Roosevelt had to ask "what the letters stood for.")

Even before scanning and electronic systems were developed it was clear that havoc would result if all



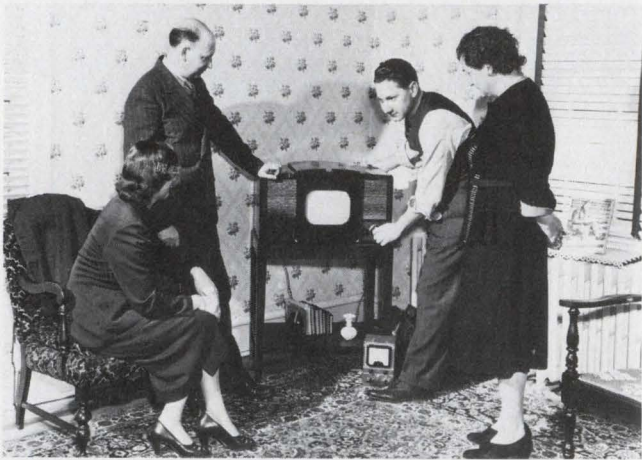

**1946—Television invaded the home** in a big way after World War II, and servicemen installing the Model 630TS—the first mass-produced receiver—became a common neighborhood event.

transmitters and all receivers weren't alike. In fact, the earliest paper on standards appeared just a few years after the first separate demonstrations of half-tone images by Jenkins and Baird in 1925.

### The battle for standards

The cry for industry-wide standards got louder in 1935 when RCA demonstrated a fully electronic system using 343 scanning lines. Spurred by the demonstration, the Radio Manufacturer's Association (RMA) established a committee to work on television standards.

In 1936, just 11 years after the first half-tone TV image, the committee presented its first proposals: 441 lines; 2:1 interlaced scanning at 30 frames per second; an aspect ratio of 4 by 3; double-sideband, negative-picture modulation; 2.5-MHz video bandwidth; and frequency-modulated sound.

The RMA worked to augment its initial proposals. In 1938, it presented the completed standards to the FCC—which promptly ignored them and announced that it would authorize limited commercial operation of television stations. Public hearings were scheduled for early 1940.

RCA-NBC jumped the standards gun with its experimental station in New York and its extensive campaign, beginning at the 1939 World's Fair, to capture the public's imagination—and pocketbook. Limited production of receivers began in January of 1939, with the proposed RMA standards. But RCA's principal competitors then—Zenith, Philco and DuMont—had their own ambitions, and took issue with technical aspects of the "standard."

The FCC got the message. In 1940, it rescinded its limited commercial operation of TV stations and stated that standards would not be set "until the engineering opinion of industry is prepared to approve

*any one of the competing systems...*" Commercial TV came to a grinding halt.

The impasse was speedily resolved with the formation of the first National Television System Committee (NTSC). Approximately 4000 meeting hours, 600,000 written words and 25 demonstrations later, the committee drew up standards, which differed from the RMA proposals only in values—525 lines, 60 fields per second, and a 4-MHz video bandwidth. Recommended to the FCC in April of 1941, they were adopted, unchanged, in July. Commercial television was born again.

The standards this first NTSC struggled over were for black-and-white TV only. But even before the b & w standards went into effect, pressure was mounting for color television. Dr. Peter Goldmark, the brilliant CBS scientist and father of the long-playing record, startled the NTSC in 1940 with an impressive demonstration of a field-sequential color system. That demonstration marked the beginning of one of the great battles of industrial America—the fight for compatible color.

### Black-and-white sees blue

Actually, color television wasn't new in 1940. Vladimir Zworykin had filed a patent as early as 1925 for a color CRT using a white phosphor covered with a checkerboard of color filters. The first actual color was shown by John Baird in 1928, and by Herbert Ives in 1929. Both leaned toward mechanical scanning.

In Baird's setup, a neon-gas discharge provided the red component, and an argon discharge produced green and blue. The scanning disc had three sequential sets of holes in a spiral, each set with its own color filters. The resulting sequential display was the predecessor of the 1940 CBS system.



**1954—Black-and-white began to give way to color** in the early 1950s with the invention of the shadow-mask picture tube (left). At right is RCA's modern "precision in-line" television tube.



Ives' display was simultaneous, not sequential, with a single set of holes and three gas-discharge tubes viewed through crossed mirrors. As with Baird's system, neon supplied red, and argon, the green and blue. But the color filters rested in front of the discharge tubes. The resulting three-channel system was the ancestor of RCA developments in the 1940s that eventually led to today's single-channel, simultaneous system.

The Ives system was one of the first to use the principles of colorimetry laid down 75 years earlier by the Scottish physicist James Clerk Maxwell. The colors were the three primaries, and the spectral sensitivities of the pickup photocells were adjusted accordingly.

Color work in the 1930s concentrated on understanding and synthesizing colored phosphors. No major equipment breakthroughs occurred until Goldmark's field-sequential system. Modeled after Baird's work, but far superior, the system mechanically rotated a set of color filters in front of a black-and-white tube to form the picture.

Wrote RCA's Zworykin: "Although the CBS mechanical color system might look like a backward step, it produces better results than any immediately available."

Nevertheless, work at RCA keyed on Ives' 1929 methods, but also used a three-tube camera and three individual picture tubes. Mirrors superimposed the three images into one display. The result was clumsy, but it was a start.

The industrial war touched off by Goldmark's breakthrough would continue off and on for the next 11 years. The battles were, for a time, quieted by the din of human combat. Experimental work and broadcasting to the public were sharply cut, too, to wait for the war's end.

### The spinning wheel grinds down

No sooner had the guns stilled in 1945, than the CBS-RCA war re-ignited. At the same time broadcasting really began to grow. By 1949, the public had bought 2,000,000 receivers; just five years later, the number rocketed to 31,000,000.

CBS persisted in advocating its field-sequential system for color TV despite its major drawback: it was incompatible with the black-and-white scanning standards. Although the CBS system was criticized for being "mechanical" (detractors spoke of "Goldmark's whirling dervish"), compatibility was the real issue. Since the sequential technique gave equal resolution and scanning time to each of the three primary-color images, it required three times the video bandwidth of monochrome TV. No such spectrum space was available. Sequential television, therefore, called for different standards. And sequential color couldn't be received on an NTSC approved set.

After WW II, an RCA group demonstrated a simultaneous system using three adjacent channels, one of which was almost identical to black-and-white and was thus compatible. For the moment, RCA had the upper hand.

But after several CBS petitions, starting in 1941, were turned down by the FCC, CBS turned the tables. Despite the opposition of nearly the entire television industry, the FCC ruled in October of 1950 that the RCA (dot-sequential) system had poor color quality. CBS was authorized to go ahead with commercial broadcasting. In *Variety*, a headline read: "RCA lays colored egg."

But the victory was short-lived. Although the U.S. Supreme Court upheld the FCC, and CBS actually began broadcasting color in June, 1951, just five months later, the broadcasting stopped. Incom-

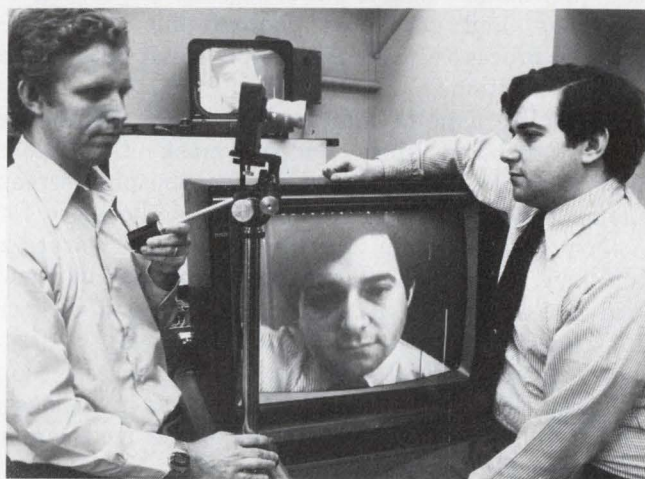

1977—Cameras without tubes shrink to inconsequential dimensions, as charge-coupled devices and other solid-state, self-scanning imaging devices begin to take over.

patibility was a flop, accepted by neither the public nor industry.

### The shadow-mask revolutionizes color

A second NTSC soon established an industry consensus on compatible color. When the standards were approved in July of 1953, the man to second the motion to adopt was Peter Goldmark.

RCA's setback proved temporary. David Sarnoff had decided to throw the entire weight of RCA resources behind color, and the program began in 1949. All the "paper patents" of the past were reviewed. Five teams of scientists were set up to explore the five most promising approaches. In just six months, RCA demonstrated the most important development in the history of color television: the shadow-mask tube.

The shadow mask was the missing link in the formation of practical color television, the low-cost



display without which all systems (except the field-sequential) were crippled. It opened the door to compatible color standards.

The idea was to deposit green, blue and red phosphors on a glass screen, then scan and excite the phosphors with electron beams to produce the colored image. The problem was to keep the red beam away from the blue and green phosphors, the green beam from red and blue, and so on.

In a 1947 patent, Dr. A.N. Goldsmith suggested thousands of tiny holes in a mask, with three electron guns spaced 120° apart. At RCA, A.C. Schroeder proposed putting the three guns together so that the beams would pass through one deflection yoke. But no one knew how to line up the several hundred thousand tiny holes with an equal number of phosphor-dot triplets.

Working within RCA's crash program, Dr. Harold B. Law solved the problem. In Law's invention—called the "lighthouse"—light simulated the shadowing of electrons, and permitted photographic and lithographic processes to locate the phosphor dots in the correct positions.

Basically, a point light source in the lighthouse shone through the shadow mask to expose photosensitive film located in the phosphor-screen plane. Indeed, the invention remains the basis for color-tube production. (Unknown to both Schroeder and Law, some of the basic ideas of the shadow mask had already been patented in 1938 by Werner Fleschsig in Germany.)

The first practical tube, with a 7-in. screen, soon followed. Then a 12-in. version. RCA was in business, but it remained for CBS to make the next major advance in color tubes.

### Better color tubes appear

In late 1953, Norman Fyler at CBS Hytron (a set manufacturer bought out by CBS) developed a curved-mask tube with the phosphors photodeposited on the curved inside face of the screen. Because each mask was destined for use with one screen only, parts didn't have to be duplicated exactly—a difficult process, RCA had discovered.

The curved mask produced larger, more appealing pictures—a benefit that has kept Fyler's design the standard for color-tube manufacturing. Ironically, RCA licensed the process from CBS until the patent expired in 1971.

The principles of photolithography intrigued others. Working on color tubes in his spare time, Dr. Ernest Lawrence, Nobel laureate and inventor of the cyclotron, silk-screened stripes, instead of dots, on a screen. A wire grill replaced the mask—allowing more electrons through—and a single beam was deflected at the grill from one color phosphor to another.

One of the first to use post-deflection focus, the Lawrence tube, though it didn't survive, paved the way

## Truly a wasteland

When Newton Minow coined his now famous remark about TV being a wasteland, he was correct in the technical sense, too. Since the 1930s, progress in television has consisted mostly of refinements. The basic principles have remained unchanged.

The practice of linear scanning, for example, a basic tenet going back to the earliest days of TV, wastes a great deal of precious frequency spectrum by continuously repeating already-transmitted information. In fact, over 90% of the time is spent in redundant scanning.

What is really needed is a system that transmits only changes—new information—in a scene, and only those changes to which the human eye and brain can react. Instead of megahertz bandwidths, only kilohertz or tens of kilohertz would be needed. With such a slash in bandwidth, other benefits follow: reduced noise and decreased reliance on bandwidth for picture quality.

To show only changes, a receiver must memorize scenes, then compare new transmissions with earlier ones to decide if changes have occurred. With today's 16-k RAMs, memorizing a few hundred thousand picture elements economically isn't as impossible as it once seemed. And denser memories are on the way.

for Sony's present tube, the Trinitron.

Perhaps the only other tube given a chance for survival in the early 1950s was Philco's so-called "Apple" tube. Developed over a 10-year period, the Apple tube had no shadow mask; nor did it need three guns. The Apple tube not only looked like an ordinary black-and-white tube but in fact wasn't much different.

Key to the Apple tube was the beam-index technique, in which an ordered array of vertical red, green and blue stripes are put down on the screen. A single scanning beam varies in intensity on a point-by-point basis in accordance with the desired brightness of the image.

For a black-and-white image, adjacent stripes were made to receive equal currents. For color, the beam intensity was modulated at a much higher rate, and the red, green and blue stripes were excited independently in response to the amounts of red, green or blue light called for by the transmitted signal.

### Keeping track of the beam

The registry between the current-density pattern and the stripe structure on the Apple tube had to be held to 1/20,000 of the screen width. To do so required feedback control of the beam. This major developmental effort of the Apple program resulted in the beam-index approach.

In that approach, index stripes of phosphorescent



material are placed behind the color stripes. When bombarded by the electron beam, the index material emits ultraviolet pulses, which are picked up by a photomultiplier tube. Thus, as the beam scans the screen, a series of current pulses "tell" the beam's location to the control circuitry. The Apple tube, in effect, shifted the complexity of the color set from the tube itself to the electronic circuitry—no problem with the transistors and ICs of today, perhaps, but a severe one at the time, given the limitations of vacuum-tube technology.

The shadow-mask tube had too much of a head start, however, and Philco killed the project before it went into large-scale production. 1954 saw the first large-scale-production mask tube, the 21AXP22. Only 100 hours of color telecasting were available that year. Over the next 10 years, hundreds of improvements were made, and in 1964 color television finally came into its own.

Black-and-white transmission also improved steadily in the 1950s. The image isocon was developed to give a better s/n ratio than the image orthicon, and a search for simplicity centered on photoconductive vidicons made with thin-film depositions. As deflection angle and depth shrunk CRT picture size swelled. Better phosphors brought brighter pictures—from 2 fL in 1950 to 100 fL by 1974.

In 1956, Alexander M. Poniatoff showed the world his video tape-recording machine. With it, the first prerecorded television program—"Douglas Edwards and the News"—was broadcast coast to coast. Poniatoff's company's name was composed of his initials, with "ex" for excellence, tacked on.

In 1956, the first transistorized receiver was introduced—and with it the age of miniaturization in TV. It also marked the beginning of the end for vacuum tubes in both radio and television.

### "Transistors will never succeed"

When the transistor first appeared, CBS had to make a decision. Should it sponsor semiconductor research? CBS chairman William Paley asked Charles Stromeyer, the chief engineer of Hytron, what he thought. "The transistor is a toy that will never beat the vacuum tube," responded Stromeyer. (Later he was made president of Hytron.)

For television, the 1960s and early 1970s brought bigger, better tubes and expanded applications. Among the significant advances were Sony's vertically striped Trinitron, Zenith's (and RCA's) black-matrix screen, and RCA's Precision-in-Line System. Instant replay—an Ampex development—became commonplace.

Television landed on the moon in 1969 and sent back excellent color pictures produced by a field-sequential color system. Satellites began to orbit the earth, some relaying TV programs around the world, some taking weather pictures, and some spying.

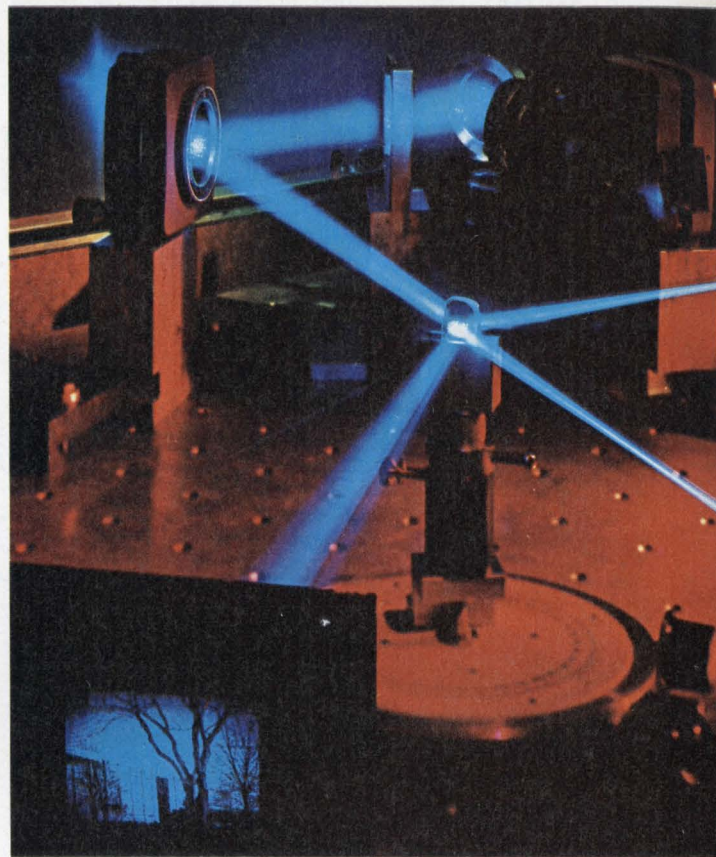

**1977—Is three-dimensional television** the next sensation? Experiments with laser-based holographic equipment have already produced 3-D pictures in the laboratory.

Recently, palm-sized cameras have been built around solid-state, self-scanned image sensors—bucket-brigade circuits, charge-coupled devices and charge-injection sensors. Giant 6-ft-screen projection systems, such as those marketed by Advent, are creating a new excitement in television.

But what of the future? Has television come as far as technology can bring it? The vision of thin, flat-panel displays has reached the laboratory demonstration stage, as has the science-fiction fantasy of three-dimensional television. And there is much talk of two-way television in every home as a central medium of communication.

Experiments have already begun in broadcasting circularly polarized signals, instead of linear—so all existing TV antennas may become obsolete. More and more analog circuits are being shoved aside by digital circuits as LSI takes over. And GSI (grand-scale integration) isn't far behind. Frame storage, as well as other digital hardware for TV, is now available.

As memory prices tumble, the home receiver should become a target for digital encroachment. An all-digital receiver to process a digitally encoded transmission may prove feasible. Such a system would require new standards, a third NTSC—and the spending of billions of dollars just to replace the 120-million existing receivers. ■■



# Think 'IR' for hybrid circuits.

# Nobody makes as many standard types and ratings.



**Low Cost**  
**7.5 to 35 Amp**  
**Rectifier Bridges**  
 Voltages thru 800V.  
 Surge up to 300 Amps.  
 Case Temperature: 75°C



**SCR, Triac and Transistor** Paks/paks  
 SCR's: 25-65A; thru 1200V  
 Triacs: 40-100A; thru 1200V  
 Darlington Transistors:  
 10-25 A; thru 400V.

**35 to 100 Amp**  
**Rectifier Bridges**  
 Case Temperature: 75°C  
 Voltages thru 1000V  
 Surge up to 1000 Amps.



We've been the industry leader in power hybrid modules for years, originating many of today's industry standards. But there are more important reasons to make IR your source.

First, we make our own chips using advanced technologies such as our hard-glass passivation and laser scribing to increase voltage stability and component reliability. We are not dependent on other suppliers for uniform chip quality or delivery.

Second, since we have been a major power semiconductor house for over 30 years, we have the know-how for proper bonding and heat transfer that assures long life.

Contact your IR Salesman or Distributor or write for data on the types you need. You can't do better!  
 International Rectifier, 233 Kansas St., El Segundo, California 90245. Telephone: (213) 322-3331.

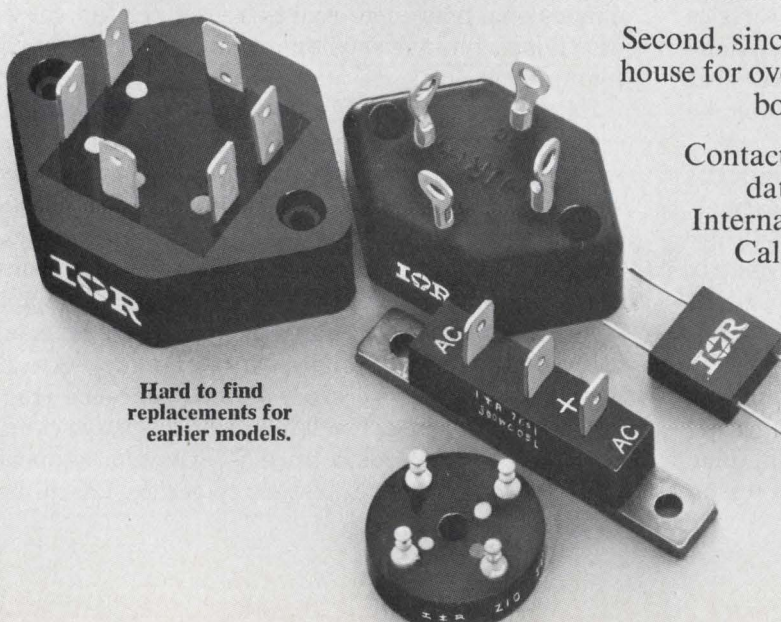

Hard to find replacements for earlier models.

# International Rectifier

... the innovative semiconductor people





# Intel is a good second source for the 8080A microprocessor.

What's that you say?  
Intel is the *primary* source for the 8080A, not a secondary one?  
Sez who?

Let's look at the facts.

National Semiconductor has more of the things you want and need in microprocessing systems.

We have twice as many support products (our 8000 Series).

We have a broad line of other electronic components, which Intel doesn't, to provide a total solution to any design problem.

We just sunk a million and a half dollars into state-of-the-art microprocessor testing facilities.

And finally there's price.

We make all our 8000 Series products on the larger, 100mm dedicated wafers. Which means more stuff for less bucks.

And there's National's legendary volume manufacturing efficiency.

So, we can beat Intel's prices. Right down the line. It's up to you. Buy from the first. Or buy from the best.

National Semiconductor  
2900 Semiconductor Drive  
Santa Clara, CA 95051

ED9-1

Gentlemen: Please send me information on your 8080A family.

Name \_\_\_\_\_ Title \_\_\_\_\_

Company \_\_\_\_\_

Address \_\_\_\_\_

City \_\_\_\_\_ State \_\_\_\_\_ Zip \_\_\_\_\_

All 8000 Series products are available from your local National Distributor: Hall-Mark, Hamilton/Avnet, Liberty, Carlton Bates, Avnet, Bell Industries, Elmer, Hamilton Electro Sales, Century, Harvey, Schweber, Wilshire, Hammond, Pioneer, Advent, P.I. Burks, Lionex, R-M, Summit, Radio, Almac/Stroum, CAM/RPC, Mace, Sterling, Taylor, Bowtec, L.A. Varah, Electro Sonic, Preico, Semad.

 **National Semiconductor**



# The 8080A diagram

At this writing, National Semiconductor is offering 60 support products for its 8080A microprocessor. (Most are off the shelf; all are compatible with National's standard MICROBUS,<sup>TM</sup> and with microprocessors of the future.)

## Micro Bus

### Digital I/O

Part No.	Description
8202	Tri-State 8-Bit Bus Driver
8203	Tri-State 8-Bit Bus Driver (Inverting)
82LS05	1 Out of 8 Binary Decoder
83C06	8-Bit I/O Latch
8208	8-Bit Bidirectional Bus Driver
8212	8-Bit Input/Output Port
8213	Bidirectional 8-Bit I/O Port
8216	4-Bit Bidirectional Bus Driver
8226	4-Bit Bidirectional Bus Driver (Inverting)

### Peripheral Control

Part No.	Description
8244*	90-Key Keyboard Encoder
8245	16-Key Keyboard Encoder
8246	20-Key Keyboard Encoder
8247*	4-Digit Display Controller
8248*	6-Digit Display Controller
8253*	Programmable Interval Timer
8254	Programmable Bit Addressable Interface
8255	Programmable Peripheral Interface
8257*	Programmable DMA Controller
8258*	Advanced Programmable DMA Controller
8259*	Programmable Interrupt Controller
8272*	Floppy Disk Formatter/Controller
8276*	CRT Controller
8285	Character Generator
8292	8-Bit A/D Converter with 16-Channel Analog Mux
8294	3-3/4-Digit DVM with Multiplexed BCD Outputs
8298*	LLL 8080A "Basic" Interpreter Plus Hex Debugger



# Intel couldn't run.

Intel offers only 29 support products.  
Which leaves us with 31 more ways we can help you  
get the job done.  
And that's kinda nice.

## 8080A Microprocessor

Part No.	Description
8224	Clock Generator and Driver for the 8080A CPU
8228	System Controller and Bus Driver for the 8080A CPU
8238	System Controller and Bus Driver for the 8080A CPU

## Communications

Part No.	Description
8250	Asynchronous Communications Element
8251	Programmable Communications Interface
8252*	Advanced Programmable Communications Interface
8261*	Programmable Communications Subsystem
8274*	Multi-Protocol Communications Controller-SDLC, ADCCP, Bisync, DDCMP
8283*	Advanced SDLC, ADCCP Protocol Controller

## Memory

Part No.	Description
8356	2048X8 ROM, 128X8 RAM I/O
8154	128X8 Static RAM with 16-Bit I/O
8364/	8192X8 MOS Mask ROM
8364E*	(E is 2708 Compatible)
8316A/E	2048X8 MOS Mask ROM
8332E	4096X8 MOS Mask ROM (2708 Compatible)
1702A	256X8 EPROM
8704	512X8 EPROM
2708/8708	1024X8 EPROM
8101A-4	256X4 Static RAM with Separate I/O
8111A-4	256X4 Static RAM with Common I/O
8102A	1024X1 Static RAM
74C920	256X4 CMOS Static RAM with Separate I/O
74C921	256X4 CMOS Static RAM with Common I/O
74C929	1024X1 CMOS Static RAM
2114	1024X4 Static RAM
MM257	4096X1 Static RAM
DM87S296*	512X8 Bipolar PROM
5290	16K Dynamic RAM
8316A/E	Mask ROM (2708 Compatible)
DM74S472*	512X8 Bipolar PROM/20-Pin DIP
MM5204	512X8 EPROM

\*Available soon.



# How do you resolve two signals spaced 1 Hz apart at 2 MHz?

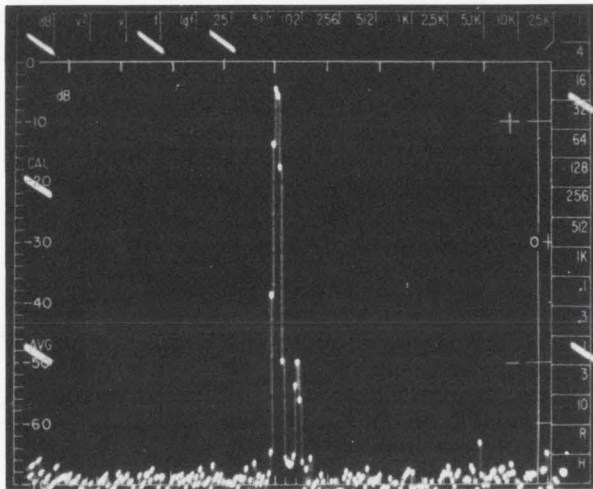

With an EMR Model 1510 Digital Real-Time Spectrum Analyzer and EMR Model 1520 Digital Spectrum Translator. Simply add the optional EMR Model 1521 Range Extension Module to the 1520 Translator, and you have real-time spectrum analysis at frequencies up to 2 MHz!



The CRT photograph illustrates the result. The input signal consisted of two discrete frequencies spaced 1.0 Hz apart, with a 50 dB difference in amplitude. The frequency range covered is 25.6 Hz centered about 1.990000 MHz, and the frequency resolution is 0.1 Hz!

Only EMR offers that much resolution at frequencies up to 2 MHz in real time.

So if you have an analysis problem requiring high-resolution/high-frequency real-time spectrum analysis, contact EMR... we will arrange for a demonstration or detailed information.

Sangamo Weston, EMR Telemetry Division  
P.O. Box 3041, Sarasota, FL 33578  
813-371-0811

**SANGAMO WESTON**  
**Schlumberger**

CIRCLE NUMBER 147

80D

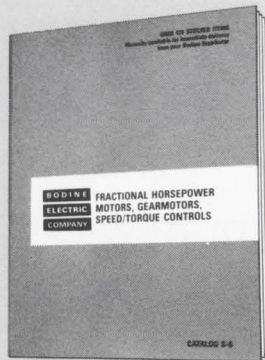

## NEW! CATALOG

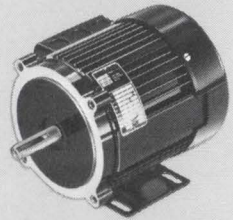

## NEW! MOTORS

Higher Hp.  
[up to 1/2]

425 STOCK fhp (1/2000 to 1/2 Hp) motors, gearmotors, and speed/torque controls listed. Included are Bodine's new TEFC 48 frame A-C induction motors and gearmotors. Also new 32 and 42 frame PM D-C motors, gearmotors and speed controls.

32 pages packed with over 150 photos, charts, diagrams and graphs. Plus helpful information on proper selection and application, mounting, performance, safety, custom designing... Send for Catalog S-6, or see your Bodine Distributor (your now source for all items in Catalog S-6).

**BODINE**  
**ELECTRIC**  
**COMPANY**

Bodine Electric Co., 2500 W. Bradley Pl., Chicago, IL 60618

CIRCLE NUMBER 148

## You get what you spec!

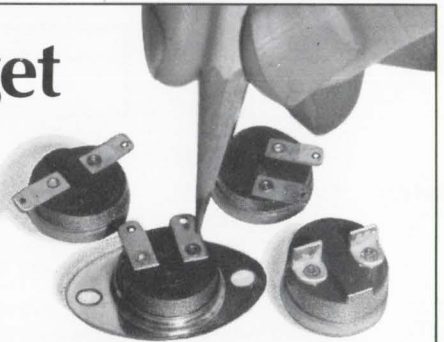

## When it comes to thermostats, PCI supplies just what you need.

Say you're designing computer terminals, power supplies, business machines, or other electrical or electronic equipment. You need precise temperature control to meet critical standards. You need a precision thermostat. At a competitive price.

Look no further. Specify PCI Series 5003 wafer type thermostats. They're U.L. recognized. Rated 5A res., 120V ac., they'll operate within a range of -20°F to 350°F. You specify the setting. We give you a standard tolerance range of ±5°F to ±8°F... to a minimum of ±2°F to ±5°F. Differentials are as low as 8°F. Each thermostat is factory set and sealed. Also provided... a selection of mounting and terminal configurations. 240V ac (Series 5004) units can also be supplied—also U.L. recognized.

Send for Application Data Form.

PCI thermostats... 100% inspected.

PROTECTIVE **pci** CONTROLS INC.

A subsidiary of North American Philips Controls Corp.  
Frederick, Md. 21701 • (301) 663-5141

CIRCLE NUMBER 149

ELECTRONIC DESIGN 18, September 1, 1977



# need a precision drawn metal enclosure?

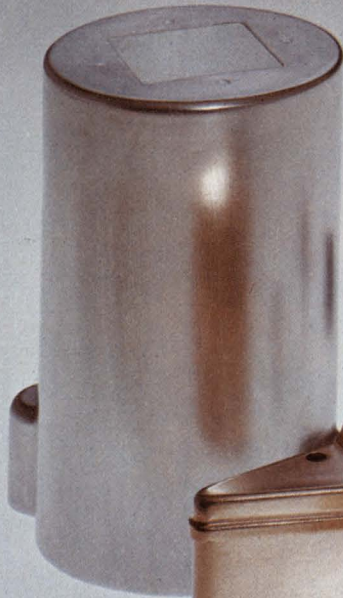

How about an **ALUMINUM** instrument cover...



or a **TITANIUM** component housing...



maybe a **MU-METAL** magnetic shield...



perhaps a pie shaped **COPPER** enclosure...



or a pure **NICKEL** battery container...

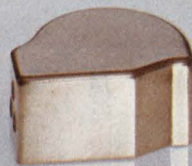

or a **BRASS** housing for micro-circuits...



even a .010 **STAINLESS STEEL** detector case.

These are only a few of the more than **1600 SPECIAL** shapes we draw in addition to over **7000 STANDARD ROUND, SQUARE** and **RECTANGULAR** sizes we stock. Write for a copy of our new 84 page catalog today. Yours for the asking.



symbol of quality since 1940  
CIRCLE NUMBER 43

# Hudson

**Tool & Die Company, Inc.**

Main Office: 36 Malvern Street, Newark, New Jersey 07105  
(201) 589-1800 TWX 710-995-4445

Florida Division: Post Office Box 2613, Ormond Beach, Florida 32074

Visit our booth — number 1503 — at WESCON (904) 672-2000 TWX 810-832-6216



**You want to combine  
a 28-key calculator with  
a 7-function wristwatch.**

**Now find a MOS company  
that knows the  
right combination.**



# Hewlett-Packard did.

Not surprisingly, they came to AMI.

We'd already helped them to develop circuits for most of their hand-held calculators. And we're also one of the world's leading producers of CMOS watch chips.

We needed every bit of this experience. The specs for HP's incredibly powerful "wrist instrument" were extremely tight. Yet by working closely together, we were able to shrink the five

circuits' size even further. And, with power a critical factor, we helped to develop a "sleep mode" to shut down the voltage when not in use.

For all its state-of-the-art features, there wasn't a single chip failure during life tests. That kind of reliability is one more reason twice as many major companies come to us for custom designs than anybody else. This leadership goes back

to 1966, when we were the first company to mass produce MOS.

So, if you want to know how to make a great idea work, maybe it's time you got in touch with us. Write to AMI Marketing, 3800 Homestead Road, Santa Clara CA 95051. Or call your nearest AMI sales office. Between us, we'll find another combination for success.

**AMI**  
AMERICAN MICROSYSTEMS, INC.



The  
performance  
you  
need.

The  
convenience  
you  
want.

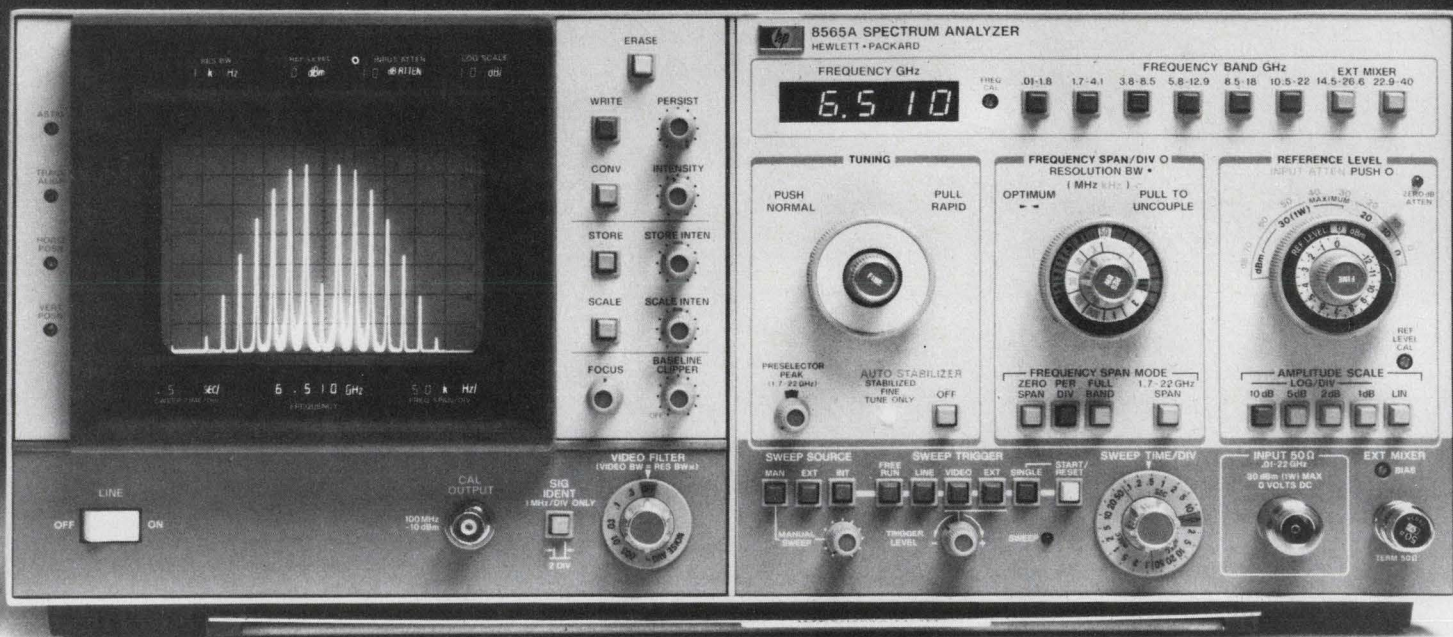

## HP's 8565A Microwave Spectrum Analyzer gives you both.

Here's a combination of fully-calibrated performance, with wide dynamic range from 10 MHz to 22GHz (extendable to 40 GHz), plus operating features that make it extremely easy to use.

Frequency response is within  $\pm 1.2$  dB to 1.8 GHz, and from  $\pm 1.7$  dB at 4 GHz to  $\pm 4.5$  dB at 22 GHz. These figures include all input circuitry effects as well as frequency band gain variations. Internal distortion products are 70 dB down from 10 MHz to 18 GHz; 60 dB, 18 to 22 GHz.

Resolution bandwidths from 1 kHz to 3 MHz are provided, with 100Hz optionally available. The resolution filters are all synchronously tuned to prevent ringing. For frequencies from 1.7 to 22 GHz, an internal preselector provides more than 60 dB rejection, permitting measurements of distortion products as small as 100 dB down.

As for convenience, the 8565A makes most measurements using just three controls: tuning frequency, frequency span and amplitude reference level.

Resolution, video filtering and sweep time are automatically set to the proper values. Bright LED's in the CRT bezel give you all pertinent operating conditions right there with the trace being viewed. And a scope camera records these data along with the CRT trace.

The 8565A Spectrum Analyzer gives you the capability you need and the convenience you'll fast appreciate. Domestic U.S. price is \$17,850 (add \$800 for 100 Hz resolution). Find out more by calling your nearby HP field office, or write.

HEWLETT  PACKARD

1507 Page Mill Road, Palo Alto, California 94304



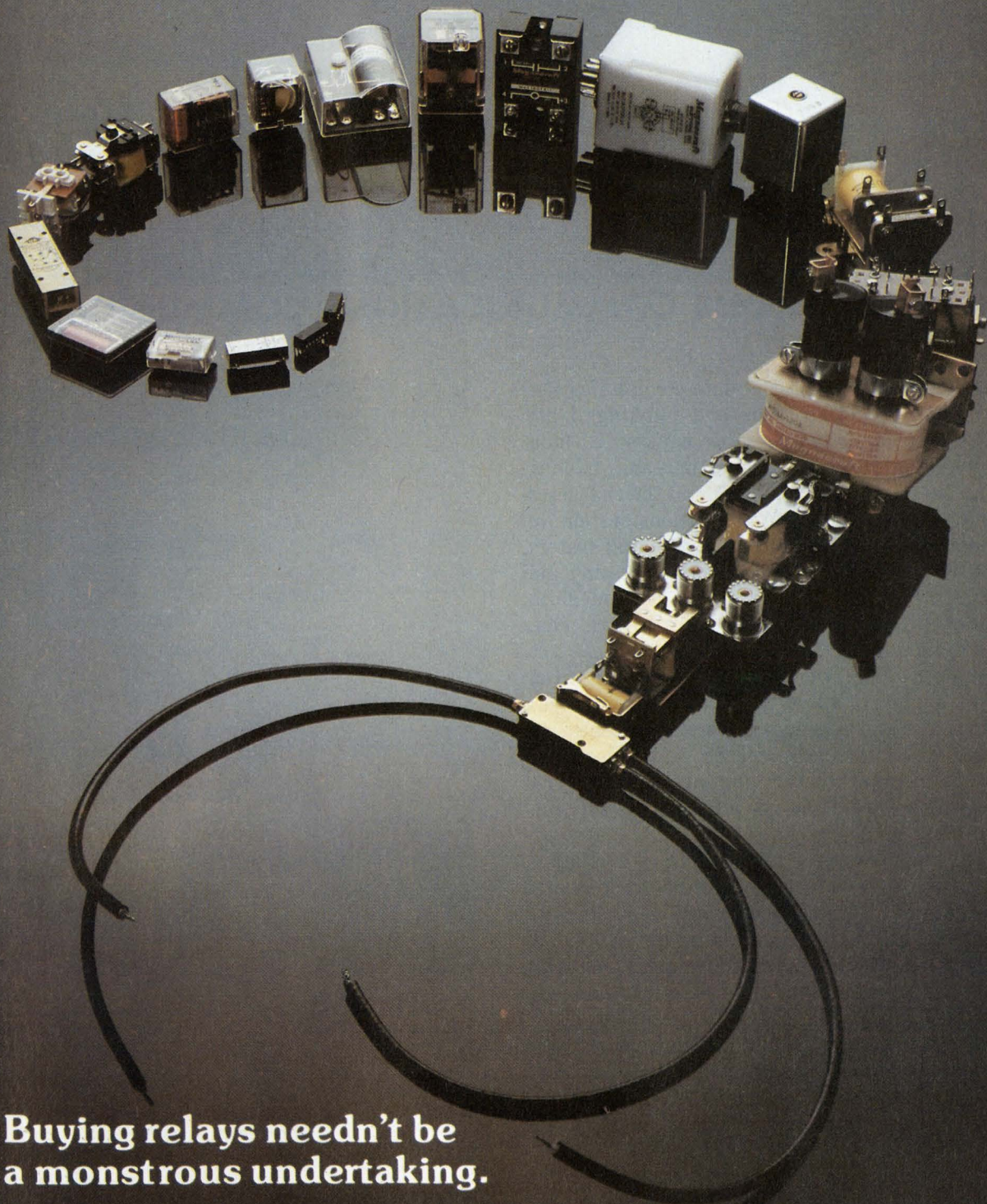

**Buying relays needn't be  
a monstrous undertaking.**

**With 1200 stock relays,  
we're the only name  
you need to know.**

**Magnecraft<sup>®</sup>**  
ELECTRIC COMPANY

5575 NORTH LYNCH AVENUE

● CHICAGO, ILLINOIS 60630 ● 312-282-5500

WRITE FOR OUR STOCK CATALOG NO. 277

See us at

 **WESCON 77**

BOOTH 1337



# Data Communications

The first "advanced" data-communications systems employed flags and blinking lights. These semaphore techniques superseded more "primitive" jungle drums, smoke signals and yodeling. Yet in all these methods can be found the characteristics that define a data-communications system: an agreed upon message set, a coding/decoding system, a transmission medium, and signal-generating and receiving devices appropriate to the medium. Semaphore techniques simply allowed easy alphanumeric coding.

As a matter of fact, well-organized networks of flag and light systems "speeded" messages in the era beginning after the Crusades (11th to 12th centuries) to the middle of the 19th century, when electricity became the medium for carrying messages. Governments, armies as well as powerful individuals and companies set up their own systems. Some systems were even available on a fee basis to individuals.

Many of Napoleon's victories can be attributed to the good communications he was able to attain with such systems. Some banking families and individual investors and speculators made financial killings, because they employed such "advanced" data links to bring them advance news information. And venerable news services, such as Reuters, are said to have scooped others with such data channels.

But the real advance into modern data communications, came only about 137 years ago. Sir Charles Wheatstone, a noted physicist in England, and Samuel F. B. Morse, a successful portrait painter in the United States, both patented electrical telegraphic devices around 1840. Both used electromagnets to convert electrical energy sent over wires into mechanical motion at the receiver.

Wheatstone used a dial-face pulsing mechanism at the transmitter to generate transmitted pulses that were converted—step by step—at the receiver into equivalent dial positions showing the alphabet.

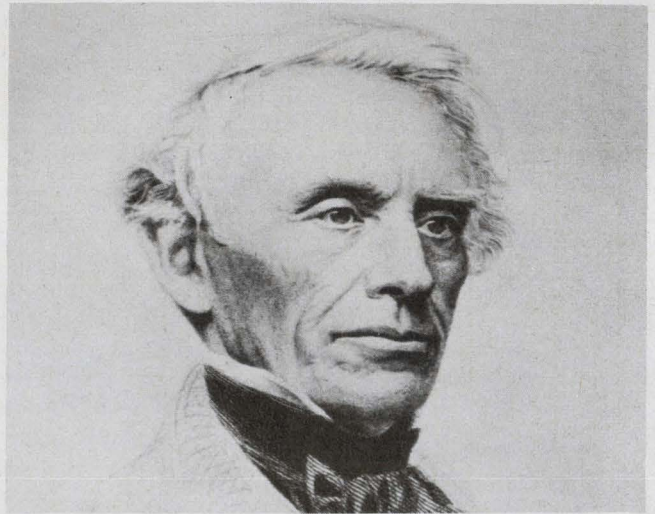

**1840 and 1948—Samuel Morse optimized his dot-dash code** by taking advantage of the normal distribution of letter usage in the English language. For example, the most often used letter, "e," became the simplest code—a dot. Claude E. Shannon derived the now famous equation that gives the maximum data rate of a communications channel, based upon statistically behaving transmitted data and noise.



Morse's device, though mechanically simpler, used a sophisticated code system. He invented the dot-dash code, and printed out the dots and dashes on a paper tape at the receiver, which could be deciphered into a message by a trained operator.

### Dots and dashes prove efficient

The Morse code was so efficient that it is still used in simple high-frequency radio-communications systems. Morse speeded transmission by assigning the shortest codes to the most frequently used characters. Moreover, telegraph operators soon learned to recognize Morse's characters by their sounds. So the printer was eliminated. This not only simplified Morse's approach even further, it even accelerated actual communication. A receiving operator could write (later type) the message, while decoding it by ear instead of reading a tape and deciphering the message. Subsequently, the invention of teletypewriters eliminated the operator both as decoder and typist.

Building a telegraph system wasn't easy for Morse. Having been educated as a painter and sculptor (Yale 1810), he knew little of the new science of electricity. Unfamiliar with Ohm's theory of the galvanic circuit,

he was forced at considerable expense to laboriously establish for himself the feasibility of conducting electricity over long insulated wires. Had he understood Ohm's work, his "Experiments made with 160 pairs of Grove's battery passing through 160 miles of insulated wire," described in a letter to the editor of the American Journal of Science of 1843, wouldn't have been necessary.

Congress, thereafter, was convinced to provide \$30,000, and Morse set up a successful telegraphic line between Boston and Washington, DC, by 1844. He formed a private stock company a year later. But when the United States became involved with war against Mexico, government funds were cut off. Disappointed when Congress declined to accept his proposal to make the telegraph a public utility, Morse left the field for others to develop.

### Telegraph lines cover the nation

Along with the Pony Express, the steam-locomotive railroad and the discovery of gold in California (1847), telegraphy helped open the West. Western Union, organized in 1856, and other companies such as the American Telegraph Company, crisscrossed the coun-

**1840**

Samuel Morse invents the first practical telegraph, which uses a highly efficient dot-dash code.

**1844**

A telegraph line between Boston and Washington, DC goes into operation. Thereafter, lines begin to crisscross the continent.

**1866**

Cyrus Field successfully lays down the first Atlantic telegraph cable after two other attempts fail.

**1876**

Alexander Graham Bell demonstrates the first practical telephone.

**1878**

A patent issued to David Brooks describes the use of twisted pairs for reducing interference in telephone lines.

**1895**

Guglielmo Marconi communicates via wireless signals near Bologna, Italy.

**1900**

Michael I. Pupin describes his "loading-coil" invention for telephone, which enhances long-distance telephone without repeater amplifiers.

**1915**

John Carson invents single-sideband transmission.

**1924**

Harry Nyquist shows that a minimum bandwidth is required to transmit telegraph signals at a specific rate.

**1928**

R.V.L. Hartley formulates a theory of information that defines data quantity as the logarithm of the number of symbols employed.

**1929**

The coaxial cable is developed by Herman A. Aftel and Lloyd Espenschied, which can carry many voice

channels or wideband signals on a single, shielded wire.

**1931**

Waveguide transmission demonstrated by George Southworth allows wideband signal transmission on microwaves.

**1933**

E.H. Armstrong combats noise and interference with his newly patented wide-band frequency-modulation transmission system.

**1937**

A.H. Reeves describes pulse-code modulation.

**1939**

Homer Dudley demonstrates the high redundancy of information in human speech by inventing the vocoder.

**1944**

Microwave relay links begin to appear as part of communications systems.

**1948**

Claude E. Shannon introduces the Information Theory.

**1950**

S.O. Rice shows that error probability decreases exponentially with code length in Gaussian-noise channels.

**1956**

First voice cable laid under the Atlantic, with special high-reliability repeater vacuum-tube amplifiers spaced 39 nautical miles apart.

**1965**

First commercial communications satellite, Early Bird (INTELSAT I), is launched from Cape Kennedy by COMSAT.

**1974**

Western Union launches first two domestic satellites —WESTAR—and leases channels to its subscribers.



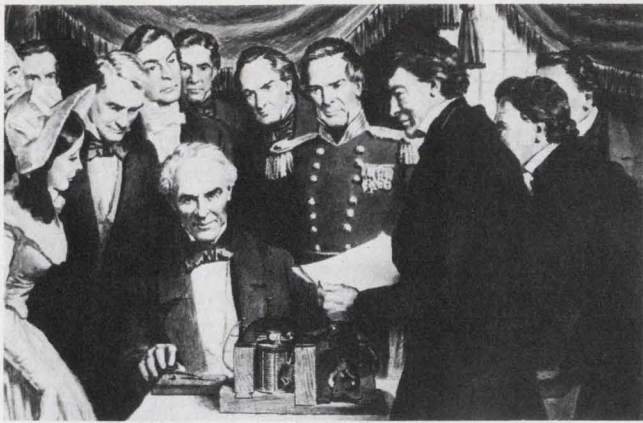

1844 - 1865—Telegraph wires spanned the continent and played an effective role for both sides in the Civil War.



1844—Telegraphic communications between Boston and Washington, DC started amid appropriate fanfare. The equipment used was crude, but effective. The receiver provided a printed-on-tape representation of the code, later replaced by merely a sounder, which experienced operators learned to read aurally.

try with telegraph lines.

Hardly had the various telegraph systems begun to cash in on their investments, than the Civil War broke out. A week after hostilities ignited, the Washington government with unusual stupidity closed down the system in the capitol to "prevent espionage."

Fortunately for the North, General George McClellan, like Napoleon, recognized the tactical advantages of good military communications. He ordered a separate communications department set up under the Secretary of War. The Union army first used the telegraph on June 3, 1861.

In the years that followed, techniques for traffic handling were developed. Without an organized traffic-handling system, often several operators tried to send messages at the same time with nightmarish results. Apparatus and transmission-line technology were improved. Multiplexing methods allowed more than one message at a time to traverse a line. And line-capacitance discharge problems were alleviated.

Manual writing and typing of received messages and hand keying of the Morse code gave way in 1875 to automatic teletypewriting. Jean Maurice Emile

Baudot, an officer in the French telegraphic service, developed a five-unit (bit) code. When this code was combined with a time-division system of synchronous switches (developed in 1852 by Moses G. Farmer to multiplex a telegraph line), one at each end of the line, printing telegraphy was reborn, only this time, it used the alphabet.

Meanwhile, the oceans were being bridged with marine cables. Repeated failures during the 1850s had cost many millions. Finally, in 1866 Cyrus Field, aboard the *Great Eastern*, a vessel outfitted for cable laying, linked Valentia Bay in Ireland with Heart's Content in Newfoundland. By the end of the 19th century, all the world's principal cities were linked by submarine cables.

The Western Union Telegraph Company grew after its Wild West days, absorbed other companies and continued to provide America with telegraphic services. Like others, it tried to break Alexander Graham Bell's telephone patent of 1876, but failed, and was soon overwhelmed by the telephone.

Today, Western Union operates two public dial-up telegraph networks: a telex network, compatible with the worldwide telex system, and the TWX (teletypewriter exchange) network, which it purchased from AT&T. Having extensively experimented with on-line computer systems, Western Union now offers a wide range of services. In 1974, it distinguished itself by sponsoring the United States' first two domestic satellites—the Westars. Western Union leases satellite channels and also carries subscriber traffic on them.

### Telephony overshadows telegraphs

But telegraphy was destined to be overshadowed by the telephone. As data-communication traffic increased slowly, telephony raced ahead. By 1880, telephone lines began spanning the continents. Soon, the oceans were carrying conversations. Similarly, wire-



# Pulse-code modulation: The wave of the future?

Pulse-code modulation (PCM) converts analog signals into digital in three steps: (1) sampling (2) quantization and (3) coding.

Sampling theorem tells us that a band-limited signal with no frequencies above  $W_0$ , when periodically sampled at a rate of  $2W_0$  samples per second (or faster), the samples will specify the signal without loss of information.

In quantization, the sample amplitudes are limited to specific levels. In the accompanying figure, eight levels are used. These levels are then represented by a digital-pulse code.

Digital pulses are more immune to noise than the original analog signal, because the circuit need only decide whether a pulse is present or absent to receive it accurately. To receive an analog signal accurately, its precise value must be "measured." Moreover, digital signals can be restored and retained in repeaters, whereas analog signals accumulate errors and usually can't be "repaired." And by the use of sophisticated codes and more bits than the bare minimum—the illustration uses the minimum—the remaining effects of noise can be virtually eliminated or corrected.

More bits allow greater differences or "individuality," between the codes that represent the levels, so that it takes more than a change in only one pulse to make a code "look like" another. Or, the extra (redundant) bits can be used for implementing special error detecting and correcting codes. The more bits each code word has, the lower the error rate can become.

However, one drawback to PCM is quantization noise because of the limited number of levels. But this noise can be made small by using a large number of quantization levels. Of course, as the number of levels increases, the number of bits required to encode each level and the bandwidth requirement increases.

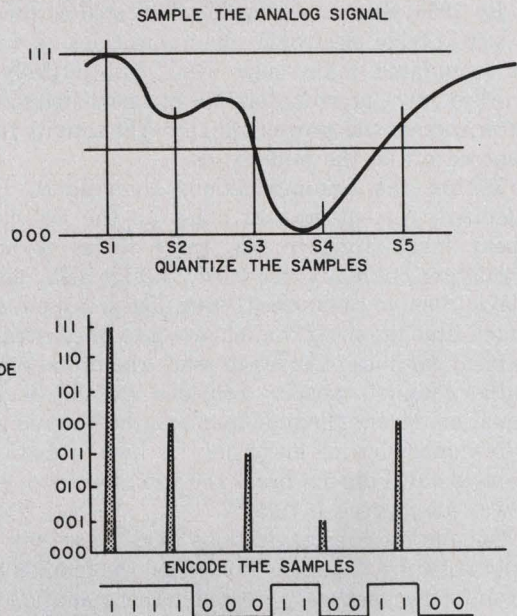

If each of the samples is encoded into an  $n$ -bit code word, then  $2nW_0$  pulses per second must be sent. With the system operating at the Nyquist limit, it requires ( $nW_0$ ) Hz of bandwidth. Thus, noise immunity is purchased at the expense of bandwidth. Is it a good deal?

The answer depends upon the relative "costs" of signal power and bandwidth in any given application. When spectrum space is limited, merely increasing the power of the transmitter might be better.

When PCM is compared with wideband FM—another way of trading off bandwidth for noise immunity—PCM comes out ahead. When both systems operate above threshold, the received  $s/n$  ratio varies as the log of the bandwidth for FM, but directly as the bandwidth for PCM.

less systems, which first carried only data communications, were eventually overshadowed by voice systems.

So data communications languished for decades until the Computer Age—which dawned after World War II.

In the ensuing years, American Telephone and Telegraph Co.'s network of telephone circuits grew so large that it dwarfed all the other communications systems. Then, in the late 1950s and 60s, when computers started talking to each other, AT&T provided the data links. But the system was optimized for analog-voice, not digital-data signals. (Though modem (modulator-demodulator) circuits were developed to convert digital data to analog signals suitable for phone-line handling, this approach was at best a compromise. Data are better handled by all-digital systems.

Digital data-handling methods make possible high-

quality signal transmission under conditions of high noise and interference that are impossible with any analog system. A binary (or digital) signal can be shaped and timed over and over, so that the original signal-to-noise ratio is retained, even with a long chain of repeaters. And simple time-division multiplexing systems are easier to build with digital methods. With analog modulation, noise is cumulative: Each repeater contributes more noise and distortion to the original signal. What's more, analog multiplexing requires complex and expensive analog frequency-shifting and filtering circuits.

Ironically, electrical signaling, which began as a digital data-communications system with Morse's invention, was eclipsed by Bell's voice networks—digital gave way to an analog, so to speak. But now the trend is shifting to all-digital communications systems, which are optimized for data—not voice—handling. But until digital-transmission networks are widely



## The Information-Theory bandwagon

By 1956, Shannon's ideas had created as much of a stir outside electronic communications as within. It stimulated many new ideas, but pitifully few worked out. Unfortunately, the stir persisted too long after success was proven unlikely. The activity finally tapered off in the mid-sixties.

Within the communications community, David Slepian's remembrances point up the activity: "I spent much time in the early fifties trying to straighten out many who tried to design ideal radars," David Slepian reminisced. "But then I, myself, spent much time pursuing that elusive goal of constructing explicit families of codes to reach the promised land—the channel capacity provided by the Shannon equation. Every three or four months I would enjoy a few moments of glory only to have a fatal flaw pointed out. I did not break the habit for many years. I was very green in 1951."

Outside the communications field the activity was duly noted by Shannon. He decried the faddish craze his information theory created in this quotation from his paper, "The Bandwagon," published in the *IEEE Transactions on Information Theory*, Mar. 1956, p. 3:

"Information theory has, in the last few years, become something of a scientific bandwagon. Starting as a technical tool for the communication engineer, it has received an extraordinary amount of publicity

in the popular as well as the scientific press. This has been due to connections with such fashionable fields as computing machines, cybernetics and automation. As a consequence, it has perhaps been ballooned to an importance well beyond its actual accomplishments.

"Applications are being made to biology, psychology, linguistics, fundamental physics, economics, the theory of organization, and many others. In short, information theory is currently partaking of a somewhat heady draught of general popularity.

"Although this wave of popularity is certainly pleasant and exciting for those of us working in the field, it carries at the same time an element of danger. Seldom do more than a few of nature's secrets give way at one time. It will be all too easy for our somewhat artificial prosperity to collapse overnight when it is realized that the use of a few exciting words like *information*, *entropy*, *redundancy*, do not solve all our problems.

"I personally believe that many of the concepts of information theory will prove useful in these other (noncommunications) fields—and indeed some results are already quite promising—but the establishing of such applications is not a trivial matter of translating words to a new domain, but rather the slow tedious process of hypothesis and experimental verification."

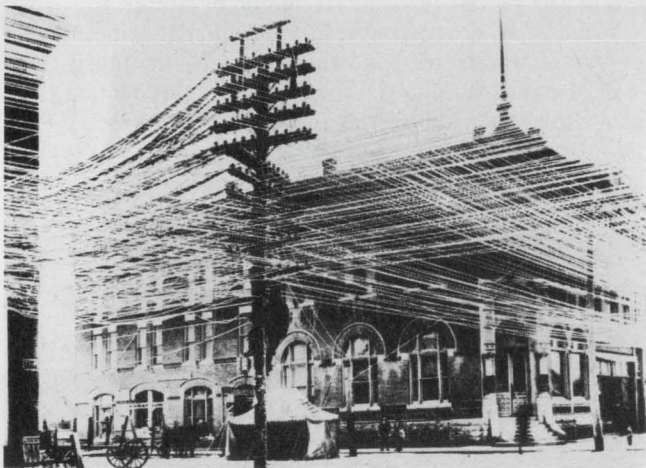

**1899—Wire line congestion** such as this in Pratt, Kansas, led to extreme unreliability in bad weather, forcing the introduction of underground cable. The inherently high attenuation of cables posed a serious problem, but this was alleviated when Campbell and Pupin (1899) worked out the theory of periodic loading.

available, data communicators will have to use noisy telephone networks, designed primarily for basic voice communications.

Old teletypewriter, or subvoice-grade channels, still carry considerable data (teletypewriter) traffic directly at 45 to 300 bits/s. But for higher rates, modems are needed. The early 1950s modems handled 600 to

the 1200-bit/s on standard 3000-Hz voice lines. Improvements in the 1960s, such as automatic delay-distortion-correction and multilevel modulating systems, raised the data-rate capability on a voice channel to 4800 bits/s. The early 1970s has seen the rate leap to 9600 bits/s. However, while dial-up systems can now be used with 1200 to 4800 bits/s rates, rates to 9600 bits/s need more elaborate phase and error correcting and less noise than is feasible on ordinary dial-up lines.

### It's only the beginning for data-traffic growth

Meanwhile, data traffic on analog-voice channels grows rapidly despite technical difficulties. In fact, today's data traffic is merely a link on a long chain. The first telegraph circuit between Baltimore and Washington built by Morse was a single-channel. Now coaxial cables can carry up to 10,800 voice channels, which also can be used for data with modems.

Microwave radio relays, which are less expensive to build than coaxial-cable systems, began to be installed after World War II. Now they are used more extensively than coaxials for both short and long-haul communications trunks.

Today, microwave antennas are outlined against many city skylines. Tokyo has a microwave-antenna tower that looks like the Eiffel Tower, but is actually



40-ft taller. London has a famous revolving restaurant located just above a microwave antenna. Moscow outdoes them all with an antenna tower 250-ft taller than the Empire State Building.

Privately owned microwave links have been set up. The American Electric Power Service Corporation, for example, has more than a thousand miles of private microwave links. RCA Communications services all of Alaska with phone and data channels which to a great extent are linked by microwave systems.

Though most microwave channels are used for voice or TV transmission, many primarily handle data. And more will do so.

But spectrum congestion and the interference of criss-crossing microwave beams in major cities limit further expansion at the microwave frequencies. And since microwave links are limited to line-of-sight distances between repeater stations, long distances require many stations.

However, communications satellites, a form of microwave radio link, can span distances halfway around the world in one jump. Probably the major practical product to come out of the space program, communications satellites of today easily handle hundreds of thousands of voice and data channels.

### Satellites link data systems

On April 6, 1965, the world's first commercial satellite, Early Bird, was boosted by rockets into the sky over Cape Kennedy by COMSAT, a private company formed to launch and operate communications satellites. A Pacific Ocean satellite followed in 1967. These satellites soon linked computer systems carrying data for such systems as Pan America's real-time Panamac reservation service and IBM's laboratories between major cities on both sides of the Atlantic and later, the Pacific.

Four generations of COMSAT satellites were launched from 1965 to 1971—INTELSAT I (or Early Bird), II, III and IV. Canada launched the ANIK ("brother" in Eskimo) satellites. Then came the French-German Symphonie satellite. In 1974, Western Union launched WESTAR. AT&T operates TELSTAR and RCA has SATCOM. The end is not in sight.

Satellites are powered by solar batteries and have limited power capabilities. Earth stations, however, can beam high-powered signals from large highly directional "dish" antennas at the satellites. The received signals from the satellites, though weak, are captured by similar large antennas with high-gain figures.

One problem with phone conversations via satellite is the roughly 0.5-s delay between a transmitted message and return response, due to the considerable distance the signal must travel. This delay, however, is not troublesome in data communications, which is likely to dominate much of the future satellite traffic.

A 36-MHz retransmitting transponder in WESTAR



1960—Radio-relay stations like this Western Electric TH microwave system between the Denver-to-Salt-Lake-City route standing atop Buckhorn Mountain (8306 ft) in Colorado, start taking over from cables and lines.

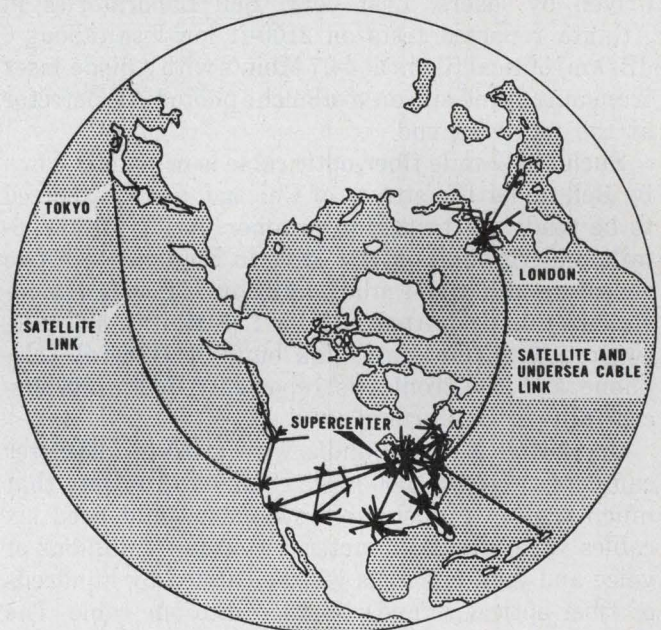

1970—Data began to be carried over two-thirds of the globe by General Electric's Mark III network, to provide business and industry with easy communications. Undersea cables, satellites and local and long-distance phone lines were included in the network.

can handle  $50 \times 10^6$  bits/s of data. In fact, in recent experiments with advanced data modems,  $72 \times 10^6$  bits/s have been relayed. Like most of the newer satellites, WESTAR uses pulse-code modulation (PCM), even for carrying voice, because the channel bandwidth capacity is high and power in a satellite is limited.



The future of all space communications clearly lies with digital data methods. Digital-data transmission techniques are simple, low-power, light-weight and have many favorable electrical properties. The recent Viking space probes primarily used digital methods to communicate over vast distances. And the future space-shuttle vehicle, Enterprise will do the same.

### Ground data links are also improved

Ground links will get better. The microwave spectrum eventually will become saturated, so nonradiating ground links will have to supplement them. By 1980, the equivalent of 250,000 voice channels is expected to be carried on a helical waveguide in an all-digital system. Bugs in such systems are being worked out now.

The mid-1970s have seen the arrival of AT&T's all-digital Dataphone Digital Service, which can handle PCM in 64,000-bit/s channels without the need for modems. The AT&T system is still experimental. Other all-data systems are in development—many by companies competing with AT&T—and channel capacity will certainly increase rapidly for the rest of the century.

By the year 2000, single optical cables will probably carry several billion bits per second on fine glass fibers driven by lasers. Last year, Bell Laboratories in Atlanta reported tests on 2100-ft low-loss (about 6 dB/km) optical fibers at 44.7 Mbit/s with a diode-laser transmitter and silicon-avalanche photodiode detector at the receiving end.

Such a 1-½-mile fiber-optic cable is being laid down by Bell under the streets of Chicago, and is expected to be ready for tests this summer. A 140 Mbit/s, 6-mile underground optical cable in England with two repeaters at 2 and 4 miles, built by ITT, was demonstrated this past April. And a 1.55-Mbit/s, 5.6 mile, two-repeater fiber-optic link built by General Telephone and Electronics is reportedly operating successfully in California.

Currently, a fiber bundle with a 0.5-in. diameter can carry about 50,000 voice channels. To carry that much traffic, copper-cable systems would need six cables with a 3-in. diameter. Eventually, millions of voice and data channels will be carried by hundreds of fiber-optical strands bundled into one cable. The technology to do it is already available; the only limitation is economics.

### Theory is alive and healthy

Technology is not a limitation because communications theory has been alive and healthy since World War II. As a matter of fact, data-communications theory has forged considerably ahead of applications in recent years.

In 1948, Claude E. Shannon published his classic paper, "The Mathematical Theory of Communications." It rocked the communications community by

refuting legions of communications schemes that tried to pack unlimited amounts of data into limited bandwidth channels.

Shannon expressed mathematically that the data-rate capacity of a noisy channel is ultimately limited by its bandwidth and signal-to-noise ratio in special ways. Shannon's theory had elements that weren't new. But put all together, his concept added up to important new insights.

One of the ideas in Shannon's paper was first introduced by Harry Nyquist. He showed that the maximum data rate of a telegraphic signal was limited by the bandwidth of the channel. Nyquist presented his discovery in his classic paper, "Certain topics in Telegraph Transmission Theory," published in the *Transactions of the AIEE*, Feb., 1928. But he ignored the effects of noise.

Another idea, first put forward by R.L.V. Hartley, quantified information as the logarithm of the number of symbols in a communication-system's code set. But Hartley ignored the statistical nature of the message source.

Borrowing these ideas, Shannon included his own concepts of statistically controlled message selections from a limited message set and the statistical effects of noise.

### A lot of wisdom, but little hardware

But practical results from Shannon's work, though avidly sought, were hard to produce. Wisdom rather than hardware has been the main product of the past quarter-century of labor in communications theory.

Shannon's work was related to Sadi Carnot's (1791-1832) thermodynamic theory by John R. Pierce, research worker at Bell Laboratories, writer of science fiction, and early confidant of Shannon: "It (Shannon's work) divided the (communications) world into two parts—the possible and that which was not. . . . Ingenious people no longer invented coding and modulation schemes that were analogous to perpetual motion (proved impossible by Carnot)."

Looking back, David Slepian, another early worker (1950) at Bell Laboratories in Communications (later called Information) Theory recalled that the celebrated Shannon equation,  $C = W \log(1+s/n)$ , was treated with suspicion by many experienced communications engineers. "Some resented all the public attention and brouhaha accorded the theory, when in fact it did so little in a practical way. Others went overboard and tried to apply it to everything in sight without understanding its meaning. Many still don't."

### Many schemes proposed—few work

The post-World War II world was filled with many novel modulation schemes for handling data—many were proposed and even used for military communications. Most didn't work as proposed, because they violated criteria set down by Shannon and the others



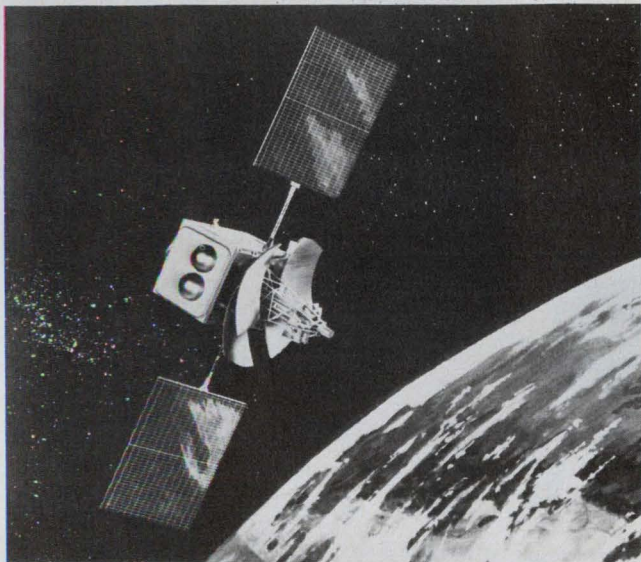
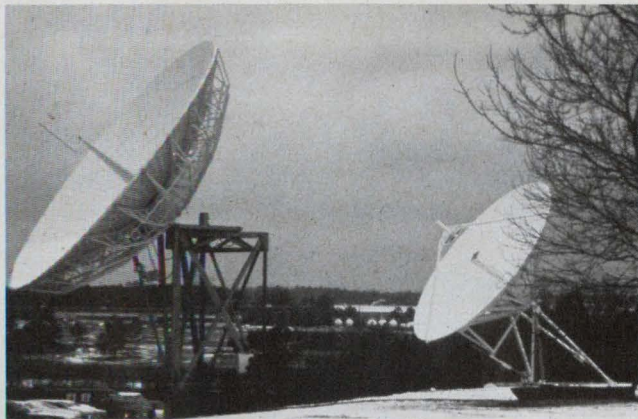

**1977—Earth stations** (Scientific Atlanta) and satellites, like RCA's Satcom II, connect communications links, reaching regions heretofore inaccessible.

before him.

Nevertheless, many digital-modulation schemes worked well—pulse-length, pulse-position and pulse-code modulation. Pulse-code modulation was exciting enough to be considered the wave of the future. But it hasn't happened yet.

All the digital-modulation methods, including the early (1936) Armstrong FM system, which is analog, combat noise by increasing the bandwidth used for transmission. They allow bandwidth to be exchanged for signal-to-noise ratio.

A PCM communications system, in particular, has a low-threshold signal-to-noise of about 20 dB for error rates of about 1 in  $10^8$  bits. Amplitude-modulated signals require a signal-to-noise ratio of 60 to 70 dB for the same error rate. PCM therefore needs much less signal power, but more bandwidth.

Where considerable bandwidth is available, but power is limited—say, in a small spacecraft like the Mariner—PCM is obviously a superior data-communications method. And, since future channel widths will be plentiful, wider and cheaper, PCM should dominate the future of data communications.

Furthermore, error-detecting and correcting codes, uniquely applicable in PCM, offer the potential of

extremely low error rates, even in very noisy band-limited channels. In today's data-transmission channels, keeping the error rate down is a relentless battle.

### Often you can ignore errors

The easiest approach is to ignore errors—done in the majority of telegraph (teletypewriter) links operating today. English text has high redundancy (at least 50%) so that despite garbling, the correct text is usually clear from the context of the message, when read by humans. A very badly garbled message can always be retransmitted.

On some data, such as statistical information, errors need only be detected: Some data can be discarded without distorting the results. Errors of 1 bit in  $10^5$  in data from slowly changing instrument readings or from English text are generally acceptable. However, such an error rate is intolerable on computer programs, financial data, stock reports and much other industrial and commercial information.

In such systems, error-correcting codes become a possible solution. Reduction to an error rate of 1 in  $10^{12}$  bits—about one error every three months—or better, is readily attainable, today.

### Coding theory advances slowly

Error-correcting code theory goes back even before Shannon's work. Conceived in the early 1940s, coding theory was born and suckled through the next decade and out of its diapers by 1960. As early as 1950, S. O. Rice showed that for Gaussian-noise channels, error probability decreased exponentially with code length. By 1960, exponential bounds on error probabilities had been established on a broad class of communication-channel types.

Major contributions in the 1960s involved cleaning up proofs and simplifying derivations of new codes. From this turmoil of activity, most simple block codes were found to perform nearly as well as the best "fancy" codes. The search for the ultimate code, consequently, was dismissed as futile.

Though Code Theory started independently of Shannon's Information Theory, it produced an unexpectedly detailed and precise form of Shannon's work. However, aside from proving that most codes were "good," little hardware or improvement in communication networks followed directly. The ideas were too expensive to apply extensively in the 1960s.

But in the 1970s, improved digital hardware, LSI circuits and solid-state memories are making applications of both PCM and error-detecting-and-correcting codes practical. And now the introduction of low-noise digital communications channels threatens to eliminate the need for elaborate correction codes. However, widespread availability of the low-error digital networks isn't here yet. Thus, error-detecting-and-correcting codes is still a fruitful field and indispensable in communicating with spacecraft. ■



# How to get more mileage from discrete components.

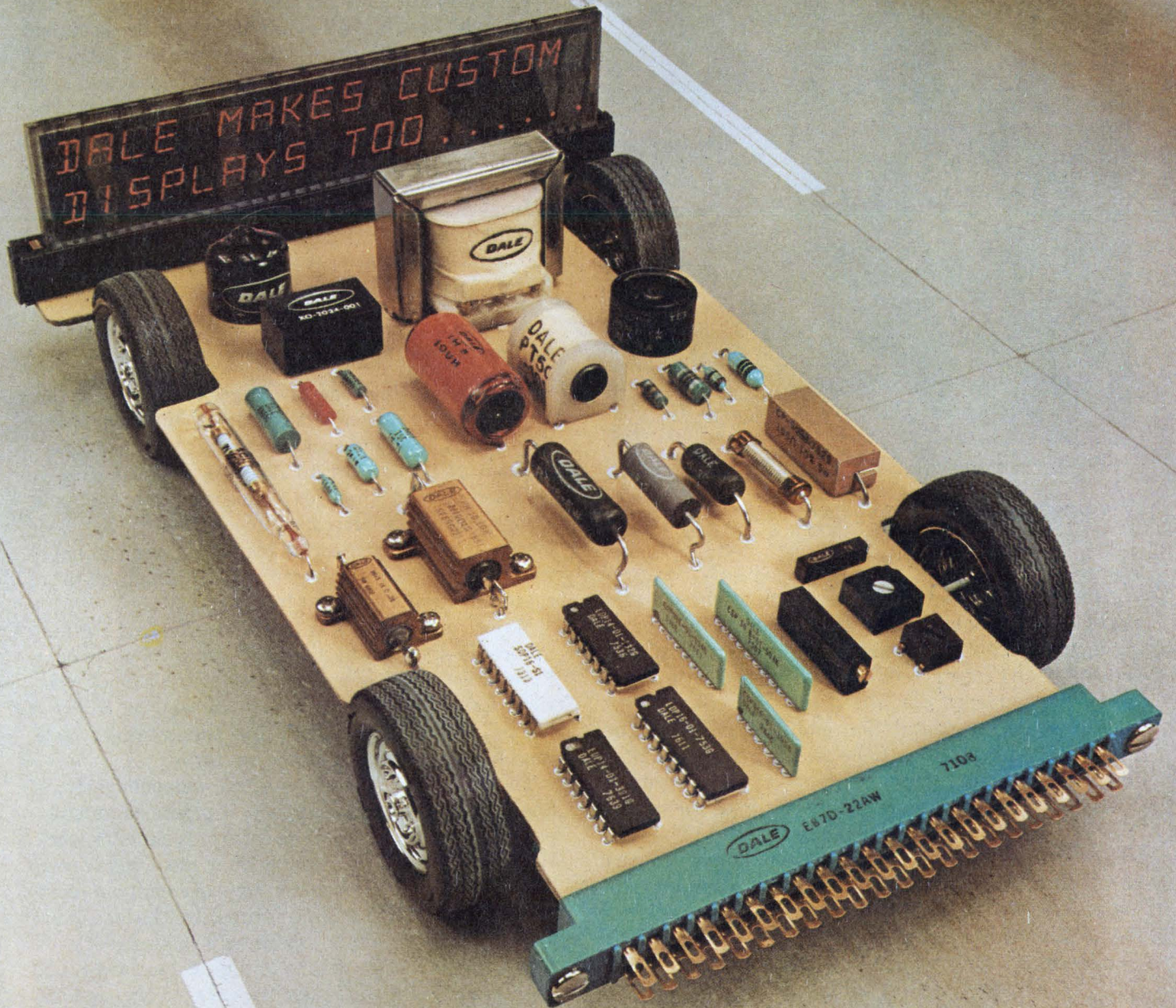



# Start with Dale...

because we're making a lot more of the discretes you need on and around your board. And we're geared to save you time, energy and money with this growing family of products.

## RESISTORS

The industry's broadest line to meet commercial, industrial and military requirements...including everything from the most stripped-down wirewound to glass-enclosed metal film.

## RESISTOR NETWORKS

Space-saving SIP and DIP models, including the first DIP qualified to MIL-R-83401. Very competitive prices plus one-week delivery from stock.

## TRIMMERS

Dale's low profile 700 Series and single turn 100 Series (3/8" square) interchange with all popular competitive models and give you performance advantages in a wide choice of pin spacings.

## INDUCTORS

Expanded production makes Dale a major supplier of roll-coated chokes. And,

we're gaining steady acceptance as a source of filter inductors and low power laminated transformers.

## CONNECTORS

Get excellent price and delivery on .156" edgeboards and 2-piece rack and panel styles plus board interchangeability with a wide range of other styles.

## ARRESTERS

Dale offers overvoltage protection for everything from lightning to transients within a circuit. Exclusive patented design with Mil. qualification.

## CRYSTALS

Our newest line. Includes compact, low-cost clock oscillators for DIP applications plus temperature compensated oscillators, voltage controlled oscillators and a broad range of filter designs.

It's a fact. Dale has more of the discretes you need. More standard parts from a strong distributor network...more capability to meet your special needs...more of the quality you've come to expect from Dale. It adds up to more mileage for your efforts and your budget when you call your man who sells Dale.



**Dale makes your basics better.**

DALE ELECTRONICS, INC.  
1300 28th Avenue, Columbus, Nebraska 68601  
*A Subsidiary of The Lionel Corporation*  
IN CANADA: Dale Electronics Canada Ltd.  
IN EUROPE: Dale Electronics GmbH,  
8 Munchen 60, Falkweg 51,  
West Germany

CIRCLE NUMBER 49

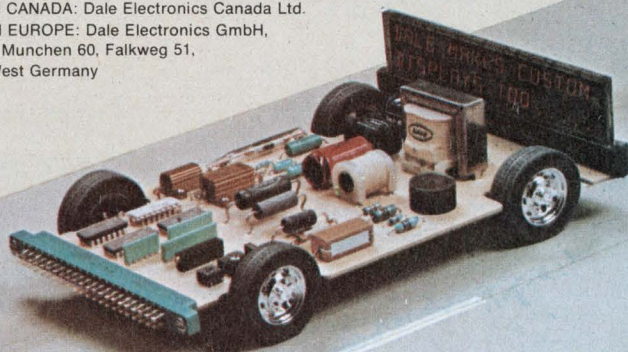



# ENCORE!

## WESTON reintroduces the DMM 6000 autoranging portable

**Better performance, new options, more accessories than any other low-priced field service DMM**

The Weston DMM 6000 is making an encore. It was a great field service instrument when first introduced and proved itself in dozens of applications. Now it is even better. Improved circuitry has substantially reduced response time of the autoranging digital readout for faster measurements. Better contrast and longer life have been achieved for the LCD display. Brightly lit rooms or even direct sunlight do not affect readability.

New options offered with the 6000 include a manual rangehold operation feature and display backlighting for easy readability in dark locations.

New accessories extend the versatility of the 6000 to cover a host of special uses and applications to make it a more valuable measurement instrument.

These are new additions to an already proven-superior field service instrument. The standard features that contributed to making it the best buy ever in a portable DMM still support the 6000. Autoranging in a low priced portable is unmatched by

any major instrument manufacturer. Low power circuitry that operates from two 9V transistor batteries with up to 350 hrs. life eliminates time consuming battery recharging. Weak battery condition is automatically indicated 8-10 hrs. in advance to eliminate lost time in the field.

Couple these major features with things such as automatic zero, automatic overrange, automatic minus polarity. Add in unusual features that include a full 10 amp AC/DC current range and a special "Hold" function for measurements in hard-to-reach locations. Package all this in a rugged, small, lightweight case. Offer it at the low price of \$195\* with Weston quality manufacturing and worldwide service and nobody can match it. Bravo!

\*Price in U.S. only

WESTON INSTRUMENTS

a DIVISION of SANGAMO WESTON, INC.

614 Frelinghuysen Avenue, Newark, New Jersey 07114

Canada: 1480 Dundas Highway, Mississauga, Ontario

Europe: Ingolstadter Str. 67a8 München 46, W. Germany

SANGAMO WESTON

Schlumberger



High Voltage Probe



R.F. Probe



AC Clamp-on Probe



"Hold" Function Probe



Light Meter Attachment

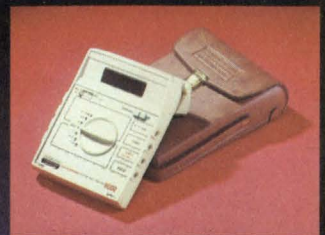



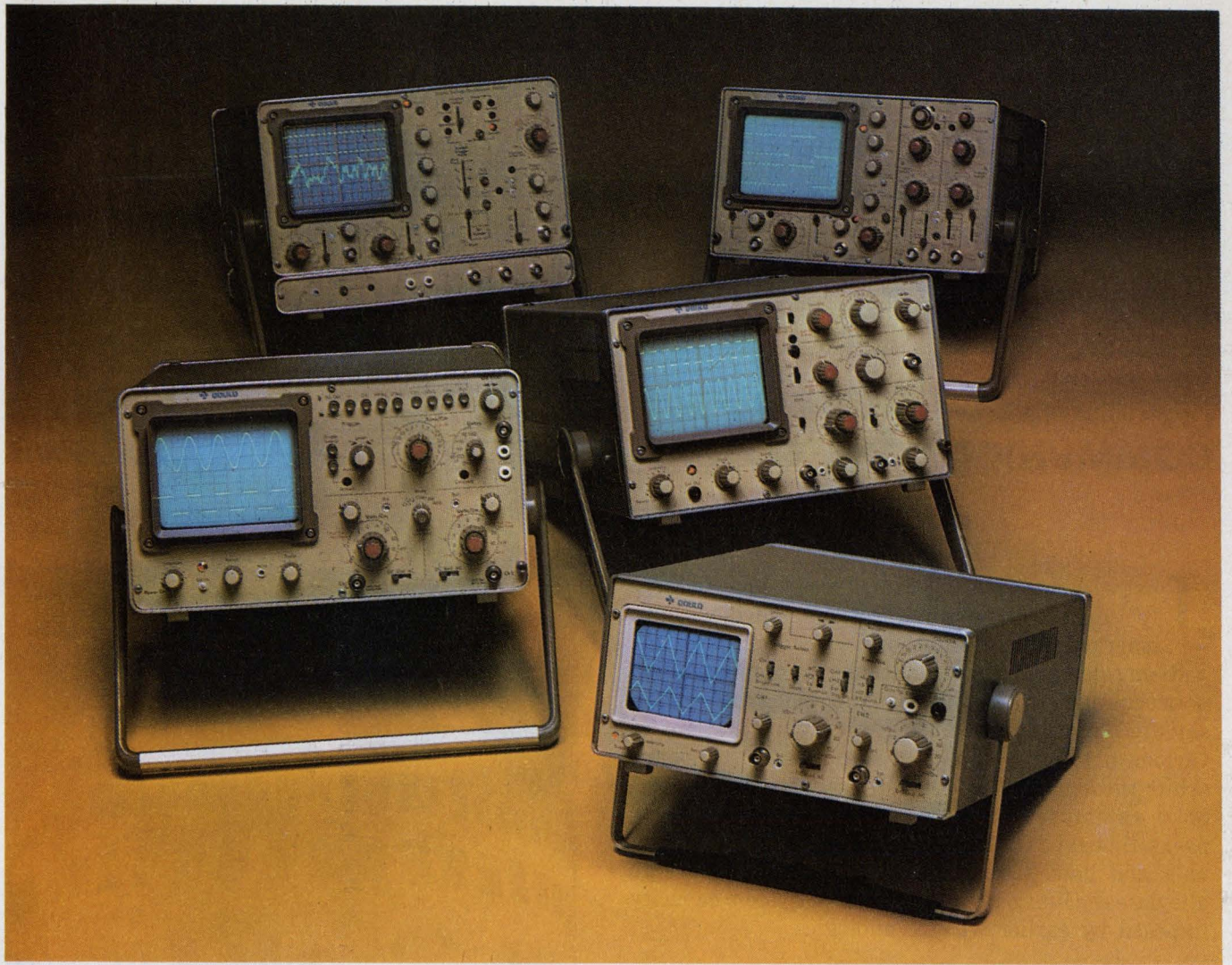

# Gould Oscilloscopes They have a name for reliability

Ask electronics people what the Gould name means to them and most would agree that reliability stands high on the list. In fact we are sure enough of our reliability to give you a 2-year warranty on our entire line of oscilloscopes. Of course, performance is also important, so we offer you four oscilloscopes covering a frequency range from DC to 50MHz, plus a unique digital storage model with options for hard copy and binary output.

There's a Gould scope to suit your needs. Economy is also a consideration. Gould oscilloscopes are competitively priced. But because we build them for the long haul, your instrument pays dividends through years of trouble-free service. Reliability says it all and that's what the Gould name is all about. So when you're looking for reliability, look for our name. For oscilloscopes and other fine instruments, you can rely on Gould.

For details write Gould Inc., Instrument Systems Division, 3631 Perkins Avenue, Cleveland, Ohio 44114. Or call the number below.

**FOR BROCHURE CALL TOLL FREE AT (800) 325-6400. EXTENSION 77.**  
In Missouri: (800) 342-6600

 **GOULD**

See us at Wescon Booths 1843-1849.





# Modern media

**J**ust within the last 25 years, two new and strikingly different communications media have emerged: satellite and optical communications.

Rising demands for instantaneous communication between any two points on the globe have been satisfied by signals beamed from ground stations of various nations to dozens of satellites in stationary orbits throughout the world. Shorter in range, fiber-optic communications, a fast-growing technology, packs thousands of telephone conversations, TV signals and data signals on hair-thin glass fibers to alleviate the limits to communication-system capacity imposed by earlier wire technologies.

## Satellite Communications

Astronauts' walking on the moon and the Vikings' transmission of pictures and data from Mars have dramatized the Space Age. But the relatively mundane accomplishments of unmanned satellites are having an immediate and profound effect on everyday living throughout the world.

Among the dozens of such satellites now orbiting the globe are those for hemisphere-to-hemisphere communications, weather observations and environmental studies.

At the turn of the century the only way to learn of widespread major news events was to read about them in a newspaper—sometimes days or weeks after they took place. Today, communications satellites, which have helped halve the cost of transoceanic and transcontinental telephone calls, are making the world smaller and involving everyone more directly in global happenings. These satellites make it possible to watch major events as they occur practically anywhere on earth.

The first satellite "voice" from space was the "beep-

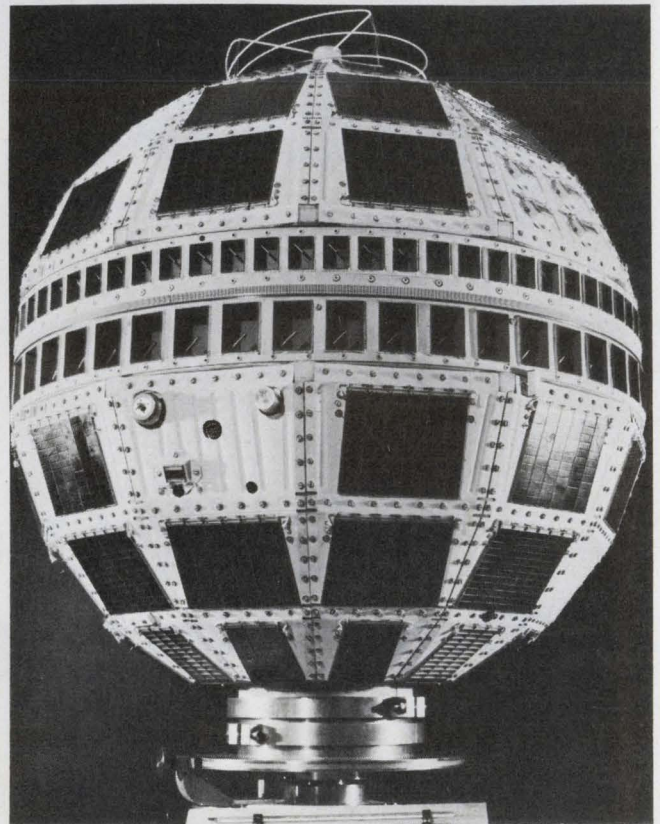

**1963—The Telstar II satellite** had two rows of microwave antennas around its center to receive signals sent up from the earth and relay them back down. Solar panels provided its communications power.

beep" of Russia's Sputnik tracking transmitter as it orbited the world in October of 1957. The event immediately shocked the United States into feverish competition. In December, 1958, Project Score (Signal Communications by Orbiting Relay Equipment) was launched aboard an Atlas rocket.

Score's equipment, built for the Army Signal Corps by RCA's Astro-Electronics Division in Princeton, NJ, broadcast the first voice message from outer space. The satellite carried an RCA tape recorder that was



triggered from the ground to transmit words of peace from the President, Dwight D. Eisenhower. It also performed a number of other communication experiments.

The first true U.S. communications satellite, a tiny magnesium sphere called Echo I, was placed into a 1000-mile-high orbit on August 12, 1960. The sphere opened to release an aluminum-coated Mylar balloon that inflated to 100-ft in diameter. Voice, music, picture, facsimile and Teletype signals were bounced off Echo from one part of the U.S. to another part, and from the U.S. to Europe.

This satellite gleamed like a bright star at night and was visible to millions of people throughout the world as a symbol of U.S. space efforts at the time. But at the same time, Echo I carried no communications electronics, and tracking proved difficult at certain parts of its orbit. So the next Echo was designed to carry a beacon transmitter for more precise tracking. Echo II, a 135-ft sphere with a substantially more rigid structure than Echo I, was launched on Jan. 25, 1964.

Between Echo I and Echo II, it had become obvious that satellite performance could be improved orders of magnitude with even low-power, on-board equip-

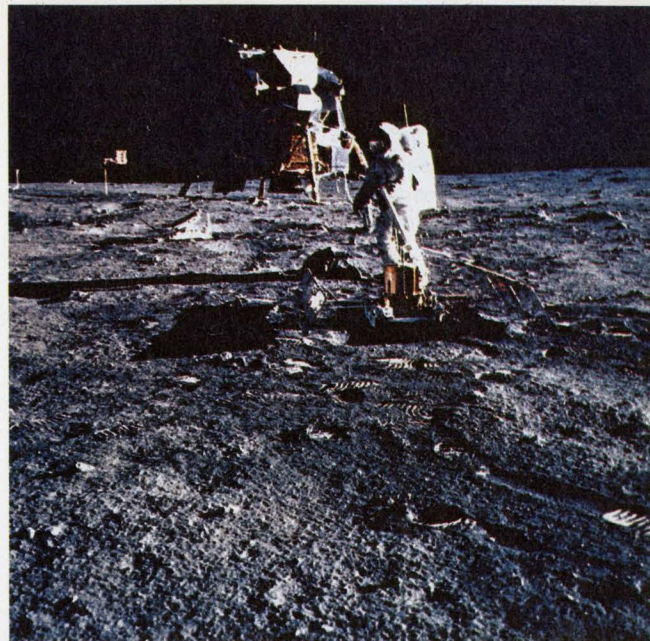

**1969**—In the greatest communications feat the world had ever known, astronauts Neil Armstrong and Edwin Aldrin, Jr. sent back TV pictures of the moon's surface and of their own activities.

## Satellite Communications

**1955**

John R. Pierce, Bell Laboratories, publishes a paper outlining the advantages of satellites for world communications.

**1957**

Sputnik is launched, giving the U.S. scientific and military community new impetus to study and explore space.

**1960**

The first voice from space is a taped message from President Eisenhower beamed from an orbiting Atlas. Voice, music, TV and other signals between the U.S. and Europe are bounced off Echo I, a 100-ft aluminized Mylar balloon.

**1962**

The first view of the earth's weather as seen from space is transmitted by Tiros I.

Telstar I, the world's first active satellite, carries telephone communications and TV signals across the Atlantic.

**1965**

Comsat's first satellite, the Early Bird, I, carries 240 voice channels, TV and data signals.

**1969**

Comsat puts high-capacity Intelsat III-F3 satellite, with 1200 two-way voice circuits, TV and commercial services in orbit over the Pacific Ocean. TV pictures, voices and data are transmitted from the Moon's surface to Earth in first manned lunar landing, by the Apollo XI crew.

**1976**

After 11-month, 500-million mile journey, Viking I sends back first pictures of Mars' surface.

## Optical Communications

**1870**

John Tyndall gives first demonstration of sending light down a dielectric pipe, a stream of water. Fiber optics use same principle.

**1880**

Alexander Graham Bell applies for patents on a Photophone that transmits sound signals on a beam of light.

**1955**

The foundations of fiber-optics technology are established in a doctoral thesis by Narinder S. Kapany at the University of London.

**1960**

Dr. Theodore H. Maiman invents the laser, which opens the doors to optical communications systems with hundreds of GHz bandwidth.

**1962**

The first gallium arsenide solid-state laser is announced by R.N. Hall of GE and 10 days later by M.I. Nathan of IBM.

**1966**

The theoretical limit of loss in optical fibers is established by K.C. Kao as orders of magnitude below best available ones.

**1970**

Corning Glass develops a fiber with the low attenuation of 20 dB/km—a breakthrough.

**1971**

An improved fiber with a dispersed index of refraction is produced by Nippon Electric in Japan.

**1977**

Telephone companies in the U.S. and abroad set up operational fiber-optic systems.



## Anxious moments with Telstar

With all the advance publicity given to Telstar and with the impending live TV coverage by CBS, NBC and ABC, key people working on the project were apprehensive because the Bell System had no contingency plan in case the launch or the satellite itself failed.

"We had to be right the first time," remembers Robert E. Sageman, who was satellite-projects engineer in 1962. "We had tested the Telstar in simulations of every conceivable space environment. But the rocket success was somewhat disappointing in those early years."

Robert Latter, an engineering director at AT&T, rose before the 4:30 a.m. blastoff to turn on the monitoring equipment he had assembled in his basement.

"I was anxious to see if the launch was a success," he recalls. "I knew if I could pick up the vhf tracking signal from the satellite on its first orbit, we'd be in good shape."

Latter was not disappointed. Because of Telstar's orbit he was able to receive the signal at his New Jersey home even before it was picked up on the giant horn antenna at Andover, Maine.

Personnel at Andover had heard that the launch was perfect. But the orbit was such that the satellite was not accessible to the ground station for over 12 hours after launch. All day, reports trickled in from tracking stations around the world that all was going well. But it was an anxious moment when Telstar finally rose above the horizon in Maine. Within minutes the antennas had locked onto the tracking beacon and transmitted commands to turn on the broadband amplifier.

It was only when the first voice signals came through and television pictures appeared on the TV monitors that the engineers manning the ground station gave a collective sign of relief. And a cheer.

ment. Such a quantum jump took place with the development of solar-powered, active-repeater satellites, which amplified the signals that they relayed between widely separated ground stations.

### Telstar leads the way

Telstar, designed by Bell Laboratories, was the first of the solar-power satellites. Launched on July 10, 1962, the basis for Project Telstar had been established in the Research Department of Bell Labs two years before Sputnik circled the earth.

In 1955, Dr. John R. Pierce published calculations showing that satellites would play an important role in communications. He discussed the relations among power, bandwidth, antenna gain, receiver performance and orbit parameters.

The National Aeronautics and Space Administration decided, in 1958, to launch a large, aluminum-coated balloon to study the effects of various

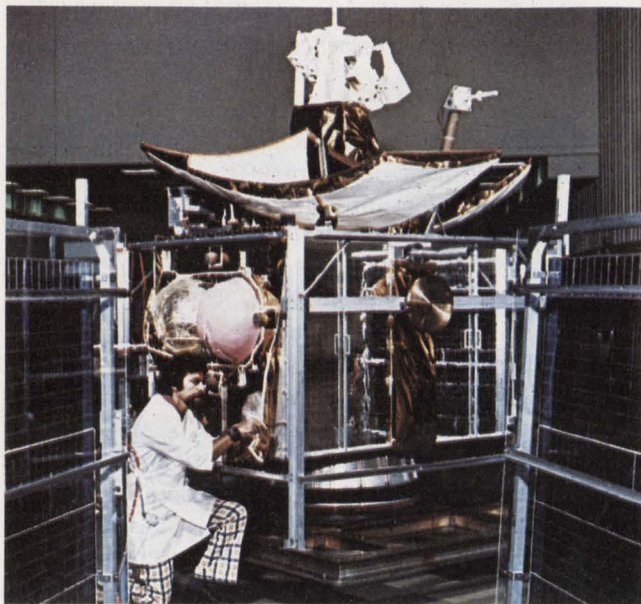

1975—Final tests of RCA's Satcom I made prior to launch on December 12th.

phenomena on orbit stability, Pierce proposed the Echo I experiments to investigate the use of passive or orbiting reflectors for communications. Bell Laboratories set up a transmitting and receiving station at Holmdel, New Jersey, to work with a companion station at Goldstone, CA, designed and operated by Bell's Jet Propulsion Laboratory.

The Echo I experiments produced the first two-way telephone conversations via satellite. They also confirmed the predictions of the loss to be encountered in the radio path as well as the stability and wide-band performance of the radio medium.

The results of these experiments were studied. So was the possibility of applying microwave-radio-relay technology—already used in Bell's overland links—to transoceanic links in the form of a microwave repeater in the sky.

Most of the tools to do it were already available from research and development in widely scattered fields. The transistors and solar cells had been developed (some 1000 transistors and 3600 solar cells were used in Telstar I).

Low-noise maser amplifiers were available. Long-lived traveling-wave tubes (TWTs) and horn-reflector antennas and FM-feedback receivers from Echo I were at hand.

### AT&T and NASA join forces

To design and build the first active satellite-communication system, American Telephone & Telegraph Co. (AT&T), entered into a cooperative agreement with NASA. AT&T would build Telstar I and NASA would launch it into space. AT&T reimbursed NASA for launching costs and the use of the Minitrack Stations around the world—they had been set up originally for project Mercury—to collect telemetry



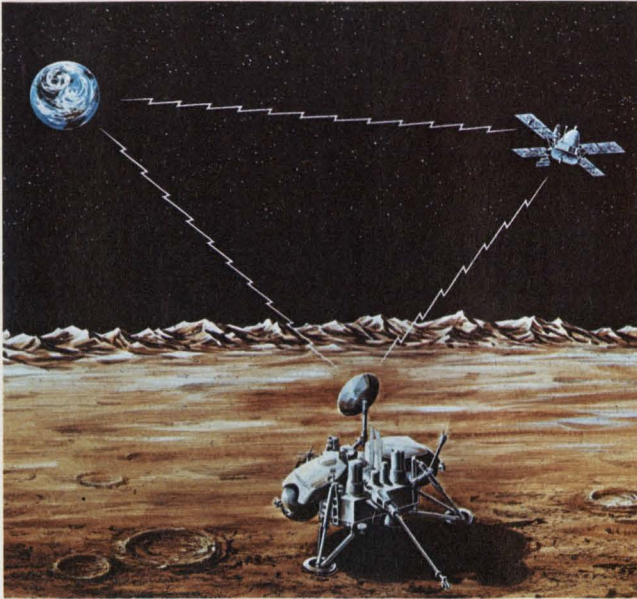

**1976—The Viking Lander spacecraft** touched down on Mars' surface and relayed pictures and data 250,000 miles to earth through the Viking Orbiter.

data from the satellite.

Telstar I was to be the first satellite to be placed in a high enough orbit—about 3502 nautical miles when farthest from earth—to penetrate the maximum electron and proton radiation levels of the Van Allen Belt, which are about 2000 nautical miles above the earth. When closest to earth, the satellite was 593 nautical miles away. The Van Allen Belt had been discovered in 1958 by the first American scientific satellite, the Explorer I. But very little was yet known about the radiation to be encountered by Telstar I. As a result, instrumentation for monitoring this, 14 telemetry channels, TWT currents, temperatures and critical power levels in the microwave repeater was put on board. Their signals were to be telemetered back to earth at 136 MHz, for which the Minitrack stations were equipped. Commands from the tracking stations were sent up at 123 MHz to turn the microwave repeater on and off and for other functions.

Frequencies for the communication repeater, which preferably would lie between 1 and 10 GHz, had been widely allocated for ground services. It was decided to share frequencies in the 4-GHz and 6-GHz bands used in point-to-point, common-carrier microwave systems. The final design of Telstar's repeater received and transmitted single-channel TV, multi-channel two-way telephone conversations, and high-speed data. Signals from the ground were received at 6390 MHz and re-radiated back down at 4170 MHz.

### Solar power a must

While ground-based communications systems get their power from conventional sources, active satellites must generate power from the sun to continue receiving and transmitting for long periods of time. Telstar I was designed to function for two years. For

this period it was calculated that it would use about 200 kWh at an average power of 10 to 12 W. The power system of Telstar I combined the output from a solar-cell array with a rechargeable nickel-cadmium battery to be used when the satellite was shielded from the sun by earth, and when drawing peak power.

Developing the solar-cell panel was a major step forward in itself. Since the main problem was expected to be radiation damage from the Van Allen Belts, the cells had to have high efficiency and be radiation-resistant. The first solar cells, developed by Bell Labs in 1954 and 1955, were p-n types, with 11% efficiency.

From 1956 to 1961, all commercial solar cells produced in the U.S. were p-n units—a p-type layer diffused into n-type silicon. But an n-p cell was determined to be better for space. In 1960, the U.S. Army Signal Research and Development Laboratory developed an n-p solar cell with the highest radiation damage resistance to date.

Verifying this high resistance, Bell went on to develop n-p cells with extremely thin junctions—on the order of  $0.4 \mu\text{m}$ , or about 1/250th the thickness of a human hair. This increased efficiency of the cells at the short end of the wavelength spectrum. A new type of contact, evaporated titanium with a top layer of silver, was developed to protect and to reduce resistive losses. On top of this, an antireflection coating of silicon monoxide was deposited to reduce undesired reflection from the cell surface to a minimum. Transparent 0.03-in.-thick sapphire plates were mounted on top of each cell to shield it against radiation and to protect it against micrometeoroid abrasion.

The 3600 solar cells on Telstar I's surface were each  $1 \times 2 \text{ cm}$  in area and 0.04 cm thick. Although 500 of the cells would produce the 10 to 12-W average power, only half the 3600 cells would be illuminated at any one time, and only a small number of these would get the full power of the sun's rays. (The in-space performance of the solar-cell output was within 2% of that anticipated.)

A large ground antenna that could transmit to and receive from the satellite and track it as well was built on a hilltop at Andover, ME. It was connected to existing nationwide communications by special microwave systems. Echo I's Holmdel station was adapted to receive Telstar's signals.

### New TWT for ground transmitter

Telstar's Andover ground station was the first application in which a special broadband, high-powered TWT—the M4040—was developed for the transmitter's output amplifier. Bandwidth was 50 MHz, TWT gain 26.5 dB and maximum output about 2 kW. The conventional slow-wave helix was discarded in the M4040 because it generated too much heat. The heat-dissipation problems were licked by incorporating a disc-loaded, circular-waveguide, slow-wave circuit into the tube and fastening it directly to the



outer shell.

"Something old and something new" were incorporated in the ground-station receiver. The "old" was the FM-feedback receiver invented by J.C. Chaffee at Bell Labs in the early 1930s. His concept was first revived and proved highly useful in the Echo I experiments. With this receiver, the Andover station increased the useful threshold at which the FM signal could be detected by 4 to 5 dB.

The "new" element in the receiver was a high-gain maser amplifier with a noise temperature of 3.5 K compared to 3000 K for conventional amplifier circuits. The low noise permitted extremely weak signals to be amplified. The maser amplifier was of traveling-wave design, with a ruby crystal for the active element. Gain was 40 dB at a 3-dB bandwidth of 16 MHz.

After only a few hours in space, Telstar had successfully relayed TV, voices, data and facsimile. The early weeks of the orbit saw many historic firsts, including taped and live TV from Europe, color and two-way TV tests, two-way telephone between New York and Paris, and transmission of a variety of digital data, as well as high-speed, two-tone facsimile copy such as pages of *The New York Times*. But eventually Telstar I's performance degraded. It went silent in 1963.

Difficulties with Telstar I were diagnosed from the ground to be caused by ionization of gases in the command decoder's transistors. In Telstar II, which was launched on May 7, 1963, these transistors were sealed in vacuum packages. Telstar II was also placed in a higher orbit—a 6700-nautical mile apogee—where it would encounter less radiation, and also provide longer mutual visibility between Bell's Andover ground station and ground stations in Europe.

## A change in the weather

While Telstar I was establishing a series of firsts in active communications-satellite technology, major electronics organizations were at work producing satellites and other space vehicles for NASA. But these were sending pictures taken in space back to earth. One major NASA effort was devoted to learning more about the earth's weather.

About a century and a half before, Heinrich Wilhelm Brandes gathered daily weather observations made throughout Europe. Plotting the data he had compiled, he created the world's first weather map. From this rudimentary beginning evolved techniques for regularly acquiring and assembling weather information. In 1870, what is now the National Weather Service was formed. Stations around the nation gathered weather data, visually at first and later with instruments. The instruments were both land-based and carried aloft by balloons, kites and sounding rockets.

As late as 1960, however, meteorology was still plagued with serious gaps in worldwide weather

## Trials of developing a weather satellite

"We don't ask much," a NASA official told RCA's Abe Schnapf over lunch one day in the spring of 1960. "Just get the satellite into orbit and get us one usable TV picture, and you're in business."

But a lot was riding on that "one usable picture." So 300 scientists, engineers, space technicians and support personnel were put to work on the world's first weather satellite at RCA's fledgling Astro-Electronics Division at Princeton, NJ.

They had to fill a tall order—fit 42,000 components, including an array of miniature TV cameras, videotape recorders, transmitters, solar cells and rechargeable batteries into a 42-in.-diameter by 19-in.-high drum.

One problem was to control the spin speed of the satellite when in orbit. Some engineers developed a spin-speed regulator known as the yo-yo. It had a long cable with a small weight at the end.

"We rotated an experimental satellite drum at high speeds in a field on RCA's grounds to test the design," Schnapf recalls. One day the cable unwrapped and the yo-yo's weight and cable went flying off into a local farmer's field. He carried it back the next day, hopping mad."

observation. There was no way of systematically acquiring weather data over more than 80% of the globe. Storms and other weather phenomena over seas, deserts and other undeveloped lands frequently went undetected or were studied long after they had formed. What's more, whatever weather information could be gleaned from such areas had to come from ships and aircraft passing through, or other sources not equipped to gather precise meteorological data.

## Tiros I gives first weather picture

Seventeen years ago, one answer to meteorology's blind spots roared into orbit from Cape Canaveral, FL. On April 1, 1960, the world's first weather satellite, the Tiros I (for Television Infrared Observation Satellite) was launched by NASA. Within a few hours, it had transmitted the first view of earth's weather as seen from a space orbit. A completely new era in weather observation was ushered in by this drum shaped spacecraft, developed by RCA's Astro-Electronics Division, Princeton, NJ, for NASA's Goddard Space Flight Center.

Tiros I led the way for increased weather exploration in space. Nine more Tiros went up from 1960 to 1965. So did nine Environmental Survey Satellites (Essa), from 1966 to 1969, an Improved Tiros (Itos), in 1970, and five more advanced designs in the Tiros program, from 1970 to 1976. The program, managed by the National Oceanic and Atmospheric Administration is scheduled to continue through 1984.



"Tiros I weighed only 260 pounds, but it was one of the most sophisticated satellites placed into orbit by the U.S. at that time [1960]," recalls Abraham Schnapf, manager of satellite programs for RCA. "Over the span of 17 years, the satellites have taken more than 3.5-million pictures and logged 7.6 billion miles of space travel. The first views of the earth were rudimentary compared with pictures produced by the latest weather satellites in the series." Interestingly, the average life span of each satellite has been more than twice the design life.

Since the Essa system has been operational, no major storm anywhere on earth has gone undetected. In addition to providing weather-forecasting data, weather satellites are now being used to help predict water runoff from melting snows, to aid ships navigating through ice floes and to assist fishermen in locating promising fishing grounds.

Most important, however, the weather sentinels have helped prevent countless losses of lives and property over the past 17 years by providing advance warning of storms. Airlines, shipping and other weather-dependent commercial enterprises now use satellite pictures routinely to keep abreast of weather conditions.

### **Communication satellites increase**

The development of active communications satellites, like that of the weather satellites, has been continuing at a growing pace. The first communications satellite to be launched after Telstar I was Relay I, which was designed and built for NASA by RCA. It was launched on December 13, 1962, but an early failure in the power supply crippled the electronics in the craft and cast a pall of gloom over the participants. Fortunately, the designers were able to recommend a "fix" in space and it was returned to operational status. By early 1963, Relay I was transmitting the first color-TV pictures between the U.S. and Europe and conducting simultaneous voice relays between the U.S. and Brazil. Another first was transmission across the Pacific Ocean—from the continental U.S. to Japan.

Relay II was launched on January 21, 1964, with similar communication capabilities. Besides handling communications, both Relays operated as scientific research spacecraft, and sent back data on the space environment.

Another major advance in communications satellite technology was marked with the advent of NASA's Syncom series. These vehicles were the first to be launched to operate in a geosynchronous orbit at an altitude of 22,300 miles above the earth. In this orbit, the satellite travels around the globe at the same speed as the earth rotates. Thus, it seems to stay in one spot in the sky. These spacecraft opened the door to the era of commercial communications satellites because unlike the earlier satellites they were able to provide continuous coverage. Their predecessors were shielded

by the earth from grounding stations during portions of their orbit.

Syncom I, however, immediately ran into trouble. Launched Feb. 14, 1963, it lost radio contact on the first orbit. But this disappointment was softened with the launch of Syncom II on July 23 of that year, into an almost synchronous orbit. It drifted slightly. Syncom III, in August of 1964, hit the mark when it was boosted into the first truly stationary orbit.

### **First commercial satellite launched**

The first commercial global-communications satellite, the Early Bird I, followed in April of 1965. Launched by NASA for the Comsat Corp. into a geostationary orbit over 27.5° West longitude, it could provide 240 voice channels, television, or high-speed data.

Comsat was the Communications Satellite Corp., created in 1962 by Congress to handle U.S. overseas satellite facilities. Comsat planned to expand service with a second satellite. However, the Intelsat II, launched in October of 1966, ran into trouble. The apogee-motor nozzle was blown off in space shortly after the motor ignited and the geostationary orbit was not achieved. Instead, it provided only about eight hours' daily service.

Trouble dogged the third Comsat venture, the Intelsat II-B. Part of its capacity was to be used by NASA to support the Apollo series of spacecraft. Launched on Jan. 11, 1967, the Intelsat II-B's retro-motor fired to place it in a geostationary orbit about 176° East in the vicinity of the Marshall Islands. But its capacity was reduced when one of its four TWTs failed.

The fourth Comsat attempt, Intelsat II-C, was successful. Sent up on March 23, 1967, it was placed in a synchronous orbit about 5° West over the Atlantic Ocean.

To back up Intelsat II-B, Intelsat II-D was sent aloft in September of 1967. Its capacity was similar to previous ones. It was placed out over the Pacific at 176° East. Comsat and NASA collaborated in tests to determine what the minimum angular separation of Intelsat II-B and D could be without producing intersatellite interference.

Comsat continued to fund launchings and NASA to make them. An Intelsat III F-1 third-generation satellite crashed due to a control-system failure on launch, in September of 1968. In December, an F-2 was put into orbit for service between the U.S. and Puerto Rico. Intelsat III F-3 was boosted into orbit in February of 1969 over the Pacific to provide a new high capacity of 1200 two-way circuits for voice, TV and other commercial services.

### **Moon pictures capture imaginations**

Five months later, on July 21, 1969, interest in Intelsat launchings was to be distracted by the most



dramatic communications from space the world had ever seen—TV pictures and voices of Astronauts Neil Armstrong and Edwin Aldrin, Jr., outside the Apollo XI Lunar Module at Tranquility Base on the moon. On the moon's surface, the astronauts used vhf backpack transceivers, sending on 259.7 MHz and receiving on 296.8 MHz, to communicate with one another and, by way of the Lunar Module, with earth.

The vhf transceiver in the Lunar Module, part of the Module-communication subsystem, was designed by RCA's Communications Systems Division, Camden, NJ, for Grumman, the prime Apollo contractor. It was sensitive enough to receive AM voice signals from the Command Module orbiting overhead, and voice plus biomedical data from astronauts outside the Lunar Module.

For communication between the Module and NASA's Space Flight Network on earth, an S-band transceiver in the Module received voice and range interrogations on a carrier of 2101.8 MHz. The transceiver sent pulse-code-modulated voice, biomedical data and wideband TV signals on a carrier frequency of 2282.5 MHz with an output of 20 W. The output was fed to either an S-band, 26-in. steerable dish antenna mounted on the Module or to an antenna erected on the moon for communications from the lunar surface to earth during the Module's stay on the moon. The erectable antenna unfolded like an umbrella to a 10-ft-dia. dish.

### **Comsat gets competition**

Meanwhile, Comsat's domination of space communications was coming to an end. From January, 1970, to January, 1976, 10 more of the Intelsat series satellites were successfully launched. But so were a number of others from U.S. domestic competition as well as from U.S. allies. Four United Kingdom Skynet satellites were placed in orbit. Three NATO space vehicles, three Canadian Telesat satellites and two French-German Symphonie communications satellites were all launched by NASA.

Western Union sent up two Westar satellites in 1974. RCA's first domestic communications satellite, Satcom I, went into orbit Dec. 12, 1975. RCA claimed it carried twice the communications capacity as that of any previously orbited, Delta-launched spacecraft. It had 24 channels, each of which could carry a color-TV signal, or 1000 voice circuits, or more than 60 Mbits/s of digital data. A similar vehicle, the Satcom II, was sent aloft March 26, 1976, to double RCA's Satcom-system capacity.

In 1974, AT&T Long Lines and General Telephone and Electronics announced plans to jointly operate a domestic-communications satellite system. The two companies now own and operate seven earth stations.

Comsat General Corp., a subsidiary of Comsat, owns and operates two Comstar satellites for AT&T and GTE that were launched in May and July of 1976. Comsat General also put into orbit three maritime-

communications satellites, Marisat A, B, and C, between February and October of last year.

The sky above may seem crowded now. But it will get even more so because of the increasing demands worldwide for greater communications-systems' capacities. Since the first Intelsat was launched in 1965, 17 other commercial-communications satellites have been added. As a result, TV traffic increased 8500% and transoceanic telephone communications jumped 1700% in just over a decade.

## **Optical Communications**

Carrying information from one place to another on a beam of light is hardly new. Alexander Graham Bell proposed several methods of communicating with light in a patent application in 1880. In one of his proposals, sunlight bounced off a mirror and through a lens that focused it into a narrow beam impinging on a reflective, shutterlike diaphragm. The diaphragm vibrated in response to spoken sounds. These vibrations varied the amount of light reflected through a second lens that aimed the beam at a selenium-cell receiver.

The changes in light intensity varied the resistance of the cell and the current through a telephone receiver that was connected in series with the cell and a set of batteries. Sound was produced by the receiver diaphragm, but the system was too inefficient to be practical.

The prospect of using light as a medium of immense information-carrying capacity again stimulated some 80 years later by invention of the most spectacular electro-optical device to emerge in the 20th century—the laser. In the late 1950s, Dr. Theodore H. Maiman, a physicist at Hughes Research Laboratories in Malibu, CA, pursued what many of his contemporaries thought was a fruitless task of trying to obtain coherent optical emission from a crystal. In July of 1960, the fruitless task bore fruit, with 10-kW pulses of red light at 694.3 nm from an "optical maser" using a ruby crystal. The crystal was pumped by a pulsed mercury arc.

The fantastic theoretical bandwidths of a laser communication system—all existing TV channels and thousands of other data channels could be put on a single beam—stimulated developments, not only in lasers, but in other electro-optical components that would be used for such a system.

By March of 1961, six kinds of lasers were being used experimentally. Ruby lasers were operational at Hughes, Bell Laboratories, Raytheon, and other plants. Samarium-doped and uranium-doped calcium fluoride lasers had been developed at IBM. Significantly, Bell had also developed the first cw helium-neon gas-discharge laser, pumped by a 28-MHz rf signal.

### **Optical modulators sought**

A search for broad-bandwidth optical modulators was also in progress. Experimental modulators being



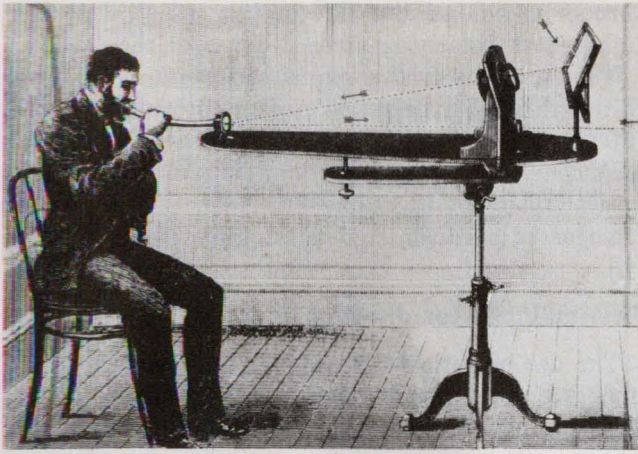

**1880**—The first optical-communications system, the Photophone by Alexander Graham Bell, focused sunlight on a vibrating diaphragm and sent the modulated light on to a selenium photodetector connected to a telephone receiver. The system was impractical.

used were Kerr cells with losses of 80%, and consequently were unsatisfactory. The first microwave optical modulator was a Pockels-cell device produced in 1961 by Sperry Gyroscope in Great Neck, NY. It was a solid-state, crystalline equivalent of a Kerr cell with somewhat higher efficiency.

About this time, both germanium and gallium-arsenide crystals were found to be transparent to infrared. Infrared-laser beams could be modulated by applying voltages across the semiconductor crystals. But they were low-power devices of limited bandwidths, so eventually they were abandoned.

Another obstacle to laser-communication systems was the lack of detectors for ultra-broadband optical signals. But by 1962 Philco developed a silicon planar epitaxial photodiode that could demodulate laser signals up to 5 GHz. A microwave traveling phototube also appeared at this time. Developed by Dr. Burton J. McMurtry of Sylvania's Microwave Device Division and Professor A. E. Siegman of Stanford University, the tube had a photosensitive thermionic cathode and a broadband helix like that of a conventional TWT. When optical signals modulated at microwave frequencies were projected onto the cathode, microwave photocurrents were produced and amplified by the helix. The output was a microwave signal that could be demodulated with standard circuits. But these turned out to be devices whose time had not yet come.

A breakthrough in solid-state laser technology came in September of 1962 when R.N. Hall and fellow researchers at the General Electric Research Laboratory obtained laser radiation from a gallium-arsenide device. Just 10 days later, an IBM research team headed by M.I. Nathan announced similar success. The laser properties of gallium arsenide were also verified by RCA scientists and others that same year.

But devices like the Philco photodiode, the Sylvania photo-TWT and the solid-state laser were relatively undeveloped. That plus the lack of simple, efficient broadband modulation systems and sensitive re-

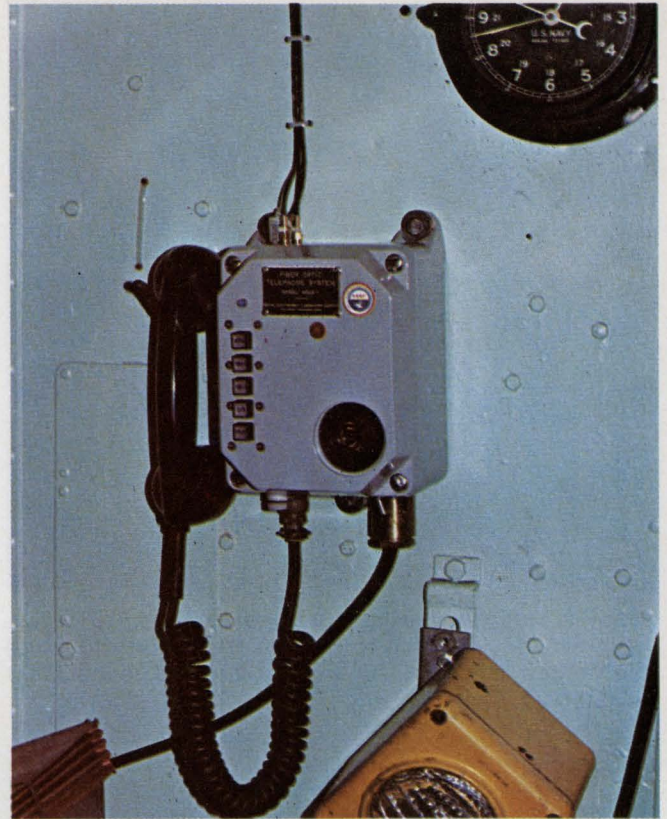

**1973**—A six-station fiber-optic telephone system was installed aboard the U.S.S. Little Rock. The fiber-optic links demonstrated substantially better reliability than system switches, ICs and power supplies.

ceivers stalled the progress of laser-system development for a time.

In the mid-1970s, point-to-point earthbound laser-communications systems were studied by several military agencies and by Bell Labs. These studies unanimously concluded that the reliability of such laser links was insufficient for military and telephone communications because of degradation by fog. As a result, these concepts were, for the most part, abandoned and development work transferred, instead, to millimeter-wave systems.

Today, only ground-based laser links that primarily carry computer data between nearby buildings have proven successful. But in the outer reaches of space, reliable long-distance communications over thousands of miles is still considered an attractive use of high powered laser systems.

Even though point-to-point laser links have not proven reliable for high-capacity communications, the related semiconductor technology developed in the 1960s would figure significantly in the solid-state fiber-optic communications systems developed earlier in this decade. A byproduct of the early laser studies was light-emitting diodes, with the first commercial display being introduced in 1968. The sensitivity of silicon photodiodes and phototransistors was increased and noise figures lowered. Meanwhile, developments in p-i-n and avalanche photodiodes were to make them almost ideal candidates for fiber-optic



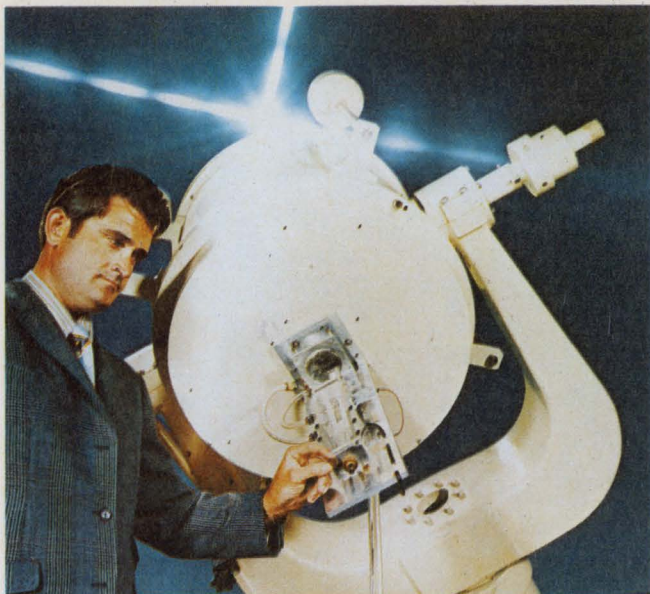

**1975—A sun-powered laser** was developed by GTE Sylva-  
vania for the Air Force to test the feasibility of passing  
information between earth-orbiting satellites up to 43,000  
miles apart.



**1977—Special fiber-optic cables** developed to withstand  
the rigors of being yanked through telephone manholes  
and conduits have been put in General Telephone and  
Electronics' operating optical communications system in  
Long Beach, California.

systems operating in the megahertz to gigahertz  
regions of the spectrum.

Fiber-optic communications systems have today  
received much publicity as an exciting new technology,  
but the principal of using a transparent "light pipe"  
to guide optical energy was demonstrated back in 1870.  
John Tyndall, a renowned British physicist showed  
members of the Royal Society in England that light  
shining inside of a container of water was guided out

through a hole in the side of the vessel. The light  
followed the spurting stream down to the floor.

This was the first demonstration of light trans-  
mitted through a dielectric medium by means of total  
internal reflection. Visible light from LEDs, which  
isn't coherent, is guided in multiple modes through  
optical fibers by the same principal. Coherent light  
from lasers is transmitted in a single waveguide mode.

### First methods for drawing fibers

The use of optical-fiber systems to pipe light and  
images around corners and for many other unique  
applications was first proposed by Dr. Narinder S.  
Kapany, the father of fiber optics. In his doctoral  
thesis delivered in 1955 at Imperial College of the  
University of London in England, he described the  
first methods for drawing fibers. In later papers, he  
would correctly analyze the various modes by which  
light is transmitted by a fiber. But around 1955, he  
was principally interested in developing fiber-optic  
image bundles as "fiberscopes" for visual internal  
medical examinations.

In a paper published in 1958, Kapany proposed a  
photoelectric remote spot scanner, which was a direct  
precursor of fiber-optic computer-card card readers  
that were to appear in the late 1960s.

Using fiber-optic bundles for transmission over  
distances greater than a few feet was unthought of  
in the late 1950s because of the high optical attenua-  
tion of available glass.

A 10-ft bundle constructed by Kapany of the lowest-  
loss fibers available transmitted only 50% of the light.

In 1963, computer designers were seeking to in-  
crease the operating speeds of computer logic from  
the submicrosecond to the subnanosecond region. But  
the semiconductors available were too slow. The Air  
Force funded programs by American Optical and RCA  
to investigate the concepts of computers that would  
combine lasers and optical fibers.

A computer using lasers as the active elements was  
proposed by Walter Kosonocky of RCA. The laser  
energy was to be carried by optical fibers containing  
active-emission ions and saturable-absorptive ions.  
With a 1- $\mu$ m fiber and a 100-ps laser pulse produced  
at a 1 GHz rate, Kosonocky deduced that a logic  
element requiring only 10 mW could be produced.  
Unfortunately, neither the optical-fiber material nor  
the pumping power needed for GHz rates was avail-  
able. And before these problems could be solved,  
semiconductor technology had advanced to higher  
speeds and lower cost. So the idea of a computer using  
lasers and optical fibers was dropped.

### Fiber development stimulated

But three years later, a milestone report was  
published by Dr. K.C. Kao and G.A. Hockham of  
Standard Telecommunication Laboratories in En-  
gland. They established that the fundamental limit



of attenuation in fibers was due to scattering. Eliminating the scattering would theoretically provide fibers with attenuations of less than 1 dB/km. These concepts grabbed the attention of researchers at Bell Labs and at the major glass companies.

The breakthrough that signaled the start of full-scale development efforts in fiber optic communications systems came in 1970. The first low-loss fiber was developed by Corning Glass Works. This dope-deposited silica fiber had an exceptionally small attenuation of 20 dB/km. Previous losses had been as great as 1000 dB/km and even higher. The 20-dB loss was a magic figure for the telephone companies because it compared directly with losses encountered in coaxial cables used for microwave land lines.

In late 1971, Nippon Electric in Japan produced an improved glass fiber, called Selfoc, that was particularly suited as low-loss transmission line for single-mode (cw) laser energy at a bandwidth of hundreds of GHz. The Selfoc was fabricated with a dispersed index of refraction that varied smoothly from a maximum at the fiber center to a minimum at the circumference. This contrasted with conventional fibers that were fabricated with a glass core of one index surrounded by a thin cladding of a lower index. This type is still widely used with the multimode radiation of LEDs, primarily because of lower cost. Dispersed-index fibers like the Selfoc are now made by suppliers in this country.

Early in 1972, Corning announced an even lower-loss fiber with an attenuation of 4 dB/km. Continuing efforts in this direction have resulted in a recent Japanese announcement of about 0.2 dB/km in the laboratory, which is approaching the theoretical limit.

By 1972, fiber-optic links were appearing in digital-computer applications to connect peripherals either to other peripherals or to mainframes. The U.S. military was interested in these systems because they were much smaller and lighter than copper conductors. In 1973, a six-station fiber-optic telephone station was placed aboard the Navy flagship, the U.S.S. Little Rock.

As 1973 came to a close, a massive international effort was under way to perfect all elements of fiber-optic communications systems—fibers, cables, connectors, LED and laser emitters, broadband photosensors, emitter-driving circuitry and sensitive receivers. Companies in Canada, England, Europe and Japan pursued the same objectives on first generation systems. In the U.S., organizations like Bell Laboratories, General Telephone and Electronics, International Telephone and Telegraph along with the military services were working independently and with supplies to improve systems elements and investing sizable sums of money.

By 1976, the worldwide campaign for better fiber-optic communications had borne fruit. High-brilliance LEDs capable of operating at hundreds of Mbits/s were now available. Families of efficient connectors had been designed. And low-loss fibers were being



1977—An Illinois Bell lineman compares the new 1/2-in. optical cable installed for the Bell System's tests in Chicago with the large wire cable it replaces.

produced by suppliers both here and abroad.

Fiber cables, developed only a short time before, now offered good protection in realistic working environments. Moreover, a major problem that has plagued lasers for fiber-optic systems—short lifetimes—appears to have been solved just this year. This past June, Bell Labs announced it had developed a laser with a projected life of one-million hours.

The culmination of many of these individual efforts has resulted in several historic firsts in fiber-optic communications in 1977.

For example, the world's first optical communications system to provide regular telephone service was placed in operation April 22 between General Telephone Company of California's long-distance switching center in Long Beach and a local exchange building 5.6 miles away in Artesia. The system, developed by GTE Laboratories in Waltham, MA, provides a 24-channel route at a T-1 1.544-Mbits/s. Two repeaters are used. The California cable has six fibers: two for handling calls between the local switching equipment in Artesia and the long-distance center in Long Beach, two for testing and two for spares. The light sources are high-radiance LEDs emitting at 815 nm.

On May 11 in Chicago, the Bell System began evaluating the first lightwave-communications service to provide not only telephone but data and video-signal service as well. The system carries this traffic over a 1.5-mile underground cable containing 24 optical fibers. Signals are sent between two Illinois Bell switching offices, and between one of those facilities and a downtown Chicago office building. ■■



Now AMP's most versatile interconnection system is even more so.

We've added a whole family of pin headers.





Top performance in a tiny space. AMPMODU posts, receptacles and headers make your packaging designs as tight as necessary.

We've also made it easier to place pins on a board. Forget about positioning pins one at a time. Forget costly front-end insertion equipment. Because AMP engineering ability shows up in our recently introduced AMPMODU pin headers.

Pins are fully protected. Headers are polarized and have self-retention locking latches. Headers fit everywhere on a board, including board center.

Ten basic header styles offer several thousand possible variations. You can approach mass termination with AMPMODU headers. Up to 80 positions.

These headers now complement the AMPMODU interconnection system, which features dual cantilever spring beams in the receptacle, five basic contact types and board to board or board to wire versatility. The forgiving nature of the receptacle design also ensures a uniform, positive electrical contact with the mating posts, everytime.

At AMP our application, service and sales engineers are located throughout the world, and are ready to help you with prototyping as well as providing a complete after-sale service.

For more facts about AMPMODU headers, write or call Customer Service. (717) 564-0100. AMP Incorporated, Harrisburg, PA 17105.

AMP has a better way.

**AMP**  
INCORPORATED

CIRCLE NUMBER 53

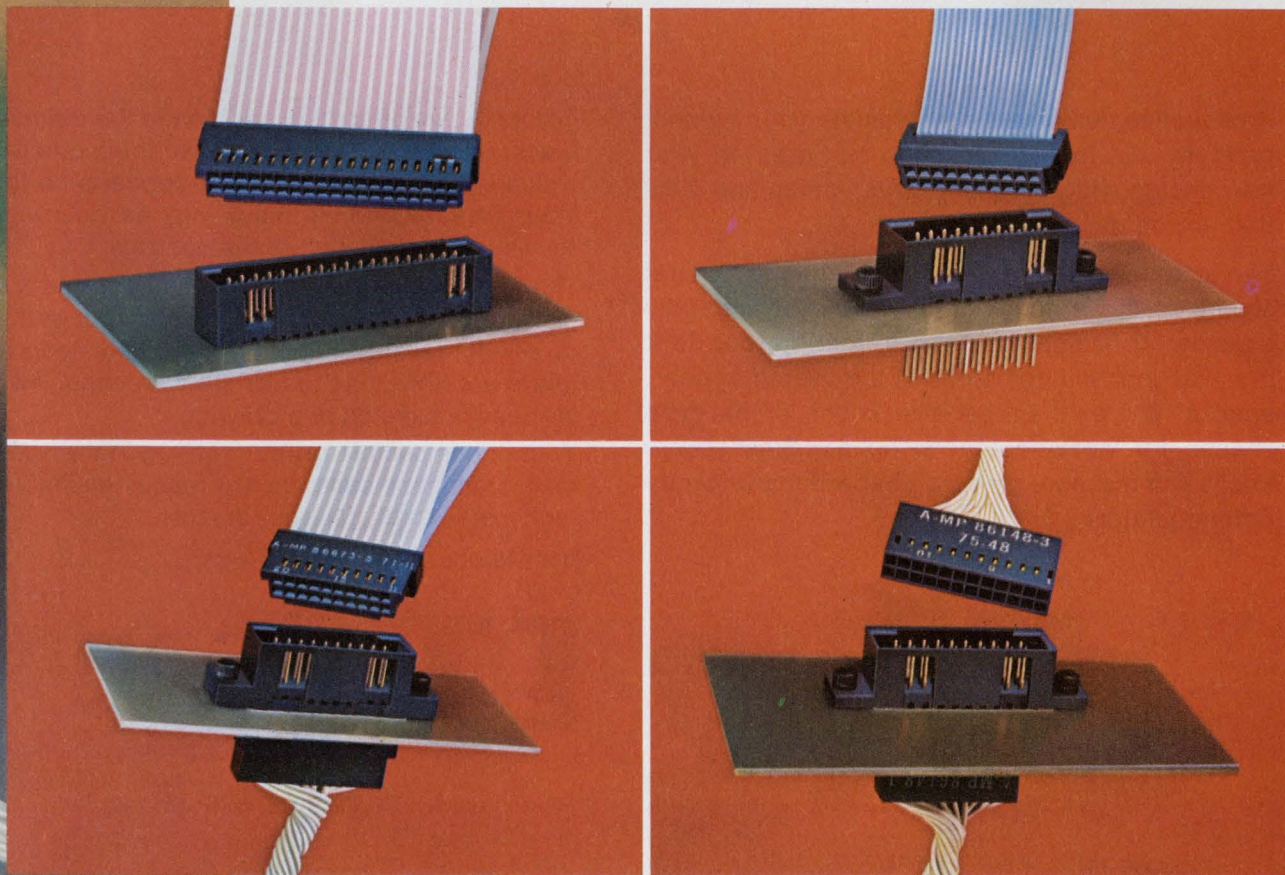



# The finishing touch... Rogan knobs and dials.

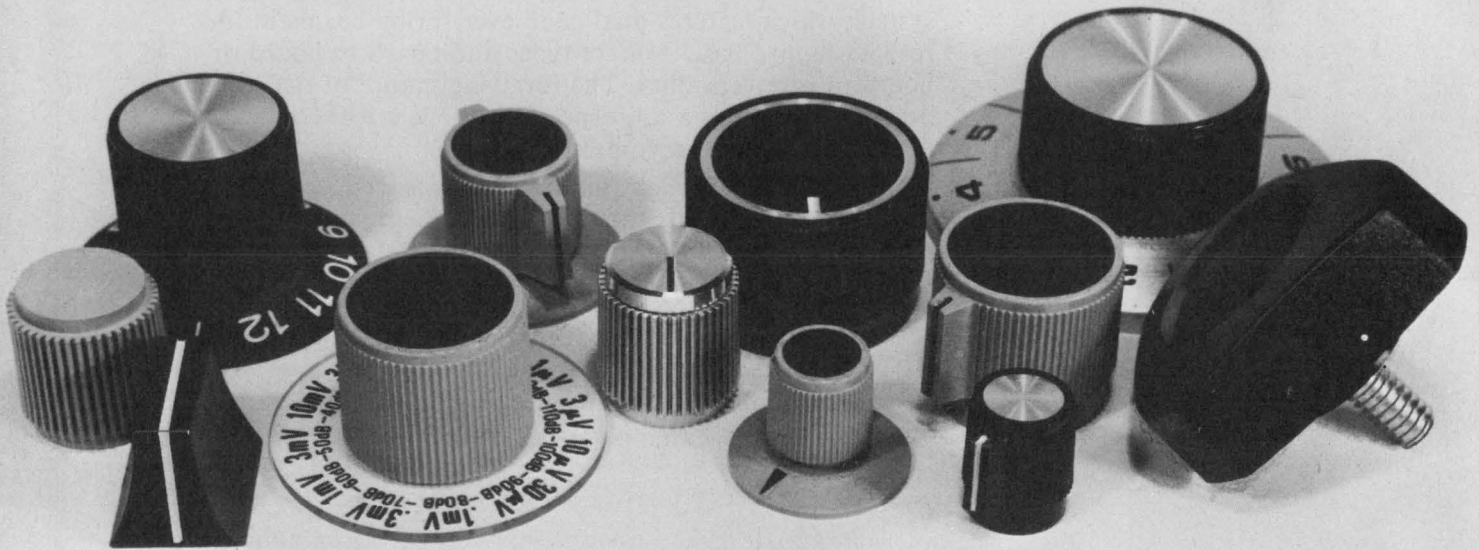

Prospective customers will evaluate your product carefully . . . from the outside in. Finish-off your new design with the best looking knobs and dials that are on the market . . . Rogan's.

The sizes, the shapes, the colors, and the general styling of these components should be carefully considered. Match the knob to the job, but do it in a way that will complement the overall appearance of the unit. Larger-size knobs or bar-type shapes for heavy-detent switches. Smaller-size knobs and the more graceful shapes for low-torque potentiometers.

Colors . . . we offer 16 in addition to the ubiquitous black. As an option, you can have the matte finish, which imparts a dull-anodized appearance to the knob. The decorative inlays may be color-coded for visual identification of the controls.

The application of special nomenclature is a specialty of ours. The plastics are either hot-stamped or silk-screened. Aluminum dials and decorative inlays are either etched or silk-screened. All that we need is a sketch or a drawing.

Your phone call places our catalog in the evening mail. Evaluation samples are readily available for legitimate prototype requirements.

**If it's knobs and dials, it's Rogan.**

 **ROGAN**  
CORPORATION

3455 WOODHEAD DRIVE  
NORTHBROOK, ILLINOIS 60062  
TELEPHONE (312) 498-2300



# P/rel™ Bio-Mechanical Interface to the Digital World

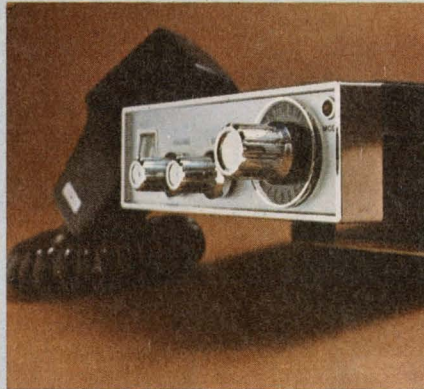
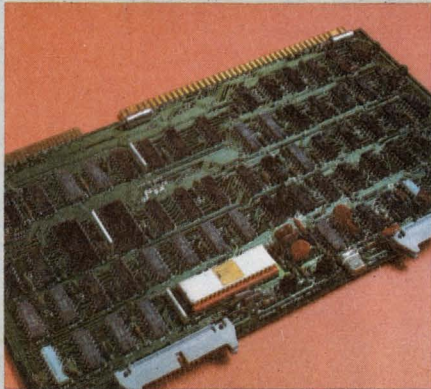

**P/Rel . . . Standard Grigsby's programmable rotary encoded logic switch or control is fully programmable to any code.**

When you need design flexibility, Standard Grigsby's P/Rel will do the job. No other programmable rotary switch offers the design engineer as much versatility, with as low a cost, as the P/Rel switch.

You can use the P/Rel as a detented switch for feeding encoded information direct to your digital logic circuit. Or, use it without a detent, as a "digital pot," and eliminate the cost of expensive A-D conversion.

Find out how your product can use the standard or miniature P/Rel. Send for Free literature.



**standard grigsby, inc.**

920 Rathbone Avenue, Aurora, Il. 60507  
Phone: (312) 844-4300

IN EUROPE: W. Gunther GMBH, Virnsberger Strasse 51,  
D 85 Nurnberg 1, West Germany Phone: 0911/65521



## Vladimir Zworykin

# The man who was sure TV would work

**H**as modern television turned out the way you envisioned it?

The little man with the friendly smile and twinkling eyes leans back in his chair, his hands clasped thoughtfully before him, as he ponders the question. "Not completely," he begins. "From the very start, I dreamed about the commercial possibilities of television. But I never visualized it as a main source of entertainment. I never thought that millions of people would sit in front of this box from morning till night as they do today."

The narrator, Dr. Vladimir Kosma Zworykin, invented both the iconoscope and kinescope. His more than 120 other patents include gunnery controls and electronically controlled missiles and automobiles.

On June 30, the acknowledged father of television celebrated his 88th birthday. Despite his age, Dr. Zworykin still shows up for work each day at the David Sarnoff Research Center in Princeton, NJ. In fact, RCA has assigned a special office and a secretary to him in recognition of his past achievements and present potential. He is a company consultant and honorary vice president.

**"It's a matter of self-preservation," Zworykin observes. "If you work all your life, you have to continue working."**

Getting back to the subject of today's television, he says he is disappointed at the emphasis on crime and violence and their potentially harmful effect on children. "The pictures from the Moon were the biggest accomplishment of television so far," he states. "I think the next step should be the greater use of TV as an educational medium and as an instrument to promote international understanding."

Born in Mourom, Russia, some 200 miles east of



Moscow, Zworykin was the youngest of seven children. He got his undergraduate training at the Petrograd Institute of Technology and received his electrical engineering degree in 1912. At the Institute, he worked with Professor Boris Rosing, whom Zworykin credits with both his own decision to become a scientist and his particular interest in television and electronics.

"Rosing was trying to transmit pictures by wire in his own physics laboratory. Needless to say, I was soon his understudy," Zworykin recalls. "It was a glorious three years, and what a perfect school it turned out to be!"

As early as 1906, Professor Rosing believed that the solution to practical television was to be found not in mechanical systems, such as the scanner of the German inventor, Paul Nipkow, but in the development of a method employing cathode-ray tubes. When Zworykin left the Institute, he was convinced that the solution to the problem of television would ultimately



be found in the application of electronics.

Dr. Zworykin immigrated to the United States in 1919. Soon after his arrival here, he went to work for Westinghouse Laboratories in Pittsburgh.

**"I was a dreamer. I had ideas and I wanted to work. I found that under the conditions in Russia at the time, work was impossible."**

The country had been thrown into turmoil, he notes—particularly the educational system. "There was constant talking all the time and endless meetings. All the spirit was taken out of your work."

Incidentally, he has been invited to the Soviet Union nearly a dozen times as an honored guest and lecturer.

Zworykin still recalls his first job at Westinghouse—assembling vacuum tubes on a production line.

"The assembly was cumbersome and took a lot of time. There was a tremendous number of rejects—about 70%. I did this for about three months and almost went crazy."

Finally, he and a glassblower at the plant got together after hours and constructed a bottle-like apparatus with which it was possible to make and test 100 tube filaments at once. Not only was the production rate of vacuum tubes increased, but the rejection rate was cut to 30 percent.

"Everybody was excited," Zworykin remembers, "but my boss decided to keep it quiet because of scheduling considerations. One day I got the flu and stayed home for a few days. Suddenly, I got a phone call to come to the laboratory because there was a shortage of filaments. I told them I'd be there but to get the automatic apparatus ready and not to forget to change the tank containing CO<sub>2</sub> gas. The gas was needed to supply the inert atmosphere for filament production." When Zworykin arrived, he checked the setup and threw the current switch.

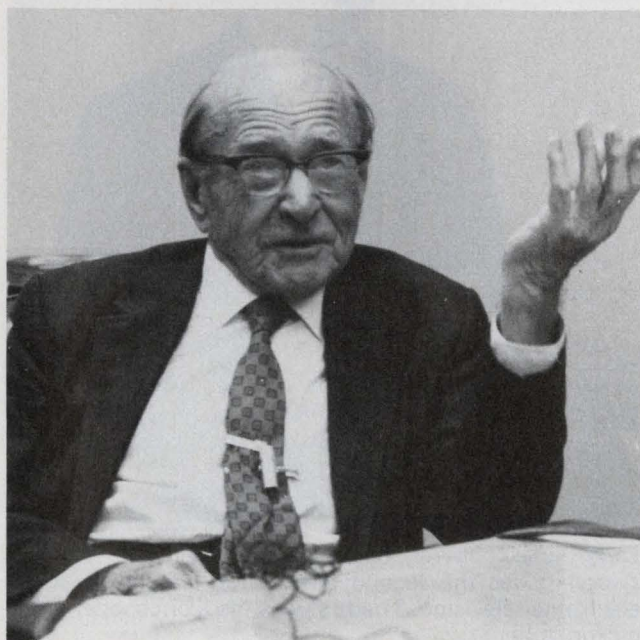

**"Everything blew up. A six-foot piece of ceiling landed on my hands. Somebody had substituted a hydrogen gas tank for the CO<sub>2</sub> tank."**

In those days the tanks weren't color-coded.

"Luckily, I wasn't hurt, but there was a great deal of damage," Zworykin relates. "To my surprise I wasn't fired and for days there was a great deal of commotion. Everyone was asking: 'Who's this guy Zworykin, coming from Russia and trying to make a bomb.'"

In time, he began investigating photoelectric emission and resumed his research in television. After trying in vain to interest the company in developing an all-electronic TV system, he left Westinghouse. Eighteen months later he returned with greater freedom to work on his many ideas.

In 1923, Zworykin came up with two ideas that not only helped make television practical but essentially marked the beginnings of modern electronics as well. He invented the iconoscope—the "eye" of the television camera—and the kinescope, or TV picture tube.

By the end of the year, Zworykin had managed to combine these elements into the first electronic television system. He exhibited it to a group of Westinghouse executives. "By present standards the demonstration wasn't very impressive," he recalls. "The transmitted pattern was a cross projection on the target of the camera tube. A similar cross appeared with low contrast and rather poor definition on the screen of the cathode-ray tube."

This result indicated that his devices were sound—but needed tremendous improvement. Even so, Westinghouse continued to resist the idea of television.

In 1929, after refining the iconoscope and kinescope, Zworykin demonstrated the first practical all-elec-





**Dr. Zworykin in 1910**, two years before he received his electrical engineering degree from the Petrograd Institute of Technology.

tronic television system at a meeting of the Institute of Radio Engineers at Rochester, NY. This achievement so impressed David Sarnoff, then vice president and general manager of the Radio Corporation of America, that he invited Zworykin to join RCA as director of its Electronic Research Laboratory and continue the commercial development of his invention.

This association led to the perfection of the iconoscope, which not only remained the primary television pickup tube until it was superseded by the image orthicon but also was the basis of later important developments in the field.

Remembering Sarnoff ("He was a brilliant man without much education"), Zworykin fondly recalls many years of fruitful association.

**"At the very beginning he asked me whether I could build a television system. I told him 'try me, I'll show you.'**

Then he asked me whether it could be put into production and at what cost. I said about \$100,000. After that, in all his speeches he used to say: 'Look at Zworykin. How he deceived me. Before we got a dollar back from television, we spent \$50-million.'"

There were two approaches to commercial television

at the time, Zworykin remembers. "Either you sold a TV program such as was done in England at the time, or you sent the program free and got money from the equipment you sold. From the U.S. point of view that was the right way. I remember Sarnoff saying 'Americans like to get something for free.' He liked novelty and new inventions."

In 1934, 10 years after he became a naturalized U.S. citizen, Zworykin began to travel extensively for RCA. The beginning of World War II found him in Lebanon, where he managed to get on a plane bound for England.

About to sail for the United States aboard the S.S. Athenia, he suddenly remembered that he had left his tuxedo in a trunk he had abandoned in Beirut. He decided to wait for a later vessel so he could buy the formal wear needed for first-class travel in those days.

**The change in plans saved his life. The Athenia, victim of a German U-boat attack, never reached port. The torpedoed vessel sank off the Irish coast. Among the missing were 28 Americans.**

Back in the United States, Zworykin continued working. In 1944, the German High Command claimed he had invented a secret device that could pierce fog and clouds to give aircraft navigators "visual maps by which to fly." Questioned by reporters, Zworykin laughed off the story.

In fact, he was working at RCA on infrared image tubes that led to the sniperscope and snooperscope



**Early kinescope**—or television picture tube—held by Zworykin was the second major step leading to an all-electronic television. The first was his iconoscope, or TV-pickup tube.





An experimental electronic-imaging tube examined by Zworykin, seated, and Dr. George A. Morton of the RCA research staff in Camden, N.J. during the late 1930s.

which appeared towards the end of World War II.

Zworykin and his associates would test models of infrared imaging systems in automobiles traveling at night near Princeton, NJ, without headlights. One time he was picked up by the local police, who "thought I must have been a spy riding around in a car without lights near the RCA labs."

After World War II, Zworykin continued to work on inventions and new applications for electronics. For example, he thought that it should be possible to divert hurricanes with a small expenditure of power when the hurricane was forming. He discussed this problem with Dr. John Von Neumann, of the Institute for Advanced Study at Princeton.

Out of these discussions grew the concept of using a computer to predict the weather. It had soon become apparent that the related mathematics was too involved to handle any other way.

Automatic control of automobiles was another early Zworykin idea. Now he believes that the point has been reached where automatic control of automobiles on highways is not only feasible but necessary. In the 1950s, he and his associates at RCA demonstrated that traffic signals could be used to prevent traffic jams and that experimental radio transmitters could be placed along freeways to control specially equipped cars automatically.

Television hasn't been Zworykin's only contribution to electron optics.

**Under his direction James Hillier and his associates developed the electron microscope, an instrument that has contributed greatly to advancing both the biological and physical sciences.**

The list of achievements goes on and on, from development of the radio endosonde—a tiny FM transmitter that can be swallowed—to TV-guided missiles.

Along with his 120 U.S. patents, Zworykin has

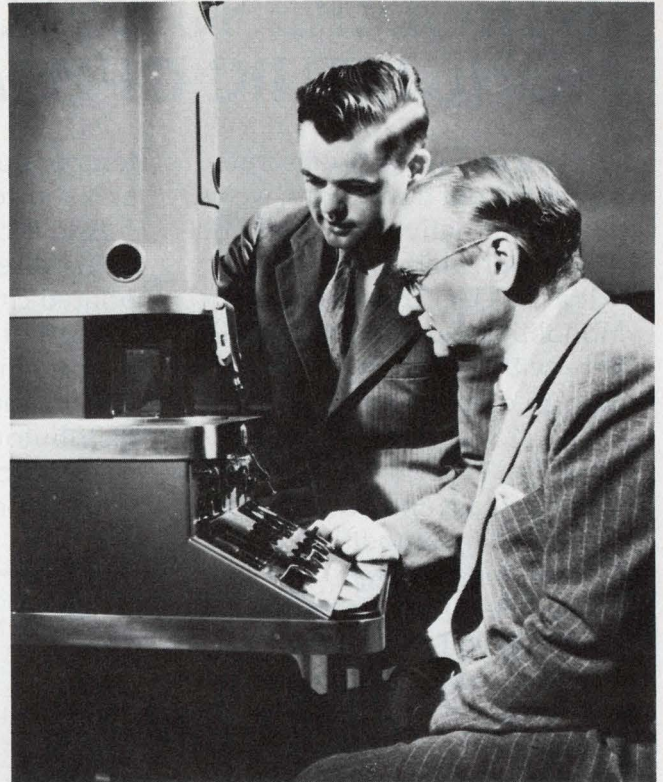

The RCA electron microscope is shown in a 1942 photo with its inventors—Dr. Vladimir Zworykin (seated) and Dr. James Hillier.

received 27 outstanding awards. These include the National Medal of Science awarded by President Lyndon B. Johnson in 1966, a Presidential Certificate of Merit in 1948, Chevalier of the French Legion of Honor, the Order of Merit of the Italian Government and the Faraday Medal of the British Institution of Electrical Engineers.

For some years after his retirement from RCA in 1954, Dr. Zworykin was director of the Medical Electronics Center at the Rockefeller Institute in New York. He was particularly concerned with making electronic methods much more useful to medicine and the life sciences.

Zworykin lives in Princeton with his wife, Katherine, a retired physician. He likes to hunt pheasant for relaxation. It is, he notes, an aggressive sport—unlike fishing, which he would find too passive.

In the winter the Zworykins soak up the sun in Florida where he is a professor-scientist at the University of Miami.

Besides being company consultant and honorary vice president for RCA, Zworykin is a consultant to several other companies. "Consultants are like geldings," Zworykin points out. "They run with the other horses but don't participate."

In his case, this view may not be too accurate. As RCA President Robert W. Sarnoff pointed out in 1969 on the occasion of Zworykin's 80th birthday, "Even in the 15 years since his so-called 'retirement' from a remarkably productive career, he has accomplished more than many men do in a lifetime." ■■



# INTRODUCING DELCO ELECTRONICS' MONOLITHIC OPERATIONAL AMPLIFIER

If you're now using discrete power output transistors, we've got an alternative that gives you design versatility.

It's the DA-101—Delco's Monolithic Operational Amplifier—with all the circuitry you need in one compact package.

The Monolithic Operational Amplifier (MOA) has two separate gain and power stages contained in a modified dual-in-line package.

The DA-101 operates from a 10- to 16-volt DC supply and can be used in an audio bridge configuration with floating speaker output, or as two separate amplifier-speaker systems.

The MOA means weight savings in more ways than one. Besides reducing the total number of components you need, the MOA has a copper mounting surface to assure ample heat transfer to the convectory. The tab negative or ground connection eliminates the need for mica insulation.

In fact, the design of one power megaphone showed a components weight savings of 65 per cent.

Our new MOA means added design application flexibility, too. In automotive and home entertainment systems, two-way communication systems, power megaphones, motor controls, various H switch applications, and more.

Another advantage of our Monolithic Operational Amplifier is its durability. It has integral protective circuitry for not only overvoltage, but

temperature, current conditions and shorted outputs as well.

And it can be mounted by either direct soldering to a printed circuit board or through the use of a suitable socket.

For more information, contact an authorized Delco distributor, your nearest Delco sales office, or return the coupon on the right.

## ABSOLUTE MAXIMUM RATINGS

Supply Voltage	24V
Operating Voltage	16V
Peak Current	3A
Storage Temperature	-55°C to 150°C
Power Dissipation	22W

## ELECTRICAL CHARACTERISTICS

	TYPICAL
$V_{CC} = 14V$ dc	
Indic. $P_{out} = 0W$	40mA
Differential Input Bias Current	0.80 $\mu A$
Open Loop Gain	90dB
Power Out @ 5% Distortion	
4 $\Omega$ Bridge	6W
4 $\Omega$ Non-bridge	3.5W

## THERMAL CHARACTERISTICS

Thermal Resistance, $R_{\theta jc}$ (Typical)	4° C/W
---	--------

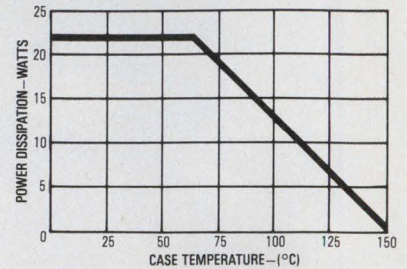

## DIMENSIONS AND CONNECTIONS

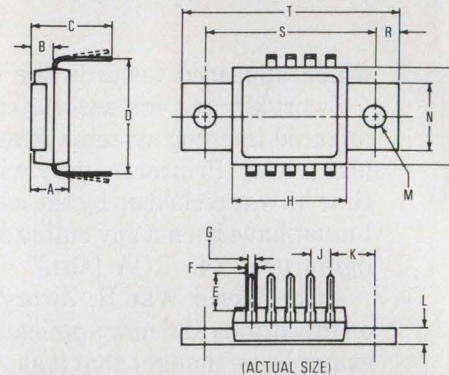

SYMBOL	INCHES		MILLIMETERS	
	MIN.	MAX.	MIN.	MAX.
A		220		5.59
B	.127	.133	3.22	3.38
C	4.23	4.43	10.746	11.254
D	6.28	6.32	15.95	16.05
E	2.15	2.25	5.463	5.717
F	.044	.048	1.13	1.21
G	.015	.019	0.39	0.47
H	6.44	6.50	16.37	16.52
J	.095	.105	2.413	2.667
K	.275	.285	6.983	7.237
L	.086	.096	2.183	2.437
M	1.220	1.280	3.100	3.250
N	.369	.379	9.373	9.627
P	.539	.549	13.693	13.947
R	.120	.130	3.053	3.307
S	.955	.965	24.253	24.507
T	1.199	1.219	30.446	30.954

## AUDIO BRIDGE CIRCUIT

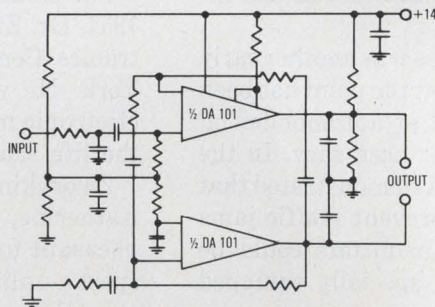

## TWO SEPARATE AMPLIFIERS CIRCUIT

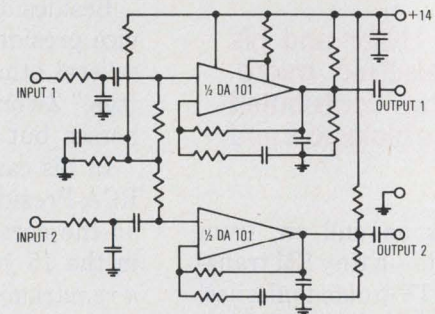



**NOW AVAILABLE FROM THESE DISTRIBUTORS  
IN PRODUCTION QUANTITIES.**

**ALABAMA**

HUNTSVILLE  
Powell Electronics  
(205) 539-2731

**ARIZONA**

PHOENIX  
Sterling Electronics, Inc.  
(602) 258-4531

**CALIFORNIA**

GARDENA  
Bell Industries  
Electronics Distributors Div.  
(213) 321-5802

GOLETA  
R.P.S. Electronics, Inc.  
(805) 964-6823

LOS ANGELES  
Kierulff Electronics, Inc.  
(213) 725-0325

R.P.S. Electronics, Inc.  
(213) 748-1271

PALO ALTO  
Kierulff Electronics, Inc.  
(415) 968-6292

SAN DIEGO  
Kierulff Electronics, Inc.  
(714) 278-2112

R.P.S. Electronics, Inc.  
(714) 292-5611

SUNNYVALE  
Bell Industries  
(408) 734-8570

**COLORADO**

DENVER  
Kierulff Electronics, Inc.  
(303) 371-6500

**CONNECTICUT**

NORWALK  
Harvey Electronics  
(203) 853-1515

**FLORIDA**

CLEARWATER  
Diplomat/Southland  
(813) 443-4514

MIAMI SPRINGS  
Powell Electronics/Florida  
(305) 592-3260

**ILLINOIS**

ELK GROVE VILLAGE  
Kierulff Electronics, Inc.  
(312) 640-0200

SKOKIE  
Bell Industries  
Electronics Distributors Div.  
(312) 282-5400

**INDIANA**

INDIANAPOLIS  
Graham Electronics  
Supply, Inc.  
(317) 634-8202

**MARYLAND**

BALTIMORE  
RESCO/Baltimore  
(301) 823-0070

**MASSACHUSETTS**

BILLERICA  
Kierulff Electronics, Inc.  
(617) 935-5134  
(617) 667-8331

NEWTON  
The Greene-Shaw Co., Inc.  
(617) 969-8900

**MICHIGAN**

LIVONIA  
Pioneer/Michigan  
(313) 525-1800

**MINNESOTA**

MINNEAPOLIS  
Stark Electronics Supply Co.  
(612) 332-1325

**MISSOURI**

KANSAS CITY  
Walters Radio Supply, Inc.  
(816) 531-7015

ST. LOUIS  
LCOMP-St. Louis  
(314) 291-6200

**NEW JERSEY**

CINNAMINSON  
Wilshire Electronics/  
Philadelphia  
(609) 786-8990  
(215) 627-1920

CLIFTON  
Wilshire Electronics/  
New Jersey  
(201) 340-1900  
(212) 244-8930

**NEW MEXICO**

ALBUQUERQUE  
Sterling Electronics  
(505) 345-6601

**NEW YORK**

BINGHAMTON  
Harvey Electronics  
(607) 748-8211

BUFFALO  
Summit Distributors, Inc.  
(716) 884-3450

FARMINGDALE  
Wilshire Electronics/  
Long Island  
(516) 293-5775

FREEPORT  
Milgray/New York  
(516) 546-6000

WOODBURY  
Harvey Electronics  
(516) 921-8700  
(212) 895-9260

**OHIO**

CINCINNATI  
United Radio, Inc.  
(513) 761-4030

CLEVELAND  
Pattison Supply Co.  
Industrial Electronics Div.  
(216) 441-3000

DAYTON  
Pioneer/Dayton  
(513) 236-9900

**OREGON**

PORTLAND  
Almac/Stroom Electronics  
(503) 292-3534

**PENNSYLVANIA**

PHILADELPHIA  
Almo Electronics  
(215) 698-4000

PITTSBURGH  
CAM/RPC Electronics  
(412) 782-3770

**SOUTH CAROLINA**

COLUMBIA  
Dixie Radio Supply Co., Inc.  
(803) 779-5333

**TEXAS**

DALLAS  
Sterling Electronics  
(214) 357-9131

HOUSTON  
Harrison Equipment  
Co., Inc.  
(713) 652-4700

Sterling Electronics  
(713) 627-9800

**WASHINGTON**

SEATTLE  
Almac/Stroom Electronics  
(206) 763-2300

Kierulff Electronics, Inc.  
(206) 575-4420

SPOKANE  
Almac/Stroom Electronics  
(509) 928-0679

**IN CANADA:**

Zenronics Ltd.  
Toronto (416) 635-2822  
Ottawa (613) 238-6411  
Montreal (514) 735-5361

**OVERSEAS:  
EUROPEAN  
INQUIRIES:**

European Parts &  
Accessories Marketing  
Group  
General Motors Continental  
Plant 2, Noorderlaan,  
Postbus 9  
B-2030, Antwerp, Belgium

**ALL OTHER  
OVERSEAS  
INQUIRIES:**

General Motors Overseas  
Operations  
Parts & Accessories Dept.  
767 Fifth Avenue  
New York, N.Y. 10022  
(212) 486-4412

**DELCO ELECTRONICS  
REGIONAL SALES  
OFFICES**

Charlotte, North Carolina  
28209  
4600 Park Road  
(704) 371-5160  
Van Nuys, California 91404  
Box 2968  
(213) 988-7550

**GENERAL SALES  
OFFICE**

700 E. Firmin, Kokomo,  
Ind. 46901  
(317) 459-2175



**FOR MORE INFORMATION ABOUT  
DELCO'S NEW MONOLITHIC  
OPERATIONAL AMPLIFIER, MAIL  
THIS COUPON TO:**

**Delco Electronics Division  
General Motors Corporation  
Marketing Services MS A-213  
700 E. Firmin Street  
Kokomo, Indiana 46901**

NAME \_\_\_\_\_

TITLE \_\_\_\_\_

COMPANY \_\_\_\_\_

ADDRESS \_\_\_\_\_

CITY \_\_\_\_\_ STATE \_\_\_\_\_ ZIP \_\_\_\_\_

PHONE \_\_\_\_\_





# Last week Helen Kratzer had visitors from Hamilton- Junior Corn had a new calf- and Wabash made one million coils.

It was a typical week in Wabash, Edna Fitch and Gladys Sands made 4 pots of their famous chicken noodle soup for the church supper, Tommy Butcher had to stay after school again and things were humming over at the Wabash plant.

Coils, ranging in size so small that 150 can be placed in a teaspoon to some weighing over 10 lbs. were moving off high speed production lines.

No wonder. Wabash is the country's largest maker of molded coils including epoxy, nylon,

and engineered thermoplastic and thermoset material with over 20 standard epoxy formulations and hundreds more that can be adapted for specific application such as heat, cold, rain, salt and sun.

Things change quickly nowadays. But two things you can count on. Whether it's next week or next year, Edna and Gladys' chicken soup will still be the best around—and Wabash will still be the nation's leader in coil manufacturing.



*Coils, Relays & Transformers*  
**wabash**  
of  
**Wabash, Indiana**  
and Huntington, Indiana; Farmington, Missouri;  
Tipton, Iowa and South Boston, Virginia  
For information and quotes write or call:  
Wabash, Inc., Dept. CB-5, 810 N. Cass St., Wabash, Ind. 46992 Tel: 219/563-3111 TWX 810-290-2724



Shown: custom engineered thermoplastic and thermoset molded coils for automotive applications.





# Increase Reliability and Performance with Custom Quartz Crystals.

McCoy Electronics offers a larger variety of Quartz Crystals than any other supplier. With a frequency range of 700 Hz to 250 MHz and a variety of housings available such as solder seal, glass, and cold weld, McCoy crystals have found broad uses in commercial, industrial, military, and high reliability applications.

McCoy specializes in applications where strict control of motional parameters is dictated, tight stabilities are needed, or in any program requiring experienced technological resources.

In addition, McCoy crystals are proven to be economical for the buyer in terms of consistent performance and high quality, thereby eliminating the costly burden of replacement.

We invite your use of McCoy's expert engineering and marketing staffs in developing specifications for custom crystals individually tailored to meet your needs.

Please write for our free catalog.

 **MCCOY**  
**ELECTRONICS COMPANY**  
a subsidiary of **OAK Industries Inc.**

MT. HOLLY SPRINGS, PA. 17065 • 717-486-3411 - TWX: 510-650-3548

CIRCLE NUMBER 59



## Wescon '77

# The biggest show



Wescon '77, to be held September 19 through 21, will be the largest Western Electronic Show and convention to be held in San Francisco since 1969, according to show officials.

Some 30,000 visitors are expected to attend the three-day show, which will occupy all of Brooks Hall and the adjacent Civic Auditorium.

More than 400 companies will introduce products and systems at 680 booths. In 1975, the last time the show was held in San Francisco, 340 companies and 520 booths were on hand.

The San Francisco show will be the first three-day Wescon, and the first to open on a Monday. The three-day schedule was adopted to avoid conflict with Yom Kippur, which falls on September 22. In addition, Wescon '76 exhibitors surveyed last summer overwhelmingly suggested that Wescon be scheduled as a three-day event as an experiment.

All but two of Wescon's program sessions will be held in the Continental Ballroom complex of the San Francisco Hilton Hotel.

Some of the more important technical papers

will be presented at Session 9, which will focus on the need for faster and more accurate fault diagnosis of digital PC boards carrying microprocessors and LSI chips. A related Session 4 will deal with problems experienced in testing electronic components and boards automatically.

The different methods of getting data into and out of computers, particularly microprocessors, will be covered at Sessions 2, 21, 24 and 26. New LSI peripheral circuits are available that enhance the performance of computer systems. For microprocessors, dedicated function controllers for floppy discs, SDLC protocol, CRT terminals and d/a and a/d converters increase the performance and versatility of systems. For larger computers, bipolar LSI high-performance memory controllers and media-encryption bit slices are available.

Other related sessions—notably 3, 20 and 27—will focus on designing with the latest single-chip and bit-slice devices.

Finally, the rapid displacement of LEDs by liquid crystal displays is having a profound effect



# since '69?

## Contents

**Test Measurement**—Printed-circuit boards that carry microprocessors need faster testers..... 122

**Integrated Circuits**—Interfacing with microprocessors is improved by LSI chips..... 124

**Microprocessors**—One-chip or bit-slice, you should know their limits..... 126

**Consumer**—LCD watches, calculators will one day run on 5 and 10-year batteries..... 130

on digital watch and calculator technology. Future trends in these technologies will be ticked off and examined at Session 30, with special emphasis on advances in lithium batteries and LC displays.

Dr. Bernard Oliver, vice president for research and development at Hewlett-Packard Co. and past president of the IEEE, will deliver the keynote address at the Wescon luncheon, which will be held at the St. Francis Hotel on Sunday, September 18.

For a preview of Wescon turn to the following pages.

This Wescon special report was prepared by Andy Santoni and Jim McDermott.





# PC boards with $\mu$ Ps need faster testers

Production-testing of printed-circuit boards carrying microprocessors has run into problems stemming from the microprocessor's high data rates, circuit complexity, complex failure modes and use of bus architectures. Many of the older static-type testers simply aren't fast enough. As a result, new test techniques as well as combinations of both new and old have been devised to circumvent the  $\mu$ P-board problems. The particular approaches recommended by experts in the field will be revealed in Session 4, "Automatic Test Equipment for a Production Environment," and Session 9, "ATE Test Techniques for Complex Digital Assemblies."

### Test speed increased

Dynamic logic and dynamic memories of many of the microprocessors have minimum speeds that are substantially higher than can be achieved by stored-program testers, Tom Bush, senior project manager at GenRad, Concord, MA, will point out in his Session 9 paper, "Unique Problems Encountered in Testing Microprocessor-Controlled PC Boards." While many microprocessor boards need 100 to 500 kHz and higher, conventional stored-program testers operate at sampling rates of only 500 to 1000 Hz.

The microprocessors need speed, principally, to exercise their dynamic logic and dynamic memories fast enough to keep them "alive." To overcome this speed problem, GenRad has evolved a technique that is used in its new tester, the 1796 Analog-Digital Test System. The technique uses a local memory and an associated dedicated computer which are inserted between the pin electronics and the main computer in the tester.

The main computer loads up the dedicated computer and memory with the desired tests. Then the main computer lets the dedicated computer take over to apply the test patterns and capture the test responses. The tests can be made at high enough speeds to keep the dynamic logic alive.

When the local computer has exhausted the local memory, or has applied all the tests loaded in it, it signals the main computer. The main computer then unloads the local memory and analyzes data in it.

PC boards carrying microprocessors tend to be bus

oriented—which is another problem, Bush notes. To overcome this, the tester should drive the bus, then go into a disconnected state, sensing while it waits for some other part of the logic to respond to the signals.

That is, test data are put on the bus at the periphery of the board. When they enter the bus, some circuit is activated. Then the microprocessor puts a response back on the bus. The tester should then be disconnected from the bus in order to "listen" to the responses that come back down the bus lines.

For boards that require testing at megahertz rates, the pin electronics must be connected and disconnected at high speed to achieve this stimulate-listen function. For this reason, driver-sensor electronics for the 1796 are designed to allow the pin electronics to be connected and disconnected at MHz speeds.

### Both tests and troubleshooting needed

Testing  $\mu$ P boards actually takes two separate phases, according to Noel P. Lyons, product marketing



**Four processors running in parallel** allow the user of the Fluke Trender 3040A to test microprocessors at clock rates up to 10 MHz. Stored sequences run at 1.5 MHz, and automatic sequences operate at 5-million patterns per second.





A special memory and an associated microcomputer are located between the main computer and the pin elec-

tronics in the new GenRad 1796 tester. This architecture gives high-speed tests for microprocessors.

manager of Fluke Trendar, Mountain View, CA. Besides running at much higher speeds than has been typically required for random-logic boards, the tester must do troubleshooting, Lyons will explain at Session 4 in "Microprocessor Boards and Automatic Board Testers."

For troubleshooting, the tester must be able to resolve down to at least a 2-MHz strobe rate, or a 500-ns resolution, says Lyons—or even higher to see each machine cycle of the microprocessor. To resolve any trouble, every clock cycle must be seen. Otherwise, clock cycles that might have indicated trouble may go undetected.

With the Fluke Trendar 3040A,  $\mu$ P or LSI boards can be tested at clock rates up to 10 MHz and data rates to 5-million patterns per second. A built-in logic analyzer catches dynamic failures on the fly. It can fully test microprocessor boards with either user-defined test patterns or automatically generated patterns, interchangeably.

A new interface provides full handshaking communication to clock, to synchronize and to control the board from the tester, or the tester from the board. Stored sequences run up to 1.5-million patterns per second, while automatic sequences operate at rates to 5-million patterns per second. And since all pins are tested at each test step, up to 1.2-billion pin tests are provided per second.

Instead of trying to turn a general-purpose mini-computer into a test system, Fluke designed the 3040A with four processors running in parallel to manage the sequencing and test control.

One big problem in testing microprocessor boards

with simulator-based testers is that with so much circuitry on the chip set, a particular function can't be modeled before being exercised. There simply isn't enough core space available.

A solution will be outlined by Edward Steinberg, principal engineer at Digital Equipment Corp., Maynard, MA at Session 9 in "A Black Box Approach to Testing and Fault Isolating an 8080 Chip Set on an Existing ATE."

"We've come up with a simplified method," Steinberg explains, "in which we consider the PC board a black box. We say we don't have to know everything that's inside, for several reasons. All we have to know is that if we apply a certain type of stimulus to it and ask it to execute to certain limited instructions, we know what the reply should be for minimal instruction sets."

By asking the  $\mu$ P to execute a few key things, DEC is able to check for PCB manufacturing type defects, without having to exercise the whole chip set dynamically and execute extensive tests. This reasoning is that the  $\mu$ P chip is checked at incoming inspection and should therefore be good. And the basic PCB-system design is assumed to be good.

But not the manufacturing process. Certain questions should be answered, including

- Is the chip inserted correctly?
- Are there any solder shorts?
- Are there any bent pins?

With these concerns in mind, a simple instruction set that can exercise all the inputs and outputs and make sure they are going up and down correctly will suffice, according to Steinberg.



A "stuck fault" model is used to detect whether or not there are any stuck ONEs or ZEROs. To generate the model, faults are deliberately inserted in the PC-board circuits.

For example, all the outputs and inputs can be tied to key points to induce a stuck ONE or ZERO. Then the circuit can be tested to see whether or not the simulated stuck ONEs or ZEROs can be detected.

Also, it is important to be able to probe backwards through the circuits to find such a fault, says Stein-

berg. So probing may have to be set up.

Such an approach is used by DEC with its GenRad 1792 Tester, which is basically a static, or step-by-step, system. It makes the individual tests, one at a time and relatively slowly.

But between these steps a lot of pulses may occur, which may be difficult to detect conventionally. But adding a GenRad's pulse-catching probe to the 1792 tester and combining them with the black-box approach will keep track of the in-between pulses. ■■

## Integrated Circuits

---

# Interfacing with $\mu$ Ps improved by LSI chips

How to interface with microprocessors will be the main target of the semiconductor sessions at Wescon. Microprocessors are useless without ways of getting data into and out of them, many papers will point out in different ways. And new LSI chips designed to work with  $\mu$ Ps do the job more easily and at lower cost than their SSI and MSI counterparts.

The evolution of microprocessor peripheral chips from bipolar small and medium-scale devices to general-purpose MOS LSI chips will be described in a paper at Session 2 by Ken McKenzie of Intel Corp., Santa Clara, CA. What's more, the latest parts are dedicated to functions such as control of floppy discs, CRT displays and communications via protocols like SDLC.

Peripheral chips may also be required to handle analog signals, points out Barry Harvey of Siliconix Inc., Santa Clara, CA. Where conversion between analog and digital signals is needed, the choice rests among converters that employ dual-slope, successive-approximation, and quantized-feedback techniques. The decision can be based on the hardware and software requirements for each chip, as well as the speed and noise rejection needed in the conversion, says Harvey.

While one class of microprocessor peripheral chips serves to interface the processor to other circuits, a second type of peripheral chip can extend the power of the CPU itself. "The microprocessor has become pervasive in controller and random-logic replacement applications," says Andrew Allison of Advanced Micro Devices, Sunnyvale, CA, in Session 2. However, Allison goes on to note, using MOS microprocessors in high-performance applications has been inhibited by weak arithmetic capability and system throughput constraints.

"Ironically, the appearance of LSI peripheral controller circuits accentuates this problem by making it easy to interface peripheral devices that have high throughput requirements to microcomputers," says Allison. His solution: Chips performing such functions as arithmetic operations more quickly in hardware than the microprocessor can in software.

Still, efficiently written software can be fast enough for many applications. By cutting chip count, it can even be less expensive than peripheral devices—especially in high-volume production, according to Dennis Block,  $\mu$ P applications engineer of RCA's Solid State Division in Somerville, NJ. "While there are families of input and output devices varying in sophistication from simple byte-I/O parts through keyboard scanners to floppy-disc controllers, the use of these parts—and their additional cost—may not be justified," says Block in a Session 24 paper.

Using the input/output capabilities of the microprocessor itself, Block goes on, an engineer may be able to take maximum advantage of the microprocessor by building functions into software, instead of hardware.

One way to interface microprocessors to peripherals is to consider the peripheral a location in memory, according to Mitch Gooze, NMOS  $\mu$ P-family product marketing engineer at Motorola Semiconductor Products Division, Austin, TX, in his Session 24 paper. This approach can be simpler than addressing peripherals through special ports in the CPU chips.

### Talking with the analog world

Memory-mapped I/O is an extremely flexible I/O-handling architecture, agrees Dave Kress, product-marketing specialist at Analog Devices Semi-





Testing boards containing microprocessors and peripheral chips can be simplified with automatic test systems like GenRad's 1795-HD. Testing still has to be considered when designing boards, though, to keep costs down, say Wescon speakers.

conductor in Wilmington, MA. Kress will examine this technique and others as they apply to interfacing microprocessors to analog signals at Session 24. "Microprocessor-based measurement, computing and control systems are fast-growing applications areas that almost always require some interaction between

digital circuits and analog variables," says Kress.

Other applications would have been impossible without combining  $\mu$ Ps with efficient analog interfaces, says George Bryant, manager of systems engineering at Datel Systems Inc., Canton, MA. Among the applications to be described by Bryant at Session 26 are a system to monitor the status of over 100 sensors attached to a nuclear reactor during preoperational testing, a patient-monitoring system for hospitals, and an airborne system for testing variations in pressure and temperature at very high altitudes.

Still another application for microprocessors handling analog data will be presented at Session 26 by M.L. Roginski, a senior engineer at Lockheed-Georgia Co. in Marietta. The system applies and monitors loads via 59 channels on a C-141 aircraft for fatigue testing. The Intel SBC80/10 microcomputer-based system performs calibrations, sends data to 118 servo-controlled d/a converters to control load-function generation, reads peaks, records data on an incremental magnetic tape recorder, checks load limits, displays data, and interacts with an operator through a CRT terminal.

Despite predictions that the explosive growth of digital data processing, fed by new integrated circuits, would lead to the demise of analog circuitry, David

## Timetable to the technical sessions at Wescon/77

<b>MON. Sept. 19</b>  10 AM	1. Energy Alternatives	2. New Advances in Peripheral Circuits I	3. Program Development for $\mu$ Ps: Emulation and Simulation	4. ATE for a Production Environment	5. Satellite Systems of the 1980s	Engineering Careers and the Problems After 40 (Panel)
<b>MON. Sept. 19</b>  2 PM	6. Engineering Career Problems Getting to the Bottom Line (Panel)	7. Advances in $\mu$ P Peripheral Circuits II	8. Designing with $\mu$ Ps: Difficulties and Dilemmas	9. ATE Test Techniques for Complex Digital Assemblies	10. Applications of Time Domain Measurement Systems	Your Job Interview: The Million Dollar Decision (Panel)
<b>TUES. Sept. 20</b>  10 AM	11. Integrated Injection Logic Comes of Age	12. Large Scale Computers	13. Programmable Pocket Calculators: Onward and Upward	14. Developing Investor Appeal (Panel)	15. Packaging Clinic: Leadless vs. Tape Chip Carriers	
<b>TUES. Sept. 20</b>  2 PM	16. Advances in Bipolar LSI Logic	17. New Generation Semiconductor Memory Devices (Panel)	18. Switching Power Supplies	19. In a Dead Heat to the Executive Suite	20. Use of Bit-Slice $\mu$ Ps in Digital Signaling Systems	
<b>WED. Sept. 21</b>  10 AM	21. Analog Interface in $\mu$ P Systems	22. Home Computer. Next Billion Dollar Market?	23. Transition to Distributed Processing	24. Microprocessors: Communications with the Real World	25. IEEE Region 6 Student Papers Competition	
<b>WED. Sept. 21</b>  2 PM	26. A/D and D/A Acquisition and Distribution with Microprocessors	27. Single-Chip Microcomputers Find More Than a Niche	28. "IC's in Testing Land" (Film/Panel)	29. Applications of Quartz Crystals	30. Trends in Digital Watch Technology	



Fullager of Intersil Inc., Cupertino, CA, doesn't see it that way.

"Far from causing the demise of analog systems, the reverse has occurred," says Fullager, who will speak at Session 21. "Nearly all the data being processed (with the notable exception of financial data) consist of physical parameters of an analog nature—pressure, temperature, velocity, light intensity and acceleration, to name a few." So  $\mu$ P converter products should play a big role in developing data-acquisition systems.

Replacing conventional converters with microprocessors and suitable interface electronics cut costs significantly, according to David Chung, vice-president of Untech Inc., Sunnyvale, CA. He will describe ways to use microprocessors to convert analog signals to digital and vice versa at Session 21.

"The basic strategy," says Chung, "involves the introduction of a catalytic quantity—a pulse width or

frequency—through which the desired analog quantity becomes compatible with the microprocessor."

Still and all, applying LSI peripheral chips in microprocessor systems is not without its problems, says Mark Mayes of GenRad Test Systems Division, West Concord, MA—even though "myriad available microprocessor peripheral chips offer the engineer unparalleled flexibility in design." Even though the combination of special-function and general-purpose devices yields modules with very high functional density, Mayes points out in a Session 24 paper, "testing boards this complex can be very difficult and expensive."

However, there are ways to keep the cost down, he adds. "The engineer can cut testing costs substantially by keeping effective test methods in mind during board design." Especially important is leaving access to points on the board that can lead a technician or a test system to pinpoint any faults. ■■

## Microprocessors

# One-chip or bit-slice —know their limits

Easing the problems of designing with microprocessors—especially the latest single-chip and bit-slice devices—will be the primary target of four Wescon sessions on microprocessors and how to use them. These sessions will complement the  $\mu$ P-related semiconductor device sessions.

The flexibility and low cost of single-chip  $\mu$ Ps will be the focus of Session 27. Aimed at relatively simple and very high volume needs, these chips are already being applied in controllers, appliances, consumer products, and for logic replacement, says Dan Hammond of Mostek Corp., Carrollton, TX, who is session chairman.

The prospective single-chip  $\mu$ P user has some studying to do before placing an order, however, says Matt Biewer of Pro-Log Corp., Monterey, CA. In his Session 27 paper, Biewer will compare the architectures and instruction sets of popular single-chip devices. Designers must make the same analyses before they can select the best  $\mu$ P for each application, he warns.

While Biewer hopes designers will take advantage of the power of single-chip  $\mu$ Ps, he warns that they do have limitations. Their instruction sets are not as extensive as some of the chip-set  $\mu$ Ps. And it is much more difficult to get at their internal workings for program design and system debugging.

But compared with their older  $\mu$ P relatives, single-

chip devices shine when it comes to cost, says John Bryant of Texas Instruments Inc., Houston. At Session 27, Bryant will describe the microcomputer section of a low-cost data terminal that uses an 8080-type  $\mu$ P, and compare this with a similar design using the one-chip TMS9940. The increased density of the single-chip  $\mu$ P cuts the cost of the final product because it "significantly reduces the chip count," says

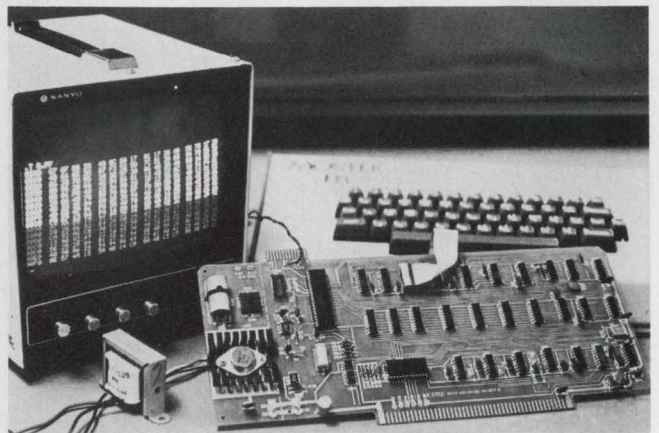

**Low-cost single-chip microprocessors**, a focal point of  $\mu$ P sessions at Wescon, fit applications such as this Mostek 3870-based video adapter board. The VAB-2 board becomes the core of a video terminal when connected to an ASCII keyboard and a video monitor.



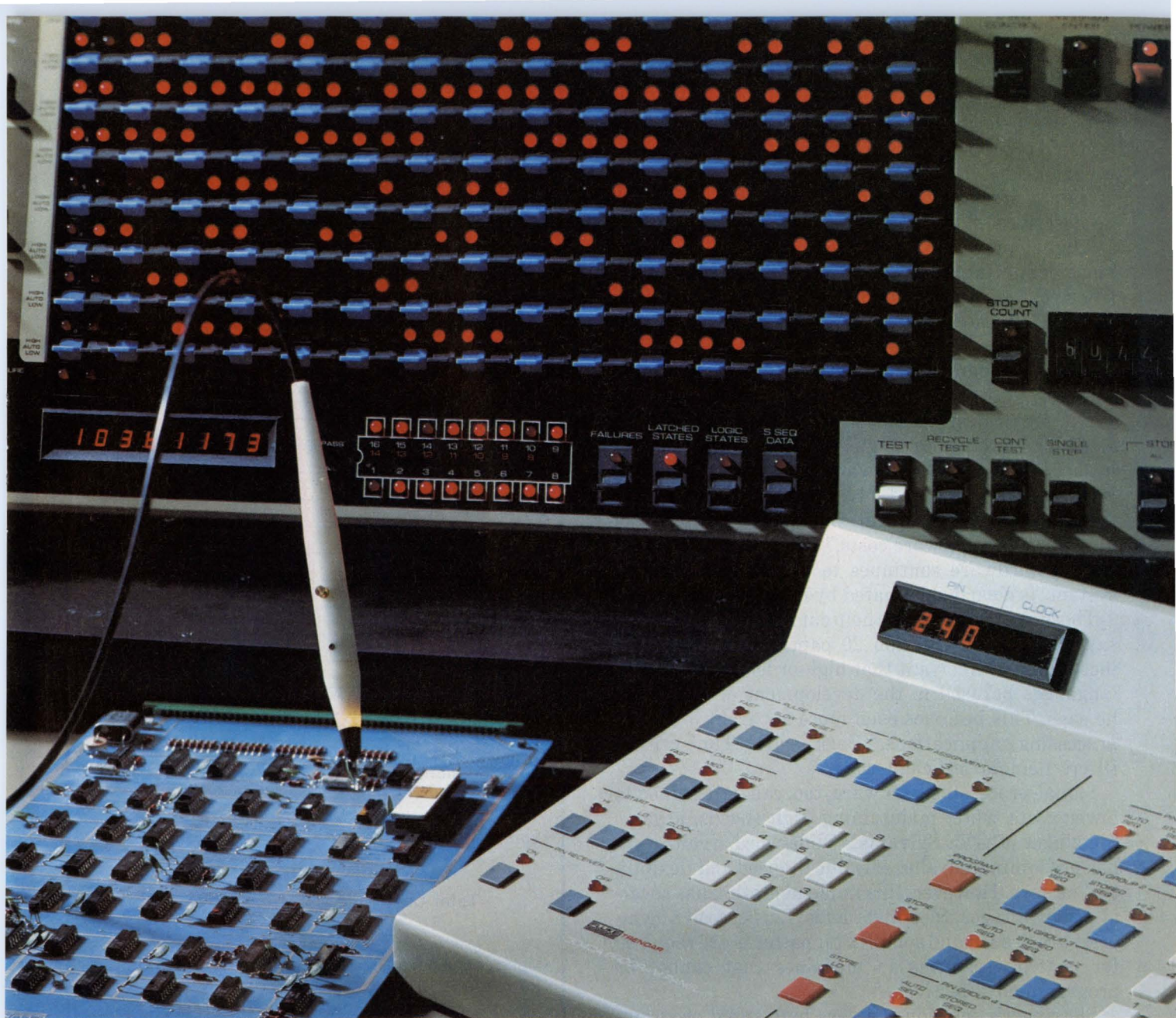

# THE ONLY LOGIC TESTER DESIGNED FOR MICROPROCESSOR BOARDS.

A fresh start for logic board testing.

Microprocessors are here.

If you are like most electronic manufacturers, you're either using  $\mu$ P's or you plan on using them soon. But how do you test your boards so you can ship a dependable microprocessor-based product?

With the new Fluke Trendar 3040A.

For a fraction of the cost, it does what other systems can't do. It fully tests microprocessor boards with either user-defined bit-by-bit test patterns or automatically-generated patterns, interchangeably, via simple push-button commands. A unique

new interface allows the necessary handshaking between  $\mu$ P board and tester. Any type of advanced digital logic board can be tested at system operating speeds. Diagnosis can be made by an operator using the guided clip/probe option.

And it not only performs higher confidence tests, it cuts your costs. It eliminates the programming delays and complexities of mini-computers and their peripherals. Editing is on-line. The effect of a program change on circuit behavior is instantly displayed. Programs

are done in a fraction of the time.

All this at a price you can afford. For data out today, dial (415) 965-0350. Fluke Trendar, a subsidiary of John Fluke Mfg. Co., Inc., 630 Clyde Avenue, Mountain View, CA 94043.

Fluke (Nederland) B.V., P.O. Box 5053, Tilburg, The Netherlands. Phone: (013) 673-973. Telex: 52237.



CIRCLE NUMBER 60

SEE US AT WESCON, BOOTH 1242!



Bryant.

Where cost is less important than performance, bit-slice processors are preferred. One such application is signal processing, where large amounts of data must be handled quickly to filter out noise. The demands of signal processing on microprocessor systems will be described in Session 20.

"Signal processing constantly demands more and more computation to yield finer and more accurate filtering," says Howard Cohen of GTE Sylvania Inc.'s Eastern Division in Needham, MA. Compared with older, discrete filter designs, "bit-slice devices offer attractive economics," says Cohen, chairman of Session 20.

The major design decision to be made in designing a bit-slice microcomputer is whether to put the cost in hardware or in software, says P. C. Barr of Raytheon Co., Wayland, MA. "Over the last 10 years there has been a radical shift in the balance of hardware and software costs," he says. Today, as the cost of hardware continues to drop, the cost of the system "is clearly dominated by the cost of software."

There are techniques to help cut the cost of software, says Barr in his Session 20 paper. "It is becoming increasingly important that high-order programming languages be used in the development of software," he says. This becomes even more apparent in signal-processing applications, Barr adds. Time-critical filters demand efficient code.

Signal-processing hardware, too, can be designed to lower costs while maintaining high speeds, says L. Sletzinger of GTE Sylvania. "Wide-word architecture has predominated, allegedly due to speed and flexibility," he says. However, this implementation has several disadvantages, Sletzinger adds: Large, costly memories are needed and complex bit patterns are required for control, resulting in machines that cannot be programmed effectively.

Sletzinger's solution is a very high-speed programmable signal processor configured architecturally like a classic minicomputer. Its two-level decode scheme is as fast and as flexible from a practical standpoint as an equivalent single-level, wide-word machine. "It is more economical of hardware and is easily programmed into a new application," adds Sletzinger.

### How to integrate hardware and software

Solving the problems of writing software, designing hardware, then hooking them together into a working system will be described at Session 3.

"Writing a program, putting it in PROM, and then debugging it can be a time-consuming and costly process," notes Dick Woods, application engineer at Data I/O Corp., Issaquah, WA. Development times can be reduced drastically by emulating the PROM or ROM with a RAM that can be altered as development progresses.

Once hardware and software are designed, the system has to be debugged. Finding the source of the

## Technical session order form

Please send me the following Wescon 77 technical session preprints at \$3.00 per session (average: four papers per session), plus \$1 mailing charge per complete order. I understand this order will be mailed to my address within three weeks after receipt. Offer good until Dec. 1, 1977.

Session No.	Quantity	Session No.	Quantity
2		18	
3		19	
4		20	
5		21	
7		22	
8		23	
9		24	
10		25	
11		26	
12		27	
13		29	
15		30	
16			

Total Sessions × \$3 = \$ \_\_\_\_\_

Plus \$1 Mailing Charge = \$ \_\_\_\_\_

Total Cost = \$ \_\_\_\_\_

Make check payable to Wescon 77 and mail with this form to:

**Wescon 77**  
999 N. Sepulveda Blvd.  
El Segundo, CA 90245

Date \_\_\_\_\_

Name \_\_\_\_\_

Firm \_\_\_\_\_

Street Address \_\_\_\_\_

City, State, Zip Code \_\_\_\_\_

problem can be simplified, says Bruce Gladstone of Microkit Inc., Los Angeles: "Design debugging can be split so that both hardware and software can be separately examined."

Of the tools available to the engineer for hardware and software troubleshooting,  $\mu$ P-development sys-



# Status symbols



**the first thing  
pushbutton controls  
indicate is the  
quality of your product**

In a world where first impressions mean so much, why settle for esthetically (and functionally) inferior pushbutton switches, when you can choose EAO pushbutton controls at competitive prices? EAO holds the line on price, AND quality. With EAO on your panel you don't have to accept second-class appearance or performance... hot spots, fuzzy legends, tinny-looking bezels, uncoordinated configuration and size, and faulty human engineering. EAO controls enhance your product.

And EAO gives you complete design freedom. You can select mechanical or electronic switches... combine up to 9 lens colors with bezels in rectangular, round, square or dual

rectangular shapes... choose switch and contact combinations from 1 to 4 poles momentary or alternating action... even harmonize the full range of lighted and non-lighted pushbutton controls with compatible key lock designs.

Available contact arrangements and contact materials have ratings from low-level to 10A @ 250 VAC. No matter how complex or wide-range your needs, EAO Status Symbols allow you to single-source all requirements.

Write or call today for samples, technical data, and prices on these and other Unimax LPB switches. Unimax Switch Corp., Ives Road, Wallingford, Connecticut, 06492; Tel. (203) 269-8701.



**Unimax Switch**

CIRCLE NUMBER 61



tems are the most powerful, says Tom Clark, design engineer at Tektronix Inc., Beaverton, OR. "The fully packed microprocessor development system offers the designer the most flexibility for system prototyping—high-level language capability, in-circuit emulation tools, and special test modes for troubleshooting." But not all of these features are needed by every designer, and other tools—logic analyzers and microprocessor analyzers—may be preferred in some cases.

The availability of development tools is a key factor in selecting the right microprocessor, says Ken Rothmuller of Hewlett-Packard Co., Santa Clara, CA, in his Session 8 paper. "Microprocessor selection is influenced by two radically different criteria: product-related technical considerations, and product development issues." Cost, performance, power consumption, parts count, and flexibility are the predominant technical factors narrowing the selection, he notes, adding: "The final decision will be based on these factors and more qualitative product development criteria, such as development tools, in-house expertise, past and future usage, and compatibility."

Choosing a programming language is also important to designing  $\mu$ Ps. The simpler language to program may use too much memory space for the application, and the choice may be difficult simply because of the

large number of languages available.

"Microcomputer programming languages have become more numerous than the variety of micros themselves," says Carol Ogdin, a consultant in Alexandria, VA, who will present a paper at Session 8. "The designer is faced with choices between Basic, Fortran, assembly languages and a host of proprietary forms. And languages touted as being 'standard' may be less than useful in many applications."

A real problem is to educate the designer to apply and program microprocessors efficiently. "The single most important factor limiting the growth of microprocessor applications is the dearth of qualified designers with knowledge and skills in microcomputer applications engineering and programming," says Robert Ulrickson, president of Logical Services Inc., Mountain View, CA, in his Session 8 paper. "Managers have found that they cannot just go out and hire the talent they need. They must retrain their own engineers in microcomputer design and programming to avoid product obsolescence due to competition generated by the rapid introduction of newer and better LSI devices." The education gap should be closed, Ulrickson suggests, through college courses, intensive training seminars, microcomputer-development kits, self-study courses and on-the-job training. ■■

## Consumer

---

# LCD watches, calculators to run on 5-year cells

The rapid displacement of LEDs by liquid crystal displays is creating an evolution in digital watch and calculator technology. LCDs permit the use of power-free tritium backlighting for night viewing. This feature, together with the micropower drain of LCDs and CMOS watch circuitry, will stimulate the emergence of solid-state lithium-iodide batteries, with lives of 5 to 10 years, as the coming generation of watch and calculator power. LCDs, tritium backlighting, lithium-iodide batteries and future continuous-display technologies will all be examined in detail in Session 30: "Trends in Digital Watch Technology."

### Tritium backlights need no power

Tritium light sources are valuable to LCD design because they eliminate the battery drain required by

incandescent-bulb backlighting. Tritium-bulb backlights produce a light output of between 0.1 and 0.2 ft-L in the yellow-green spectrum, which is the most efficient, according to Harry Dooley, vice chairman of the board for American Atomics Corp. The light is needed to reflect normal ambient light back through the liquid-crystal cell for contrast. But, notes the author of the Session 30 paper, "Tritium Light Sources," by the time the tritium light penetrates the reflector coating behind the liquid-crystal cell, it is reduced to between 0.04 and 0.05 ft-L. This light, however, is still four to five times brighter than the radiation from watches with painted tritium hands and dials. (Tritium paint, used for some 20 years, replaced the older radium paint and its harmful gamma radiation.)

The tritium backlighting systems are made with flat



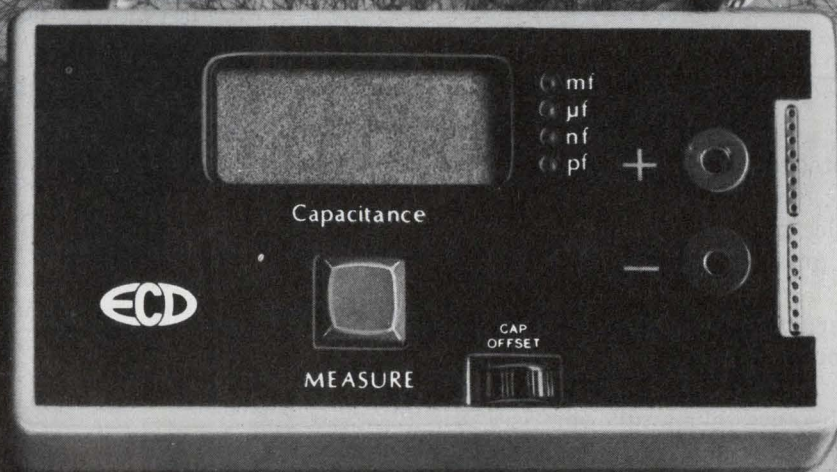

## My shirt, yes...my C-Meter, no.

Test the kind of guy who'll give you the shirt off his back: ask him for his C-Meter.®

He knows that his C-Meter gives him a definite edge. It exposes an obvious efficiency: capacitors are easier to measure than resistors.

No more twiddling and nulling. No need for expensive, tight-tolerance capacitors or tweak pots. With its pushbutton speed, high accuracy (0.1%), small size

and versatility (0.1 pf to 0.2 farads), the C-Meter makes you a more productive engineer.

You owe it to yourself to try one on. It'll cost no more than a fine suit: stocked locally at only **\$289.00.**

ECD CORP.  
196 Broadway, Cambridge  
Mass. 02139 (617) 661-4400



SALES OFFICES: AL, Huntsville (205) 533-5896; AZ, Scottsdale (602) 947-7841; CA, Costa Mesa (714) 540-7160; CA, Sunnyvale (408) 733-8690; CO, Denver (303) 750-1222; FL, Winter Haven (813) 294-5815; GA, Chamblee (404) 457-7117; IL, Elk Grove Vill (312) 593-0282; IN, Indianapolis (317) 293-9827; MD, Silver Spring (301) 622-4200; MA, Wakefield (617) 245-5940; MN, Minneapolis (612) 781-1611; MO, Kansas City (816) 358-7272; So. NJ/Philadelphia (215) 674-9600; NM, Albuquerque (505) 299-7658; NY, Great Neck (516) 482-3500, (212) 895-7177, Syracuse (315) 446-0220; NC, Raleigh (919) 787-5818; OH, Centerville (513) 433-8171; TX, Houston (713) 688-9971; TX, Richardson (214) 231-2573.



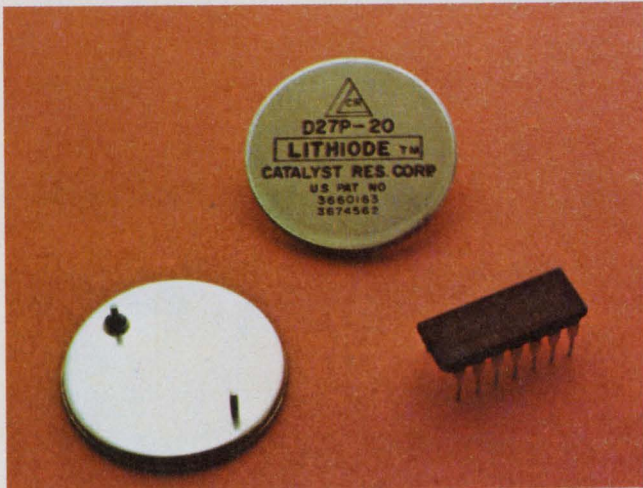

**Lithium-iodide batteries have unusually high energy content** and are suited for watches and calculators. Batteries, like these from Catalyst Research Corp., have been incorporated in over 100,000 Pacemakers without a failure.

glass tubing that is coated on the inside with phosphor. Tritium gas, called  $H_3$ , is forced into the tube, which is then laser-sealed. Electrons from the gas excite the phosphor coating and provide light output for many years.

The colors can be varied by changing the phosphor coating, Dooley says, but the yellow-green is the most cost-efficient.

Most of the watch displays take a tube that is 0.25 in. wide by 0.8 in. long. To backlight a 1/2-in. digit, two or more tubes can be placed in parallel. The tubes are typically 0.040-in. (1-mm) thick, but can be made thinner. Prices for a tritium tube run from \$2 to \$3 in hundred-thousand quantities.

Because the tritium sources are radioactive, they are subject to strict environmental and quality-control tests required by the U.S. Nuclear Regulatory Commission. They must withstand impact drop, reduced pressure and high vibration.

Nevertheless, these devices radiate less radioactivity than the tritium paints, and are licensed for distribution as a product that is exempt from regulation because of the rigorous safety analysis that they have undergone to qualify. The Commission also insists that the display module containing the tube is rugged.

Not only are these tubes useful for watch and calculator LCDs, Dooley points out, but they also can figure in a variety of industrial-meter designs. For these purposes, curved 2.5-in. tritium tubes have been produced for backlighting analog dials.

#### Lithium-iodide batteries ideal for watches

The high efficiency of 2.8-V lithium-iodide battery cells stems from its special physical and chemical

properties. What might be a disadvantage in most applications—a low output current of a few microamperes—is almost ideal for watches and calculators with LCDs because of the batteries negligible self-discharge rate. Virtually all the battery energy is available, over five to 10 years.

While a typical 250-mA lithium battery is more expensive than a typical 75-mAh silver-oxide cell, it makes available more than three times the energy. For example, a typical 75-mAh cell costs about 30 cents, OEM. But the silver-oxide cell has relatively high self-discharge rates. As a result if the battery isn't used, a considerable amount of the potential power will be lost, Dr. Alan Schneider, chief scientist for Catalyst Research Corp., Baltimore, will point out in "Lithium Cells for Watches and Calculators."

Another plus is that the 2.8-V output is sufficiently higher than standard—1.5-V—units to increase the contrast of the LCD figures. The lithium cell can run at a 3 or 4- $\mu$ A drain for 10 to 12 years. When used in calculators, the same cell can provide power at 70  $\mu$ A for some 3500 hours or more. This converts to from 7 to 10 years of useful life.

Long-life applications are possible because the self-discharge rate of these cells is extremely low—less than 10% in 10 years. Given a low current drain on the cell, the voltage drop is less than 0.1 V. And the cells' energy density is high, about 8.33 Wh/in<sup>3</sup>.

Lithium-iodide cells are highly reliable. They are solid-state, and self-healing. What's more, they don't corrode or fracture. And since no gases are generated during operation, the cells can be hermetically sealed by fusion welds and glass-to-metal seals. More than 100,000 cells have been used in Pacemakers—with no reported failures.

The unusual solid-state nature is due to a lithium anode being brought into contact with a cathode composed of iodine and poly-2-vinylpyridine. The

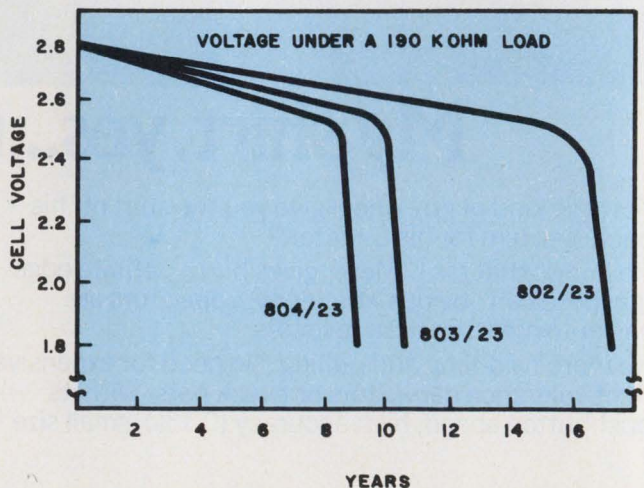

**The high performance of lithium-iodide cells**, projected from five years' test data, stems from low current drain and negligible self-discharge rates.



reaction forms the third component necessary for any cell, the electrolyte, which in this case is solid lithium iodide.

As current is drawn from the cell, lithium is oxidized and iodine is reduced, to form additional lithium iodide. The lithium iodide, which serves as both electrolyte and separator, increases internal resistance by accumulating as the cell is discharged. The result is an initial decline in the voltage (see figure). Later, when the poly-2-vinylpyridine loses most of its iodine, the cathode begins to rise in resistance, which decreases voltage fairly sharply.

### New displays being developed

But even as liquid-crystal displays are beginning to dominate the marketplace, other types of low-power displays are on the way. Pleochroic-dye and electrochromic and electrophoretic devices, among other future continuous watch displays, will be described at Session 30 by Dr. Sun Lu, manager of liquid crystal displays, of Hewlett-Packard, Santa Clara, CA.

One advantage of the pleochroic-dye system is close to a 180° viewing angle, which is much larger than that of LCDs. Also, contrast is high, and no polarizer is required.

The pleochroic-dye system, according to Lu, consists of about 1% concentration of a pleochroic dye in regular liquid-crystal material. This dye has molecules that are shaped like cigars, and if the light comes from one side of the molecules, a strong color appears. But if the light is transmitted through the length of the molecule, it is practically transparent.

When an electric field is applied to the cell, the dye molecules tend to follow the rotation of the liquid-crystal molecules, so that cell can be switched from a noncolor to a color state. The displays using these dyes have white digits on a background of purple, blue, or black.

Right now the dyes are sensitive to fading in sunlight, but Lu believes that this problem will be solved within the next year or so.

Electrochromic and electrophoretic displays, while possible, require different driving circuitry. They probably won't be economically feasible for some time to come. ■■

Despite all the attention focused on minis and micros, large-scale computer systems are continuing to make progress on their own—in hardware, software and support systems. For a preview of the significant papers on large-scale computing systems, see the Wescon special report in the September 13 issue.

# STAMP OUT "almost right" Trimmer Capacitors

—specify all-sapphire  
units that never vary!

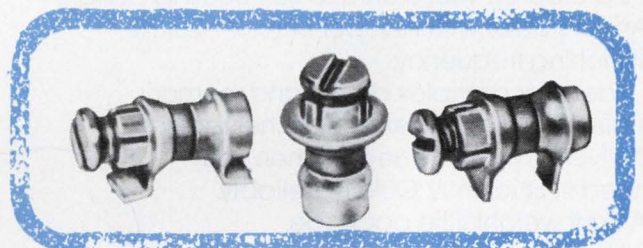

When you need superior performance at microwave frequencies, Voltronics' new precision sapphire dielectric trimmer capacitor is the only answer. You can't settle for a unit that's "almost right" or even "almost" all sapphire.

Only the Voltronics unit achieves the *entire* capacitance with a sapphire dielectric—the best dielectric material known! (Other, so-called sapphire units achieve almost one-fourth of the capacitance with mica—producing a non-linear curve.)

What's more, you can count on this new unit to give unvarying, reliable long life. The dielectric constant of the Voltronics sapphire does not vary with frequency, and its loss tangent is constant and below 0.0003, out to 10 GHz. It's chemically inert, totally moisture resistant, and one of the strongest materials known!

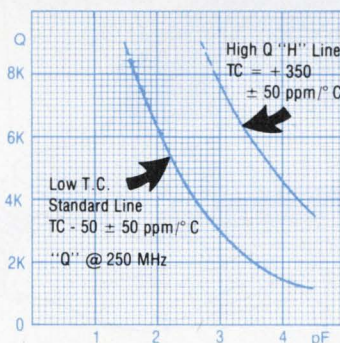

Other Voltronics advantages include metalized electrode bands fired into the sapphire, for lowest loss and no chance of slippage; and positive stops at each end to prevent disassembly or breakage.

Two types are available—a high-Q and a standard line (see curves at left).

Cost? \$5 to \$3 in quantities of 50 to 1,000. Designer kits are available at reduced prices. For complete information, use the Reader Service Card, or write to us at Dept. ED-3.

West Street, East Hanover, N.J. 07936  
telephone: 201-887-1517 twx: 710-986-8253

CIRCLE NUMBER 63



# Just Delivered:

## Elxon's Spanking New Switcher

This new 8 pound baby has really arrived. You couldn't ask for more (or less) in a 250 Watt Switching Power Supply. It's got just about everything. Full rated operation up to 50°C (Derated to 70°C). Complete built-in protection against overload, short circuit, or over voltage with foldback current limiting. And state-of-the-art design utilizing IC controls to minimize component count...which maximizes reliability.

It's next to impossible to get this switcher down. Forget about brownouts. It's full-rated in the worst. Temperature rise? Don't worry! It's protected with a unique self cooling design. And it's quiet with its super efficient 20KHZ switching frequency.

Ideal for complex digital and memory systems, this new Elxon Switcher really delivers. What you need. When you need it. Efficiently. Quietly. Reliably. A light weight little package with a great big heart!

Write for complete specifications or visit our Booth #1012 at Wescon 77, September 19-21 and see our spanking new switcher for yourself. It'll grow on you!

**Another Ugly™ Made Beautifully by ELPAC.**



**ELPAC ELECTRONICS, INC.**  
3131 So. Standard Avenue  
Santa Ana, California 92705  
(714) 979-4440  
TWX 910-595-1513

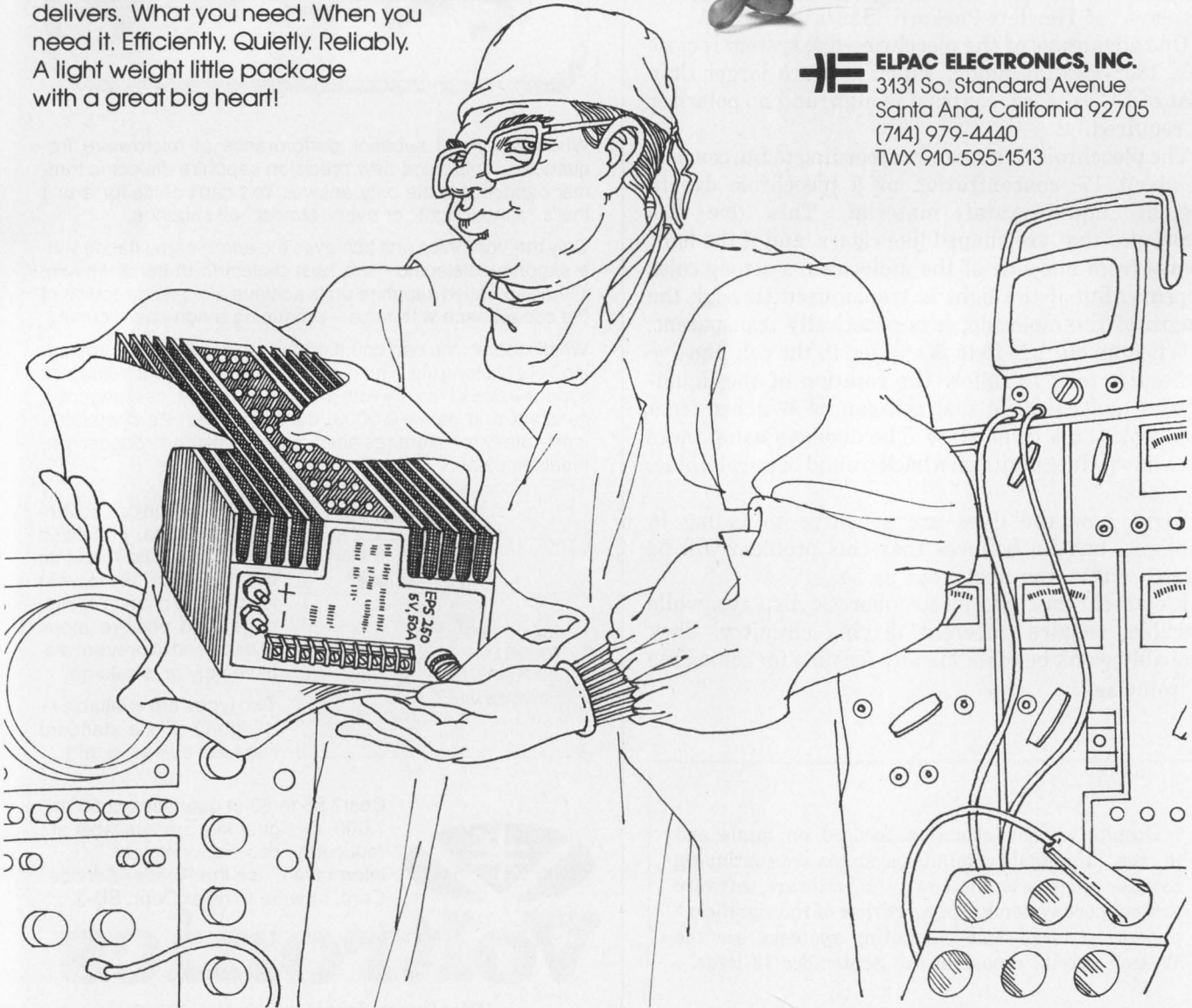





**Get  
professional  
coaching on  
your solenoid  
problems.**

Nobody, but nobody, builds more solenoids than Dormeyer Industries. So when you need a laminated, folded frame, box frame, "C" frame, or tubular type solenoid for commercial applications, give a holler for Dormeyer.

We have plenty of standard units that can be shipped immediately from stock. Or, if you want fast help on solving solenoid application problems just watch our engineering team go into action. You'll have the competitive edge with Dormeyer's know-how and economical prices on your side.

Make it easy on yourself. Write or call today for the new Dormeyer "Coach's Kit" with a complete solenoid catalog.

**DORMEYER INDUSTRIES, A Division of A. F. DORMEYER MFG. CO., INC.**  
3418 N. Milwaukee Avenue, Chicago, IL 60641 • (312) 283-4000 • TWX: 910-221-3831





# The big three in electronics.



**FRANZIS-VERLAG GMBH**  
Karlstrasse 41, D-8000 Muenchen 2  
phone: (0 89)-5 11 72 77  
telex: 5 22 301 frzis d

Germany's leading publishinghouse  
for electronics

**ELO**

The new magazine covering electronics in practice and as a hobby. 30,000 circulation at the start in 75, increasing to 122,000 copies in only one and a half years. Published monthly. It is especially conceived for the interested amateur and all people interested in hi-fi and electronics as a hobby.

## Elektronik

The leading German magazine covering applied electronics and data processing. Enjoys eminent editorial status and a circulation from 32,000 copies monthly. The contact-card reader-service assures your advertisements of greater success.

## Funkschau

The big publication in the field of radio, tv, hi-fi and electronics, 26 issues published yearly, with a circulation of 120,000 which includes over 13,000 copies outside Germany. These are the guarantee for your successful advertising campaign.

**USA:** INTA Advertising, Inc.  
1560 Broadway, New York, N. Y. 10036  
phone: (212) 575-92 92

**USA:** Elmatex International  
7742 Redlands Street  
Suite H 3021  
Playa Del Rey, CA 90291

**United Kingdom:** Publicitas Limited  
525/527 Fulham Road, London SW 6 1 HF  
phone: 01 - 3 85 77 23,  
telex: 919 223 Almilon

**Switzerland:** Exportwerbung AG  
Neptunstrasse 20, CH-8032 Zürich  
phone: 01-47 46 90, telex: 53 327

**Japan:** International Media Ltd.  
1, Shiba-Kotohiracho, Minatoku,  
Tokyo, phone: 5 02-06 56, telex: J 22633

**Korea:** International Marketing Corp.  
C. P. O. Box 6533, Seoul, Korea  
phone: 74. 75 35

**CIRCLE NUMBER 66**

PLEASE VISIT US AT OUR BOOTH NUMBER 63 AT WESCON 77, SAN FRANCISCO



# The Panasonic Plus: you get more power transistor than you pay for.

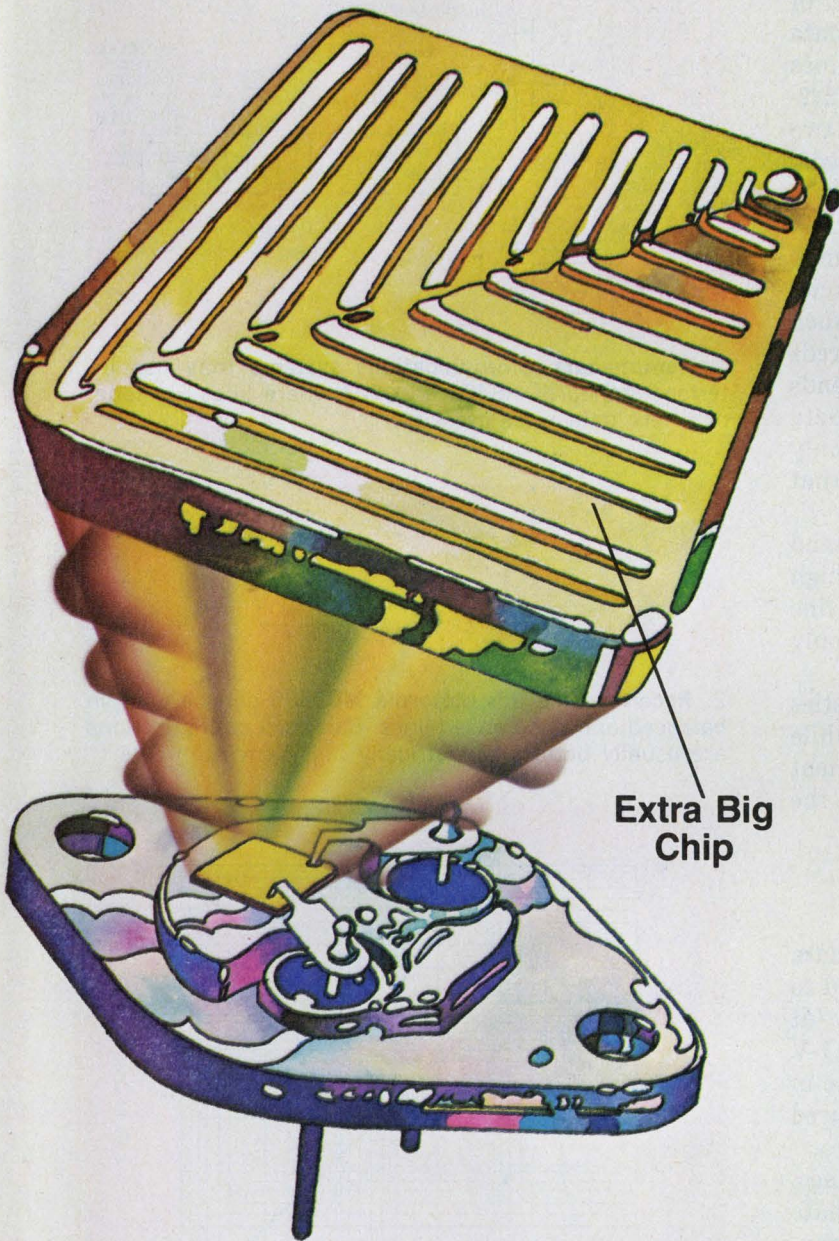

Extra Big Chip

One look at the extra big chip in any Panasonic power transistor makes it obvious—not all transistors are created equal.

Because of our extra big chip and proprietary construction we could rate these devices higher, but we don't. They're always conservatively rated. Which, along with our rigid QC system, is why we have such a low rejection rate.

That's part of the Panasonic Plus...one reason to switch to our power transistors. There's also competitive pricing and broad range.

Many of our power transistors are matched to 2N numbers, and are available in standard TO plastic or metal packages, in a complete range of power, voltage and current ratings. And we also offer a line of small signal transistors, Hall Effect devices, and 4-bit microprocessors. All at prices that are highly competitive with those of other makers of quality semiconductor devices.

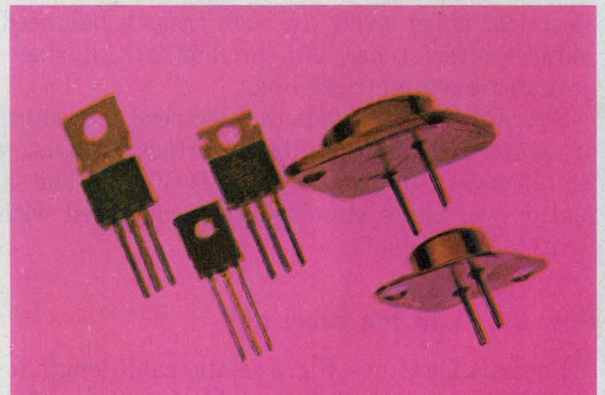

For complete information and prices, write to Panasonic Electronic Components, One Panasonic Way, Secaucus, N.J. 07094; or call (201) 348-7269.

## Specifications

	TO-3	TO-66	TO-126	TO-202 TO-220
V <sub>ceo</sub> (V)	80-1500V	40-300V	18-300V	20-300V
I <sub>c</sub> (A)	100m-6A	100m-2.5A	50m-1.5A	100m-4A

Also available: TO-92 and other semiconductor packages

**Panasonic**<sup>®</sup>  
just slightly ahead of our time

CIRCLE NUMBER 67



## Revised data-interface standards

permit faster data rates and longer cables. New chips, and RS232 adapters, simplify their use.

Distributed processing and the growing number of intelligent peripherals are demanding more of data communications equipment, especially longer lines and higher data rates. Since the conventional RS232-C interface standard can't handle these demands, two new interface specs, RS422 and RS423 have emerged.

For example, remote terminal clusters that interface with a host computer over a high-speed data communication channel (Fig. 1) have become common in systems for interactive design and commercial applications like banking. The distance between such terminals and a concentrator can easily be hundreds of feet, although the RS232-C standard recommends only a 50-ft separation. And while a high-speed data link between the concentrator and modem may be only a few feet, at speeds above 20 kilobaud, even that presents a problem for RS232-C.

Furthermore, industrial applications often demand system performance in an environment with high electrical noise levels. In such cases a balanced line reduces interference, but the RS232-C interface only provides asymmetrical links.

Standard RS422 covers the electrical characteristics of *balanced-voltage* digital interface circuits, while RS423 covers *unbalanced circuits* (Fig. 2). The salient features of these standards are compared with the RS232-C in Table 1.

### How long can the cable be?

For balanced lines, Fig. 3 relates cable length to data rate. For unbalanced lines, cable length is related to the pulse slope  $dV/dt$  in Fig. 4. The value of  $dV/dt$  to be used with Fig. 4 is that of the fastest 0.1-V interval. But to avoid measuring every signal line in an equipment group, a faster  $dV/dt$  than measured is often specified for the whole group.

To prevent near-end crosstalk on unbalanced lines, the 10-to-90% rise time in RS423 should approximate 30% of the bit time. The relationship between maximum data rate and rise time is also shown in Fig. 5. Far-end crosstalk and signal loss effectively restrict both new standards to a maximum cable length of 1200 m (approximately 4000 ft).

**Dusty Morris**, Engineer, Information Processing Equipment Engineering, Motorola, Inc. Semiconductor Group, 5005 E. McDowell Rd., Phoenix, AZ 85008

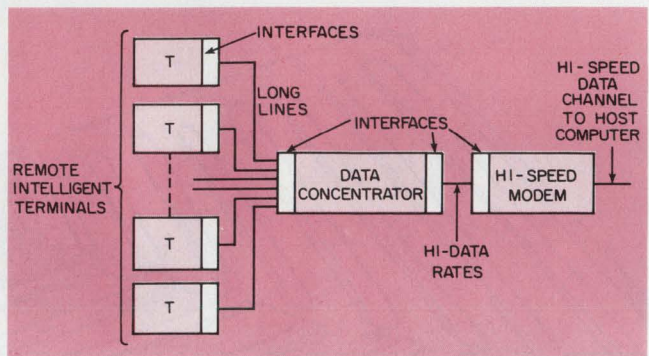

1. **Remote-data-communications systems** may use interface standards RS422 and 423 where lines are long, or where data rates are high.

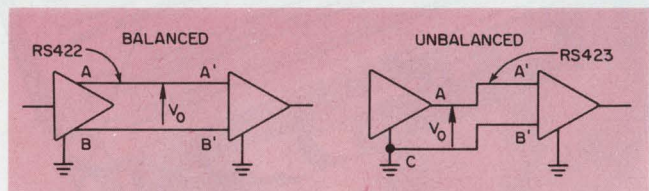

2. **Receivers like this Motorola MC3486** can be used in balanced and unbalanced lines. Balanced configurations are usually better in electrically noisy environments.

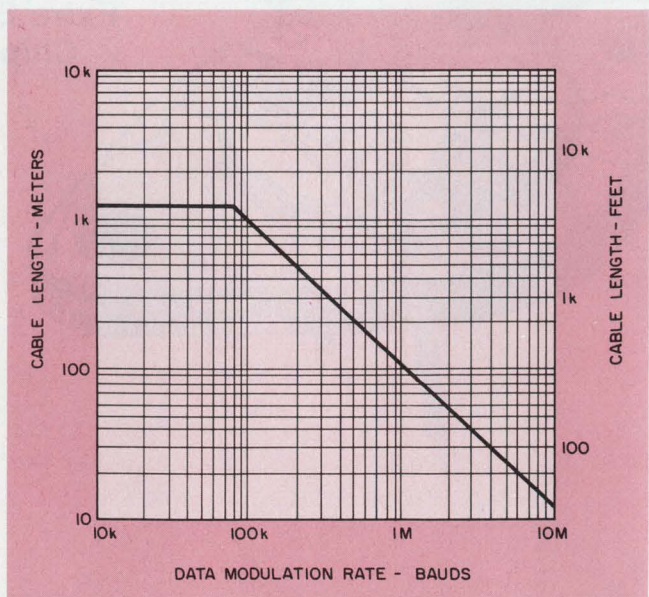

3. **Permissible cable length depends on the data modulation rate.** The graph is valid for twisted-pair cable, 24 AWG, and a balanced interface.



The graphs in Figs. 3, 4 and 5 have been calculated for 24-AWG twisted-pair cable, and a capacitance of 52.5 pF/m (16 pF/ft). Cables with lower resistance permit longer lengths, while higher capacitance shortens the permissible length. If more than 1200 m of cable are needed, a modem may have to be inserted.

For the unbalanced line, pulse shape also affects the cable length, because crosstalk can become excessive. If the rise and fall time is controlled by

capacitive loading, the wave shape is exponential. But the pulse rise and fall can also be made linear by programmed control of the driver.

A 10-V signal with linear wave shape and a 10-to-90% rise time of 30  $\mu$ s has a  $dV/dt$  of 0.267 V/ $\mu$ s (=8 V/30  $\mu$ s). The RC-shaped signal with the same maximum  $dV/dt$  has a 10-to-90% rise time of 82  $\mu$ s. So the data rate for linear wave shaping is 10 kbaud, and for RC wave shaping, 3.7 kbaud (Fig. 5). In other

**Table 1. Comparison of the old and new interface standards**

Parameter	RS232	RS422	RS423
Line length (recommended max—may be exceeded with proper design).	50 ft	1200 m (4000 ft) See Fig. 3	1200m (4000 ft) See Fig. 5
Input Z	3 to 7 k $\Omega$ 2500 pF	> 4 k $\Omega$	> 4 k $\Omega$
Max frequency (baud)	20 kbaud	10 Mbaud	100 kbaud
Transition time* (time in undefined area between "1" and "0") tr = 10 to 90%	4% of $\tau$ or 1 ms	tr $\leq$ 0.1 $\tau$ : $\tau \geq$ 200 ns tr $\leq$ 20 ns: $\tau <$ 200 ns	tr $\leq$ .3 $\tau$ : $\tau <$ 1 ms tr $\leq$ 300 $\mu$ s: $\tau >$ 1 ms
dV/dt (wave shaping)	30 V/ $\mu$ s	See transition time	See Fig. 4
Mark (Data "1") Space (Data "0")	-3 V +3 V	A < B A > B	A = Negative B = Positive
Common mode voltage (for balanced receiver)	-	-7 V < V <sub>CM</sub> < +7 V	-
Output Z	-	< 100 $\Omega$ Balanced	< 50 $\Omega$
Open-circuit output voltage (V <sub>o</sub> ) V <sub>t</sub> = loaded V <sub>o</sub>	3 V <  V <sub>o</sub>   < 25 V  5 <  V <sub>o</sub>   < 15 V 3 to 7k $\Omega$ load	V <sub>o</sub>   $\leq$ 6 V **  2V or .5V <sub>o</sub> <  V <sub>t</sub>   † 100 $\Omega$ balanced load	4 V $\leq$  V <sub>o</sub>   $\leq$ 6 V   V <sub>t</sub>   $\geq$ .9  V <sub>o</sub>   450 $\Omega$ load
Short circuit current	500 mA	150 mA	150 mA
Power-off leakage (V <sub>o</sub> applied to unpowered device)	> 300 $\Omega$ 2 V <  V <sub>o</sub>   < 25 V V <sub>o</sub> applied	< 100 $\mu$ A 0 V < V <sub>o</sub> < 6 V V <sub>o</sub> applied	< 100 $\mu$ A  V <sub>o</sub>   < 6 V V <sub>o</sub> applied
Min receiver input for proper V <sub>o</sub>	> $\pm$ 3 V	200 mV differential	200 mV differential

\*  $\tau$  is bit period

\*\* across output, or output to ground

† whichever is greater



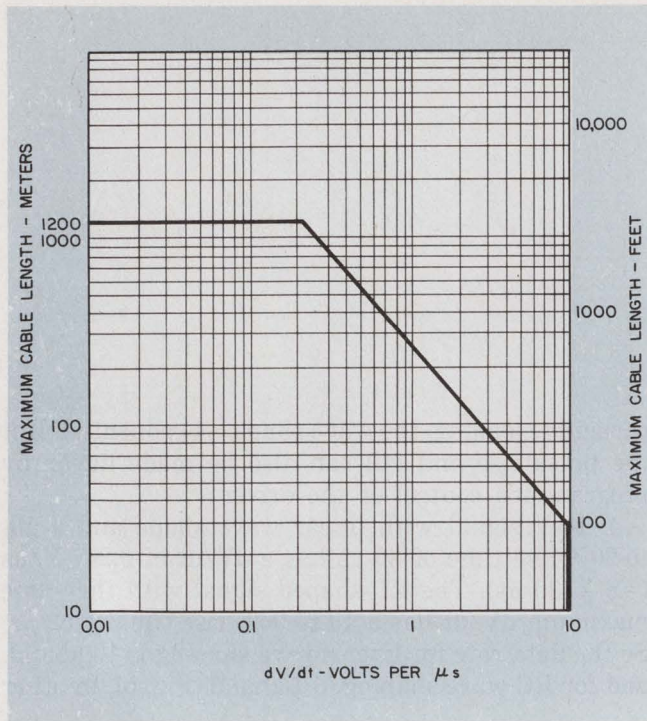

4. Pulse slopes also determine how long interconnecting cables can be. Here,  $dV/dt$  is defined as the steepest part of the pulse slopes.

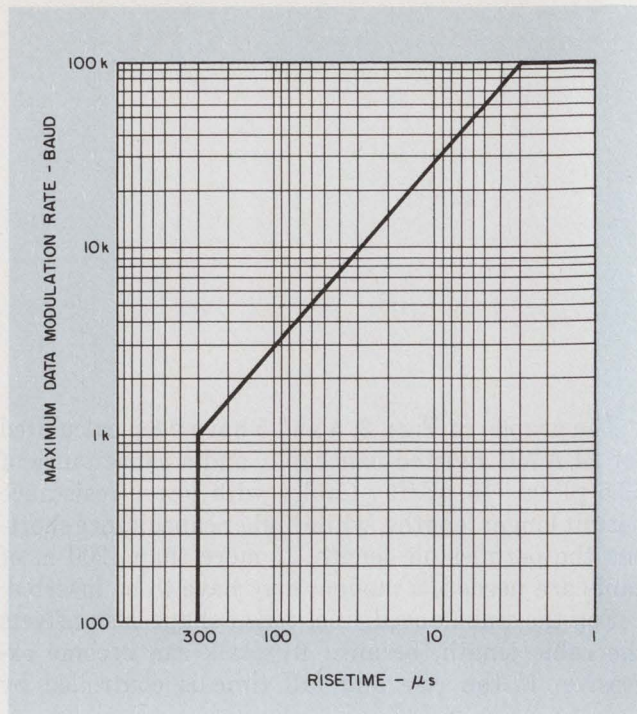

5. The maximum data-modulation rate is limited by the 10-to-90% rise time of the pulses. If the data rate is too high, near-end crosstalk may result.

words, linear wave shaping allows a 2.7 times higher data rate than an exponential wave.

#### Build a fast interface—fast

The new standards are easily implemented, for instance, with the Motorola MC3486 quad line receiver and the MC3487 quad balanced line driver, or the MC3488 dual unbalanced line driver. The MC3486 and 3487 employ Schottky TTL technology with three-state outputs and operate from a single 5-V supply. To minimize input loading, the data inputs of the driver and the three-state control inputs of both devices are pnp-buffered. These high-impedance drivers and receivers can be connected directly to MOS microprocessor I/O devices such as peripheral interface adaptors, asynchronous communication interface adaptors, or synchronous serial-data adaptors (Fig. 7).

The four receiver chains in the MC3486 and the four driver chains in the MC3487 operate independently of each other. Propagation delays are typically 25 ns through the receivers and 15 ns through the drivers.

#### Rejuvenating the pulse train

Hysteresis in the receivers enhances input-noise immunity and "squares up" input edges, which may be degraded by the longer cables permitted under standards RS422 and 423. Rise and fall times at the driver outputs are typically less than 20 ns. The differential-input threshold of the receivers is  $\pm 0.05$

V, and the output short-circuit current of any single driver exceeds 35 mA.

In contrast, the MC3488 operates from split power supplies, over a range of  $\pm 9$  to  $\pm 12$  V. To control near-

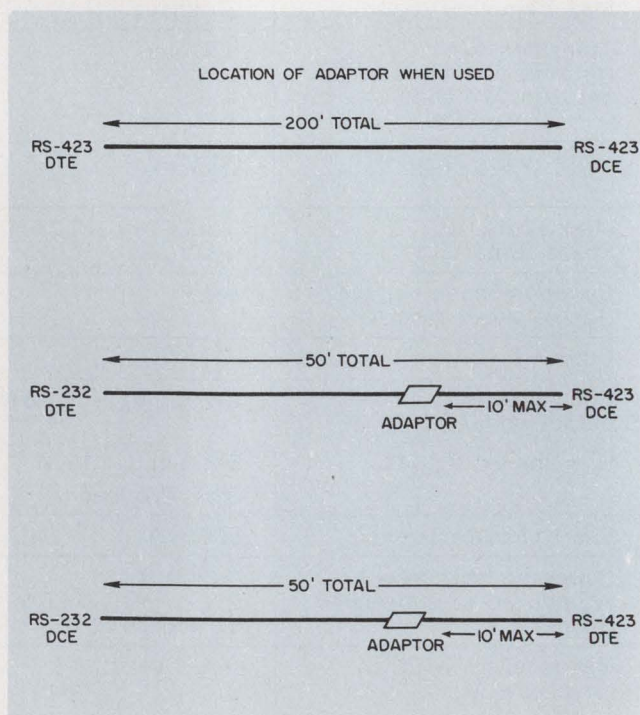

6. Adaptors can be used to interconnect equipment that works to different RS standards. The location of these adaptors is shown above.



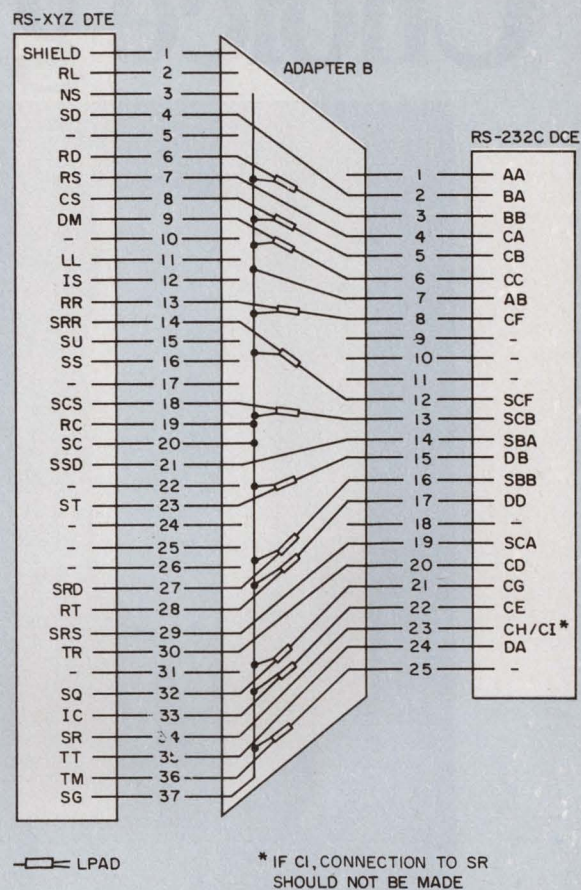
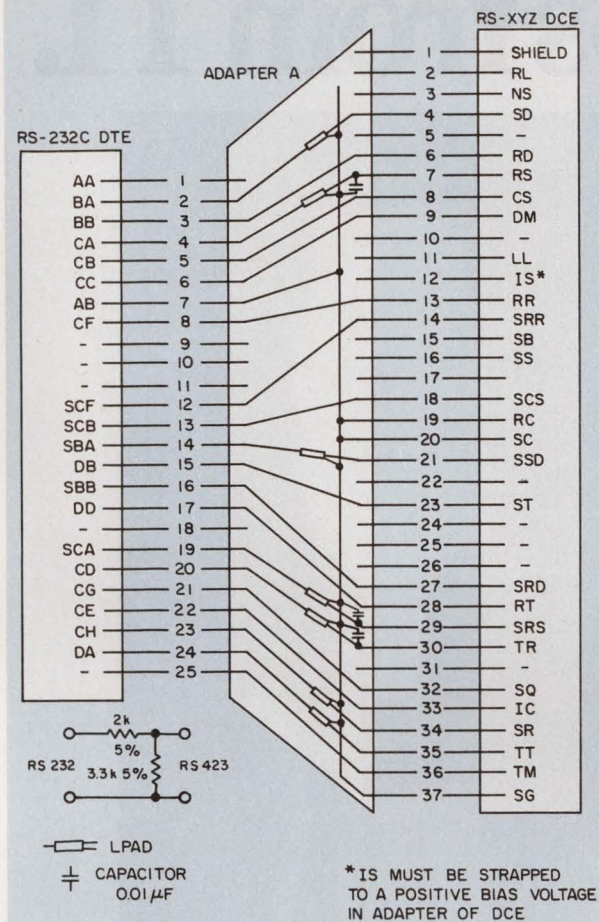

**7. Interconnections between RS232 and RS423 are governed by standard RS-XYZ, which applies to these interface adapters.**

end crosstalk, a common control pin provides output slew-rate control over two orders of magnitude. Linear wave shaping in the driver allows higher data rates than exponential wave shaping with capacitors. Driver-input pins are also pnp-buffered to minimize input loading, while the current needed for output control is kept low.

So much for the new standards. But what about older equipment? It has not been forgotten. RS-XYZ covers the interconnection between the old and new standards (Fig. 5). The proper interconnections between 25-pin RS232 connectors and 37-pin RS423 connectors are explained in Fig. 6. Circuit ground is tied to frame ground through a 100-Ω, 1/2-W resistor to prevent high-ground loop currents. The L pad in Fig. 6 is used to protect the RS423 receivers from the higher RS232 voltages, but is not needed with MC3486 receivers.

Although the new standards and the discussed hardware allow up to 80 times longer cables or up to 200 times faster data rates, the new drivers and receivers cost no more than those for RS232. ■■

**Acknowledgment:**

Figs. 3, 4, 5 and 7 were taken from the complete RS standards with permission of the Electronic Industries Association, 2001 Eye St. NW, Washington, DC 20006.

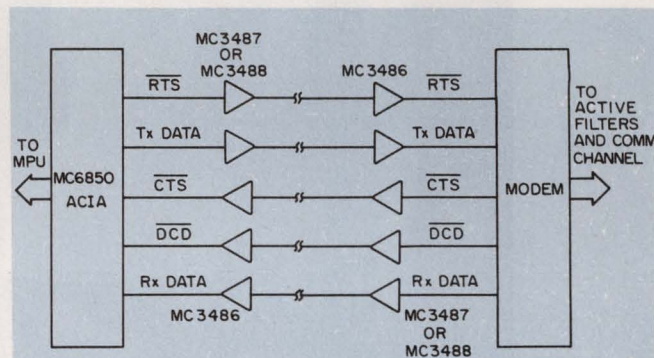

- ACIA — Asynchronous Communication Interface Adapter
- DCE — Data Communications Equipment
- DTE — Data Terminal Equipment
- RTS — Request to send — DTE asks DCE for permission to send data.
- CTS — Clear to Send — DCE grants DTE permission to send data.
- DCD — Data Carrier Detect — DCE indicates to DTE that received signal is present.
- Tx Data — Data from DTE to DCE.
- Rx Data — Data from DCE to DTE.

**8. For interface drivers and receivers, the shown Motorola components can be used.**



# Choice grips from TI.

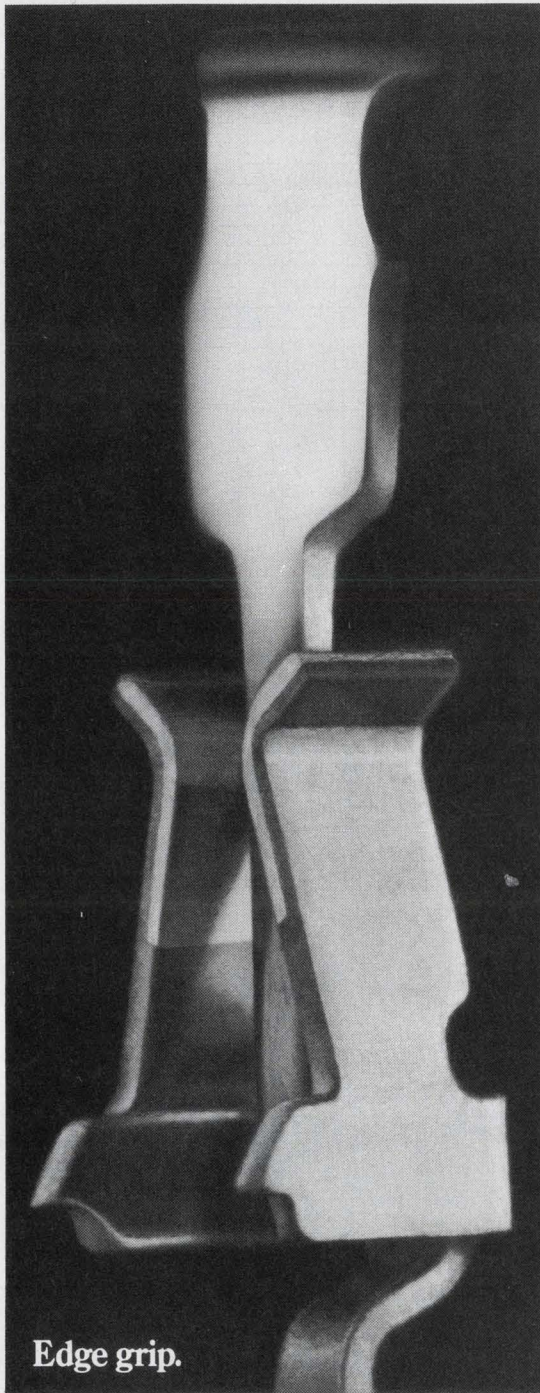

Edge grip.

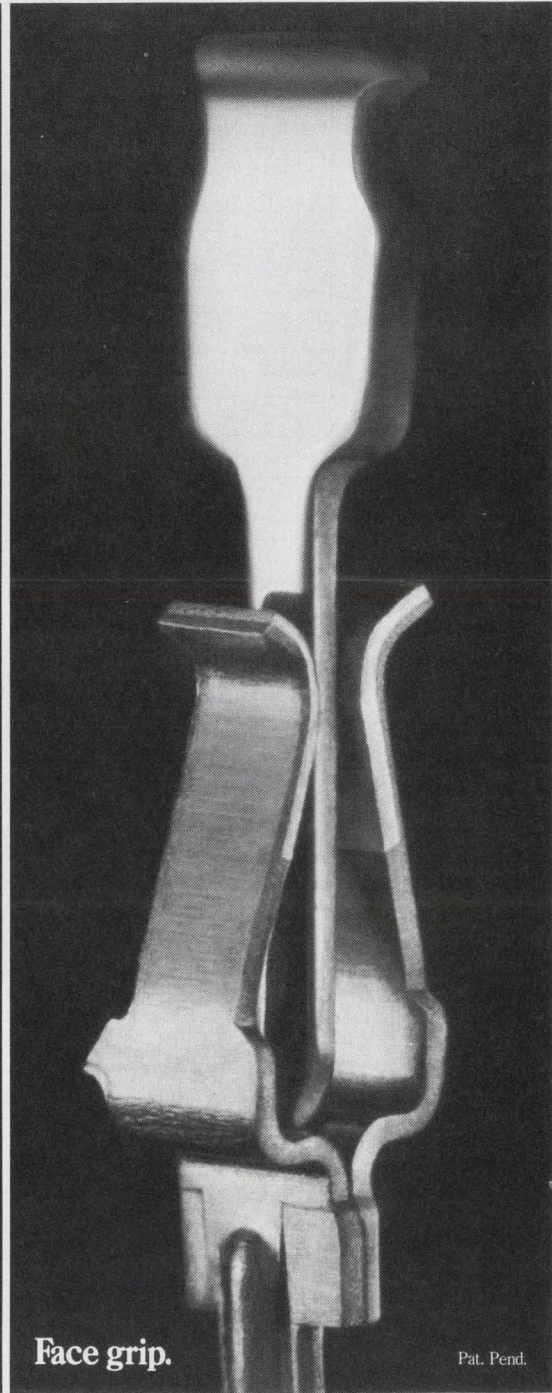

Face grip.

Pat. Pend.

Choose your grip from the world leader in dual-in-line sockets. We offer the best values in both face grip and edge grip designs from the most complete line of low profile solder tail IC sockets in the industry. Get off-the-shelf delivery from your local TI distributor. Write Mail Station W1, Attleboro, MA 02703. Or call Connector Systems Marketing, (617) 222-2800, Extension 268 or 269.

**Edge grip:** Gold or tin contact surfaces • 8-40 positions • 94V-0 insulator material • 75 $\mu$ " min. gold or 200 $\mu$ " min. tin inlay • CA 725 copper alloy • Optimum contact pressure • Facilitates automatic insertion • Dual beam contact construction • Chamfered entry design

**Face grip:** Optimum insertion/withdrawal ratio • 8-64 position • 94V-0 insulator material • 75 $\mu$ " min. gold or 200 $\mu$ " min. tin inlay • CA 725 copper alloy • Facilitates automatic insertion • Dual beam contact construction • Open insulator design • Ribbed contact termination • Chamfered entry design

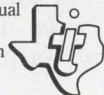

**TEXAS INSTRUMENTS**  
INCORPORATED



# Berg Right-Angle Headers are the smart choice for Raytheon Intelligent Terminals.

Berg Shielded Right-Angle Headers consist of glass-filled polyester housings having .025" square pins (on .100", .125" or .150" grid) which are molded in position for maximum strength. They have an integral top shield to protect the pins from damage.

Raytheon Data Systems likes these headers and uses them, as well as Berg female receptacles and other .025" sq. connectors, in their programmable terminal systems. Raytheon has found that it can rely on Berg Electronics to supply the con-

ductor and equipment that precisely meet interconnection needs.

Berg is experienced. We read interconnection needs like Raytheon reads alpha-numeric displays. We have the products, the background, and the back-up to do the job. Your job. Let's work on it, together. Berg Electronics Division, E. I. du Pont de Nemours & Company, New Cumberland, PA 17070. Phone 717-938-6711.

**DU PONT BERG ELECTRONICS**  
REG. U.S. PAT. & TM. OFF.

CIRCLE NUMBER 69

We serve special interests—yours!

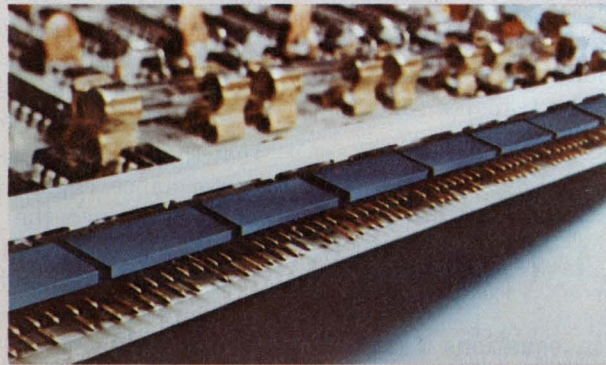



## Design active low-pass filters with stock resistors and capacitors. Six frequency decades can be covered with simple component changes.

Using  $\pm 1\%$  resistors and  $\pm 5\%$  capacitors, you can quickly design and build low-pass filter circuits, while forcing each capacitor to match a value in your stock. With present day FET-input op amps, use a systematic design procedure that works for circuits having upper cut-off frequencies ranging from hundredths of a hertz to tens of kilohertz.

### Begin with basics

Fig. 1 is a schematic of a two-pole, low-pass active filter. Conventional circuit analysis leads to the voltage transfer function:

$$\frac{V_2(s)}{V_1(s)} = \frac{\omega_0^2}{s^2 + 2\zeta\omega_0 s + \omega_0^2} \quad (1)$$

where  $s = \sigma + j\omega$ , the complex frequency

$\zeta = 1/2Q$ , the damping factor, and

$\omega_0 = 2\pi f_0$ , the undamped natural frequency.

Assuming an ideal op amp, the transfer function in terms of the circuit component becomes

$$\frac{V_2(s)}{V_1(s)} = \frac{(R_1 R_2 C_1 C_2)^{-1}}{s^2 + s \left( \frac{1}{R_1 C_1} + \frac{1}{R_2 C_1} \right) + (R_1 R_2 C_1 C_2)^{-1}} \quad (2)$$

Equating like coefficients in equations 1 and 2 yields, among others

$$C_2 \leq \zeta^2 C_1. \quad (3)$$

This type of filter is commonly designed by assigning a value of  $R_1 = R_2$  and calculating  $C_1$  and  $C_2$ . The calculations may actually consist of simply looking up normalized capacitance values in a table, and then denormalizing to the actual frequency and resistance. The two objections to this procedure are that Eq. 3 makes it unnecessarily restrictive, and generally, the calculated capacitor values differ from available stock values. Either this error is accepted, special capacitors are purchased, or the desired value is obtained by trimming. None of these alternatives are appealing,

**Keith Timothy**, Senior Design Specialist, Datum Inc., 1363 S. State College Blvd., Anaheim, CA 92806. Formerly with Preston Scientific.

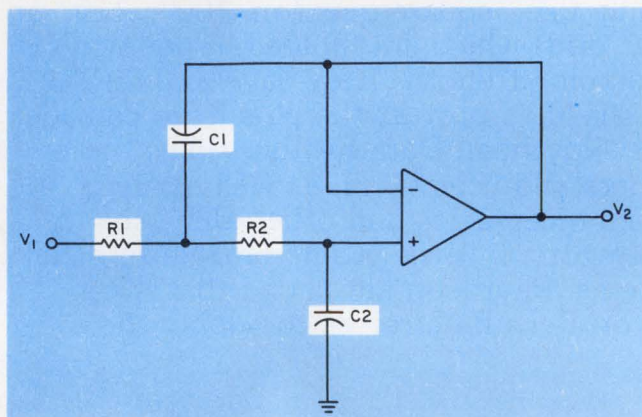

1. **Standard value resistors and capacitors** can be easily designed into this unity-gain, low-pass active filter.

and this procedure will assume no arbitrary relationships, such as  $R_1 = R_2$ . Capacitors, with the poorest resolution, are assigned stock values. Resistors, with finer resolution, are calculated.

Before plunging into the design, consider the effects that the values of passive components have on filter performance. High values of resistance can cause drift problems, since the amplifier input current drift,  $\Delta I_{BIAS}/\Delta T$ , is multiplied by total resistance  $(R_1 + R_2)$ . Low resistor values increase input loading.

Capacitors at the high end should be chosen with care due to their inherently greater cost and size. As the cut-off frequency increases, stray capacitance can adversely affect the filter.

### Design a stock-value filter

Select a stock value of  $C_1$  from

$$C_1 \geq \frac{2}{\zeta \omega_0 (R_1 + R_2)_{\max}} \quad (4)$$

If  $\omega_0$  is a high frequency, you may have to increase  $C_1$  to reduce the effects of stray capacitance. Assign the largest stock value of  $C_2$  from Eq. 3.

Find  $R_1$  from

$$R_1 = \frac{\zeta + \sqrt{\zeta^2 - C_2/C_1}}{\omega_0 C_2} \quad (5)$$

Find  $R_2$  from

$$R_2 = \frac{1}{\omega_0^2 R_1 C_1 C_2} \quad (6)$$



Iteration, to adjust the final component values to your design, may be necessary. The cut-off frequency can be scaled without changing the damping. Simply divide the values of either  $R_1$  and  $R_2$  or  $C_1$  and  $C_2$  by the frequency ratio. When the cut-off frequency changes by decades, you can obtain new component values by inspection. Further, this method of decade switching does not introduce any additional round-off error.

To see how this method works, design a 7-Hz, two-pole Bessel filter where  $\zeta = \sqrt{3}/2$  and  $\omega_o/\omega_c = \sqrt{3}$ . The change in bias current for the op amp can be 10 nA max causing a 1-mV change in voltage over the temperature range.

From the amplifier specs,

$$(R_1 + R_2)_{\max} = \frac{10^{-3}\text{V}}{10^{-8}\text{A}} = 0.1\text{ M}\Omega$$

and calculate  $\omega_o$  from the frequency

$$\omega_o = \omega_c \sqrt{3} = 2\pi(7)\sqrt{3} = 76.3$$

With Eq. 4,  $C_1 \geq 0.303 \times 10^{-6}$ . Assign  $C_1$  a value of  $0.33 \mu\text{F} \pm 5\%$ .

With Eq. 3,  $C_2 \leq 0.248 \times 10^{-6}$ . Assign  $C_2$  a value of  $0.22 \mu\text{F} \pm 5\%$ .

With Eq. 5,  $R_1 = 0.0689 \times 10^6$ . Assign  $R_1$  a value of  $68.1 \text{ k}\Omega \pm 1\%$ .

Finally, with Eq. 6,  $R_2 = 0.0349 \times 10^6$ . Assign  $R_2$  a value of  $34.8 \text{ k}\Omega \pm 1\%$ .

Going back to the original conditions for the amplifier  $(R_1 + R_2)_{\max} = 68.1 + 34.8 = 102.9 \text{ k}\Omega$  and  $102.9 \text{ k}\Omega > 100 \text{ k}\Omega$ .

Since  $(R_1 + R_2)$  is greater than the originally allowed value of  $100 \text{ k}\Omega$ , you can iterate if necessary by increasing  $C_1$  to the next higher stock value and recalculate the components.

Now assume that  $\omega_o$  is to be changed to  $700 \text{ Hz}$ . Simply change the capacitor values so that

$$C_1 = \left(\frac{7}{700}\right)(0.33 \times 10^{-6}) = 3300 \text{ pF} \pm 5\%$$

$$C_2 = \left(\frac{7}{700}\right)(0.22 \times 10^{-6}) = 2200 \text{ pF} \pm 5\%$$

Let  $\omega_o$  increase to  $70 \text{ kHz}$  and recalculate the capacitors once again. Now,  $C_1 = 33 \text{ pF}$  and  $C_2 = 22 \text{ pF}$ ,  $\pm 5\%$ . But watch out. Stray capacitance across  $C_2$  can be about  $10 \text{ pF}$ . A minimum value for  $C_2$  should be about  $1000 \text{ pF}$ . In this case, recalculate the resistors while keeping the capacitors at the values of the  $700 \text{ Hz}$  example. This gives  $R_1 = 681 \Omega$  and  $R_2 = 348 \Omega$ ,  $\pm 1\%$ . These resistor values are low enough to cause input loading problems. Reassign  $C_1$  a stock value as low as

$$(\sqrt{3}/2)^{-2} (1000 \times 10^{-12}) = 1330 \text{ pF} \pm 5\%$$

and iterate to find the other components. ■■

# OSCILLATORS

1Hz to 300MHz

SINE OR SQUARE

**WOULD YOU BELIEVE** - SERIES 76-A page of oscillators covering frequencies from 1Hz to 300 MHz. No more sorting through 24 pages of can sizes.

**ANALOG ENGINEERS** - we haven't forgotten you. Accutronics Series 76 covers a frequency range of 60Hz to 300MHz. Example Model XE covers a frequency range from 60Hz to 1MHz with an output voltage of 1VRMS into 10K ohm load with +12VDC supply. Distortion of less than 5% is held over a temperature range of  $0^\circ\text{C}$  to  $60^\circ\text{C}$  with  $\pm 0.001\%$  frequency stability. A wide variety of temperature ranges are available along with various mounting configuration. Model XF covers from 1MHz to 300MHz with an output of +10dbm into 50 ohm with distortion at -25db minimum. Frequency stability is  $\pm 0.001\%$  from  $0^\circ\text{C}$  to  $60^\circ\text{C}$ .

**DIGITAL APPLICATION** - Engineers specifying digital outputs will find it easy to find their requirement in our Series 76. Example - Model XA covers 1Hz to 5MHz with C-Mos outputs. Model XB covers 1Hz to 25MHz with TTL outputs. Models XC and XD cover frequencies from 10MHz to 300MHz with TTL, ECL, MECL outputs. Frequency stabilities of  $\pm 0.001\%$  from  $0^\circ\text{C}$  to  $60^\circ\text{C}$  are standard with wider temperature ranges available.

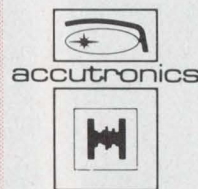

Please write or call Wayne Benson

**312-232-2600**

for more information and pricing on our complete oscillator product line.

**accutronics**

A HAMMOND COMPANY

628 NORTH STREET • GENEVA, ILLINOIS 60134







## R 6500: the third generation microprocessor system

Now you can move up to the proven 2 MHz performance of an NMOS 8-bit microprocessor, the R 6500 from Rockwell.

Third-generation R 6500 architecture and instructions with 13 powerful addressing modes make it easier for you to design more functions in, more cost out. And the R 6500 is design-compatible with systems you may now be using.

## R 6500 economics are on your side

Smaller R 6500 chips and single 5V power supply keep costs down as performance goes up. To get the right fit, choose from 10 software-compatible CPUs, eight versatile I/Os, ROMs, RAMs, and memory-I/O-timer circuits.

## Rockwell adds solid development support

For fast and efficient system design, Rockwell offers SYSTEM 65—one of the smartest and lowest-cost disk-operating, complete development systems available. It's equipped with two mini-floppies, resident two-pass assembler, text editor and monitor/debug package.

KIM-1, TIM, timeshare, complete documentation, plus extensive applications engineering are also available.

## Rockwell is delivering in volume now

R 6500 DIP circuits are already being produced in quantity with Rockwell's N-channel, silicon-gate, depletion load process. All of the initial family of 18 different chips will

be in volume production by the 4th quarter of 1977.

And new chips are in design. The first, now in prototype production, is a fully-static 32K ROM.

## A Rockwell one-day seminar can get you started

Plan now to attend a free, one-day seminar at a city near you. You'll see the SYSTEM 65 in operation and get all the information you need to start designing the R 6500 into your application.

CITY	DATE	CITY	DATE
EAST			
Rochester	9/19	Detroit	9/26
Boston	9/20	Cleveland	9/27
Bridgeport	9/21	Chicago	9/28
New York City area	9/23	Minneapolis	9/30
Philadelphia	10/13	Dallas	10/10
Washington D.C.	10/12	WEST COAST	
CANADA			
Toronto	10/17	Bay Area	10/3 & 10/4
Montreal	10/18	Seattle	10/5
		Denver	10/6
		Los Angeles	10/19
		Orange County	10/20

For your reservation or R 6500 brochure, send the coupon below or write: D-727-C, Marketing Services, Microelectronic Devices, Rockwell International, P.O. Box 3669, Anaheim, CA 92803, U.S.A. or phone (714) 632-3729.

<input type="checkbox"/> I would like to attend a Rockwell R6500 seminar on _____ in _____.	C
Have a Rockwell rep confirm it with me.	
<input type="checkbox"/> Send me your new R6500 brochure.	
I have <input type="checkbox"/> have not <input type="checkbox"/> worked with the 6500.	
Name _____ Title _____	
Company _____ Ph _____	
Street _____ City _____	
State _____ Zip _____	



**Rockwell International**

...where science gets down to business



# Ideas for design

## Emulate a seven-segment decoder with a subroutine in a $\mu$ P control program

A 98¢ IC can decode and drive a seven-segment numerical display, but a  $\mu$ P can easily perform the function as a small part of a large control program. Further, emulating the decoder exemplifies those parallel-logic problems that a  $\mu$ P can solve in a sequential fashion.

Fairly complicated, yet prosaic, Fig. 1 shows an F8  $\mu$ P's output-port configuration and the table, an F8's assembly-language program for converting the seven-segment code to a decimal output. The routine executes in 38  $\mu$ s and occupies 26 bytes of memory—called "firmware," when contained in a nonvolatile ROM or PROM.

The F8's I/O ports latch and have high drive capability. In fact, an FND807 LED numerical display driven directly by the F8 can be easily read from across a room under normal light conditions. Modified to be a subroutine in a real control program, the program in the table might appear as follows:

```

CLR
OUTS-OPRT
STRT DCI 0
LR A, REG (load binary number
        stored in REG ACC.)
ADC
LM
OUTS OPRT
POP (exit to main routine)
    
```

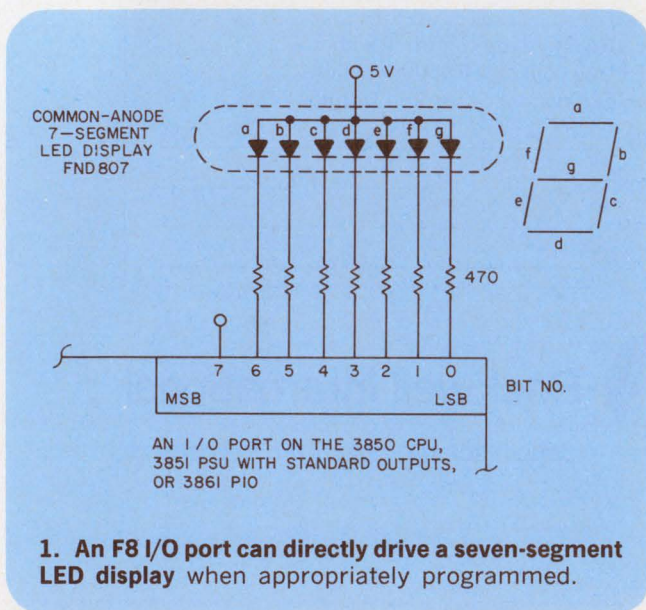

The register, designated REG, would be one of the F8's 64 internal RAM locations that store the binary number to be displayed. Sixteen additional locations are needed for table look-up.

Jon Colt, Applications Engineer, Fairchild, 1641 Wellshire Lane, Dunwoody, GA 30338.

CIRCLE NO. 311

```

*
*           HEX DIGIT DISPLAY SUBROUTINE
*
* TO BE USED WITH THE FAIRCHILD F-8 KIT1A, OR COMPARABLE HARDWARE
* CONFIGURATION CONTAINING THE 3851A 'FAIRBUG' PSU.
*
* DISPLAYS HEX DIGITS 0 THRU F ECHOED FROM AN ASCII KEYBOARD INPUT
* TO A 7-SEGMENT, COMMON ANODE NUMERIC L.E.D. DISPLAY INTERFACED
* DIRECTLY TO I/O PORT #5 THRU 470-OHM CURRENT-LIMITING RESISTORS.
*
*
*           TITLE 'HEX DIGIT DISPLAY SUBROUTINE'
*           ORG 0          PROG TO BE LOADED @ LOC 0.
*           EQU H'83AD'    VERY CONVENIENT TTY KBD INPUT
*                           ROUTINE IN 'FAIRBUG'.
*           OPRT          EQU 5          ASSIGN VALUE TO LABEL
*           CLR           CLR           LOAD ACC WITH 00, AND
*           OUTS OPRT     CLEAR I/O PORT #5
*           DCI 0         SET DATA COUNTER TO 0000.
*           PI TTYI      JMP TO KBD INPUT ROUTINE.
*           NI H'7F'     MASK OUT PARITY BIT.
*           ADC          ADD THE INPUTTED DIGIT TO THE
*                           VALUE OF THE DATA COUNTER
*                           (=0000; REMEMBER?)
*
*           LM          LOAD THE CONTENTS OF THE
*                           MEMORY LOCATION POINTED TO BY
*                           THE DATA COUNTER INTO THE ACC.
*
*           OUTS OPRT    OUTPUT ACC CONTENTS > PORT 5.
*           JMP STRT     DONE; GO BACK AND WAIT ON
*                           ANOTHER KEYBOARD ENTRY. DON'T
*                           FORGET THAT THE F-8'S I/O PORTS
*                           ARE LATCHING, SO THERE'S NO
*                           NEED TO DO ANY SOFTWARE REFRESH,
*                           OR PAY FOR ADD'L I.C.'S (LATCHES).
*
*
*           NUMERAL LOOK-UP TABLE
*
*           ORG H'30'     THE FOLLOWING BIT PATTERNS (RE-
*                           QUIRED IN ORDER TO DISPLAY THE
*                           DIGITS 0-9) ARE TO BE LOADED INTO
*                           MEMORY STARTING AT LOC 30 (HEX).
*
*           DC H'7E'
*           DC H'30'
*           DC H'6D'
*           DC H'79'
*           DC H'33'
*           DC H'5B'
*           DC H'5F'
*           DC H'70'
*           DC H'7F'
*           DC H'7B'
*
*
*           ALPHABETIC LOOK-UP
*
*           ORG H'41'     THE FOLLOWING DATA--NEEDED TO DIS-
*                           PLAY THE HEX DIGITS A THRU F-- ARE
*                           TO BE LOADED INTO MEMORY STARTING
*                           AT LOCATION 41.
*
*           DC H'77'
*           DC H'1F'
*           DC H'4E'
*           DC H'3D'
*           DC H'4F'
*           DC H'47'
*
*           END          ASSEMBLER DIRECTIVE (PSEUDO-OP) ONLY.
    
```



# Four very small ways to improve on your PC design.

With four types of switches—rockers, pushbuttons, toggles and DIPs—Cutler-Hammer offers one of the industry's broadest and most unique selections of PC subminiatures.

Each of the hundreds of available styles provides the reliability you've come to expect from Cutler-Hammer. With ratings to 6 amps, each conforms to standard circuit board mounting requirements.

PC switches, along with accessories and decorative hardware, are distributor stocked for local availability. And since most are manufactured in the United States, we offer fast reaction time on solder lug and wire wrap terminal variations, as well.

To improve your next design in any number of small ways, contact your Cutler-Hammer Sales Office or Switch Distributor.

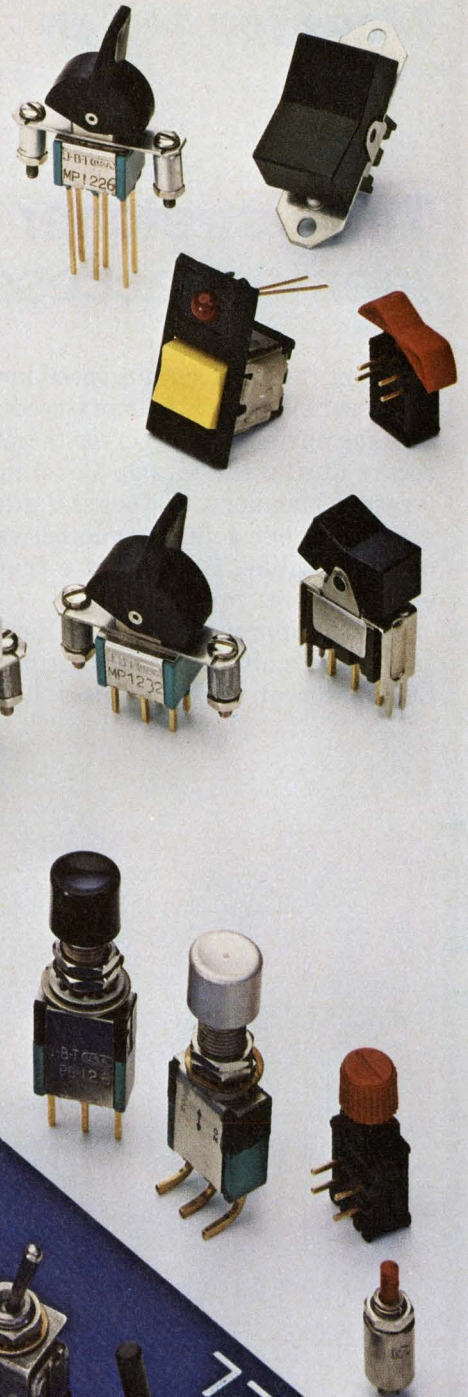

 Switch to No.1

  
**CUTLER-HAMMER**  
SPECIALTY PRODUCTS DIVISION, Milwaukee, Wis. 53201  
CIRCLE NUMBER 73



## Time stretcher speeds memory access in Z80 $\mu$ P

One of the most serious speed limitations in microprocessor systems is memory-access time. The worst-case memory-access cycle for the Z80 microprocessor occurs during the  $M_1$  (Op Code) machine cycle. The larger the memory, the longer the delay. A high-speed memory is one solution; another solution makes use of the wait line. However, the first is expensive; the second wastes processor time.

An easy approach uses one IC and one flip-flop (Fig. 1a). The circuit stretches the time of the clock's ( $\phi$ ) LOW interval between pulses  $T_2$  and  $T_3$  (Fig. 1b).

If about 30% of the wait time is used normally in the  $M_1$  cycle, and the memory adds another wait cycle, the total time is increased by about 10%. However, the circuit in Fig. 1a stretches the  $M_1$  cycle only by about  $0.1 \mu\text{s}$ , so that  $t_{\text{ACC}}$  becomes  $0.55 \mu\text{s}$  to accommodate most off-the-shelf memories. Consequently, the time increases only about 2.5%.

*Avner Rachmilevitch, Physiologisches Institut der Universitat, Lehrstuhl II, 3400 Göttingen, Humboldtalle 7, Germany.* CIRCLE NO. 312

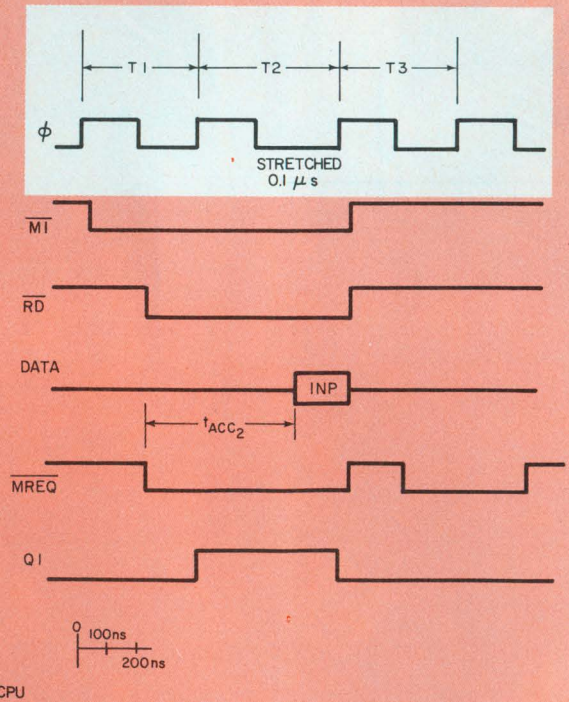
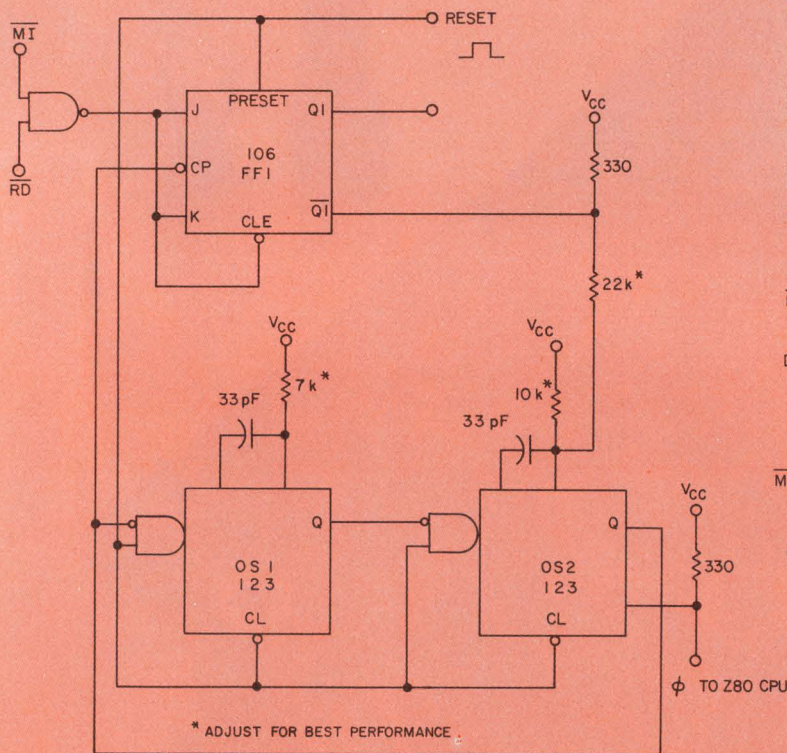

1. The LOW interval of  $T_2$  is stretched by a higher time constant in OS<sub>2</sub> than OS<sub>1</sub> (a). Flip-flop FF<sub>1</sub> sets on the rising edge of  $\phi$ , when  $\bar{M}1$  and RD are both

LOW, and resets on the next rising edge of  $\phi$ , or  $T_3$ . The flip-flop stays reset until the next  $M_1$  cycle (b), when another memory access is needed.



# Datel's 8080 A/D-D/A Advantage

## SINETRAC 800

- ▶ 32 channel A/D - D/A input card slides directly into Intel's MDS-800 or SBC-80/10/20 Microcomputers.
- ▶ Only 2 cards needed for 80 single-ended or 64 differential A/D channels!
- ▶ Super-software supplied on paper tape with full listings in manuals.
- ▶ On-board channel counters and scan-timers reduce CPU housekeeping for fastest speed: True 40 kHz total I/O rate using DMA.
- ▶ Expandable in increments of 48 A/D or 8 D/A channels up to 256 channels each.

DATEL SINETRAC-800  
32 CHANNEL  
ANALOG DATA ACQUISITION  
SYSTEM  
\$495

DATEL SINETRAC-800  
8 CHANNEL  
D/A DISTRIBUTION SYSTEM  
\$495

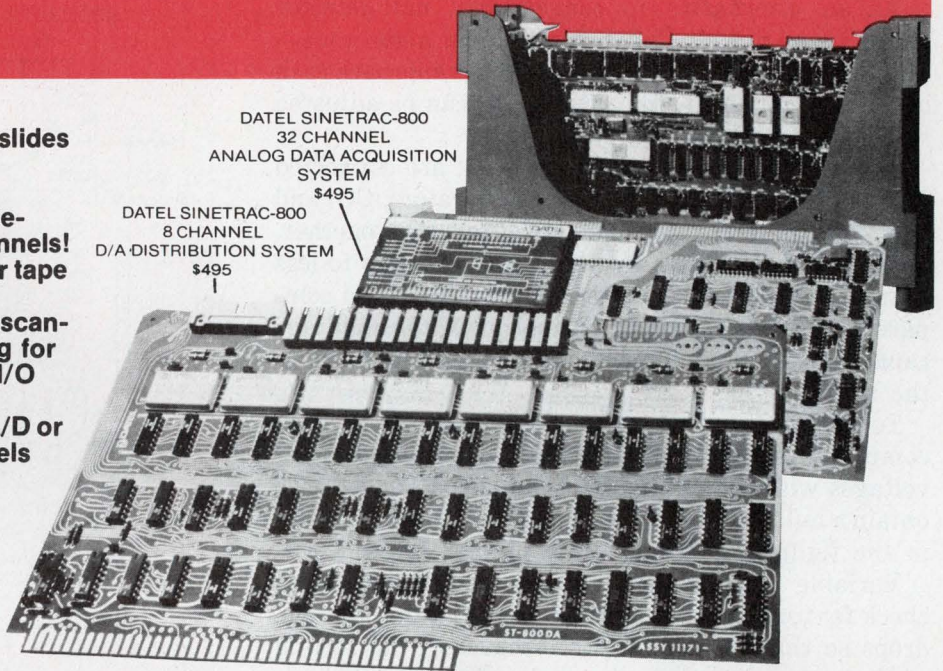

COVERED BY GSA CONTRACT

You'll find complete specifications on this product and more than 300 data conversion circuits and systems in Gold Book.

Just check Gold Book's Volume 3. That's Datel's complete Engineering Product Handbook, in its own separate volume. More than 290 pages of D/A & A/D Converters, Multiplexers, Sample-Holds, Op Amps, Power Supplies, Digital Panel Meters, and Printers, Digital Calibrators, Data Loggers, Digital Cassette Recorders, and Data Acquisition Systems. Each fully detailed on individual data sheets.

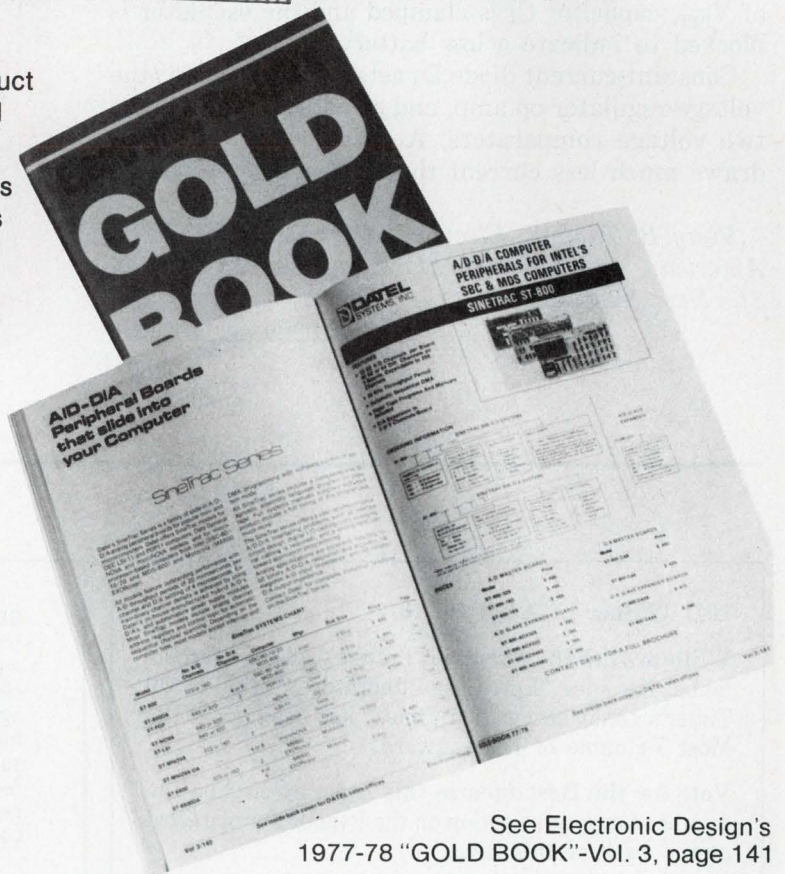

**D** **DATEL**  
**SYSTEMS, INC.**

1020 Turnpike St., Canton, MA 02021  
Phone: (617) 828-8000

See Electronic Design's  
1977-78 "GOLD BOOK"-Vol. 3, page 141

Santa Ana, CA (714) 835-2751, (L.A.) (213) 933-7256 • Sunnyvale, CA (408) 733-2424 • Gaithersburg, MD (301) 840-9490 • Houston, TX (713) 932-1130  
OVERSEAS: DATEL (UK) LTD—TEL: ANDOVER (0264) 51055 • DATEL SYSTEMS SARL 620-06-74 • DATELEK SYSTEMS GmbH (089) 78-40-45

CIRCLE NUMBER 74



## Ideas for design

# Two voltage comparators provide null detection for bridge circuits

As an alternative to conventional null-detector circuits, the circuit shown can give an audio tone—or a tone null—when two input voltages approach each other. The high tone (or null) region can be adjusted with offset-voltage controls.

The two input voltages,  $V_1$  and  $V_2$ , are connected criss-cross to the inputs of two comparators, CO<sub>1</sub> and CO<sub>2</sub>. The comparator outputs are wire-ORed together. When the difference between  $V_1$  and  $V_2$  drops to less than both comparator-offset settings, the ORed comparator outputs go HIGH. At this point, the oscillator capacitor,  $C_1$ , is unclamped and an audio tone drives the speaker.

To create a symmetrical window about  $V_1 = V_2$ , both comparators are trimmed for equal, overlapping offset voltages with the 3-k $\Omega$  potentiometers,  $R_2$  and  $R_3$ . To obtain a null, simply connect resistor  $R_1$  (shown dotted in the figure) and remove the jumper across  $D_1$ .

Variable resistor  $R_4$  and diode  $D_2$  add a battery-check feature to the circuit. When the battery voltage drops so that  $D_2$  can conduct because of the setting of  $V_{REF}$ , capacitor  $C_1$  is clamped and the oscillator is blocked to indicate a low battery.

Constant-current diode  $D_3$  acts as reference for the voltage-regulator op amp, and provides power for the two voltage comparators. A constant-current diode draws much less current than a zener diode would.

*Vijay B. Tandon, Electrical-Mechanical Engineer, American Foundation for the Blind, Inc., 15 West 16 St., New York, NY 10011.*

CIRCLE NO. 313

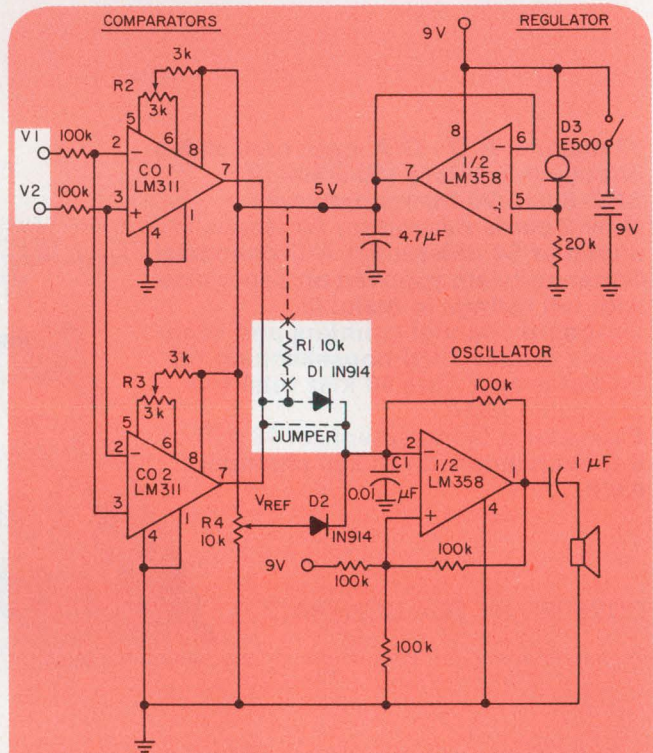

**A comparator circuit can provide either a null or tone output** when  $V_1$  approaches the value of  $V_2$ . With  $R_1$  and  $D_1$  in the circuit and the jumper removed, the circuit acts as a null detector. Put the jumper in, disconnect  $R_1$  and you get a tone where before you got a null.

### IFD Winner of April 26, 1977

**William Olthoff, Euratom, Petten 1724, the Netherlands.** His idea "Low-Cost Integrator Multiplies 555 Timer's Delay Range 100 Times" has been voted the Most Valuable of Issue Award.

**Vote for the Best Idea in this issue** by circling the number for your selection on the Reader Service Card at the back of this issue.

**SEND US YOUR IDEAS FOR DESIGN.** You may win a grand total of \$1050 (cash)! Here's how. Submit your IFD describing a new or important circuit or design technique, the clever use of a new component or test equipment, packaging tips, cost-saving ideas to our Ideas for Design editor. Ideas can only be considered for publication if they are submitted exclusively to ELECTRONIC DESIGN. You will receive \$20 for each published idea, \$30 more if it is voted best of issue by our readers. The best-of-issue winners become eligible for the Idea of the Year award of \$1000.



# Datel's New Low Priced Digital Panel Meter

MODEL DM-3100

## FEATURES

- ▶ Miniature case with 0.5" LED display
- ▶ Bipolar, differential  $\pm 2$ VFS input
- ▶ 3½ Digit resolution with Autozeroing
- ▶ LCD display available at additional cost
- ▶ Additional ranges — customer programmable
- ▶ 4½ digit resolution also available — \$59 (100's)
- ▶ Additional current and ohmmeter capability — customer programmable

**\$29\***

\*\$35 (1-99) \$29 (100-499)



You'll find complete specifications on this product and more than 300 data conversion circuits and systems in Gold Book.

Just check Gold Book's Volume 3. That's Datel's complete Engineering Product Handbook, in its own separate volume. More than 290 pages of D/A & A/D Converters, Multiplexers, Sample-Holds, Op Amps, Power Supplies, Digital Panel Meters, and Printers, Digital Panel Instruments, Data Loggers, Digital Cassette Recorders, and Data Acquisition Systems. Each fully detailed on individual data sheets.

And it's available to you in Gold Book.

**DATEL**  
SYSTEMS, INC.

1020 Turnpike St., Canton, MA 02021  
Phone: (617) 828-8000



See Electronic Design's 1977-78  
"GOLD BOOK"—Vol. 3, page 226

Santa Ana, CA (714) 835-2751, (L.A. Exchange) (213) 933-7256 • Sunnyvale, CA (408) 733-2424 • Gaithersburg, MD (301) 840-9490  
OVERSEAS: DATEL (UK) LTD—TEL: ANDOVER (0264) 51055 • DATEL SYSTEMS SARL 603-06-74 • DATELEK SYSTEMS GmbH (089) 78-40-45

CIRCLE NUMBER 75



Hayden Book Company  
wishes

# Electronic Design®

HAPPY 25<sup>th</sup> ANNIVERSARY

And reminds *ED* readers that some of the best selections from *Electronic Design* have been published in these 4 collections:

## 400 IDEAS FOR DESIGN Volume 2

#5067-4, cloth, 1971, 288 pages, \$13.75

## 400 IDEAS FOR DESIGN Volume 3

#5111-5, cloth, 1976, 352 pages, \$13.95

## MICROPROCESSORS: New Directions for Designers

Edited by Edward A. Torrero

#5777-6, paper, 1975, 144 pages, \$10.95

## MICROPROCESSOR BASICS

Edited by Michael S. Elphick

#5763-6, paper, 1977, 224 pages, \$9.95

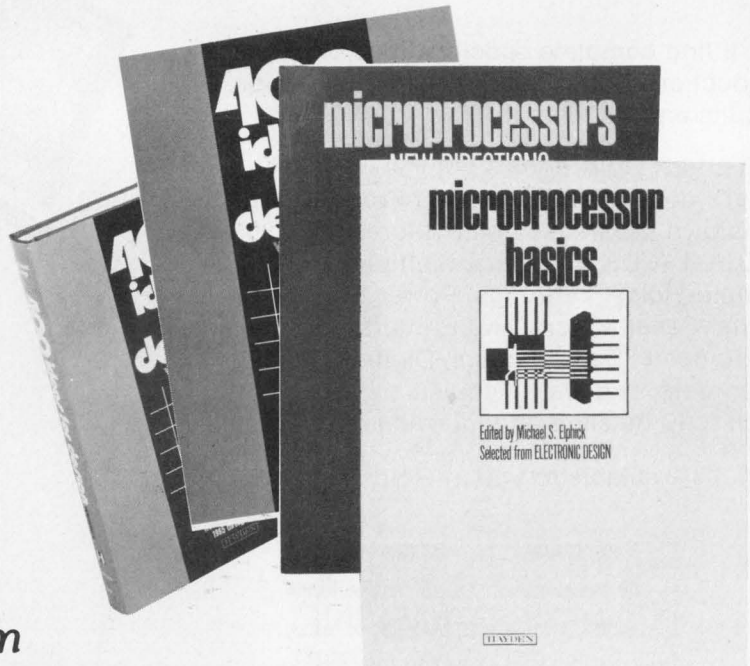

All available from

**Hayden Book Company, Inc.**

50 Essex Street, Rochelle Park, New Jersey 07662



# Datel's Hybrid A/D's-D/A's New Low Prices, Stock Delivery

**MODELS ADC-HX, ADC-HZ, DAC-HZ**

## ADC-HZ12BGC

12 Bits Resolution  
8  $\mu$ sec. Conv. Time  
20 ppm/ $^{\circ}$ C Gain Tempco  
32 Pin Glass DIP

**\$119\*** (1-24)  
**\$77.50\*** (100's)

## ADC-HX12BGC

12 Bits Resolution  
20  $\mu$ sec. Conv. Time  
20 ppm/ $^{\circ}$ C Gain Tempco  
32 Pin Glass DIP

**\$82.50\*** (1-24)  
**\$45.00\*** (100's)

## DAC-HZ12BGC

12 Bits Resolution  
3  $\mu$ sec. Setting Time  
20 ppm/ $^{\circ}$ C Gain Tempco  
24 Pin Glass DIP

**\$39.00\*** (1-24)  
**\$25.00\*** (100's)

### COVERED BY GSA CONTRACT

You'll find complete specifications on this product and more than 300 data conversion circuits and systems in Gold Book.

Just check Gold Book's Volume 3. That's Datel's complete Engineering Product Handbook, in its own separate volume. More than 290 pages of D/A & A/D Converters, Multiplexers, Sample-Holds, Op Amps, Power Supplies, Digital Panel Meters, and Printers, Digital Panel Instruments, Data Loggers, Digital Cassette Recorders, and Data Acquisition Systems. Each fully detailed on individual data sheets.

And it's available to you in Gold Book.

\*U.S.A. Domestic Price Only

**D** **DATEL**  
**SYSTEMS, INC.**

1020 Turnpike St., Canton, MA 02021  
Phone: (617) 828-8000



• Santa Ana, CA (714) 835-2751, (L.A. Exchange) (213) 933-7256 • Sunnyvale, CA (408) 733-2424 • Gaithersburg, MD (301) 840-9490



# Arrow-M R Relays

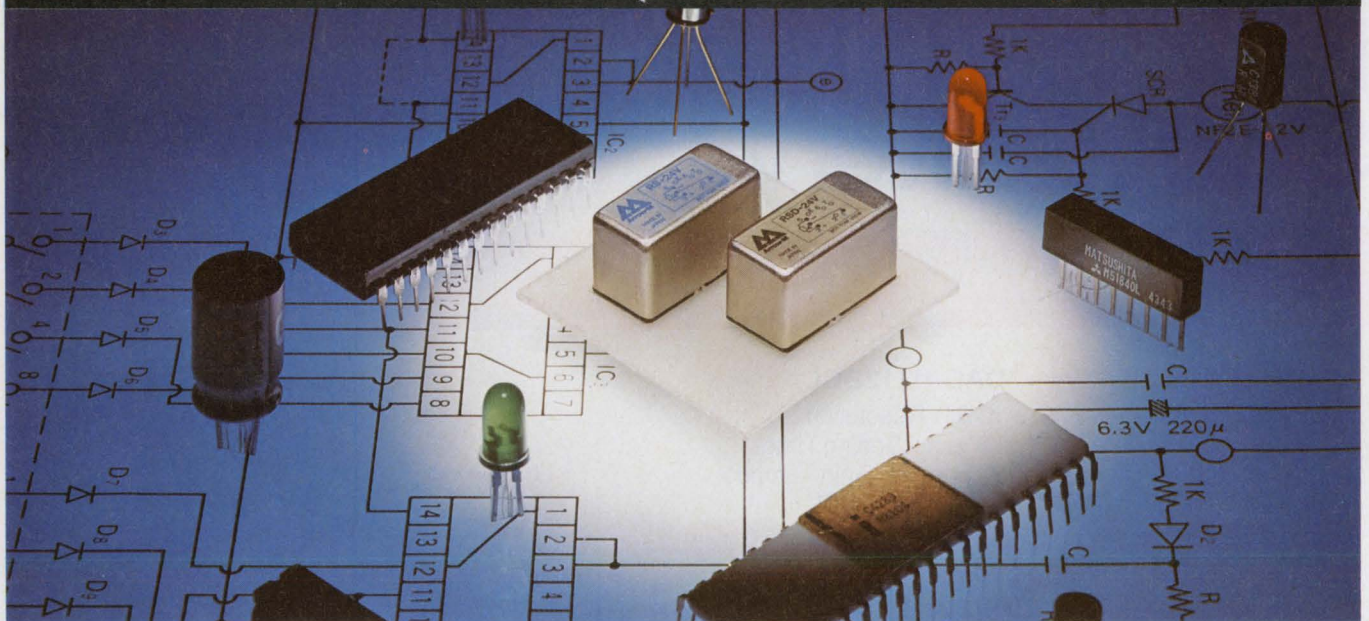

The many advantages and unique capabilities of Arrow-M's R Relays are far too extensive to be covered here. Therefore, we'd like to whet your creative appetite with a few outstanding facts:

1. Arrow-M R Relays are available in 1 Form C contacts which can carry a high current capacity of 1 Ampere 20 watts, and are capable of resisting welding at higher inrush currents. The dry circuit type which can switch current as low-level as 100uA is available in addition to the power type.

2. *High Speed:* Arrow-M R Relays can be operated at 500 cycles/sec.

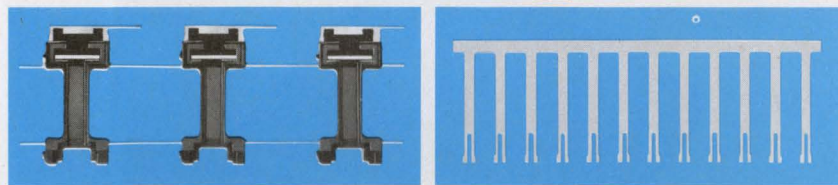

3. Greater reliability and lower cost, due to simultaneous automatic fabrication of coil bobbin, contact and terminal.

4. In addition to the standard there are 1 coil and 2 coil latching types, which are useful for logic circuit design as a memory component.

5. Not only can they be automatically wave soldered on PC boards with a high density of electronic parts, but they are simple to clean with most degreasers and detergents without affecting maximum contact reliability.

6. *High Sensitivity:* Minimum operating power: Single Side Stable 80 mw/Bistable 40 mw

7. *Longer Life:* Mechanical: More than  $10^9$  operations. Electrical: More than  $10^6$  operations. (1A 20vdc, 0.3A 110vac)

## The tiny power memory reed

Relays for Advanced Technology



Hungry for more information?  
For exact specifications  
on all of our relays,  
write or call your  
nearest Arrow-M office.

**Arrow-M Corporation**  
250 Sheffield Street  
Mountainside, NJ 07092  
(201) 232-4260

*Mid-Western Office:*  
600 E. Higgins Rd.  
Elk Grove Village, Ill. 60007  
(312) 593-8535

*Western Office:*  
22010 So. Wilmington Ave.  
Suites 300 & 301  
Carson, Calif. 90745  
(213) 775-3512



# New products

## Digital-panel thermometer automatically scans inputs

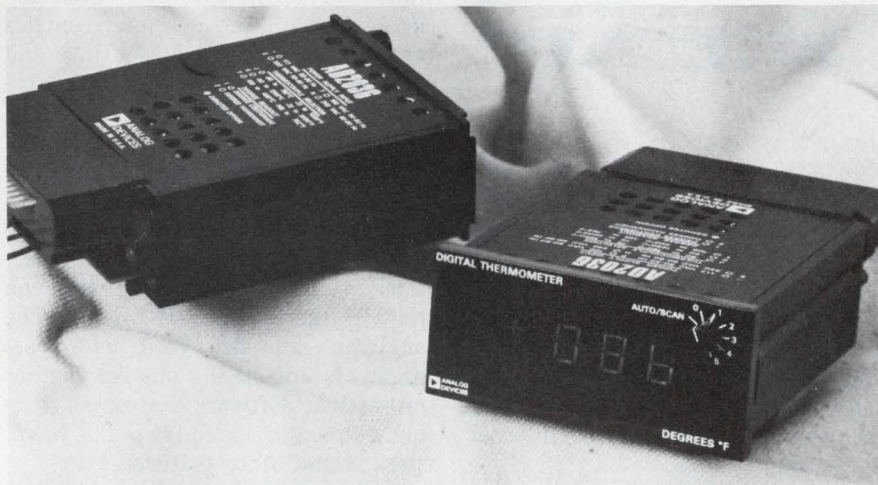

Analog Devices, Route 1 Industrial Park, P.O. Box 280, Norwood, MA 02062. (617) 329-4700. P&A: See text.

The AD2036 is the first digital-panel temperature meter to scan thermocouples (up to six) automatically, manually or under control of external BCD signals. The 3½-digit, line-powered unit includes all the thermocouple-linearization circuitry, internal scan multiplexing, and logic needed for computer or peripheral interfacing—all for \$349.

With a miniature, front mounted knob, you can select a channel manually or scan automatically. Or, using external components, you can scan under computer control.

The AD2036 can be specified for interfacing with type J, K, or T thermocouples, and the readout calibrated in either °C or °F. Inputs are connected directly to a 12-pin barrier strip at the rear of the device. Resolution is 1°, with typical full-span accuracy ranging from 1.5 to 2.0 C, depending on the temp range specified.

The thermometer can interface directly with data printers, re-

orders, and process-control systems by means of built-in, isolated parallel-BCD outputs. BCD-output data includes the channel number with each temperature reading.

In the automatic-scanning mode, all six channels are scanned unattended at 3.2 s per channel, with 1.6 and 0.8 s optionally available. A built-in 5-V-dc supply (10 mA) is available to power external logic.

The AD2036 has 0.5-in. (13 mm) LED readouts and comes in a 3.92 × 1.67 × 6.43-in. (100 × 42 × 163.3 mm) case, which fits the popular standard panel cutout originated by Weston for line-powered DPMs. Opto-isolation at the front end protects against voltages on the analog input of up to 250 V rms.

Specs of the Analog Devices meter include an input impedance of 100 MΩ, a bias current of only 10 nA and a common-mode voltage of ±350 V pk maximum. The CMV between channels is 6 V. Tempo of the 2036 is as follows: of span and + temp, 100 ppm; of span and - temp, 120 ppm; of zero, 0.05°/°C. Delivery is from stock.

CIRCLE NO. 302

## DMM? Counter? Logic probe? All and more

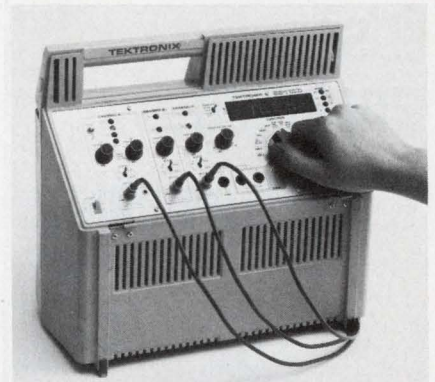

Tektronix, P.O. Box 500, Beaverton, OR 97077. (503) 644-0161. \$1995; 8 wks.

The 851 digital tester combines the functions of a DMM, a counter, pulse-width discriminator, thermometer and logic-state indicator into a single portable unit. Features include a single, unambiguous knob to select all functions; autoranging on all functions; a 5-digit LED display; logic-state indicators on three channels; and a built-in calibrator. The 5-digit multimeter, with floating inputs, measures ac and dc voltage and resistance. Input signal polarity is automatically checked and displayed by the DMM. With the built-in 35-MHz counter you can analyze gated events, take transition counts, and measure duty factor and frequency ratios.

Booth No. 2038 CIRCLE NO. 303

## Recorder charts span 240 mm on each channel

Yokogawa Corp. of America, 5 Westchester Plaza, Elmsford, NY 10523. (914) 592-6767. 6 pens, approx. \$500; 9 pens, approx. \$7000; 6-8 wks.

Series 3061 6 and 9-channel, full-span flat-bed recorders simultaneously use the full 240-mm chart span for each of the 6 or 9 channels. Each of the pens are available in different colors. Independent amplifiers per channel provide 13 ranges from 0.5 mV/cm to 5 V/cm plus a zero position and vernier adjustment. Accuracy is ±0.25% of span, chart speeds range from 2 cm/hr to 60 cm/min and are pushbutton selectable. Additional features include "Z"-fold or roll charts, and conductive-plastic feedback potentiometers.

Booth No. 2019 CIRCLE NO. 304



Setting new  
rotary switching standards

it's  
small...  
it's  
enclosed...  
it's affordable...

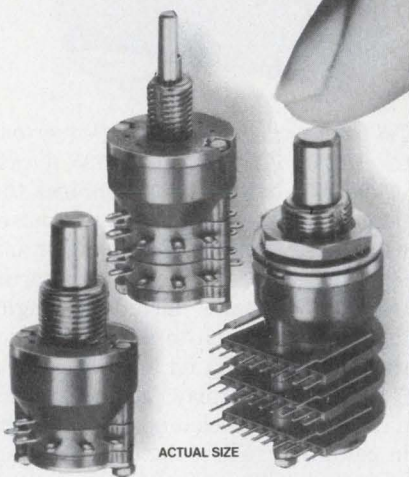

## it's Grayhill Series 71!

- from logic switching up to 1/4 amp
- 1/2" diameter
- contamination-free construction

Here's maximum versatility and quality in a compact switch that reflects state-of-the-art capabilities and state-of-the-economy pricing. Grayhill's Series 71 Switches are available with such options as up to 12 positions, 30° or 36° angle of throw; up to 6 poles per deck, up to 12 decks; fixed or adjustable stops; solder lug or PC terminals; 1/8", 1/4", or 4mm shaft diameters, and concentric shafts. They have a gold plated contact system, diallyl phthalate insulation, molded-in terminals. For complete information, see EEM or contact Grayhill, Inc. 561 Hillgrove, La Grange, IL 60525.



CIRCLE NUMBER 79

## INSTRUMENTATION

### Spectrum analyzer boosts accuracy and resolution

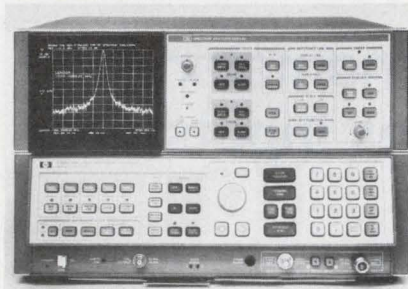

Hewlett-Packard, 1501 Page Mill Rd., Palo Alto, CA 94304. (415) 735-1550. P&A: See text.

The ingredients for a new level of performance have been blended into the 100-Hz-to-1500-MHz HP 8568A spectrum analyzer: a frequency-tuning accuracy of 150 Hz, or better, a resolution of 10 Hz even at the top frequency, and a stability that doesn't depart from the 10<sup>-9</sup>/day shown by the internal reference.

Along with those specs, noise sidebands 200 Hz from the carrier in the 10-Hz resolution bandwidth setting are at least 80 dB down. Line-related sidebands are at least 85 dB down. In amplitude, the HP unit accepts signals ranging from -137 to 30 dBm with ac

or de-coupled inputs. The calibrated display range covers 90 dB. Over-all amplitude accuracy is ±2.5 dB.

Great pains have been taken to ensure that the analyzer's potential performance isn't offset by difficult operating procedures. Keyboards set functions and values—made even easier because of the  $\mu$ C-based controls and CRT readout of all settings and measurement data. With tunable markers, memory and zoom, the analyzer can focus on a signal, display the frequency and amplitude, and store the settings for later recall.

Furthermore, everything can be done automatically. All 8568A functions are remotely programmable via the HP interface bus (IEEE-488). The analyzer can also feed its measurements out on the bus for further processing. Software can control tuning, automatic search for peaks, zoom, storage and other features.

Such performance isn't inexpensive, and the HP 8568A carries a \$27,800 price tag. An automatic system (the 8581A) includes the 8568A, the HP 9825A desktop computer and the 9866B printer—all for \$45,600.

Booth No. 2051 Circle No. 315

### Compact DPM stands just 15/16 in. high

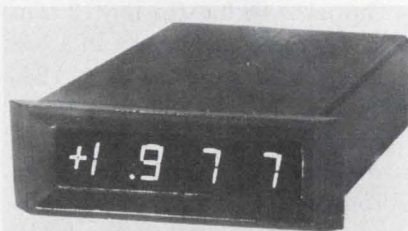

Non Linear Systems, P.O. Box N, Del Mar, CA 92014. \$59.

Model PM-350 (Thriftmeter) 3-1/2-digit DPM measures only 15/16 × 2-7/8 × 3-7/16 in., even with a 0.3-in. LED numeric readout. Accuracy is ±(0.05% reading +0.05% full scale). The unit comes in five fixed voltage ranges from 0.1 V dc to 1000 V dc. The Thriftmeter is bipolar with automatic polarity and includes overload indication. It is powered by a nominal 5-V-dc power supply. Power consumption is 1 W.

CIRCLE NO. 305

### Wattmeter line gets new members



Zi-Tech Div., 2151 Park Blvd., Box 26, Palo Alto, CA 94302. (415) 326-2151. Start at \$1050; 30-45 days.

A digital wattmeter measures single and three-phase true line power regardless of waveform or power factor, to an accuracy of better than 0.5%. Current transformers allow measurement of power levels from a few watts to 1000 W and greater. The units feature 3-1/2-digit display and optional BCD recording output. A chart-recording wattmeter is also available for analysis of power usage patterns.

Booth No. 1058 CIRCLE NO. 306



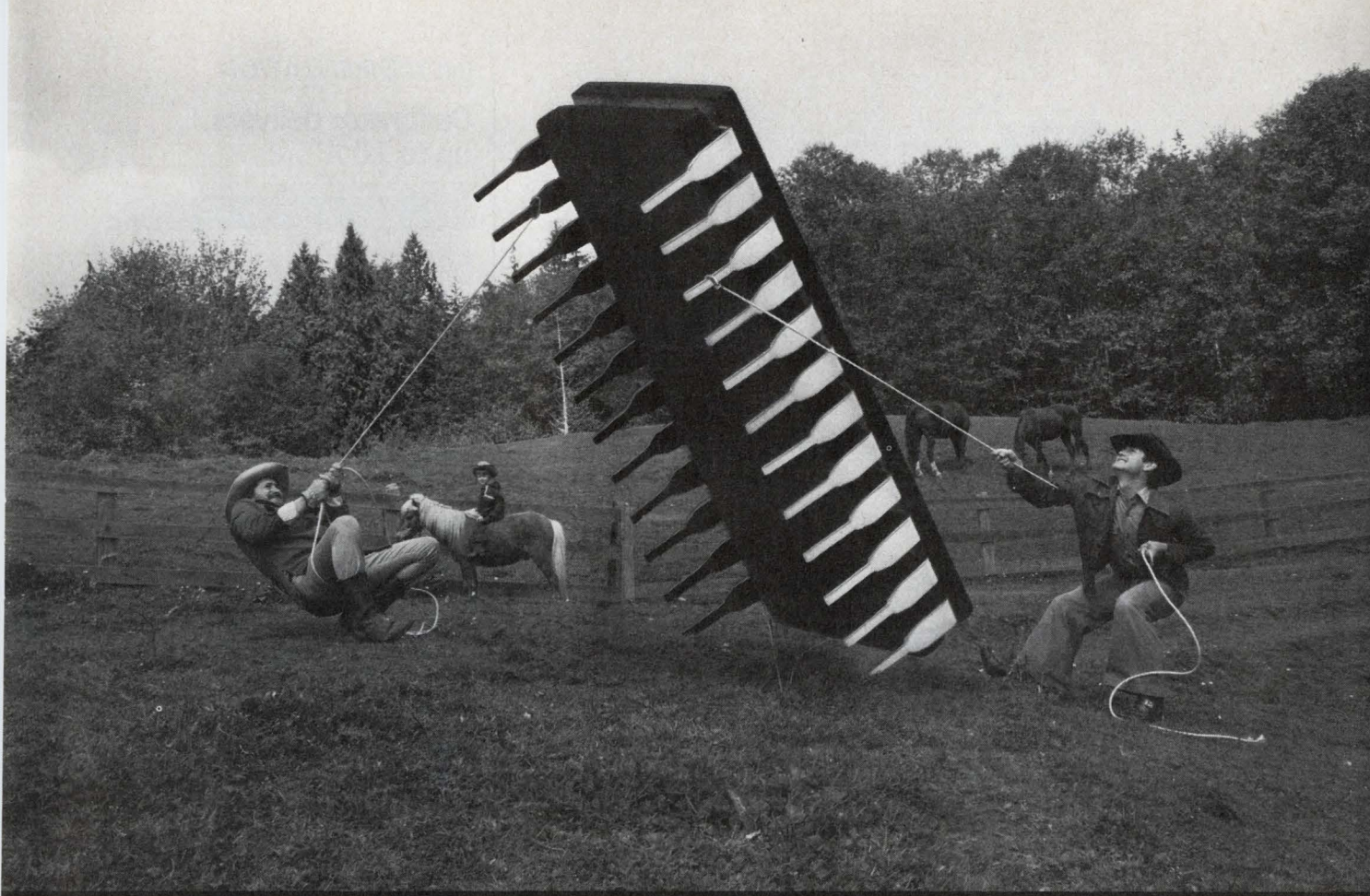

## HOLD DOWN PROM SOFTWARE DEVELOPMENT COSTS WITH DATA I/O SYSTEMS.

With Data I/O PROM programming systems you can develop and test PROM programs before committing a single PROM.

You simply load your program into the system using the Data I/O PROM Programmer keyboard or remote interface. The programmer system can emulate any commercially available PROM—including MOS.

You can then review the program as many times as you need to check against truth tables, edit or make changes. Once the program is perfect, you can begin programming with the assurance that the first PROM you program will work.

Data I/O Universal Programmers interface with all microprocessor developmental systems.



Programmers from \$1095.00

**HOW TO SELECT THE RIGHT PROM PROGRAMMER FOR YOUR NEEDS.**

### We'd like to tell you more.

This fact filled tabloid gives you valuable information about PROM programming technology. To get your copy, circle reader service number or contact Data I/O Corporation, P.O. Box 308, Issaquah, WA 98027. Phone 206/455-3990.

# DATA I/O

**THE PROM PROGRAMMER PEOPLE.**



# Alternate Timebase Display

Gives you the whole picture  
for \$1395.\*



Continuous indication of where DELAYED T.B. measurements are taken.

- Eliminate BACK-AND-FORTH SWITCHING
- Forget MIXED-SWEEP limitations

The PM 3214 is the latest addition to the Philips oscilloscope family. At 25 MHz and 2mV sensitivity, the PM 3214 incorporates all the triggering facilities found on the latest, most expensive oscilloscopes available: AC, DC, TV and an auto position that derives its trigger from the peak to peak signal input. Trigger selection from either channel, line and external sources as well as composite triggering for ASYNCHRONOUS signals. Composite triggering in A-B display derives its source from the differential signal, allowing measurement of signals riding on high AC or DC components. The 18.5 lb. portable is double insulated and even has an internal battery option. Supplied with two probes and a protective front cover, the PM 3214 is a money saving solution to many oscilloscope requirements. If you don't need DELAYED TIMEBASE the economy priced PM 3212 has all the triggering and overall performance of the PM 3214 at only \$ 1,155.00\*.

For immediate detailed information utilize our toll-free Hotline number: 800 631-7172 (New Jersey residents call collect), or contact: Philips Test & Measuring

In the U.S.:  
85 Mc Kee Drive  
Mahwah, New Jersey 07430  
Tel. (201) 529-3800

In Canada:  
6 Leswyn Road  
Toronto, Ontario, Canada M6A 1K2  
Tel. (416) 789-7188

\* U.S. Domestic Price Only

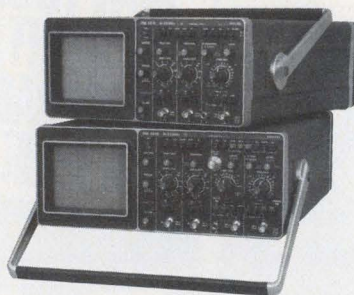

## PHILIPS

CIRCLE NUMBER 81

## INSTRUMENTATION

### Calibrator delivers up to 10 A

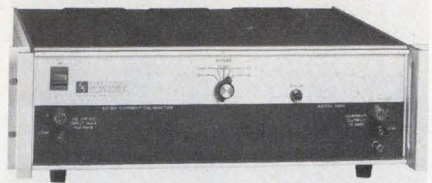

Electronic Development Corp., 11 Hamlin St., Boston, MA 02127. (617) 268-9696. \$1350; stock.

Model 3200, 10-A ac and dc calibrator speeds the calibration of wattmeters, meter shunts, ac and dc current meters as well as current reading DVMs and DMMs. The 3200 has 5 ranges: 10 and 1 A, 100, 10 and 1 mA, and can be resolved to 1 nA. Accuracy in the dc mode is  $\pm 0.01\%$  of the setting, and in the ac mode is 0.05% of the setting. Booth No. 1040

CIRCLE NO. 307

### Portable DMM is RFI shielded



B&K Precision, 6460 W. Cortland Ave., Chicago, IL 60635. (312) 889-9087. \$119.95; stock.

A new RFI-shielded 3-1/2-digit portable DMM, Model 2810, boasts such features as 0.01- $\Omega$  resolution and selectable high-/low-power ohms. Basic dc accuracy is 0.5%. The 3-1/2-digit display uses 0.3-in. LED readouts. Twenty-nine overload protected ranges provide maximum resolution. Auto-ranging capability reduces the need for frequent range changes. Ac and dc voltage ranges cover from 100 mV to 1000 V with 100% overrange reading and automatic polarity indication. Four ac and four dc current ranges read from 1  $\mu$ A to 2 A.

Booth No. 2076

CIRCLE NO. 308





## Hand-held DVOM offers large-scale performance

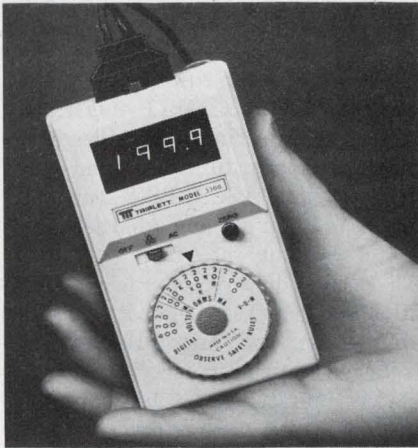

Triplett Corp., Bluffton, OH 45817.  
(419) 358-5015. \$175; stock.

Model 3300 3½-digit DVOM is only 3-in. wide by 5⅝-in. long by 1⅜-in. deep. The unit features a 0.3-in.-high LED readout with polarity indication, 0.5% accuracy and low-power ohms, five functions and 22 ranges. A snap-in battery-pack, with NiCd batteries and ac adapter/charger, recharges separately or within the tester. A fused probe provides for both high-energy and normal-use circuit protection. Typical dc accuracy is 0.5% of reading.

Booth No. 1844, 46 CIRCLE NO. 434

## Spectrum analyzer stores measured data

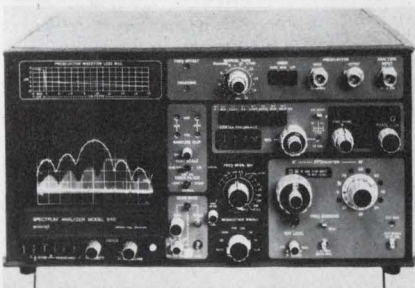

Nelson-Ross, 5 Delaware Dr., Lake Success, NY 11040. (516) 328-1100.  
\$8850 to \$10600.

A digital memory with interface capability is incorporated into the compact N-R 600 Series rf/microwave spectrum analyzers, 100 kHz to 40 GHz. The memory provides non-fading flicker-free display storage. It also retains data for recall at will. On-screen comparisons can be made between incoming signals vs stored reference displays. An input/output memory interface is provided for use with data storage and signal processing accessories. The I/O is adaptable for use with an IEEE-488 format data bus.

Booth No. 1458 CIRCLE NO. 435

# COMPARE THE TOP-RATED 4½-DIGIT DMMs.

Put these three 4½-digit multimeters side-by-side and you'll want the Keithley 172.

The 172 gives you superior accuracy, resolution and convenience with no compromise—at a competitive price.

If you want more evidence, send for our detailed "Comparative Guide to 4½-digit DMMs." The Keithley 172 rates best—not on every factor, but on most.

If you want hands-on proof, put our 172 side-by-side with the Fluke 8600A, HP 3465A, or any other 4½-digit DMM. The Keithley will stand alone.

Check the chart below or make your own comparison, you'll pick the Keithley 172.

### Fluke 8600A



### HP 3465A



### Keithley 172



	Fluke 8600A	HP 3465A	Keithley 172
Functions & Ranging:			
dcV	Auto/Manual	Manual	Auto/Manual
acV	Auto/Manual	Manual	Auto/Manual
dcA	Manual	Manual	Auto/Manual
acA	Manual	Manual	Auto/Manual
ohms	Auto/Manual	Manual	Auto/Manual
Basic Accuracy (dc volts @ 25°C ambient)	±0.02% reading + 1 digit	±0.02% reading + 1 digit	±0.01% reading + 1 digit
Full Range Display (Counts)	19999	19999	29999
HI/LO Ohms	No	No	Yes
Ohms Configuration	2 terminals	2 terminals	2 or 4 terminals
Lighted Function Indicator	No	No	Yes
Price	\$549	\$510	\$525

Comparison based on manufacturers' published specifications. Prices are domestic U.S. for ac line-operated instruments.

It's easy to make your own comparison. Use coupon. Or call (216) 248-0400.

**KEITHLEY INSTRUMENTS**, 28775 Aurora Road, Cleveland, Ohio 44139.

In Europe: D-8000 München 70, Heiglhofstrasse 5, West Germany, (089) 7144065.

- Send specs on the Keithley 172. I'll make my own comparison.
- Send "Comparative Guide to 4½-digit DMMs." I need more proof.
- Bring in a Keithley 172 so I can make a side-by-side comparison.

Name \_\_\_\_\_ Title \_\_\_\_\_

Company \_\_\_\_\_

Address \_\_\_\_\_

City \_\_\_\_\_ State \_\_\_\_\_ Zip \_\_\_\_\_

Phone \_\_\_\_\_

**KEITHLEY**  
The measurement engineers.

CIRCLE NUMBER 82



## MICRO/MINI COMPUTING

### Development system does two jobs at a time

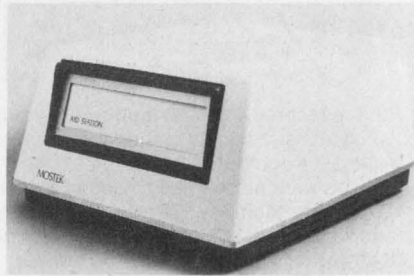

Mostek, 1215 W. Crosby Rd., Carrollton, TX 75006. (214) 242-0444. From \$850; stock.

A development station designed to provide a "base" environment for one or more microcomputer systems under development, the Aid Station, will accept up to thirteen 12 x 8.5 in. cards in two groups of six and seven. Wrapped-wire pins on the motherboard of the XAID-100 allow for busing between the two. The station also features a 115 V ac power supply with a pre-wired connector assembly and forced air cooling. The front panel and two rear panels can be drilled for mounting of controls, indicators and connectors. The Aid Station power supply can support at least two complete systems simultaneously. A typical user application could be a Z80 as system number 1 and the user's own development boards as system number 2. As a further aid to system prototype fabrication a breadboard configured with power and ground on a 10 x 12 matrix and an extender card are available.

Booth No. 1608-1610 CIRCLE NO. 309

### Remote controlled tape deck uses cassettes

Triple I, 4605 North Stiles, Oklahoma City, OK 73118. Jack Morrow (405) 521-9000. \$462 (100 qty); stock.

A complete tape-drive unit, the STR-150, provides full remote signal control of all transport functions. It includes read/write electronics, control and timing logic, and motor control logic. The recorder accepts any asynchronous 8-bit parallel data word and records in a self-clocked serial mode. A speed tolerant recording technique is used to store the data and this technique also assures total unit-to-unit tape compatibility.

Booth No. 1728 CIRCLE NO. 310

### Alphanumeric printer lets you pick interface

Practical Automation, Trap Falls Rd., Shelton, CT 06484. Maurice Teichner (203) 929-5381. \$472 (unit qty); 2 wks.

The Model DMTP-6- $\mu$ P, an alphanumeric printer, provides selectable interface functions and baud rates. Parallel ASCII, RS-232 or a current loop input are available as well as switchable baud rates from 110 to 1200. All needle drivers, character generation and required diagnostic routines are provided by a microprocessor controller. The printer uses a 7 x 5 dot-matrix impact printhead to produce the 63 ASCII characters. A needle stroke twice as long as that of other needle printers ensures crisp multiple-copy printing without adjustment. Printing speeds are as high as 110 characters per second. The number of characters per line are software controllable from 80 to 132 characters. Paper width is 8.5 in.

CIRCLE NO. 320

### 21 column impact printer produces 3 lps, maximum

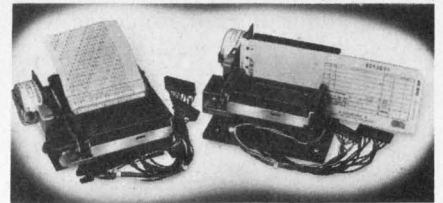

Sheldon Sodeco Printer Corp., 4 Westchester Plaza, Elmsford, NY 10523. Peter Engstrom (914) 592-4400. 100 qty prices: \$116 (numeric), \$130 (alphanumeric); stock.

A series of 21-column numeric and alphanumeric impact printers, the PR2100, measure just 2.3 x 5.8 x 6 in. The units print at speeds up to three lines per second for numeric models and 1.5 lps for full alphanumeric. Spanning hammers form characters for each group of three columns, a design innovation that lowers the cost of drive electronics and increases reliability by reducing the number of moving parts. Start-up time is 750 ms, and paper slewing of up to 10 lps are among the design features of Series PR2100 printers. Units use standard, inexpensive paper tape and a 2-color ribbon in a snap-in cartridge for quick, easy replacement. Power consumption of the drive motor is 3 W. Options include special drums, vertical mounting, single line slip validation and special voltages.

CIRCLE NO. 321



now you have  
a choice!

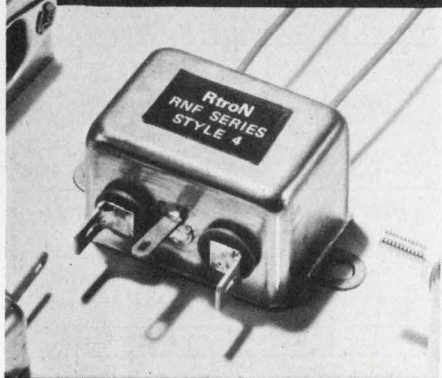

## RFI/EMI FILTERS

For Data Processing,  
Industrial Control and  
Instrument Application

Rtron's RNF Type Filters represent three series of the most widely used, low cost filters available. Over 100 combinations of current and case style to choose from. "L" Series - low cost for general applications to combat line to ground noise. "P" Series - for suppression of line to line as well as line to ground interference. "T" Series - most effective for low impedance load applications. All types are U.L. Recognized and meet C.S.A. requirements. Rated at 115/250 VAC. Low leakage current insures safety.

For complete catalog and  
details, write

**Rtron** corporation

P.O. Box 743, Skokie, Illinois 60076  
(312) 679-7180

CIRCLE NUMBER 83



# THE SWEETEST AM/FM MODULATION METER THIS SIDE OF HEAVEN.



...with features that are simply  
unavailable on competing units  
at any price.

Like a digital display for better accuracy on either AM or FM than any other meter; like built-in post-detection Butterworth filters; and the ability to be controlled and talk to your system through the IEEE-488 Bus.

Even more, the 82AD combines the "easy on the mind" features of automatic tuning and leveling found in the latest service-type modulation meters, with the versatility and accuracy of high-quality lab-type manual meters.

Music to your ears? Well listen to this:

**Carrier Range:** 10 MHz—1.2 GHz  
**Sensitivity:** 10 mV to 520 MHz, 30 mV to 1.2 GHz  
**FM Deviation:** 10, 100, 300 kHz fs  
**FM Accuracy:** 2% of reading at rates from 30 Hz to 100 kHz  
**AM Range:** 10, 100% fs  
**AM Accuracy:** 2% of reading from 10 to 90% AM, 30 Hz to 100 kHz  
**BW Options:**

IEEE-488 Bus Interface; battery supply

Ask your nearest Boonton rep to let you see the 82AD, and he'll also bring along a free record album containing hits of the Big Band Era. The record is yours to keep. But we're betting you'll want the 82AD, too. Write or call Boonton Electronics, Rt. 287 at Smith Rd., Parsippany, N.J. 07054; (201) 887-5110.

## BOONTON





**Add-on memory for DEC LSI-11 holds up to 32 k**

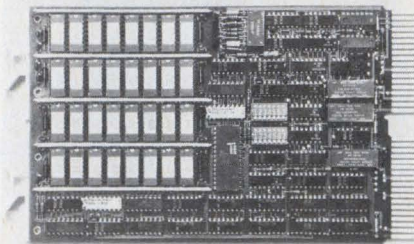

Monolithic Systems, 14 Inverness Dr. East, Englewood, CO 80110. Robert Billhimer (303) 770-7400. \$2075 (28 k version); stock.

A dual-height memory for the DEC LSI-11 provides up to 32 kwords in a single option slot. Designated the MSC 4601, the memory is available in 4, 8, 16, 24, 28 and 32 kword configurations. All versions are available with either on-board, distributed refresh or external refresh. An on-board DIP switch assigns the address position in 1 k increments, anywhere in the 0 to 31 k range on the bus. The board's access time is 450 ns and the cycle time is 625 ns. Provision for battery backup is also included.

CIRCLE NO. 322

**Paper-tape reader does 5, 6, 7, or 8-level tape**

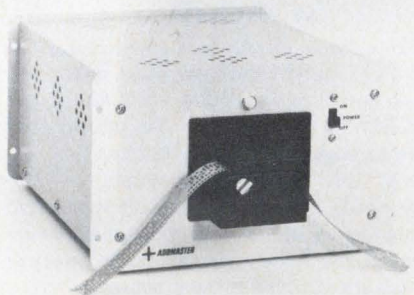

Addmaster, 416 Junipero Serra Dr., San Gabriel, CA 91776. Dennis Moore (213) 285-1121.

The Model 610 paper tape reader handles 5, 6, 7, or 8-level tape and includes its own power supply and crystal controlled clock, with provision for external clock. Available outputs are either buffered parallel, serial RS-232, or current loop. Transmission rate is programmable by the user, from 50 to 9600 baud, with 7 to 11 frames/character. Transmission may be controlled manually or by X ON/X OFF commands. Input power is 110/220/240 V ac, 50/60 Hz.

Booth No. 1634 CIRCLE NO. 323

**Encryption/decryption calculator adds security**

Datotek, 13740 Midway Rd., Dallas, TX 75240. Fred Kinch (214) 233-1030. \$1650 (unit qty); stock.

The DH-26, a microprocessor-based security device, can perform enciphering/deciphering functions. About the size of a calculator the unit accepts a predesignated code and then permits the user to key-in a message in five-letter segments. After each segment has been entered, the operator presses the "equals" key, which causes the five characters to be enciphered and displayed. The resulting "scrambled" text can then be copied down, and communicated to the desired recipient via any medium. The recipient of the message then uses another DH-26 to decipher the message by reversing the enciphering procedure. The algorithm used makes possible a huge number of codes (1,000,000 × 10<sup>46</sup>).

CIRCLE NO. 324

**Tape deck evaluation kits have all you need**



Triple I, 4605 North Stiles, Oklahoma City, OK 73118. Jack Morrow (405) 521-9000. From \$199 to \$502; stock.

Cassette transport evaluation packages provide all the major building blocks necessary to design an analog or digital cassette-based system. Included in each evaluation package is the company's Phi-Deck tape transport, motion control board, remote control box, power supply, connecting hardware, and various sensing and status options. Digital packages include a two-channel read/write board and digital heads. Analog packages include a stereo record/play board and analog heads. Other features are also available. In all, twelve different evaluation packages are available.

Booth No. 1728 CIRCLE NO. 325

# Monsanto

**Products Are Available from These Distributors:**

- AVNET ELECTRONICS
- CESCO ELECTRONICS
- DIPLOMAT/ALTALAND
- ELMAR ELECTRONICS
- HAMILTON/AVNET
- HAMMOND ELECTRONICS, INC.
- HARRISON EQUIPMENT CO.
- KIERULFF ELECTRONICS
- LIBERTY ELECTRONICS
- R.A.E. ELECTRONICS
- SCHWEBER ELECTRONICS
- SEMICONDUCTOR SPECIALISTS
- SHERIDAN SALES

For technical assistance contact our representative in your area:

- A.P.J. Associates, Inc.  
Plymouth, MI. (313) 459-1200
- Beacon Electronic Associates  
Huntsville, AL. (205) 881-5031  
Ft. Lauderdale, FL. (305) 971-7320  
Maitland, FL. (305) 647-3498  
Atlanta, GA. (404) 351-3654  
Charlotte, NC. (704) 525-7412  
Oak Ridge, TN. (615) 482-2409  
Falls Church, VA. (703) 534-7200
- Bob Dean, Inc.  
Ithaca, NY. (607) 272-2187
- CMS Marketing  
Oreland, PA. (215) 885-5106
- Cantronics  
Downsview, Ont. Canada. (416) 661-2494  
Montreal, Que. Canada. (514) 341-5207
- Comtronic Associates  
Melville, L.I., N.Y. (516) 249-0505
- CPS, Inc.  
Orange, CT. (203) 795-3515
- Datcom  
Waltham, MA. (617) 891-4600
- Harvey King, Inc.  
San Diego, CA. (714) 566-5252
- Ed Landa Company  
Los Angeles, CA. (213) 879-0770
- Lorenz Sales Inc.  
Cedar Rapids, IA. (319) 393-6912
- Midwest Marketing Associates  
Chagrin Falls, OH. (216) 247-6655  
Dayton, OH. (513) 433-2511
- Mycrosystems Marketing  
Dallas, TX. (214) 238-7157  
Houston, TX. (713) 783-2900
- Wm. J. Purdy Company  
Burlingame, CA. (415) 347-7701  
Albuquerque, N.M. (505) 266-7959
- Spectrum Associates  
Phoenix, AZ. (602) 997-6324
- Straube Associates  
Denver, CO. (303) 426-0890  
Salt Lake City, UT. (801) 943-5650
- Sumer, Inc.  
Rolling Meadows, IL. (312) 394-4900  
Milwaukee, WI. (414) 259-9060
- Technical Associates, Inc.  
Eden Prairie, MN. (612) 944-3034
- Technical Representatives, Inc.  
Olathe, KS. (913) 782-1177  
Hazelwood, MO. (314) 731-5200
- Valentine-Schillinger  
Greenwood, IN. (317) 888-2260  
South Bend, IN. (219) 291-6258
- Waggoner-Ver Hill Associates  
Pittsburgh, PA. (412) 241-5202
- Western Technical Sales  
Portland, OR. (503) 297-1711  
Bellevue, WA. (206) 641-3900



# Big. Bright. Flexible. Low voltage. Low power. Low cost. What more can we say?

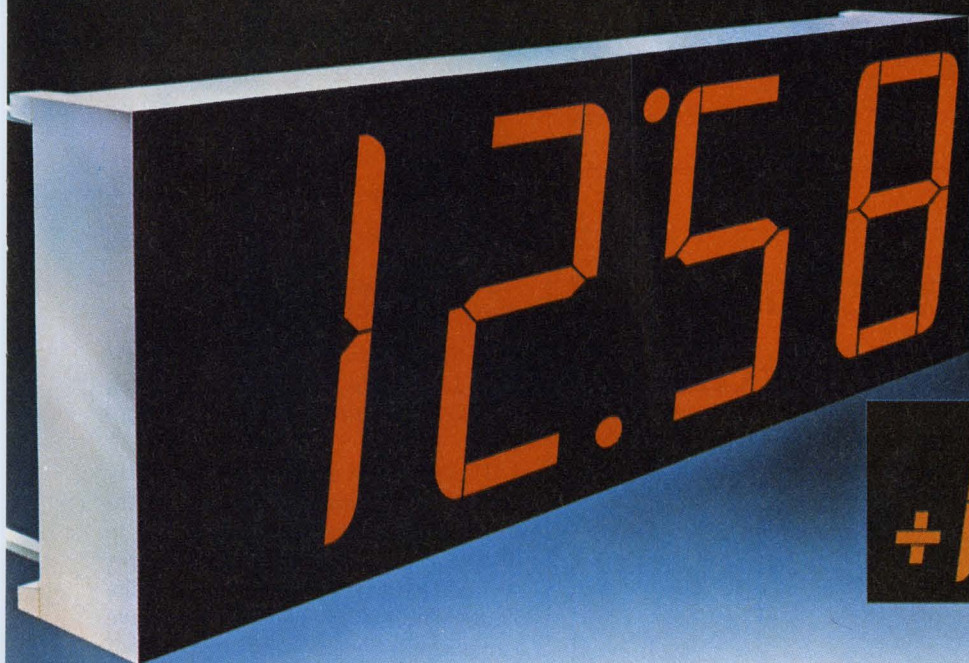

8453.27

50038240

+1594

## Plenty.

### DESIGN IS SIMPLE — DIRECT DRIVE FROM IC LEVELS.

Higher brightness output means you don't need as much current. You can drive directly from MOS circuitry with as little as 3-5 mA.

### BUILD A BETTER STICK.

Get the cost advantages of a stick with the high reliability, quality, and flexibility of Monsanto displays. They come in single- or double-digits, with or without overflow ( $\pm 1$ ) readouts. So, you can build your own display — whether it's 3½ digits or 12 digits.

You can eliminate costly stick connectors by mounting our 0.6" displays directly to your PC board. And Monsanto categorizes its displays by output, so you don't have to sort for brightness.

### UPGRADE YOUR PRESENT 0.4" READOUT.

The package size of our 0.6" digit is no larger than most 0.4" displays, so you can use our larger, easier to read,

sculptured font design to give a new bright face to your product. They're available in high-efficiency orange or red through our stocking distributor in your area. Appearance, high brightness, large digit, design simplicity. Everything comes together in our 0.6" LED displays. Put 'em together yourself!

### WRITE OR CALL TODAY.

For more information or a demonstration, contact Monsanto Commercial Products Co., Electronics Division, 3400 Hillview Ave., Palo Alto, CA 94304.

Telephone: (415) 493-3300.

# Monsanto: the science company.

CIRCLE NUMBER 85



### Quad op amps offer tight input offset matching

Precision Monolithics, 1500 Space Park Dr., Santa Clara, CA 95050. Shelby Givens (408) 246-9222. From \$2.75 (100-qty); stock.

The OP-09 quad op amp has a 500  $\mu$ V max input offset voltage. Its

common-mode rejection ratio is 100 dB min and the minimum open loop gain is  $10^5$ . The OP-09 is also pin compatible with the RM/RC4136. The top commercial grade (OP-09E) has an offset of 800  $\mu$ V max. from 0 to 70 C, while the top military grade (OP-09A) has 1 mV max from -55 to +125 C. Offset voltage match between amplifiers is within 750  $\mu$ V max and common-mode-rejection-ratio match is 94 dB, min. 14-pin hermetic DIPs.

CIRCLE NO. 326

### Passivated rectifiers handle 3 A at 1000 V



Solid State Devices, 14830 Valley View Ave., La Mirada, CA 90638. Dee Peden (213) 921-9660. From \$0.69 (100-qty); 10 days.

Glass-passivated, hermetically sealed high-voltage rectifiers withstand peak-reverse voltages of up to 1000 V at an average forward-current of 3 A. Designated the RG3 Series, the 50, 100, 200, 400 and 600-V devices have a maximum reverse-recovery time of 150 ns. The 800 and 1000-V units have 250 ns and 500 ns recovery times, respectively. Maximum forward-voltage drop is 1.3 V at a 3 A load while maximum reverse current at rated voltage is 5  $\mu$ A. The units will withstand a peak surge-current of 100 A for 8.3 ms—a single 60-Hz half sine-wave super-imposed on rated load. Typical junction capacitance for the low-to-medium-voltage devices is 35 pF and drops to 25 pF for the 800 and 1000 V units. Operating temperature range is -65 to +175 C. The rectifiers have a maximum diameter of 0.25 in. and weigh 0.02 oz.

Booth No. 1203

CIRCLE NO. 327

**Q:** Is there a recorder just for spectrum analyzers?

**A:**

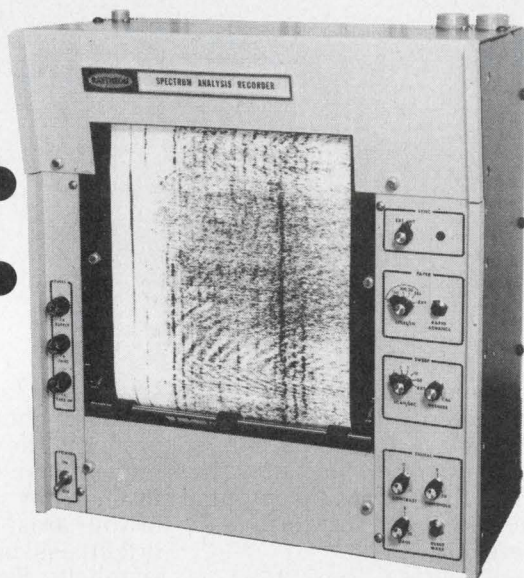

The new 19" rack-mounting SPECTRUM ANALYSIS RECORDER from Raytheon. It's the first dry paper line scanning recorder specifically developed for direct plug-in operation with commercially available spectrum analyzers.

Any new or existing spectrum analyzer equipped with the SAR-097 will have a lot more going for it. Like infinitely variable 100:1 speed range—5 sec/scan to 50 milliscan... stylus position encoder... automatic recorder synchronization... computer/analyzer compatibility... high resolution and dynamic range... all-electronic drive. And more.

If you design and build—or buy and use—spectrum analyzers, you don't have to settle for multi-purpose recorders any more. The SAR-097 is here. For full details write the Marketing Manager, Raytheon Company, Ocean Systems Center, Portsmouth, Rhode Island, 02871. U.S.A. (401) 847-8000.



CIRCLE NUMBER 86

### Three-state outputs come on a/d converters

Teledyne Semiconductor, 1300 Terra Bella, Mountain View, CA 94040. (415) 968-9241. From \$8.95 (100 qty); 4 wks.

Monolithic a/d converters with a three-state outputs are available in 8, 10 and 12-bit word lengths. Housed in 24-pin DIPs, the CMOS units perform a conversion in 1 to 20 ms. Operating ranges of 0 to 70 and -40 to +85 C are available, with plastic and ceramic packages, respectively.

CIRCLE NO. 328



# the only one of its Kind

THE NEW **IMMOBILIZED ELECTROLYTE** TECHNOLOGY  
THAT'S MORE RELIABLE THAN GEL

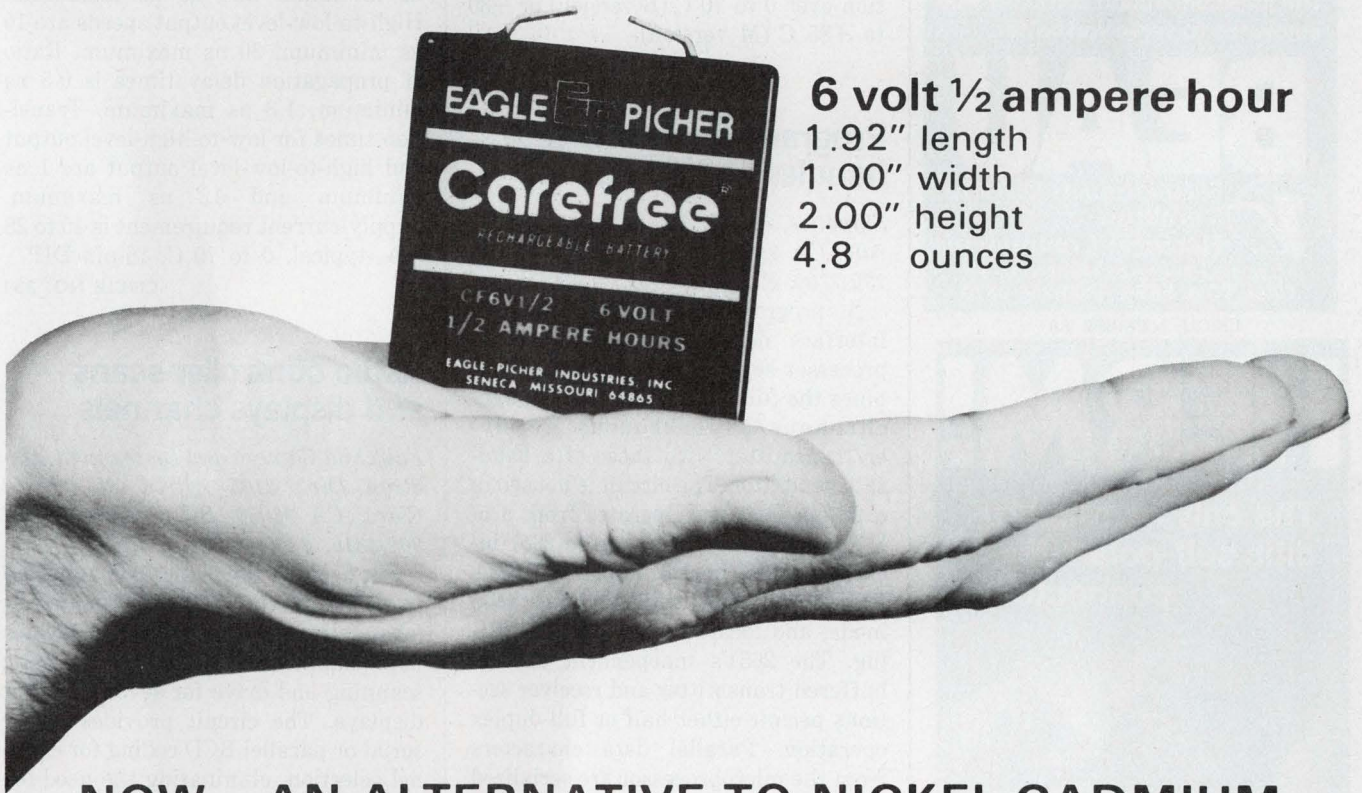

## NOW...AN ALTERNATIVE TO NICKEL CADMIUM

- No memory conditioning required
- No cell reversal
- Less expensive
- Better float life
- Entirely maintenance-free
- Spill-proof and rechargeable

Also available in 30 other sizes  
from 1/2 to 40 ampere hours

**EAGLE  PICHICER**

SINCE 1843

EAGLE-PICHER INDUSTRIES, INC. Commercial Products Department ED

P.O. Box 130, Seneca, Mo. 64865 Telephone (417) 776-2258

CIRCLE NUMBER 87



# PULL!

The only barrier strips with non-twist, non-pull-out terminals.

The interconnection company that innovates to serve you better.

# BEAU

Beau Products Division  
Vernitron  
Electrical Components

P.O. Box 10, Laconia, N.H. 03246 / N.H. tel.: 524-5101  
CALL TOLL FREE: (800)258-0370

CIRCLE NUMBER 88

# HERM!

The only hermaphroditic self-polarizing connectors.

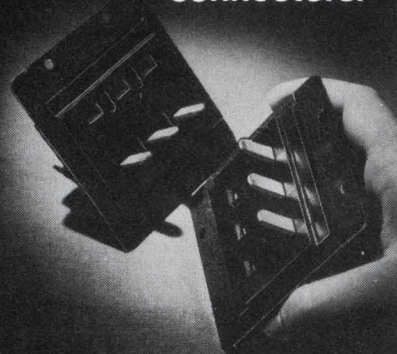

The interconnection company that innovates to serve you better.

# BEAU

Beau Products Division  
Vernitron Corporation  
P.O. Box 10, Laconia, N.H. 03246  
N.H. tel.: 524-5101

CALL TOLL FREE: (800)258-0370

CIRCLE NUMBER 89

## ICs & SEMICONDUCTORS

### High-speed counters run at 1.2 GHz

*Plessey Semiconductors, 1641 Kaiser Ave., Irvine, CA 92714. Dennis Chant (714) 540-9979. From \$32 (100 qty); stock.*

Three low-power, high-speed decade counters have upper operating frequencies of 1.2 GHz (SP8677), 1.1 GHz (SP8676), and 1 GHz (SP8675). All three devices feature a self-biasing clock input, clock inhibit for direct gating, ECL III-compatible inputs and ECL II-compatible outputs, an input dynamic range of 400 to 1200 mV, and a typical power dissipation of just 470 mW. Devices are available for operation over 0 to 70 C (B version) or -30 to +85 C (M version).

CIRCLE NO. 329

### Programmable interface handles serial links

*Signetics, 811 E. Arques Ave., Sunnyvale, CA 94086. Robert Lanford (408) 739-7700. \$13.70 (100 qty); stock.*

A programmable communications interface designed for 8-bit microprocessor serial communications combines the functions of a universal synchronous/asynchronous receiver/transmitter with those of a baud-rate generator. The circuit is housed in a 28-pin DIP and operates from a 5-V supply. Capabilities of the 2651 include modem control, support of IBM's Bisync protocol, asynchronous echo mode, and local and remote self-testing. The 2651's independent double-buffered transmitter and receiver sections permit either half or full-duplex operation. Parallel data characters from the microprocessor are serialized for transmission by the unit. Simultaneously, the 2651 assembles an incoming bit stream into parallel characters for input to the microprocessor. Characters from 5 to 8 bits long can be handled. Three status pins have open-drain outputs to facilitate a wire-OR interrupt request input to the microprocessor. The internal baud-rate generator provides 16 different program-selectable baud rates, from 50 to 19.2 kbits/s, for the transmit and receive clocks. Alternatively, external baud rates may be selected and divided by one, 16 or 64 by an on-chip programmable divider.

CIRCLE NO. 330

### Line receivers mate with IBM 360/370 gear

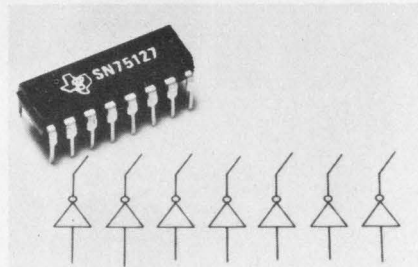

*Texas Instruments, P.O. Box 5012, Dallas, TX 75222. Dale Pippenger (214) 238-2011. From \$2.12 (100-qty); stock.*

The SN75127 seven-channel line receiver meets the requirements of the IBM system 360/370 input/output interface specifications. Propagation delay time, low-to-high-level output is 7 ns minimum and 25 ns maximum. High-to-low-level output speeds are 10 ns minimum, 30 ns maximum. Ratio of propagation delay times is 0.5 ns minimum, 1.3 ns maximum. Transition times for low-to-high-level output and high-to-low-level output are 1 ns minimum and 12 ns maximum. Supply-current requirement is 15 to 28 mA, typical. 0 to 70 C, 16-pin DIP.

CIRCLE NO. 331

### Radio controller scans and displays channels

*Fairchild Camera and Instrument, Electron Div., 3105 Alfred St., Santa Clara, CA 95050. Bill Callahan (415) 962-3816. \$8 (1000-qty); stock.*

For use with domestic 40-channel CB transceivers or German equipment (channels 4-15) the FCB8010, provides both channel section with automatic scanning and drive for seven-segment displays. The circuit provides either serial or parallel BCD coding for channel selection, eliminating the need for a BCD-coded rotary switch. Externally selectable search and scan modes, as well as increment-up or down modes are available. The search mode is selectable for either busy or vacant channels, while the scan mode will remain on a busy channel for three seconds before advancing to the next busy channel. Slew up or down operates at two channels per second, increasing to six channels per second starting with the third channel. Emergency Channel 9 is externally selectable for immediate reception but transmitting on Channel 9 is inhibited unless specifically selected.

CIRCLE NO. 332



# At our plant, teams like this make sure reliable ICs arrive at your plant.

This typical 3" wafer photolithography production line employs sophisticated automated wafer-handling equipment. In a positively-vented clean-room environment, the specially-trained staff skillfully puts each wafer through photoresist coating, masking, exposure to ultraviolet light, developing, etching, and inspection, all with a high degree of productivity and product excellence.

At Sprague Electric's Semiconductor Division, we have accumulated over fifteen years of intensive experience in the manufacture of *innovative* semiconductor devices . . . devices making special contributions to technology . . . devices manufactured under the most exacting QAR program . . . devices that assure total customer satisfaction.

We have built the kind of operation it takes to produce semiconductors compatible with today's as well as tomorrow's requirements.

We proudly invite customers and prospects to tour our plant, the nation's finest semiconductor facility of its type. Here you will see the magnitude of effort that goes into properly designed and manufactured devices. You'll be pleasantly surprised!

Write or call George Tully or Bob Milewski to arrange a visit. You can reach them at the Semiconductor Division, Sprague Electric Co., 115 Northeast Cutoff, Worcester, Mass. 01606. Tel. 617/853-5000.



4SS-7117R1

#### FOR FAST INFORMATION, CALL YOUR NEAREST SPRAGUE SALES OFFICE:

ALABAMA, Sprague Electric Co., 205/883-0520 • ARIZONA, Sprague Electric Co., 602/279-5435 • CALIFORNIA, Sprague Electric Co., 213/649-2600, Wm. J. Purdy Co., 415/347-7701, KCE Corp., 714/278-7640 • COLORADO, Wm. J. Purdy Co., 303/777-1411 • CONNECTICUT, Sprague Electric Co., 203/261-2551 • DIST. OF COLUMBIA, Sprague Electric Co. (Govt. sales only), 202/337-7620 • FLORIDA, Sprague Electric Co., 305/831-3636 • ILLINOIS, Sprague Electric Co., 312/678-2262 • INDIANA, Sprague Electric Co., 317/253-4247 • MASSACHUSETTS, Sprague Electric Co., 617/899-9100, Sprague Electric Co., 413/864-4411 • MICHIGAN, Sprague Electric Co., 517/787-3934 • MINNESOTA, HMR, Inc., 612/920-9200 • MISSOURI, Sprague Electric Co., 314/781-2420 • NEW JERSEY, Sprague Electric Co., 201/696-8200, Sprague Electric Co., 609/795-2299, Trinkle Sales Inc., 609/795-4200 • NEW MEXICO, Wm. J. Purdy Co., 505/266-7959 • NEW YORK, Sprague Electric Co., 516/549-4141, Wm. Rutt, Inc., 914/698-8600, Sprague Electric Co., 315/437-7311, Mar-Com Associates, 315/437-2843 • NORTH CAROLINA, Electronic Marketing Associates, 919/722-5151 • OHIO, Electronic Salesmasters, Inc., 800/362-2616, Sprague Electric Co., 513/278-0781 • PENNSYLVANIA, Sprague Electric Co., 215/467-5252, Trinkle Sales Inc., 215/922-2080 • TEXAS, Sprague Electric Co., 214/235-1256 • VERMONT, Ray Perron & Co., Inc., 617/762-8114 • VIRGINIA, Sprague Electric Co., 703/463-9161 • WASHINGTON, Sprague Electric Co., 206/632-7761 • CANADA (Ontario), Sprague Electric of Canada, Ltd., 416/766-8123 • CANADA (Quebec), Sprague Electric of Canada, Ltd., 514/683-9220



CIRCLE NUMBER 90

... and you thought we  
only make great capacitors.



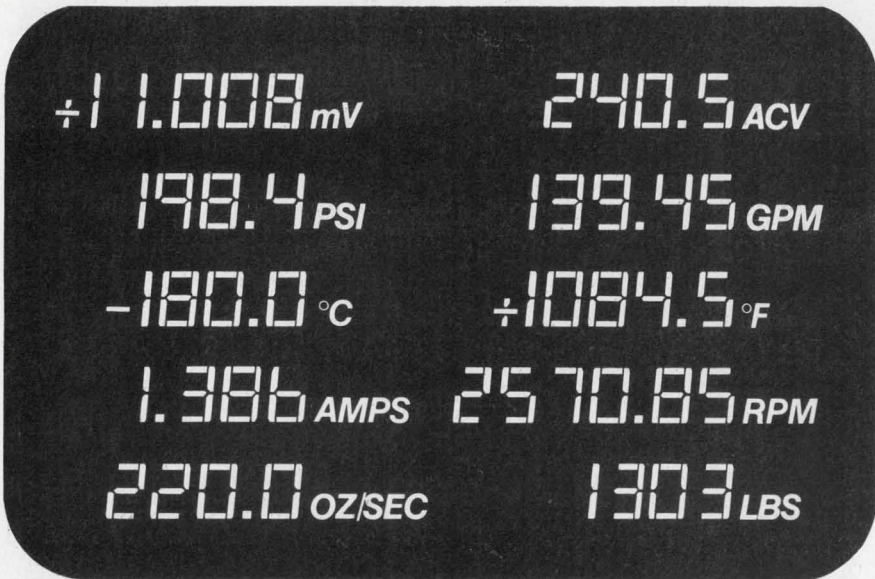

# United Systems' Indicators Will:

- MEASURE voltage and current; ac, true rms or dc.
- CONVERT the output of any transducer/transmitter to display in engineering units.
- DISPLAY temperature (C or F) directly from thermocouple, RTD, or thermistor sensors.
- INTERFACE readily into your system by optional "single line enable" parallel BCD output.
- INDICATE when a predetermined limit is exceeded, through relay closure or logic level output from optional internal comparator alarm.

And with United Systems' exclusive adaptors these indicators change, in the field, to perform any measurement listed above and more!

For additional information contact your United Systems Representative or call the factory (513) 254-6251.

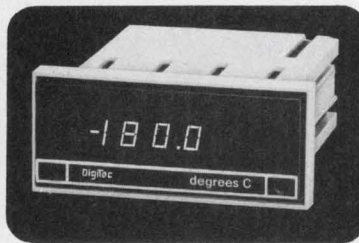

**DigiTec.** **UNITED SYSTEMS CORPORATION**

918 Woodley Road, Dayton, Ohio 45403  
(513) 254-6251, TWX (810) 459-1728

United Systems Corp: Precision measurements to count on  
CIRCLE NUMBER 91

## ICs & SEMICONDUCTORS

### High voltage rectifiers handle up to 150 kV

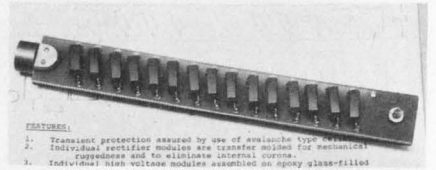

**FEATURES:**  
1. Transient protection assured by use of avalanche type diodes.  
2. Individual rectifier modules are transfer molded for mechanical ruggedness and to eliminate internal corona.  
3. Individual high voltage modules assembled on epoxy glass-filled

Solid State Devices, 14830 Valley View Ave., La Mirada, CA 90638. Dee Peden (213) 921-9660. From \$75 (unit qty); 4 to 6 wks.

High-voltage rectifier assemblies in the PRA series handle peak reverse voltages of 100, 125 and 150 kV at a maximum forward current of 750 mA. Peak powers are 7.5, 9.375 and 11.25 kW, respectively. The rectifiers have a maximum reverse leakage at rated PRV of 1  $\mu$ A, while maximum forward surge rating is 30 A. Maximum forward voltage drop at maximum rated current is 230 V for the 100 kV units, 255 V for the 125 kV elements and 275 V for the 150 kV assemblies. All ratings are based on operation in an oil bath. The assemblies are available either with ferrule connectors for convenient fuse-clip mounting or with threaded studs. The ferrule units are 1.125  $\times$  0.76  $\times$  8.27 in. or  $\times$  9.4 or 10.4 in. for the 100, 125 and 150 kV assemblies, respectively. The stud mounted devices measure 1  $\times$  0.875  $\times$  6 in.

Booth No. 1203 CIRCLE NO. 333

### DMA controller transfers data at 1.25 MHz max

Zilog, 10460 Bubb Rd., Cupertino, CA 95014. Jim Gibbons (408) 446-4666. From \$49 (unit qty); stock.

The Z80-DMA, a dynamically programmable, single-channel direct-memory-access circuit, operates at transfer rates up to 1.25 MHz. The NMOS device provides all address, timing and control signals for transferring blocks of data between two ports within a Z80-based system. The Z80-DMA features three classes of operation (transfer only; search only; and search and transfer) and four modes of operation (byte-at-a-time; burst; continuous; and transparent). Search or transfer rates can go up to 1.2 Mbytes/s. Housed in a 40-pin plastic or ceramic DIP, the current operates from a 5-V supply and single-phase TTL-level clock. The Z80-DMA will be available in standard, extended and military temperature ranges.

CIRCLE NO. 334



# Specifier's QPL Shopping List.

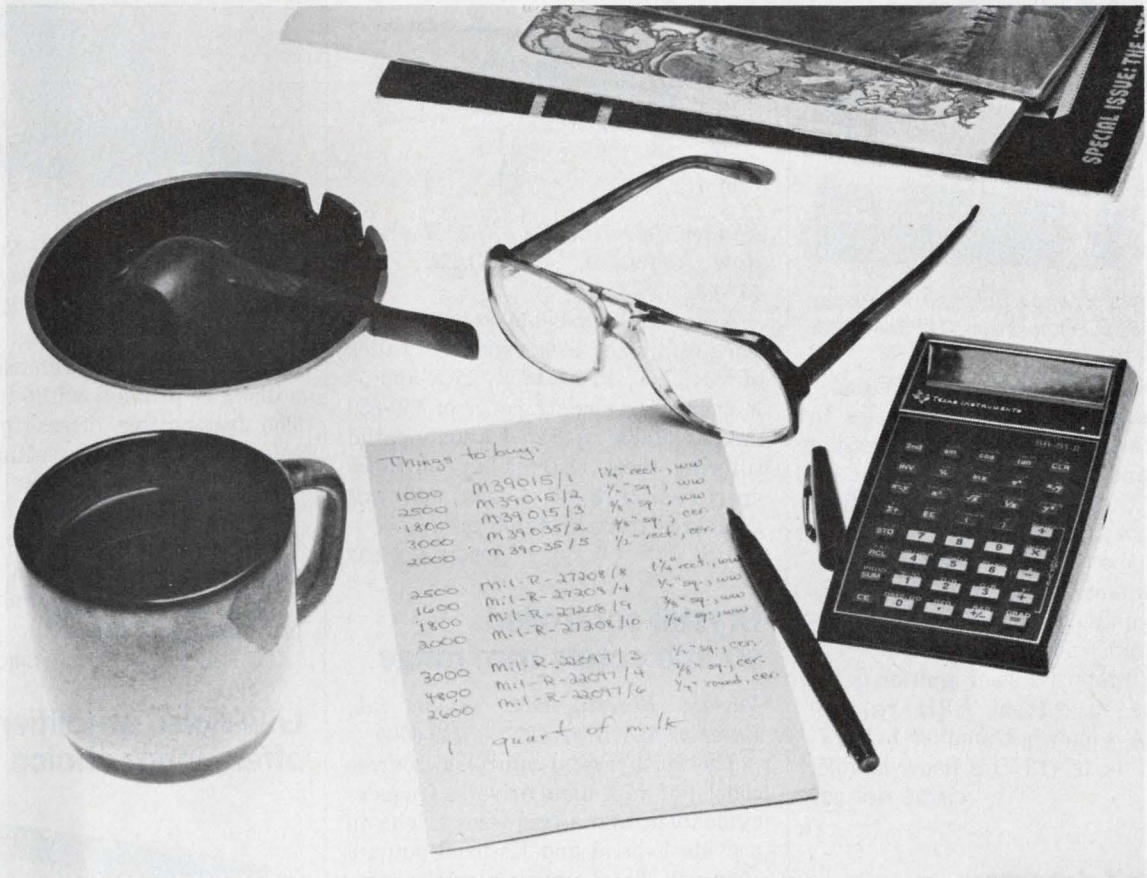

Shop the Weston Mil-Qualified Trimmer Supermarket for great selection and quality!

WESTON MIL-QUALIFIED TRIMMERS			
Type	Mil. Spec.	Term.	Description
RTR12	M39015/1	L.P.Y	1 1/4" Rectangular, Wirewound
RTR22	M39015/2	L.P.W.X	1/2" Square, Wirewound
RTR24	M39015/3	L.P.W.X	3/8" Square, Wirewound
RJR24C.F	M39035/2	P.W.X	3/8" Square, Cermet
RJR28C	M39035/5	P	1/2" Rectangular, Cermet
RT12C2	Mil-R-27208/8	L.P.Y	1 1/4" Rectangular, Wirewound
RT22C2	Mil-R-27208/4	L.P.W.X	1/2" Square, Wirewound
RT24C2	Mil-R-27208/9	L.P.W.X	3/8" Square, Wirewound
RT26C2	Mil-R-27208/10	P.W.X	1/4" Square, Wirewound
RJ22C	Mil-R-22097/3	L.P.W.X	1/2" Square, Cermet
RJ24C.F	Mil-R-22097/4	L.P.W.X	3/8" Square, Cermet
RJ50C	Mil-R-22097/6	P	1/4" Round, Cermet

Weston Mil-Qualified Trimmers will meet all your most demanding applications because they're designed and manufactured to the highest government standards for consistently superb performance. For model specifications, check our chart. With 12 Mil-Qualified Trimmers to choose from, we're sure you'll find just what your shopping list calls for. And on the way home, don't forget to stop for that milk!

**SANGAMO WESTON**  
**Schlumberger**

WESTON COMPONENTS & CONTROLS  
A Division of Sangamo Weston, Inc.  
Archbald, Pa. 18403  
Tel. (717) 876-1500  
TWX 510 656-2902  
Telex 83-1873



RTR12



RTR22



RTR24



RT22C2

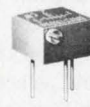

RT26C2



RJ50C

CIRCLE NUMBER 92



### Laser supply trades ballast for efficiency

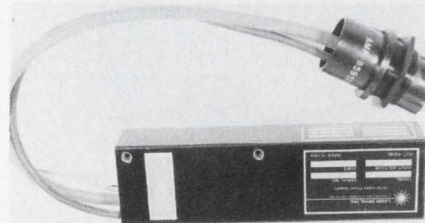

Laser Drive, Inc., 14 S. Drive, Valencia, PA 16059. P. Thackray (412) 586-7716. From \$110 (unit qty).

A line of highly regulated HeNe laser power supplies offers efficiencies to 92%, by using a new energy conversion circuit and an Electronic Ballast instead of the normally required ballast resistor. Available with 115 V ac, and 115/230 V ac inputs, the supplies feature complete fault protection, feedback-regulated start voltage and output current, and small size—1.5 × 1 × 5.4 in. An internal laser ignition delay conforms to current BRH requirements. A somewhat smaller battery-operated model (12 V) is also available.

CIRCLE NO. 335

### Infrared detector includes amplifier

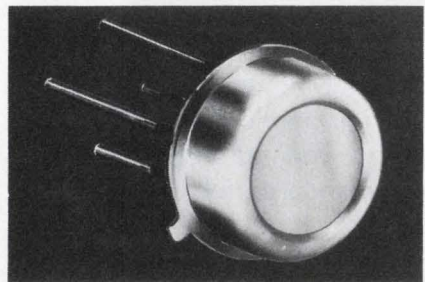

Eltec Instruments, Inc., Central Industrial Park, Daytona Beach, FL 32014. W. Hodges (904) 252-0411. \$29 (100 qty); stock.

Model-408 pyroelectric infrared detectors provide  $10^5$  V/W at 2 to 15  $\mu$ m. The detector consists of an LiTa sensing element and a complete impedance-converting source follower with voltage-mode amplifier which changes the high impedance signal from the sensing element into an easily usable, low-impedance voltage signal. A germanium window is available at no extra cost to hermetically seal the sensing element and the electronics against contamination, physical damage, visible light and electrical noise.

CIRCLE NO. 336

### Broadband systems expand laser beams

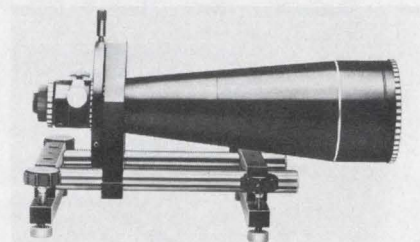

Klinger Scientific Co., 83-45 Parsons Blvd., Jamaica, NY 11432. (212) 657-0335. Stock.

A line of laser-beam expander systems offers the user expansion ratios of 4 ×, 7 ×, 15 ×, 16 ×, 25 × and 50 × over a wavelength range of 450-650 nm. Available with or without spatial filtering, these systems have entrance apertures of 3 or 4 mm and exit apertures from 16 to 78 mm.

CIRCLE NO. 337

### Crystal-controlled source enters mm range

Varian, Beverly Div., Salem Rd., Beverly, MA 01915. (617) 922-6000.

The 9692 crystal-controlled sources consist of an X-band driver, a frequency doubler, and a frequency tripler to provide K-band and Ka-band outputs of 10 mW. The doubler and tripler units may be mounted separately and connected to the common X-band driver. Doubler frequency is 16 to 24 GHz, and tripler frequency is 24 to 36 GHz.

CIRCLE NO. 338

### Mixer spans full 1 to 26-GHz band

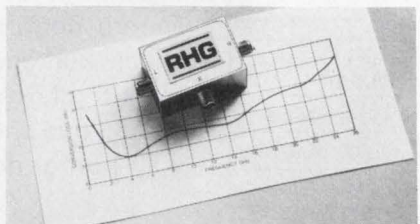

RHG Electronics Laboratory, Inc., 161 E. Industry Court, Deer Park, NY 11729. (516) 242-1100. \$695; 8 wks.

A multi-octave double-balanced mixer, the DMS1-26, features low noise and a frequency range of 1 to 26 GHz, in an hermetically sealed housing. Typical noise figures are 7.8 dB for 18 to 26 GHz, and 7.0 dB for the 2 to 18-GHz band. The DMS1-26 measures 3.81 × 2.54 × 1.52 cm (1.5 × 1 × 0.6 in.). Typical VSWRs are 2:1 for rf and 2.5:1 for the local oscillator.

CIRCLE NO. 339

### Fiber-optic system spans 2 km

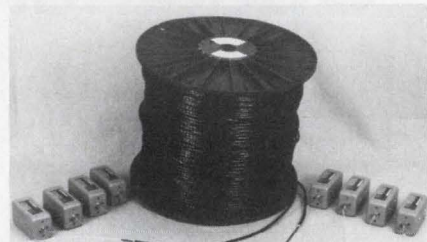

ITT, 7635 Plantation Rd., Roanoke, VA 24019. Bob Blanchard (703) 563-0371. \$3000 (less cable); 60-90 days.

The Model 2-D digital fiber-optic transmission system can transmit over a distance of 2 km without repeaters. The transmitter offers four switch-selectable LED drive settings; the receiver uses an avalanche photodiode detector. Maximum data rate is 20 Mbit/s. Inputs and outputs are TTL-compatible, with AGC on the output voltage. An analog signal output is provided for monitoring.

CIRCLE NO. 340

### Low-noise amplifier offers input choice

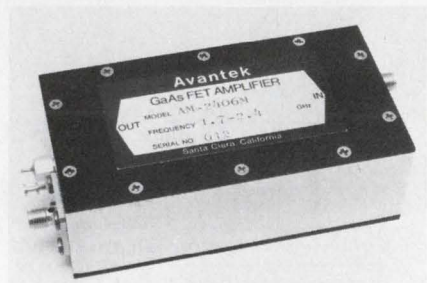

Avantek, Inc., 3175 Bowers Ave., Santa Clara, CA 95051. W Berridge (408) 249-0700. 8 wks.

A pair of similar low-noise transistor preamplifiers for 1.7 to 2.4 GHz troposcatter or telemetry receiving systems offers the user a choice of GaAs-FET, or bipolar-transistor input stages. The AM-2406 uses two GaAs FETs in a balanced first stage to provide a 2.0-dB noise figure and 1.5:1 max input VSWR. The similar AM-2405 uses two arsenic-emitter, silicon planar transistors in its balanced input stage, providing a 2.5-dB noise figure with 1.25:1 input VSWR. The gain of both units is 22 dB with  $\pm 1.0$  dB flatness. Both types feature +3-dBm output power (at the 1-dB gain compression point), and 1.25:1 output VSWR. The AM-2405 and -2406 are packaged in aluminum cases measuring 3.336 × 1.98 × 1.33 in.

CIRCLE NO. 341



# now, variable attenuators DC to 18 GHz from one source

...it's the winning combination from Merrimac

## AUDIO, IF, & VHF CONTINUOUSLY VARIABLE ATTENUATORS DC TO 500 MHz



The winning combination is 17 different manually variable or current controlled variable attenuators ideally suited for power levelling or control over broad frequency ranges.

Low cost models with attenuation ranges to 40 dB with various drives and connectors are available as standard off the shelf items.

Following are 4 standard items illustrating Merrimac's capability in low frequency variable attenuators.

MODEL NO.	FREQ. RANGE (MHz)	ATTEN. RANGE (dB)	CONN.	TYPE OF DRIVE	PRICE
ARS-1	DC-400	To 20	PC Pins	SCREW/LOCK	\$ 65.00
ARM-1	DC-400	To 20	SMA FEMALE	SCREW/LOCK	85.00
AR-5	DC-200	To 40	BNC FEMALE	SCREW/LOCK	95.00
ARE-1	2-200	To 30	BNC FEMALE	0 To +15V	165.00

Send For:

- Catalog M-127 and M-130  
IF Signal Processing Components, DC-3 GHz  
CIRCLE NUMBER 126

For additional information on Merrimac's entire standard line of over 750 catalog items of IF, Microwave and Ferrite components, please send for Merrimac's new M77-3 catalog.

CIRCLE NUMBER 128



*now there is one...in signal processing*

EXPORT REPRESENTATIVES DAGE CORP.  
STAMFORD, CONNECTICUT 06902  
(203) 324-3123 TWX 710-474-2490 Telex: 96-5928

## UHF & MICROWAVE CONTINUOUSLY MANUALLY VARIABLE COAXIAL ATTENUATORS 300 MHz TO 18 GHz

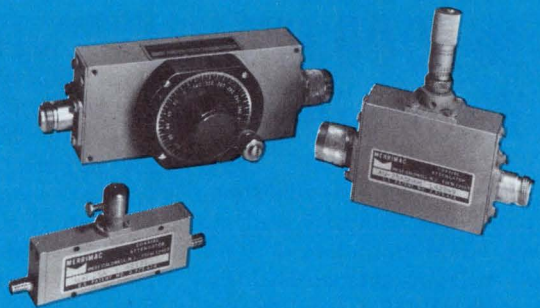

The winning combination is 80 different manually variable attenuators with attenuation levels to 80 dB, including 55 new models featuring panel mountable units with screw, knob, turns counting dials and micrometer drives.

Standard models include Type N or SMA connectors in a wide variety of packages and ultra-broadband frequency ranges.

Following are 4 standard items illustrating Merrimac's capability in microwave attenuators.

MODEL NO.	FREQ. RANGE (GHz)	ATTEN. RANGE (dB)	CONN.	TYPE OF DRIVE	PRICE
AU-46AN	.5-8	To 55	Type N	KNOB/DIAL	\$295.00
AUM-25A	.5-12	To 40	SMA	SCREW	165.00
AU-25AMN	1-10	To 30	Type N	MICROMETER	195.00
ASM-15-11K	4-18	To 15	SMA	SCREW	210.00

Send For:

- New Catalog M77-1 Microwave Component Catalog - DC-18 GHz  
CIRCLE NUMBER 127

**Merrimac**  
INDUSTRIES, INCORPORATED  
POST OFFICE BOX 986, 41 FAIRFIELD PL., W. CALDWELL, N.J. 07006  
• 201 575-1300 • TWX 710-734-4314



# NEW

## ULTRA WIDEBAND AMPLIFIER



Model 1W1000

## 1 to 1000 MHz 1 Watt Linear

Here's a unique, all-solid-state amplifier that delivers 1 watt of swept power output from 1 to 1000 MHz instantaneously. It's the Model 1W1000 from Amplifier Research. A reliable, unconditionally stable unit, the new Model 1W1000 provides 1 watt of linear power over three decades of bandwidth.

Its performance is matched only by its versatility. For example, Model 1W1000 can be used with high-level sweepers, VSWR measuring systems and network analyzers. It's also used to increase the sensitivity of spectrum analyzers, oscilloscopes and wideband detector systems. It has all the bandwidth you'll ever need. For complete information, write or call:

Amplifier Research  
160 School House Road  
Souderton, PA 18964  
215-723-8181



Your Best source for RF Power Amplifiers

CIRCLE NUMBER 93

## COMPONENTS

### Hi-temp thermostat has QPL listing

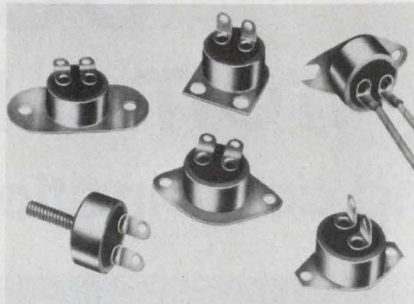

Elmwood Sensors, 1655 Elmwood Ave., Cranston, RI 02907. Bill Venturino (401) 781-6500.

A hermetically-sealed thermostat, the 3MS1, has received a QPL listing under MIL-S-24236. The spst switch is rated to 7-A with resistive load and operates over a temperature range from -34 to 260 C. Available with narrow or wide differentials, the device is pre-set and tamperproof. The case is heliarc-welded to form a hermetically-sealed steel housing, with a glass-to-metal seal at the terminal junction. A variety of mounting brackets and terminal forms are available, as well as custom packages.

Booth No. 1529-1531 CIRCLE NO. 342

### Two-color LED offered in improved version

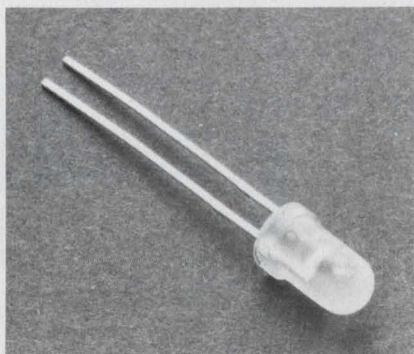

OPCOA, 330 Talmadge Rd., Edison, NJ 08817. Cary Ratner (201) 287-0355. \$0.95 (100-qty).

An improved version of the CSL-310L two-color LED uses a T 1- $\frac{3}{4}$  bipolar device. Illumination in either red or green is possible by reversing the polarity of the voltage to the device. The luminous intensity is 2 millicandelas for red and 4 millicandelas for green, at a forward current of 25 mA. Both colors are intensity matched for the apparent identical intensity under ambient light conditions.

CIRCLE NO. 343

### Counter signals before end of cycle occurs

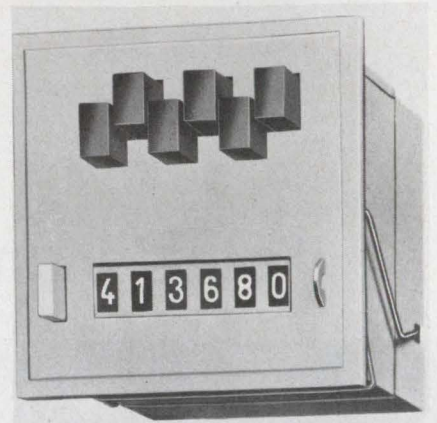

Kessler-Ellis, Atlantic Highlands, NJ 07716. Leslie Gleason (201) 291-0500. \$50 (1-qty); stock.

A six-digit counter, designated the MVS16, has a presignal feature that warns the user before an end of cycle occurs. The feature is activated by an spdt switch on the front panel, and can operate at any factory-fixed count prior to the standard zero-switch point applications. Any predetermined number can be set into the counter by the six, staggered, pushbuttons on the front panel. Manual, electric or automatic reset returns the counter to the preset number so the cycle can begin again. Operation is from any ac or dc voltage up to 240 V, with count speed capability up to 40 counts per second. Five different mounting styles are available, including plug-in, standard panel and spring-mount.

Booth No. 1010 CIRCLE NO. 344

### Ironless rotor motor works at high temp

Electric Motor Engineering, 6331 Hollywood Blvd., Los Angeles, CA 90028. Edward Reese (213) 469-7393.

Encapsulation of the windings allows the Copal-LS motor to withstand temperatures in excess of 120 C without deformation. The ironless rotor motor offers a high temperature winding and a 3-mm shaft as standard features. Applications include cassettes and capstans, X-Y recorders, medical instrumentation and high speed printers. Skew winding construction gives the motor low rotor inertia, fast response time, high starting torque and low starting voltage. High reliability operation is achieved by using precious metal for the commutator and brushes.

Booth No. 1228, 1230, 1232

CIRCLE NO. 345



# Two new ways to cut costs in isolated systems without sacrificing performance.

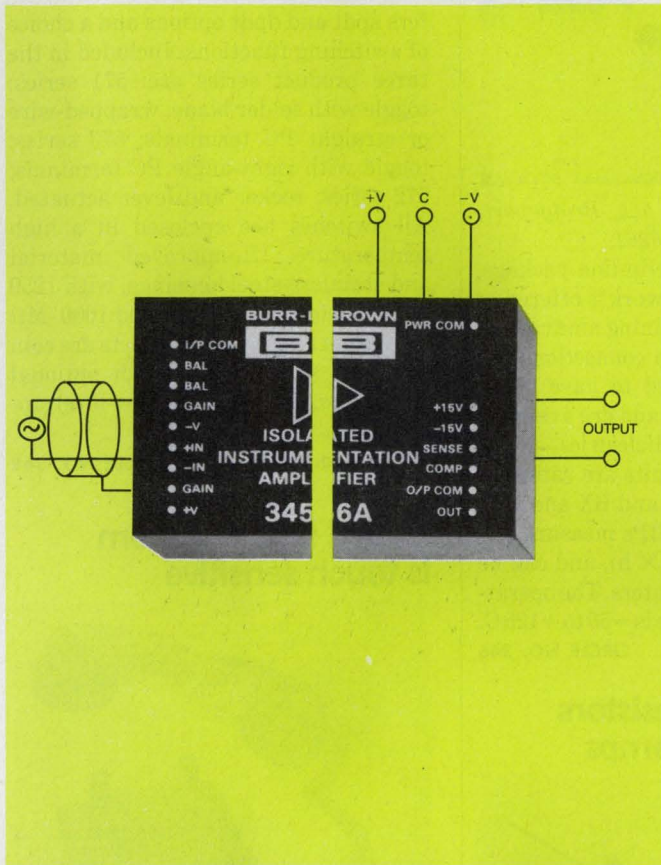

## Choose Burr-Brown's new Isolated Instrumentation Amplifier with true three-wire input.

Burr-Brown's new 3456 gives you true three-wire instrumentation amplifier input with CMR of 110 dB min at  $G=100$ ,  $\pm 0.02\%$  max gain non-linearity and  $\pm 1 \mu V/^{\circ}C$  max input offset drift. And it provides input-to-output isolation rating of 2000V peak continuous (5000V test), isolation impedance of  $10^{12}$  ohms in parallel with 14 pF and isolation mode rejection of 130 dB at 60 Hz. Single-quantity prices start at \$145.

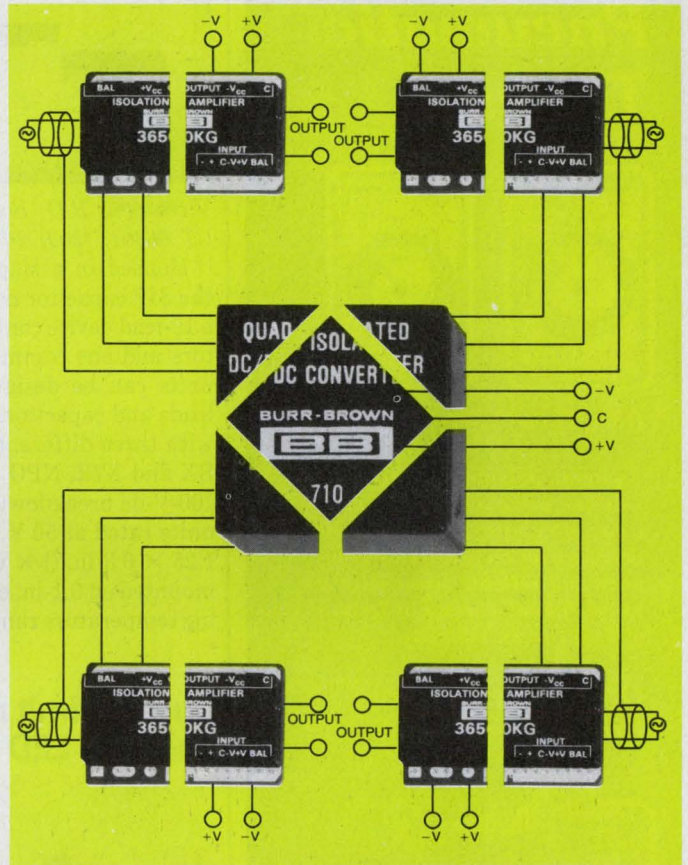

## Power four optically-coupled isolation amplifiers with our new Quad Isolated Supply.

Combine Burr-Brown's new Model 710 with four 3650KG Optical Isolation Amplifiers and you get optical isolation at low cost per channel.

The 3650KG provides  $\pm 0.05\%$  max gain nonlinearity and  $\pm 5 \mu V/^{\circ}C$  max input offset drift. Combined with the 710, each isolated channel provides 600V continuous isolation voltage channel-to-channel and input-to-output rating (2200V test) and 1  $\mu A$  max leakage current at 240V/60Hz. Single quantity prices are \$69.00 for the 3650KG and \$39.00 for the 710.

To get full details on these isolation amplifier developments, contact Burr-Brown, International Airport Industrial Park, Tucson, Arizona 85734. Phone (602) 294-1431.

See us at WESCON, Booths 1622-24.



*A revolution in price and size*

CIRCLE NUMBER 94



# New Electro Pneumatic Timer

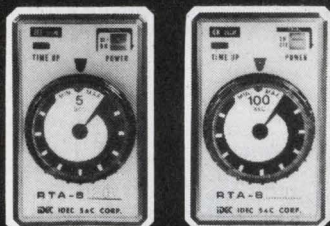

## RTA Type

A plug-in pneumatic timer with extreme accuracy, IDEC's RTA timer offer both on delay and off delay operation type. It is a compact and reliable timer with a rated thermal current of 7A and a large output capacity.

## Other Fine Quality Products from IDEC

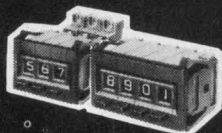

## Digital Switches

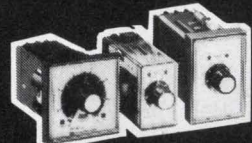

## Motor Timers



## Relays

For Catalog and Information,  
please contact:

# idcc

IDEC SYSTEMS & CONTROLS  
CORPORATION

3553 Ryder St., Santa Clara,  
California 95051

Tel: (408) 738-4332 • Telex: 340601

Cable: IDEC, SANTA CLARA

See us at Booth No. 825 & 827

CIRCLE NUMBER 95

## COMPONENTS

### Save space, reduce cost with capacitor networks

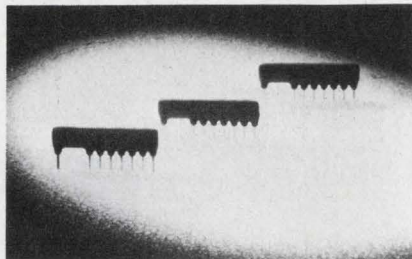

Vitramon, P.O. Box 544, Bridgeport,  
CT 06601. (203) 268-6261.

Housed in a single-in-line package, the SIP capacitor network is offered as a 10-lead device containing nine capacitors and one common connection. The units can be designed to have fewer leads and capacitors, and are available with three different dielectrics—NPO, BX and X7R. NPO units are rated for 100-V-dc breakdown, and BX and X7R units rated at 50 V. SIPs measure 1 × 1.25 × 0.3 in. (l × w × h), and can be mounted on 0.1-in. centers. The operating temperature range is -55 to +125 C.

CIRCLE NO. 346

### Current-limit resistors built into LED lamps

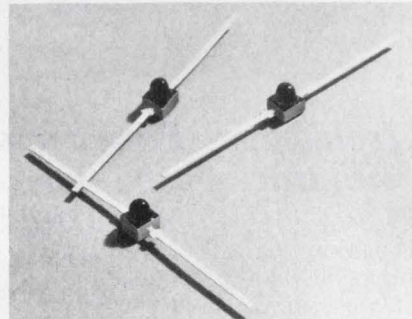

Hewlett-Packard, 1501 Page Mill Rd.,  
Palo Alto, CA 94304. (415) 493-1501.  
Both \$0.53 (1000-qty); stock.

Two 5-V LED lamps containing built-in current-limiting resistors in a compact package eliminate the need for an external resistor. The HLMP-6600 and HLMP-6620 use red LEDs and also have built-in reverse-protection diodes, allowing operation from a 5-V source without additional biasing components. At 5 V dc, the HLMP-6600 draws 10 mA, while providing 2.4 millicandelas of axial luminous intensity. The HLMP-6620 draws 5 mA and provides 6 millicandelas. The lamps can be mounted on 0.1-in. centers, compared to 0.125-in. centers for previous lamps with on-board resistors.

Booth No. 2051

CIRCLE NO. 347

### Small switch line has rocker, toggle, lever

Dialight, 203 Harrison Pl., Brooklyn,  
NY 11237. (212) 497-7600. From \$0.79  
(10,000-qty); stock.

A line of subminiature switches offers spdt and dpdt options and a choice of switching functions. Included in the three product series are: 571 series; toggle with solder blade, wrapped-wire or straight PC terminals; 573 series; toggle with right-angle PC terminals; 572 series; rocker and lever actuated. All switches are enclosed in a high temperature UL-approved material and stainless-steel housings, with 1250 V rms dielectric strength and 1000-MΩ insulation resistance. Contacts are coin silver or silver plated with optional gold plate, or silver for low-level applications.

Booth No. 1115-1117 CIRCLE NO. 348

### Sealed switch system is touch sensitive



Oak Switch, Crystal Lake, IL 60014.  
Dodi Almcraantz (815) 459-5000.

Thick-film techniques are used in the TIP pushbutton switch system which provides a flat, sealed data-entry surface. A smooth Mylar surface replaces traditional pushbutton switches, allowing any number of switches of the same or different size to be printed on a Mylar sheet in any configuration. Any picture or symbol can be used since pushbutton caps are not required. By means of either apertures in the housing or lamp isolation masks, selected switches can be backlit. In applications where compactness is important, the switching assembly can be made as thin as 0.05 in.

Booth No. 1225-1227-1229-1231

CIRCLE NO. 349



**LONG SCALE**  
3 1/2",  
4 1/2" Round  
3 1/2" Century



**CENTURY SERIES**  
1 1/2", 2 1/2"  
3 1/2", 4 1/2"



**WIDE-VUE**  
1 1/2", 2 1/2"  
3 1/2", 4 1/2", 8"

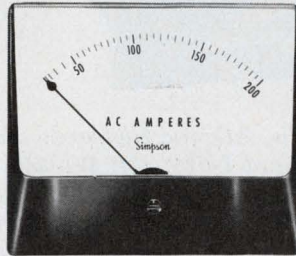

**BOLD-VUE®**  
2 1/2", 3 1/2"



**DIGITAL PANEL METERS**  
Low Cost series 2860  
Deluxe series 2850, 2852

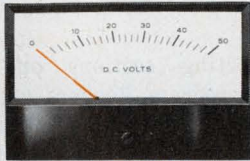

**DESIGNER SERIES**  
3 1/2", 4 1/2"

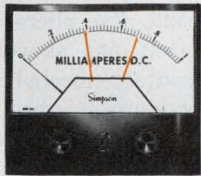

**RUGGED SEAL**  
(Metal Cased)  
3 1/2", 4 1/2"  
4x6"

**RECTANGULAR**  
2 1/2", 3 1/2"  
4 1/2"

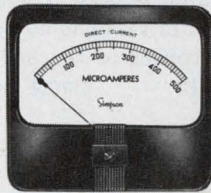

# Panel Meters Stock or Special SIMPSON has 'em!

Analog, digital, or Ana-Led®, if it's made, Simpson makes it.  
Over 1500 styles, sizes, ranges. If it's a special, we'll make it for you.

**ROUND**  
(Commercial and MIL spec)  
2 1/2", 3 1/2"  
4 1/2"



**EDGEWISE**  
3 1/2"



**ANA-LED SOLID STATE PANEL METERS**  
Bar or dot display



**EDGEWISE Barrel Type**  
1 1/2", 2 1/2"



**STACKABLE EDGEWISE**  
1 1/2", 2 1/2"



**RUGGED SEAL**  
3 1/2", 4 1/2"  
4x6"

**EDGEWISE**  
3 1/2"



**CONTACTLESS METER RELAYS**  
single or double setpoint models available in DC microamp, milliamp, millivolt, AC ampere, AC voltage and temperature ranges.



**SIMPSON ELECTRIC COMPANY**  
853 Dundee Avenue, Elgin, Illinois 60120  
(312) 697-2260 • Cable SIMELCO • Telex 72-2416





## COMPONENTS

### Metal-film resistors offer low TCR

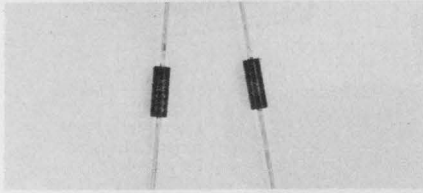

Allen-Bradley, 1201 S. Second St., Milwaukee, WI 53204. (414) 671-2000. \$0.25 (1000-qty); 10 wks.

Temperature coefficient of resistance as low as  $\pm 10$  ppm/ $^{\circ}$ C is offered in the type FM series of metal-film resistors. Approval to MIL-R-10509F for style RN55, characteristic E, is available in resistance values of 49.9 to 100 k  $\Omega$ . The units are rated at 0.25 W at 70 C, derated to 0.1 W at 125 C. The following initial resistance tolerances are available:  $\pm 1\%$ , 0.5%, 0.25%, 0.1% and 0.05%. The nominal resistance range for the series is 20  $\Omega$  to 357 k  $\Omega$  in standard EIA, MIL and IEC values. Available TCRs are  $\pm 25$ ,  $\pm 15$ , and  $\pm 10$  ppm/ $^{\circ}$ C.

Booth No. 1092

CIRCLE NO. 353

### D-cell can hold memory in miniature counter

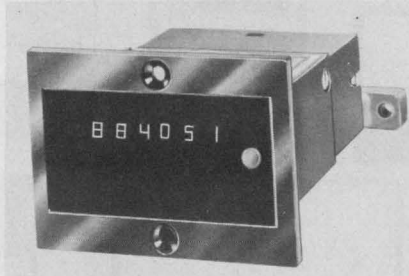

Kessler-Ellis, Atlantic Highlands, NJ 07716. Richard Laird (201) 291-0500.

A D-size battery can sustain the memory of the Model-H07 counter for up to two years if main power should fail. For short-term power interruption, a built-in capacitor will hold the memory for two hours. Without external power, the counter display shuts off, and memory retention is accomplished with only 5- $\mu$ A of current. The 7-digit LED display can register up to 10 million counts at speeds of up to 5-MHz while operating on voltages of from 5 to 30-V dc. The counter housing is 1  $\times$  2  $\times$  3 in., and is interchangeable with available units.

Booth No. 1010

CIRCLE NO. 354

### Program headers replace packaged DIP switches

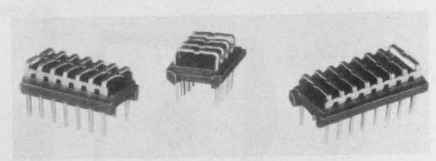

Aries, P.O. Box 231, Frenchtown, NJ 08825. (201) 996-4096. 16-pin from \$0.68; 14-pin, from \$0.58; 8-pin, from \$0.53; stock.

Interconnecting sections on the Model-6750 program headers can be removed or left in place, to generate a user-required program. Available in 8, 14, and 16-pin styles, they come pre-programmed or can be programmed by the user with needle-nose pliers or a header tool. Adjacent pins, as well as opposing pins, are interconnected until the pre-slotted section is snapped out. A protective snap-on cover is provided, which can be marked to identify the interconnections. The header body is glass-filled thermoplastic, and the pins are spring-quality brass with gold over nickel plating. Pin 1 is denoted by a 45 $^{\circ}$  angle on one corner of the body.

Booth No. 1713

CIRCLE NO. 355

# SERVO-TEK YEARS AHEAD!

We salute ELECTRONIC DESIGN, for 25 years a leader in the communications magazine field, reporting every advancement from telegraphy to fiber optics. They've been years ahead. We've been years ahead too, in the design of tachometer generators, servomotors, speed indicating systems, gear drives, torque units and now, digital comparators. For over 30 years our rotating components and control systems have been leaders in the electronics field. You can look forward to our continuing leadership!

FREE CATALOG of rotating components available.

## SERVO-TEK<sup>®</sup> PRODUCTS COMPANY

1086 Goffle Road  
Hawthorne, NJ 07506  
201-427-3100

Servo-Tek of California, Inc.  
8155 Van Nuys Boulevard  
Van Nuys, CA 91402  
213-786-0690

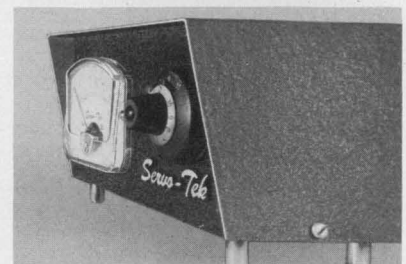
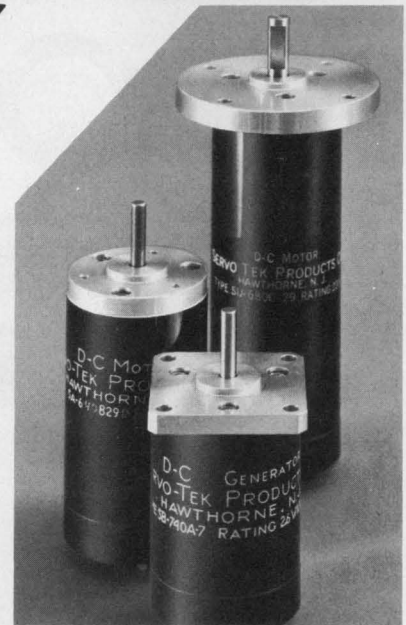

CIRCLE NUMBER 97



## Pushbutton switch, LEDs in single DIP package

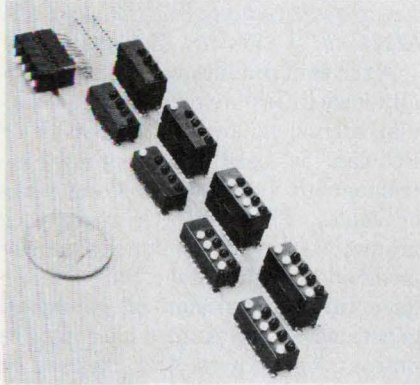

Licon, 6615 W. Irving Park Rd., Chicago, IL 60634. Rich Francke (312) 282-4040.

Normally open pushbutton switches combined with LEDs are mounted in a single 18-pin DIP. The Type 43 can contain up to 4 LEDs and 5 momentary switches in a single package. The units use miniature T-1 size red LEDs and spst normally open switches, and can be soldered directly to PC boards or mounted in sockets. They are suitable for testing logic circuits, checking logic codes and programming micro-processor systems—indicating codes immediately. Other uses include in-house and field testing of erasable memory systems such as EPROMs. Booth No. 1031-1033 CIRCLE NO. 436

## Vibration transducer measures G forces



Columbia Research, MacDade Blvd. & Bullens Ave., Woodlyn, PA 19094. (215) 532-9464. \$425 (1-qty); 6 wks.

Acceleration is displayed directly in G on the 3-1/2-digit, D-1101 digital vibration transducer. An integrated piezoelectric accelerometer is combined with a signal-conditioning digital display package in the instrument. Transducers spanning a range of 2 G to 2000 G full-scale are available. The unit operates from 115-V ac with a nominal power consumption of 2.5-W. Packaged in a DIN standard case, the instrument measures 3.78 in. (W) × 1.89 in. (H) × 2.75 in. (D).

CIRCLE NO. 437

# MEET OUR FAMILY OF GRABBERS



MODEL 4233 MICRO GRABBER  
Tests high density packaging



MODEL 3925 MINI GRABBER  
Tests conventional packaging



MODEL 4011 THREADED GRABBER  
Accepts 6-32 threaded leads



MODELS 3780 - 3789 GRABBER LEADS  
10 choices of connectors other end

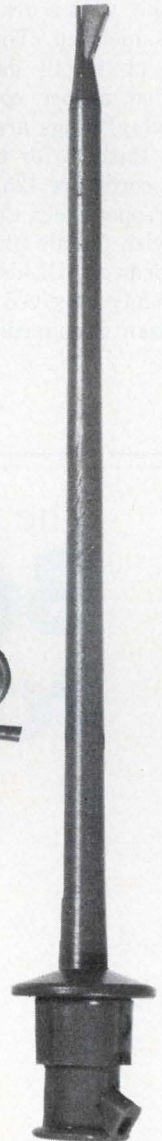

MODEL 4225 MAXI GRABBER  
Tests high rise packaging

All Grabbers shown actual size

Our Grabber family is five years old now, and we're adding new members to keep pace with the complexities of state-of-the-art electronic packaging. Grabber is our name for a series of test clips designed to simplify testing of electronic packages from conventional components to maximum density DIP's. They're rugged, dependable, versatile, and very easy to use. Write for our catalog and get the complete story on the whole family of Grabbers. Find out why they are your best solution to your electronic testing problems.

AVAILABLE THROUGH YOUR  
FAVORITE ELECTRONIC  
PARTS DISTRIBUTOR

## ITT POMONA ELECTRONICS

1500 East Ninth St., Pomona, Calif. 91766  
Telephone (714) 623-3463, TWX: 910-581-3822



CIRCLE NUMBER 98



## PACKAGING & MATERIALS

### Shielded power cords reduce interference

Belden Corp., 2000 S. Batavia Ave., Geneva, IL 60134. (312) 232-8900.

Two versions of UL-listed shielded power cords and cord sets are designed to minimize electronic interference in the power supplies of business machines, and test equipment. The shielded cords reduce the need for filtering devices on sensitive electronic test equipment and office machines using microprocessors. Two types of shielding are available on the cords—Beldfoil® with a drain wire, or copper serve shielding. The cords are SJT-type, 14 to 18 gauge, with three stranded copper conductors. Heavy-duty vinyl plugs are molded onto the cords. Ratings for the 14, 16, and 18 gauge cords are 125 V and 15, 13 and 10 A, respectively. Cords sets are available with female plugs or connectors. The cords are UL-listed under Section 62 and have received approval from the Canadian Standards Association.

CIRCLE NO. 356

### Induction motor for fans adjusts speed to altitude

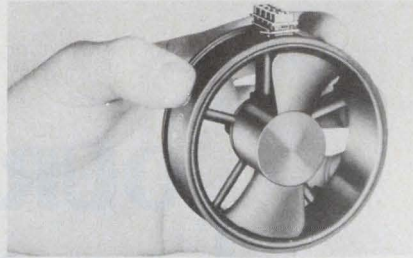

Rotron Inc., Woodstock, NY 12498. (914) 679-2401.

Cooling fans for avionic applications, where altitudes at which the fans operate vary from sea level to several miles high, will automatically adjust blade speed to compensate for air pressure changes when equipped with Rotron's Altivar induction motors. The motor automatically changes shaft speed with variations in load over a range of 5% to 90% of synchronous speed. Conventional fans designed to deliver the required amount of air at 50,000 feet would be greatly oversized for sea-level performance and power required would be too high.

CIRCLE NO. 357

### Plastic tubing replaces conventional EMI shielding

Emerson & Cuming Inc., Canton, MA 02021. (617) 828-3300. See text.

A series of conductively or magnetically-loaded flexible plastic hollow tubular extrusions known as Eccoshield® FC can be used to suppress electromagnetic interference along wires or cables. These materials are used around vacuum tube filament leads or unshielded high-voltage wires to reduce the transmission of rf signals generated at one point which may be unwanted elsewhere. And, they can be used as replacements for conventional EMI filters and ferrite transmission line beads. Shielding against radiated energy is also provided by these filter tubes, particularly by the conductively-loaded type. All types are available sheathed in a highly conductive silver containing resin. The sheathed tubing is preferred for shielding applications. Eccoshield FC can be supplied in a wide range of extrusion sizes. In quantities of 1-49 feet, Eccoshield FC has a price range of \$1.26 - \$3.42 per foot.

CIRCLE NO. 358

The Head-Start 16K ROM.

# Beat the pack to your market.

Synertek's two-week turnaround on the SY2316B (Intel's 2316E), the SY2316A, or the SY4600 gives you the head start you need to beat the pack to the market.

**If you want to lead, you have to get the quickest start.**

Synertek gives you that quick start to 16K ROM production by maintaining a ROM inventory that needs only the last custom mask before

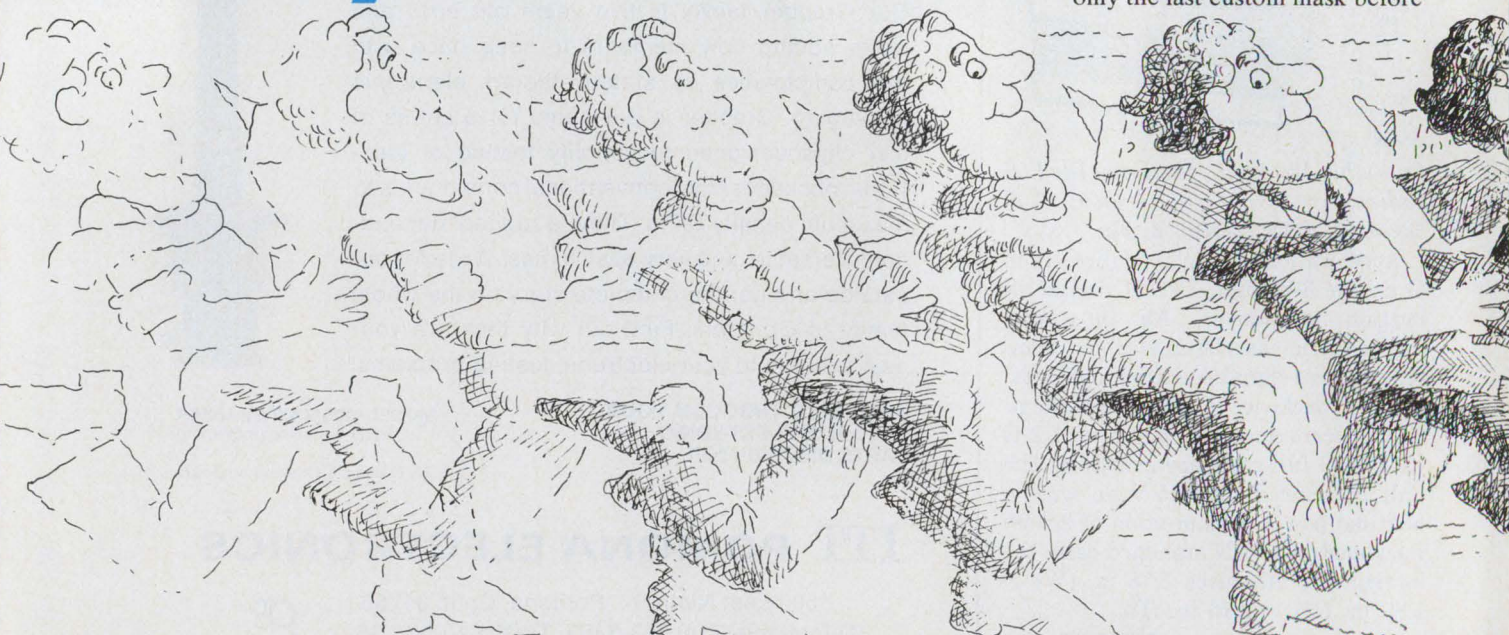



## Miniature connector has dense polar connections

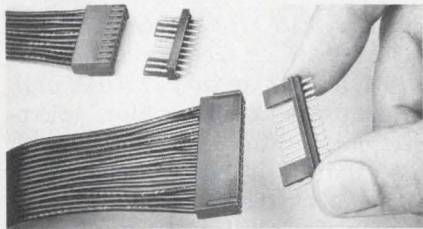

Method Electronics Corp., 1700 Hicks Rd., Rolling Meadows, IL 60008. (314) 392-3500.

High density, positive locking and polarized interconnections are features of the POL-R-LOK miniature connector. The small header and mating crimp receptacle are available with 2 through 28 positions on 0.100-in. centers. Either straight or right angle 0.025-in. square pins are available on the headers and the receptacle has bellows contacts that can accommodate 22 to 30 AWG leads. Standard contacts are tin-plated brass, but gold plated over nickel brass contact are also available. Nominal current rating at maximum 250 V ac is 2.5 A.

CIRCLE NO. 359

## $\mu$ P and dishwasher join to form PCB cleaning system

Electronic Controls Design, Inc., 13626 S. Freeman Rd., Mulino, OR 97042. (503) 656-0604.

A high quality front-opening commercial dishwasher with a heavy-duty stainless steel tub and a microprocessor-based programmable control unit have combined to yield a PC board cleaning system, the Model 620 $\mu$ P. Length of wash time, percentage of chemical concentration, and number of rinses are entered into the microprocessor from front panel thumb-wheel controls. A large-size 4-digit LED display reads out the entered limits, then switches to continuous readout of remaining cycle time as soon as the Start button is pressed. The wash cycle is preceded by a 3-minute pre-rinse using 160 F Clear water, primarily to bring circuit boards up to wash temperature. Addition of chemical concentrates is fully automatic, and the supply tank is continuously monitored. An audible signal warns when the chemicals are depleted.

CIRCLE NO. 360

## Soldering iron is small and works on low voltage

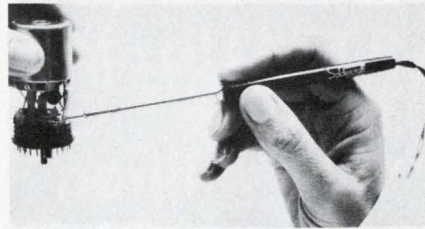

Mitchell-Hughes Co., 7534 Atoll Ave., North Hollywood, CA 91605. (213) 983-2535.

The Soldercraft Model 6A is a miniature low-voltage production soldering iron designed for microcircuit and fine instrument work. It is 6 in. long and weighs only 1/4 oz. The soldering iron, when powered by a multitap 18 W low-voltage transformer, will provide controlled temperatures of 700 degrees at 6 V, 625 degrees at 5.5 V, 555 degrees at 5 V and 480 degrees at 4.5 V from its 3/32 tip. The pencil size and light weight reduces operator fatigue. Heat is generated entirely within the tip resulting in maximum efficiency and fast heat recovery.

CIRCLE NO. 361

delivery to you. Your data base (tapes, card, EPROMS, etc.) is used to generate verification media, test tapes, and the last mask in about a week. A few days later, we ship your ROMs.

### Two weeks is the promise.

This whole technique of last mask programmability permits us to deliver your prototypes two weeks

after verification. This gives our customers great flexibility in adapting their hardware for new options, software changes or last-minute schedule changes. In your market and ours, the race belongs to the swift.

We're in the business of responding to reality. Today's reality is that everybody needs everything *yester-*

*day*. We can't quite do *that*, but we can give you an extra week or two of ROM lead time. It's up to you to convert it into time in the sun.

Call your local Synertek rep or distributor or call Larry Hester at the factory. 3050 Coronado Drive, Santa Clara, CA 95051. (408) 984-8900. TWX 910-338-0135.

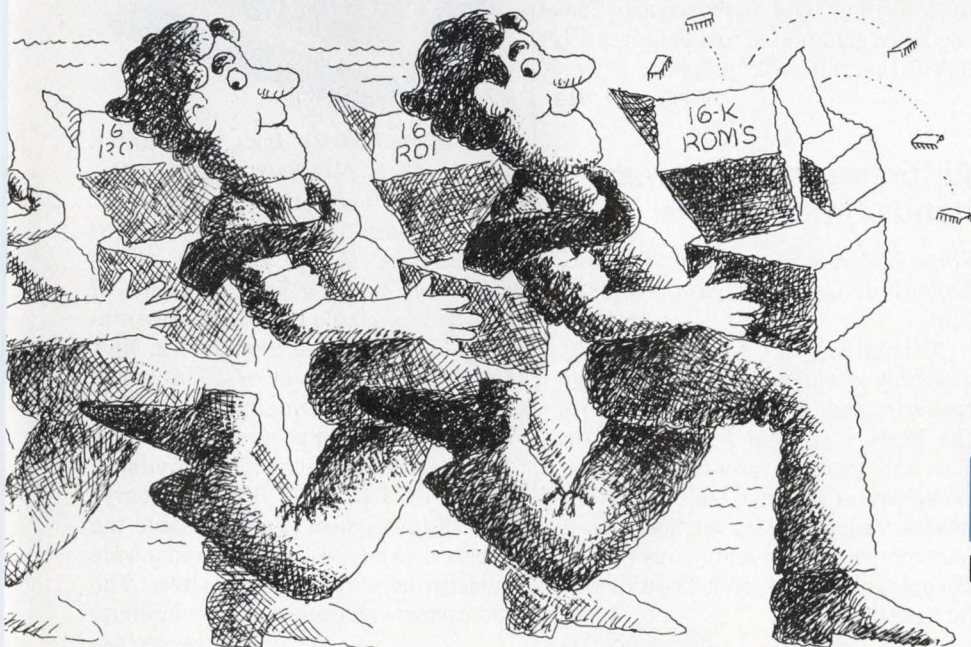

CIRCLE NUMBER 99

**Synertek.**  
**Solutions.**  
**Not problems.**



Get .09 to  
117.0 lb.-in.  
Torque  
100 million  
times

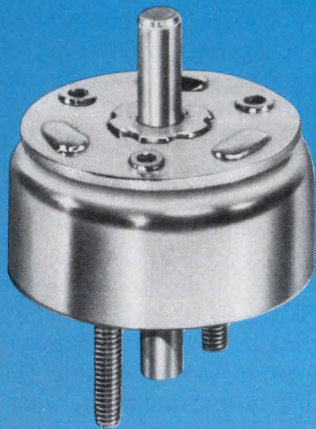

A rotary solenoid will give you direct rotary stop-and-go action without complicated linkages or circuitry. It's simple, has superior shock and vibration resistance, high torque to size ratios, and provides rated torque over the full stroke.

Ledex invented it. We invented the way to make it smaller and more efficient. We invented the way to improve reliability and extend duty life. We're the primary source when reliable quality and delivery are important.

250 standard models in stock for prototype work, ship in 48 hours. 117.0 to .09 lb.-in. torque range. 25° 35° 67½° and 95° strokes, DC or 115VAC rectified power.

Send your requirements for any prototype unit.

Ledex Inc., 123 Webster Street,  
Dayton, Ohio 45401.  
Phone: 513-224-9530.



CIRCLE NUMBER 100

## PACKAGING & MATERIALS

### PCB copper cleaner works in a hurry

Shipley Co., Inc., 2300 Washington St.,  
Newton, MA 02162. (617) 969-5500.

A fast-acting acid cleaner, has been designed that will remove photoresist residues, light oxides, oils, fingerprints, and organics from copper surfaces prior to electroplating. Intended for use in the manufacture of PC boards, Acid Cleaner 1118 is an acid aqueous solution with a pH of approximately 1.0. In use a bath is maintained between 130° and 160° F, and panel immersion time is from 3 to 5 minutes. The yield is typically 20,000 square feet per gallon of concentrate.

CIRCLE NO. 362

### Low-cost circuit carriers protect expensive ICs

Augat Inc., 33 Perry Ave., Attleboro,  
MA 02703. (617) 222-2202. \$2.86:  $\mu$ P carrier, \$1.72: PROM carrier (100 qty); stock.

Two circuit carriers protect expensive microprocessors and PROMs. Multiple insertions and withdrawals of these devices can damage fragile leads with conventional socketing techniques. To protect them, the 40-pin microprocessor or 24-pin PROM is installed in the carrier, and the entire package is plugged into an IC socket or packaging panel. The carrier design is similar to Augat's 500 Series IC sockets. But they have a smaller diameter pin of phosphor-bronze base material to withstand a high number of insertions and withdrawals. Contacts are gold plated and held in a UL 94V-0 thermoplastic polyester body.

CIRCLE NO. 363

### Air pressure unit powers hand crimping tools

Force Electronics, 343 S. Hindry Ave.,  
Inglewood, CA 90301. (213) 776-1324.  
\$400.

"Crimptitis," the pain suffered by assembly workers from frequent hand tool crimping, can be eliminated with the Force Universal Power Crimper. The unit uses air pressure to power crimp 90% of the hand tools most often used in crimp to wire applications. A foot control is used and leaves both of the operator's hands free. The unit sells for under \$400.

CIRCLE NO. 364

### Substrate connectors handle up to 81 contacts

Elco Corp., 2250 Park Place, El Segundo,  
CA 90245. Bennet Brachman (312)  
675-3311. \$0.07 per contact (OEM qty).

Connectors designed for micro-electronic substrates, Series 8403, with 0.365 and 0.51-in. contact spacing can be mounted either by soldering, press-fit or a combination of press-fit and reflow soldering. And they're available as individual components or as part of a complete connector package. The connectors accept 0.025-in. ceramic substrates, 0.031-in. glass-epoxy cards or other substrates of a compatible thickness, such as flexible circuits, glass and plastic packages. Up to 81 contact positions are available; standard sizes are 16, 40, 64 and 81. Current rating is 1.8 A at 30 C and contact resistance is 10 m $\Omega$  maximum. Contact material is phosphor bronze, per QQ-B-750 CA-510, and the insulator is polyester per UL 94 VO, glass reinforced.

CIRCLE NO. 365

### Board-assembly station speeds all PC work



Fancort Industries Inc., 111 Clinton Rd.,  
Fairfield, NJ 07006. (201) 575-0610.  
From \$140 (unit qty); stock.

A PC-board-assembly station, called Combo-Rak, allows assembly, wave soldering, cleaning and inspection of boards in a single holding-fixture station. Combo-Rak is available in four sizes to fit 10, 12, 14 or 16-in. wave-solder machines including Hollis, Electrovert and Dee machines. Adjustable 19-in. hardcoated extruded aluminum rails with 0.075 and 0.15-in. grooves and stainless steel spacers enable the operator to adjust the unit to fit a wide variety of circuit-board sizes. The aluminum rails resist solder buildup.

CIRCLE NO. 366



# 8 Bit A to D/D to A Converter - the first priced at only \$4.50\*

The Ferranti Model ZN425E—an 8 bit dual mode analog to digital/digital to analog converter features:

- Single chip monolithic construction
- Typical settling time 1.0  $\mu$ s for 1 L.S.B. step
- 8 bit binary counter, R-2R ladder network and switches
- On-chip precision voltage reference
- Self-contained, precision ramp generator
- TTL and CMOS compatible

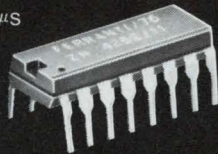

better by design

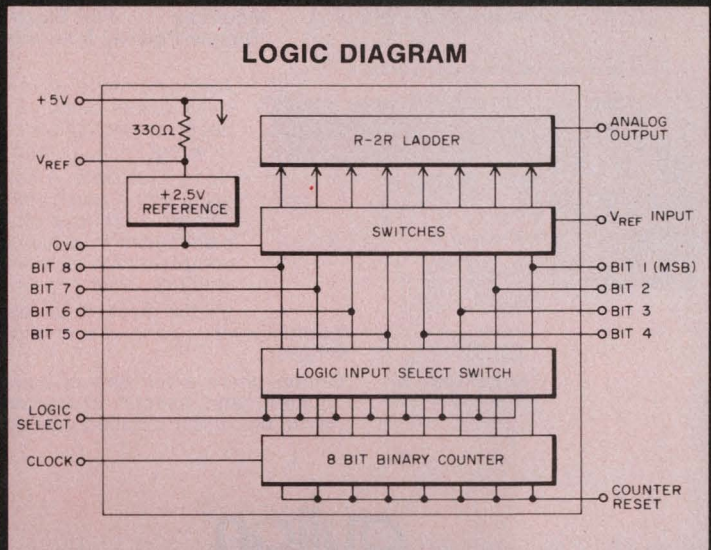

\*1000 piece price

FOR COMPLETE SPECIFICATIONS, CONTACT: FERRANTI ELECTRIC, INC. / SEMICONDUCTOR PRODUCTS EAST BETHPAGE ROAD, PLAINVIEW, NEW YORK 11803 PHONE: (516) 293-8383 / TWX: 510-224-6483

CIRCLE NUMBER 101

## MDB SYSTEMS presents... The DEC PDP-11\* Connection

GP Logic Modules · Peripheral Controllers · Communications Interfaces · Special Purpose Modules

New: MDB DR11C General Purpose Interface and MDL-11 Asynchronous Serial Line Adapter

MDB Systems products always equal and usually exceed the host manufacturer's specifications and performance for a similar interface. MDB interfaces are software and diagnostic transparent to the host computer. MDB products are competitively priced; delivery is usually within 14 days ARO or sooner.

Here are some MDB Systems connections to DEC PDP-11 computers:

- General Purpose Interfaces
  - 11C Module with 16 bit input and 16 bit output registers; 20 user wire wrap positions.

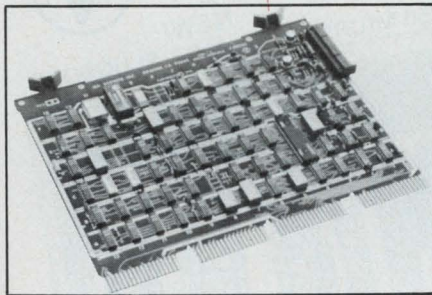

Pins and sockets optional.  
1710 Module with 40 IC positions for user logic; sockets optional.

11B Direct Memory Access Module with 12 IC positions for user logic.

DR11C, a direct DEC equivalent. Digital I/O Module.

Wire Wrappable Module with 70 IC positions, sockets optional.

Unibus Terminator.

- Communications Modules
  - MDL-11 Asynchronous Line Adapter.
  - MDL-11W Asynchronous Line

Adapter with line frequency clock.

MDU-11 Synchronous Serial Line Adapter.

- Device controllers for most major manufacturer's Printers

Card equipment

Paper tape equipment

All controllers are software transparent and use PDP-11 diagnostics.

Check first with MDB Systems for your PDP-11 computer interface requirements.

MDB also supplies interface modules for Data General NOVA\* and Interdata computers and for DEC's LSI-11 microprocessor.

# MDB

MDB SYSTEMS, INC.

1995 N. Batavia St., Orange, California 92665  
714/998-6900 TWX: 910-593-1339

\*TMs Digital Equipment Corp. & Data General Corp.

CIRCLE 271 FOR PDP-11; 272 FOR NOVA; 273 FOR INTERDATA; 274 FOR LSI-11.



# New 20 column full alphanumeric printer



Featuring Quiet Thermal Printing . . .  
64 Characters ASCII Subset . . . 2.5  
Line/Sec. Print Rate . . . Panel  
Mounting . . . Full Electronics . . .  
Simple Paralle! Interface

Alphanumeric printers don't have to use complex mechanical print mechanisms, with their inherent clicking and banging. Now, Gulon's AP-20 printer gives you a quiet, reliable, non-impact thermal printhead/print mechanism in a handsome unit complete with all electronics including power supply.

It's the most significant advance in printers yet . . . and at a price that's hard to resist.

Gulon offers a full line of alphanumeric, numeric and special character printers. Write or call for detailed catalog.

**gulton**<sup>®</sup>

Measurement & Control Systems Division  
Gulon Industries Inc., East Greenwich, Rhode Island 02818  
401-884-6800 • TWX 710-387-1500

See us at Wescon Show, Booth 1752-54.  
CIRCLE NUMBER 109

## MOUNT ANYTHING ON A VECTOR PLUGBORD

FROM RELAYS TO MICROPROCESSORS

Now Over 100 Models to Choose From, Plus Terminals, Sockets & Accessories



NEW!  
4350 MICROPROCESSOR PLUGBORD

"AN ADVERTISER IN E. D. SINCE ITS INCEPTION"

MODEL 4350 Holds 6 - 24-Pin  
Microprocessors  
PLUS 59 - 14- or 16-Pin DIPs

FOR MORE VECTOR  
See Our Pages In  
EEM  
and  
GOLD BOOK

**Vector**

— YOUR BEST CHOICE FOR MICROPROCESSOR PLUGBORDS

ELECTRONIC COMPANY, INC.

12460 Gladstone Avenue, Sylmar CA 91342 (213) 365-9661 - TWX (910) 496-1539 46476

Visit us at WESCON Booth 1535 and 1537

CIRCLE NUMBER 110

## MODULES & SUBASSEMBLIES

### High-gain dc amp drives heavy loads

*Singer, 1150 McBride Ave., Little Falls, NJ 07424. D. Katz (201) 256-4000.*

Dc amplifiers in the C703722 series contain an output-bridge circuit that drives 200-W loads. Internal resistors permit voltage or current-feedback connection, with gains of 20 V/V in the voltage mode and 0.5 A/V in the current mode. The unit operates with power from Mil-Std 704, category-B supplies and conforms to MIL-STD 202M method 204, for vibration. Output-bridge current is limited to 200 mA and is adjustable to 10 A with external resistors. The amplifier also features overload protection. 3.25 × 2.25 × 0.94 in.

CIRCLE NO. 374

### Fast 14-bit a/d units match prices to specs

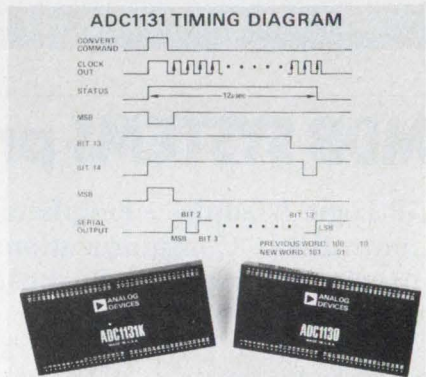

*Analog Devices, Route 1 Industrial Park, P.O. Box 280, Norwood, MA 02062. (617) 329-4700. See text; stock.*

Complete 14-bit a/d conversions take 12- $\mu$ s max for the ADC1131 and 25- $\mu$ s max for the ADC1130. Versions of the 1131 boasting accuracies of  $\pm 1$  LSB and 1/2 LSB max sell for \$279 and \$369, in 1 to 9 qty, respectively. The slower 1130 delivers accuracy of  $\pm 1/2$  LSB typ and  $\pm 1$  LSB max and sells for \$239. All units provide max gain tempo of 10 ppm/ $^{\circ}$ C and operate with no missing codes from 0 to 70 C. Both these successive-approximation modules convert analog-input voltages into natural-binary, offset-binary and two's-complement-coded outputs. Data are formatted into both parallel and serial outputs. Short-cycling connection allows conversions of less than 14 bits to take less time. 2 × 4 × 0.4 in.

CIRCLE NO. 375





# DIGITAL "TIME-OF-DAY" CLOCKS

- Manual Thumbwheel Time Setting
- Input Power – 1 Watt Nominal

PLANETGEAR® Snap Action Transfer  
and Large Digits Eliminates  
Readout Errors



- Superior Accuracy
- Extremely Reliable
- Extraordinary Life
- Panel Mount

For more information, send for our Clock/Counter catalog or get in touch with one of our sales engineers. They are always ready to help.



## HAYDON SWITCH & INSTRUMENT, INC.

1500 Meriden Road, Waterbury, Conn. 06705 (203)756-7441

CIRCLE NUMBER 104

## EXPANDED LSI-11\*

Before



After



**WE HAVE GOTTEN TOGETHER WITH  
D.E.C.'s\* L.S.I. 11  
NOW SEE WHAT IS ON THE WAY...**

Power Supplies; Packaging; RAM, EPROM & Multi-Access Memory Floppy Disk; D.M.A.; SYNCH & ASYNCH Ports; Peripheral Interfaces, CAMAC Interface; Prototype Modules & many, many others.

Write or call (415)657-7555



**STANDARD ENGINEERING CORPORATION**

44800 Industrial drive • fremont, calif. 94538 • 415 657-7555

\*Trademark Digital Equipment Corporation

CIRCLE NUMBER 105

ELECTRONIC DESIGN 18, September 1, 1977

## The fabulous Phi-Deck® family of 5 cassette transports under \$100 in quantities of 10

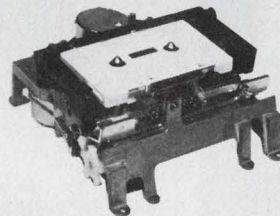

Featuring:

- Die-cast frames
- Remote controllable
- Precise, fast head engage/disengage
- Quick braking
- Search FF/rewind 120 ips
- Speed ranges from .4 to 20 ips

**Electronic packages and mag heads for most applications**

For application in:

- |                                   |                                       |
|-----------------------------------|---------------------------------------|
| 1. Micro processing               | 7. Security/automatic warning systems |
| 2. Data recording/logging/storage | 8. Test applications                  |
| 3. Programming                    | 9. Audio visual/education             |
| 4. Instrumentation                | 10. Telephone interconnect            |
| 5. Industrial Control             | 11. Hi-Fi                             |
| 6. RS-232 Data storage            | 12. Point of sale                     |



Title I Incorporated

4605 N. Stiles P.O. Box 18209  
Oklahoma City, Oklahoma 73118 (405) 521-9000

- I am interested in application no. \_\_\_\_\_
- Have Representative call  Send application notes

Name \_\_\_\_\_ Title \_\_\_\_\_

Company Name \_\_\_\_\_

Address \_\_\_\_\_

City \_\_\_\_\_ State \_\_\_\_\_ Zip \_\_\_\_\_

Phone Number \_\_\_\_\_

CIRCLE NUMBER 106



# The Seastrom Touch



30,000 part numbers in stock for immediate delivery. . . all types of washers, shims, spacers, lugs, clips, clamps, plugs, insulators, military standards, etc.

## TRY US FOR SIZE!

Send for your FREE 250 page fully illustrated 40B catalog.



## SEASTROM

MANUFACTURING CO., INC.

701 Sonora Ave. • Glendale, Calif. 91201  
(213) 245-9121 TWX 910-497-2271

CIRCLE NUMBER 107

## MODULES & SUBASSEMBLIES

### 16-bit d/a converter is crammed into a DIP

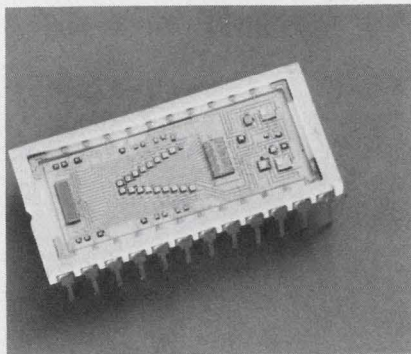

Micro Networks, 324 Clark St., Worcester, MA 01606. J. Munn (617) 852-5400. \$135 (100 qty); stock to 4 wks.

The 16-bit MN3310, is claimed to have the best monotonicity of any DIP d/a converter—14 bits over the 0 to 70-C range. In addition the hybrid converter uses only 420 mW and settles in 35  $\mu$ s. DIP, 24-pin.

Booth No. 1106 CIRCLE NO. 370

### Stable oscillators span 16-MHz range

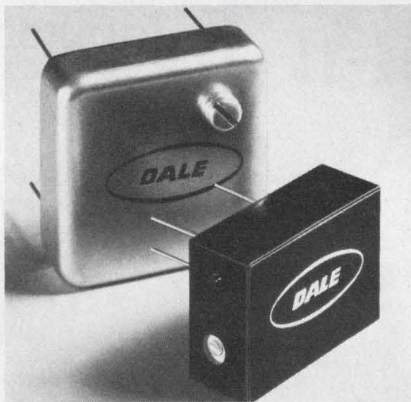

Dale Electronics, 930 W. 23 St., Tempe, AZ 85232. (602) 967-7875.

Two series of temperature-compensated crystal oscillators, the TCXO 2211 and TCXO 2200, operate in the 4 to 20-MHz range. Standard frequency stability is  $\pm 1$  ppm from  $-40$  to  $+70$  C or 0 to  $+55$  C. Both oscillator series are TTL compatible and provide a frequency-trim control for precise adjustment. The hermetically sealed 2211 series operates from 12 V dc at 15 mA and occupies  $2 \times 2 \times 0.75$  in. The epoxy-molded 2200 operates from 5 V dc and occupies  $1.75 \times 1.20 \times 0.650$  in.

CIRCLE NO. 371

### Hybrid active filter changes easily

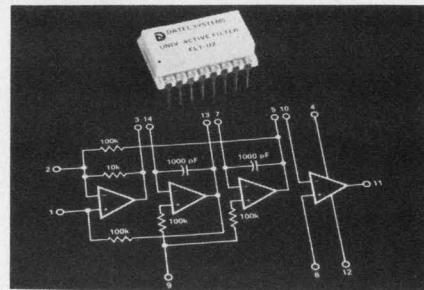

Datel Systems, 1020 Turnpike St., Canton, MA 02021. E. Murphy (617) 828-8000. \$16 (1-9 qty); stock.

With external components, the FLT-U2 active filter becomes any of the popular types like Butterworth, Bessel, Chebyshev or elliptic. The basic unit gets its second-order transfer function from three op amps, and simultaneously produces low-pass, bandpass and high-pass outputs. The hybrid 16-pin DIP also has a fourth uncommitted op amp with 3-MHz gain  $\times$  bandwidth. The filter can deliver accuracy of 5% in the range of 0.001 Hz to 200 kHz with a Q range of 0.1 to 1000.  $\pm 12$ -V input range,  $\pm 10$ -V output range.  $\pm 5$  to  $\pm 18$ -V power-supply range. 0 to 70-C operation.

CIRCLE NO. 372

### Optical encoder mounts directly to motor



Gould, 340 Fordham Rd., Wilmington, MA 01877. (617) 658-5410.

Kit-Coder, a modular encoder, mounts directly onto the servo motor, thus eliminating a coupling and separate bearings. The encoder consists of a glass disc on an aluminum hub that mounts on the motor shaft, plus a module containing an LED light source and phototransistor. Up to three channels, with or without, electronics are available in a 1-1/2 in. diameter case. Line counts of up to 1000 pulses per rev are available. The Inconel-deposited pattern on the glass disc prevents wipe-outs during installation. The gap between disc and sensor is between 0.005 and 0.01 in. Each sensor has an individual light source.

Booth No. 2029

CIRCLE NO. 373



**MEPCO/ELECTRA**

# SPR 5000 Y

**RESISTOR...  
ONE SIZE  
ONE STYLE**

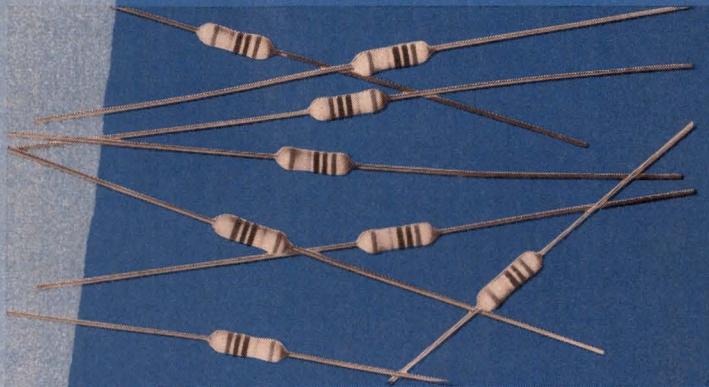

## **For all standard precision applications**

You're looking at the state-of-the-art in discrete film resistor technology. Mepco/Electra's SPR 5000 Y—the only resistor that gives you everything you need for all your 1%, 100 PPM applications ... in one size, one style.

Whether you're building automotive, instrumentation or communications equipment, with all the tight space requirements, high power handling capabilities, and broad range of values these applications require, you'll find what you need in SPR 5000 Y ... with this big plus—reduced resistor inventory.

**MEPCO/ELECTRA SPR 5000 Y:**

**DUAL RATED**—1/4W & 1/2W.

One resistor can be used in both 1/4 and 1/2W applications, which means dual power handling capability in the smallest possible size.

**BROADER RESISTANCE RANGE**—10  $\Omega$  to 22 M $\Omega$

Widest resistance range for any resistor with comparable tolerance and T.C.'s.

**REPLACES RN55, RN60 and RN65—**

Perfect replacement for these MIL styles with the added plus of a broader resistance range, dual rated ... and at a better price.

**CWV**—350V Max.

**STANDARD TOLERANCE**—1%

**STANDARD T.C.**— $\pm 100$  PPM ( $\pm 50$  PPM available)

In the market for a standard precision resistor that offers better than standard specs? Find out about SPR 5000 Y. For more information ... Call M/E at (817) 325-7871. Or write Mepco/Electra Inc., P. O. Box 760, Mineral Wells, Texas 76067.



See us at the WESCON Show  
CIRCLE NUMBER 108



### Crystal filter has switchable bandwidths

CTS Knights, 400 Reimann Ave., Sandwich, IL 60548. (815) 786-8411. \$23 (1000 qty)

The bandwidth, of the 8-pole crystal filter, switches electrically from wide-band AM to narrow-band SSB when 7-Vdc at 50 mA is applied to the switch

terminal. Min 3-dB bandwidth is 6 kHz in the AM mode and 2.7 kHz in the SSB mode. Center frequencies range from 10 to 13 MHz. Other operating characteristics include a temperature range of -20 to +60 C, min bandwidth at 3 dB of 6 kHz with the switching current off and 2.7 kHz with the switching current on. Termination is either 50-Ω, resistive; or 2.5-kΩ and 4.8 pF, natural. Max center-frequency drift is 20 ppm. 0.688 × 2.375 × 1 in.

CIRCLE NO. 367

### Interface option adds ASCII communications

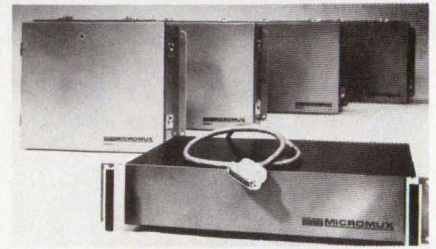

Burr-Brown, International Airport Industrial Park, Tucson, AZ 85734. (602) 294-1431. See text; stock to 60 days

The MM6116, an RS-232C interface receiver with a switch-selectable baud-rate option, gives serial ASCII communications capability to the company's remote data-acquisition system and permits interfacing with intelligent peripherals, process control μPs, minis and CPUs. The unit provides switch-selectable 110, 150, 300, 600, 1200 or 2400-baud rates. This is in addition to two and four-wire, 20-mA current-loop operation of the basic package. The interface's clear-to-send feature allows computers to take data from the system in character or block increments. A basic 16-channel, remote, data-acquisition system, with the interface receiver costs \$2490.

Booth No. 1065 CIRCLE NO. 368

### 8-bit converter ties right onto data bus

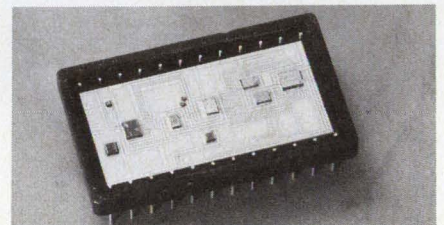

Micro Networks, 324 Clark St., Worcester, MA 01606. J. Munn (617) 852-5400. From \$75 (unit qty); stock to 4 wks.

Three-state outputs allow the 8-bit MN5150 to interface directly with the data bus of popular 8-bit μPs. Additional features include 2.5-μs conversion time, seven selectable input ranges, both unipolar and bipolar, and an internal reference. Other important parameters of the hybrid DIP converter are no missing codes from 0 to 70 C (-55 to +125 C for the H version); consumption of 680 mW and TTL-compatible control inputs and outputs. Both serial and parallel-data outputs are available. The converter can be short cycled for faster conversion with lower resolution.

Booth No. 1106 CIRCLE NO. 369

**No. 2**  
 IN A SERIES  
**LOW NOISE**  
**MICROWAVE TRANSISTOR**  
 UPDATES FROM AVANTEK

$G_{NF}$ : 9.5 dB  
 $NF_{opt}$ : 3.0 dB  
 $I_c$ : 5 mA  
 Frequency: 4.0 GHz  
**Avantek AT-4690**

**Guaranteed Specifications**

Type	$NF_{opt}$ dB (max)	$G_{NF}$ dB (typ)	$I_c$ mA	$G_{max}$ dB (min)	$I_c$ mA	$f_{test}$ GHz	$f_T$ GHz (typ)
AT-4690	3.0	9.5	5	12	15	4.0	8.5

**Excellent Noise Figure, Gain and Dynamic Range**

The designer need only look to the typical performance curves of Avantek's AT-4690 to determine it's exciting potential. High gain and low noise figure, even at current levels up to 20 mA! Now you can design amplifiers with fewer stages and get more usable power.

The Avantek 70 mil stripline package is as dependable as the 4690 it contains. All Avantek transistors feature superior gold metallization and hermetic sealing to ensure consistent, reliable performance.

Availability? Of course! Remember Avantek is only a phone call away. Orders placed by noon will normally ship the same day.

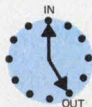

**Fast Delivery**

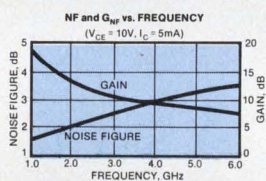
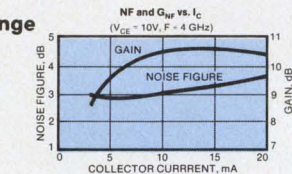

Contact: Avantek Transistor Applications Engineering (408) 249-0700

3175 Bowers Ave., Santa Clara, CA 95051 TWX 910-339-9274 Telex: 346 377

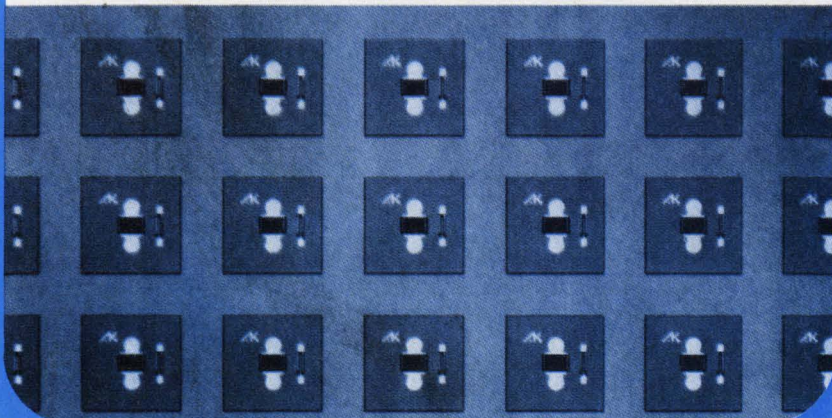

CIRCLE NUMBER 103



# NEW FROM BISHOP!

## TECHNICAL MANUAL & 106 Free! CATALOG

Featuring The World's Largest Selection of PC Drafting Aids

- NEW Expanded & Separate Technical Reference Data Manual
- Hundreds of Work-Saving Tips & Ideas
- Over 15,000 PC Drafting Symbols & Tapes
- Custom PC Patterns & Symbols Made To Your Specifications
- NEW Precision Grid Line
- NEW PUPPETS™ PC Layout System Patterns & Sizes
- NEW PreKut Tape Shapes



Over 120 Pages!  
Includes Product Samples

- NEW Precision Slit PC Artwork Tape
- NEW "TO" Symbols
- NEW Reduction Marks
- NEW Prespaced Pad Patterns
- NEW Reference Designation, Letter & Number Kits
- NEW Color Core Width Coding
- NEW Dual In-Line Patterns
- NEW Continuous Connector Patterns



Call Or Write For Your Free Copy

### Bishop Graphics, Inc.

5388 STERLING CENTER DRIVE, P.O. BOX 5007  
WESTLAKE VILLAGE, CALIFORNIA 91359  
PHONE: (213) 991-2600 / TELEX: 66-2400

CIRCLE NUMBER 111

## NYLON CAPTIVE STANDOFF

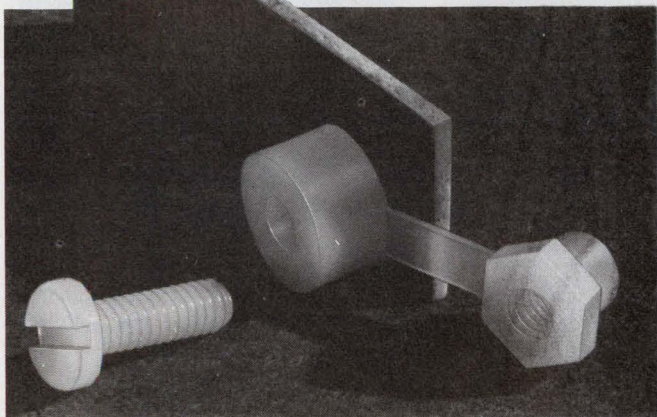

Designed to eliminate mounting problems in hard-to-reach locations. Especially suited for use as a spacer in separating or stacking PC boards ... also for any type of application requiring components to be rigidly mounted and at same time be electrically isolated. All nylon ... 4 sizes, 1/4", 3/8", 1/2" and 1", for both 6-32 and 8-32 screws.

**FREE SAMPLES** — write for sample packet, literature and prices.

### Weckesser COMPANY, Inc.

4444 West Irving Park Road • Chicago, Illinois 60641 • 312/282-8626

CIRCLE NUMBER 112

ELECTRONIC DESIGN 18, September 1, 1977

## A CRT Yoke for all reasons

### Military

Airborne (HUD, HDD, VSD, HSD), shipboard, ground systems, missile systems.

Compact, lightweight, encapsulated to withstand physical stress. Special ferrite core designs.



### Commercial

Computer terminals, monitors, medical applications, hard-copy machines, etc.

Engineered and tooled for volume production. Cost-effective and geometry corrected.



### Special Designs

Phototypesetting, random graphics, flying spot scanners, mappers, vidicons.

Designed for low residual and superior resolution using special assembly techniques.



Send us your reasons for needing a better yoke. We'll supply technical data sheets, recommendations, engineering assistance.



# syntronic

Syntronic Instruments, Inc.  
100 Industrial Road, Addison IL 60101  
Phone (312) 543-6444

See Pages 405 to 408 in EEM

CIRCLE NUMBER 113



# DATASTAR

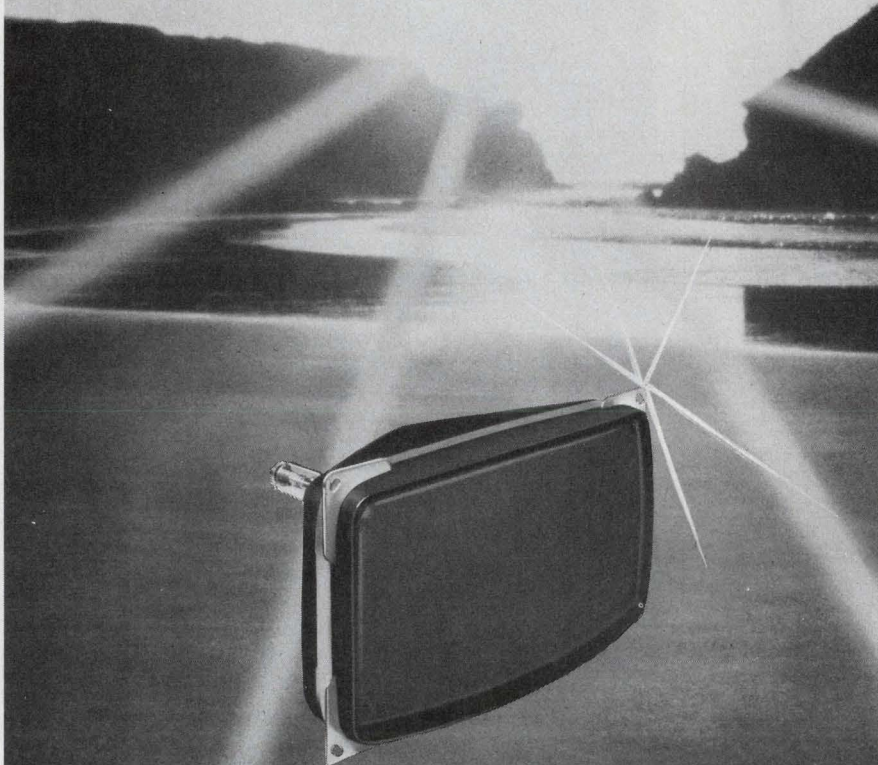

the bright new answer to data viewing problems, available only from CLINTON... THE ANSWER PEOPLE IN CRT'S. Clinton's new DATASTAR high Contrast Phosphors (available in versions of P-4 and P-31) are the first and only phosphors developed specifically for information display applications.

With Clinton's new DATASTAR high contrast phosphors the operator does not have to adjust the tube to a high brightness level in order to achieve good readability under high ambient light conditions. This also means less spot distortion and delayed screen/phosphor discoloration, common to alpha-numeric displays. In addition, DATASTAR phosphors are significantly more resistant to discoloration, therefore the Clinton CRT has a longer useful field life.

Combine the advantages of DATASTAR phosphors with Clinton's high resolution SUPERTUBES, and you have a CRT display unequaled in quality and performance. DATASTAR... Just one more innovation from CLINTON... THE ANSWER PEOPLE IN CRT'S.

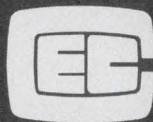

**CLINTON  
ELECTRONICS  
CORPORATION**

6701 Clinton Rd., Rockford, Ill. 61111 Phone 815-633-1444 Telex 257-484

CIRCLE NUMBER 114

## POWER SOURCES

### Switchers deliver popular voltages

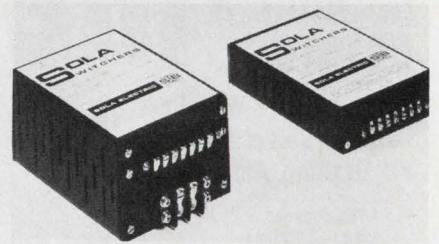

Sola Electric, 1717 Busse Rd., Elk Grove Village, IL 60007. I. Roane (312) 439-2800. \$169.15 to \$254.15 (50-90 qty); stock.

Four high-frequency switching-regulator dc power supplies in the 86 series deliver 5 V at 10 or 20 A and  $\pm 12$ ,  $\pm 15$  V at 1.5 A. They feature 75% efficiency for the fully loaded 5-V output at nominal input-line voltage (115 or 230 V ac). The units are convection cooled, and are short-circuit proof. Tracking outputs; no audible noise. 1.7 lb;  $6.5 \times 4.5 \times 1.5$  in.

Booth No. 4004

CIRCLE NO. 376

### 12-V gel battery is line's most powerful



Power Sonic, P.O. Box 5242, 3106 Spring St., Redwood City, CA 94063. B. Ender, (415) 364-5001. \$4615 (1 to 9 qty); stock.

A sealed rechargeable gel-type battery, the model PS-12200, delivers 12 V for 20 Ah. This makes it the most powerful of the 15 others in the company line. Features of the maintenance-free unit include: a self-discharge rate of 0.1% per day, an operating range from  $-40$  to  $+140$  F. An internal resistance of 24 m $\Omega$  when the battery is fully charged and a max discharge current of 100 A with standard terminals. The 17.6-lb dc source is leak-proof and usable in any position.  $6.89 \times 6.54 \times 4.92$  in.

Booth No. 1059

CIRCLE NO. 377



## Fault relay adjusts for current, delay



Gould, 501 Office Center Dr., Fort Washington, PA G. Bond (215) 628-7637.

Adjustable for both current sensitivity and time delay, the GRC-100 ground-fault relay can be set, at seven discrete steps, for 100 A to 1200 A and at six separate time delays, from instantaneous to 0.5 s. The ground-fault relay works together with the company's TMC test and monitor panel. The monitor provides determination of system status and tests a circuit without interrupting service. The monitor's magnetic target shows if the relay has tripped and the pilot light indicates that control power is available to actuate the breaker. The target maintains the correct indication even if control power is removed. The units are used in conjunction with appropriate ground-fault sensors.

Booth No. 2029

CIRCLE NO. 378

## Power-failure tester interrupts 3- $\Phi$ lines

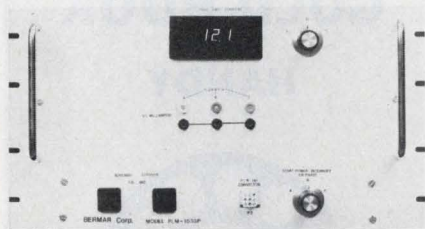

Bermer, Box 1043, Nashua, NH 03060. (603) 888-1300. \$3200; 3 to 6 wks.

Simulate power failures, in 3-phase systems of up to 40-A per phase, with the Model 1033P ac-power interrupter. You can also test the ability of systems to recover from power failures of various durations. The unit interrupts 3-phase power for any duration from one half cycle to 999 half cycles on a one-shot or repetitive basis. A true-rms digital voltmeter on the panel measures current in any of the phases and current-output-sampling jacks allow observation of one, two or all three phases.

CIRCLE NO. 379

# Be sure you're using the most up-to-date GE miniature lamp design data.

Out-of-date information could affect your designs adversely and new data on new lamps could lead the way to new ideas. Take a minute to check the dates on these seven catalogs be sure you've got the most up-to-date information at your fingertips, and help you pick the best GE miniature lamps for each of your design needs.

- All catalogs are free.
- Data and information is current.
- Organized for quick, easy, accurate reference.
- Saves you valuable time.



#3-5257-R

### Halogen-Cycle Lamps

Revised April, 1977. The 12 pages feature greatly expanded data including lamp specifications, characteristics, design considerations and selection guide.



#3-7070

### Miniature Lamps

Revised April, 1977. Features almost 100 new lamps not previously listed; covers almost 600 lamps, 40 pages.



#3-5259R2

### All-Glass Wedge Base Lamps

Revised March, 1977. Contains all specifications and data for 11 newest wedge base lamps plus revised drawings and engineering specifications on the full line.

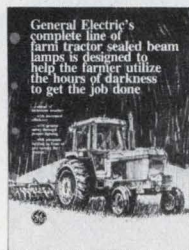

#3-6383

### Farm Tractor Sealed Beam Lamps

Revised September, 1976. Four pages feature the expanded line farm equipment, including diagrams of lamp beam patterns.



#3-6016

### Sub-Miniature Lamps

Revised May, 1976. Includes latest data on more than 194 lamps of 1/4" diameter and smaller, 28 pages.



Form 5000

### Miniature, Sealed Beam and Glow Lamps

Revised February, 1976. Features 36 pages of technical lamp data covering 950 lamps, both miniature and sealed beam. Lists lamps in numerical order.



#3-5211

### Sealed Beam Lamps

Revised September, 1975. Lists electrical and physical specifications, applications and numerical index in 16 pages.

## To get your free GE lamp catalogs today.

Call your local GE Miniature Lamp Products Dept. Specialist. Or write: General Electric Miniature Lamp Products Dept. #3382, Nela Park, Cleveland, Ohio 44112.

**GENERAL ELECTRIC**

CIRCLE NUMBER 115



MILITARY APPLICATIONS

# AD CONVERTERS

by

# MSK

Accuracy

Speed

Size

Repairability

Military

Temp. Range  
-55°C to +125°C

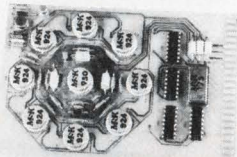

- 4 Bit/50 nSec; Low Cost
- Ideal for Radar Scan Converters
- Holds Absolute Accuracy Over Temperatures
- Tracks a 10 MHz Analog Input

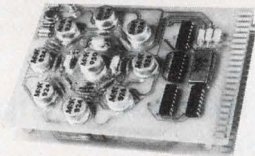

- 9 Bit/200 nSec.
- < 2 Bit Drift Over Temperature
- Insensitive to Clock Frequency

For Further Information Call or Write  
**M.S. Kennedy Corp.**

Pickard Drive, Syracuse, New York 13211  
Tel. 315-455-7077

CIRCLE NUMBER 116

## POWER SOURCES

### Small UPS span 500 to 1000-VA range

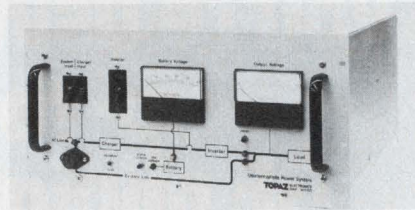

*Topaz Electronics, G. Williams, 3855 Ruffin Rd., San Diego, CA 92123. (714) 279-0831.*

Models in the 82000 series of uninterruptible power systems supply 500 VA, 1000 VA and 1500 VA for 60-Hz applications, and 400 VA for 50-Hz applications. Standard models feature system voltmeters and system-status monitoring and control indicators. Options include a 1/4-cycle static-transfer switch, a battery-float-equalize switch, a low-battery audible alarm and an acknowledgement switch. Standard 19 in. rack-mounted battery modules using sealed, maintenance-free batteries are available. Any 72-V lead-acid or nickel-cadium battery bank may be used to supply the back-up for times of up to 8 h. 100 to 146 lbs.

Booth No. 4020 CIRCLE NO. 380

### Metered bench supply has 2-A capacity



*Electro Industries, 4201 W. Irving Park Rd., Chicago, IL 60641. Nathan Schwartz (312) 736-0999. \$99 (unit qty).*

The Model 3002A offers constant voltage and constant current operation in two selectable ranges, 0 to 15 or 15 to 30 V dc. Line regulation is 0.1% for ±10% line changes, and load regulation is 0.5% from no load to full load. The series-regulator circuit uses two temperature-compensated zener diodes to maintain long term stability and limit ripple voltage to 250 μV rms. Additional units can be connected in series or parallel for higher output capability. The output can be floated for positive or negative operation.

CIRCLE NO. 381

“CUT - BEND”

### New Cutting and Bending Unit for Components

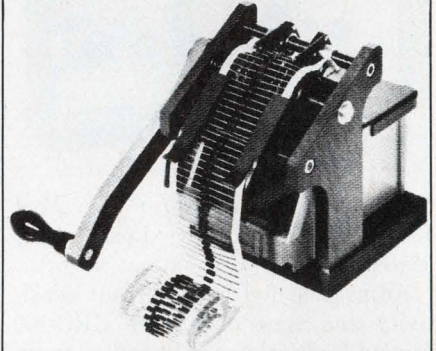

This new system (patent pending) made it possible to offer a low cost unit of very high efficiency. With each crank turn 24 components are cut to length and bent from the roll, giving more than 20,000 components per hour.

Technical data:

The cutting/bending wheels resp. leglength of components (from stock) = 4, 5, 6 or 10mm. Wire diameter: up to 1mm. Spacings: from 5 to 40mm. Fixation: very easy with screw clamp. Sizes 145mm wide, 160mm high, 175mm long. Representative sought.

**Suter-Elektronik**

Arvenweg 16, CH-3604 THUN/Switzerland  
Tel. 033/36 47 87

CIRCLE NUMBER 117

## KEEP

Electronic Design's

# GOLD BOOK

## HANDY

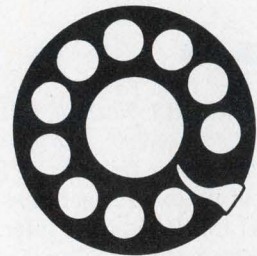

### When You Call

Save time when you contact suppliers. Check their catalog pages first in *Electronic Design's* GOLD BOOK. Maybe the information you need is right at your fingertips.



## DATA PROCESSING

### Thermal printhead handles 14 columns

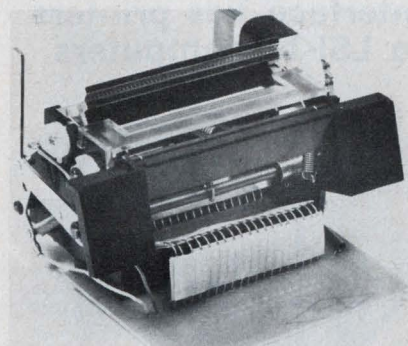

Facit-Addo Inc., 66 Field Point Rd., Greenwich, CT 06830. (203) 622-9150.

A 5 × 7 matrix alphanumeric printhead, the 4506 has a 14 column capacity, line spacing of 4.5 mm, and a printing speed of 2 lines/s. Printing on temperature-sensitive paper, the unit has a single moving part—the line-feed solenoid. The printhead can be incorporated into calculators, cash registers, and measuring or data logging systems.

CIRCLE NO. 384

### Scanner reads bar code



Skan-A-Matic, P.O. Box S or Route 5 West, Elbridge, NY 13060. R. P. Walker (315) 689-3961. \$1400.

A 2-of-5 bar code reader which offers a wide choice of optical scanners, signal conditioners and outputs has been designated the V11010, and is available as a complete system or in any combination of its components. The V11010 detects the change in reflected light between the bars and spaces of Skan-A-Matic's 2-of-5 bar code. Signal-conditioning circuitry converts the input to a square-wave signal. Special output circuitry permits direct interfacing to printers, teletypewriters and computers.

CIRCLE NO. 385

### Slower speed increases paper tape punch life

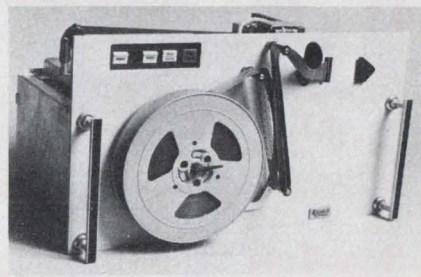

Remex Div. Ex-Cell-O Corp., 1733 Alton St., Irvine, CA 92713. (714) 557-6860. P&A: see text.

Series 6075 paper tape reader/punches have a longer life resulting in part from a punch rate of 75 char/s, compared with 120 char/sec for the older 6120 Series. Remex estimates the punch mechanism will maintain its longitudinal registration for 25 million characters. The reader mechanism operates asynchronously at up to 300 char/s, or continuously at higher rates. Prices are \$2150 for perforator-only models, \$2675 for a fanfold reader/punch, and \$2750 for a roll-tape reader/punch, with delivery in 60 days.

CIRCLE NO. 386

# PYROFILM MAKES IT!

## HIGH VOLTAGE RESISTORS

- Up to 40,000 Volts
- 10 sizes
- Up to 1,000M Ohms
- Temp. Coef. as low as  $0 \pm 100$  PPM/°C
- Up to 5¼ Watts

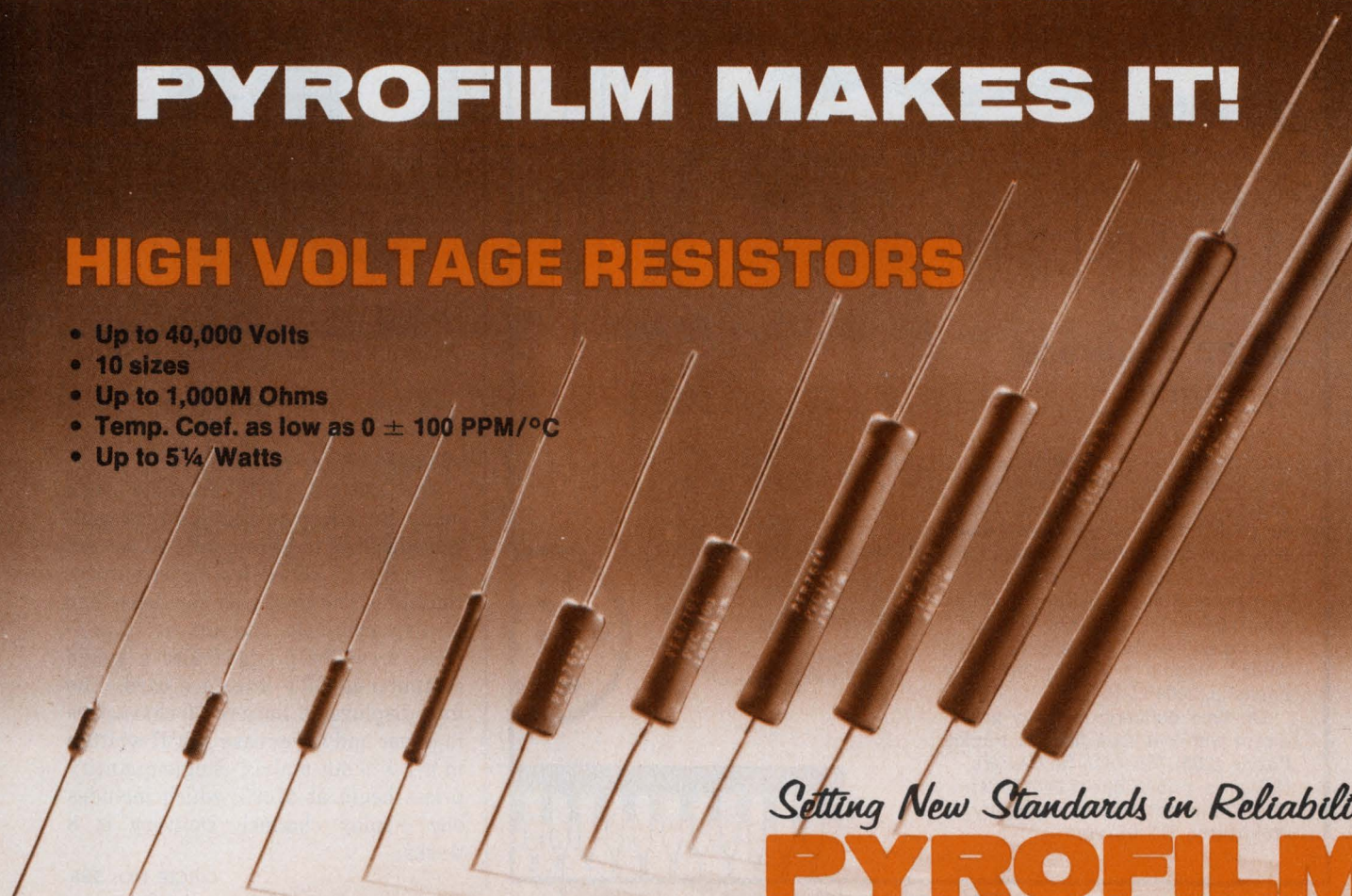

Setting New Standards in Reliability  
**PYROFILM**

60 S. Jefferson Road • Whippany, N. J. 07981 • (201) 887-8

CIRCLE NUMBER 118



# M-tron Quartz crystals



AT CUT Crystals 800 KHz to 200 MHz

#### COMMERCIAL

- Nation's largest capacity for commercial use crystals.
- Frequencies available for:
  - CB, Toy and Scanner Radio applications.
  - Color TV, Video Games and Clock applications.
  - Microprocessor and Mini-computer applications.
- Computer-aided Crystal Design Program assures fast delivery.
- 100% Quality Audit of Critical Parameters.

#### HIGH RELIABILITY

- QPL approvals to MIL-C-3098.
- Advanced hermetically sealed packaging techniques.
- Frequencies available for Avionic and Marine Radio applications.

PHONE 800-843-6842 • TWX: 910-668-3603

**M-tron** INDUSTRIES, INC., Box 630, Yankton, S.D. 57078  
A Div. of Lynch Corp.

CIRCLE NUMBER 119

## DATA PROCESSING

### Interface ties printers to LSI-11 computers



*Houston Instrument Div. of Bausch & Lomb, One Houston Square, Austin, TX 78753. (512) 837-2820. \$1150, 30 days.*

The 012 interface mounts in a 4-slot-wide card position in an LSI-11 computer mainframe or extender chassis. The interface contains all the logic and hardware, including cable, to control an 8200 Series line printer and respond to PDP-11 Unibus commands.

CIRCLE NO. 387

### Controller drives four CRT computer displays

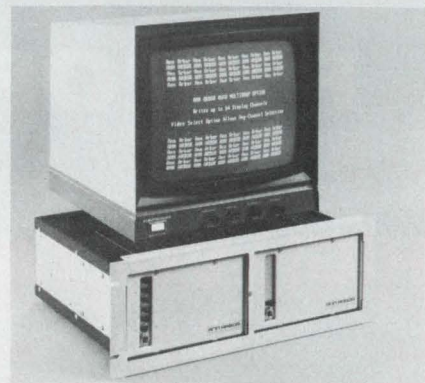

*Ann Arbor Terminals Inc., 6107 Jackson Rd., Ann Arbor, MI 48103. (313) 769-0926. P&A: See text.*

The R2050R CRT controller with quad multidrop option permits multiple displays to be remotely addressed and written over a single communications line. The controller can drive four display channels and up to 16 controllers can be plugged into a single computer-to-CRT interface card. The unit displays 20 lines of 50 characters in upper and lower case ASCII written in a 7 x 9 dot matrix. Single quantity prices begin at \$1095, which includes one display channel. Delivery is 8 weeks.

CIRCLE NO. 388

Specify

thinsheet

when accuracy  
is critical

Thinsheet can provide thin gauge strip rolled to your tolerance requirements... no matter how exacting they are. Specify the best for your components, printed circuits and semiconductors: Thinsheet. In copper, brass, bronze, phosphor bronze, nickel, nickel alloys, nickel silver, CDA 194, stainless steel, or tin coated metals. Gauges .020" to .0005". Widths 1/16" to 26". Tolerances  $\pm .0001$ ".

On time delivery; in many areas direct with our own fleet of trucks. Phone (203) 756-7414 (in Newark, N.J. area, phone direct 642-1624). The Thinsheet Metals Company, Waterbury, CT 06720.

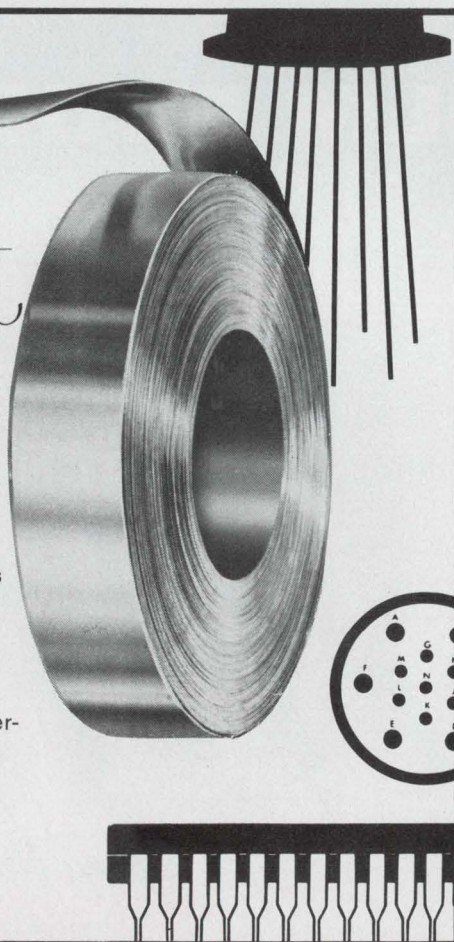

CIRCLE NUMBER 120



## Frame-grab option for TV displays

Grinnell Systems, 2986 Scott Blvd., Santa Clara, CA 95050. J. Metzler (408) 988-2100. See text.

Combined with the high-speed RAM refresh memories used in Grinnell graphic displays, the "frame-grab" option gives users the ability to grab, digitize and store a full video frame of any RS-170 video signal in real time, ready for further computer processing and analysis. The frame-grab plug-in card fits into standard Grinnell display controller cabinets, but is available only for new systems. Prices of the option card range from \$1000 to \$3000, depending on display system and resolution.

CIRCLE NO. 389

## Printer is controlled by a microcomputer

Dataroyal Inc., 235 Main Dunstable Rd., Nashua, NH 03060. (603) 883-4157. \$1595 (100 qty), 60 days.

The Model 7000 is the first of a series of low-cost intelligent printing systems designed for microcomputer control, combining an 8-bit  $\mu$ C with a 120 character/s parallel printer. It includes a parallel interface, and produces an ASCII character set in either standard or extended widths. Additional interfaces or character sets are readily available with a change in PROMs. The transport consists of a lead screw and servo motor for bidirectional printing, and a stepping motor controls bidirectional paper handling.

CIRCLE NO. 390

## Spruced-up mini is tougher, faster

Norden, Norwalk, CT 06856. (203) 838-4471. From \$2000 (OEM qty); December, 1977.

The LSI-11M is built under license from DEC to withstand military airborne, shipboard, ground-based, mobile and space environment, using LSI-11 software. The 16-bit microcomputer is based on the architecture of the DEC LSI-11, but is four times faster. Manufactured under MIL-9858A, the unit meets MIL-E-5400, MIL-E-16400, and MIL-E-4158. Options include 4 kwords of RAM, core memory of 16 or 32 kwords, a PROM module, and parallel and serial I/O interfaces.

CIRCLE NO. 391

# Check the finest lighted display PUSHBUTTON SWITCHES

QPL  Seismic qualified

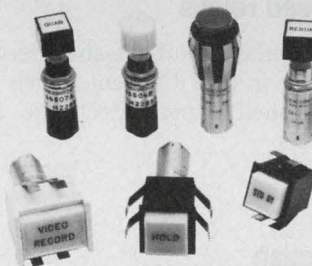
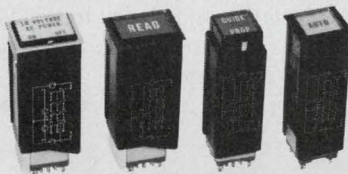
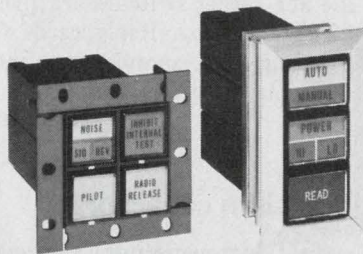

### Matrix System—

Four lamp message display. Square or rectangle. Up to 4PDT switching. Momentary, alternate, latch-down, or magnetic held action. Solder, wire wrap, PC, or crimp pin terminals. Full servicing from front of panel. Easy rear mount with flange or front mount with dress bezel.

### Individual Mount—

Same pushbutton and switching options as Matrix System. Use for entire layout or to isolate function from matrix array with look-alike appearance. Quick and easy to mount. Relamp from front of panel.

### Single Lamp—

Low cost military or industrial/commercial switches built to exacting specifications. 2PDT or 2 circuit switching. Momentary or alternate action. Solder or PC terminals. Wide selection of pushbutton sizes, colors, styles, and legend types. Bushing or snap-in bezel mount.

## LOW PROFILE KEYBOARDS

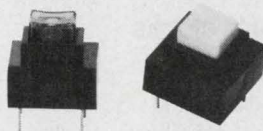
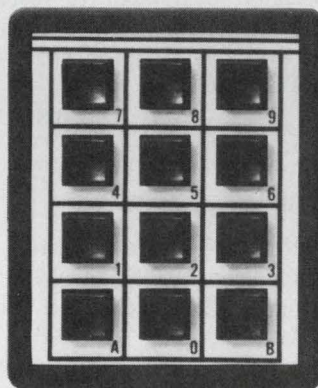

### LED Keyboards—

Lighted keys for visual indication of function status. 10, 12, or 16 station. Square or round keys. Attractive color selection. Clear, sharp keytop marking or two color overlay decal. Universal circuit and pin-out. Interfaces with most logic. Easy front mount.

### Unlighted Keyboards—

Same design features as LED Keyboards except unlighted. Low cost, dependable, attractive. Wide choice of colors offers custom design at off-the-shelf prices.

### Keyswitch Modules—

Single station modules, LED or unlighted. Square or round keys in choice of color with keytop marking. Mount on PC or prepunched boards with holes on .100 centers.

When you think switch... or keyboard... think STACOSWITCH.  
Write today for free general catalog.

**STACOSWITCH**  
a STACO, INC. company  
1139 BAKER STREET, COSTA MESA, CALIF. 92626  
(714) 549 3041 TWX: 910/595-1507

Other STACO Company products:  
Custom Transformers, STACO,  
INCORPORATED, Richmond,  
Indiana; Variable Transformers,  
STACO, INCORPORATED,  
Dayton, Ohio.

CIRCLE NUMBER 121



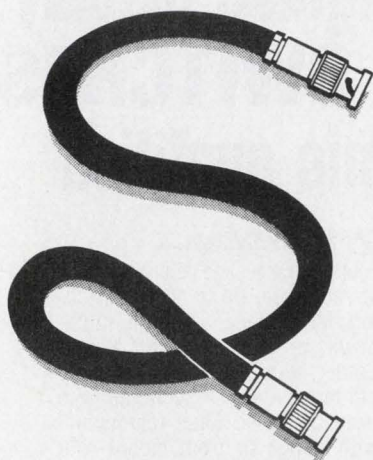

## VITEK's Filter Cable\* can solve your VHF & UHF filtering & interconnecting problems INEXPENSIVELY!

- Looks like coaxial cable —
- Pliable like coaxial cable —
- Has the longevity of coaxial cable —
- Can be fitted with connectors or solder-joined like coaxial cable —

But there's one major difference —  
IT'S A FIRST-RATE FILTER!

For any filtering and interconnecting problem up to 1 GHz, neither price nor the physical viability of the filter has to be a determining factor in the solution. Vitek's innovative filter cable is priced way below any comparable filter on the market.

**So the other thing our cable looks like is SAVINGS... with a Capital S.**

For further information regarding our filter cable or for assistance with your filtering and interconnecting problems, call or write to:

VITEK ELECTRONICS, INC.,  
200 Wood Avenue,  
Middlesex, N.J. 08846,  
Tel: (201) 469-9400

**VITEK** ELECTRONICS,  
INC.

CIRCLE NUMBER 122

## Evaluation samples

### Switches

Dimensions and electrical and materials specifications for miniature toggle and rocker switches are given in a 22-page catalog. Reply cards for requesting free samples are included with the catalog. Dialight.

CIRCLE NO. 392

### Tantalum capacitors

Tantalum capacitors are available for immediate delivery to OEMs. Spec sheets will accompany each sample. Noble Electronics.

CIRCLE NO. 393

### Reed relays

Miniature off-the-shelf reed relays come in 1344 different models and off-the-shelf types. Electronic Applications.

CIRCLE NO. 394

### Polish

Plastic polishes No. 1 and 2 are specially formulated to restore and maintain plastic surfaces. The polishes are available in 8 and 64-oz. bottles. NOVUS Inc.

CIRCLE NO. 395

### Miniature cable

Miniature stainless steel cables range from 0.006 to 0.046-in.-dia., either bare or nylon coated. Cable Mfg. & Assembly Co.

CIRCLE NO. 396

### Quartz clocks

Two digital quartz clocks, the SCO-1000 and SCO-2000, bring reliable, stabilized timing pulses to CPUs, MPUs and other data processing functions. The clocks are well-suited to logic boards conforming to standard-DIP lead spacing, and can be loaded with 10 TTL gates. They feature a frequency range of 1 to 20 MHz, and a frequency stability of 0.01%. Sentry Manufacturing.

CIRCLE NO. 397

## Application notes

### Signature analysis

Signature analysis, a new concept recently developed by HP for troubleshooting  $\mu$ P-based products, gives the serviceman the ability to locate faults in complex digital circuits right down to the component level. A 50-page booklet written for the circuit designer and service manager explains SA, how it can be designed into a product, and how it is used. Hewlett-Packard, Palo Alto, CA

CIRCLE NO. 398

### CRT displays

"Pincushion Distortion, a Significant Factor in CRT Displays" is the subject of an app note. Syntronic Instruments, Addison, IL

CIRCLE NO. 399

### V/f, f/v converters

Problems that can be solved by voltage-to-frequency and frequency-to-voltage converters are detailed in a six-page note. Teledyne Philbrick, Dedham, MA

CIRCLE NO. 403

### Digital IFM

Theory and practical operation of the digital frequency discriminator (digital IFM) in hostile electronic environments as part of a countermeasures system are covered in a 16-page manual. Anaren Microwave, Syracuse, NY

CIRCLE NO. 404

### Sensors and switches

"Logic Interface Handbook," a 26-pager, helps simplify the problems of making solid-state position sensors and manual switches compatible with industrial control systems. Micro Switch, Freeport, IL

CIRCLE NO. 405

### Radar noise figure

The "why?" and "how?" of continuous, on-line monitoring of radar noise figure are outlined in a bulletin. Ailtech, Farmingdale, NY

CIRCLE NO. 406



# PANDUIT® PAN-TERM® TERMINALS

Now available  
New Short Locking Forks  
for applications having  
limited space for  
connections.

Part of the complete line  
of PAN-TERM® terminals,  
disconnects, splices,  
wire joints and  
crimping tools.

Sold through  
Authorized  
Panduit  
Distributors

FREE  
SAMPLES

## PANDUIT

CORP.  
Tinley Park, Ill. 60477 Phone: (312) 532-1800  
In Canada: Panduit (Canada) Limited

Visit PANDUIT at WESCON, Booth 1221-1223  
CIRCLE NUMBER 123



**TYPE OF**  
Glass tubular capacitors,  
temperature range of  $-50^{\circ}$   
to  $85^{\circ}$  C, offer continuous  
operation at  $85^{\circ}$  for 10,000  
hours. Standards thru  
60 KVDC.



**TYPE LK**  
CP70 style.  
Unusually good  
electrical char-  
acteristics in a  
very small unit.  
Used for filters,  
bypass and cou-  
pling. Tempera-  
ture range,  
 $-55^{\circ}$  to  $105^{\circ}$  C,  
10,000 hours  
life at  $85^{\circ}$  C.  
Standards thru  
50 KVDC.

## DUAL DIELECTRIC CAPACITORS



Write for Literature.

Plastic Capacitors, Inc.  
2623 N. Pulaski Road  
Chicago, Illinois 60639  
(312) 489-2229

"Serving industry  
for 25 years"

CIRCLE NUMBER 124

ELECTRONIC DESIGN 18, September 1, 1977

# Locate this remote time code reader

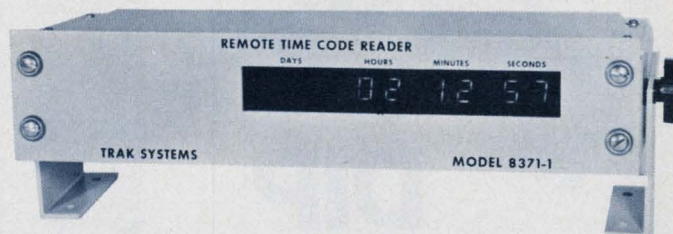

## ANYWHERE

The Model 8371 Remote Time Code Reader accepts a serial time code input on 100, 250, or 1000 Hz carrier and displays time of day in hours, minutes, and seconds. An additional three digits displaying day of year are optionally available or may be added in the field merely by plugging in three display digits and three integrated circuits. The input code is also provided as an output to allow "daisy-chaining" of units. Brackets are provided to allow mounting of the unit from the top or bottom with an adjustable tilt of  $45^{\circ}$ .

### SPECIFICATIONS

#### Code Input

Formats: IRIG B, IRIG E, NASA 36BIT, XR3, 2137 (specify)  
Impedance: 150K ohms  
Level: 0.5 to 10.0 Vpp without adjustments  
Modulation Ratio: 2:1 to 6:1  
Carrier Frequency: 100 Hz (IRIG E), 250 Hz (XR3), 1000 Hz (others)  
Connector: BNC

#### Code Output

Same as input

#### Synchronization

Display updates within  $\pm 5$  ms of "on-time" (once per second)

#### Display

Type: Seven-segment LED's  
Color: Red  
Height: 0.5 inches  
Reading distance: 30 feet  
Viewing angle:  $60^{\circ}$  minimum

#### Power Requirements

Voltage: \*110 or 220 VAC 10%  
Frequency: 50 to 400 Hz  
Power: 15 Watts nominal  
Switch: Rear-panel On-Off power switch

#### PHYSICAL

Weight: 4 pounds  
Height: 3.0 inches  
Width: 14 inches  
Depth: 5.0 inches (excluding  $3/4$ " heat sink)

\*Unit is delivered with internal jumper strapped for 110 Vac operation. This strapping may be changed in the field to convert the unit for 220 Vac operation.

Price: \$585, quantity 10. Add \$75 for days display

For further information call:  
TRAK SYSTEMS  
4722 Eisenhower Boulevard  
Tampa, Florida 33614  
Phone (813) 884-1411



CIRCLE NUMBER 125



**GET  
HIGH  
PERFOR-  
MANCE**

# DIP REED RELAYS

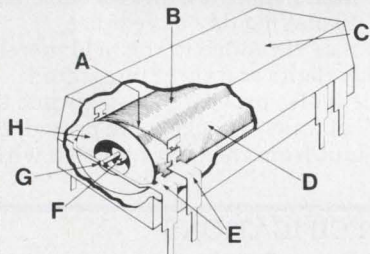

- A. Slack in Coil Connections Prevents Breakage, a Common Problem With Other Relays
- B. Magnet Wire Fusion Tested By Wire Manufacturer And Sample Tested By E.I.S.C. At Incoming Inspection
- C. Epoxy Molded. Excellent For Tough Environmental Applications And High Insulation Requirements
- D. Precision Wound Coils For Maximum Efficiency
- E. Special Design Locks Terminals Preventing Internal Damage Or Loosening
- F. Instrument Grade Reed Capsules 100% Tested At Incoming Inspection And Final Inspection
- G. Joint 100% Inspected
- H. Epoxy Bobbin For High Insulation Resistance

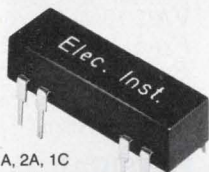

- Forms 1A, 2A, 1C
- TTL Compatible
- High Insulation Resistance
- Low Profile

**...AT  
LOWEST  
COST!**

Send for **FREE CATALOG.**  
See us in EEM.

See us at  
**WESCON**  
Booth 1023

**EI&S**

**Electronic Instrument &  
Specialty Corp.**

42 Pleasant Street, Stoneham, Mass. 02180  
(617) 438-5300

CIRCLE NUMBER 131

## New literature

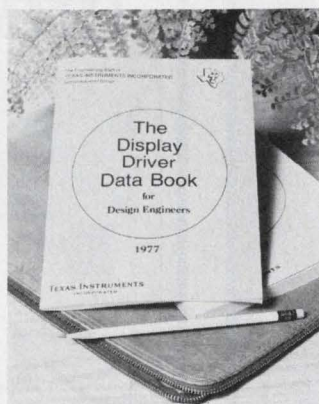

### Display drivers

A 71-page data book covers display-driver ICs, including MOS-to-LED, thermal printhead, high-voltage seven-segment decoder/cathode and latch/decoder/cathode drivers. Texas Instruments, Dallas, TX

CIRCLE NO. 407

### Switching transistors

The XGST series of high-voltage switching transistors is featured in an eight-page catalog. General Semiconductor, Tempe, AZ

CIRCLE NO. 408

### Instruments, systems

Instruments and systems for industrial process applications are described in a 108-page catalog. The Foxboro Co., Foxboro, MA

CIRCLE NO. 409

### Fastener adhesive

The properties and performance characteristics of high-temperature microencapsulated fastener adhesive are described in an eight-page bulletin. 3M, St. Paul, MN

CIRCLE NO. 410

### Thick-film compositions

Standard thick-film resistor, conductor, dielectric and insulating ink compositions are described in a six-page bulletin. Tables of properties and test data are included. Electro Materials Corp. of America, Mamaroneck, NY

CIRCLE NO. 411

### Shielding products

A folder describes rf-sealing, caulking, adhesive and lubricating products, conductive gaskets and all materials necessary for the construction of an rf-shielded enclosure. Emerson & Cuming, Canton, MA

CIRCLE NO. 412

### CCTV accessories

Over 700 CCTV accessories are covered in a 40-page catalog. RCA Closed Circuit Video Equipment, Lancaster, PA

CIRCLE NO. 413

### Silicon photodetectors

Specifications, photos and schematics highlight a 24-page silicon-photodetector catalog. Integrated Photomatrix, Mountainside, NJ

CIRCLE NO. 414

### Power supplies

"Modular Power Supplies for Data Conversion Systems" is a guide to the conversion-system designer in that it details why his type of designs impose unique constraints on power supplies. Analogic, Wakefield, MA

CIRCLE NO. 415

### Trimmer capacitor

Six technical bulletins deal with the selection, use and characteristics of trimmer capacitors. Voltronics, East Hanover, NJ

CIRCLE NO. 416

### Analysis system

A 16-page brochure describes the TN-1710 modular multichannel-analysis system. Tracor Northern, Middleton, WI

CIRCLE NO. 417

### Magnetic heads

Four magnetic-head products are described in a series of data sheets. Magnetic Head Div. of Applied Magnetics, Goleta, CA

CIRCLE NO. 418

### Switches

Environment-sealed switches are the subject of a six-page bulletin. Control Switch, Folcroft, PA

CIRCLE NO. 419



# INGENUITY

in creating Stepper Motors.

Like our Model LMS:  $7\frac{1}{2}^\circ$  step angle. Torque ranges to 10 oz. in. at 75 P.P.S. Start-stop rates of 450 steps/second. Slew capability to 1100 steps/second.



And that's not all you get at

# MOLON

3737 Industrial Ave., Rolling Meadows, Ill. 60008  
Phone: (312) 259-8700

CIRCLE NUMBER 132

# littel - THUMBWHEEL<sup>®</sup>

Series LTU Economy Switch

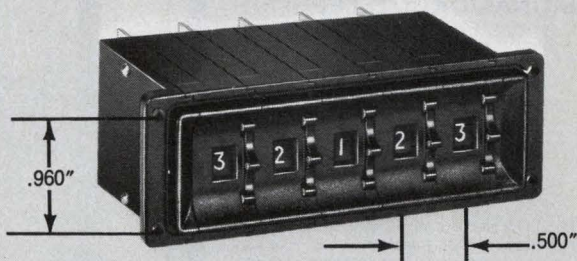

- Switchcraft Quality Thumbwheel Switch
- Only .960 mounting centers
- Rear of panel mount
- Mil-approved materials
- Large easy to read dial characters
- More output codes
- More reliable
- Specials available

Send for new littel-Thumbwheel<sup>®</sup> Switch Data Sheet.

# SWITCHCRAFT<sup>®</sup>

Chicago, Illinois 60630 • Phone (312) 792-2700  
© Registered Tradenames of Switchcraft, Inc.

CIRCLE NUMBER 134



**MINIATURE CERAMIC TRIMMERS TYPE CD5:** This new range of miniature ceramic disc trimmers has been designed to meet the requirements of mechanical and electrical reliability when the available space is minimal. 5mm in diameter and 4.4mm maximum height they are designed for applications such as electronic clocks and watches but, in addition, available for other conventional uses. **Ranges 0.9 to 25pF.**

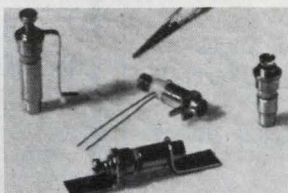

**MINIATURE UHF TRIMMER CAPACITORS TYPE PTU/TUT:** This range of trimmers was first developed for the UK III satellite. The ability of the capacitors to operate over a wide frequency range enables them to be used even into the microwave region with complete confidence. (Actual self resonance frequency at C max type PTU/1.2 is 46Hz.) **Capacitance range 0.2pF to 3pF.** Printed circuit chassis, and strip line styles available.

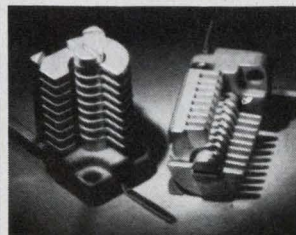

**10mm AIR DIELECTRIC SOLID ELECTRODE MINI TRIMMERS:** This range of OXLEY sub miniature air dielectric trimmer capacitors have both stator and rotor assemblies machined from solid bar eliminating practically all soldered joints. **Capacitance values from 2pF to 25pF.**

OXLEY<sup>®</sup>

The most versatile range of trimmer capacitors

See them on **STAND 1016/8 WESCON**

Oxley Incorporated PLAZA SUITE 900, 3250 WILSHIRE BOULEVARD  
LOS ANGELES, CALIFORNIA 90010. PHONE (213) 383-8270 TWX 1 910 321-2903

OXLEY<sup>®</sup> Oxley Developments Co. Ltd.

ULVERSTON · CUMBRIA · LA12 9QG · ENGLAND  
CABLES OXLEY ULVERSTON · TELEX 65141 · TELEPHONE 0229 52621

CIRCLE NUMBER 133

ELECTRONIC DESIGN 18, September 1, 1977

## subminiature piezoelectric tuning forks

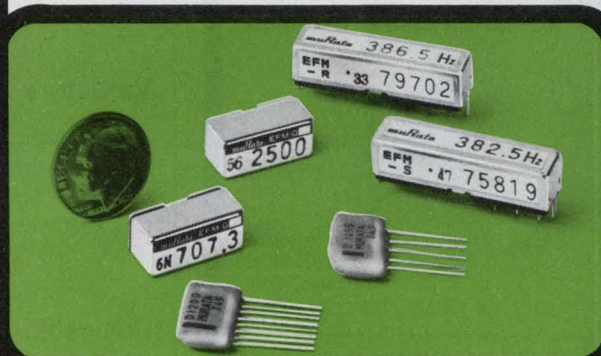

- For coding and decoding • 360 Hz to 2900 Hz and E.I.A. frequencies • Diminutive size —1.26"x.306" in sq. • —20° to 60°C operation
- Extremely stable and reliable

Designed for both consumer and industrial tone signaling and control systems such as paging, traffic signaling, alarms, and remote instrumentation. Write for complete technical data.

**muRata**  
CORPORATION OF AMERICA

First in ceramics

1148 Franklin Road, S.E.  
Marietta, Georgia 30067  
Tel: 404-422-9777  
Telex: 54-2329  
TWX: 810-763-4723

CIRCLE NUMBER 135



# Circuit Savers

**NEW**  
SIGNAL/DATA/TELEPHONE  
PROTECTION



The SLP protectors were expressly designed to protect signal/data/telephone lines from transient overvoltages caused by lightning, heavy machinery, elevator motors, generators, etc. The SLP interfaces between the signal lines and the sensitive circuit to provide a sophisticated blend of high speed (nanoseconds) voltage limiting and brute force protection. The SLP's recover automatically to standby when the need for protection has passed.

Output Clamp Voltage Level  $\pm 5V$  to  $\pm 200V$   
Input Voltage Level (max) to  $\pm 35KV$  (1 Out)  
Energy Handling to 50 joules  
and higher

**BULLETIN 301**

Full line of protection modules for every hi-lo voltage/current requirement. Write or call for data.

160 Brook Avenue, Deer Park, N.Y. 11729  
Telephone: 516-586-5125

# MCG Electronics

CIRCLE NUMBER 136

# Circuit Savers

**NEW**  
AC POWER LINE PROTECTOR



Protects  
110, 220, 380,  
440 VAC line  
1 $\phi$ , 3 $\phi$  - 50/60/400 Hz

The Series P operates rapidly to prevent damage to equipment operating on the AC power lines, by switching rapidly to a clamping state whenever a transient exceeds the clamping threshold. The units operate on overvoltages of either polarity, on 1 $\phi$  and 3 $\phi$  lines and recover automatically when the transient expires. Severe transient conditions cause the protector to switch to a crowbar mode and cause an external fuse or circuit breaker to operate.

**CATALOG 801**

Full line of protection modules for every hi-lo voltage/current requirement. Write or call for data.

160 Brook Avenue, Deer Park, N.Y. 11729  
Telephone: 516-586-5125

# MCG Electronics

CIRCLE NUMBER 137

## NEW LITERATURE

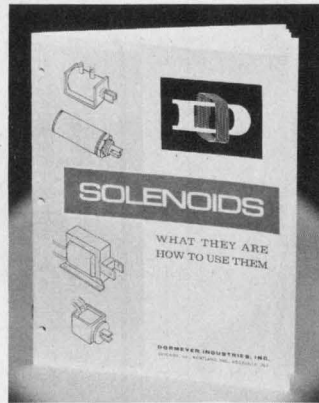

### Ac, dc linear solenoids

The fundamentals of applying ac and dc linear solenoids for commercial and consumer equipment are given in a 16-page catalog. Dormeyer Industries, Chicago, IL

CIRCLE NO. 420

### Polyester resin

Molding and processing parameters for thermoplastic polyester resin are detailed in a 42-page brochure. General Electric, Plastics Div., Pittsfield, MA

CIRCLE NO. 421

### Power modules

High-density power modules are listed in a catalog. Etatech, Placentia, CA

CIRCLE NO. 422

### Varactors

A 72-page catalog contains information on silicon and gallium arsenide varactors and silicon switching diodes. GHZ Devices, Chelmsford, MA

CIRCLE NO. 423

### Bus cable

Passive, completely insulated, bus-cable assemblies are described in a four-page brochure. Amphenol, Bunker Ramo Corp., Oak Brook, IL

CIRCLE NO. 424

### Circuit-board hardware

Described in a 24-page booklet is electronic hardware, including component/cable clips, circuit-board support/spacers, hold downs and ejectors. Richco Plastics, Chicago, IL

CIRCLE NO. 425

# Available Now!



### MICROPROCESSOR

#### **BASICS**, edited by Michael S.

Elphick. Here's the nitty-gritty on design selected from *Electronic Design* for the eight currently popular microprocessors: 8080, 6800, F8, PACE, IMP, 2650, 1802, and 6100. Each chapter discusses one model, detailing its advantages, disadvantages, architecture, capabilities, and includes many illustrations of its applications. #5763-6 paper 224 pp., \$9.95

### ORGANIZING AND DOCUMENTING DATA PROCESSING INFORMATION,

by Thomas R. Gildersleeve. Write sharp, precise DP documents that command attention. This book will show you how to... prepare a first draft... shape your sentences for reading ease... organize a document for quick study. Filled with examples of great DP writing and scores of exercises for practice. #5739-3 paper, 160 pp., \$7.95

Please send the book(s) checked on 15-day examination. At the end of that time, I will send payment, plus postage and handling, or return the book(s) and owe nothing. On all prepaid orders, publisher pays postage. Prices are subject to change without notice. Offer good in U.S.A. and Canada only.

NAME \_\_\_\_\_

COMPANY \_\_\_\_\_

ADDRESS \_\_\_\_\_

CITY \_\_\_\_\_

STATE/ZIP \_\_\_\_\_

Send to:

Hayden Book Company, Inc.  
50 Essex Street, Rochelle Park  
New Jersey 07662

#77-62



## PYROELECTRIC IR DETECTOR

with HIGH GAIN CM AMPLIFIER

**MODEL  
408**

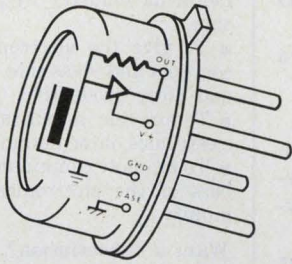

Detector Area 2 mm dia  
D\* (@10 Hz)  $2.3 \times 10^8 \text{ cm} \sqrt{\text{Hz/W}}$   
Voltage Responsivity 150 000 V/W

**LOW PRICE \$29.00 EA. (100)**

Price includes uncoated Germanium window  
or AR coated Germanium window (Ge 10.6  $\mu\text{m}$ )

**ELTEC INSTRUMENTS, INC.**

P. O. BOX 9610  
DAYTONA BEACH, FLORIDA 32020 - U.S.A.  
PHONE: (904) 252-0411 • TWX 810-832-6294

CIRCLE NUMBER 138

# SEALED SWITCH

**NEW! Series LTS sealed  
Thumbwheel Switch provides  
environmental protection.**

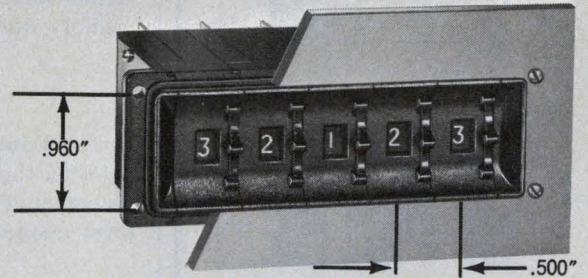

littel-Thumbwheel® Switch offers . . .

- Clear windows, sonically sealed
- "O" ring on shaft
- RTV sealant
- Rubber panel gasket
- Positive tactile characteristics
- Dust and moisture resistant construction

Send for Series LTS, littel-Thumbwheel®  
Sealed Switch Data Sheet.

**SWITCHCRAFT®**  
INC.

Chicago, Illinois 60630 • Phone (312) 792-2700

® Registered Tradenames of Switchcraft, Inc.

CIRCLE NUMBER 140

## CHOCKED FULL OF TECHNOLOGY!!

**Model D-72C  
Two Element X-Y, T  
Recorder**



### Features

- 1. Two element time axis**  
Model D-72C permits time recording by two systems; mechanical recording chart feed and time axis sweep by time.
- 2. High performance chart attraction**  
Troubles due to faulty attraction of the chart due to friction during chart feed has been completely eliminated regardless of the temperature or feed rate.
- 3. Automatic chart replacement in XY recording**  
The chart can be automatically fed and stopped at the end of chart replacement with one touch by loading roll chart.
- 4. Remote control terminals**
  - Pen up-down
  - X-axis electronic time sweep trigger
  - Mechanical time feed recording chart start/stop
  - XY chart automatic replacement feed trigger
- 5. Easy-to-install optional chart take-up device (Optional)**
- 6. Felt tip pen (Optional)**
- 7. High input impedance 10M $\Omega$  fixed (Optional)**

• For further information, please contact:

**Riken Denshi Co., Ltd.**  
5-5-2, Yutenji, Meguro-ku, Tokyo, Japan. TELEX: 0246-8107

**PAYTON ASSOCIATES INC.**

244 Delaware Avenue, Buffalo, New York 14202 Phone: (716) 852-6213, 855-1314

CIRCLE NUMBER 139

ELECTRONIC DESIGN 18, September 1, 1977

# VICTORY SELECTIVITY THERMISTORS

New-Low cost SensiChips® • Small size • From .020" sq. to .300" sq. • Thickness from .005 to .070 in. • Resistances from 5 K ohms to 1 meg. • Typical response time 4 seconds. • Protective coating available.

**VECO VICTORY ENGINEERING CORP.**

VICTORY ROAD, SPRINGFIELD, NEW JERSEY 07081  
TWX: 710-983-4430 TEL: 201-379-5900

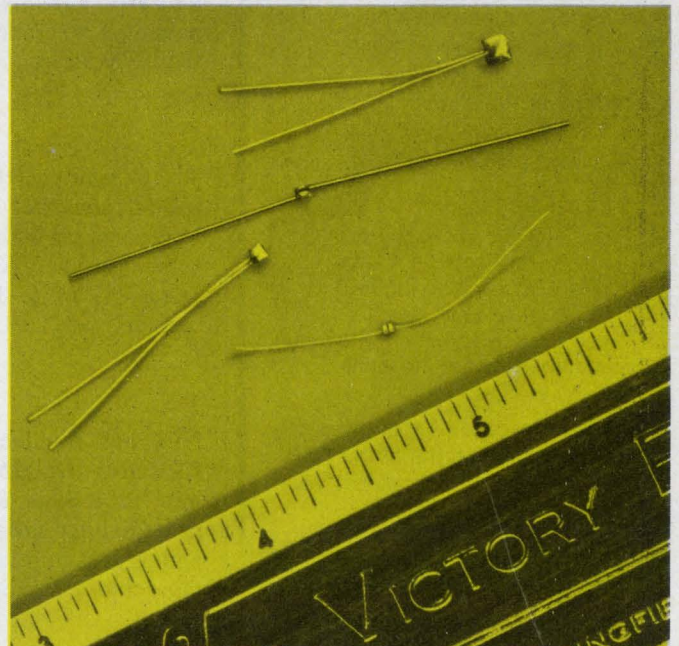

CIRCLE NUMBER 141



ELECTRONIC DESIGN's function is:

- To aid progress in the electronics manufacturing industry by promoting good design.
- To give the electronic design engineer concepts and ideas that make his job easier and more productive.
- To provide a central source of timely electronics information.
- To promote communication among members of the electronics engineering community.

**Want a subscription?** ELECTRONIC DESIGN is circulated free of charge to those individuals in the United States and Western Europe who function in design and development engineering in companies that incorporate electronics in their end product and government or military agencies involved in electronics activities. For a free subscription, use the application form bound in the magazine or write for an application form.

If you do not qualify, paid subscription rates are as follows: \$30.00 per year (26 issues) U.S./Canada/Mexico, \$40.00 per year (26 issues) all other countries. Single copies are \$2.50 U.S. and all other countries. The Gold Book (27th issue) may be purchased for \$30.00 U.S./Canada/Mexico, and \$40.00 all other countries.

**If you change your address,** send us an old mailing label and your new address; there is generally a postcard for this in the magazine. You will have to requalify to continue receiving ELECTRONIC DESIGN free.

**The accuracy policy of ELECTRONIC DESIGN is:**

- To make diligent efforts to ensure the accuracy of editorial matter.
- To publish prompt corrections whenever inaccuracies are brought to our attention. Corrections appear in "Across the Desk."
- To encourage our readers as responsible members of our business community to report to us misleading or fraudulent advertising.
- To refuse any advertisement deemed to be misleading or fraudulent.

Individual article reprints and microfilm copies of complete annual volumes are available. Reprints cost \$6.00 each, prepaid (\$5.00 for each additional copy of the same article), no matter how long the article. Microfilmed volumes cost \$23 for 1976 (Vol. 24); \$30 for 1973-75 (Vols. 21-23), varied prices for 1952-72 (Vols. 1-20). Prices may change. For further details and to place orders, contact Customer Services Dept. University Microfilms, 300 N. Zeeb Rd., Ann Arbor, MI 48106. (313) 761-4700.

**Want to contact us?** If you have any comments or wish to submit a manuscript or article outline, address your correspondence to:

Editor  
ELECTRONIC DESIGN  
50 Essex St.  
Rochelle Park, NJ 07662

**Motorola's Integrated Circuit Div.** is second-sourcing Fairchild's 65-k CCD memory device.

CIRCLE NO. 426

**Intech/Function Modules** has announced the A-221, a pin-for-pin replacement for Analogic's MP221 low-level chopper amplifier.

CIRCLE NO. 427

First JAN-qualified MIL-M-38510 LSI MOS 4-k dynamic RAMs are now available from **Texas Instruments.**

CIRCLE NO. 428

**General DataComm** has added the GDC 1000A and 1001B FCC-registered data couplers to its product line. The couplers feature reliability, mounting flexibility equivalent to the WECO 1000A and 1001B units.

CIRCLE NO. 429

**Silicon Transistor** has received qualification approval per MIL-S-19500/498 for high-voltage, fast-switching power-transistor Types JAN-2N6306 and JAN-2N6308.

CIRCLE NO. 430

**Hughes Aircraft's Solid State Products Div.'s** family of CMOS  $\mu$ P components are second sources of the RCA CDP1800 series.

CIRCLE NO. 431

**The Computer Products Div. of Electronic Memories and Magnetics** has introduced an enhancement that can extend the useful life of 360/65s. EMM can install up to 8 Mbytes of add-on memory per CPU.

CIRCLE NO. 432

**National Semiconductor's 8192-bit EPROM, the MM2708,** is organized into 1024 8-bit words and features programming speed of 100 s typ, low power consumption during programming and a maximum access time of 450 ns.

CIRCLE NO. 433

## FAILURE OF PULSE CAPACITORS GIVING YOU A PAIN IN THE CIRCUIT BOARD?

Here's a straight-from-Europe remedy: the WIMA low-loss FKP1 polypropylene pulse capacitor manufactured by Wilhelm Westermann, a leading producer of special purpose, high performance, high reliability capacitors. The FKP1 combines the self-healing and volumetric efficiency of metallized film design with the current-carrying capabilities of film/foil construction and the inherent dielectric properties of polypropylene. They add up to the most successful type of pulse capacitor available today.

### FKP1 Specifications

Max. Pulse Rise Time

Rated DC Voltage V/Microsecond

630	2400
1000	2100
1500	5400

Power Factor at +20°C

@ 1 KHz:  $\tan \delta = 1 \times 10^{-4}$

@ 100 KHz:  $\tan \delta \leq 1.5 \times 10^{-3}$

Epoxy cast construction with radial leads for PC board mounting.

Write us for catalog that gives detailed specifications of the FKP1 and the twenty-five other types of WIMA capacitors.

### The Inter-Technical Group, Inc.

P.O. Box 23 • Irvington, NY 10533  
Tel.: (914) 591-8822 • TWX: 710-564-0802

CIRCLE NUMBER 142



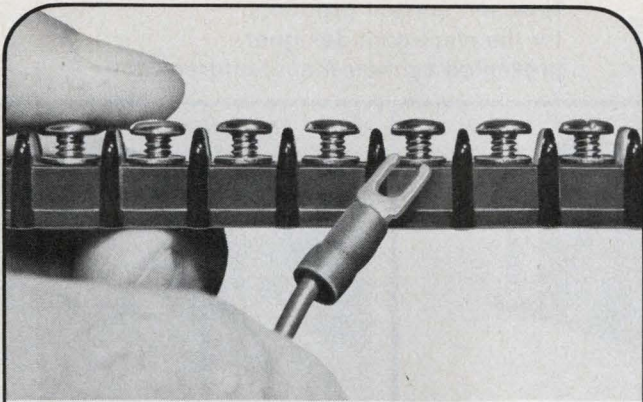

## WIRE REDDY™

Cut wiring time in half with Kulka's new Wire Reddy™ terminal boards. Either brass or cost-saving steel screws are in place and ready to receive wire ends or terminals. Other time-saving hardware in the line are Kliptites™ and wire wraps. All are in Kulka's catalog.

# Kulka®

A NORTH AMERICAN PHILIPS COMPANY

520 S. Fulton Ave., Mt. Vernon, NY 10551 Tel: 914 644 4024

See this at our Wescon Show Booth #1131  
CIRCLE NUMBER 143

## OEM COMPUTER CARD

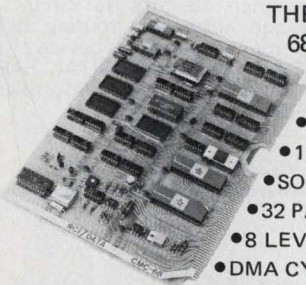

THE MOST POWERFUL  
6800 BASED OEM  
COMPUTER CARD

- 1MHz CRYSTAL CLOCK
  - 1K BYTES STATIC RAM
  - SOCKETS FOR 4,2708/2716
  - 32 PARALLEL I/O PORTS
  - 8 LEVEL INTERRUPT CONTROLLER
  - DMA CYCLE STEAL LOGIC
  - SERIAL EIA OR LOOP INTERFACE
  - FULLY BUFFERED PROCESSOR BUS
- \$555  
(SINGLE UNIT)

## CMC-68/15

FIRST IN A FAMILY OF COMPLETE  
MICROCOMPUTER BOARDS AND  
SUPPORT PRODUCTS, including

- \* RRB-8K: 8K RAM and 8 or 16 K EPROM
- \* WWB-68: WIRE WRAP BOARD
- \* TAB-68: BACK PLANE/CARD CAGE

**RCI/**  
**DATA** 520 Victor St. Saddle Brook, N.J.  
(201) 843-3768 07662

CIRCLE NUMBER 144

ELECTRONIC DESIGN 18, September 1, 1977

# METAL·MITE®

Switchcraft Quality  
Thumbwheel Switch

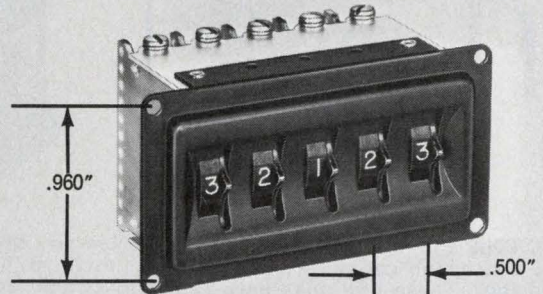

Series "MM" Modular Metal-Mite® Switch

They're low cost switches, but individual modules can be removed/replaced without dismounting switch.

- Only .500 wide
- Individual modules available
- All metal construction
- Up to 20 stations
- Double detent tactile characteristics

Send for new Metal-Mite® Switch Data Sheet.

## SWITCHCRAFT®

INC.

Chicago, Illinois 60630 • Phone (312) 792-2700

® Registered Tradenames of Switchcraft, Inc.

CIRCLE NUMBER 145

## Join the IMC Book Club\*



Free 24 page catalog  
contains facts on IMC's  
Off-The-Shelf precision  
cooling devices.

This airmover catalog is  
devoted to technical infor-  
mation and illustrations on  
the full line of Tubaxial  
Fans, Propeller Fans and  
Centrifugal Blowers. IMC  
Boxer®, Fulmar®, Condor®  
and IMCair® airmovers  
are featured.

For immediate service  
please call Fred Taylor,  
Sales Manager-  
603/332-5300

\*Product Literature Broadside  
and request card  
will be sent to you along  
with this catalog.

SERVING INDUSTRY OVER 25 YEARS

**imc**

25  
Motors  
Fans  
Blowers

**IMC MAGNETICS CORP.**

NEW HAMPSHIRE DIVISION  
ROUTE 168, ROCHESTER, NEW HAMPSHIRE 03867

CIRCLE NUMBER 146



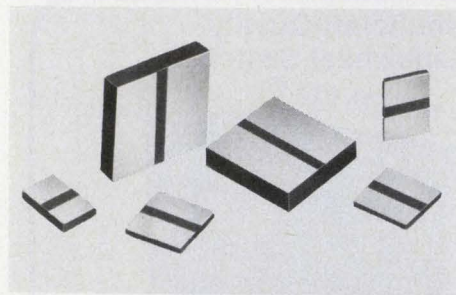

**CERAMIC CHIP CAPACITORS.** SPLIT-CHIP, is a new concept in ceramic chip capacitor technology. These new units have two broad electrodes on one face and eliminate conventional wrap-around end terminations. This new concept provides lower cost and easier assembly. SPLIT-CHIPS are available in five standard sizes from .040" x .030" to .130" x .090" and .015" thick and in all popular dielectrics and capacitance ranges. JOHANSON DIELECTRICS, INC., Box 6456, Burbank, Ca. 91510 213-848-4465

CERAMIC CHIP CAPACITORS

181

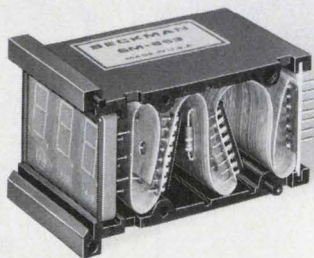

**New way to pack added security** into your design. R/flex circuits do several jobs at once and accordion fold to fit. Eliminate multiple circuit boards and jumpers; mount components directly on circuit. Made in 1 to 6 layers, various sizes and shapes, with or without plated-through holes. Rogers Corp., Chandler, AZ 85224 (602) 963-4584. (EUROPE: Mektron NV, Ghent, Belgium; JAPAN: Nippon Mektron, Tokyo)

FLEXIBLE CIRCUITS

184

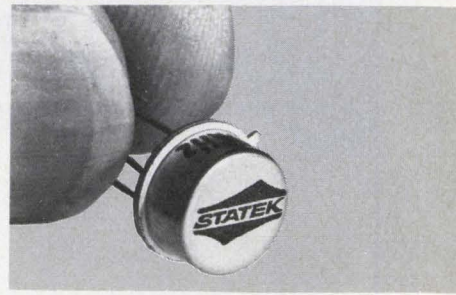

**LOW COST QUARTZ CRYSTALS** Use Statek 10 to 300 kHz quartz crystals in TO-5s . . . they eliminate count down for oscillators, filters, tone generators, timers . . . They're rugged, accurate & resistant to high vibration and shock. Prices low as \$1.70 ea. in 1000 qty. Send your written application & we'll send you a sample. Call or write for literature. Details in Gold Book and EEM \* STATEK CORP. \* 512 N. Main, Orange, Ca. 92668 \* (714) 639-7810 \* Telex 67-8394

QUARTZ CRYSTALS

187

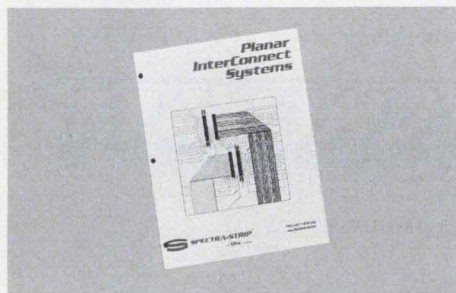

**SPECTRA-STRIP'S NEW PLANAR PRODUCT CATALOG & DESIGN GUIDE.** AT LAST a complete catalog and design guide for planar connectors, ribbon and flat cables, flex circuits and planar interconnects. 86 pages on new products, connector applications, custom product designs, ultra flexible and high temperature cables, IDC connector designs and low cost interconnects. For your FREE copy write: Spectra-Strip Marketing Services, P.O. Box 415, Garden Grove, CA 92642

PLANAR CATALOG

182

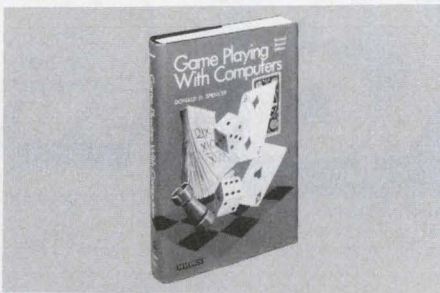

**GAME PLAYING WITH COMPUTERS,** Revised Second Edition, by Donald D. Spencer. This volume presents over 70 games, puzzles, and mathematical recreations for a digital computer. The reader will also find brand-new "how to" information for applying mathematical concepts to game playing with a computer. #5103-4, 320 pp., \$16.95. Circle the Info Retrieval Number to order your 15-day exam copy. When billed, remit or return book with no obligation. Hayden Book Co., 50 Essex St., Rochelle Park, N.J. 07662.

GAMES-PLAYING GUIDE

185

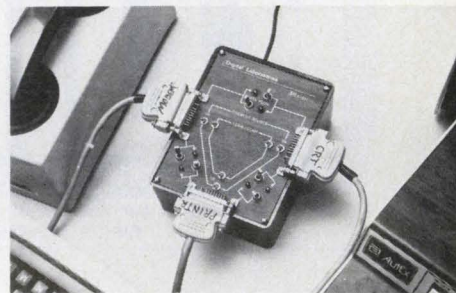

**UNIVERSAL JUNCTION UNIT . . .** for three devices, RS232C or current loop.

. . . Six switches provide all 63 interconnects that are possible between three I-O devices. LED's indicate data flow. . . . Designed to provide circuit compatibility and easy data routing between different manufacturer's devices. . . . \$350 (1-4) from DIGITAL LABORATORIES, 600 Pleasant St., Watertown, MA 02172 (617) 924-1680

3 PORT RS232 & 20 MA LOOP

188

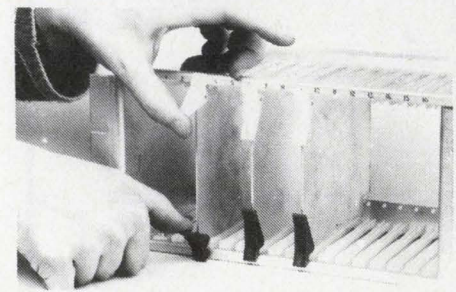

**FREE SAMPLES** of low-cost Electro-Flex card guides and ejectors. Guides in 3", 4", 6" and 8 1/2" lengths have built-in bow to aid card retention. Ejectors feature longer sure-grip handle for greater strength, improved leverage and damage-free extraction; stainless roll pins included. Both in UL-approved nylon. Card rack and complete metal fabricating literature also available. Electro-Space Fabricators, Topton, Pa. 19562. (215) 682-7181.

CARD GUIDES - EJECTORS

183

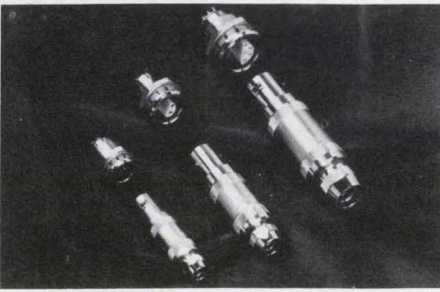

**LEMO CONNECTORS** are perfect for front panel applications. Superb design and craftsmanship complement any front panel design. The Quick Lock mechanism allows easy connection & disconnection. Panel space is saved because finger clearance is required on only two sides. The all metal shell is rugged and an effective strain relief grips the cable securely. Coax & multipin types from 2-18 pins are available from stock. Lemo U.S.A. Inc., 2015 2nd St., Berkeley, Ca 94710. Tel: 415/548-1966, Tx 335-393.

CONNECTORS

186



**MAY I HELP SPEED LEAD BENDING OPERATIONS?** Cut costs by 50%! Fast, exact, thumbwheel control adjusts to precise measurements. Match pointers with eyelet holes in circuit boards by adjusting knurled wheel with thumb, automatically spacing bends for insertion of component into boards. All axial lead components accommodated. From 1/2" x 1 1/2" long with max. distance between inside of bends of 1.725". Harwil Co., 1548 17th Street, Santa Monica, CA. 90404. (213) 829-2310

COMPONENT LEAD BENDER

189



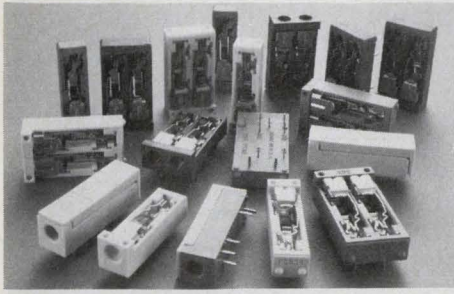

**NEW PCB-JACKS**, designed for PC-board mounting, are 1/2 the size of conventional Bantam jacks, 1/3 the size of Long-frame jacks. Solder them directly to the PC-board and eliminate connecting wires and mounting hardware. Compatible with Bantam plugs. ADC Products, 4900 W. 78th, Minneapolis, MN 55435. (612) 835-6800.

PC-BOARD JACKS

190

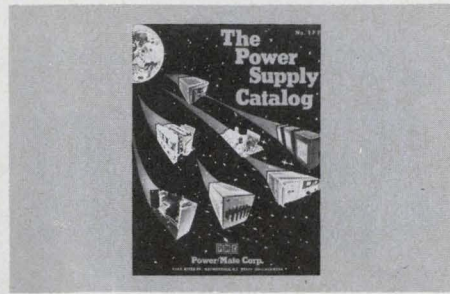

**Free New '77 catalog** contains over 34,500 quality power supplies from the world's largest manufacturer, Power/Mate Corp. Power Supplies for every application including submodulars, open frame, variorated, encapsulated, laboratory & system. All units UL approved and meet most military and commercial specs for industrial and computer uses. Power/Mate Corp., 514 S. River St., Hackensack, NJ 07601 (201) 343-6294

POWER SUPPLIES

193

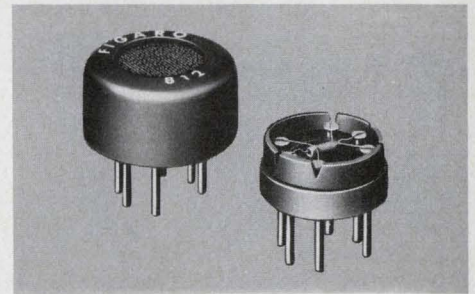

**FIGARO GAS SENSOR TGS** is a gas sensitive semiconductor. When combustible gas is absorbed on the sensor surface, a marked decrease of electrical resistance occurs. Major features of the sensor include high sensitivity, long term reliability and low cost. The applications are: GAS-LEAK ALARM, AUTOMATIC FAN CONTROL, FIRE ALARM, ALCOHOL DETECTOR, etc. Figaro Engineering Inc., North America Office-3303 Habor Boulevard, Suite D-8, Costa Mesa, Calif. 92626 Tel: (714) 751-4103 Telex: 678396

GAS SENSOR

196

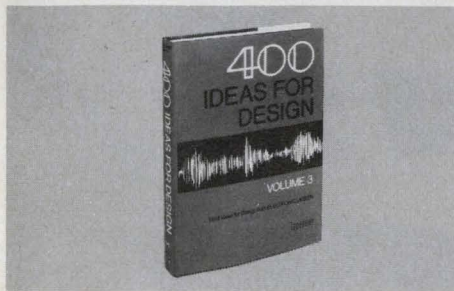

**400 IDEAS FOR DESIGN, Volume 3**, ed. by Morris Grossman. Brainstorm with the experts! Volume 3 of 400 IDEAS FOR DESIGN contains the best selections from *Electronic Design* that were published between 1971 and 1974. You'll find a wide range of ideas from very complicated to simple, but unique, approaches. #5111-5, 348 pp., \$13.95. Circle the Info Retrieval Number to order your 15-day exam copy. When billed, remit or return book with no obligation. Hayden Book Co., 50 Essex St., Rochelle Park, N.J. 07662.

IDEAS FOR DESIGN

191

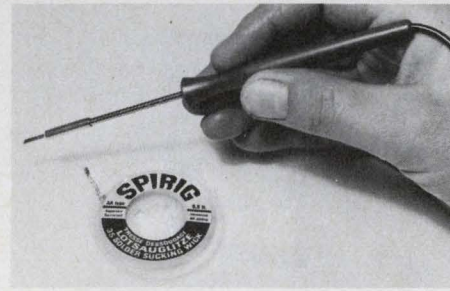

**3S-WICK® De-solder Braid.** Spirig produces the vacuumized (pat. pend.) solder removal wick in unequalled technology to meet any standards worldwide. 3S-Wicks unique three dimension combination solves all electronics desoldering problems. 3S-Wick pat. pend. Spirig also produces pencil soldering irons. Dealers and distributor inquiries welcomed. USA: Spirig-Signalarm, PO Box 3128, Springfield, Mass. 01101, (413) 788-0224 Internat: Spirig, PO Box 160, CH-8640 Rapperswil, Switzerland TX 75400

3S-WICK DE-SOLDER BRAID

194

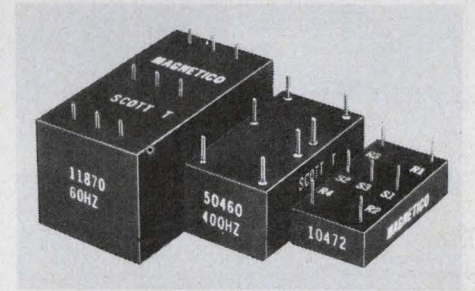

**Scott T Transformer.** 11870: 60HZ, 90v, L-L in. 1.1x2.1x1.1. 50460: 400 HZ, 90v, L-L in. 7/8x1-5/8x11/16. 50642: 400HZ, 11.8v, L-L in. 7/8x5/8-11/16. 10472: 400-HZ, 11.8v, L-L in. 3/4x1-1/2x3/8. All with 6v RMS sine & cosine output. MAGNETICO, INC., 182 Morris Ave., Holtsville, N.Y. 11742 516-654-1166.

TRANSFORMER

197

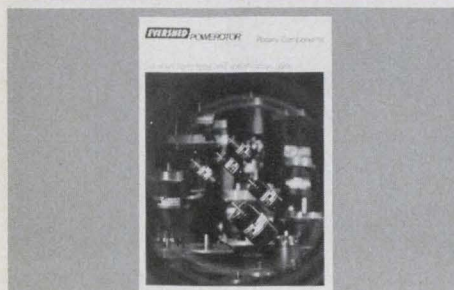

**Free catalog** describing the Powerotor range A.C. and D.C. servomotors, tach-generators, geared motors, steppers and associated amplifiers. Power range up to 100 watt output for 50, 60 and 400 Hz up to 360 Watt D.C. Nato frame sizes 08 to 45 including some motor-tach combinations. Evershed and Vignoles Limited, Actor Lane, Chiswick, London W4 5 HJ, England telex 22583. See us at Wescon Booth #1022.

ROTARY COMPONENTS

192

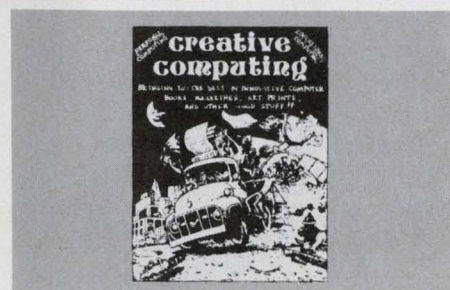

**CREATIVE COMPUTER**, hobby computing's #1 software and applications magazine, has it all . . . from putting a system together to maximizing its potential . . . equipment profiles, programming, games, puzzles, reviews, and more—even fiction! Subscription rate: \$8.00 one year/6 issues. Circle the Info Retrieval Number to start your subscription immediately. We'll bill you. Or send payment now and receive FREE one additional issue. **CREATIVE COMPUTING, P.O. Box 789-M, Morristown, NJ 07960**

CREATIVE COMPUTING

195

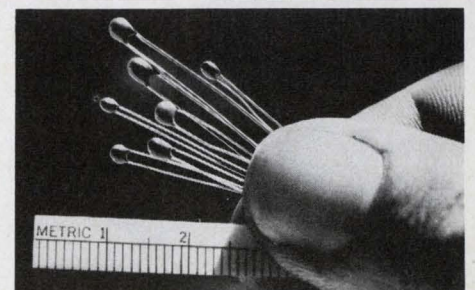

**THERMISTORS** with leads and coating are highly reliable low cost components in small dimensions more compatible with modern circuit design. R @ 25°C 100Ω to 1 meg Ω ±10% to ±1%. CURVE MATCHED INTERCHANGEABLES to ±.25°C. POINT MATCHED INTERCHANGEABLES to ±.2°C. Call or write for HP97 or TI SR52 THERMISTOR LINEARIZATION PROGRAM. WESTERN THERMISTOR CORPORATION, 403 Via El Centro, Ocean-side, CA 92054 (714) 433-4484.

THERMISTOR

198



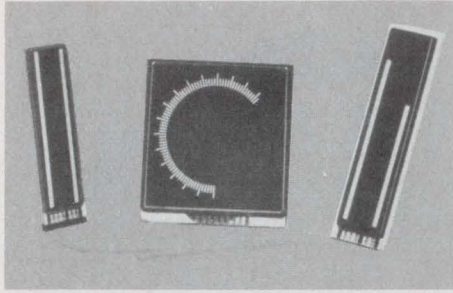

**EASY READERS!** Burroughs Bar Graphs are ready for your application. These devices provide instant visual readout of analog information with digital accuracy. They're currently in wide use in automobiles, aircraft, process control systems and instrumentation. Models include dual linear with 1/2 or 1% scales, a dual resettable, for measuring performance against preset ranges, as well as a 120 element circular design. Circle the reader service number for complete information or call Hamilton/Avnet or Cramer Electronics.

BAR GRAPHS

199

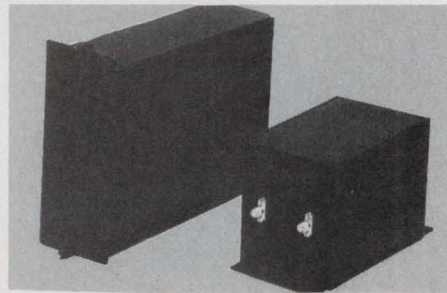

**LOGARITHMIC VIDEO AMPLIFIERS.** A line of high frequency Unipolar and Bipolar Logarithmic Video amplifiers which feature bandwidths of 40 Mhz and dynamic ranges to 80 DB. Linearities to  $\pm 0.5$  DB are available on special order. Matched units can be provided. Both standard and custom designs are available. MVP Electronics, 1161 North Tustin Street, Orange, Calif. 92667. Tel: 714-639-9246.

LOGARITHMIC AMPLIFIERS

202

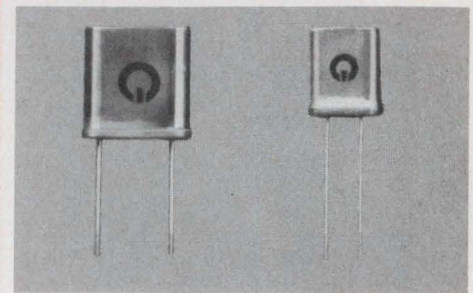

**HIGH STABILITY LOW COST QUARTZ CRYSTAL** for  $\mu$ -processor and clock oscillator. Accuracy is  $\pm 0.002\%$  at 25°C, Frequency change over -10 to +55°C is within  $\pm 20$ ppm. 1.000, 1.8432, 2.000, 2.097152, 2.4576, 3.2768, 4.0000, 5.0000, 5.0688, 5.1850, 5.7143, 6.5536, 10.0000, 18.0000, 18.4320, 20.0000, 22.1184 Immed. Divy. \$1.85 ea. 10 MHz up in HC-18/u; (Min. 100 pcs.) Q-MATIC CORP., 3194-D Airport Loop Dr., Costa Mesa, CA 92626, (714) 545-8233, Telex 678389

CRYSTAL

205



**New medium-scale, multi-use computer system from Harris.** Powerful VULCAN Virtual Memory Operating System supports more than 50 terminals simultaneously. Greater I/O throughput. MOS Memory with error correction. Powerful micro processor based CPU. Operates with ANSI 74 COBOL, FORGO, SNOBOL, FORTRAN, RPG II, extended BASIC. Handles multi-stream batch processing, multi-concurrent RJE's (host and remote). Harris Computer Systems, 1200 Gateway Dr., Ft. Lauderdale, Fl. 33309 (305) 974-1700.

COMPUTER SYSTEMS

200



**INTEGRITY AND RECOVERY IN COMPUTER SYSTEMS**, by T. K. Gibbons. Here is a step-by-step guidebook that places at your fingertips all the techniques and strategies you need for locating and correcting errors and failures and for re-establishing complete system integrity and reliability as quickly as possible. #5454-8, 144 pp., \$9.95. Circle the Info Retrieval Number to order your 15-day exam copy. When billed, remit or return book with no obligation. **Hayden Book Co., 50 Essex St., Rochelle Park, N.J. 07662.**

INTEGRITY & RECOVERY

203

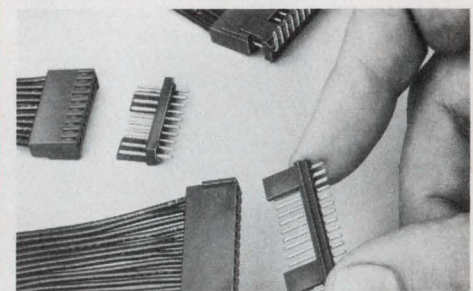

**NEW "POL-R-LOK" MINIATURE CONNECTORS FEATURE POLARIZED LOCKING INTERCONNECTS ON .100 CENTERS** for consumer electronic applications. Locking polarizing header and mating crimp receptacle available with 2 - 28 positions. Straight or right angle .025" square pins. Receptacle bellow contacts accommodate 22.1184 Immed. Divy. \$1.85 ea. 10 MHz thermoplastic molded connector bodies. 3.5 amp nominal at 250VAC. METHODE ELECTRONICS, INC 1700 Hicks Road, Rolling Meadows, ILL 60008. (312) 392-3500.

MINIATURE CONNECTORS

206

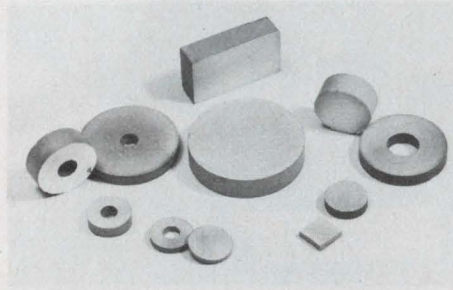

**ECONOMICAL AND RELIABLE PIEZOCERAMICS.** Quality piezoelectric polycrystalline ceramic elements are available in standard disc, plate and ring shapes. These elements offer a wide temperature range and provide a broad range of properties for sensors or high output power appliances. Write for free catalog. LINDEN LABORATORIES, INC., Box 920, State College, PA 16801, 814-355-5491. A RESOURCE MANAGEMENT CORPORATION SUBSIDIARY.

PIEZOCERAMICS

201

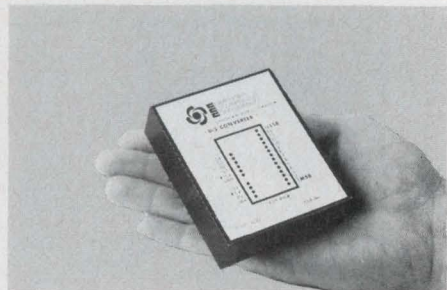

**DIGITAL TO SYNCHRO CONVERTERS—** 14, 12 or 10 bit input, 11.8/90V, 400 or 60Hz transformer isolated output, accuracy  $\pm 4$ ,  $\pm 15$  or  $\pm 30$  min. Driving 1VA, 2VA (2.6" x 3.1" x 82"H module) or 5 VA loads (4 1/2" x 9 1/4" PC card). Price from \$350 in qty. Other CCC products are Synchro to Digital or DC, and DC to Synchro Converters, Solid State C.T.'s or CDX's, and Absolute Encoders. Send for Free Catalog & Application Notes. Computer Conversions Corp., East Northport, N.Y. 11731 (516) 261-3300.

DIGITAL TO SYNCHRO

204

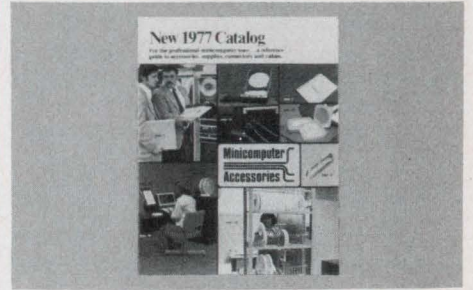

**FREE— The New Minicomputer Accessories 1977 Summer Catalog.** Hundreds of standard (but hard to find) minicomputer products. Disk Cartridges, Mag Tape, Floppy Disks, Binders, I/O Connectors, Cables, Racks. Much more. Packed with time and money saving ideas. All products fully guaranteed. Same day shipment. Write or call: (415) 969-5678. MCA Minicomputer Accessories, 1015 Corporation Way, PO Box 10056-M, Palo Alto, Ca. 94303

1977 SUMMER CATALOG

207



# Electronic Design

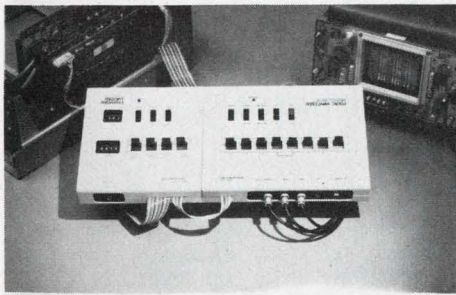

What happens when you mate our 8-bit Model 100-A Logic Analyzer with our 16-bit Model 10 Trigger Expander? You get a 24-bit logic analyzer package with more features for your dollar than any other data domain instrument available. That's why EDN Magazine recently selected the Model 100A/10 as one of the top new products for 1977. And it's stocked locally for under \$600.00. For more information, contact Paratronics, Inc., 800 Charcot Avenue, San Jose, CA 95131. Tel. (408) 263-2252.

LOGIC ANALYZER PACKAGE 208

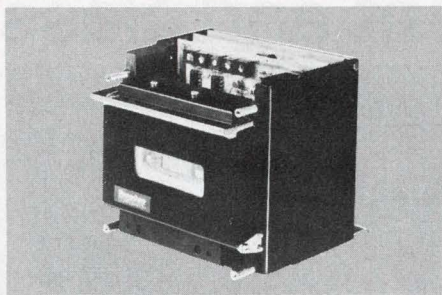

**HIGH SPEED RECORDER FOR MICRO-PROCESSORS** Model 764 has a patented constant speed tape drive using only 2 moving parts. No capstans, tachometers or clock tracks are necessary. Records up to 32,000 bits per second. Searches at 100 inches per second. Can store up to 5 megabits per 300 foot cassette. ANSI/ECMA compatible. Priced under \$500.00/OEM quantities. MEMODYNE CORPORATION, 385 Elliot Street, Newton Upper Falls, MA 02164. Telephone (617) 527-6600.

MICROPROCESSOR RECORDER 211

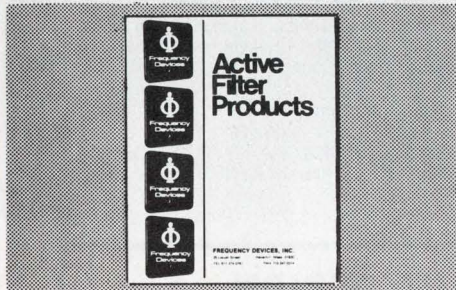

**ACTIVE FILTERS** of all types are described in the Short Form Catalog. Lowpass, Highpass, Bandpass, Band Reject, Fixed, Tuneable and Programmable components in simple to complex multipole configurations. Available as finished off-the-shelf components. Break, Center and cutoff frequencies from 0.001 to 50KHz. are available. FREQUENCY DEVICES, INC., 25 Locust Street, Haverhill, MA 01830. Tel: (617) 374-0761 TWX 710-347-0314.

ACTIVE FILTER CATALOG 209

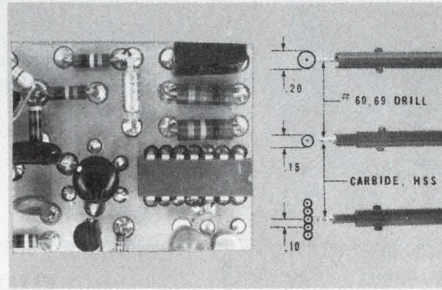

**NO ETCH BREADBOARDS . . . WIRE-WRAP BREADBOARDS** with isolated pad drill-mill construction. Quickly duplicate any etched board; build circuits from full-size artwork. Add components to and/or change circuitry of previously etched boards. Complete freedom in wire-wrap design/layout. Ideal for high frequency ground plane construction. A kit of three IP6003C with #60 carbide drills, \$30.00 (\$12.50 ea.). A. F. Stahler Company, P.O. 354, Cupertino, CA 95014 (408) 252-4219.

NO ETCH BREADBOARDS 212

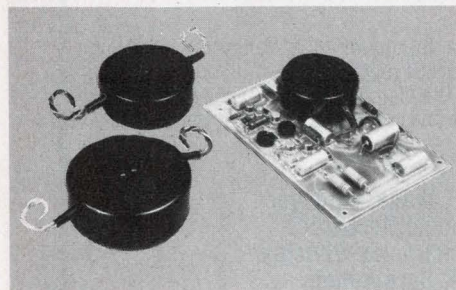

**AVEL-LINDBERG** toroidal transformer offers many electrical and mechanical advantages combined in attractive, uniform presentation in the range of standard power transformers. Toroids also have 50% less weight and volume; a lower height profile for slimline electronics and an incredible 8:1 lower radiated interference field. To order see Avel-Lindberg distributors listed in GOLD BOOK 77-78.

TOROIDAN TRANSFORMER 210

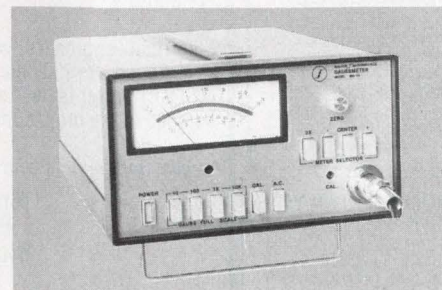

**BROAD RANGE GAUSSMETERS.** Measure AC and DC magnetic fields. Read from milligauss to kilogauss to analyze magnetic circuits, measure residual fields, stray fields, absolute and differential fields. Models available: MG-2A analog display, 8 F.S. ranges from 10 G to 30 KG; MG-3A, analog display, 11 F.S. ranges from 1 G to 100 KG; MG-3D, digital display, 5 F.S. ranges from 10 G to 100 KG. Write Walker Scientific, Inc., Dept. QA/Rockdale Street, Worcester, MA 01606/(617) 852-3574.

BROAD RANGE GAUSSMETERS 213

## Advertising Sales Staff

Susan G. Apolant  
Sales Coordinator

### Rochelle Park, NJ 07662

Robert W. Gascoigne  
Thomas P. Barth  
Stan Tessler  
Constance McKinley  
50 Essex St.  
(201) 843-0550  
TWX: 710-990-5071  
(HAYDENPUB ROPK)

### Philadelphia

Thomas P. Barth  
(201) 843-0550

### Boston 02178

Gene Pritchard  
P.O. Box 379  
Belmont, MA 02178  
(617) 489-2340

### Chicago 60611

Thomas P. Kavooras  
Berry Conner, Jr.  
200 East Ontario  
(312) 337-0588

### Cleveland

Thomas P. Kavooras  
(312) 337-0588

### Los Angeles 90045

Stanley I. Ehrenclou  
Burt Underwood  
8939 Sepulveda Blvd.  
(213) 641-6544

### Texas

Burt Underwood  
(213) 641-6544

### San Francisco

Robert A. Lukas  
465 S. Mathilda, Suite 302  
Sunnyvale, CA 94086  
(408) 736-6667

### England

Constance McKinley  
50 Essex St.  
Rochelle Park, N.J. 07662  
Phone: (201) 843-0550

### Europe

Sanders, W. J. M.  
Raadhuisstraat 24  
Graft-De Ryp, Holland  
Phone: 02997-1303  
Telegrams: Euradteam-Amsterdam  
Telex: 13039-SIPAS

### G. Nebut

Promotion Presse Internationale  
7 ter Cour des Petites Ecuries  
75010 Paris, France  
Telephone: 5231917, 1918, 1919

### Dieter Wollenberg

Erikastrasse 8  
D-8011 Baldham/Muenchen  
Germany  
Telephone: 0 8106/4541

### Tokyo

Haruki Hirayama  
EMS, Inc.  
5th Floor, Lila Bldg.,  
4-9-8 Roppongi  
Minato-ku, Tokyo, Japan  
Phone: 402-4556  
Cable: EMSINCPERIOD, Tokyo





# Electronic Design

## recruitment and classified ads

PLACE YOUR AD AT ONLY \$45 PER COLUMN INCH IN

### Electronic Design

— GET A REPEAT AD FREE!

With our 2 for 1 plan, your net cost in *Electronic Design* is only \$22.50 per column inch, lowest among all the national newspapers and electronics media. You get a total of 165,402 exposures to EDEM engineers and engineering managers (not counting 10,600 more among general or corporate managers) at only 27¢ per thousand! You can't beat the price. You can't beat the coverage and you can't beat the quality.

YOU REACH ENGINEERS WITH TITLES LIKE THESE:

- Chief Engineer • Development Engineer • Design Engineer • Project Engineer • Electronic Engineer • Engineer-Supervisor • Section Leader • Staff Engineer • Systems Engineer • Test Engineer • Standards Engineer • Master Engineer

### Electronic Design RECRUITMENT ADVERTISING RATES

15% commission to recognized agencies supplying offset film negatives. 2% 10 days, net 30 days. Four column makeup. Column width 1-3/4" x 10".

SPACE	DIMENSIONS		COST
	Wide	Deep	
One column inch	1-3/4"	x 1"	\$45.
2 col. in.	1-3/4"	x 2"	\$90.
1/16 page (1/4 col.)	1-3/4"	x 2-1/2"	\$112.
1/8 page (1/2 col.)	1-3/4"	x 5"	\$225.
1/4 page (1 col.)	1-3/4"	x 10" Vert.	\$450.
	3-1/2"	x 5" Hor.	
1/2 page (2 cols.)	3-1/2"	x 10" Vert.	\$900.
	7"	x 5" Hor.	
3/4 page (3 cols.)	5-1/4"	x 10"	\$1350.
1 page	7"	x 10"	\$1800.

NOTE: EACH RECRUITMENT AD YOU PLACE WILL BE REPEATED FREE OF CHARGE!

### LATE CLOSING DATES

*Electronic Design* is mailed every two weeks. Because of its timeliness, personnel recruitment advertising closes only two weeks before each issue's mailing date.

1977 Mailing Date	Recruitment Closing Date	Issue Date on Cover
Aug. 26	Aug. 12	Sept. 13
Sept. 9	Aug. 26	Sept. 27
Sept. 23	Sept. 9	Oct. 11
Oct. 7	Sept. 23	Oct. 25
Oct. 21	Oct. 7	Nov. 8
Nov. 4	Oct. 21	Nov. 22
Nov. 18	Nov. 4	Dec. 6
Dec. 2	Nov. 18	Dec. 20



### HOW TO PLACE YOUR AD CALL THE RECRUITMENT HOT LINE 201-843-0550

Camera-ready film (right reading negatives, emulsion side down) or camera-ready mechanicals must be received by deadline. Or, if you wish us to set your ad (typesetting is free) simply pick up the phone and call our RECRUITMENT HOT LINE — (201) 843-0550. Ask for:

Constance McKinley  
RECRUITMENT ADVERTISING MANAGER  
ELECTRONIC DESIGN

50 Essex Street, Rochelle Park, New Jersey 07662

### MOVING UP? ATLAS

HAS

NATIONWIDE OPENINGS

DESIGN ENGR. — AC TRANSFORMERS, FERRO-MAGNETICS, PROGRAMMER ANALYSTS, DEVELOPMENT ENGR. — INVERTER SYSTEMS, SCR, UPS, APPLICATIONS PROGRAMMERS, CHIEF ENGR. — UPS, SYSTEMS PROGRAMMERS

**18K to 40K++**

EOE — EMPLOYER PAID

### ATLAS AGENCY

412 West 6th Street, Suite 820  
Los Angeles, CA 90014

ATTN: LIONEL HARRIS — BOB ASCHER  
(213) 627-9611

### WELLS ELECTRONIC SEARCH INC. NATIONWIDE

SYS ARCHITECTURE - HARD/SOFTWARE  
Mini-Micro Terms From Concept 38,000  
SR SYS ENG/ANALYST - Elint. Sigint. Comint  
25-35,000  
PRINCIPAL DEV/ENG - Magnetic Flow Meter  
24-33,000  
SEMICONDUCTOR DES DEV Process All  
Disciplines 16-35,000  
BIOMED - Ultra Sound, X-Ray, CT Scanner,  
Gamma Camera 16-32,000  
ADV DEV - Ph.D./MS Programmable  
Controller 18-32,000  
ENGS-FSS Pabx Ckt Des Software Dev  
16-32,000  
CKT DES ENG - A/D - D/A & Signal  
Conditioning Ckts 18-26,000  
SR SOFTWARE ENG Process Control  
25-35,000  
DESIGN ENG POS 16-20,000  
CONTACT  
D.L. Sweeny 212-949-8498 Dept. F  
WELLS RECRUITING SYSTEMS INC.  
545 5th Ave., NYC, NY 10017 (AGENCY)

## CIRCUIT DESIGN ENGINEERS

### MOS/LSI NON-VOLATILE MEMORY DESIGN

NCR Microelectronics Division leads the industry in development and production of P channel MNOS memories. We are expanding our engineering department in order to develop larger non-volatile memories including N channel MNOS. Office, lab, test and process facilities have been enlarged in our existing modern facility to provide an excellent engineering environment in a suburban Dayton community.

Electrical engineers with a minimum of 2 years circuit design experience are needed. MOS/LSI memory design is a definite plus. MSEE or better is desirable. The memories and devices designed will be used in the most complete and cost effective systems in the world.

Send your resume and salary history to:

Mr. T.F. Wade, Manager  
Personnel Resources  
Microelectronics Division  
NCR Corporation  
8181 Byers Road  
Miamisburg, Ohio 45342

# NCR

An Equal Opportunity Employer

### ENGINEERS

Needed for FEE-PAID positions THROUGHOUT THE U.S. Over 1,000 client companies. Send resume and salary history or request confidential application today.

### ATOMIC PERSONNEL, INC.

Suite D-2, 1518 Walnut St. Phila. Pa 19102  
Empl. Agcy - All Technical Fields -  
Est. 1959

Engineers, Designers, Draftsmen  
Electronics, Civil, Pipe,  
Mechanical

U.S. and overseas jobs. Send resumes to:

### Adia Technical Services

465 So. Mathilda, Suite 101  
Sunnyvale, CA 94086 — 408-733-2882

### DESIGN ENGINEERS TO \$30,000

CRT DISPLAY CIRCUITS  
LINEAR DEFLECTN AMPLS  
SECURE COMM SYSTEMS  
CONTROL SPACE AND INSTRN

### BRJ ASSOCIATES

1590 E22nd St., Scotch Plains, N.J. 07076  
201-322-8050

### UNADVERTISED OPENINGS

\$16-35K

- Hd/Software Des
- Pwr Supply Des
- Test Engrng
- Mfg Engr & QC
- Radar
- Electro Optics
- Microwave Comm
- Marketing

Let our engineers assist you in advancing your career, or improving your choice of location. Due to our success, many NATIONWIDE companies have retained us to fill their confidential, unadvertised openings. Discretion assured. Contact Tech. Dir.

Corporate Advisors Professional Placement  
12955 Biscayne Blvd., Miami, 33181  
(305) 891-4801

### ENGINEERS SCIENTISTS TECH-SALES

\$15,000 to \$30,000

Fee Paid. Nationwide coverage.  
TECH-PLACE INC.

421-D S 2nd St. Elkhart, IN 46514  
Licensed employment agency



# Technological Leadership for 3 Decades!

Ampex, headquartered on the San Francisco Peninsula, is the company that "invented" the magnetic recording industry.

The technology pioneered by Ampex over three decades has affected many aspects of our modern lifestyles, and has established Ampex as a leader in magnetic recording. Our continued effort in developing new technology has always been the key to our leadership. Right now our Advanced Technology, Data Products and Audio-Video Systems Divisions are embarking on several new programs. To insure the success of these programs we are seeking innovative graduate engineers with experience in the fields listed below.

Opportunities like this don't happen very often. But they're happening at Ampex now.

## Advanced Technology Division

- electron beam and optical recording
- magnetic recording
- tape or film handling
- servos
- high-bit rate digital circuit design
- optics
- signal analysis
- pattern recognition
- high frequency circuit
- communications theory

## Data Products Division

- circuit/systems design of very high-bit rate systems

- disk read/write systems and equalizing systems for tape recorders
- codes for magnetic recording
- precision servo systems for both linear positioners and rotating systems
- mechanical design of high precision systems in disk recorders and in longitudinal, helical and transverse scan tape recorders

## Audio-Video Systems Division

- analog videotape signal systems
- digital video signal processing
- servo systems
- videotape editing
- professional audio recorders
- head technology
- TV cameras

If you think you have something valuable to offer in any of these or closely related areas, and if you would like to join some of America's most talented engineers, please send your resume or a letter outlining your qualifications to: Ampex Corporation, ATTN: Corporate Staffing Manager, Building 2, 2655 Bay Road, Redwood City, CA 94063. Or you can send us this coupon and we'll get back to you. We are an equal opportunity employer m/f.

**Manager Corporate Staffing  
AMPEX Corporation  
Building 2, 2655 Bay Road  
Redwood City, CA 94063  
Dept. 9**

Occupation \_\_\_\_\_  
Years of Experience \_\_\_\_\_  
Employer \_\_\_\_\_

Name \_\_\_\_\_  
Address \_\_\_\_\_  
City, State, Zip \_\_\_\_\_  
Phone \_\_\_\_\_





# BIOELECTRONICS ENGINEER

## FOR DEVELOPMENT OF ELECTRONIC INSTRUMENTATION FOR EYES

We are looking for a person experienced with lasers and optical systems, preferably with a knowledge of biomedical applications, to work at a large medical center. Projects will involve the design and construction of electronic instrumentation for eyes. A background in electronics and electrical engineering is required; a knowledge of computer technology would also be helpful.\* Ph.D. degree not necessary.

### REPLY TO:

**Ophthalmic Research Foundation, Inc.**  
18 East 73rd Street  
New York, N.Y. 10021

\*This is an opportunity to exercise initiative and innovation.

## Join TRW In So. California!

TRW Defense and Space Systems Group, headquartered in Redondo Beach, California and employing over 11,500 people, is a major operating unit of the worldwide corporation of TRW, Inc. Our modern facilities offer an unmatched, campus-like environment and are surrounded by beaches, mountains, deserts, varied cultural centers and the joys of sunny Southern California living! major operations within our division are located in San Bernardino, Vandenberg AFB, San Juan Capistrano and Sunnyvale, California and in Washington, D.C.

We are a team-oriented company committed to quality...quality in the work we turn out and in the professionals we bring in. The recent award of the TD-1193 Multiplexer/Demultiplexer, AM/FRC Digital Radio contract has created extraordinary opportunities for telecommunications professionals. In addition, our long-term contractual commitments in support of the National Military Command System (NMCS) and the Worldwide Military Command and Control System (WWMCCS) have created unique positions for progressive individuals capable of creative and innovative analysis in the areas of national level C<sup>3</sup> systems. We invite you to explore exceptional career opportunities in the following positions:

- Digital Circuit Designer
- Multiplexer Design Engineer
- Operations Research Analysts
- Applications Engineers
- Test Engineers
- Digital Systems Engineers
- Antenna Design Engineers
- Systems Test Engineers
- RF Engineers
- RF System Designer
- Digital Modem Designer
- Product Design Engineers
- LSI Applications Engineers
- Communications Systems Engineers
- Communications Systems Analysts
- Signal Processing Systems Engineers
- Microwave Engineers

At TRW, you will be a recipient of our nationally recognized Flexible Benefits Plan. If you thrive on challenge in an atmosphere which stresses professional freedom and achievement, please send your resume in complete confidence to:

**Professional Placement, Box AE-100**

**One Space Park  
Redondo Beach, Calif. 90278**

An equal opportunity employer M/F/H

**TRW**  
DEFENSE AND SPACE SYSTEMS GROUP



# Software & Hardware Design Opportunities at the Forefront of the Evolution in Telecommunications!

Consider the growth potential, and unparalleled creative latitude involved in a technical evolution that encompasses an industry as large as the telephone systems of the U.S. and other countries.

It is underway! And GTE Automatic Electric, a major member of the GTE Family, whose research and development expenditures ranked among the top 50 R&D spenders in U.S. Industry in 1976, is leading the way with a major expansion of the engineering, and all related support staffs. Our assignment... research and develop the communications systems of the future. Not a single system project, but a continuing evolution of sophisticated high speed, computer-controlled telecommunications systems.

We have career openings for skilled professionals with experience in virtually every segment of digital and analog related software development and hardware engineering. These are some of our most immediate positions:

## SOFTWARE DESIGN ENGINEER

Responsible for the specification, design and testing of telephone systems support software, network and control software, or maintenance and diagnostics software. Prefer a minimum of 3 years' experience in structured design, coding, testing and documentation of programs; development with large data base on multi-file computers and real-time systems, HIPO design documentation, TSO usage and software simulation techniques. Requires a BS or MS in Computer Science or Electrical Engineering, and specialized study in the use of PL/I Fortran, Assembler, Entil 8080 and PDP-11 programming languages.

## HARDWARE DESIGN ENGINEER

Primary responsibilities will cover the specification and design of the Common Control hardware system and development of control processors, memories, peripheral controllers, network, network controllers, and trunks. Prefer a minimum of 3 years' experience in diagnostic software and hardware development in large real-time systems, system architectural planning, digital logic design, and TSO and structural programming techniques. Requires a BS or MS in Electrical Engineering or Computer Science and specialized study in logic design, assembly or computer language programming and fundamentals of sequential design.

## THICK FILM ENGINEER

Responsibilities will focus on the review and analysis of circuit design for possible application to thick film packaging, hybrid design, providing liaison with circuit designers and submitting documentation to engineering departments. Prefer 3 or more years' experience in thick film hybrid microelectronic design and processing. Requires a BS or MS in Electrical Engineering and specialized study in circuit design, hybrid design, costing, functional trimming and materials in hybrid processing parameters.

## TELETRAFFIC ENGINEER

Responsible for the analysis of teletraffic probability and queuing problems on digital and analog switching systems and the development of computer programs for switching systems. Prefer a minimum of 3 years' experience in real-time control systems teletraffic problems, systems equipment quantity specifications, and exposure to switching system specifications. Requires a BS or MS in Electrical Engineering, Computer Science or Math, a strong statistical background and experience in PL/I or Fortran programming and model simulation.

## ELECTRONIC PACKAGING ENGINEER

Will be engaged in the development and evaluation of electronic system packaging for effectiveness and cost reduction purposes. Includes development of packaging standards and maximizing effectiveness of hardware systems with respect to packaging density, thermal efficiency and I/O constraints at the PWC and file levels. Prefer 3 or more years' experience in electronic system packaging design and development and the functions of PWC generation. Requires a BS in Electrical Engineering, Mechanical Engineering or Applied Sciences and specialized study in packaging mechanics, materials and production processes.

## COMPUTER AIDED DESIGN ENGINEER

Responsible for specification, design and implementation of integrated Computer Aided Design/Computer Aided Manufacturing (CAD/CAM) systems. Includes planning and design of information system architecture, data base systems, simulation systems, and the development of interactive user access and PCB Physical Design system. Prefer a minimum of 3 years' experience in software development for CAD or CAM systems, data base systems, data base administration, and interactive graphic systems or computer systems. Requires a BS, MS or PhD in Electrical Engineering, Computer Science, or Math and specialized study in high level programming languages and techniques.

## CIRCUIT DESIGN ENGINEER

Will analyze, evaluate and test integrated circuit assemblies, discrete devices and prototype systems; generate specifications, parameter measurements and operational life testing; design test circuits and perform failure analysis on semiconductors. Prefer a minimum of 3 years' experience in integrated circuitry, design of logic systems (digital TTC IC families), failure analysis and assembly processes. Requires a BS or MS in Electrical Engineering or Physics and specialized study in semiconductors, integrated circuits, digital circuits, electrical measurement and programming.

Let's talk about the evolution in telecommunications, and what it can mean to your career. One of our representatives is standing by:

**CALL TOLL FREE  
(800) 323-1966**

In Illinois (800) 942-0491  
Monday thru Friday  
from 8 am to 5 pm cst

If unable to call, please send your resume to:  
Manager of Employment

**GTE AUTOMATIC ELECTRIC LABORATORIES**  
400 N. Wolf Road  
Northlake, IL 60164

**GTE AUTOMATIC  
ELECTRIC LABORATORIES**

An Equal Opportunity Employer M/F



## NEW ENGLAND RECRUITERS

ELECT-TECH, a division of New England Recruiters, specializing in Electrical and Electronic Engineers has over 150 positions thru-out N.E. and the North East. The following are just a sample of the positions that are available.

### DATA-TELE COMMUNICATIONS

PRODUCT MGRS (3) to 30K  
Degree Comm Syst., modems or tele. networks  
PRINCIPLE-PROJ. ENGS. (2) to 27K  
Degree Data-Comm. Syst. modems, micro-processors  
SYSTEMS ENGS. (3) to 25K  
Degree Telephone, switching syst. Telex, micro  
PRODUCT DESIGN (2) to 24K  
Degree Design Data-Comm. Syst. micro hard/soft  
SR. ENGS. (3) to 20K  
Degree Data-Comm. test equip. or modems or TDM's.

### SEMI-CONDUCTORS

LAB DIRECTOR to 40K  
Degree Advance develop. Pilot research MOS semi-cond.  
PROCESS ENGS. (2) to 25K  
Degree Process develop. semi-cond.

### POWER SUPPLIES

MANAGER (2) to 30K  
Degree Superv. exp. power supplies, series & switching.  
DESIGNERS to 25K  
Degree converters, inverters, switching regulators.

### COMPUTERS

ANALOG DESIGN (3) to 25K  
Degree Heavy Analog circuits, amplifiers power supplies.  
CPU DESIGNER OR PROGRAM to 25K  
Degree-Design and interface mini or micro hard/soft  
COMPUTER-ARCHITECT (3) to 25K  
Degree Logic design, processor, mini or micro hardware  
PACKAGING to 25K  
Thermo-Anal., cooling, enclosures, PC boards.

### ELECTRONICS

SR. PROJECT (2) to 28K  
Degree Mini-Comp microprocessor hard/soft.  
SR. CONTROLS (3) to 26K  
Degree mini-comp. micro hard/soft controllers  
SYSTEMS ENGS. (2) to 25K  
Degree Design optical, mechanical systs.  
DIGITAL DESIGN to 30K  
Degree Design ECL, Hi-speed digital logic.  
QC MGR. (MEDICAL) to 25K  
Degree QC exp. medical Co. FDA regulations.

### ELECTRICAL

PROJECT ENG. to 25K  
Degree Instrum. & controls heavy equip.  
ENG. MGR. to 31K  
Degree exp. in micro, sub-fract. or fract. HP motors.  
DESIGN TRANSMISSION Open  
Degree Design of power transmission systems.  
PROJECT ENG. Open  
Degree Design elect/Mech. Controls & speed drive systems. Integral motors.

ALL FEE PAID  
NEW ENGLAND RECRUITERS  
900 Chapel Street  
New Haven, CT 06510  
(203) 624-0161

## SENIOR ENGINEER MICROWAVES

Here is a real opportunity to grow! We need a solid electronic engineer with management ambitions and leadership qualities on our team. Experience in amplifiers and communication systems using microwave tubes is very desirable. You need to be a graduate engineer with a minimum of five years of design experience. The right man will either assume now or be capable of growing into a position of chief engineer.

You will find that working at Cober is stimulating and rewarding. We offer a full fringe benefit package including profit sharing.

Please send resume to: Don Scofield  
Cober Electronics Inc.  
7 Gleason Avenue  
Stamford, Connecticut 06902

## P.O.S. Terminal Design Engineer

To perform hardware design and some systems work on a next generation hospitality terminal including communications from the terminal to the CPU and peripherals. Some microprocessor architecture knowledge would be helpful.

A degree plus 2 or more years design experience will qualify.

NCR's P.O.S. facility is located in rural east central Ohio.

*We invite you to respond as soon as practical.*

**Mr. Robert W. Donovan**  
Terminal Systems Division  
NCR Corporation  
P.O. Box 728  
Cambridge, OH 43725

# NCR

An Equal Opportunity Employer

**Constance McKinley**  
RECRUITMENT ADVERTISING MANAGER  
ELECTRONIC DESIGN  
50 Essex Street, Rochelle Park, New Jersey 07662  
(201) 843-0550

I'm interested in placing recruitment  
advertising in *Electronic Design*

Issue \_\_\_\_\_ Size of ad \_\_\_\_\_

My copy is enclosed  I need more information

Name \_\_\_\_\_

Title \_\_\_\_\_

Company \_\_\_\_\_

Address \_\_\_\_\_

City \_\_\_\_\_ State \_\_\_\_\_ Zip \_\_\_\_\_

Telephone \_\_\_\_\_

# SPECIAL 2 RECRUITMENT ADS

FOR THE  
PRICE OF

# 1

Double the  
coverage . . .  
double the  
effectiveness  
of every ad  
you place!

## Electronic Design

BRINGS YOU  
THE HIGHEST  
NUMBER OF  
QUALIFIED EOEM  
ENGINEERS AND  
ENGINEERING  
MANAGERS  
ANYWHERE  
. . . AT THE  
LOWEST COST  
ANYWHERE!



# Engineers... are you pigeonholed?

We won't keep you pigeonholed in the same old assignment, year after year. After all, variety is the spice of a life's work. And we have a commitment to it. We make our living selling variety: command and control systems, complete air defense systems, radar systems, sonar systems, computer systems and much more. We're part of a company of 36,000 people, active in more than 550 major product areas in 80 technologies. Plenty of room for developing interests, plenty of room for growth.

Our Systems Division engineers enjoy technical diversity because of our program variety, and growth opportunities that we're steadily expanding. They benefit from the technically oriented management which put us on our strong growth curve. And they enjoy a good professional environment, where many of our people wear 10, 15, and 20 year service pins.

Any more good news? Well, yes. We're hiring now.

**For quick action, reach for your phone instead of your resume...** call Richard Navarro collect (714) 871-4080, Ext. 2136 between 8 A.M. and 4 P.M. Monday through Friday. Or send your resume to: Professional Employment—Ground Systems Group C, 1901 W. Malvern, Fullerton, CA 92634.

U.S. citizenship required • Equal opportunity M/F/H/C employer

**HUGHES**

HUGHES AIRCRAFT COMPANY

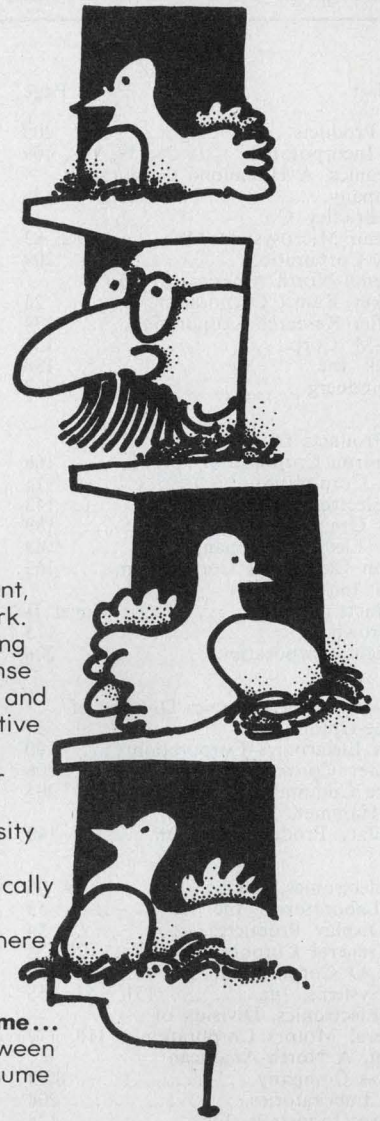

**Communications System Engineers.** Must understand hardware/software interaction, signal processing, spread spectrum.

**Senior Systems Engineers.** Tactical, strategic system application of radar, sonar communications, electro-optical software, data processing and command and control technologies.

**Communication Analysts.** Lead/direct application of systems theory, applied math, estimation, probability to communication system problems.

**Data Processing and Software Analysts.** System level data processing architecture analysis, design, performance evaluation for multisensor systems.

**Display System Engineers.** Long term opportunity to lead display product definition/selection for military C&C Systems.

**Radar Systems Engineers.** Lead/direct radar system conceptual design/analysis. Integration of radar, weapon, command and control systems.

**Senior Air Defense Engineers.** BSEE, Math or Physics, project management experience in real-time hardware software systems.

**Hardware System Engineers.** Large scale data processing, peripheral, display systems design, specification, integration checkout.

**Systems Analysts.** Systems Theory, applied math background. Variety of problems requiring modern analysis techniques.



# Advertiser's index

Advertiser	Page	Advertiser	Page	Advertiser	Page
ADC Products.....	205	Harris Computer Systems.....	206	Q-Matic Corporation.....	206
AMP, Incorporated.....	38, 39, 108, 109	Harris Semiconductor, A Division of Harris Corporation.....	4, 5	RCA Solid State.....	Cover IV
Accutronics, A Hammond Corporation Company.....	145	Harwil Co.....	204	RCI/Data.....	203
Allen Bradley Co.....	15	Hayden Book Company, Inc.....	154, 200, 204, 205, 206	Raytheon Company, Ocean Systems Center.....	166
American Microsystems, Inc.....	82, 83	Haydon Switch & Instrument, Inc.....	185	Rental Electronics, Inc.....	32H
Ampex Corporation.....	209	Heinemann Electric Company.....	12, 13	Repco, Incorporated.....	6
Amphenol North America division Bunker Ramo Corporation.....	26	Hewlett-Packard.....	52, 53, 84	Riken Denshi Co., Ltd.....	201
Amplifier Research Corporation.....	174	Hudson Tool & Die Co.....	81	Rockwell International.....	146, 147
Arrow-M Corp.....	156	Hughes Aircraft Company.....	213	Rogan Corporation.....	110
Avantek, Inc.....	188	IMC Magnetics Corporation.....	203	Rogers Corporation.....	204
Avel-Lindberg.....	207	ITT Pomona Electronics.....	179	Rostone Corporation.....	32
Beau Products Division, Vernitron Corporation.....	168	Idec S & C Corp.....	176	Rtron Corporation.....	162
Belden Corporation.....	11	Intel Corporation.....	8, 9	Sangamo Weston, Inc. Sangamo Data Recorder Division.....	10
Berg Electronics, Inc.....	143	International Rectifier.....	80	Sangamo Weston Inc. Weston Components & Controls... ..	171
Bishop Graphics, Inc.....	189	Inter-Technical Group.....	202	San-O Industrial Corp.....	192
Bodine Electric Company.....	80D	Johanson/Dielectrics, Inc.....	204	Scientific Atlanta Inc./Optima Div.....	96 A-B-C-D
Boonton Electronics Corporation.....	163	Johanson Manufacturing Corp.....	22	Seastrom Manufacturing Co., Inc.....	186
Bourns, Inc., Trimpot Products Division.....	Cover II	Keithley Instruments, Inc.....	161	Servo-Tek Products Company.....	178
Burr-Brown.....	175	Kennedy Corporation, M. S.....	192	Shugart Associates.....	30
Burroughs Corporation.....	206	Kueka Electric Corp.....	203	Signetics Corporation.....	21
Centralab, The Electronics Division of Globe-Union, Inc.....	31	Lexed, Inc.....	182	Simpson Electric Company.....	177
Clinton Electronics Corporation.....	190	Lemo USA, Inc.....	204	Spectra-Strip Marketing Services.....	204
Computer Conversions Corp.....	206	Linden Laboratories, Inc.....	206	Spirig-Signalarm.....	205
Creative Computing.....	205	Littelfuse.....	23	Sprague Electric Company.....	33, 169
Cutler-Hammer, Specilatly Products Division.....	149	MCG Electronics.....	200	Stacoswitch, A Staco Inc. Company..	195
Dale Electronics, Inc.....	94, 95	MDB Systems, Inc.....	183	Stahler Company, A.F.....	207
Dana Laboratories, Inc.....	55	*M-O Valve Co. Ltd.....	31	Standard Engineering Corporation....	185
Data Display Products.....	54	M-Tron Industries, Inc.....	194	Standard Grigsby, Inc.....	111
Data General Corporation.....	29, 36	MVP Electronics.....	206	Stanford Applied Engineering, Inc....	18
Data I/O Corporation.....	159	Magnecraft Electric Company.....	85	Statek Corp.....	204
Datel Systems, Inc.....	151, 153, 155	Magnetic, Inc.....	205	Suter-Elektronik.....	192
Delco Electronics, Division of General Motors Corporation..	116, 117	*Matsuo Electric Co. Ltd.....	24	Switchcraft, Inc.....	199, 201, 203
Dialight, A North American Phyliss Company.....	80D	McCoy Electronics Company.....	119	Syntronic Instruments, Inc.....	189
Digital Laboratories.....	204	Memodyne Corporation.....	207	Synertek.....	180, 181
Dormeyer Industries, Inc.....	135	Merrimac Industries, Incorporated... .	173	TRW Defense and Space Systems Group.....	210
ECD Corporation.....	131	Mepco/Electra, Inc.....	187	Technical Wire Products, Inc.....	56
*EMI Technology, Inc.....	176A-B	Methode Manufacturing Co.....	206	Texas Instruments, Incorporated.....	34, 35, 142
EMR Telemetry.....	80D	Microswitch, A Division of Honeywell.....	68, 69	Thin Sheet Metal.....	194
Eagle-Picher Industries, Inc.....	167	Miller-Stephenson.....	14	Trak Systems.....	197
Electro Space Fabricators, Inc.....	204	Mini-Circuits Laboratory, A Division of Scientific Components Corp.....	2	Triple I, A division of the Economy Co.....	185
Electronic Instrument & Specialty Corp.....	198	Mini Computer Accessories.....	206	Unimax Switch Corporation.....	129
Electronic Navigation Industries.....	7	Molex, Incorporated.....	32F-G	United Systems Corporation.....	170
Elektronik, Inc.....	136	Molon.....	199	Vector Electronic Co., Inc.....	184
Elexon Power Systems.....	134	Monsanto Company.....	164, 165	Victory Engineering Corp.....	201
Eltec Instruments, Inc.....	201	MuRata Corporation of America.....	199	Vitek Electronics, Inc.....	196
Evershed and Vignoles Limited.....	205	NCR.....	208, 212	Voltronics Corporation.....	133
*Exar Integrated Systems.....	15	National Semiconductor Corporation.....	80 A-B-C	Wabash, Inc.....	118
Ferranti Electric, Inc.....	183	New England Recruiters.....	212	Walker Scientific, Inc.....	207
Figaro Engineering, Inc.....	205	Nichicon (America) Corporation.....	Cover III	Wavetek San Diego, Inc.....	1
Fluke Trendar.....	127	North American Philips Controls Corp.....	80D	Weckesser Company, Inc.....	189
Fluke Trendar.....	127	Ohmite Manufacturing Company... ..	24, 25	Wescon 77.....	144 A-B-C-D
Frequency Devices, Inc.....	207	*Oscilloquartz SA.....	25	Western Thermistor Corporation.....	205
GTE Autometric Electric Laboratories.	211	Oxley Developments Co., Ltd.....	199	Weston Instruments, Inc.....	96
General Electric Company, Miniature Lamp Products Department.....	191	Panasonic Electronic Components.....	137		
Gold Book, The.....	*32, 215	Panduit Corporation.....	197		
Gould, Inc. Control & Systems Division.....	57	Paratronics, Inc.....	207		
Gould, Inc., Instrument Systems Division.....	97	*Philips Electronic Components and Materials.....	23		
Grayhill, Inc.....	158	Philips Test & Measuring Instruments, Inc.....	160		
Guidline Instruments, Inc.....	32E	Plastic Capacitors.....	197		
Gulton Industries, Inc., Measurement & Control System Division.....	184	Power/Mate Corp.....	205		
		Precision Monolithics, Incorporated.....	16, 17		
		Pyrofilm Corporation.....	193		

\*Advertisers in non-U.S. edition



# The New 1977-1978 **GOLD BOOK** Has Just Been Published

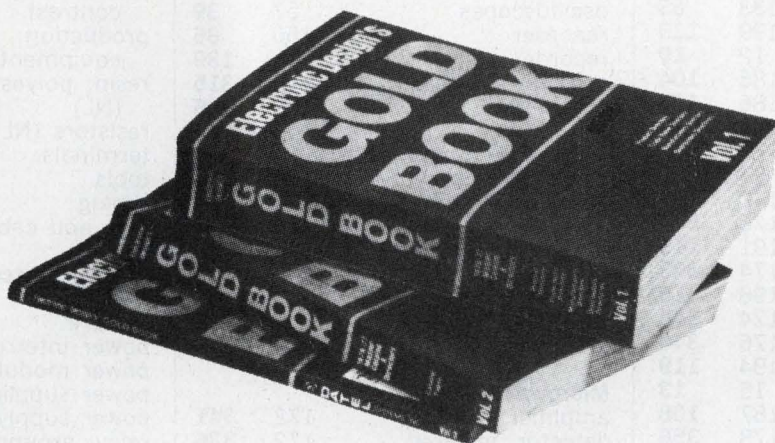

## And Completely Outdates Last Year's Edition

If you are currently a subscriber on **ELECTRONIC DESIGN's** qualified circulation file, you need do nothing. You will receive your new **GOLD BOOK** automatically. If you wish additional copies for other members of your company, you may order them now using the convenient coupon form below.

If you are not currently an **ELECTRONIC DESIGN** subscriber on our controlled circulation list, you may order your own multi-section set of the new **GOLD BOOK** by completing the form below. Shipment will be made promptly on receipt of your payment or company purchase order.

**HERE IS WHAT YOU AND YOUR COMPANY  
WILL FIND IN THE UPDATED 1977-78**

### **GOLD BOOK**

- **Three sections** containing 2,496 pages of information to quickly locate products used by the electronics industry.
- **A Product Directory** with 5,434 product categories.
- **A Trade Name Directory** of 9,814 listings.
- **A Manufacturers' Directory** listing 8,057 companies in the electronics industry.
- **Two Distributors' Directories** with 2,050 distributors listed.
- **A Giant Compendium of Manufacturers' Data Pages** with specifications.

### MAIL TODAY WITH PURCHASE ORDER

Electronic Design's **GOLD BOOK** 449R  
Hayden Publishing Co., Inc.  
P.O. Box 13803, Philadelphia, Pa. 19101 U.S.A.

Here is our purchase order for \_\_\_\_\_ sets of the 1977-1978 **GOLD BOOK** at \$30.00 per set—for U.S., Canada and Mexico. (All other countries: \$40.00 per set)

Check enclosed for \$\_\_\_\_\_.  Bill us.

Name (Print) \_\_\_\_\_

Title \_\_\_\_\_

Company \_\_\_\_\_

Address \_\_\_\_\_

City/Province \_\_\_\_\_

State/Country \_\_\_\_\_

Zip or Postal Code No. \_\_\_\_\_

**QUANTITIES ARE LIMITED. PLACE ORDER TODAY!**



# Product index

**Information Retrieval Service.** New Products, Evaluation Samples (ES), Design Aids (DA), Application Notes (AN), and New Literature (NL) in this issue are listed here with page and Reader Service numbers. Reader requests will be promptly processed by computer and mailed to the manufacturer within three days.

Category	Page	RSN	Category	Page	RSN	Category	Page	RSN
<b>Components</b>			lab recorder	157	<b>304</b>	knobs and dials	110	<b>54</b>
capacitors	33	<b>281</b>	modulation meter, FM	163	<b>84</b>	motors	180	<b>357</b>
capacitors	202	<b>142</b>	oscillators	145	<b>70</b>	phosphors, high contrast	191	<b>115</b>
capacitors, trimmer	133	<b>63</b>	oscilloscopes	57	<b>39</b>	production equipment	181	<b>360</b>
capacitors, trimmer	199	<b>133</b>	recorder	166	<b>86</b>	resin, polyester (NL)	200	<b>421</b>
circuit breakers	12	<b>10</b>	recorder	201	<b>139</b>	resistors (NL)	198	<b>411</b>
clocks, digital	185	<b>104</b>	spectrum analyzer	158	<b>315</b>	terminals	168	<b>88</b>
components	186	<b>107</b>	wattmeter	158	<b>306</b>	tools	182	<b>364</b>
counter, electrical	174	<b>344</b>	<b>Micro/Mini Computing</b>			tubing	180	<b>358</b>
counter, electrical	178	<b>357</b>	calculator, encrypting	164	<b>324</b>	wire and cable	180	<b>356</b>
discrete components	95	<b>49</b>	deck, cassette	162	<b>310</b>	<b>Power Sources</b>		
indicators	170	<b>91</b>	memory, add-on	164	<b>322</b>	batteries	167	<b>87</b>
lamps, LED	176	<b>347</b>	packages, evaluation	164	<b>325</b>	battery	190	<b>377</b>
lamps, miniature	191	<b>115</b>	printer, alphanumeric	162	<b>320</b>	power interrupter	191	<b>379</b>
LEDs	174	<b>343</b>	printer, 21 column	162	<b>321</b>	power modules	200	<b>422</b>
magnetic heads (NL)	198	<b>418</b>	reader, paper tape	164	<b>323</b>	power supplies	198	<b>415</b>
motors	174	<b>345</b>	system development	162	<b>309</b>	power supply, lab	192	<b>381</b>
network, capacitor	176	<b>346</b>	<b>Microwave</b>			relay, ground-fault	191	<b>378</b>
quartz crystals	194	<b>119</b>	amplifier	172	<b>341</b>	supply, switching	190	<b>376</b>
resistors	15	<b>13</b>	detector, infrared	172	<b>336</b>	UPS	192	<b>380</b>
resistors	187	<b>108</b>	filter-optic data link	712	<b>340</b>	voltage regulator	21	<b>16</b>
resistors, metal film	178	<b>356</b>	frequency source	172	<b>338</b>			
switches	149	<b>73</b>	laser expander	172	<b>337</b>	<b>new literature</b>		
switches	176	<b>348</b>	mixer	172	<b>339</b>	analysis system	198	<b>417</b>
switches	199	<b>134</b>	power supply, laser	172	<b>335</b>	book club	203	<b>146</b>
switches	201	<b>140</b>	<b>Modules &amp; Subassemblies</b>			bus cable	200	<b>424</b>
switches	203	<b>145</b>	amp, dc	188	<b>374</b>	CCTV accessories	198	<b>413</b>
switches, PB	195	<b>121</b>	amplifier, wideband	174	<b>93</b>	circuit-board hardware	200	<b>425</b>
switches, program	178	<b>358</b>	CCTV Accessories (NL)	198	<b>413</b>	display drivers	198	<b>407</b>
switches, pushbutton	176	<b>349</b>	converter, a/d 8-bit	184	<b>369</b>	fastener adhesive	198	<b>410</b>
thermostat	174	<b>342</b>	converter, d/a 16-bit	186	<b>370</b>	instruments, systems	198	<b>409</b>
trimmers	171	<b>92</b>	converters, a/d	188	<b>375</b>	magnetic heads	198	<b>418</b>
tuning forks	199	<b>135</b>	converters, a/d	190	<b>116</b>	resin, polyester	200	<b>421</b>
			converters, a/d	192	<b>116</b>	resistors	198	<b>411</b>
<b>Data Processing</b>			encoder, optical	186	<b>373</b>	shielding products	198	<b>412</b>
graphic display	195	<b>389</b>	filter, active	186	<b>372</b>	silicon photodetectors	198	<b>414</b>
interface, computer	194	<b>387</b>	filter, switchable	184	<b>367</b>	solenoids	200	<b>420</b>
interface, computer	194	<b>388</b>	interface, computer	184	<b>368</b>	switches	198	<b>419</b>
microcomputer	9	<b>7</b>	oscillator, crystal	186	<b>371</b>	transistors	198	<b>408</b>
microcomputer	29	<b>24</b>	power splitter/combiner	2	<b>3</b>	trimmer capacitor	198	<b>416</b>
mini, military	195	<b>391</b>	rf links	6	<b>5</b>	varactors	200	<b>423</b>
paper tape reader	193	<b>386</b>	<b>Packaging &amp; Materials</b>					
printer	195	<b>390</b>	board-assembly station	182	<b>366</b>	<b>application notes</b>		
printhead, thermal	193	<b>384</b>	bus cable (NL)	200	<b>424</b>	converters, v/f, f/v	196	<b>403</b>
scanner, bar code	193	<b>385</b>	chemical cleaner	182	<b>362</b>	CRT displays	196	<b>399</b>
			circuit-board hardware (NL)	200	<b>425</b>	digital LFM	196	<b>404</b>
<b>ICs &amp; Semiconductors</b>			circuit carrier	182	<b>363</b>	noise figure radar	196	<b>406</b>
assemblies, rectifier	170	<b>333</b>	connectors	26	<b>23</b>	sensors and switches	196	<b>405</b>
controller, DMA	170	<b>334</b>	connectors	39	<b>33</b>	signature analysis	196	<b>398</b>
controller, radio	168	<b>332</b>	connectors	168	<b>89</b>			
converters, a/d	166	<b>328</b>	connectors	181	<b>359</b>	<b>evaluation samples</b>		
counters, high-speed	168	<b>329</b>	connectors, substrate	182	<b>365</b>	capacitors, tantalum	196	<b>393</b>
display drivers	198	<b>407</b>	fastener adhesive (NL)	198	<b>410</b>	miniature cable	196	<b>396</b>
interface, serial	168	<b>330</b>	filter cable	196	<b>122</b>	polish	196	<b>395</b>
op amps, quad	166	<b>326</b>	hand tools	181	<b>361</b>	read relays	196	<b>394</b>
receiver, line	168	<b>331</b>	headers, right-angle	143	<b>69</b>	switches	196	<b>392</b>
rectifiers, 3 A	166	<b>327</b>	interconnection system	109	<b>53</b>	quartz clocks	196	<b>397</b>
<b>Instrumentation</b>								
ac/dc calibrator	160	<b>307</b>						
attenuators, variable	173	<b>126</b>						
DMM	160	<b>308</b>						
DPM	157	<b>302</b>						
DPM	158	<b>305</b>						
digital tester	157	<b>303</b>						
function generator	1	<b>2</b>						
instruments, systems	198	<b>409</b>						



# Quality Capacitors for the Automotive, Computer, Home Entertainment and Industrial Electronic Industries:

Aluminum Electrolytic Capacitors, Ceramic Capacitors, Film Capacitors, Oil Filled Capacitors—without P.C.B.'s, Metallized Paper Capacitors and Wax Paper Capacitors

## REPRESENTATIVES

**ALABAMA**  
Interp Assoc., Inc.  
(205) 881-3677

**ARIZONA**  
Chaparral-Dorton  
(602) 263-0414

**CALIFORNIA (Northern)**  
12 Incorporated  
(408) 985-0400

**CALIFORNIA (Southern)**  
J. J. Riley Assoc.  
(213) 374-3468

**COLORADO**  
Electrodyne  
(303) 757-7679

**FLORIDA (Northern)**  
This territory available.

**FLORIDA (Southern)**  
This territory available.

**GEORGIA**  
Interp Assoc., Inc.  
(404) 394-7756

**ILLINOIS**  
Midwest Electronic Ind.  
(312) 777-9700

**INDIANA**  
Midwest Electronic Ind.  
(317) 253-0590

**IOWA**  
Midwest Electronic Ind.  
(319) 362-4410

**KANSAS**  
Dy-Tronix, Inc.  
(816) 737-1100

**MASSACHUSETTS**  
This territory available.

**MICHIGAN**  
Greiner Assoc., Inc.  
(313) 499-0188

**MINNESOTA**  
Robert W. Marshall Co.  
(612) 929-0457

**MISSOURI**  
Dy-Tronix, Inc.  
(314) 731-5799

**NEBRASKA**  
Dy-Tronix, Inc.  
(816) 737-1100

**NEW JERSEY (Northern)**  
Dolan Assoc.  
(201) 382-2797

**NEW JERSEY (Southern)**  
BGR Assoc.  
(215) 657-3301

**NEW YORK (Bohemia)**  
Migra Electronics  
(516) 567-3555

**NORTH CAROLINA**  
Component Sales  
(919) 782-8433

**OHIO (Cleveland)**  
KW Electronic Sales, Inc.  
(216) 831-8292

**OHIO (Dayton)**  
KW Electronic Sales, Inc.  
(513) 890-2150

**OHIO (Worthington)**  
KW Electronic Sales, Inc.  
(614) 888-0483

**PENNSYLVANIA (Eastern)**  
BGR Assoc.  
(215) 657-3301

**PENNSYLVANIA (Western)**  
KW Electronic Sales, Inc.  
(412) 487-4300

**TEXAS**  
William Reese Assoc.  
(214) 638-6575

**UTAH**  
Electrodyne  
(801) 486-3801

**WASHINGTON**  
Ray Over Sales  
(206) 454-4551

**BRITISH COLUMBIA (Vancouver)**  
Ray Over Sales  
(206) 695-6179

**DISTRIBUTORS**

**West Coast**

**LOS ANGELES, CA**  
JACO Electronics  
(213) 887-6400

**PALO ALTO, CA**  
Eric Electronics  
(415) 969-4500

**SEATTLE, WA**  
Bell Industries  
(206) 747-1515

**Midwest**

**BEACHWOOD, OH**  
Sheridan Sales Co.  
(216) 831-0130

**CHICAGO, IL**  
Hall Mark Electronics  
(312) 437-8800

**CHICAGO, IL**  
Midwest Electronic Ind.  
(312) 777-9700

**DALLAS, TX**  
Hall Mark Electronics  
(214) 231-6111

**DALLAS, TX**  
KA Electronic Sales  
(214) 634-7870

**DAYTON, OH**  
Sheridan Sales Co.  
(513) 277-8911

**FARMINGTON, MI**  
Sheridan Sales Co.  
(313) 477-3800

**FLORISSANT, MO**  
Sheridan Sales Co.  
(314) 837-5200

**INDIANAPOLIS, IN**  
Sheridan Sales Co.  
(317) 547-7777

**MINNEAPOLIS, MN**  
Hall Mark Electronics  
(612) 925-2944

**OVERLAND PARK, KA**  
Sheridan Sales Co.  
(913) 383-1636

**READING, OH**  
Sheridan Sales Co.  
(513) 761-5432

**East Coast**

**HUNTSVILLE, AL**  
Hall Mark Electronics  
(205) 539-0691

**FT. LAUDERDALE, FL**  
N.R.C.  
(305) 792-2600

**ORLANDO, FL**  
Hall Mark Electronics  
(305) 855-4020

**HAUPPAGUE, LONG IS.**  
JACO Electronics  
(516) 273-5500

**BOHEMIA, NY**  
A.D.I. Electronics  
(516) 567-3555

**PHILADELPHIA, PA**  
Hall Mark Electronics  
(215) 355-7300

**PITTSBURGH, PA**  
Sheridan Sales Co.  
(412) 244-1640

**Canada**

**MONTREAL, QUEBEC**  
Audio Electronics, Inc.  
(514) 735-6197

**TORONTO, ONTARIO**  
Audio Electronics, Inc.  
(416) 459-0720



NICHICON (AMERICA) CORPORATION • 6435 N. Proesel Ave. • Chicago, IL 60645 • (312) 679-6530  
Division of NICHICON CAPACITOR LTD., Kyoto, Japan

# The pulse of the industry.





# Designer's guide to the hot numbers in LICs.

**BiMOS Op Amps:** they mix technologies to match circuit needs.



## CA3140

Most useful op amp since the 741. MOS/FET input plus bipolar speed and 4-44 V supply voltage. Does most jobs better than 741 or many premium op amps — at far less cost.

## CA3160 CA3130

Universal op amp, available with compensation (3160) or without (3130). Very low priced, yet with features for general purpose, FET input (1,500,000 M $\Omega$ ), wideband (15 MHz), micropower and high current uses.

## CA3100

Wideband op amp (40 MHz) for both large and small signals. High open-loop gain, slew rate (25 V/ $\mu$  sec) and output current, plus fast settling time.

BiMOS combines the best of Bipolar and MOS in versatile, easy-to-use, low-cost op amps that are simple to manufacture in high volume. It's the op amp technology of today — and tomorrow. Millions of BiMOS devices have been produced and sold. Most are available off the shelf.

CIRCLE NUMBER 161

**Variable Op Amps:** as easy to use as a transistor.

## CA3080

Programmable op amp: differential voltage input, current output. Variable voltage, power, bandwidth, slew rate, input and output current. \$0.59 @ 1K.

## CA3094

Programmable power switch/amplifier. Adds integral Darlington output to CA3080 circuit to provide 300 mA peak current.

## CA3060

Variable op amp array: 3 variable op amps plus zener bias regulator to use as current control or voltage reference source. All on one chip.



CIRCLE NUMBER 162

**Micro Power Op Amp.**

## CA3078

Delivers up to 6.5 milliamps with standby power as low as 0.7 microwatt. Programmable input terminal for tailoring response and slew rate without sacrificing power.

CIRCLE NUMBER 163

## Gold CHIP

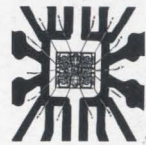

The metalization is gold, and the chip is hermetically sealed with a layer of silicon nitride. The result is corrosion-free, extended life added to the economy of an advanced, rugged plastic package. In short, Gold CHIP (Chip Hermeticity In Plastic) gives you better than standard plastic reliability at the same price as plastic.

There are over 25 Gold CHIP types including these popular numbers: CA301A, CA307, CA311, CA324, CA339, CA555, CA741, CA747, CA748, CA1458, CA3401, CA3724, CA3725.

CIRCLE NUMBER 164

## ARRAYS

RCA amplifier, diode and transistor arrays help you reduce parts cost, save space, cut insertion costs and increase reliability. Choose from 24 different arrays that allow you to create new circuit designs and do the jobs you want done.



RCA Array circuit diagrams and free sample offer

CIRCLE NUMBER 165

For more information, contact your local RCA Solid State distributor.

Or write: RCA Solid State, Box 3200, Somerville, NJ 08876; Sunbury-on-Thames, Middlesex TW16 7HW, England; Ste.-Anne-de-Bellevue, Quebec, Canada; Fuji Bldg., Tokyo, Japan.

**RCA Linear experience is working for you.**

# RCA