

Electronic Design[®] 26

VOL. 25 NO.

FOR ENGINEERS AND ENGINEERING MANAGERS — WORLDWIDE

DEC. 20, 1977

Solar cell activity quickens as many firms strive to reduce cost and improve efficiency. Solar concentrators are used to boost power output, while computers

are employed to optimize solar arrays. But there is still a way to go before cells can be made by continuous processing. For an overview, turn to page 24.



Another Colorful Innovation...

Conductive Plastic Trimmers at Carbon Prices.

Just when you thought "low cost" also meant "low performance", along comes the dazzling new Bourns® Model 3355. Compare it to the CTS 201, Mepco 46X or Piher PT15. Our revolutionary conductive plastic element vs. their carbon... fact is we outperform them all. To prove it, we spec important characteristics such as CRV at 1% and a TC of 500 PPM/°C... the others don't. And only the 3355 has board-wash capability, a UL-94V-1 flammability rating and an optional choice of nine rotor colors. The standard blue is priced at just 11¢ each (100,000 pieces)... about what you'd expect to pay for the lower performance carbon types.

Send today for complete details on a colorful new way to design in superior performance for your cost effective needs — the Model 3355 Trimmer. Direct or through your local distributor.

TRIMPOT PRODUCTS DIVISION, BOURNS, INC., 1200 Columbia Ave., Riverside, CA 92507. Phone: 714 781-5050 — TWX: 910 332-1252.

CATALOG SHEET SPECIFICATION COMPARISONS

CHARACTERISTIC	BOURNS 3355	CTS 201*	MEPCO 46X*	PIHER PT15*
Element	Conductive Plastic	Carbon	Carbon	Carbon
Temperature Coefficient	500 PPM/°C	No Spec	No Spec	1000 PPM/°C
Contact Resistance Variation	1.0% max.	No Spec	No Spec	No Spec
Power Rating	.25 W at 70°C	.25 W at 55°C	.25 W at 55°C	.25 W at 40°C
Flammability	UL-94V-1	No Spec	No Spec	UL-94
Board Wash Capability	Yes	No Spec	No Spec	No Spec

*Source: CTS Series 201 Data Sheet, Mepco Data Sheet ME1004, Piher Data Sheet F-2002 Rev 7/73

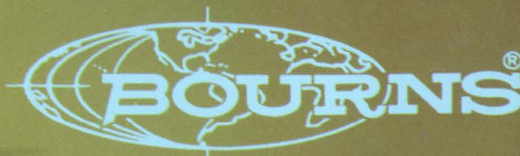
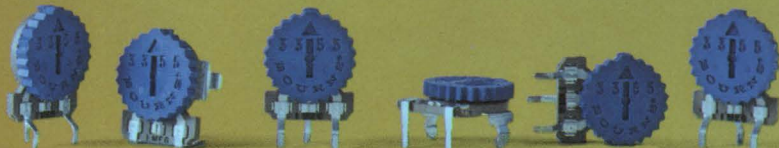

For Immediate Application — Circle 130

For Future Application — Circle 230

International Marketing Affiliates: European Headquarters — Switzerland 042/23 22 42 • Belgium 02/218 2005 • France 01/2039633 • Germany 0711/24 29 36 • Italy 02/32 56 88 • Netherlands 70/87 44 00 • United Kingdom 01/572 6531 • Norway 2/71 18 72 • Sweden 764/20 110 • Japan 075/921 9111 • Australia 02/55-0411 03/95-9566 • Israel 77 71 15/6/7

Here's what you get in our new Model 802 pulse generator: four simultaneous outputs over the frequency range of 5 Hz to 50 MHz — fixed level sync, TTL and TTL, plus a variable 5-volt output. The upper and lower pulse levels are independently adjustable, and so are width and delay. For operational modes, the 802 gives you continuous, triggered, gated, and double

pulse. You won't find features like these anywhere else for under \$600. Now if you need even more versatility, we've got that, too. The Model 801 (top left) does everything the 802 does, and more — including adjustable rise/fall from less than 7 nsec. It goes for \$995. Our Model 145 (bottom left) is a full-fledged pulse generator and a function generator

as well for just \$895.

So if you're looking for high performance, low price, and top quality in pulse generators, the only name you need to remember is ours. WAVETEK, 9045 Balboa Ave., P.O. Box 651, San Diego, CA 92112, Phone (714) 279-2200, TWX 910-335-2007. U.S. prices only.

WAVETEK®

CIRCLE NUMBER 2

**At \$595,
our newest pulse generator
is no bargain.**



It's a steal.

The most significant price breakthrough in DOUBLE-BALANCED MIXERS!

...from Mini-Circuits of course!

\$2.95

500 pieces

\$3.95 (10-49)



Model SBL-1

Model SBL-1,
metal case, non hermetic seal

Frequency Range, MHz

LO 1-500 RF 1-500 IF DC-500

Conversion Loss, dB

	Typ.	Max.
One Octave from Band Edge	5.5	7.5
Total Range	6.5	8.5

Isolation, dB

	Typ.	Min.
Lower Band Edge to LO-RF	50	35
One Decade Higher LO-IF	45	30
Mid Range LO-RF	45	30
LO-IF	40	25
Upper Band Edge to LO-RF	35	25
One Octave Lower LO-IF	30	20

Lower Band Edge to LO-RF 50 35

One Decade Higher LO-IF 45 30

Mid Range LO-RF 45 30

LO-IF 40 25

Upper Band Edge to LO-RF 35 25

One Octave Lower LO-IF 30 20

Signal, 1dB Compression Level +1dBm

Impedance, All Ports 50 ohms

Electronic Attenuation Min (20mA) 3dB

For demanding industrial and commercial applications, where low-cost and high-performance are critical; model SBL-1 will fill your need.

Don't let the low price mislead you. As the world's number one manufacturer of double-balanced mixers, Mini Circuits' has accumulated extensive experience in high-volume production and testing, a key factor in achieving a successful low cost/high performance line of products.

The tough SBL-1 covers the broad frequency range of 1-500 MHz with 6 dB conversion loss and isolation greater than 40 dB. Only well-matched, hot-carrier diodes and ruggedly constructed transmission-line transformers are used. Internally, every component is bonded to the header for excellent protection against shock, vibration and acceleration.

Here are some of the steps taken to ensure quality: Every SBL-1 is RF tested two times, every solder connection is 100 per cent inspected under a high power microscope, all transformer leads are double-wrapped, and all components are rated for more than +85 °C operation.

Of course, our one-year guarantee applies to these units.

World's largest manufacturer of Double-Balanced Mixers

Mini-Circuits

MINI-CIRCUITS LABORATORY

A Division of Scientific Components Corp.

2625 East 14th Street Brooklyn, New York 11235 (212) 769-0200
Domestic and International Telex 125460 International Telex 620156

OUR NEW ADDRESS
AND PHONE NO. IS

WE'VE GROWN

Customer acceptance of our products has been so overwhelming, we've been forced to move to larger facilities — THANKS.

International Representatives: **AFRICA:** Afitra (PTY) Ltd. P.O. Box 9813, Johannesburg 2000, S. Africa **AUSTRALIA:** General Electronic Services, 99 Alexander Street, New South Wales, Australia 2065 **ENGLAND:** Dale Electronics, Dale House, Wharf Road, Frimley Green, Camberley Surrey **EASTERN CANADA:** B.D. Hummel, 2224 Maynard Avenue, Utica, NY 13502 (315) 736-7821 **FRANCE:** S.C.I.E. - D.I.M.E.S., 31 Rue George - Sand 91120 Palaiseau, France **GERMANY, AUSTRIA, SWITZERLAND, DENMARK:** Industrial Electronics GMBH 6000 Frankfurt/Main Klüberstrasse 14 West Germany **INDIA:** Gaekwar Enterprise, Kama Mahal, M.L. Dananukar Marg, Bombay 400 026, India **ISRAEL:** Vectronics, Ltd., 69 Gordon Street, Tel-Aviv, Israel **NETHERLANDS, BELGIUM, LUXEMBOURG:** Coimex, Veldweg II, Hatterm, Holland

NORWAY: Datamatik AS, Ostensjoveien 62, Oslo 6, Norway **SINGAPORE & MALAYSIA:** Electronics Trading Co. (PTE) Ltd., 87 Bukit Timah Road, Singapore 9, Malay Peninsula **SWEDEN:** Integerad Elektronik AB, Box 43, S-18251, Djursholm, Sweden

U.S. Distributors: **NORTHERN CALIFORNIA:** PENNSTOCK Co., Foothill Office Center, 105 Fremont Avenue, Los Altos, CA 94022 (415) 948-6533 **SOUTHERN CALIFORNIA, ARIZONA:** Crown Electronics, 11440 Collins Street, No. Hollywood, CA 91601 (213) 877-3550 **NEW YORK:** NEW YORK MICROWAVE DISTRIBUTORS COMPANY, 61 Mall Drive, Commack NY 11725, 516 543-4776

21/REV/D

NEWS

- 19 **News Scope**
- 24 **Solar-cell technology is advancing on all fronts,** but progress is still slow—A special report.
- 30 **Integrated circuit packages are changing shape** to handle the growing number of LSI chips.
- 135 **Washington Report**

TECHNOLOGY

- 142 **Drive servos with a switching amplifier.** With a switching servo amplifier in your loop, you get high efficiency in a compact control package.
- 148 **Design power inductors step by step.** Concentrate on the power dissipated in the windings instead of wrestling with magnetic characteristics.
- 156 **Consider mask-programmable arrays** instead of custom-designed circuits. Arrays offer the flexibility of custom circuits with almost 'stock' delivery.
- 160 **Four-phase logic is practical** when implemented with high-density MOS large-scale arrays. Low power and high speed can overshadow disadvantages.
- 166 **Shrinkable plastic tubes,** boots and caps can solve many of your insulating problems neatly and efficiently. Even odd shapes can be protected.
- 172 **International Technology**
- 174 **Ideas for Design:**
Optocoupled line-receiver input discriminates against narrow noise pulses. Upper and lower thresholds can be set independently in comparator circuit. Use double-buffer characteristic of a UART and still avoid overrun errors.

PRODUCTS

- 182 **Instrumentation:** Temperature controller keeps components out of the ovens.
- 188 **Micro/Mini Computing:** Bit-slice development system looks like a compact instrument.
- 192 **ICs & Semiconductors:** Regulator delivers 3 to 30 V and limits currents to 1.8 A.
- | | |
|---------------------|-----------------------------|
| 186 Data Processing | 198 Modules & Subassemblies |
| 191 Power Sources | 200 Packaging & Materials |
| 196 Components | |

DEPARTMENTS

- 139 **Editorial:** I hear you
- 7 Across the Desk
- 201 Application Notes
- 202 New Literature
- 211 Employment Opportunities
- 214 Advertisers' Index
- 216 Product Index
- 216 Information Retrieval Card
- Cover:** Cover designed by Art Director, Bill Kelly.

64K MEMORY

**EVER SINCE OUR GREAT
MEMORY BREAKTHROUGH
THE OLD INDUSTRY
STANDARD AIN'T WHAT IT
USED TO BE.**

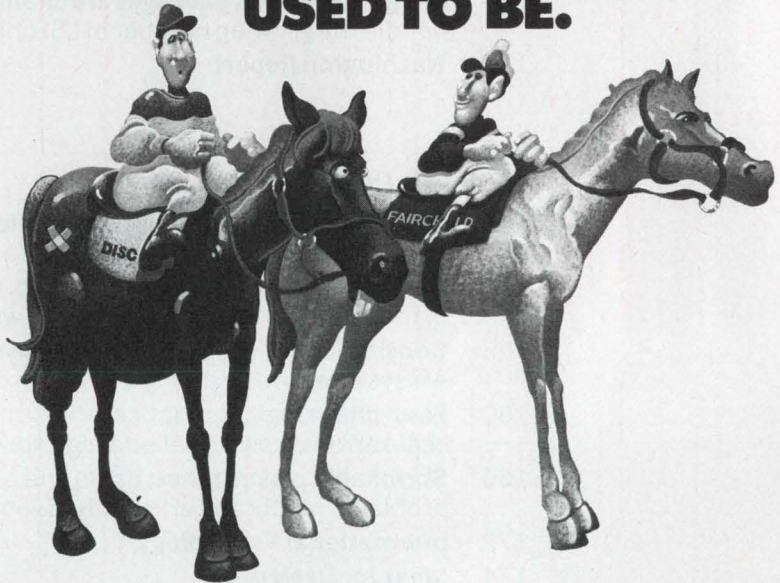

When we introduced the Fairchild 64K F464, we said it had the stuff to be the industry standard someday. We even started out with a second source. Apparently, a lot of memory people took us seriously. Response has been so positive, we've already increased our production capacity.

Plugging the gap between MOS and magnetic memories, the F464 is the first semiconductor Bulk Storage Device (BSD).

The F464 is the densest semiconductor memory ever made. A compact die size of less than 40,000 mil² — not much larger than today's 16K RAMs. All packaged neatly in a standard 0.3-inch 16-pin DIP.

HIGH PERFORMANCE, LOW OVERHEAD.

There has never been a device like the F464.

It's a 65,536 x 1-bit dynamic serial memory organized as 16 randomly accessible shift registers of 4096 bits each. The four address bits are decoded on-chip to select which one of these 16 shift registers is to be accessed. Control inputs include Write Enable and Chip Select. It requires standard power supplies of +12 V and ± 5 V.

All inputs (except the clocks) are directly TTL compatible. The two high-frequency and two low-frequency clock inputs are low capacitance 12 V signals which can be easily generated with simple logic.

The logic required to generate this 4-phase clock costs less than one memory chip and is generated only once per system.



Part Number	Maximum Frequency (MHz)	Maximum Active Power Dissipation (mW)
F464-4	2	238
F464-3	4	298
F464-2	5	336

Speed and power dissipation for F464 family.

from 2 MHz (F464-4) to 5 MHz (F464-2). The minimum frequency for the SPS structure is 1 MHz. Since all 16 registers shift simultaneously, the average random access time (called latency) is only 410 μ s at 5 MHz — a truly significant performance improvement over other bulk memory technologies! And, at the same time, the power dissipation remains low: typically 3.5 μ W/bit at 5 MHz, and 0.6 μ W/bit during standby at 1 MHz. Three part types are available to cover a wide range of maximum speed requirements.

These performance benefits make the F464 a natural for hybrid head-per-tracks or fixed-head discs, extended cache, and many other high-density memory applications.

Other outstanding F464 characteristics include solid state ruggedness, speedy data rates and the most semiconductor memory per square centimeter in the industry. Not bad for a small chip!

LOW COST, HIGH VERSATILITY.

The new F464 is three to four times less expensive per bit than RAMs. It is also cost-competitive with all fixed-head discs.

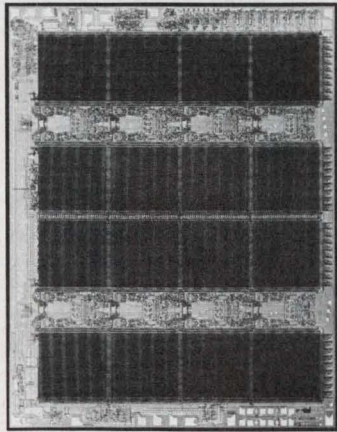

FOLLOW THE LEADER.

Fairchild pioneered CCD technology. We introduced the world's first commercially available charge-coupled device in 1973. Today, we offer the world's broadest line of CCD products. It stands to reason we'd be the ones to make CCD memories a reality.

For more information on the F464 (or our other CCD products), contact your Fairchild sales office or representative today. Or write directly to our MOS/CCD Division at Fairchild Camera and Instrument Corporation, P.O. Box 880, Mountain View, California 94042. TWX: 910-373-1227.

So you don't pay for memory overhead every time you expand. This lower overhead cost means lower system costs to you.

Maximum data rates range from 2 MHz (F464-4) to 5 MHz



So there are no trade-offs between price and performance. The F464 gives you the best of both.

F464 applications range from typical computers to atypical portable memories and digital delays.

And once you order, you can rest assured that you'll get prompt delivery. Fairchild has a 250,000-square-foot plant in San Jose, California that's totally dedicated to VLSI technology and production.

FAIRCHILD
CALL US ON IT.

Get hold of the new TO-220, TRIAC's, SCR's from Hutson

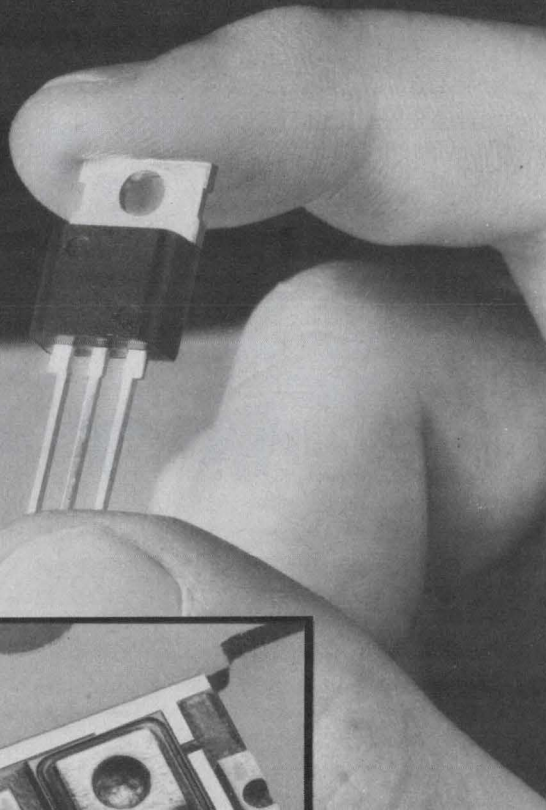

... the first with a face down chip for high volume production!

Hutson is first with the TO-220 isolated device with face down chip that gives you improved thermal, electrical and mechanical performance. Hutson can produce more devices per day than ever before.

So call Hutson for your needs and remember . . . you got it first from Hutson . . . a leader in thyristor applications technology and one of the largest manufacturers of thyristors!



HUTSON INDUSTRIES

2019 W. VALLEY VIEW LANE
DALLAS, TEXAS 75234 (214) 241-3511
TWX 910-860-5537

EUROPEAN OFFICE: 30 RUE PIERRE SEMARD. YERRES, 91, FRANCE
TEL: Paris 948-8258 TELEX 21311

CIRCLE NUMBER 5

Publisher

William Maass

Editors

Editorial Offices
50 Essex St.
Rochelle Park, NJ 07662
(201) 834-0550
TWX: 710-990-5071
(HAYDENPUB ROPK)
Cable: Haydenpubs Rochellepark

Editor-in-Chief George Rostky

Managing Editors:

Ralph Dobriner
Michael Elphick

Senior Associate Editor

Stanley Runyon

Associate Editors:

Sid Adlerstein
Dave Bursky
Morris Grossman
Gene Heftman
Andy Santoni
Max Schindler

Contributing Editors:

Peter N. Budzilovich, Jules H. Gilder,
Sidney Moskowitz, Nathan Sussman

Editorial Field Offices

East

Jim McDermott, Eastern Editor
P.O. Box 272
Easthampton, MA 01027
(413) 527-3632

West

Dick Hackmeister, Western Editor
8939 S. Sepulveda Blvd., Suite 414
Los Angeles, CA 90045
(213) 641-6544
TWX-1-910-328-7240
Dave Barnes, Western Editor
465 S. Mathilda, Suite 302
Sunnyvale, CA 94086
(408) 736-6667

Editorial Production

Marjorie A. Duffy, Production Editor
James Keane, Copy Editor

Art

Art Director, William Kelly
Richard Luce, Anthony J. Fischetto

Production

Manager, Dollie S. Viebig
Helen De Polo, Nancy Hurey

Circulation

Director, Barbara Freundlich

Information Retrieval

Paula Greenleaf

Advertising Promotion

Judith Nappo

Reprints

Maxine Sassano

ELECTRONIC DESIGN 26, December 20, 1977

Across the desk

More—much more— on professionals

Your editorial, "The professionals" (ED No. 15, July 19, 1977, p. 51) agreed with my personal experience. When my wife developed cancer, I learned all I could, and found that many people feel that cancer can be treated as a nutritional-deficiency disease.

Early this year, my wife learned she had a large tumor in the bladder. Shortly afterwards, about 3/4 of the tumor was removed. However, when my wife was released from the hospital, I was informed that the tumor was malignant.

After a checkup about three weeks later, my wife was given a prescription for an antibiotic and told to come back for a second operation. I asked the doctor about vitamin therapy, including laetrile. He ended up saying I could give my wife anything I wanted to as long as I had her back at the hospital for the second operation.

I learned of a doctor who specialized in nutrition. He examined my wife and prescribed a daily consumption of 3 grams of vitamin C, 50,000 units of vitamin A, 800 units of vitamin E, one high-potency vitamin-mineral supplement, 100 grams of pangamic acid and 2 grams of amygdalin (laetrile). **WARNING:** Vitamins of this potency should never be taken without a doctor's prescription. I obtained those vitamins, and my wife followed her doctor's instructions, including the antibiotic he'd prescribed, until the second operation.

The complete tumor was removed in a short operation, there were no side effects, and I was informed that a second biopsy proved that the tumor was now benign.

After this experience, I feel there is a strong link between nutrition and

cancer. Until proven unnecessary, laetrile should be allowed to be used as part of a nutritional approach to preventing and treating cancer.

Edgar W. Van Winkle
439 Edgewood Place
Rutherford, NJ 07070

I have generally been impressed with the thought, if not the idea, behind most of your editorials. However, that unfortunate epic included in the July 19, 1977, issue, "The professionals," insults not only my own intelligence but Mr. Rostky's.

While vitamins B₁, B₂, B₃, C, and D may well have been known to prevent and/or cure many diseases prior to general recommendation by the medical profession, laetrile is *known* to cure only terminal wealth! Tests with the former substances will cure disease in any test animal commonly used—but laetrile has yet to cause any discernible reaction beyond cyanide poisoning if used in excess. It belongs in the same category as "Dr. Monster's Super Buzz Bomb for Cancer, Arthritis, Ear Wax, and Editorial Ignorance." Neither laetrile nor anything else will cure any of those conditions.

One must wonder whether Mr. Rostky would be so glib if a loved one steadfastly ignored the advice of physician to treat an operable cancer and then died—after thousands of dollars and several years of treatment with laetrile.

To refuse to sanction quackery is true "professionalism."

Richmond E. Young
307 Bakerdale Rd.
Rochester, NY 14616

I hardly ever take the time—that most precious of all commodities—to
(continued on page 12)

giga-trim capacitors for microcircuit designers

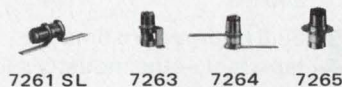
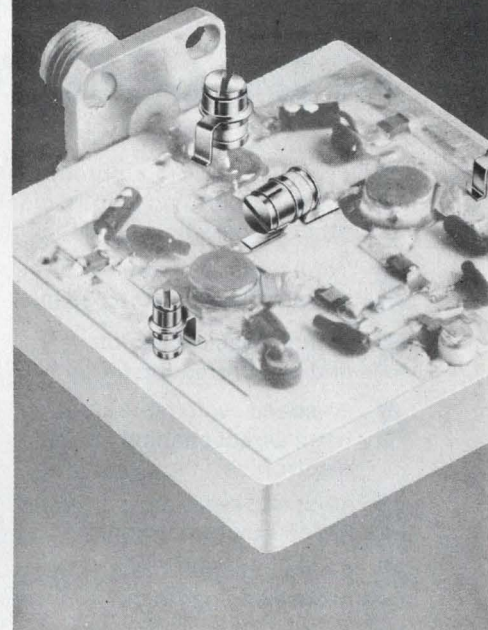

Giga-Trim® (gigahertz-trimmers) are tiny variable capacitors which provide a beautifully straight forward technique to fine tune RF hybrid circuits and MIC's into proper behavior. They replace time consuming cut-and-try adjustment techniques and trimming by interchange of fixed capacitors.

Applications include impedance matching of GHz transistor circuits, series or shunt "gap-trimming" of microstrips, external tweaking of cavities, and fine tuning of crystal oscillators.

Johanson

MANUFACTURING CORPORATION

BOONTON, NEW JERSEY 07005

201 / 334-2676

CIRCLE NUMBER 6

Electronic Design welcomes the opinions of its readers on the issues raised in the magazine's editorial columns. Address letters to Managing Editor, Electronic Design, 50 Essex St., Rochelle Park, NJ 07662. Try to keep letters under 200 words. Letters must be signed. Names will be withheld upon request.

SABRE X is Here!

Your ten best reasons for buying it are benefits no other tape recorder/reproducer provides

1. Programmable microprocessor control of tape speeds, operating modes, monitor/alarm and other diagnostic testing functions
2. Tape transport with ten speeds from 240 to 15/32 ips
3. 2^o time base expansion and/or contraction ratios
4. 10-speed switchable all-band Direct channel electronics
5. 10-speed switchable all-band FM channel electronics
6. 6 megabit digital data processing per track
7. Usable Direct/FM/Digital channel electronics at 240 ips
8. 88.8 hour record time per tape reel — the industry's longest
9. 4.0 MHz/Track direct Record/Reproduce system
10. The same manufacturing excellence that has made Sangamo a leader in tape recorders for over 16 years

IRIG tape recording/reproduction was never like this. But then, that's the whole point of SABRE X: pushing back the horizons of *our* technology to help you push back yours. We know your needs. So we've given you still more features, including serial and/or parallel high density electronics, vacuum tape tensioning and modular design. We've made it easy to customize the unit with options ranging from coded computer control, data monitoring and a voice/time code to a tape servo and remote control. We've freed you for virtually unlimited applications, including data reduction, deep space, satellite and space networks, mass data storage and security. We've got your number: SABRE X.

For additional information, call or write:
Sangamo Weston, Inc.
Sangamo Data Recorder Division
P.O. Box 3347
Springfield, Illinois 62714
TEL (217) 544-6411

SANGAMO WESTON

Schlumberger

CIRCLE NUMBER 7

SABRE X

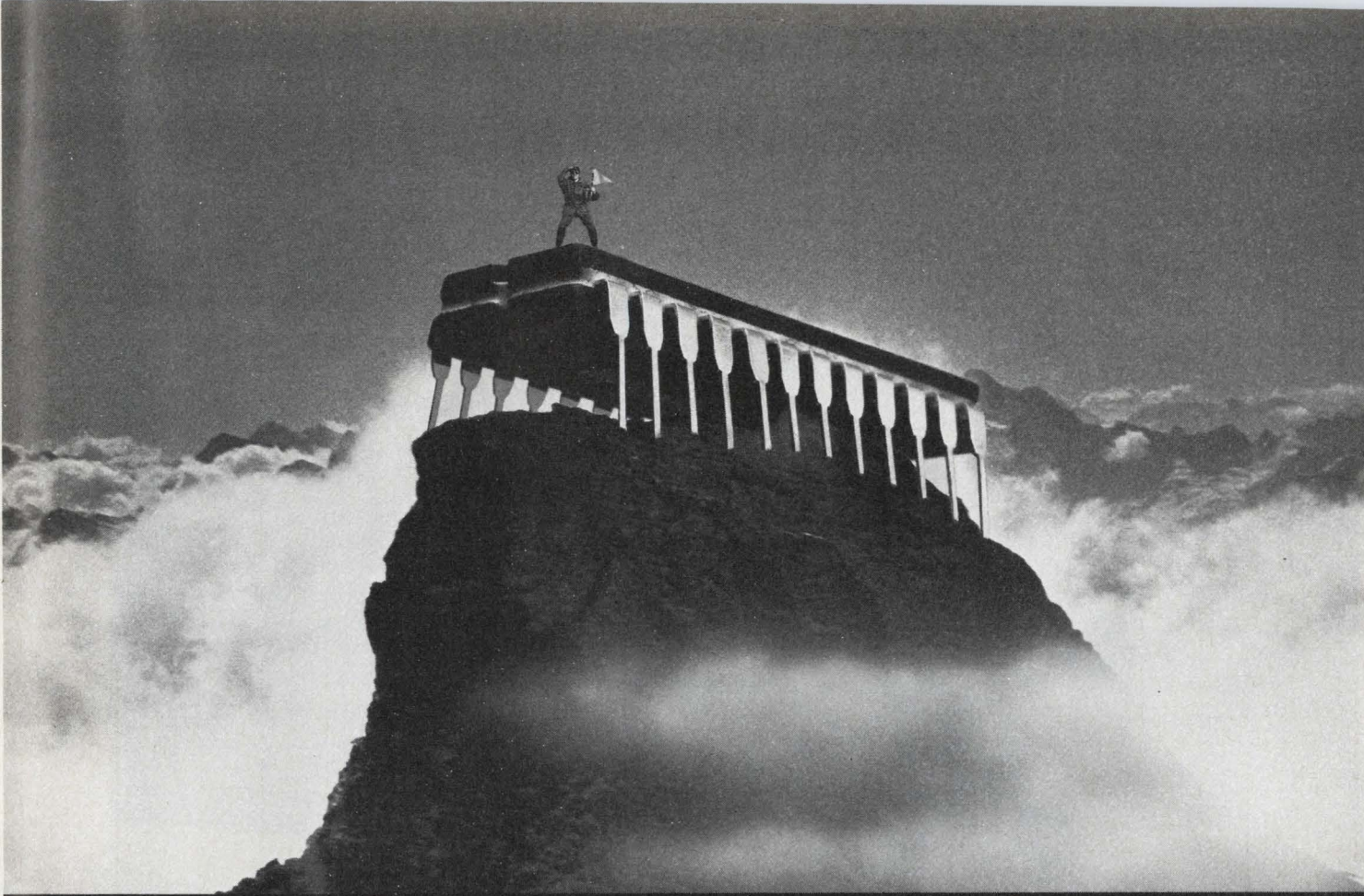

HOW DOES DATA I/O KEEP YOU ON TOP OF PROM PROGRAMMING TECHNOLOGY?

We allow you complete design flexibility.

Data I/O programmers are capable of programming all of the more than 200 PROMs currently available.

You'll always be programming to PROM manufacturers' approved specifications.

Data I/O Program Card Sets are tested and certified by the PROM manufacturers themselves before we approve them for manufacturing and distribution to our customers.

If manufacturers change specifications, we

keep our customers updated on how to make proper adjustments to the card sets.

To help you reduce programming costs and reach maximum yields and reliability, we also offer a universal calibrator so that you can conduct your own periodic calibration tests.

We're there when you need us. Data I/O is a worldwide organization. Our field sales and service offices are staffed by Data I/O personnel. Our customers have direct access to us through people who understand the products.

We'd like to tell you more.

This fact filled tabloid gives you valuable information about PROM programming technology. To get your copy, circle reader service number or contact Data I/O Corporation, P.O. Box 308, Issaquah, WA 98027. Phone. 206/455-3990.

HOW TO SELECT THE RIGHT PROM PROGRAMMER FOR YOUR NEEDS.



Programmers from \$1095.00.

DATA I/O

THE PROM PROGRAMMER PEOPLE.



THE GREAT 4K STATIC RAM RACE

In a world of claims and counter-claims, one thing is clear. EMM SEMI is still in the lead. Of course, we not only had a healthy head start, but we field a whole family of 4K static RAMs.

We *delivered* the industry's first 4K static RAM in 1975, a full year and a half before anyone else. We are now delivering 7 basic static RAM types with many versions

of each, and producing them at a greater monthly rate than our nearest competitors combined.

By now we have more 4K static RAMs operating in a wider range of customer equipment than anyone else in the semiconductor memory business — from 10 Megabyte IBM add-on memory systems to hobbyist microprocessor kits.

Whatever your application, from mass storage to telecommunications, from medical electronics to toys and games, chances are there's an EMM SEMI static RAM just right for you. Please call or write today for full details — and ask about our byte oriented RAMs, too.

Memory at work **EMM SEMI, Inc.**

a subsidiary of Electronic Memories & Magnetics Corporation • 3883 N. 28th Avenue, Phoenix, Arizona 85107 • (602) 263-0202

CIRCLE NUMBER 9

Datel's Microelectronic Data Acquisition System

HDAS-16/HDAS-8

- ▶ 16 Single-ended Channels or 8 Differential Channels
- ▶ 12 bits Resolution
- ▶ 50 KHz Throughput Rate
- ▶ Internal Instrumentation Amplifier
- ▶ Three-State Data Outputs
- ▶ Military and Commercial Temperature range available
- ▶ 62-pin Miniature Package
- ▶ Priced at \$295.00* (1-9)

*U.S.A. domestic price only



COVERED BY GSA CONTRACT

You'll find complete specifications on this product and more than 300 data conversion circuits and systems in Gold Book.

Just check Gold Book's Volume 3. That's Datel's complete Engineering Product Handbook, in its own separate volume. More than 290 pages of D/A & A/D Converters, Multiplexers, Sample-Holds, Op Amps, Power Supplies, Digital Panel Meters and Printers, Digital Calibrators, Data Loggers, Digital Cassette Recorders, and Data Acquisition Systems. Each fully detailed on individual data sheets.

And it's available to you in Gold Book.

 **DATEL**
SYSTEMS, INC.
1020 Turnpike St., Canton, MA 02021
Phone: (617) 828-8000



See Electronic Design's
1977-78 "Gold Book"-Vol. 3, page 135

Santa Ana, CA (714) 835-2751, (L.A.) (213) 933-7256 • Sunnyvale, CA (408) 733-2424 • Gaithersburg, MD (301) 840-9490 • Houston, TX (713) 932-1130
OVERSEAS: DATEL (UK) LTD—TEL: ANDOVER (0264) 51055 • DATEL SYSTEMS SARL 620-06-74 • DATELEK SYSTEMS GmbH (089) 78-40-45

CIRCLE NUMBER 10

THE TRAVELERS OFFERS YOU A CUSHION BETWEEN A ROCK AND A HARD PLACE

Unemployment, even if it is temporary, can be like being between a rock and a hard place. With all the job hunting, interviewing and decisions to be made, the last thing you need to worry about is your health insurance.

Until, of course, you need it. In many cases, your group health plan expires when you leave your company. If you are currently "between positions," or have just started a job where your health benefits aren't yet in effect, The Travelers has the answer for you.

It's our 60- or 120-day interim medical COM PAC policy. COM PAC covers hospitalized covered family members up to \$100 a day for room and board. And, this benefit is payable for up to 500 days. The Travelers COM PAC plan also pays for:

- Intensive Care Charges • Physician's In-Hospital Visits • Specific Surgical Charges • Home Health Care • Emergency Room Charges • Specific Outpatient Surgical Charges • Up To The Limits Provided

COM PAC also offers other innovative coverages, including coverage for Second Surgical Opinion Charges and Postoperative Outpatient Care Charges.

COM PAC may also be the perfect temporary health insurance program for your son or daughter who is now out of college, seeking his or her first job, and who's no longer covered under your health insurance plan.

The Travelers COM PAC plan is a non-renewable contract. For further details of the coverage, including its exclusions, limitations and costs contact your local Travelers independent agent or broker. Or, write Frank Forbes, Program Manager, LHFS, 8GS, at The Travelers for our new "IF" brochure — with no obligation.

The Travelers COM PAC Plan. It can cushion you against the rock and the hard place.



THE TRAVELERS

The Travelers Insurance Company, One Tower Square, Hartford, Connecticut 06115

This program is currently not available in the following states:
New York, New Jersey, New Hampshire, Pennsylvania, South Carolina,
Texas, Wisconsin, South Dakota, Nevada, Minnesota, Michigan,
Maryland.

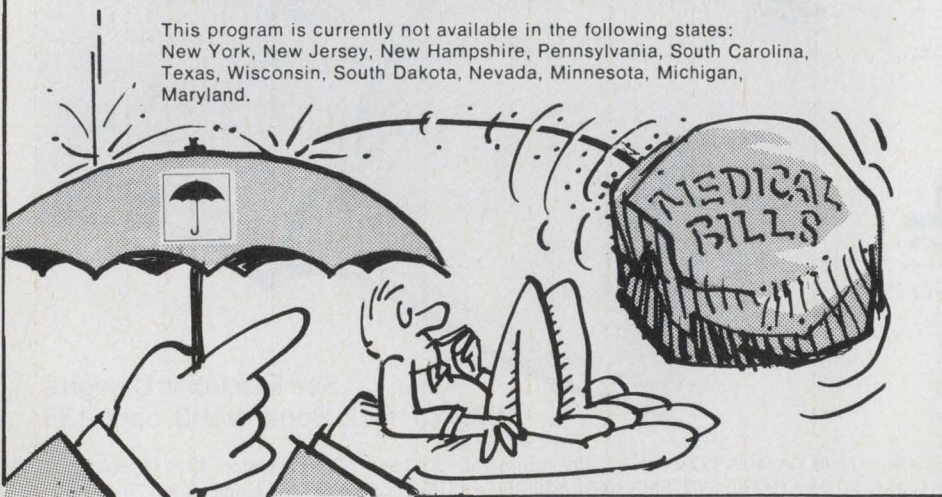

CIRCLE NUMBER 11

Across the desk

(continued from page 7)

write emotional letters, but I cannot resist joining the laetrile/professionalism fracas. I have no personal knowledge concerning the effectiveness of laetrile, but I remember when hypnosis was introduced to the public. The AMA immediately attacked the validity of the process and pressed for vigorous prosecution of the practitioners. Some years later when hypnosis was a little better understood, the AMA decided that it was real but could be practiced only by MDs.

Acupuncture has been treated in precisely the same manner. First there was no such thing—now (in California) it can be practiced only by MDs. As Linus Pauling points out in *Vitamin C and the Common Cold*, the British government knew for years that limes prevent scurvy, but found it more expedient to impress fresh sailors than to protect the health of those on board.

The official reaction to Pauling's book was immediate and predictable. The staff "doctor" of the L.A. Times said in his review that Linus Pauling was not qualified to comment on the efficacy of ascorbic acid because he wasn't even a doctor. What a classic example of the high regard that "doctors" have for themselves.

I remember when the director of the Oak Ridge National Laboratory stated in a press conference that one of the principal reasons for expediting the search for a cancer cure was to eliminate the restrictive emission standards that nuclear power plants are saddled with. He retracted the statement the next day, but the mentality is unchanged. Sickness and medicines are *very* big business in America.

I'll never have any faith in the medical establishment until it puts human values ahead of profit motives. I appreciate immensely the human values that you express in your editorials and wholeheartedly agree with your sequel editorial in the Sept. 13 issue. If the typical dyed-in-the-wool doctor is a "professional"—much less a healer—I'd rather be a ditchdigger than be lumped in the same category as such bigoted charlatans.

Jerry Chamkis

Solar Dynamics, Inc.
3904 Warehouse Row
Austin, TX 78407

(continued on page 204)

Datel's 16 Bit, Microelectronic D/A Converters

DAC-HP16BMC & DAC-HP16DMC

- ▶ 16 Bit Binary or 4 Digit BCD Coding
- ▶ 15ppm/°C Tempco, max.
- ▶ Linearity to 0.003%
- ▶ 0 to +10V or ±5V Output
- ▶ 35μsec. Settling Time (Binary Version)
- ▶ Priced from \$119.00* (1-24)

\$77⁵⁰*
(100's)

*U.S.A. domestic prices only

COVERED BY GSA CONTRACT

You'll find complete specifications on this product and more than 300 data conversion circuits and systems in Gold Book.

Just check Gold Book's Volume 3. That's Datel's complete Engineering Product Handbook, in its own separate volume. More than 290 pages of D/A & A/D Converters, Multiplexers, Sample-Holds, Op Amps, Power Supplies, Digital Panel Meters and Printers, Digital Calibrators, Data Loggers, Digital Cassette Recorders, and Data Acquisition Systems. Each fully detailed on individual data sheets.

And it's available to you in Gold Book.

D **DATEL**
SYSTEMS, INC.

1020 Turnpike St., Canton, MA 02021
Phone: (617) 828-8000



See Electronic Design's
1977-78 "Gold Book"-Vol. 3, page 112

Santa Ana, CA (714) 835-2751, (L.A.) (213) 933-7256 • Sunnyvale, CA (408) 733-2424 • Gaithersburg, MD (301) 840-9490 • Houston, TX (713) 932-1130
OVERSEAS: DATEL (UK) LTD—TEL: ANDOVER (0264) 51055 • DATEL SYSTEMS SARL 620-06-74 • DATELEK SYSTEMS GmbH (089) 78-40-45

CIRCLE NUMBER 12

SIEMENS

No matter which IC test system you have, we've got your DIP handler.

No other DIP handlers can match the performance of the Siemens 1108 Series. It's a complete line, adaptable to virtually any DIP handling requirement and any IC test system. There are three standard configurations: ambient, hot, and

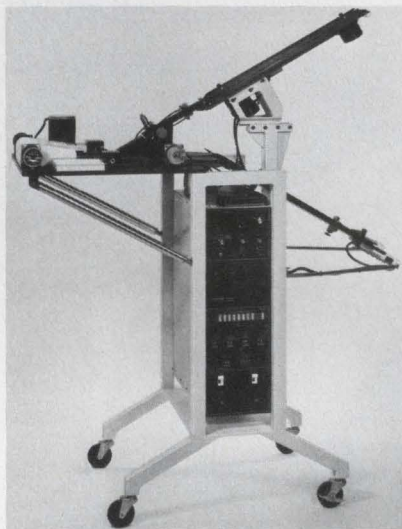

hot/cold. Field retrofit kits are available, so you can upgrade from ambient to temperature capability as the need arises.

Siemens offers a maximum rate of 10,000 devices per hour *including* 250 ms of test time. And you get that speed not only in ambient testing, but in environmental testing as well. No other handlers made today have both these important features.

The 1108 Series is designed for the high-volume end user as well as the IC manufacturer, and is equally at home in either environment. Moreover, all Siemens handlers are backed by experienced applications engineers who can help you get the most for your test dollar.

For the full story, write or call Cliff Small, **Siemens Corporation**, Measurement Systems Division, 3 Computer Drive, Cherry Hill, New Jersey 08034. (609) 424-2400.

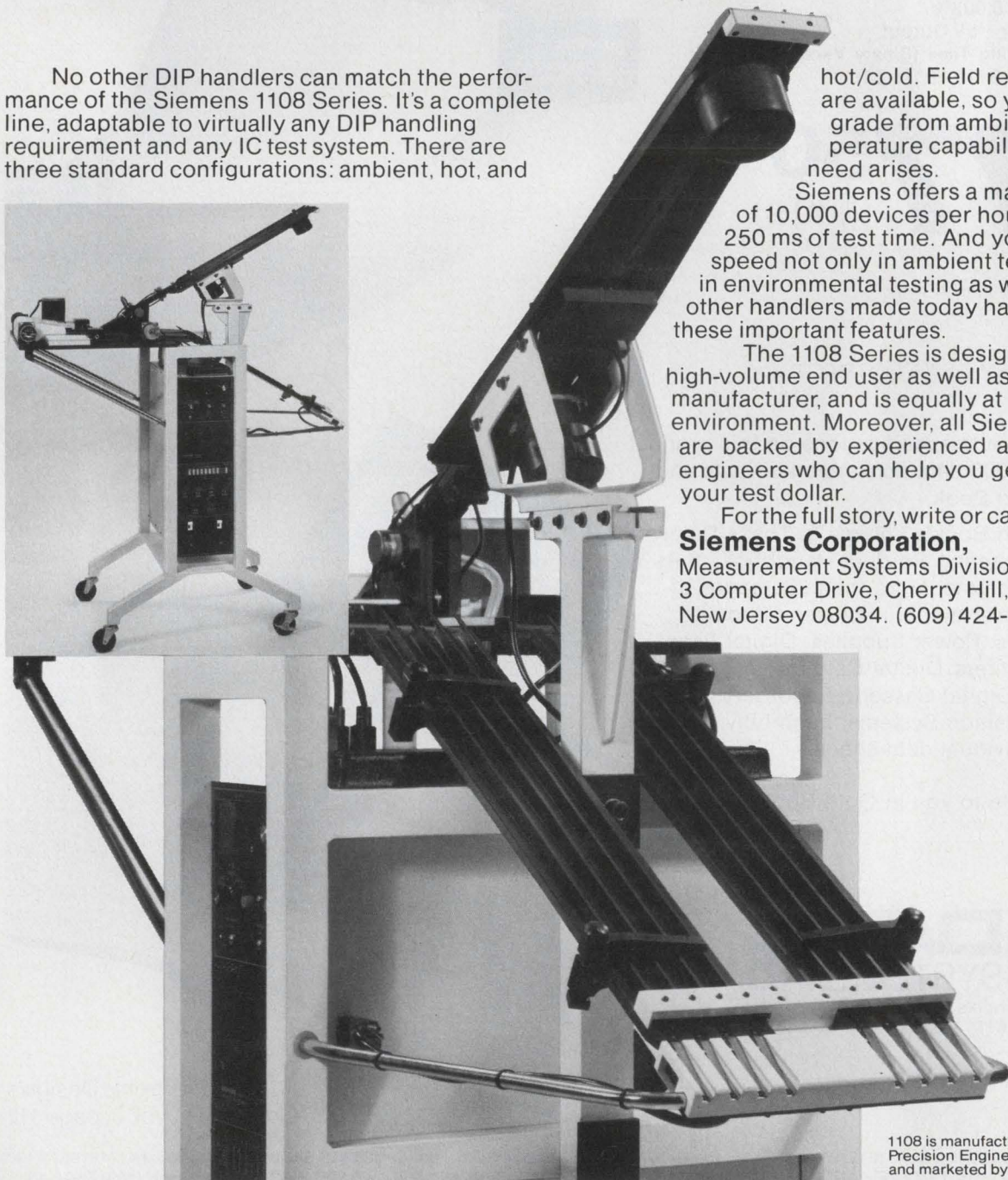

1108 is manufactured by Precision Engineered Products, Inc. and marketed by Siemens.

CIRCLE NUMBER 13

ELECTRONIC DESIGN 26, December 20, 1977

Datel's New Low Priced Digital Panel Meter

MODEL DM-3100

FEATURES

- ▶ Miniature case with 0.5" LED display
- ▶ Bipolar, differential ± 2 VFS input
- ▶ 3½ Digit resolution with Autozeroing
- ▶ LCD display available at additional cost
- ▶ Additional ranges — customer programmable
- ▶ 4½ digit resolution also available — \$59 (100's)
- ▶ Additional current and ohmmeter capability — customer programmable

\$29*

*\$35 (1-99) \$29 (100-499)



You'll find complete specifications on this product and more than 300 data conversion circuits and systems in Gold Book.

Just check Gold Book's Volume 3. That's Datel's complete Engineering Product Handbook, in its own separate volume. More than 290 pages of D/A & A/D Converters, Multiplexers, Sample-Holds, Op Amps, Power Supplies, Digital Panel Meters, and Printers, Digital Panel Instruments, Data Loggers, Digital Cassette Recorders, and Data Acquisition Systems. Each fully detailed on individual data sheets.

And it's available to you in Gold Book.



1020 Turnpike St., Canton, MA 02021
Phone: (617) 828-8000



See Electronic Design's 1977-78
"GOLD BOOK"-Vol. 3, page 226

Santa Ana, CA (714) 835-2751, (L.A.) (213) 933-7256 • Sunnyvale, CA (408) 733-2424 • Gaithersburg, MD (301) 840-9490 • Houston, TX (713) 932-1130
OVERSEAS: DATEL (UK) LTD—TEL: ANDOVER (0264) 51055 • DATEL SYSTEMS SARL 620-06-74 • DATELEK SYSTEMS GmbH (089) 78-40-45

CIRCLE NUMBER 14

WHY LIMIT YOURSELF TO LESS THAN 300 MHz?

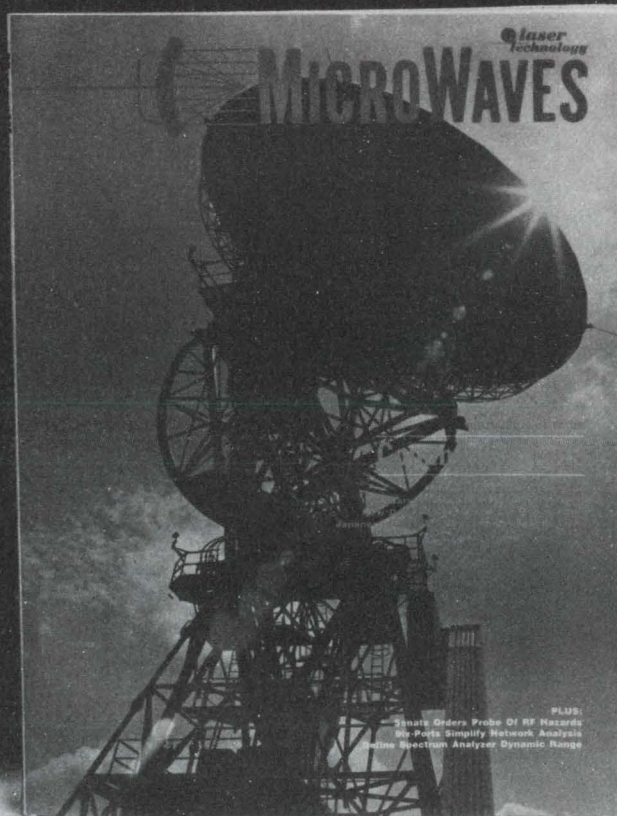

There's a lot going on these days above the 300 MHz range ... and there's a lot going on in *MicroWaves*.

A decade or so ago, microwave engineers were the "plumbers" of this industry. They worked in small groups in a machine-shop type atmosphere. Today it's different.

The machine shop is gone — replaced by a solid-state environment. The separate worlds are coming back together.

Even if your work involves frequencies below 300 MHz, don't

you owe it to yourself to keep up to date with what's happening in microwaves? Every month *MicroWaves* magazine delivers a balanced editorial package of news, technology and products for microwave specialists. It's *FREE* to qualified subscribers (who also receive our annual Product Data Directory — an invaluable aid in product sourcing).

To obtain an application form for your free subscription, just circle the number shown below on your Reader Service Card.

KEEP UP TO DATE WITH
 **MICROWAVES**

FREE TO SUBSCRIBERS WHO QUALIFY

JUST CIRCLE  ON READER SERVICE CARD

Berg Minisert Sockets display "high reliability" on Tektronix Oscilloscopes

The Berg Minisert™ is a miniature, low-profile P.C. socket which allows .400"-tight board-to-board spacing. The Minisert provides positive, functional reliability over repeated insertion/withdrawal cycling; its elastomeric seal keeps out contaminants.

Tektronix likes the repeated pluggability the Minisert socket affords in using transistors, LED's, lamps, IC's and other components. Tektronix has found it can rely on Berg Electronics . . . to supply the product and the application machines

that precisely meet its interconnection needs.

Berg is experienced. We read interconnection needs like Tektronix reads waveforms. We have the products, the background and the back-up to do the job. Your job. Let's work on it, together. Berg Electronics, Division, E. I. du Pont de Nemours & Co., New Cumberland, Pa. 17070—Phone (717) 938-6711.

DU PONT BERG ELECTRONICS
REG. U. S. PAT. OFF.

CIRCLE NUMBER 16

We serve special interests—yours!

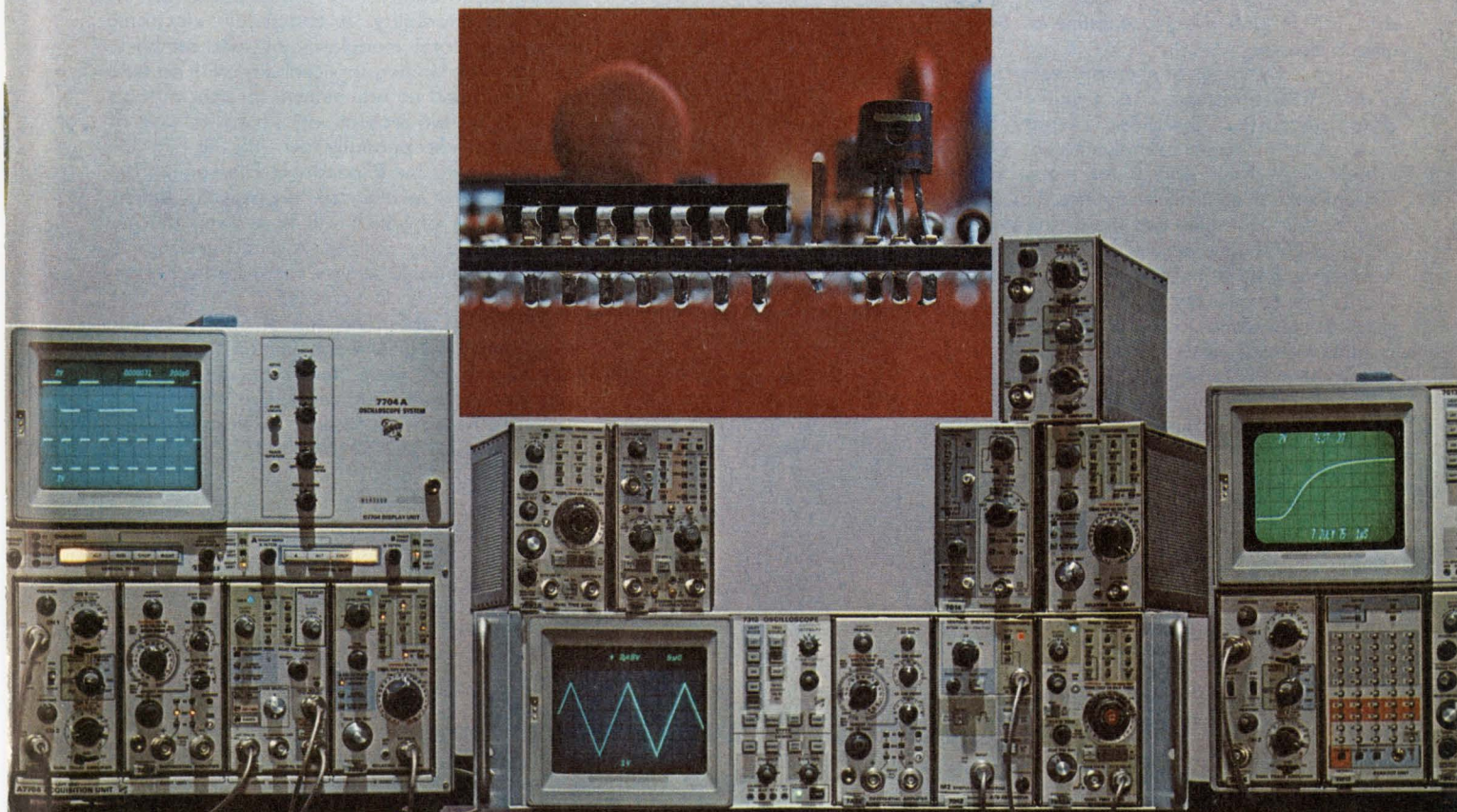

Another first for ISS

THE INDUSTRY'S FIRST "SMART" FIXED MEDIA DRIVE

Announcing another in a long line of industry firsts from ISS—the EFF 735—the first disk drive of its kind ever to employ an on-board microprocessor.

The advantages of microprocessor power in a disk drive are impressive. Complete internal drive diagnostics. Simplified circuitry because most analog circuits are eliminated. No field adjustments—ever. And a lot more, including microprocessor controlled routines that ease the load on the controller and the mainframe.

The EFF 735 gives you 353.8 megabytes on a single spindle using a fixed and sealed disk. There's one spindle per drive and each drive has its own internal power supply and air filtration system. Average access time is 23 milliseconds.

With our fixed head option, you get another 1.26 megabytes and zero access time.

Besides the microprocessor, the EFF 735

gives you a sweeping lineup of operating and maintenance features. A single phase motor. Dual port capability. A completely electronic tachometer. Total modularity of subassemblies. And truly outstanding serviceability, with no field adjustments and no requirement for special tools—one of the big reasons why your total cost of ownership is exceptionally low with the EFF.

EFF stands for Expandable File Family. The 735 is the first member of this new ISS family, later versions of which will have even greater capacities and capabilities. And all versions will be field upgradable so you can increase performance as your needs increase.

ISS is an operating unit of Sperry Univac bringing technological leadership for the generations ahead. For more details on the new EFF 735, write or call OEM Marketing, ISS, 10435 N. Tantau Avenue, Cupertino, California 95014, telephone (408) 257-6220.

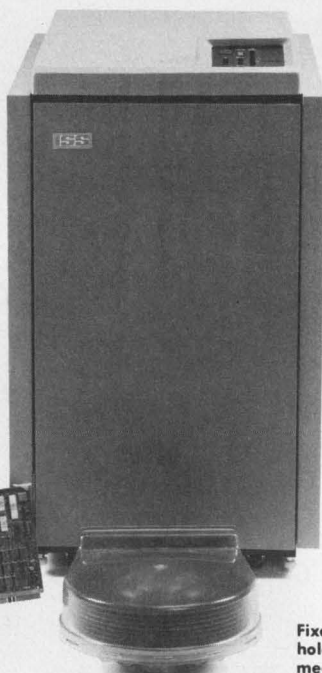

Microprocessor makes it a "smart" drive.

Fixed disk pack holds 353.8 megabytes.

EFF 735. The first "smart" disk drive.

SPERRY  UNIVAC

Sperry Univac is a Division of Sperry Rand Corporation

CIRCLE NUMBER 17

Speeders beware: The cops can fake you out

The hide-and-seek played by motorists with devices that pick up police radar a couple of miles before it can identify their speeding cars is about to become "radar poker." The reason? A low-cost decoy transmitter that can be mounted alongside or away from the highway to confound a Fuzzbuster, a Super Snooper or other CB "early warning" systems with false alerts.

The Solure is the first electronic countermeasure that promises to cut down the effectiveness of such cop alerts. Developed by Transportation Safety Associates, the decoy radar operates at 10.525 MHz in the X band, just like a Fuzzbuster and police radar. To be self-sufficient, the decoy is powered by batteries recharged by a bank of solar cells, and operates up to 40 hours on a single charge.

Anticipating countermeasures,

Transportation Safety has incorporated a timer that can deactivate the system when it would be prone to vandalism—from midnight to 7:00 AM.

With a Solure set up every 10 miles or so, a speeder with a Fuzzbuster will not know which is the real radar and which is not.

"We'll be playing poker with him," says Walter W. Friel, director of traffic safety for Washington, the first state to purchase and install many of these devices. "By stationing a patrol car at random in these series, we'll further increase system effectiveness."

Meanwhile, radars are appearing that operate in the K band. The present Fuzzbusters can't detect them and improved models will probably cost twice as much. But for \$30, says Friel, the X-band decoys can be modified to play speed poker on the K band.

Ultrasonic transducer tests without contact

Usually, ultrasonic transducers for nondestructive testing have to send energy between the transducers and body being inspected, either through bonding or immersion in a liquid. A new ultrasonic transducer system generates and detects ultrasonic waves simply by being placed close to the surface under test. What's more, the transducer is not confined to examining flat surfaces. It also works in a vacuum and at high temperatures that would destroy bonds and vaporize liquids.

In the ultrasonic transducer, a dc magnetic field interacts with a radio frequency field in the surface of either a conducting object or an insulating material with a conducting coat.

The magnet-rf transducer system operates on a unique phenomenon and does not rely on piezoelectric or magnetostrictive effects. Rf electromagnetic fields are produced in the surface of the

test object by means of planar coils placed adjacent to the surface, according to Dr. Bruce W. Mayfield, who helped invent the transducer system. These coils are energized with 1 to 2- μ s bursts of rf at a repetition rate of about 100 Hz. Peak pulse power is on the order of one to a few kW.

A dc magnetic field, which may be produced either by an electromagnet or, in recent designs, by a 3.5 to 4-kilogauss samarium-cobalt permanent magnet, is oriented perpendicular to that of the electric vector of the rf field. The ultrasonic waves are generated in the surface of the material at the rf excitation frequency. The waves are produced on the atomic lattice of the metal under test by interatomic forces generated by rf eddy currents interacting with the magnetic field.

The ultrasonic waves travel through the metal and if a flaw is present acoustic energy is reflected. After an rf burst is applied to the transducer, the coils are switched to a receiver, which amplifies the reflected energy

and displays it as echoes on a scope.

The coil-magnet system generates bulk waves and typically operates at frequencies up to 0.5 MHz. But with proper transducer design there is no practical upper limit, according to Maxfield, currently at Lawrence Livermore Laboratories, Livermore, CA. Normal system bandwidth is one to one-and-a-half octaves.

For substantially higher frequencies, surface acoustic waves (SAW) can be generated, Maxfield notes. In this case, rf bursts are applied to a meander line deposited on a piece of Mylar or other insulating substrate. Once the dc magnetic field is properly oriented surface waves result.

This approach provides a noncritical and noncontact way to produce SAW waves that is simpler than conventional methods requiring edge transducers bonded to the SAW-device surface. Maxfield points out that now SAW waves can be generated in a surface too rough for a conventional SAW-transducer.

One possible way to use this improved SAW system is in the inspection of tubing and pipe now performed by eddy-current testing.

The magnet-rf system is available for license through the Research Corp., 405 Lexington Ave. in New York City, 10017.

Inverter efficiency goes up with precision Xformers

Precision transformers in a power inverter make it 50% more efficient by getting rid of power-robbing resistors. A precision input transformer to the transistor power switch guarantees a fixed voltage to each transistor, and a precision output transformer guarantees a fixed output load on each transistor. So resistors for balancing the load are unnecessary.

In a conventional inverter, which is 60 to 70% efficient, the transformers have a single or center-tapped winding connected to the transistors. Current sharing is set by resistors between the transistors.

In the power inverter from Elgar Corp., San Diego, a dc signal is chopped and the resulting ac waveform is fed to a transformer with multiple output windings. Each winding feeds one of many transistors in parallel, a configuration chosen to share the inverter's current load and increase power-output. The transistor outputs are fed

into another transformer, which has multiple input windings. This transformer raises the voltage to the desired level, while isolating the transistor circuitry from the load.

Without resistors, efficiency climbs to 90%, according to John Waterman, Elgar marketing vice-president.

This efficient inverter circuitry is used in a series of Elgar power inverters designed for harsh environments. But in a commercial package the Elgar inverters will cost about the same as older designs, says Waterman.

CIRCLE NO. 318

Fiber-optic connector cuts interface losses

Connecting the ends of individual fiber-optic strands instead of bundles cuts the interface losses of a fiber-optic connector from a typical 3 dB to 1 dB or less.

Both electrical and optical lines are housed in this connector, which has been developed by Hughes Aircraft's Connecting Devices Div. for airborne applications.

Dead space between round fibers in a bundle prevents optical conductors from being precisely aligned. Losses usually hover around 3 dB. That is, fully half the light is lost in passing through an optical interface between bundles. Previous loss-reduction techniques have included arranging the bundle in geometric shapes, but the actual fiber-to-fiber alignment was left pretty much to chance.

A single optical fiber is all that's necessary to transmit data from one place to another, and by eliminating all redundant fibers Hughes has developed an optical interconnect scheme that reduces the interface loss to 1 dB or less.

"Axial alignment is the most crucial consideration in an optical connector," explains Jim Wittmann, Military Products Manager for the Hughes division in Irvine, CA. "A coaxial misalignment of a mere 500 micrometers will create an optical loss approaching 1 dB." Angular misalignment and a nonoptimum gap between the two ends add to the interface loss—a .005 in. gap causes a 2-dB loss. But if two ends actually meet, shock and vibration will destroy the smooth glass faces. The ideal gap, according to Wittmann, is .001 in., which causes a minimum loss of 0.5 dB.

It is possible to reduce the alignment losses to zero. So far, Hughes has

demonstrated an over-all loss as low as that by crimping soft bushings over the ends of glass fibers. Machined bushings provide mechanical stability so the fibers can be securely mounted in a two-section alignment tube, one section on either side of the interfacial gap. The gap is controlled by a 1-mil-thick washer. Mechanical springs bias the bushings together against the washer, so the assembly stands up to shock and vibration.

Three moisture-proof seals of elastic silicone keep atmospheric contaminants out of an interface, which is recessed 1/4 in. inside the connector body.

The new optical connector is designed to support a multiterminal data bus for carrying avionics control signals in weight-critical military aircraft. It meets MIL-C-85028 in lieu of a MIL Spec on airborne optical connectors, according to Wittmann. The units go for \$2 to \$3 per mated line.

CIRCLE NO. 319

Brain cells monitored by tiny FM transmitter

A miniature FM transmitter may help shed light on the workings of that most complex and mysterious of all organs, the brain. A 16-by-16-mm cylinder attached to a tiny electrode, has been inserted into a laboratory animal's brain to monitor the electrical signals of a single cell. The animal can go about its business, unimpeded by the long and cumbersome wires that were necessary in past studies.

The transmitter was developed by David Pettijohn, a research associate and electronics specialist in the Dept. Psychology at the Massachusetts Institute of Technology in collaboration with Dr. Howard Eichenbaum, a postdoctoral fellow and Anne Deluca, a research associate.

This brain-cell instrument, according to Pettijohn, may revolutionize the rapidly expanding field of psychology, which records and studies the firings of single brain cells in response to specific stimuli. The long-range goal, he notes, is to better understand how information flows within the brain.

Individual brain cells range from 10 to 50 microns, and recording from them requires a tiny high-impedance electrode flexible enough to move "as the brain sloshes around."

The electrode is composed of a bundle of platinum-iridium wires, each 25 microns in diameter. To be stiff enough

to penetrate the brain, the bundle is encased in a shaft of dextrose, which provides temporary support until it dissolves in the brain. The individual wires then can spread out and move with the brain fluid.

Weighing only four grams, the transmitter is manufactured by Midguard Electronics, Newton, MA, under license to MIT. The unit contains a FET and four other transistors to amplify and broadcast the signal from the electrode. The FET provides high impedance at the transmitter input and drives a high-power-gain Darlington amplifier whose output in turn provides the signal to the output oscillator.

Powered by a standard 1.5-V hearing-aid battery, the transmitter has a broadcast range of 10 meters (about 30 feet). Bandwidth is 1.5 to 12 kHz and is pretuned during assembly to a broadcast frequency specified by the user.

Currently, single cells can be recorded from several days to two weeks. About 30 of the transmitters have been manufactured to date and are being tested in many laboratories.

In addition to animal studies, the transmitter may prove useful for recording electroencephalographic data for studying epilepsy, exercise physiology and neurological diseases.

μ p-controller pen gauges signatures

A piezoelectric sensor pen and tablet can, under microprocessor control, analyze signatures by measuring not only the pressure exerted by the pen on paper, but also the pen's accelerations. Developed at Sandia Laboratories, Albuquerque, NM, the pen was described at the International Electron Devices Meeting in Washington, DC, earlier this month.

The pen has a central, slightly flexible shaft that supports two long, thin sensors mounted 90° apart. The shaft is mounted within a rigid tube; one end is fixed to the tube and the other has a ballpoint-pen tip. When the pen is in use, the shaft can flex, and the accelerations of the pen can be measured in x and y coordinates. A sensor platen detects the third axis of information—pen pressure.

The pen's measurements are more valuable than Fourier analysis of pressure outputs or voiceprints in applications such as computer-room security, says Errol Eernisse, Supervisor of the Solder State Device Physics Division at Sandia.

Surprise!

Another missed delivery on MECL III parts may not be the kind of surprise you were looking for, but it could be the best thing that's happened to you all month.

Because Plessey's ECL III is available from stock.

You can get our ECL III devices as identical "me-too" plug-ins, including the lo-Z parts you can't get any-
place else.

Or you can get Plessey ECL III with lower delays and much higher operating speeds. Our SP16F60, for example, is the world's fastest Dual 4-Input OR/NOR Gate, with a switching speed of just 500 pico-seconds. And all our other products are available with typical values as good as MECL's maximums, and maximums

that have to be experienced to be believed.

We can select for certain specifications (such as threshold voltage or slew rate on our SP1650/1, toggle rates or delays on our SP1670). We'll

even screen to 883B if you need it.

And all this comes with the reliability you've come to expect from Plessey, so call or write for ECL III details today.

We think you're more than ready for a pleasant surprise.

 **PLESSEY SEMICONDUCTORS**

1641 Kaiser Avenue, Irvine, CA 92714. (714) 540-9979

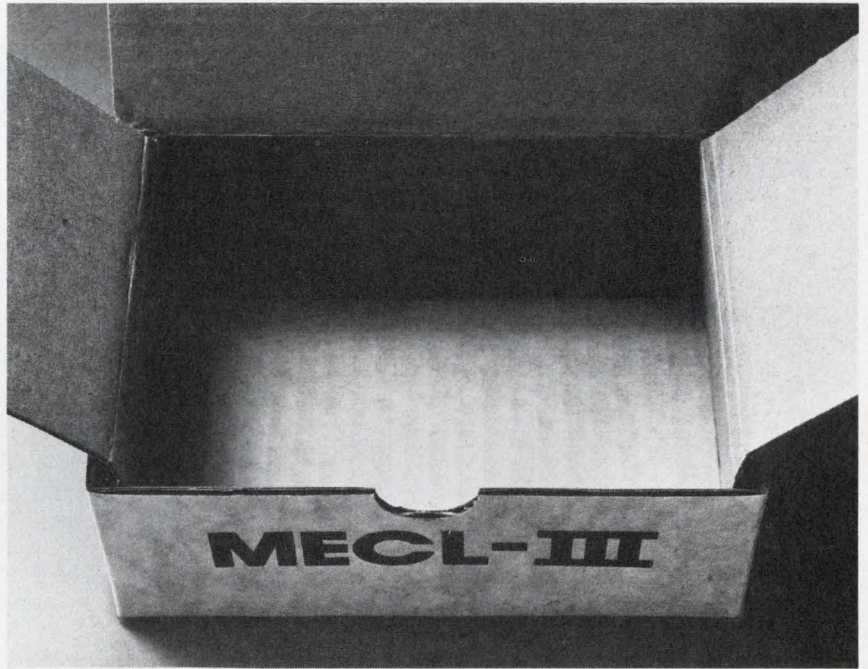

PLESSEY'S ECL III IN STOCK:

SP1648	Voltage controlled oscillator
SP1650	Dual A/D comparator, Hi-Z
SP1651	" " Lo-Z
SP1658	Voltage controlled multivibrator
SP1660	Dual 4-1/P OR/NOR gate, Hi-Z
SP1661	" " Lo-Z
SP1662	Quad 2-1/P NOR gate, Hi-Z
SP1663	" " Lo-Z
SP1664	Quad 2-1/P OR gate, Hi-Z
SP1665	" " Lo-Z
SP1666	Dual clocked R-S Flip-Flop, Hi-Z
SP1667	" " Lo-Z
SP1668	Dual clock latch, Hi-Z
SP1669	" " Lo-Z
SP1670	Master-slave D Flip-Flop, Hi-Z
SP1671	" " Lo-Z
SP1672	Triple 2-1/P exclusive-OR gate, Hi-Z
SP1673	" " Lo-Z
SP1674	Triple 2-1/P exclusive NOR gate, Hi-Z
SP1675	" " Lo-Z
SP1690	UHF prescaler type D Flip-Flop
SP1692	Quad line receiver
SP16F60	Dual 4-1/P OR/NOR gate

- After what I've been through, your ECL III sounds incredible:
- Call me with proof—I'm ready to be convinced.
- Don't call me—just send me the following parts and bill me:

_____ Qty _____

_____ Qty _____

_____ Qty _____

Name _____

Telephone _____

Company _____

Address _____

City/State/ZIP _____

Plessey Semiconductors, 1641 Kaiser Avenue, Irvine, CA 92714.
Telephone (714) 540-9979.

State-of-the-art brought down to earth

AMP connectors with unique Bonded Lubrication cut insertion force up to 40%.

Without compromising performance.

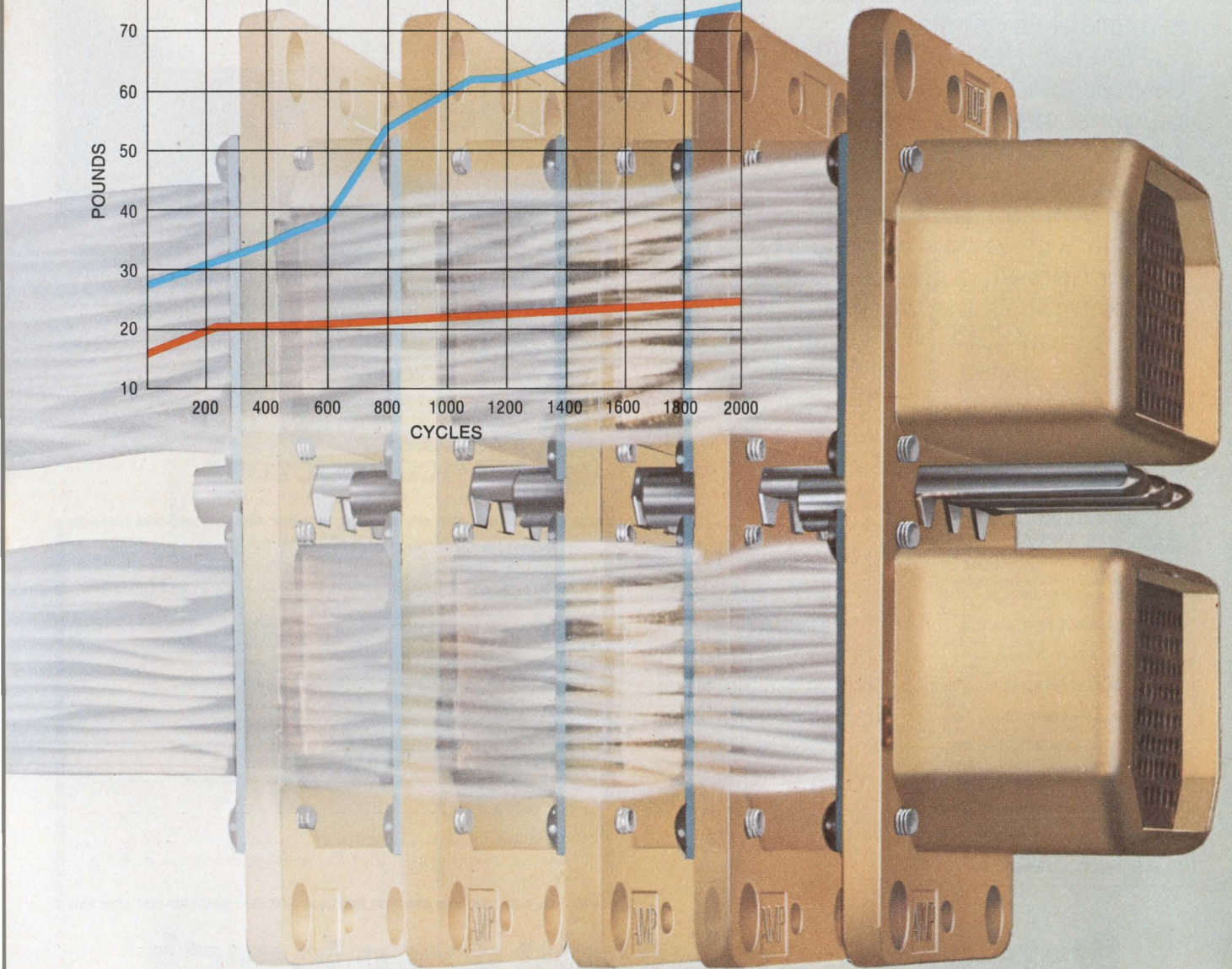
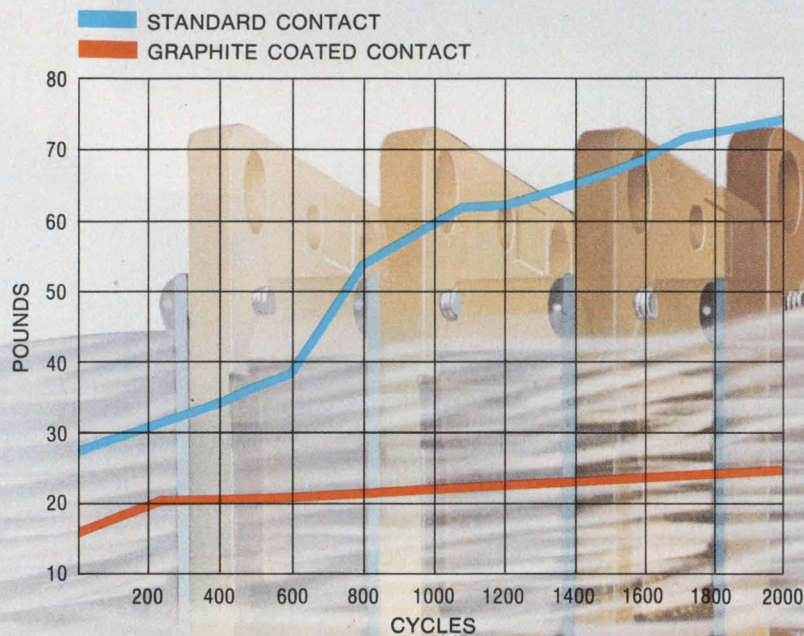

They give you all the advantages of lower insertion force without sacrificing proven contact geometries, or electrical stability. Insertion and extraction forces can be reduced as much as 40% which also results in extended contact life by more than 100% (as the table indicates).

The secret of this outstanding, exclusive improvement lies in the integration of lubricant and plating material, which now can be used on both round or flat contact surfaces. Where used, plating thickness can be cut appreciably with no change in electrical stability. That's why Bonded Lubrication has become one of the industry's most significant and cost effective performance breakthroughs.

And there are many more ways AMP Bonded Lubrication can improve your designs. It facilitates the use of larger pin counts with resulting savings in space, size, weight, materials and assembly time. It reduces servicing and maintenance because there is less damage, wear and replacement of mating contacts. And with it come the advantages

of AMP technical assistance . . . first rate engineering help in design, production or prototype planning. Because we want to help you get the most out of your product and ours.

AMP Bonded Lubrication is already available in a variety of our connectors. In our DUALATCH line, for example, it extends cycle life to a minimum of 20,000 insertions and withdrawals . . . a 100% increase. In our ARINC front release connectors and MI Series metric types, it further increases their premium reliability, ruggedness and overall ability to meet performance requirements. And in our ECONOMATE printed circuit connectors, it ensures even greater protection against board damage and contact wear.

Why not put all the advantages of the better way, AMP Bonded Lubrication, to work in your products. For technical information just call Customer Service at (717) 564-0100. Or write on your Company Letterhead to AMP Incorporated, Harrisburg, PA 17105. For product information, please circle the reader service number.

AMP has a better way.

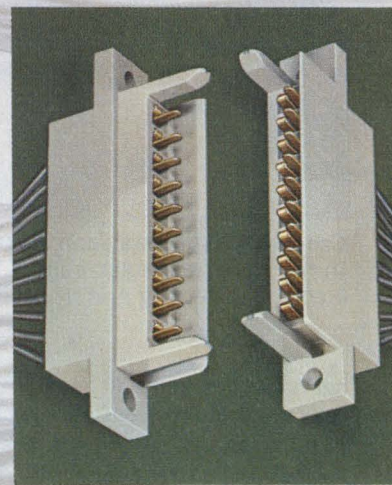
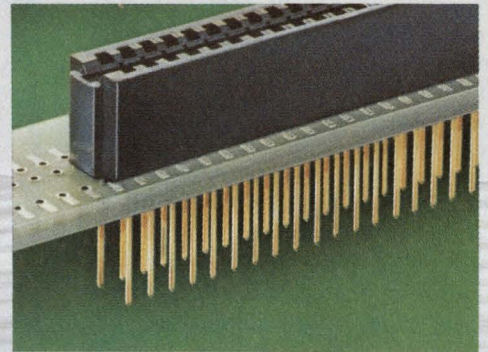
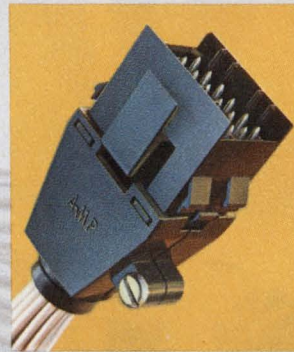
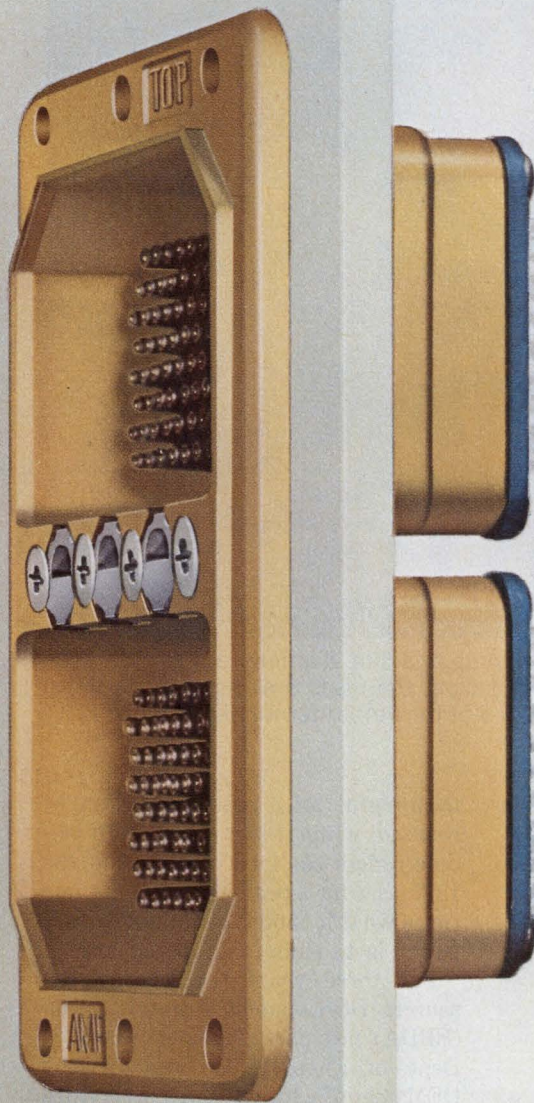

The dramatic difference in wear between Bonded Lubrication and ordinary contacts is shown by these electron images.

AMP

INCORPORATED

AMP, DUALATCH, & ECONOMATE are trademarks of AMP Incorporated.

CIRCLE NUMBER 19

Solar-cell technology

Little by little, solar-cell technology is being directed by the federal government toward increasing the nation's energy supplies. While solar-electric, or photovoltaic power systems have a long way to go before they actually compete with fossil-fueled power plants, there are signs indicating that progress is being made:

- Commercial use of photovoltaic power in the field has increased to 500 kW, from 100 kW in 1970.

- The 1978 price of a unit of solar power, a peak watt (W_p), is expected to get down near \$13—from \$90 in 1970.

- Silicon-fabrication techniques are breaking away from the 20-year-old Czochralski growth process and edging into high-volume and potentially low-cost silicon ribbons and sheets.

- A dozen materials are being studied for their photovoltaic effect; single-crystal silicon still dominates, but polycrystal silicon, gallium arsenide and cadmium sulphide are getting increased attention for special uses.

- Optical concentrators are increasing the effective area of solar arrays by converting more incident energy than would otherwise fall on the cells.

- Computers are helping to configure and optimize complete commercial photovoltaic power systems, according to load, geography, weather and even the cost of money.

The impetus is free energy—a cloudless summer day with the sun shining brightly yields a peak energy distribution of about 1 kW/m^2 , the maximum solar irradiation defined by a peak watt. Just lying in the sunlight, a 2-in. diameter solar cell provides $1/4 W_p$, a 3-in. wafer $1/2 W_p$, and a 4-in. wafer, $1 W_p$.

Each unit cell outputs a fixed volt-

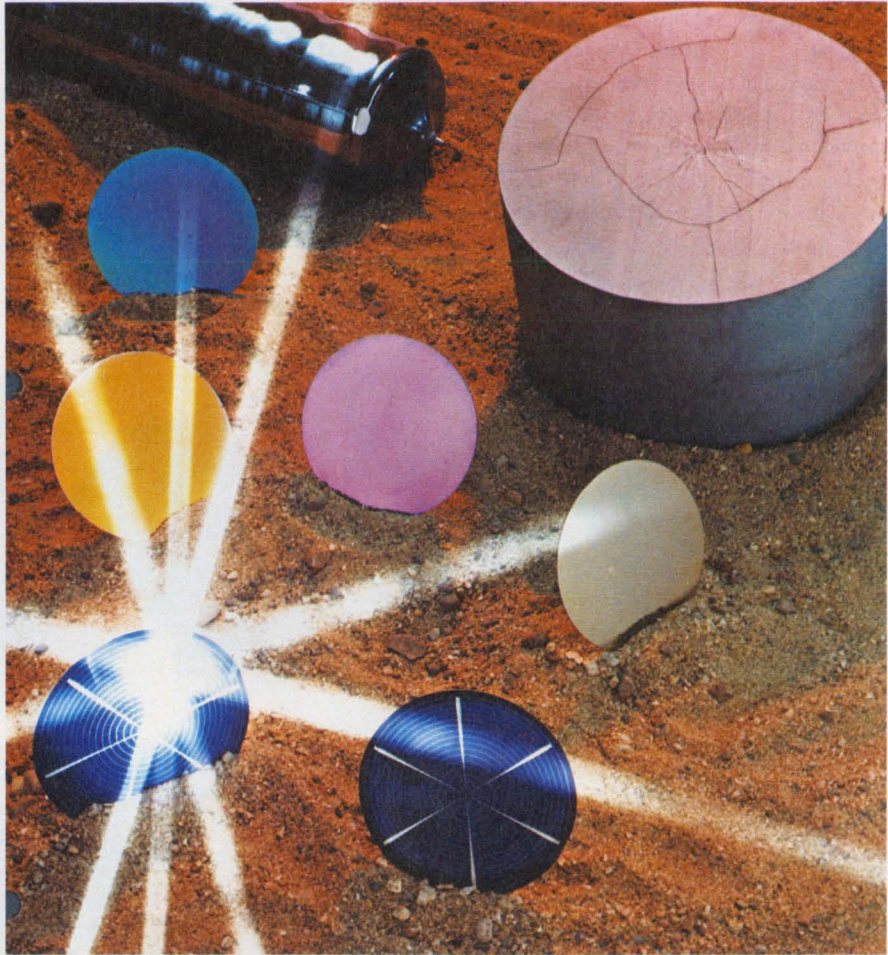

Czochralski-grown silicon crystals with up to a 5-in. diameter are sliced wafer-thin to produce solar cells. After diffusion, the discs are metalized with an electron-collecting grid. It becomes one of the output terminals. (Motorola).

age, about a half-volt (see box). The cells are normally configured in series-parallel arrays to provide a specific voltage and current capability. Except for the cost involved, there is *no limit* to the number of cells that can be interconnected.

The price volume quandary

But solar-cell technology faces a dilemma. Without high-volume orders,

meaningful price reductions can't be realized; without low prices, high volume orders can't be placed. And the 1977 price for a peak watt, \$15, is three times what it should be if photovoltaic power is to enjoy widespread use.

For three years the Energy Resources Development Administration (ERDA), now part of the newly created Dept. of Energy, has been funding OEM manufacturers and universities in an over-all solar-electric cost-reduc-

Dick Hackmeister
Western Editor

advances—but slowly

tion program, which relies on the federal government's three existing research facilities. The Jet Propulsion Laboratory in Pasadena, CA, researches and develops raw solar-cell material, fabricating large-area sheets, encapsulating the finished cells, integrating them into modules and testing the completed array. Sandia Laboratories in Albuquerque, NM, designs and evaluates optical concentrators and "total energy" systems, and power-conditioning and storage subsystems, and identifies over-all system tradeoffs. Lewis Research Center in Miami, OH, tests and demonstrates real-life systems in the field. Through Lewis, the largest solar-electric array was installed and set into operation—a 25-kW (W_p) irrigation-water pump station in Nebraska.

Introducing SERI

Soon, however, federal solar-energy R&D will be consolidated under the roof of the Solar Energy Research Institute (SERI) in Golden, CO. Created by Congress, SERI is just now getting staffed and organized under the directorship of Dr. Paul Rappaport, recognized as one of the country's leading experts in photovoltaic conversion.

Since petroleum is the most portable energy source around, Rappaport sees its use only for the transportation industry. Stationary facilities will ultimately be powered by the sun, Rappaport predicts. But more efficient solar-cell manufacturing processes are needed before that can happen. Because low-production volume requires a great deal of manual intervention, Rappaport advocates shifting away from the batch-oriented schemes to a continuous-flow process that can be automated. "Just sawing a boule of silicon into wafers adds 35 cents to the price of each watt," he notes.

Most of today's commercially avail-

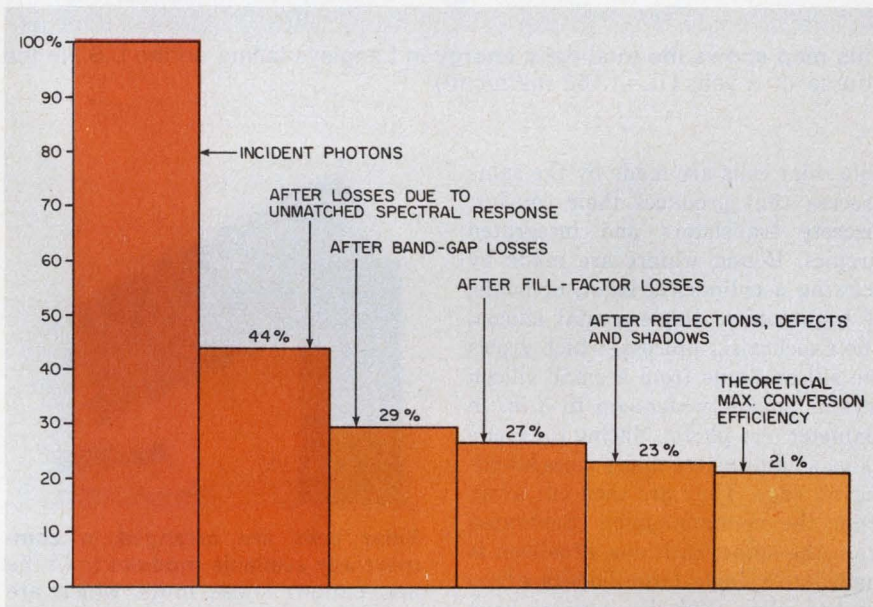

Even the best solar cells won't reach more than 21% conversion efficiency, according to theory. Today's devices range from 8 to 18%.

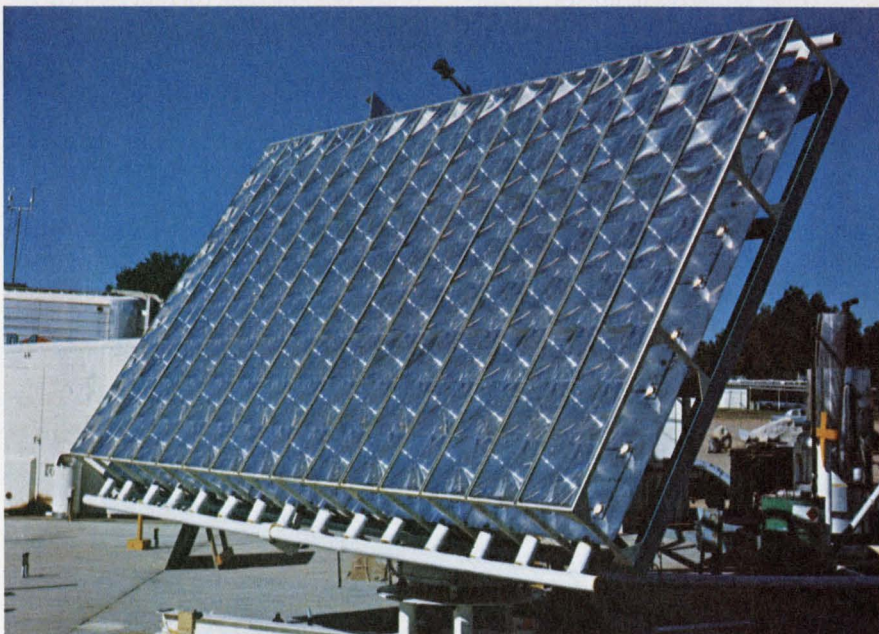

Generating 1000 W_p , this two-axis tracking array uses fresnel lenses to concentrate solar energy 60 times. Lenses are 80% efficient; grooves are turned inward to prevent dirt from accumulating.

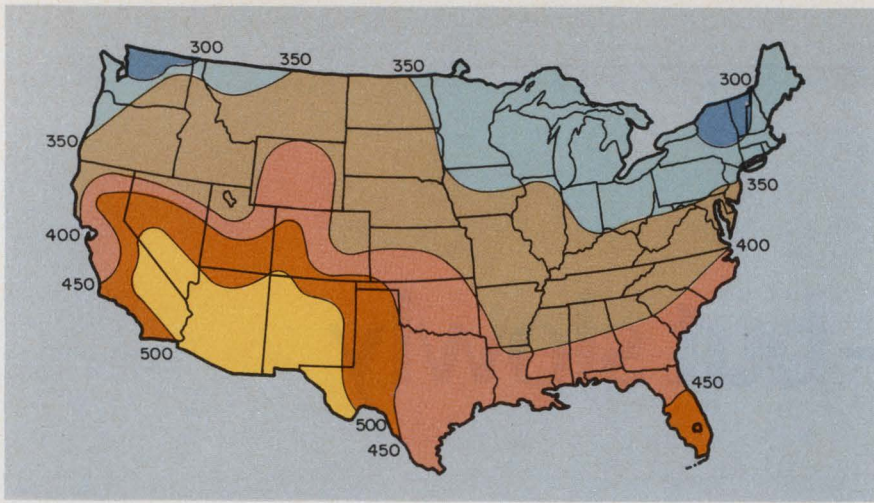

This map shows the total daily energy in Langleys falling on the U.S., in the course of a year ($1L=1.162 \text{ mWh/cm}^2$).

able solar cells are made by the same process that produces their cousins, discrete transistors and integrated circuits. Round wafers are made by growing a cylindrical ingot, or boule, of high-purity, single-crystal silicon. The Czochralski process, which grows the silicon boule from a small silicon crystal, makes wafers up to 5 in. in diameter (see photo). Slicing the boule like a salami leaves many discs standing on edge. They are then cut away from the common spine. Separated from the spine, each disc of silicon is made into a single, large diode (see box) by the same diffusion process that creates ICs and transistors, except that the wafer surface isn't masked and only a single diffusion step is necessary. (Interestingly, it makes no difference whether the *p* side or the *n* side of the junction faces the sun.)

Finally, an ohmic, current-collecting grid is deposited over the face of the wafer. It becomes one of the solar cell's output terminals—the other terminal is formed by metal deposited on the backside of the cell. Output voltage polarity is determined by the direction

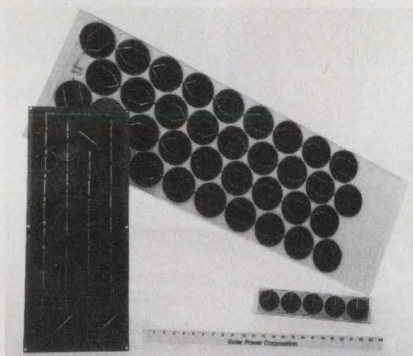

Solar cells are arranged in commercially available modules to fit the application. These units, which are available from Solar Power Corp., North Billerica, MA, generate $25 W_p$, $9.2 W_p$ and $1.4 W_p$, respectively.

of the *p-n* junction; current flows in the forward direction.

The ultimate in efficiency

Growing silicon in boules is great for producing quarter-inch IC chips (the wafers are scribed, then cracked into squares). But the process is woefully inappropriate for making carpet-sized



The largest photovoltaic installation yet is this 25-kW_p array at an irrigation-water pumping station in Nebraska.

sheets of the material to collect and convert sunlight. Several firms are currently under contract to the Jet Propulsion Laboratory to produce large-area silicon, either in ribbons or in sheets. These companies include Mobil-Tyco (Waltham, MA), Motorola (Phoenix, AZ), RCA (Princeton, NJ), Rockwell International (Anaheim, CA), Honeywell (Bloomington, MN), Westinghouse and General Electric (Schenectady, NY).

Other JPL contractors are working to alter the existing batch-manufacturing process with such alternatives as ingot casting and improved sawing or cutting of the boules. These contractors include Texas Instruments (Dallas, TX), Varian (Lexington, MA), Coors (Golden, CO), Crystal Systems (Salem, MA) and Eagle Picher (Miami, OK).

Meanwhile, commercially available solar arrays are beset with problems. For one thing, they are only about 12% efficient—that is, they convert incident sunlight into usable electric power at the rate of 120 W/m^2 . Small-area laboratory devices have reached efficiencies as high as 18%, but theoretically no cell can exceed 21%.

For silicon, unmatched spectral response reduces the available photons to 44% efficiency. The band-gap limit further reduces them to 29%, and fill factor brings the number down to 27%. After surface reflections and defects, the figure is 21%, which still doesn't allow for dirt, metal-mask shadows and I^2R losses.

Geographical location has a profound effect on a solar array's output. Peak watts are generated only during the ideal conditions of summer sun and clear skies. Even then, peak watts occur only at noon. Averaging peak power with cloud cover, night darkness, and the sun's acute angle of incidence in winter cuts the annual amount of usable power down to 25% of the peak in Phoenix, and down to 16% of the peak in Boston (see map).

Temperature takes a toll, too, and a solar array with a supposed 15-V output will droop to 13 V if noontime temperatures hit 110 F (43 C). Evaluation arrays purchased by JPL are spec'd for operation at 150 F (65 C), but that's probably overkill for most OEM applications.

Problems on earth

Properly interconnected and potted, solar cells can be expected to operate indefinitely. In fact, solar cells have

READ THESE TEN CHAPTERS. AVOID CHAPTER 11.

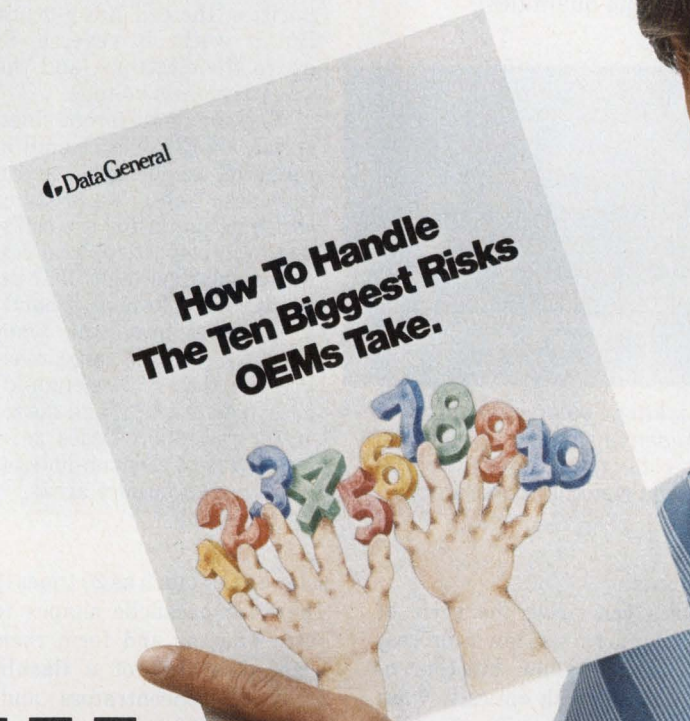

- I want to see how a computer vendor can help me. Send me your book today.
- I'm too busy to read another book. Have your salesman come and show me the way.

Name _____
Title _____
Company _____
Department _____ Phone _____
Address _____ City _____
State _____ Zip _____

Data General, Westboro, MA 01581, (617) 366-8911. Data General (Canada) Ltd., Ontario.
Data General Europe, 59-65 rue de Courcelles, Paris, France. Data General Australia, Melbourne (03) 82-1361.

 **Data General**

ED 1220

We make computers that make sense

© Data General Corp., 1977

been used in space for years, and the Jet Propulsion Lab has not been able to find a measurable degradation or failure yet. But back on earth, a few reliability problems do crop up. The chief culprit, not surprisingly, is the encapsulating, or potting material of a solar-cell module.

Although a module needn't be hermetically sealed, it must be weatherproof and impervious to moisture so that it can withstand day/night temperature cycling. Moisture on the cell's surface degrades the unit's performance rapidly. It causes extra losses by absorption and refraction, and it promotes the growth of organic substances that block valuable sunlight.

Another performance degrader, odd-ly enough, is the sun, whose ultraviolet rays darken the encapsulant material.

There is even a problem with the most used encapsulant, silicone rubber. Its sticky surface collects dirt. Manufacturers cover the module's face with clear plastic or tempered glass to make the module better able to clean itself: The surface should wash clean in the rain, and snow should slide off.

Cell interconnections within the module can also become failure mechanisms, so multiple, redundant connections must be made to the disc.

Since solar arrays make power while the sun shines but never at night, power conditioning and storage facilities are prime requisites for any commercial solar-electric system.

Automobile-type, lead-acid storage batteries remain the only realistic power buffers. Vendors combine them with solar-cell modules, a shunt regulator, a blocking diode (to prevent shorting out the batteries at night), mounting hardware and cabling to configure a complete OEM solar power generator.

System configuration is called "sizing," which normally includes a computer analysis of the site's latitude, longitude, altitude, mean temp and yearly "in-solation"—which refers to the amount of time the site is in the sun, or "in sol." The unit of measure of insolation is the Langley, which is equal to 1.162 mWh/cm² (see map).

Armed with a description of the power required and the site's solar circumstances, a computer determines the most efficient system for that application: the number of solar modules and their series-parallel connections, the array's compass heading and tilt angle, the number of batteries required and their interconnections, as well as projected system performance on a



This two-axis, three-section tracking concentrator generates 300 W_p, and uses a solar-powered μ P and stepping motors to follow the sun. RCA expects this "fly's eye" concentrator to cost \$1/W_p in volume quantities.

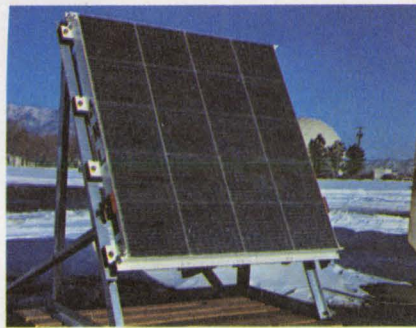

A nontracking, solar concentrator uses high-density strips of cells and parabolic reflectors to generate 100 W_p. (Argonne National Laboratory).

monthly basis.

Computers can drive the price of flat-plate solar arrays as low as process and materials will allow, but concentrators can accomplish optically what process and materials can't—an effectively large solar cell. Concentrators are considered the "hot" price-reduction strategy, and are being intensively developed; some may become commercially available as early as mid-1978, after testing at Sandia.

Concentrating on the sun

Concentrators can gather and focus more of the sun's energy on available solar cells using parabolas, fresnel and optical lenses. Tests at Sandia show that concentrators can boost the equivalent efficiency of silicon solar cells above 15%, and gallium arsenide cells to almost 20%; they are most effective in the southwestern United States where sunlight is most intense and least diffuse. Both tracking and non-tracking concentrators show promise.

Nontracking concentrators effectively multiply the surface area of a

The 'Un-led,' and how it works

Operating, the solar cell is a light-emitting diode working backwards.

A conventional LED, like the type that might be used as a display in your watch, has a depletion layer formed in the semiconductor material by oppositely doped impurities. An external energy source—voltage—excites the electrons to conduct through the depletion layer. Excess energy is given off as photons, which you can see.

A solar cell, too, has a depletion layer formed in the semiconductor material by oppositely doped impurities (the cell is a p-n junction). But it works in reverse. Photons excite the electrons, and the junction develops a voltage.

Working on different sides of the street, a LED doesn't emit a broad range of wavelengths, and a solar cell doesn't absorb a broad range—which accounts for the cell's losses due to imperfect spectral response.

The solar cell and LED do share limitations. The energy band gap ($\Delta \cong 1.5$ eV) limits the amount of energy either one can convert. And because they're less-than-ideal diodes, both the LED and the solar cell suffer reflection losses as well as losses due to electron-hole pairs recombined in impure areas.

solar cell as much as 20 times (20 suns). They use parabolic shapes to collect extra photons and form them into a beam, like that of a flashlight. An array of concentrators and a like number of solar cells are mounted on a rack that looks like a backyard swing. The rack tilts the array at the best angle for the site's latitude, and is adjusted seasonally.

Beyond a concentration ratio of 20 suns or so, the optical alignment of sun, lens and cells becomes too critical for a fixed-frame array—because of the earth's rotation. The sun must be tracked.

The tracking speeds involved are slow enough for stepping motors to move the frame of a tracking concentrator—it's all under μ P control. Together, the stepping motors and the μ P consume only a small fraction of the energy they help collect.

The highest concentration ratio to date is in RCA's "fly's eye" (see photo). With a concentration ratio of 300 suns, the tracking must be very accurate: the unit updates its position 30 times a minute. ■■

THE TELETYPE® MODEL 43:
ALL THE TALK YOU'VE HEARD ABOUT IT IS TRUE.



When something as good as the Teletype model 43 teleprinter comes along, it naturally generates a lot of talk. And for a lot of good reasons.

Delivering true 30-character per second throughput, upper and lower case printing in a 132-column format, the model 43 has an exclusive, Teletype-developed 9-wire matrix impact printhead mechanism. This unique feature provides superior service life as well as exceptional print quality, even on multiple copies.

Under the cover, we kept hardware and moving parts to a minimum for maximum reliability. Solid-state circuitry and only five modular components—plus a built-in test capability—mean service is not

only fast, but also simple.

Another convenient cost-saving feature of the model 43 is that it's designed to use 12" wide by 8½" long fanfold paper. Tear off the serrated margins and you've

got a 132-character line on the handy 11" x 8½"

paper. When you add up all the model 43's features, you'll think there's been a mistake when you see the low price. But it's true. Because on a price/performance basis, the model 43 is simply unsurpassed.

The Teletype model 43. After all the good things you've heard about it, no wonder nothing even comes close.



Teletype is a trademark and service mark registered in the United States Patent and Trademark Office.

CIRCLE NUMBER 21

IC packages are changing shape to handle growing LSI chips

Pressure is mounting for the re-design of IC packages, both to accommodate the increased size and complexity of LSI chips and to bring down the cost of consumer ICs. As a result, new IC-package standards have been proposed and new packages are being developed.

Putting more and more circuitry on a digital chip is not only increasing chip size, but in effect is making the standard DIPs too small. But lengthening the packages to add more pin-out connections extends internal leads and adds parasitic capacitance that loads down the circuits, limits operating speeds and adds undesirable delays.

Moreover, the rectangular shape of the DIP packages requires excessive board area. This holds down the number of packages that can be mounted in a given space.

Meanwhile, high-volume, low-cost consumer applications such as calculators, clocks and video games, are suffering because the IC package now costs as much or more than the chip.

The standard DIP cavity, 300 mils wide, is just getting too small for the new memories being developed, says

John Hewkin, strategy manager of MOS Memories for Texas Instruments in Houston. For a memory that will take only 16, 18 or 20 pins, the chip is getting to be almost too big to fit into a standard package.

"For example, our new 64-k RAM will barely fit into a 16-pin, 300-mil package," Hewkin observes. "We could live with a 400-mil package width for LSI for the foreseeable future, but the 300-mil unit is marginal."

The industry has acclimated itself to the specific DIP sizes because of the massive investment in packaging equipment. But agreement is almost universal that new package designs are needed. Hewkins points out that TI has tentatively put off making wide memories because of existing package limits.

However, in what has been termed a rare show of collaboration, new standards for LSI packages are being coordinated by package users, package manufacturers, and the semiconductor manufacturers.

Tentative specifications have been developed by the Joint Electronic Device Engineering Councils for a family of LSI chip-carrier packages that will permit a system user to change from one package to another without re-designing the system.

Two square-package series—one for

PC-board use, the other for high-density ceramic packaging—are being proposed by the JEDEC JC-11.3.1 Task Group, headed by Daniel I. Amey of Sperry Univac, which spearheaded the industrywide effort over two years ago. Mechanical details and dimensions have been resolved. According to Amey, pin-identification details still have to be finalized.

Square is fine

A square format was determined to be most efficient in terms of circuit density. Also, the format minimizes the lead length of all connections, and consequently reduces parasitic lead capacities. The basic package has contact pads for interfacing with a connector or mounting directly to the PC board or ceramic substrate. The leads on the leaded version are located on the sides to act as spring contacts for mating with a socket.

Type I, geared to PC-board use, has contact pads or leads located on 50-mil centers. Designed for 28, 44, 52, 68, 84, 100, 124 and 156-lead packages. Type I ranges from about 0.45 in. to 2.05 in. square.

The Type II series proposed by JEDEC is like the Type I series except that the leads are on 40-mil centers,

Jim McDermott
Eastern Editor

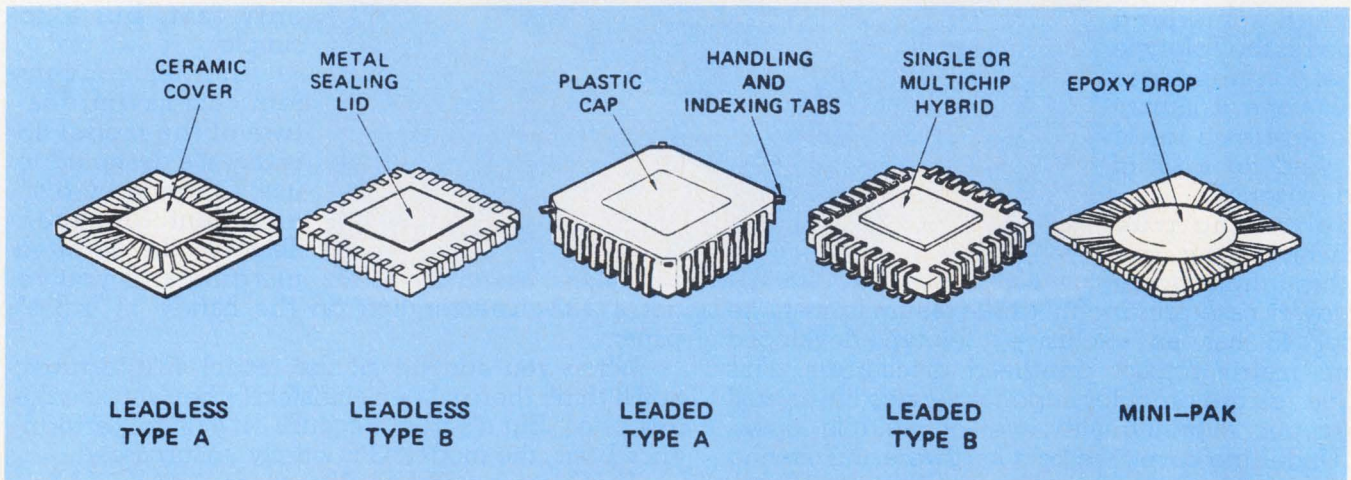

New LSI IC packages proposed by JEDEC have features shown above. One style has leads on 50-mil centers and

is for PC-board mounting. The other style, with leads on 40-mil centers, mates with ceramic substrates.

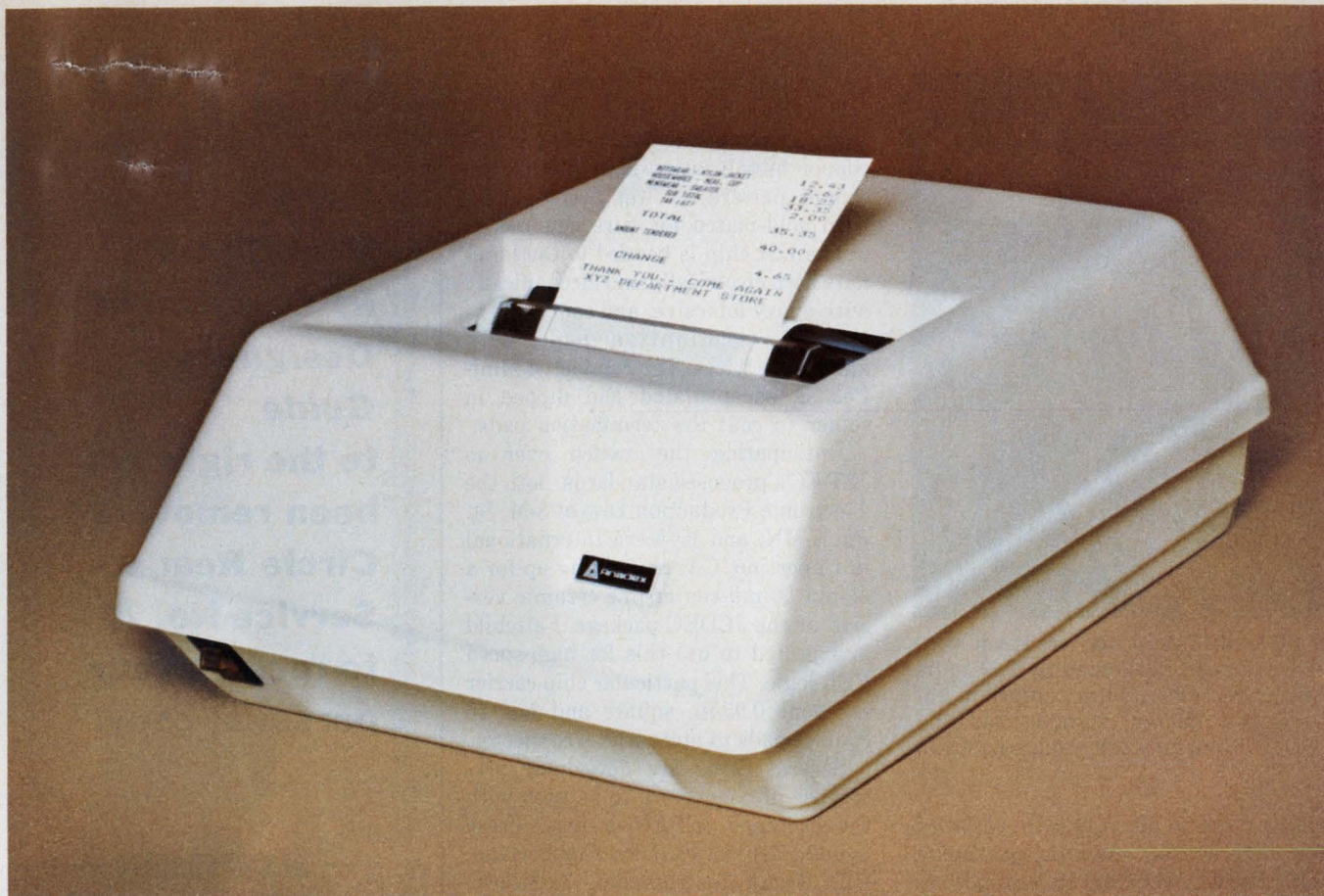

Our new
mini/micro
computer
printers...
"the easy
ones."

Features:

- Three popular ASCII input configurations
- Forty characters per line
- Internal data storage
- Double-width character selection
- Power line filter
- Optional tally-roll and/or fast paper feed

EASY TO INTERFACE

The new DP-1000 Series Printer family fits right into most mini-micro computer and modem applications – thanks to three popular ASCII formats available in four different basic models.

Standard Baud rates from 110 to 2400 Baud, and internal storage of up to 104 characters (more optionally) with "hand-shake" control signals, let you pick from a variety of off-the-shelf configurations to fit your specific application.

EASY TO USE

A time-proven, dot matrix impact printing element can print 64 alpha-numeric and special symbols in 40 characters/line at 50 CPS on single or multiple-copy paper rolls. Options such as Tally Roll take-up and Fast Paper Feed, make the printers easy to fit point-of-sale and related fields.

Combining form and function, the modern package blends with virtually any surroundings, while

its flip-top design allows convenient access for paper replacement and servicing.

EASY ON BUDGETS

Best of all, single-unit prices for the DP-1000 Series start at under \$700, with substantial Dealer and OEM quantity discounts.

Want to see a demonstration in your office, or more details? That's easy too. Just contact Ken Mathews at Anadex; 9825 DeSoto Avenue; Chatsworth, CA 91311; Telephone (213) 998-8010; TWX 910-494-2761.



CIRCLE NUMBER 22

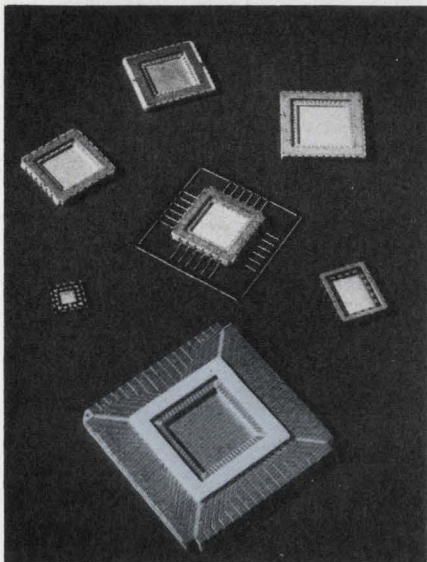

A 68-lead IC-chip carrier, lower center, has been developed by 3-M to be one of the new 50-mil centerline LSI packages being standardized by JEDEC. Chip carriers are also shown.

rather than on 50. Primarily designed for high-density ceramic packaging with direct attachment to ceramic substrates, Type II devices would have 40, 48, 64, 80 and 96 pins.

Both leadless and leaded variations of Types I and II have been proposed (see figure). The design of these new leadless and leaded types will affect mounting requirements. For example, leadless type A is intended to be mounted with the chip bonded to the top surface for better heat dissipation. A mating connector is required.

Leadless type B can be mounted directly on a ceramic substrate with the chip on the bottom of the carrier. For PC-board mounting, however, a connector is needed.

Leaded type A, a molded plastic nonhermetic package, is designed for reflow soldering to either ceramic or PC board substrates. It is intended for continuous-carrier-film automated die attachment and package mounting. Leaded type B is simply a leaded version of leadless types A and B, aimed at reflow soldering.

Even before JEDEC came up with proposed DIP standards, companies were responding to the packaging problem. For example, a 28-pin leadless design by General Instrument called the Mini-Pak eliminates the lead frame, molds and molding compounds, which provides substantial savings in consumer applications. Interestingly enough, the Mini-Pak is now a part of

the proposed JEDEC standard.

The Mini-Pak board is made of an epoxy or composite laminate on which copper metallization is produced. The copper pattern is first nickel-plated, then gold-plated for wire bonding.

The LSI chip is bonded to the laminate both electrically and mechanically with epoxy adhesive, and connected to the 28 termination pads with aluminum wires. The completed Mini-Pak is encapsulated and dipped in solder to coat the termination pads.

Anticipating the switch over to JEDEC's proposed standards, both the Electronic Production Div. of 3-M, St. Paul, MN, and Kyocera International in Cupertino, CA, are tooling up for a 68-pin 50-mil-center-line ceramic version of the JEDEC package. Fairchild is expected to use this for high-speed ECL logic. This particular chip carrier is about 0.95-in. square and has 68 contact pads to mate with a connector.

Several firms are developing prototypes of connectors to be used with the proposed JEDEC designs. These include Berg Electronics, Cumberland, PA, Texas Instruments, Attleboro, MA, and AMP Inc., Harrisburg, PA.

Interestingly, AMP had decided months ago that a new low-cost chip package was needed. So it went ahead before the JEDEC proposals were finalized and developed a flat, 24-pin package for mass application. The AMP package, called a "pre-molded packet," also has its leads on 50-mil centers, six to one side. The package is slightly less than 0.4-in. square.

The AMP device can be soldered easily to PC boards, even those that may warp during soldering operations. The packet frame is molded with six leads extending from each side. The chip is inserted inside the carrier, bonded, and capped after being filled with silicon gel for chip protection.

The leads are folded back underneath the flat pack for a springlike effect. As the PC board expands and contracts during a soldering operation, the compliant leads protect the package itself from any strain. On some boards, for example, ceramic carriers can't be soldered because PC-board strains produced by soldering can crack the fragile carriers.

Industry consensus is that the standard 14, 16, 18 and 24-pin DIPs will be around for a long time yet in many low-cost, noncritical applications. For the LSI circuitry, however, the new 40-pin and up packages will be needed. ■■

**If the
Mini-Circuits
RF Components
Designers
Guide
to the right has
been removed,
Circle Reader-
Service No. 70
to receive your
personal copy.**

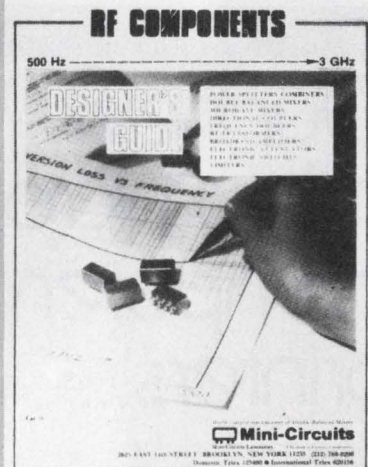

Contents of this 100-page handbook include:

- Power splitter/combiner application notes
- Power splitter/combiner selector chart
- Power splitter/combiner specifications
- Directional coupler application notes
- Performance specs on directional couplers, double-balanced mixers, amplifiers, electronic attenuator/switches, limiters, RF transformers, frequency doublers

The New 1977-1978 **GOLD BOOK** Has Just Been Published

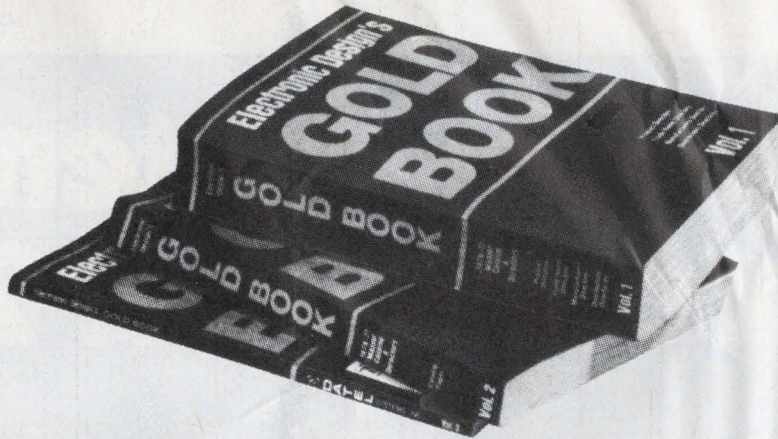

And Completely Outdates Last Year's Edition

If you were a subscriber on **ELECTRONIC DESIGN's** qualified circulation file in July 1977, you have been automatically sent your new **GOLD BOOK**. If you wish additional copies for other members of your company, you may order them now using the convenient coupon form below.

If you were not an **ELECTRONIC DESIGN** subscriber on our controlled circulation list, you may order your own multi-section set of the new **GOLD BOOK** by completing the form below. Shipment will be made promptly on receipt of your payment or company purchase order.

**HERE IS WHAT YOU AND YOUR COMPANY
WILL FIND IN THE UPDATED 1977-78**

GOLD BOOK

- **Three sections** containing 2,496 pages of information to quickly locate products used by the electronics industry.
- **A Product Directory** with 5,434 product categories.
- **A Trade Name Directory** of 9,814 listings.
- **A Manufacturers' Directory** listing 8,057 companies in the electronics industry.
- **Two Distributors' Directories** with 2,050 distributors listed.
- **A Giant Compendium of Manufacturers' Data Pages** with specifications.

MAIL TODAY WITH PURCHASE ORDER

Electronic Design's **GOLD BOOK** 449R
Hayden Publishing Co., Inc.
P.O. Box 13803, Philadelphia, Pa. 19101 U.S.A.

Here is our purchase order for _____ sets of the 1977-1978 **GOLD BOOK** at \$30.00 per set—for U.S., Canada and Mexico. (All other countries: \$40.00 per set)

Check enclosed for \$_____. Bill us.

Name (Print) _____

Title _____

Company _____

Address _____

City/Province _____

State/Country _____

Zip or Postal Code No. _____

QUANTITIES ARE LIMITED. PLACE ORDER TODAY!

It's a stand-alone sweep-signal generator that provides all the performance of much higher priced competitive instruments.

To back up that sweeping statement, consider the following: The Model 2002 sweeps from 1 MHz to 2.5 GHz in four bands with 20 milliwatt output, $\pm 1\%$ display linearity, and ± 0.5 dB flatness. Consider also that it includes an internal 10 dB per step attenuator which in conjunction with a continuously variable pin diode attenuator

results in an output power range of +13 to -77 dBm. Plus a band-stacking option that lets you cover the entire 1 to 2500 MHz frequency range in one sweep. A ± 2 dB amplitude slope adjustment that compensates for frequency dependent variations in test set-ups is also available along with a deluxe marker module containing 1, 10, 50 and 100 MHz harmonic markers that operate over the entire frequency range of the unit. Finally, consider the price: \$2,700 for the basic

unit and only a total of \$3,200 if ordered with the bandstacking, deluxe marker module and slope adjustment options. Compare the prices against those of available competitive units.

WAVETEK Indiana Incorporated,
66 N. First Ave., P.O. Box 190
Beech Grove, Indiana 46107
Telephone: (317) 783-3221
TWX 810-341-3226

WAVETEK

CIRCLE NUMBER 23

A sweeping statement about our Model 2002:



Washington report

Another \$1.5-billion slated for B-1

The Air Force will spend another \$1.5-billion to test the B-1 bomber as a possible alternative to cruise missiles, despite President Carter's decision in June not to order the bomber into production.

The figure came to light when the Air Force submitted to Congress its quarterly Selected Acquisition Report (SAR), which lists the projected total costs of the Pentagon's 45 largest weapons-systems programs. The latest SAR estimates that B-1 costs will total \$4.9-billion, or \$19.9-billion below the previous estimate, which was projected before the decision not to produce 240 aircraft. The Air Force has already spent nearly \$3.5-billion on three prototype B-1s and will get a fourth in early 1979. That aircraft will be used to test its special defensive electronic countermeasures system, and the Air Force expects B-1 flight tests to continue for at least another three years.

The latest SAR projects that all told the Air Force's top 45 programs will cost \$179.5-billion, or \$19-billion less than projected in the last report. Program increases will be worth \$900-million, with the largest to be an extra \$103-million for 12 Navy A-7E attack aircraft, which were added by Congress to a program that the Pentagon has been trying to end for at least three years.

Air Force sensor to detect aircraft from space

An experimental sensor system scheduled to be launched into orbit by the Air Force in March 1981 will be used to detect enemy strategic aircraft from space. The first sensor package, whose code name is Teal Ruby, is being built by Rockwell International Corp.'s Space Div. at Downey, CA.

If it becomes operational, the system will provide early warning of an attack by the Soviet Union's new Backfire long-range supersonic bombers and, possibly, its cruise missiles. Operating frequencies are classified, but it is believed that the Teal Ruby sensors will use the infrared spectrum to detect the effluent gases of the bomber and cruise-missile engines. Each type of engine has its own identifiable spectral "signature," which can be used to locate the engine's aircraft.

Rockwell has completed the design of the Teal Ruby sensor and has recently received a \$3.3-million contract from the Air Force's Space and Missile Systems Organization to build the first sensor package, which will be launched from NASA's Space Shuttle. The program has cost \$24-million to date.

Battlefield sensors are going automatic

Prototypes of an automated battlefield sensor system to detect movements of enemy troops are being built by RCA for testing by the Army Electronics Command (ECOM). The sensors in the Remotely Monitored Battlefield Sensor System (REMPASS) will work like the unattended ground sensors used in Vietnam except that they will use a more advanced data-communications system.

The REMPASS's magnetic, seismic, acoustic and infrared sensing devices remain passive until activated by enemy movements. Then they send back signals via vhf radio link, directly or by means of repeaters either on the ground or in helicopters.

At least six engineering models will be delivered to ECOM. RCA's Automated Systems Div., Burlington, MA, recently won a \$9-million contract from ECOM to integrate the sensors with the improved communications system.

Power system for space is on the way

An isotope power supply capable of generating up to 2 kW for spacecraft is being developed for the Department of Energy. The Brayton Isotope Power System (BIPS) is a closed-cycle gas-turbine electrical generator that takes the heat generated from a plutonium isotope and converts it into electric power through a generator driven by a high-speed turbine. Prime contractor Garrett AiResearch Manufacturing Co. of Phoenix is testing it in an altitude chamber simulating space conditions.

The generator is due to complete a 1000-hour endurance run next May. If it passes, a BIPS may be tested on NASA's Space Shuttle in late 1981 or early 1982. The ultimate goal is 50,000 hours, or nearly six years of operation. An earlier 15-kW Brayton power system developed by Garrett for NASA recently passed the 30,000-hour endurance mark at the agency's Lewis Research Center in Cleveland.

Superconductive receiver operates in millimeter region

The first successful operation of a superconductive heterodyne receiver in the millimeter-wave region has been reported by scientists at the National Bureau of Standards Cryogenics Div., Boulder, CO. Superconductive methods have already been demonstrated for microwave receivers and magnetometers.

The millimeter-wave receiver is tunable over the 200 to 325-GHz waveguide band. The system's noise temperature (single-sideband) is estimated at 823 K, with an instantaneous bandwidth of 20 MHz. This temperature is an order-of-magnitude improvement over the best uncooled mixer receivers at this frequency, according to NBS, and is comparable to the noise performance of helium-cooled indium-antimony bolometers, which are limited to i-f bandwidths of less than 2 MHz.

The mixer is a point-contact Josephson junction mounted in a single-mode waveguide. A 300-GHz backward-wave oscillator is used as the local oscillator to produce a nominal 9-GHz i-f signal, which is amplified by a low-noise ruby maser.

One potential application for the new receiver is astrophysical observation of the line spectra of molecules.

Capital Capsules: The Office of Federal Procurement Policy is expected to reaffirm the government policy of **contracting out as much work as possible to industry rather than having it done "in-house" by government employees.** This policy is required by Office of Management and Budget circular A-76, but inflation and tight federal budgets have forced government agencies to keep work in-house in order to protect employment levels. The new policy statement is expected to require Commerce Department certification that no commercial source is available before in-house activity can be undertaken....**NASA is reviewing all its field centers work forces to meet President Carter's requirement that its total work force be cut back by 500 jobs this year.** Sources say NASA may have to close a field center.



FROM 20 Hz TO 4,500 MHz

S-D has just the right counter for your communications and low frequency needs.

Communications Counters

Systron-Donner offers you a choice of no less than *four* communications counters from 100 MHz to 4,500 MHz. Small and lightweight, all of these counters feature the latest advances in high speed, precision frequency measurement.

- **Sensitivity:** 10mV RMS (Models 6241A, 6242A, 6243A). Model 6244A: 10mV RMS to 500 MHz, -13 dBm above 500 MHz.
- **Overload protection:** Withstands high input signal levels without damage.
- **Display:** 8 LED digits, 0.1 Hz resolution.
- **Tone measurement (opt.):** Example: measure 1020.01 Hz automatically in 1 sec.
- **Meet the whole family:** 100 MHz Model 6241A—\$595; 512 MHz Model 6242A—\$795; 1250 MHz Model 6243A—\$995; 4500 MHz Model 6244A—\$2150.

Low frequency counters, 10 and 80 MHz

Not all low cost counters are alike! S-D's are different because they can *accurately* measure most of the signals encountered in low frequency applications. Here's why:

- Three-position attenuator: x1, x10, x100. (avoids false counting)
- Offset control allows measurement of *non-sinusoidal* waveforms
- Four selectable gate times from 0.1 Hz to 100 Hz
- 25 mV RMS sensitivity
- Advanced input circuitry to assure error-free measurements.

Model 6202B (10 MHz), \$295. **Model 6203B** (80 MHz), \$325. (U.S. prices only).

For sales assistance, contact Scientific Devices or Systron-Donner at 10 Systron Drive, Concord, CA 94518. Phone (415) 676-5000.

SYSTRON  DONNER

CIRCLE NUMBER 24

Make us your headquarters for

EMI/RFI FILTERS

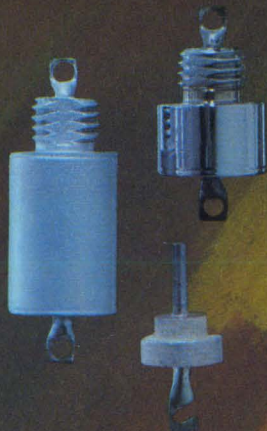

Passive Filter Headquarters:

Centralab Los Angeles is a one-stop source for reliable miniature ceramic low pass Feed Thru's/Filters. They're cost effective from 30 KHz to beyond 1 GHz. Threaded or solder mount for easy installation. Proven in AC as well as DC applications. Monolithic and multi-element. Standard products or computerized custom designs, including multi-circuit custom packages. Call Rich Colburn at (213) 240-4880.

Active Filter Headquarters:

That's Centralab Milwaukee. Solve design problems and cut costs with our thick film hybrids. Band pass, low pass, high pass and band reject. Cost effective for low to medium frequencies. Let us put our design and manufacturing expertise to work for you. Call Don Weiland at (414) 228-2872.

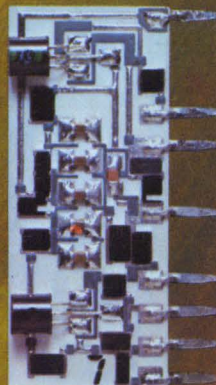

CENTRALAB
Electronics • GLOBE-UNION INC.

4561 Colorado Blvd., Los Angeles, California 90039
5757 North Green Bay Ave., Milwaukee, Wisconsin 53201

CERAMIC CAPACITORS • FILTERS • POTENTIOMETERS • SWITCHES
THICK FILM CIRCUITS • TRIMMER RESISTORS

CIRCLE NUMBER 25

I hear you

A story is making the rounds about this 70-year-old gentleman whose doctor urged him not to marry his 25-year-old ladyfriend. "It could prove fatal," the doctor warned.

Well, the old gent didn't have complete faith in his doctor. He saw him mainly as a specialist in extracting fees. But he was troubled. So he stroked his chin for a few minutes as he meditated. Finally the old campaigner arrived at a decision: "I'll take my chances. If she dies, she dies."

It's likely that this tale is apocryphal. But it's not likely that our hero was the first—or last—to hear just what he wanted to hear. The world is full of people with one-track ears.

Look at Charlie, the chief engineer at a small test-equipment company. When reminded of his large staff turnover, and the extraordinary number of his engineers who left to work for his competition, Charlie saw this as a tribute—proof that the training he provided made superior engineers.

If you were to tell Charlie that some of his working conditions made morale so poor that he was actually spending lots of money to train staff for his competition, he wouldn't hear it. He couldn't hear it. He could hear only praise.

Jack, on the other hand, could hear only condemnation. If you were to tell Jack that his new design was splendid, but that it might be improved with a slightly larger display, he would arch up and claw at you. Even the mildest suggestion was an attack.

Me? I'm different. I hear exactly what people tell me. There's never any coloration due to my background and make-up. How about you?



GEORGE ROSTKY
Editor-in-Chief

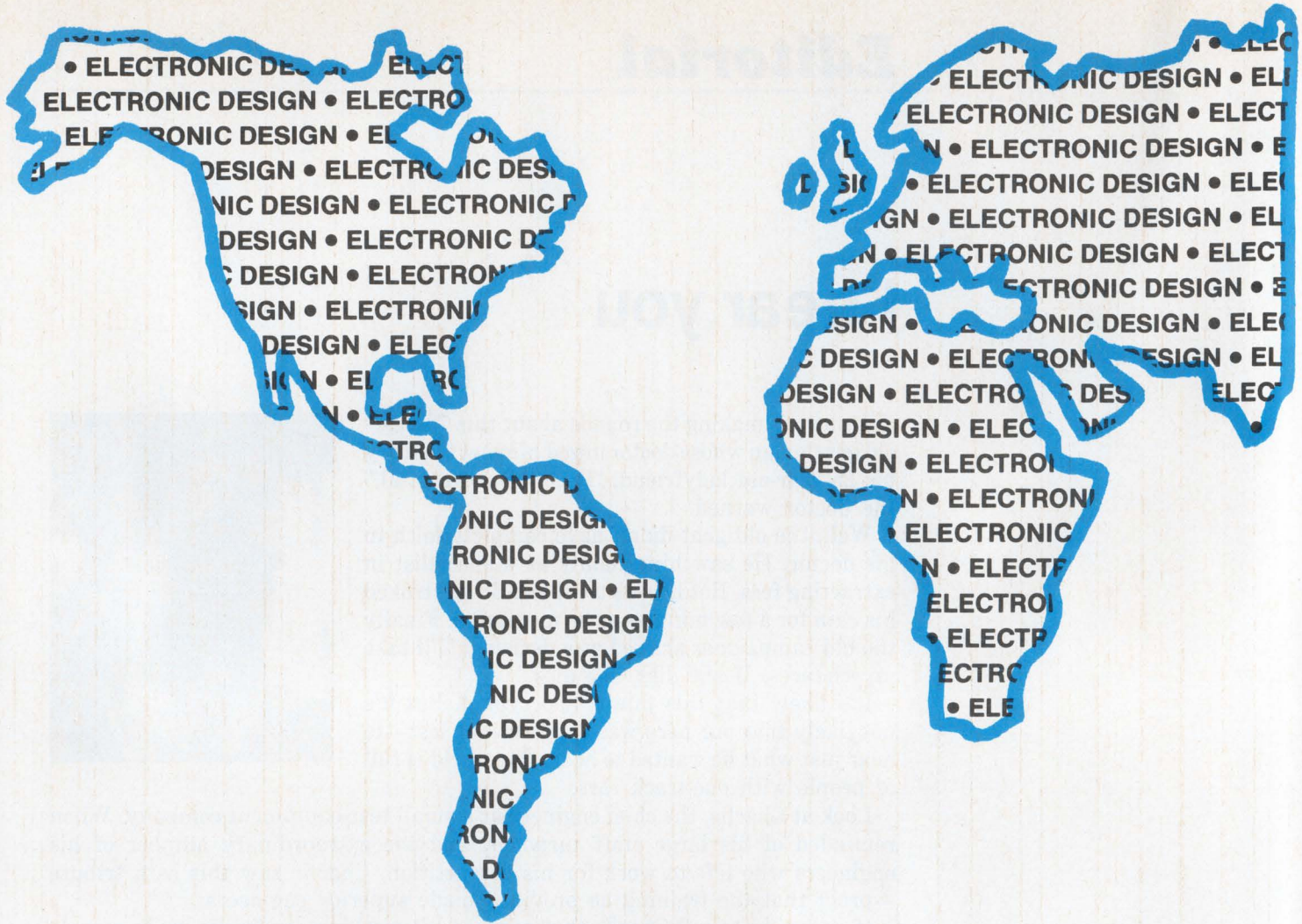

FOR ENGINEERS & ENGINEERING MANAGERS WORLDWIDE

Electronic Design's popularity overseas continues to increase — especially in Europe. The growing fraternity of *Electronic Design* subscribers is now pushing toward the 100,000 mark — and more than 16,000 are located *outside* the U.S.A. In fact, we now have more OEM engineering managers and engineer subscribers in Europe than any

Electronic Design 13

Connector selection shaking you up? Small wonder. Cable/panel connector specs are not readily unscrambled. Catalogs deliver all dimensions, not crucial derating factors; splatter superlatives, not available tradeoffs. "Leave the choosing to us," say spec-string vendors. To see what information catalogs blur over, rattle to p. 54.

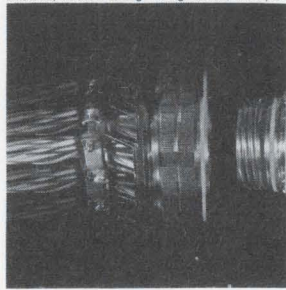

other U.S. journal. Engineers throughout the world look to the U.S. for leadership, and they turn to *Electronic Design* for the same reasons you do. If your company sells in Europe, or is thinking of starting up, pass the word to your marketing people. Maybe they aren't aware of our power, influence and authority among key specifiers overseas.

BEST READ ELECTRONICS PUBLICATION IN THE WORLD

TDK's materials play their part.

Our coils, transformers and filters are made of our unique ferrite and ceramic materials. They are unique because of our proven designing, winding, insulation material, precision processing and other techniques that shape them. No wonder then that our choke coils, reactors, special power supplies, noise filters, balun transformers and high-voltage units are also so distinctive. And they all meet world quality standards, too. They're probably what you are looking for to increase the reliability and efficiency of your end-products. If so, we'd be glad to hear from you.



Coils, transformers, and filters. They are part and parcel of TDK, too.

You may have heard our name being bandied about when it comes to coils, transformers and filters. These are just three of the secondary products we've been working on for years in combination with our ferrite core material and ceramic capacitors. But have you heard that these items are just a small part of our total product repertoire?

To get the record straight, we make ferrite cores and ceramic capacitors for televisions and radios, ferrite magnets for speakers and motors, PTC

thermistors (heat-sensitive elements), electric wave absorbers and many more. We supply them to the world's assembly makers.

With our ferrite cores for communications equipment we combine proprietary low-loss and high-permeability materials with sophisticated processing technology. Then again, we're kept busy supplying the world's music fans with cassette tapes — virtually all audiophiles have heard about our ED and SA series. Even our tapes, however,

take their cue from our magnetic material technology which began with our ferrites.

We already hear whispers about us in industries across the world like automobiles, business machines, medical electronics and industrial equipment, which are starting to use our parts. Although we're sure that everything you hear about us is true, we only hope that you don't mistake the part for the whole.



TDK ELECTRONICS CO., LTD. 14-6 Uchikanda 2-chome, Chiyoda-ku, Tokyo 101 Japan Phone: Tokyo 031/257-2525
TDK CORPORATION OF AMERICA 2041 Rosecrans Avenue, Suite 365, El Segundo, California 90245 U.S.A. Phone: (213) 644-8625 **CHICAGO BRANCH** 2906 West Peterson Avenue, Chicago, Illinois 60659 U.S.A. Phone: (312) 973-1222
NEW YORK BRANCH 755 Eastgate Blvd., Garden City, N.Y. 11530 U.S.A. Phone: (516) 248-5230 **EL PASO BRANCH** 3501 Frutas Street, El Paso, Texas 79905 U.S.A. Phone: (915) 533-5799
TDK ELECTRONICS CORP. (Handles recording tapes only) 755 Eastgate Blvd., Garden City, N.Y. 11530 U.S.A. Phone: (516) 746-0880
TDK DE MEXICO S.A. de C.V. (Handles ferrite magnets only) Carr. Juárez-Parvenir, Parque Ind. A.J. Bermúdez, Cd. Juárez, Chih., Mexico Phone: 3-88-27
MH&W INTERNATIONAL CORP. (Handles professional ferrites only) 14 Leighton Place, Mahwah, New Jersey 07430 U.S.A. Phone: (201) 891-8800 Telex: 134 484
MH&W INTERNATIONAL (CANADA) LTD. (Handles professional ferrites only) 6358 Viscount Road, Mississauga, Ontario, L4V 1H4 Phone: (416) 245-3606
MONTREAL 7575 Trans-Canada Highway, Suite 305, St. Laurent, Quebec, H4T 1V6 Phone: (514) 331-2827

CIRCLE NUMBER 26

Drive servos with a switching amplifier.

With a switching servo amplifier in your loop, you get high efficiency in a compact control package.

Delivering power with low losses in the output stage, a switching servo amplifier (SSA) requires far less heat sinking than a similarly rated linear amplifier. The switching mode power output provides typically ± 75 V at ± 10 A to drive a dc servo motor. And whether you're building a position or velocity servo, an SSA controls equally well in either case. Of course, you can build your own servo amp stage by stage, but an SSA module allows you to eliminate hardware design of your control unit.

Within an SSA package you'll find all the conventional servo amplifier stages—summing block, gain stage, compensation network and power amplifier. System control is performed by this single module—you supply a motor and feedback elements to complete the servo loop.

For position servos, the feedback element can be a potentiometer, resolver, or any element that provides electrical output as a function of position. Tachometers are often used as feedback elements to sense velocity. An SSA's input summing block simultaneously accepts signals supplied by two feedback elements and a reference source.

At an SSA's output, power is supplied to a motor with high efficiency. Dissipation in the amplifier is minimized by switching mode operation, with the output transistors connected in a bridge circuit.

Crossing the "H" bridge

In an SSA's power amplifier, four output transistors are operated in the switching mode, in an "H" or "transistor bridge" configuration.

In the SSA block diagram of Fig. 1, G_B represents the power stage, including the control electronics. The "H" bridge portion of G_B is shown schematically in Fig. 2. Arranging the output transistors, Q_1 through Q_4 , in a bridge circuit allows current to flow in two directions through the motor, which consequently develops torque in both the clockwise and counter-clockwise directions.

When Q_1 and Q_2 are turned on by a driver, current flows in the direction of the current arrow, $i(t)$, in Fig.

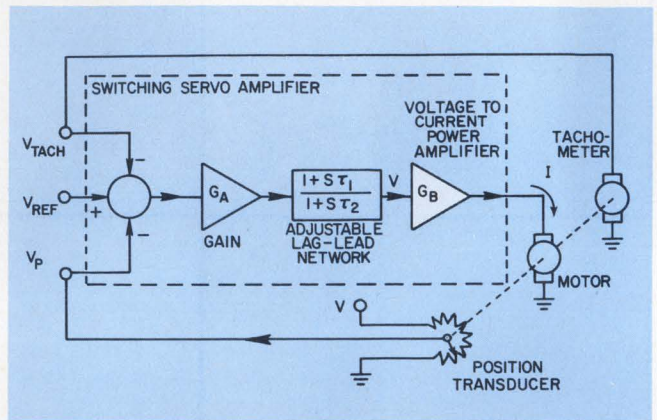

1. A complete servo amplifier is housed in a single switching servo amplifier (SSA) package. Depending on feedback elements, either a position or velocity servo can be built. In the SSA block, G_B represents not only the power-amplifier stage but also the control electronics section that provides drive signals.

2. At this time Q_3 and Q_4 are in the nonconducting (off) state. Turning Q_3 and Q_4 on (and Q_1 and Q_2 off) causes current to flow in the direction opposite to the arrow. Switching takes place continuously; at no time is the "H" bridge totally off—even when the motor is at rest.

With the motor at rest, current is delivered to it first in one direction, then in the other. The average current is then a triangular waveform centered on the zero axis as shown in Fig. 3.

While circulating current through the motor with no resulting motion seems wasteful, it prevents the servo system from exhibiting a dead zone at zero speed or "zero" position. As a result, both small and large mechanical disturbances can be corrected by the servo.

The cycle of events that generates the waveform of Fig. 3 further explains how the "H" bridge operates. When Q_1 and Q_2 are turned on by a driver in the control electronics, the supply voltage, V_s , appears across the inductor, L (Fig. 2). Current flows in the direction of the current arrow, $i(t)$. (This is an ideal case, which assumes no saturation drops across the transistors, and zero motor back-emf.) Since $V_s = L(di/dt)$, i is a ramp of current as shown in Fig. 3 for the interval $0 < t < t_1$.

Next Q_1 and Q_2 turn off while Q_3 and Q_4 turn on.

Current continues to flow in the same direction through L because of the inductor's collapsing field. Free-wheeling diodes D_3 and D_4 provide a continuous path for current flow. At the same time a $-V_s$ appears across L . This condition is shown in Fig. 3 for the interval $t_1 \leq t < t_2$.

At $t = t_2$, the inductor field totally collapses, and Q_3 and Q_4 maintain $-V_s$ across L . A negative ramp of current occurs in the $t_2 \leq t \leq t_3$ period since $di/dt = -V_s/L$. Finally, Q_1 and Q_2 are again turned on, as Q_3 and Q_4 go off.

motor. A signal proportional to motor current is fed back to the control-electronics input. Operating the "H" bridge as a current amplifier rather than a voltage amplifier becomes important when an SSA is used in a position servo.

Current sources are better

Sensing current in the "H" bridge and comparing it with the control electronics' input voltage produces a voltage-to-current transform. Current feedback,

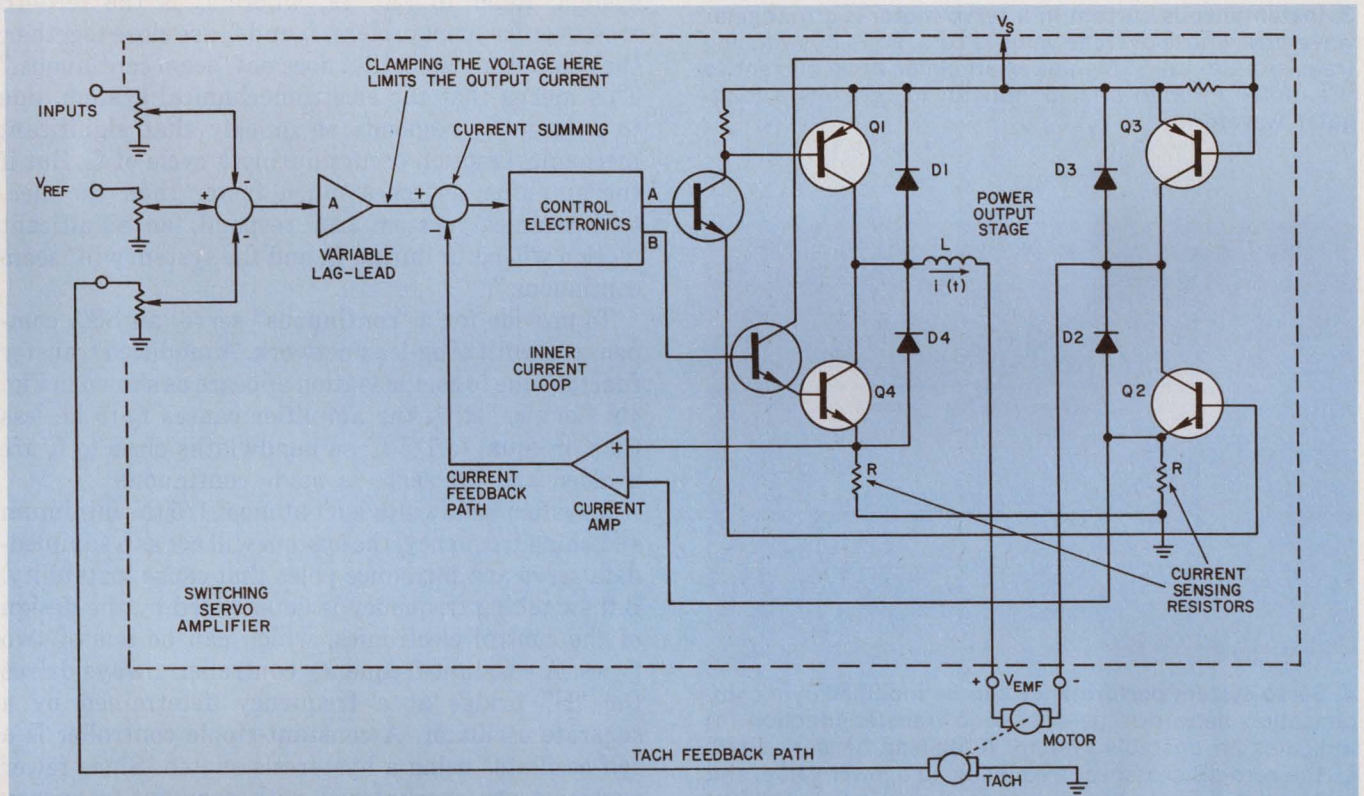

2. Motor drive in an SSA is provided by an "H" bridge. Alternate pairs of switching transistors, Q_1 through Q_4 , allow current to flow in the motor in two directions. An "H" bridge is a current source that senses current flow

through a motor and feeds it back to a summing junction at the control-electronics input. Current-source drive makes position servos stable and is a "universal" feature of all SSAs on the market.

Even after Q_3 and Q_4 are off, a current of $-I$ continues to flow through L on a path provided by D_1 and D_2 —until the inductor field again collapses. The entire cycle then repeats itself.

Time delays are built into the amplifier to allow one transistor pair to turn off before the other pair comes on. This avoids a low impedance path from V_s to ground through the transistors. In Fig. 2, Q_1 must be fully off before Q_4 turns on, or V_s will have a direct path to ground through them. The delays don't affect the waveforms because the diode pairs conduct immediately after a transistor pair is turned off. And the diode pairs allow enough time for recovery and turn on of the appropriate set of transistors.

In the emitter legs of Q_2 and Q_4 of Fig. 2, notice that two resistors sense current flow through the

from the current op amp in Fig. 2, is returned to the junction at the control-electronics input. There, it's summed with voltage from the output of the compensation network.

When a motor is driven from a current source, your servo system can benefit several ways:

- Position servos are stabilized by current drive, which results in a second-order system. On the other hand, voltage drive causes a third-order, or unstable system. (It doesn't matter what type of drive you use in a velocity servo, since it is naturally stable with either current or voltage sources. But since SSAs are designed as "universal" controllers, current drive is employed to ensure that every application is stable.)

- Current-limiting to the motor is easily provided. Clamping the input voltage of the power stage to a

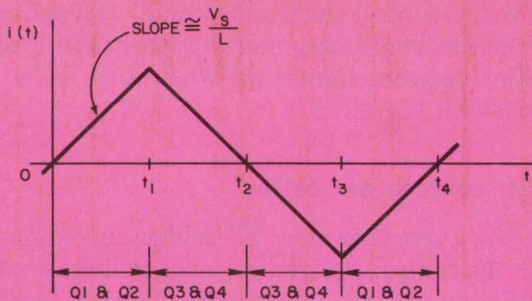

3. Instantaneous current in a servo motor is a triangular waveform whose average value is zero. Pairs of switching transistors in an SSA's power amplifier drive current to the motor through a fixed inductor to generate a triangular waveform.

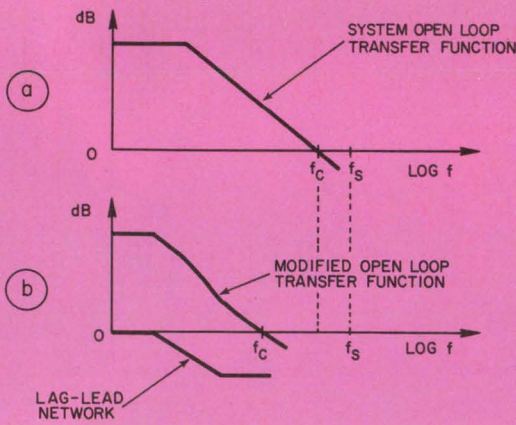

4. Servo-system performance can be modified by a compensation network. The open-loop transfer function (a) indicates an unstable system. A lag-lead network shifts f_c , the zero-dB crossover frequency, to a lower value, and restores stability to the system as shown in the modified transfer function (b).

maximum value sets the maximum current level, no matter what the input command dictates. And when the current limit is reached, the output transistors don't have to come out of saturation, which may occur with other types of current limiters.

■ Inductor L , which is required in current-drive systems, smoothes the output of the "H" bridge and provides almost pure dc to the motor (Fig. 2). A relatively large inductor (about 1 mH) prevents current spikes—and protects the output transistors. Since current in L cannot change instantaneously, the inductor buys time, in effect, to detect faults and shut the system down before currents become excessive. Servo performance is not affected by an inductor as long as the output is operated as a current source.

■ Short-circuits are protected against automatically. Current is delivered independently of load.

So great are the advantages of a current-source

output that virtually all SSAs are designed in this way. And reliability and ease of use make it a universal output stage.

But before a current-source power stage can drive a motor, your SSA must condition and control the input signals. To see how, examine the functions of the compensation network and control electronics.

System control—points to ponder

In a high-gain servo, the zero-dB axis crossing of the open-loop transfer function can occur too close to the switching frequency, f_s ; the result is an unstable system. Refer to Fig. 4a, where f_c is the zero-dB crossover frequency. Here, f_c and f_s are close together; the result is a system that does not "seem continuous." This means that the electromechanical system, due to a large f_c , responds so quickly that significant mechanical motion occurs during a cycle of f_s . But if the amplifier switches much faster than the electromechanical system can respond, no significant motion will occur during f_s , and the system will "seem continuous."

To provide for a "continuous" servo, an SSA compensates with a lag-lead network. A modified transfer function due to compensation appears as shown in Fig. 4b. Compensating the amplifier causes f_c to be less than or equal to $1/5 f_s$, so bandwidths close to f_s are avoided and the servo is made continuous.

If system bandwidth isn't at most $1/5$ the minimum switching frequency, the system will act as a sampled-data servo and introduce poles that cause instability. But switching frequency is determined by the design of the control electronics, which can be one of two types. A constant-frequency controller always drives the "H" bridge at a frequency determined by a separate oscillator. A constant-ripple controller is a self-oscillator using a hysteresis switch. Since fewer problems are encountered with constant-frequency types, they're more widely used in SSAs. But at low system speeds, they can generate large ripple currents.

Because the back-emf of a motor operating at low speed is small, the voltage across the inductor is almost equal to the supply voltage. Therefore, $di/dt = V_s/L$ produces a large ripple current that depends on system speed as shown in Fig. 5. To see how large the ripple current can be, assume that an SSA has a switching frequency of 5 kHz. The period of the switching waveform is then $200 \mu s$, and in $t/4$ or $50 \mu s$, the waveform rises from zero to its maximum current. If V_s is 75 V and the inductor is 1 mH, the rate of change of current will be

$$\frac{di}{dt} = \frac{V_s}{L} = \frac{75}{10^{-3}} = 75 \times 10^3 \text{ A/s,}$$

and

$$\Delta I = \frac{di}{dt} (\Delta t) = 75 \times 10^3 (50 \times 10^{-6}) = 3.75 \text{ A.}$$

Peak currents of 3.75 A heat the motor and serve

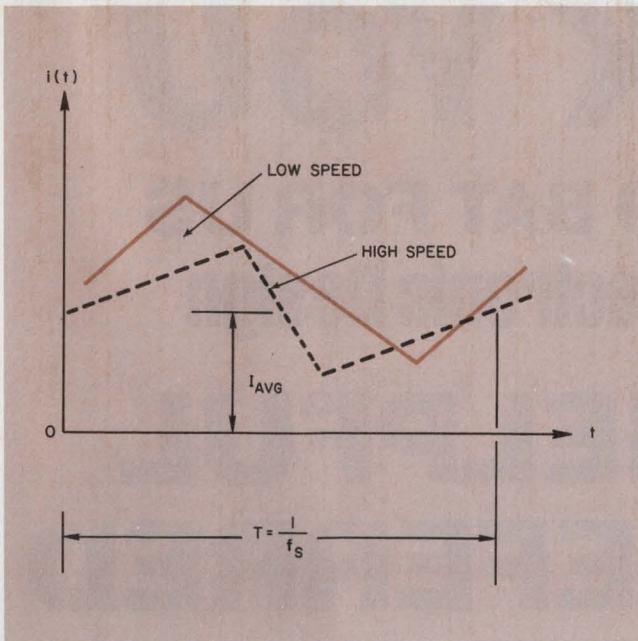

5. **Ripple current in a servo motor is a function of motor speed.** With constant frequency control, ripple current is large at low motor speeds, increasing motor heating. But current must circulate through a motor at all times to prevent a system dead zone.

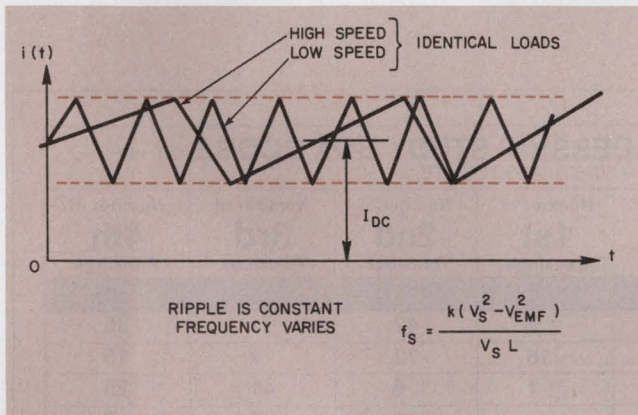

6. **Ripple is constant**, regardless of motor speed with a constant ripple controller. However, frequency variations can lead to instability in position servos.

no purpose other than to prevent a dead zone. But this problem can be overcome by constant-ripple control, which is designed to sense ripple and keep it independent of speed. Although ripple is fixed (Fig. 6), frequency varies depending on the speed of the motor, and this introduces other problems. When frequency varies, it can pass through a mechanical resonant point of the servo causing uncontrollable disturbances or loss of control. And because the switching frequency determines the upper limit of servo bandwidth, system bandwidth can vary. But as already shown, system bandwidth must be at least five times less than the minimum switching frequency for a system to be "continuous." Large frequency swings, therefore, can produce conditions that cause instability. ■■

AHAM

When you need small or large heat sinks who can solve your problems?

AHAM HEAT SINKS CAN

AHAM HEAT SINKS

27901 FRONT STREET
 RANCHO CALIFORNIA, CALIF. 92390
 (714) 676-4151 TWX (910) 332-6201

CIRCLE NUMBER 30

THANK YOU

FOR GOING TO BAT FOR US
BY VOTING **Electronic Design**

- **MOST HELPFUL**
 - **MOST PREFERRED**
- OF ANY ELECTRONICS PUBLICATION
IN THE WORLD!**

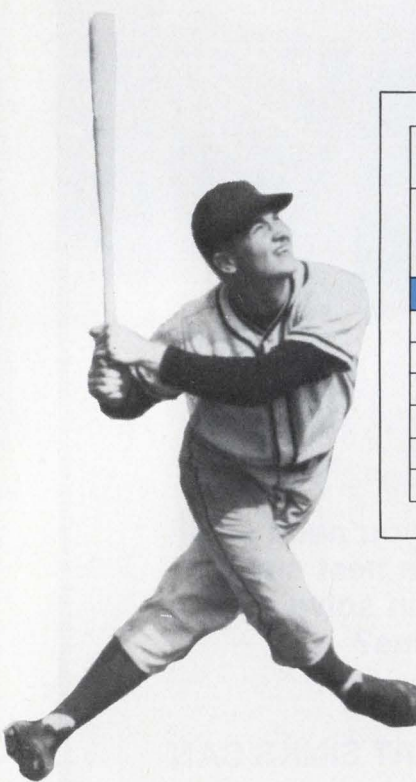

INDEPENDENT READERSHIP STUDY BOX SCORE (Oct. 1977)				
(175 STUDIES TO DATE)				
PUBLICATION	Number of 1st Rankings	Number of 2nd Rankings	Number of 3rd Rankings	Number of 4th Rankings
ELECTRONIC DESIGN	152	18	4	1
Electronics	2	42	34	35
EDN	16	72	7	15
Electronic Products Magazine	1	6	41	26
Electronic News	—	3	6	8
EET	—	3	8	23
ECN	—	—	—	2

The results are now in, and for the 18th straight year *Electronic Design* has been voted first in "Read Regularly" as well as the "Most Helpful" and "Most Preferred" electronics publication in the world.

Look at the score board. 152 "wins" for *Electronic Design*. The runner-up, *EDN*, has won 16. Some well-known electronics publications have won none at all!

Thank you for going to bat for us. It's often a bother to fill in the many readership questionnaires you must receive. We appreciate the time and trouble you take to stand up and be counted . . . to state your preference and loyalty to this magazine. We're doing everything we can to continue to deserve your support.



VARTA EXPANDS ITS LINE OF BUTTON CELLS TO GIVE YOUR DESIGN A FLYING START.

The latest addition to our line of button cells is a brand new range of rechargeable nickel-cadmium batteries — batteries that offer you a lot more design flexibility.

They incorporate a unique PK mass technology for high efficiency and improved performance, particularly at high-current rates. This higher current capacity means that VARTA nickel-cadmium rechargeable batteries make better sense than ever before.

These new button cells are a result of VARTA's policy to bring you the most advanced battery technology. And we bring them to you at very competitive prices in more than 100 countries around the world.

With more products under our wing, it's never been more important for you to know about VARTA. Write us for more information.



VARTA BATTERIES INC.

85 Executive Boulevard, Elmsford, New York 10523

CIRCLE NUMBER 32



Design power inductors step by step.

Concentrate on the power dissipated in the windings instead of iterating hard-to-determine magnetic characteristics.

When efficiency, size and cost requirements dictate power inductors for filtering, relax. There's a straightforward and exact alternative to the indirect and vague design procedures normally used. To design an efficient power choke fast, and without being bogged down in the tedious repetition of conventional iterative processes, just follow 11 steps that focus on optimizing the magnetic characteristics:

1. Determine the total current.
2. Select the core material.
3. Determine the optimum flux density and magnetic-field strength.
4. Select the minimum-sized magnet wire.
5. Determine the minimum effective volume.
6. Select the minimum-sized core.
7. Determine the number of turns.
8. Determine the air gap.
9. Check the incremental effect.
10. Determine the total power loss.
11. Determine the maximum operating temperature the inductor must withstand.

Follow this step-by-step method to determine the optimum magnetic characteristics without the usual lengthy iteration. The power dissipated in the coil's windings then becomes the major factor that limits the inductor's minimum size.

Finding the coil current

But before you can start, distinguish between the maximum incremental current, I_m , and the rated current at maximum temperature, I_r . The incremental current is the total instantaneous ac or pulse current (I_{pk}) and dc offset or bias (I_{dc}):

$$I_m = I_{pk} + I_{dc} \quad (1)$$

Since these currents together change the choke's inductance, the minimum inductance is determined by I_m .

The rated current is the total effective ac, I_{eff} , and I_{dc} :

$$I_r = I_{eff} + I_{dc} \quad (2)$$

These currents heat the inductor, so I_r determines the minimum size of the magnet wire.

Walter V. Manka, Senior Design Engineer, American Precision Industries Inc., 270 Quaker Rd., Box 130, East Aurora, NY 14052

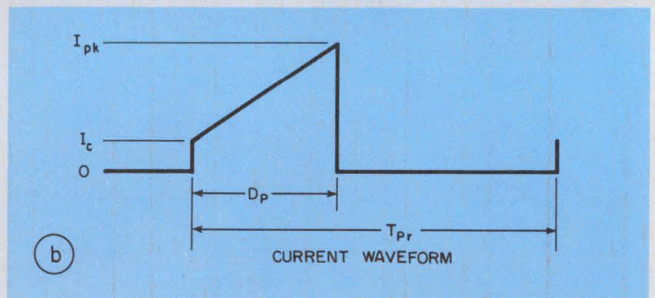
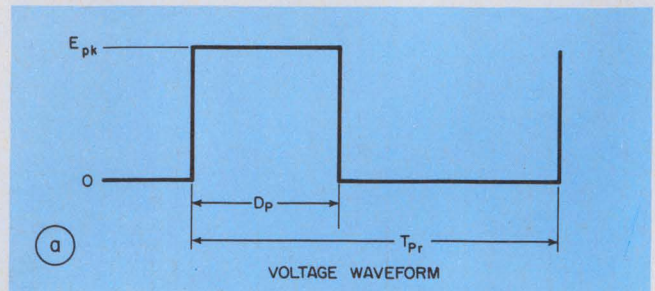

1. A trapezoid of current (a) results when a square wave of voltage (b) is impressed on an inductor. The initial jump of current, I_c , ramps up to the final value, I_{pk} , with a slope that depends on coil inductance and resistance.

With a sine wave of E_{ac} , the maximum rms voltage across the choke, I_{eff} depends on L_m , the incremental inductance at I_m , and the operating frequency, f :

$$I_{eff} = E_{ac}/2\pi f L_m \quad (3)$$

also

$$I_{pk} = \sqrt{2} I_{eff} \quad (4)$$

Be careful in assigning a value to f —it may not be the line frequency. For instance, with a 60-Hz three-phase full-wave-bridge rectifier, f is 360 Hz.

For pulse excitation of the choke, as in switching regulators, the voltage and current waveforms are shown in Fig. 1. When a choke handles pulses rather than sine waves, I_{pk} depends on the pulse excitation voltage (E_{pk}), the pulse duration (D_p), the L_m and the core-loss current (I_c), which is due to hysteresis and eddies:

$$I_{pk} = (E_{pk} D_p / L_m) + I_c \quad (5)$$

Choose the proper core and you can keep I_c less than 10% of I_{pk} :

$$I_c \leq 0.1 I_{pk} \quad (5a)$$

The pulse-repetition time, t_{pr} , comes into play for I_{eff} .

$$I_{eff} = \sqrt{D_p (I_p^2 + I_{pk} I_c + I_c^2) / 3} \quad (6)$$

Once you've determined the values for the ap-

Table 1. Average values of common core materials.

Material Designation	Freq. Range (Hz)	Temp. Range (°C)	U _i (G/Oe)	B _s (G)	B _r (G)	H _i (Oe)
Electrical Steels⁴						
Silicon Iron	20 to 1 k	-55 to +300	500	17.5 k	12 k	5.5
Silectron	20 to 10 k	-55 to +375	1.5 k	16.5 k	14 k	0.83
Alloy 48	20 to 8 k	-55 to +250	1 k	12.5 k	10 k	1.25
HY-MV 80	20 to 25 k	-55 to +230	10 k	8 k	4.4 k	0.18
Supermalloy	20 to 25 k	-55 to +230	50 k	7.3 k	4 k	0.033
Supermendur	20 to 2 k	-55 to +460	1.5 k	21 k	19 k	0.67
Molypermalloy Powders						
MPP 14 ²	400 k to 1 M	-55 to +250	14	6 k	10	214
MPP 26 ²	400 to 650 k	-55 to +230	26	6 k	10	115
MPP 60	400 to 250 k	-55 to +200	60	6 k	10	49.8
MPP 125	40 to 100 k	-55 to +200	125	6 k	200	23.2
MPP 160	40 to 70 k	-55 to +200	160	6 k	200	18.1
MPP 200	40 to 30 k	-55 to +175	200	6 k	200	14.5
MPP 300	40 to 25 k	-55 to +150	300	6 k	300	9.5
MPP 550	40 to 20 k	-55 to +125	550	6 k	650	4.86
Powdered Irons						
Carbonyl SF ²	2 to 50 M	-55 to +125	7.5	8 k	10	533
Carbonyl E ²	200 k to 10 M	-55 to +125	10	8 k	10	400
Carbonyl C ²	100 k to 2 M	-55 to +125	20	8 k	10	200
Carbonyl GQ4 ²	50 k to 1 M	-55 to +125	35	8 k	10	114
Carbonyl HA	1 to 100 k	-55 to +105	60	8 k	2200	48.3
75 Powder	400 to 50 k	-55 to +105	75	8 k	2200	38.7
90 Powder	400 to 10 k	-55 to +105	90	8 k	2200	32.2
Ferrites³						
F40	10 to 80 M	-55 to +250	40	2400	750	20.6
F125	200 k to 10 M	-55 to +250	125	2350	1200	4.6
F175	100 k to 5 M	-55 to +230	175	2550	1400	3.28
F250	50 k to 4 M	-55 to +200	250	2200	1100	2.2
F400	10 k to 2.5 M	-55 to +175	400	2700	1100	2
F750	1 k to 1.5 M	-55 to +125	750	4000	1800	1.47
F1000	1 k to 1 M	-55 to +125	1000	4200	1700	1.25
F1500	1 k to 650 k	-55 to +125	1500	4000	1100	0.97
F2000	400 to 500 k	-55 to +125	2000	4400	1500	0.72
F2300	400 to 300 k	-40 to +105	2300	4000	1200	0.61
F2700	400 to 250 k	-30 to +105	2700	4700	2000	0.50
F5000	400 to 100 k	-25 to +105	5000	4300	1200	0.31
F10000	400 to 80 k	-25 to +90	10000	4300	1200	0.16

Notes:

(1) For specific data and tolerances, refer to individual suppliers. (2) Excessive heating occurs before incremental effects are observed. (3) There are no standard designations for equivalent materials between ferrite suppliers. Designation used is for convenience. (4) Frequency range of electrical steel depends on material thickness. The thinner the material, the higher the frequency range.

Glossary of inductor terms

Symbol	Terminology	Units
A_c	Cross-sectional area of the core	cm ²
A_{Lo}	Initial-inductance index	H/turn ²
A_{Lm}	Incremental-inductance index	H/turn ²
A_s	Total surface area	cm ²
B	Maximum operating-flux density	G
B_r	Residual-flux density	G
B_s	Saturation-flux density	G
C_v	Core loss per unit volume	W/cm ³
C_{vf}	Core-loss factor	W/cm ³ /Hz
d_i	Insulated-wire diameter	in.
d_o	Bare-wire diameter	in.
D_p	Pulse duration	s
E_{ac}	Ac-excitation voltage	rms V
E_{pk}	Pulse-excitation voltage	pk V
f	Design operating frequency	Hz
G_t	Thermal conductance	W/°C
H	Maximum operating magnetic-field strength	Oe
H_i	Intrinsic magnetic-field strength	Oe
I_c	Core-loss current	A
I_{dc}	Dc current (offset or bias)	A
I_{eff}	Effective current	A
I_f	Fusing current	A
I_m	Maximum incremental current	A
I_{pk}	Pulse current	A
I_r	Rated current at max temperature	A
I_{ro}	Rated current at room temperature	A
k	Winding-utilization factor	---
L	Inductance	H
L_c	Magnetic-path length of the core	cm
l_e	Effective magnetic-path length	cm
l_g	Total air-gap length	cm
L_m	Incremental inductance at I_m	H
l_{tm}	Mean length per turn	ft
L_o	Initial inductance	H
N	Total turns	turns
p	Dc resistance per unit length	Ω/ft
P_c	Core loss	W
P_t	Total power	W
P_w	Winding loss	W
r	Thermal coefficient of resistance	Ω/Ω/°C
R_{dc}	Dc winding resistance	Ω
S_d	Surface dissipation	W/cm ² /°C
T_a	Ambient temperature	°C
T_m	Maximum operating temperature	°C
T_o	Reference temperature	°C
T_{pr}	Pulse-repetition time	s
T_r	Temperature rise	°C
t_{pi}^2	Winding density	turns/in. ²
U_e	Effective permeability	G/Oe
U_i	Initial permeability	G/Oe
U_m	Incremental permeability	G/Oe
V_e	Effective volume	cm ³
V_{em}	Minimum effective volume	cm ³
V_c	Actual core volume	cm ³
W_a	Winding cross-sectional area	cm ³

appropriate coil currents, you can select a core material from the hundreds of magnetic materials available. Table 1 lists a representative cross-section of several popular core materials.

To pick the right core material, you need to know the required f , maximum operating temperature, T_m , core properties you need, cost, geometry and winding limitations, among other things. But whenever possible, and especially for switching regulators, use gapped-ferrite cores.

The core loss per unit volume, C_v , depends on the core-loss factor:

$$C_v = C_{vf} f \quad (7)$$

The crux of this entire procedure is that it determines explicitly—without iteration—optimum values for maximum operating flux density, B , and maximum operating magnetic-field strength, H , for the selected core material. Empirical analysis has shown that incremental effects begin approximately when the intrinsic magnetic-field strength, H_i , equals the saturation-flux density, B_s , minus the residual-flux density, B_r , all divided by twice the initial permeability, U_i , or

$$H_i = (B_s - B_r) / 2U_i \quad (8)$$

Thus, for inductors passing substantial dc, you must lower the maximum operating flux density to the differential flux density, $B_s - B_r$, rather than just B_s :

$$B = B_s - B_r \quad (9)$$

Maximum operating field strength depends not only on B , but also on incremental permeability, U_m :

$$U_m = U_i L_m / L_o \quad (10)$$

where L_o is the choke's initial low-level ac value of inductance with no dc, and L_m is the desired inductance value at I_m .

Now you can find H :

$$H = B / U_m \quad (11)$$

Because of the large variations in the permeabilities of many magnetic materials, especially the electrical steels, specify U_i at no more than 40 G. And expect variations in U_i , B_s and B_r at high temperatures.

Minimizing magnet-wire size

Having found values for B and H , you can figure out the thinnest magnet wire that you can use.

The size of the magnet wire is limited by its current rating, I_r . However, the usual current rating for copper wire doesn't apply to inductors. Ratings based on a current density of 1000 circular mils/A—the loading that causes a 2% voltage drop per 100 ft of standard house wiring—aren't realistic.

Instead current ratings for industrial and military inductors are based on a more practical consideration—maximum temperature rise. Since these ratings range typically from 5 to 20% of the wire's fusing current, rating the inductor wire at 10% of its fusing current is realistic, not to mention convenient for calculation. This rating applies at T_m .

At 20 C, the fusing current for bare-copper magnet wire of diameter d_o is found by

Table 2. Magnet Wire Design Data.

AWG Size	Bare Wire				Single Film					Double Film				
	Max OD	Max I	Max Tensile Strength	Ω/ft	Max OD	ft/lb	Ω/lb	Tpi	Tpi ²	Max OD	ft/lb	Ω/lb	Tpi	Tpi ²
10	0.1024	33.6	82.4	0.00100	0.1047	31.6	0.0316	9.551	91.22	0.1061	31.5	0.0315	9.425	88.83
11	0.0912	28.2	65.3	0.00126	0.0935	39.8	0.0501	10.70	114.4	0.0948	39.7	0.0500	10.55	111.3
12	0.0812	23.7	51.8	0.00159	0.0834	50.3	0.0800	11.99	143.8	0.0847	50.0	0.0795	11.81	139.4
13	0.0724	19.9	41.2	0.00200	0.0746	63.3	0.1266	13.40	179.7	0.0757	62.9	0.1258	13.21	174.5
14	0.0644	16.7	32.6	0.00252	0.0666	79.9	0.2013	15.02	225.5	0.0682	79.3	0.1998	14.66	215.0
15	0.0574	14.1	25.9	0.00318	0.0594	101	0.3212	16.84	283.4	0.0609	100	0.3180	16.42	269.6
16	0.0511	11.8	20.5	0.00402	0.0531	127	0.5105	18.83	354.7	0.0545	126	0.5065	18.35	336.7
17	0.0455	9.94	16.3	0.00505	0.0475	159	0.8029	21.05	443.2	0.0488	158	0.7979	20.49	419.9
18	0.0405	8.35	12.9	0.00639	0.0424	201	1.284	23.58	556.2	0.0437	199	1.272	22.88	523.6
19	0.0361	7.02	10.2	0.00805	0.0379	253	2.037	26.39	696.2	0.0391	251	2.020	25.58	654.1
20	0.0322	5.92	8.14	0.0101	0.0339	318	3.212	29.50	870.2	0.0351	315	3.182	28.49	811.7
21	0.0286	4.95	6.42	0.0128	0.0303	402	5.146	33.00	1089	0.0314	397	5.082	31.85	1014
22	0.0254	4.15	5.07	0.0162	0.0270	508	8.230	37.04	1372	0.0281	503	8.149	35.59	1266
23	0.0227	3.50	4.05	0.0203	0.0243	633	12.85	41.15	1694	0.0253	625	12.69	39.53	1562
24	0.0202	2.94	3.20	0.0257	0.0217	806	20.71	46.08	2124	0.0227	794	20.41	44.05	1941
25	0.0180	2.47	2.54	0.0324	0.0194	1013	32.82	51.55	2657	0.0203	990	32.08	49.26	2427
26	0.0160	2.07	2.01	0.0410	0.0173	1282	52.56	57.80	3341	0.0182	1260	51.66	54.95	3019
27	0.0143	1.75	1.61	0.0514	0.0156	1608	82.65	64.10	4109	0.0164	1580	81.21	60.98	3718
28	0.0127	1.47	1.27	0.0653	0.0140	2033	132.8	71.43	5102	0.0147	1990	129.9	68.03	4628
29	0.0114	1.25	1.02	0.0812	0.0126	2525	205.0	79.37	6299	0.0133	2470	200.6	75.19	5653
30	0.0101	1.04	0.801	0.104	0.0112	3215	334.4	89.29	7972	0.0119	3140	326.6	84.03	7062
31	0.0090	0.874	0.636	0.131	0.0100	4065	532.5	100.0	10000	0.0108	3950	517.4	92.59	8573
32	0.0081	0.747	0.515	0.162	0.0091	5000	810.0	109.9	12076	0.0098	4880	790.6	102.0	10412
33	0.0072	0.626	0.407	0.206	0.0081	6369	1312	123.5	15242	0.0088	6170	1271	113.6	12913
34	0.0064	0.524	0.322	0.261	0.0072	8064	2105	138.9	19290	0.0078	7870	2054	128.2	16437
35	0.0057	0.441	0.255	0.331	0.0064	10210	3380	156.2	24414	0.0070	9940	3290	142.9	20408
36	0.0051	0.373	0.204	0.415	0.0058	12760	5295	172.4	29727	0.0063	12440	5163	158.7	25195
37	0.0046	0.319	0.166	0.512	0.0052	15800	8090	192.3	36982	0.0057	15300	7834	175.4	30779
38	0.0041	0.269	0.132	0.648	0.0047	19920	12908	212.8	45269	0.0051	19300	12506	196.1	38447
39	0.0036	0.221	0.101	0.847	0.0041	26040	22056	243.9	59488	0.0045	25100	21260	222.2	49383
40	0.0032	0.185	0.0804	1.08	0.0037	33110	35759	270.3	73046	0.0040	32200	34776	250.0	62500
41	0.0029	0.160	0.0661	1.32	0.0033	40100	52932	303.0	91827	0.0036	39500	52140	277.8	77160
42	0.0026	0.136	0.0531	1.66	0.0030	51000	84660	333.3	111111	0.0032	49800	82668	312.5	97656
43	0.023	0.113	0.0475	2.14	0.0026	65800	140.8k	384.6	147928	0.0029	63700	136.3k	344.8	118906
44	0.0021	0.0985	0.0346	2.59	0.0024	79400	205.6k	416.7	173611	0.0027	76300	197.6k	370.4	137174
45	0.00176	0.0756	0.0243	3.62	0.00205	104k	376.5k	487.8	237954	0.00230	99600	360.6k	434.8	189036
46	0.00157	0.0637	0.0194	4.54	0.00185	132k	599.3k	540.5	292184	0.00210	126k	572.0k	476.2	226757
47	0.00140	0.0536	0.0154	5.71	0.00170	162k	925.0k	588.2	346020	0.00190	153k	873.6k	526.3	277003
48	0.00124	0.0447	0.0121	7.29	0.00150	205k	1.494M	666.6	444444	0.00170	199k	1.451M	588.2	346020
49	0.00111	0.0379	0.0097	9.09	0.00130	258k	2.345M	769.2	591716	0.00150	252k	2.291M	666.6	444444
50	0.00099	0.0319	0.0077	11.4	0.00120	312k	3.557M	833.3	694444	0.00140	306k	3.488M	714.3	510204
51	0.00088	0.0267	0.0061	14.5	0.00110	416k	6.032M	909.1	826446					
52	0.00078	0.0223	0.0048	18.4	0.00100	555k	10.21M	1000	1.000M					
53	0.00070	0.0190	0.0038	22.9	0.00085	667k	15.27M	1176	1.384M					
54	0.00062	0.0158	0.0030	29.1	0.00075	859k	25.00M	1333	1.777M					
55	0.00055	0.0132	0.0024	37.0	0.00070	1.090M	40.33M	1429	2.041M					
56	0.00049	0.0111	0.0019	46.6	0.00065	1.380M	64.31M	1538	2.367M					
Units	Inches	Amperes	Pounds	Ω/ft	Inches	ft/lb	Ω/lb	Tpi	Tpi ²	Inches	ft/lb	Ω/lb	Tpi	Tpi ²

Maximum ODs, Ω/ft and ft/lb are taken from Materials and Processes Handbook. Maximum rated current is 10% of the fusing current at 20°C. Maximum tension is based upon a tensile strength of 10.00 PSI. Ω/lb is derived from $(\Omega/\text{ft}) \times (\text{ft}/\text{lb})$. Tpi = $1/\text{Max OD}$. Tpi² = $(1/\text{Max OD})^2$.

$$I_f = 10,244 d_o^3 \quad (12)$$

As a result, the current rating at 20 C is

$$I_{r0} = 0.1 I_f, \quad (13)$$

Furthermore, for a required I_r , the magnet wire's minimum current rating at 20 C must be

$$I_{r0} = I_r [1 + 0.00393 (T_m - 20)] \quad (14)$$

Current ratings for copper magnet wire, based on Eq. 13, are tabulated in Table 2 along with other selected magnet-wire design data.

Finding the effective volume

Using your values for B and H, determine the minimum effective volume, V_{em} , that will sustain your inductor's operating conditions.

$$V_{em} = 0.4\pi \times 10^8 L_m I_m^2 / (B H). \quad (15)$$

For ungapped cores like toroids, the actual core volume must equal or exceed V_{em} . But meeting this requirement may make the core size excessive. Fortunately, however, an air gap in the magnetic circuit can reduce core size significantly. If the air-gap length, l_g , is small with respect to the effective magnetic-path length, l_e , the equivalent effective volume, V_e , is:

$$\begin{aligned} V_e &= A_c l_e \\ &= A_c (l_c + U_i l_g) \\ &= V_c + (A_c U_i l_g), \end{aligned} \quad (16)$$

where l_e is the magnetic path length of the core, A_c is the core's cross-sectional area and V_c is the actual volume.

To get the L_m when you select the core gap ensure

$$V_e \geq V_{em}. \quad (17)$$

Armed with the minimum effective core volume, select the smallest core that can sustain the required inductance. With the help of core-size indexes pick a core from magnetic-core catalogs. They also provide data for the winding area, W_a , and for A_c that you can use in

$$W_a A_c = 5.067 \times 10^8 L_m I_m d_i^2 / (k B). \quad (18)$$

Here d_i is the diameter of the insulated-wire (double-film insulation is recommended), and k is the winding-utilization, or "fit," factor. For toroidal windings, k is typically 0.4; for bobbin windings, 0.8.

The core must satisfy Eqs. 15 and 18. Often, the core's geometry is severely limited by mounting space and dc winding resistance, R_{dc} . (Other factors that affect core geometry are compared in Table 3.)

Even slug-type inductors can be designed with this step-by-step procedure, but you must empirically determine l_g and V_e for slugs.

Now that you know the material, size and geometry of the core, you can calculate the maximum value of the incremental inductance index, A_{Lm} , from

$$A_{Lm} = (B A_c)^2 \times 10^{-16} / (L_m I_m^2). \quad (19)$$

Then with A_{Lm} , compute the number of turns, N , required for the L_m you need:

$$N = \sqrt{L_m / A_{Lm}} \quad (20)$$

Take N and H , and determine l_e :

$$l_e = 0.4\pi N I_m / H. \quad (21)$$

For cores without air gaps, such as toroids, make sure that

Table 3. Core-geometry selection criteria.

Selection Factor	E-U-I Cores	Pot Cores	Toroid Cores	Slug Cores	Other Shielded Cores
Core Cost	Low	High	Low	Low	High
Winding Cost	Low	Low	High	Low	Low
Winding Flexibility	Excellent	Fair	Good	Good	Fair
Mounting Flexibility	Good	Good	Fair	Fair	Good
Shielding	Fair	Excellent	Good	Poor	Good

$$l_c \geq l_e. \quad (22)$$

For cores with air gaps, compute the air-gap length from

$$l_g = (l_e - l_c) / U_i. \quad (23)$$

Now you can find the effective permeability:

$$U_e = U_i / [1 + (U_i l_g / l_c)]. \quad (24)$$

For core geometries in which an air gap interrupts the magnetic circuit twice, the inserted material thickness should be half that computed in Eq. 23.

The air gap affects the initial-inductance index, A_{L0} , as follows:

$$A_{L0} = 0.4\pi \times 10^{-8} A_c / [(l_c / U_i) + l_g]. \quad (25)$$

Calculate the initial inductance, L_0 , from

$$L_0 = A_{L0} N^2. \quad (26)$$

Next, compute the percent change in inductance L

$$\%L = [(L_m / L_0) - 1] 100. \quad (27)$$

Don't let the inductance change more than 25%. Next, compute P_t , the total power dissipated by the complete inductor—both the winding and the core. First determine the power dissipated in the windings, P_w .

The d_i used for the magnet wire when finding the minimum-sized core is the minimum for the I_r . However, the W_a of the actual core may be able to accept a wire with a large diameter and thereby lower the windings' power loss. The maximum diameter for the insulated wire is related to the winding density in turns per inch, t_{pi}^2 , by

$$d_i = \sqrt{1 / t_{pi}^2}. \quad (28)$$

The winding density must conform to

$$t_{pi}^2 = 6.452 N / (k W_a). \quad (29)$$

Select a wire with the best size for lowest dc resistance per unit length, p . The dc winding resistance, for a particular mean length per turn, l_{tm} , is found with

$$R_{dc} = N l_{tm} p. \quad (30)$$

Compute P_w , using R_{dc} , the reference temperature T_0 , the wire's thermal coefficient of resistance (r), and the T_m and I_r :

$$P_w = I_r^2 R_{dc} [1 + r (T_m - T_0)]. \quad (31)$$

If T_0 is 20 C, r is 0.00393; if T_0 is 25 C, r is 0.00385.

Now, determine the core loss, P_c , from the data for

core loss per unit volume, C_v , which most core manufacturers either graph or tabulate. If necessary, you can extrapolate the value of C_v for your conditions:

$$P_c = C_v V_c \quad (32)$$

Finally, the total power dissipated by the inductor

$$P_t = P_w + P_c \quad (33)$$

Of course, since you haven't built your inductor yet you can only estimate its maximum operating temperature. Surface dissipation, S_d , is the wide-ranging variable that makes determining the T_m fuzzy. The many material variations plus nonuniformity in construction and processing can significantly alter S_d . But, you can at least calculate a value for S_d that is close enough for a first-order estimate.

Find S_d at the ambient temperature, T_a , by

$$S_d = 0.0014 + 1.217 \times 10^{-6} T_a^{1.585} \quad (34)$$

With the total surface area, A_s , and S_d , approximate thermal conductance:

$$G_t = A_s S_d \quad (35)$$

Then the temperature rise:

$$T_r = P_t / G_t \quad (36)$$

and finally the crucial variable, T_m :

$$T_m = T_a + T_r \quad (37)$$

If you find the T_m gets too high, reduce it by increasing A_s , R_{dc} , or both.

Putting the steps all together

To see how all the equations work together, consider an inductor meeting the following requirements:

- $L_o = 5.6$ mH at 0-Adc.
- $L_m = 4.7$ mH minimum at 1.4-A pk and 20 kHz with a 34% duty cycle.
- $T_r = 60$ C maximum at 20 C ambient, therefore $T_m = 80$ C.
- $I_{dc} = 0$.
- The inductor must be mountable on a PC board and shielded.
- The inductor must be small.

Step 1: Determine the total current. Because I_{dc} is zero, from Eq. 1,

$$I_m = 1.4 + 0 \\ = 1.4 \text{ A}$$

For a 34% duty cycle at 20 kHz,

$$t_{pr} = 1/20 \times 10^3 \\ = 5 \times 10^{-5} \text{ s,}$$

and

$$P_d = 0.34 \times 5 \times 10^{-5} \\ = 1.7 \times 10^{-5} \text{ s.}$$

Assuming that I_c is 10% of I_m ,

$$I_c = 0.1 \times 1.4 \\ = 0.14 \text{ A.}$$

Although not specified in this design, E_{pk} is always of interest, so from Eq. 5,

$$E_{pk} = (1.4 - 0.14) 4.7 \times 10^{-3} / (1.7 \times 10^{-5}) \\ = 348 \text{ V pk.}$$

From Eq. 6,

$$I_{eff} = \sqrt{\frac{1.7 \times 10^{-5} [1.4^2 + (1.4 \times 0.14) + 0.14^2]}{3 \times 5 \times 10^{-5}}} \\ = 0.497 \text{ A.}$$

And from Eq. 2,

$$I_r = 0.497 + 0 \\ = 0.497 \text{ A.}$$

Step 2: Select the core material. Choose F2000 ferrite for the core material because, as you can see from Table 1, it has the greatest operating flux density. From the table,

$$B_s = 4400 \text{ G.}$$

$$B_r = 1500 \text{ G.}$$

And from Table 2,

$$U_i = 2000 \text{ G.}$$

$$T_m = +125 \text{ C.}$$

From the supplier's data, at 2900 G and 20 kHz,

$$C_{vf} = 12 \mu\text{W/cm}^3/\text{Hz.}$$

Therefore, from Eq. 7,

$$C_v = 12 \times 10^{-6} \times 20 \times 10^3 \\ = 0.24 \text{ W/cm}^3$$

Step 3: Determine the optimum B and H. From Eq. 9,

$$B = 4400 - 1500 \\ = 2900 \text{ G.}$$

From Eq. 10,

$$U_m = 2000 \times 4.7 \times 10^{-3} / 5.6 \times 10^{-3} \\ = 1679 \text{ G/Oe.}$$

From Eq. 11,

$$H = 2900/1679 \\ = 1.73 \text{ Oe.}$$

Step 4: Select the minimum-sized magnet wire.

With an 80-C value for T_m in Eq. 14,

$$I_{ro} = 0.497 [1 + 0.00393 (80 - 20)] \\ = 0.614 \text{ A.}$$

From the data in Table 3, the thinnest wire that can accommodate I_{ro} is AWG 33, whose

$$p = 0.206 \Omega/\text{ft,}$$

and

$$d_i = 0.0088 \text{ in.}$$

Step 5: Determine the minimum effective volume.

From Eq. 15,

$$V_{em} = 0.4\pi \times 10^8 \times 4.7 \times 10^{-3} \times 1.4^2 / (2900 \times 1.73) \\ = 231 \text{ cm}^3.$$

To provide this effective volume, an upgapped core would have to fill a 6.13-cm cube—much too large for mounting on a PC board. Use a gapped core instead; and since shielding is required, make it a pot core.

Step 6: Select the minimum-sized core. From Eq. 18,

$$W_a A_c = \frac{5.067 \times 10^8 \times 4.7 \times 10^{-3} \times 1.4 \times 0.0088^2}{0.8 \times 2900} \\ = 0.1113 \text{ cm}^4.$$

A search through core catalogs reveals the smallest standard pot core that you can use is 22 × 13 mm. For this core

$$A_c = 0.63 \text{ cm}^2$$

and

$$W_a = 0.292 \text{ cm}^2.$$

Therefore,

$$W_a A_c = 0.292 \times 0.63 \\ = 0.1840 \text{ cm}^4,$$

which is, of course, large enough. From the catalogs, you get the following additional core data:

$$\begin{aligned}l_c &= 3.15 \text{ cm.} \\V_c &= 2 \text{ cm.} \\A_s &= 18.02 \text{ cm}^2. \\W_o &= 0.0453 \text{ in.} \\l_{tm} &= 0.145 \text{ ft.}\end{aligned}$$

Step 7: Determine the number of turns. From Eq. 19,

$$A_{Lm} = (2900 \times 0.63)^2 \times 10^{-16} / (4.7 \times 10^{-3} \times 1.4^2) = 3.623 \times 10^{-8} \text{ H/turns}^2.$$

Then from Eq. 20

$$\begin{aligned}N &= \sqrt{4.7 \times 10^{-3} / (3.623 \times 10^{-8})} \\&= 360 \text{ turns}\end{aligned}$$

Step 8: Determine the air gap size. From Eq. 21,

$$\begin{aligned}l_e &= 0.4\pi \times 360 \times 1.4 / 1.73 \\&= 366 \text{ cm}\end{aligned}$$

Then, from Eq. 23,

$$\begin{aligned}l_g &= (366 - 3.15) / 2000 \\&= 0.182 \text{ cm} \\&= 0.072 \text{ in.}\end{aligned}$$

The air gap interrupts the magnetic circuit twice, so the spacer should be 0.036 in. thick—half the computed value of l_g .

Check V_e in Eq. 16:

$$\begin{aligned}V_e &= 2 + (0.63 \times 2000 \times 0.182) \\&= 231 \text{ cm}^3.\end{aligned}$$

Therefore, V_e complies with the V_{em} required by Eq. 17.

Step 9: Determine the incremental effect. From Eq. 25,

$$\begin{aligned}A_{LO} &= 0.4\pi \times 10^{-8} \times 0.63 / [(3.15/2000) + 0.182] \\&= 4.31 \times 10^{-8} \text{ H/turn.}\end{aligned}$$

Then, from Eq. 26,

$$\begin{aligned}L_o &= 4.31 \times 10^{-8} \times 360^2 \\&= 5.59 \text{ mH,}\end{aligned}$$

which is close enough to the required 5.6 mH. If L_o isn't close enough, change the turns ratio appropriately—a simple process using Eq. 26.

Step 10: Determine the total power loss. From Eq. 29,

$$\begin{aligned}\text{tpi}^2 &= 360 / (0.8 \times 0.0453) \\&= 9934 \text{ turns/in.}^2\end{aligned}$$

From the wire data in Table 2, you can use AWG 32 heavy-film wire instead of AWG 33. Then,

$$p = 0.162 \text{ } \Omega/\text{ft.}$$

From Eq. 30,

$$\begin{aligned}R_{dc} &= 360 \times 0.145 \times 0.162 \\&= 8.46.\end{aligned}$$

From Eq. 31,

$$\begin{aligned}P_w &= 0.497^2 \times 8.46 [1 + 0.00393 (80 - 20)] \\&= 2.54 \text{ W.}\end{aligned}$$

From Eq. 32,

$$\begin{aligned}P_c &= 0.24 \times 2 \\&= 0.48 \text{ W.}\end{aligned}$$

Note that the core loss is much smaller than the winding loss. From Eq. 33,

$$\begin{aligned}P_t &= 0.48 + 2.54 \\&= 3.02 \text{ W.}\end{aligned}$$

Step 11: Determine the maximum temperature.

From Eq. 34,

$$\begin{aligned}S_d &= 0.0014 + 1.2717 \times 10^{-6} \times 25^{1.585} \\&= 0.0016 \text{ W/cm}^2/\text{ }^\circ\text{C.}\end{aligned}$$

From Eq. 35,

$$\begin{aligned}G_t &= 0.0016 \times 18.02 \\&= 0.02883 \text{ W/ }^\circ\text{C.}\end{aligned}$$

From Eq. 36,

$$\begin{aligned}T_r &= 3.02 / 0.02883 \\&= 105 \text{ C.}\end{aligned}$$

From Eq. 37,

$$\begin{aligned}T_m &= 20 + 105 \\&= 125 \text{ C.}\end{aligned}$$

This value of T_m is too high. The open construction of the proposed inductor doesn't have enough surface to limit T_r to 60 C max. From Eq. 36, the minimum thermal conductance required is

$$\begin{aligned}G_t &= 3.02 / 60 \\&= 0.0503 \text{ W/ }^\circ\text{C}\end{aligned}$$

Therefore, from Eq. 35, the minimum A_s required is

$$\begin{aligned}A_s &= 0.0503 / 0.0016 \\&= 31.43 \text{ cm}^2.\end{aligned}$$

The maximum diameter and height of the pot core are 0.866 inches and 0.536 inches, respectively. So you should be able to encapsulate it, with thermally conductive epoxy, in a round or rectangular plastic shell. The nearest suitably sized round shell has an outside diameter of 1.187 inches, a height of 0.75 inches, and a thickness of 0.03 inches. Therefore,

$$\begin{aligned}A_s &= 5.01 \text{ in.}^2 \\&= 32.32 \text{ cm}^2.\end{aligned}$$

Combining Eqs. 35, 36 and 37,

$$\begin{aligned}T_m &= 20 + 3.02 / 0.0016 \times 32.32 \\&= 20 + 58 \\&= 78 \text{ C,}\end{aligned}$$

which meets the required design goal. ■■

Bibliography

- Cut Cores Catalog MCC-100, Magnetics Inc., Butler, PA, 1976.
- Design Manual for Tape Wound Cores TWC-300, Magnetics Inc., 1976.
- Ferrite Core Catalog, Fair-Rite Products Corp., Wallkill, NY, 1975.
- Ferrite Core Catalog, Krystinel Corp., Port Chester, NY, 1975.
- Ferrite Core Catalog FC-305 12F, Magnetics, Inc., 1976.
- Ferrite Core Catalog, Stackpole Carbon Co., St. Mary's, PA, 1975.
- Grossner, N. R., *Transformers for Electronic Circuits*, McGraw-Hill, New York, NY, 1970.
- Linear Ferrite Magnetic Design Manual, Ferroxcube Corp., Saugerties, NY, 1976.
- Linear Ferrite Materials and Components Catalog, Ferroxcube Corp., 1976.
- Magnetic Laminations Catalog ML-303T, Magnetics Inc., 1976.
- Molypermalloy Powder Cores Catalog MPP-303S, Magnetics Inc., 1976.
- Polydoroff W. J., *High Frequency Magnetic Materials*, John Wiley & Sons, New York, NY, 1960.
- Powdered Iron Core Catalog, Arnold Engineering Co., Marengo, IL, 1972.
- Powdered Iron Core Catalog, Micrometals Co., City of Industry, CA, 1974.
- Powdered Iron Core Catalog, Pyroferic Inc., Bronx, NY, 1975.

'SWITCHER' OUTPUT FILTER CAPACITORS THAT REALLY PUT OUT

If you're working with switching-type power supplies, you'll want to know about new electrolytic capacitors featuring low equivalent series resistance (for example, 3 m Ω @ 57,000 μ F/7.5V) and low internal inductance. Type 622D EXTRALYTIC[®] Capacitors are the first of their type to meet the power supply designer's need to know, for worst case design, the maximum and minimum ESR of a capacitor, as well as the need to hold the nominal ESR to a tolerance of \pm 30% at 20 kHz. To simplify calculations for the



equipment designer, Type 622D capacitors have a symmetrical capacitance tolerance of a tight \pm 20% instead of the wide asymmetrical tolerance customarily associated with low-voltage electrolytic capacitors. These new capacitors are designed for operation over the wide temperature range of -55°C to $+85^{\circ}\text{C}$. They are furnished in a $1\frac{3}{8}$ " diameter case with lengths ranging from $2\frac{1}{8}$ " to $5\frac{5}{8}$ ". Capacitance values from 2,800 to 67,000 μ F are available as standard, and voltage ratings range from 5 to 55 WVDC.

For complete technical data, write for Engineering Bulletin 3459 to: Technical Literature Service, Sprague Electric Company, 347 Marshall Street, North Adams, Mass. 01247.

THE BROAD-LINE PRODUCER OF ELECTRONIC PARTS



a
**General
Cable**
subsidiary

Consider mask-programmable arrays

instead of custom-designed circuits. Arrays offer the flexibility of custom circuits with almost 'stock' delivery times.

When the design you're working on calls for a custom circuit, but you can't tolerate a six to 12-month design turnaround or a large cost, try an uncommitted array and get a custom part for almost standard prices. Available with either digital or linear formats, an uncommitted array becomes a price and performance alternative to a custom circuit since just a final metallization layer must be deposited to interconnect the prediffused transistors, gates, and passive components.

Developing a "from the ground up" custom design can cost about \$50,000 on up, depending on the complexity of the IC. Development and processing can take anywhere from six months to well over a year. With a mask-programmable array, however, your development time can be cut to several weeks—the time it takes to generate the metal masks from an interconnection diagram. Moreover, you can keep development to about \$10,000—and get prototypes in six to eight weeks.

Of course, the development dollars that an array vendor puts into an uncommitted device array must be repaid somehow, so you will end up paying his costs in the form of higher chip prices than those charged by a custom IC manufacturer. The custom IC vendor does all the development from the ground up, thus shaving chip costs to the bone by keeping the silicon area of the die to a minimum.

But you can't really compare total design costs without knowing how many devices using arrays will be produced. In fact since production cost per unit for a purely custom device will drop more rapidly than the cost of an uncommitted array, any economic decision you make depends almost entirely on the number of chips to be purchased.

For 10,000 and under, uncommitted arrays are usually more favorable, while for more than 10,000 a totally custom circuit usually looks more attractive. Table 1 shows how the two alternatives compare when 10,000 units are purchased yearly, and the development costs for a similar circuit are estimated at \$50,000 and \$10,000 for the custom and uncommitted circuits, respectively.

Although uncommitted arrays look good for low

Frank Deverse, President, International Microcircuits, 3004 Lawrence Expressway, Santa Clara, CA 95051.

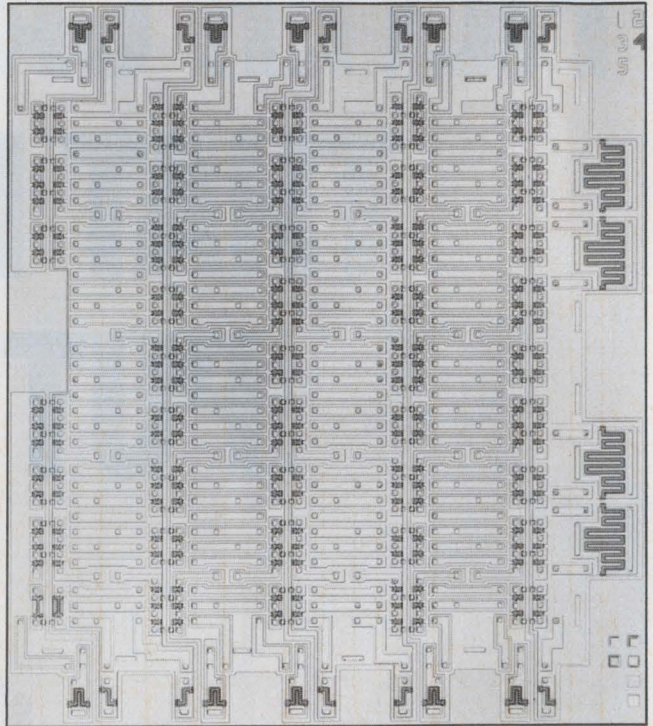

Typical of uncommitted digital arrays, this MasterMOS Model S chip contains 106 p-channel and 106 n-channel transistors, 10 medium-power buffers, four large n-channel devices with high-current capability, and one p-channel and one n-channel high-impedance device. The chip is 65 × 74 mils, with pads of 4 × 4 mils.

volumes, less than a dozen companies offer mask-programmable units (Table 2). The differences in these arrays are essentially the differences between the semiconductor processes they are made from. For example, if you're looking for a CMOS array, you can go only to about three companies—and you will find little, if any, differences between the arrays.

Check the process and performance

How many processing steps are required to produce finished devices also depends on technology. CMOS wafers require only one step—etching the aluminum interconnects—while other technologies require two or more steps.

Of course, you'll have to make some performance compromises between the mask-programmed arrays and custom-designed circuits. CMOS arrays, for in-

stance, operate in the 1 to 4-MHz region and require several microwatts of power. True custom devices typically can perform at slightly higher frequencies and at lower power levels.

In addition, since most available arrays are pointed toward digital applications, most wafers are made with many small circuit elements or gates. The small elements are not suited for linear applications, and another array must often be used when designing linear devices (some typical array specs for the CMOS digital version are listed in Table 3).

Still, designing with an uncommitted array is fairly simple, since all the transistors are already placed on the wafer. All you have to worry about is designing the logic of the functions to be implemented on the

chip. Then, working with an array manufacturer, you figure out the interconnections needed on the chip.

Divide the procedure into steps

Although the design procedure will vary slightly from one company to the next, depending on the technology, the CMOS arrays from International Microcircuits can be designed by following six simple sequential steps:

1. Define circuit functions and design the logic required to implement those functions. Breadboarding is often valuable at this point for checking the circuit functions and verifying all operating modes.

2. Convert the detailed logic design to a complete circuit design that includes every transistor and every logic element. You should now count logic elements and input and output lines to help you select the right-sized array for your design.

3. Sketch interconnecting lines on a large drawing of the appropriate array. This requires part intuition and part trial and error to arrive at the best grouping of components and eliminate any crossovers. The sketch need only show the points that are to be connected, and not the exact routing of the interconnecting lines.

The three previous steps can be done without the

Table 1. Custom cost vs array cost

	Custom	Prediffused
Development cost	\$50,000 (\$5/unit)	\$10,000 (\$1/unit)
Production cost	\$20,000 (\$2/unit)	\$30,000 (\$3/unit)
Total	\$70,000 (\$7/unit)	\$40,000 (\$4/unit)

Table 2. Major uncommitted array vendors

Manufacturer	Array capability	Circle No.
Exar, 750 Palomar Ave., Sunnyvale, CA 94086. (408) 833-7700.	Bipolar (linear and I ² L digital)	511
Ferranti, E. Bethpage Rd., Plainview, NY 11803. (516) 293-8383.	Bipolar	512
Interdesign, 1255 Reamwood Ave., Sunnyvale, CA 94086. (408) 734-8666.	Bipolar, CMOS and NMOS	513
International Microcircuits, 3004 Lawrence Expressway, Santa Clara, CA 95051. (408) 735-9370.	CMOS	514
Master Logic, 761 E. Evelyn Ave., Sunnyvale, CA 94086. (408) 732-7777.	CMOS	515
Microcircuits Technology, 975 Comstock St., Santa Clara, CA 95050. (408) 249-2501.	CMOS, NMOS and PMOS	516
Motorola Semiconductor, 5005 E. McDowell Rd., Phoenix, AZ 85008. (602) 244-6900.	Bipolar (ECL)	517
RCA Solid State, Route 202, Somerville, NJ 08876. (201) 685-6000.	CMOS	518
Siemens, Oskar-von-Miller Ring 18, D-8000, Munchen 2, Federal Republic of Germany.	Bipolar (ECL)	519
Stewart Warner Microcircuits SWAP (now part of Dionics, 65 Rushmore St., Westbury, NY 11590. (516) 997-7474).	Bipolar (I ² L)	520
TRW, 14520 Aviation Blvd., Lawndale, CA 90260. (213) 679-4561.	Bipolar (TTL)	521

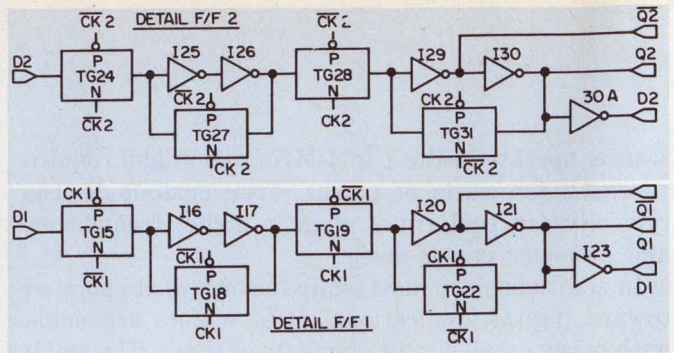
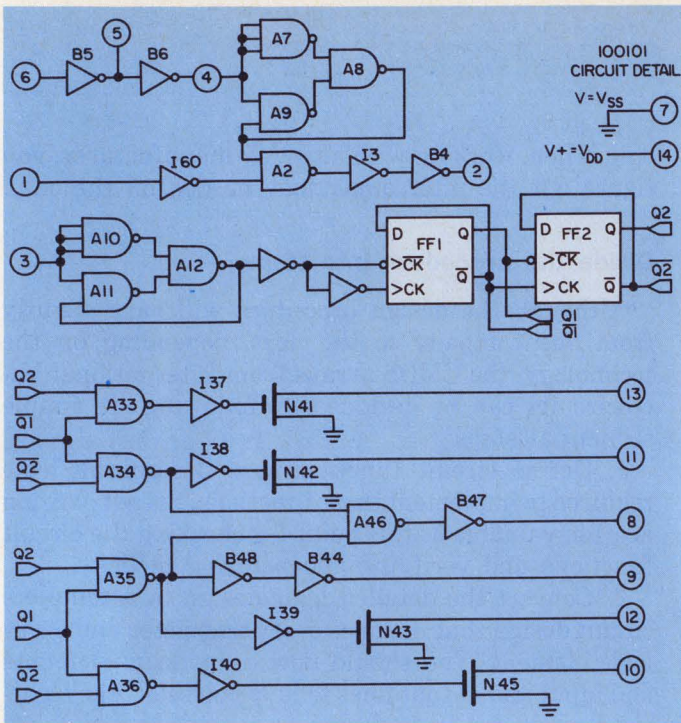

Designing a circuit with an uncommitted array can be broken into three steps. Start with the logic diagram of the circuit (left), which in this example is a four-channel scanner, and then transform the logic diagram into a discrete device diagram (above) so that the metal interconnect patterns can be defined (below).

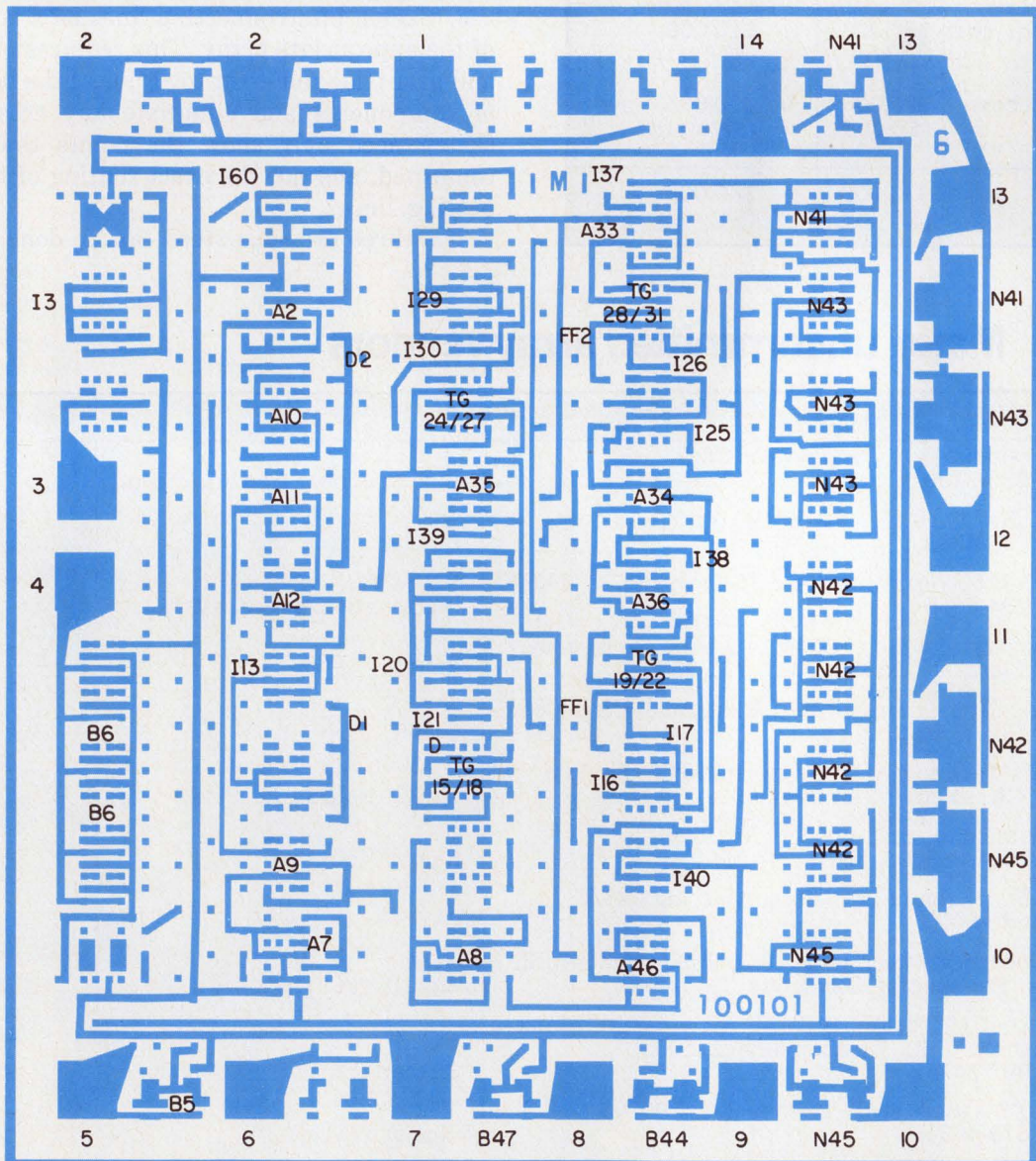

Table 3. Sample array specifications

Capacitance	
Aluminum over thick oxide	0.02 to 0.025 pF/mil ²
Aluminum over thin oxide	0.2 to 0.25 pF/mil ²
N+ to P-	0.25 to 0.3 pF/mil ²
P+ to N-	0.08 to 0.12 pF/mil ²
Threshold voltages (adjacent complementary devices at 1 μ A)	
N channel	0.5 to 1.5 V
P channel	0.6 to 2.3 V
Punch-through voltages	
	30 V at 0.4 mils
	20 V at 0.35 mils
Breakdown voltages at 1 μ A	
N+ to P-	18 V
P+ to N-	30 V
Sheet resistivity	
P- type wells	1000 to 3000 Ω/\square
P+ diffusion	40 to 80 Ω/\square
N+ diffusion	8 to 12 Ω/\square
Over-all system limits	
V _{dd} - V _{ss}	15 V (max), 0.5 V (min)
Input voltage	V _{dd} +0.5 V to V _{ss} -0.5 V
Output voltage	V _{dd} +0.5 V to V _{ss} -0.5 V
Junction temperature	150 C (max), -55 C (min)
*Max toggle frequency	2 MHz at 15 V
Typical propagation delays	
Two-input NOR	70 ns at 5 V
Two input NAND	90 ns at 5 V

* assumes a D-type flip-flop built from array devices

aid of the array vendor, but the next three steps usually require hand-in-hand cooperation:

4. Working from the sketch, technicians prepare precise artwork that indicates all interconnecting lines. The artwork is then checked against the logic design and circuit design to minimize the possibility of a layout error.

5. A photomask is produced from the artwork and is used to etch the aluminum interconnections on the preprocessed wafer.

6. The finished chips are inspected, diced, packaged, tested and then shipped to the customer.

The array manufacturer can enter this design schedule at any time up to the preparation of the photomask artwork. However, the earlier the vendor gets involved, the easier the design procedure. Some vendors even maintain a staff of applications engineers that can help you design your circuit, or at least give you some basic guidelines as to what the arrays can and can't do. ■■

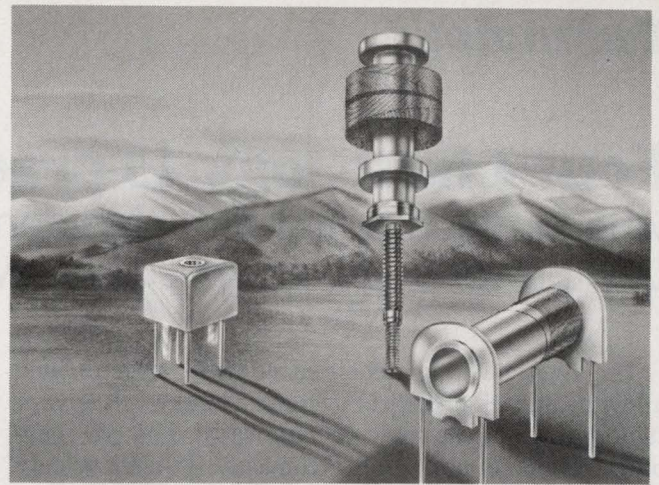

Coil well.

You've struck it rich if you need wound tunable coils with overlapping inductance ranges. CAMBION's broad standard line is immediately available from stock. Custom coils in a wide spectrum of inductances and configurations also available.

Standard micro-mini inductors, shielded and unshielded types, molded chokes, are yours for the asking. For custom needs, the difficult takes a little time. The impossible takes a little longer. Write for the best catalog in the field. Cambridge Thermionic Corporation, 445 Concord Avenue, Cambridge, MA 02138. Phone: (617) 491-5400. In California, 2733 Pacific Coast Highway, Torrance, CA 90505. Phone: (213) 326-7822.

CAMBION[®]
Guaranteed to be the right connection.

CIRCLE NUMBER 34

ALCOSWITCH[®]

WORLD'S SMALLEST SWITCHES
FOR INDUSTRIAL APPLICATIONS

A truly subminiature switch family designed specifically for printed circuit applications. Fully meets today's subminiaturization standards. These switches contain the most-asked-for features as outlined below.

- LOWER DENSITY
Allows clearance on PC boards spaced on 1/2" centers.
- COMPLEMENTARY PUSHBUTTON
Soon available in many styles and configurations.
- CLOSER SPACING ON PANELS
Allows 3 single pole switches per linear inch.
- CASE MATERIAL
Flame retardant Diallyl Phthalate.
- UNIFORM 0.1" SPACING
Between all terminals and anchor pins.
- GOLD PLATED CONTACTS
Most needed for logic circuitry.
- HIGH TORQUE BUSHING
Withstands mechanical abuse.
- SLIDE SWITCH DESIGN
Utilizes toggle action design.
- DIP SWITCHES TOO!
We may be late in DIPS, but, we've got one of the largest variety including; rockers, slides and pianos too! All with high quality features, excellent tactile feel and off-the-shelf delivery.
- Ask Customer Service for details and a copy of our 76 page catalog.

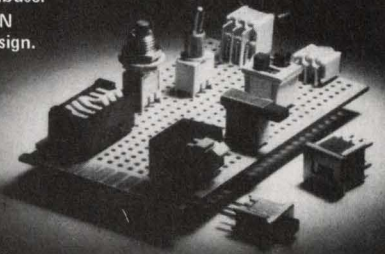

ALCO ELECTRONIC PRODUCTS, INC.
1501 ORGOOD STREET, NORTH ANDOVER, MA 01845 U.S.A.

TEL: (617) 685-4371 TWX: 710 342-0552

A SUBSIDIARY OF **AUGAT**[®] INC.

CIRCLE NUMBER 35

Four-phase logic is practical

when implemented with high-density MOS large-scale arrays. Low power and high speed can overshadow any disadvantages.

The high packing densities of MOS circuits now allow designers of digital systems to take full advantage of four-phase logic economically. Though four-phase logic is not a new concept,¹ it isn't widely understood, so here's a quick review of its characteristics.

Four-phase logic offers the following advantages:

- Very low power consumption—only a few micro-watts per stage.
- Higher speeds than conventional DTL, TTL and even many CMOS-logic systems—typically only 10-ns delay in a four-phase stage.
- Simple circuitry, highly compatible with computer-aided methods—all "components" are MOS devices.

But four-phase logic also has some disadvantages:

- The logic system is dynamic—inputs and outputs occur only in specific time slots.
- The system needs a four-phase clock—the timing intervals must be accurately determined.
- The rules of interconnection must be strictly observed—even though they are simple and easily handled by computer-aided design.

Nevertheless, the advantages outweigh the disadvantages, especially in large-scale programmable-logic arrays (PLAs), programmable-gate arrays, and μ Ps. And converting conventional logic circuits into four-phase logic is simple—once you know how four-phase logic works.

Inherent capacitance holds the signal

Fig. 1 shows a basic four-phase "stage" configured as an inverter. Phase-1 ($\phi 1$) of the system's clock powers the series string of MOSFET transistors T_1 , T_2 and T_3 ; phase 2 ($\phi 2$) clocks the gate input of T_2 ; and the logic-signal input is applied to the gate of T_3 .

The $\phi 1$ clock, applied to the gate and drain of T_1 , turns T_1 on, and negatively charges the small inherent capacitance, C , of the next stage's input gate. After this charging time (CT), $\phi 2$, which holds T_2 on, allows the charge on C to remain or reverse, depending on the logic-signal input to T_3 .

A ONE (corresponding to a negative level) on the

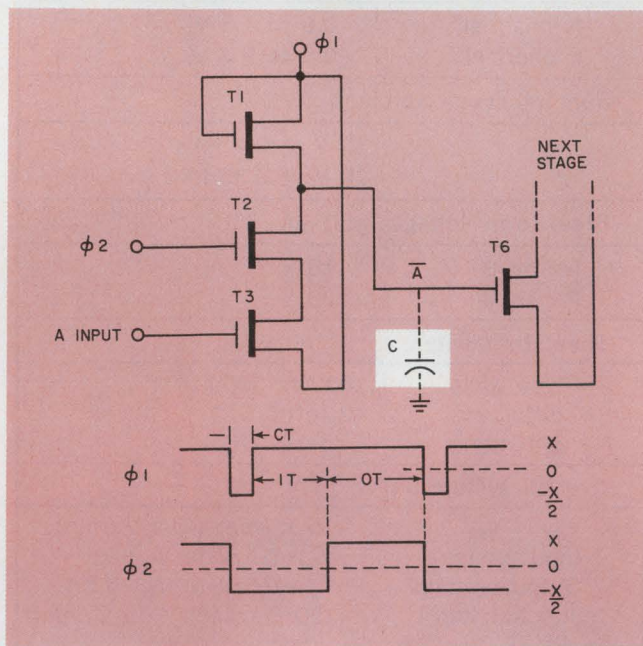

1. In a four-phase inverter, the inherent small capacitance of the next stage's input charges during time CT of clock $\phi 1$. The state of this capacitance is determined, during the input time (IT), by the condition of the logic input A . During the output time (OT), the output—the state of C —transfers to the next stage.

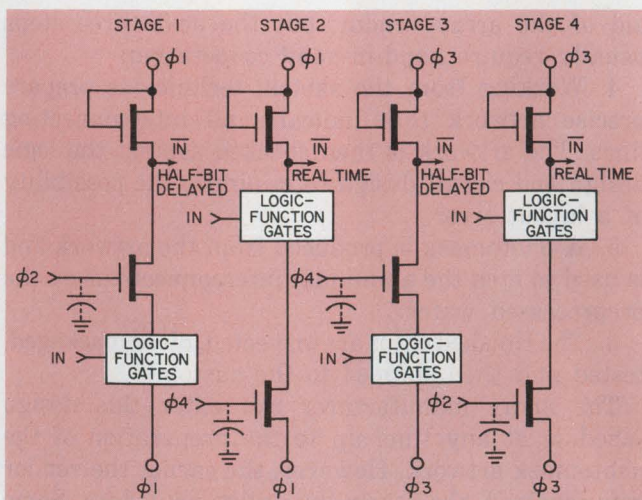

2. Four-phase logic requires the use of four stage configurations. The rules for stage interconnection are relatively simple. Besides, the different stage delays add logic flexibility, and available computer programs can easily obey all the rules consistently.

Satya Pal Asija, P. E., Senior Applications Analyst, International Defense Systems Div., Sperry Univac Corp., St. Paul, MN 55117

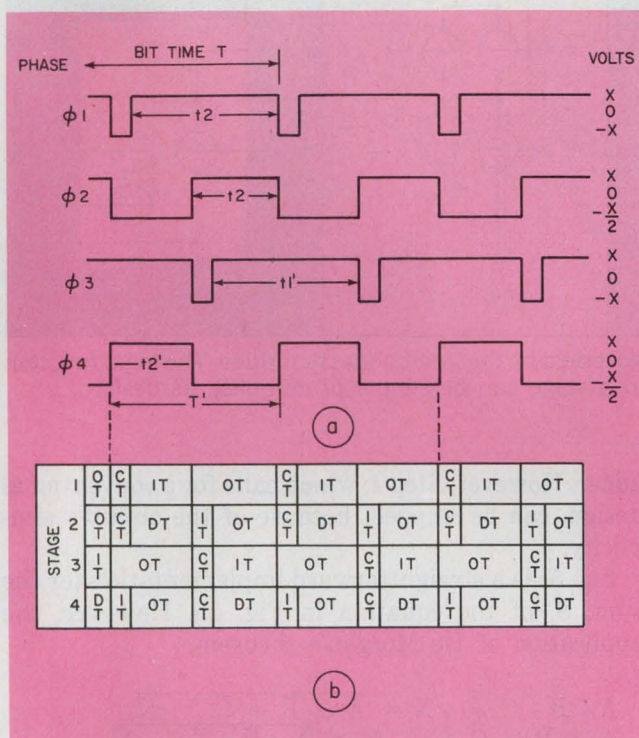

3. A four-phase clock is needed for four-phase logic (a), and the clock-signal transitions define the output time (OT), input time (IT), charge time (CT) and dummy, or idle, time (DT) of each of the four stage configurations.

input to T_1 turns T_3 on, discharges C and recharges it positively to ZERO, since ϕ_1 is now positive and T_1 has turned off. Conversely, a ZERO (positive level) input to T_3 retains the negative charge on C ; clearly, the stage acts as an inverter. This part of the circuit's operation is called the input time (IT).

When ϕ_1 and ϕ_2 are both positive, T_1 and T_2 are cut off and C is isolated. This part of the operation is called the output time (OT). Another operational interval, called idle—or dummy—time (DT), doesn't occur in the stage type just discussed—Stage 1—but does in two other types of stages—Stages 2 and 4 that we'll look at later (Fig. 2).

The voltage polarity that represents a ONE or ZERO depends upon the logic fabrication—PMOS or NMOS. Since PMOS gates conduct when the gate is negative with respect to the source, the convention is to use ONES to represent negative levels.

Low-threshold PMOS four-phase logic systems readily operate with 7-to-8-MHz clocks, and well

designed NMOS systems can work up to 16 MHz. For example, General Instruments' MEM 3064, a 64-bit serial accumulator, operates at 5 MHz, contains 400 PMOS devices on a 58×58 -mil chip, and dissipates only 40 mW. And LSI Computer Co. (Melville, NY) is developing four-phase custom PMOS and NMOS arrays for miniaturized computers like the Control Data 469 miniature computer.

Four clock phases are needed

Fig. 3a shows the complete set of timing and wave shapes—the four phases of the clock needed to power a complete PMOS four-phase logic system (other wave configurations are possible¹). ONES and ZEROS propagate—as in a shift register—through a logic system made up of properly interconnected combinations of the four coupling, or “stage,” circuits shown in Fig. 2. Clock pulses under control of the logic conditions charge and discharge the small inherent capacitances of the logic-input gates of each successive stage. The gate capacitance is, about 0.2 pF typically, with a series impedance of about 25 k Ω ; therefore, a stage output can easily drive a dozen other stages.

In addition to four clock phases, four stage configurations are needed (Fig. 2) because, unfortunately, a stage can't drive another with the same configuration; nor can the stages be connected to each other randomly. A stage may drive its next consecutively numbered stage—Stage 1 may drive Stage 2, 2 may drive 3, and so on. Stage 4 then drives Stage 1. In addition, Stages 1 and 3 may drive each other, so there are six legal combinations in all. All other stage connections are illegal—for example, Stages 2 and 4 can't connect to each other directly.

Furthermore, the logic-signal inputs to Stages 2 and 4 don't propagate through a clocked MOS gate to get to the output; thus their outputs are immediate (real time), whereas stages 1 and 3 outputs are delayed half a clock time of ϕ_2 or ϕ_4 , respectively. Also, note that the outputs of all the stage types are inverted.

These legal-connection rules may seem complicated, at first. But they are easy to remember and they give you considerable flexibility, especially when you design dynamic and sequential systems, such as shifting, counting and time multiplexing circuits. For example, a Stage-1 inverter connected to a Stage-3 inverter generates an output equal to the input, but delayed by one bit. This combination of stages, therefore,

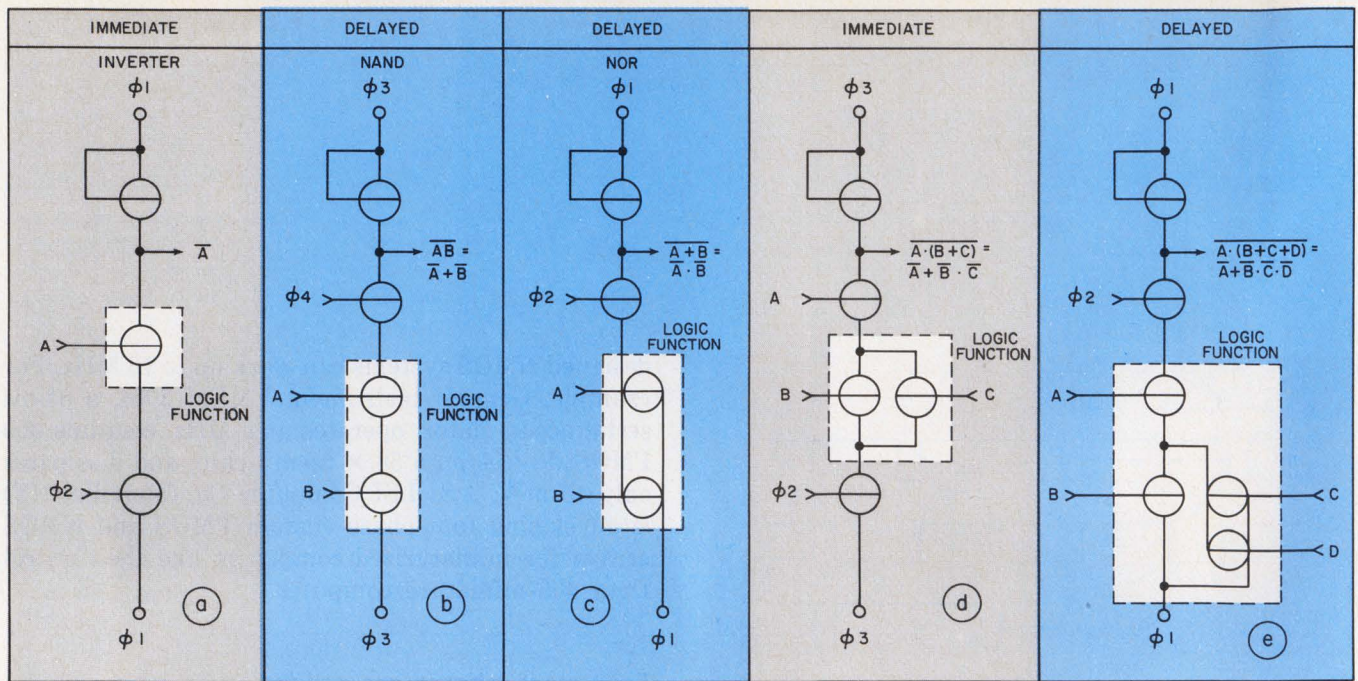

4. Logic functions implemented in four-phase logic must be "carried" in one of the four stage configurations as

governed by the interconnection rules. The logic function in a stage can be simple or complex, as desired.

becomes one stage of a shift register.

Fig. 4 shows a few examples of some simple logic functions in four-phase configurations: an inverter, a NAND gate, a NOR gate and two NAND/NOR combinational circuits. You can easily compile a collection of your own simple-logic building blocks.

But, if you're building complex logic structures, take care: Often the MOS characteristics limit the circuit to only two or three serial OR-gate functions. To overcome serial-OR limitations, alternate vertical-parallel OR (Fig. 4c) and horizontal-parallel-OR (Fig. 4d) configurations. The difference between the vertical and parallel configurations lies in the way the IC-chip designer structures the gates and current paths in the MOS devices. Further, to optimize the circuit density on the chip, the use of real-time stages and delayed stages should be alternated.

Five steps to four-phase logic

Designing four-phase logic circuits boils down to five simple steps. Note that the first four steps are merely the steps of ordinary logic design:

1. Draw a truth table.
2. Map the truth table on a Karnaugh map.
3. Write the logic equation in its simplest form.
4. Lay out the circuit in conventional logic and use one type of logic gate only—all ANDs, ORs, NANDs or NORs.
5. Transform the design into a four-phase circuit, drawing the MOS gates as bubbles.

A conventional logic design can be transformed into four-phase logic many ways—the number is directly proportional to its complexity. For example, Fig. 5 takes you through the steps in designing a two-bit full

adder. However, Step 4, which calls for a conventional design, can be skipped, because of the circuit's simplicity.

Fig. 5c is a straightforward implementation for the sum, S, of the equation in Fig. 5b. However, the application of De Morgan's theorem,²

$$A \cdot B \cdot C \dots N = \overline{\overline{A} + \overline{B} + \overline{C} \dots \overline{N}},$$

$$A + B + C + \dots N = \overline{\overline{A} \cdot \overline{B} \cdot \overline{C} \dots \overline{N}},$$

eliminates the need for a separate inverter after each logic term before the ORing operation, and thus greatly simplifies the logic design in Fig. 5d.

The logic for the carry, $C_{(n+1)}$, also is shown in two versions: Fig. 5f is a straightforward application of the equation in Fig. 5b, and Fig. 5f is a somewhat simpler version. ■■

References

1. Boysel L.L., and Murphy, J.P., "Four-Phase LSI Logic Offers New Approach to Computer Designer," *Computer Design*, April, 1970, pp. 141-146.
2. Asija, S.P., "Instant Logic Conversion," *IEEE Spectrum*, December, 1968, pp. 77-80.

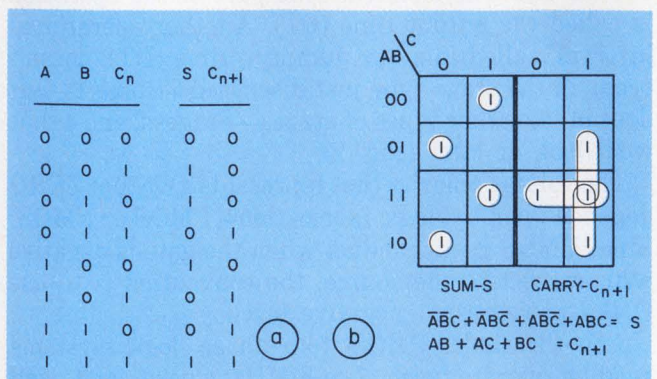

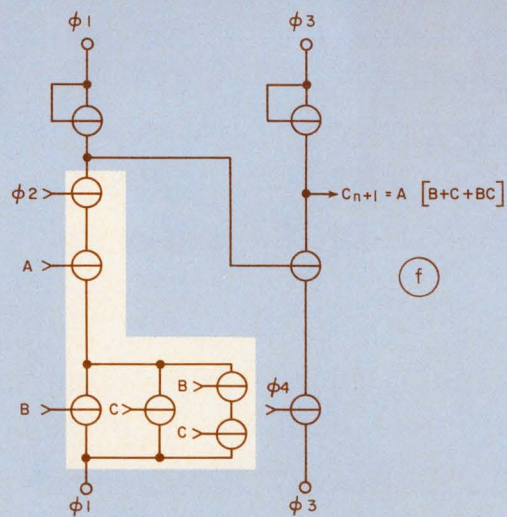
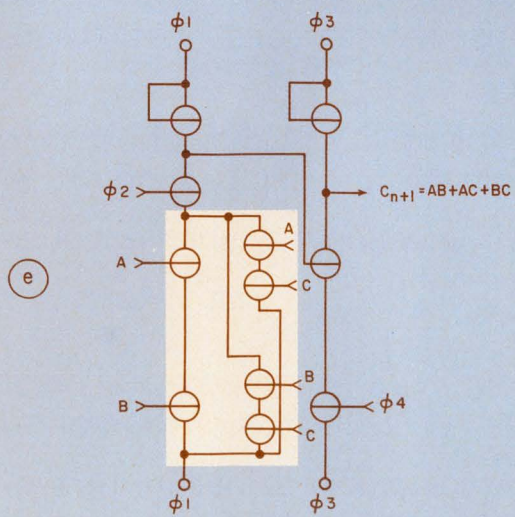
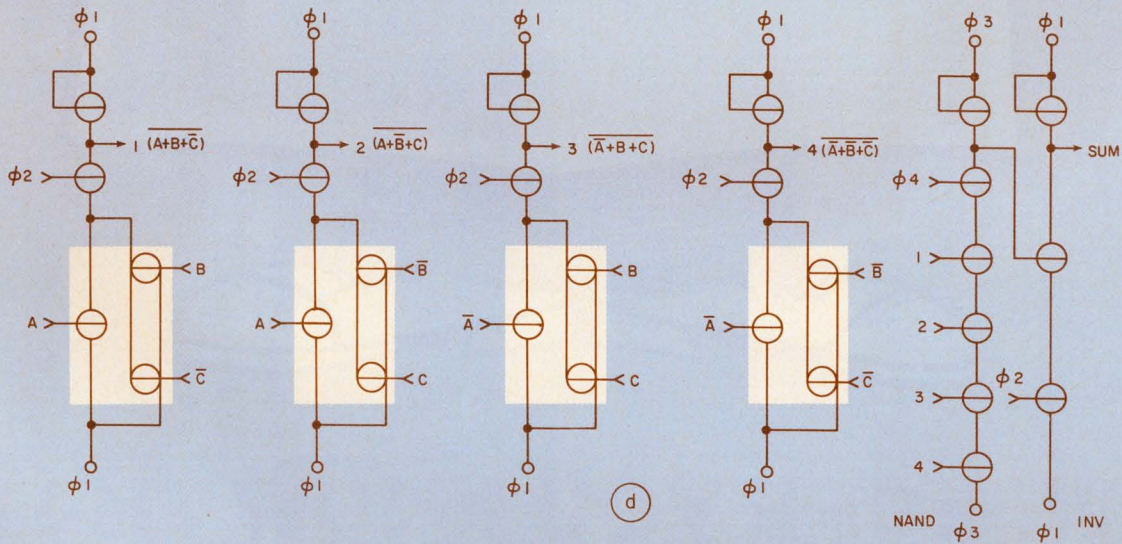
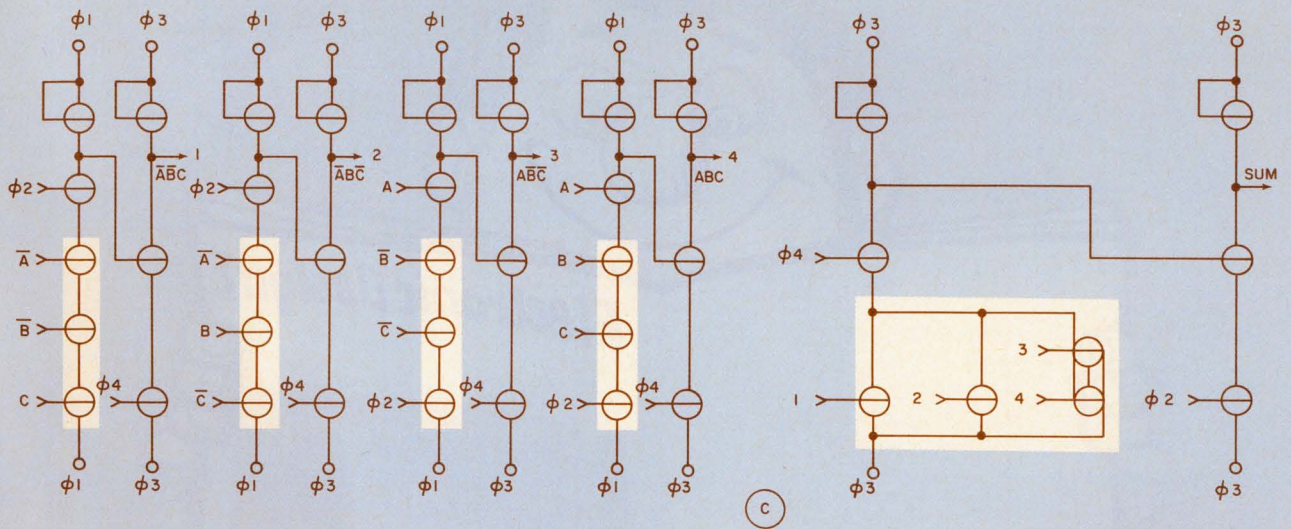

5. A two-bit full-adder design example is taken through the suggested design steps from truth table (a) and Karnaugh map (b) to variations of the design—direct

implementation (c and e)—or use of De Morgan's theorem (d and f). However, because of the simplicity, Step 4—the conventional-logic design—is skipped.



WE HOPE YOU KNOW THAT...

- **ELECTRONIC DESIGN'S** paid and qualified circulation is now approaching the 100,000 mark. That's an increase of almost 80,000 from our first issue twenty-five years ago!
- **ELECTRONIC DESIGN**, of all electronics publications, is now the circulation leader among electronics engineers and engineering managers!
- **ELECTRONIC DESIGN** has more engineering management subscribers than any electronics publication in the world ... 58,222, by title, as of June 1977!
- **ELECTRONIC DESIGN** reaches more OEM engineers and engineering management in Europe than any U.S. electronics journal!
- **ELECTRONIC DESIGN** leads all industrial magazines in the world in its response from readers ... more than 1,500,000 forecast for 1977!

YOU'RE IN GOOD COMPANY IF YOU READ ELECTRONIC DESIGN

**BEST READ, MOST HELPFUL, MOST PREFERRED
ELECTRONICS PUBLICATION IN THE WORLD!**

WHO NEEDS A VIDEO OP AMP

**With 1 GHz Gain Bandwidth Product
and
70 Nanosecond Settling to 0.01%?**

Far more people than you would have imagined! People who require the performance of a true differential input op amp at frequencies from DC to beyond 100 MHz, with the ease of using a 741 at 100 kHz. Those who want a ± 5 volt output to reach an accuracy of 0.01% in 70 nanoseconds. Others who require this state-of-the-art performance from -55°C to $+125^{\circ}\text{C}$, and many more who require the high reliability provided by MIL STD 883 processing.

Your application may not need the full temperature range or the hermetically sealed DIP, but for many industrial applications these and other features of the new Video Op Amp offer you vital reliability.

All of this and more is available to you off-the-shelf with the 1435 - **The op amp that solves problems you didn't even try to solve before!**

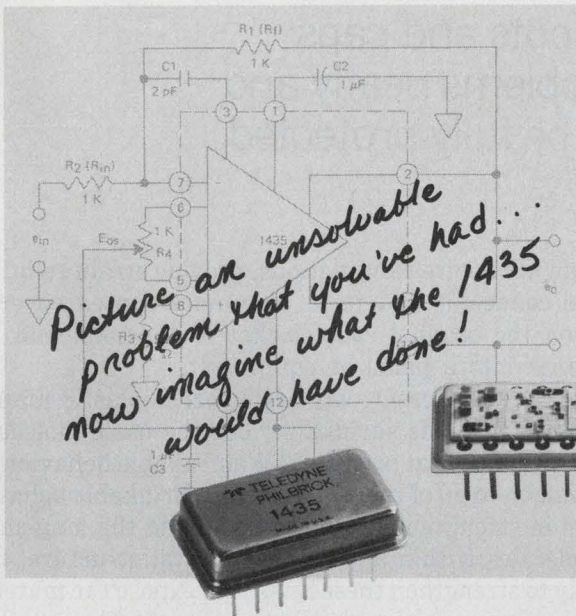

TELEDYNE PHILBRICK

Allied Drive at Route 128
Dedham, Massachusetts 02026
Tel: (617) 329-1600

TWX: (710) 348-6726
Telex: 92-4439
Cable: TELEPHIL

CIRCLE NUMBER 36

KEYBOARD SWITCHES for INSTRUMENT PANELS

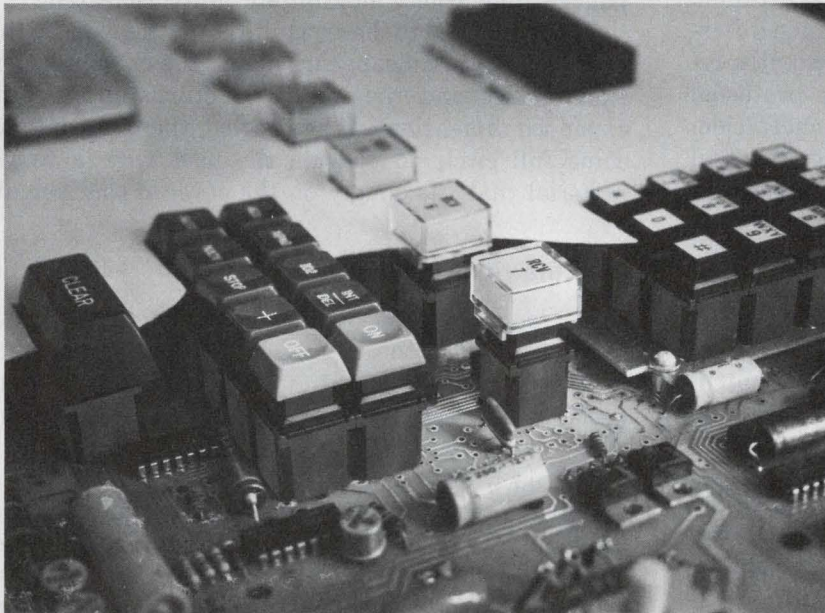

Now is the time to stop hand wiring to expensive panel-mounted switches.

Mechanical Enterprises' keyswitches are available at about *half-the-cost*. And, they are *self-supporting* on the PC board without the need for metal sub-plates.

Our switches feature —

- Sealed contacts or inexpensive gold bar mechanical contacts
- 3/4" or 5/8" spacing, or stand-alone
- Selection of legending systems including doubleshot keytops
- Lighted models in three lens styles, all relampable from front
- Single or double pole, NO or NC
- Momentary or alternate action
- Wave solderable
- 20 million cycle life at TTL loads with guaranteed low bounce

Please phone for a free sample with keytop.

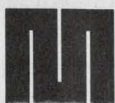

Mechanical Enterprises, Inc.

8000 Forbes Place Springfield, Virginia 22151 (703) 321-8282 TWX 710-832-0942

Germany - NEUMULLER GMBH, MUNICH / U.K. - TEKDATA Ltd., STOKE-ON-TRENT / France - TEKELEC AIRTRONIC, SEVRES / Switzerland - DIMOS, AG ZURICH

CIRCLE NUMBER 37

Shrinkable plastic tubes, boots and caps can solve many of your insulating problems neatly and efficiently. Even irregular shapes can be fully protected.

Heat shrinkable plastics are a substantial portion of the insulating materials used today. Tubing is by far the commonest form, but boots, caps and transition pieces also are used in large quantities. Even many irregularly shaped objects, formerly insulated with tape, are now protected with special heat-shrinkable forms rapidly and at low cost.

The good insulating and mechanical properties of most shrinkable plastic tubing, along with its compatibility with ordinary wire-insulation plastics make such tubing eminently suitable for covering splices to provide both electrical and mechanical protection. As an added bonus, splices have a neater appearance with tubing, rather than with electrical tape.

Furthermore, shrinkable tubing is easy and convenient to use. It cuts easily with scissors, electrical cutters or standard paper cutters. And automated cutting equipment is available. Some tubing manufacturers and distributors even supply pieces cut to order. Standard industry packages contain 4-ft tubing lengths, but some suppliers offer 2-ft lengths, which are easier to store and handle. But even 6-in. packages are readily available.

You can fabricate your own cables, and jacket them for both protection and identification. Damaged flexible cord and cable jackets can be conveniently repaired with shrinkable sleeving, and thus protected against any further damage or moisture penetration. Encapsulating and moisture-proof tubing can seal connectors and splices. Also, shrinkable tubing can serve as strain-relief bushing for cords and connectors. And besides being available in a wide range of colors, the tubing can be surface-printed with characters.

Another major tubing application is to insulate connector terminations. The tubing is slipped over individual connector wires before they are terminated. After termination, the tubing is placed over the wire/connector-terminal joint and shrunk to both insulate the connection and relieve it from strain.

In addition, end caps, which are tubes closed on one end, are used to protect bundles of splices and to prevent moisture from penetrating the cut ends of cable when in storage. And connector boots are specially shaped to fit connector profiles. They protect

individual wire terminations, provide strain relief for the connector and form an uninterrupted covering from the original cable jacket to the connector entrance into a panel or equipment.

Several different polymeric thermoplastic materials can be made shrinkable, but the basic molecular interactions that produce this shrinkable behavior are common to all of them. The key to shrinkable behavior lies in strengthening the links among the long-chain molecules within a polymer's crystal structure. One way to strengthen these links is to expose the material to radiation under controlled conditions. The radiation produces a crosslinking of the molecules that strongly binds the long-chains together.

With crosslinking, if the material is heated to the crystalline melting point, it doesn't melt, but becomes soft and rubbery. The crystal structure dissolves, but the crosslinks hold the molecules together in a viscous mass that prevents the material from melting and flowing. In this soft state, the material can be stretched, which puts the crosslinks under tension. If cooled while held in the expanded state, the crystal structure reforms, but the material retains its expanded dimensions indefinitely, until reheated.

When reheated to the crystalline melting points, the crystal structure disappears again, the crosslink tension relaxes and the material returns to its pre-expanded dimensions. When cooled, the material has come full circle to provide the user with a tough material that fits snugly on the covered component.

Pick the right material

The large choice of available shrinkable materials may make selection difficult. But at the same time, the large range of properties allows you to meet your needs more precisely. The following short list of the most commonly used materials should help you find what you want:

1. *Irradiated flexible polyolefin* is by far the most commonly used shrinkable plastic. The material has good electrical and mechanical properties for most general-purpose applications. It is popular because it is both low-cost and available in a wide range of sizes and colors. Shrink temperature is a cool 121 C.

2. *Irradiated semirigid polyolefin* is a physically stiffer and stronger version of polyolefin, and it's used

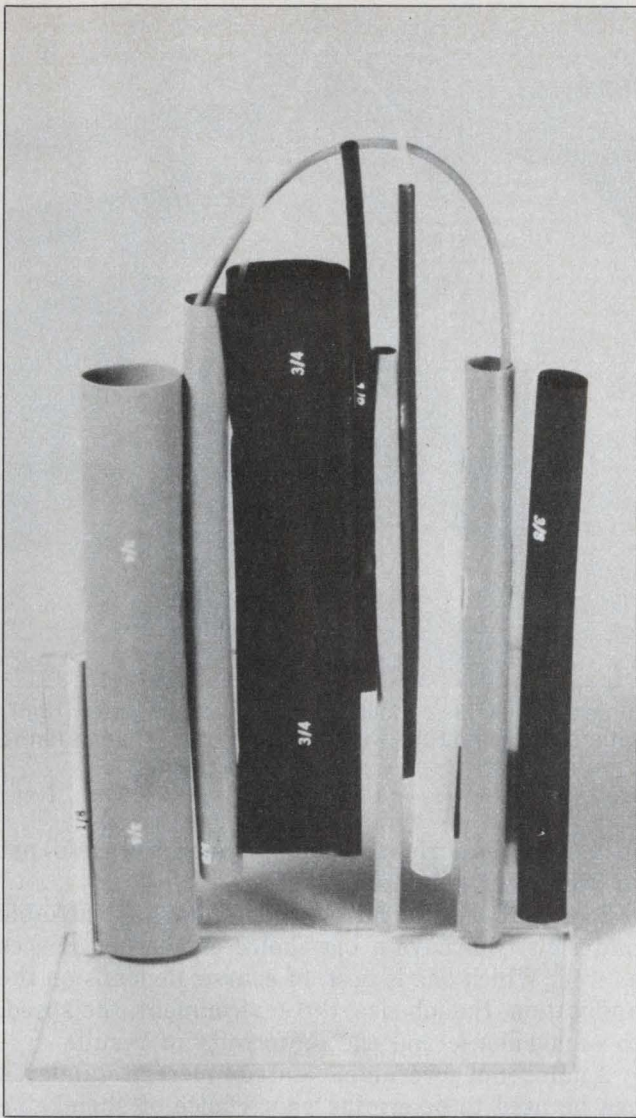

1. Heat-shrinkable tubing is available in many sizes and types of materials to suit almost any application.

primarily for the strain relief of soldered connections and terminals. Shrink temperature is 135 C and price is about 1-1/3 times the flexible variety.

3. *Surface-irradiated polyolefin* behaves differently from the other shrinkable materials. Because only its outer surface is irradiated and shrinkable, the inner surface can melt and flow when heated to the shrinking temperature. When the outer surface shrinks, the melted inner material squeezes into the crevices of the covered item to provide excellent mechanical adherence and protection against vibration and strain. Shrink temperature is 135 C, and its price is about three times that of flexible polyolefin.

4. *Mastic-lined polyolefin* is coated inside with meltable mastic. As the tubing is heated and shrinks, the mastic melts and flows. Unlike the interior of surface-irradiated polyolefin, which hardens completely when cooled, the mastic material remains somewhat viscous to provide a strong barrier against moisture. The material is particularly suitable for sealing outdoor connections and for protecting connec-

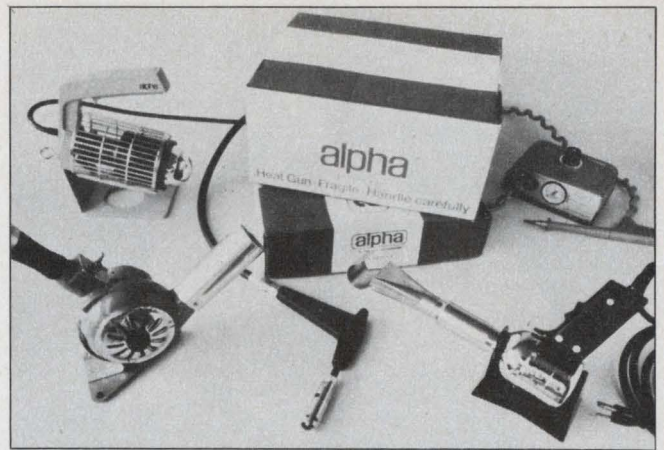

2. Heating devices for shrinkable tubing come in many styles and with a variety of attachments to provide uniform and rapid heating where needed.

tions directly buried in the ground. Shrink temperature is 135 C, but the price is high—about 5-1/2 times flexible polyolefin.

5. *Irradiated vinyl* is the most economical of all the shrinkable tubing. Unlike most of the other materials, it is available in long lengths, so it is suitable for jacketing long cables. However, vinyl's insulating capability is slightly inferior to polyolefin, and is available only in black. Shrink temperature is high—175 C. A nonirradiated shrinkable vinyl is also available, but the irradiated material offers several distinct advantages: it has indefinite shelf life, withstands solder-iron heat, resists splitting and possesses low longitudinal shrinkage.

6. *Irradiated Kynar* is a high-temperature plastic capable of continuous operation at 175 C. It is nonflammable, resistant to severe environmental conditions and physically very strong. Because of its high strength, Kynar tubing can be very thin walled. Standard tubing is transparent and shrink temperature is 175 C. The material is about three times more expensive than flexible polyolefin.

7. *Irradiated neoprene*, also available in long tube lengths, is very flexible and durable as a cable jacket, but it is used more for mechanical protection than for electrical insulation. It comes in black and its shrink temperature is 175 C. Price is about five times that of flexible polyolefin.

8. *Teflon*, or tetrafluoroethylene in chemical terminology, doesn't melt and therefore doesn't require irradiation. Instead, Teflon undergoes a crystal-structure transition at 327 C, which makes it pliable so that it can be stretched. The molecular bonds, thus put under tension, when reheated to 327 C are relieved and the material shrinks. Since Teflon doesn't melt or burn, and resists almost all chemical attack, it can fit many tough applications. But its price is over 4-1/2 times that of flexible polyolefin.

9. *Fluorinated ethylene propylene*, or FEP, is a meltable grade of Teflon. Shrinkable FEP has the chemical-resistance properties of TFE, but not the continuous-duty rating—204 C as opposed to 250 C

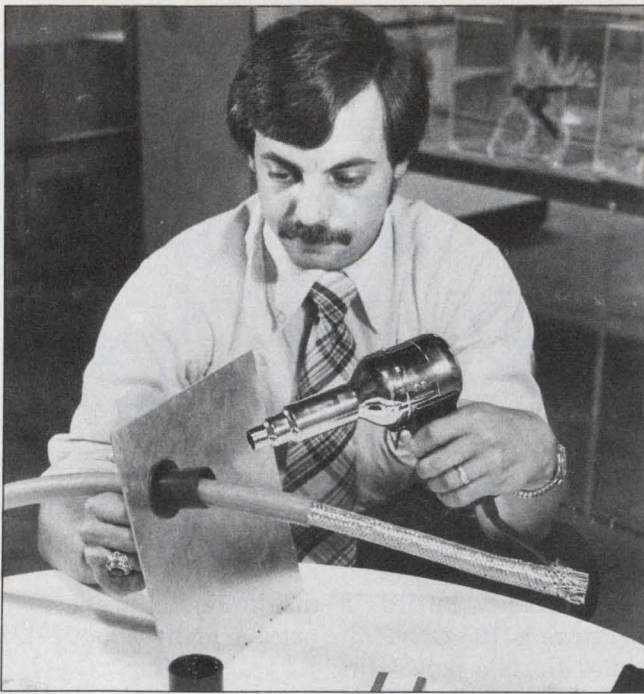

3. The hot-air gun is the most popular heating tool for shrinkable material. It can be used to shrink a feed-through seal around a heavy-duty control cable (left) or

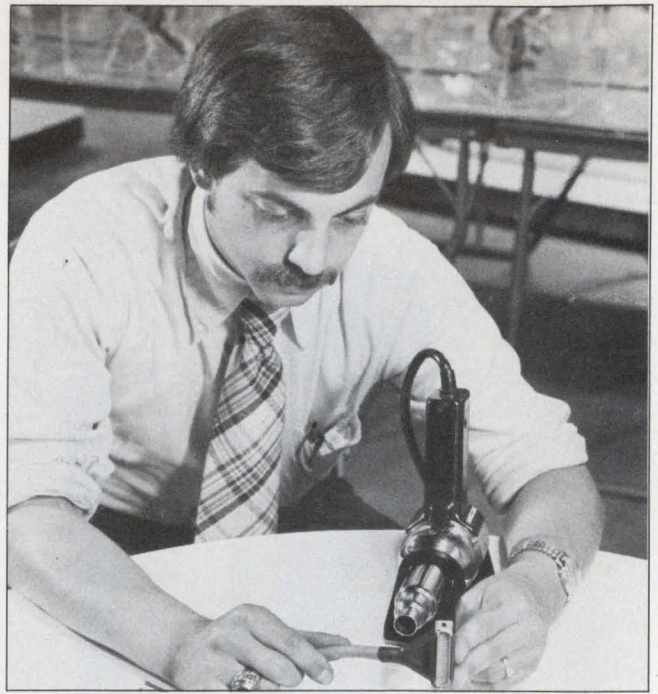

mold a shrinkable connector cover to a connector (right) without damaging the wires or connector. A clean flame or infrared can do the job in some cases.

for TFE. It's easier to install, however, because its shrink temperature is a lower 176 C. But it costs nearly five times more than flexible polyolefin.

Shrinking is easy

Shrinkable materials can be heated with a cigarette lighter or even a match. But large tubing sizes can't be heated evenly with a small flame. Also, open flames often can't be used in some environments, sensitive components can be damaged and soot residues can destroy the material's appearance and compromise its insulation protection. A hot-air gun, however, is both safe and clean.

A gun can supply a required shrink temperature uniformly over a large area. An electric heating element raises the temperature of air, which is forced out of the gun nozzle with a fan. Guns come in many sizes and for different temperatures. In some, the temperature can be precisely adjusted. And by using differently shaped nozzles, an operator can concentrate the gun's output as required. The results obtained will be uniform and quick. Obviously, shrinking should take as short a time as possible, both to maximize production and to protect heat-sensitive circuit components.

But electric power isn't always available, say, to seal pipe joints and to splice large underground power and communications cables. Very large tubing used outdoors is often shrunk with a propane torch. At other times, for delicate small jobs, an infrared heat gun, which relies on a material's absorption of infrared radiation rather than hot-air convection for heating, is more convenient. Infrared can produce almost

instantaneous shrinkage, but you must be careful not to overheat the material.

So not only do you have a wide choice of shrinkable materials; you have a big choice of heating devices as well. Which one is best, of course, depends on the application, the job size, the environment, the speed, the convenience and the uniformity of results.

A number of government and commercial standards can be used to determine your choice of shrinkable material. The most widely used spec is MIL-I-23053. Although intended for military procurement agencies, the spec also has been adopted by many industrial-equipment makers, so that many drawings for commercial-grade equipment call out shrinkable materials by referring to this spec.

MIL-I-23053 includes an extensive list of the shrinkable materials you may use, with dimensional data and tolerances for each material. Tests for tensile strength and resistance to solvents, oils and fungus growth are provided. And the properties of the material before and after heat aging are specified.

Some shrinkable material is recognized by Underwriters' Laboratories (subject 224). But because UL—in this case—is more conservative than the military, UL doesn't list as many types. The flammability requirements are especially severe, since UL emphasizes fire safety. To ensure traceability, UL requires that the material be surface-marked with the manufacturer's name or UL-file identification number, and a temperature rating.

But UL marking should be requested by the user. Most users don't require the UL marking, although they may use UL-type tubing to be sure of getting high performance. ■■

**On
Jan. 4, 1978**



**You Can Win an
Acapulco Holiday
For Two!**

Electronic Design's Famous

Top Ten Contest



ALL YOU HAVE TO DO IS PICK THE 10 TOP SCORING ADS IN ELECTRONIC DESIGN'S JANUARY 4 ISSUE

WIN FOR YOURSELF

That's right ... you can win a 10-day prepaid vacation for two in fabulous Acapulco *plus* \$1,000 cash or one of 99 other valuable prizes. There's nothing to write; no slogans; no drawings or gimmicks. All you have to do is pick the 10 advertisements that our readers will best remember having seen in the January 4 issue.

Acapulco is paradise. You'll stay at the exotic Paraiso Marriott — an "island" 22 stories high. You can sun, swim, sail, skin dive, take a parachute ride over Acapulco bay or browse through quaint shops. In the evening you can choose from sizzling night life or take a relaxed moonlight stroll on the beach. It's a perfect blend of casual sophistication, carefree excitement and spirited adventure. *And you get \$1,000 cash to cover air transportation, bar bill or incidentals!*

FREE RERUNS FOR THE TOP TEN ADS

One of the biggest bonuses for companies who have an advertisement in the Top Ten Contest issue is often overlooked. It's the chance to get a free rerun of that ad with the extra impact, extra inquiries and sales that can result. (For a two-page spread in full color it can be worth more than \$5,000 for your company.)

HERE'S HOW TO ENTER:

- (1) Read the rules contained in the January 4 issue.
- (2) Pick the 10 ads that you think *Electronic Design's* readers will best remember having seen.
- (3) List these ads by company name and Reader Service Number on the entry card. Mail before February 28, 1978.

Your selections will be checked against Reader Recall, *Electronic Design's* method of measuring readership.

NOTE: SEPARATE CONTEST FOR ADVERTISERS AND THEIR AGENCIES

If you are an advertiser or an advertising agency, there's a separate "advertiser" contest for you with separate prizes for the top three winners. First and second prizes are the same in both the advertiser and reader contests. That means you can win an Acapulco holiday for two plus \$1,000 cash or a \$600 personal computer. Third prize is a digital wristwatch, \$100 value. The free reruns for the winning ads and extra readership for *all* advertisements in the issue make the Top Ten Contest issue one of the year's outstanding advertising opportunities.



First Prize! **10-Day Vacation for Two** **at the Exotic** **Paraíso/Marriott** **in Acapulco** **Plus \$1,000 Cash!**

Includes first class air conditioned accommodations for two, plus modified American plan meals (breakfast and dinner) for 10 days, 9 nights. Subject to space availability May through Dec. 1978. The \$1,000 cash award may be used for incidental expenses, luncheons, local transportation, air transportation etc.

2nd PRIZE



PET PERSONAL COMPUTER

The Personal Electronic Transactor computer by Commodore Business Machines is a complete home data processing system that features BASIC language, a CRT display and cassette-tape mass storage. You can do your taxes, balance your checkbook, plus much, much more.

\$600 VALUE

3rd PRIZE

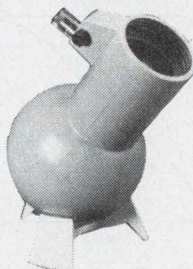

WIDE FIELD TELESCOPE

There's no other telescope like it! Edmund's Astroscan® 2001 4 1/4" F/4.4 Newtonian wide field reflector gives clear, bright, spectacular wide-angle views of stars, moon, comets. It's portable, easy to use. No complicated set up. Just insert the eye piece and focus. Top quality optical system.

\$150 VALUE.

4th & 5th PRIZES



DIGITAL WRISTWATCH

\$100 VALUE

6th through 100th PRIZES

Hayden Technical Books

NOTE: COMPLETE ENTRY BLANKS
AND RULES WILL APPEAR IN
JANUARY 4, 1978 ISSUE

NDRO logic circuits use Josephson effect

Josephson junctions are potential memory elements for ultra-high-speed logic circuits. But retaining information on readout has complicated the logic circuitry. Now, a nondestructive-readout (NDRO) memory cell based on the Josephson effect has been designed at the University of Karlsruhe, West Germany.

The equivalent circuit of an NDRO memory cell (Fig. 1) consists of two Josephson junctions, having unequal maximum currents, connected by an inductance. The inductance and the two junctions form an interferometer loop. Information is stored according to the presence or absence of a single flux quantum.

As with all superconducting switches, operation is fast, with pulses of the order of 100 ps. A major advantage of the NDRO cell, however, is that external bias currents are not required to preserve the stored information. In addition, the control pulses for all access lines have the same polarity and amplitude, so simple drive circuits can be used.

Individual memory cells are selected by a word line, which supplies gate

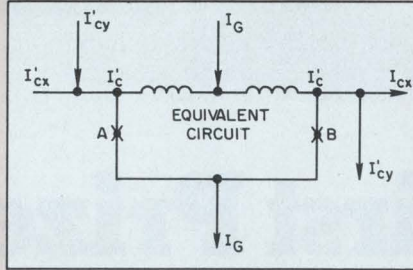

current I_G , and by two control lines that are inductively coupled to the cell. One control line, I_{CX} , is at right angles to the word line, I_G , while the other control line, I_{CY} , runs in a staircase pattern through a matrix of cells.

A read operation is performed by applying control currents I_G and I_{CX} . If I_{CX} is switched off before I_G , the information in the cell isn't changed by the read operation. If all three currents are applied simultaneously, a ZERO is written in the cell. To unite a ONE, only currents I_{CX} and I_{CY} are applied.

The cell can be easily fabricated since the inductance connecting the two junctions consists of a superconducting strip deposited on top of a thick oxide layer.

turns ratio (see Fig. 1). Each output port is connected to every other output port by a resistor of NR_0 , so that the number of resistors required is $1/2N(N-1)$. $N-1$ transformer windings are connected in series between each output port and the input port, so that $1/2N(N-1)$ transformers are required.

Connections for the resistor and transformer when $N=4$ are shown in Fig. 1 and Fig. 2, respectively. The complete four-way splitter is obtained by combining the two sets of connections. The input impedance is R_0/N and each output-port impedance is R_0 .

A four-way splitter has performed well over a 10:1 frequency range.

Improved fiber-breaking 'sparked' by Post Office

Limitations of the latest technique for breaking optical fibers cleanly for splicing—spark erosion—have been overcome by modifying the spark gap and its electrodes.

When the end of an optical fiber is joined to another fiber or optical component, the fiber end must be of very high quality. But the spark-erosion technique has not always given repeatable high-quality results.

Investigations by the British Post Office have led to a more reliable spark-gap technique that allows simple mechanization of the fiber-breaking process. With the spark technique the fiber is placed between two electrodes and subjected to a high-voltage spark that is fired at the rate of a few thousand pulses per second. The fiber can be broken by hand, but for better results, it is pulled apart mechanically.

The British Post Office also found that the commonly used platinum or tungsten-carbide electrodes were inferior to copper or steel electrodes. The former wear away quickly and it is thought that the fiber is weakened by surface damage caused by accelerated metal ions.

It was also learned that the best breaks can be obtained with a diffuse spark, which is achieved with a bundle of wires, instead of with a solid electrode, on one side of the spark gap.

N-way power splitter cuts insertion losses

Normally, a radio-frequency power splitter, which divides power applied to its input port equally among a number of output ports, is put together with simple two-way splitters as building blocks. But if the number of output ports is not a power of two, unused ports are terminated internally—splitter-insertion loss goes up. Now, with a technique developed at the European Space Research and Technology Center in Noordwijk, Holland, low-loss splitters with any number of output ports can be designed easily.

An N-way splitter (one input, N outputs) consists of resistors and ideal inverting transformers—with a 1:-1

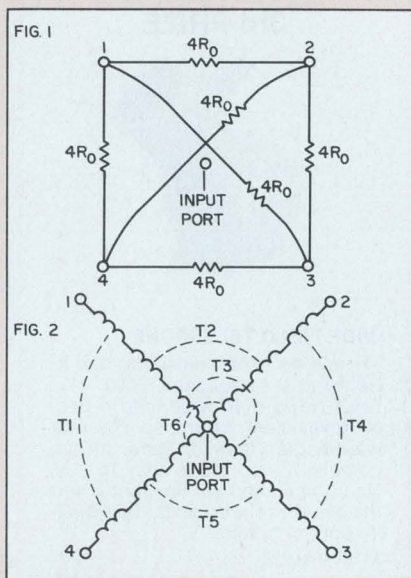

NSITY • HI-DENSITY • HI-DENSITY • HI-DE CONNECTORS

These two-piece, Hi-Density connectors offer the best combination of cost and performance available. They are ideal for use on single sided, double sided and multilayer boards and are well suited for applications where shock and vibration are a factor (tests show better than 200 Hz at 20 g.).

- Easy contact removeability to replace worn or broken pins
- Polarization with or without loss of contact.
- Shrouded male plug prevents accidental damage to pins.

For Full Details & Information, contact your local VERO representative or write to us directly at:

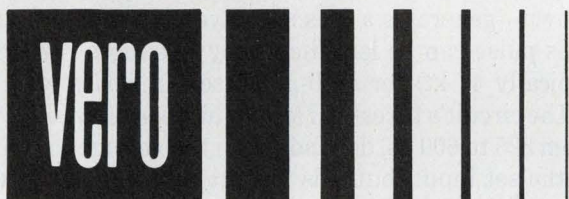

171 Bridge Road, Hauppauge, N.Y. 11787
(516) 234-0400 TWX: 510-227-8890

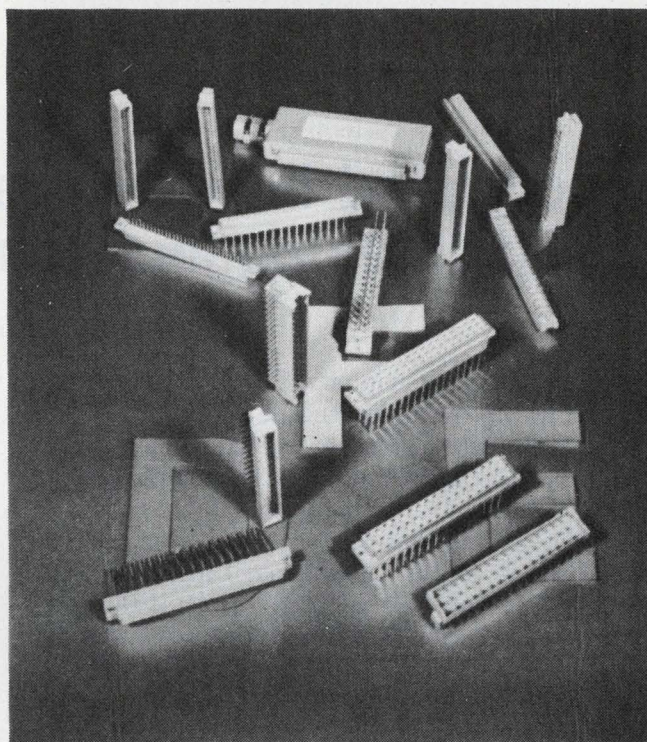

CIRCLE NUMBER 38

CONFORMER

Just add a little heat and Essex /Stancor Heat-Shrinkable Tubing conforms to your every need.

Even when the heat's not on, our new line of tubing and sleeving outperforms them all. At Essex, we engineer for performance and doublecheck for quality. No matter how tough the application, we have you covered. Essex/Stancor products are available off-the-shelf from electronic distributors everywhere. For more information, see your local distributor or write us for our free catalog:

Essex/Stancor, 3501 W. Addison St.,
Chicago, IL 60618, 312/463-7400.

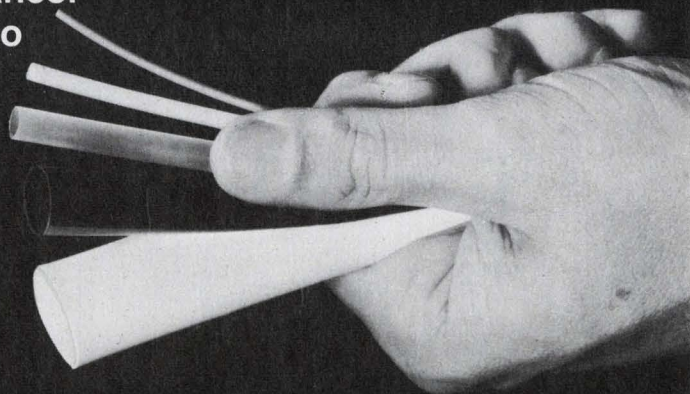

**ESSEX
GROUP**



Subsidiary of
**UNITED
TECHNOLOGIES**

CIRCLE NUMBER 39

Optocoupled line-receiver input discriminates against narrow noise pulses

The simple optocoupled interface in Fig. 1a connects a data line to the receiving end of a data link that features pulse-length discrimination to enhance noise-pulse rejection. A rugged red LED, D₁, can bypass any reasonable fault currents to protect the relatively fragile optocoupler input diode.

Normal 20-mA signal pulses about 1 ms wide pass about 15 mA through the LED and cause it to emit a visible flash for each pulse—a useful test feature. The LED's peak current rating—1A for 1 μ s—enables the circuit to handle most transients safely.

During an input pulse, capacitor C discharges with time constant CR₄; during quiescent periods C recharges with a shorter time constant, CR₃. If the input pulse is so short that C can't discharge below the set threshold-voltage of the circuit's set/reset bistable, the circuit remains in its set state and no output is generated. If the pulse is longer, at the end

of the input pulse the bistable is briefly reset, before being set again when C recharges.

Thus, each input pulse greater than the threshold length—about 500 μ s with the component values shown—generates a 6- μ s negative-going output pulse. This pulse can be lengthened by putting a resistor—typically 47 k Ω for a 30- μ s pulse—in series with D₂.

The circuit's threshold length has been found to vary from 325 to 600 μ s, depending on the voltage threshold of the set input, but this variation isn't important in our application. Of course, the threshold length can be adjusted by changing the time constant CR₄.

T.M. Napier, MSc., Electronics Engineer, Radiation Protection Group, CERN European Organization for Nuclear Research, 1211 Geneva 23, Switzerland.

CIRCLE NO. 311

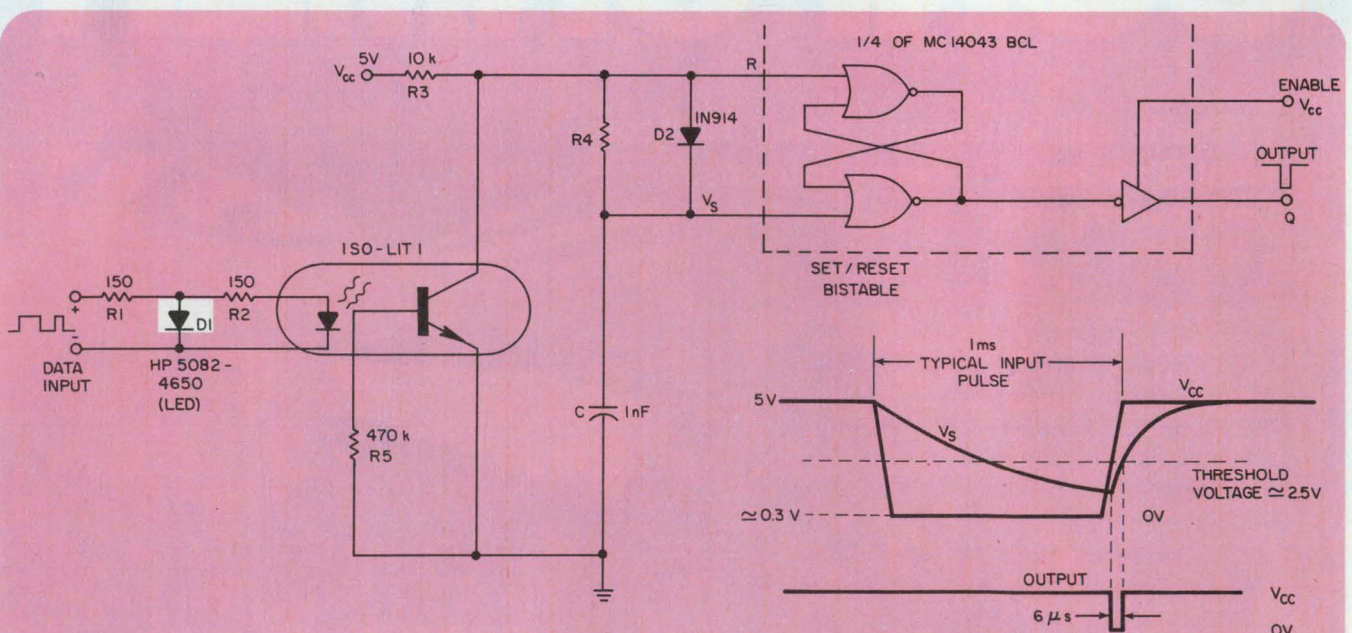

1. An optically coupled data-line receiver input uses a LED to protect the optocoupler unit from over-

loads. Also, the LED shows a visual flash when data are being received.

HERE'S YOUR CHANCE TO TRY FIBEROPTICS.



Here for the first time is a reasonably priced, off-the-shelf fiber optic engineering kit with all the electronic and mechanical components necessary for use in TTL systems up to 5 mbps.

Augat developed it to give engineers a quick and easy way of evaluating the exciting new technique of fiber optic interconnection in their existing or prototype systems. The price

give you all you need to know to use it... even assuming no prior experience in fiber optics.

The kit contains a 5-meter length of Hytel†-jacketed cable terminated with ferrules that have precision ground and polished ends. All connector

5 mbps over a temperature range of 0 to 55°C without drifts or inadvertent comparator switching usually associated with non-temperature referenced pre-amps.



Cable Assembly

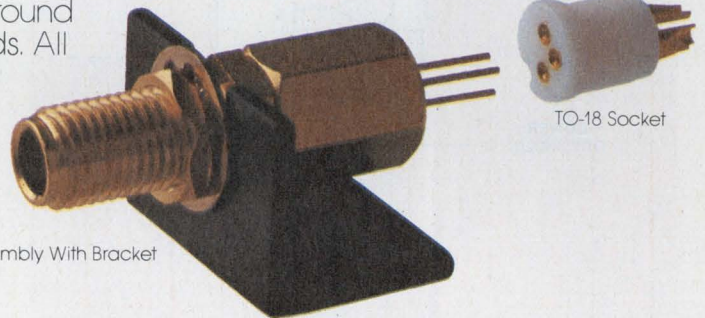

Detector Assembly With Bracket

TO-18 Socket

is right.* And the kits are in stock at Augat's nearly 200 worldwide distributor locations.

The combination of the kit's driver, emitter, cable assembly, pre-amp, and detector provide the necessary elements for a complete TTL-compatible digital fiber optic system. We've even included mounting brackets and sockets for convenience. And its comprehensive instruction manual will

elements feature gold-plated brass construction to ensure the integrity of shielded enclosures.

The temperature referenced pre-amp operates from dc to

All components of the kit are available separately. Standard accessories include butt splices, o-ring seals, and cables of other lengths. For more details and a list of Augat distributors, write Augat, Inc., 33 Perry Avenue, P.O. Box 779, Attleboro, Mass. 02703.

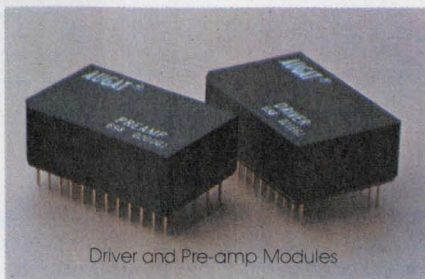

Driver and Pre-amp Modules

AUGAT®

Augat interconnection products. Isotronics microcircuit packaging, and Alco subminiature switches.

*Complete Kit (No. 698-OK-002): \$190. Kit less driver and pre-amp (No. 698-OK-001): \$99.50.

†Dupont trademark

Ideas for design

Upper and lower thresholds can be set independently in latching-comparator circuit

Here's a simple way to provide hysteresis in a comparator circuit that overcomes the problems of conventional hysteresis circuits. It uses two comparators and a set-reset latch (Fig. 1a). The circuit is used to "clean up" noisy inputs to digital systems.

The usual way of introducing hysteresis employs positive feedback around the comparator. But the amount of hysteresis is a function of the feedback ratio, which is affected both by input impedance and output voltage. These interactions make independent control of threshold and hysteresis difficult.

In the set-reset latch circuit, the two thresholds can be adjusted independently to the limits of the required dead band. When an input exceeds the upper threshold, the latch sets to provide a ONE output. Only an input below the lower threshold can then reset the output to ZERO. Inputs within the dead band produce low levels at both comparator outputs, and the latch isn't affected.

A fast, single-chip implementation of the latch

circuit uses a Signetics NE 521 dual comparator (Fig. 1b). The chip includes Schottky TTL-gated outputs, which are connected to form a latch.

Another advantage of the latched-comparator circuit is that it can be modified so that data are clocked into the latch only during specific intervals. Instead of a set-reset flip-flop, use a j-k flip-flop with the dual comparator (Fig. 2). Not only are data clocked, thus ignoring any noise spikes or false levels between clock transitions, but hysteresis applied to the valid input data can't be affected by such spikes. The output of the flip-flop can change only when both the input is above (or below) the dead band and a clock edge goes low.

R. S. Viles, Technical Specialist, Xerox Research (UK) Ltd., 99 Bridge Rd. E., Welwyn Garden City, Hertfordshire AL7 1LQ, England.

CIRCLE NO. 312

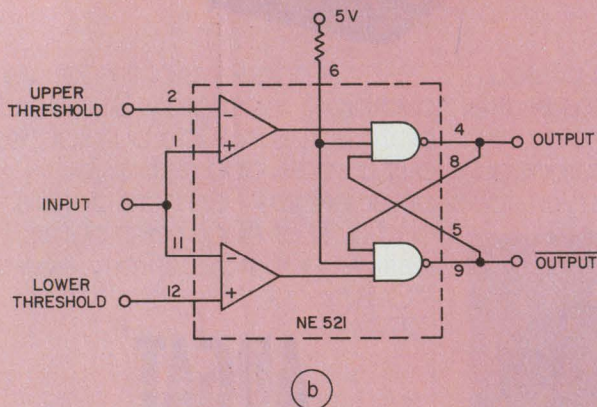
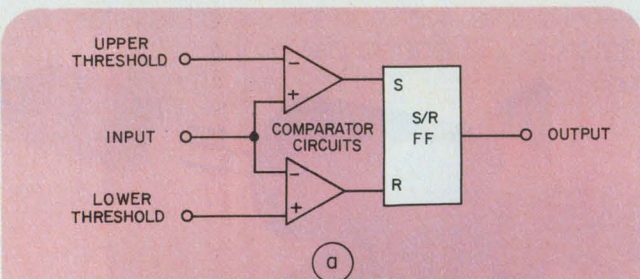

1. A set-reset flip-flop allows hysteresis to be introduced into a comparator circuit. And the threshold levels of the dead band can be set independently of each other.

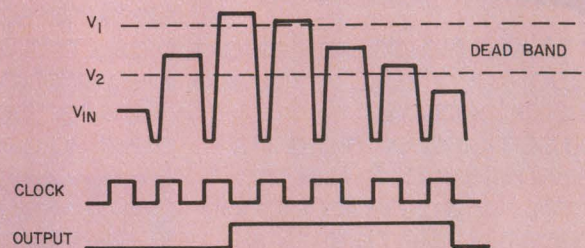
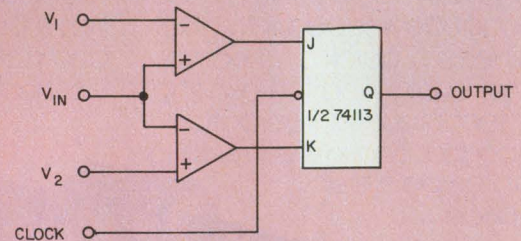

2. A j-k flip-flop following the comparators allows the circuit to be clocked to synchronize input data. In addition to hysteresis from the comparators, clocking helps reduce noise rejection even further.

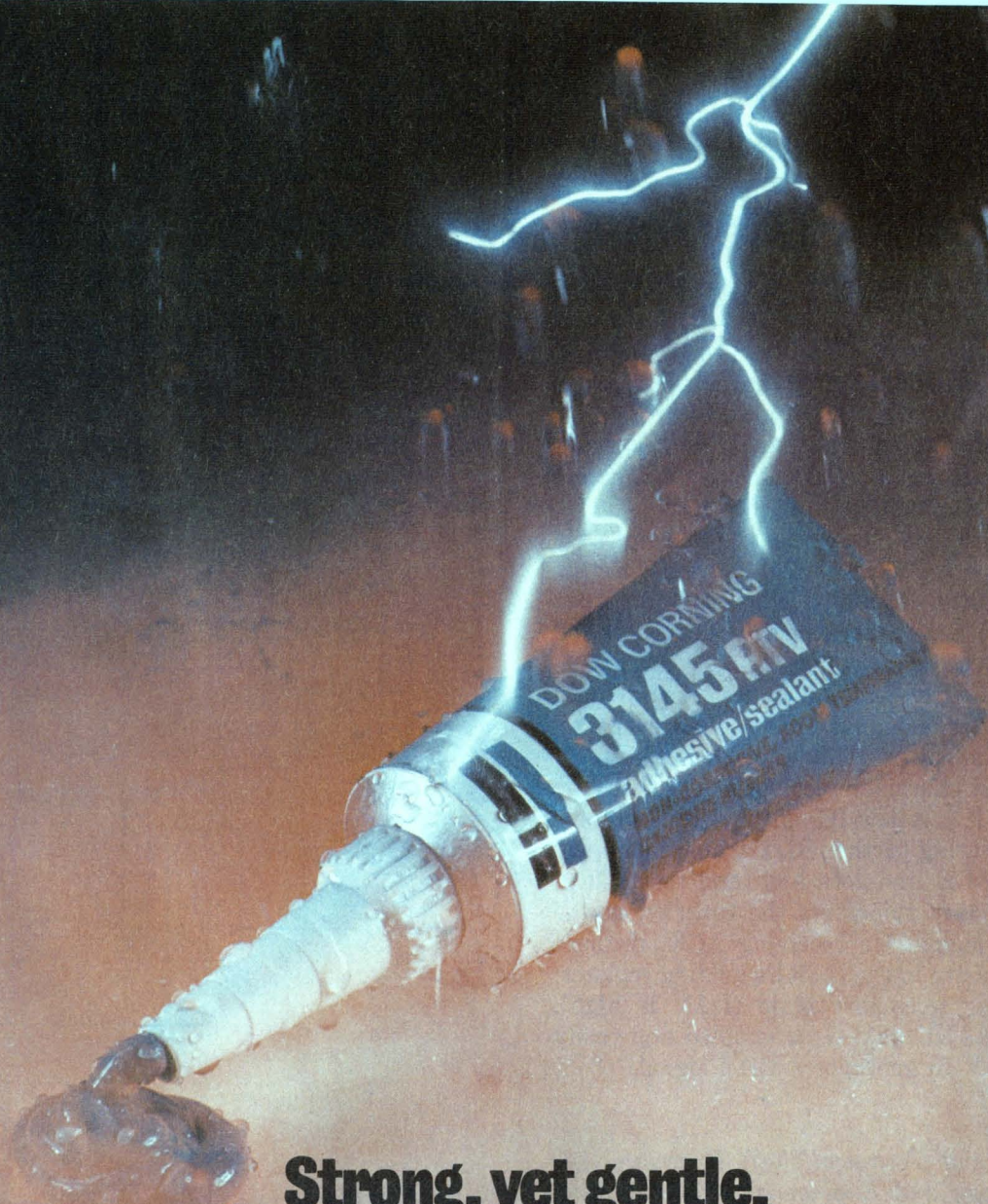

Strong, yet gentle.

That's why you should use Dow Corning® 3145 silicone rubber adhesive/sealant for your critical bonding and sealing jobs on electrical/electronic equipment.

Because it's strong, Dow Corning 3145 sealant easily withstands extended exposure to harsh environments. It's stable from -65 to 250 C. Has excellent tear strength. Resists moisture. Protects against high-voltage leaks. And virtually never needs maintenance.

Because it's gentle, you can safely use Dow Corning 3145 sealant on any material. Its noncorrosive cure won't affect copper or corrosion-sensitive equipment.

Besides meeting Mil Spec MIL-A-46146, Dow Corning 3145 is also recognized under the Component Program of U.L. up to 180 C for elongation, and up to 200 C for adhesion and dielectric strength.

When your application demands high performance—from mounting resistors to sealing or gasketing high-temperature electrical components—choose the sealant that's tough but doesn't hurt. Dow Corning 3145 sealant.

For complete facts, write Dow Corning Corporation, Dept. A-7540, Midland, Michigan 48640. Tell us about your application and we'll send a free sample.

DOW CORNING

DOW CORNING

CIRCLE NUMBER 41

Use double-buffer characteristic of a UART and still avoid overrun errors

You can use the double-buffer characteristics of a UART to speed data communications with a simple handshake structure. When the UART in the figure receives and transfers a character to its holding register, its output labeled DAV goes high.

Output DAV remains in this state as long as a character remains in its register. However, if \overline{RDAV} doesn't go low after a second character has been received, the UART may receive a third character and produce an overrun error.

The handshake circuit in the figure depends on a received acknowledge signal (ACK) to prevent an overrun. On initial power-up, R_1 and C_1 reset both IC₁ and IC₂. The first character received makes \overline{RDY} go low, which sets IC₂. A low IC₂ output from \overline{Q} stops DAV from generating further \overline{RDY} transitions until the handshake ACK line goes high and resets IC₂.

The \overline{RDY} signal supplements the function of the UART's \overline{RDAV} signal. On receiving ACK, if there should be a character in the UART's holding register, \overline{RDY} immediately goes low again (DAV is high). Otherwise, the NAND gate G₁ is enabled and ready for the next DAV to generate a \overline{RDY} signal.

Ban Bong, Senior Technical Staff Engineer, Advanced Technology and Engineering Dept., Collins Government Telecommunications Group, Rockwell International, Cedar Rapids, IA 52406.

CIRCLE NO. 313

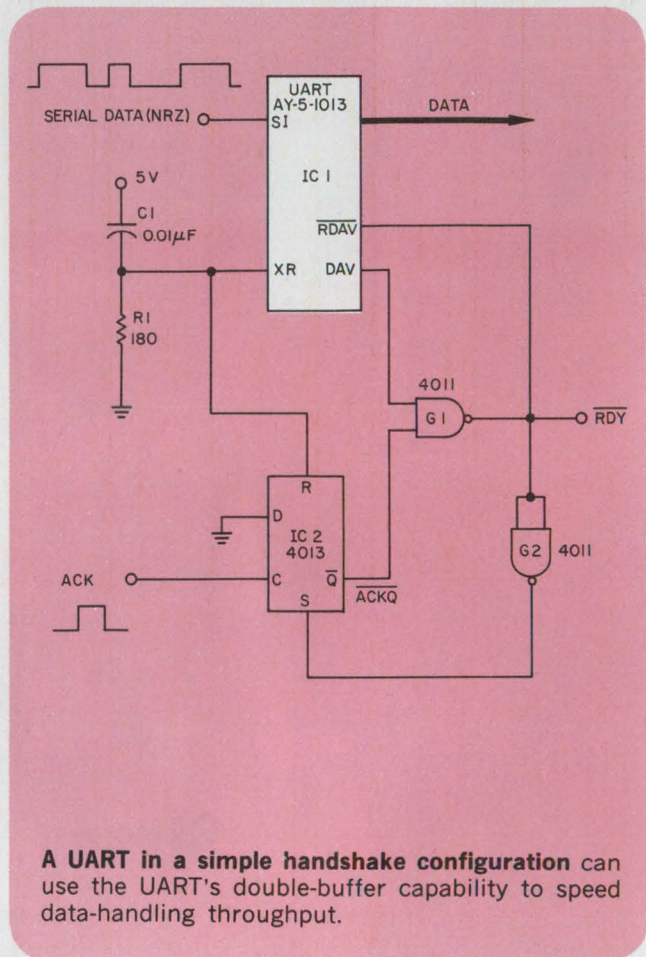

IFD Winner of August 16, 1977

Mike Yakymyshyn, Edmonton Telephones, 10405-104 Ave., Edmonton, Alberta, Canada T5J-OK7. His idea "Control the Speed and Phase of a dc Motor by Comparison Against a Control Frequency" has been voted the Most Valuable of Issue Award.

Vote for the Best Idea in this issue by circling the number of your selection on the Reader Service Card at the back of this issue.

SEND US YOUR IDEAS FOR DESIGN. You may win a grand total of \$1050 (cash)! Here's how. Submit your IFD describing a new and important circuit or design technique, the clever use of a new component or test equipment, packaging tips, cost-saving ideas to our Ideas for Design editor. Ideas can only be considered for publication if they are submitted exclusively to ELECTRONIC DESIGN. You will receive \$20 for each published idea, \$30 more if it is voted best of issue by our readers. The best-of-issue winners become eligible for the Idea of the Year award of \$1000.

Pretty face

REPEAT

UP

DOWN

COMP

STOP

YES NO

OUT

A B

C D

1 2

Sound design

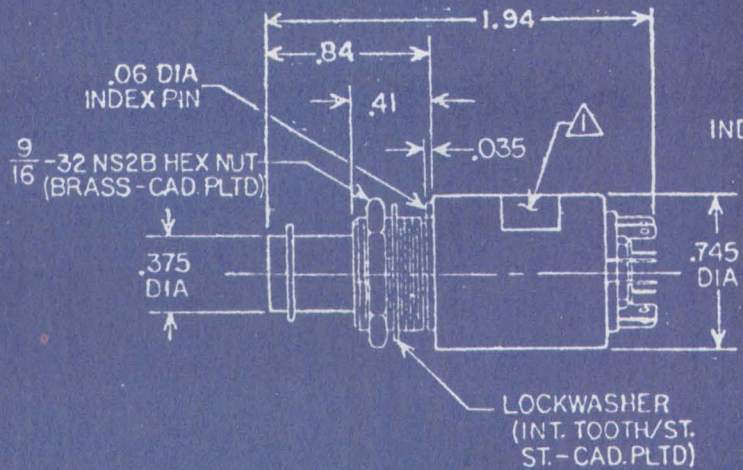
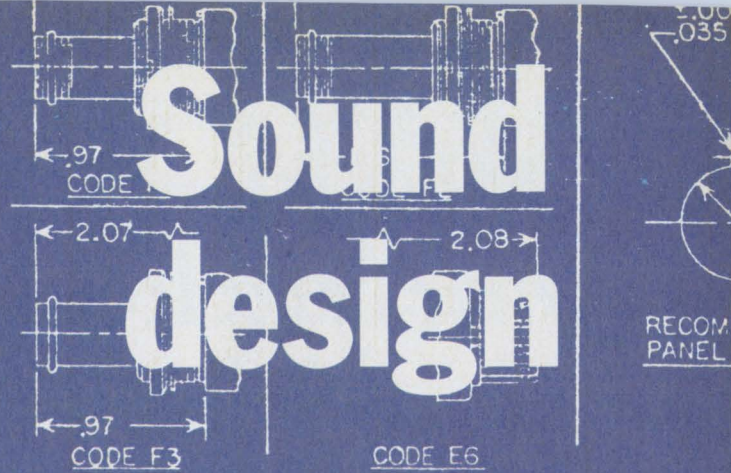

CODE	MODIFICATION DESCRIPTION
*D4	O-RING (ETHYLENE PROPYLENE) ON PLUNGER, EPOXY
*D5	SILICONE RUBBER BOOT, SEALED AT CASE NECK, BEA EPOXY SEALED BASE.
E3	SWITCH CONTACTS AND TERMINALS GOLD PLATED FOR RESISTANCE APPLICATIONS AND GREATER SOLDERABIL
E4	PROVIDES LAMP CIRCUIT WITH MAKE & BREAK CONTACT OF SWITCH CONTACTS. LAMP GOES ON WHEN PLU PROCEED, GOES OFF WHEN PLUNGER IS RELEASED.
E5	ALL NORMALLY OPEN SWITCH CONTACTS CLOSE BEFORE CLOSED CONTACTS OPEN.
E6	PROVIDES SWITCHLIGHT TERMINALS THAT ACCEPT AMP RECEPTACLES (0.016 TAB STYLE A).
F1	SINGLE LIGHT GANGSWITCH MOUNTING (MECHANICALLY PROVIDES PLUNGER LENGTHENED 0.125 IN.. PLUNGER SPANNER NUT FOR MOUNTING.
F2	MULTI-LIGHT GANGSWITCH MOUNTING (MECHANICALLY PROVIDES PLUNGER LENGTHENED 0.312 IN.. PLUNGER SPANNER NUT FOR MOUNTING.
F3	GANGSWITCH (NON-INTERLOCKED). PROVIDES PLUNGER 0.125 IN. AND SPANNER NUT FOR MOUNTING.
F4	SWITCHLIGHT FURNISHED WITH ROUND SPANNER NUT I STANDARD HEX NUT.
G2	SWITCHLIGHT SUPPLIED WITH LOWER (16 OZ) OPERAT

Just what you'd expect from CLARE.

Bright. Handsome. And functional.

Clare switchlights and gangswitches offer wide versatility to the front panel designer to meet most human engineering requirements. And behind the visual esthetics are the reliability, practical design and manufacturing skills that mean quality that is usually found only in custom switchlights. Just what you'd expect from Clare. Write

or call for complete details on the Pendar series switchlights and gangswitches. C. P. Clare & Company
3101 W. Pratt Avenue, Chicago, IL 60645. (312) 262-7700.

We help you compete

C. P. CLARE & COMPANY
GENERAL INSTRUMENT CORPORATION



We've just terminated your flexcircuit connector cost problems... without sacrificing reliability.

**Burndy Flexlok™ connectors combine
high-reliability with low-cost design
to slash installed costs 66%.**

Now, for less than 1¢ per contact, you can enjoy all of the design and production benefits of flexible circuitry and flat cable.* That's a lot less than the 3¢ to 10¢ you'd normally expect to pay with other connectors.

But Flexlok not only costs less initially, it costs less to install. That's because it comes fully assembled, inspected and ready for soldering and cable insertion. *No separate handling. No loose contacts to assemble. No assembly machines or tools. No special operator training.*

What's more, these savings are all yours without sacrificing reliability. That's because Flexlok connectors feature Burndy's patented GTH™ contact design that delivers gas-tight, high-pressure, good-as-gold contact even under adverse environment. Hard to believe? The proof is in the cost comparisons and performance data shown below.



*Flat-flat and flat-round types.

BURNDY CONNECTS

INTERNATIONAL SALES AND MANUFACTURING: BRUSSELS, BARCELONA, PARIS, ROTTERDAM, STOCKHOLM, STUTTGART, TURIN, ZURICH, ST. HELENS (ENG.), TORONTO, SYDNEY, TOKYO, MEXICO CITY, SAO PAULO.

Here's proof!

FLEXLOK COST COMPARISON

	GTH Flexlok FC & RC	Clamp Type Pressure Tin	Insulation Displacement	Insulation Piercing	Solder Connections
Piece Price* (per line)	1¢+	2¢-3¢	3¢-5¢	5¢-10¢	5¢-10¢
Special Conductor Preparation	None	Required	None	None	Required
Installation Tooling (Purchase/Rental)	None	Yes	Yes	Yes	Yes
Operator Training Required	None	None	Skilled	Skilled	Skilled

*In Quantity

†Average price.

FLEXLOK DESIGN FEATURE COMPARISON

Design Simplicity	1 piece	2 pieces or more	2 pieces or more	2 pieces or more	2 pieces or more
Conductor Types Accommodated	Round Flat Flex. P.C.	Flat Flex. P.C.	Round	Round Flat	Round Flat Flex P.C.
Top or Side Entry Available	Yes	No	No	No	No

FLEXLOK PERFORMANCE DATA

Contact Resistance Test Data		MIN.	MILLIOHMS MAX.	AVG.
Test Group 1	Initial Contact resistance	7.00	7.60	7.26
	After thermal shock	7.10	7.50	7.25
	After durability (5 cycles)	7.10	7.80	7.39
	After moisture resistance (10 days)	7.20	8.70	7.68
	After vibration	PASSED		
	After mechanical shock	8.20	25.20	12.30
Grp. 2	Insulation resistance (megohms X 10 ⁶)	.002	9.50	5.26
	Dielectric withstanding voltage No breakdown @ 500V AC	PASSED		
	Initial contact resistance	7.00	7.50	7.25
Grp. 3	After thermal shock	7.20	7.90	7.46
	Ammonium Sulfide exposure (3 min.)	7.20	8.00	7.59
Grp. 3	Initial contact resistance	7.10	7.50	7.25
	After gas tightness	7.00	7.60	7.24

Report No. G7515-755 (Summary) Mated with tin/lead plated flexible printed circuitry.

For details, call or write: Burndy Corporation, Norwalk, Connecticut 06856 (203-838-4444).

 **BURNDY**
Offices in principal cities throughout the United States

CIRCLE NUMBER 43

Temperature controller keeps components out of the ovens



Thermonics, Inc., 750 N. Mary Ave., Sunnyvale, CA 94086. Jim Kufis (408) 733-6122. \$4950; 30 days.

Component-temperature tests come out of large temperature chambers and right to the lab or production bench with the T-2050 precision temperature forcing system. In a chamber that is just slightly larger than a component being tested, temperatures can be controlled accurately and quickly from -60 to 150 C, which is wider than the military spec range.

Tests are performed without having to modify test equipment or remove components from PC boards. Not only that, but with the T-2050, Thermonics claims to have eliminated the problems of temperature gradients, repeatability errors, moisture, frost, long leads and high-frequency ringing that occur with ovens, temperature chambers, bell jars, fluorocarbon baths and temperature probes.

Temperatures within ± 1 C are achieved over the full range by directing a continuous stream of dry nitrogen over a device under test. A remote

temperature sensor close to the DUT closes the loop, and feeds the proprietary proportional-control temperature controller. So the DUT is immersed in a stream of dry gas that forces, then maintains the precise temperature set by the operator.

Test temperature is set with a knob that controls the set-point reading on the digital display. The operator sets gas flow rate, using a lockable 10-turn pot to choose a volumetric flow rate between 100 and 600 standard ft^3/h , which can produce linear velocities greater than 2000 ft/min .

"Because we move the gas over the DUT at a high flow rate, we can guarantee precise temperature repeatability of ± 0.5 C and accuracy and stability of ± 1 C, says Jim Kufis, Thermonics president. "Also, the gas flow can be increased to dissipate component heat up to 60 W. Fast flow is the key to the exact repeatability of test results."

Operation is simple. Connect the LN_2 container, insert the DUT in the test fixture, turn power on, and select the desired test-temperature and gas flow.

The rest is automatic.

When performing only hot tests, the system may be connected to a source of N_2 or dry air instead of LN_2 . The digital readout on the temperature controller can be switched to show either the temperature selected or the actual DUT temperature. An analog panel meter indicates the volumetric gas flow, which determines the speed of temperature changes. The system's thermal response allows full-range temperature change, from -60 C to 150 C or vice versa, in just 7.5 min.

Designed to be compatible with virtually all manual and automatic test systems, the T-2050 can be used with several types of fixtures that incorporate the gas outlet and temperature sensor. These include a general-purpose thermal cap, a thermal test socket for ICs, and a thermal rail for component handlers, which presoaks ICs to temperature before they reach the test head.

"An unusual use is to temperature-test hybrids before encapsulation," Kufis points out. "We may also be able to provide the ability to temperature-test circuits while they are still in the wafer stage."

Designed for bench-top operation and movable from one work area to another, the T-2050 weighs 40 lb and measures $17 \times 17 \times 14$ in.

CIRCLE NO. 301

Logic-state analyzer plugs into Tek scope

Scanoptik, P.O. Box 1745, Rockville, MD 20850. Jerry Shumway (301) 977-9660. \$3250; 8 wks.

Logic-state analyzer, LC-732, plugs into Tektronix 7000 oscilloscopes. The single-module unit has 32-channel capability and fits in a four-wide scope without affecting normal scope operation. For triggering, the device matches a 16-bit μC address bus or 8-bit data bus, or both combined for a full 24-bit word trigger. After address match, there is a digital delay capability up to 65,000 counts. The memory stores 64 words of 32 inputs, and presents the information in hexadecimal characters on the scope.

CIRCLE NO. 303

Don't waste money and ruin PROMs. Move up to a first-rate programmer.

What defines a first-rate programmer?

A first-rate programmer is easy to use, safe (U.L. listed), reliable, backed with a long-term warranty, and flexible enough to handle advances in PROM technology, a combination you get only with a Pro-Log programmer.

Our systems take the mistakes out of programming.

Our Series 90 PROM Programmer walks you through the programming process so there's less chance for misprogramming. Separate sockets for master and copy PROMs make it impossible to accidentally destroy a valuable master.

Vendor-approved programming, full portability, free 2-year warranty.

Using vendor-approved PROM personality modules, Pro-Log's field-proven programmers program every major MOS and bipolar PROM. They also program generic PROM families and do gang programming.

They weigh less than 20 pounds so they go where you need them. And they're backed by the longest warranty in the industry, 2 full years parts and labor.

A first-rate programmer is economical, too.

A Series 90 master control unit costs only \$1,800. A Series 92 PROM Duplicator master control unit costs only \$1,145. Single PROM personality modules cost from \$325 to \$450. Generic modules start at \$350. Gang modules which program 8 PROMs simultaneously are \$895. All modules come U.L. listed and fit both the Series 90 and the Series 92. Options include CMOS RAM buffer (to 4K bytes), RS-232 (terminal or modem) interface, TTY, parallel interfaces, paper tape reader, U.L. listed erase light, checksum option, and Auto-baud.*

Find out what else a truly first-rate programmer has to offer.

Call or write for a free pamphlet giving you comparison checkpoints. Pro-Log Corporation, 2411 Garden Road, Monterey, CA 93940. Phone (408) 372-4593.

 **PRO-LOG**
CORPORATION

Microprocessors at your fingertips.

*Trademark, Pro-Log Corporation.

CIRCLE NUMBER 44



Adapter converts scope to logic analyzer

Mid-South Instrument Services, P.O. Box 1252, Gretna, LA 70053. (504) 393-0450. \$74.95; stock.

The MS-1 multiplexer switch is a compact adapter for converting any single channel oscilloscope into a multichannel logic analyzer. The adapter features 2, 4 or 8 channels of displayed data which are switch-selectable, and it operates in either chop or alternate-sweep modes. Up to eight data lines may be sampled, while displaying the digital-logic levels and timing relationships on the scope. Each input channel is multiplexed through an analog switching device, so that waveforms as well as logic levels are preserved. Size is $5\frac{1}{2} \times 3 \times 1\frac{1}{4}$ in. With a 9-V battery, the current drain is less than 6 mA.

CIRCLE NO. 304

Digital-pulser probe boasts bit of automation

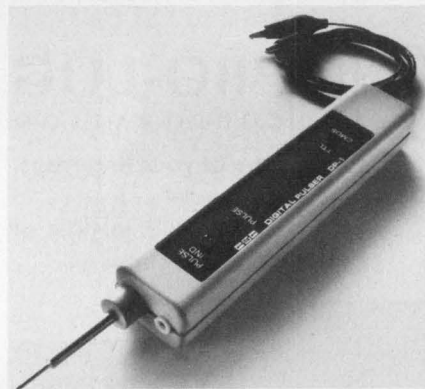

Continental Specialties, 44 Kendall St., New Haven, CT 06509. (203) 624-3103. \$74.95.

In digital pulser, DP-1, internal circuitry monitors the node being probed, then presets the dual-mirror output circuitry to pulse the node the other way. The probe delivers a 50-mA pulse in the CMOS mode, 100 mA in the TTL mode, to kick most lines with no need to desolder, unplug or isolate. Power is derived from the circuit being tested, and a switch selects threshold levels to trigger either CMOS or TTL. If the pulse pushbutton is held down for more than a second, the probe delivers trains of about 100 pulses/s.

CIRCLE NO. 305

Frequency counter has period mode, too

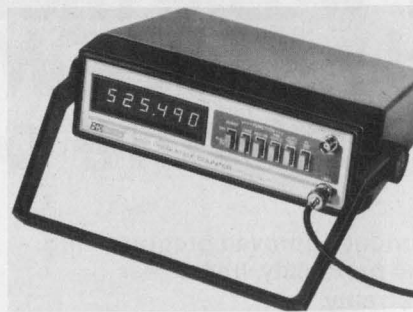

B & K-Precision, 6460 W. Cortland Ave., Chicago, IL 60635. Myron Bond (312) 467-1326. \$450; stock.

Model 1850 frequency counter measures from 5 Hz to 520 MHz with a period measurement capability from 5 Hz to 1 MHz. The counter is fully autoranging in either auto or prescale modes, with automatic decimal point position and MHz/kHz readout. The display is a six-digit, 0.43-in.-high LED, with leading-zero blanking. A TCXO time base is standard for 1-ppm stability over a 0 to 50 C range. For period measurements, resolution is 1 ns. The function switch selects μ s (100-period average) or auto-display reading. In auto, a one-period or a 10 or 100-period average is selected.

CIRCLE NO. 306

Gen pulses to 10 MHz with 5-ns rise/fall time



Dytech, 2725 Lafayette St., Santa Clara, CA 95050. (408) 241-4333. \$185; stock to 4 wks.

Pulse generator, Model 750, has rise and fall times of less than 5 ns over a range of 10 Hz to 10 MHz. The output is variable from 0 to 10 V across a high impedance and 0 to 5 V across a 50- Ω load. Pulse widths and delays are adjustable from 50 ns to 100 ms. The trigger output is a fixed-width square wave of less than 50 ns and 5 V, open circuit. Both the external and gate inputs can be driven by low-power logic, an ac signal or by another 50- Ω generator.

CIRCLE NO. 307

Resolve down to 0.1 $\mu\Omega$ with digital ohmmeter



Valhalla Scientific, 7707 Convoy Ct., San Diego, CA 92111. (714) 277-2732. \$2495; stock.

The Model 4275 digital ohmmeter resolves 0.1 $\mu\Omega$. Measurement range covers 1 m Ω to 100 Ω . Test current on the most sensitive range is 10 A with a minimum compliance voltage of 10 V dc. Six decade ranges are pushbutton selectable with 100% overrange capability. Heavy-duty, industrial-grade, gold-plated Kelvin clip cable sets terminated in Bendix connectors are available in lengths up to 20 ft. Options include automatic temperature compensation, BCD outputs and rack adapter.

CIRCLE NO. 308

16-channel digital latch mates with Tek scope

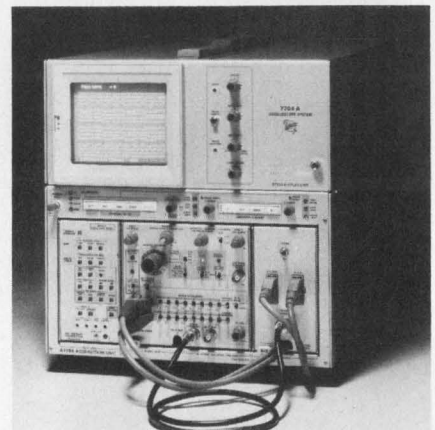

Tektronix, P.O. Box 500, Beaverton, OR 97077. Wyn Giluck (503) 644-0161. \$1475; 4 wks.

The company's logic-analyzer line using 7000 series oscilloscopes has been extended with the 16-channel DL2 digital latch. This module provides the designer using a 7D01 logic analyzer the ability to latch pulses occurring asynchronously to systems activity. The pulses can be as narrow as 5 ns at the probe tip, with an amplitude as small as 500 mV centered on a threshold set by the user. The P6451 data-acquisition probes connect to the DL2 which then interfaces to the 7D01.

CIRCLE NO. 309

If you think logic analyzers, recorders or scopes are the only way to debug digital circuitry, you're wrong.

We'll You'd like to take the
show you. guesswork out of debugging
the complex circuitry you've
designed. Make it less of an art
and more
of a science.

You'd like to have a known, stable signal to input to your circuit, so you can tell whether its output is on target. But the multiple pulse or wave generators, flip flops, logic gates or other gear you've been using to generate your word and timing patterns just aren't enough. You can't program them easily or with any guarantee they're accurate.

You'd rather have a single instrument that has multiple channels and is easily programmed. So you can input *exact* duplicates of the real programs your circuit will be handling. So you can tell at a glance whether your output is right.

But nobody makes a single unit like that, right? Wrong!

Interface Technology is going to show you.

We'll show you a self-contained, low-cost, small digital debugging tool for \$2,500 and up. A multi-channel, microprocessor-controlled data and timing generator that's programmable with only 16 instructions. A general purpose tester that can generate large amounts of digital data, that's interactive, can respond to external stimuli and make decisions. A benchtop instrument that can be used rack-mounted as part of a computer-driven system, or as the core of a low-cost, stand-alone digital test system.

We'll show you how our multi-channel programmable digital systems can lower your design time. We'll show you how you can be *sure* about your final product. And we'll show you how we're already working for people like General Dynamics, Rockwell and Hughes and how we can work for designers like you.

We'll put the whole show on the road and demonstrate our digital test systems for you in person. And all you have to do is call collect: (213) 966-1718. Or write to the address below.

interface
TECHNOLOGY

852 North Cummings Road • Covina, California 91724 • (213) 966-1718

CIRCLE NUMBER 45

The "Most Portable" portable recorders ...by GULTON



Portables you can really carry. Our 2 channel portable weighs under 30 lbs. and our 8 channel unit weighs only 65 lbs.

Compact size is equally important in a portable instrument because this determines ease of handling. The Gulton 8 channel recorder (our largest) measures an extremely compact 17½" x 19" x 6". And this small size includes plug-in signal conditioners.

Compare these specifications with other so-called portable multichannel recorders. Write or call for 12 page portables catalog.

gulton®

Measurement & Control Systems Division
Gulton Industries Inc., East Greenwich, Rhode Island 02818
401-884-6800 • TWX 710-387-1500

CIRCLE NUMBER 46

RF detectors for every application

100 kHz to 18.5 GHz
Field replaceable diodes

You can get the detector suited to your needs from WILTRON's broad line.

And in all of these high-performance detectors the diodes are field replaceable.

Note, too, the variety of available connectors: BNC, N, APC and SMA (see table).

Discounts to 15% in quantity. Stock delivery.

Call Walt Baxter at WILTRON now for details.

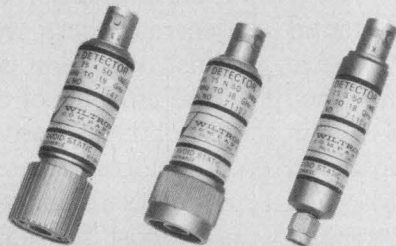

Model	Range	Connectors In	Out	Flatness	Price \$
71B50	100 kHz-3 GHz	BNC Male	BNC Fem.	±0.5 dB	70
73N50	100 kHz-4 GHz	N Male	BNC Fem.	±0.2 dB	75
74N50	10 MHz-12.4 GHz	N Male	BNC Fem.	±0.5 dB	145
74S50	10 MHz-12.4 GHz	SMA Male	BNC Fem.	±0.5 dB	165
75A50	10 MHz-18.5 GHz	APC-7	BNC Fem.	±1 dB	190
75N50	10 MHz-18.5 GHz	N Male	BNC Fem.	±1 dB	170
75S50	10 MHz-18.5 GHz	SMA Male	BNC Fem.	±1 dB	170



825 EAST MIDDLEFIELD ROAD • MOUNTAIN VIEW, CA 94043 • (415) 969-6500 • TWX 910-379-6578

CIRCLE NUMBER 47

DATA PROCESSING

Flexible disc system is fully programmable



Tri-data, 800 Maude Ave., Mountain View, CA 94043. Melinda Magnett (415) 969-3700. \$1995.

FlexiFile, a flexible disc system, can be used for program loading, data logging, and on-line data collection, and is fully user-programmable from its front panel. A text-editing software package is included which features insert and delete, file merging and character-string search. Equipped with the RS232 and/or current loop interface, the device will accommodate a terminal and modem simultaneously at independent baud rates. The user can prepare his data off-line and then batch-process it to a CPU at a high transfer rate.

CIRCLE NO. 320

Hi-density tape systems mate with CDC computers

Control Data, P.O. Box 0, Minneapolis, MN 55440. (612) 853-7600.

A series of high-performance magnetic tape subsystems that record data at densities up to 6250 bytes/in. is available for CDC's large-scale computers. The CDC 677 and 679 tape transports and 7021 controllers are for use with the CYBER 170, CYBER 70, and 6000-series computer systems running under NOS/BE and NOS operating systems. Six 9-track models of the 679 tape transports operate at speeds of 100, 150 or 200 in/s. Three models are offered with 800 or 1600 bit/in. densities, NRZI or phase-encoded (PE) recording. Three units feature 1600 bit/in. PE recording, or group-coded recording, at a density of 6250 bytes/in. All units provide data transfer at rates of 160,000 to 1.25 million char/s.

CIRCLE NO. 321

Tablet digitizer converts graphic data to digital

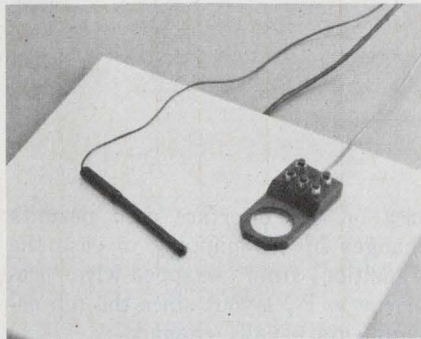

GTCO, 1055 First St., Rockville, MD 20850. (301) 279-9550. \$750 up (large qty).

The Datalyzer tablet digitizer, when used with a cursor and electronic controller, converts graphic data into a digital format for computer processing. The device provides graphic data inputting similar to a keyboard operation for inputting alphanumeric data. A crystal-controlled electromagnetic scanning method is used with a free-movement cross wire/pen cursor. Graphics can be digitized from source materials up to a thickness of 1 in. Standard tablets have an 11 × 11, 14 × 14, 11 × 17 and 20 × 20-in. active area.

CIRCLE NO. 322

Any popular mini reads these diskettes



Techtran Industries, 200 Commerce Dr., Rochester, NY 14623. (716) 334-9640.

Type 9512 micro-discs recorded on the Model 9512 recorder from any RS-232 terminal or data logger can be read on any popular minicomputer disc system. Diskettes generated on-line from the DEC, RCA or Intel systems can be read off-line by the micro-disc, back to an ASCII terminal or, via the RS-232 communications interface, to a remote location. The diskettes provide total random access by character string, easy editing, bidirectional skip and economical data storage and retrieval.

CIRCLE NO. 323

Video system is crammed onto 5 × 10-in. board

IOR, P.O. Box 28823, Dallas, TX 75228. (214) 358-2671. \$399; stock.

The VDS2K video system contains all address decoding necessary for both memory-mapped and isolated I/O on a 5 × 10-in. PC board that is fully S100-bus compatible. Video output is either XYZ-TTL compatible or composite video. A Greek, upper/lower case character with a 7 × 9 matrix in a 9 × 12 field is displayed with attribute availability. The actual display consists of 1920 char organized as 30 lines of 64 char plus a 128-char, nondisplayable buffer. There is 2 k of memory with under 500-ns read/write time. A screen of data can be changed in under 800 μs.

CIRCLE NO. 324

Cluster system accesses local databases fast

Delta Data Systems, Woodhaven Industrial Park, Cornwells Heights, PA 19020. Barry Maser (215) 639-9400.

The Model 6500 cluster-computer system is for storage and immediate access to local databases in a stand-alone or a distributed processing environment. The system permits up to eight video display terminals to share access to a processor, a host communications port, up to 1.5×10^6 char of storage and up to two printers.

CIRCLE NO. 325

Desktop unit scrambles for data security

Datotek, 13740 Midway Rd., Dallas, TX 75240. (214) 233-1030.

A portable, self-contained, desktop encryption unit, DC-26, has a full-size keyboard and thermal page printer. As the message to be enciphered is typed, the characters appear on a five-character LED display. By continued typing, the characters are shifted off the display, enciphered and printed. Messages are deciphered by entering the scrambled characters in five-character groupings, with the characters being successively shifted off the display, deciphered and printed. A key generator provides an almost infinite number of user-selected key variables (10^{52} possibilities), making the possibility of unauthorized interception extremely remote.

CIRCLE NO. 326

We'll show you:

PACIFIC COAST

Ward/Davis Associates
Lawndale, CA 213-542-7740
La Jolla, CA 714-459-3351
Sunnyvale, CA 408-245-3700

MID-ATLANTIC

Eastern Instrumentation of New York
Englewood, NJ 201-567-9505
Eastern Instrumentation of Philadelphia
Philadelphia, PA 215-927-7777
Naco Electronics
Syracuse, NY 315-699-2651
Utica, NY 315-732-1801
Fairport, NY 716-223-4490
Creative Marketing Associates
McLean, VA 703-893-6612

ROCKIES/SOUTHWEST

BFA Corporation of Arizona
Scottsdale, AZ 602-994-5400
Denver, CO 303-837-1247
Albuquerque, NM 505-292-1212
Las Cruces, NM 505-523-0601
Salt Lake City, UT 801-466-6522

NEW ENGLAND

Instrument Dynamics
Wakefield, MA 617-245-5100

SOUTH CENTRAL

Data Marketing Associates
Houston, TX 713-780-2511
Dallas, TX 214-661-0300
San Antonio, TX 512-828-0937
Austin, TX 512-451-5174
Norman, OK 405-364-8320

MIDWEST

Carter Electronics, Inc.
Minneapolis, MN 612-559-1976
Chicago, IL 312-585-5485
Indianapolis, IN 317-293-0696
Milwaukee, WI 414-464-5555
St. Louis, MO 314-569-1406
Overland Park, KS 913-649-6996

interface

TECHNOLOGY

Bit-slice development system looks like a compact instrument



Step Engineering, 154 San Lazaro Ave., P.O. Box 61166, Sunnyvale, CA 94086. Steve Drucker (408) 733-7837. P&A: see text.

An instrument for developing bit-slice microcomputers combines the functions of several ROM simulators, a logic analyzer, and a command-language CRT terminal in a single 5-1/4 × 18 × 20-in. package. The STEP-2 Microcode Array Simulator and Processor Diagnostic System is a new type of tool for checking out real-time firmware/hardware, diagnosing faults, and patching microcode.

Step Engineering prefers to call the STEP-2 an instrument, not a development system, because it has a fixed program, it's much more compact than earlier units, and it's easier to operate. Learning its 14 English-language interactive commands is just as easy as learning the functions and the controls of a scope or logic analyzer, according to the company.

The STEP-2 is small because it performs no software tasks. Instead it

concentrates its power on firmware/hardware checkout. Moreover, where doing an assembly would tie up the typical development system and halt hardware tests, the STEP-2's hardware checkout won't be disrupted because the software is developed elsewhere, in a mini or large computer, and transmitted to the STEP-2 through the RS232 interface. Also, a new assembly can be loaded down-line from another computer when it's needed.

To simulate the macrocode and microcode memories of the application hardware, the memory can be partitioned into two independent arrays that operate simultaneously. Up to 96 kbits of user memory in STEP-2 can be switch-configured efficiently for widths of 8 to 96 bits and depths of 1 to 12 k, and cycled at 20 MHz.

Plug-in memory interface cards provide three options to optimize connection to the user's system: nonbuffered for high-speed direct connection, buffered and latching. A wrapped-wire

area on the interface card permits changes in bit mapping to ease the transition from wrapped-wire prototype to PC layout since the pin assignments usually change.

Any bipolar ROM can be emulated by the STEP-2 regardless of ROM organization. Optional ROM emulator plug-ins enable the STEP-2 to interface directly with existing user PROM sockets. The STEP-2 user interface consists of a 5-in. CRT display and alphanumeric keyboards. The display features an 8-line × 32-character fully formatted, word-oriented output with 1/4-in. characters.

A full ASCII keyboard with separate cursor-control keypad and hex data-entry keypad controls the instrument, manipulates data and communicates with external computers.

Input to the STEP-2 comes through a serial-communications link, RS232, or a 20-mA current-loop, at 110 to 9600 baud. And with a modem interface, the STEP-2 can be hooked up to a time-sharing facility over a phone line.

A word-oriented object-code editor (in ROM) permits address information and object code to be displayed in either octal or hex. An "expand" feature permits a selected portion of object-code word to be displayed and modified in binary.

Several diagnostic outputs are provided to help with system debugging. What's more, processor activity can be monitored directly on the CRT. Multiple real-time breakpoints allow conditional-jump analysis. The breakpoint state is displayed on the CRT and duplicated on BNC connector outputs.

Program execution can be monitored with a real-time trace, which includes combinatorial breakpoint triggers with a cycle counter and programmable relationship between trace length and trigger.

Delivery is scheduled to begin this month with the real-time trace option to be available the first quarter of 1978. Prices start at \$9000, which includes 64 kbits of high-speed reconfigurable memory, and run to \$14,000, with all options.

CIRCLE NO. 327

Add-on memory provides 2 Mbytes for PDP-11/70

Monolithic Systems, 14 Inverness Dr. E., Englewood, CO 80110. Karen Garritano (303) 770-7400. \$9525; 6 wk.

An add-on memory, MSC 3602, for the DEC PDP-11/70, provides up to 2 Mbytes in a self-contained unit. It is expandable in 64-kbyte increments to 4 Mbytes with an additional 5¼-in. chassis. Access time of 500 ns and cycle time of 700 ns permit using the PDP-11/70's memory bus at the maximum data rate. MSC 3602 is a 10½-in. high freestanding or rackmount chassis that includes power supply and forced-air cooling.

CIRCLE NO. 328

I/O card provides real-time clock

Hewlett-Packard, 1501 Page Mill Rd., Palo Alto, CA 94303. Mike Malone (415) 493-1501. \$600; 4 wks.

An I/O card provides both a real-time clock and timing generator for use with the HP 9825A desktop computer. The HP 98035A card provides real-time information in months, days, hours, minutes and seconds. The device can interrupt at a specific time, after a time delay or a periodic interval. A counter is incremented every millisecond and an internal battery holds real time for up to two months. Error checking and external triggering is provided.

CIRCLE NO. 329

Controller has remote switch for 16 channels

International Data Sciences, 100 Nashua St., Providence, RI 02904. (401) 274-5100. \$1090; 4 wk.

Model 8962 controller and power module provides individual remote control for 16 channels of A, B switching when used with the Model 8931 remote control panel. It drives eight Model 8909 or eight Model 8914 two-channel modules used for front-end processor A, B switching of EIA or telephone line interfaces. The master control switches all 16 channels to A or B. Individual A, B switching is provided on each switching module or at the 8931 panel. LEDs display the status of 12 key signals.

CIRCLE NO. 330

μC card can be easily expanded

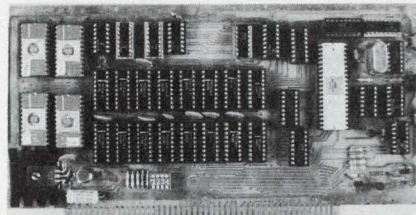

CGRS Microtech, P.O. Box 368, Southampton, PA 18966. (215) 757-0284.

With the CGRS "Microputer 6000," S-100 bus users can take advantage of a standard packaging scheme and have the high speed and versatility of the 6502. The computer card contains 4 k of EPROM (2708) and 2 k of RAM (2111) in addition to the 6502 microprocessor and TTL support logic. The unit can be easily expanded with an available line of support products including a front panel, I/O cards, packaging and software.

CIRCLE NO. 331

GPIB CONTROLLER and Matrix Switching System



IEEE 488 BUS

- S-D Model 3530 Instrumentation Controller is designed specifically for IEEE BUS applications!
- Controls any IEEE-488 compatible instrument!
- Universally accepted high-level language BASIC!
- Microcomputer with up to 56K byte memory!
- RS232C/TTY current loop interface standard!

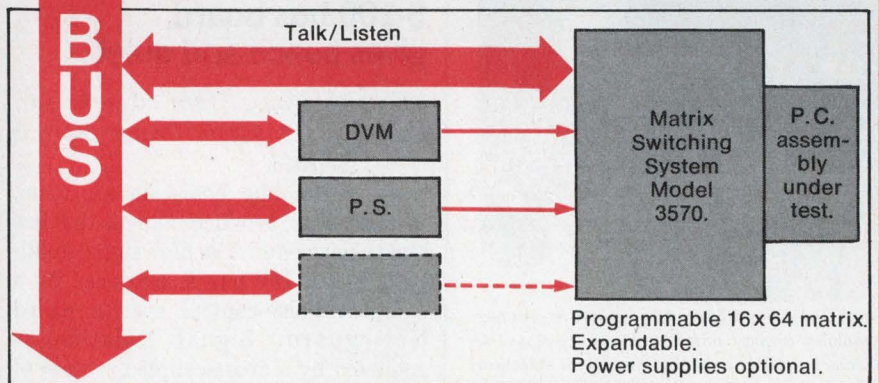

For more information, call, write or circle the reader service number below. Systron-Donner Data Products Division, 935 Detroit Avenue, Concord, CA 94518. Phone (415) 798-9900. Abroad, contact Systron-Donner in Munich, Leamington Spa, U.K., Le Port Marly, France, and Melbourne.

SYSTRON  DONNER

CIRCLE NUMBER 50

LOW COST ONE-PART CONDUCTIVE EPOXY



ECCOCOAT® 341 is a moderately conductive surface coating based on silver and epoxy. Pricing is far below that of silver lacquers. Has excellent weathering characteristics and is resistant to salt spray. Can be air dried at room temperature.

CIRCLE NO. 141

FIRE RETARDANT FREE SPACE ABSORBER

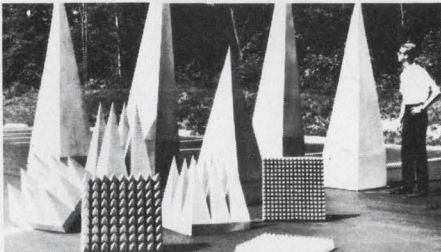

ECCOSORB® VHP-NRL conforms to non-flammability requirements of ASTM D-1692-74 and meets all requirements of tests 1, 2 and 3 of NRL Report 7793. It provides highest broadband performance at both normal and wide incidence angles of all known absorbers. Light-weight, flexible and tolerant of physical abuse. Many types available.

CIRCLE NO. 142

CRYSTAL CLEAR EPOXY CASTING RESIN



Several transparent Stycast® resins are offered for making display embeddings or castings. A convenient chart is available to aid in selection of the most appropriate system. It is yours for the asking.

CIRCLE NO. 143



**EMERSON &
CUMING, INC.**

CANTON, MASSACHUSETTS 02021 U.S.A.

Manufacturing at Canton, MA, Northbrook, IL, Gardena, CA, U.S.A.
Scunthorpe, ENGLAND, Oevel, BELGIUM, and Kuriyama, JAPAN

Sales Offices in Principal Cities

MICRO/MINI COMPUTING

Interface lets PDP-8 act like PDP-11

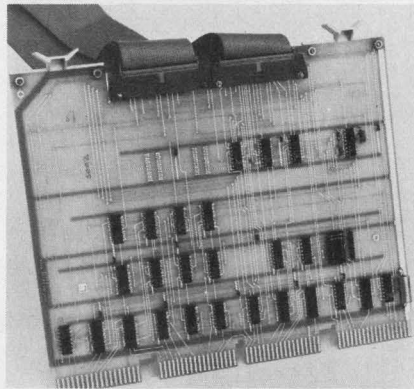

Digitek, 5950 Sixth Ave., Seattle, WA 98108. Frank Mauger (206) 762-3933. \$960; 4 to 8 wks.

A logic card, Model DK 8/11, provides the PDP-8 with a 16-bit parallel interface. The card allows direct compatibility between the DEC PDP-8 Omnibus and peripherals and systems that normally would interface to the DEC PDP-11 DR11C general purpose interface. The device converts the PDP-8 12-bit words into 16-bit DR11C-compatible words. It plugs into one Omnibus slot and is completely compatible with the DEC DR11C interface, including all necessary control and handshaking signals so that a PDP-8 can communicate directly with a 16-bit minicomputer.

CIRCLE NO. 332

S-100 bus board gives peace and quiet

Thinker Toys, 1201 Tenth St., Berkeley, CA 94710. George Morrow (415) 527-7548.

An S-100 bus board in kit form, Wunderbus, produces signals that are "textbook clean." The high signal quality of the S-100 bus is produced by a complex noise-control system called Noiseguard. Signal isolation is achieved by a cross-coupled system of ground lines that are interlaced between signal lines, and cross-coupled ground planes. This system surrounds each signal in a cocoon of extremely quiet space to eliminate noise and cross-talk between signal lines. Each data line is actively terminated by a circuit that absorbs signal reflections and noise.

CIRCLE NO. 333

Nonvolatile CMOS RAM allows memory expansion

Wintek, 902 N. 9th St., Lafayette, IN 47904. (317) 742-6802. \$339.

Microprocessor memory expansion with nonvolatile memory is possible with the CMOS RAM/Battery module. Memory is retained during power-off conditions including when the module is unplugged from the system bus. Two size AA nickel-cadmium batteries allow for power-off periods of up to one year. The module can accommodate up to 2 kbytes in multiples of 256 bytes and has write protection. The module comes on a 4.5 × 6.5-in. 44-pin PC board.

CIRCLE NO. 334

Static RAMs mate with S-100 bus

Dynabite, 4020 Fabian Way, Palo Alto, CA 94303. Mike Watts (415) 494-7817. \$525 to \$995; stock.

Modules of 16-k and 32-k static RAMs are available with access times of 450 or 250 ns. The 250-ns units are compatible with 4-MHz Z-80 processors. Both 16-k RAM modules feature bank select, allowing up to eight separate banks of up to 64 k to reside in the same system. The module may be addressed in four separate 4-k blocks along 4-k boundaries. Each of these blocks may be individually write protected. The 32-k modules offer 4-k boundary addressing and complete buffering.

CIRCLE NO. 335

Add-on parity memory mates with PDP-11's

Amplex, 200 N. Nash St., El Segundo, CA 90245. Clyde Cornwell (213) 640-0150. \$4950 to \$12,750; 4 wks.

An add-on parity memory, ARM-1100P, provides 32 to 128 kwords of memory for any DEC PDP-11 computer using a Unibus structure. The device can expand memory from any 8-k boundary in 32-k increments up to the maximum of 128 kwords. The memory uses only one CPU slot and needs just one Unibus load. Each unit is supplied with wired card rack, power supply, interface, parity control, cooling fans and interconnecting cables. An access time of 375 ns and a full cycle time of 700 ns is provided.

CIRCLE NO. 336

POWER SOURCES

**Supplies deliver 1 kW
with high efficiency**

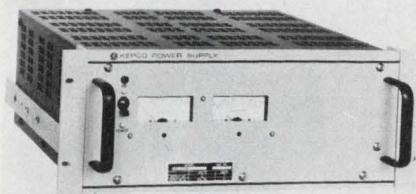

Kepco, 131-38 Sanford Ave., Flushing, NY 11352. Paul Birman (212) 461-7000. \$590; stock.

Ferroresonant power supplies, Type PRR, provide efficiencies of 70 to 80% with 1-kW output at 12 to 48 V dc. The units have automatic current limiting, brownout protection, built-in blower and recessed metering. Line regulation at 120-V input is $\pm 1\%$ max for $\pm 15\text{-V}$ line change at full load. Output voltage increases 0.75 to 1.5-V for 100 to 50% load change depending on output voltage rating. A $+1\%$ change in line frequency produces about $+1.5\%$ output-voltage change.

CIRCLE NO. 337

**HV supply regulates
current and voltage**

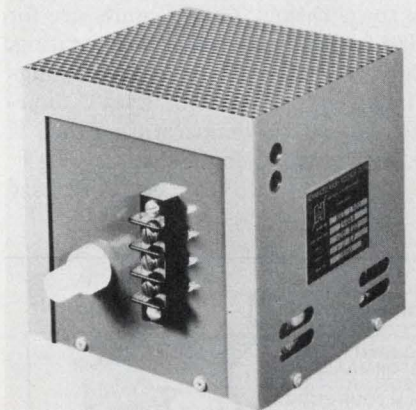

Advanced High Voltage, 14532 Armin-ta Ave., Van Nuys, CA 91402. John Richardson (213) 997-7222. From \$680; 3 to 4 wk.

High-voltage dc-to-dc converters with outputs to 18 kV at 80 W (Series 1300) are voltage and current regulated. Remote programming of voltage and current is a feature as is the self-contained adjustment of voltage and current. Other features include line and load regulation of 0.1% and an adjustable switching frequency to minimize specific interference. Input voltage is 24 to 32 V dc. Size: 5 x 4.75 in. Weight: 5 lb.

CIRCLE NO. 338

Memory Power

Eternacell® 10 year lithium primary battery for semiconductor memories

Don't risk memory failure. Eternacell® high reliability, lithium primary batteries are the ideal standby power source for all types of volatile memory applications. The reasons:

- Steady voltage (2.9 volts per cell) at low continuous current
- Shelf life of up to 10 years
- Highest energy per unit weight and volume
- No recharging
- Hermetically sealed
- Designed for pc board mounting

For complete information and pricing write:
Power Conversion, Inc.,
70 MacQuesten
Parkway South,
Mt. Vernon, N.Y. 10550.
Or call (914) 699-7333

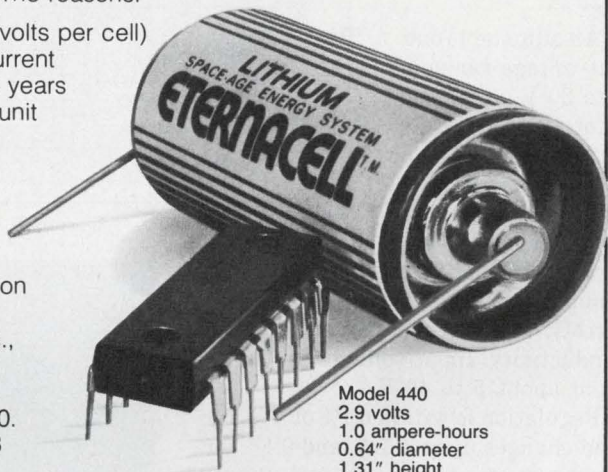

Model 440
2.9 volts
1.0 ampere-hours
0.64" diameter
1.31" height

Power Conversion

CIRCLE NUMBER 51

Four ways to build better Power Chokes... with ferrite cores from Fair-Rite

When designing switch mode power supplies, you can provide more stable inductance for the filters in the presence of DC load currents, by using these types of ferrite cores:

1.



Gapped pot cores for exceptional shielding qualities.

2.

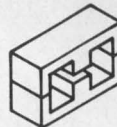

Gapped E-cores, giving moderate shielding at lower cost.

3.



Round bobbins; priced lower yet; no shielding qualities, but highly stable.

4.

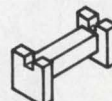

Square bobbins; most economical; without shielding properties, but least affected by DC.

Write for FREE application note on use of the Hanna curve to select the proper air gap for ferrite cores. All, and much more, from:



FAIR-RITE PRODUCTS CORP.

Wallkill, NY 12589 Phone 914-895-2055 TWX: 510-249-4819

FERRITE CORES FOR THE ELECTRONICS INDUSTRY

CIRCLE NUMBER 52

Regulator delivers 3 to 30 V and limits currents to 1.8 A

SGS-ATES, 79 Massasoit St., Waltham, MA 02154. Ruben Sonnino (617) 891-3710. P&A: See text.

An adjustable output-voltage range of 3 to 30 V on a regulator is nice enough, but the L200 also offers an adjustable current limit of 0 to 1.8 A. Housed in the new five-lead TO-220 package, the monolithic regulator can be mounted directly to a heat sink for good thermal conductivity. Input voltages can range from about 5 to 40 V.

Regulation is within 0.1% of V_{out} for load changes up to 1.5 A, and 0.1% for input-voltage changes of 10 V. Ripple rejection is greater than 70 dB for a 10-V change in V_{in} and generated noise is typically less than 40 μ V over 10 Hz to 100 kHz. An on-chip band-gap element not only provides a low reference voltage, but reduces noise as well.

During load variations, thermal drift of the output current is 100 ppm/ $^{\circ}$ C, and current stability is better than 0.2% of I_{out}/V . During no-load operations, the regulator draws just 5 mA of quiescent current (at a 20-V, V_{in}).

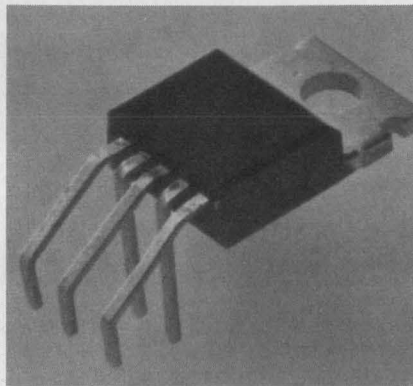
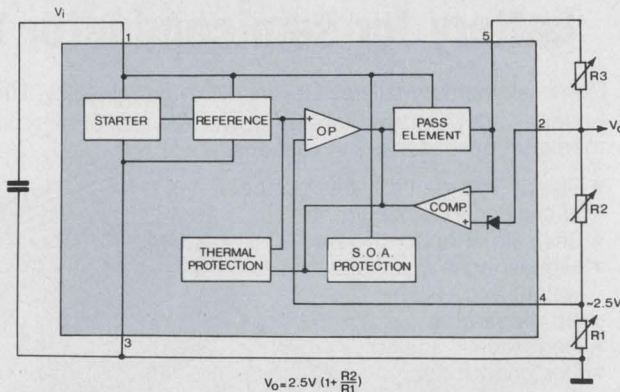

Thermal resistance from junction to ambient is 50 C/W and from junction to case, 3 C/W.

In 1 to 99 quantities, the L200 costs \$4.20. Delivery takes from 4 to 6 weeks.

CIRCLE NO. 302

Molded triacs claim highest power rating

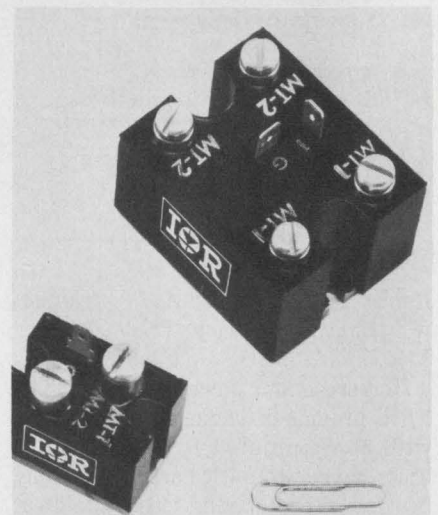

International Rectifier, 233 Kansas St., El Segundo, CA 90245. (213) 322-3331. \$15.48 to \$80.28 (100 qty); 4 to 6 wks.

Molded power triacs for operation to 1200 V, 50 and 100 A rms, with surge ratings to 900 A, are said to offer the highest power ratings of any available. The molded triac assemblies have an isolated metal base plate, isolated to 2000 V rms, that improves heat transfer. Type T50AC units have current ratings of 50 A rms with a 400-A surge rating; T100AC units are for 100 A rms, with 900-A surge rating. Both types are available with ratings of 400, 600, 800, 1000 or 1200 V. Junction operating temperature range is -25 to +125 C for all units.

CIRCLE NO. 339

SHERLOCK OHMS & DR. WATTS

IN THE CASE OF THE PENTAGON POOPSIE!

by DUMONT



QUALITY AND PERFORMANCE YOU EXPECT... AT A PRICE WITHIN YOUR BUDGET!

6010 MINISCOPE

CALL US TOLL FREE (800) 631-1043 FOR IMMEDIATE DELIVERY.

DE FOREST

A Subsidiary of DUMONT OSCILLOSCOPE LABORATORIES, INC. 40 FAIRFIELD PLACE • WEST CALDWELL, N. J. 07098

- 10 MHZ
- PUSH BUTTON OPERATION
- TRIGGERED SWEEP
- RECHARGEABLE BATTERY AVAILABLE

CIRCLE NUMBER 53

Timer/sequencer delays from μ s to months



Exar Integrated Systems, 750 Palomar Ave., Sunnyvale, CA 94086. Brooks Hamilton (408) 732-7970. \$0.90 (100 qty).

A long-range timer/sequencer IC capable of time delays from microseconds to months (designated the XR-2242) contains a precision time base oscillator and an 8-bit binary counter. Upon triggering, it provides an accurate time delay of 128 times an RC constant. Since it uses the count-down principle, cascading several timer circuits causes the total time interval to increase geometrically. The time base oscillator is accurate to 0.5% and has a tempo of less than 100 ppm/ $^{\circ}$ C.

CIRCLE NO. 340

Clock signals provided at up to 15 rates

Harris Semiconductor, P.O. Box 883, Melbourne, FL 32901. (305) 724-7430. See text; stock

CMOS programmable bit-rate generators, HD-4702 and HD-6405, provide clock signals for digital data-transmission systems. The HD-4702 can be programmed for one of 13 bit rates while the HD-6405 extends to 15 selectable rates. The HD-4702 has TTL-compatible pull-up circuitry and is pin-out and specification identical to 34702 devices. The HD-6405 has no pull-up circuitry but offers standard high-impedance CMOS inputs. The HD-4702 and 6405 operate at 2.4576 MHz and dissipate only 4.5 and 4 mW, respectively. The devices come in 16-pin plastic or ceramic DIPs in either -40 to $+85$ C, -55 to $+125$ C ranges. 100 quantity prices are \$9.40 for the plastic; \$15.16 for the ceramic and \$20.90 for the ceramic hi-temp.

CIRCLE NO. 341

Receiver IC meets IBM 360/370 I/O spec

Texas Instruments, P.O. Box 5012, M/S 308 (attn: SN75128/129), Dallas, TX 75222. Dale Pippenger (214) 238-2165. \$2.33/\$3.10 (100 qty); stock.

Two new eight-channel line receiver ICs meet the IBM 360/370 I/O specification. Type numbers SN75128 and SN75129 feature common strobes for each group of four receivers. The

SN75128 has an active-high strobe; the SN75129, an active-low strobe. Schottky-diode-clamped transistors allow low current requirements, while maintaining fast typical switching speeds of 16 ns. The receiver input resistance is specified from 7 k to 20 k and input threshold from 0.7 V to 1.7 V. The ICs are output compatible with DTL and TTL. The devices are offered in either 20-pin plastic or ceramic DIPs.

CIRCLE NO. 342

No. 1
IN A SERIES
LOW NOISE
MICROWAVE TRANSISTOR
UPDATES FROM AVANTEK

G_{NF} : 7.5 dB
 NF_{opt} : 3.5 dB
Frequency: 4.0 GHz
Avantek AT-4641

Guaranteed Specifications

Type	NF_{opt} dB (max)	G_{NF} dB (typ)	I_C mA	G_{max} dB (min)	I_C mA	f_{test} GHz	f_T GHz (typ)
AT-4641	3.5	7.5	5	8	15	4.0	8.0

Built-In Reliability

The AT-4641 features a superior gold metallization system and hermetic packaging. All Avantek transistors are manufactured under the most stringent quality controls, assuring the designer of high MTBF's.

Fast Delivery

Concerned about a supplier located halfway around the globe? Avantek is just a phone call away. Orders placed by noon will normally ship the same day.



OUTLINE DRAWING

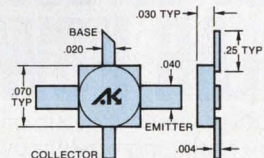

Dependable Performance

The AT-4641 is a proven performer in critical military and space applications with HI REL screening available as a standard option. It features a very high dynamic range among its impressive specifications. Reliability, performance, and immediate availability — Avantek's AT-4641 is your solid choice.

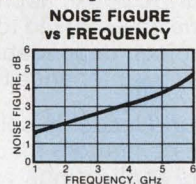

Contact: Avantek Transistor Applications Engineering (408) 249-0700

3175 Bowers Ave., Santa Clara, CA 95051
TWX 910-339-9274 Cable: AVANTEK

SEM photo of AT-4641 (1000X magnification).

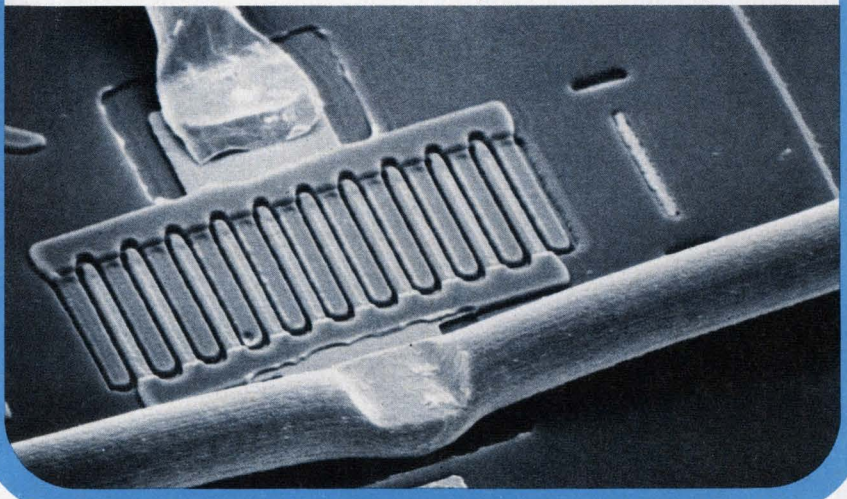

CIRCLE NUMBER 54

for
remote
locations...

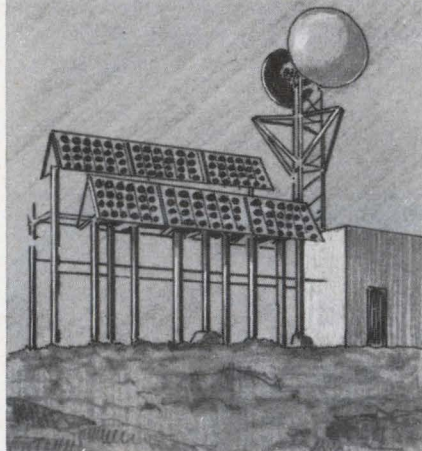

Cost Effective SOLAR POWER

Our sun-powered electric generators are replacing costly powerlines, and expensive manned power generators for remote locations all over the world.

For microwave links, radio repeater stations, signaling devices, or any remote power application, our systems have proved to be economical, dependable and virtually maintenance free.

As a world leader in solar power electric generators for communications applications, we guarantee the right system for you.

Write us for user references plus a free computer analysis with preliminary cost estimate for your application.

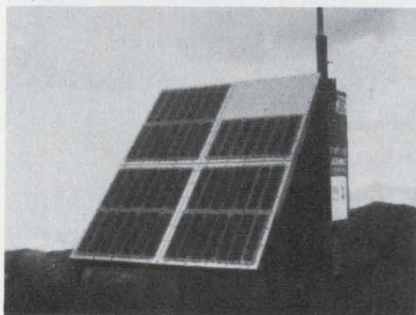

Solar Power Corporation
5 Executive Park Drive
North Billerica, Massachusetts 01862
Tel. (617) 667-8376
TWX. 710-347-7692

CIRCLE NUMBER 60

ICs & SEMICONDUCTORS

One-chip data system can save a bundle

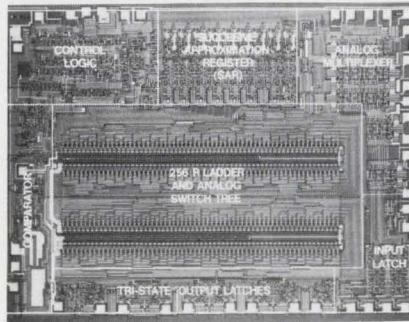

National Semiconductor, 2900 Semiconductor Dr., Santa Clara, CA 95051. Jerry Zis (408) 737-5831. \$19.95 (100 qty); stock.

A one-chip data-acquisition system can replace \$100 to \$200 worth of hybrid and discrete-component analog boards. Included on a single 28,000-sq mil CMOS chip (ADC0816) are a true 8-bit a/d converter with latched outputs, a 16-channel expandable multiplexer with address input latches, provision for handling external signal conditioning and all the logic control needed for mating the chip to all standard μ Cs. The 40-pin device performs a conversion in 50 μ s. At 25 C, the linearity, zero error and full-scale error are less than ± 0.5 LSB each.

CIRCLE NO. 343

TTL-to-MOS drivers have three-state outputs

Texas Instruments, P.O. Box 5012, M/S 308 (Attn: SN75357), Dallas, TX 75222. Dale Pippenger (214) 238-2165. \$1.41 to \$2.47 (100 qty); stock.

Two quadruple TTL-to-MOS driver ICs, SN75357 and SN75375, feature three-state outputs. The 75375 has individual supply voltages for each of the four drivers, capable of operating from 5 to 24 V. The 75357 has low transient current during switching, making it useful for mating with CMOS systems. It has a high-level output voltage variable from 5 to 13.2 V. Individual supply voltage pins on the 75375 allow individual adjustment of V_{OH} levels to match various load conditions. Typical propagation delay is 31 ns and the output-current drive capability is 150 mA. The circuit has two NAND and two inverting drivers. Both circuits operate from 0 to 70 C and are in plastic (N suffix) or ceramic (J suffix) DIPs.

CIRCLE NO. 344

Gold helps produce rugged vhf power devices

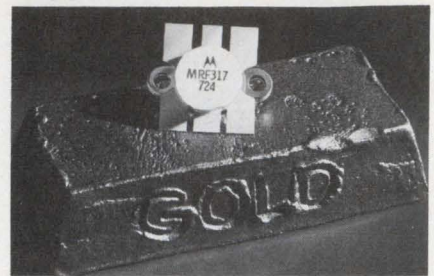

Motorola, P.O. Box 20912, Phoenix, AZ 85036. Alan Wagstaffe (602) 244-6394. \$11 to \$39.50; stock.

Dissimilar metal interfaces, which can impair reliability of military grade rf power transistors, are eliminated in the MRF314-317 series of vhf devices. Gold chip metallization, gold wirebonds and gold-plated package interfaces produce ruggedness suitable for new wideband, multimode vhf systems. The 28 V, 30 to 100-W series offers gains from 9 to 10 dB at 150 MHz, and is characterized from 30 to 200 MHz. Ruggedness is assured by 100% testing to withstand a load VSWR of 30:1 at rated output power.

CIRCLE NO. 345

Single-chip μ C aims at high-volume control use

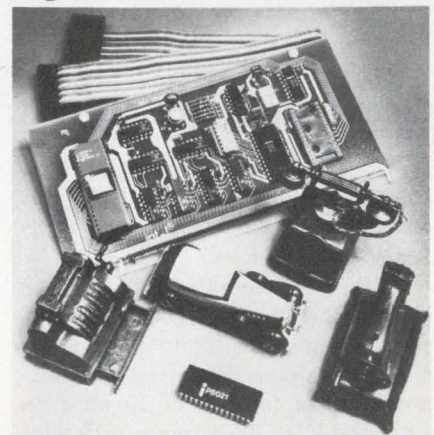

Intel, 3065 Bowers Ave., Santa Clara, CA 95051. Rob Walker (408) 249-8027. \$3 (OEM qty).

The 8021 single-chip μ C is a low-cost general-purpose IC for high-volume control uses. The chip contains an 8-bit control processor, 64 bytes of read-write data memory, 1024 bytes of program memory, 21 I/O lines and all other generally required functions, including a programmable interval timer and event counter, system clock and oscillator. Operation is from a 4.5 to 6.5-V supply.

CIRCLE NO. 346

Logic arrays are field programmable

Texas Instruments, P.O. Box 5012, M/S 308 (Attn: S330), Dallas, TX 75222. Gerald McGee (713) 494-5115. \$9 (100 qty); stock.

Schottky TTL field-programmable logic arrays (FPLA), the SN54S/74S330 and SN54S/74S331, feature a built-in capability of multi-dimensional expansion of their basic 12 input \times 50 product term \times 6 output organization. A special circuit is included that can decode true product terms to automatically enable the FPLA outputs. The result is expandability to virtually any size array without external logic or control. This control option is activated by fusing a single link. Additionally, the S330/S331 can be programmed to stand alone; i.e., the outputs are constantly enabled when system power is applied. The arrays come in 20-pin DIPs.

CIRCLE NO. 356

Power driver operates at 80 V and 300 mA peak

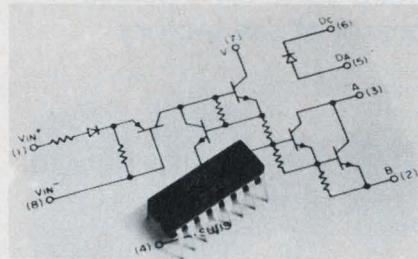

Dionics, 65 Rushmore St., Westbury, NY 11590. Manny Sussman (516) 997-7474. \$1.38 (10,000 qty); stock.

DI-446 is a universal dual high-voltage, high-current power driver in a 16-pin plastic DIP operating at voltages to 80 V and peak currents to 300 mA. The circuitry allows the device to operate with either "positive-true" or "negative-true" inputs from logic systems. The logic threshold voltage can be adjusted, thereby providing excellent noise immunity for input signals having an absolute voltage level between ± 40 V. A fully isolated high-current diode provides transient suppression if an inductive load is to be driven.

CIRCLE NO. 357

Zener diodes made to user specs

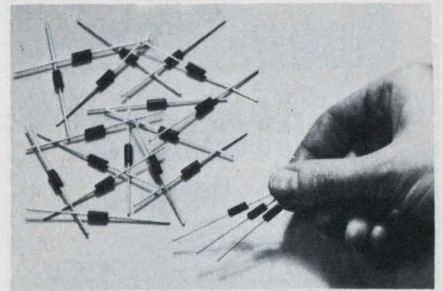

American Power Devices, 7 Andover St., Andover, MA 01810. Bob Dimodana (617) 475-4074. \$0.065 to \$0.30 (1000 qty).

A series of 2.5 to 5-W zener diodes can be made to customer specification. Specifications with tolerances as close as $\pm 1\%$ and zener voltages ranging from 3.3 to 62 V can be met. The diodes have silicon-oxide-passivated junctions, and are produced in epoxy and double plug packages. Planar oxide processing results in diodes with low leakage current, uniform sharp reverse breakdown voltages, and uniform heat dissipation. DO-7, DO-35, AIEE and AIRX axial lead and glass transfer-molded packages are available.

CIRCLE NO. 358

PYROFILM MAKES IT!

High Voltage FLATSO Resistors

- Four Sizes
- High Voltage Up to 20,000 Volts
- Resistance Range 50 Ω - 300M
- Power Range Up To 2 Watts
- Temp. Coefficient 0 \pm 250ppm/ $^{\circ}$ C
- Radial Lead, Flat Profile



Setting New Standards in Reliability

PYROFILM

Engelmann Microwave Co. - Affiliate of Pyrofilm Corporation

60 S. Jefferson Road • Whippany, N. J. 07981 • (201) 887-8100

CIRCLE NUMBER 55

Open-Frame Switchers!

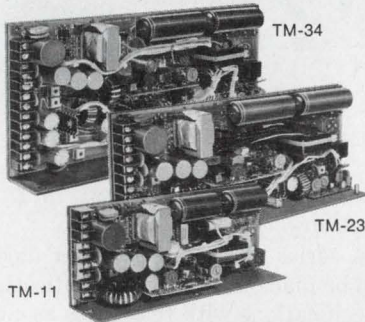

LH's low-cost, single- and multiple-output Tiny-MITE switchers are perfect choices for high-volume OEM computer and terminal applications. TM-11 packs 100 watts in a 9.5" L x 4" W x 2.5" H package. TM-23 packs 150 watts in 12" L x 5" W x 2.8" H. TM-34 packs 175 watts in 13.0" L x 6" W x 2.75" H.

- Output voltage — TM-11: 5V $\pm 5\%$ @ 100W. TM-23 main output: 5V $\pm 5\%$ @ 20 amps. Various voltages on 2nd and 3rd outputs. TM-34 main output: 5V $\pm 5\%$ @ 20 amps. Various voltages on 2nd, 3rd, and 4th outputs.
- Wide input variation — 92-130 or 180-260 VAC, 47-450 Hz.
- Ripple and noise — 1% or 50 mv peak to peak.
- Efficiency — TM-11: 75%, TM-23 and TM-34: 70% nominal.
- Line regulation — 0.4% over entire input range.
- Load regulation — 0.4% from no load to full load.
- Response time — 200 μ sec to 1% after 25% load change @ 5 amp/ μ sec.
- Over-voltage protection — standard on main output.

World's largest switcher manufacturer!

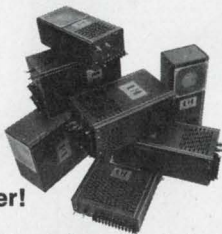

LH Research produces the industry's broadest line of single- and multiple-output switchers. And nobody packs more power in smaller packages or offers more features. 1 through 7 outputs, up to 2.26w/in.³, 80% efficiency, and 2-year guarantee. Less than 65¢/w in quantity.



LH RESEARCH, INC.

1821 Langley Avenue, Irvine, CA 92714
(714) 546-5279

CIRCLE NUMBER 56

COMPONENTS

Solid-state time delays preset at the factory

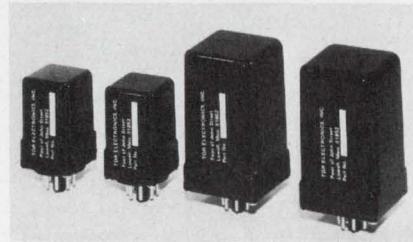

TDR Electronics, Foot of John St., Lowell, MA 01852. Gil Rogers (617) 459-0151. \$18.04 up; 2 to 4 wks.

TDR solid-state time-delay modules, factory preset, provide repeatable time delays from 1 to 300 s. The modules operate from 10 to 250 V ac or dc. Some types are available with total isolation between control and load circuits. The devices operate from -55 to 85 C and timing variation is $\pm 10\%$ over the voltage and temperature range. Repeatability is $\pm 3\%$ at fixed operating conditions and reset time is 500 ms. Off-state resistance is 20 k Ω , minimum.

CIRCLE NO. 359

Capacitors boast better rf characteristics

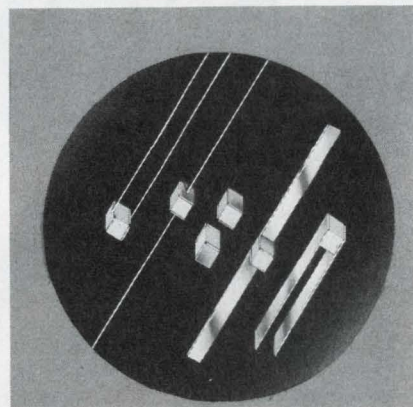

Republic Electronics, 176 E. 7th St., Paterson, NJ 07524. George Wolter (201) 279-0300. \$0.43 to \$0.88 (OEM); 8 to 10 wks.

A new ceramic formulation provides rf capacitors, Type 013Q, with a Q greater than 10,000 at 1 MHz, a QC product greater than 100,000 at 30 MHz and the ability to pass 4 A at 250 MHz with no power loss. The units are available in sizes from 0.1 to 1000 pF with voltage ratings from 100 to 500 V dc and a TC of 90 ± 20 ppm/ $^{\circ}$ C. Size is 0.110 in.² by 0.1 in. thick. Chips or five standard-lead types are available.

CIRCLE NO. 360

Panel pot has plastic resistance element

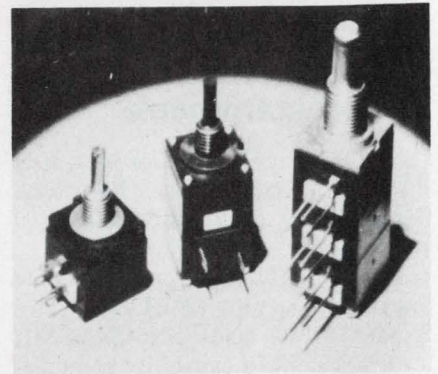

Allen-Bradley, 1201 S. Second St., Milwaukee, WI 53204. (414) 671-2000.

Conductive-plastic resistance elements and signal-level circuit switches are now offered in the MOD POT series of panel potentiometers. The conductive-plastic, unitized resistance element affords smooth rotation and low turning torque. Also, contact-resistance variation is less than 0.2% and roll-on/roll-off, less than 0.25%. The switch is tested with current levels as low as 15 mA and an open-circuit voltage of 5 V. Resistance range and tolerances are 100 Ω to 1 M Ω , $\pm 10\%$ or $\pm 20\%$. Linear, modified-log clockwise and counter-clockwise resistance tapers are available.

CIRCLE NO. 361

Drop out time delayed by solid-state timer

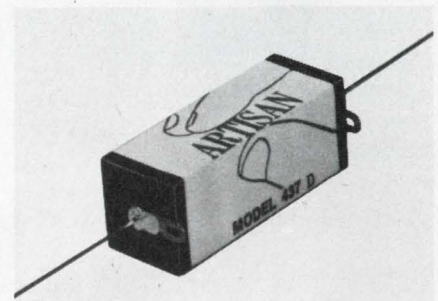

Artisan Electronics, 5 Eastman Rd., Parsippany, NJ 07054. Alan Seman (201) 887-7100. \$5; 2 to 3 wks.

The Model 437D solid-state timer delays the drop-out time of a relay when wired in series with a 48-V-dc relay coil. The relay picks up in the normal time. With wire leads and solder lugs, the timer's square package is easily mounted. Operating on 30 to 60 V dc at 10 to 500 mA, the timer's delay can be preset from 10 ms to 600 s.

CIRCLE NO. 362

Metal-film resistors meet MIL spec

International Components, 105 Maxess Rd., Melville, NY 11746. Mel Karasik (516) 293-1500. \$36/M (5000 qty); stock to 12 wks.

The MF-25 1/4-W evaporated metal-film resistors have a special epoxy coating for protection in severe environments. Characteristics meet MIL-R-22684 equivalent to the RN-55. Resistance ranges from 20 Ω to 350 k Ω in standard 1% values. The tolerance is $\pm 1\%$ with a TC of 100 ppm/ $^{\circ}$ C. Packaging is on tape and reel, magazine pack, bulk pack or cut and formed to customer requirements.

CIRCLE NO. 363

Ultramini fan weighs only 1.7 oz

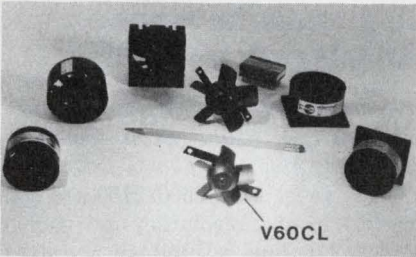

Micronel, 8 Kane Industrial Park, Hudson, MA 01749. S.W. Linko (617) 568-8542.

With an output of 10 cfm in free air, the Model V60CL fan has an impeller diameter of 2.3 in. and weighs only 1.7 oz. It features a multivane impeller driven by a high-efficiency ac motor.

CIRCLE NO. 364

Multiposition rotary switch mounts on PC

Janco, 3111 Winona Ave., Burbank, CA 91504. (213) 845-7473.

Printed-circuit rotary switches, Series 2481, are for direct circuit-board or flex-circuit mounting use. These compact switches are 1 in. in diameter and available in 8, 10, 12, 16, 20, 22 and 24 positions. The shaft must be pulled in order to exit or enter certain pre-designated positions. Secondary circuits are made or completed when the shaft is pulled. Completely enclosed and explosion-proof, the switches offer BCD output and meet or exceed MIL-S-3786 and/or MIL-S-22710.

CIRCLE NO. 365

Micromini capacitors can mount on any side

Corning Electronics, Corning, NY 14830. (607) 974-9000.

A line of microminiature solid-tantalum capacitors with a unique coplanar design allows them to be mounted on any of their four sides. Called "Minichip" capacitors and desig-

nated the MK series, they are available in five case sizes and have electrical values ranging from 0.1 μ F at 50 V to 47 μ F at 10 V. Special ratings are available. The components have high resistance to mechanical shock, a low DF/ESR rating and good electrical stability. They can be used with automatic handling equipment and a vibratory bowl feed.

CIRCLE NO. 366

3 new relays from Gould Allied Control



E6 series solid state relay (SSR)

10, 25 and 40 amps—designed for in-line power switching of resistive and reactive loads, especially under low power factor conditions. Optically isolated. "Integral cycling" provides automatic load surge compensation into reactive loads. Offers infinite cycle life and the ability to cycle faster than e/m relays.

Miniature magnetic latching relay (MPCL)

0.6" PC board spacing—smallest in the industry. Two completely isolated coils designed for continuous duty with identical low power consumption, eliminating polarity reversal. Long life assured by patented hingeless armature construction. High armature holding force in latch position accompanied with simple permanent magnet circuit.

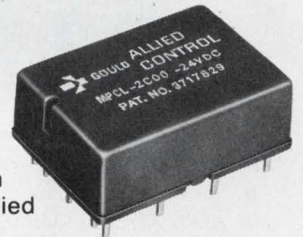

Low-profile DIP relay (DR)

Lowest profile DIP relay available (only 0.38" high). Most sensitive DPDT relay—200 MW max. at pull-in, with 1 amp 28 VDC switching and 5 amp carrying capacity. Fits standard 16-pin IC sockets, and its footprints are interchangeable with other e/m DIP relays. Costs less than 2 SPDT equivalent reeds.

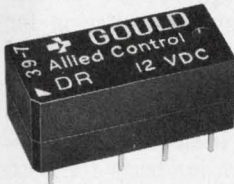

New relays to meet customers' ever increasing demands. Write for literature to Gould, Inc., Controls Division, 131 Relay Road, Plantsville, CT 06479. Telephone (203) 621-6771.



Manufacturer of I. T. E. & Allied Control Products

CIRCLE NUMBER 57

MILITARY
APPLICATIONS

ADC CONVERTERS

by

MSK

Accuracy

Speed

Size

Repairability

Military

Temp. Range

-55° C to +125° C

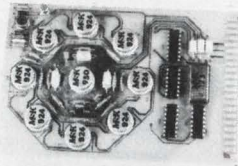

- 4 Bit/50 nSec; Low Cost
- Ideal for Radar Scan Converters
- Holds Absolute Accuracy Over Temperatures
- Tracks a 10 MHz Analog Input

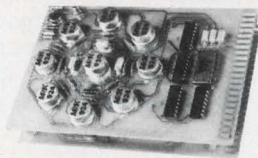

- 9 Bit/200 nSec.
- < 2 Bit Drift Over Temperature
- Insensitive to Clock Frequency

For Further Information Call or Write
M.S. Kennedy Corp.
Pickard Drive, Syracuse, New York 13211
Tel. 315-455-7077

CIRCLE NUMBER 58

MODULES & SUBASSEMBLIES

Synchro to digital unit fits into single module

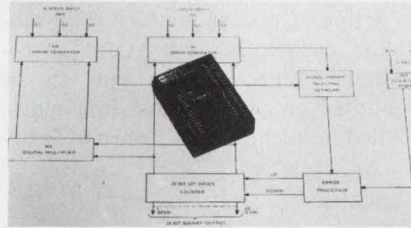

Natel Engineering, 8954 Mason Ave.,
Canoga Park, CA 91306. Ed Berman
(213) 882-9620. \$1195; stock to 6 wks.

Two-speed 20-bit synchro to digital (s/d) conversion is available in a single standard module. Model 2SD412 is 2.6 × 3.6 × 0.8 in., weighs less than 10 oz and is available with both TTL and LPTTL outputs at power consumptions of 3.5 and 2 W, respectively. Both binary and nonbinary ratios between the fine and coarse synchros are offered. Accuracy is 0.001° at a speed ratio of 36:1. Standard inputs are 11.8, 26 or 90-V rms. The 400-Hz reference can either be 26 or 115-V rms.

CIRCLE NO. 367

Light pens easily mate to CRT system

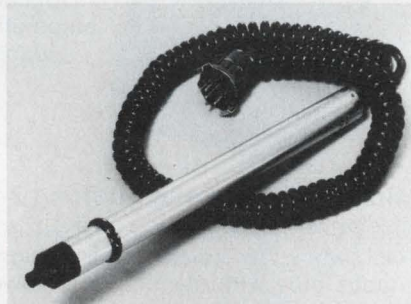

Information Control, 9610 Bellanca
Ave., Los Angeles, CA 90045. Ron Hoover
(213) 641-8520. \$450/\$475.

Two models of light pens, LP-210 and 211, simplify system interfacing for interactive CRT systems because of their high sensitivity and fast response. Sensitivity (with average brightness, P-31 phosphor, 20-mil spot, 60 Hz) is 2.0 foot-lamberts for both models. Response time is less than 300 ns. Spectral response is from 4200 to 11,000 Å; minimum vector speed is 20 cm/ms; minimum input separation is 20 μs. The LP-210 is activated by touching the operator's index finger to the pen's barrel. Model LP-211 has an actuation tip, enabled by pushing against the CRT faceplate.

CIRCLE NO. 368

Op amps operate in harsh environments

Teledyne Philbrick, Allied Dr. at Route 128, Dedham, MA 02026. Frank Goodenough (617) 329-1600. \$62 to \$158 (unit qty.); stock.

Four high-performance military-grade op amps, Models 1036, 1036-20, 1037 and 1037-20 can operate in harsh industrial and military environments from -25 to +85 C. The 1036/1036-20 output swings ±10 V at ±50 mA and its offset voltage (E_{os}) tempco is ±10 μV/°C. The output of the 1037/1037-20 (a FET input device) swings ±140 V at ±10 mA. Its initial E_{os} of ±2 mV eliminates any need for a trim potentiometer. The devices use hi-rel MIL components and meet environmental conditions of MIL-STD-202 and are processed to MIL-STD-883.

CIRCLE NO. 369

A/d converter resolves 16 bits with 500 mW

Phoenix Data, 3384 W. Osborn Rd., Phoenix, AZ 85017. Srinii Iyer (602) 278-8528. \$725 up; 8 to 12 wks.

The Model ADC 2000/2100 a/d converters have a resolution of 1 part in 65,535 (16 binary bits) with a total power consumption of only 500 mW. Accuracy is ±0.004% and linearity is ±0.002%. All output and control signals are CMOS/TTL-LS compatible. The Model 2000 size is 5 × 4.5 × 0.5 in. on a PC card and the Model 2100 is encased in 3 × 4 × 0.4 in.

CIRCLE NO. 370

DIP clock provides ECL output

Vectron Labs, 166 Glover Ave., Norwalk, CT 06850. Larry Jawitz (203) 853-4433. \$95; 4 to 10 wks.

The CO-633 DIP-compatible crystal oscillator operates from -5.2 V dc and provides a stable ECL-compatible output. Frequency is in the 5 to 125-MHz range. Initial accuracy is ±50 ppm for the CO-633A while that of the CO-633B is ±10 ppm. Stability of each type is ±25 ppm from 0 to +70 C. Package size of the 14-pin unit is 0.5 × 0.8 × 0.5 in. Options include the MIL-range CO-633-2 with stability of ±50 ppm from -55 to +125 C and the CO-633-3 that provides ±3 ppm from 0 to +50 C.

CIRCLE NO. 371

Fixed-head memories operate on 48 V dc

Vermont Research, Precision Park, North Springfield, VT 05150. E.W. Hinkley (802) 886-2256. See text.

Fixed head memory, Model 4016-DC, operates on 48-V-dc input power for use in telecommunications systems where power interruptions cannot be tolerated. The device has a storage capacity of 37.9-Mbits and access time of 8.5 ms. The memory occupies 12.25 vertical in. on a 19-in. rack. All electronics, power conversion and controls are outside the media enclosure and easily accessible for maintenance. OEM price at 100/year is \$12,370 for ac units and \$13,390 for dc units at 4.64-Mbyte capacity.

CIRCLE NO. 372

Active filters enhance bio-medical signals

Frequency Devices, 25 Locust St., Haverhill, MA 01830. W. Morse (617) 374-0761. \$120; 2 to 4 wks.

Two types of active filters have frequency and transient responses that enhance bio-medical electronic signals. Model 7438 is a low-pass filter which provides 40 dB of attenuation at frequencies 15.5% above the cutoff frequency. Model 7439 high-pass filter attenuates all frequencies 15.5% below the defined cutoff, rolling at the same rate as the 7438. Used in cascade, the two devices provide a flat-bandpass filter with steep skirts. Cutoff frequencies between 1 and 1000 Hz are available.

CIRCLE NO. 373

Cable-matching amp spans dc to 1 MHz

Ross Engineering, 559 Westchester Dr., Campbell, CA 95008. (408) 377-4621. \$800 to \$1200; 4 to 8 wks.

A battery or ac operated, dc to 1 MHz, wideband, matching amplifier and 50-Ω cable driver acts as a buffer stage. Its 1 to 10-MΩ input impedance matches high-impedance output to a low-impedance load. The maximum output voltage ranges up to 12-V pk with input voltages from 12 to 1000 V pk and to 450-kV pk with a proper voltage divider. The device has a built-in battery charger.

CIRCLE NO. 374

With 87 different switching supplies to choose from, no wonder people are switching to Power/Mate.



But at Power-Mate we know it's not enough to offer you 87 different switching models in 10 different case sizes.

From 2 volts to 28. In currents all the way up to 200 amps.

And we know it's not enough to build them to the highest quality standards in the industry.

Standards you've come to expect from Power-Mate.

When you need a switcher fast, your entire business could depend on ours. So Power-Mate stocks all models

for immediate delivery on every switching model we make from both our East and West Coast plants.

The same goes for our open frame, modular and miniature models, as well as our laboratory supplies.

Whether starting from scratch, updating your system, or in need of emergency service, it's good to keep Power-Mate's name and number in mind.

Because knowing where to get the switchers you want isn't much good, unless you can get them when you want them.



POWER/MATE CORP.

514 S. River St./Hackensack, New Jersey 07601/(201) 343-6294/TWX (710) 990-5023
17942 SkyPark Circle/Irvine, California 92714/(714) 957-1606/TWX (910) 595-1766

The world's largest supplier of quality power supplies.

CIRCLE NUMBER 59

Save Your Copies of Electronic Design in handsome library files or binders

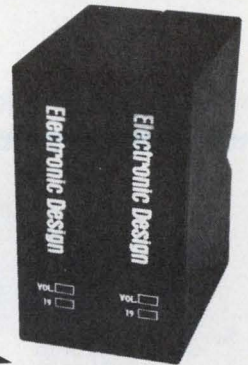

Keep your valuable copies neat and organized for ready reference. Each rugged case or binder holds half a year's issues. Richly covered in dark green leatherette and embossed with 16K gold lettering — a handsome and practical addition to your bookshelf or desk.

Mail to: Jesse Jones Box Corp., Box 5120, Philadelphia, Pa. 19141

Please send me: _____ Library Cases at \$4.95 each; 3 for \$14; 6 for \$24, postpaid.

_____ Binders at \$6.50 each; 3 for \$18.75; 6 for \$36, postpaid.

(Add \$1. each outside U.S.A. to cover additional postage and handling)

Check or money order (U.S. funds) for \$_____ enclosed.

Name (Print) _____

Title _____

Company _____

Address _____

City/Province _____

State/Country _____

Zip or Postal Code No. _____

Satisfaction guaranteed or money refunded. Allow 5 weeks for delivery.

Use socket cards for probing and testing

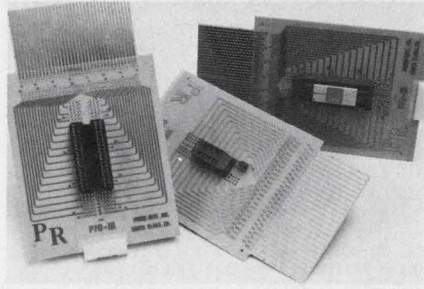

Probe-Rite, 2725 Lafayette St., Santa Clara, CA 95050. (408) 249-1255. \$25 (24 qty); stock to 3 wks.

Two probing socket cards, P48-VI and P70-III, for use with manual probers and hand-plugged automatic testers, have a 0.1-in. spaced pattern. The boards include a programming area, edge connector, straight-through wiring, universal numbering system and standardized card dimensions for easy retrofit to most probing machines. A center-socket feature permits the die under investigation to be located directly below the optics when the card is placed in a probing machine.

CIRCLE NO. 375

Mini terminal blocks handle solderless lugs

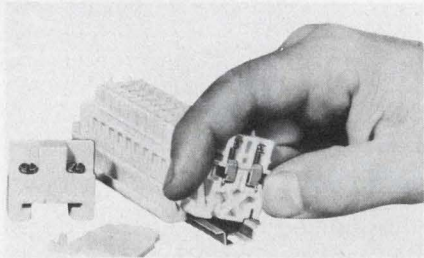

Square D Co., Milwaukee, WI 53201. (414) 332-2000.

Terminal blocks, Type GM3, are UL recognized and have solderless box lugs that accept #10 to #22 copper or aluminum wire. The blocks are made of rugged break-resistant thermoplastic polyester and are rated at 300 V. Designed for snap-in and snap-out mounting, their compact size accommodates up to 48 terminals/ft of mounting track. Other features include a built-in wire strip gauge and marking area. Jumpers and separable connectors are available as accessories.

CIRCLE NO. 376

Knock-in wire mounts save space

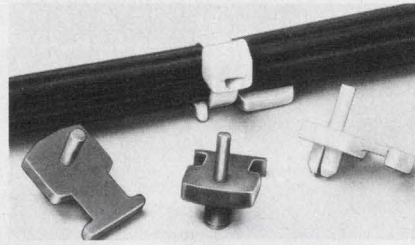

Panduit, 17301 Ridgeland Ave., Tinley Park, IL 60477. (312) 532-1800. Free samples.

Low-profile, knock-in cable-tie mounts are available to secure wires on panels where space is at a premium. The mounts insert into pre-drilled holes and their plastic pins tapped down. The mount then sits flat on the panel surface. Three mounts are available in three sizes: KIMS-H500, 0.196 dia; KIMS-H430, 0.169 dia; KIMS-H366, 0.144 dia. Material is 6/6 nylon. Dimensions are 0.75 x 0.5 x 0.12 in. installed height.

CIRCLE NO. 377

Logic jumpers provide up to 40 pins

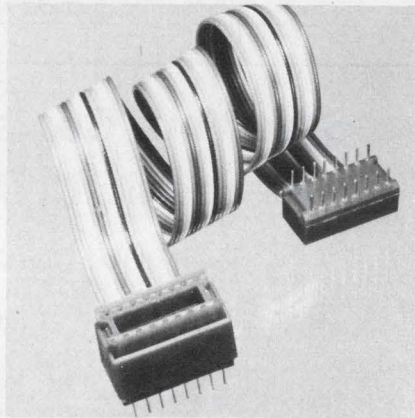

Aries Electronics, P.O. Box 231, Frenchtown, NJ 08825. (201) 996-4096. See text.

Logic jumpers (DIPer) in 8 through 40-pin configurations are available using EIA color-coded, 26-gauge stranded wire. A female/male plug is wired on one wire end, and the other end can be terminated with a male plug or furnished with stripped and tinned wires for customer termination. Bifurcated contacts are gold plated for good electrical contact with either round, flat or square pins. The jumpers are available in any desired length from 6 to 10 in. Prices are \$4.12 to \$26.10 depending on number of pins and length of jumper.

CIRCLE NO. 378

Pneumatic connector fits directly on PC boards

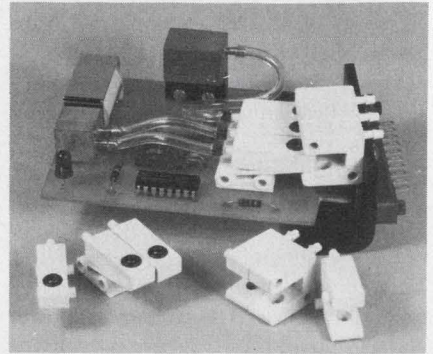

Linear Dynamics, P.O. Box 534, Wakefield, MA 01880. Don Denomme (617) 245-7157.

Series 22 Pneutronics edge connector is compatible with most PC-card rack and motherboards. When mounted in conjunction with a standard PC-board edge connector, the Series 22 provides for a simultaneous plug-in of both electronic and pneumatic circuitry in a compatible modular package. Designed for quick disconnect operation, its construction requires no locking mechanism or fasteners to hold male and female connectors together under pressure or vacuum.

CIRCLE NO. 379

IC-lead straightener adjustable to suit

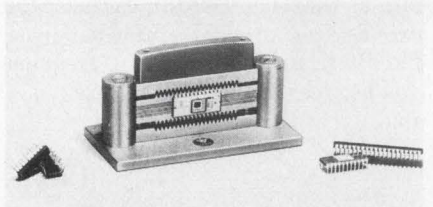

Micro Electronic Systems, 8 Kevin Dr., Danbury, CT 06810. (203) 746-2525. \$199.50; stock.

A manual IC lead straightener, Fix-a-DIP, includes the proper number of adjustable spacers to accommodate IC widths of 0.3, 0.4, 0.5 and 0.6 in., 2 to 40-pin DIPs. The unit can be factory adjusted to the width primarily required, and then later adjusted to other required widths. The device has a dual set of specially cut racks, spring loaded in the open position. A very badly bent IC lead must be hand straightened slightly, before it is inserted into the rack. Actuation of the soft plastic handle on the top of the unit straightens all the leads.

CIRCLE NO. 380

Application notes

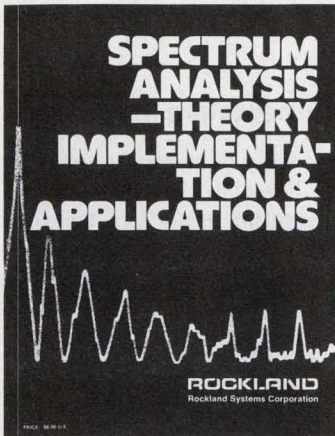

Spectrum analysis

This may be the finest exposition on spectrum analysis that you're likely to see for a long time. It covers the fundamentals, the constraints, the math, the three fundamental approaches and the architecture in 48 well written, well illustrated pages. Rockland Systems, West Nyack, NY

CIRCLE NO. 381

Ferrite toroids

Highlighted in a 24-page catalog is a section containing design and application guidelines for the ferrite user. Included are formulas, material properties and coating information pertaining to rf, wideband and pulse transformers. Ferronics, East Rochester, NY

CIRCLE NO. 382

Designing stamped parts

A 32-page guide outlines design techniques, for stamped parts, that cut costs and improve part quality. Dayton Rogers Mfg. Co., Minneapolis, MN

CIRCLE NO. 383

Chip capacitors

"Understanding Chip Capacitors" covers all phases of ceramic-chip capacitor technology. The handbook is illustrated with performance graphs and comprehensive tables. Johanson Dielectrics, Burbank, CA

CIRCLE NO. 384

Testing quartz crystals

"Crystal Testing Using a Spectrum Analyzer and Tracking Generator" discusses the characterization of quartz crystals for use in filters or oscillators using a conventional spectrum analyzer and tracking generator. Marconi Instruments, Northvale, NJ

CIRCLE NO. 385

PROM programmer

An application note describes, for users of the SC/MP low cost development system (LCDS), a method of programming MM5204 and MM4204 PROMs that is both inexpensive and highly efficient. National Semiconductor, Santa Clara, CA

CIRCLE NO. 386

Connector cross-reference

MIL-C-39012 Series SMA coaxial connectors and Sealectro part numbers are listed in a cross-reference. Rf Components Div., Sealectro, Mamaroneck, NY

CIRCLE NO. 387

An 8½ inch Microprocessor Controlled Impact Printer for just \$345*

Now that's what we call Practical!

Laugh all the way to the bank, OEM's. With both matrix impact print head and built-in microprocessor controller, our DMTP-6uP is a budget printer in price only. In practice, it's one of the greats.

You can print 80-96 columns of both data and text at a fast 110 cps. Turn out up to four copies at once on regular 8½ inch roll paper, even on fan-fold forms and labels. Not only are all needle drivers and diagnostic routines included with the microprocessor, but you can choose the interface function you want — parallel ASCII, RS-232C/I-Loop, or switch-selectable baud rates from 110 to 1200. You even get the economy of easily-replaceable ink rollers and a self-reversing 10-million character life ribbon.

* \$345 in 100 qts.; single units \$472

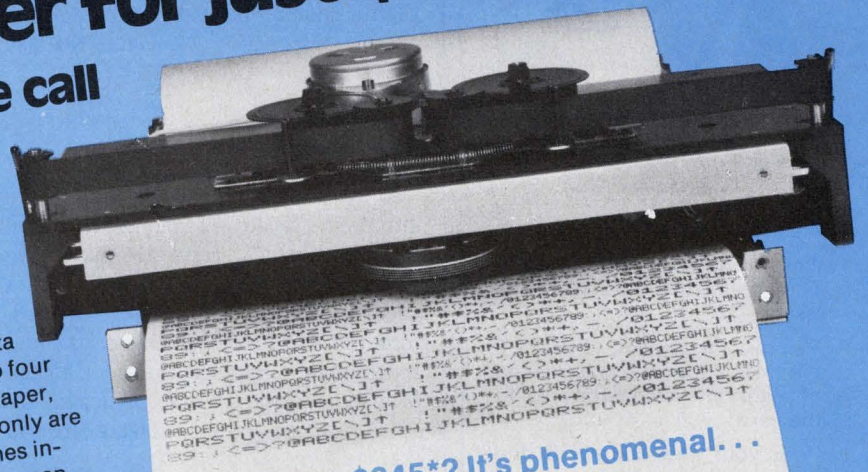

All that for \$345*? It's phenomenal...
and it's also very Practical.



PRACTICAL AUTOMATION, INC.
Trap Falls Road, Shelton, CT. 06484
Tel: (203) 929-5381

CIRCLE NUMBER 62

CUSTOM HYBRIDS

Call Frank Albertson
(714) 759-2411

Or send for new brochure:
500 Superior Ave., Newport Beach, CA 92663

HUGHES

HUGHES AIRCRAFT COMPANY

MICROELECTRONIC PRODUCTS DIVISION

CIRCLE NUMBER 63

CUSTOM BIPOLAR LSIs

Call Dennis Olson (714) 759-2411

Or send for new brochure:
500 Superior Ave., Newport Beach, CA 92663

HUGHES

HUGHES AIRCRAFT COMPANY

MICROELECTRONIC PRODUCTS DIVISION

CIRCLE NUMBER 64

MOVING?

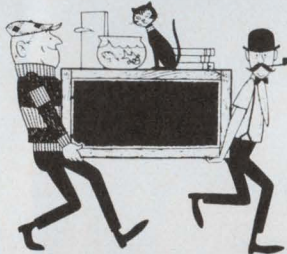

If you've recently moved or plan to in the near future, tell us, and we'll send your issues to you at your new office.

For fast, accurate service:

1. Detach the Change of Address Form bound into the back of this issue.
2. Remove the mailing label from the front cover of this issue and affix it to the designated area on the card.
3. Print your new address in the grid provided.
4. Write date that the change becomes effective. (Please allow 6-8 weeks for processing).
5. Affix proper postage to card and mail today!

New literature

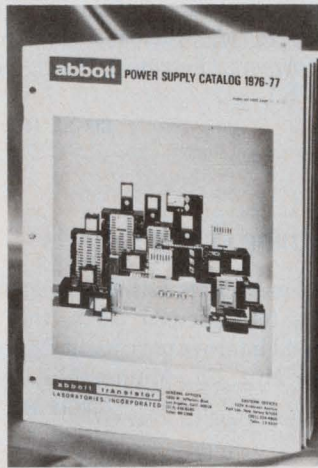

Power supplies

Over 3500 standard power-supply modules with complete electrical specifications, operating parameters, dimension charts, and prices are listed in a 60-page catalog. Abbott Transistor, Los Angeles, CA

CIRCLE NO. 388

Relays

A 32-page catalog describes 878 models of reed, general-purpose, solid-state, power and sensitive relays, photocontrols and opto-isolators. The catalog contains specifications, schematics, outline drawings, and mounting templates, as well as complete ordering and pricing information. Sigma Instruments, Braintree, MA

CIRCLE NO. 389

Indicator lamps

Described in a 16-page catalog are standard lenses, incandescent and neon indicators, cartridge hardware and lampholders. Each page covers a separate CM series: showing features, dimensional drawings, electrical and mechanical specifications. Chicago Miniature Lamp Works, Chicago, IL

CIRCLE NO. 390

Plotter points

A four-page brochure describes plotter-point replacements for digital plotters. Koh-I-Noor, Bloomsburg, NJ

CIRCLE NO. 391

Trimming pots

Technical specifications on sub-miniature trimming potentiometers are given in a four-page bulletin. Murata, Marietta, GA

CIRCLE NO. 392

Instrumentation amplifiers

The theory of operation for both the Model 176 and 178 encapsulated instrumentation amplifiers is covered in a six-page brochure. The brochure also discusses common-mode rejection and frequency response. Calex Mfg., Pleasant Hill, CA

CIRCLE NO. 393

PROM programmers

A 48-page guide describes PROM programmers, microprocessor system analyzers, microprocessor systems and support hardware, and design courses and seminars. Pro-Log, Monterey, CA

CIRCLE NO. 394

Accelerometers

Photos, specifications and descriptions cover piezoelectric accelerometers. BBN Instruments, Cambridge, MA

CIRCLE NO. 395

Data-acquisition system

The RECON remote data-acquisition and control system is described in a brochure. Photographs show typical installations for pump-station control, environmental monitoring, electric-power distribution, mining and energy management. Sangamo-Weston, Sarasota, FL

CIRCLE NO. 396

Electronic enclosures

An eight-page brochure describes Accent vertical cabinets. Scientific-Atlanta, Optima Div., Tucker, GA

CIRCLE NO. 397

Low-power Schottky TTL

A six-page folder covers 165 low-power Schottky-TTL circuits. Included are operating-life-test data and a discussion of the company's Product Enhancement Program (PEP). Texas Instruments, Dallas, TX

CIRCLE NO. 398

Connectors

A 64-page catalog features micro-miniature connectors and interconnect systems. Performance data, line and cutaway drawings and termination configurations are included. ITT Cannon Electric, Santa Ana, CA

CIRCLE NO. 399

Encoders

Application information and electrical specifications for high resolution, absolute and incremental optical shaft-position encoders are given in a 20-page catalog. Litton Encoder Div., Chatsworth CA

CIRCLE NO. 403

Slide, rocker switches

A 25-page slide-and-rocker-switch catalog explains the company's new numbering system, switch-material specifications, UL and CSA ratings, and options. Schematics and PC layouts are included for each switch and the bulletin contains examples of custom designs and suggested wiring diagrams. Stackpole, Farmville, VA

CIRCLE NO. 404

Voltage starters

Solid-state reduced-voltage starters are featured in a four-page brochure. Allen-Bradley, Milwaukee, WI

CIRCLE NO. 405

Switchers

Specifications, outline dimensions, and single-unit prices of single and multiple-output switches are given in an eight-page catalog. Trio Labs, Plainview, NY

CIRCLE NO. 406

Dedicated system

Two brochures describe the HP 2026 System. The 12-page overview brochure describes system features, and gives a list of peripherals and user-support programs. The 40-page price/configuration guide includes information on warranty, base-system equipment and options. Hewlett-Packard, Palo Alto, CA

CIRCLE NO. 407

IPC technical reports

"How to Avoid Metallic Growth Problems on Electronic Hardware" discusses the problem in depth, reports on an industry survey on electromigration problems conducted by the IPC, and provides a series of positive actions that may be taken to inhibit or reduce the occurrence of this phenomena. Another report "Additive Process Evaluation" defines the results of a cooperative testing program in which 140 panels were submitted by IPC member companies for testing. The cost is \$5 per copy. IPC, 1717 Howard St., Evanston, IL 60202

CIRCLE NO. 408

CMOS microprocessors

Features, descriptions, functional diagrams and instruction summary for the series 1800 CMOS μ Ps are given in a 20-page catalog. Hughes Solid State Products Div., Newport Beach, CA

CIRCLE NO. 409

Disc drives

Design features, specifications and interface information on the 3300-series disc drives are given in an eight-page bulletin. Okidata, Mount Laurel, NJ

CIRCLE NO. 410

IEEE Introduced
a new interface standard.
National Instruments introduced
a new standard interface.



IEEE introduced the new standard 488-1975 General Purpose Interface Bus; and its popularity continues to grow.

National Instruments introduced a complete package that allows PDP-11 users the versatility of using the growing number of instruments that comply with the IEEE 488-1975 standard bus. Now, PDP-11 users can configure complete computer control measurement systems, at low cost, and with commercially available instruments.

Our complete package includes the GPIB11-1 plug-in board, completely developed software, cables and connectors — everything you need to interface with 488-1975 compatible instruments. We offer off-the-shelf

delivery and thorough applications assistance. And we back your GPIB11-1 with in-depth service, testing and a one year guarantee.

Now, the best part of our introduction. Low prices. National Instruments GPIB11-1 is so low priced, that it makes conversion truly low cost, in addition to being easy. Our quantity discount schedule will make large users and OEM's even happier.

We would like to introduce you to our complete package that allows you to benefit from the IEEE 488-1975 GPIB standards, and the new instruments that meet them. Write or call us, today, for technical information and prices.

New standard interfaces from

NATIONAL INSTRUMENTS
8330 Burnet Road
Austin, Texas 78758
Phone (512) 453-3475



CIRCLE NUMBER 65

Across the desk

(continued from page 12)

I support your viewpoint on "Professionals" 100%. The lack of professionalism, as it might be called, is not only a sore thumb for the engineering community, but a sore thumb for most cross-sections of our society.

Ron Stier

Belden Corp.
P.O. Box 1327
Richmond, IN 47374

Don't let them put you down! Your laetrile editorial strikes at the heart of the biggest issue facing all of us, a government that can tell us the best things to buy, the proper foods to stuff our mouths with, the best way to be treated for disease—and people who collectively know little more about the real facts than any of us on the outside. Why can they do this? Because we let them. Why do they do it? Because they claim through a "feeling" for humanity that they are doing what is "best."

How can your scientific and logical readers simultaneously demand freedom to study, to investigate, to work and to live without interference and then claim that the Government must "protect" those "others" who are not as capable? Logical opinions do not necessarily come from people dealing with logic. When some of your more vocal readers can distinguish between grades of freedom and how they can be distributed between us and the unfortunate and misinformed, then publish their letters—and not before.

Stanley A. Fierston

7 Pickwick Road
Marblehead, MA 01945

Most people missed the most important point of the laetrile controversy. The issue is individual freedom, not the effectiveness or ineffectiveness of laetrile.

Each of us owns himself. Governments do not own us. If I want to shoot mayonnaise into my veins, that is my business and not any government's (by the way, some dumb kid did shoot mayonnaise when he couldn't get heroin and he promptly died). As far as I know, mayonnaise is not yet a controlled substance.

I don't care if laetrile is dangerous or safe, effective or ineffective, or some combination thereof. If I want to use laetrile, I will use it. Governments have no right to prevent my making it or buying it from someone who does make

it. I am an adult human being. I am responsible for earning my own living and keeping myself properly nourished, etc. Am I not also capable of determining or hiring someone to determine the safety, effectiveness, cost desirability, etc., of things that I wish to obtain and use?

I am an individual. I shall continue to do as I please while I observe the rights of others. I shall not knowingly violate anyone else's rights (property rights, human rights, etc.). Governments are hereby put on notice: Go jump in the lake!

David Michael Myers
Chief Engineer

Autocybernism Unlimited
Hughesville, MD 20637

I notice that two respondents who disagreed with your laetrile editorial mentioned thalidomide. I think that story needs to be told over and over until everyone comprehends what really happened and the implications.

Based on prescribed laboratory tests, many nations approved the manufacture and sale of this potent tranquilizer. The United States did not. Subsequently, in Europe and elsewhere, a rash of severely deformed children was traced to the use of this drug by their pregnant mothers. The United States was largely spared this horrible tragedy. The Food & Drug Administration selected one of its top women "researchers," and in a public ceremony presented her an award for having prevented the distribution of this drug in the U.S.

But why did this entrenched bureaucracy fight against thalidomide? Was it inadequate testing, a lack of effectiveness, or, as proved to be the case, very undesirable side effects—items the FDA is supposed to monitor? Hell, no! the decision was based on protecting the status quo, something the gone-to-seed bureaucracy is superb at. There already were approved drugs on the market to do the same job!

Raymond D. Musick

Western Electric Co.
1111 Woods Mill Rd.
Ballwin, MO 63011

Professionalism in the medicine business is nothing much more than a public relations technique to ensure a high income for the average physician and to protect him against the consequences of his own stupidity and arrogance.

Stupidity and arrogance? Those are the words.

Until about 1900, the chances of anyone being improved by a visit to a physician in the United States were about 50%. Lower in most other places. Even today, about 20% of hospital cases are due to iatrogenic (physician-caused) problems, and a large additional number to unnecessary, and frequently harmful, medical procedures and surgery, according to medical profession sources. Also, the various surveys conducted by the AMA show 10 to 20% of practicing physicians to be utterly incompetent or too drunk to practice, and perhaps 50% to be relatively incompetent.

Other places may be worse. About 100 years ago, for example, at the University of Gottingen Hospital, there was a period of three years during which not a single live mother or baby came out of the maternity wards. All were killed by puerperal fever induced by the physicians, physicians too arrogant even to consider the possibility that Semmelweis might have been right.

The medicine men will either ignore me, attack me on irrelevant grounds, or claim that things are different now. But of course they are not. The tradition of Gottingen lives on.

The physician of today is a body repairman, who hasn't a clue as to how the body works. He knows almost nothing of physics, damn little of microchemistry, a little bit about the essential chemical reactions of the body, and absolutely nothing about the internal workings of the brain. "Reputable" psychiatrists (MDs all) still go in for the gruesome procedures of electroshock "therapy," which is on a par with attempting to repair a large computer complex by passing lightning bolts through the power supplies.

But the tradition of medical infallibility lives on, and it is still almost impossible to get a physician to stand up in court and testify that a fraternity member goofed.

And the future will be no better. Go to any reputable university. Go to the elementary physics class and pick out the students who are failing. Give or take about 10%, these are the pre-med students, your physicians of tomorrow.

You're in good hands with the AMA.

Dr. Yale Jay Lubkin

Director of Engineering

Ben Franklin Industries, Ltd.
Casey Creek, KY 42723

(continued on page 206)



Wherever fast, portable heat is the need

Heating shrink tubing is just one of many jobs the Master Flameless Heat Gun performs in electronic assembly. It's the perfect source of fast, portable heat for drying components, heat-checking circuitry, softening plastics and adhesives, melting solder, etc. Industrial quality for production line duty. Twelve models: 200°F to 1000°F, 120V or 230V, standard or UL listed. Special application attachments available.

For FREE complete line catalog from the originators of heavy duty heat guns, contact your electronic distributor or call or write:

MASTER
appliance corporation

In Canada, contact Martin Industrial Sales Ltd. 4445 Harvester Road, Burlington, Ontario

2420 — 18th Street,
RACINE, WIS. 53403
(414) 633-7791

CIRCLE NUMBER 66

C&K's Pushbutton Switches with Snap-in Bezels make the screwdriver obsolete.

specify
8161J82ZQ



specify
8125J81ZB

specify
8268J82ZQ

specify
8221J81ZB

C&K has four unique submini pushbutton switches with snap-in bezels that make a screwdriver unnecessary in panel assembly. These time-and-money saving switches simply snap into a panel hole and a nickel-plated steel mounting spring holds the switch firmly in place. The switches are available in 1-amp and 6-amp models in SPDT and DPDT configurations. Also .4VA for low energy circuits. LED illumination is available on certain models. For specifics, write or call today. With these new switches, the next time you pick up a screwdriver will be in your local tavern.

C&K Components, Inc., 103 Morse Street,
Watertown, MA 02172 Tel: (617) 926-0800
TWX: 710-327-0460 TELEX: 92 2546
Free Engineering Sample on Request.

CIRCLE NUMBER 68

AUTHOR'S GUIDE



If you've solved a tricky design problem, if you have developed special expertise in a specific area, if you have information that will aid the design process... share it with your fellow engineer-readers of *Electronic Design*.

Articles you have authored not only raise your own professional status, but help build your company image as well. The readers benefit, your company benefits.

To help you prepare material that meets *Electronic Design's* high editorial standards, our editors have prepared a special author's guide entitled "Writing for *Electronic Design*." It covers criteria for acceptability, form, length, writing tips, illustrations, and payment for articles published. It's available without cost.

It's easy to write for *Electronic Design*, but it's often hard to get started. Send for your copy of our Author's Guide today.

Circle No.
250

ANALOG PRECISION, INC.

announces

BUBBLE MEMORY SYSTEMS

For information, write or call:

Analog Precision, Inc.
1620 North Park Avenue
Tucson, AZ 85719
(602) 622-1344

CIRCLE NUMBER 69

Across the desk

(continued from page 204)

Laetrile should be judged on the question of whether it is helpful or harmful. There appears to be more evidence than many are aware of that it is helpful and little, if any, evidence that in normal doses it is harmful. The medical community itself is very divided on this subject. However, many doctors are using and supporting it. Even if laetrile is proved to be just another placebo (many of which have been used effectively by the medical profession for years), there is no reason to ban it. We cannot overlook the psychological cure of diseases and the relief of pain—in fact, this approach should be researched and expanded. Who cares how a person is helped as long as he is really helped?

Also, much evidence exists as to the dangers of smoking—but where is the big movement to ban it? The tobacco industry is, of course, much too wealthy and powerful to let that happen. And as we all must admit, it is the wealthy, hence powerful, groups that direct our government, not good old common sense and “what’s best for the people.”

As to the medical profession, reader Brody (ED No. 19, Sept. 13, 1977, pp. 188-190) seems to exemplify the members whose attitudes have resulted in a lack of faith in the medical community. We are aware of the countless number of unnecessary operations performed yearly, the fraud in Medicare programs, the ever increasing interest in more money rather than in the patients’ health, and in many cases outright incompetence.

Then we read such statements as “I most respect the medical profession for looking out for #1” and “I’d rather be a rotten S.O.B (don’t worry Doc—you are) with a good, steady income and some solid security than that really hard working Nice Guy who’s out of a job...” Where’s the RESPECT Dr. Brody talks about? Professionalism certainly does mean respect *and* dedication to the profession, not to money! Certainly money is important and EEs should fight for a much better deal. But having a high income certainly does not make you a professional. Nor does a high formal education such as a Ph.D make you honest and trustworthy.

I became an EE and remain one because I love the *profession*. I spend a great deal of my own time and money

studying and trying to improve my knowledge and ability. There are many other jobs where I could make more money and have greater security, but I stay in electronics because it is more than just a job to me. It is my profession and even hobby—my second favorite thing, if you will (after all, I was a male before I was an EE).

Jerry Petrel

Electronics Design Engineer

3208 Navajo Way
Nevada Test Site
Las Vegas, NV 89108

It occurred to me in reading your second laetrile editorial (ED No. 19, Sept. 13, 1977, p. 51) that most people who agree with your position would not bother to write.

I am an electronics designer who gets his laetrile by eating about five peach or plum pits every day—to hell with the FDA.

Your outspokenness is very much appreciated—keep up the good work!

Czako Funk

Project Engineer

Fitch Creations, Inc.
North Greensboro St.
Carrboro, NC 27510

Three cheers for your September 13 stand on professionalism. If enough specialists in all fields cannot become personally responsible to the public at large for their own conduct and for their own set of priorities, we are all probably doomed.

Who can police the professional but other similarly trained professionals? An everyone-for-himself-to-hell-with-everyone-else attitude destroys the mutual trust on which modern (technologically enslaved) society depends.

F.L. Walker

Principal Engineer

Raytheon Data Systems
1415 Boston-Providence Turnpike
Norwood, MA 02062

Judging from the negative replies in the September 13 issue, your July 19 editorial on professionals using the current “nonprofessional topic”—laetrile—was sorely needed.

You picked a good selection of letters, as they covered just about every irrationality and prejudice associated with laetrile. As you stated in your rebuttal, the negative replies—and some of the positive ones—missed the basic idea of the editorial: A pro-

fessional who does not keep an open mind is not professional—or worse. Unfortunately, the medical-industrial complex is the most unprofessional group around—except for big government.

Keep on reminding us of our professionalism.

Peter E. Sluka

Western Electric
Naperville, IL 60540

By the way...

The computer-program illustration that appeared in ED No. 21, Oct. 11, 1977, p. 36 was reproduced from an article that appeared in the May, 1977, issue of BYTE magazine.

Misplaced Caption Dept.



When the recession hit and our funds for development were cut off, we could understand that. But now, the situation is actually worse . . .

Sorry. That’s a sculpture of Diadoumenos (Roman copy) by Polykleitos, which stands in the Athens National Museum.

Anonymous con

Occasionally, Mr. Rostky is so bright he’s out of sight. He reminds me of our QC Dept.—great at pointing out problems they do not have to solve.

Name withheld

Marconi Instruments Ltd.
St. Albans, Herts, UK

Electronic Design

ELECTRONIC DESIGN's function is:

- To aid progress in the electronics manufacturing industry by promoting good design.
- To give the electronic design engineer concepts and ideas that make his job easier and more productive.
- To provide a central source of timely electronics information.
- To promote communication among members of the electronics engineering community.

Want a subscription? ELECTRONIC DESIGN is circulated free of charge to those individuals in the United States and Western Europe who function in design and development engineering in companies that incorporate electronics in their end product and government or military agencies involved in electronics activities. For a free subscription, use the application form bound in the magazine or write for an application form.

If you do not qualify, paid subscription rates are as follows: \$30.00 per year (26 issues) U.S./Canada/Mexico, \$40.00 per year (26 issues) all other countries. Single copies are \$2.50 U.S. and all other countries. The Gold Book (27th issue) may be purchased for \$30.00 U.S./Canada/Mexico, and \$40.00 all other countries.

If you change your address, send us an old mailing label and your new address; there is generally a postcard for this in the magazine. You will have to requalify to continue receiving ELECTRONIC DESIGN free.

The accuracy policy of ELECTRONIC DESIGN is:

- To make diligent efforts to ensure the accuracy of editorial matter.
- To publish prompt corrections whenever inaccuracies are brought to our attention. Corrections appear in "Across the Desk."
- To encourage our readers as responsible members of our business community to report to us misleading or fraudulent advertising.
- To refuse any advertisement deemed to be misleading or fraudulent.

Individual article reprints and microfilm copies of complete annual volumes are available. Reprints cost \$6.00 each, prepaid (\$5.00 for each additional copy of the same article), no matter how long the article. Microfilmed volumes cost \$23 for 1976 (Vol. 24); \$30 for 1973-75 (Vols. 21-23), varied prices for 1952-72 (Vols. 1-20). Prices may change. For further details and to place orders, contact Customer Services Dept. University Microfilms, 300 N. Zeeb Rd., Ann Arbor, MI 48106. (313) 761-4700.

Want to contact us? If you have any comments or wish to submit a manuscript or article outline, address your correspondence to:

Editor
ELECTRONIC DESIGN
50 Essex St.
Rochelle Park, NJ 07662

Rustrak miniature temperature recorders

**Thermocouple, Thermistor,
Resistance Bulb Types.**

Ranges and spans to suit practically any temperature measurement application. Sensors available. In stock at your local authorized Rustrak distributor.

Attention OEM's. Custom mounting arrangements, colors, nameplates, chart paper and scales available.

New 32 Page Catalog. Provides details on DC, AC, Temperature, Servo, Multichannel, Event and a variety of special recorder types.

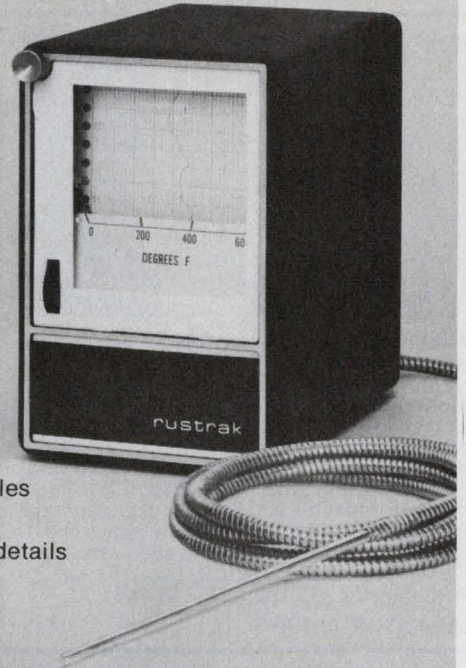

gulton

Measurement & Control Systems Division
Gulton Industries Inc., East Greenwich, Rhode Island 02818
401-884-6800 • TWX 710-387-1500

CIRCLE NUMBER 71

KEEP

Electronic Design's

GOLD BOOK

HANDY

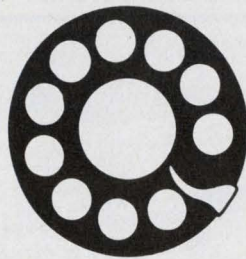

When You Call

Save time when you contact suppliers. Check their catalog pages first in *Electronic Design's* GOLD BOOK. Maybe the information you need is right at your fingertips.

CUSTOM CRYSTAL FILTERS

Call Vic Gill (714) 759-2411

Or send for new brochure:
500 Superior Ave., Newport Beach, CA 92663

HUGHES

HUGHES AIRCRAFT COMPANY
MICROELECTRONIC PRODUCTS DIVISION

CIRCLE NUMBER 72

STANDARD ELECTRONIC MODULES

Call Ed Gray (714) 759-2411

Or send for new brochure:
500 Superior Ave., Newport Beach, CA 92663

HUGHES

HUGHES AIRCRAFT COMPANY
MICROELECTRONIC PRODUCTS DIVISION

CIRCLE NUMBER 73

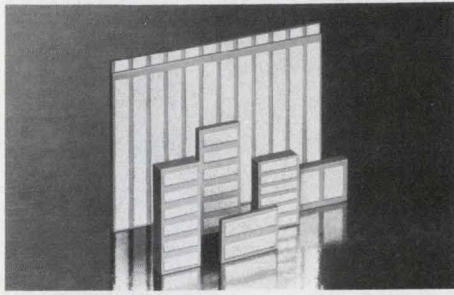

MULTIPLE CAPACITOR ARRAYS are single-plate multiple capacitance elements and serve as replacements of individually bonded chips in hybrid circuits. They are perfect for multiple circuit coupling, filtering, by-pass and high voltage meter multiplier circuits. They are easy to install and provide savings over the assembly of individual capacitors. Multiple capacitor arrays available in a variety of dielectric characteristics to meet specific requirements. **JOHANSON DIELECTRICS, INC.**, Bx 6456, Burbank, Ca. 91510 213-848-4465.

CAPACITOR ARRAYS

181

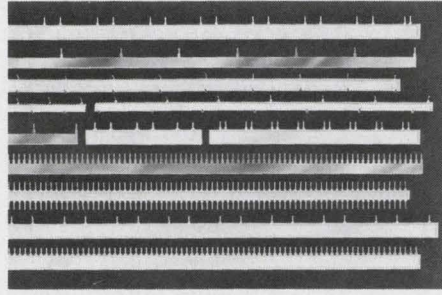

MINI/BUS® BY ROGERS, low-cost, low-inductance, high capacitance printed circuit board bus bars for noise reducing voltage distribution, are available in a variety of ready-to-ship designs. Prototype kits are also available from stock. Call or write Mini/Bus product specialist for a complete list. Rogers Corporation, Chandler, AZ 85224. Phone: (602) 963-4584. (EUROPE: Mektron NV, Gent, Belgium; JAPAN: Nippon Mektron, Tokyo.)

BUS BARS

184

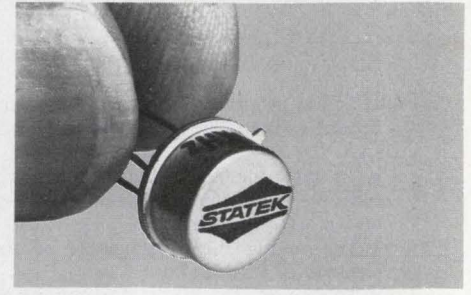

LOW COST QUARTZ CRYSTALS Use Statek 10 to 300 kHz quartz crystals in TO-5s . . . they eliminate count down for oscillators, filters, tone generators, timers . . . They're rugged, accurate & resistant to high vibration and shock. Prices low as \$1.70 ea. in 1000 qty. Send your written application & we'll send you a sample. Call or write for literature. Details in Gold Book and EEM * **STATEK CORP.** * 512 N. Main, Orange, Ca. 92668 * (714) 639-7810 * Telex 67-8394

QUARTZ CRYSTALS

187

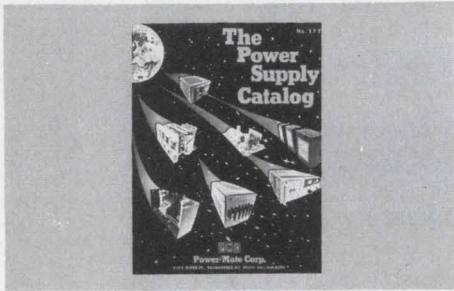

Free New '77 catalog contains over 34,500 quality power supplies from the world's largest manufacturer, Power/Mate Corp. Power Supplies for every application including submodulars, open frame, varigated, encapsulated, laboratory & system. All units UL approved and meet most military and commercial specs for industrial and computer uses. Power/Mate Corp., 514 S. River St., Hackensack, NJ 07601 (201) 343-6294

POWER SUPPLIES

182

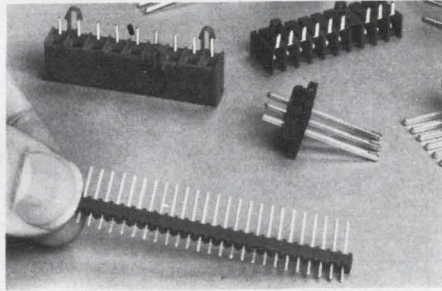

NEW FAMILY OF MINIATURE TERM-ACON SERIES CONNECTORS will solve majority of PC board interconnect problems. Moderately priced reliable designs for .100", .200" and .156" center pin spacings for hi-density to general purpose usage. U/L flame retardant Nylon material conforms to MIL-STD-202E. Polyester 94V-0 rated connectors are also available. **METHODE ELECTRONICS, INC.**, 1700 Hicks Road, Dept. PR, Rolling Meadows, Illinois 60008. (312) 392-3500.

PC BOARD CONNECTORS

185

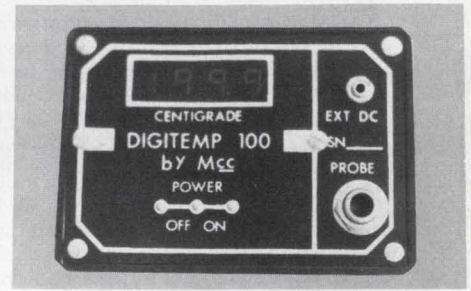

DIGITEMP 100 digital temperature meter spans $-55^{\circ}\text{C}(-67^{\circ}\text{F})$ to $+150^{\circ}\text{C}(302^{\circ}\text{F})$ with $\pm 0.5^{\circ}\text{C}$ accuracy. Temperature is displayed to 0.1°C resolution on a large 0.33 LED display. A variety of fully-interchangeable plug-in probes are available including a fast response surface, submersible and bolt-down probes. Uses a 9V transistor battery or 110 VAC adapter. Display unit \$155, Surface probe \$25. Delivery 2 to 4 weeks. Mid-continent Communications Co., 1103 Broadway, Oak Grove, Mo. 64075 (816) 625-4765.

DIGITAL TEMPERATURE METER

188

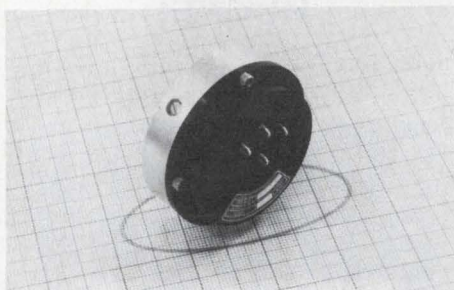

LOW COST PENDULUM CP17-0601-1 provides vertical references for monitoring and control of pitch and roll angular displacements. Replaces expensive vertical gyros for many instrument and control system applications. Potentiometric output; hermetically sealed; fluid damped; range of $\pm 45^{\circ}$; resolution less than 0.20° ; linearity within 0.5; total error band of $\pm 1\%$ full scale. Wide range of models available. **Humphrey, Inc.**, 9212 Balboa Ave., San Diego, CA 92123. Tel. (714) 565-6631

PENDULUM

183

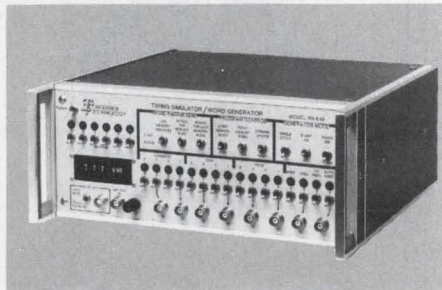

RS-648 Timing Simulator/Word Generator is intended for lab use by engineers and technicians who are debugging digital circuitry or for production testing. It provides eight output channels and 16 memory words and is programmable to allow users to simulate exactly the desired timing signals or data transfers needed for device test. From Interface Technology, 852 North Cummings Road, Covina, CA 91724. (213) 966-1718.

TIMING SIMULATOR

186

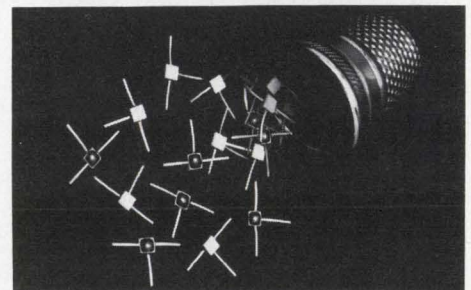

TaFilm™ precision subminiature resistor networks from TRW, the world's smallest 1/4-watt resistor, has proven its performance, reliability and space-saving design in ultra-high-speed computers, line terminations and microwave attenuation. Useful at frequencies up to 2 gigahertz, the network offers low noise and excellent high-frequency characteristics for RF or high-speed switching operations. TRW/IRC Resistors, an operation of TRW Electronic Components, 4222 S. Staples St., Corpus Christi, TX 78411. (512) 854-4872.

RESISTOR NETWORKS

189

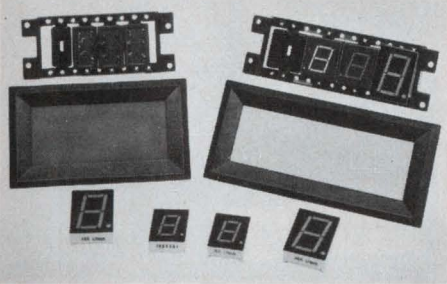

ATLAS MOUNTING HARDWARE FOR LED DISPLAYS Series 1750/51 accommodates most mfr's 0.3" to 0.5" character LEDs; Series 1752/53 accepts 0.6" to 1.1" characters. This versatile, unitized plug-in pkg comes complete w/ front bezel containing a hi-contrast, non-glare filter, and self-contained socket assy holding up to 8 displays. Ea. socket accepts up to 18-pin DIP pkg w/ optional .3" or .6" vert. pin row spacing. Avail. immed. IEE, 7740 Lemona Ave., Van Nuys, CA 91405, (213) 787-0311, ext. 268.

MOUNTING HARDWARE

190

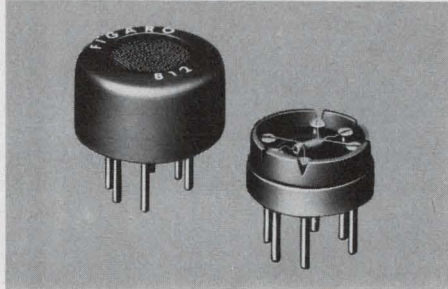

FIGARO GAS SENSOR TGS is a gas sensitive semiconductor. When combustible gas is absorbed on the sensor surface, a marked decrease of electrical resistance occurs. Major features of the sensor include high sensitivity, long term reliability and low cost. The applications are: GAS-LEAK ALARM, AUTOMATIC FAN CONTROL, FIRE ALARM, ALCOHOL DETECTOR, etc. Figaro Engineering Inc., North America Office-3303 Harbor Boulevard, Suite D-8, Costa Mesa, Calif. 92626 Tel: (714) 751-4103 Telex: 678396

GAS SENSOR

193

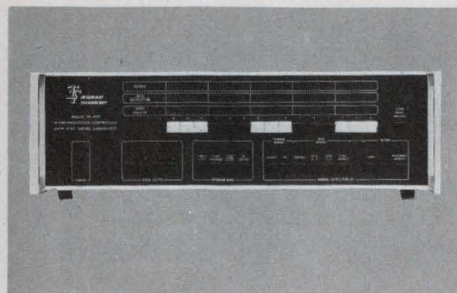

RST-432 Microprocessor-Controlled Data and Timing Generator provides engineers and test technicians with known, fixed control, clock and data inputs to stimulate dynamic devices being tested and to react to response signals from them. The key is the ability to generate signals simply and at the dynamic rate of the device being tested. RST-432 can be used as a subsystem component of large test systems. From Interface Technology, 852 North Cummings Road, Covina, CA 91724. (213) 966-1718.

DATA GENERATOR

191

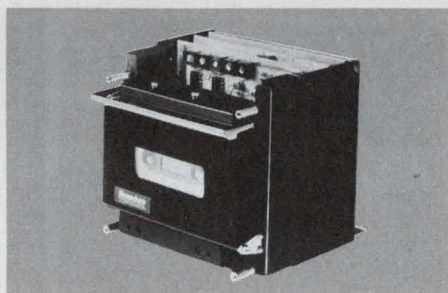

HIGH SPEED RECORDER FOR MICRO-PROCESSORS Model 764 has a patented constant speed tape drive using only 2 moving parts. No capstans, tachometers or clock tracks are necessary. Records up to 32,000 bits per second. Searches at 100 inches per second. Can store up to 5 megabits per 300 foot cassette. ANSI/ECMA compatible. Priced under \$500.00/OEM quantities. MEMODYNE CORPORATION, 385 Elliot Street, Newton Upper Falls, MA 02164. Telephone (617) 527-6600.

MICROPROCESSOR RECORDER

194



LEM's THYRISTOR TEST AND MEASURE EQUIPMENT are the first on the market and permits the accurate measure of turn-off, t_q , dV/dt , stored charge Q_r , V_T , as well as static characteristics under totally independent regulation of parameters I_r , dI/dt , V_{DR} , V_R , dV/dt . Standard and custom design. Data sheets and reference on request. LEM SA 14 E Rte St-Julien CH 1227 GENEVA SWITZERLAND tx 28 94 22 Phone (022) 42 29 00

THYRISTOR TEST EQUIPMENT

192

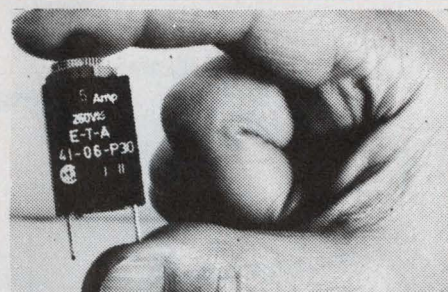

Overcurrent Protector, manual reset eliminates fuse replacement. Convenient panel mounting. 19 fractional ratings from 0.1 to 5 amp. Other models up to 400 amp. Trip-free and fool-proof, UL and CSA approved. High quality, low cost \$1.39 ea. in 1000 lots. E-T-A Products Co. of America, 7400 N. Croname Rd., Chicago, Ill. 60648. Tel: (312) 647-8303. Telex: 253780.

CIRCUIT BREAKER

195

Electronic Design

Advertising Sales Staff

Susan G. Apolant
Sales Coordinator

Rochelle Park, NJ 07662

Robert W. Gascoigne
Thomas P. Barth
Stan Tessler
Constance McKinley
50 Essex St.
(201) 843-0550
TWX: 710-990-5071
(HAYDENPUB ROPK)

Philadelphia

Thomas P. Barth
(201) 843-0550

Boston 02178

Gene Pritchard
P.O. Box 379
Belmont, MA 02178
(617) 489-2340

Chicago 60611

Thomas P. Kavooras
Berry Conner, Jr.
200 East Ontario
(312) 337-0588

Cleveland

Thomas P. Kavooras
(312) 337-0588

Los Angeles 90045

Stanley I. Ehrenclou
Burt Underwood
8939 Sepulveda Blvd.
(213) 641-6544

Texas

Burt Underwood
(213) 641-6544

San Francisco

Robert A. Lukas
465 S. Mathilda, Suite 302
Sunnyvale, CA 94086
(408) 736-6667

England

Constance McKinley
50 Essex St.
Rochelle Park, N.J. 07662
Phone: (201) 843-0550

Europe

Sanders, W. J. M.
Raadhuisstraat 24
Graft-De Ryp, Holland
Phone: 02997-1303
Telegrams: Euradteam-Amsterdam
Telex: 13039-SIPAS

G. Nebut

Promotion Presse Internationale
7 ter Cour des Petites Ecuries
75010 Paris, France
Telephone: 5231917, 1918, 1919

Dieter Wollenberg

Erikastrasse 8
D-8011 Baldham/Muenchen
Germany
Telephone: 0 8106/4541

Tokyo

Haruki Hirayama
EMS, Inc.
5th Floor, Lila Bldg.,
4-9-8 Roppongi
Minato-ku, Tokyo, Japan
Phone: 402-4556
Cable: EMSINCPERIOD, Tokyo

★ABP

BPA

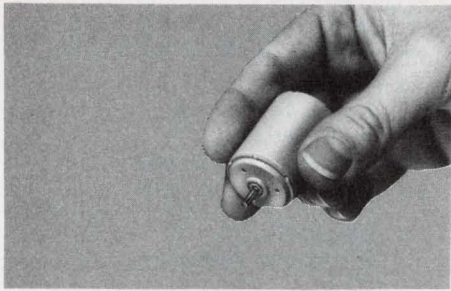

MINIATURE IRONLESS ROTOR DC MOTORS offer efficiencies to 80%, low inertia, rapid response and high starting torque. 24V and 12V dc models available. Motor time constants are 17MS and 23MS respectively. Rotor torque is 100 and 50 gcm and starting torque 600 and 230 gcm, respectively. 12V dc units can be ordered with either single or extended double shaft. Tach versions available. For reel/capstan drives, chart/pen drives, etc. North American Philips Controls Corp., Cheshire, CT 06410. (203) 272-0301.

NAP CONTROLS

196

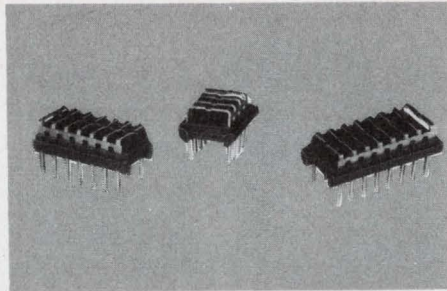

DIP Program Header (patent applied for) Now . . . you can program within the header itself and eliminate costly DIP switches. Available pre-programmed or can be programmed using needle nosed pliers or Aries Program Header tool to remove interconnecting sections between opposing pins or adjacent pins. Protective snap-on cover is provided which can be marked to identify program. Available 8, 14, 16 pin on .300 centers. ARIES Electronics, Inc., B 231, Frenchtown, NJ 08825. (201) 996-4096. TWX 510-235-3391

DIP PROGRAM HEADER

199

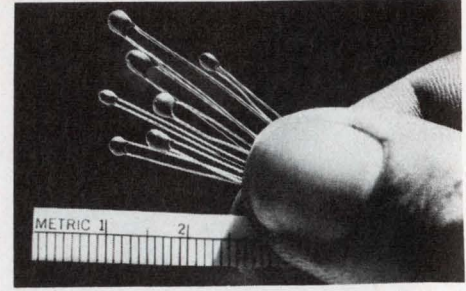

THERMISTORS with leads and coating are highly reliable low cost components in small dimensions more compatible with modern circuit design. R @ 25°C 100Ω to 1 meg Ω ±10% to ±1%. CURVE MATCHED INTERCHANGEABLES to ±.25°C. POINT MATCHED INTERCHANGEABLES to ±.2°C. Call or write for HP97 or TI SR52 THERMISTOR LINEARIZATION PROGRAM. WESTERN THERMISTOR CORPORATION, 354 Via Del Monte, Ocean-side, CA 92054. (714) 433-4484.

THERMISTOR

202

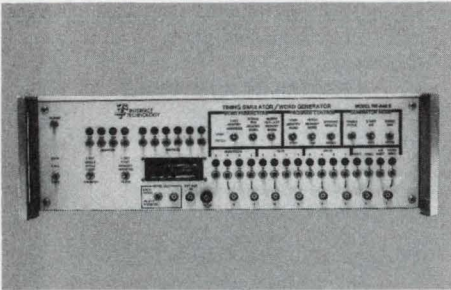

RS-648E Timing Simulator/Word Generator is an expanded version of the RS-648 which provides eight output channels and 256 memory words, including first memory address parameter. It's also intended for lab use by engineers and technicians who are debugging digital circuitry or for production testing. From Interface Technology, 852 North Cummings Road, Covina, CA 91724. (213) 966-1718.

TIMING SIMULATOR

197

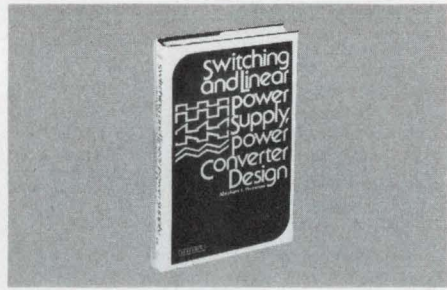

SWITCHING AND LINEAR POWER SUPPLY, POWER CONVERTER DESIGN, by Abraham I. Pressman. A "how-to-design" book written from a power supply designer's point of view. Provides all the circuits, systems, magnetics, and thermal design skills you need to design a modern power supply system. #5847-0, 384 pp., \$19.95. Circle the Info Retrieval Number to order your 15-day exam copy. When billed, remit or return the book with no obligation. Hayden Book Co., 50 Essex St., Rochelle Park, N.J. 07662. Offer good in USA and Canada only.

200

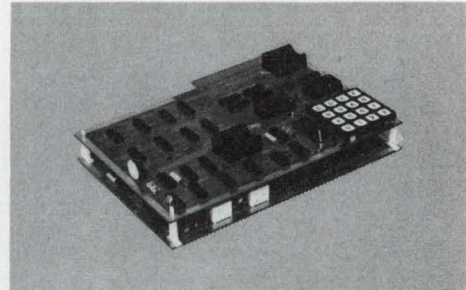

Program is entered via a hex keypad & verified on a FND500 before you actually program a location. During Program cycle a compare L.E.D. verifies that the data programmed is the same as data entered and then auto-steps to the next address loc. You can also copy an existing PROM. Requires +5, -9 & +80 volts. Kit: \$239.95, Assembled: \$349.95, Brief case: \$599.95. Allow 2 wks. del.—Antistatic Workbench station: \$14.95. (FOB Ontario) PROM-DATA CO., 1726-C East 4th, Ontario, CA. 91764 (714) 986-4321

1702A EPROM PROGRAMMER

203

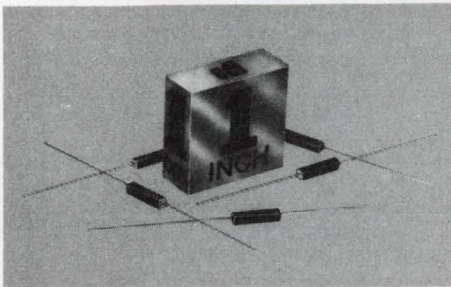

ELECTRONIC DEVICES INC. DEVELOPS 3,000 TO 12,000 VOLT, MINIATURE SILICON RECTIFIERS WITH 1" LONG LEADS. These fast recovery 25 mA rectifiers have 1" leads for easier assembly into PC boards and high voltage multipliers. They feature small size (0.4" x 0.110") avalanche characteristics, low leakage, 3A surge, 300 ns. recovery and 125°C ambient temp. For samples and spec. write Electronic Devices, Inc., 21 Gray Oaks Ave., Yonkers NY 10710 (914) 965-4400.

HV SILICON RECTIFIER

198

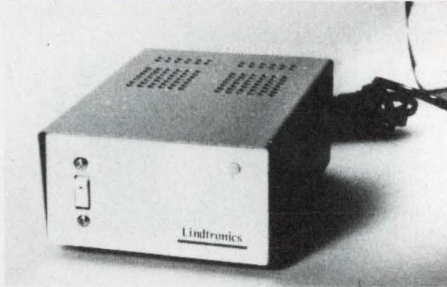

TRIPLE OUTPUT REGULATED DC SUPPLY — compact DC supply ideal for micro-processor and memories, Model 477-3 supplies 5V @ 500 ma, +12V @ 100 ma and -5V @ 200 ma regulated outputs, input 110V 60Hz, the unit is enclosed in a compact steel case and complete with AC line cord with fuse. Unit price \$24.00. Lindtronics, P.O. Box 1792, North Brunswick, N.J. 08902.

REGULATED DC POWER SUPPLY

201

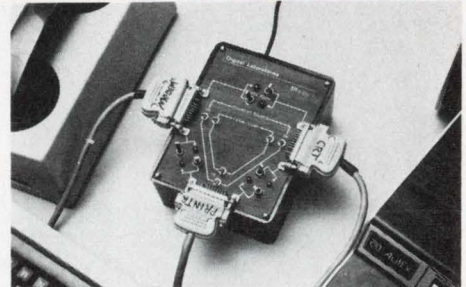

UNIVERSAL JUNCTION UNIT . . . for three devices, RS232C or current loop.

. . . Six switches provide all 63 interconnects that are possible between three I-O devices. LED's indicate data flow. . . . Designed to provide circuit compatibility and easy data routing between different manufacturer's devices. . . . \$350 (1-4) from DIGITAL LABORATORIES, 600 Pleasant St., Watertown, MA 02172 (617) 924-1680

3 PORT RS232 & 20 MA LOOP

204

Electronic Design

recruitment and classified ads

PLACE YOUR AD AT ONLY \$55 PER COLUMN INCH IN

Electronic Design

— GET A REPEAT AD FREE!

With our 2 for 1 plan, your net cost in *Electronic Design* is only \$27.50 per column inch, lowest among all the national newspapers and electronics media. You get a total of 165,418 exposures to OEM engineers and engineering managers (not counting 11,668 more among general or corporate managers) at only 33¢ per thousand! You can't beat the price. You can't beat the coverage and you can't beat the quality.

YOU REACH ENGINEERS WITH TITLES LIKE THESE:

- Chief Engineer • Development Engineer • Design Engineer • Project Engineer • Electronic Engineer • Engineer-Supervisor • Section Leader • Staff Engineer • Systems Engineer • Test Engineer • Standards Engineer • Master Engineer

Electronic Design RECRUITMENT ADVERTISING RATES

15% commission to recognized agencies supplying offset film negatives. 2% 10 days, net 30 days. Four column makeup. Column width 1-3/4" x 10".

SPACE	DIMENSIONS		COST
	Wide	Deep	
One column inch	1-3/4"	x 1"	\$55.
2 col. in.	1-3/4"	x 2"	\$110.
1/16 page (1/4 col.)	1-3/4"	x 2-1/2"	\$130.
1/8 page (1/2 col.)	1-3/4"	x 5"	\$275.
1/4 page (1 col.)	1-3/4"	x 10" Vert.	\$550.
	3-1/2"	x 5" Hor.	
1/2 page (2 cols.)	3-1/2"	x 10" Vert.	\$1100.
	7"	x 5" Hor.	
3/4 page (3 cols.)	5-1/4"	x 10"	\$1650.
1 page	7"	x 10"	\$2200.

NOTE: EACH RECRUITMENT AD YOU PLACE WILL BE REPEATED FREE OF CHARGE!

LATE CLOSING DATES

Electronic Design is mailed every two weeks. Because of its timeliness, personnel recruitment advertising closes only two weeks before each issue's mailing date.

Issue Date	Recruitment Closing Date	Mailing Date
Jan. 4	Dec. 9	Dec. 23
Jan. 18	Dec. 23	Jan. 6
Feb. 1	Jan. 6	Jan. 20
Feb. 15	Jan. 20	Feb. 3
Mar. 1	Feb. 3	Feb. 17
Mar. 15	Feb. 17	Mar. 3
Mar. 29	Mar. 3	Mar. 17
Apr. 12	Mar. 17	Mar. 31



HOW TO PLACE YOUR AD

CALL THE RECRUITMENT HOT LINE 201-843-0550

Camera-ready film (right reading negatives, emulsion side down) or camera-ready mechanicals must be received by deadline. Or, if you wish us to set your ad (typesetting is free) simply pick up the phone and call our RECRUITMENT HOT LINE — (201) 843-0550. Ask for:

Constance McKinley
RECRUITMENT ADVERTISING MANAGER
ELECTRONIC DESIGN

50 Essex Street, Rochelle Park, New Jersey 07662

KEEP

Electronic Design's
GOLD BOOK
HANDY
When
You Call

Save time when you contact suppliers. Check their catalog pages first in *Electronic Design's* GOLD BOOK. Maybe the information you need is right at your fingertips.

TECHNICAL WRITER

High fidelity equipment manufacturer needs person capable of analyzing state of the art hi-fi circuitry and writing theory of operation about same. Educational background unimportant; ability and knowledge are. Send resume to Mr. Michael Salvati,

Sony Corp. of America
47-47 Van Dam Street
L.I.C., NY 11101

We are an equal opportunity employer.

Help your
Heart...
Help your
Heart Fund

American Heart Association



\$18K to \$40K

THE BEST & THE BRIGHTEST

The Best and the Brightest come to P n' B first. Because, when we select you as a client we market you continuously to over 500 electronic, computer and aerospace companies until we find you what you want. You are our client but the companies pay all fees and expenses. So send your resume today! We'll be in touch with you.

P n' B Consultants, Inc., Box 4940, Wayne, Pa. 19087
The Engineers Who Talk Your Language

ELECTRONIC ENGINEERING OPPORTUNITIES

We are a leading manufacturer of precision analog and digital instrumentation and test equipment offering challenging opportunities in the following areas:

PROJECT ENGINEER

BSEE with minimum of 3 years experience in both analog and digital circuit design. Will have complete project responsibility from conception to manufacturing.

SR. ELECTRONIC ENGINEER

BSEE with solid state experience and some supervisory background in the design and development of electronic analog measuring instruments and displays. Will have supervisory responsibility for small engineering groups on project from conception to engineering releases.

Starting salaries commensurate with experience, including full range of company benefits. If you have the experience and background we seek, please forward resume including salary history to:

Personnel Department



SIMPSON ELECTRIC COMPANY

853 Dundee Avenue, Elgin, Illinois 60120

(312) 697-2260

An Equal Opportunity Employer

Recruitment Ads Pull

Test Equipment Design Engineers

*If you can solve problems like these,
you belong with a leader in the fore-
front of technology...Kearfott*

Problem 1.

Design and program a device utilizing a microprocessor that completely simulates a MIL-STD-1153A Multiplexer Bus System, including typical failure modes, for use in testing avionic units.

Problem 2.

Develop a system to precisely control gyro or accelerometer temperature profile during the transient warm-up interval using advanced control techniques, including computer programs and complex computer interface devices.

Problem 3.

Design a computer-controlled test system capable of performing a full repertoire of acceptance and diagnostic tests on a navigation system with minimum operator involvement.

Kearfott has a reputation for recognizing, encouraging and rewarding performance on the job. If you have a BSEE along with a strong background in special test equipment, current digital design technology and computerized test systems, and related experience with HP 21 MX computer and microprocessors, you can make the most of your knowledge here.

You'll be dealing with a broad range of programs involving test equipment projects for computer-controlled inertial guidance systems, airborne computers, digital and communications/signal processing equipment for some of the most significant aerospace projects there are.

We provide fully commensurate salary, a fine benefits package and ample opportunity for sustained professional growth. Send your resume and salary history to Mr. E. DeGennaro, Singer Company, 1150 McBride Avenue, Little Falls, N.J. 07424.

Kearfott

a division of The **SINGER** Company

An equal opportunity employer M/F who creates opportunities

GOOD BOOKS ARE HARD TO FIND.



WHY HIDE YOURS?

We are always looking for well-written manuscripts, or book proposals, for works on topics of interest to professional engineers that will advance their understanding of the state of their art.

What have you been working on?

What can we do for each other?

Let me know.

S. WILLIAM COOK
EDITORIAL DIRECTOR



Hayden Book Co., Inc.

50 ESSEX STREET
ROCHELLE PARK, N.J. 07662

SPECIAL

2

RECRUITMENT ADS

FOR THE PRICE OF

1

Double the coverage . . .
double the effectiveness
of every ad
you place!

Electronic Design

BRINGS YOU
THE HIGHEST
NUMBER OF
QUALIFIED EOEM
ENGINEERS AND
ENGINEERING
MANAGERS
ANYWHERE
. . . AT THE
LOWEST COST
ANYWHERE!

ENGINEERS

McDonnell Douglas, St. Louis, has immediate, challenging openings for engineers on such exciting projects as Cruise Missile Guidance Systems for Tomahawk, ALCM, and GLCM; Harpoon Missile; F-15 Air Superiority Fighter; F-18; and AV8B. If you have background and education in any of the following areas, you owe it to yourself to investigate the possibility of joining the McDonnell Douglas Team!

GUIDANCE AND CONTROL MECHANICS

- Digital Flight Control Design/Analysis
- Guidance Law (Midcourse & Terminal) Design/Analysis
- Inertial Navigation System Analysis
- GNC Software Design Development and Validation
- Trajectory Analysis, Route Selection, Profile Scheduling

ELECTRONICS

- Systems Engineering & Integration
- Resident Systems Engineers (L.A., San Diego)
- Automatic Test Equipment & Software
- Embedded Microprocessor Architecture/Design
- Digital, Analog & RF Equipment/Circuit Design
- Field Test (Pt. Mugu, CA) • Inertial Guidance

RELIABILITY

- Data Analysis
- Failure Mode and Effect Analysis
- Circuit Analysis
- Part Stress Analysis
- System Safety

SUPPORT EQUIPMENT

- Electronic Equipment Packaging
- Electrical/Electronic Systems Design
- Automatic Test Equip Hardware Design
- P.C.B. Design/Layout
- Electronic Testability Analysis
- Aircraft ATE Studies

AVIONICS SYSTEMS ENGINEERING

- Fire Control Systems • Digital Flight Control Systems
- Digital Computer System Definition • Inertial Guidance Systems
- Computer Software Engineering for Operational and Support Programs
- Control and Displays • System and Performance Analysis

OPERATIONS ANALYSIS • WEAPON SYSTEM ANALYSIS

St. Louis is a great place to raise a family. Imagine a city with the industry of the North, the hospitality of the South, the culture of the East and the progress of the West . . . That's the spirit of St. Louis. To investigate where you would fit on the MDC Team.

If unable to call, please send your resume in confidence to:

W. B. Kellenberger, Section Manager
Professional Employment, Department ED-20
P.O. Box 516, St. Louis, MO 63166

MCDONNELL DOUGLAS



CORPORATION

An Equal Opportunity Employer

U.S. Citizenship Required

MODEL 612



Paper Tape Transmitter

50-9600 baud
 RS 232 / Current loop or parallel outputs available
 5-8 level tape, 7-11 frames per character
 Stops and starts on character at all speeds
 Uses manual control or x-on, x-off
 90-260 volt, 50-60 Hz power
 Even or odd parity
 Desk top or rack mount

Addmaster Corporation
 416 Junipero Serra Drive San Gabriel, California 91776
 Telephone: (213) 285-1121

CIRCLE NUMBER 76

NEW!



A mighty big catalog about some mighty small switches.

This 44 page catalog consolidates the complete line of C&K small switches into a single, fact-filled, easy-to-read volume. It includes everything you need to know about toggles, rocker and lever handles, printed circuit mountings, snap-acting pushbuttons, 6 AMP alternate action and momentary pushbuttons, subminiature and microminiature pushbuttons, illuminated rockers, miniature power, slide, and thumbwheel switches — plus how-to-order information and a complete list of worldwide C&K distributors. Ask for your free copy and we'll show you a million and one ways to turn on the juice.

C&K Components, Inc. 103 Morse Street, Watertown, MA 02172
 TEL: (617) 926-0800 TWX: 710 327-0460 TELEX: 92 2546
 Free Engineering Samples on Request.

CIRCLE NUMBER 77



3M Brand Light Control Film Improves Readout Readability.

Microlouvers within the film enhance contrast, screen out ambient light. Works equally well on LED and CRT displays. For information on how you can use 3M Light Control Film in your product write: Visual Products Division, Industrial Optics, 3M Center, St. Paul, MN 55101.



CIRCLE NUMBER 79

ELECTRONIC DESIGN 26, December 20, 1977

Join the IMC Book Club*

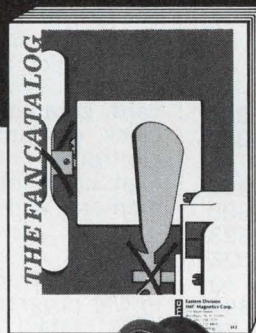

Free 92 page Catalog features specialty propeller and tubeaxial fans.

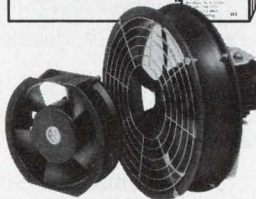

This catalog shows more than 100 standard designs, including 60 HZ, 400 HZ, multi HZ and DC versions plus a description of IMC's IMCool™ and Boxer™ models. Information regarding the full line of accessories to fit the Boxer™ fan is included.

For immediate service please call Gene Egan, V.P. Sales 516/334-7070.

*Product Literature Broadsheet and request card will be sent to you along with this catalog.

SERVING INDUSTRY OVER 25 YEARS

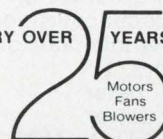

IMC MAGNETICS CORP.

EASTERN DIVISION

570 MAIN STREET, WESTBURY, NEW YORK 11590

CIRCLE NUMBER 78

Product index

Information Retrieval Service. New Products, Evaluation Samples (ES), Design Aids (DA), Application Notes (AN), and New Literature (NL) in this issue are listed here with page and Reader Service numbers. Reader requests will be promptly processed by computer and mailed to the manufacturer within three days.

Category	Page	RSN	Category	Page	RSN	Category	Page	RSN
Components			regulator, voltage	192	302	op amps	198	369
accelerometers (NL)	202	395	TTL (NL)	202	398	video op amps	165	36
capacitors	7	6	timer sequencer	193	340	voltage starters (NL)	203	405
capacitors	155	33	transistors	193	54	Packaging & Materials		
capacitors (AN)	201	384	transistors, vhf power	194	345	adhesive sealant	177	41
capacitors, rf	196	360	triacs, high-power	192	339	connector, pneumatic	200	379
capacitors, tantalum	197	366	triacs, SCRs	6	5	connectors	23	19
digital panel meters	15	14	μ C, single-chip	194	346	connectors	173	38
encoders (NL)	203	403	Instrumentation			connectors	181	43
fan	197	364	analyzer, adaptor	184	304	connectors (NL)	203	399
ferrite cores	191	52	analyzer, logic-state	182	303	electronic enclosures	202	397
ferrite toroids (AN)	201	382	controller, temp	182	301	(NL)	159	35
filters	138	25	counter, frequency	184	306	fans	205	66
indicator lamps (NL)	202	390	counters	137	24	heat gun	173	39
keyboard switches	165	37	dedicated system (NL)	203	407	heat-shrinkable tubing	200	378
LED-readout displays	III	231	digital latch	184	309	jumpers, logic	200	380
potentiometers	196	361	instrumentation			lead straightener, IC	200	377
relays	197	57	controller	189	50	mounts, wire	200	375
resistors, metal-film	197	363	miniscope	192	53	socket-card, probing	17	16
switch, rotary	197	365	ohmmeter, digital	184	308	sockets, PC	190	141
switches	205	68	probe, digital-pulser	184	305	surface coating	200	376
switches	215	78	pulse generator	1	2	terminal blocks		
switches, slide,			pulse generator	184	307	Power Sources		
rocker (NL)	203	404	relays (NL)	202	389	batteries	191	51
switchlights	179	42	spectrum analysis (AN)	201	381	batteries, Ni-Cd	147	32
time delay, solid-state	196	359	standard interface	203	65	power supplies (NL)	202	388
timer, solid-state	196	362	sweep-signal generator	134	23	power supply, HV	191	338
trimmers	II	130	temperature recorders	207	71	supply, ferroresonant	191	337
trimming pots	202	392	Micro/Mini Computing			switchers (NL)	203	406
tunable coils	159	34	bus board, S100	190	333	switching supplies	199	59
Data Processing			CMOS microprocessors			new literature		
bubble-memory system	205	69	(NL)	203	409	accelerometers	202	395
cluster system	187	325	card, computer	189	331	CMOS microprocessors	203	409
digitizer, tablet	187	322	clock, real-time	189	329	connectors	203	399
disc drive	16	15	controller	189	330	disc drives	203	410
disc drives (NL)	203	410	logic card, interface	190	332	electronic enclosures	202	397
disc system, flexible	186	320	memory, add-on	189	328	encoders	203	403
diskettes	187	323	memory, add-on parity	190	336	IPC technical reports	203	408
encryption unit	187	326	memory, nonvolatile	190	334	indicator lamps	202	390
impact printer	201	62	PROM programmer	183	44	PROM programmers	202	394
PROM programmers (NL)	202	394	PROM programmers	9	180	plotter points	202	391
paper-tape transmitter	215	76	RAM, static	190	335	power supplies	202	388
portable recorders	186	46	system development	188	327	relays	202	389
recorder/reproducer	8	7	Microwave & Lasers			switchers	203	406
subsystem, tape	186	321	double-balanced mixers	2	3	switches, slide, rocker	203	404
teleprinter	29	21	fiber-optics	175	40	TTL	202	398
video system	187	324	Modules & Subassemblies			voltage starters	203	405
IC & Semiconductors			amplifier, matching	199	374	application notes		
CCD memory	5	4	clock	198	371	capacitors	201	384
CMOS	IV	232	converter, a/d	198	370	connector		
chip, d/a converter	194	348	converter, s/d	198	367	cross-reference	201	387
chip, data-acquisition	194	343	converters, a/d	198	58	designing stamped parts	201	383
chip, remote-control	194	347	converters, d/a	13	12	ferrite toroids	201	382
detectors, rf	186	47	crystal filters	207	72	PROM programmer	201	386
diodes, zener	195	358	custom hybrids	202	63	quartz crystals	201	385
driver, power	195	357	data-acquisition system	11	10	spectrum analysis	201	381
driver, TTL to MOS	194	344	data-acquisition system	202	396			
ECL III	141	27	filter, active	199	373			
generator, bit-rate	193	341	instrumentation amplifiers					
line receiver	193	342	(NL)	202	393			
logic arrays	195	356	light pens	198	368			
RAM, 4-k static	10	9	memories, fixed-head	199	372			

When you need LED readout displays or more than LED readout displays...

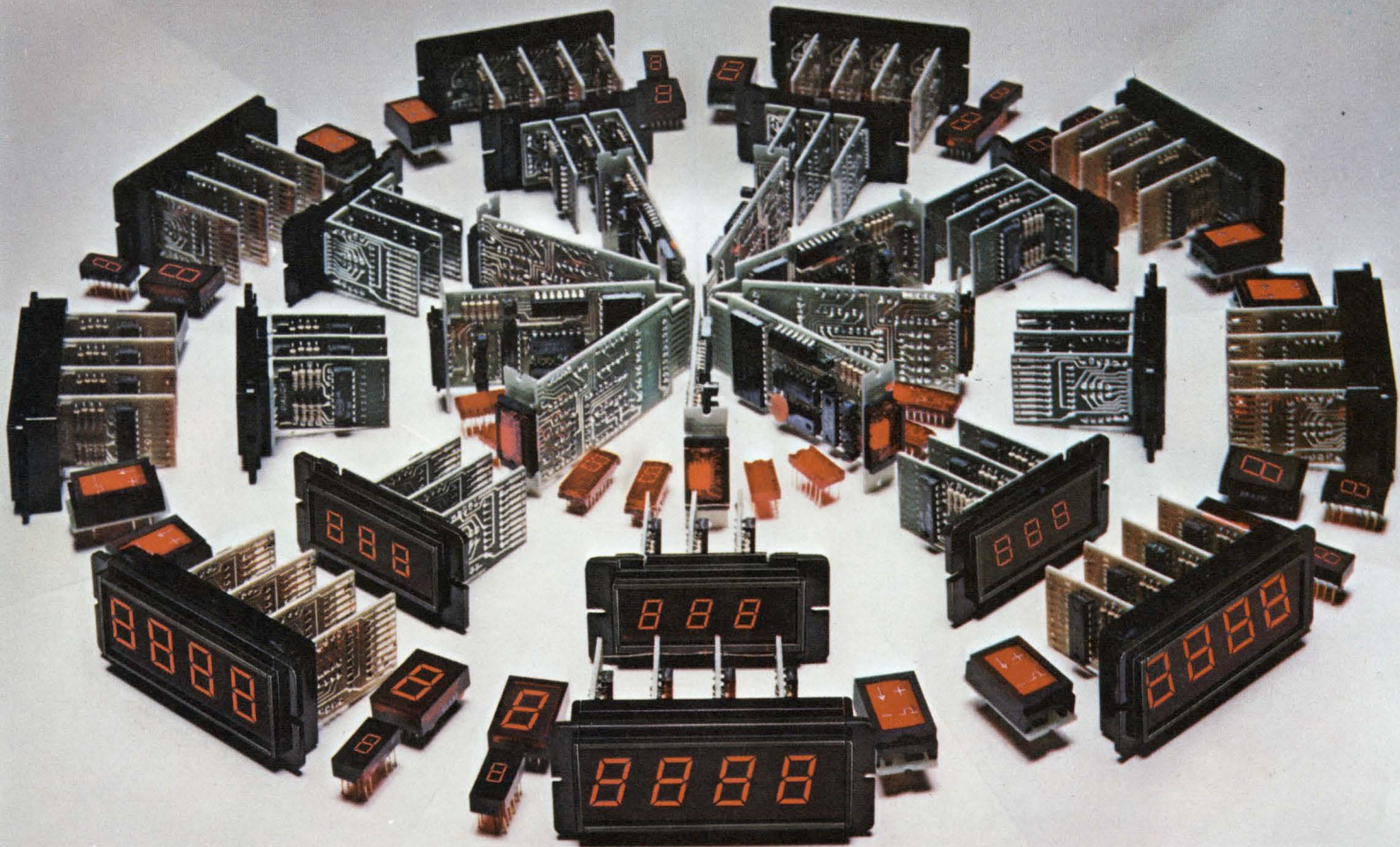

Come to Dialight. For built-in circuitry for example. If that's the type of convenience you're considering, then Dialight's the first place to look . . . because Dialight's the first in value-added LED readout displays.

For many years now we've been offering not only the latest technology, but also the latest in time and labor-saving pre-engineered displays. These can be ordered any way you wish: with or without on-board decoder/driver, with or without code generator, in any

number of digits in an assembly, complete with bezel for instant panel mounting.

We also offer high brightness, low cost design flexibility with a choice of discrete and assembly displays with character heights of .270", .300" and .600".

For your free copy of our new Readout Product Selector Guide, call or write to us at Dialight today.

DIALIGHT
A North American Philips Company

Dialight meets your needs.

Dialight, 203 Harrison Place, Brooklyn, N.Y. 11237 (212) 497-7600

CIRCLE NUMBER 231

RCA first in CMOS.

First in CMOS microprocessors.

RCA 1800 combines elegant COSMAC architecture with CMOS benefits. Result: the performance you want — plus maximum flexibility with minimum parts count.

Cost-effective COSMAC architecture. Since our CDP1802 CPU accepts compact 1-byte instructions, you need less memory. Registers store data with 1-byte access. And they act as pointers, so individual instructions don't need addresses.

Built-in I/O. The CPU has interrupt, DMA, flags in and bit control out, so you need less I/O. And we offer a wide range of low-cost I/O devices, including our unique 2-mode UART.

Easily expandable memory. Build up to 65K without adding any address management parts. RCA offers the ROMs you'll need and CMOS RAMs as well.

Full-range design support. From the basic Microtutor learning tool to a complete COSMAC Development System with floppy disk. All geared to help you translate the CMOS advantage into true system cost effectiveness.

For more information, contact your local RCA Solid State distributor. Or contact RCA Solid State headquarters in Somerville, NJ; Sunbury-on-Thames, Middlesex, England; Quickborn 2085, W. Germany; Ste.-Anne-de-Bellevue, Quebec, Canada; Sao Paulo, Brazil; Tokyo, Japan.

When you say CMOS, say RCA first.

The RCA 1800 Microprocessor Family

CDP 1802	COSMAC CPU
CDP 1821S	1024x1 High-speed RAM
CDP 1822	256x4 Low-cost RAM
CDP 5101	256x4 Industry-standard RAM
CDP 1822S	256x4 High-speed RAM
CDP 1824	32x8 RAM
CDP 1831, 2	512x8 ROM (with or without latch)
CDP 1833, 4	1024x8 ROM (with or without latch)
CDP 1852	Byte I/O
CDP 1853	I/O decoder
CDP 1854	UART
CDP 1856, 7	Bus buffer/separators
CDP 1858, 9	Address latch/decoders
CDP 1861	TV interface

Coming in 1978

CDP 1823S	128x8 High-speed RAM
CDP 1851	Programmable I/O
CDP 1855	Multiply/Divide Unit

And these major parts: 4K RAM, 4K EPROM, 1-chip COSMAC microcomputers — all in CMOS.