

electronics®

CRYOGENIC TANK CIRCUITS

*Measuring Q's
over 100,000, p 43*

LOW FREQUENCY FERRITE DEVICES

*Physical effects
extend range, p 56*

MAGNETIC FILM LOGIC CIRCUITS



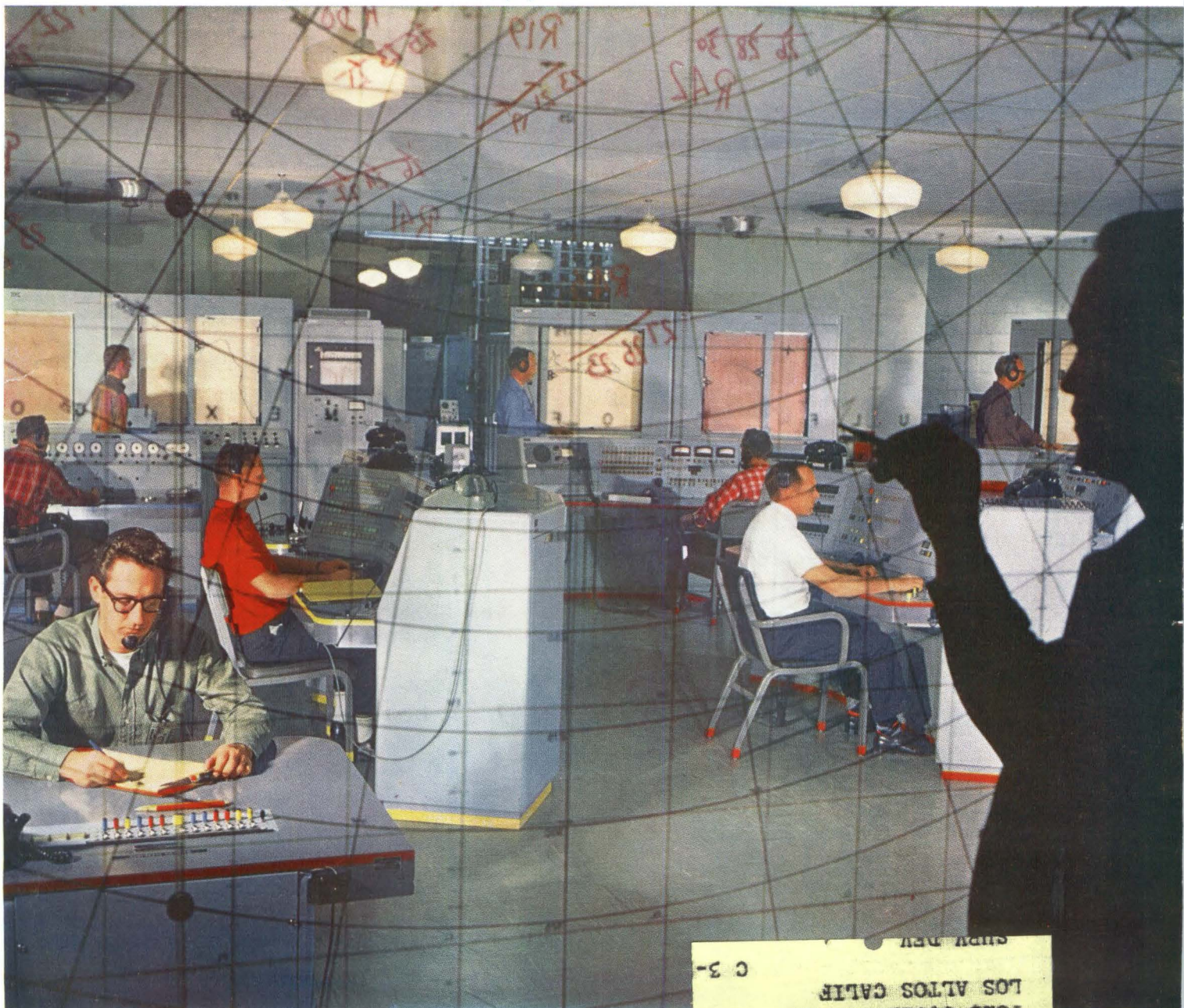

*New idea in computer
technology, p 62*

TRACKING A BOMARC interceptor missile across the Gulf of Mexico



R D SKINNER
1020 COVINGTON RD
LOS ALTOS CALIF
C 3-

Yours in this **STANDING WAVE INDICATOR**

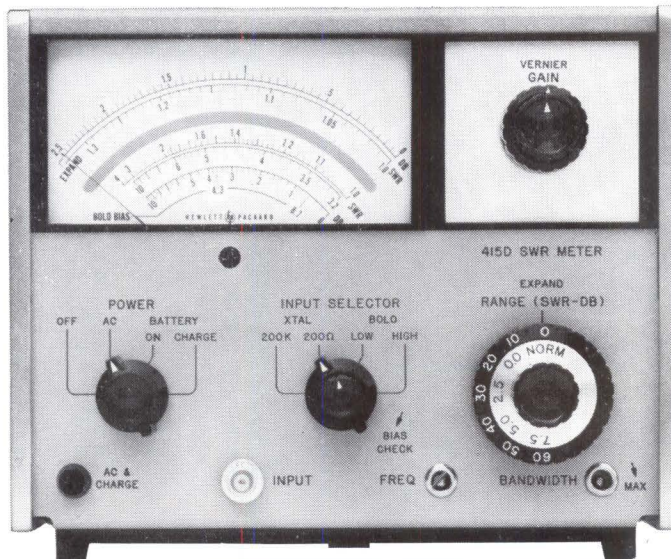

-  Pinpoint resolution for precise attenuation measurements
-  Scale expansion with no "blind spots" no resetting
-  Built-in bolometer protection
-  AC or battery operation
-  All solid state design



Model 415D Standing Wave Indicator is a high-gain, low-noise solid state amplifier and voltmeter calibrated for square-law detectors to read directly in SWR or db. The amplifier is tunable, 980 to 1,020 cps, for matching source modulator or for optimizing several instruments in one system. Variable bandwidth (15 to 100 cps) permits both high sensitivity testing and swept-frequency work.

For highest resolution on precise attenuation measurements, you can expand to full scale each 2.5 db portion of any 10 db range with no "blind spots," and the reference is maintained automatically! This expansion gives you 24 calibrated ranges, 0 to 60 db, in 2.5 db steps. The 415D also reads directly in SWR; it is ideal for measuring reflection coefficient and extremely useful as a null indicator for audio-frequency bridges.

Two peak-limited bias currents, readable on the front-panel meter and adjustable $\pm 10\%$, prevent accidental bolometer burnout. Other inputs permit operation with crystals and as a null detector.

The 415D has both an ac output for use as a high-gain tuned amplifier and a dc recorder output. High stability with line changes makes the instrument ideal for long-term monitoring. An internal battery pack (optional) makes the 415D completely portable. It is housed in the new  modular cabinet, which can mount in half of a rack 7" high, combining conveniently in a single rack width with such companion instruments as  431 Power Meter.

SPECIFICATIONS

Frequency:	1,000 cps variable 5%, other frequencies between 400 and 1,500 cps available
Sensitivity:	0.1 μ v rms at 30 cps bandwidth (lower sensitivity at 0° C)
Noise:	5 db below full scale with 0.1 μ v rms sensitivity and minimum bandwidth
Range:	70 db in 10 and 2.5 db steps
Meter Scales:	SWR: 1-4; 3-10; EXPAND 1-1.3. DB: 0-10; EXPAND 0-2.5 Bolo Bias: 4.3 and 8.7 ma indicated.
Accuracy:	± 0.1 db/10 db step, maximum cumulative ± 0.2 db; ± 0.1 db switching from any 10 db step (NORM) to any 2.5 db step (EXPAND) except ± 0.05 db switching to 0.0 (EXPAND); ± 0.02 db linearity on EXPAND scales
Input:	Bolo: 200 ohms, bias 8.7 or 4.3 ma; Crystal: 200 ohms, 200 K
Output: (one side grounded)	DC: 1 ma into 1,500 ohms maximum AC: 1 v rms in EXPAND, 0.5 v rms in NORM (across 10 K minimum)
Power:	115 or 230 v $\pm 10\%$, 50 to 1,000 cps, 2 watts
Dimensions:	7 $\frac{1}{2}$ " x 6 $\frac{1}{2}$ " x 12 $\frac{1}{2}$ "; 8 lbs., 11 lbs. with battery
Price:	\$325.00; \$425.00 with battery

Data subject to change without notice. Prices f.o.b. factory

HEWLETT-PACKARD COMPANY

1501 Page Mill Road, Palo Alto, California, Area Code 415, DA 6-7000. Sales and service representatives in all principal areas; Europe, Hewlett-Packard S. A., 54 Route des Acacias, Geneva; Canada, Hewlett-Packard (Canada) Ltd., 8270 Mayrand Street, Montreal. 8261

electronics

A McGraw-Hill Weekly 75 Cents



W. W. MacDONALD, Editor

J. M. CARROLL, Managing Editor
SENIOR EDITORS: Samuel Weber, George W. Sideris. **SENIOR ASSOCIATE EDITORS:** Michael F. Wolff, John F. Mason. **ASSOCIATE EDITORS:** Michael F. Tomaino, Sylvester P. Carter, William P. O'Brien, Sy Vogel, Leslie Solomon, George J. Flynn, Laurence D. Shergalis, George V. Novotny, Leon H. Dulberger. **ASSISTANT EDITORS:** Nilo Lindgren, Stanley Froud, Stephen B. Gray, Roy J. Bruun, Barry A. Briskman. **REGIONAL EDITORS:** Harold C. Hood (Pacific Coast, Los Angeles), Thomas Maguire (New England, Boston), Cletus M. Wiley (Midwest, Chicago). **ART DIRECTOR:** Howard R. Berry. **ASSISTANT ART DIRECTOR:** John C. Wright, Jr. **EDITORIAL ASSISTANTS:** Lorraine Rossi, Virginia T. Bastian, Lynn Emery, Ann Mella, Lorraine Werner, Alice M. O'Brien. **FOREIGN NEWS BUREAU:** Director, John Wilhelm; Alyne Elias, Betsy Wilson. **LONDON—**John Shinn, Derek Barlow, Nicholas Landon. **BONN**—Bruce Bendow, Richard Mikton, Silke McQueen. **BRUSSELS—**Peter Forbath. **PARIS—**Robert Farrell, Arthur Erikson. **MILAN—**Marc A. Messina. **MEXICO CITY—**Wesley Perry, Jr. **RIO DE JANEIRO—**Leslie Warren. **MOSCOW—**Stewart Ramsey. **TOKYO—**Richard Haloran, Charles Cohen, John Yamaguchi.

W. W. GAREY, Publisher

MAIN CONTROL ROOM at the Air Force's Eglin Gulf Test Range during a low-level test of a Bomarc interceptor missile. Vitro Electronics personnel handle tracking and instrumentation. *The range can track from Key West to New Orleans; it is used for missile testing, space probe and countermeasures development* **COVER**

SPACE CONTRACTS. NASA has just outlined its upcoming equipment needs. *Here they are—but better get those bids in early since contracts are usually sewed up long before launch* **18**

BIOTELEMETRY: Prime Space Need. Air Force wants better sensors, smaller equipment for its manned space flights. *One need is on-board data processors* **20**

BIGGEST BLACK BOX. Last weekend, the Defense Department opened its latest seismic monitoring station. *This station includes a real-time computer and displays* **24**

CARCINOTRON Goes to 510 Gc. French forge ahead in mm-wave devices, are now at 0.6 mm. *The line of other mm-wave devices is filling out, too* **24**

UNITED NATIONS Seeks Get-Rich Ideas. Administrators mull over 1,800 papers on how to help underdeveloped nations. *Electronics is considered a good investment for such countries* **26**

LASER COMMUNICATIONS System Carries Tv Video and Audio. This week, a technique for superimposing a 3-Gc microwave carrier on a laser beam is being demonstrated. *The system could be the prototype for a practical optical relay* **28**

UNDERSEAS LASER Researchers Get Coherent Green Light Source. High-power green beam is produced from infrared laser's output. *This is expected to aid studies of submarine laser uses* **30**

SUPERCONDUCTING TANK CIRCUITS: Special Techniques to Measure Q. Three new circuits measure Q's greater than 100,000 in experimental superconducting resonant circuits. At these values only pulse decay time gives useful measurements. *Test circuits utilize time-delay, elapsed-time and R-C bridge methods.* By W. H. Hartwig, University of Texas **43**

DIODE DATA REGISTERS: First Circuit Design Details. Transmission of data to and from rapid-access storage registers is accomplished without mixing or gating transistors. *A typical register uses only two transistors and four diodes per digit.* By W. Orvedahl and J. H. Sheperd University of Chicago **48**

ANTENNA OPERATING IMPEDANCE: New Measurement Principle. Operating impedance of an antenna may differ from its self-impedance because of mutual coupling to adjacent radiators or effects of nonlinear loads. *This new measuring device uses a known feedline segment with an auxiliary line segment and tuning impedance.* By C. S. Wright, Delta Electronics **51**

electronics

February 22, 1963 Volume 36 No. 8

Published weekly, with Electronics Buyers' Guide as part of the subscription, by McGraw-Hill Publishing Company, Inc. Founder: James H. McGraw (1860-1948).

Title ® registered U.S. Patent Office; © copyright 1963 by McGraw-Hill Publishing Co., Inc. All rights reserved, including the right to reproduce the contents of this publication, in whole or in part.

Executive, editorial, circulation and advertising offices: McGraw-Hill Building, 330 West 42nd Street, New York 36, N. Y. Telephone Longacre 4-3000. Teletype TWX N.Y. 212-640-4646. Cable McGrawhill, N. Y. PRINTED IN ALBANY, N. Y.; second class postage paid at Albany, N. Y.

OFFICERS OF THE PUBLICATIONS DIVISION: Shelton Fisher, President; Vice Presidents: Joseph H. Allen, Operations; John R. Callahan, Editorial; Ervin E. DeGraff, Circulation; Donald C. McGraw, Jr., Advertising Sales; Angelo R. Venezian, Marketing.

OFFICERS OF THE CORPORATION: Donald C. McGraw, President; Hugh J. Kelly, Harry L. Waddell, Executive Vice Presidents; L. Keith Goodrich, Executive Vice President and Treasurer; John J. Cooke, Vice President and Secretary.

Subscriptions are solicited only from those actively engaged in the field of the publication. Position and company connection must be indicated on orders. Subscription rates: United States and Possessions, \$6.00 one year, \$9.00 two years, \$12.00 three years. Canada: \$10.00 one year. All other countries \$20.00 one year. Single copies, United States and Possessions and Canada 75¢. Single copies all other countries \$1.50.

THE PUBLISHER, UPON WRITTEN REQUEST FROM ANY SUBSCRIBER TO OUR NEW YORK OFFICE AGREES TO REFUND THAT PART OF THE SUBSCRIPTION PRICE APPLYING TO COPIES NOT YET MAILED.

Subscribers: Please address change of address notices, subscription orders or complaints to Fulfillment Manager, Electronics, at above address. Change of address notices should provide old as well as new address, including postal zone number if any. If possible, attach address label from recent issue. Allow one month for change to become effective.

Postmaster: Please send Form 3579 to Fulfillment Manager, Electronics, 330 West 42nd Street, New York 36, New York.



Audited Paid Circulation

ARC-PROTECTION CIRCUIT: Protects High-Voltage Electron Devices. Sudden faults such as breakdown or flash-over can destroy devices designed for low average power when used in high peak power circuits. Traveling-wave tubes need special protection. *A comparator distinguishes between fault currents and large pulse currents; thyatron discharges power supply when triggered.*
By. D. D. Mawhinney, Radio Corp. of America 54

NONRECIPROCAL DEVICES: Now You Can Use Them at Low Frequencies. Once gyrators, isolators and circulators were applicable only at microwave frequencies. Now, however, these useful devices can be employed from low audio through r-f. *They make use of the Hall effect and of coupling between separately excited electric and magnetic fields.*
By. J. H. Silverman, Clevite Corp. 56

NEW CLAPP OSCILLATOR Features 3-to-1 Dynamic Range. The r-f accelerating system of the zero-gradient synchrotron required a precision oscillator tunable from 5 to 15 Mc. *This circuit uses two transistors in the common-collector connection; it has almost no drift.*
By R. E. Daniels and A. D. Cook, Argonne National Laboratory 60

THIN MAGNETIC FILMS CREATE LOGIC CIRCUIT. Thin magnetic films have been used for some time for rapid-access storage. *Now these thin-film circuits can be used to make up the logic circuitry of a computer.*
By. M. Williams, General Electric Co., Ltd., England 62

DEPARTMENTS

Crosstalk. <i>Let's Look at the Civilian Sector</i>	3
Comment. <i>Lab Courses. Square-Wave Generator</i>	4
Electronics Newsletter. <i>Plasma Sheath Blackout Problem is Fading</i>	7
Washington This Week. <i>Pentagon Is Going Ahead with Plan to Set Profits</i>	12
Meetings Ahead. <i>Computer and Data Processing Symposium</i>	32
Research and Development. <i>Fiber-Optics Servo Built Into Tape Handler</i>	66
Components and Materials. <i>Inflating Antennas in Outer Space</i>	74
Production Techniques. <i>Prototype Parts Produced Efficiently</i>	82
New Products. <i>A-D Converter Does Not Load Instruments</i>	90
Literature of the Week	101
People and Plants. <i>Dale Electronics Opens New Plant</i>	102
Index to Advertisers	113

Let's Look at the "Civilian Sector"

ELECTRONICS is a growth industry. It is imperative that it continue to be a growth industry and a vital force in the nation's economic progress.

Some of electronics' spectacular growth in recent years has been won competitively in the consumer, business and industrial markets. But, let's face it, much of our industry's growth has been virtually forced upon us by the cold war.

The major single factor in electronics' growth over the past decade has been a rapid upswing in military electronics needs and dollars.

As we have already reported, the Department of Defense's upcoming budget provides for a relatively small overall increase for military electronics and DOD may decide to keep the lid on future spending (*ELECTRONICS*, p 18, Jan. 25, and p 7, Feb. 8). In other words, the military electronics growth curve could flatten out. DOD could keep development of new weapons systems to a minimum—Skybolt and RS-70 may be straws in the wind. This could create serious problems for those who have based their operations almost wholly on military R&D.

Individual companies can still prosper as military systems are updated through microminiaturization and other new technologies. But this is not necessarily industry growth. If the pie remains more or less the same size year to year, we cannot all have a bigger piece.

Space electronics seems pregnant with opportunities. Plans are to increase space spending some 70 percent in fiscal 1964. But an administration that can decide it does not want air-launched ballistic missiles and new manned bombers, one that can consider a strategy of stalemate, could put a ceiling on the space effort too.

These considerations make this year, this month, this week, the time for every company to freshly appraise its capabilities in civilian electronics. To suggest an abandonment of military electronics would be foolish but it is clear, we think, that the industry can no longer count on automatic yearly increases in defense sales. It should begin now to put far more initiative into growing with the "civilian sector," as the Pentagon calls the rest of America.

Other economic forces at work make this an opportune time for a fresh look at civilian electronics. Population increases, labor's demands

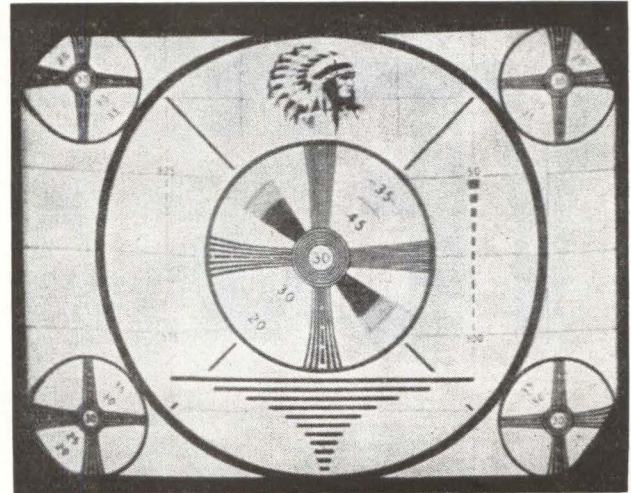

for a shorter work week, consumer interest in new labor-saving and entertainment devices provide a built-in spur. The recently enacted tax credit for modernization and automation will help. Proposed income tax cuts could make more consumer dollars available and, the administration hopes, expand industrial development still more.

Further, cutback or even stabilization of military production or R&D would give industry the additional brainpower needed to vigorously pursue civilian electronics. At present, an estimated two-thirds of available technical manpower is employed in defense, space and atomic programs.

There is hardly any civilian electronics market that could not profit from military electronics technology. A few already broached, or proposed but moving along slowly are:

Automatic guidance for air, sea and land transportation; fully automatic, efficient, industrial process controls; ultrasonic and electron-beam materials processing; teaching machines; medical diagnostic, patient-monitoring and prosthetic systems; small, economical atomic power and heating plants; solar-cell-powered appliances and entertainment equipment; pocket tv; stereo tv; automatic housekeeping and food preparation devices; merchandising computers to maintain individual inventories for super-market customers.

Anyone with a little imagination who is up-to-date on his electronics R&D can think of dozens more—dozens of potential civilian electronics jackpots.

our stock answer is YES

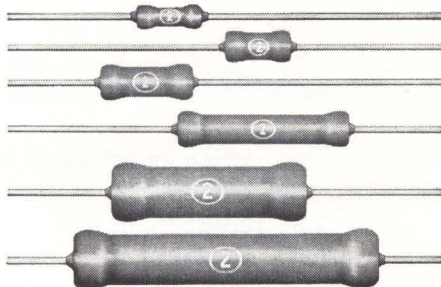

ALL UNITS ACTUAL SIZE

ALL AXIAL LEAD BLUE JACKET RESISTORS

*in 1, 2, 3, 5, 7 and 10-watt
power ratings are carried in
factory stock for immediate
delivery. Place your order now
with your nearest Sprague
District Office or Sales
Representative. Key
Sprague Industrial Distributors
carry most popular ratings
in local stocks.*

SPRAGUE ELECTRIC COMPANY
35 Marshall Street, North Adams, Mass.



COMMENT

Lab Courses

I would appreciate your publication of this comment as a reply to the letter written by Robert D. Freed in the Jan. 4 issue (p 4):
Dear Mr. Freed:

I would be inclined to agree with your decision, and it must be your own decision, of course, and I suggest that you might find an easier trail to a BS degree if you would switch out of Electrical Engineering. I might even make the suggestion that you would find your place in an abstract field such as mathematics, which has no laboratory courses at all.

In the matter of relative credits allowed towards the laboratory work, I can offer the following analysis: engineering must work within the general regulations as formulated for the University and it has been suggested that the "three-to-one" scale is not realistic, but I would like to point out that one class hour is supposed to be joined with two hours of outside study. It is apparent that many students, in other fields of study, are able to reduce this ratio, and thus a typical student is working a week of some twenty hours rather than the fifty hours expected.

This shrinkage is not as great for laboratory hours, and thus these periods seem to be more demanding. I also admit that some course-laboratory units do extend the work by requiring the student to prepare an engineering report in neat and polished form.

The engineering colleges have invested much to insure that their students will include some work with modern equipment, since this type of work is expected in the engineering job after graduation. Laboratories have been a key feature of the engineering education system for many years, changing only in the manner indicated by the growth of engineering itself. It has been estimated that each undergraduate student in a good college will make contact with equipment valued in the region of \$25,000, and he should learn techniques that form a valued part of his engineering work.

It has been said that people gen-

erally get about what they are willing to work for, and while our engineering students do not have as light a work-week as other students, their salary figures do make amends for this extra work. Industry generally pays for people to get things done, and the laboratory program is a beginning step. I wish to pose a question to you, sir: would you be pleased if your medical doctor had graduated from a type of medical school that had trained him without laboratory course work?

In summary, you asked another question about engineering laboratory course work. It is my suggestion that we might study our methods to make more efficient use of the time involved, but I would never suggest that the engineering colleges should try to compete with other fields of study. It is my honest belief that dedicated students with strong motivation will elect to carry the work load required for engineering study with pride and honor. We need these dedicated men.

Sincerely,
MILTON H. CROTHERS
Associate Professor

College of Engineering
University of Illinois
Urbana, Illinois

Square-Wave Generator

I think that the ingenious Simple Square-Wave Generator (p 47, Dec. 21, 1962) can be made even simpler, by using only one diode instead of two.

Unless there is a requirement for two oppositely-phased square waves, one from each collector, it is necessary to modify only one of the basic multivibrator collector circuits, the one from which the square wave is to be taken.

The purpose of the diode is to modify the waveform at the collector to which it is connected, but it does not influence the multivibrator action. A diode connected to Q_1 does not affect the waveform at Q_2 , and is therefore unnecessary if the signal is taken off Q_2 . I have verified this experimentally.

I hope we see more circuits as elegant and useful as this one.

L. ROBERT DUCLOS
Radio College of Canada
Montreal, Quebec

HERE'S AN INDICATOR TUBE THAT'S HIGHLY RELIABLE AS WELL AS ECONOMICAL

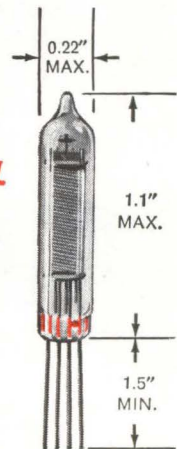

TUNG-SOL 6977
SUBMINIATURE INDICATOR TUBE

The Tung-Sol 6977 is a filamentary, high-vacuum, subminiature indicator with a fluorescent anode. It operates with AC or DC current, direct or parallel supply, and is designed for mounting flat on printed circuit boards behind display panels.

The 6977, now available in volume quantities, meets the high reliability requirements of specification MIL-E-1/1466A (EL). Electrical, environmental and life-test procedures insure that the Tung-Sol 6977 will perform reliably despite shock, vibration and critical life requirements. Computer, business machine, instrumentation and control equipment manufacturers can confidently place this tube on their own "qualified" products list. The Tung-Sol 6977 also provides true operating economy. Its high input impedance, low B+ feature and small signal requirements make it adaptable for transistor circuits. Power drain is exceptionally low. A single 6977 requires less than 1/4 square inch of panel display space. Mounted in multi-tube arrays on printed circuit boards, 40 tubes can be packed into 10 square inches of panel display space.

For further details on operating characteristics and specifications, and for information on indicating circuit configurations, consult Tung-Sol Electric Inc., Newark 4, New Jersey. TWX: 201-621-7977.

TYPICAL OPERATION

Heater Voltage AC	1.0 volt
Heater Current	30 mA
Anode Voltage DC	50 volts
Grid Resistance	100,000 ohms
Grid Supply Voltage	
—for max. light output	0 volt
—at zero light output	-3 volts
Anode Current	
—for max. light output	585 μ A
—at zero light output	5 μ A max.

Technical assistance is available through:
Atlanta, Ga.; Columbus, Ohio; Culver City, Calif.; Dallas, Tex.; Denver, Colo.; Detroit, Mich.; Melrose Park, Ill.; Newark, N. J.; Seattle, Wash. In Canada: Abbey Electronics, Toronto, Ont.

CENTER LINE

TUNG-SOL®
QUALITY

Thiokol Panelyte Copper-Clad Sheet meets the rigid demands of sophisticated circuitry in atomic radiation detection equipment

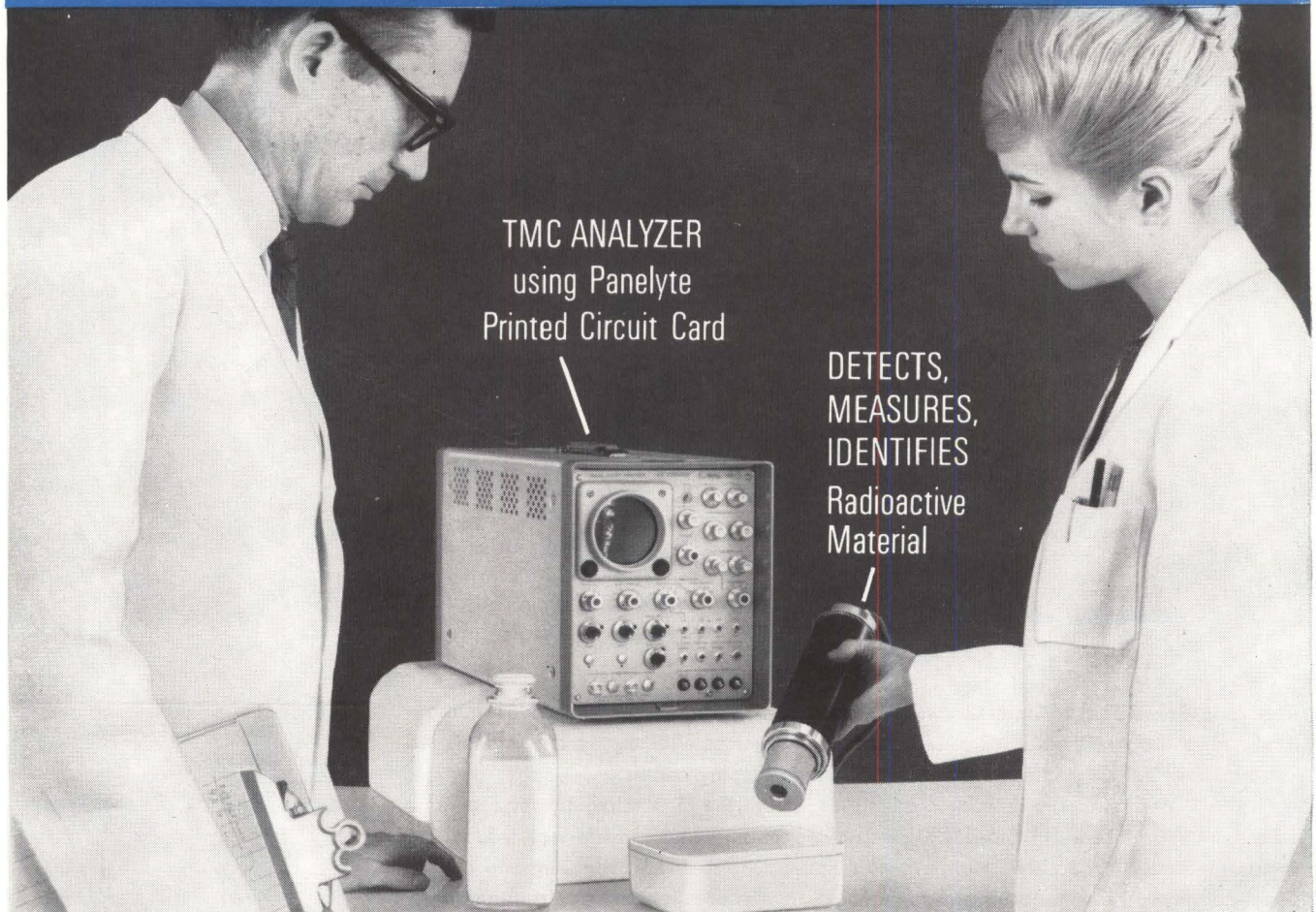
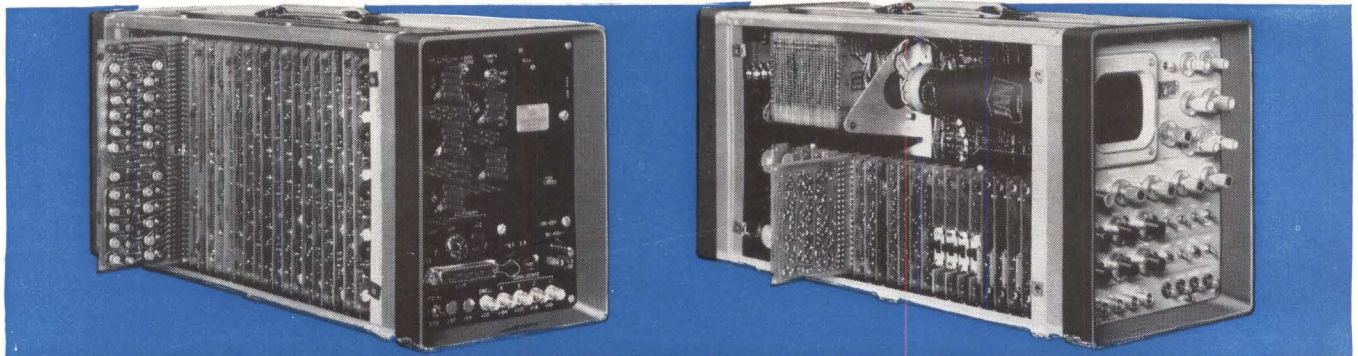

One of the highly intricate new tools now available to scientists and engineers to evaluate radiation is the multi-channel pulse height analyzer produced by Technical Measurements Corporation, of North Haven, Connecticut. For the many complex electronic circuits built into this instrument—as shown in the cutaway photos above—TMC uses Thiokol Panelyte copper-clad plastic sheet, only.

Panelyte copper-clad circuit boards combine the high electrical and physical properties needed in this demanding application. A glass epoxy G-10 Thiokol Panelyte Grade 1615, combining high insulation resistance and mechanical strength, was selected exclusively for this specialized application. High strength and solder resistance are specified by TMC Engineering and are provided by this superior grade.

Panelyte copper-clad and other electrical grades of sheet stock meet NEMA and government specifications. For full

information, write to Panelyte. Or see the Product Design Section of Sweet's Catalog. For rapid delivery, call the nearest Panelyte office or distributor.



LAMINATED SHEET, ROD, TUBE, HIGH PRESSURE MOLDINGS AND FABRICATED PARTS

THIOKOL CHEMICAL CORPORATION

Panelyte Industrial Division N. Enterprise Ave., Trenton 4, N. J.

Plasma Sheath Blackout Problem Fades

THREE PROPOSALS for getting communications through the ion sheath that surrounds reentering space vehicles were made last week. General Dynamics says it has a transponder that has transmitted through the blackout zone on a dozen missile flights. Avco also has a transponder that has passed tests in an aircraft, though it has not yet been tried in a missile.

NASA plans an early flight test of the water-injection technique (p 20, May 11, 1962).

NASA announced at its industry conference last week (see p 18) that it has already tested the water-injection technique successfully under simulated reentry conditions.

Both the GD and Avco transponders operate a C band, which is not blocked by the plasma sheath. GD's transponder weighs 21 lb. Its radio signals are picked up by the Azusa tracking system. The transponder first provides tracking data. When the reentering vehicle's impact point has been determined, a ground command switches the transponder from tracking to voice communications service.

The Avco system transmits radar signals to FPS-16 tracking radar. An 8-oz encoder converts the analog speech input to pulses that are transmitted by the 11-lb transponder. Decoders on the ground radar reconvert the pulses to analog voltages. Avco has a \$60,000 NASA contract to continue work on this project.

Consumer Electronics Set Sales Records in 1962

FACTORY SALES of radios in 1962 were the highest since 1947, tv had its best year since 1956 and phonograph sales set a new record, EIA's Marketing Services department reported last week. Distributor sales were equally brisk in 1962—distributors did set a new record for radio sales. The 1962 totals for factory sales were: radio, 19,161,906

including 7,249,857 auto radios and 1,227,081 f-m sets; tv, 6,471,160 including 598,446 with uhf tuners; phonographs, 4,954,434 including 3,601,409 stereo sets.

Two Roads for Lasers Seen at Paris Parley

PARIS—After plumbing the state of the laser art last week, 1,000 scientists left the Third Quantum Electronics Symposium convinced the time is near for a split up between laser applications and basic work pointed on new ones. The split up will probably come in next few years, MIT's C. H. Townes predicted.

Impending outspill of lasers from laboratory into systems was signaled at the symposium by emphasis on nonlinear optics, key to modulation and demodulation. Steps in that direction: ssb suppressed-carrier modulation at frequencies up to microwave region by potassium-dihydrogen-phosphate (KDP) crystal; optical mixing with cadmium-selenide crystal; second-harmonic generation in KDP and ammonium-dihydrogen-phosphate crystal; an

f-m/a-m optical frequency converter based on traveling-wave phototube. Efficiency of 75 percent was reported for a gallium-arsenide laser.

One of the reports that attracted attention was the possibility that rare-earth chelates offer easy pumping, high quantum efficiency, narrow emission widths and potentially could match frequencies of solid-state laser amplifiers.

Field-Effect Devices Head Solid-State Show

PHILADELPHIA—Trend to field effect devices in integrated circuits was much in evidence this week at the International Solid State Circuits Conference. Fairchild Semiconductor reported fabrication of complementary *n* and *p* type field-effect metal-oxide semiconductor triodes (Mots) from silicon by planar diffusion. Devices resemble insulated-gate-field-effect transistors developed by RCA (p 45, Feb. 15). Fairchild says Mots lend themselves to logic-net design without resistors or other components and that leakage current is so low that

Rough Week for Synchronous Satellites

WASHINGTON—About the same time last week that NASA trackers lost the Syncom satellite, the Air Force phased out its Advent synchronous orbit program. Air Force is now requesting proposals, due March 15, for a 10,000-mile-orbiting satellite system.

Advent has a long history of troubles. DOD shifted it from Army to Air Force (p 7, June 15, 1962) after booster development and weight problems delayed its launch date three years (p 12, June 1, 1962).

As for Syncom, a few days ago NASA was still scouring the skies and poring over telemetered data, trying to determine where the errant bird might be. The satellite was launched toward a synchronous orbit 22,300 miles over the Indian Ocean and was tracked to apogee. It was lost when its apogee motor was fired to back the satellite into position.

Under the assumption that no component failure caused the loss, NASA is still scheduling the next Syncom launch for before July 1 and a third before October 1. If components are the problem, some delay in launch is expected

10⁷ inverter circuits would use less than 1 watt of standby power.

Motorola proposed two new logic elements incorporating field-effect transistors. Breadboard experiments confirm expected high input impedance and low power drain coupled with high-frequency response. Elements are suitable for the DTL system and lend themselves to integration.

Westinghouse described work leading to an audio amplifier in integrated form. Field-effect transistors in series with a bipolar transistor (Unibi) give high input impedance as well as high current gain. The 3-watt amplifier has been incorporated in integrated silicon structures.

Two-Color Theory to Get Tryout in Space Sensor

BOSTON—First application of the two-color perception theory (p 9, Oct. 27, 1961) may be a device to eliminate the color-blindness of unmanned satellites and cut down on the amount of excess data they transmit.

Sylvania's Applied Research Laboratory has a \$62,000 NASA contract to study means of developing an electronic system able to sense color like a human does.

Sylvania says the device is at least two years away. It would hopefully "see" the entire spectrum, not just spot one color by wavelength analysis. This could permit a space probe to better identify minerals on planets, for example, or help a weather satellite to discriminate better between cloud and land masses.

Integrated-Circuit Radio-Tv in 3 Years?

CHICAGO—First integrated circuits for consumer products should be available by the end of 1963 and others will be ready for radio and tv in 2 or 3 years, C. H. Knowles, of Westinghouse, predicted at the Chicago IRE meeting last week.

Photographic techniques, he said, can already deposit 100 three or four-transistor amplifiers on a square-inch wafer for \$50. Mass

production should increase density to 200 circuits and reduce costs to \$12 for the same size wafer.

Russians See Organic Semiconductor Diodes

MOSCOW—Russian scientists are developing organic semiconductor rectifiers and expect practical results in two or three years, according to Tass, the official news agency. Tass quoted Academician Alexander Frumkin as saying such rectifiers have been made, but that as yet their current-handling capabilities are weak and that their efficiency is low. Frumkin is director of the Institute of Electrochemistry.

Beam Plasma Tube Amplifies at 23 Gc

RCA ANNOUNCED last week that it has an experimental beam-plasma amplifier tube that provides a net gain of 8 db at 23 Gc. After the beam is bunched in a helix, its electron density is increased by resonance in a 3-cm cavity filled with cesium plasma. The bunches are then amplified through another helix. Signal on the second helix is identical to, but stronger, than that on the first helix. The plasma in the cavity is produced by a Penning discharge and its density is variable up to 10^{13} ions/cm³. Beam voltage is 1.4 Kv.

Develop Circuits for Microminiature Radar

ANAHEIM, CALIF. — Basic circuits for a microminiature monopulse radar receiver have been developed by Autonetics division of North American Aviation. Thin-film hybrid circuits are used in the system, which employs attenuators rather than variable amplifiers for gain control. Each attenuator has a dynamic control range in excess of 30 db, while introducing only six degrees of phase shift. System also includes a wideband video amplifier with a gain of 20 db over 10 to 150 Mc.

In Brief . . .

BRITAIN has now equipped three Vulcan bomber squadrons with Blue Steel, rocket-powered bombs with range of 150 miles.

EIA MEMBERS have voted to split the present Tube and Semiconductor division in two. G. W. Keown, Tung-Sol, heads the new Tube division and S. L. Levey, Philco, the Semiconductor division.

GENERAL PRECISION will build solid-state degaussing systems for Navy ships under a recently awarded \$800,000 contract.

MOTOROLA will develop a transponder for the Apollo spacecraft. Equipment will be used from about 4,000 miles out to the moon for psk telemetry, f-m and tv transmissions.

SEVEN MORE TIROS meteorological satellites will be built by RCA for NASA. Contract price will run between \$11 million and \$12 million.

FAA IS FURNISHING nearly \$5 million worth of air traffic control and air navigation equipment for a 1,900-mile controlled airway stretching from Ankara, Turkey, to Tehran, Iran, to Karachi, Pakistan.

RAYTHEON will help MIT's Instrumentation Laboratory design and develop the on-board digital computer for the Apollo command module. A \$15,029,420 NASA contract also calls for Raytheon to build the computer and its associated ground support equipment.

ELECTRONIC Industries Association of Japan wants to place controls on tv exports, to forestall price-cutting in the U. S.

PHILIPS' Brazilian subsidiary will put up a million-dollar plant near Sao Paulo to manufacture electronic equipment for communications and movie industries.

IN ENGLAND, BBC is buying 12 of Marconi's new tv audio and video transmitters. The uhf-tv transmitters use identical 4-cavity klystrons for both video and audio output.

NUMBER ONE IN ELECTRICAL CONNECTORS...

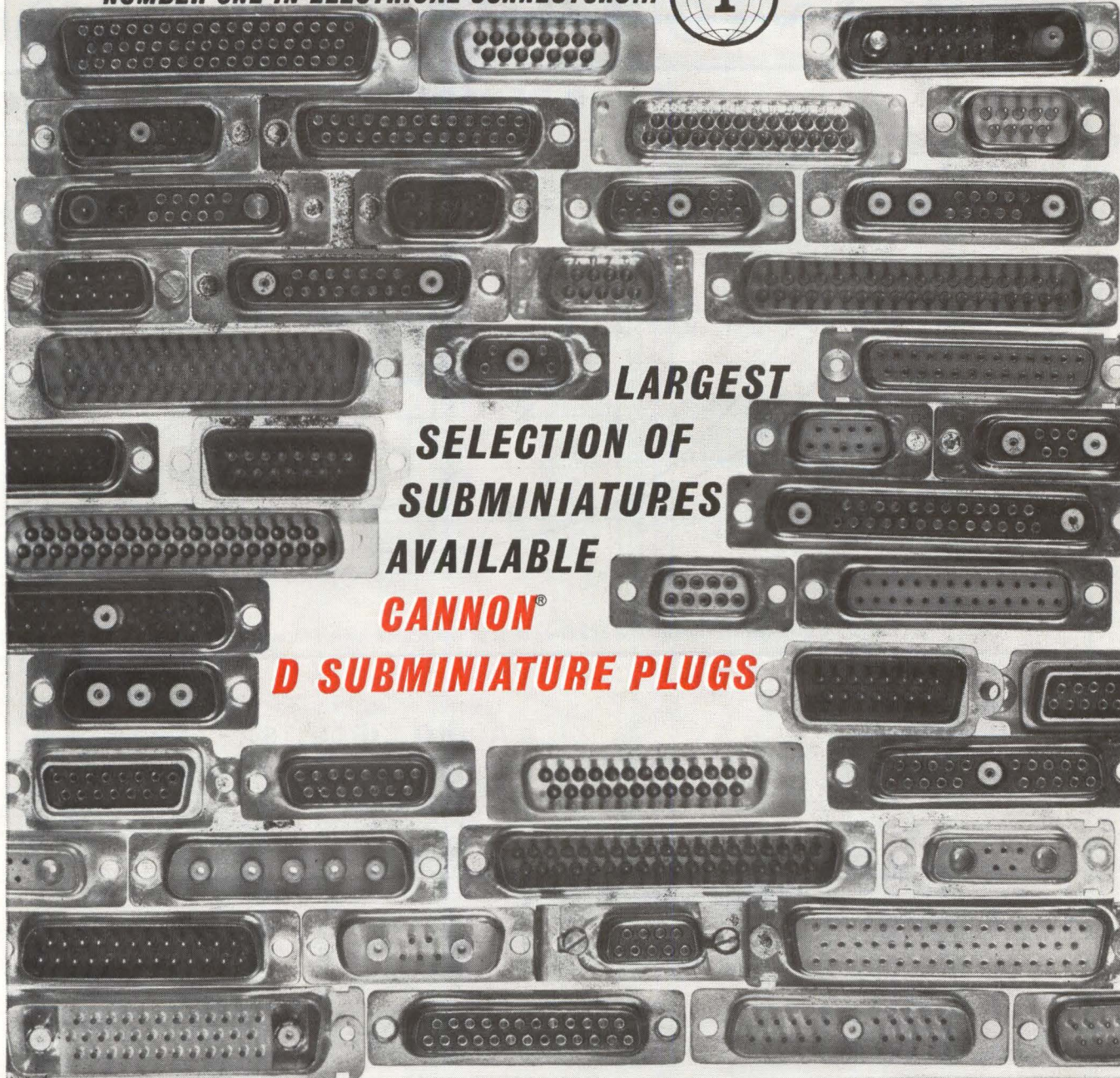

**LARGEST
SELECTION OF
SUBMINIATURES
AVAILABLE**

**CANNON®
D SUBMINIATURE PLUGS**

SIZES FROM 9 TO 50 CONTACTS

- SOLDER POT CONTACTS
- CRIMP REMOVABLE SNAP IN CONTACTS
- CRIMP REAR-RELEASE CONTACTS
- HERMETICS
- COAXIAL INSERTS
- HIGH VOLTAGE INSERTS
- COMBINATION LAYOUTS
- MOISTURE RESISTANT
- VIBRATION RESISTANT
- HIGH ALTITUDE
- LOW MAGNETIC PROPERTIES
- CORROSION RESISTANT
- PRINTED CIRCUIT APPLICATIONS
- CUSTOM APPLICATIONS

Contact your Cannon Authorized Distributor or write to:

© "CANNON" IS A TRADEMARK REGISTERED IN U. S. PAT. OFF. AND FOREIGN COUNTRIES BY CANNON ELECTRIC COMPANY

CANNON ELECTRIC COMPANY

3208 Humboldt Street, Los Angeles 31, California

ADDITIONAL PLANTS IN: SANTA ANA & ANAHEIM, CALIF. • PHOENIX, ARIZ. • SALEM, MASS. • TORONTO • LONDON • PARIS • BORNEM, BELGIUM • TOKYO • MELBOURNE

Sales offices and representatives in principal cities of the world



Now 1~ to 14gc low-noise

10 DECADES OF LOW-NOISE DEVICES

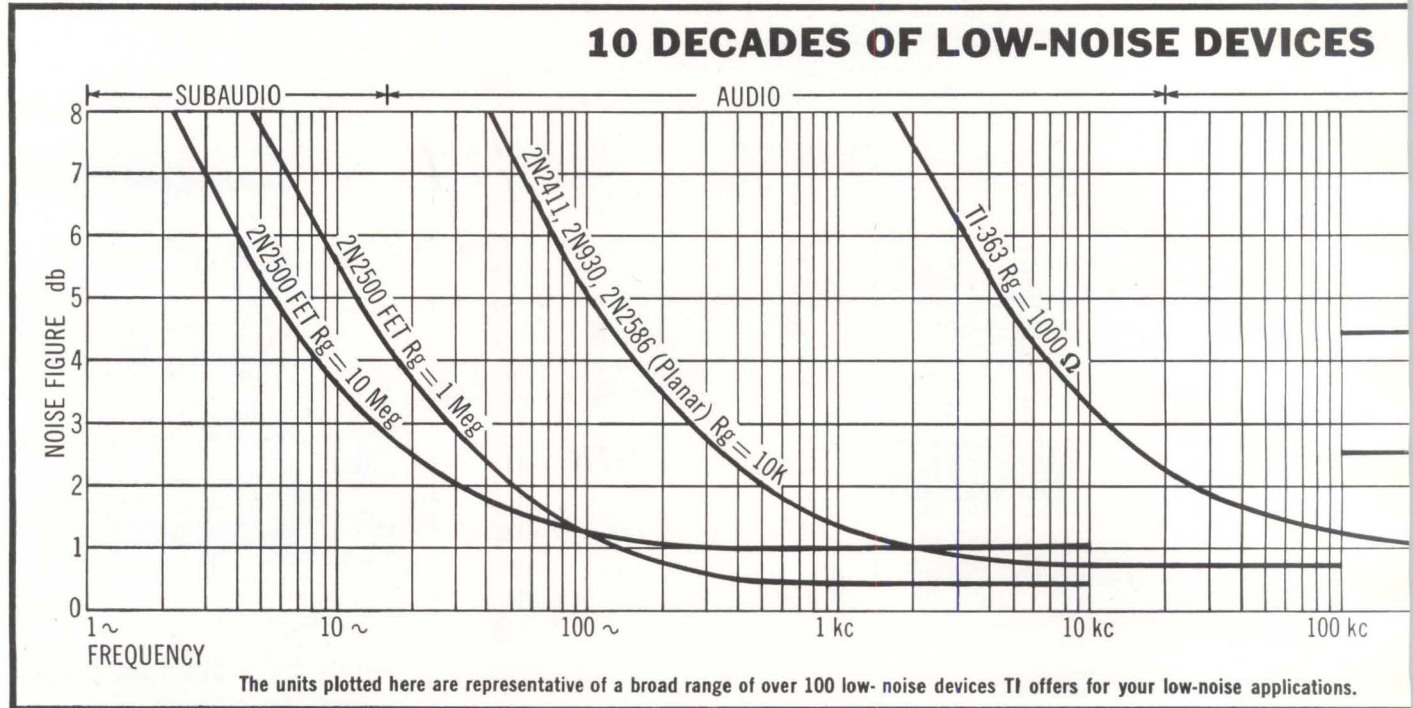

Low-noise devices for your SUBAUDIO CIRCUITS

Texas Instruments 2N2497-2500 series field-effect transistors give the design engineer extremely low-noise characteristics — as low as 5 db at 10 cycles. They are ideal for such low-frequency equipment as null-detection apparatus, medical research equipment, oscillographic and magnetic tape recorders, oscilloscopes and all types of low-level transducers. ■ The circuit below illustrates how Texas Instruments 2N2500 silicon field-effect transistors are used to achieve low-noise, low-frequency operation.

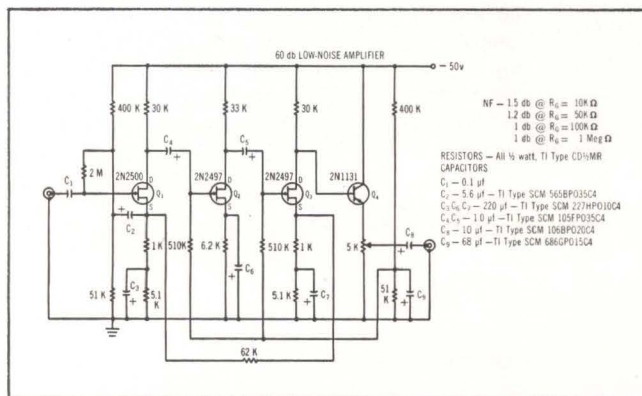

This circuit gives you a maximum voltage gain of 60 db ± 0.5 db from -55°C to 125°C with built-in gain adjustment. You also get good low-frequency response and stable circuit operation. ■ Write for your technical information file on low-noise TI devices for your subaudio applications.

TI cannot assume any responsibility for any circuits shown or represent that they are free from patent infringement.

Low-noise devices for your AUDIO CIRCUITS

Now you can design the low-level, high-gain amplifier shown below with typical noise figure as low as 1 db. Advanced low-level planar technology of Texas Instruments 2N929 and 2N2586 makes possible high gain at low current levels, plus the extremely low leakage currents necessary for true low-noise performance.

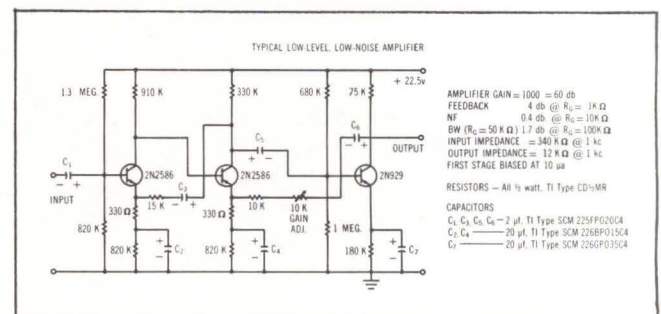

For high-impedance transducer applications, TI 2N930 and 2N2586 devices permit typical 1 db noise figure at emitter currents below 1 microampere, and generator resistances over 1 megohm. These special characteristics allow direct coupling of low-level, high-impedance sources... advantages previously available only with vacuum tubes and field-effect transistors. High gain at low levels plus very thin regions in these units combine to offer low power consumption and high radiation resistance to make the 2N930 and 2N2586 ideal for space applications. ■ A technical information file on almost 50 TI low-noise devices for audio circuits is yours upon request.

SEMICONDUCTOR COMPONENTS
DIVISION



solid-state amplification

FROM TEXAS INSTRUMENTS

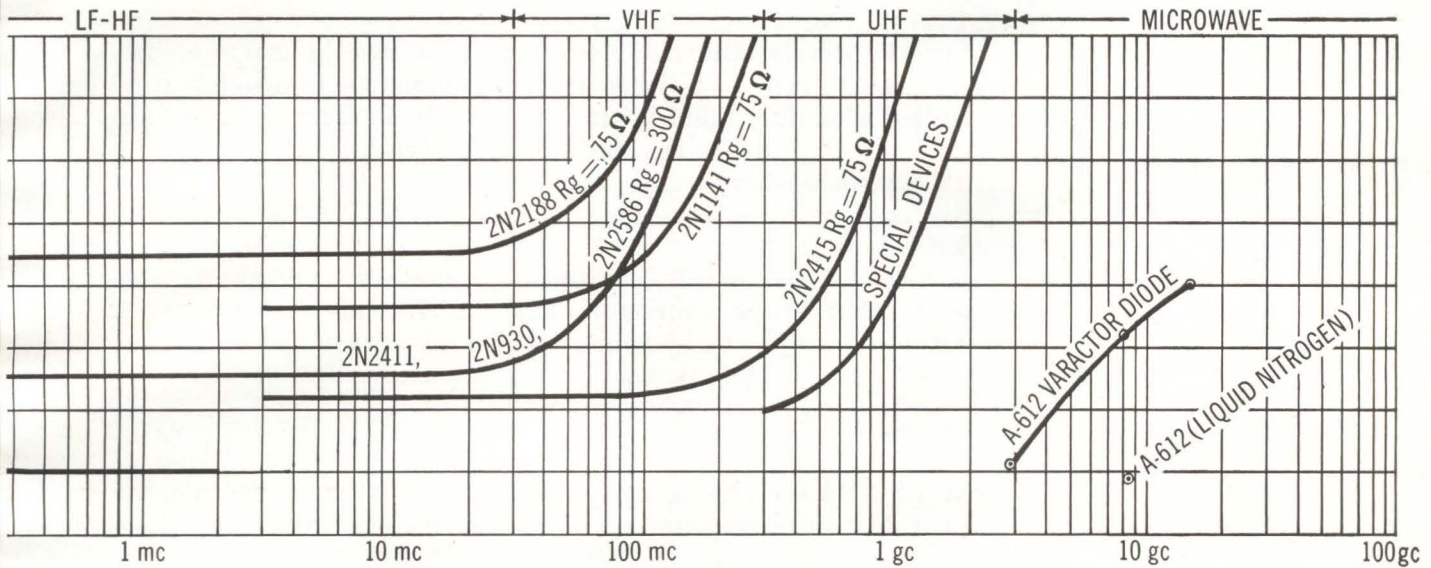

Figures shown are not theoretical; all are achieved measurements from actual circuit operation.

Low-noise devices for your LF-UHF CIRCUITS

For your low-noise, high-frequency receiver and preamplifier applications, TI 2N2415 germanium mesa transistors give you a typical noise figure of 2.4 db at 200 mc, maximum available gain of 15.5 db at 500 mc with a f_{MAX} of 3 gc. ■ In the following circuit, HRB-Singer, Inc. utilizes 2N2415 transistors and "multiple feedback" techniques to achieve a uniform low noise figure, nominally 6 db, over the entire frequency range of 300 to 1000 mc with an average gain of 35 db. Unique design provides stable operation over a temperature range of -30° to $+70^{\circ}$ C and eliminates the need for RF tuning capacitors.

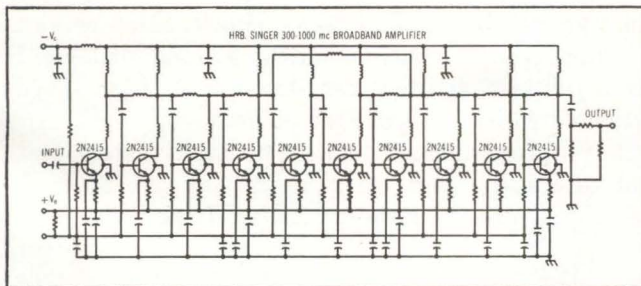

Another line of TI low-noise communications devices is the Dalmesa 2N2188 and TI363 series of germanium alloy diffused mesa transistors. These advanced units offer you ultra-high performance from dc to 100 mc, typical mid-frequency noise figures of less than 2 db, and increased high-frequency stability through guaranteed maximum output capacitance of 2.8 pf at 9 volts. ■ Investigate TI's wide selection of low-noise transistors for LF-UHF circuits by writing for a free fact file on these devices.

Low-noise devices for your MICROWAVE CIRCUITS

Now you can design microwave circuits for highest frequencies at lowest noise with the new GaAs Pill Varactor Diode from Texas Instruments. These new subminiature devices offer you minimum cutoff frequency of 90 gc to 150 gc at -2 volts with low junction capacitance $- C_j$ @ 0 bias from 0.15 to 0.75 pf. Your production-line requirements for identical plug-in units are met through tight control of junction and package characteristics. ■ These features offer you the lowest package capacitance and inductance in industry today—backed up with TI varactor manufacturing capacity to meet your tightest production schedules. ■ TI GaAs Pill Varactor Diodes are particularly applicable to low-noise parametric amplifiers, harmonic generators, microwave switches, sub-harmonic oscillators, phase shifters and parametric limiters.

FOR FULL INFORMATION . . .

. . . write for a fact-filled file of technical data on low-noise TI devices designed for application in your frequency range. Please address your card or letter to Department 605 and specify which of these four information files you desire.

1. SUBAUDIO
2. AUDIO
3. LF-UHF
4. MICROWAVE



TEXAS INSTRUMENTS
INCORPORATED
13500 N. CENTRAL EXPRESSWAY
P. O. BOX 5012 • DALLAS 22, TEXAS

February 22, 1963

Ask your authorized TI distributor about "Transistor Circuit Design," an informative new hardbound book for circuit designers authored by 32 TI engineers and published by McGraw-Hill.

19605

WASHINGTON THIS WEEK

PENTAGON IS GOING AHEAD ON PLAN TO SET PROFITS

NEW PROCUREMENT REGULATION is being drafted by the Pentagon. It incorporates recommendations of the Logistics Management Institute for a quantitative system of setting target profits or fees in noncompetitive cost-plus contract negotiations (ELECTRONICS, p 12, Dec. 14, 1962).

Thomas D. Morris, Assistant Secretary of Defense in charge of procurement policy, expects to issue the new regulation in about four to six months, after the military services and the Defense Industry Advisory Council have had a chance to iron out details.

LMI's system sets up a check list of mathematically weighted factors to guide contracting officers in establishing profit or fee objectives. Included are such items as the contractor's input in terms of labor and materiel (to distinguish between the primes' direct work and subcontractor efforts); the contractor's financial risk; his requirement for government-owned plant and equipment; and his rate of subcontracting.

Electronics Industries Association expressed considerable opposition to the preliminary draft version of the LMI plan.

NASA GETS TOUGH ABOUT R&D REPORTS

NASA IS TRYING to squeeze more reports of inventions, innovations and new developments out of its contractors. New regulations require contractors to keep a more careful inventory of new developments stemming from NASA-funded research. They also make it more costly for a contractor to fail to report inventions and innovations—minimum penalties are being raised from \$5,000 to \$50,000.

NASA issued the new regulation after comparing reports by its contractors to those from the Atomic Energy Commission and Navy. Both those agencies have had stiffer reporting requirements and penalties. And, although NASA spends as much or more than Navy and AEC on R&D, NASA has been receiving fewer than a third as many reports as the other agencies.

ARMY TO BUY MAULER AND TRIPLE-DUTY TEST SYSTEM

ARMY WILL BEGIN initial production of the Mauler surface-to-air missile in fiscal 1964. General Dynamics is the prime contractor, Raytheon and Burroughs are the guidance subcontractors. Mauler uses the same type of semiactive homing guidance as Hawk. Mauler can be deployed on vehicles, in unprepared positions on the ground, or aboard ships. It is designed as a defense against very-low-flying, high-speed tactical planes and battlefield-range ballistic missiles.

Army will also begin buying operational models of multisystem test equipment (MTE), a set of missile test instruments for use at each maintenance level. MTE will be able to handle Mauler, Lance and Shillelagh missiles, eliminating the need for separate test equipment for each missile. Officials say MTE will be able to handle about 85 percent of the electronic tests required by each missile system and that "add-on equipment peculiar to each system will raise the test capability to 100 percent." RCA is the development contractor. A spokesman for the Army Materiel Command says that the production order "no doubt will be thrown open for competitive bidding."

WHO'S ON TOP IN R&D? GD

PENTAGON'S LATEST LISTING of leading R&D contractors, covering fiscal 1962, shows General Dynamics on top with \$508.1-million worth of awards. Following, in order: Lockheed, Boeing, North American Aviation, GE, Martin Marietta, Western Electric, Aerojet-General, Douglas Aircraft and Sperry Rand.

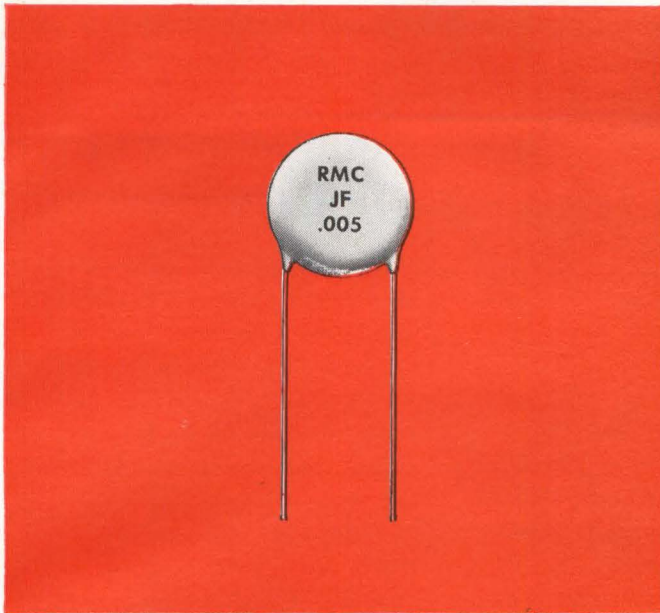

An RMC "JF" discap

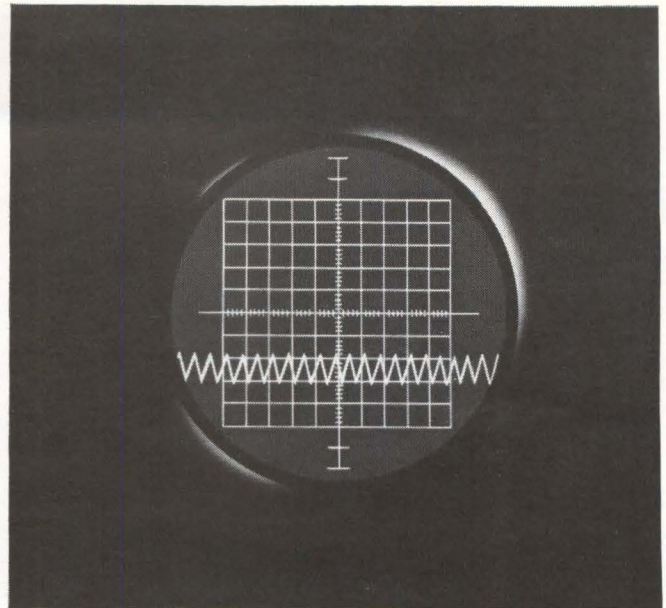

...can go through phase

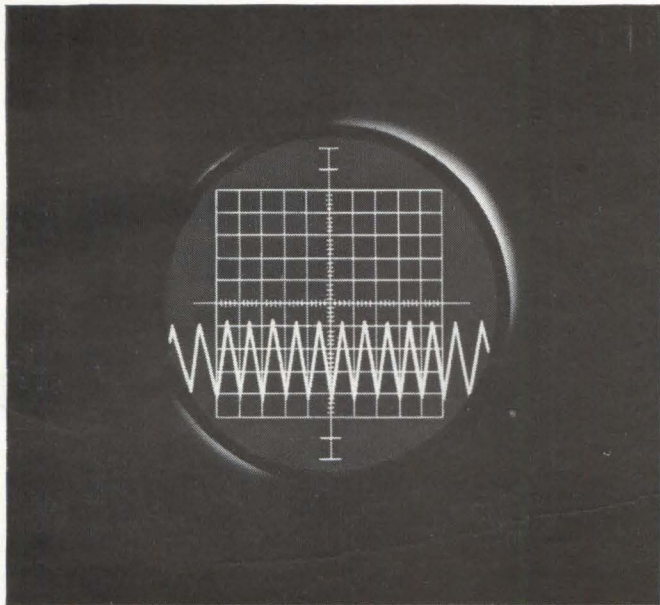

...after phase

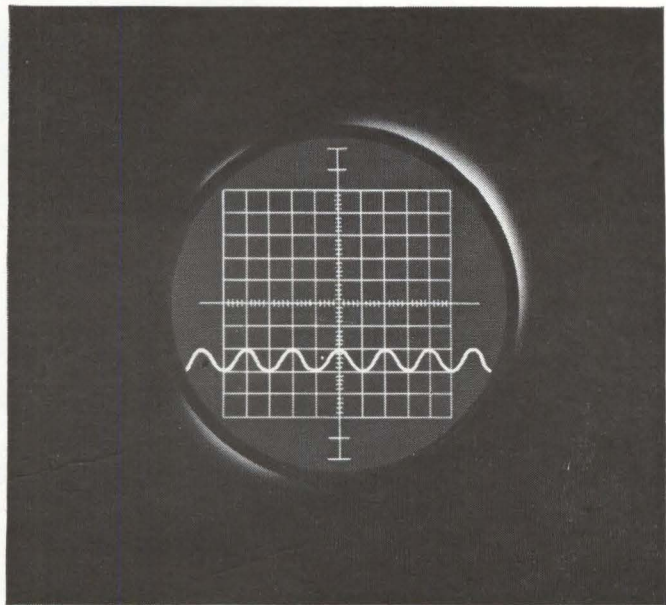

...after phase...without a faze!

VISIT BOOTH 1414, I.E.E.E. SHOW

RMC Type JF DISCAPS exhibit superior stability in applications where a wide range of frequencies is present. Rated at 1000 V.D.C., these capacitors are manufactured in capacities between 150 MMF and 10,000 MMF.

Between 10° and 85°C., Type JF DISCAPS exhibit a capacity change of only $\pm 7.5\%$ and are available in tolerances of $\pm 10\%$, $\pm 20\%$, $+80-20\%$ at 25°C. Write on your letterhead for information on these and other quality RMC DISCAPS.

DISCAP CERAMIC CAPACITORS  **RADIO MATERIALS COMPANY**
 A DIVISION OF P. R. MALLORY & CO., INC.
 GENERAL OFFICE: 4242 W. Bryn Mawr Ave., Chicago 46, Ill.
 Two RMC Plants Devoted Exclusively to Ceramic Capacitors
 FACTORIES AT CHICAGO, ILL. AND ATTICA, IND.

Mullard Tubes for Television Tuners

EC900 6HA5 TRIODE



ECF801 6GU7 TRIODE PENTODE

THE IDEAL COMBINATION FOR BETTER SIGNAL TO NOISE RATIO AND HIGH GAIN

Much of the ready acceptance by leading setmakers of these two new tuner tubes stems from the high signal to noise ratio and high gain of these types.

Other benefits include reduced microphonics, low cross modulation and better oscillator stability.

Both tubes are available with 6.3V, 0.45A or 0.6A heater ratings.

For full technical data on the EC900 and ECF801, write to the address below.

CHARACTERISTICS

EC900

g_m	14.5	mA/V
E_b	135	V
I_b	11.5	mA
E_c	-1.0	V
μ	72	
r_p	5.0	k Ω
E_c (10:1 reduction in g_m)	2.4	V
E_c (100:1 reduction in g_m)	5.3	V

ECF801

Pentode Section			Triode Section		
g_m	11.0	mA/V	g_m	9.0	mA/V
g_c	5.0	mA/V	μ	20	
I_b	10	mA	E_b	100	V
E_b	170	V	E_c	-3.0	V
E_{c2}	120	V	I_b	15	mA
E_{c1}	-1.2	V			

Full details on the Mullard range of tubes for television, stereo and high-fidelity available from:

INTERNATIONAL ELECTRONICS CORPORATION,
81 SPRING STREET, NEW YORK 12, N.Y. 
Worth 6-0790

Mullard

ELECTRONIC TUBES

Mullard is the trade mark of Mullard Limited

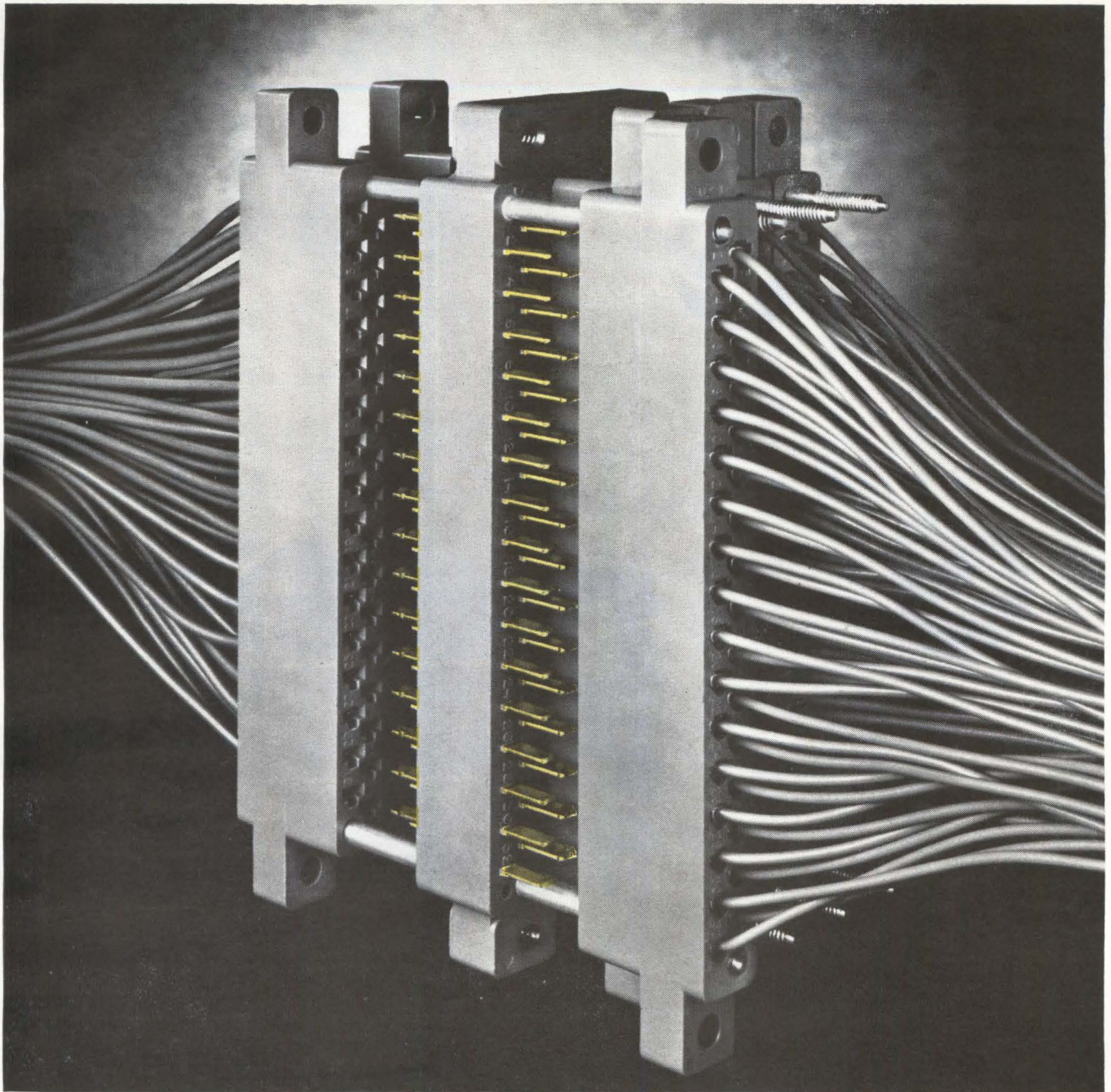

Propensity for density!

192 connections in a cubic area approximately 3.375"—that's the AMP-BLADE* Multi-Circuit Feed-Thru Connector. This high density potential, combined with feed-thru versatility, permits wide variations in both intra- and inter-rack connections, and makes possible complete modularization in all rack wiring installations.

Feed-thru block consists of 128 male tabs on one side commoned in with 64 male tabs on the other side. Choice of either 2 to 1 or 4 to 2 circuit combinations. 32 position female housings accept all standard AMP-BLADE receptacle contacts. Receptacle housings are not preloaded, meaning you pay for only those contacts necessary.

Receptacle contacts are crimp, snap-in type. Available in strip form for high-speed applications with A-MP* automachine tooling. This patented, compression-crimp method of contact application provides rates of 3,000 uniform terminations per hour.

*Trademark of AMP INCORPORATED

Standard AMP Contact Plating: .000030" gold over .000030" nickel.

Package all your rack wiring with this high-density connector. Get feed-thru variability. Get consistently high AMP quality. Specify AMP-BLADE Multi-Circuit Feed-Thru Connectors. Wherever your need... whatever your need, AMP puts an end to every circuit problem.

Complete information available on request.



AMP products and engineering assistance are available through subsidiary companies in: Australia • Canada • England • France • Holland • Italy • Japan • Mexico • West Germany

CIRCLE 15 ON READER SERVICE CARD

CIRCLE 16 ON READER SERVICE CARD →

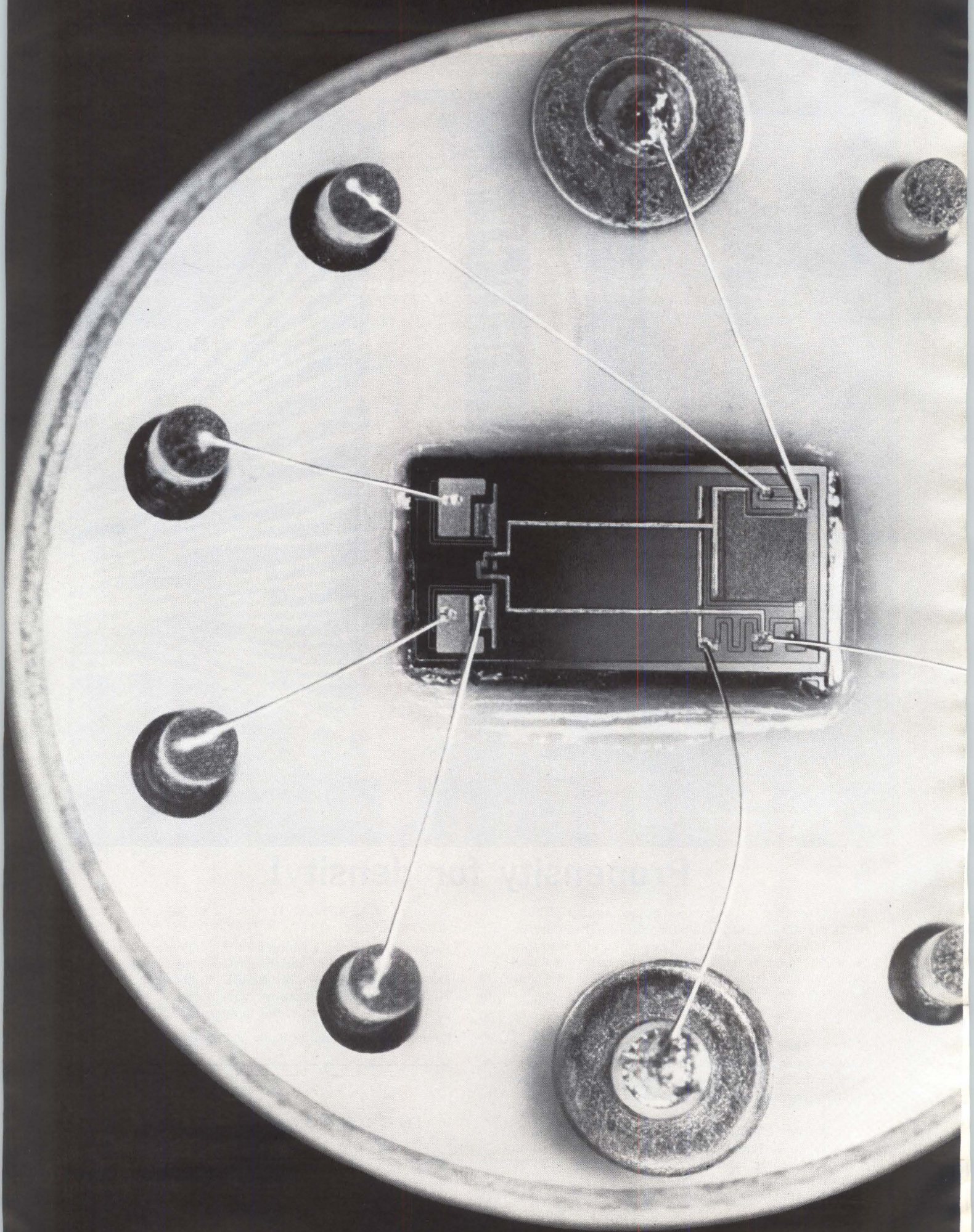

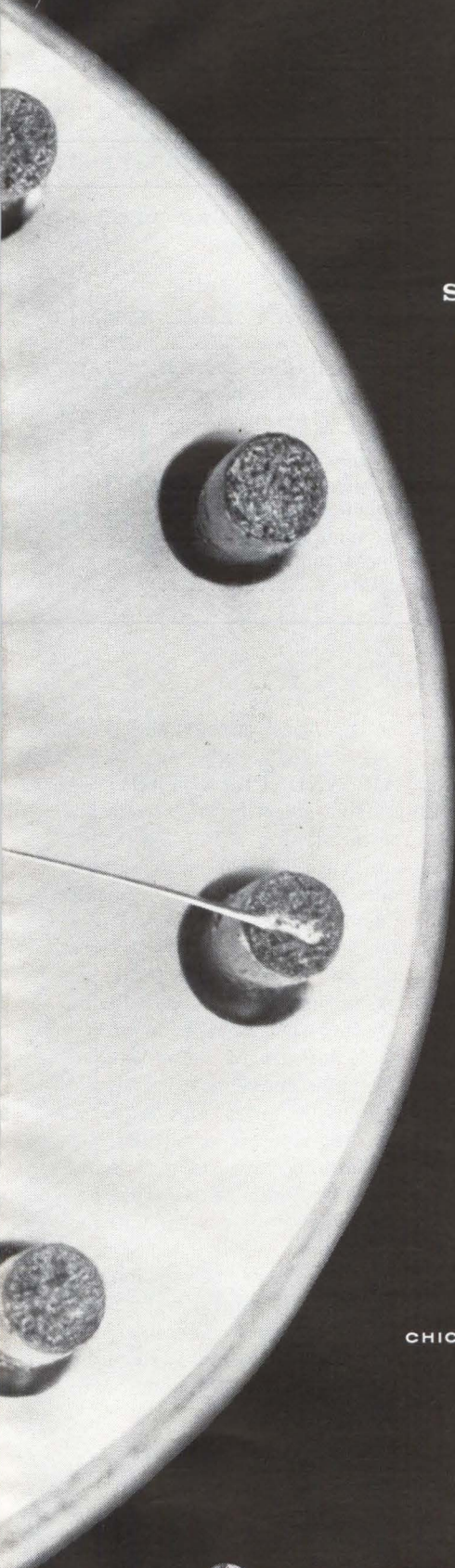

SCIENTISTS AND ENGINEERS: Today's electronic systems for military and space programs demand smaller, lighter weight equipments with lower power consumption and the highest order of reliability. These needs have forced a marriage of the best features of advanced semiconductor and thin film integrated circuit techniques, and resulted in such functional electronic blocks as the tiny compatible circuit shown at left.

This is but one example of how Motorola scientists and engineers are enhancing their leadership position in integrated electronics.

To implement dynamic integrated circuit applications programs jointly funded with each of the three services, NASA and other government agencies, we can offer immediate opportunities to both systems and equipment design engineers experienced in the following areas:

HOW SMALL CAN YOU THINK?

Integrated circuits...key to improved reliability

Specification of design constraints imposed by integrated circuits, trade-off analyses for integrated electronic implementation, and electronic systems specification and optimization, microminiature transistor circuit design, special solid state and semiconductor device utilization, computer-aided circuit design, and subminiature packaging techniques, including thermal considerations or basic training in the solid state sciences.

✍ We are particularly interested in programs from which your experience was obtained and the extent of your technical responsibility. Please address detailed information to our Manager of Engineering at the location of your choice for immediate and confidential attention.

Military Electronics Division



MOTOROLA

An equal opportunity employer

SCOTTSDALE, Arizona, 8201 East McDowell Road

CHICAGO 51, Illinois, 1450 North Cicero Avenue / RIVERSIDE, California, 8330 Indiana Avenue



ACTUAL SIZE 120 mc RF high frequency linear amplifier integrated circuit custom built by Motorola's Semiconductor Products Division.

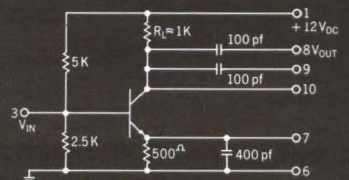

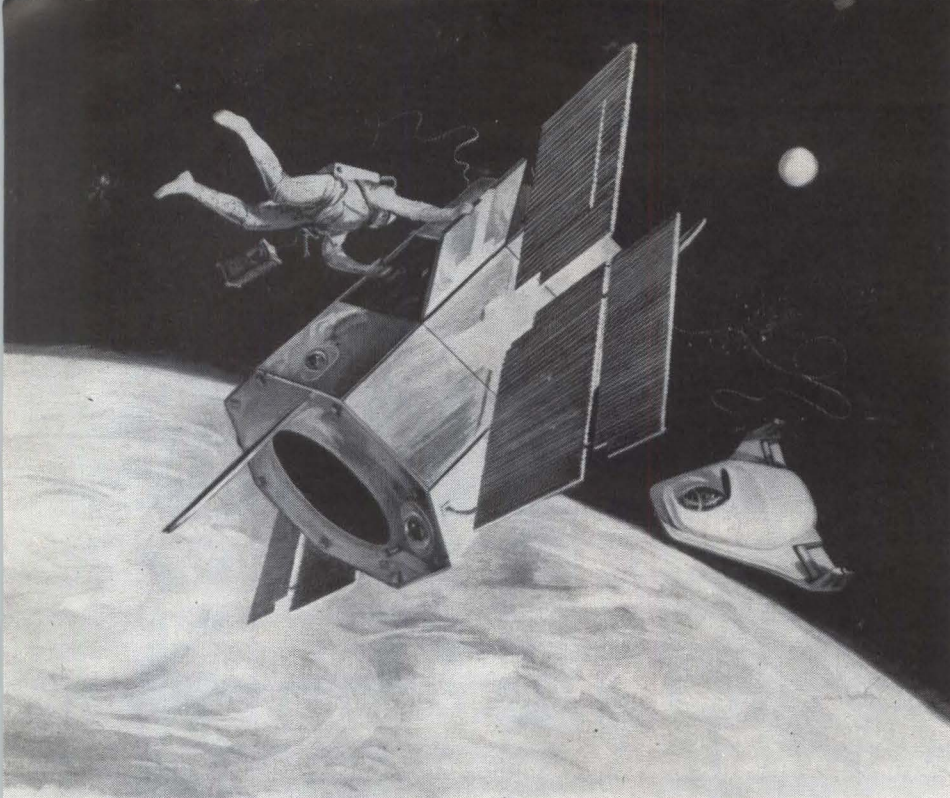

REPAIRABLE SATELLITES. Typical of new NASA contracts is recent award to Grumman for study of ways to make the Orbiting Astronomical Observatory suitable for in-orbit repair

NASA outlines upcoming programs—but better put your bids in early

By JOHN F. MASON
Senior Associate Editor

WASHINGTON, D. C.—The way to get new contracts with the National Aeronautics and Space Administration is to go after the little-known projects that to the layman seem “far out.” The well-publicized “future” projects such as Gemini, Apollo, the big orbiting observatories, and many others are almost finished as far as new contract awards are concerned.

The market is there, however, and it's big. What it consists of was described in detail last week at the two-day NASA-Industry Program Plans Conference.

Subcontracts for Gemini have all been awarded. Apollo is sewed up except for subcontracts Grumman will award for the lunar excursion module (LEM). Improved equipment will still be accepted for both Gemini and Apollo if new techniques can be devised quickly. They include: lower weight power supplies, communications during reentry, speech compression tech-

niques, microminiaturized equipment and bioinstrumentation, smaller and more reliable tape recorders, heat exchangers and insulating materials, reliable high temperature sensors, and cooling techniques.

Still open are the advanced manned space projects beyond Apollo: a lunar logistic system, a lunar base, earth orbiting space stations, and planetary missions.

Study contracts will be awarded soon for logistic systems, lunar exploration techniques, means for exploiting lunar materials, operational concepts for longer lunar missions, and physiological monitoring techniques (see p 20).

GEOPHYSICS AND ASTRONOMY—Beyond the big observatories, NASA plans to orbit an Advanced Orbiting Solar Observatory (AOSO) in late 1966. Three study contracts are already out.

Other NASA needs are: a radio astronomy satellite, gravity stabilized, with a large erectable antenna; a combination of satellites and space probes to measure charged particles and magnetic fields; a heavy satellite inside another satellite to study gravity and relativity. This work, during 1967-71, will tie

NOW'S THE TIME “FAR-OUT”

NASA BUDGET REQUEST FOR

Manned Space Flight, Total	3,193,641
Spacecraft Development and Operations	1,647,441
Launch Vehicle Development	1,319,454
Supporting Programs	226,746
Aerospace Medicine	21,840
Integration and Checkout....	157,378
Systems Engineering	47,528
Space Applications, Total	136,559
Meteorology	73,085
Communications	55,771
Other Applications	7,703
Advanced Application Satellites	1,604

in with the Apollo program.

LUNAR AND PLANETARY — Competitive selection of a contractor for developing a 120-lb Pioneer spacecraft for interplanetary measurements will begin soon. Proposals were sent out by the Ames Research Center in January. Ames will also solicit industry studies in the spring on a 300-lb Solar Probe spacecraft to augment Pioneer.

Several designs are being studied for a Mariner spacecraft for Mars/Venus capsule entry and landing. Design decision is expected by spring. Industry studies are to begin before summer on possible designs for Voyager—another Mars/Venus craft.

Also under study are missions to the other planets, flights out of the plane of the ecliptic, and missions to explore comets and asteroids. Nuclear or electric propulsion will be required.

COMMUNICATIONS — NASA wants intermediate-altitude active-repeater satellites with increased communications capability, multiple access, passive or semipassive control system for orienting the satellite toward the earth.

Also, stationary, fully stabilized

TO GET THOSE SPACE CONTRACTS

FISCAL 1964, R&D AND OPERATIONS (IN \$1,000)

Industrial Applications	6,099	Space Vehicle Systems	111,407
Unmanned Investigations In		Electronic Systems	59,286
Space, Total	754,765	Human Factor Systems	24,387
Spacecraft Development		Propulsion & Space Power...	268,783
and operations	605,233	Nuclear-Electric Systems	89,605
Geophysics and Astronomy..	232,624	Nuclear Rockets	118,919
Lunar and Planetary		Chemical Propulsion	35,075
Exploration	331,270	Space Power	25,184
Bioscience	41,339	Aircraft Technology, Total	45,126
Launch Vehicle		Supporting Operations, Total	318,046
Development	149,532	Tracking & Data	
Space Research and		Acquisition	261,608
Technology, Total	463,863	Facility, Training &	
Launch Vehicles		Research Grants	56,438
and Spacecraft	195,080	TOTAL	4,912,000

high-gain satellites, with high communications gain and a long orbital lifetime; station-keeping and attitude control provided by electrical thrusters, and solar or nuclear power supplies.

NASA will award a study contract this year to determine state of the art in all-electric antenna beam-shaping and steering techniques and tracking. For transmitter improvement, r-f-to-r-f frequency conversion without intermediate frequency amplification will be studied. Future satellites must be available to a number of users.

METEOROLOGY — Besides contract opportunities in a new synchronous weather satellite, for which a study contract is out, Goddard will begin programs on: image orthicon cameras to observe clouds at night; electrostatic tape cameras for higher resolution cloud pictures and more efficient data storage; improved ir or other atmospheric radiation sensors, particularly spectrometers; sensors operating in other parts of the spectrum, such as sferics, passive microwave, and possibly radar; and improved controls, power, recording, and command subsystems.

A contract award is pending to

survey the requirements for a satellite to collect data from remote automatic weather stations, oceanographic buoys, constant level balloons and other sources.

Improved data handling, storage, reduction and initial presentation to the using meteorologists is a requirement. On board systems must partially process the information before transmitting it.

ELECTRONICS AND CONTROL — More research is needed on rendezvous and horizon sensors. Part of the program is to investigate environment parameters that could be exploited.

Communication through the plasma sheath will be attempted soon in a flight experiment during which water will be injected into the ionized flow field. Work is needed on materials and techniques to achieve digital outputs from transducers. Emphasis should be placed on new principles such as molecular electronics and solid state transducers.

Needed for Apollo are several translunar antennas, three 85-ft lunar antennas, unified S-band systems at primary stations, and three tracking ships. Procurement for the ships will begin in fiscal 1964.

THE POTTER MT-36 digital magnetic tape transport

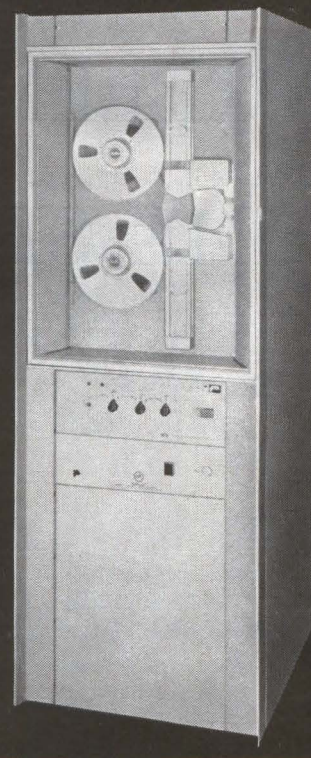

MT-36: THE MOST RELIABLE TRANSPORT in its price range

The Potter MT-36 Digital Magnetic Tape Transport offers maximum reliability for computer systems requiring an economical transport. The Potter MT-36 features:

- **NO PROGRAM RESTRICTIONS...** up to 200 commands per second at 36 ips.
- **SOLID STATE CIRCUITRY...** photo electric sensing minimizes the need for switches and relays.
- **VACUUM TROUGH GUIDES...** provide smooth tape stops.
- **IMPROVED PINCH-ROLLER CIRCUITS...** offer fast tape starts and stops.
- **EASE OF MAINTENANCE...** drive electronics and fully regulated power supply are mounted on individual plug-in boards.
- **RAPID TAPE THREADING...** Just 15 seconds for complete threading.
- **BUILT IN TAPE CLEANER...** vacuum on trough guide removes all loose oxide and dust.

For full information and specifications on the MT-36 Digital Magnetic Tape Transport, write today.



POTTER INSTRUMENT CO., INC.

TAPE TRANSPORT DIVISION
151 Sunnyside Boulevard • Plainview, New York

BIOTELESCANNER *transmits data on biological substances to base station for identification*

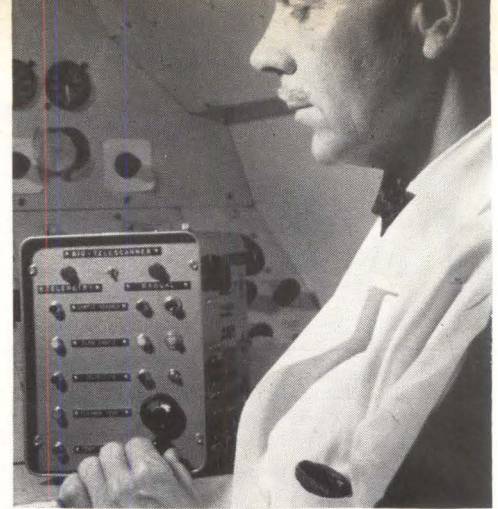

BIOTELEMETRY: PRIME SPACE NEED

Physiological data processors and better sensors are wanted

BROOKS AFB, TEXAS — Aerospace medical requirements for projects such as Gemini and Apollo, the Manned Orbital Development Station, X-20 (Dyna-Soar) and Aerospace Plane were presented this month by the Aerospace Medical Division of the Air Force Systems Command, and the Air Force School of Aerospace Medicine.

Maj. Gen. R. L. Bohannon, Air Force Deputy Surgeon General, pointed out the general direction electronics must take:

- Biotelemetry data gathering must be improved and equipment miniaturized more and more as flights become longer.

- Much of the data must be partially processed in the spacecraft for immediate use by automatic controls before it is telemetered to earth.

- An ideal system would automatically adjust environmental conditions to remedy ill effects on

astronauts. Automatic systems, however, are probably a long way off due to cost and complexity.

On NASA/USAF Gemini flights (ELECTRONICS, p 18, Feb. 8), crewmen will be monitored to determine effects of prolonged weightlessness and other space-flight phenomena.

However, on operational missions like Apollo, physiological data will be of more interest to the crewmen themselves than to research teams on the ground. On board data-processing is essential since there will be no time to monitor reams of raw data from sensors. A system that alerts crew and ground stations to abnormal physical conditions is desired. State-of-the-art equipment could handle this assignment, Robert M. Adams, chief of bioelectronics, Air Force School of Aerospace Medicine, told ELECTRONICS. The problem is determining what is abnormal and programming the computer accordingly.

SENSORS—Adams and his colleagues have developed an impressive array of tiny transmitters that can effectively radiate through body tissue. One, placed in a rabbit's body, has telemetered its electrocardiogram.

Since astronauts don't like sensors or transmitters embedded surgically, indirect methods must be used. The school is working in-house and by contract on new sen-

sors and sensing techniques. Adams and Capt. Ray W. Ware described sensors work.

- USAF would like a respiration sensor that does not require breathing through a mask. One approach tested in Mercury is to attach two electrodes to the chest. The impedance change measured with each breath is related to air volume in the lungs.

- Conventional blood pressure cuff and listening device is cumbersome. Pressure sensors might be applied to the skin over an artery. Or, several sensors could measure simultaneously parameters such as blood flow, elasticity of the vessel and blood changes, providing blood pressure and other data. Disadvantage here is complexity.

- Big problem in galvanic skin response instrumentation is to develop satisfactory electrodes.

To avoid wiring up the astronauts, each sensor might have its own transmitter feeding signals to receivers on the spacecraft walls.

BIOTELESCANNER — A device that can analyze and radio data on life forms during space explorations was unveiled. Developed by W. G. Glenn, W. E. Prather and Heinz Jaeger, the Biotelescanner has successfully sent data from Brooks to Germany and Japan by telephone and radio relay.

The operator places a sample solution in one of 55 gel diffusion analysis columns. A photoelectric scanner detects precipitin reactions. Analog voltage changes are relayed to home base and matched against known specimens. It can also be used for measuring changes in astronauts' body fluids.

AEROSPACE doctors want a blood-pressure sensor less cumbersome than this cuff for the X-15 and X-20 programs. Man holds microphone-preamplifier retention pad. Other sensors are electrocardiograph electrodes

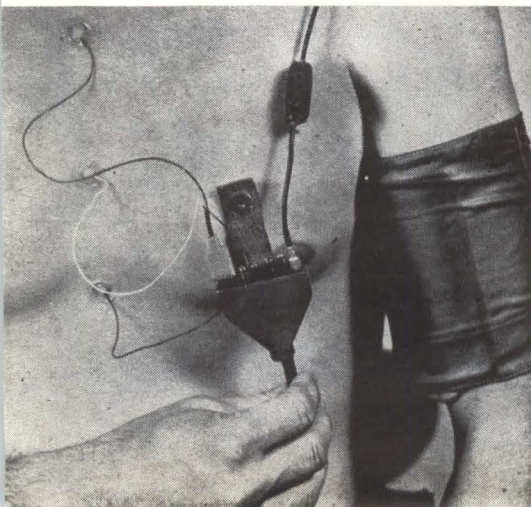

GUARD AGAINST READ/WRITE ERRORS WITH RELIABLE TAPES OF MYLAR®

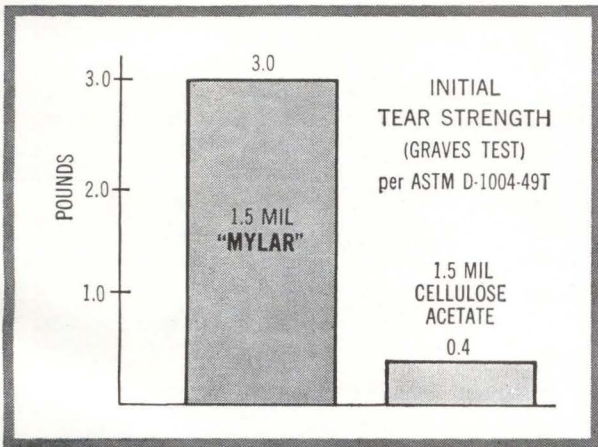
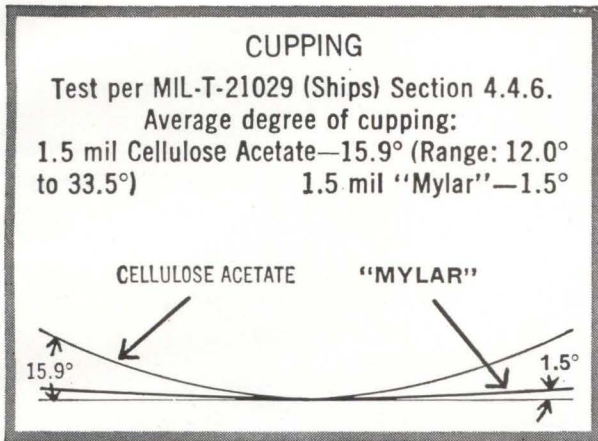

Unstable tape can cup or ruffle—cause read/write errors because the tape loses contact with the recording and playback heads. Dimensionally stable "Mylar"* polyester film base prevents tape cupping or ruffling. It does not shrink from dryness or swell from excess humidity, but maintains the original width and flatness of the tape.

"Mylar" is strong . . . has an ultimate break strength over 20,000 psi! Tapes of "Mylar" can resist edge nicks, stretching or breaking from sudden stops and starts. And since it contains no plasticizer to dry out, tapes of "Mylar" can be stored indefinitely without becoming brittle.

A stable tape assures accurate data acquisition—helps prevent costly read/write errors and loss of valuable test data. Tapes of "Mylar" have this stability. To be sure you'll get the best performance, insist on a base of "Mylar" on your next order for magnetic tape. Write for the free booklet on comparative test data. Du Pont Company, Film Dept., Wilmington 98, Delaware.

*"Mylar" is Du Pont's registered trademark for its brand of polyester film. Only Du Pont makes "Mylar".



Better Things for Better Living . . . through Chemistry



E. I. du Pont de Nemours & Co. (Inc.)
Film Department, Room #12, Wilmington 98, Delaware.

Please send free, 12-page booklet of comparative test data to help me evaluate magnetic-tape reliability.

Name _____ Position _____

Company _____

Address _____

City _____ Zone _____ State _____

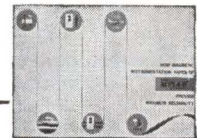

ReCap

The latest
technical information on Fansteel
Rectifiers, Capacitors, and Semiconductors

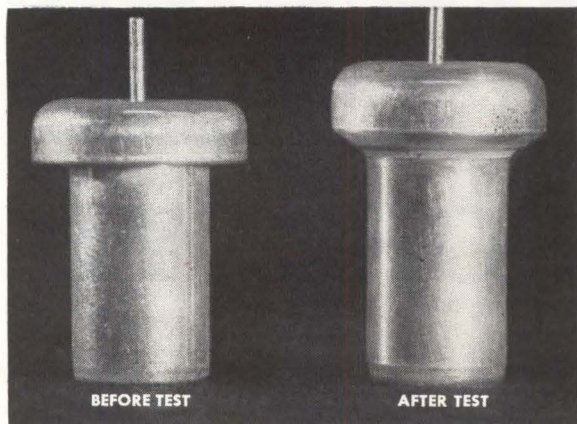

Crimp-sealed Fansteel tantalum capacitors stay leak-proof* even in outer space

Fansteel Type CL44 and 45 tantalum capacitors are crimp-sealed by a patented process that produces a virtually hermetic seal, even in the vacuum of outer space encountered by modern spacecraft.

Built to conform to Characteristic C of specification MIL-C-3965, these space age capacitors operate from -55°C to 125°C. Ratings range from 1.7 to 560 microfarads, and from 6 to 85 volts, as specified in MIL-C-3965.

Now these high-performance tantalum capacitors are being produced at Fansteel's expanded facilities. Your Fansteel field sales engineer can quote price and off-the-shelf delivery.

*This photo (twice actual size) shows a Fansteel "PP" type tantalum capacitor before and after being subjected to internal pressures of 600 psi. As shown, the test resulted in a stretching and deformation of the silver case, but no failure or leakage whatsoever in the seal.



Shrinkable, transparent insulation jackets add only 0.008 inches to capacitor diameter

Now Fansteel straight-sided tantalum capacitors can be outfitted with clear plastic insulating sleeves that provide high dielectric strength within a minimum of space.

These snug-fitting jackets are shrunk into place. No cement is required. Data on capacitor cases can be easily read. Yet the excellent insulating properties of the polyester material provides permanent and positive protection, even in highly miniaturized circuits where components may be mounted side-by-side.

FANSTEEL

METALLURGICAL CORPORATION

RECTIFIER-CAPACITOR DIVISION

North Chicago, Illinois.

Your Fansteel Rectifier-Capacitor Sales Offices, Representatives, and Distributors

339 Auburn St.
AUBURNDALE 66, MASS., DEcatur 2-7880
214 Main St., HACKENSACK, NEW JERSEY
Diamond 2-2878 (HACKENSACK)
LONgacre 3-6940 (NEW YORK)

606 Edmondson Avenue
BALTIMORE 28, MARYLAND
Phone: 747-6244

11750 Shaker Boulevard
CLEVELAND 20, OHIO, SKYline 2-2900

3304 North Harlem Avenue
CHICAGO 34, ILLINOIS, TUxedo 9-3200

7415 Wayzata Boulevard
MINNEAPOLIS 26, MINNESOTA
Phone: 544-2210

Dale Hjort
P. O. Box 13405
DALLAS 20, TEXAS, FLeeTwood 2-4038

2425 Mission Street
SAN MARINO, CALIF., MUrray 2-2125

175 S. San Antonio Road
LOS ALTOS, CALIFORNIA
Phone: 941-0261

Howe and Howe, P. O. Box 10497
4344 E. Indian School Road
PHOENIX, ARIZONA, Phone: 265-9185

J. C. Rowley and Company
955 Folsom, SALT LAKE CITY, UTAH
DAvis 2-2041

Emory Design & Equipment Co.
P. O. Box 9013, BIRMINGHAM 13, ALABAMA
TR 1-1369

also: P. O. Box 426A, HUNTSVILLE, ALABAMA
Phone: 536-8543

W. Ben Wimberly Co.
532 S. Ft. Harrison Ave.
CLEARWATER, FLORIDA

Phone: 446-7072
also: 500 S. Osceola St.
ORLANDO, FLORIDA
Phone: GA 5-3083

Canada

D. T. Shaw Company
2340 Lucerne Road
MONTREAL 16, QUEBEC
735-1541

also: P. O. Box 33
WESTON, ONTARIO
CHerry 4-5072

Aviation Electric Pacific Ltd.
VANCOUVER A.M.F.
BRITISH COLUMBIA
CRestwood 8-2184

Stocking Distributors

Kann-Ellert Electronics
2050 Rockrose Ave., BALTIMORE, MD.
TUxedo 9-4242

also: 611 DeKalb Pike
KING OF PRUSSIA, PA.
Phone: 265-3505
also: 11222 Triangle Lane
SILVER SPRING, MD.
Phone: 949-5200

Kierulff Electronics, Inc.
2884 Middlefield Road
MOUNTAINVIEW, CALIF. Phone: 968-6292

Westates Electronics Corp.
6344 Arizona Circle
LOS ANGELES 45, CALIF.
Phone: 645-0700

Solid State Electronics Co. of Texas
P. O. Box 20299, DALLAS 20, TEXAS
FLeeTwood 2-4038

R & D Supply, Inc.
1492 Highland Ave., NEEDHAM, MASS.
HILLcrest 4-4500

Solid State Electronics, Inc.
1925 Harlem Ave., CHICAGO 35, ILLINOIS
Phone: 889-8033

Radio & Electronic Parts Corp.
3235 Prospect Ave., CLEVELAND 15, OHIO
UTah 1-6060

Eastern Radio Corporation
312 Clifton Ave., CLIFTON, NEW JERSEY
GRegory 1-6600 (CLIFTON)
CHickering 4-2268 (NEW YORK)

The Low Bonn Co.
1211 LaSalle Ave., MINNEAPOLIS 3, MINN.
FE 9-6351

Avionics Sales, Inc.
6770 Perimeter Rd. S., SEATTLE 8, WASH.
PArkway 3-7602

What kind of a component buyer are you?



SKEPTIC

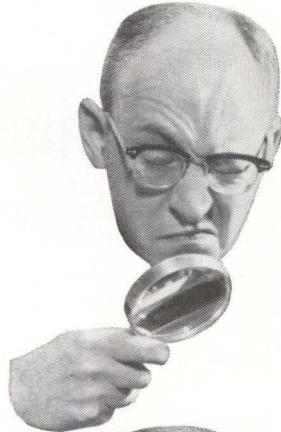

NIT-PICKER



SHOPPER



PANIC-BUTTON PUSHER

It takes all kinds of buyers to make a market. Fansteel makes components—capacitors, rectifiers, and diodes—for the buyer who cares. Like you, perhaps.

If you've been using tantalum capacitors for very long, you may be a bit skeptical of many suppliers' claims and counterclaims. The policy at Fansteel is to give you less to be skeptical about. If we can't document a claim, we don't make it. We're Skeptics, too. We have to be.

The Nit-Picker is, in many ways, our best friend. He's a man who examines things closely—even minutely. Fansteel components are made to be examined—and tested, qualified, specified . . . and used. And so they are.

When brands are alike, it pays to

be a Shopper. That's why it has always been a Fansteel practice to give you more than a low price on which to base your choice . . . things like certified reliability tests, application engineering, and honest ratings and data.

Buyers push panic buttons when they need capacitors fast—often right away. We can't always make delivery as fast as that, but we have built a network of stocking distributors and field warehouses to anticipate demand before it occurs. We've

put down many a panic, maybe yours.

Perhaps you don't fit any of these archetypes. We would be surprised, though, if we couldn't meet your component needs. After all, that's our business at Fansteel.

FANSTEEL

METALLURGICAL CORPORATION
RECTIFIER-CAPACITOR DIVISION
North Chicago, Illinois.

BLAST SIGNATURES— Key To Test Ban Treaty

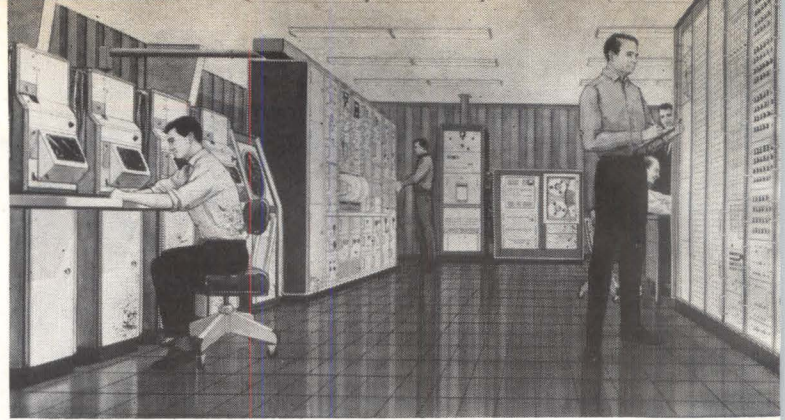

REAL-TIME COMPUTER, right, processes seismic data

*New station to study
underground atom blasts
for identification data*

By LAURENCE D. SHERGALIS
Associate Editor

MCMINNVILLE, TENN.—Identification of nuclear explosions is the major problem in the way of an effective test ban treaty. How do you know if a disturbance is a nuclear explosion, a quarry blast, or an earthquake?

New equipment put into operation this week at the Cumberland Plateau Seismological Observatory here will begin a series of experiments to determine the peculiar characteristics of various underground blasts.

It is possible, with present equipment to detect underground atomic explosions at distances of about 6,000 miles, according to Charles Bates, Chief of Vela Uniform

Branch, Nuclear Test Detection Office of the Advanced Research Projects Agency of DOD. But, he emphasized, this is the threshold of detection, not identification. The new equipment, installed at this station will enable scientists to investigate low-level signals, which may be the solution to identifying different types of underground blasts.

This station, one of three similar stations built by Texas Instruments Inc. and Geotechnical Corp., conforms to specifications laid out in 1958 by the Geneva Conference of Experts in support of continuing international negotiations for a test ban treaty. Data taken here will be used to evaluate these stations' capabilities as underground nuclear control posts. Results of these observations could determine the number and types of stations necessary to effectively monitor atomic tests on foreign soil.

ARRAY PROCESSOR — Included

at the Cumberland Plateau station is an engineering prototype of a system designed to improve the sensitivity of detection equipment. The new system, called the Multiple Array Processor (MAP), enhances directional characteristics of earth disturbances and filters out ambient noise. This equipment supplements the standard seismological observatory equipment in the station. It uses time delay and filtering to provide detection and identification capabilities greater than that available on straight-forward station observation equipment.

SEISMIC WAVES — Waves generated by a blast are of two major types, body and surface waves. Body waves travel through the interior of the earth and include P waves, that is particle motion parallel to the direction of propagation, and S or shear waves, perpendicular to the direction of propagation. P waves reach the seismometers first, with the S waves following close be-

Carcinotron Goes to 510 Gc

*French forge ahead
in mm wave devices,
are now at 0.6 mm*

PARIS—Just about everywhere you looked at the International Electronics Show last week there were signs of a strong trend toward smaller packages and better performance.

That trend, as much as anything else, is key ingredient in the French

recipe for keeping sales curves rising like well-made soufflé. The industry last year turned in sales of \$960 million, up 18 percent over 1961. Components accounted for a third of the total.

CARCINOTRONS—In tubes, the French are especially strong. Trend has carried frequencies up point where CSF (Compagnie Generale de Telegraphie San Fils) now has a prototype carcinotron capable of several milliwatts output at 0.6-mm

wavelength, or 470 to 510 Gc.

Still another out-in-front prototype in the works at CSF is a carcinotron amplifier with 20-db gain and 15-db signal-to-noise ratio at 3.5 mm.

CSF currently is marketing a line of carcinotrons ranging from a 4-mm unit with 10-watt output down to a 1-mm unit with 50-mw output. Backing up these tubes is a line of millimetric components—detectors, wavemeters, variable attenuators, waveguide elements and

hind. Surface waves are the slowest, and are the most complex. All of these waves are effected by the characteristic of the earth structure between the source and the station.

While the conventional station equipment records only raw data from the seismometers, the TI system processes the inputs from each unit by shifting the response from each seismometer in time and then summing the results. It operates on both P and S waves and records the output on film as well as displaying a visual presentation on a cathode ray tube. This display shows direction and indicates intensity of the blast. An output related to average power of the wave is also recorded. This is an integration of amplitude over a time period of about 8 seconds, and observers feel that this power characteristic may contain a great deal of information relating to the type of blast.

MONITOR TRYOUTS — Tests to be conducted with the equipment include monitoring an underground nuclear blast in a salt dome near Hattiesburg, Miss., later this year. Another test to be monitored will be an underground explosion in Nevada but away from the Nevada test site. Monitoring of the underground tests at the Nevada test site will continue.

Work on the stations has been conducted under contracts with the Air Force Technical Applications Center (AFTAC) under cognizance of the Advanced Research Projects Agency (ARPA).

like. For the 90 to 140-Gc range, the line is complete except for a gyrator and a ferrite isolator. The line is fairly complete for the 140-220 GC range and shades off to prototypes of a detector, frequency doubler and waveguide elements for the 220 to 335 Gc band.

Other tube standouts at the show were klystrons for linear particle accelerators. Thomson-Varian, joint company set up by France's Thomson-Houston and Varian associates of Palo Alto, had at its exhibit a klystron that delivers in S-band operation a minimum of 25 Mw peak and 30-Kw average. CSF

Pulse Network Problems Solved by Experienced Systems Engineers

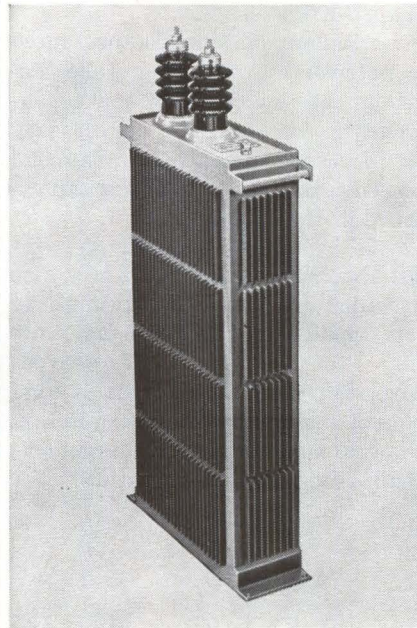

Typical Large Pulse-Forming Network designed by Sprague to meet a specific customer need.

Prompt cooperation on customers' pulse network problems is readily available from Sprague Electric Company's Pulse Capacitor and Network Section.

Sprague has much to offer to designers of radar systems, laser systems, tube testing systems, and other specialized systems. A highly-technical special engineering section devoted exclusively to pulse capacitors and networks includes systems as well as pulse network engineers. *Sprague can help you with your problems because Sprague fully understands your problems!*

But Sprague service does not end here. Following up the design aspect, these specialists can quickly and efficiently estimate pulse network sizes and prices for bidding purposes. They are also equipped to give quick reaction capabilities for your breadboard and prototype units.

A pioneer in pulse networks, Sprague is a major supplier of custom units from less than 1 KV up to 500 KV over a broad range of power levels.

For application engineering assistance, or additional information, write to Pulse Network Section, Sprague Electric Company, 35 Marshall St., North Adams, Massachusetts.

45PN-104-G3

CIRCLE 208 ON READER SERVICE CARD

SPRAGUE[®] MODEL 500 INTERFERENCE LOCATOR

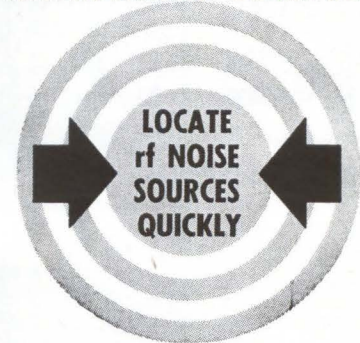

This versatile instrument is a highly sensitive interference locator—with the widest frequency range of any standard available unit! Model 500 tunes across the entire standard and FM broadcast, shortwave, and VHF-TV spectrums from 550 kc. to 220 mc. in 6 bands.

It's a compact, portable, rugged, versatile instrument—engineered and designed for most efficient operation in practical field use. It features a transistorized power supply, meter indications proportional to carrier strength as well as sensitivity of 5 microvolts minimum for 5% meter deflection over entire tuning range.

For full details, send for brochure IL-106.

SPRAGUE ELECTRIC COMPANY
35 Marshall Street, North Adams, Mass.



CIRCLE 25 ON READER SERVICE CARD

25

FOR SALE OR LEASE

To Manufacturers
or Distributors of
Light Metal Fabrications,
Air or Space Borne
Systems or Components

YOU should be Located in
this Rapidly Growing, Leading
Metropolitan Center of the
New South . . .

Center of the Biggest Con-
centration of Weapons and
Facilities Acquisition in our
Arsenal of Defense. Largest
U. S. Naval and Air Defense
Complex — Headquarters of
NATO and such Commands
as SACLANT . . . CINCLANT-
FLEET . . . COMAIRLANT . . .
FMFLANT . . . ARMED FORCES
STAFF COLLEGE . . . the huge
NAVY SUPPLY CENTER —
Convenient to LANGLEY AIR
FORCE BASE and NASA at
WALLOPS ISLAND.

A wide selection of sites of
all sizes . . . served by eight
trunkline railroads . . . Hamp-
ton Roads, largest ice-free
harbor on Atlantic Seaboard
. . . direct North-South truck
routes to be shortened by
the now-building \$200,000,000
Chesapeake Bay Bridge Tun-
nel. Ample skilled and semi-
skilled labor force.

For information and cost-free sur-
vey of your location needs, write:

Sidney S. Kellam, Chairman

or

W. Fred Duckworth, President
and General Manager.

**TIDEWATER
VIRGINIA**



**DEVELOPMENT
COUNCIL**

300 Boush St., Norfolk 10, Va.

showed a klystron with comparable characteristics—30 Mw peak output and 20-Kw average.

La Radiotechnique also presented a noteworthy receiving tube development—triodes that make neu-
tron-dyne compensation unnecessary in r-f cascode circuits. An internal screen cuts down anode-grid capaci-
tance in the tube to 0.36 pf.

TRANSISTOR TV—The show also provided a tipoff that transistor tv sets would soon find their way onto the French markets. Prototypes turned up on several stands as component makers made their pitch to show setmakers what could be done. High-frequency transistors for

such sets should be in mass produc-
tion around mid-year.

A representative example of what semiconductor manufacturers are readying for quantity production is Cosem's silicon transistor for video amplifiers. It has rise-time of 50-nsec, overshoot less than 5 percent, output voltage of 90 v peak-to-peak.

Whether they plan to go solid-state or not, French tv makers now have choice of two implosion-proof tv tubes. One, by Sovirel, eliminates any chance of implosion by a steel band that extends about four inches back from the tube face. Self-protection in other tube, by Alradio-technique, comes from a glass fiber sheath backed up by a metal band.

UN Seeks Get-Rich Ideas

*Electronics considered
good investment for
underdeveloped nations*

TWO THOUSAND scientists and administrators met at Geneva recently to discuss ways for underdeveloped nations to leapfrog into the Twentieth Century, skipping as many of the embryonic stages of the Industrial Revolution as possible. Sponsored by the United Nations, the get-together lasted for 16 days—and more than 1,800 papers.

Under electronics, more papers were delivered on establishing faster, cheaper and more efficient communications than on any other subject. Telephone installations in Africa, microwave relays in Australia and broadcasting in India were among the case histories presented.

CHEAP MANPOWER — Three Italians—A. Alberigi Quaranta, G. P. Bolognesi and F. A. Grassini—suggested that establishing semiconductor industries might be a good investment of scarce resources in new countries.

Repetitive elementary operations, they said, "necessary in the building-up of semiconductor devices, are well suited for a production

through unexperienced manpower, who may acquire, in a very short time, all the ability and skill necessary." Basic research, they claimed, is not necessary for an industry producing mostly for the entertainment market. Cheap manpower is a big advantage "because of the quick rate of obsolescence that the continuous improvements in the state of the art imposes upon fixed machinery."

Signal Detector

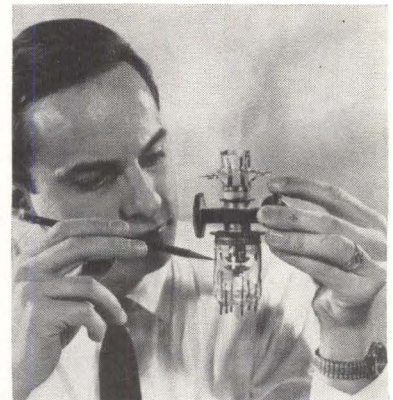

LASER DEMODULATOR tube uses a photo emissive surface to detect microwave modulation in visible light. Developed by National Science and Engineering Co., and Douglas Aircraft Co., the new component is intended for use in laser communication systems

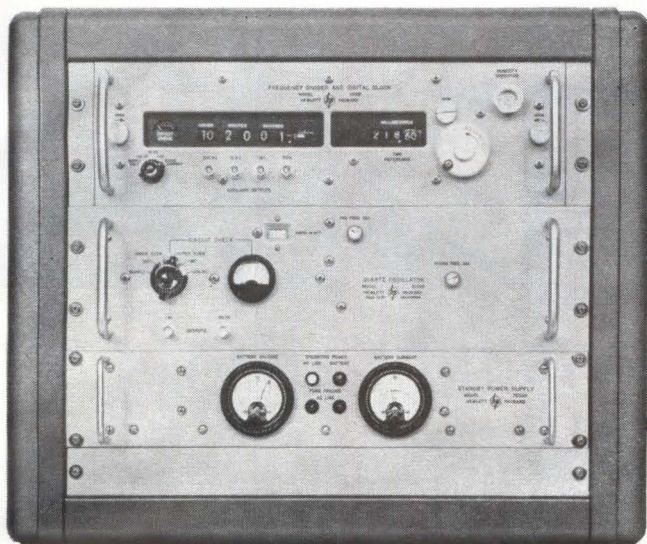

1 part
in 10^{10}
short-term
stability

103AR, 104AR Quartz Oscillators
115BR Digital Clock
725AR Standby Power Supply

In these hp quartz oscillators now available
for quick delivery

These two quartz oscillators, with 1 part in 10^{10} short-term stability (averaged over 1 second) are ideal as frequency sources in primary frequency/time standard systems. Recent advances in manufacturing and aging techniques for these oscillators and their quartz crystal resonators now allow quick delivery at much lower prices.

The 104AR, available for only \$2300, is identical to the 103AR, \$1900, except that it provides a 5 mc output of extreme spectral purity in addition to the 1 mc output. Spectra as little as 2 cps wide may be obtained in the X-band region with the 104AR by multiplication of the 5 mc output. This spectral purity is essential for doppler measurements, microwave spectroscopy and similar applications involving reference multiplication.

Driven by the quartz oscillator, the 115BR Frequency Divider and Clock provides precise time of

day information and permits comparison with standard broadcast signals for absolute accuracy. Continuous operation of the oscillators and related equipment in such a system can be assured by Hewlett-Packard Standby Power Supplies, which keep systems operating even when line power fails.

Both the 103AR and the 104AR provide 1 mc and 100 kc sinusoidal output signals, plus separate 100 kc outputs for driving the 115BR Frequency Divider and Clock. Completely solid state, all components are conservatively rated for assured high performance. A double oven with proportional control maintains precise temperature stability in both oscillators.

Here are the ultimate in low-cost, efficient and stable frequency-generating oscillators for primary and secondary standards applications. Ask your hp representative for a demonstration.

Specifications; 103AR, 104AR

Output Frequencies: 5 mc (104AR), 1 mc, 100 kc, 1 v rms into 50 ohms; 100 kc for driving 115BR Frequency Divider and Clock

Aging Rate: $< \pm 5$ parts in 10^{10} per 24 hours*

Stability: As a function of input voltage: $< \pm 1$ part in 10^{10} for changes of ± 4 v from 26 v dc; as a function of load: $< \pm 1$ part in 10^{10} for any load impedance change from 50 ohms; as a function of ambient temperature: $< \pm 3$ parts in 10^{10} for changes of $\pm 25^\circ$ C from 25° C; rms deviation, due to noise and frequency fluctuations, of 1 and 5 mc (104AR only) output; (constant input voltage, load and temperature):

Averaging Time	5 MC Output (104AR only)	1 MC Output (103AR, 104AR)
1 ms	5 parts in 10^9 rms	1 part in 10^7 rms
10 ms	5 parts in 10^{10} rms	1 part in 10^8 rms
0.1 sec	1 part in 10^{10} rms	1 part in 10^9 rms
1 sec	5 parts in 10^{11} rms	1 part in 10^{10} rms
10 sec	5 parts in 10^{11} rms	5 parts in 10^{11} rms

RMS phase deviation of 5 mc output (104AR only):

Averaging Time	RMS Phase Fluctuation at 5 MC
1 ms	1.6×10^{-4} radian
10 ms	1.6×10^{-4} radian
100 ms	3.2×10^{-4} radian
1 sec	1.6×10^{-3} radian
10 sec	1.6×10^{-2} radian

Harmonic Distortion: Down more than 40 db from rated output
Non-Harmonically Related Output: Down more than 80 db from rated 1 mc output; down more than 66 db from rated 5 mc output

Temperature Range: 0 to 50° C

Dimensions: 19" wide x $5\frac{1}{4}$ " high x $11\frac{1}{2}$ " deep behind front panel

Power Requirements: 22 to 30 volts dc, approximately 5 watts operating, 10 watts maximum during warmup; dual power connectors at rear; operates from 724BR or 725AR Standby Power Supply

Complementary Equipment: Model 725AR Standby Power Supply with battery, 2 ampere-hour standby capacity, \$645; Model 115BR Frequency Divider and Clock, \$2750

Price: Model 103AR, \$1900; Model 104AR, \$2300

*Achieved within 21 days of continuous operation

Data subject to change without notice. Prices f.o.b. factory.

HEWLETT-PACKARD COMPANY



1501 Page Mill Road, Palo Alto, California, Area Code 415, DA 6-7000. Sales and service representatives in all principal areas; Europe, Hewlett-Packard S.A., 54 bis Route des Acaas, Geneva; Canada, Hewlett-Packard (Canada) Ltd., 8270 Mayrand Street, Montreal

8255

GT&E SCIENTISTS *adjust the system they designed for optimum tv transmission*

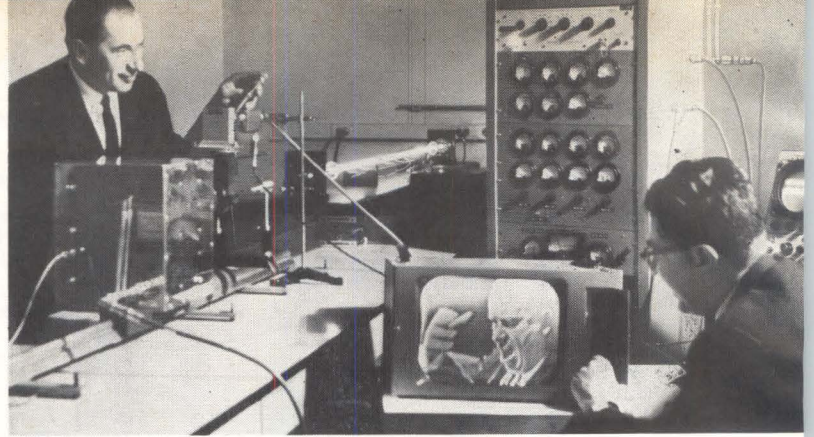

LASER BEAM

Carries Tv Video and Audio

Practical optical relay may result from system transmitting 3-Gc signal

By SAMUEL WEBER, Senior Editor

BAYSIDE, N. Y.—Successful transmission and detection of a 3-Gc microwave subcarrier superimposed on a laser beam and bearing television video and audio modulation was demonstrated here this week by scientists of General Telephone and Electronics Laboratories.

The experimental system is believed to be the first practical uti-

lization of the inherent wide-bandwidth capability of the laser. Although the tv transmission path was only a few feet long, the system might be considered a crude prototype of a practical laser optical relay.

LAB SETUP—Key components of the optical transmitter and receiver were an electro-optical modulator developed at the laboratories for low-power microwave drive, and a traveling wave tube photodetector, developed by B. J. McMurtry of Sylvania's Microwave Device division, and A. E. Siegman of Stanford (ELECTRONICS, p 37, July 20, 1962).

The system designed by S. M. Stone and L. R. Bloom, is shown in the upper block diagram. An ordinary tv receiver is used as the source of video and audio signals, which are superimposed on a 3-Gc microwave subcarrier. After passing through two twt amplifiers, approximately 2 to 3 watts of subcarrier power are available to modulate the coherent c-w output of the helium-neon laser.

The electro-optical modulator is a cavity type first described by I. Kaminow of Bell Labs, utilizing the Pockels effect in a crystal of KDP (potassium dihydrogen phosphate). This type of modulator produces a polarization modulation of the laser beam. A linear analyzer or polarizer is used to convert this to amplitude modulation at the receiving end.

The beam is focused on the photocathode of the twt photodetector, which converts the laser signals to microwave. After passing through a chain of twt's, the video is detected and displayed on a monitor. System sensitivity is about -95 dbm; signal-to-noise ratio approximately 15 db.

LASER NOISE LOW—GT&E scientists noted with some satisfaction that within the limits of the experiment, the system noise contributed by the laser beam was negligible.

There has been some concern that quantum noise in the beam might present a problem in communications applications. In practice, the major noise contribution came from the first twt amplifier.

According to Bloom, it is still too early to predict if economics or en-

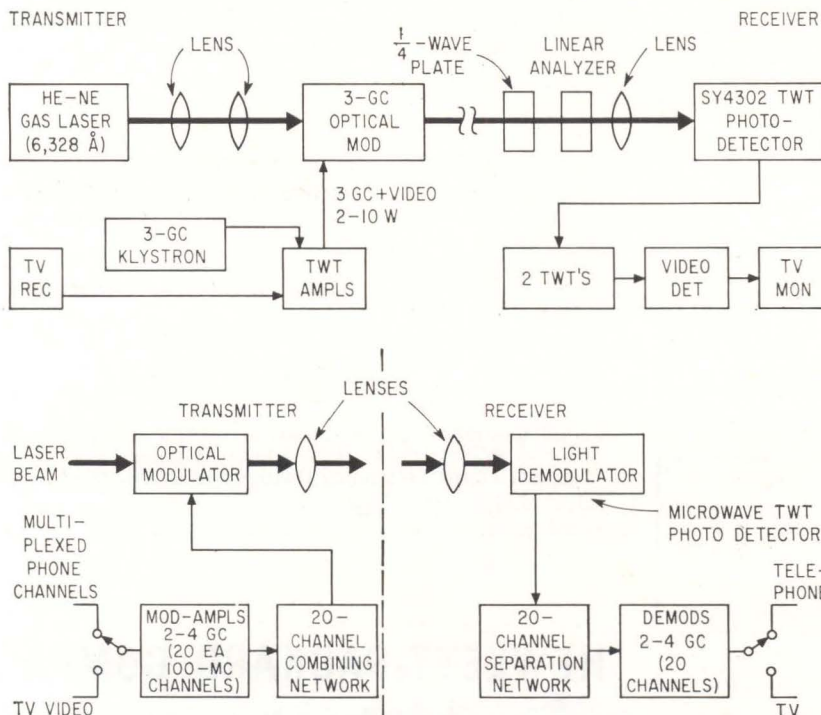

EXPERIMENTAL microwave transmission link (top) carries tv and audio over laser beam. Lower diagram indicates how system might be expanded into high-capacity optical relay

gineering considerations will dictate the replacement or augmentation of microwave systems by laser systems. However, he does expect that simple links will be established within the next five years.

FULL-SCALE SYSTEM—How the experimental laboratory setup might be expanded into a full-scale laser communication link containing many thousands of channels is shown in the lower block diagram.

Realization of such a system would require use of a modulator with greater bandwidth than the 10-Mc capability of the cavity type now available. GT&E presently has under development a traveling wave type of modulator, utilizing a long crystal in a stripline slow-wave structure. Such a device will have a bandwidth of several Gc. Other major requirements for the system is higher output power from the laser, or alternatively higher quantum efficiency of the photodetector.

All the microwave elements shown in the diagram are conventional, and the power levels required for the modulator are of the same order of magnitude as that used in present microwave link transmitters.

Bloom points out that the gas laser might be replaced by other coherent light sources, such as solid-state lasers. However, superior stability, spectral purity and ease of modulation give gas lasers the edge for this application now.

Weather Bureau Looks at Stradap

U. S. WEATHER BUREAU is showing strong interest in Stradap (ELECTRONICS, p 7, Jan. 25), weather radar data processor that quickly and automatically makes digital maps showing intensity and height of storms.

Robert Simpson, deputy director of meteorological research for the Weather Bureau, told ELECTRONICS: "We very much like the principle involved here."

Simpson said the Weather Bureau hopes to borrow a Stradap system from the Air Force Cambridge Research Laboratories and install it at a weather station in Norman, Okla., by spring. He said he has also proposed that the bureau set up a network of 4 to 6 Stradap stations.

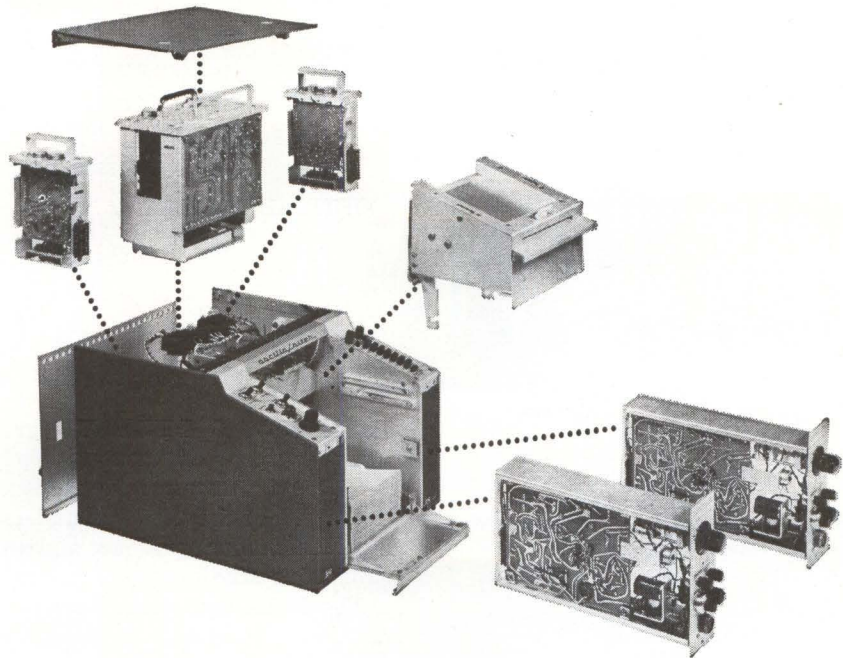

All the features you want in a medium frequency recorder

The *oscillo/riter** recorder incorporates all the features you want for top performance, convenience and reliability. Modular construction and all transistorized electronics provide complete accessibility and maximum reliability; interchangeable

able amplifiers handle more recording jobs; extended frequency response; top panel push buttons select 8 chart speeds from 1 mm/sec to 250 mm/sec; choice of roll or Z-fold chart paper, interchangeable ink or heat writing with Texas Instruments exclusive rectilinear recording system. Write for full information.

*A trademark of Texas Instruments Incorporated.

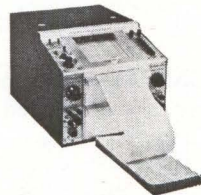

INDUSTRIAL
PRODUCTS
GROUP



TEXAS INSTRUMENTS
INCORPORATED
P. O. BOX 66027 HOUSTON 6, TEXAS

SENSING • RECORDING • TESTING • DIGITIZING INSTRUMENTS
THE INSTRUMENTS OF TEXAS INSTRUMENTS

566

CIRCLE 29 ON READER SERVICE CARD

**HELP YOUR POST OFFICE
TO SERVE YOU BETTER
BY
MAILING EARLY IN THE DAY
NATIONWIDE IMPROVED MAIL SERVICE
PROGRAM**

A RELIABLE PLUG-IN 25 AMP RELAY

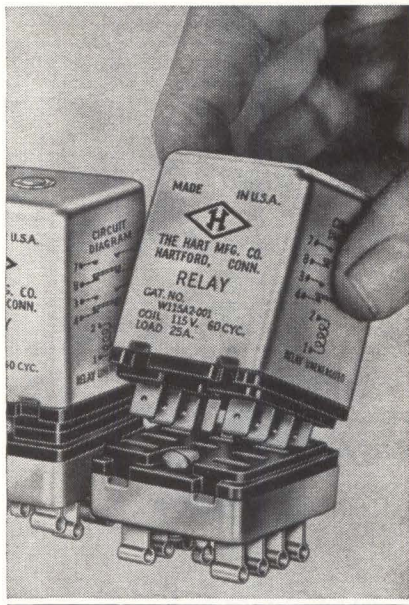

More compact than most 10 amp relays

Now, with Hart Series W dpdt relays you can fit as many as fourteen 25-amp circuits into a space measuring only 1½" x 1⅞" x 11½"!

Easy to install or remove—Spade terminals for socket or quick-disconnect installation. Also solder terminals.

Long, trouble-free service—Functional construction with oversized solid silver contacts and contact bar assure long-time, dependable switching. Series W relays have given well over a million cycles at a 15-amp load.

SPECIFICATIONS

CONTACTS:

Arrangement—dpdt, double make, double break. Other arrangements and sequences.

Load—25 amp resistive, 120 or 240 V a-c
25 amp ind., 120 V a-c (75% p.f.)
12½ amp ind., 240 V a-c (75% p.f.)
1 hp 120 V a-c, 2 hp 240 V a-c
25 amp resistive 28 V d-c

MOUNTING: Panel, side or socket

DIMENSIONS: 1½ x 1⅞ x 1⅞ inches.

U/L APPROVAL: U/L File 31481

COMPLETE DATA and specifications are available—new 8-page Relay Guide.

 **HART**
MANUFACTURING CO.
202 BARTHOLOMEW AVENUE
HARTFORD 1, CONNECTICUT
Telephone: Area Code 203: 525-3491
A SUBSIDIARY OF OAK MANUFACTURING CO.

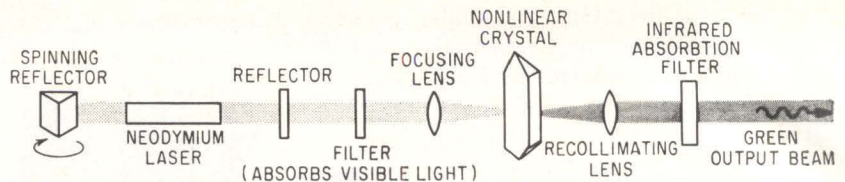

OPTICAL FORMAT of intense coherent green light source

Undersea Coherent Light

INTENSE, COHERENT green light source (ELECTRONICS, p 7, Feb. 15) can now provide researchers with a device useful in undersea communications, guidance and anti-submarine studies.

The device uses a nonlinear material (see diagram) to frequency-double the output of an infrared laser, producing an easily collimated beam at 5,300 angstroms.

Possible tasks for underwater light (ELECTRONICS, p 24, June 9, 1961) include:

- Secure communications between submarines
- Mine detection without triggering sonar-activated pickups
- Guidance systems for torpedos and other unmanned submersibles
- Precision outlining of a target.

SOURCE INTENSITY—The new green light source was developed at Lear Siegler's Laser Systems Center, Ann Arbor, Mich.

Conversion is made from 1.06 microns in the near infrared to 0.53

microns in the green portion of the visible spectrum, with an efficiency of 1 to 3 percent.

An output-pulse intensity of 10 Kw has been reported, with a bandwidth of 2 angstroms centered at 5,300 angstroms, roughly equal to a high-efficiency white light source of 300 Kw, on a pulse basis.

The narrow beam angle of the green light source, one milliradian, also provides an optical gain of up to 1 billion, over that of an omnidirectional white light source (assuming recollimation of the green light source).

The nonlinear materials tried include KDP (potassium dihydrogen phosphate) and ADP (ammonium dihydrogen phosphate).

Three sharp lines in the green optical region were observed 15 Å apart. Each are 2 Å wide with 90 percent of the energy in one line, at 5,305 Å. The actual frequency may be shifted as a function of the host material in the neodymium crystal of the exciting laser.

Noncryogenic Associative Core Memory

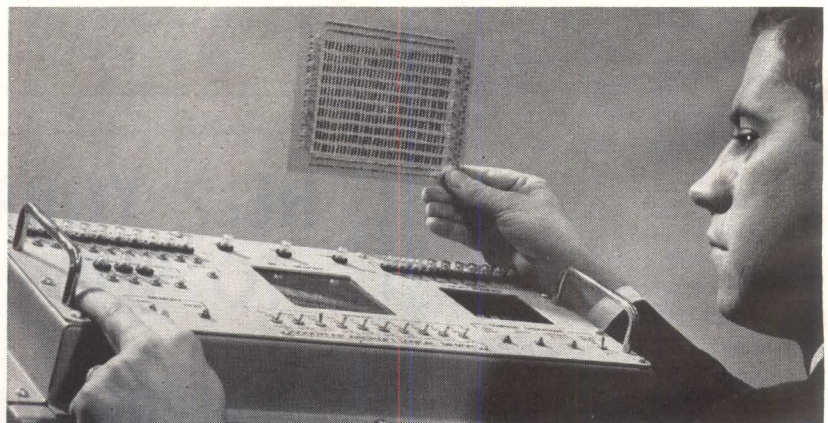

FIRST PHOTOS of its associative memory (see p 7, Oct. 12, 1962) were released last week by Goodyear Aircraft. Company says it can simultaneously compare 32,000 10-digit numbers. Memory arrays are made up of multiaperture ferrite devices. The portable feasibility model contains 8 10-bit words. Words can be up to 200 bits long

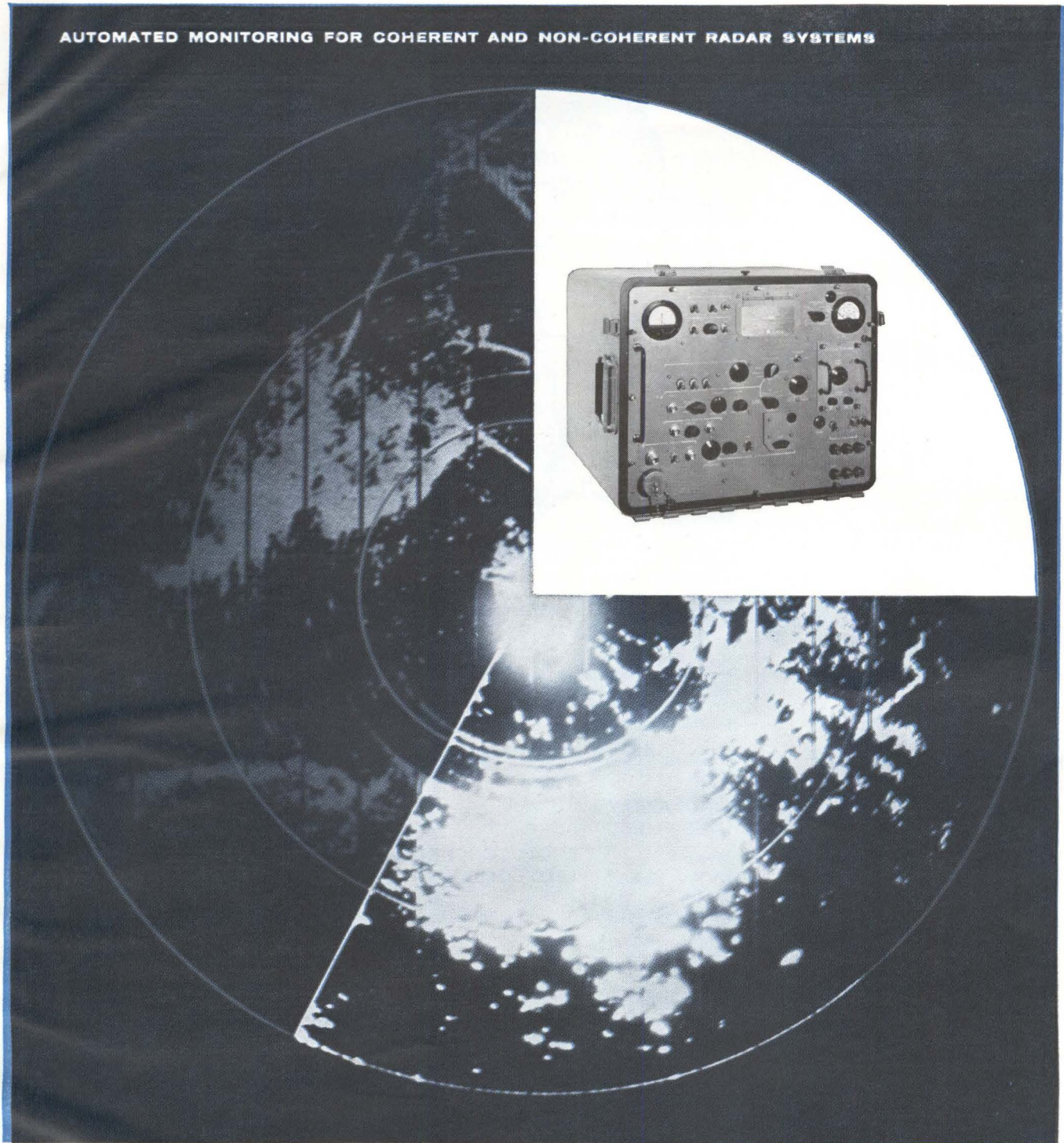

Sperry Assures Radar Availability. Sperry's Radar Performance Analyzers provide *complete overall* performance measurement and monitoring for field maintenance support, operational monitoring and factory evaluation of every type surveillance radar . . . matched filter, pulse compression, coherent or non-coherent MTI, doppler, pulse doppler or conventional types. □ Over 50 basic radar types currently in use, many previously requiring special test equipment, may be tested with Sperry's new **rpa**. Optional field tested circuitry is available for even more specialized test requirements. □ Modular format — for interchangeable use of various electronic units and r-f front ends — provides economical comprehensive test capability at multi-radar sites and in factory test applications. □ Company sponsored effort on Radar Performance Analyzers for tracking radar applications, doppler altimeters and beacon transceivers is under way. □ Write or call for complete information about Sperry's new economical Radar Performance Analyzers, **SPERRY MICROWAVE ELECTRONICS COMPANY**, Clearwater, Florida.

SPERRY
 DIVISIONS OF
 SPERRY RAND
 CORPORATION

"CLAIREXCOR NYC — TELEGRAM

"AT 1201 PST TODAY DEC 14 1962 THE MARINER 11 SPACECRAFT MADE ITS CLOSEST APPROACH TO THE PLANET VENUS WITHIN THE PLANNED MISS CORRIDOR THIS INTERPLANETARY FLIGHT HAS SET MANY WORLD RECORDS INCLUDING COMMUNICATIONS DISTANCE QUANTITY AND SIGNIFICANCE OF DATA RECEIVED THREE AXIS ATTITUDE CONTROL AND INTERPLANETARY SPACE MANEUVER.

"WE ARE PLEASED TO REPORT THAT YOUR CADMIUM SULFIDE PHOTOCONDUCTOR DETECTORS USED IN THE MARINER 11 SUN SENSORS AND SUN ATE HAVE OPERATED SUCCESSFULLY THROUGHOUT THE COMPLETE 109 DAY FLIGHT YOUR DETECTORS HAVE PLAYED A KEY PART IN THE SUCCESS OF THIS HIGHLY SUCCESSFUL MISSION.
JET PROP LAB G W MEISENHOLDER R SCHMIDT R G FONEY J M WHALEN"

THE EYES OF A MODERN MARINER



CLAIREX PHOTOCONDUCTIVE CELLS recently served as the detectors in the sun-sensing "eyes" of Mariner II, our Venus space vehicle, controlling reference attitude prior to the critical mid-course correction maneuver which reduced the "miss" from 233,000 to 21,000 miles! The sun sensors also served as panel-orientors throughout the flight for maximum power output of the solar cell panels, signalling position errors to the pitch and yaw stabilization jets.

The Clairex cells in Mariner II were the standard CL-605 type now in use in hundreds of other more earth-bound applications. Special single-crystal Clairex components, however, have been utilized in Ranger and other space probe projects as radiation detectors.

MID-COURSE CORRECTION AFFECTS FLIGHT PATH

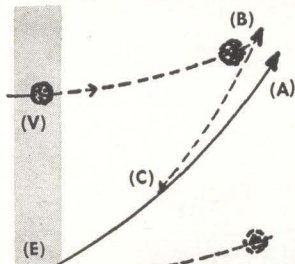

Redirecting vehicle from destination (A) to (B) in vicinity of Venus required flight correction at point (C) by applied jet propulsion of short duration. The vehicle's maneuvers prior to corrective propulsion were based on initial proper sun reference via the photoconductive sun sensors.

SUN SENSING ARRAY ON MARINER VEHICLE

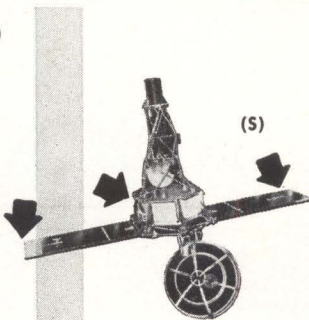

Throughout the life of the craft, prior and subsequent to mid-course correction, the sun sensors (S) signalled error-correcting commands to the stabilization jets for pitch and yaw control, thus keeping the solar cell banks properly oriented for maximum power output.

PHOTOCONDUCTIVE CELL COMPONENTS

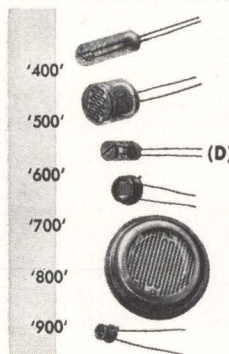

Six Standard Series of photoconductive cells, including the Mariner II type, (D), are manufactured by Clairex Corporation. Illustrated are units of both Cadmium Sulfide and Cadmium Selenide, in glass or metal containers, offering a wide range of response characteristics.

Technical design data available on request.

"The light touch in automation and control"

CLAIREX CORPORATION

8 West 30th Street, New York 1, New York

THE OLDEST MANUFACTURER OF CADMIUM SULPHIDE AND CADMIUM SELENIDE PHOTOCONDUCTIVE CELLS

See us at the I.E.E.E. Show—Booth 1217

MEETINGS AHEAD

SOLID STATE CIRCUITS INTERNATIONAL CONFERENCE, IRE-PGCT, AIEE, University of Pennsylvania; Sheraton Hotel and U. of P., Philadelphia, Pa., Feb. 20-22.

RESIDUAL GASES IN ELECTRON TUBES SYMPOSIUM, Italian Society of Physics; Scientific and Technical Assoc., Milano, Italy, March 12-15.

THIN-FILM VACUUM METALLIZING CONFERENCE, Society of Vacuum Coaters; Park-Sheraton Hotel, New York City, March 14-15.

PACIFIC COMPUTER CONFERENCE, AIEE; California Institute of Technology, Pasadena, Calif., March 15-16.

BIONICS SYMPOSIUM, United States Air Force; Biltmore Hotel, Dayton, Ohio, March 18-21.

IEEE INTERNATIONAL CONVENTION, Institute of Electrical and Electronics Engineers; Coliseum and Waldorf-Astoria Hotel, New York, N. Y. March 25-28.

ENGINEERING ASPECTS OF MAGNETO-HYDRODYNAMICS SYMPOSIUM, IRE-PGNS, AIEE, IAS, University of California; UCLA, Beverly, Calif., April 10-11.

OHIO VALLEY INSTRUMENT-AUTOMATION SYMPOSIUM, ISA, et al; Cincinnati Gardens, Cincinnati, Ohio, April 16-17.

CLEVELAND ELECTRONICS CONFERENCE, IRE, AIEE, Case Institute, Western Reserve University, ISA; Hotel Sheraton, Cleveland, April 16-18.

OPTICAL MASERS SYMPOSIUM, IEEE, American Optical Society, Armed Services, et al; United Engineering Center, New York City, April 16-18.

INTERNATIONAL NONLINEAR MAGNETICS CONFERENCE, IRE-PGEC, PGIE, AIEE; Shoreham Hotel, Washington, D. C., April 17-19.

SOUTHWESTERN IEEE CONFERENCE & ELECTRONICS SHOW, IEEE (Region 5); Dallas Memorial Auditorium, Dallas, Texas, April 17-19.

NATIONAL ELECTROMAGNETIC RELAY CONFERENCE; Oklahoma State University; OSU, Stillwater Okla., April 23-25.

ADVANCE REPORT

COMPUTERS AND DATA PROCESSING SYMPOSIUM, Denver Research Institute; Elkhorn Lodge, Estes Park, Colorado, June 26-27. March 1 is the dead line for submitting 150-word abstracts to: W. H. Eichelberger, Denver Research Institute, University of Denver, Denver 10, Colorado. Symposium theme is the advanced treatment of basic problems in computer technology. Papers will be presented in the fields of: components, logic design, philosophy of computer design, artificial intelligence. Also, such subjects as adaptive or self-organizing systems, learning systems, pattern recognition, game-playing machines and other subjects which imply simulation of human thought or problem-solving processes. Although it is anticipated that program will include many invited papers, some papers will be selected from papers submitted without invitation.

... they're all made by Delco Radio



DO-5 22-40 ampere Rectifiers—Silicon.



TO-36 10 ampere—High Voltage, High Power Silicon.



TO-36 15 ampere—High Power Germanium.



TO-3 3,5,7 ampere—High Power Germanium.



Stud Mount 15 ampere Rectifiers—Silicon.



Press-Fit 18 ampere Rectifiers—Silicon.



TO-3 4,5 ampere—High Power Germanium.



TO-36 25,35,50 ampere—High Power Germanium.



TO-41 10 ampere—High Speed NU-BASE Germanium.

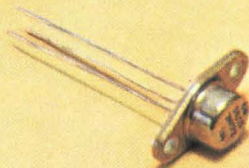

TO-37 1.5 ampere—Medium Power Germanium.

Meeting your requirements with reliable power semiconductors is Delco Radio's specialty. Our expanding line now offers you the widest range of voltage capabilities in the industry, and they're built to meet or exceed the toughest reliability standards. Our new semiconductor catalog lists all products with complete data. Send for your copy today. The name again . . .

DELCO
DEPENDABILITY
RADIO
RELIABILITY

Division of General Motors • Kokomo, Indiana

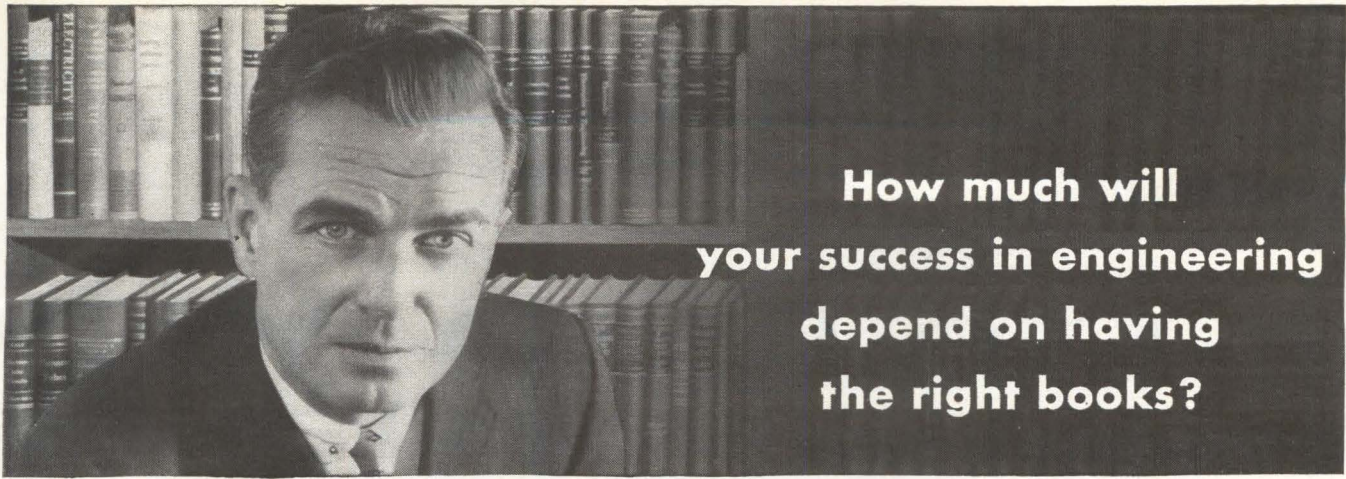

How much will
your success in engineering
depend on having
the right books?

The Electronics and Control Engineers' Book Club helps you keep ahead in your field . . . at a savings

Start your membership with any of these selections:



Electronic Switching, Timing, and Pulse Circuits by J. M. Pettit. Provides a practical understanding of operation of complex circuits.

Publisher's Price, \$8.50
Club Price, \$7.25

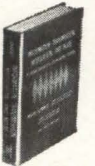

Information Transmission, Modulation, and Noise by M. Schwartz. A unified approach to communication systems.

Publisher's Price, \$11.75
Club Price, \$9.95



Mathematics for Electronics with Applications by H. M. Nodelman and F. W. Smith, Jr. Methods for solving practical problems.

Publisher's Price, \$7.00
Club Price, \$5.95



Digital Computer and Control Engineering by R. S. Ledley. Full coverage from basic electronic design to advanced programming techniques.

Publisher's Price, \$14.50
Club Price, \$12.35



Modern Transistor Circuits by J. Carroll. Presents almost 200 modern transistor circuits in 101 separate articles.

Publisher's Price, \$9.00
Club Price, \$7.65



Magnetic Recording Techniques by W. E. Stewart. Full description of magnetic recording methods and devices.

Publisher's Price, \$9.00
Club Price, \$7.65



Wave Generation and Shaping by L. Strauss. Essential features and techniques of practical wave-generating and -shaping circuits.

Publisher's Price, \$12.50
Club Price, \$10.65

Your engineering career owes a great deal to books. Why not take advantage of this convenient, economical way to have the best professional books available when you need them? THE ELECTRONICS AND CONTROL ENGINEERS' BOOK CLUB brings you the essential technical literature in your field. It also helps you overcome today's high cost of building a professional library by saving you an average of 15% from publisher's prices.

How the Club Operates. You regularly receive free of charge *The Electronics and Control Engineers' Book Bulletin*. This gives complete advance notice of the next selection-of-the-month, as well as many alternate selections. If you want the main selection you do nothing; the book will be mailed to you. If you want an alternate selection—or no book at all—you can notify the Club by returning the convenient card enclosed with each *Bulletin*.

Saves You Time and Money. You agree only to the purchase of three books in a year. Certainly out of the large number of books in your field offered in any twelve months there are at least three you would buy anyway. By joining the Club you save both money and the trouble of searching.

Send No Money Now. Just check the book you want as your first selection on the coupon below. With it you will be sent *Electronic Designers' Handbook* for only one dollar. Take advantage of this offer and receive two books for less than the regular price of one. (If coupon is detached, write to The Electronics and Control Engineers' Book Club, Dept. L-2-22, 330 W. 42nd St., New York 36, N. Y.)

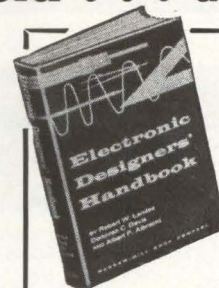

ACCEPT THIS
\$17.50 BOOK
FOR ONLY **\$1.00**

with membership in
**The Electronics and
Control Engineers'
Book Club**

ELECTRONIC DESIGNERS' HANDBOOK

By R. W. Landee, D. C. Davis,
and A. P. Albrecht

Provides fundamentals and data to help you in the design of all types of electronic equipment. A large number of the circuits used in many different applications are covered, together with theoretical and technical discussions and explanations, design examples to show application of theory, and graphical and tabular data needed in day-to-day design work.

Electronic Designers' Handbook is typical of the selections of THE ELECTRONICS AND CONTROL ENGINEERS' BOOK CLUB. All books are chosen by qualified editors and consultants. Their thoroughgoing understanding of the standards and values of the literature in your field guarantees the authoritativeness of the selections.

(NOTE: If you already own this volume, you may substitute any other book on this page as your DOLLAR book. Check two books below and you will receive the higher priced selection for only \$1.00.)

CLIP AND MAIL THIS COUPON TODAY

The Electronics and Control Engineers' Book Club, Dept. L-2-22
330 West 42nd Street, New York 36, N. Y.

Please enroll me as a member of The Electronics and Control Engineers' Book Club. You will bill me for my first selection indicated at right at the special club price and \$1 for *Electronic Designers' Handbook* (or alternate choice), plus few cents delivery costs. (The Club assumes this charge on prepaid orders.) Forthcoming selections will be described in advance and I may decline any book. I need take only 3 selections or alternates in 12 months of membership. (This offer good in U. S. only.)

PLEASE PRINT

Name

Address

City..... Zone..... State.....

Company

NO RISK GUARANTEE:

If not completely satisfied, you may return your first shipment within 10 days and your membership will be canceled.

Send as my first selection: (If more than one book is checked we will send the higher priced selection as your \$1.00 book.)

- Electronic Switching, Timing, and Pulse Circuits, \$7.25
- Information Transmission, Modulation, and Noise, \$9.95
- Mathematics for Electronics with Applications, \$5.95
- Digital Computer and Control Engineering, \$12.35
- Modern Transistor Circuits, \$7.65
- Magnetic Recording Techniques, \$7.65
- Wave Generation and Shaping, \$10.65

Send your first shipment within 10 days
L-2-22



Type 230-A

10 to 500 MC POWER AMPLIFIER

— for Low-Level Applications

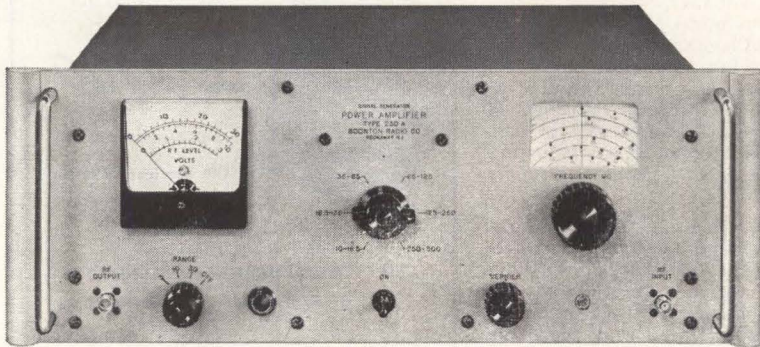

The BRC Power Amplifier Type 230-A is the ideal RF amplifier for low-level applications exhibiting a typical noise figure of 6 to 8 db. Three tuned, cascaded stages of grounded-grid amplification provide up to 30 db gain and a maximum power output of 5 watts. Typical applications include:

RECEIVER PRE-SELECTOR — The Type 230-A, when used as a pre-selector with conventional communications receivers, will readily provide fractional microvolt sensitivities.

TUNED SELECTIVE FILTER — BRC 230-A provides a convenient means for the selective amplification of RF signals in the 10 to 500 Mc. range with excellent rejection of undesired frequencies.

HARMONIC AMPLIFIER — The new power amplifier may be used to amplify desired harmonics in the output of signal generators and frequency synthesizers thereby extending their useful range.

FREQUENCY COUNTER PRE-AMPLIFIER — Type 230-A as a pre-amplifier for conventional frequency counters, such as the 524/525, will provide a 15 to 30 times improvement in input sensitivity. Remote, off-the-air frequency measurements of FM broadcast and communication transmitters may be readily performed.

RF MILLIVOLTMETER PRE-AMPLIFIER — When used as a pre-amplifier for RF millivoltmeters, such as the 411, the 230-A will provide 15 to 30 times improvement in sensitivity.

BOONTON RADIO COMPANY

A Division of Hewlett-Packard Company



GREEN POND ROAD, ROCKAWAY, NEW JERSEY
Tel. 627-6400 (Area Code 201) TWX: 201-627-3912 Cable Address: Boonraco

RF RANGE: 10 to 500 Mc.

BAND RANGES: 10-18.5 Mc. 65-125 Mc.
18.5-35 Mc. 125-250 Mc.
35-65 Mc. 250-500 Mc.

RF GAIN: 30 db (10-125 Mc.)
27 db (125-250 Mc.)
24 db (250-500 Mc.)

RF BANDWIDTH: >700 Kc.* (10-150 Mc.)
>1.4 Mc.* (150-500 Mc.)

*Frequency interval between points 3db down from max. response

RF OUTPUT:

RANGE: Up to 15 volts*

*Across external 50 ohm load
IMPEDANCE: 50 ohms.

CALIBRATION:

0.2 to 3 volts f.s.;
increments of approx. 5%.

1.0 to 10 volts f.s.;
increments of approx. 5%.

2.0 to 30 volts f.s.;
increments of approx. 5%.

ACCURACY: ±1.0 db of f.s. (10-250 Mc.)
±1.5 db of f.s. (250-500 Mc.)

LEAKAGE: Effective shielding is greater than 40 db.

RF INPUT:

LEVEL: <0.316 volts* (10-125 Mc.)
<0.446 volts* (125-250 Mc.)
<0.630 volts* (250-500 Mc.)

*For 10 volt output into 50 ohms
IMPEDANCE: 50 ohms

AM RANGE: Reproduces modulation of driving source 0-100% up to 5 volt max. carrier output

AM DISTORTION: <10% added to distortion of driving source

FM RANGE: Reproduces modulation of driving source except as limited by the RF bandwidth

FM DISTORTION: Negligible distortion added to distortion of driving source for deviations and modulation frequencies <150 Kc.

INCIDENTAL AM: <10% added to modulation of driving source at 150 Kc. deviation

MOUNTING: Cabinet for bench use; by removal of extruded strips suitable for 19" rack mounting

POWER REQUIREMENTS:
105-125/210-250 volts,
50-60 cps, 150 watts

Price: \$1200.00 F.O.B. Rockaway, N. J.

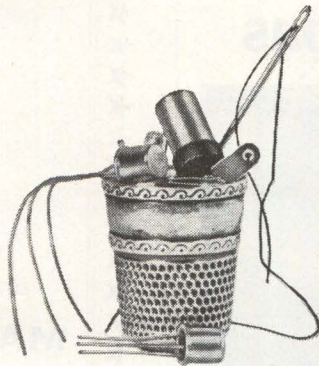

**This could be
all the
inventory
you need**

Because Air Express delivers overnight—anywhere in the USA

Why stock 10,000 parts when 1,000 might be enough? Duplicate parts inventories drain away profits...and they're no longer always necessary. Air Express shipments let one do the job of many.

Air Express distribution works as simply as this: Salesmen or customers phone in their orders. You call Air Express. Then we pick up your shipments...put them on the first flight out...and our trucks deliver them to your customers the next day...anywhere in the U.S.A.

Cost? Less than you think. For example, 20 lbs. travels 649 miles for only \$5.56.

Air Express alone can offer this service, because only Air Express has scheduled service between 2,500 airport cities... plus scheduled surface express connections with another 21,000 off-airline cities. And Air Express shipments have official priority with all 38 scheduled airlines—first cargo aboard after air mail.

To reduce expense and speed shipments, specify Air Express. Call your REA Express office for Air Express service.

AIR EXPRESS
DIVISION



Flame-Retardant laminated plastics for electrical and electronic applications



There are now 4 flame-retardant Synthane laminates to help the designers of computers, missile control equipment, transformers, circuit breakers or any other components subject to flame or heat.

These four grades FR-1, FR-2, FR-3 and FR-4 not only have excellent flame retardance but they combine many more properties desirable in an electrical insulation, such as low moisture absorption, low dielectric losses, mechanical strength and machinability. Supplied plain or copper clad. It will pay you to send for samples for your own evaluation and test . . . or write for information.

SYNTHANE

CORPORATION **S** OAKS, PENNA.
Glendale 2-2211 TWX Valley Forge 735U

Synthane-Pacific, 518 W. Garfield Ave., Glendale 4, Calif. TWX GLDL 4417U

Synthane Corporation, 36 River Rd., Oaks, Pa.

Gentlemen:

Please send me your Engineering Bulletins on:

New Flame-retardant Grades New High-temperature Grades

Name _____

Address _____

City _____ Zone _____ State _____

VISIT US AT IEE E, BOOTHS 4421-23

I E E E

HEAR

DISTINGUISHED
SPEAKERS &
PANELISTS

at

I-TRIPLE-E's

International Convention
and Exhibition in New York

MARCH 25, 26, 27, 28

The COLISEUM at Columbus Circle
& The WALDORF ASTORIA HOTEL

admission: MEMBERS \$1.00; NON-MEMBERS \$3.00
MINIMUM AGE: 18

SHOW

(formerly the IRE Show)

MEASURE DISPLACEMENTS

of $\pm 0.050''$ to $\pm 3''$ with
6 VDC EXCITATION,
DC OUTPUT

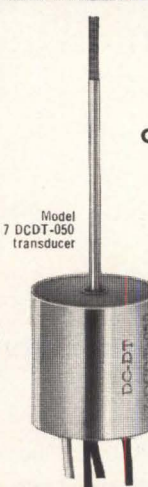

Now you can have all differential transformer transducer advantages in linear displacement measurements — without external carrier systems or phase shift and balancing problems. Sanborn 7 DCDT Series are miniature, hermetically sealed units with carrier systems built-in. Features include unlimited resolution, high accuracy and high sensitivity. Delivery from stock. Modifications available on special order.

MODEL	FULL SCALE STROKE (inches)	FULL SCALE OUTPUT (VDC)	OUTPUT IMPED. (K ohms)	FREQ. RESP. (3 db down at cps)	PRICE (FOB Waltham, Mass.)
7 DCDT-050	± 0.050	± 1.5	2.2	350	\$ 99
-100	± 0.100	± 2.8	3.0	170	104
-250	± 0.250	± 1.5	5.0	120	119
-500	± 0.500	± 3.3	5.3	135	132
-1000	± 1.000	± 4.8	5.5	114	141
-2000	± 2.000	± 4.6	5.2	128	155
-3000	± 3.000	± 5.0	5.0	100	162

TRANSDUCER DIVISION
SANBORN COMPANY
175 Wyman St., Waltham 54, Mass.

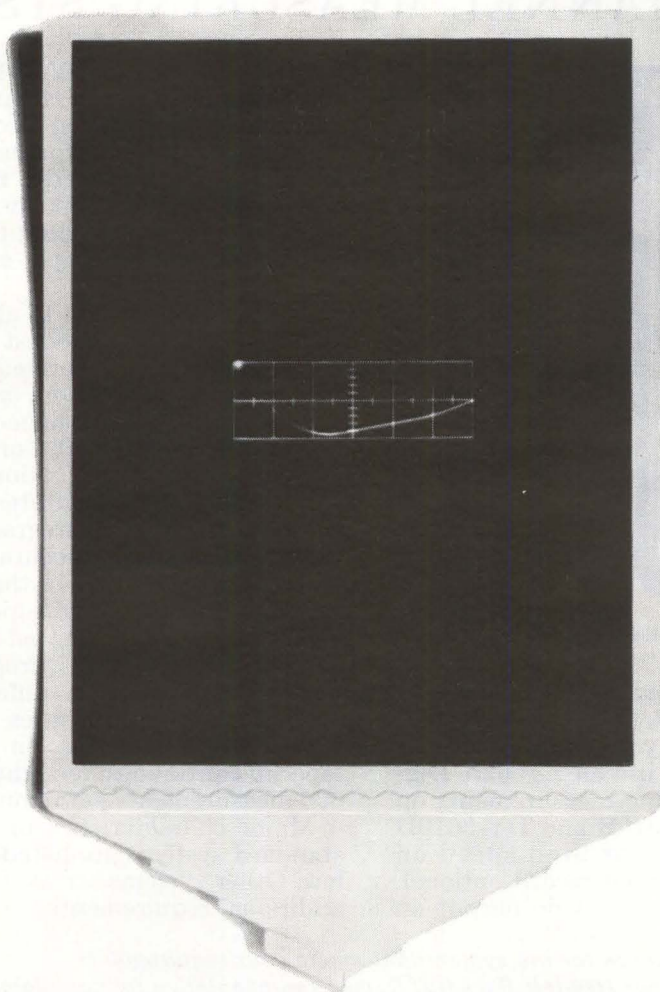

2 nanoseconds/cm: impossible to photograph until now

Polaroid has a new film that is so fast, it will reproduce scope traces that are almost invisible to the naked eye. The one above, a scintillation pulse, has never been photographed until now. Pulse duration was ten nanoseconds. Scope sweep speed was 2 nanoseconds/cm. *The new 10,000-speed Polaroid PolaScope Land film produced a finished usable print ten seconds after exposure.*

The maximum writing speed of the 10,000-speed film is about twice that of the Polaroid Land

3000-speed film, which is currently the standard for high speed photography. The new film not only gets "impossible" pictures, it also produces far better shots of slower pulses and steady state waveforms. Because of its high speed, less light is required; camera aperture and scope intensity can be reduced considerably, producing sharper pictures.

And besides oscillography, the PolaScope film opens up new possibilities in applications where light is at a premium, such as pho-

tomicrography and metallography. It is not suited, however, for pictorial work due to its high contrast and relatively coarse grain.

PolaScope film (designated Type 410) is packed twelve rolls to a carton. The price is about the same as the 3000-speed film.

The film can be obtained through industrial photographic dealers. For the name of the dealer nearest you, write to Technical Sales Department, Polaroid Corporation, Cambridge 39, Massachusetts.

New Polaroid Land 10,000-speed film for oscillography.

DATA ACQUISITION WITH DYMEC SYSTEMS

RECORD DATA ON PRINTED OR PUNCHED TAPE WITH DYMEC MULTICHANNEL MEASURING SYSTEMS

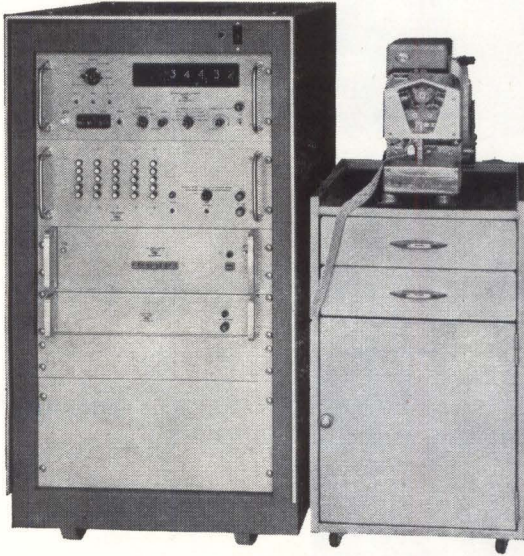

DY-2010B

Standard Dymec Data Acquisition Systems are available with printed tape, punched tape or punched card output, to give you the type of permanent record you need. The DY-2010A and DY-2010C use an hp 562A Digital Printer for recording measurements on paper tape. The DY-2010B and DY-2010D record measurements at high speed on punched tape with printed record optional. Other standard systems provide output on

punched cards. The DY-2010B and D offer logging rates up to 10 channels per second. On printed tape you can record up to 11 columns of information for each channel, including the function, the measured quantity, with decimal point position and polarity, and the channel identification number. Standard punched tape systems provide IBM 8-level code.

Advantages common to all systems of the DY-2010 Series are modest cost, fast delivery, high reliability derived from standard design and construction, and proved performance. You get a designed, tested system. You don't have to wait—or pay—for "custom" engineering, fabrication or testing time.

Each system incorporates the DY-2401A floated and guarded integrating digital voltmeter which permits accurate measurement of low-level dc signals in the presence of severe common mode and superimposed noise.

The DY-2010B, pictured here, scans up to 25 3-wire signal sources, programs the digital voltmeter to measure different types and levels of signals, measures the signals and records measurements on punched paper tape at continuous recording speeds up to 600 measurements per minute.

Major characteristics of the 2010 Series standard systems are listed in the chart below. Other systems are available to fit many additional requirements.

Check for the system that meets your requirements, then call or write your Hewlett-Packard/Dymec representative for complete information.

	DY-2010A	DY-2010B	DY-2010C	DY-2010D
Scanner Input	Up to 25 3-wire signal sources; to 100 channels with slave scanners; programming capability permits measurement of mixed types and levels of signals		Up to 200 guarded 3-wire inputs; to 600 non-guarded 1-wire inputs	
Voltage Ranges	100 mv to 1000 v full scale; overranging to $\pm 300\%$ of full scale on four most sensitive ranges; 0.01% stability on four highest ranges			
Frequency Ranges	10 cps to 300 kc; sample period 0.01, 0.1 or 1 sec; accuracy ± 1 digit \pm time base accuracy			
Display	5 digits of data, range, function (polarity), channel number, all included in front-panel readout, logged on output recording device			
Measurement Speed	Up to 5 channels per sec	Up to 10 channels per sec	Up to 5 channels per sec	Up to 10 channels per sec
Effective Common Mode Rejection	105 db	105 db	130 db	130 db
Output	Printed paper tape (9 column, alphanumeric)	Perforated tape (10 character, 8-level IBM code)	Printed paper tape (10 column, alphanumeric)	Perforated tape (10 character, 8-level IBM code)
Price	\$8,675	\$10,800	\$10,965	\$12,850
Options	Time of day information, ac voltage and resistance measurements, 10 mv full-scale sensitivity, cabinet			

Data subject to change without notice. Prices f.o.b. factory.

DYMEC

A Division of Hewlett-Packard Company



Dept. E-22, 395 Page Mill Road, Palo Alto, Calif. Phone (415) 326-1755 TWX 415-492-9363

8210

Jay J. Chacran, Senior Microwave Engineer, shown 1/25 actual size ■ Model 2731 Magic Tee Balanced Mixer, shown 2/3 actual size



From ONE ENGINEER to ANOTHER

■ "In selecting balanced microwave mixers, you are usually concerned with five basic parameters . . . RF bandwidth, IF, noise figure, VSWR and isolation. ■ At the current state of the art, RF bandwidths may reach 160% through S-band, and signal frequencies may extend to 70 GC with relatively narrow bandwidths. IF may be above or below RF through X-band. With advanced crystals and IF noise figures of 1.5 db, noise figures of 6.5 db are attainable. VSWR as low as 1.2 and isolation as high as 30 db are feasible; however, low VSWR and high isolation are usually incompatible over a relatively broad band."

Jay J. Chacran/Senior Microwave Engineer

■ Mr. Chacran's group is currently developing balanced mixers through 40 GC. One recent development, a Ku-band crossbar mixer, is now in production. ■ Our standard line of stock components already includes coaxial balanced mixers covering the 125-8000 MC spectrum in octave-band steps, with standard IF's as high as 120 MC. Models are available in single and dual output configurations. With the standard crystals supplied and an IF noise figure of 1.5 db, noise figures of 7.5 db are typical. This line includes TEMLINE Balanced Mixers featuring nominal VSWR of 1.5, as well as Magic Tee Balanced Mixers featuring minimum LO-to-signal isolation of 20 db. ■ Modifications of these standard units are available for IF's up to 600 MC. ■ Please inquire regarding special designs. ■



See us at IRE booth #1223



SAGE LABORATORIES, INC.

3 HURON DRIVE • NATICK, MASSACHUSETTS • Cable Address: SAGELABS — NATICK

An Important Message to Users of Logic Elements Who Demand High Performance at Sensible Prices

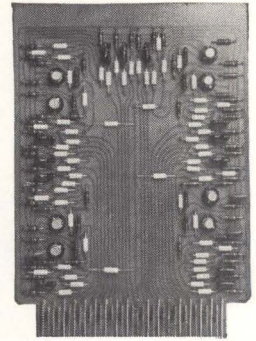

INTERCONTINENTAL INSTRUMENTS INC. MAKES AVAILABLE—for the first time—a complete line of NAND logic elements, with frequency ranges to 10 mc—at prices comparable to units capable of only 500 kc clock rates.

In addition to the elements described in the table below, the new $\bar{3}$ line includes, at comparable low prices, Counter Flip Flops, Schmitt Triggers, Crystal Oscillators, Power, Indicator and Nixie Drivers. Thus, this group of compatible elements can meet virtually any logic circuit requirement and permits previously unobtainable economy in complex circuit design.

HIGH FREQUENCY OPERATION AT LOW FREQUENCY PRICE. $\bar{3}$ logic modules are available in two distinct types: one for 3 mc, the other for 10 mc operation. Cost-conscious engineers will see from the table that the prices for these units are about what you'd expect to pay for units with far lower frequency capability. How come Intercontinental's low price tag? It's simply the result of thoughtful design that allows the use of cost-stabilized components to an extent that was impossible in designs of a year or two ago—without sacrifice of performance.

DESIGNED FOR CRITICAL APPLICATIONS, these elements pro-

vide performance that would be impressive at any price. For example, frequency specifications are for worst-case conditions. In practice, count rates of 6 mc and 20 mc have been achieved. Rise and fall time for the 3 mc units is 17 nanoseconds and propagation delay is 20 nanoseconds. For the 10 mc units rise time is 8 nanoseconds, propagation delay is 10 nanoseconds. In addition to their specified loads, the 3 mc card can drive 120 uufd stray capacity and the 10 mc unit will drive 50 uufd. Operating temperature of both types is -20°C to $+55^{\circ}\text{C}$.

ALL UNITS IN THE NEW $\bar{3}$ LINE are available for either tray or chassis mounting and are constructed on $\frac{1}{16}$ " glass epoxy G-10 laminated board, using dip soldering techniques. Tray mounted cards are fitted with 35 pin Vari-con self-wiping connectors; chassis-mount cards have 23 pin connectors. Packing density? Standard trays hold 26 of these cards, rack-mount chassis will hold up to 125 in the standard $5\frac{1}{4}$ " panel height.

We believe it will pay you to investigate the performance—and economy—these elements can provide. The table tells part of the story, but only part. Complete data is yours for the asking. A call is all it takes.

TYPICAL MODULES	APPLICATION	LOGIC CAPABILITY	UNITS PER CARD	PRICE	
				3 MC	10 MC
DC Set and Reset Flip Flop	Storage elements	One DC Set input, one DC Reset input, with corresponding node points	4	\$40	\$64
General Purpose Flip Flop	Shift register, binary counter, b-c decimal counter, storage register, etc.	One AC set input, two level controlled AC inputs	4	\$60	\$90
Digital Gate	Logic gates, inverter storage flip flop	8 two-input expandable digital gates	8	\$40	\$64
Relay Driver	Operate heavy duty relays, stepping switches	1A at up to 60 v	4	\$92	
Crystal Oscillator and Power Amp.	Clock signals over extended frequency range	500 kc to 10 mc	1	\$125	
Free Running Multivibrator	Variable frequency timing signals	80 kc to 10 mc in 3 overlapping ranges	2	\$141	
Nixie Driver and Decoder Driver	1-2-2-4 or 1-2-4-8 b-c decimal decoder	11 low impedance outputs	1	\$77	



INTERCONTINENTAL INSTRUMENTS INCORPORATED

123 GAZZA BOULEVARD, FARMINGDALE, NEW YORK • (516) MYRTLE 4-6060

The art of Q measurement has been extended to permit evaluation of superconductive resonant circuits. Three circuits have been devised to measure high values of Q obtained in the h-f/vhf range

Novel Test Techniques Measure Q in

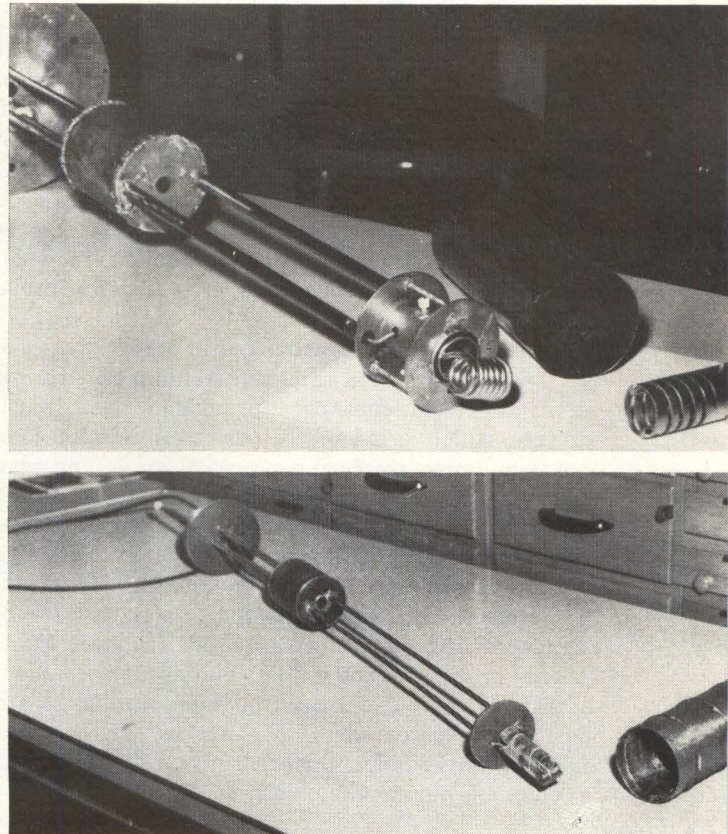

MOUNTING and coupling probes for 58-Mc (above); solid dielectric configuration (below)

Cryogenic Resonant Circuits

By WILLIAM H. HARTWIG, Department of Electrical Engineering, University of Texas, Austin, Texas

ACCURACY is improved and the time needed to measure high values of Q is reduced by three newly devised measurement circuits. They are being used in experiments with superconducting resonant cir-

cuits, which are being investigated in an effort to obtain high values of Q (greater than 100,000) in the h-f/vhf range. The work is being conducted in the Electronic Materials Research Laboratory, Department of Electrical Engineering, University of Texas.

HOT SOLUTIONS FOR A COLD PROBLEM

The intriguing phenomenon of superconductivity may prove useful in still another area—high-Q resonant circuits. However, measurements associated with these circuits defy conventional methods. Some ingenious solutions have been devised that not only permit these high values of Q to be measured but are helping to pinpoint the loss mechanisms that affect Q in cryogenic tanks

The Q of a resonant circuit is a measure of its usefulness in an oscillator, filter or other frequency-sensitive circuit. The use of superconductors permits lumped circuit components to have values of Q comparable to quartz crystals and cavities in the h-f/vhf region. The problems of measuring Q of such devices require unconventional approaches.

SUPERCONDUCTING TANKS—The range of frequencies under investigation dictates the use of lumped L-C circuits. Although the attainable Q from

a helical inductor and parallel-plate capacitor configuration is less than from a cavity, economy in the use of liquid helium and physical size make the use of distributed structures prohibitive.

Lead and alloys of lead and tin are the most convenient among the available metals. Transition temperature from normal to superconducting is 7.2 deg K, which permits operation in liquid helium baths.

Circuits can be fabricated in any of several ways to suit the purpose. A 17-Mc configuration made of a single piece of lead foil using glass as a supporting structure and as the dielectric material is shown in Fig. 1. The 58-Mc circuit in the top photograph was made of brass coated with an alloy of 75 percent lead and 25 percent tin, which can be applied like solder. Superconducting shield cans are used to prevent losses from radiation.

Circuits are being constructed in other forms using a variety of bulk and thin-film techniques. However, all of the techniques used provide a clean, smooth surface, which is essential to ensure minimum losses.

The circuits are mounted as shown in the photographs. The outer shell of the capacitor and the shield can that slips over the entire assembly are at ground potential. Energy is coupled in and out through two coaxial cables made of thin-walled stainless steel tubes. Since this material is a poor conductor of heat, it reduces boil-off of liquid helium.

The probes in the upper photograph couple r-f energy to the inner capacitor shell through a small hole in the outer shell. The probes can be rotated away from the hole, which permits a 40-db variation in coupling during the experiment.

COOLING SYSTEM—The circuit is placed in the double dewar system shown in Fig. 2, which is composed of an evacuated outer dewar containing liquid nitrogen and an evacuated inner dewar. The circuit is placed in the inner dewar, and the air is replaced by gaseous helium. This procedure prevents water frost and frozen air from interfering with the experiment when liquid helium is poured into the system.

The outer dewar is filled with liquid nitrogen to precool the system before the liquid helium is introduced. The liquid helium is transferred in through a special evacuated double stainless steel tube from

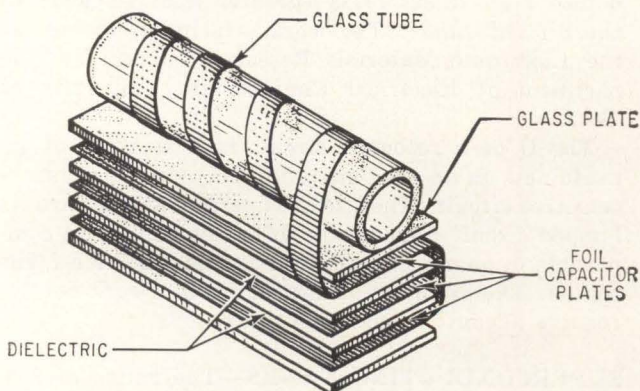

SUPERCONDUCTIVE circuit using lead foil and glass dielectric is resonant at 17 Mc—Fig. 1

a large storage vessel. The resonant circuit can be cooled to 4.2 deg K in this manner with the expenditure of about 4 liters of liquid helium, 1 liter of which will have blown off as a gas in the transfer process. The remaining 3 liters keep the circuit at constant temperature for over 12 hours without refilling.

RESONANT CIRCUIT Q—The Q of a resonant system is

$$Q = \frac{\omega_o \text{ peak energy stored}}{\text{average power loss}}$$

where ω_o is the resonant frequency in radians per second. Therefore

$$\frac{1}{Q} = \frac{1}{\omega_o} \frac{\text{loss 1} + \text{loss 2} + \dots + \text{loss } n}{\text{peak energy stored}} = \frac{1}{Q_1} + \frac{1}{Q_2} + \dots + \frac{1}{Q_n}$$

The second form of the equation accounts for n loss mechanisms. Thus, $1/Q_c$, $1/Q_R$, $1/Q_D$ and $1/Q_o$ can be considered measures of the losses resulting from coupling, radiation, dielectric dissipation and the intrinsic loss in the superconductor. Their sum is the reciprocal of the loaded Q, which is indicated by the symbol Q_L , so that

$$\frac{1}{Q_L} = \frac{1}{Q_c} + \frac{1}{Q_R} + \frac{1}{Q_D} + \frac{1}{Q_o}$$

MEASURING METHODS—Because the techniques usually used to measure Q at lower frequencies (substitution, bridges) become prohibitively tedious at values of Q much above 10^2 , they were not seriously considered. Instead the circuit was driven with a pulse-modulated carrier at the resonant frequency, and decay time was measured. This method is superior in this application because it does not require an ultrastable signal source nor an unrealistic pulse rise time.

The only precision measurement needed is of time. The oscilloscope has sweep speeds accurate to ± 3 percent, and time required for the decay is in milliseconds. Therefore, relatively short-term instability is permissible in both circuit and signal generator without introducing significant measurement error.

Decay time is proportional to Q and is difficult to measure at low values of Q. However, this presents no problem because Q can be measured by more conventional means if it is low.

The decrement method of Q measurement gives a value of Q in terms of resonant frequency and decay rate of the signal in which

$$Q_L = \frac{\omega \Delta t}{2 \ln (e_1/e_2)}$$

as shown in Fig. 3A. Several values of Q_L can be gotten from a single record simply by measuring several sets of voltages and time intervals and averaging them.

Two systems have been in use that provide an adequate measurement using the decrement method. The circuit in Fig. 4A is the simpler means for observing the rise and decay of r-f energy in a high-Q tank with a resonant frequency within the passband of the cathode-ray oscilloscope (CRO). Its greatest limitation is the tight coupling needed to obtain a sufficient signal level for the cro.

In principle, the higher gain of the i-f amplifier used in the heterodyne circuit in Fig. 4B permits the coupling to be reduced below the level where it would limit Q . The heterodyne circuit also allows the frequency range to be extended. The ultimate limitations in this method are imposed by linearity, bandwidth and noise in the mixer and i-f amplifier. The adjustable coupling that has been incorporated in the resonant circuit design is adequate to ensure linear operation.

The minimum Q that can be measured is one having a time constant, $2Q/\omega$, about 10 times the rise time of the amplifier and associated circuits. When the time constant of the tank circuit drops below $10 \mu\text{sec}$, conventional bandwidth measurements are used to determine Q .

TIME-DELAY METHOD—A variation of the heterodyne method is shown in Fig. 4C. The cro sweep is triggered by the delayed leading edge of the pulse that keys the oscillator. Vertical gain of the cro is increased until a presentation is obtained similar to curve *a* in Fig. 3B. Some point is chosen (1) as a fiducial mark. Attenuation is increased by a known amount, A , which is less than 0 db, resulting in curve *b*. Time delay is then reduced, which causes curve *b* to move to the right an interval Δt where point 2 coincides with the fiducial mark. The derivation follows directly from the equalities

$$A \epsilon \exp - \omega t_2 / 2Q = \epsilon \exp - \omega t_1 / 2Q = \epsilon \exp - \omega (t_2 + \Delta t) / 2Q$$

From the equation, Q is calculated

$$Q = 4.34 \omega \Delta t / A \text{ (in db)}$$

This method of measurement requires that the cro have good d-c balance since a vertical shift between the horizontal axes of curves *a* and *b* would introduce an error in the time delay. The time-delay method for measuring Q in resonant circuits is convenient for high signal-to-noise ratios.

ELAPSED-TIME METHOD—Measurement time is decreased and accuracy increased by the elapsed-time method, which provides automatic measurement suitable for a continuous recording or print-out system. Basically, time interval Δt is measured between two points on the decay curve using an elapsed-time counter.

The setup for this technique is shown in Fig. 5A. The pulse that triggers the r-f generator is inverted, differentiated and passed through a negative clipper. These processes provide a positive spike at the end of the r-f pulse.

Amplitude of the output pulse from the receiver is set at a predetermined level by adjusting it for a red-line reading on the peak-reading voltmeter. The Schmitt trigger circuit is adjusted to fire when the pulse reaches a predetermined lower level. Schmitt trigger output is differentiated and clipped to provide a positive spike at the time that the exponential decay reaches a convenient value, such as $1/\epsilon$. The

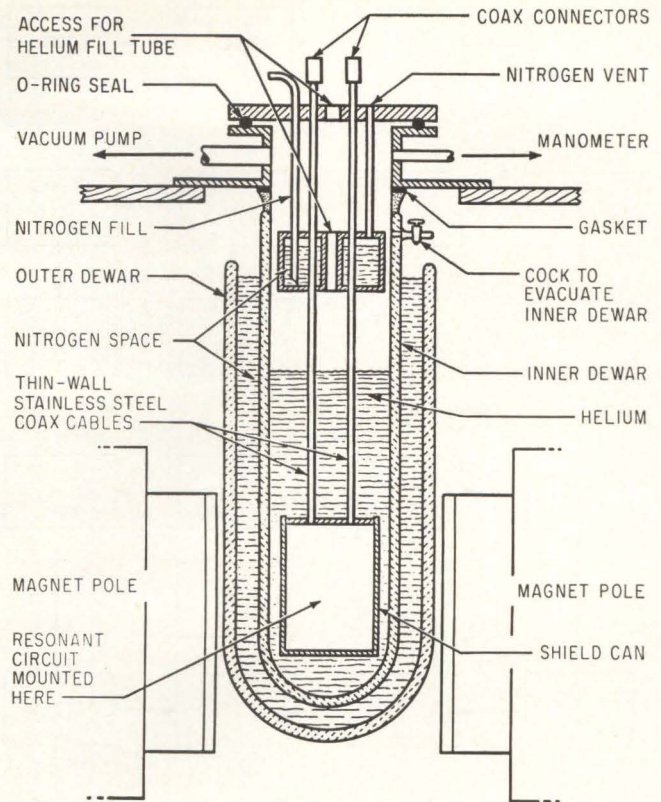

DOUBLE dewar system maintains tank circuits at superconducting temperatures—Fig. 2

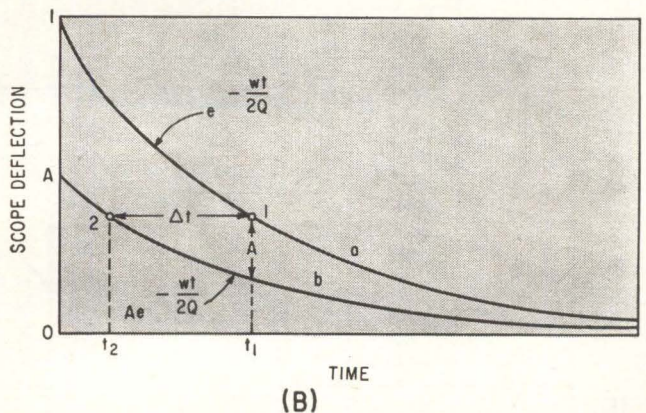
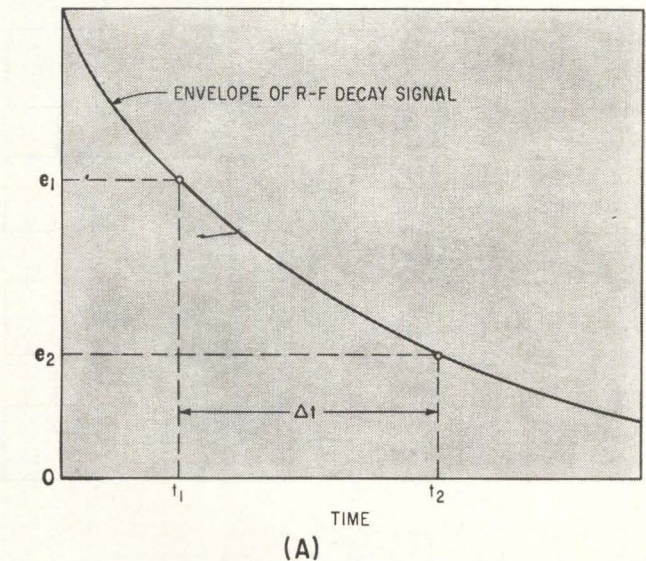

DECREMENT method measures Q in terms of resonant frequency and decay rate (*A*), and time-delay circuit provides scope presentation like that at (*B*)—Fig. 3

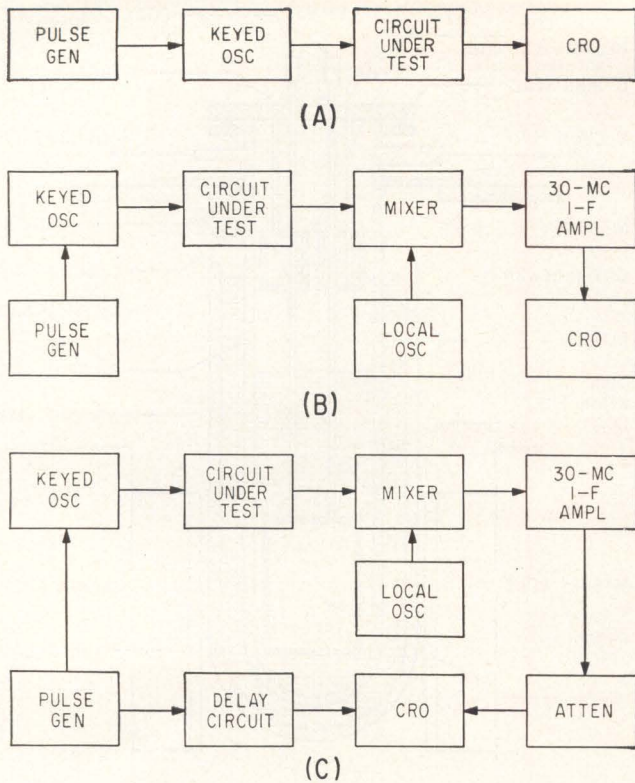

DECAY can be displayed directly (A), the decay envelope can be displayed using the heterodyne circuit (B), or the time-delay circuit (C) can be used to measure Q —Fig. 4

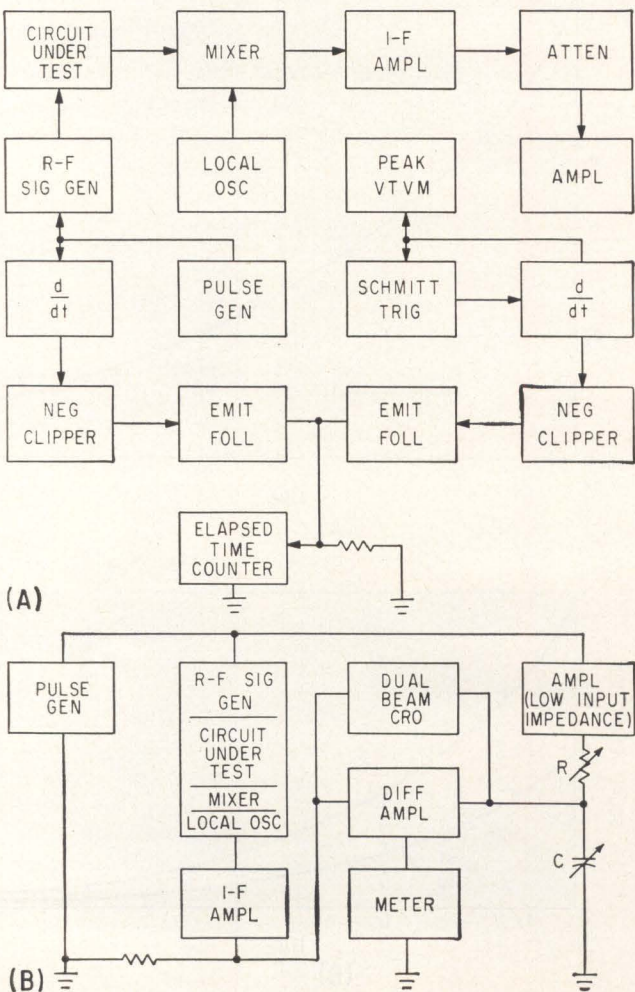

spikes from the pulse generator and the Schmitt trigger are fed into separate emitter followers that work into a common load. Thus, a pair of identical pulses are provided that are separated in time by an amount proportional to Q of the circuit under test. The leading spike starts the elapsed-time counter and the lagging spike stops it. The Q is simply this elapsed time multiplied by a constant. The constant is determined from the settings of the amplifier and Schmitt trigger and from the frequency. After the system has been set up, Q is calculated from the equation

$$Q = K\Delta t$$

The advantage of this method is that the error resulting from noise can be reduced significantly by averaging a large number of time measurements.

R-C BRIDGE METHOD—In the last of the three methods, a circuit reads Δt accurately, even in the presence of considerable noise. Two exponential decay signals are compared and one is adjusted to coincide with the other. The comparison can be made with a dual-beam cro or by obtaining a minimum output from a differential amplifier.

Output of the i-f amplifier in Fig. 5B is a partially integrated rectangular pulse. The time constant of the receiver output pulse is $2Q_L/\omega$, and the time constant of the integrator is RC . Therefore, when the equipment is adjusted for minimum meter deflection,

$$Q_L = \omega RC/2$$

These methods for measuring Q are designed to yield accurate results quickly. They are very satisfactory over a range of many decades of decay times and resonant frequencies. Accuracy is limited by noise in the mixer and i-f amplifier; however, as Q increases, required bandwidth decreases proportionately.

LOSS MECHANISMS—To achieve the highest possible Q consistent with mechanical stability, every loss mechanism must be minimized. The effect of reducing the temperature of even normal metals like copper and silver improves Q fivefold. When the metal becomes superconducting, additional improvement of several orders of magnitude can occur.

At room temperature, the dominant loss mechanism is I^2R in the conductor. Radiation losses depend on frequency. At lower frequencies, a shield may actually degrade Q , but this is almost never true in superconducting resonant circuits. A superconductive shield on a 58-Mc circuit at this laboratory raised Q from 5,000 to more than 200,000. The shield must be designed with care since it can be considered a single shorted turn loosely coupled to the resonant inductor. As a consequence, a closely wound coil of many turns may induce a current in the shield with a surface density equal to or greater than that in the coil itself. The high Q denotes high circulating current, which may exceed the critical current and cause the super-

ELAPSED-TIME method (A) increases accuracy, while R-C bridge method (B) can be used with considerable noise present—Fig. 5

conductor to switch back to the normal state during the peaks of the cycle. If this possibility is recognized, the statement about shields never degrading Q in superconducting resonant circuits need not be qualified by the word almost.

Losses in the shield are of the same nature as the intrinsic losses in the superconductor itself. Thus

$$\frac{1}{Q_R} + \frac{1}{Q_o} = \frac{\alpha}{Q_o},$$

where α exceeds unity.

DIELECTRIC LOSSES—At room temperature, losses in the capacitor dielectric rarely limit Q of a resonant circuit, but this is not the case for a superconducting tank. With only dielectric dissipation, Q_D of a circuit is simply

$$Q_D = 1/\tan \delta,$$

where $\tan \delta$ is the loss tangent of the material. Values of $\tan \delta$ for glass, polystyrene and other common insulators range typically from 10^{-3} to 10^{-4} at room temperature in the frequency range of interest. At low temperatures, the losses drop appreciably. Little is known about dielectric losses at helium temperature, but teflon and quartz appear to be the best selections. Using these materials, values of Q above 100,000 might be expected and possibly as high as 1 million.

To avoid the limitations imposed by dielectric losses, capacitors should be built with a minimum of dielectric support. With only a fraction of the electric field in a dissipative medium, Q_D can be raised until inadequate support introduces mechanical instability. The relationship is

$$Q_D = \frac{1}{\tan \delta} \left(1 + \frac{C_o}{C_D} \right),$$

where C_D is the capacitance of the dissipative material, C_o is capacitance in a nondissipative medium and the circuit capacitance is $C_D + C_o$. In the circuit in Fig. 1, Q was only 22,600 at 17 Mc, which was shown to be limited to dielectric dissipation in the glass dielectric.

COUPLING LOSSES—Coupling losses may prove to be the limiting mechanism for a practical superconducting resonant circuit. Using capacitive probes, the equivalent circuit for the r-f decay is shown in Fig. 6A. Tank inductance and capacitance are L and C , and R is the intrinsic surface impedance of the device plus the equivalent resistance of the dielectric dissipation process. Total coupling capacitance is C_1 , and r_1 is the resistance seen looking toward the generator and detector circuits. Coupling capacitance is about 10^{-13} farad and can be reduced a hundredfold during the experiment. The value of r_1 is about 25 ohms, which is much less than the reactance of C_1 .

The presence of the coupling circuits causes a decrease in resonant frequency in accordance with the relationship.

$$\omega = \frac{\omega_o}{(1+x)^{1/2}} \approx \omega_o \left(1 - \frac{1}{2}x \right)$$

where $x = C_1/C$ and $\omega_o = 1/(LC)^{1/2}$. In practice, x

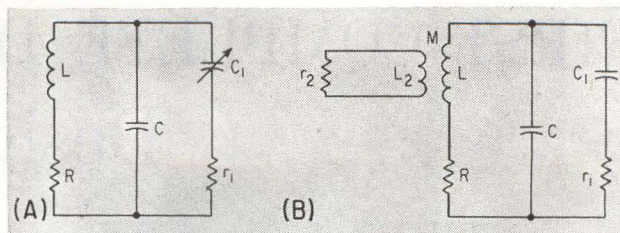

EQUIVALENT circuits of superconductive tank have capacitive (A) and mixed (B) coupling—Fig. 6

$< 10^{-3}$ and may reach 10^{-6} with suitably sensitive detectors. The effect on resonant frequency is less serious than the losses introduced. Calculating Q results in

$$\frac{1}{Q_L} = \frac{1}{Q_o} + \frac{r_1 x^2}{\omega_o L} = \frac{1}{Q_o} + \frac{1}{Q_C}$$

For Q_o to be measured as $10^6 \pm 10$ percent, Q_C must be 10^7 or greater.

If minimum detuning is desired, one coupling circuit can be inductive and the other capacitive. The dependence of Q on an inductively coupled circuit terminated in a resistance is

$$\frac{1}{Q_L} = \frac{1}{Q_o} + k^2 Q_2$$

where $k^2 = M^2/LL_2$, $Q_2 = \omega_o L/r_2$ and $\omega = \omega_o (1 + \frac{1}{2}k^2 Q_2^2)$. With the mixed coupling of the circuit in Fig. 6B, resonant frequency is essentially independent of coupling when

$$C_1/C = k^2 Q_2^2$$

An interesting design problem and a useful possibility is the conception of single vernier adjustment that can perform this function in the cryogenic environment.

SUPERCONDUCTIVE TANK Q—Loaded Q in excess of 10^6 has been measured at 36 Mc. When corrected for the effects of loading, unloaded Q was 1.3×10^7 . This value is not regarded as an upper limit. More recent experiments using improved techniques indicate further increase in Q_L and Q_o can be expected. In fact, since surface resistance of a superconductor approaches zero as frequency or temperature approach zero, there is little reason to limit Q_o unless circulating current exceeds the critical value.

The improvement in Q_L when a circuit becomes superconducting is indicated by Q measurements of 200 at room temperature, 500 at 77 deg K in liquid N_2 , 1,100 at 7.2+ deg K and 10^6 at 4.2 deg K.

As a matter of practical interest, the loaded Q of a superconductive resonant circuit will probably be limited by coupling losses below a few hundred megacycles. Above that frequency, the reduction in surface impedance in a superconducting resonant circuit is not as pronounced.

The author acknowledges the assistance of Thomas G. Milner, now of Minneapolis-Honeywell Development Laboratory. This project is sponsored by the U. S. Army Research and Development Laboratory, Fort Monmouth.

FIRST COMPLETE DETAILS

Designing Data Registers

Both coincidence and buffer circuits are designed without gating transistors.

Multilateral communication between registers is possible through a central bus

MULTIPLE DATA channels between registers in a computer can be selected and controlled using semiconductor diodes in place of the usual input and output gating transistors. All possible data channels among any number of registers can be provided, and the number of diodes required for a complete dual channel transmission system of n registers is $4n$. The channels are independent. A transmission may be made from any register directly to any other register, without the use of an intermediate register.

BASIC CONCEPT—A single data distribution bus system is accessible to all registers in the array. The registers are arranged so that they are not normally in communication with this central distribution bus, but are isolated by buffer diodes. For a particular transmission, any register may be selected as transmitter, and any other register may be selected as receiver by altering the potential on a single associated line. Transmission will be effected automatically by the central distribution bus.

Selection is made by overcoming the normal inverse bias on the buffer diodes. This is accomplished by altering the potential of the entire register structure in the sense required. Conceptually, if the potential of the entire structure, including the register power supply, were altered by a fixed amount, the only change in current would be that in the buffer diodes. In

practice, since the register circuits are designed so that the current from the power supplies is nearly constant for the expected potential changes within the register structure, the power supplies are allowed to remain at a fixed potential. Changes in current as a result of this are of a sense favorable to the processes desired, since base currents increase as loads are applied, and decrease when changes of state are in order.

CIRCUITS—Figure 1 is a bistable circuit of the form used in the registers. The Eccles-Jordan type circuit uses surface-barrier transistors with saturation biasing. The saturated circuit concept is easy to apply in this system, since the output potentials at the collectors are well defined with respect to the common emitters, and the varying potential is applied to the registers by varying the potential on the common emitter lines. Other types of bistable circuits have been used with registers operating at varying potentials; an example is the flow gating system in the ILLIAC II computer at the University of Illinois.¹

In a system of three storage registers of two digits each, Fig. 2, the flip-flops are diagrammed with the resistors omitted. The common emitter lines are shown as being operable at any one of three potential levels: a quiescent level of zero, an upper level of 1.5 v, and a lower level of -1.5 v.

The pairs of vertical lines in Fig. 2 are the central distribution buses, which are common to all registers in the system. The outer two lines in each column are connected through diodes to the collectors of the register transistors. They will therefore follow the most positive of all collectors in the register column.

The inner lines are connected to the outer lines by a system, symbolized by a small battery, that keeps an inner line constantly 2.0 v more negative than its associated outer line.

If the registers all have their emitter lines occupying the quiescent, or zero potential, the inner vertical conductors will both be at least 2.0 v more negative than the nominal level of the transistor bases, which are always within about 300 mv of the emitter potential. The diodes will therefore be reverse biased and these lines will have no conducting connection to any base. The registers will thus be independent of the state of the central distribution system.

TRANSMISSION—To accomplish a transmission, one register is selected as transmitter by raising its common emitter line to the upper potential level. The most positive inner vertical conductor will then be at least 0.5 v more negative than the bases of the register transistors, so the register flip-flops will still be unaffected by the state of the central distribution bus. The latter, however, now corresponds to the state of the transmitting register.

A second register is selected as receiver, by reducing the potential of its emitter line to the lower potential level. When this point is reached, one of the inner conductors will now exceed the nominal potential level of the base of the

WHERE TO FIND THEM

Simpler circuits and a more flexible system result from using the diode logic as described in this article. These features are in the MANIAC III computer designed and built at the Institute for Computer Research, University of Chicago. The work was performed with the division of research of the U. S. Atomic Energy Commission under contract AT(11-1)614

With Simple Diode Circuits

By W. ORVEDAHL, Rice University, Houston, Texas

J. H. SHEPHERD, Institute for Computer Research, University of Chicago, Chicago, Illinois

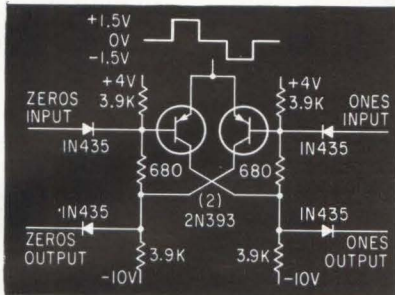

FLIP-FLOP with component values is typical of the type used in the registers—Fig. 1

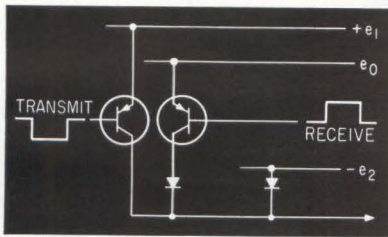

SATURATED switches control the three potential levels that are applied to the emitter lines of the registers—Fig. 3

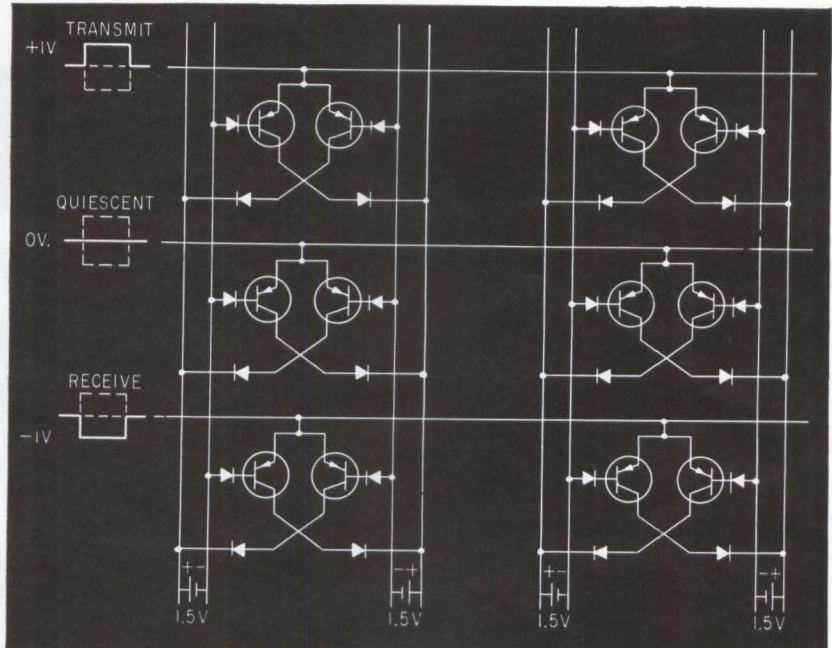

THREE STORAGE registers of two digits each. Flip-flops are drawn with resistors omitted—Fig. 2

transistor in the receiving register, and conduction through the diode will force that base, and hence the register, to conform to the state of the central distribution buses. The transmission is then complete, and the other registers in the array remained undisturbed. If the opposite selections had been made, the transmission would have been in the opposite direction.

The MANIAC III Computer is equipped with eight 48-bit registers arranged in this fashion. They are used as a small rapid access store, and they communicate, through the central distribution bus, with all other registers in the computer. There are also ten 14-bit index registers of similar form in the computer. All of these are realized with just two transistors and four diodes per digit, arranged as in Fig. 2.

Three discrete potential levels that may be applied to the emitter lines of the register must be controlled with a reasonable degree of stability and accuracy. The saturated switches, Fig. 3, fulfill this requirement.

A column of an arithmetic register, Fig. 4, consists of a pair of flip-flops, so that when shifting or adding is performed, both the old and the new register information are maintained independently. The upper flip-flop of the pair communicates with the central distribution bus for transmitting. The lower flip-flop is the receiver. Its emitter potentials are fixed and the selection of the register for receiving is made by the dual channel transistor coincidence gates shown between the two register flip-flops.

Since the receiving register is at a fixed potential, and is isolated from the central distribution sys-

tem by separate transistor gates, the potential step (symbolized by a battery in Fig. 2) is not applicable to this part of the system. Instead, a noninverting amplifier is provided between the input and the output conductors of the central distribution system. The amplifiers provide level restoration to 1.5 v at the inputs of the receiving gates. These amplifiers may be switched off, so that the arithmetic registers are independent of the central distribution bus, and hence may be shifted independently and simultaneously.

Shifting is regarded as a transmission within the register itself, from the upper rank of flip-flops to the lower rank, one place removed to the left or to the right. Accordingly, three selection gates for receiving are shown, two for the two types of shift and one for receiving in column, either from the upper

rank or from another register through the central distribution bus.

For transmitting, the potential of the emitter lines of the upper rank is raised to its most positive level. At all other times these emitter lines are kept at the lower of the two levels. When the rank is at the lower level, the diodes D_1 and D_2 will be biased to force the state of the upper rank to agree with that of the lower register. Because of this condition, transmission into

this register pair from elsewhere is received in both register ranks, and a transmission from the upper register rank will always be equivalent to a transmission from the lower. For a transmission within the register pair, such as in shifting, the displaced contents will be assimilated by the upper rank in the period between transmissions, so it renders the control of the shifting process simple. It is not necessary to supply a two-phase pulse for the two transmissions re-

quired in a shift. A simple pulse train, and a static selection of the gate which determines the direction of shifting, effects the desired results.

COUNTING — Counting up or down can be accomplished by a transmission within the register itself, in column, controlled according to the logical requirements of counting. These are realized by providing for transmission of complemented digits, and then arranging that, for counting up, the presence of a zero in any stage will prevent transmission in all stages of higher order. For counting down, the presence of a 1 prevents transmission. A register structure arranged for counting is illustrated in Fig. 5. The lower register will advance by one for each positive pulse applied to the emitter line of the upper rank. Assimilation of the new number by the upper rank occurs between pulses, just as it does in shifting.

OTHER FEATURES — It might have been difficult to show in advance that the existence of $n(n-1)$ transmission paths would be useful or valuable. Nevertheless, many simplifications were achieved because of the nature of the transmission system as the computer evolved. For example, it was found desirable to be able to carry out an addition without the sum being accepted by the accumulator register. The sum first appears in the register of the upper rank. The accumulator is the lower rank. Transmission to the accumulator is optional, and the sum may be transmitted to any other register in the computer, and may be received in any register in direct form or in displaced form, by selection of the gates.

A sum from the adder, or any word standing in any register, may be placed on the central distribution bus without selecting a receiving register. On this bus it may be compared with a given configuration of zeros and ones, wired in as a diode array. Thus, any word anywhere in the system can be compared to zero, or any other fixed value provided.

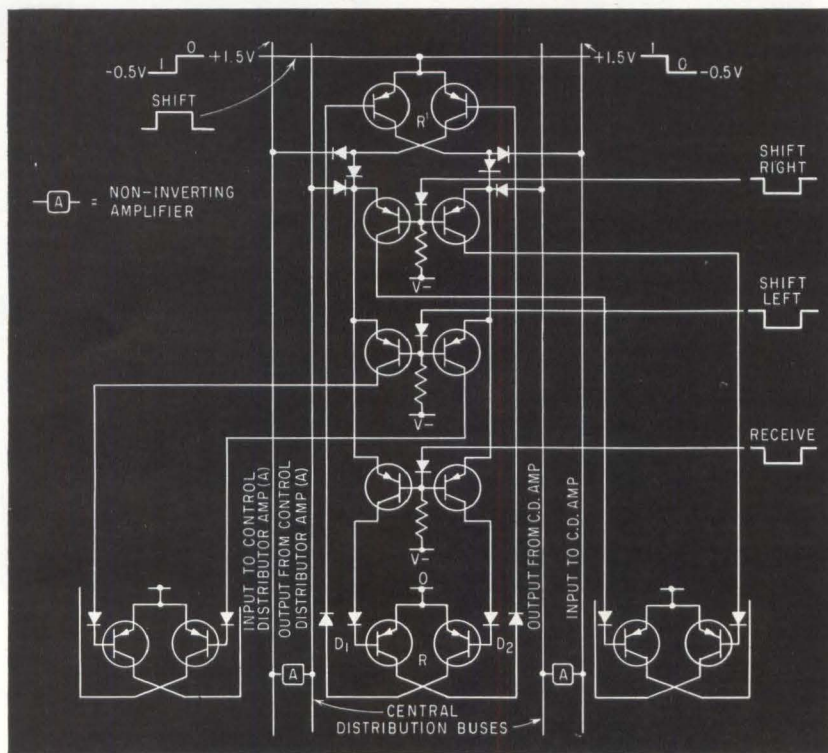

ARITHMETIC register consists of a pair of flip-flops R and \bar{R} . Flip-flop \bar{R} is the receiver and connection to the proper register for receiving is made through the coincidence gates shown—Fig. 4

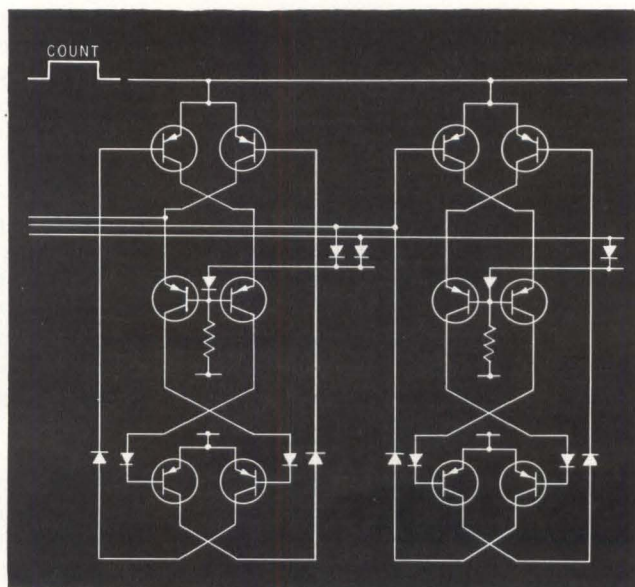

REGISTER arranged for counting. Flip-flops are drawn in simplified form—Fig. 5

(1) W. T. Poppelbaum, "Flow Gating", Western Joint Computer Conference, April 1958.

MEASURING the hot resistance of a 75-watt incandescent bulb with the prototype model of the bridge

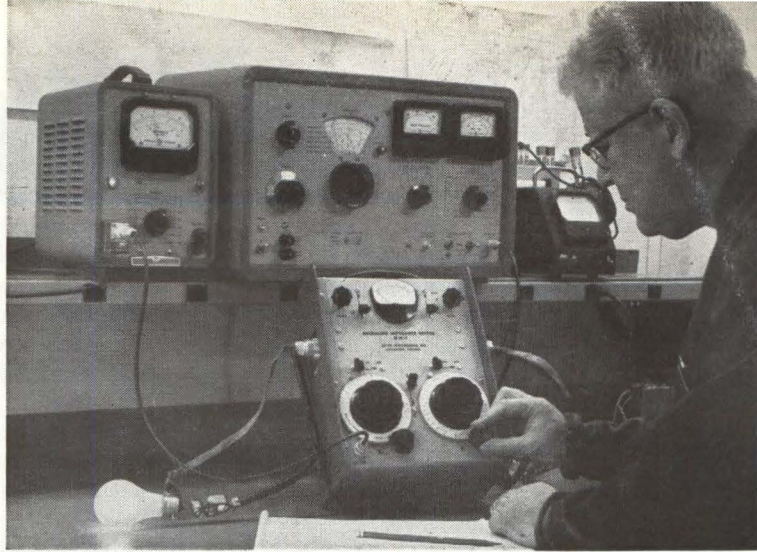

Unique Bridge Measures

Antenna Operating Impedance

This bridge, using what the author believes to be a new principle, measures the impedance of a load under power, with a minimum of insertion effects

By CHARLES S. WRIGHT, Delta Electronics, Inc., Alexandria, Virginia

IT IS IMPOSSIBLE in many instances to measure the operating impedances of an antenna, or other device, with common bridge circuits. The term operating impedance, as used here, is the ratio of the voltage across the terminals of the load to the current passing the terminals of the load, when the load is operating in its normal environment and with normal operating power. One radiator of a directional antenna, for example, exhibits an operating impedance that may differ substantially from its self-impedance, due to mutual coupling between adjacent radiators. As another example, many loads are nonlinear and their oper-

ating impedance varies according to the power applied.

If an operating impedance bridge is to be inserted in a directional antenna system to measure a single element of the system, it must have a negligible insertion effect; that is, it must not disturb the normal operation of the element being measured, or any other part of the system. This bridge is designed to have a small insertion effect.

OPERATION—Figure 1A is a simplified schematic, illustrating the principles. The circuit between the generator G and the load Z_L is interrupted by a short length of transmission line, having a charac-

teristic impedance of Z_{01} . To this short length of transmission line is lightly coupled a second section of transmission line having a characteristic impedance of Z_{02} . The coupling coefficient between the two lines is k . Across the secondary line nearest the load is a meter circuit. Across the end of the secondary line nearest the generator is a variable standard resistance and a variable standard reactance. The combination of these standards is identified as Z_S .

There will be two waves on the main transmission line: one direct wave carrying energy from the generator to the load, identified as W , and a reflected wave identified as $\Gamma_L W$. Quantity Γ_L is the reflection coefficient of the load impedance Z_L for the characteristic impedance of Z_{01} . Because of the coupling k , these two waves induce waves in the secondary line. One wave is induced traveling toward Z_S , of magnitude kW , and another wave is induced traveling toward the meter of magnitude $k\Gamma_L W$. If the load impedance Z_S is not equal to Z_{02} , a third wave will exist on the line of magnitude, $k\Gamma_S W$. The direction of travel of this wave will be toward the meter. Γ_S

THE BULB EXPERIMENT

The lead photo shows a 75-watt bulb, heated by connecting the input terminals of the bridge to a 115-volt a-c source through a Variac, and the output terminals to the bulb. With this connection, the total energy dissipated by the bulb goes through the bridge circuit. An r-f signal is also coupled to the bridge input.

Taking measurements at 1 Mc of the bulb operating resistance versus applied rms voltage, the resistance varied from its cold value of 20.8 ohms, to 162 ohms at 120 volts excitation. The r-f reactance of the bulb remained substantially constant at $+j7$ ohms for all applied voltages

is, of course, the reflection coefficient of the impedance Z_s for the characteristic impedance Z_{02} .

Therefore, two waves arrive at the meter circuit. They are $k\Gamma_s W$ and $k\Gamma_L W$. If these two waves are of equal magnitude and opposite time phase, the meter indication will be zero. The null condition of the bridge will be

$$k\Gamma_L W = -k\Gamma_s W \quad (1)$$

Or

$$\Gamma_L = -\Gamma_s \quad (2)$$

The reflection coefficients Γ_L and Γ_s are

$$\Gamma_L = \frac{Z_L - Z_{01}}{Z_L + Z_{01}}; \quad \Gamma_s = \frac{Z_s - Z_{02}}{Z_s + Z_{02}} \quad (3)$$

Replacing Γ_L and Γ_s in Eq. 2 with these definitions and solving for Z_L

$$Z_L = \frac{Z_{01} Z_{02}}{Z_s} \quad (4)$$

Or

$$Z_L = Y_s (Z_{01} Z_{02}) = Y_s C \quad (5)$$

The load impedance is directly proportional to the shunt admittance of the standard circuit. The constant of proportionality C is the product of the characteristic impedance of the main transmission line and the auxiliary transmission line. This constant has first-order independence of frequency. A standard circuit, using a parallel-con-

nected variable resistance and variable reactance, can be calibrated directly in the series equivalent load impedance.

The simplified circuit is useful for many purposes, but has several limitations as a general-purpose measuring instrument. For example, if the load impedance Z_L is zero, the standard shunt resistance must be infinite. Also, if the reactive component of the load is inductive, a variable capacitor can be used as a standard. On the other hand, if the load is capacitive a variable inductor is required for the standard. A satisfactory variable inductor of sufficiently high Q is not obtainable.

BIASING CIRCUIT—These limitations may be removed by adding a biasing circuit. Figure 1B shows a simplified schematic similar to Fig. 1A, with the biasing circuit. A short length of transmission line is inserted between the generator and the load impedance to be measured, and the secondary line is lightly coupled. Three connections are brought from the secondary line, indicated by terminals A , B and C . The line between terminals C and B is used as the secondary line shown in Fig. 1A. The line section between terminals B and A is the bias section. As before, the

variable standards are parallel-connected across terminal C and an r-f meter circuit is connected across terminal B . A biasing impedance is connected across terminal A . The waves induced on the two secondary line sections from the direct wave W and the reflected wave $\Gamma_L W$, are shown in Fig. 1B. The total of the waves arriving at the meter circuit is equated to zero:

$$\Gamma_s + \Gamma_L + 1 + \Gamma_L \Gamma_b = 0, \quad (6)$$

where Γ_b is the reflection coefficient of Z_b terminating the bias line.

When these reflection coefficients are replaced by their defining impedance ratios, and the resulting equation is solved for Z_L , then

$$Z_L = \frac{C}{2} Y_s - \frac{C}{2} Y_b \quad (7)$$

This result is obtained, assuming an exact center tap of the secondary line. Other tap ratios may be used, but they will modify this equation. Equation 7 is similar to Eq. 5, except that a negative term has been added. This means that the negative of the bias admittance Y_b is effectively in parallel with the admittance of the standard Y_s . The two limitations of the circuit in Fig. 1A are now circumvented, and the requirement for an infinite resistance standard no longer exists. When Z_L is zero, it is only necessary that Y_s and Y_b be equal. Neither is required to be zero. It is not necessary to have a variable inductor for capacitive loads. The variable capacitor standard can be switched from terminal C to terminal A . Equation 7 shows that this has the effect of reversing the sign of the susceptances of this standard.

COMPLETE CIRCUIT—Figure 2 is a schematic of a complete circuit for a practical bridge, using these principles. The coupling box is shown separately; it contains the main transmission line and the auxiliary line (see Fig. 3). Terminals A , B and C of this coupling box correspond to the A , B and C terminals of Fig. 1B. The resistor marked R DIAL is the shunt resistor of the standard circuit. It is directly driven by a front-panel dial, and is calibrated in ohms. The

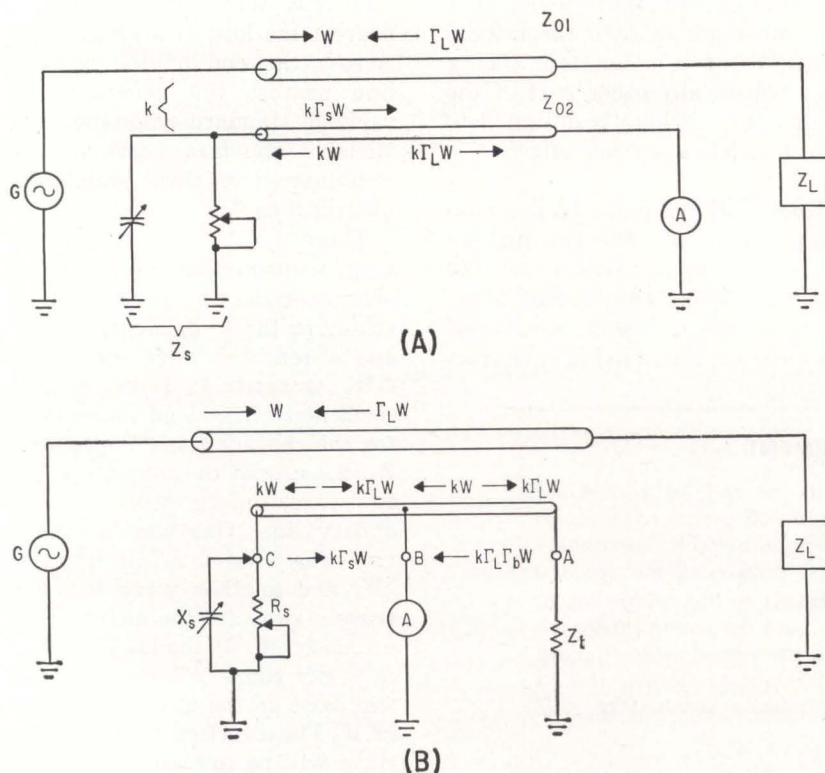

SIMPLIFIED SCHEMATIC of the bridge (A) to illustrate principles; similar configuration with biasing circuit added (B)—Fig. 1

variable capacitor marked X_r , DIAL is a variable reactance standard and it is connected directly to a front-panel dial, which is calibrated in reactive ohms at 1 Mc. The variable resistor marked R_o , SET and the variable capacitor marked X_o , SET are the bias impedances. These are internal to the instrument and normally require no readjustment after once being set. The LC switch shifts the reactive standard from terminal A (for capacitive loads), to terminal C (for inductive loads). The small zero-set capacitor is likewise switched by the LC switch. Range extension components are provided. These can be switched directly across the standards, and have the effect of adding a fixed equivalent load of resistance or reactance to dial readings. For example, if the +100-ohm-scale extension resistor is switched in, and a dial reading of 10 ohms is obtained, a load resistance of 110 ohms is indicated. The small lead compensating capacitor can be set so that measurements can be made using 12-inch output leads, without further lead corrections.

The meter circuit forward-reverse switch is normally in reverse position for bridge operation. This position is connected to the B terminal of the coupler box. The null indicating meter can be connected directly or through a tuned circuit. The tuned circuit gives added sensitivity to the meter for low-power operation and selectivity, when required. The meter may also be switched across the C terminal by throwing the forward-reverse switch in the forward position. The meter then reads the voltage across the standard resistor. With the dials set to indicate the Z_o of the circuit being measured, the forward and reverse power and standing-wave ratio can be read from the meter by operating the forward and reverse switches. During this operation, the bridge performs as a normal directional coupler.

The lead photo shows the bridge, using the circuit of Fig. 2. This particular model is intended for operation on broadcast frequencies. It will give accurate measurements over the frequency range of 500 Kc to about 5 Mc. It has a power handling capacity of about 5 Kw, and an insertion effect equivalent to nine inches of 150-ohm coaxial line.

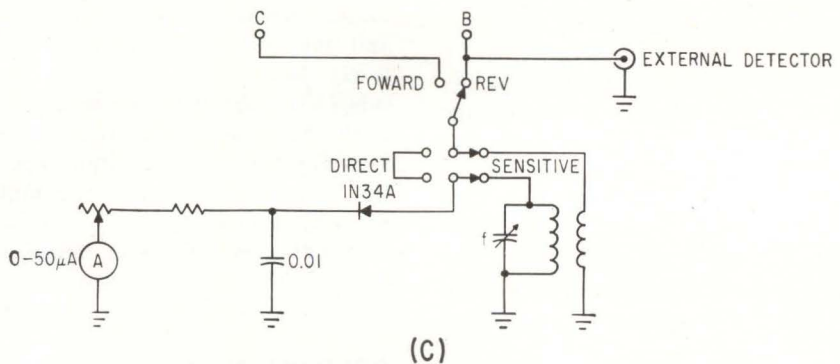
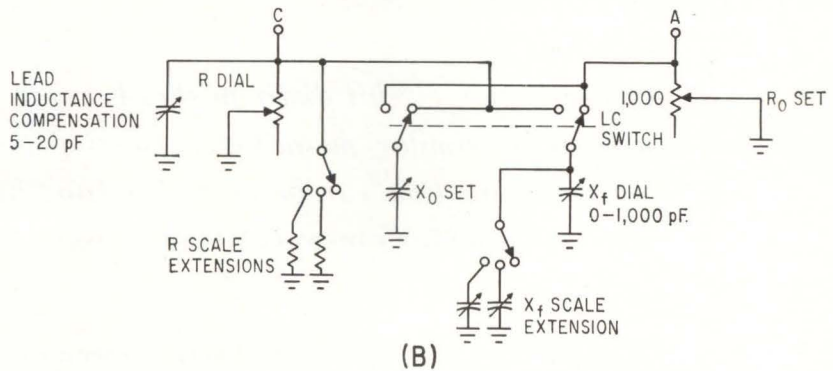
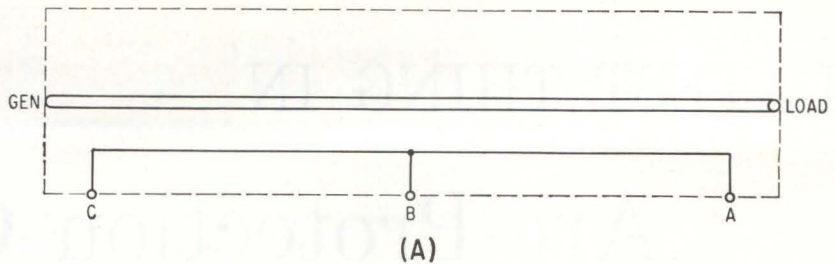

COMPLETE CIRCUIT components: coupler box (A); bridge section (B); meter circuit (C)—Fig. 2

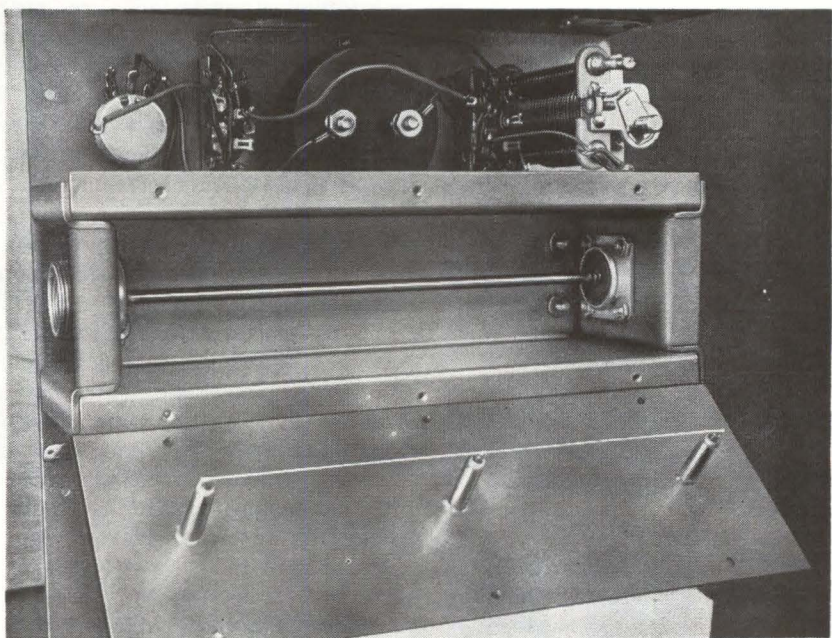

COUPLING BOX internal construction. A copper rod between the center terminals of the large uhf connectors forms, with the coupler box walls, the primary transmission line. A short length of solid copper conductor on three stand-off terminals forms the secondary line, which is coupled to the primary line when the box is assembled—Fig. 3

LATEST THING IN

Arc-Protection Circuits

Arc-protection circuit distinguishes between peak pulse currents and fault currents of similar magnitude. Developmental tubes that require high electrode potentials can be protected from breakdown and flash-over during preliminary operation and testing

By DANIEL D. MAWHINNEY

Electron Tube Division
Radio Corporation of America
Harrison, New Jersey

CURRENTS at unspecified times as well as excessive currents are sensed by a newly developed arc-protection circuit. It protects high-voltage electron devices from the effects of sudden faults, even during pulse operation. The circuit has proved satisfactory for protecting developmental high-voltage devices during preliminary operation and testing.

When devices and components that consume low average power are operated in a high peak power pulse circuit, faults can quickly destroy them. In addition to protection from long-term overloads, complete protection must be provided for sudden faults, such as breakdown or flash-over. These faults are com-

mon in preliminary operation and testing of high-voltage electron devices, such as power, transmitting and microwave tubes. Even relatively low-power traveling-wave tubes are subject to severe arc-type faults because of the high voltages at which they operate. Pulse operation requires an even more complex protection circuit, which can discriminate between peak pulse currents and fault currents of similar magnitude and rise time.

OPERATION—A simple discriminating and protecting circuit has been developed that uses some well established techniques to protect both tube and test equipment during testing of developmental pulsed kilowatt traveling-wave tubes. The circuit has performed satisfactorily at input voltages up to 10 kilovolts and at pulse lengths from 10 to 100 microseconds.

Operation of the arc-protection circuit is shown in Fig. 1. The protected device, which is operated from a power supply of substantial capacity, is keyed by a positive grid or anode pulse. Currents that normally flow in the tube electrodes are similar in duration to the driving pulse, and their magnitudes have predetermined maximum values. A current-sensing element samples current in the tube electrode of interest. This sample is mixed with a sample of the grid input pulse in a comparator circuit, which produces an output when the current sample exists without a simultaneous canceling driving pulse. This

condition represents current that either greatly exceeds a predetermined magnitude or occurs at an unspecified time. On a statistical and functional basis, current at an unspecified time is far more likely.

Output from the comparator is amplified and fed to a trigger generator stage, which serves a double function. The trigger generator produces a sharp trigger pulse for an electronic crowbar thyatron, which discharges the energy stored in the power supply and protects the arcing tube by providing a low-impedance shunt path for the discharge current. In addition, the trigger circuit operates primary control relays that cut off power to the supply and pulser and that indicate overloads to the operator.

COMPARATOR—The comparator function is performed by V_1 , V_2 and V_3 in Fig. 2, which act as an inhibitor and anticoincidence circuit. A sampled pulse waveform is applied to the grid of the cutoff cathode follower V_1 , which provides signal isolation and a low-impedance source for cathode-drive operation of pentode V_3 . A similar positive grid pulse is simultaneously applied from a series current-sampling resistor in the power-supply return of the protected tube element.

The simultaneous occurrence of these two pulses results in no net output because of the canceling effect of the two positive signals. As the current pulse tends to cause conduction in V_3 , the pulse sample from the cathode follower maintains

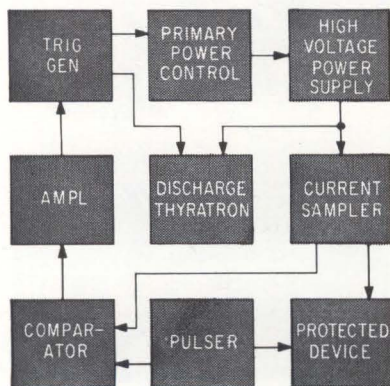

COMPARATOR determines when current in protected tube element occurs without a simultaneous drive pulse—Fig. 1

Gyrators, isolators and circulators operate from low audio frequencies through the r-f range. Passive elements are based on coupling between separately excited electric and magnetic fields and the Hall effect

Now You Can Use Nonreciprocal

By JEROME H. SILVERMAN*

Electronics Div.,
Clevite Corp.
Cleveland, Ohio

PASSIVE nonreciprocal network elements for low frequencies could permit simultaneous transmission and reception from a single antenna. Devices based on the low-frequency gyration could also act as couplers for introducing two-terminal amplifiers into a line or be used to suppress standing waves.

A group of devices with electrical inputs and outputs has been developed that exhibit nonreciprocal behavior from low audio frequencies through the r-f range. These devices use coupling between separately excited electric and mag-

netic fields¹ and also the Hall effect.²

The ideal gyration¹ was introduced as a linear passive two-port network element that, combined with conventional reciprocal network elements, can explain and predict behavior of nonreciprocal systems. The ideal gyration, characterized by coefficient a (called the gyration resistance) and by a polarity, is contrasted with the ideal transformer in Fig. 1A.

The ideal gyration gyrates a current into a voltage. Thus, in a magneto-mechanical transducer (loudspeaker), the mechanical force generated is proportional to current in the driving coil; in an electromechanical transducer (capacitor microphone), an applied force develops a proportional voltage. If the two transducers are coupled acoustically or mechanically, the com-

bination gyrates currents into voltages much as an ideal gyration. In fact, the behavior of such nonreciprocal systems can be simulated by the analog of an ideal gyration cascaded with a reciprocal two-port network. Such systems with additional reciprocal networks can be used to construct passive isolators and circulators.

EM GYRATORS—Two designs of electromechanical (EM) gyrators have been made. These structures, the butt-joint and the composite-beam, are shown in Fig. 1B and 1C. The EM gyration is a band-pass device with bandwidths of 2 to 4 percent and efficiencies from 50 to 95 percent.

The butt-joint unit is a full-wave structure designed so that the stress node is at the butt joint,

* Now with Victoreen Instrument Co., Cleveland, Ohio

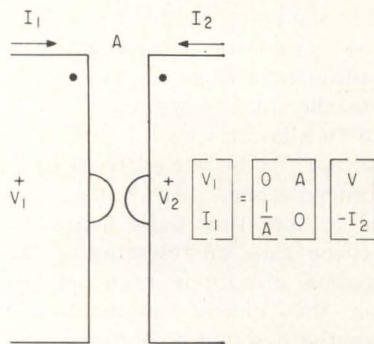
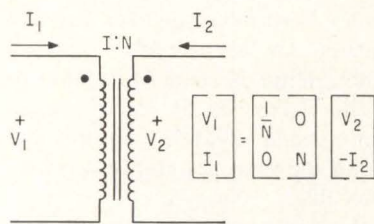

(A)

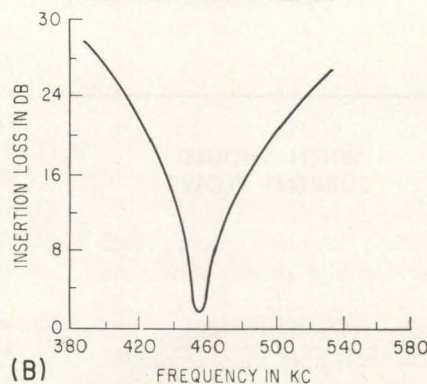
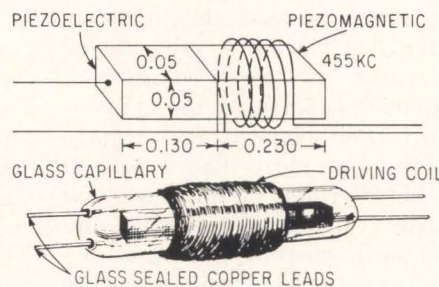

(B)

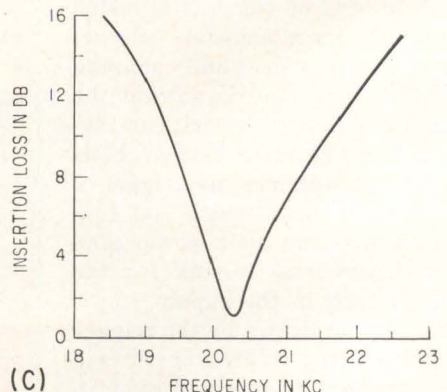
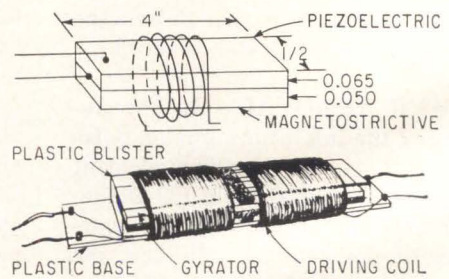

(C)

IDEAL transformer is contrasted with ideal gyration (A). Butt-joint (B) and composite-beam (C) gyrations are shown with their response curves—Fig. 1

PACKAGED 100-Kc gyrator appears at left followed by 100-Kc composite-beam transducer, packaged 455-Kc gyrator and 455-Kc butt-joint transducer

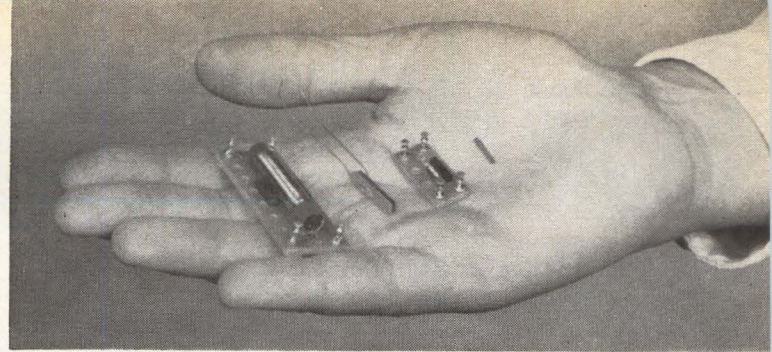

Devices at Low Frequencies

which limits the effects of bonding adhesive on performance. Conventional techniques are used in designing the transducer elements.² Various Clevite PZT (lead-zirconium titanate) piezoelectric transducer ceramics and either Ferroxcube or Kearfott piezomagnetic ferrites are used. The polarizing bias is effectively built into the piezoelectric material but is provided for the ferrite by external magnets. This structure is effective from about 100 Kc to 1.2 Mc.

The composite-beam construction is effective in both the extensional mode and the flexural mode. For example, the 20-Kc extensional mode EM gyrator in Fig. 1 can be used at 1 Kc in the flexural mode simply by providing the proper mounting conditions. This operation results because the composite beam structure is initially designed as a flexural unit. Thicknesses of the two transducer elements are chosen so that the interface is at the neutral axis of the beam. In both modes, upper and lower frequency limits are imposed by transducer size and mounting.

EQUIVALENT CIRCUIT — One equivalent circuit for the EM gyrator of either structure is shown in Fig. 2. Losses are not included since electromechanical Q 's are several hundred. The equivalent circuit is verified by the data for a 40-Kc composite beam length expander.

The transducer properties are a function of the design of the elements and are limited by material properties and optimizing of the parameters in the fabricated unit. Bandwidth can be decreased by adding external inductance at the piezomagnetic terminals or capacitance at the piezoelectric terminals. Bandwidth can be increased to as much

as 10 or 12 percent by adding capacitance to the piezomagnetic terminals and inductance to the piezoelectric terminals.³

The padding elements can be connected in a variety of series and shunt configurations to vary system impedance between a few ohms

and well over 10,000 ohms at any of the operating frequencies.

By combining piezoelectric and piezomagnetic transducers with complementary frequency-temperature dependencies, such as PZT-6 and Ferroxcube 7B, EM gyrators have been made with characteris-

MICROWAVE TECHNIQUES AT LOW FREQUENCIES

The usefulness of passive nonreciprocal elements at microwave frequencies has been demonstrated by their wide acceptance. Unfortunately, this usefulness has been restricted because the operating principles of these devices are not applicable at lower frequencies. Nonreciprocal behavior has now been achieved at lower frequencies using other phenomena

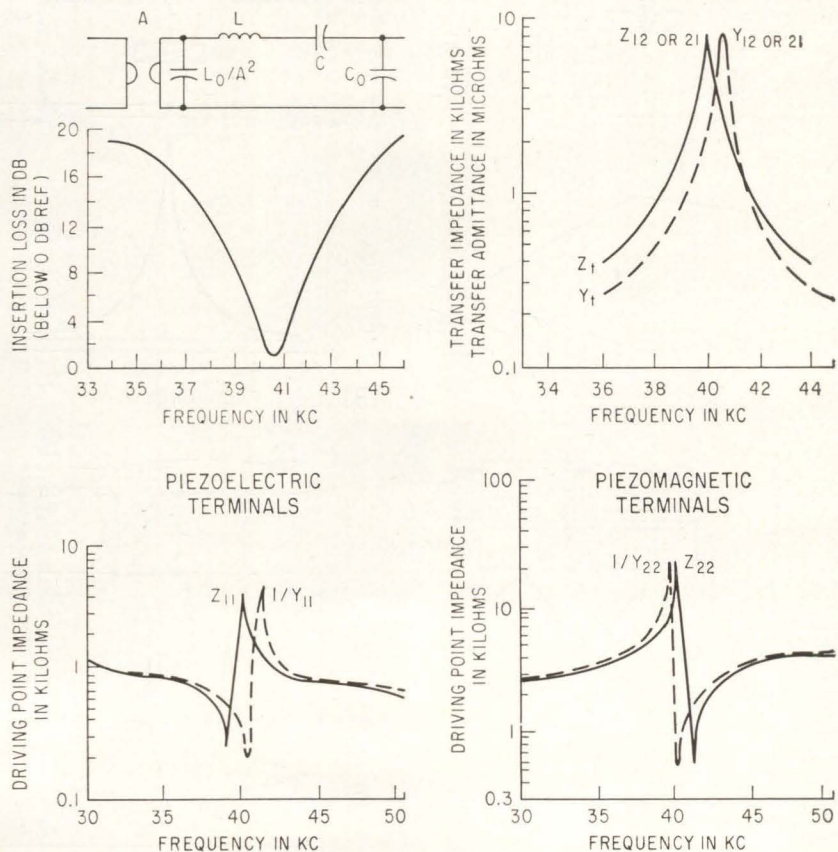

EQUIVALENT circuit at upper left is verified by data plotted for 40-Kc composite beam length expander—Fig. 2

tics stable within ± 0.1 percent over -40 to $+100$ deg C.

HALL GYRATOR—A Hall gyrator can be realized by applying a magnetic field to the Hall transducer and treating the driving pickup electrodes as two terminal pairs or ports. The equivalent circuit, Z parameters and dimensions of an InSb Hall gyrator are shown in Fig. 3A. The Hall gyrator is inherently broad-band, operating from d-c to microwaves. In practice, frequency is limited by the transformers used to couple it to loads.

Theoretical minimum insertion loss of a four-terminal Hall gyrator was calculated to be 7.66 db.⁴ In practice, this loss is 9 to 12 db. It can be reduced by using more than one contact per edge and by connecting these contacts in parallel through multiple secondaries on the driving transformers. A 24-terminal InSb Hall gyrator has a reported insertion loss of only 3 db.⁵

ISOLATORS — To construct an isolator, an external network is required with the EM gyrator.⁶ The

ideal neutralizing network would provide high isolation over a broad bandwidth without reducing system efficiency in the pass direction below that of the gyrator.

Only parallel networks are considered, since four-terminal networks in series with the EM gyrator produce difficulties resulting from leakages and stray capacitance. Network and gyrator transfer admittances should be matched in magnitude and phase within 1 percent for 40-db isolation over the frequency range. Also, network input and output admittances should be much smaller than the gyrator. These requirements are difficult to meet unless frequency range is restricted.

In Fig. 3B, isolation at a single frequency is obtained by neutralizing with a capacitor at peak transfer admittance. Pass direction efficiency exceeds 90 percent with peak isolation at 32 db. An inductor is required in series with the load at the piezoelectric terminals to obtain maximum power transfer. A capacitor in series with the piezomagnetic driving coil

modifies transfer characteristics so a resistor can be the neutralizing element, as in Fig. 3C. Pass direction loss is 2.5 db with average isolation of 20 db.

To neutralize the broadbanded EM gyrator, again first consideration is given to system transfer characteristics, which are of the fourth order. The required fourth-order neutralizing network in parallel with the broadbanded EM gyrator results in the characteristics in Fig. 3D. The 100-Kc composite-beam gyrator is broadbanded by a shunt capacitor at the piezomagnetic terminals and a series inductor at the piezoelectric terminals. These elements are selected to be resonant with the clamped inductance and clamped capacitance of the EM gyrator at mechanical resonance. Isolation remains relatively higher over a considerable band, although the combination has only a 4-percent bandwidth.

It is again possible to neutralize with a resistor. Transmission characteristics are shown in Fig. 3E. Pass bandwidth is only slightly reduced from the broadband gyra-

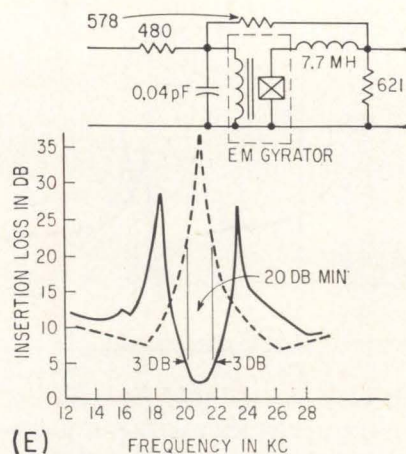
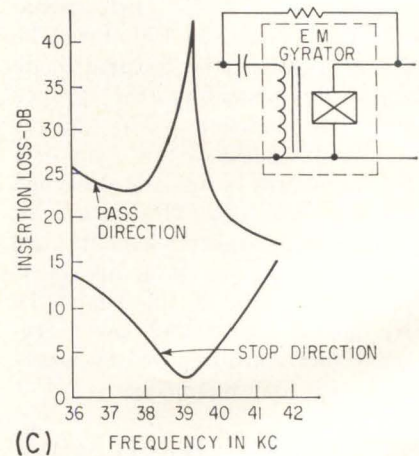
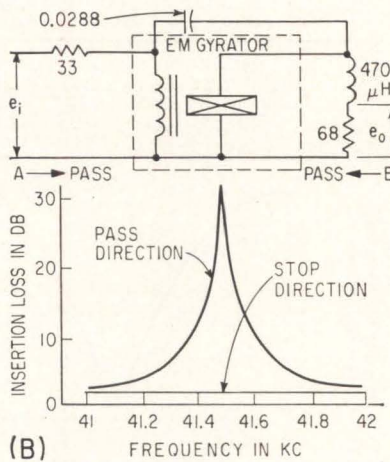
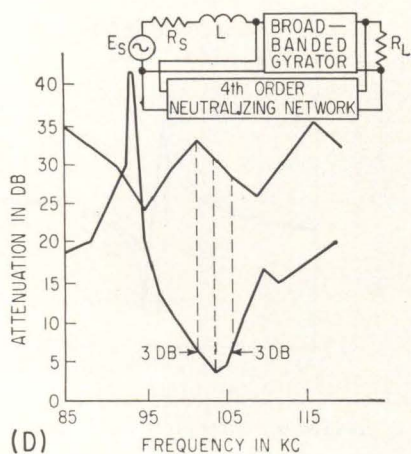
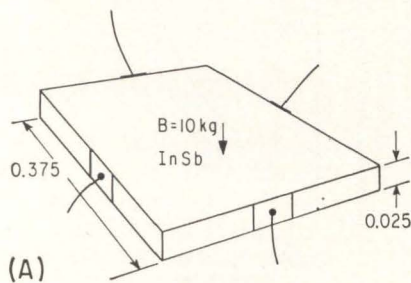
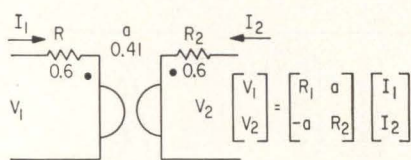

STRUCTURE, parameters and equivalent circuit are shown for a Hall gyrator (A). Isolation at one frequency (B) is obtained by neutralizing with capacitor at peak transfer admittance, while arrangement at (C) permits a resistor to be used. Fourth-order neutralizing network is used with broadbanded gyrator (D), while resistive network (E) is used with 20-Kc broadbanded isolator—Fig. 3

tor, and minimum isolation of 20 db can be obtained over this band.

One neutralizing method results in an acromatic isolator.⁷ A network in parallel with the EM gyrator is an exact duplicate of the pi filter portion of Fig. 2. The network and the gyrator each have a specified resistance in cascade. This arrangement results in an isolator with filter-type pass characteristics and high, constant isolation.

In a modification of this method, the transducer and network are combined into one transducer.⁸ The transducer, which consists of two piezoelectric and one piezomagnetic element (or conversely), yields similar results.

On one Hall isolator, the Hall gyrator is neutralized with resistive networks. A single resistor is sufficient in Fig. 4A. Loss in the pass direction of a Hall isolator is considerably lower than in the same unit used as a gyrator. Pass direction losses of multicontact Hall isolators can be as low as 1 db.⁹

CIRCULATORS—The circulator is a passive multiterminal device in which injected energy circulates preferentially to the next adjacent channel. Power reflected from or delivered by one adjacent channel circulates successively to the next. Network theorists have shown that an ideal gyrator with a third terminal pair added as in Fig. 4B behaves as a circulator if the system is properly terminated.⁹ The circulator is matched for maximum power transfer by the terminations required for circulation.

A nonreciprocal system may be loosely interpreted as an ideal gyrator of complex gyration impedance equal to $1/y_{12}$ and with shunt admittances at the input and output of y_{11} and y_{22} , as in Fig. 4C. A circulator results if the system is connected as in Fig. 4B and properly terminated. Comparisons of the driving point admittances with the required terminations revealed that this type circulator is not matched for maximum power transfer.

The parameters of the Hall gyrator are real, and the parameters of the EM gyrator in combination with external networks can be made real at one frequency.¹⁰ Transducer gains between the various channels calculated in terms of the two-port parameters of the nonrecipro-

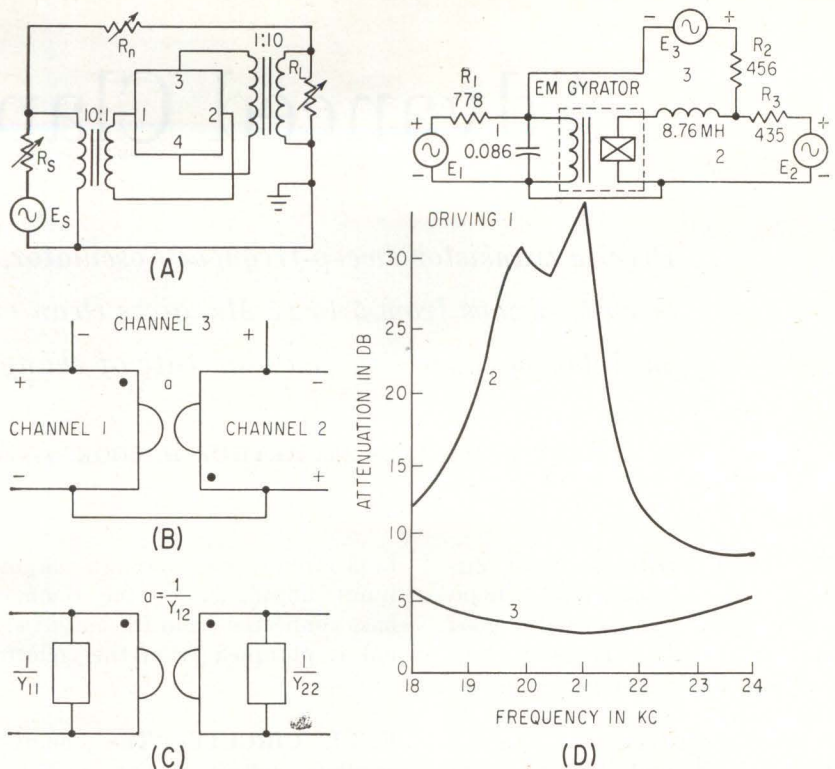

RESISTIVE network (A) neutralizes Hall isolator. Adding third terminal pair to ideal gyrator (B) forms circulator. Nonreciprocal system (C) is interpreted as ideal gyrator with complex gyration resistance. Characteristics are shown driving one channel of EM circulator (D)—Fig. 4

cal system are $G_{112} = [1 - (y_{11}/y_{12})]$ $[1 - (y_{22}/y_{12})]$, $G_{123} = 1 - (y_{12}/y_{12})$ and $G_{131} = 1 - (y_{11}/y_{12})$. Since $G_{112} = (G_{123})(G_{131})$, the loss driving channel one must be greater than the loss driving either of the remaining channels.

In the EM gyrator broadbanded by shunt capacitance and series inductance, the parameters all became real at about the same frequency near the center of the passband. Also, the required termination at any channel is the same as that required to make an isolator of the remaining pair. Thus, it is only necessary to neutralize each channel to block energy flow between the remaining channels.

The characteristics when driving one channel are shown in Fig. 4D. When driving the other channels, characteristics are similar but with

pass direction losses of 2 db and 0.2 db. The direction can be reversed by interchanging connections to the high and ground leads at one end of the gyrator.

The EM gyrator is an inexpensive device that can readily be fabricated of commercially available materials. Hall gyrators are much more expensive and somewhat bulky because of the large biasing magnet required. However, Hall gyrators may be useful because of their passivity and frequency invariance.

Portions of this work were performed under contract to Rome Air Development Center.

The author acknowledges the contributions of D. R. Curran and C. P. Germano of Clevite Corp. and J. D. Schoeffler of Case Institute of Technology.

REFERENCES

- (1) B. D. H. Tellegen, The Gyrator, A New Electric Network Element, *Philips Res Rep*, 3, p 81, 1948.
- (2) C. P. Germano and D. R. Curran, Low Frequency Gytrators, *Proc Electronic Components Conf*, p 24, May 1961.
- (3) W. P. Mason, "Electromechanical Transducers and Wave Filters," D. Van Nostrand Co., Inc., New York, p 235, 1948.
- (4) R. F. Wick, Solution of the Field Problem of the Germanium Gyrator, *J Appl Phys*, 25, p 741, June 1954.
- (5) G. Arldt, Efficiency and Linearity of Multicontact Hall Plates, *Intl Solid*

- State Circuits Conf*, Feb. 15, 1961.
- (6) J. H. Silverman, D. R. Curran and J. D. Schoeffler, Passive Electromechanical Gytrators and Isolators, *Proc Natl Electronics Conf*, p 521, October 1961.
- (7) H. Gamo, On Passive One-Way Systems, *Trans Intl Symp on Circuit and Info Theory*, p 283, 1959.
- (8) M. Onoe and Mitsuo Sawabe, A Piezoelectric-Piezomagnetic Gyrator, *Proc IRE Intl Conf*, March, 1962.
- (9) J. E. Storer, "Passive Network Synthesis," McGraw-Hill Book Company, New York, p 239, 1957.
- (10) J. H. Silverman, The Electromechanical Circulator, *IRE Trans on Component Parts*, 2, p 81, June 1962.

Advanced Clapp Oscillator

Precise transistor sweep-frequency oscillator, based on Clapp circuit, sweeps from 5 to 15 Mc, gives clean output waveform, high frequency modulation capability and high rate of change of frequency

By ROBERT E. DANIELS and ARTHUR D. COOK, Argonne National Laboratory, Argonne, Illinois

THE SIMPLIFIED oscillator circuit (Fig. 1) is essentially a transistor Clapp^{1,2} circuit with good frequency stability. Transistors Q_1 and Q_2 are in the common-collector configuration. The tank circuit is composed of inductor L_1 and capacitors C_1 , C_2 , and C_3 in the configuration suggested by Clapp. The resonant frequency of this circuit is determined by inductor L_1 and the equivalent capacitor C_E

$$C_E = \frac{C_1 C_2 C_3}{C_1 C_2 + C_2 C_3 + C_1 C_3}$$

If capacitors C_2 and C_3 are much larger than C_1 , then $C_E \approx C_1$, and the effects of capacitance changes in C_2 and C_3 , including the transistor shunting capacitance, are greatly reduced. The frequency of the oscillator is then determined by L_1 and C_1 and is independent of transistor parameters.

The signals across capacitors C_2 and C_3 are at a low impedance; however, this is where feedback occurs and these signals are distorted. A much cleaner output signal can be obtained by connecting a transistor, in the common-base connection, into the ground return lead of L_1 . The circulating current in the

tank circuit flows through the low-input impedance of the common-base connection, and the output signal is obtained from the collector load.

FULL CIRCUIT—The complete oscillator circuit is shown in Fig. 2. The inductance is a Vari-L Model EXP-146 (see photo), with 80 turns on the r-f winding and 148 turns on the bias winding. Rough tuning is accomplished by adjusting the bias current, which changes the permeability of the ferrite core and the inductance of the r-f winding. The oscillator frequency changes from 5 to 15 Mc for a current change from zero to 800 ma. The frequency sensitivity to bias current can be increased by increasing the number of bias turns.

Capacity C_1 is composed of a 6.8-pf mica capacitor in parallel with two Varicaps, connected cathode to cathode. The reverse bias on these Varicaps can be varied to provide an oscillator fine-tuning adjustment with a range of about ± 3 percent. Modulating frequencies higher than 100 Kc can be used with this input.

Choke L_2 provides a d-c path for the quiescent current through tran-

sistor Q_3 and is chosen to appear as a small capacitor at the operating frequencies. Resistor R_3 adjusts the quiescent current.

The Q of the tank circuit changes with frequency and the collector voltage is servoed to maintain a constant output amplitude. The simple servo shown in Fig. 2 regulates the output amplitude to about 1 volt ± 10 percent across the frequency band.

This circuit is immersed in a constant temperature, silicone oil bath with the ferrite immersed directly in the oil. The frequency is swept from 5 to 15 Mc, fifteen times a second with the rate of change of frequency as high as 200 Mc/sec². The drift over a six month period has been less than 0.1 percent.

APPLICATION—The oscillator is part of a wideband frequency shifter, which generates a signal 1 Mc higher in frequency than a programmed 4 to 14-Mc reference signal.

The 4 to 14-Mc signal is generated by an oscillator similar to the one described, and it is programmed by an analog signal obtained from our synchrotron. This same analog

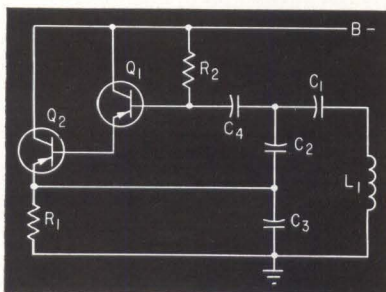

SIMPLIFIED CIRCUIT, a Clapp oscillator—Fig. 1

HOW IT'S BEING USED

The zero-gradient synchrotron now under construction at Argonne National Laboratory requires a precision sweep-frequency oscillator for the radio-frequency accelerating system. This oscillator must be electrically tunable across the frequency range of 5 to 15 Mc, and should have both rough and fine tuning.

A zero-gradient synchrotron is a charged-particle accelerator that has a uniform magnetic field and therefore no gradient

Features 3-to-1 Dynamic Range

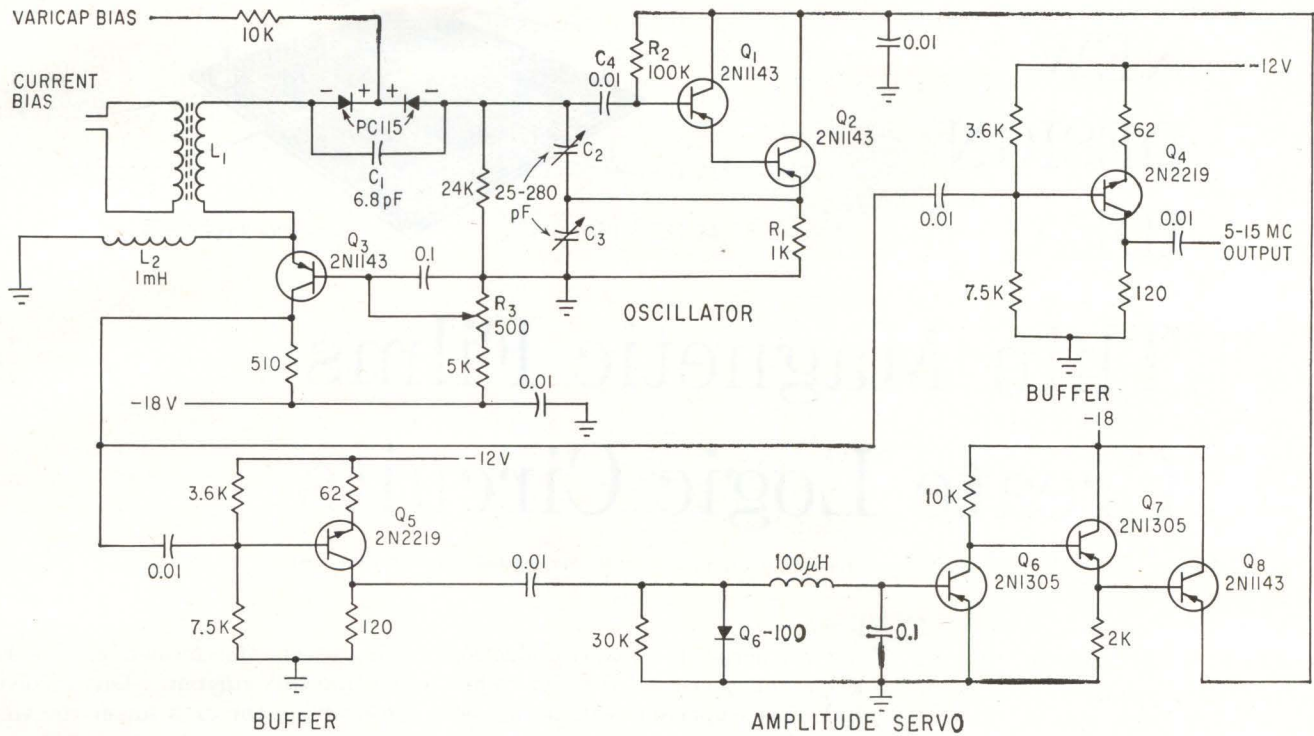

SWEEP FREQUENCY OSCILLATOR with output buffers and amplitude servo—Fig. 2

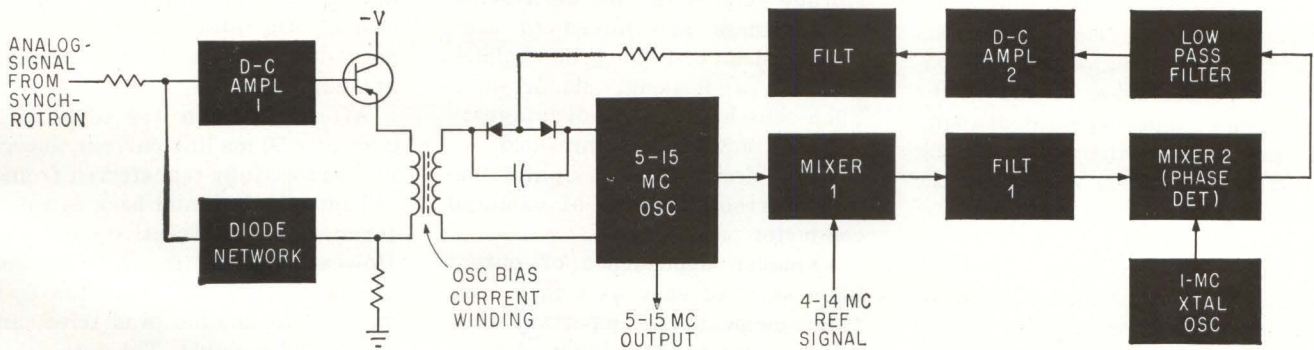

WIDEBAND FREQUENCY SHIFTER built around sweep frequency oscillator—Fig. 3

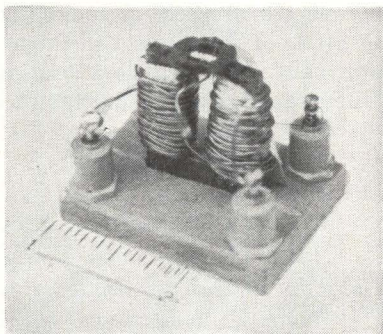

INDUCTOR L_1 for sweep-frequency oscillator

signal is connected to the input of the diode function generator, shown in Fig. 3, which provides rough tuning of the 5-15 Mc oscillator.

The output of the 5 to 15-Mc oscillator is mixed with the reference 4 to 14-Mc signal, and the difference signal recovered at the output of filter 1. This difference signal is mixed with a 1-Mc signal from a crystal oscillator in a phase detector and the output is filtered, amplified, and then connected to the Varicap input of the 5 to 15-Mc

oscillator. This causes the 5 to 15-Mc oscillator to track the 4 to 14-Mc oscillator across the band. The servo has a correction range of about ± 100 Kc.

This work was performed under the auspices of the U. S. Atomic Energy Commission.

REFERENCES

- (1) J. K. Clapp, An Inductance-Capacity Oscillator Of Unusual Frequency Stability, *Proc IRE*, Vol. 36, p 356, Mar. 1948.
- (2) E. Keonjian, Stable Transistor Oscillator, *Trans IRE—Circuit Theory*, p 38, Mar. 1956.

MAGNETIC FILM gate employs magnetic-film conducting substrate and a floating planar linkage

NEW DESIGN IDEA

Thin Magnetic Films Create Logic Circuits

By M. Williams The General Electric Co. Ltd., Central Research Labs, Wembley, England

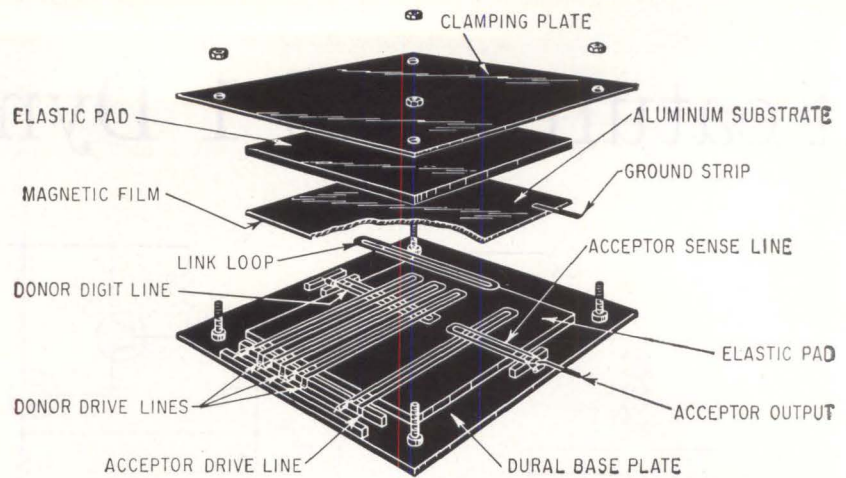

A SIMPLE method of linking multi-element magnetic film memory cells has been used in the construction of a magnetic film gate. The method relies on the magnetic film having a conducting substrate. Linkages between cells are made by a floating planar conducting loop that transfers majority information by conservation of flux in the closed link. The exploded drawing of the gate and the accompanying general explication will make the method clear.

LINKAGE PROBLEMS—The idea of using the outputs of a group of magnetic film storage cells (using orthogonal fields) as the digit current for another cell is fairly obvious, but the realization of practical devices is difficult and descriptions have necessarily been speculative.¹

One difficulty is that although the flux may be temporarily conserved in a short-circuit link, most of the flux change neutralizing the flux of one film cell may simply be an air flux change. This can be overcome, in principle, by a conducting substrate², which gives a low inductance to conductors close to the substrate.

A second difficulty is closing the link. Joining it to the substrate is

not attractive for mass production and involves risks to the film. When links are superimposed, fixing becomes even more difficult.

A simple solution to these problems is afforded by symmetrical storage cells with two digit/sense lines³: these are joined to each other instead of to the ground plane, forming a floating, planar link. Such cells have these advantages:

- Very low writing threshold
- No electrostatic coupling between orthogonal sets of balanced conductor pairs
- Smaller dependence of output upon skew of easy axis than with single-element cells, important when cell outputs must balance one another in majority logic.

GATES—If four cells share a link, as in the figure, the majority output of three can set the fourth. If two cells store input information while the third stores a digit dictating the function, the unit forms an AND or OR gate, as in phase logic⁴.

In experiments, the conductors were 40 mil \times 1 mil aluminum, anodized for insulation. The 80Ni 17Fe3Go film², 1,500 Å thick, was on a polished Al substrate; it had $H_k = 2.4$ oersted and $H_c = 3.4$ oersted.

First trials involved activating a

single cell and measuring the resulting link current. This involves measuring the area under the voltage waveform from a conductor having a mutual inductance with the link. Breaking the link, putting in a known current pulse, and repeating the observation makes it possible to calculate the original link current.

After insulation was adjusted to give over 50 ma link current, energy was successfully transferred from a cell into the link and back again (a form of nondestructive readout). However, during many repetitions the signal fell off. Transfer from one cell to another was tried, and was found possible. The gate shown in the figure was then tested: digits were written into the three donor cells, and majority information was transferred, although the magnitude of the flux set in the acceptor cell varied a little according to the order in which digits were written into donor cells.

REFERENCES

- (1) W. E. Proebster and H. J. Oguey, High-Speed Magnetic-Film Logic, *Digest of 1960 International Solid-State Circuits Conf.*, p 22, Feb. 1960.
- (2) E. M. Bradley, *J Appl Phys*, 33 Suppl., p 1051, 1962.
- (3) M. Williams, *Proc Inst Elec Engrs*, London, 109 B, Suppl. 21, p 186, 1962.
- (4) R. L. Wigington, *Proc IRE*, 47, p 517, 1959.



ZZZT Put 10,000 volts to this

ribbon of glass and its properties won't break down. This is the proven dielectric that goes into all Corning capacitors. Its dissipation factor is less than .001. Its TC holds within 10ppm with absolute retrace. Its *radiation resistance* withstands 10^{18} NVTth. Put it to work for you in axial or radial lead capacitors wherever superior stability and reliability are considerations. Call your Corning distributor or write us for technical data sheets.

**CORNING
ELECTRONICS**

A DIVISION OF CORNING GLASS WORKS
3901 ELECTRONICS DRIVE, RALEIGH, N. C.



Harbor Control by OKI Electric

As shipping grows and harbor facilities become more complex, the job of control increases. To meet this problem, Japan has elected to use a millimeter wave radar system. This new system, radically different from those previously used, will be installed in the near future in ports throughout Japan. It combines ultra-high definition millimeter wave radar with CM-wave radar to make a highly efficient all-weather dynamic harbor supervision network. Reception is excellent and even buoys and mooring lines are reproduced with minute accuracy. Range and bearing resolution are accurate to within two to three meters. It is also highly effective under poor weather conditions and at maximum ranges. The core of this network, the millimeter wave generator, is made by OKI Electric, a leading maker of millimeter wave radar and telecommunications equipment. Presently under development for this system is an improved, higher capacity tube with a serviceable life of 10,000 hours. For information about these and other electronic system, write to OKI Electric Industry Co., Ltd.



Butler Roberts Associates, Inc.
A Subsidiary of OKI Electronics of America
202 East 44 Street, New York 17, N.Y.
MU-2-2989

10 Shiba-Kotohira-cho, Minato-ku, Tokyo, Japan Cable Address: "OKIDENKI Tokyo"

CIRCLE 201 ON READER SERVICE CARD

FAST DELIVERY

ANYWHERE

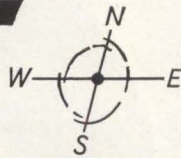

MIDWEC INSTRUMENT GRADE MYLAR DIELECTRIC

Ca-pac-i-tor's

Best Shipping Interval In The Industry—3 Weeks Standard
High Reliability and Quality
Competitively Priced

Specialists In Low Tolerance Units

Approved for use in Talos, Minute Men, Titan, Typhon,
Telephone Companies ■ 100% Test for dielectric strength,
capacitance, insulation resistance and dissipation factor

MIDWEC
OSHKOSH, NEBRASKA

write for
data sheets
and prices

SALES OFFICE: 601 So. Jason St., Denver 23, Colo.
TWX: 292-3891—Telephone SH 4-3481—DDD 303

64 CIRCLE 64 ON READER SERVICE CARD

IEEE

MEET

THE BEST BRAINS,
THE BEST PRODUCTS
IN THE INDUSTRY

at

I-TRIPLE-E's

International Convention
and Exhibition in New York

MARCH 25, 26, 27, 28

The COLISEUM at Columbus Circle
& The WALDORF ASTORIA HOTEL

admission: MEMBERS \$1.00; NON-MEMBERS \$3.00
MINIMUM AGE: 18

SHOW

(formerly the IRE Show)

electronics

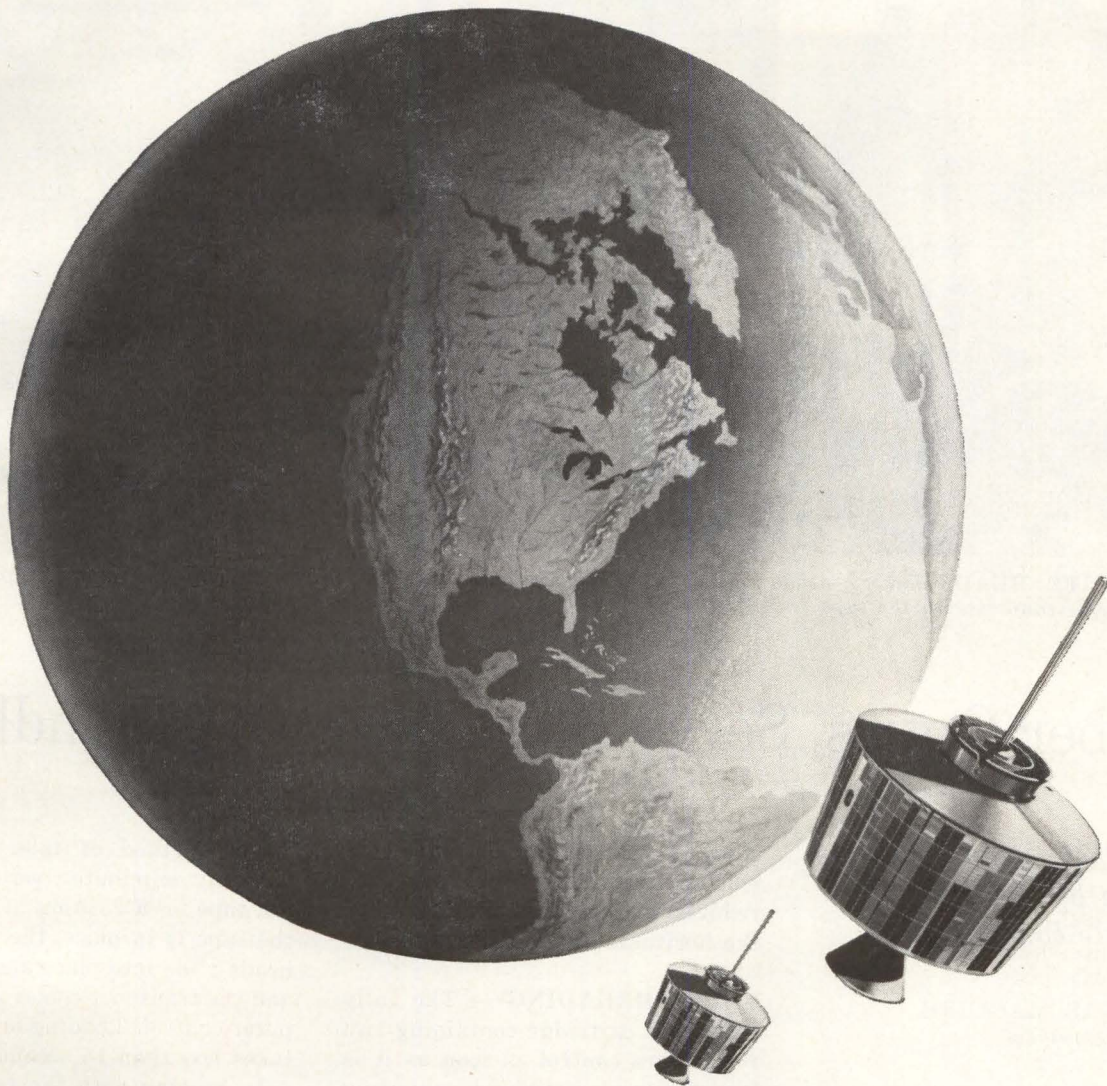

circuit designers...is your appointment in space with Hughes?

Today, Hughes is one of the nation's most active space/electronics firms. Projects include: MMRBM (Mobile Mid-Range Ballistic Missile—Integration, Assembly & Checkout), TFX(N) Electronics, SURVEYOR, SYNCOM, VATE, BAMBI, POLARIS guidance and others.

This vigor promises the qualified engineer or scientist more and bigger opportunities for both professional and personal growth.

Many immediate openings exist. The engineers selected for these positions will be assigned to the following design tasks: the development of high power airborne radar transmitters, the design of which involves use

of the most advanced components; the design of low noise radar receivers using parametric amplifiers; solid state masers and other advanced microwave components; radar data processing circuit design, including range and speed trackers, crystal filter circuitry and a variety of display circuits; high efficiency power supplies for airborne and space electronic systems; telemetering and command circuits for space vehicles, timing, control and display circuits for the Hughes COLIDAR* (Coherent Light Detection and Ranging).

If you are interested and believe that you can contribute, make your appointment today.

Please airmail your resume to:

Mr. Robert A. Martin
Head of Employment
Hughes Aerospace Divisions
11940 W. Jefferson Blvd.
Culver City 49, California

We promise you a reply within one week.

Creating a new world with ELECTRONICS

HUGHES

HUGHES AIRCRAFT COMPANY

AEROSPACE DIVISIONS

An equal opportunity employer.

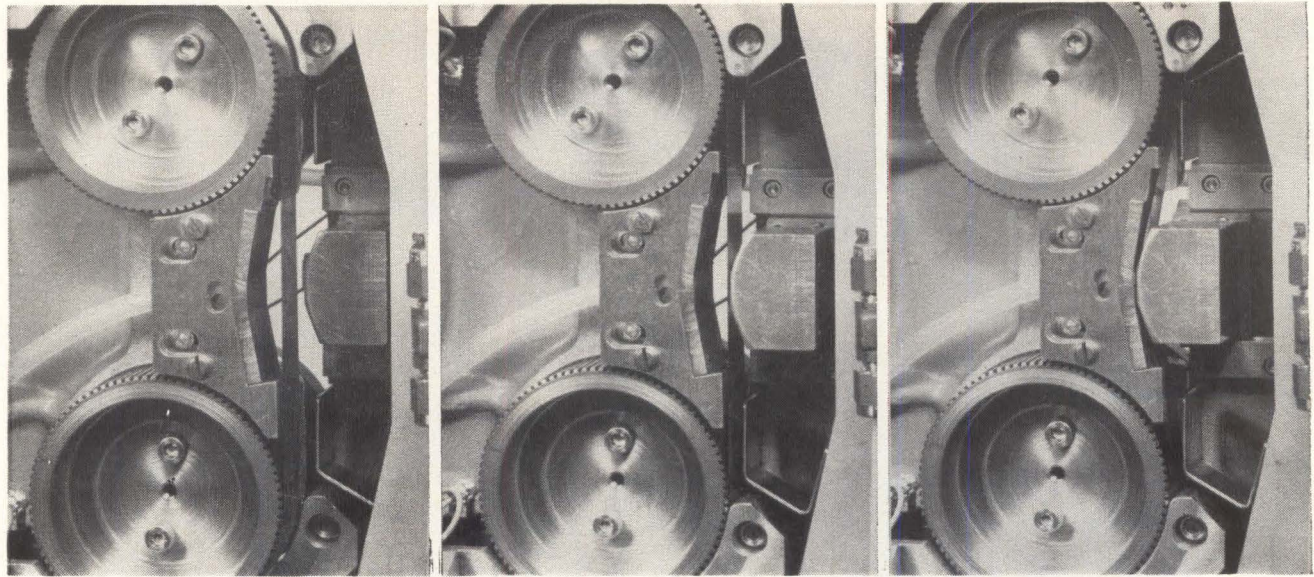

READ-WRITE HEAD, shunted aside to permit automatic threading of the tape, at left, is shown in process of returning for contact with the tape

Fiber Optics, Servo Built Into Tape Handler

Cartridge-loading unit run by fail-safe solid-state controls

By THOMAS MAGUIRE
New England Editor

FIBER-OPTICS sensing and a fully solid-state control system for automatic loading are incorporated in a compact, ruggedized magnetic-tape handler designed for military computers in field and shipboard applications.

The cartridge-loading tape transport is the result of two years of development work by Sylvania Electronic Systems. At the Data Processing Operation in Needham, Mass., units are being built under Army and Navy contracts.

About one-fourth the size of commercial tape handlers, the peripheral equipment is adaptable to any existing EDP system and is designed for operation in military environments by basic EDP personnel.

Reduced size of the units, 19 in. by 23 in. by 24 in., results from

compact packaging of data and control circuitry, also a design which reduces to 13 inches the length of the horizontal tape buffer wells.

TAPE THREADING — The fully automatic cartridge containing two reels takes control as soon as it is inserted and activated, shunting aside the read-write heads to permit threading of the tape. The tape is automatically drawn from the cartridge by air pressure and threaded into the low-vacuum horizontal buffer wells by a pneumatic

drive. Method of tape movement virtually eliminates wear, floating the tape on a cushion of air. Once the tape is in place, the read-write heads glide into place automatically and the transport comes under computer control. Loading or unloading takes less than 15 seconds.

In keeping with the requirement of small size, a proportional control servo with rate feedback is designed around a d-c torque motor driven by a transistor amplifier. This servo permits a seven-inch reel of one-inch tape to operate at 100 inches

IN-OUT BOTTLENECK

With digital and control electronics getting smaller and smaller, the peripheral input-output equipment is overshadowing computer electronics in size and weight requirements.

This story tells about one solution to this problem—a solution dictated by military needs but equally relevant to commercial computers. Development was stimulated by need for device which would operate reliably in a military environment with computers such as the Army's MOBIDIC and—for field operation—the need for a fool-proof machine operationally simple and with minimum handling and operating stresses on the magnetic tape

can you use the advantages of Kepco's STATIC MAGNETIC VOLTAGE STABILIZER

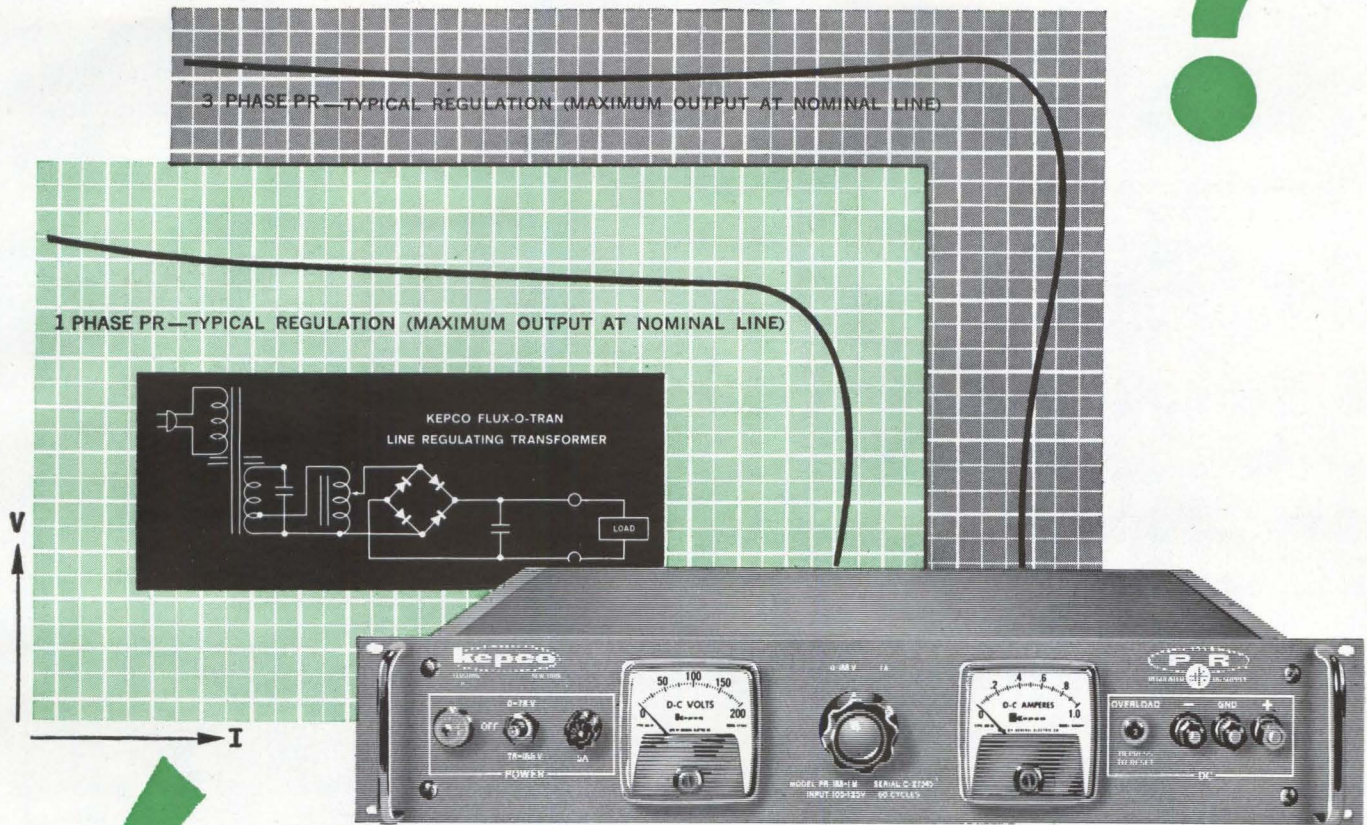

Model PR 155-1M



KEPCO POWER SUPPLIES

Kepco's **FLUX-O-TRAN** is a ferro-resonant static magnetic voltage stabilizer. Its design characteristics feature:

- output essentially free of line voltage variations
- isolation of line transients
- current limiting protection from current overloads and external short-circuit

The **FLUX-O-TRAN** is the heart of Kepco's PR GROUP of DC Power Supplies. By delivering a squared-waveform to the rectifier, the **FLUX-O-TRAN** increases rectifier utilization and improves the loading characteristics of the filter capacitors. This characteristic

provides a relatively low intrinsic source impedance, improving load regulation and affording a low ripple content. The result is a simple **FOOL-PROOF**, high efficiency source of regulated DC power in *minimum* space and at *minimum* cost.

The PR GROUP offers a wide choice of adjustable output voltage and output ratings with:

- typical ripple values 0.5 to 3%
- overcurrent protection
- no voltage overshoot
- power efficiency typically 50-70%
- reliable, efficient silicon full-wave rectification

± 1% LINE REGULATION — 105-125 V AC, 60 CPS ± 5% — 1 PHASE											± 2% LINE REGULATION 208/230 V AC ± 10% 60 CPS ± 5% — 3 PHASE		
VOLTS	0-7.5-15	0-15	0-19-38	0-38	0-40-80	0-80	0-78-155	0-155	0-165-310	0-310	0-20	0-40	0-50
AMPS	0-10	0-30	0-5	0-15	0-2.5	0-8	0-1	0-4	0-0.6	0-2	0-100	0-50	0-40
MODEL	PR 15-10M	PR 15-30M	PR 38-5M	PR 38-15M	PR 80-2.5M	PR 80-8M	PR 155-1M	PR 155-4M	PR 310-0.6M	PR 310-2M	PR 20-100M	PR 40-50M	PR 50-40
PRICE	\$345	\$495	\$325	\$475	\$325	\$450	\$325	\$430	\$345	\$430	\$1,125	\$950	\$950

for complete specifications on more than 250 standard models, write for NEW Catalog B-631

See our Catalog in  



131-38 SANFORD AVENUE • FLUSHING 52, N.Y., U.S.A.
Phone (212) IN 1-7000 • TWX# (212) 539-6623
Cable Address: KEPCOPOWER, NEWYORK

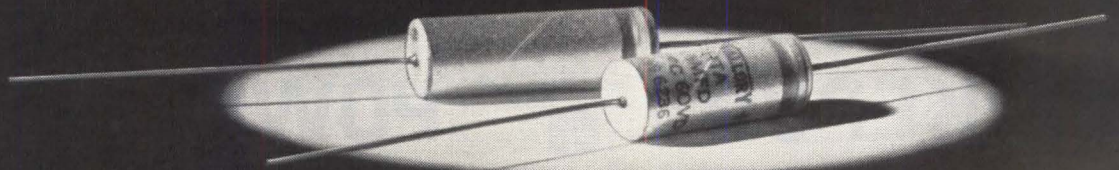

TAKE A NEW LOOK AT CAPACITOR RELIABILITY

The new breed of aluminum capacitors now emerging from Mallory engineering will emphatically change your ideas about the high cost of high reliability. Some of our newest developments have life expectancy, temperature capability and electrical characteristics approaching those of tantalum capacitors . . . at substantially lower prices.

Example: our new Type HTA aluminum electrolytic, rated at 125°C at full voltage.

Example: our new Type TPG, an 85°C aluminum capacitor which has shown exceptional stability and virtually zero failure in over a million piece-hours of certification testing.

Manufacturers faced with long warranties and tight production budgets find that these new capacitors hold exciting possibilities for electronic data processing equipment, appliances, automotive and commercial electronics. Full range of ratings and types to choose from: Computer and Premium grades; High-Capacity units, MIL-C-62 types and Miniatures.



WRITE TODAY for complete data, and engineering consultation on your own needs.

Mallory Capacitor Company
Indianapolis 6, Ind.
a division of

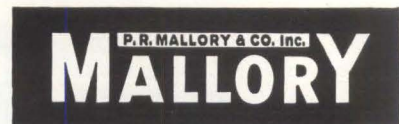

**Get Mallory High Reliability
Aluminum Electrolytics
from Mallory
Industrial Distributors
—prompt delivery—factory prices**

Computer Grade Type CG, for example. Quality and reliability suitable for use in computer power supply filters. Life-tested the equivalent of 20 years at 40° C. The following standard ratings are carried in stock by Mallory distributors. All have Mylar* sleeves. The D case is 2" by 4 1/8", the F case is 3" by 4 1/8".

Capacitance (mfd)	WVDC	Mallory No.
36000	3	CG-363U3D1
75000	3	CG-753U3F1
27500	5	CG-2752U5D1
65000	5	CG-653U5F1
18000	10	CG-183U10D1
43500	10	CG-4352U10D1
14000	15	CG-143U15D1
34000	15	CG-343U15F1
8500	25	CG-852U25D1
20000	25	CG-24U25F1
4500	50	CG-452U50D1
10000	50	CG-15U50F1
3450	75	CG-3451U75D1
8200	75	CG-822U75F1
2250	100	CG-2251U100D1
5300	100	CG-532U100F1
1550	150	CG-1551U150D1
3600	150	CG-362U150F1
1000	200	CG-13T200D1
2450	200	CG-2451T200F1
800	250	CG-82T250D1
1900	250	CG-192T250F1
700	300	CG-72T300D1
1650	300	CG-1651T300F1
550	350	CG-551T350D1
1300	350	CG-132T350F1
325	400	CG-3250T400D1
240	450	CG-241T450D1

Thousands of other ratings available on special order. Also stocks of standard ratings of HC and NP high-capacity heavy-duty electrolytics, FP and WP tubular electrolytics, miniature Type TT and many commercial and industrial grades.

For the name of the nearest Mallory distributor, write to:

**Mallory Distributor Products Co.
P. O. Box 1558
Indianapolis 6, Indiana**

*Du Pont trademark

per second with a buffer well only 13 inches long. A photoconductive position-sensor using cadmium selenide photocells senses tape position within this well and provides a d-c error signal proportional to the position of the tape loop. Current limiting prevents excessive tape acceleration, also prevents overdissipation in the drive.

FIBER OPTICS—Tape volume on each reel is sensed at the inlet to each vacuum well with an optical tape-control sensing device. The fiber optics are arranged at one end to form a narrow split aperture, with the opposite end of the fibers facing an array of photocells. The position of the tape at any given time will automatically adjust the signal output from the optical control sensing device. This output signal controls the driving rate of the real servo motors.

An additional servo loop is used for slow-speed operation— $\frac{3}{4}$ -inch per second—to sense the rate at which information is read from the tape and to vary the capstan speed so as to maintain a constant flow of information in synchronism with an external frequency. This permits use of the transport for transmission across telephone lines. Speed control is achieved by a voltage-to-frequency converter in conjunction with a synchronous motor.

The all-transistor logic exercises direct sequential control with no dependence on memory elements. It interrupts the closed-loop reel servo, takes control of the reel motors and—upon information from the well optics—directs the motors to load tape to the center of the well.

Fail-safe logic is built into the system to protect the tape. No voltage means no operation. The control system also can sense loss of vacuum, pressure or voltage in any subsystem, loss of the tape itself in the well. Operation is halted, the computer is notified and the alarm situation is displayed on the face of the tape handler, can also be displayed in the computer readout.

SERVO SYSTEM—The servo system senses both mass and position of tape and uses this combination of information to control feedback. The fiber optics technique, since it senses mass or diameter, also tells

the servo system when end of tape is approaching, so reel speed is reduced to eliminate overshooting.

For tape start-stop, a pneumatic pressure clamp technique is used in combination with electronic pulse control and electromagnetic valve drive. The high-speed valve is mounted in a manifold which is spaced in close proximity to a synchronous rotating capstan. The capstan has a specially designed surface pattern which allows the magnetic tape to be rapidly brought into mutual coupling when the high-speed valve is triggered and pressure is applied in the manifold. This surface pattern also allows for a rapid release of this tape when the pressure is turned off at the valve.

The use of pneumatic pressure to drive tape increases reliability and life of the tape since the only surface to come in contact with the oxide side of the tape is the magnetic head. The simplicity of the pneumatic drive technique eliminates complex adjustments.

For high-density circuit packaging, all digital electronics are contained in three-dimensional encapsulating sticks utilizing parallel-plate cordwood assembly techniques. The semiconductors are mounted into recesses molded into the side walls making them accessible for replacement and putting them directly into the cooling air stream.

How PCM Telemetry Helped Reactivate Telstar TV

ONE of the keys to the reactivation of radiation-disabled Telstar was its pulse-code modulated (PCM) telemetry system, contained in an 8-pound, 120-channel telemetry package within the satellite.

Built by Radiation, Inc., the solid-state telemetry unit was packaged for severe shock and acceleration, in the form of matrix of foam-encapsulated modules, held together and shielded by a light aluminum box.

The PCM telemetry system was still functioning after the radiation-induced failure occurred in the command circuit. Radiation disabled Telstar when a build-up of high-energy electron charge occurred around a semiconductor

**Preston
Neff
can
show
you...**

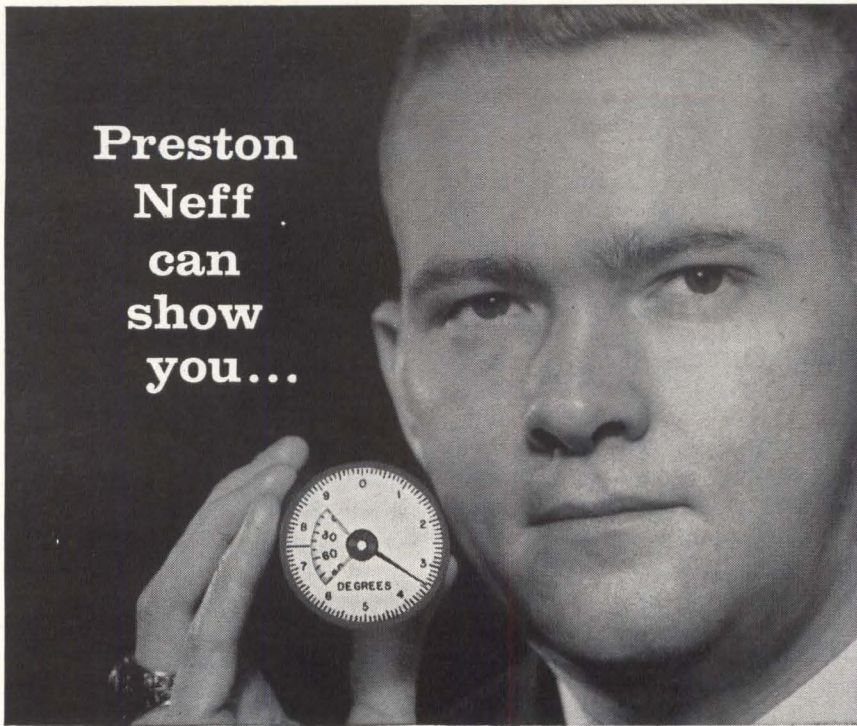





Sales Engineer, Brogan Associates, Inc.

how North Atlantic's instrument servos fill the five major systems jobs... exactly.

Measurement, remote display, data conversion, control, computation... Name the task and it's probable that the North Atlantic man can show you how to meet it precisely from NAI's comprehensive line of 3" and 2" vacuum tube and all solid state instrument servos.

Production models are available for high- and low-level ac, dc, synchro, strain gage, thermocouple, resistance bulb and other inputs. Most can be supplied with choice of pointer, counter, torque shaft or digitizer outputs. All utilize flexible design that permits any combination of input-output features to be supplied rapidly to user requirements, for both ground and airborne applications. Some are described below.

<p>SBI-201 Single Pointer DC Ratiometer</p>  <p>Input Denom. 5-50v Num. 10 mv-100v Accuracy $\pm .2$ to $\pm .5\%$ fs Resolution .1 to .2% Response .25 sec. fs</p>	<p>SBI-401 A-to D Converter</p>  <p>Input 10 mv to 100v dc Accuracy $\pm .1\%$ fs Resolution from 0.05%* Response from 2 sec fs* *depending on encoder used</p>	<p>SBI-501 Shaft Position Repeater</p>  <p>Input ac, dc or synchro Accuracy $\pm .1$ to $\pm .5\%$ fs Resolution .05 to .25% Response 7 sec. @ 15 oz-in</p>	<p>SBI-502 Three-Digit Counter Readout</p>  <p>Input ac, dc, or synchro Accuracy ± 0.5 to .1% fs Resolution .02 to .05% Response 15 sec. fs</p>	<p>SBI-503 Dual Scale Readout</p>  <p>Input ac, dc, or synchro Accuracy .05 to .1% fs Resolution .02 to .05% Response 6 sec. fs</p>
---	--	---	--	---

If there's a critical job for an instrument servo in your system design, it will be worth your while to talk to your North Atlantic engineering representative. For his name, call or write today. Or request Catalog SFC-1 for complete data.



NORTH ATLANTIC industries, inc.
TERMINAL DRIVE, PLAINVIEW, L. I., NEW YORK • OVerbrook 1-8600

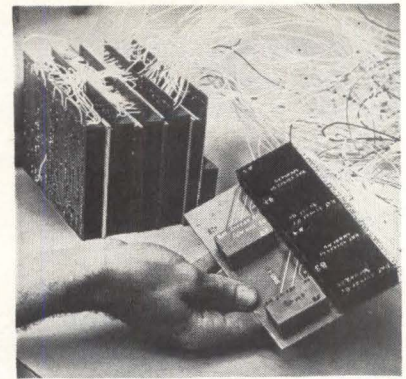

PCM TELEMETRY system for Telstar in modular packages for environmental resistance

within the zero detector circuit of the on-board redundant decoders.

The zero detector circuit is normally on at all times. A method had to be found to shut off its power to enable restoration of the semiconductor. The satellite is normally commanded by three separate start codes comprising a command code. Of the two detectors aboard, one recognizes zeros, and the other recognizes ones, the "one" being a long pulse and "zero" a short one.

REACTIVATION CODE — Bell Telephone Laboratories engineers felt that by inserting a notch into the long "one" pulse, they might succeed in forcing the "one" detector to recognize a pseudo-zero bit. They experimented with the width and shape of this notch before finding the successful shape; eventually the "one" detector was made to operate in a mode for which it had not been designed.

Tracking Accessories Keep Radar on Target

TWO RADAR ACCESSORIES — a programmer and an infrared tracker — will allow conventional tracking radars to follow high-speed rockets as they are launched, RCA says.

The programmer stores information about the angular velocity of the rocket or missile. The firing signal goes to the rocket and radar simultaneously and the programmer automatically slews the radar to follow the rocket.

The infrared acquisition system locks onto the rocket exhaust, enabling the servo loops to keep the radar on the target.

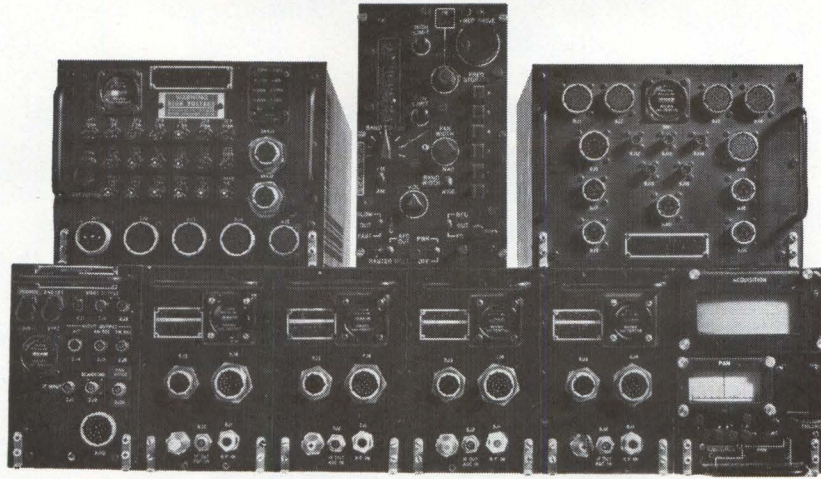

**The quality of our IF strips
has been hidden within our systems...**

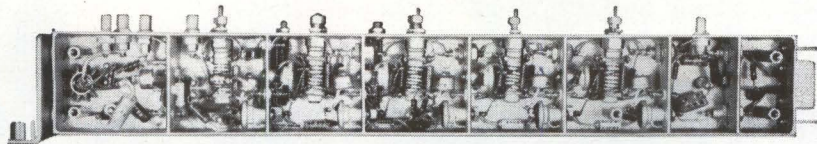

until now.

What's behind Loral's success in meeting—or exceeding—MIL-SPECS in the creation of "black boxes," both systems and subsystems, for the military for over 15 years?

The quality built into components such as this IF amplifier.

This unit, one of a series of IF amplifiers operating at center frequencies from 30 to 160 megacycles, was developed for a Loral system that meets MIL-E-5400. It is now ready for YOU through our General Products Division.

Such amplifiers are available as virtually "off-the-shelf"

items and are representative of Loral's R & D capacity to create electronic components that are the best possible buy in the smallest, most reliable package—Value Engineered throughout.

We may have, right now, the electronic component that will help YOU do an important defense job while saving YOU the unnecessary time and cost of undertaking your own R & D. For further information on our complete line of amplifiers and other precision microwave products, write: General Products Division, LORAL ELECTRONICS CORPORATION, 825 Bronx River Avenue, The Bronx 72, New York.

MIL SPEC	MIL-E-5400	BANDPASS RIPPLE	0	GAIN CONTROL	Yes	INPUT IMPEDANCE	50 ohms
PART NUMBER	IF-301	WEIGHT	11.5 oz.	AGC	Yes	OUTPUT IMPEDANCE	50 ohms IF 91 ohms video
CENTER FREQUENCY (MCS)	100	TRANSISTOR COMPLEMENT	2N1195	POWER REQUIREMENTS	25v 110 ma		VOLTAGE GAIN
BANDWIDTH AT 3db (MCS)	20	NOISE FIGURE db	7 db	DIMENSIONS	11 x 1 1/4 x 1		



You are cordially invited to visit our booth at the IEEE Show, March 25-28, 1963.



If you're a Space Electronics Engineer . . .

YOU SHOULD BE AT COLLINS

Why? Because Collins offers you a chance to make significant contributions to some of the most important space communication work now being done. □ To date, Collins has engineered the communication systems which have carried American voices from space in every flight from the X-15 to Astronaut Schirra's 6-orbit flight. Our engineers are currently readying extensive systems for NASA's Apollo manned lunar spacecraft. □ What's next? □ Further investigation into the field of space communication. Further development and refinement of the equipment and systems needed for future space flights. Further extension of Collins' leadership in the field through research, development, design and the practical application of the results in these areas to future space communication needs.

Specialists in the fields of HF, VHF and UHF equipment. Information theory, digital communications, TV, radar, and modulation techniques. Tracking and ranging. Spacecraft antennas and ground systems.

A degree in E.E., M.E., Mathematics or Physics. And since our space communication projects are in various stages of development, we need experience at all levels.



Write, noting
Dept. EL, to:

L. R. Nuss
Collins Radio Company
Cedar Rapids, Iowa

C. P. Nelson
Collins Radio Company
Dallas, Texas

E. D. Montano
Collins Radio Company
Newport Beach, California

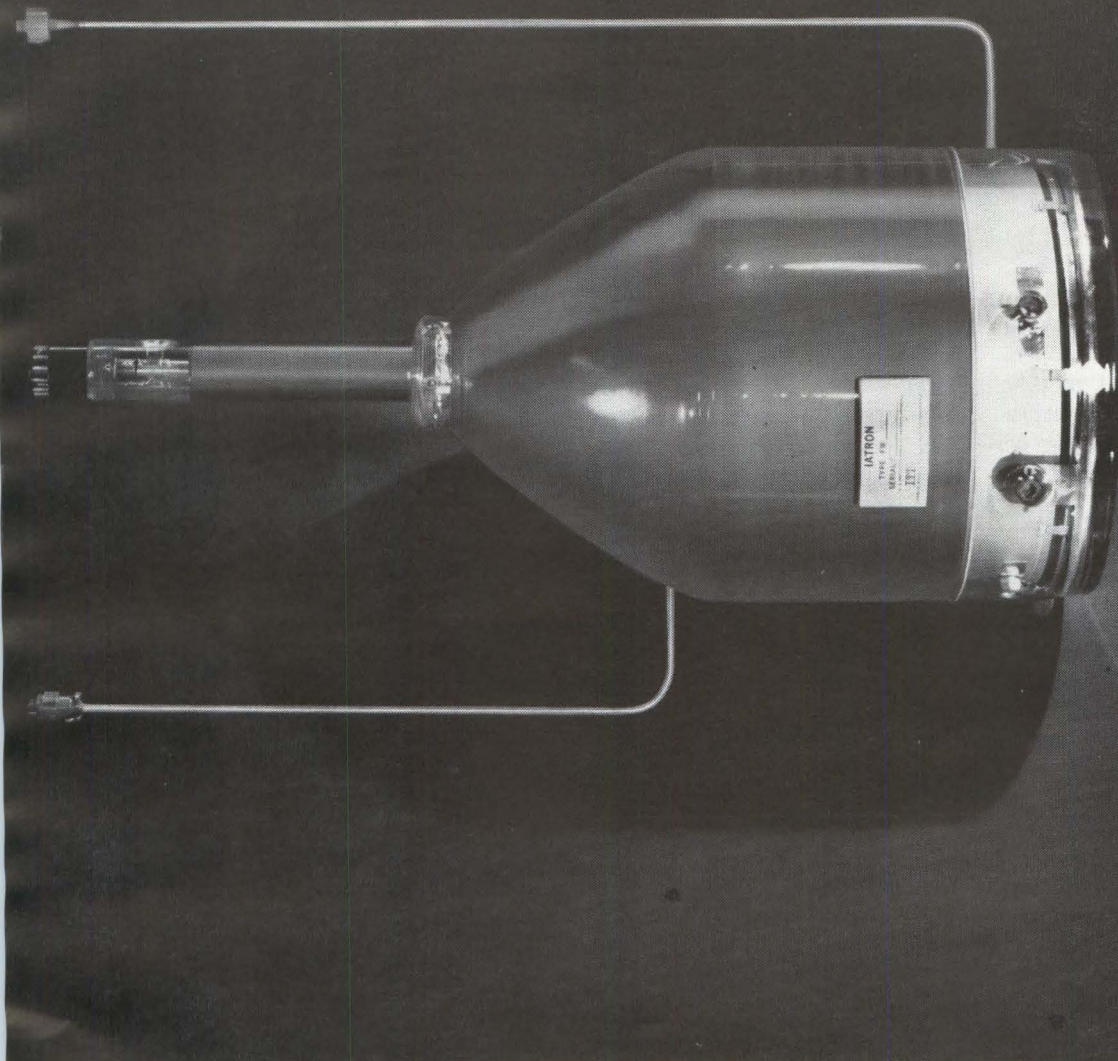

ITT 10-INCH HIGH-RESOLUTION RING-FLOOD-GUN STORAGE TUBE.

ITT

How to solve today's 8 toughest storage tube applications problems

1. **Faster writing speeds.** Supersonic radar targets require superfast writing speeds. Only ITT offers writing speeds up to 500,000 ips.
2. **Slower writing speeds.** Narrow bandwidth picture transmission requires slow writing speeds. ITT provides the slowest: less than 1.0 ips.
3. **Erase time.** Fast erase time is essential to high-speed multiple target tracking and for TV presentation at TV rates. ITT storage tubes have erase times as low as 1 millisecond—the fastest available.
4. **Resolution.** Resolution is the key limiting factor on virtually all display systems.

At 50% brightness, conventional ITT storage tubes provide up to 70 raster lines/inch.

5. **Brightness.** High ambient light conditions demand maximum brightness capability. ITT tubes are unsurpassed in average brightness of saturated display. The F-7174 is capable of 22,000 foot lamberts.
6. **Optimum display diameter.** For every application there is one "best" size storage tube. ITT makes the broadest range: 2½, 4, 5, 6, 7, 7½, 10 and 11 inch. Available with electromagnetic or electrostatic focus and deflection.

7. **Distortion.** Accurate readout calls for the elimination of distortion. Only ITT positions writing and flood guns concentrically to eliminate trapezoidal distortion.
8. **Direct vs. projection readout.** Direct readout tubes have their limitations in very large display applications. ITT's exclusive projection type tubes provide the high resolution and brightness needed to do the job.

Write for comprehensive brochure.

ITT ELECTRON TUBE DIVISION
CLIFTON, NEW JERSEY
International Telephone and Telegraph Corporation

Inflating Antennas In Outer Space

Plastic balloons two miles wide envisioned for space communications

CHICAGO, ILL.—How to construct an antenna that can “build itself” in space was discussed by Sylvania’s Chester L. Smith at Reinforced Plastics Conference this month. Smith discussed concept of having antennas put themselves together from prepackaged materials or parts of the launch vehicle itself.

Absence of gravity and atmospheric drag permits construction, in principle at least, of enormous structures. The figure shows possible form of one of these monsters.

An antenna of such heroic proportions would be used for interplanetary communications with space craft and orbiting bodies on

frequencies which are interfered with by the ionosphere.

Sheer size permits respectable gain, according to Smith, and he suggested Wullenweber antenna feed system is capable of generating many simultaneous beams needed to maintain communications with a number of different bodies at once.

Plastic film is the only practical material for such an antenna, he said.

Problem of inflating a balloon-like object more than 200 miles overhead and having it come out to a preconceived shape within $\pm\frac{1}{16}$ inch is challenging indeed, according to Smith. Work at Sylvania has centered more on the theoretical problem involved in the electrical design than on the materials engineering, however, as more money is available for this research, more and more attention will be given to

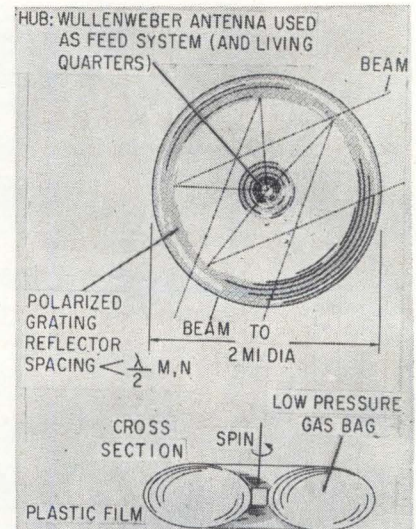

DEFORMATION experienced by bodies under spin in space could be put to work to make gigantic antenna structures. Configuration above is suggested 2-mile diameter space antenna for plane of ecliptic application

Radomes Built for Air Drop

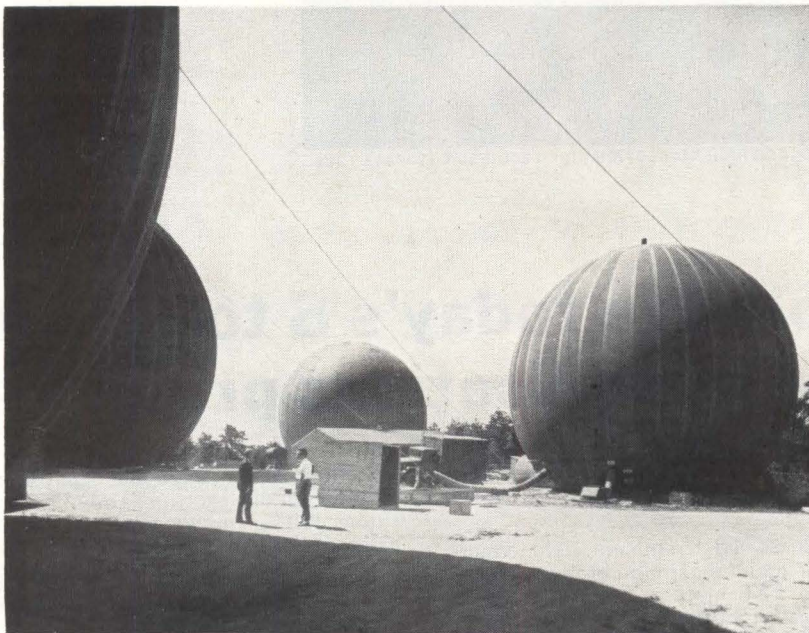

INFLATABLE RADOMES of Hypalon-coated nylon have been developed by Goodyear for use with radar antennas being built by Westinghouse for the AF and Marine Corps. Designed for use by troops in combat zones, the structures can be para-dropped from airplanes or helicopters and erected within 30 minutes. They come in two diameters, 52 and 61 feet

the materials problem.

So far, two avenues have opened up in the materials problem. After the antenna has been inflated, it may be rigidized by either curing by solar energy resins saturating a material like glass cloth, or evaporating the vehicle from a lacquer-type material. Preliminary laboratory results show promise in both approaches.

Balloons, paraboloids, cylinders and more complicated inflatables and extended surface antennas should be best candidates for development where a very high packing ratio is desired.

MICROWAVES — In general the tolerance problem becomes most acute in the microwave spectrum. But because of the inherently greater bandwidth—in terms of megacycles—the microwave region is and will remain a highly attractive area for many purposes.

While not startling to antenna designers, many of the proposed designs for outer space appear a little on the bizarre side Smith said.

A spherical lens configuration

Clifton Precision announces 4 major improvements in Servo Motor performance

**Greater
EFFICIENCY**

**Higher
TORQUE/INERTIA
RATIO**

**Lower
STARTING
VOLTAGE**

**Less heat
vulnerable
MATERIALS**

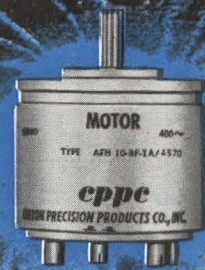

These motors provide more torque for considerably less power input. This results in a more efficient motor as well as a cooler running motor.

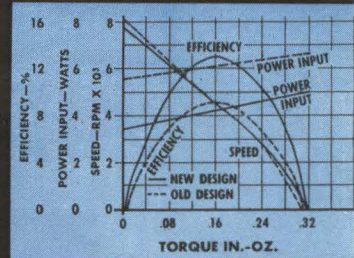

Acceleration is increased to 160,000 rad/sec² at between 2 and 3 watts/phase. Up to 200,000 rad/sec² is possible under certain conditions.

This is such an improvement that in certain motor-generator requirements, a new CPPC servo motor will now suffice.

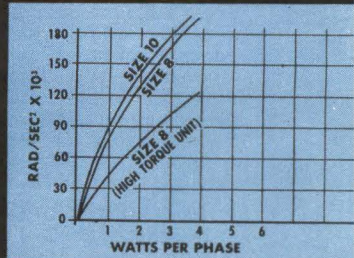

Whereas starting voltages have been specified at 3% of control phase voltage, we can now guarantee 1% and a great deal more uniformity.

Furthermore, starting voltage of these motors has been exhaustively tested so that all starting characteristics can be accurately predicted.

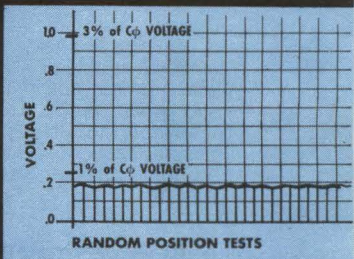

New slot and magnet wire insulation allow much less current leakage at high temperatures. In addition, new lubricants and new impregnation enable these motors to withstand 200°C plus. Solderless connections are now incorporated in our servo motor line (all connections are welded).

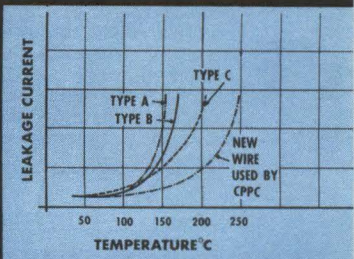

For full information: Sales Dept. 5050 State Rd., Drexel Hill, Pa. MAAdison 2-1000, TWX 215 623-6068—or our Representatives.

Be sure to see and discuss these motors in our suite, Barbizon-Plaza Hotel at the IEEE Convention, New York City, March 25-28.

CLIFTON PRECISION PRODUCTS CO., INC.

cppe

Clifton Heights, Pa.
Colorado Springs, Colo.

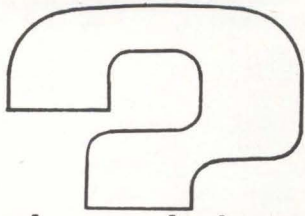

What do you need to know about

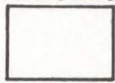

PURE FERRIC OXIDES MAGNETIC IRON OXIDES



Since the final quality of your production of ferrites and magnetic recording media depends on the proper use of specialized iron oxides—you'll find it mighty helpful to have the latest, authoritative technical data describing the physical and chemical characteristics of these materials. This information is available to you just for the asking. Meanwhile, here are the highlights.

PURE FERRIC OXIDES—For the production of ferrites, both hard and soft, we manufacture a complete range of iron oxides having the required chemical and physical properties. They are produced in both the spheroidal and acicular shapes with average particle diameters from 0.2 to 0.8 microns. Impurities such as soluble salts, silica, alumina and calcium are at a minimum while Fe_2O_3 assay is 99.5+%. A Tech Report tabulating complete chemical analysis, particle shape, particle size distribution, surface area, etc., of several types of ferric oxides, hydrated ferric oxide, and ferroso-ferric oxide is available.

MAGNETIC IRON OXIDES—For magnetic recording—audio, video, computer, and instrumentation tapes; memory drums; cinema film striping; magnetic inks; carbon transfers; etc.—we produce special magnetic iron oxides with a range of controlled magnetic properties. Both the black ferroso-ferric and brown gamma ferric oxides are described in a Data Sheet listing magnetic properties of six grades.

If you have problems involving any of these materials, please let us go to work for you. We maintain fully equipped laboratories for the development of new and better inorganic materials. Write, stating your problem, to C.K. Williams & Co., Dept. 25, 640 N. 13th St., Easton, Pa.

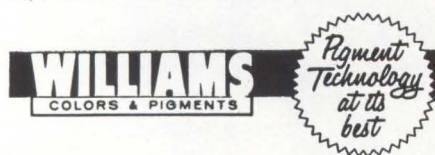

E. ST. LOUIS, ILL. • EASTON, PENNA. • EMERYVILLE, CALIF.

would be appropriate. This would consist of a cylinder surmounted by a hemisphere. Interior would be inflated by a foam generator. The hemisphere is inflated first and as it sets up, the cylinder behind it is filled and expanded. In this way the reaction is inhibited by excessive back pressure and a fairly uniform dielectric is, hopefully, obtained. One major problem to be solved is finding the right type of foam material that has a dielectric constant suitable for wide scan.

Paraboloidal reflectors were discussed. Smith said that the spherical antenna remains the most attractive geometric shape from which to make an antenna because of its mechanical simplicity. He stated that the shape is not easy to

manage from an electrical point of view.

Two types of inflatable antennas for high gain microwave applications were considered: a spherical reflector and phase-correcting sub-reflector system; and a spherical reflector with correctional sub-reflector.

New Glass Wets Tantalum Oxide

POSSIBILITY of a foil tantalum capacitor losing electrolyte has been known for many years. Since this loss is very small, until now there has been little concern, and foil capacitors have been used widely

Thin Films On Glass Slides

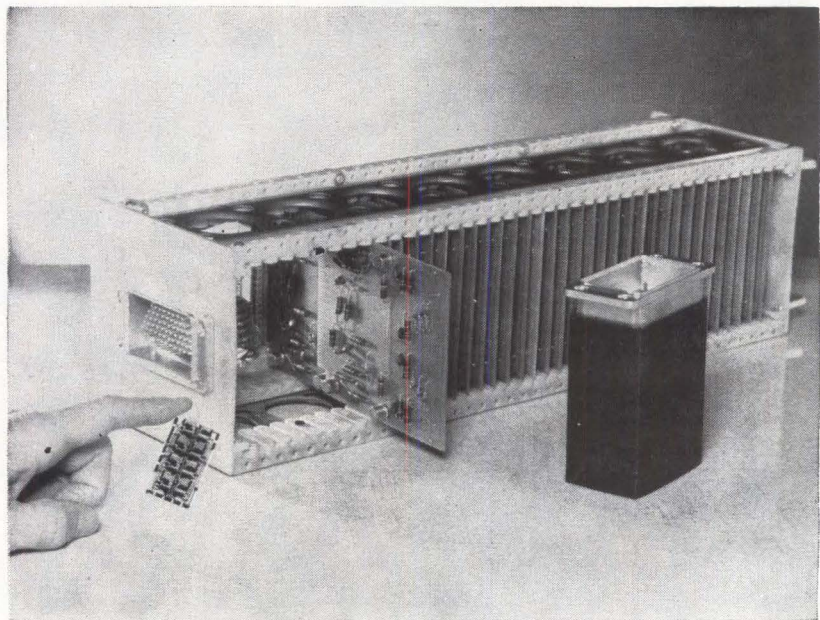

VACUUM-DEPOSITED circuit under finger, left, does work of two 4-in. sq electronic circuit cards. Small container of glass slides does work of large box of cards. Work is being conducted on quartz and ceramic substrates, as well as glass.

Conductors such as silver, gold or tungsten, and insulators like silicon monoxide or magnesium fluoride are vaporized and then deposited in layers on the slides in vacuum chambers. Masks ensure that the deposits conform to re-

quired shapes, while instruments control thickness.

Boeing seeks answers to why electrical characteristics of many materials change when they are transformed from bulk to thin film. Research includes structure and molecular orientation of thin films, adherence of coatings to slides, and manufacturing data such as vacuum, vaporizing temperatures and film-curing methods.

Amplifiers, oscillators and filters provide data for reliability studies of thin-film networks.

PUSH
BUTTON

TEST
SIGNALS!

1%
ACCURACY!

10 CPS

to
1 MC



Push-button convenience and repeatability for selecting frequencies from 10 cps to 999 KC makes the new hp 241A Oscillator ideal for supplying stable test signals for lab or production work. Just push one of five decade multipliers and three frequency push buttons to select any of 4,500 discrete frequencies. You get accuracy of $\pm 1\%$ and repeatability typically better than 0.005%.

Three-digit frequency resolution is provided by the solid-state hp 241A. Infinite resolution is provided by a vernier control, which extends the upper frequency to 1 MC.

Frequency response is flat within $\pm 2\%$ over the entire range, and a front panel control provides output levels from +10 to -30 dbm, presenting a constant output impedance of 600 ohms. Hum and noise are reduced below 0.05% of the output.

High repeatability, positive push-button operation and compact, rugged solid-state design make the hp 241A especially suitable for production line or other repetitive testing.

Write today for complete data, or call your nearest hp representative for a demonstration.

HEWLETT-PACKARD COMPANY

1501 Page Mill Road, Palo Alto, California
Area Code 415, DA 6-7000
Sales and service representatives in all principal areas
Europe, Hewlett-Packard S.A., 54-54bis Route des
Acacias, Geneva; Canada, Hewlett-Packard (Canada)
Ltd., 8270 Mayrand Street, Montreal



hp 241A
Oscillator

SPECIFICATIONS

Frequency:	10 cps to 1 MC, 5 ranges, each with 900 frequency increments with vernier overlap
Calibration Accuracy:	$\pm 1\%$
Frequency Response:	$\pm 2\%$ into rated load
Output Impedance:	600 ohms
Distortion:	1% maximum
Hum and Noise:	0.05% maximum of output
Output:	+10 to -30 dbm into 600 ohms (2.5 volts max.)
Dimensions:	6½" high x 7¾" wide x 8" deep. 13 lbs.
Price:	\$425.00

Data subject to change without notice. Prices f.o.b. factory.

7927

U T I C A[®]

UTICA

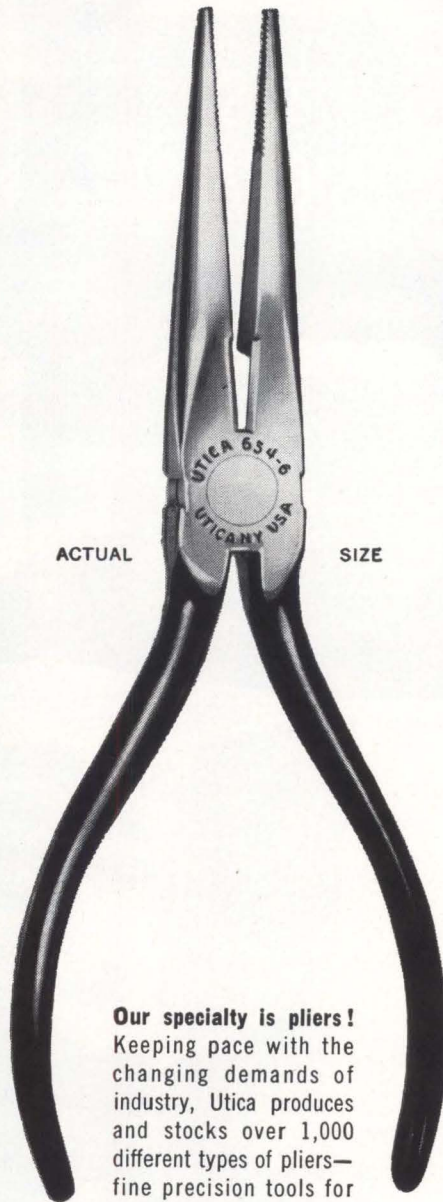

Our specialty is pliers!

Keeping pace with the changing demands of industry, Utica produces and stocks over 1,000 different types of pliers—fine precision tools for every conceivable use. Because of the job we have been able to do in many of the country's largest and most specialized plants, we believe that Utica tools can help you, too—either reduce your costs or improve your products. Contact your Utica distributor, today.

**Utica Deep Forge & Tool
Division, Kelsey-Hayes
Company, Orangeburg, S. C.**

tools the experts use!

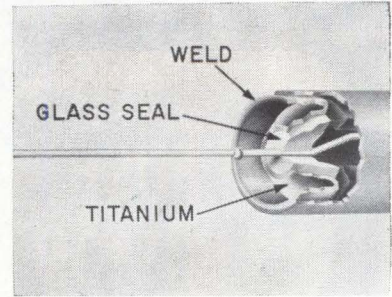

INTERNAL construction of new foil tantalum capacitor shows glass seal bond to terminal lead and titanium casing

because of their advantages of higher voltage, large microfarad ratings, self-healing characteristics and reliability.

An electrolytic capacitor contains an active electrolyte solution which forms an oxide layer on the inside lead. In the past this oxide has had a tendency to crack many hermetic seals that were developed.

Recent activity in missiles and satellites has intensified the need for better hermetic seals. The loss of electrolyte became a concern not only because of its possible effect on loss of capacitance, but also because electrolyte vapors were undesirable outside of the capacitor.

General Electric claims to have solved the problem, basically, by the development of a new glass which wets the tantalum oxide in a seal construction. The new glass, GE glass 250, is chemically stable with the electrolyte, has a leakage rate that tests better than 1×10^{-8} std cc/sec of air at one atmosphere when bonded to the tantalum lead. Glass has a coefficient of expansion near that of tantalum.

General Electric's A. F. Warner says that the new capacitors represent "one of the most significant capacitor developments since the introduction of solid tantalums."

Capacitors are now available in three MINUTEMAN-size cases at 15 to 150 volts, 75 to 610 μ F and 85 C and 125 C operation. They are polar or nonpolar, plain or etched foil construction. Units are said to withstand 5,000 psi with improved temperature and voltage characteristics.

New foil tantalum capacitors have been introduced by General Electric's Electronic Specialty Capacitor Operation, Irmo, South Carolina.

NEW TEKTRONIX SPLIT SCREEN STORAGE OSCILLOSCOPE

for storage
and
non-storage
displays



Type 564

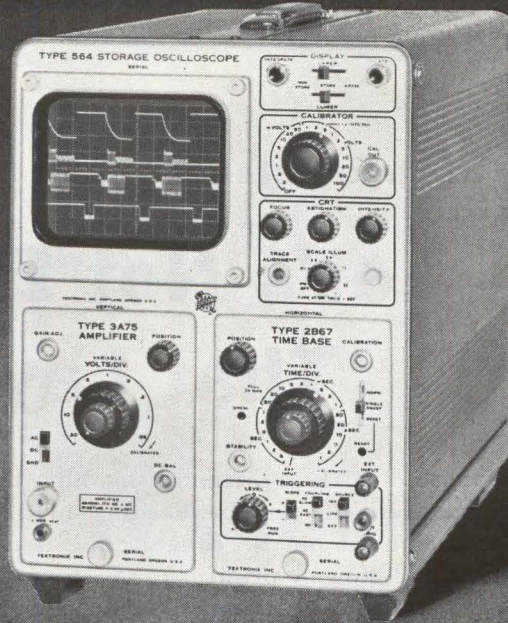

- ★ UPPER-HALF STORAGE OR NON-STORAGE
- ★ LOWER-HALF STORAGE OR NON-STORAGE
- ★ FULL-SCREEN STORAGE OR NON-STORAGE
- ★ EASY ERASE
- ★ ONLY 2 CONTROLS

- ★ TRACE-POSITION LOCATER
- ★ REPETITIVE-TRACE INTEGRATER
- ★ RECTANGULAR, CERAMIC CRT
- ★ AMPLIFIER AND TIME-BASE PLUG-IN UNITS

For storage and non-storage displays—The Type 564 has display capabilities for upper-half, lower-half, or full-screen storage or non-storage (with conventional crt operation in the non-storage mode).

The storage capability lends itself to single-shot displays at slow or medium speeds and displays of repetitive waveforms at faster speeds using the integration technique. Single-trace writing speed is faster than 25 centimeters per millisecond. On repetitive traces, the integrate feature provides an increase in stored writing rate. For example, it is possible to increase the stored writing rate by 10 times on 12 repetitive traces.

Storage time can be more than one hour; erase time approximately 250 milliseconds.

The Type 564 has display capabilities for differential, multi-trace, wide-band, delaying sweep, and sampling applications.

Type and degree of performance depend upon 2-Series and 3-Series Amplifier and Time-Base Plug-In Units used.

- Type 564 Storage Oscilloscope (without plug-in units) \$950
- Plug-In Units pictured (in full-screen-storage display):
- Type 3A75 50 mv/cm Amplifier Unit \$175
- Type 2B67 Time Base Unit with single-sweep facility. \$175

U.S. Sales Prices, f.o.b. Beaverton, Oregon

Call your Tektronix Field Engineer for more information or to arrange a demonstration.

Wide operating versatility available through 2-series and 3-series plug-ins

AMPLIFIER UNITS TYPE	PASSBAND (3-db down)	SENSITIVITY	PRICE	TIME-BASE UNITS TYPE	SWEEP FEATURES	TRIGGERING	PRICE
2A60	dc—1 Mc.	50 mv/cm—50 v/cm 4 decade steps with variable control.	\$105	2B67	1 μ sec/cm to 5 sec/cm, 1-2-5 sequence, variable between rates 5X Magnifier. Single Sweep.	Internal, External, Line; Amplitude-Level Selection; AC or DC- Coupling; Automatic or Free-Run; \pm Slope.	\$175
2A63—Differential (50:1 rejection ratio)	dc—300 kc.	1 mv/cm—20 v/cm 1-2-5 sequence, with variable control.	\$130	3B1	Normal and Delayed Sweeps—0.5 μ sec/cm to 1 sec/cm, 1-2-5 sequence 18 calibrated delay settings, 0.5 μ sec to 10 sec, variable between rates uncalibrated.	Internal or External; AC or DC Coupling; Automatic; \pm Slope Same features for Normal and Delayed Sweep Modes, except automatic.	\$475
3A72—Dual Trace (Identical Channels)	dc—650 kc. (each channel).	10 mv/cm—20 v/cm, 1-2-5 sequence, with variable control.	\$250		3B3	Normal and Delayed Sweeps—0.5 μ sec/cm to 1 sec/cm, 1-2-5 sequence. Continuously variable calibrated delay from 0.5 μ sec to 10 sec. Single Sweep for main sweep.	Internal or External; Line; AC or DC- Coupling; Automatic; \pm Slope; for Normal Sweep Mode; Same features (except no Line or Automatic) for Delayed-Sweep Mode.
3A74—Four Trace (Identical Channels)	dc—2 Mc (each channel).	20 mv/cm—10 v/cm, 1-2-5 sequence, with variable control.	\$550	3T77 Sampling Sweep (for use with 3S76)		Equivalent to 0.2 nsec/cm to 10 μ sec/cm, 1-2-5 sequence, variable between rates. 10X Magnifier.	Internal or External, \pm Slope.
3A75	dc—4 Mc.	50 mv/cm—20 v/cm, 1-2-5 sequence, with variable control.	\$175				
3A1—Dual-Trace (Identical Channels)	dc—10 Mc. (each channel).	10 mv/cm—10 v/cm 1-2-5 sequence with variable control.	\$410				
3S76—Dual Trace Sampling (for use with 3T77)	equivalent dc-to-875 Mc. (0.4-nsec risetime)	2 mv/cm—200 mv/cm, 1-2-5 sequence, with variable control.	\$1100				

Tektronix, Inc. / P. O. BOX 500 • BEAVERTON, OREGON / Mitchell 4-0161 • TWX-503-291-6805 • Cable: TEKTRONIX.
OVERSEAS DISTRIBUTORS IN 27 COUNTRIES AND HONOLULU, HAWAII.

Tektronix Field Offices are located in principal cities throughout the United States. Please consult your Telephone Directory.
Tektronix Canada Ltd: Montreal, Quebec • Toronto (Willowdale) Ontario • Tektronix International A. G., Terrassenweg 1A, Zug, Switzerland.

By Misunderstanding and Mishandling the "Cash-Flow" . . .

Let's Not Eat The Goose That Lays The Golden Eggs

Because of a basic misunderstanding, labor and management may be heading toward a battle that need not be fought. The issue is whether cash-flow or profit is the best measure of business earnings, and therefore the best measure of business' ability to raise wages, improve fringe benefits and shorten hours of work.

When business and union negotiators sit down around the bargaining table they frequently clash. This is probably inevitable. But it is pure waste—for both sides and for the public as well—when the clashes are caused by a misunderstanding rather than by realities.

The "cash-flow vs. profits" issue, should it develop as suggested by reports from Washington and the public pronouncements of labor leaders, will be a prime example of such waste.

This editorial, one of a series on business profits, is designed to point this up. It discusses the difference between cash-flow and profits. And it shows how confusion between the two might have disastrous results.

The Meaning Of Cash-Flow

Cash-flow can be calculated in various ways. One way — and the most common one among businessmen — is to add (1) after-tax profits minus dividend payments to stockholders, and (2) depreciation allowances. Another way — the one used by the AFL-CIO — is to add (1) total after-tax profits, and (2) depreciation allowances.

This adding of depreciation allowances (roughly the cost of buildings and machines either worn out in production or rendered obsolete by time) to profits (what is left over after all costs and taxes are met) may seem a clear case of adding apples and pears and coming up with a mixed fruit compote. But the practice does have its uses — as, for instance, in predicting business outlays on plant and equipment. Since cash-

flow represents the total funds corporations generate internally for replacing used-up facilities and acquiring new ones, it is a rough measure of industry's ability to invest.

But organized labor apparently sees cash-flow in an entirely different light, as being virtually the same as corporate earnings.

Here, from the June 1962 issue of *The American Federationist*, the official monthly magazine of the AFL-CIO, is an example: "The cash-flow, which is reported profits plus depreciation allowances, is the accurate measure of a company's returns since it is the amount of money left over after payment of all costs and taxes."

The key phrases in the above are (1) "profits plus depreciation" and (2) "after payment of all costs," which are linked in a way that makes the statement an out-and-out denial that depreciation is a cost. (Nor is this a mere slip of the pen. Virtually the same thing is said, in only slightly different words, four times in the same article.)

Quite clearly, however, depreciation allowances are designed to cover costs, which now and forevermore are the opposite of profits. There are no real profits or net returns to a business enterprise until all costs are recovered, including the cost of buildings and machines either used up in production or made obsolete by time. To argue otherwise is to strip logic from the language of economics, to quash intelligible conversation on the subject of profits. If business spends its depreciation allowances on higher wages or dividends, it is failing to replace its worn out and antiquated productive facilities.

The Measurement Of Profit

Aside from the dispute over the meaning of "cash-flow," "depreciation," and "profit," there is also the question of profit measurement.

Labor points out, and correctly so, that profits as reported by the U.S. Commerce Department's Office of Business Economics have been distorted over the years by revisions in the federal tax laws. Among these are several new ways of calculating depreciation allowances inaugurated in 1954, and the new Internal Revenue Procedure 62-21 introduced in mid-1962. (A recent Department of Commerce study attempts to measure the effect of some of these revisions.)

These changes were designed to enable businesses to charge off their depreciation costs at a rate more closely in line with the rate at which their facilities actually wear out and become out of date. But these more realistic techniques of figuring depreciation allowances in no way disturb this basic fact: depreciation is a cost and not a profit.

Moreover, tax changes have not permitted firms to charge off more than the original cost of their facilities, but only to speed the timing of the charges. As a result, any profit understatement owing to stepped-up depreciation during the years immediately following tax changes is necessarily followed by a profit overstatement in subsequent years.

So it is important to remember that changes in the timing of depreciation allowances work both ways. Some tend to understate current profits relative to those of earlier years. Others do the reverse.

The Correct Measure

As the chart in the box below shows, the corporate cash-flow has not been squeezed during the past several years nearly so much as profits. This alone offers a temptation to suggest that cash-flow — rather than profit — is the best measure of corporate returns or earnings.

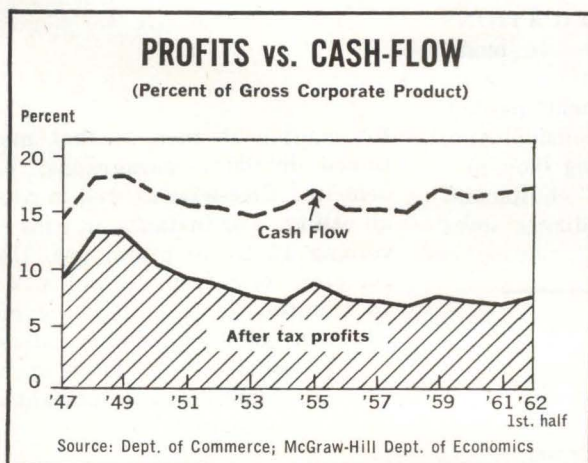

But the temptation must be sternly resisted, for profit — not profit plus depreciation — is the

correct measure of a firm's returns. Those who argue otherwise are treating the language of economics in a cruel and unusual way. They should cease and desist before killing effective conversation altogether.

Eating The Goose

There is not the slightest inclination here to suggest that the profit figures released by the U.S. Office of Business Economics are perfect. Like many statistics, they may not always reveal everything they seem to. But we should remember that they are the most comprehensive and useful measure of over-all corporate profitability we have.

It is even more important for us to remember that depreciation is a cost and not a profit. The funds attributed to depreciation allowances, like any other funds business has, can be paid out in dividends to stockholders or in higher wages to workers — but only if the economy is liquidating; only if it is failing to replace its antiquated and worn out facilities.

The depreciation reform, announced in July by the Treasury, was designed to make depreciation allowances for tax purposes more truly representative of the rate at which machinery actually wears out and becomes obsolete. This, in turn, was intended to speed up machinery and equipment replacement, which will increase productivity, cut costs and give U.S. business a better crack at world markets. It would be ironical, indeed, if this long-needed reform were used to justify wage increases so large that they would actually cut into the funds needed for our program of modernization.

This would be a pure and simple case of eating the goose that lays the golden eggs — a point both labor and management should certainly keep firmly in mind.

This message was prepared by my staff associates as part of our company-wide effort to report on major new developments in American business and industry. Permission is freely extended to newspapers, groups or individuals to quote or reprint all or part of the text.

Donald C. McGraw
PRESIDENT

McGRAW-HILL PUBLISHING COMPANY

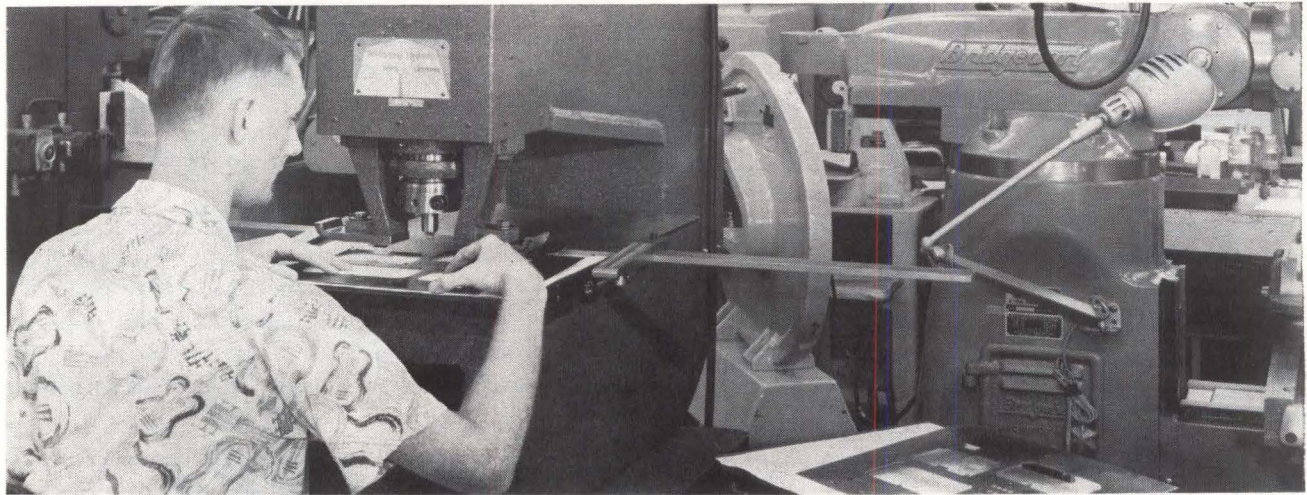

HYDRAULIC PRESS of type recommended for model-making enables operator to jog punch to within 1/16 inch of punch mark with his foot, keeping hands free for positioning workpiece

Prototype Parts Produced Efficiently

Time savings justify methodical procedures in making models

By **ARNOLD KORTE**
The Magnavox Company
Fort Wayne, Indiana

SHEET-METAL PARTS for true prototypes and models produced in limited numbers are being made for engineers at low cost, on short delivery schedules and with medium skills. Also, prototype parts come closer to performing their functions of testing for manufacturing feasibility and determining probable utility of finished manufactured products.

This has been accomplished using fabrication techniques simi-

lar to those used in actual production. Basic engineering considerations formed ground work for this approach: drilling holes, for example, in prototype parts when the production counterpart is to be stamped or pierced was thought to defeat main purposes of making a model, or prototype.

Manufacturing equipment used in making parts are in full keeping with model-shop practice, functionally and economically.

EQUIPMENT SPECIFICATIONS

—First object in effective model making, is specifying the optimum manufacturing equipment needed. Too often, this main consideration is slighted by specifying “low-production” or “tool-room” equipment. Magnavox, by standardizing specs

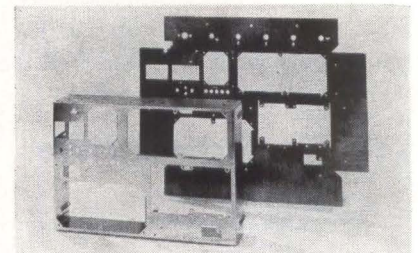

FIRST PIECE in prototype manufacturing run (rear) was used as template in producing other pieces that were formed into chassis (foreground). Template pieces are stored and used in production of any additional models that may be needed

for equipment such as that mentioned in later paragraphs, has benefited time-wise as well in overall utility. For instance, in runs involving 15 to 30 prototypes, time per piece went from 6 to 8 hours to 75 minutes. Time savings accumulated in layout, machine adjustments, tool changing. These operations consume 85 to 90 percent of total model-making time.

LAYOUT—Single layouts only are made to check individual drawings. Thus, if 30 chassis are being made only the first one is laid-out to

PROFITS AND PROTOTYPES

Reportedly, only 6 percent of industrial research projects produce a profit-making item. Fabrication of prototypes—especially sheet metal parts—is a contributor to the problem. Although models test function, manufacturing feasibility, etc. of final items, model-making seldom approximates production techniques. As a result, models often are made slowly and inadequately at high cost

How Barden gained a 50% increase in cleaning capacity for precision bearings!

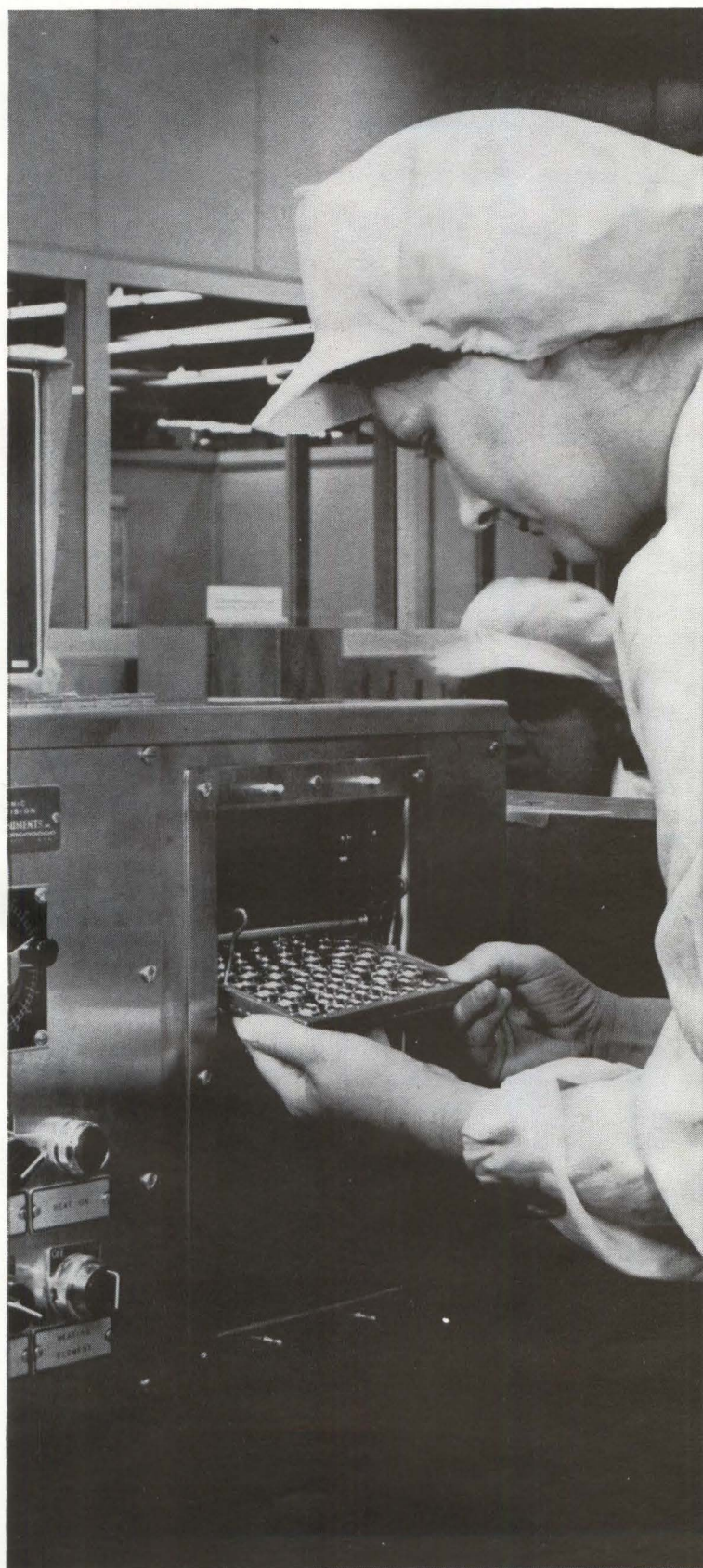

PROBLEM: Precision cleaning of assembled ball bearings for instruments used to be a time-consuming operation for the Barden Corporation, Danbury, Connecticut. Bearings up to 1" diameter went through a spray-cleaning machine at a relatively low production rate. Larger bearings were individually spray-cleaned.

SOLUTION: A new cleaning system based on an ultrasonic bath of FREON fluorocarbon solvent coupled with spray cleaning. FREON is a *selective* solvent in that it effectively removes dirt, yet has no effect on critical steel, bronze, plastic and fiber components of these bearings. Ultrasonic action combined with the extremely low surface tension of FREON digs contaminants out of the tiniest crevices. Result: Barden now cleans completely assembled bearings *in batches of hundreds*. Over-all cleaning capacity is up 50%!

And Barden reports that FREON solvents give them *better cleaning quality*. Particle count is 15% lower than before, which is a significant drop because the count was very low to start with.

Barden also points out that FREON dries quickly and leaves no residue, and that its very low toxicity and nonflammability let them operate without expensive ventilating equipment. They've found the new system economical to use, because FREON can be recovered in simple equipment—for reuse over and over again.

We'll be glad to show you how FREON solvents can improve your own cleaning operation. First, *send the coupon or Reader Service Card* for our new booklet on cleaning!

FREON[®]
solvents



BETTER THINGS FOR BETTER LIVING . . . THROUGH CHEMISTRY

MAIL COUPON FOR NEW BOOKLET ON CLEANING

E. I. du Pont de Nemours & Co. (Inc.)
FREON Products Division
N-2420-E-2, Wilmington 98, Delaware

Name _____ Title _____

Company _____

Address _____

Please send new booklet on FREON solvents for precision cleaning.

I am interested in cleaning _____

I would like to talk to a cleaning specialist.

Hoffman first to add the "M"!

400 mW Zener regulators

USN1N962B M

through

USN1N973B M

Meaning: these devices are designed to meet tough, new requirements of MIL-S-19500 /117A — the latest high reliability specification for 400 mW glass regulators. Another demonstration of Hoffman quality, these zeners are available in 11- to 33-volt ratings, and are designed for application in extreme environments as voltage regulators, clippers and limiters.

MIL-S-19500 /117A calls for: reverse leakage current controls initially and at end-of-life, temperature coefficient of breakdown voltage assurances, and more severe shock and vibration environmental assurance testing.

Units wearing the new "M" are in stock now for immediate shipment. For more information, contact your nearest Hoffman Sales Office.

Hoffman / **ELECTRONICS CORPORATION**
Semiconductor Division

4501 N. Arden Dr., El Monte, Calif. • CUMBERLAND 3-7191 • TWX: 213-442-5633

For
USN1N962B
 through
USN1N973B

plus 66 additional Mil-type zener diodes contact your nearest Hoffman Sales Office today!

EASTERN REGION

Regional Office

100 Menlo Park, Suite 209
 Metuchen, New Jersey
 Liberty 9-3500
 TWX: 201-549-2433

Baltimore District

4701 Leeds Ave., Baltimore 27, Md.
 242-8283
 TWX: 301-242-8987

Boston District

950 Watertown St., West Newton, Mass.
 WOODWARD 9-8411
 TWX: 617-332-8795

Buffalo District

R. W. Jackson Co.
 4446 Main St., P.O. Box 2668
 Buffalo 26, New York
 TF 9-0200

New York City District

310 Northern Blvd., Great Neck, L. I., N. Y.
 HUinter 7-2660
 TWX: 516-466-0639

Orlando District

601 North Fern Creek Ave.
 Room 211, Orlando, Florida
 423-2585
 TWX: 305-275-1847

Philadelphia District

Washington Lane and
 Township Line Road
 Room 111B, Jenkintown, Pa.
 WAverly 4-0307
 TWX: 215-887-2312

CENTRAL REGION

Regional Office & Chicago Office

920 Pitner Ave., Evanston, Illinois
 UNiversity 9-2400
 TWX: 312-869-3220

Dallas District

Dunbar Assoc.
 417 Meadows Bldg., Dallas 6, Texas
 214 EMerson 3-6627

Dayton District

Rm. 256, Talbot Tower
 131 N. Ludlow St., Dayton 2, Ohio
 222-4617
 TWX: 513-944-0228

Detroit District

20111 James Couzens Hwy.
 Detroit 35, Michigan
 BRoadway 3-7806
 TWX: 313-342-0884

Minneapolis District

188 Griggs-Midway Bldg.
 1821 University Ave., St. Paul 4, Minn.
 MI 6-4835
 TWX: 612-551-0901

WESTERN REGION

Regional Office and Los Angeles District

1936 Huntington Drive
 So. Pasadena, Calif.
 MUrray 2-3741

Anaheim District

2010 W. Lincoln Blvd.
 Anaheim, California
 774-3311

San Francisco District

1561 Laurel St., San Carlos, California
 LYtel 1-5796
 TWX: 415-594-8810

Seattle District

Seatronics, Inc.
 6133 Maynard Ave. S., Seattle 8, Wash.
 PARKway 5-2700
 TWX: 206-998-1255

CIRCLE 85 ON READER SERVICE CARD
 ←CIRCLE 84 ON READER SERVICE CARD

check all the drawings describing the chassis. After checkout, the chassis layout can be used as a template for the other 29 chassis. Assuming 6 hours layout time, a savings of 174 hours is realized. Then, with the single machine setup, 17 hours could be saved if each part requires 15 punch and die changes at 2½ minutes per change.

PROCESSING—The type of hydraulic press shown in accompanying illustrations (W. A. Whitney #613) keeps the punch and die in proper relationships to the workpiece for all pieces of the run. This equipment enables the model maker to jog the punch down to within 1/16 inch of the laid-out center punch mark or line.

In punching, the first piece of a run is positioned by lifting the stamping against the center of the punch, punching a hole, bringing up back gage of the press to square-up back edge of sheet metal while punch is still inserted. Back gage is then clamped and the left-hand stock stop is brought up to the workpiece and clamped to create a nest for all the remaining pieces of the lot. Hole is punched in each part before changing the punch and die for the next hole.

If a nibbling operation is to be performed, the punch is inched down to the laid-out line starting at either end of the desired opening or cut-out, the backgage and end stops are adjusted, and the part nibbled out by sliding the part along the back gage but in between the two end stops. The parts may be moved by hand in two axis: right and left, in and out.

In summary, the processing of a sheet metal part would be:

- Shear to width and length
- Layout one piece
- Setup machine, using first piece, for first-hole punching as follows: insert appropriate punch and die, inch punch down to center punch mark, punch hole, adjust gage and end stop to form a two-sided nest
- Punch that hole in all pieces
- Repeat the same procedure for each hole, slot, form, notch or nibble
- Form the piece into chassis

ALTERNATE PROCEDURE — Laying-out of the first piece can be

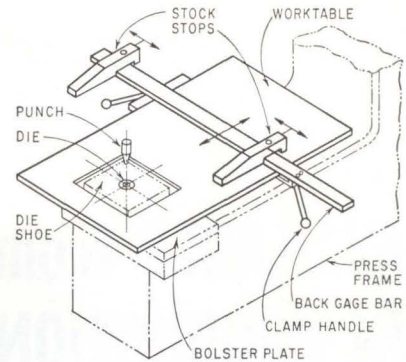

STOCK STOPS and back-gage bar of hydraulic press create a rigid nest for punching holes in remaining pieces of a run after first piece (template) is used to setup their positions

eliminated by glueing or pasting drawing to one of the sheet metal parts and then lining up press punches with proper positions on drawing. Thus, with good scaled drawings "idea prototypes" can be made quickly. At Magnavox, this technique is being carried-out using the #613 W. A. Whitney hydraulic press mentioned previously. Foot-controlled jog or inching of press ram allows both hands of the operator to effectively position the workpiece. Also facilitating accurate positioning are: 24 inch depth of throat, 21 inch work table, a 48-inch long back gage. Press is equipped with standard #28 tooling and has a 12-ton capacity.

PUNCHES AND DIES—As shown in an accompanying photo, many special punches and dies can be made and put into use within two or three hours because 1/2 and 1-inch diameter drill rods, which are readily purchased, provide the two punch-shank sizes used in the press. Similarly, 1 1/4-inch diameter drill rod provides the die-shank size in

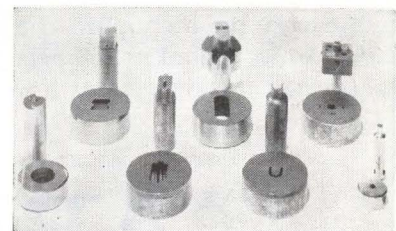

SPECIAL SHAPES and forms for punches and dies used in hydraulic press are readily made from standard drill rods and cold-roll bar stock

HIGH COERCIVE-FORCE ALNICO VIII... AVAILABLE from ARNOLD IN PRODUCTION QUANTITIES

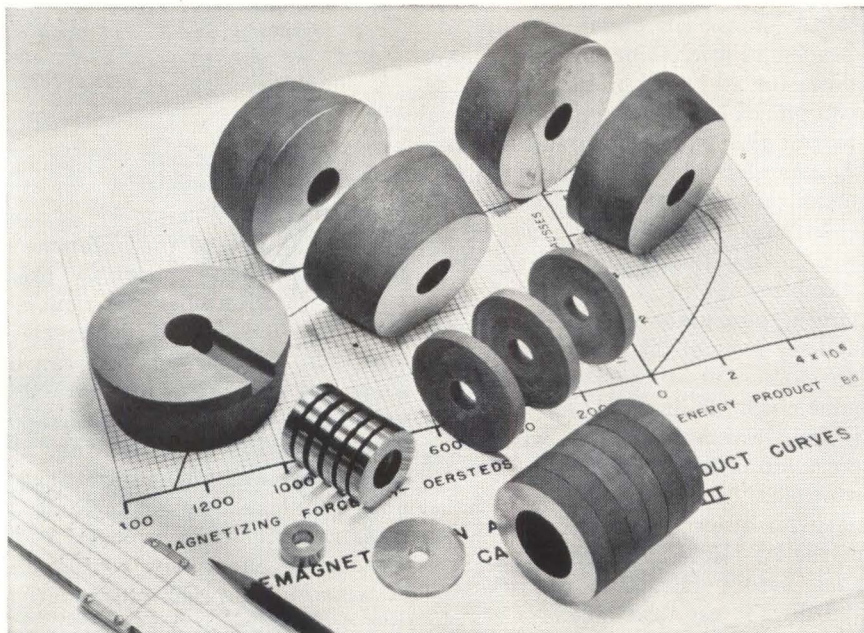

Illustrated above, a typical group of Arnold-produced Alnico VIII parts for microwave applications. The range includes cylinders of 4" or more in diameter and 13 lbs. or more in weight for tubular-type straight field focusing magnets, down to rings as small as 1/2" diameter and less than an ounce in weight for TWT stacks.

Alnico VIII possesses the highest coercive force of all the Alnicos . . . it is available from Arnold in excess of 1400 oersteds if required, and is regularly inspected at 1280 oersteds minimum. Also, its maximum energy product approaches that of Alnico V and its temperature coefficient is remarkably low.

This highly distinctive combination of parameters offers the designer many advantages: high field strength, high gap flux density, and the practical elimination of any need to provide for temperature compensation. In addition to widespread uses in microwave assemblies, Arnold Alnico VIII is also your logical choice for applications where the magnet must withstand strong demagnetizing fields, or where space restrictions limit its length.

Alnico VIII is available from Arnold in sizes and shapes engineered to your requirements, and in production quantities. • For data, ask for Bulletin PM-119.

3037 R1A

ADDRESS DEPT. E-2

ARNOLD
SPECIALISTS in MAGNETIC MATERIALS

THE ARNOLD ENGINEERING COMPANY, Main Office: MARENGO, ILL.
BRANCH OFFICES and REPRESENTATIVES in PRINCIPAL CITIES

the press to take care of most dies.

Cold roll bar stock 2 3/4-inches in diameter can be used to fabricate 3/8 and 1/2-inch flat ground tool steel having special shapes within a matter of hours.

TEMPLATES—When models are made at Magnavox, the layed-out pieces are not formed but stored as templates. Thus, if any future models are required, they serve to setput manufacturing runs, eliminating layout.

Hot and Fast Bonder Available

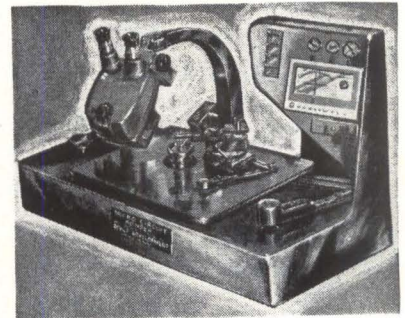

POINT-to-point bonding within a 1/4 square inch area provided by new bonding machine

BONDING MACHINE incorporating thermocompression and ultrasonic features has been announced by Device Development for use in fabrication of micrologic and integrated solid state circuitry, including thin films. Point-to-point bonding within a 1/2 inch by 1/2 inch area can be done while using the techniques alternately. Machine reportedly will attach fine wires of gold, aluminum, silver, platinum, etc. down to 1/2 mil in diameter. Additional features include: an x-y pantograph for moving optics viewing system and wire feeder simultaneously to maintain constant focus on microcircuit being worked; motorized and push-button operated pneumatic wire feed for feeding fine wire as needed in either forward or reverse direction; piggy-back manipulator that provides separate movement of bonding operation and cut-off chisels; rotary heat column with inert gas flushing and precise temperature control up to 400° C ± 1 percent; heated sapphire or tungsten carbide bonding tip where heat must be removed from work.

MAKE SURE YOU KNOW YOUR electronics BUYERS' GUIDE

Review THE CONTENTS PAGE

- **PRODUCT LISTINGS**, streamlined by engineers for engineers.
- **COMPANY STATISTICS**: number of employees, product lines, names of key people, dollar volume.
- **EDITORIAL INDEX** to electronics for July 1961 through June, 1962.
- **ABSTRACTS** of Feature Articles in the current Editorial Index.

EBG has much for you. Be sure to use it all... Review the Contents Page



Are you a COMPLETELY INFORMED electronics engineer?

Today you may be working in microwaves. But on what project will you be working tomorrow? You *could* have read **electronics** this past year

and kept abreast of, say, microwave technology. *There were 96 individual microwave articles between July, 1961 and June, 1962!*

But suppose tomorrow you work in some area of standard electronic components, in semiconductors, in systems? Would you be up-to-date in these technologies? Did you read the more than 3,000 editorial pages that **electronics'** 28-man editorial staff prepared last year?

electronics is edited to keep you current *wherever* you work in the industry, *whatever* your job function(s). If you do not have your own copy of **electronics**, subscribe today via the Reader Service Card in this issue. Only 7½ cents a copy at the 3 year rate.

electronics

February 22, 1963

IEEE

SEE

THE NEW
ELECTRONIC
WIZARDRY

at

I-TRIPLE-E's

International Convention
and Exhibition in New York

MARCH 25, 26, 27, 28

The COLISEUM at Columbus Circle
& The WALDORF ASTORIA HOTEL

admission: MEMBERS \$1.00; NON-MEMBERS \$3.00
MINIMUM AGE: 18

SHOW

(formerly the IRE Show)

What's your *present* job in electronics? What will you be working on tomorrow? Do you know the latest electronic developments *outside* your particular specialty that may affect your work?

Below is a sampling of topics within the 3,000 plus editorial pages produced per year by electronics' 28-man editorial staff. No matter where you work today, or in which job function(s), **electronics** will keep you fully informed as an electronic engineer. Subscribe today via the Reader Service Card in this issue. Only 7½ cents a copy at the 3 year rate.

electronics

**IS EDITED TO KEEP YOU FULLY INFORMED
ON ALL PHASES OF ELECTRONICS**

34 Articles	129 Articles	90 Articles	84 Articles	44 Articles	172 Articles
Air Traffic Control	Amplifiers	Antennas	Biophysics	Capacitors	Communications
158 Articles	55 Articles	97 Articles	92 Articles	95 Articles	50 Articles
Computers	Crystals	Data Processing	Detectors	Diodes & Diode Circuits	Filters
84 Articles	49 Articles	104 Articles	77 Articles	83 Articles	73 Articles
Generators	Infrared	Instruments	Lasers & Masers	Magnetics	Memories
179 Articles	96 Articles	64 Articles	53 Articles	75 Articles	48 Articles
Military Electronics	Microwaves	Modulators	Networks	Oscillators	Plasma & Ion Engineering
87 Articles	109 Articles	122 Articles	99 Articles	142 Articles	81 Articles
Pulse Techniques	Radar	Satellites	Semiconductors	Space Electronics	Switches & Switching Circuits
51 Articles	65 Articles	56 Articles	90 Articles		
Thin Films	Transducers	Transistors	Tubes		

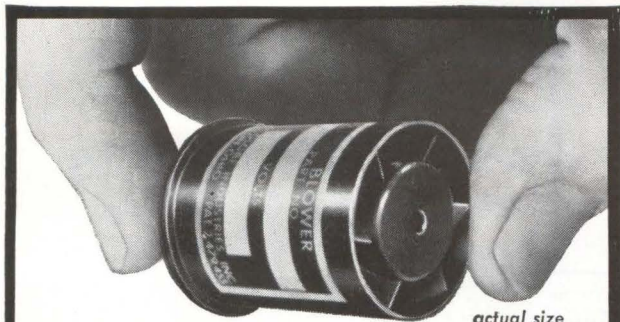

A.C. OR D.C. SMALLEST VANEAXIAL BLOWERS

Only 1 1/8" in diameter by a maximum 1 3/4" long, these smallest blowers move 10 cfm of air against 0.6" H₂O back pressure! Use these rugged sub-miniature blowers for spot cooling of critical components where space is cramped and weight is important.

VAX-1 blowers operate on 26 v.d.c. or less, or 26 v.a.c., 400 cycles. Weight is 1.4 ounces. Mounts with standard servo ring clamps. (Globe makes larger blowers also.) Request Bulletin XAV from Globe Industries, Inc., 1784 Stanley Avenue, Dayton 4, Ohio.

GLOBE

GLOBE INDUSTRIES, INC.

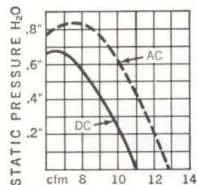

CIRCLE 202 ON READER SERVICE CARD

IEEE

SPEAK

TO OUTSTANDING
ELECTRONICS ENGINEERS,
SCIENTISTS, PHYSICISTS
at

I-TRIPLE-E's

International Convention
and Exhibition in New York

MARCH 25, 26, 27, 28

The COLISEUM at Columbus Circle
& The WALDORF ASTORIA HOTEL

admission: MEMBERS \$1.00; NON-MEMBERS \$3.00
MINIMUM AGE: 18

SHOW

(formerly the IRE Show)

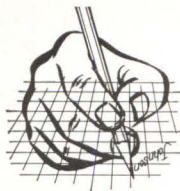

Time after time engineers specify Johnson sockets!

Whatever the choice . . . a miniature 7-pin steatite wafer—or a low-loss Kel-F socket for high power transmitting tubes . . . time and time again design and development engineers specify Johnson tube sockets! All sockets have been categorized under a socket standardization program, reducing the number of variations in each socket type. Standardized specifications and immediately available stock shortens delivery cycles — permits the selection of a Johnson socket for almost any application!

Kel-F Series—Molded of low dielectric loss-factor Kel-F plastic—designed for use with high power transmitting tubes such as the 4X150A, 4X250B, 7032, etc. Available in many designs—with or without low inductance screen grid by-pass capacitors, mounting saddle, or steatite chimney.

Bayonet Types—include Medium and Heavy Duty Medium, Jumbo and Super Jumbo 4-pin types.

Steatite Wafer Types—available in 4, 5, 6, 7, and 8 pin standard sockets, as well as Super Jumbo 4 pin, Giant 5 and 7 pin models and VHF Septar Sockets for tubes with E.I.A. Base No. E7-20 and E7-2.

Miniature Types—all steatite, available in Standard Wafer Type or Shield Base Type for 7 pin miniatures with E.I.A. Base No. E7-1.

Special Purpose Types—include sockets for tubes such as the 204A and 849, the 833 and 833A, 152TL, 304TL, 750TL, 1500T, 2-2000A, 5D21, 705A and other special purpose tubes.



E. F. JOHNSON COMPANY

3002 TENTH AVENUE S.W. • WASECA, MINNESOTA

STANDARD INDUSTRIAL, MILITARY TUBE SOCKETS

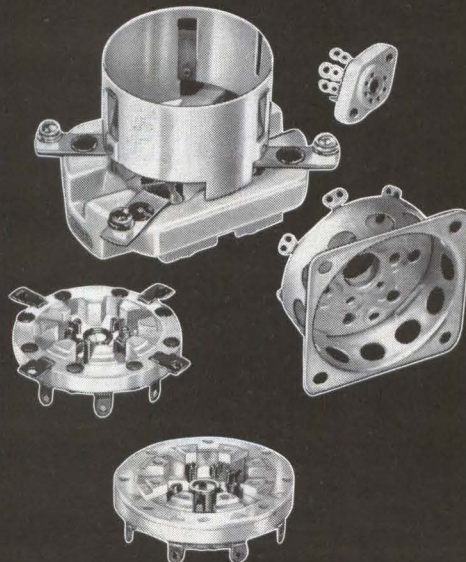

DETAILED COMPONENTS CATALOG AVAILABLE
—Write today on company letterhead!

•CAPACITORS •TUBE SOCKETS •CONNECTORS •PILOT LIGHTS
•INSULATORS •KNOBS AND DIALS •INDUCTORS •HARDWARE

A-D Converter Does Not Load Instruments

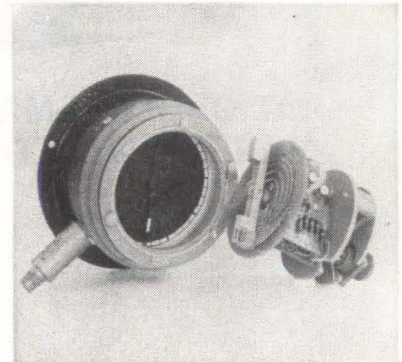
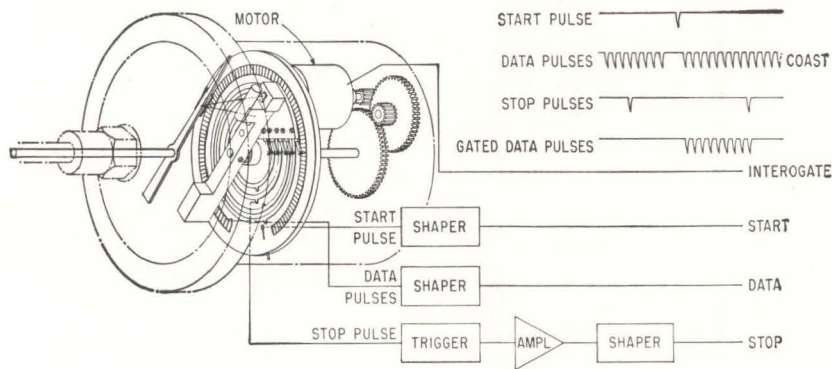

Optical takeoff converts angular dial position to digital form

RECENTLY ANNOUNCED by Berkeley Instruments, 1475 Powell Street, Emeryville 8, California is the Teladvisor angular position digitizer that can be applied to pointer-type dial instruments with no load applied to the sensor or instrument being digitized. Output is a train of pulses whose total count represents dial divisions or angular displacement. The basic input sys-

tem includes 9 angular position types, 4 rate or rotation types, 5 electrical analog types, 5 electrical pulse types and 2 digital clocks that supply signals to visual readouts, local data logging or a telemetry system. All input devices operate as shown in the sketch. An optical scanner, rotated by a small d-c motor, seeks the position of a reflector mounted on the meter pointer. As it rotates, it carries a wiper over an interrupted circular commutator track containing a single start segment and a number of data-reporting segments. The start segment signals pass through zero or refer-

ence of dial being scanned. Data reporting segments produce a pulse train representing data increments. When the scanner passes the pointer reflector, it produces a stop pulse. The scanner does not stop but rotates continuously. The device feeds a logic unit as shown in the sketch, that filters and shapes the pulses and gates the data between start and stop to external counting units. If a correct digitizing cycle is not completed within error checking time of 1.2 seconds, it supplies a false-data signal.

CIRCLE 301, READER SERVICE CARD

Linear Sawtooth Generator Has Wide Range

RELEASED by Waddell Dynamics, Inc., 5841 Mission Gorge Road, San Diego 20, California, the model L4SG solid-state linear sawtooth generator has a dynamic range of 10 μ sec to 100 seconds. The time-variable sawtooth output is of positive polarity with ground reference

and has a constant slope linear to 0.1 percent over the voltage rise. The device provides seven selectable full-scale time periods between 100 μ sec and 100 seconds with each full scale period having a vernier adjustment for 1,000 discrete divisions. The unit is self compen-

sating and is either free running repetitive or can be triggered by external sweep. As shown in the sketch, the linear voltage ramp is accomplished by charging a range capacitor through a ten-turn potentiometer from a constant-current generator. (302)

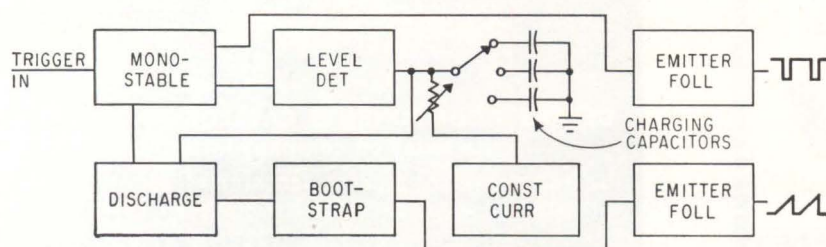

Combining Resistor and Delay Line in One Unit

ANNOUNCED by California Resistor Corp., 1631 Colorado Avenue, Santa Monica, California, the DL-120 is a compact (0.3 x 0.75 in.), three-

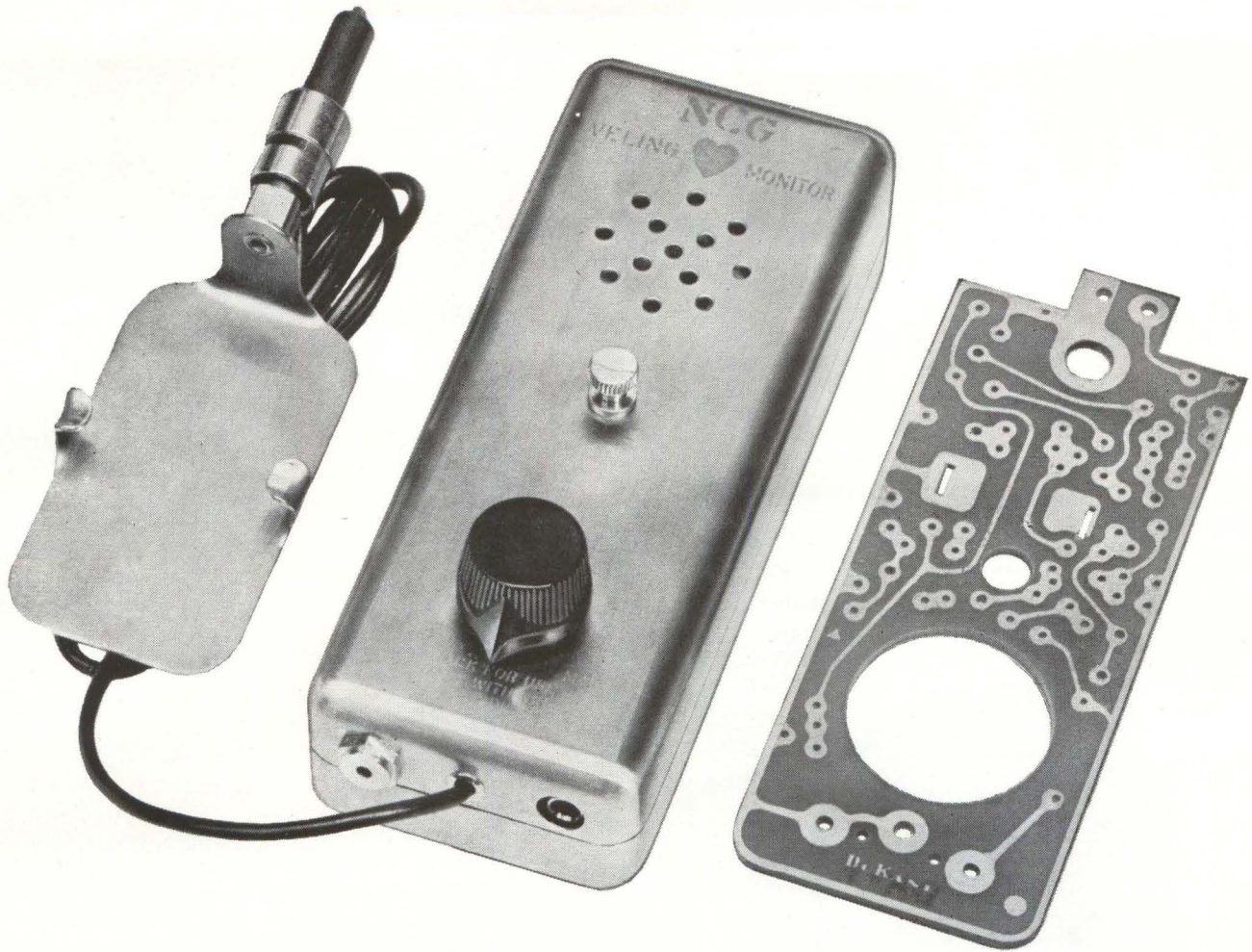

When more than dollars are at stake!

If printed circuitry for a missile proves unreliable, a tremendous investment is lost.

But if printed circuitry in a heart monitor proves unreliable, that's quite different . . . a *life* is at stake. During an operation, surgeons rely on the Veling Heart Monitor to translate the electrical activity of the

heart into audible signals. Reliability isn't just *desired*; it is absolutely *essential*.

You probably don't make heart monitors. But you do consider reliability of your product as being important . . . so you should be using Formica industrial plastics. They have **CERTIFIED RELIABILITY**.

WRITE FOR DATA ON:

- Copper clad laminates
- Electrical /electronic grades
- Mechanical grades
- Engraving stock

FORMICA CORPORATION
DEPARTMENT CS-62, CINCINNATI 32, OHIO

subsidiary of  **CYANAMID**



industrial plastics

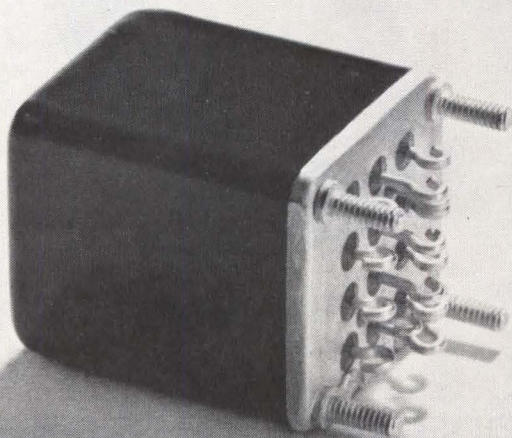

Breathing itself to death?

(Not if CEC's 24-120A Leak Detector says it's leak proof)

Even if you anticipate a very long wait between completed electronic component and blast off, you can be sure the component will remain absolutely airtight... if CEC's 24-120A can't find any leaks.

This instrument will locate leaks as small as 5×10^{-11} atm cc/sec. Fast!

As versatile as it is sensitive, this instrument tests both pressurized and evacuated components. And, equipped with the new 24-038 Test Port and Roughing Station, *automatically* tests small parts on a

test port or under a bell jar. In addition, two flanges permit probe testing from either end or via direct hookup to a large test vessel.

Portable too, the 24-120A can be hand carried, rested on a test cart, or installed on a mobile Test Port and Roughing Station. Thus, in lab, field, shop or production line, this instrument will measure up to your most demanding requirements.

For more information, call your CEC office. Or, write for Bulletin CEC 24120-X1.

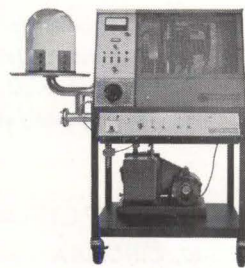

CEC

Analytical & Control Division

CONSOLIDATED ELECTRODYNAMICS

A Subsidiary of Bell & Howell • Pasadena, California

CIRCLE 92 ON READER SERVICE CARD

One more reason to measure with CEC

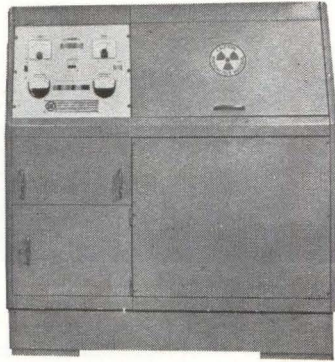

If you have to leak-check thousands of components every day, this is your answer: CEC's radiation-sensing 24-510A Radiflo Leak Detector. It's the only leak detector economically feasible for 100% checkout of mass-produced components such as transistors, diodes, and relays because it finds leaks of 1×10^{-5} to 1×10^{-11} atm cc/sec and permits checking at rates up to 2500 components per hour.

The Radiflo will activate up to 10,000 components at a time so your inspectors can swiftly check for leaks with scintillation counters—fully automatic counting stations also are available. Check out a Radiflo system now with your nearest CEC office, or write for the new eight page Bulletin CEC 24510-X1.

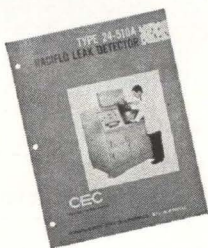

CEC

Analytical & Control Division

CONSOLIDATED ELECTRODYNAMICS

A Subsidiary of Bell & Howell • Pasadena, California

CIRCLE 93 ON READER SERVICE CARD
February 22, 1963

terminal component providing the electrical equivalent of a resistor in series with a distributed-constant delay line. Delay times range from 120 to 150 ns. While input and output load impedances are extremely nonlinear, varying from a

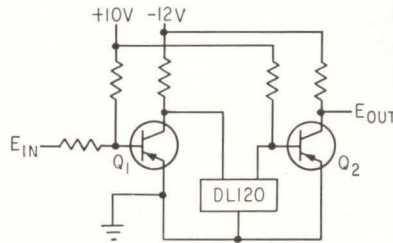

few ohms to megohms, the unit provides a delay-to-rise time ratio of better than 1:1 and a coefficient of reflection less than 0.1. Series resistance of 1,000 ohms is held to 2 percent. Power rating exceeds $\frac{1}{2}$ w at 55 C. In the sketch, the device is used in a digital logic circuit to provide both delay and current control. In this configuration, the device provides delay between E_{in} and E_{out} and also determines the i_B of Q_2 .

CIRCLE 303, READER SERVICE CARD

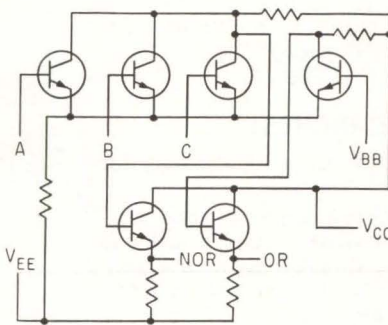

High-Speed Logic Uses Emitter-Coupled Gate

RECENTLY announced by Motorola Semiconductors, 5005 East McDowell Road, Phoenix 8, Arizona, the MC306G and MC307G are integrated circuit logic gates with a typical propagation delay of 4 ns and power dissipation of 35 mw. The epitaxial planar units consist of a 3-input logic gate with a fan in of 1 to 25, fan out of 1 to 26, propagation delay and rise time of 4 ns, fall time of 5 ns, logic swing of 0.8 v and noise immunity ± 50 percent of logic swing. Input resistance for transition region is

2,500 ohms and for conductance region is 40,000 ohms. Output resistance is 22 ohms, input capacitance is 6 pF, power requirement is $5.2 \text{ v} \pm 20$ percent and operating temperature is -55 to $+125$ C. The units are housed in hermetically-sealed, 10 lead, TO-5 headers. As shown in the sketch, the MC306G is a four transistor gate with two emitter-follower output stages. The MC307G is identical but omits the two output resistors. When a number of gates (n) are to perform an OR function, a single MC306G and ($n - 1$) MC307G gate can be used with the outputs of all gates connected together so that the output resistors of one serve as a common load for all, thus saving power in the ($n - 1$) gates. (304)

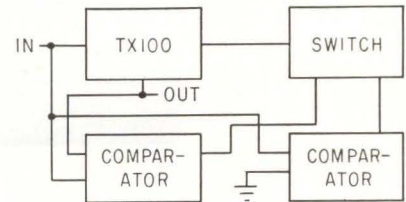

Comparing Two Analog Voltages at 200 Kc

MANUFACTURED by GPS Instrument Co., Inc., 180 Needham St., Newton, Massachusetts, the model CS-1050F high-speed electronic comparator is a solid-state unit that produces an output when the sum of two input voltages equals zero. Switching rate is 200 Kc and comparison time is 5 μsec . Sensitivity is within 5 mv for any input up to ± 100 v and can be adjusted to overcome effect of external noise. Output is a 12 v pulse of 50 μsec duration. The sketch shows use in a peak picker that detects peak value of pulses in a train ranging from 0 to 20 v at frequencies in excess of 3,000 pps with pulse widths less than 10 ms. The output is fed to a readout device. (305)

Transistor Dissipates 60 W at 150 Mc

ANNOUNCED by Clevite Transistor, 1801 Page Mill Road, Palo Alto, California, the new series of 3TX002, 3TX003 and 3TX004 high-

■ CIRCUIT DESIGNERS!

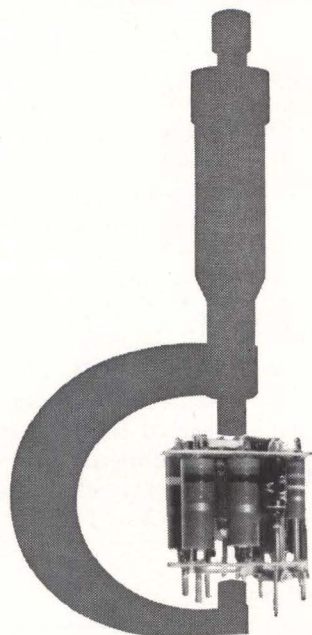

HOW SMALL CAN YOU THINK?

ELECTRONIC SUB-MICRO-MINIATURIZATION . . . a big challenge! Make it smaller. Make it more reliable. Make it precise. Good!

Now — begin again . . . **Make it smaller!**

A TYPICAL PROBLEM: Design a current supply with the following characteristics. Stability; 0.01% within fifteen minutes, with load variations of 10%. Capacity; 200 ma. Temperature Environment; -40° to $+200^{\circ}$ F.

■ SIZE: 12 CUBIC INCHES!

Intriguing? Then there's a rewarding career opportunity for you at Honeywell in Florida.

Familiarity with "state-of-the-art" circuit techniques and components as applied to micro-miniaturized circuits is just one area of our present requirements. Circuit designers experienced in design and development of analog servo circuits, digital and/or switching circuits as applied to airborne or spaceborne inertial systems are also needed.

Other opportunities exist in the following related areas:

Systems Engineers / Logic Designers / Systems Analysts / Programmers / Packaging Engineers / Rotary Component Designers / Systems Test Engineers / Materials & Component Engineers / Test Equipment Designers / Manufacturing Prototype Development Engineers / Reliability Engineers / Quality Control System Engineers.

To inquire about a career assignment leading to professional and personal advancement, write to Mr. L. B. Ericson. Your inquiry or resume will be answered promptly.



Honeywell

13350 U S. Highway 19, St. Petersburg, Florida
AN EQUAL OPPORTUNITY EMPLOYER

"A Good Place to Live . . . A Good Place to Work"

To investigate professional openings in other Honeywell facilities, send your resume to H. F. Eckstrom, Honeywell, Minneapolis 8, Minnesota.

HONEYWELL ENGINEERS ARE DOING THINGS IN FLORIDA



frequency silicon power transistors offer collector voltage ratings up to 100 v and collector current to 5 amperes. They will operate at 200 C and have saturation resistance of less than 0.2 ohm, beta relatively independent of collector current and minimal distortion. The device is made on an industry-standard TO-3 base. The intricate silicon micro-circuit has been achieved by a unique process of inverse epitaxial deposition and an emitter base of interdigitated configuration.

CIRCLE 306, READER SERVICE CARD

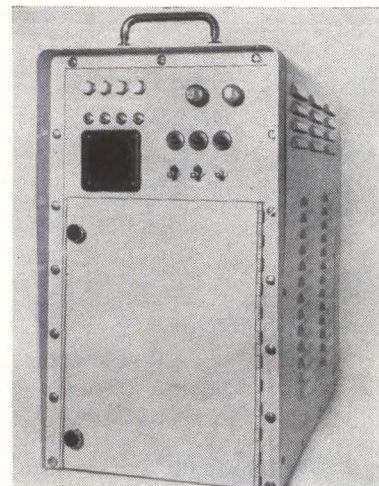

Beacon Defruiter Is Transistorized

AIRBORNE INSTRUMENTS LABORATORY, Deer Park, Long Island, N. Y., has developed a transistorized storage tube defruiter. The unit, which measures 10 by 18 by 18 in., provides a complete beacon defruiting capability on a pulse-to-pulse basis for operation in conjunction with any primary radar at any prf and at any interrogation mode interlace ratio. The flexibility and versatility of the unit is an inherent feature

of the storage tubes themselves which provide synchronous signal correlation independent of the interpulse period of the system. This frees the beacon system of delay matching problems with the primary radar. (307)



Power Divider for Microwave Use

LEL, INC., 75 Akron St., Copiague, N. Y., announces the series DSB binary power divider. It operates in the frequency range of 500 Mc to 4,000 Mc and features low insertion loss and phase coherence error of less than 1 deg. These units are available with 2, 4, and 8 outputs, each covering three octaves, and can be optimized to any particular frequency or designed to special requirements. Price is \$100. (308)

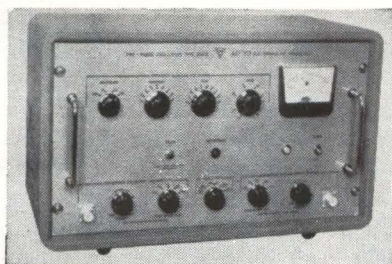

Two-Phase Oscillator Has Negligible Hum

AD-YU ELECTRONICS, INC., 249 Terhune Ave., Passaic, N. J., announces type 308G low frequency two-phase decade oscillator. It provides two output signals 90 deg phase difference from 0.1 cps to 1,000 cps. Both outputs are essentially constant throughout the entire frequency range. Both outputs have frequency stability better than 0.2 percent, and distortion less than 1.5 percent. Amplitudes of both output signals can be read on panel meter. (309)

Rotary Joint Offers Rugged Construction

ASTROLAB INC., 120 Morris Ave., Springfield, N.J. Rotary joint fea-

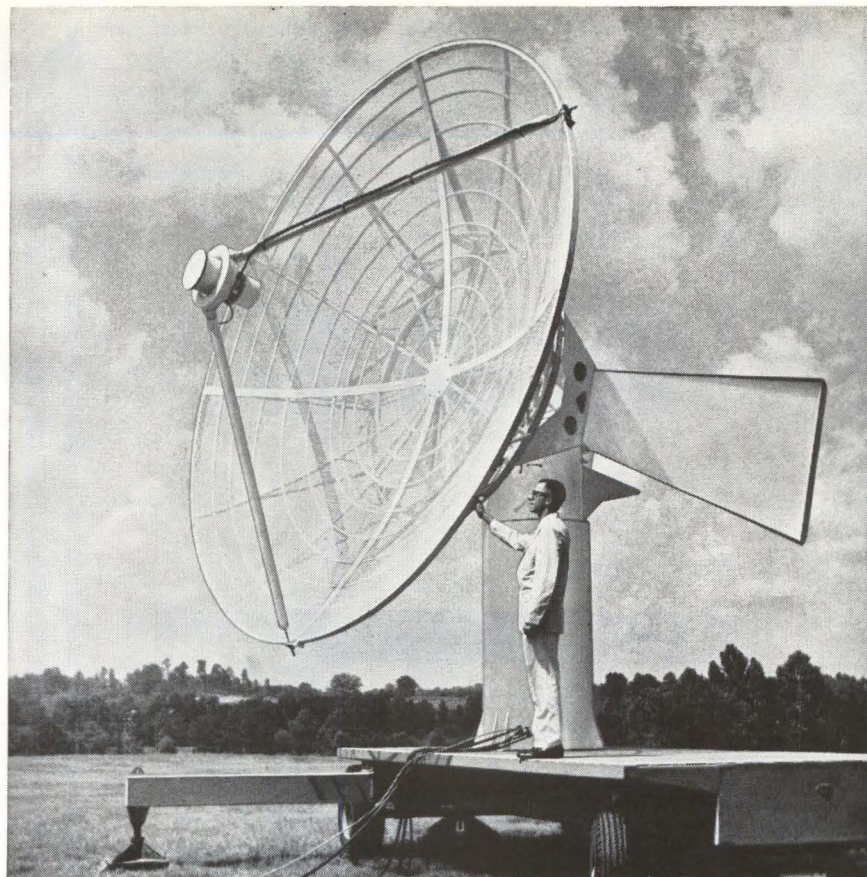

Why S-A Tracking Antenna Pedestal Systems Offer THE BEST PRICE/PERFORMANCE RATIO

Versatility, MIL SPEC compatibility, reliability, state of the art manufacturing techniques, quick delivery, and full system capability, you get them all from Scientific-Atlanta.

VERSATILITY. For antennas up to 30 feet diameter, Scientific-Atlanta offers three basic pedestals with output torques from 500 to 10,000 ft.-lbs., velocities to 30°/sec, accelerations to 30°/sec², and accuracies to 0.08° static and ±0.05°/rpm. Multiple mode operation; automatic, slave, manual or pre-programmed tracking. A full range of optional extras and accessory equipment is available to meet virtually any operational requirement.

MIL SPEC COMPATIBILITY. Scientific-Atlanta pedestals are designed to operate under MIL SPEC environmental and RFI conditions.

RELIABILITY. Scientific-Atlanta pedestal systems use solid state servos, printed circuit dc motors for long life and quick response, large parallel mounting surfaces for adaptability plus rigidity of antenna mounting, fail-safe brakes, electrical and mechanical limit stops.

MANUFACTURING. Assembly of tracking pedestals from standardized modules allows Scientific-Atlanta to meet a wide variety of customer requirements and pass along the cost benefits of mass production.

QUICK DELIVERY. Most TPS units are available 6 to 8 weeks ARO.

SYSTEM CAPABILITY. Scientific-Atlanta offers its customers a unique and proven capability to provide complete telemetry tracking systems, special antenna systems, and servo-control systems.



FOR MORE INFORMATION, please address Scientific-Atlanta, Inc., P.O. Box 13654, Atlanta 24, Georgia, phone: (404) 938-2930.

SCIENTIFIC-ATLANTA, INC.

8½" x 11" X-Y RECORDER

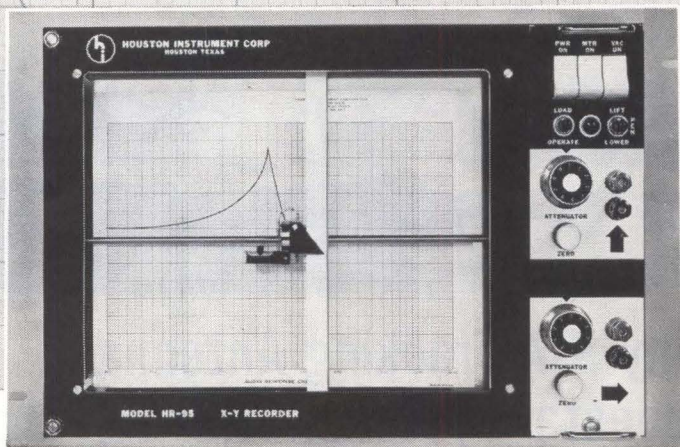

Model HR95-T0

\$1250

Performance: 1 mv/in. basic sensitivity, 15 in/sec. pen speed, 0.25% overall accuracy, 600 in/sec² peak acceleration, 0.1% resetability.

Reliability: Special emphasis on a simple, straightforward design insures continued trouble-free performance. The HR-95 is fully warranted for one year.

Flexibility: Plug-in control modules and compatibility with all standard converters and accessories, including the complete Houston Instrument line, assure the capability of the HR-95 to perform all recording functions.

Accessibility: Modular construction plus hinged recording surface permits complete access to all electrical and mechanical components in seconds.

Price: \$1250 No time base
\$1350 With time base

8 page brochure available upon request

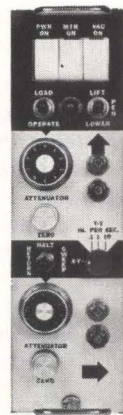

tures light weight rugged construction with low vswr. Design includes special hard chrome plating with gold flash on contacts. These contacts employ a special device to insure optimum mechanical contact at all times. The absorption material used is Astrolite. Frequency range is 15 Mc to 12.4 Gc; vswr, less than 1.5 db for any position; insertion loss, 0.3 db max from 1 Gc to 12.4 Gc; impedance, 50 ohms; power, 100 w c-w at 9,-375 Mc.

CIRCLE 310, READER SERVICE CARD

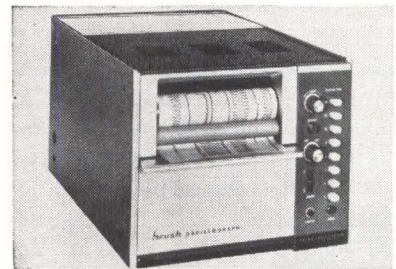

Oscillographs Have High Writing Speeds

BRUSH INSTRUMENTS, division of Clevite Corp., 37th and Perkins, Cleveland 14, O. Line of multi-channel light beam oscillographs produce crisp direct recordings through incandescent optical system with instant warm-up. Series 2300 are available with 8 or 16 channels and have a basic system response of ± 5 percent from d-c to 1,000 cps. With standard compensated galvo amplifiers system response is 2,500 cps, and signals from 0.2 to 200 mv/mm can be accommodated. Writing speed is more than 30,000 ips. (311)

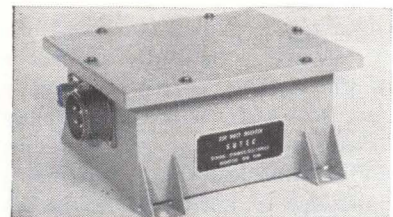

Solid-State Inverters Have Varied Uses

GENERAL DYNAMICS/ELECTRONICS, Rochester, N. Y. Line of solid-state inverters have power outputs ranging from 250 to 5,000 w, at frequencies up to 10 Kc. They are al-



houston instrument corporation

4950 Terminal Avenue/Bellaire 101, Texas

MOhawk 7-7403/Cable: HOINCO

TWX 713-571-2063

ready in service as a standby power source for a telephone switchboard, providing 60 cycle a-c power from a d-c source; as drivers for fixed-frequency high power transducers, and as signalling devices. They are operated in both pulse and continuous modes. Variations of the inverters also have been incorporated as protective devices in amplifiers and other transistorized black box systems. (312)



Portable Amplifier Has 1 W Maximum Output

CAMBRIDGE ELECTRONICS, P.O. Box No. 1, Little Falls, N.J. Model CE-1300 transistorized intercommunications amplifier has been designed to provide highly reliable portable communications in aircraft, missile and industrial noisy environments. Input impedance is 100 ohms; output impedance, 100 ohms; sensitivity—normal speaking level will produce 800 mw output; output, 1 w max; distortion, less than 5 percent; weight 4 lb; price without accessories, \$94. (313)

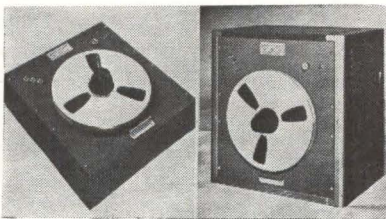

Tape Eraser Removes Magnetic Flux

GENERAL KINETICS INC., 2611 Shirlington Road, Arlington 6, Va. An ultrareliable magnetic tape bulk eraser is designed for continuous



HELIARC WELDED HERMETIC SEAL guards against thermostat failure

... when **KLIXON® M1 Precision Thermostats**
are specified for hostile environments

A helium leak rate less than 1×10^{-9} cc/sec is just one of the benefits derived from the KLIXON M1's hermetic seal. This void-free welded seal also eliminates contact contamination due to trapped solder flux, and provides unequaled resistance to salt spray, sand, dust and humidity.

High resistance to other environmental extremes also contributes to KLIXON M1 reliability. Its dependable clean-breaking, snap-action KLIXON disc operates without contact chatter or bounce under vibration of 5-2000 cps at 20 G and shock and acceleration up to 60 G. Contact life of 100,000 cycles at 5 amp, 30 V-dc is another high-reliability feature.

Fully qualified under MIL-E-5272 and MIL-T-5574, KLIXON M1 Thermostats are now in use in many high-reliability aircraft and missile applications such as the Polaris, Saturn, Atlas Series and Sidewinder. Typical uses are for controlling temperatures or activating warning systems in radar and other electronic equipment, gyros, fuel pumps, servo-motors and heating blankets as well as air conditioning, photographic, telemetering, de-icing and other equipment.

Our fast-response custom packaging team will design and produce M1 Thermostat packages to fit your special requirements.

Write today for complete specifications.

KLIXON M1
PRECISION THERMOSTAT
(actual size)



METALS & CONTROLS INC.
5002 FOREST ST. ATTLEBORO, MASS.
A CORPORATE DIVISION OF
TEXAS INSTRUMENTS
INCORPORATED

Reeves

modular strap-down gyro packages

FOR GUIDANCE... STABILIZATION... CONTROL

Operational... producible... with reliabilities and performance fully demonstrated in current satellite and aircraft programs. The following four representative types indicate the scope and experience of design, engineering, and production capabilities immediately available to aid in your advanced projects. Write for Data File 102.

THREE AXIS SATELLITE INERTIAL REFERENCE PACKAGE:

Three single-axis floated gyros and two accelerometers, with loops employing seven voltage and five power amplifiers. Current regulator and heater relay amplifiers. Amplifiers fully transistorized, individually encapsulated.

SINGLE CHANNEL SATELLITE STABILIZATION SYSTEM:

Utilizes Reeves D30S gyro, with trimmed drift rate of $0.1^\circ/\text{hr}$. Gyro loop incorporates voltage amplifier, demodulator, and d.c. power amplifier for gyro d.c. torque motor. Proportional temperature control amplifier regulates temperature.

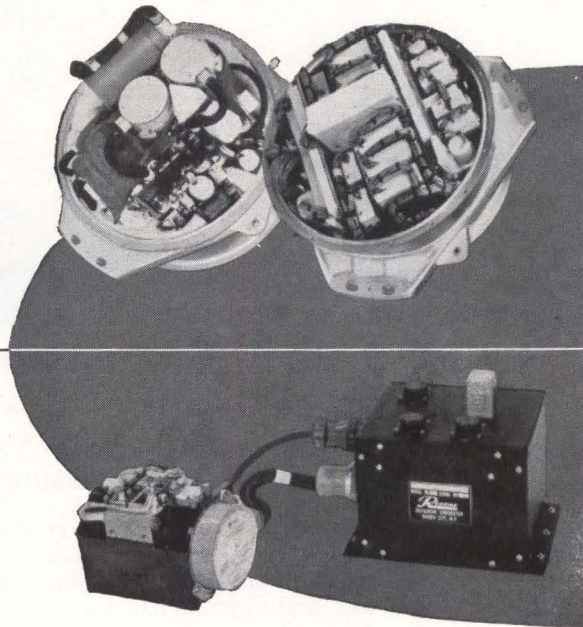

TWO CHANNEL ANTENNA STABILIZATION SYSTEM:

Each loop comprises a Reeves HIG-4 gyro and a voltage amplifier and power amplifier. Proportional temperature control amplifiers regulate temperature to ± 0.5 degrees for each gyro.



MODULAR AMPLIFIER COMPONENTS:

Transistorized, encapsulated units, readily incorporated into any system for voltage and power amplification; demodulation, and high precision temperature control.

REEVES INSTRUMENT CORPORATION

A Subsidiary of Dynamics Corporation of America, Roosevelt Field, Garden City, N.Y.

operation without overheating. The automatic unit has a complete erasure cycle of 1 minute per reel, will handle any standard reel diameter from 3 in. to 15 in. and can accommodate tape widths up to 2 in. Model K-80 accomplishes erasure by rotating the tape reel through a gradually-reduced high-flux density alternating magnetic field employing three separate magnet coils. Erasure level is 80 to 95 db, depending on the method of measurement.

CIRCLE 314 READER SERVICE CARD

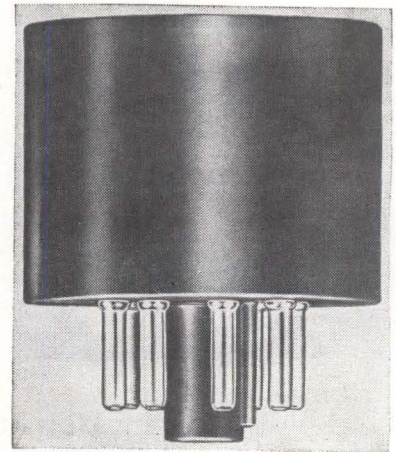

Silicon Rectifiers in Octal Base Assembly

SYNTRON CO., 241 Lexington Ave., Homer City, Pa. New development—avalanche silicon rectifiers encapsulated in an octal base assembly—is available in one complete package. The self-protecting avalanche characteristics offer complete protection against transients. For single phase capacitor filter circuits, ratings are 1.0 amp d-c half-wave, and 2.0 for the center tap or full-wave bridge. Various reverse peak voltage ratings are available from 200 to 800 v per circuit arm for the full-wave bridge, to 1,600 for the center tap and 3,200 v for the half-wave. (315)

Low-Level Transistors Are Double-Diffused

FAIRCHILD SEMICONDUCTOR, Mountain View, Calif., announces two new low-level, low-noise transistors. Both are double-diffused silicon planar devices for use in high performance amplifier circuits. The

2N2483 has a typical noise figure of 2.0 db; 2N2484 is rated at 1.8 db. Both are in the Fairchild TO-18 package. (316)

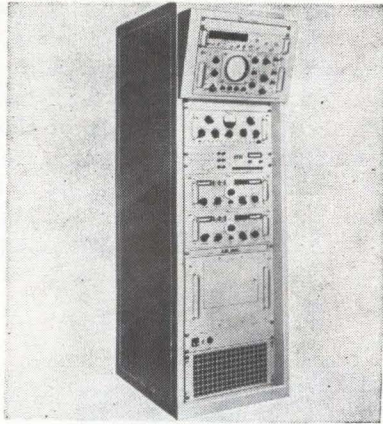

Signal Conditioner Displays PCM Data

DYNATRONICS, INC., Box 2566, Orlando, Fla. Model 5228 provides a complete ground station for collecting and displaying pcm telemetry data. System accepts serial pcm inputs in NRZ, RZ, or split-phase form from a tape playback driver, receiver, integral signal simulator, or other external source. It provides bit synchronization at extremely low S/N ratios and over wide bit-rate ranges (10-640,000 bits/sec). Integral checkout circuitry provides quick self-check of the conditioner and decom chassis and checkout of receiver. (317)

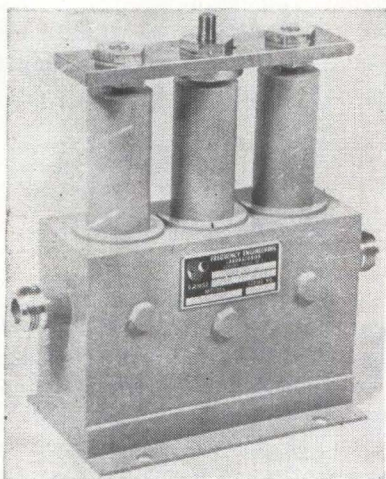

Bandpass Filter Tunes From 2 to 4 Gc

FREQUENCY ENGINEERING LABORATORIES, Asbury Park, N. J. This

Great news in metal-to-plastic electrical laminates

Bend it
Stack it
Twist it
Roll it
Flex it
Test it!

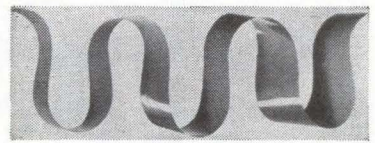
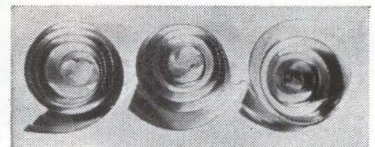
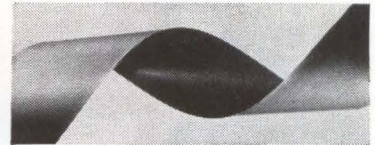
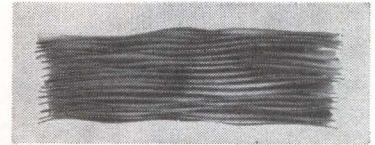

Replace expensive hand wiring with low-cost continuous processing of Schjel-Clad*.

This unique combination of flexibility and dimensional stability in Schjeldahl's metal-to-plastic electrical laminate, Schjel-Clad, can really cut costs. It permits reliable, continuous in-line processing to produce flexible wiring harnesses, computer memories and other flexible printed wiring.

Schjel-Clad is available in a variety of materials: Copper, Aluminum or Nickel bonded to Polypropylene, Mylar[†] or Teflon[†]. Each laminate is available in a wide variety of thicknesses and widths. Write or call for data sheets and samples in the sizes you need. Phone: Area Code 507, NI 5-5635.

*G. T. Schjeldahl Co., T.M. Reg. U.S. Pat. Off. [†]duPont trademarks for its polyester film; fluorocarbon resins

Putting Materials Together Through Chemistry and Mechanical Design

PRODUCTS



SERVICES

G.T. Schjeldahl Co.

SAY "SHELL-DOLL" • NORTHFIELD, MINNESOTA

**GOT A
CRACKING
PROBLEM
DUE TO
THERMAL
SHOCK
?**

SOLVE IT WITH A HARCURE EPOXY FLEXIBILIZER AND CURING AGENT

Are you running a high reject rate on such items as encapsulated and impregnated electrical components due to thermal shock? Are you seeking higher impact resistance for epoxy base glass fiber laminates, filament windings and prepregs? Do you need a better flexibilizer for fluidizing powders and epoxy tapes?

One of the Harcure family of four epoxy curing agents will solve any of these problems — is doing it right now for leading producers of epoxy structures.

WRITE FOR DATA AND SAMPLES

**HARCHEM
PRODUCT DEVELOPMENT
DEPARTMENT**

WALLACE & TIERNAN, INC.

25 MAIN STREET, BELLEVILLE 9, NEW JERSEY

THE KEY TO
BETTER PLASTICS

3-section bandpass filter tunes over a range of 2.0-4.0 Gc and has a 3 db bandwidth of 17 ± 2 Mc over the band. It is suitable for use as a pre-selector in countermeasures equipment and to eliminate spurious signals from a local oscillator. The 60 db rejection is 200 Mc max, insertion loss is 1.3 db max at f_o , and input vswr is 1.5:1 max at f_o . Filter is gang-tuned and can be furnished with a gear-driven control for single knob tuning or the tuning elements can be ganged to a bar for use in a servo operated system.

CIRCLE 318 READER SERVICE CARD

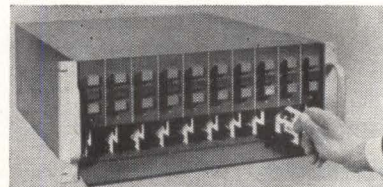

Voltage Comparator Is Highly Accurate

CALIFORNIA INSTRUMENTS CORP., 3511 Midway Drive, San Diego 10, Calif. New ECOM 1000 series analog voltage comparator eliminates complex and expensive process of digitizing unknown data prior to comparison. It provides from 1 to 10 individual channels of go, no-go comparison in each rack mounted unit. Each channel has its own set of upper and lower limits. Output information is provided in the form of front panel lights and isolated contact closures. It features 0.01 percent full scale accuracy, less than 100 ms measuring time, 1 mv resolution and 100 megohm input impedance. (319)

Waveguide Switch Used in X Band

MICRO STATE ELECTRONICS CORP., 152 Floral Ave., Murray Hill, N.J. Model S8401 is a high-speed spdt waveguide switch designed for operation over 60 Mc in the X band region. It has 32 db isolation to signals of up to 0.5 w, with an insertion loss of 0.6 db. Vswr is less than 1.5 over the frequency band. Switching speed is 2.5 nsec. The video pulse is less than 10 v at 20 ma. (320)

Literature of the Week

PRODUCT INDEX Gulton Industries, Inc., 212 Durham Ave., Metuchen, N. J. A product index folder acts as introduction to the activities of the company and its subsidiaries (321)

DATA SYSTEM Systems Division of Beckman Instruments, Inc., 2400 Harbor Blvd., Fullerton, Calif. Model 210 data acquisition and data processing systems are described in bulletin 3017-C. (322)

GENERAL PURPOSE RELAY Branson Corp., 41 S. Jefferson Rd., Whippany, N. J. Technical bulletin describes the type JR transistor sized general purpose relay. (323)

POWER PACKS Wabash Magnetics, Inc., 1375 Swan St., Huntington, Ind. Five new h-v power pack models are pictured and described in a four-page folder. (324)

MAGNETIC TAPES Minnesota Mining and Mfg. Co., 2501 Hudson Rd., St. Paul 19, Minn., offers a bulletin describing technical factors involved in the use of surface protected magnetic tapes. (325)

STANDING WAVE INDICATOR General Microwave Corp., 155 Marine St., Farmingdale, L. I., N. Y. Catalog sheet describes model 351, a direct-reading instrument designed for the measurement of vswr and attenuation. (326)

COMPONENT PLATING Platronics, Inc., 500 Commerce Road, Linden, N. J. The precision-engineered plating of electronic components is described in an illustrated brochure. (327)

SEMICONDUCTOR TEST STATION Optimized Devices, Inc., 220 Marble Ave., Pleasantville, N. Y. A 24-page technical brochure describes features of the model 1500 automatic semiconductor test station. (328)

MICROCONDUCTOR GLASS Corning Glass Works, Corning, N. Y., has available a brochure describing a glass that contains thousands of parallel, hermetically sealed conductors per square inch. (329)

FILTERS AND CAPACITORS RF Interonics, Inc., 15 Neil Court, Oceanside, L. I., N. Y. Bulletin 2610, listing rfi cylindrical filters and feed-through capacitors, provides realistic attenuation figures measured at full load per MIL-STD-220A. (330)

RATE GYROSCOPES Humphrey, Inc., 2805 Canon St., San Diego 6, Calif., has available catalog BR0001 illustrating and describing a complete line of rate gyroscopes. (331)

RELAY MANUAL Artisan Electronics Corp., 171 Ridgedale Ave., Morristown, N. J., offers a four-page manual to aid engineers to select the right relay for the job. (332)

STRIP-CHART RECORDERS Texas Instruments Inc., 3609 Buffalo Speedway,

Houston 6, Texas. Bulletins R-507, R-505 and R-508 describe latest additions to a line of rectilinear strip-chart recorders. (333)

RFI PROBLEM SOLUTION Metex Electronics Corp., Walnut Ave., Clark, N. J., has published the first of a series of bulletins discussing rfi packaging problems and their solutions. (334)

ENCAPSULATION CUPS U. S. Engineering Co., 13536 Saticoy St., Van Nuys, Calif. Brochure describes a line of molded plastic cups for encapsulating electronic components or modules. (335)

CRYSTAL UNITS Reeves-Hoffman, a division of Dynamics Corp. of America, Cherry and North Sts., Carlisle, Pa. Bulletin gives detailed specifications on A elements in three ranges: from 500 to 1,400 Kc, 1.4 to 20 Mc and 10 to 125 Mc. (336)

ULTRASONIC CLEANING National Ultrasonic Corp., Foot of James St., Somerville, N. J. Catalog No. 36 gives complete details on the ultrasonic cleaning and vapor degreasing processes. (337)

CAPTIVE HARDWARE National Radio Co., 37 Washington St., Melrose, Mass., offers a catalog and specification sheet on a line of stainless steel captive inserts for aluminum or brass. (338)

ELECTRICAL CONNECTIONS Buchanan Electrical Products Corp., Route 22, Hillside, N. J., has published a guide to correct techniques for solderless wire splicing and terminating under a wide variety of field conditions. (339)

INSULATION TESTER Western Electrodynamics, Inc., P.O. Box 98, Colorado Springs, Colo. A 4-page illustrated bulletin covers the model IT-52 insulation tester. (340)

MICROMINIATURE ASSEMBLY TOOLS Techni-Tool, Inc., 1216 Arch St., Philadelphia 7, Pa., offers a 24-page brochure on precision electronic pliers, super-fine tweezers and other items essential to the aerospace needs. (341)

DIFFRACTOMETER DATA SYSTEMS Datex Corp., 1307 S. Myrtle Ave., Monrovia, Calif. Diffractometer data and control systems are covered in bulletin 360. (342)

ULTRASONIC SEARCH UNITS Sperry Products, Division of Automation Industries, Inc., Danbury, Conn., has published a 16-page illustrated brochure entitled "What You Should Know about Ultrasonic Search Units." (343)

P-C RESISTORS Cohu Electronics, Inc., KinTel Division, 5725 Kearny Villa Road, San Diego 12, Calif. Precision printed circuit resistors are described in data sheet 23-5. (344)

NEW VIBRATING CAPACITOR



A vibrating-reed type capacitance modulator for use in measuring currents as low as 10^{-16} amperes.

Long term stability for process control. Drift ± 0.2 millivolts per day, non-cumulative.

Write for Catalog 523.



STEVENS INCORPORATED ARNOLD

7 ELKINS STREET
SOUTH BOSTON 27, MASS.

S/A-15

Dale Electronics Opens New Plant

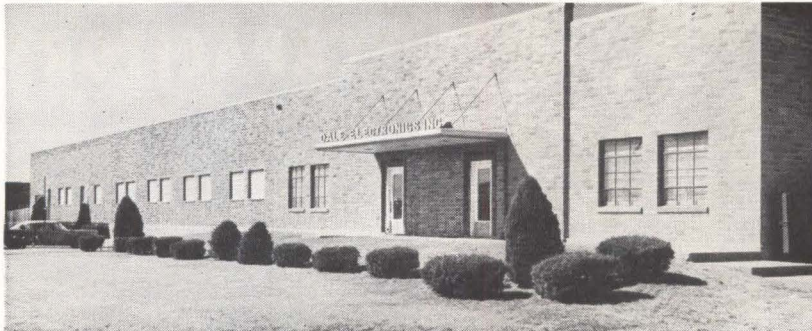

DALE ELECTRONICS, Inc., has announced the opening of a third production facility in Columbus, Neb. In making the announcement, William R. Simpson, Dale president, said the 41,120-square-foot building will initially be used for the production of precision potentiometers and trimmer pots.

Simpson said there are two principal reasons for the expansion: (1) The company needs additional space in its two present Columbus plants for the production of resistors as well as for its participation in the

Minuteman high-reliability development program. (2) The increased emphasis which the company is placing on potentiometer production made it advisable to set up a separate manufacturing facility for these products.

Operations in the new building bring the total administrative development and production space occupied by Dale in Columbus to 123,114 square feet. In addition, the company has production facilities in Yankton, South Dakota, and Scarborough, Ontario, Canada.

IBM Corporation Appoints Fellows

A NEW PROGRAM to recognize and reward its highly creative scientists, engineers and other professions has been announced by IBM Corporation.

Thomas J. Watson, Jr., IBM board chairman, said that the company has established a new rank of "IBM Fellow" to give special recognition to members of its technical staff who have outstanding records of sustained innovation and achievement. The IBM Fellows will have freedom in choosing and carrying out research projects within their field of specialty and will act as consultants to other IBM scientists and executives.

Fellows are appointed by Watson, who receives recommendations from a committee headed by Eman-

uel R. Piore, IBM vice president, research and engineering.

The first scientists and engineers named IBM Fellows are:

John W. Backus, Genung L. Clapper, Ronald D. Dodge, Charles R. Doty, Sr., Clyde J. Fitch, Frank E. Hamilton, Ralph L. Palmer, and Llewellyn H. Thomas.

Power Designs Gets West Coast Subsidiary

POWER DESIGNS INC., of Westbury, N. Y., manufacturer of precision electronic power supplies, has acquired 95 percent of the stock of Carad Corp., of Palo Alto, Calif.

Herbert Roth, president of Power Designs, said Carad's line of high voltage units and pulse modulators,

among other h-v power supplies, would complement Power Designs' line of low voltage equipment.

Carad will be known as Power Designs Pacific, Inc., with Nathan Most continuing as president and David Simmons continuing as director of engineering.

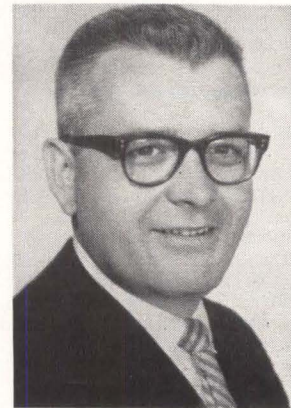

Promote Brophy to ARF Vice President

JAMES J. BROPHY has been promoted to vice president for technical development at Armour Research Foundation at Illinois Institute of Technology, Chicago, Ill. He had been serving as director of technical development since 1961.

Brophy's recent research efforts resulted in a nationally-acclaimed conference (sponsored jointly by **ELECTRONICS**) held in Chicago. He is currently continuing research in the fluctuation effects of semiconductors, the specialty for which he is best known.

Announce Formation of New Company

A NEW FIRM, known as Mil-Tor, was recently set up in the components area of the aerospace industry in Gardena, Calif. The company has two primary areas of interest—magnetic components and solid state circuits.

Mil-Tor is a privately financed company, founded by its president and chief executive officer, Alfred P. Martin. He formed the company after 10 years experience as an en-



RELAY
DJ26E1P6A
FILTORS INC

(actual size)

THE ALL-WELDED DEMI-J RELAY

50% SMALLER • USES 20% LESS POWER • GIVES FULL-SIZE PERFORMANCE

Filtors' new DEMI-J Relay is mechanically and functionally interchangeable with the best crystal-can relays, yet it is half the size and requires 20 percent less pull-in power than most crystal-can relays. The new "Super Mu" rotary relay motor, incorporating a radically new bobbinless coil, makes the DEMI-J Relay 60 percent more efficient than relays having similar configurations. The DEMI-J Relay is constructed and sealed using a unique welding process; no solder (or solder flux) is used anywhere in the assembly of this relay.

SPECIFICATIONS

AMBIENT TEMPERATURE RANGE	... -65 degrees C to 125 degrees C
DIELECTRIC STRENGTH 1000 volts rms, 500 volts between contacts, 350 volts at 80,000 feet
INSULATION RESISTANCE 1000 megohms minimum (500 volts dc, 25 degrees C, 50 percent relative humidity maximum)
CONTACT ARRANGEMENTS 1 or 2-pole double-throw
CONTACT RESISTANCE (Maximum)	... 0.05 ohm initial, 0.10 ohm after rated life
CONTACT RATING 2 amperes resistive, 1 ampere inductive (100 millijoules maximum stored inductive energy; time constant, 6 milliseconds), 4 amperes overload. Contacts for low-level circuits available
VIBRATION 30 g's from 5 to 3000 cps
SHOCK 150 g's for 11 milliseconds
OPERATE TIME (Maximum) 5 milliseconds (rated coil voltage, 25 degrees C)
RELEASE TIME (Maximum) 5 milliseconds

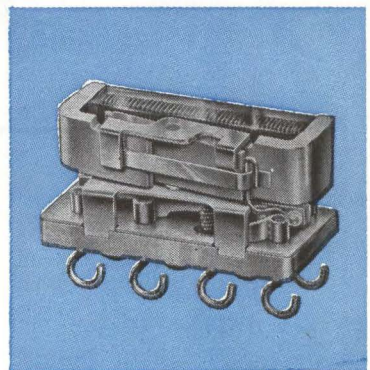

FILTORS, INC. / RELAYS EAST NORTHPORT, LONG ISLAND, NEW YORK
516—AN 6-1600

I.E.E.E. BOOTH 2412



Rixon SEPATH is an important unit in the secure voice communication link between these two gentlemen.

Secure voice communication between a tactical position at sea and the command post insures accurate and instantaneous transmission of vital information. Rixon SEPATH equipment provides the necessary multiplexing to accomplish encrypted voice transmission. SEPATH is one of many systems available through the DD line. Others?

- MODEMS for serial transmission of facsimile or digital voice over telephone lines at 3600-4800 bps . . .
- SEPATH for hf data transmission at 2400 bps . . .
- 16/32 channel TTY or mixed data/TTY multiplexing systems for bulk encryption . . .

For a demonstration of Rixon DD line data communications systems, visit us at the IEEE show, booths 3034-3035. Our engineers are eager to prove DD line flexibility . . .

RIXON ELECTRONICS, INC.

2121 INDUSTRIAL PARKWAY—MONTGOMERY INDUSTRIAL PARK—SILVER SPRING, MARYLAND
TELEPHONE: 622-2121 TWX: 301 622-2292

CIRCLE 203 ON READER SERVICE CARD



Good parts work best!

Intermediate Frequency Transformer IFT



POLYVARICON Variable Capacitor



The high standards of MITSUMI electronic components are insured by a fully-automated assembly system, and double-checked by rigid quality controls. Mitsumi Electric Company is Japan's largest manufacturer of components for radio, television and communications equipment.

MITSUMI PARTS

MITSUMI ELECTRIC CO., LTD.



gineer, the last six of which were spent designing magnetics and solid state electronics at the state-of-the-art. Martin's assignment prior to forming Mil-Tor was that of chief engineer of Power Instruments Corp. of El Segundo, Calif.

Cheesman Takes New ITT Position

APPOINTMENT of W. J. Cheesman as group manager-telecommunications of International Telephone and Telegraph Corp. is announced.

In his new position, Cheesman will head the ITT Kellogg Telecommunications division which includes the telecommunications and transmission manufacturing operations. As an integral part of his responsibilities, he will continue as president-ITT Canada, Limited.

Polarad Hires Bela Ranky

BELA RANKY has been named to the post of engineering section head of Polarad Electronic Instruments, a division of Polarad Electronics Corp., Long Island City, N.Y.

He brings to his new position at Polarad over 9 years of engineering background at Panoramic Electronics where he was a supervisory engineer.

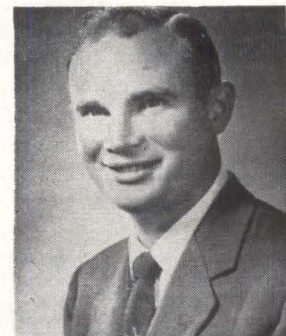

Technical Materiel Appoints Palmer

THE TECHNICAL MATERIEL CORP., Mamaroneck, N.Y., announces the appointment of James K. Palmer as vice president and director of its new wholly owned subsidiary, TMC Research Inc., in San Luis Obispo, Calif.

Before joining The Technical Materiel Corp., Palmer worked as liaison engineer for Emtech in Palo Alto, Calif.

Hooper Assumes New Position

COMPONENTS INC., Biddeford, Maine, has appointed William D. Hooper to the newly created post of manager of application engineering.

Prior to this, Hooper was manager of the electrical section of Bel-tone's Research Laboratories, Chicago, responsible for the design of hearing aids and audiometric products.

RCA Elevates C. R. Denny

APPOINTMENT of Charles R. Denny as vice president and managing director, RCA International division, is announced.

A vice president of RCA since 1958, Denny has served the firm and its wholly-owned subsidiary, the National Broadcasting Co., for more than 15 years. He is also a member of the board of directors of RCA Communications, Inc., and of RCA Great Britain, Ltd.



Appoint Bryant a Vice President

THOMAS D. BRYANT has been named a vice president of the Librascope division of General Precision's Information Systems Group in Glendale, Calif. He retains his position as manager of the Glendale branch, which he has headed since 1960.

General Precision's Information Systems Group comprises the Com-

mercial Computer division and the Research Center in addition to the Librascope division.



Loral Electronics Elects Herman

LORAL ELECTRONICS CORP., Bronx, N.Y., has elected Bernard Herman vice president, operations.

Herman has been manager of operations since 1960 and was previously manager of industrial engineering for the company.

Jerrold Electronics Reassigns Cooley

CAYWOOD C. COOLEY, JR., has been appointed manager of the Community Systems division of Jerrold Electronics Corp., Philadelphia, Pa.

The Community Systems division is responsible for the design, manufacture and marketing of equipment for community antenna television systems, as well as installation of completed systems.

Cooley, who was formerly manager of Jerrold Electronics' Industrial Products division, is also a vice president of the company.

Burnell Schedules Expansion Program

BURNELL & CO., INC., Pelham, N.Y., is expanding to the Southwest, Norman Burnell, president, announced. A new \$440,000 plant is being built to the company's specifications by the Laguna Indian Tribe at New Laguna, N.M., near Albuquerque. It will be occupied under a 25-year lease.

The new plant, expected to be ready by the middle of this year,

NEW FLEXIBLE PERMANENT SEALANT



- seal metal joints, sheet work
- seal leaks
- insulate wiring and terminals
- use as adhesive for pre-fabricated silicone rubber

For a thousand jobs, just squeeze it on and it's on to stay! No pre-mixing or priming. RTV-102 silicone rubber adheres to almost anything — glass, metal, plastics, tile, wood, silicone rubber. Sets in minutes, cures in a few hours, forms a resilient rubber that never dries out, cakes or cracks. Resists moisture, grease, weathering, many chemicals, and temperatures from -75°F to 500°F.

RTV-102 won't sag on vertical surfaces, can be smoothed over large areas, "gives" with vibration and flexing. For free evaluation sample plus technical data, write on your letterhead describing your application to Section N270, Silicone Products Department, General Electric Company, Waterford, N.Y.

GENERAL  ELECTRIC

SARATOGA INDUSTRIES REPORT

A significant advance in Precision Control of Battery Charging and Discharging

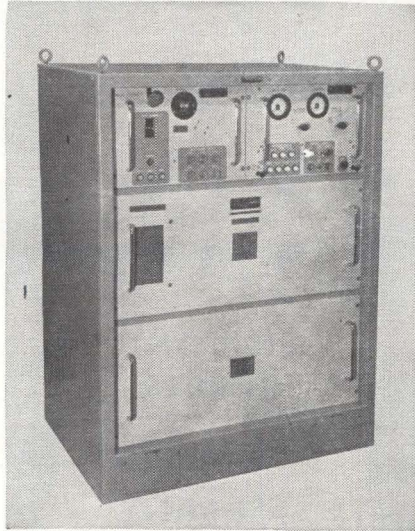

Custom designed to meet customer's functional requirements.

The SI-332-PS utilizing magnetic amplifier and semiconductor controls is pre-programmed to insure full battery power capability under all conditions. Sensing and memory circuits program the charger through high rate, low rate, and trickle charge modes as required by automatic analysis of the battery condition. During discharge modes, fast response regulator circuits prevent overvoltage conditions at the system output terminals. Non-linear resistor networks maintain the output voltage within narrow limits over a wide range of load current and state of battery charge.

Control features have also been included to provide local control or unattended remote operation.

For full information about Saratoga Industries complete design, engineering and production facilities write



SARATOGA INDUSTRIES
A Division of Espey Mfg. & Electronics Corp.
Saratoga Springs, N. Y. • Telephone 4100

will rise on a 10-acre tract. It will have 40,000 sq ft of space available for approximately 400 employees. Construction is scheduled to begin early this spring.

Scientific-Atlanta Elects Clayton

LORIMER CLAYTON, JR. has been elected vice president-research of Scientific-Atlanta, Inc. He has been associated with the Atlanta firm since 1957, most recently serving as assistant director of engineering.

LFE Electronics Names Newman

DAVID B. NEWMAN has been named to the new post of manager, advanced programs, for LFE Electronics, a division of Laboratory For Electronics, Inc., Boston, Mass. He will report to G. V. Woodrow, director of research and engineering, and will be responsible for long-range planning, weapon systems engineering and new capability development.

Before joining LFE Electronics, Newman was assistant director, advanced design, for Fairchild Electronic Systems Division, Wyandanch, N. Y.

Appoint Wundt Senior Scientist

ROLF M. WUNDT has been named a senior scientist at the Advanced Systems Planning Organization of Sylvania Electronic Systems, Waltham, Mass.

Wundt joined Sylvania in 1957 as a senior engineering specialist. His major areas of endeavor have been in antenna design and propagation theory with emphasis on buried antennas for underground communication systems.

Browne Accepts New Position

APPOINTMENT of Sidney Browne as technical advisor to the senior vice president for engineering—R&D at

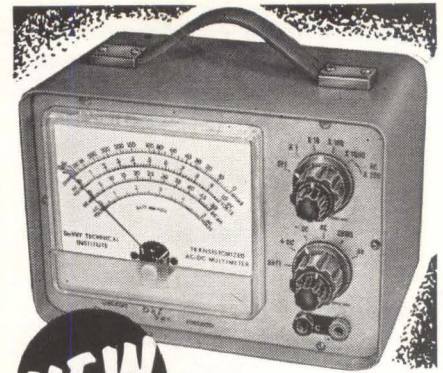

NEW DeVry TECHNICAL INSTITUTE'S

TRANSISTORIZED METER

Combines the advantages of a vacuum tube voltmeter and a sensitive microammeter plus full protection for the meter movement! High input impedance, temperature stability, silicon semiconductors, 1% attenuator resistors, wide frequency response. Order direct (not sold through distributors). Satisfaction guaranteed.

PORTABLE LOW-PRICED \$89⁵⁰
FACTORY WIRED Unwired Kit . \$64.50
F.O.B. Chicago



Product Research Division—Dept. RD-4
DeVRY Technical Institute
4141 Belmont Ave., Chicago 41, Ill.

CIRCLE 204 ON READER SERVICE CARD

A sweet little Amplifier

(and tough as nails)

NEXUS TYPE CDA-1 ALL SILICON SOLID STATE OPERATIONAL AMPLIFIER MEETS OR EXCEEDS SHOCK, VIBRATION, ETC. AS PER MIL-E-5272C. For further information on this superb analog module and other quality types write, wire or phone.

NEXUS
RESEARCH LABORATORY, INC.
19 Needham St., Dedham, Mass. 617-326-8414

CIRCLE 205 ON READER SERVICE CARD

electronics

Page Communications Engineers, Inc., Washington, D.C., a subsidiary of Northrop Corp., has been announced by Ross Bateman, senior vice president, engineering-R&D.

Browne comes to Page from the SHAPE Air Defense Technical Center in The Hague. He was deputy chief, communications group, and was directly engaged in the group's work on military defense communications problems in Europe.

Corning Appoints Charles Wakeman

CHARLES B. WAKEMAN has been named director of electronics research for the Electronic Products division of Corning Glass Works, Raleigh, N. C.

He formerly was vice president of research and development for Magnetics, Inc., of Butler, Pa.

Bell Aerosystems Advances Perkins

APPOINTMENT of Aladdin N. Perkins as director of research for the Tucson Research Laboratory of Textron's Bell Aerosystems Company has been announced.

Perkins joined Bell in Tucson in June 1962. He previously was a member of the research staff of Collins Radio Company in Cedar Rapids, Iowa, responsible for research in modern electronics network theory.

Korad Adds Two to Management Staff

KORAD CORP., Santa Monica, Calif., now conducting an expanded research and development program in the laser field, has announced that Fred P. Burns has joined its management staff. He will manage the program concerned primarily with the application of semiconductor materials to laser devices.

Burns has had management experience at Tung Sol, RCA, and Solid State Radiations, Inc.

Company also announced that Arnold Gillmer, formerly with the

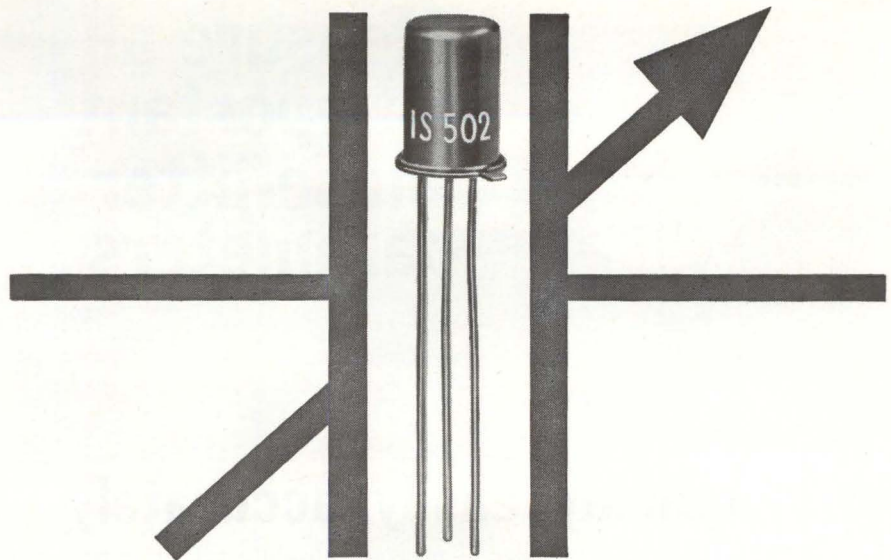

WIDE-RANGE, HIGHLY-SENSITIVE VARIABLE CAPACITANCE DIODE

(Brand: Varipico)

Fujitsu Varipico is a new diode designed to serve especially as a variable capacitor. Having a "hyper-abrupt" junction, a wide range of capacitance variation is made possible by simply varying a small negative bias voltage. The relationship of capacitance to bias voltage is: $C \propto \frac{1}{V^n}$. Since n can be set anywhere between 1 and 5, the capacitance range is very large. This makes the Varipico extremely useful in many applications such as frequency modulators, sweep generators, signal generators, frequency meters, phase shifters, converters and multipliers, and parametric amplifiers. The Varipico, hermetically sealed in a metal case, measures only 5.7 mm in diameter and 8mm in length, exclusive of leads. For full technical data and application information write to our representative shown below.



FUJITSU LIMITED

Communications and Electronics

Tokyo, Japan

Represented by: U.S.A. HAR-WELL ASSOCIATES, INC.: Southbury, Connecticut, Phone: 264-B222 THE NISSHO PACIFIC CORP. 120 Montgomery St., San Francisco 4, California, Phone: YUkon 2-7901, 7906 Canada: NISSHO (CANADA) LTD. 100. University Avenue, Toronto, Phone: EMpire 2-4794 United Kingdom: WALMORE ELECTRONICS LIMITED 11-15 Betterton Street, Drury Lane, London W.C. 2, Phone: TEMplebar 0201-5 Germany: NEUMÜLLER & CO. GMBH 8 München 13, Schraudolphstr. 2a, Phone: 29 97 24

CIRCLE 107 ON READER SERVICE CARD

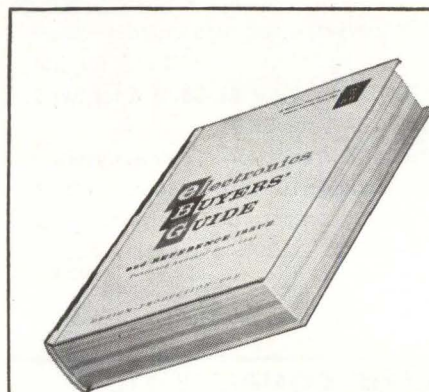

Your **electronics BUYERS' GUIDE** should be kept in your office at all times—as accessible as your telephone book.

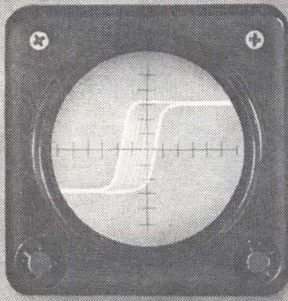

Measure all 5 important pulse-jitter parameters

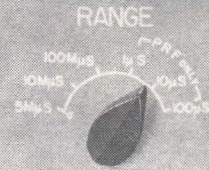

...quickly, easily, accurately

Detect jitter to 0.5 nanosec. — measure absolute prf jitter from 5-100,000 nanosec; 5-100 nanosec width or relative (pulse-to-pulse) jitter; display disturbing frequency, derive video output. This direct-reading instrument is specifically designed for jitter test. Save time, prevent error, improve accuracy in development, production, system check with the reliable, sensibly-priced **MODEL PJ-1**.

Call your POLARAD Field Engineer for a prompt, free demonstration!

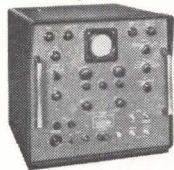

POLARAD POLARAD
ELECTRONIC INSTRUMENTS

A Division of Polarad Electronics Corporation
World Leader in Microwave Instrumentation
34-02F Queens Blvd., Long Island City 1, New York

CIRCLE 206 ON READER SERVICE CARD

ORIGIN SILICON DIODE

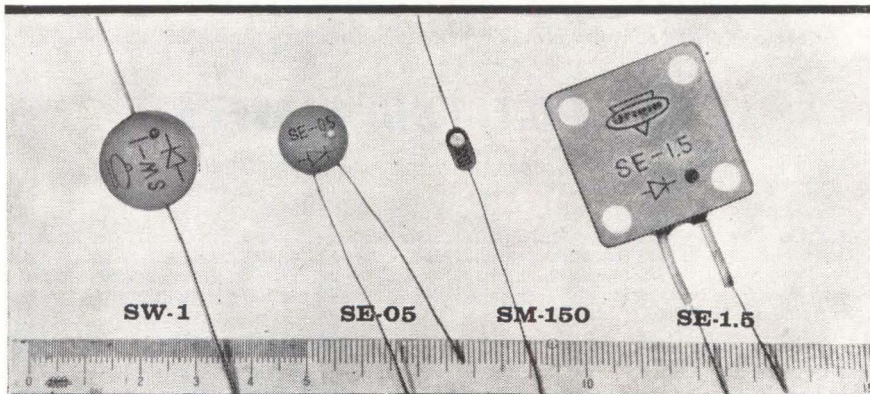

Origin diodes shown, are available in 4 models for PIV of 400, 600, 800 and 1000 volts.

Max. AC input voltages (RMS) of 280, 420, 560 and 700 volts.

Max. reverse current (at PIV, 25°C ambient) is less than 10µA, only 50µA for SW-1.

Main Products:

Semi-conductors, condenser type spot welder, synthetic enamel and miniature ball bearing.

Max. average rectified current (single phase, half-wave) is 150mA for SM-150, 500mA for SE-05, 1 A for SW-1, and 1.5 A for SE-1.5.

Surge current (for 1=one cycle) is respectively 10 A, 16 A, 30 A and 20 A. Ambient temperature operating range is -55 to +130°C for each diode.

Correction: Temperature of +13°C given in Jan. 5 & 26 copy is corrected to read +130°C.



ORIGIN ELECTRIC COMPANY LTD.

1-195 Takadaminami-cho, Toshima-ku, Tokyo, Japan
Cable Address "ORIGINELE TOKYO"

Aeronutronic division of Ford Motor Co., now heads the Engineering division at Korad. He will be responsible for the development of laser devices, and application of these devices to laser systems.

T. D. Sege Joins Eitel-McCullough

THOMAS D. SEGE has been named manager of the power grid tube division of Eitel-McCullough, Inc., San Carlos, Calif. The power grid tube division is the largest of Eimac's four manufacturing divisions.

Sege comes to Eimac from Sperry Gyroscope Co., Great Neck, N.Y., where he was chief engineer of the electronic tube division.

PEOPLE IN BRIEF

Allan Cork leaves Marquardt's Pomona div. to join Packard Bell Electronics as director of mfg., Space and Systems div. Howard J. Strauss, formerly with ESB Reeves Corp., appointed director of research of Burgess Battery Co. Sheldon O. Newman promoted to chief engineer of Sperry Gyroscope's Surface Armament div. Glenn R. Frantz, ex-Mitre Corp., named mgr. of the ZMAR program at the eastern operation of Sylvania Electronic Systems. Vinton D. Carver moves up to director of operations for the Data Systems div. of Litton Industries. Herbert R. Reiss, v-p of mfg. at Precision Circuits, Inc., elected a director. Marconi's Wireless Telegraph Co. Ltd. elevates D. G. Smee to asst. g-m. Kenneth Y. Knight of Hughes Aircraft Co. named mgr., engineering fabrication and procurement dept., ground systems group. Peter A. Denes, ex-Allen Bradley Co., now director of Gulton Industries' Components & Materials Development Lab. Frank E. Doyle leaves Sperry Utah Co. to become quality control mgr. at Jordan Electronics. Nicholas Glyptis, formerly with Multi-Tron Laboratory, Inc., appointed head of the advanced R&D labs of Wen Products, Inc.

electronics

WEEKLY QUALIFICATION FORM FOR POSITIONS AVAILABLE

ATTENTION: ENGINEERS, SCIENTISTS, PHYSICISTS

This Qualification Form is designed to help you advance in the electronics industry. It is unique and compact. Designed with the assistance of professional personnel management, it isolates specific experience in electronics and deals only in essential background information.

The advertisers listed here are seeking professional experience. Fill in the Qualification Form below.

STRICTLY CONFIDENTIAL

Your Qualification form will be handled as "Strictly Confidential" by ELECTRONICS. Our processing system is such that your form will be forwarded within 24 hours to the proper executives in the companies you select. You will be contacted at your home by the interested companies.

WHAT TO DO

1. Review the positions in the advertisements.
2. Select those for which you qualify.
3. Notice the key numbers.
4. Circle the corresponding key number below the Qualification Form.
5. Fill out the form completely. Please print clearly.
6. Mail to: Classified Advertising Div., ELECTRONICS, Box 12, New York 36, N. Y. (No charge, of course).

COMPANY	SEE PAGE	KEY #
ACF INDUSTRIES INC. Albuquerque Division Albuquerque, New Mexico	131*	1
ATOMIC PERSONNEL INC. Philadelphia, Penna.	112	2
BRISTOL COMPANY, THE Waterbury 20, Conn.	112	3
COLLINS RADIO COMPANY Cedar Rapids, Iowa	72	4
COLUMBIA UNIVERSITY Nevis Labs. Irvington-on-Hudson, N. Y.	112	5
ESSO RESEARCH & ENGINEERING CO. Linden, N. J.	110	6
FMA, INC. El Segundo, Calif.	131*	7
GENERAL DYNAMICS, ELECTRIC BOAT Groton, Conn.	110	8
HONEYWELL St. Petersburg, Fla.	94	9
NORDEN Div. of United Aircraft Corp. Norwalk, Conn.	111	10
PERSPECTIVE Needham, Mass.	131*	11
SPACE TECHNOLOGY LABORATORIES, INC. Sub. of Thompson Ramo Wooldridge Inc. Redondo Beach, California	29*	12

* These advertisements appeared in the Feb. 15th issue.

(cut here)

electronics WEEKLY QUALIFICATION FORM FOR POSITIONS AVAILABLE

(cut here)

(Please type or print clearly. Necessary for reproduction.)

Personal Background

NAME

HOME ADDRESS

CITY ZONE STATE

HOME TELEPHONE

Education

PROFESSIONAL DEGREE(S)

MAJOR(S)

UNIVERSITY

DATE(S)

FIELDS OF EXPERIENCE (Please Check)

22263

- | | | |
|--|--|---------------------------------------|
| <input type="checkbox"/> Aerospace | <input type="checkbox"/> Fire Control | <input type="checkbox"/> Radar |
| <input type="checkbox"/> Antennas | <input type="checkbox"/> Human Factors | <input type="checkbox"/> Radio-TV |
| <input type="checkbox"/> ASW | <input type="checkbox"/> Infrared | <input type="checkbox"/> Simulators |
| <input type="checkbox"/> Circuits | <input type="checkbox"/> Instrumentation | <input type="checkbox"/> Solid State |
| <input type="checkbox"/> Communications | <input type="checkbox"/> Medicine | <input type="checkbox"/> Telemetry |
| <input type="checkbox"/> Components | <input type="checkbox"/> Microwave | <input type="checkbox"/> Transformers |
| <input type="checkbox"/> Computers | <input type="checkbox"/> Navigation | <input type="checkbox"/> Other |
| <input type="checkbox"/> ECM | <input type="checkbox"/> Operations Research | <input type="checkbox"/> |
| <input type="checkbox"/> Electron Tubes | <input type="checkbox"/> Optics | <input type="checkbox"/> |
| <input type="checkbox"/> Engineering Writing | <input type="checkbox"/> Packaging | <input type="checkbox"/> |

CATEGORY OF SPECIALIZATION

Please indicate number of months experience on proper lines.

	Technical Experience (Months)	Supervisory Experience (Months)
RESEARCH (pure, fundamental, basic)
RESEARCH (Applied)
SYSTEMS (New Concepts)
DEVELOPMENT (Model)
DESIGN (Product)
MANUFACTURING (Product)
FIELD (Service)
SALES (Proposals & Products)

CIRCLE KEY NUMBERS OF ABOVE COMPANIES' POSITIONS THAT INTEREST YOU

1 2 3 4 5 6 7 8 9 10 11 12 13 14 15 16 17 18 19 20 21 22 23 24 25

Look what EE's are doing

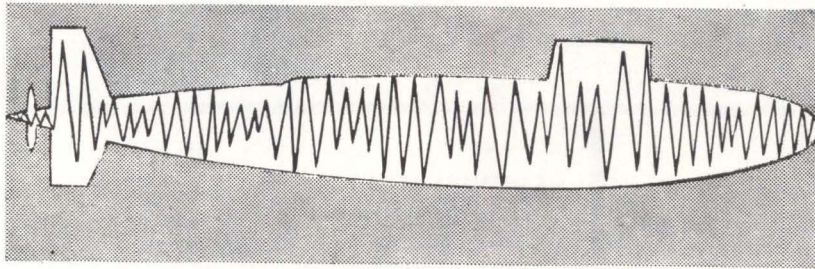

at ELECTRIC BOAT

- Design of Special Instrumentation for Measurement of Acoustic & Vibration Data
- Design & Installation of Interior Communication Systems, Navigation Systems, Ship Control Systems, Depth Control Systems, Steering & Diving Devices
- Application and Systems Engineering of Radio, Radar, Sonar & Countermeasures Systems & Components
- Design and Installation of Electric Power Plants & Distribution Systems
- Quality/Reliability Control & Assurance
- Nuclear Power Plant Systems Schematics Review
- Advanced Circuit Design
- Electronic Systems Engineering
- Missile Fire Control, Guidance and Checkout Systems & Equipment
- Installation and Test of Reactor Plant Auxiliary Power Supplies
- Integration of Control and Instrumentation Systems
- Navigation Systems and Equipment
- Procurement • Signal Systems Analysis
- Vendor Product Application Design
- Electrical Power & Control Systems & Component Design
- Test Development & Instrumentation Design
- Vendor Performance Analysis
- Process Control Engineering & Instrumentation
- Sound, Shock & Vibration Analysis

As a world of technology in miniature—incorporating missile launching systems, a nuclear propulsion plant, and life support systems—the nuclear submarine is an engineering challenge of the highest order. The Electrical and Electronic Engineer working at Electric Boat has a unique opportunity for professional development, not only in his own specialty but through broad knowledge gained in the unity of all technologies.

*Your resumes are invited. Please
address Mr. Peter Carpenter.*

GD
GENERAL DYNAMICS
ELECTRIC BOAT

Groton, Connecticut

AN EQUAL OPPORTUNITY EMPLOYER

Electrical & Electronic
Engineers

**ELECTRONIC DESIGN
& TEST EQUIPMENT
DEVELOPMENT
OPPORTUNITIES WITH**

**ESSO
RESEARCH &
ENGINEERING
COMPANY**

We are seeking creative ELECTRONIC and ELECTRICAL ENGINEERS to develop scientific instrumentation needed for our Company-wide chemicals and petroleum research effort in:

- New Products and Their Uses
- Solid Rocket Propellants
- Combustion and Lubrication
- Petroleum and Petrochemicals Processing

Diverse and challenging assignments, with full responsibility for engineering projects, provide broad design and development opportunities in such areas as:

- Electronic Circuits and Systems
- Pulse Coding and Data Conversion
- Automation and Control
- Photoelectric and Radioactive Tracer Applications

*Administrative or technical
advancement is based on performance*

Please submit resume in complete confidence to Mr. C. E. Holder, Professional Employment—Dept. 51



**RESEARCH &
ENGINEERING CO.**

P.O. Box 175, Linden, New Jersey

An Equal Opportunity Employer

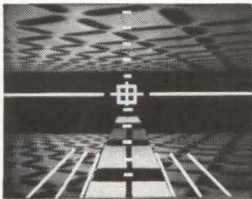
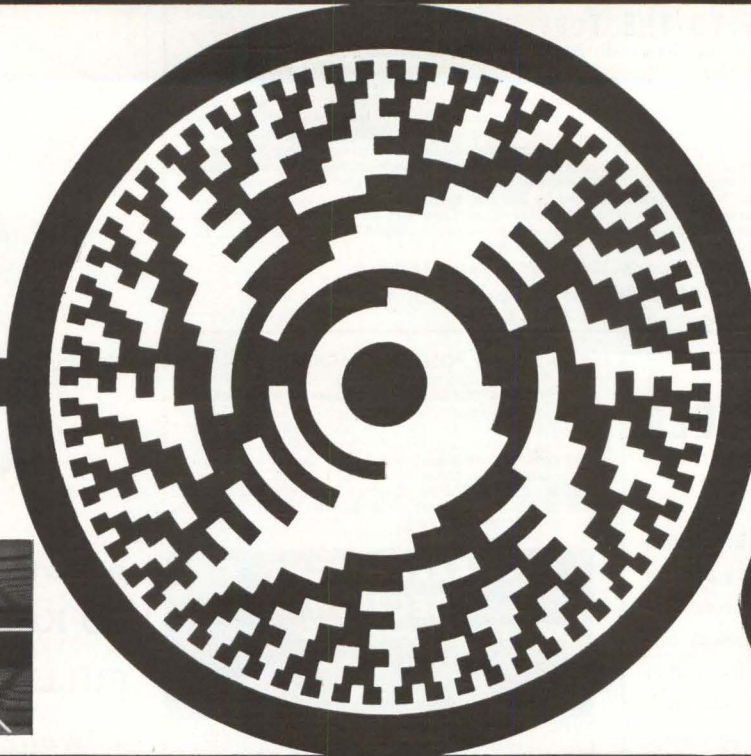
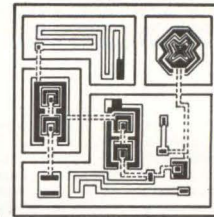

DIVERSIFY YOUR

TECHNICAL KNOW-HOW AT NORDEN

We believe in versatile engineers here — men with specialties, yes — but with broad knowledge in many allied areas. Those who have an especially strong interest in diversification are encouraged to grow into creative systems engineering. And the contacts between engineering operations and laboratory research are close. For example, circuit design engineers work hand-in-hand with applied physicists in extending the state of the art in molecular circuitry. An instance of the success of this cooperation: Norden's solid state servo amplifier, which produces a significant power level of 1.5 watts. (Work to obtain even higher outputs is underway.)

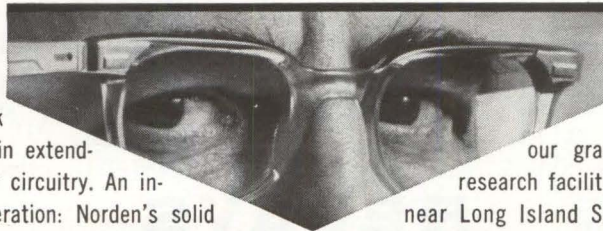

Climate for Achievement at Norden. Engineers and scientists find a working atmosphere at Norden that encourages continued learning and growth. Here, staff members work on problem-solving teams, gaining broad exposure to many technical aspects of a project. Opportunities for advanced study at nearby academic institutions are open to qualified engineers under our graduate program. Unsurpassed test and research facilities are available. And Norden's location near Long Island Sound is outstandingly attractive and convenient, easily reached from Northern New Jersey, Westchester, New York City, Long Island, and of course, all of Connecticut.

Opportunities at all technical levels on programs in the areas of submarine, helicopter, fixed wing aircraft and space vehicle display integration:

VIDEO CIRCUITS • CATHODE RAY TUBE DRIVE CIRCUITS • HIGH SPEED ANALOG & DIGITAL PROCESSING • VIDEO SIGNAL SYNTHESIS • RADAR & TV SYNCHRONIZERS • HIGH VOLTAGE POWER SUPPLIES

Also openings for:

SEMICONDUCTOR DEVICE SCIENTISTS & ENGINEERS. R&D of silicon functional electronic blocks. Requires experience with oxide masked multi-diffused structures and knowledge of transistorized circuitry.

SYSTEMS ENGINEERS. Aerospace applications of military ground support equipment; and modern microwave and optical radar systems.

RELIABILITY ENGINEERS. Review system and subsystem tests for design approval. Will recommend design modifications.

EQUIPMENT DESIGN ENGINEERS. Knowledge of stress analysis, heat transfer, high density electronic packaging.

Norden DIVISION OF UNITED AIRCRAFT CORPORATION



An Equal Opportunity Employer

Please forward your resume to Mr. James E. Fitzgerald, Employment Dept., Helen Street, Norwalk, Connecticut.

TO ENGINEERS WHO ARE LOOKING FOR THE ROUTE TO THE TOP:



Enter the sales field and benefit directly and rapidly from the effort you put forth. In sales engineering, you solve the industrial problems and make the recommendations for the technical equipment or services to produce the needed result; you gain the added benefit and satisfaction of applying your engineering and technical knowledge for the customer. Success in selling (and sales engineering is no exception) inevitably leads to greater responsibility for you, and to proportionately higher income. You are challenged to develop a stronger capability for getting along well with others, for exercising judgment, and for building the kind of background that is today most highly valued in business enterprises. These are the vital qualities which lead to the top! Sales engineering should interest you! Send us your resume. We design, develop, and manufacture instruments and control systems to be marketed nationally by our own sales team. You can be an important part of that team. Successful applicants are given a comprehensive three-months course at headquarters, with regular salary and expenses from start of employment. All replies will be held in complete confidence, and every inquiry will be answered.

Write: Charles F. Johnson, Manager of Sales Training
The Bristol Company Waterbury 20, Conn.
 (An equal opportunity employer)



PROJECT ENGINEER (Electronic)

Construction of a rapid data processing system to be used in elementary particle physics research. System involves digital electronics, mechanical-optical flying-spot scanner, precision measuring engines, high speed automatic film transport, fast magnetic-core memories, on-line 7090 computer. Academic atmosphere. Tuition exemption plan. An equal opportunity employer.

Send resume to Dr. Tycko,

COLUMBIA UNIVERSITY

Nevis Labs.

Box 137, Irvington-on-Hudson, N. Y.



E. E.'s for FEE-PAID Positions WRITE US FIRST!

Use our confidential application for professional, individualized service . . . a complete national technical employment agency.
ATOMIC PERSONNEL, INC.
 Suite 1207L, 1518 Walnut St., Phila. 2, Pa.

EMPLOYMENT OPPORTUNITIES



The advertisements in this section include all employment opportunities — executive, management, technical, selling, office, skilled, manual, etc.

Look in the forward section of the magazine for additional Employment Opportunities advertising.

— RATES —

DISPLAYED: The advertising rate is \$40.17 per inch for all advertising appearing on other than a contract basis. Contract rates quoted on request.

An advertising inch is measured 7/8" vertically on a column—3 columns—30 inches to a page.

Subject to Agency Commission.

UNDISPLAYED: \$2.70 per line, minimum 3 lines. To figure advance payment count 5 average words as a line.

Box numbers—count as 1 line.

Discount of 10% if full payment is made in advance for 4 consecutive insertions.

Not subject to Agency Commission.

POSITION VACANT

Electronics Graduate required by Research and Development Department. The applicant should be under 30 and have had experience in electronic circuits pertaining to industrial processing. Please send full details of education and practical experience and salary required to: Works Director, Southalls (Birmingham) Limited, Charford Mills, Saltley, Birmingham, 8, Eng.

SEARCHLIGHT SECTION

(Classified Advertising)

BUSINESS OPPORTUNITIES

EQUIPMENT - USED or RESALE

DISPLAYED RATE

The advertising rate is \$27.25 per inch for all advertising appearing on other than a contract basis. Contract rates quoted on request. **AN ADVERTISING INCH** is measured 7/8 inch vertically on one column, 3 columns—30 inches—to a page. **EQUIPMENT WANTED or FOR SALE ADVERTISEMENTS** acceptable only in Displayed Style.

UNDISPLAYED RATE

\$2.70 a line, minimum 3 lines. To figure advance payment count 5 average words as a line.

PROPOSALS, \$2.70 a line an insertion.

BOX NUMBERS count as one line additional in undisplayed ads.

DISCOUNT OF 10% if full payment is made in advance for four consecutive insertions of undisplayed ads (not including proposals).

OVER 2,000,000

RELAYS IN STOCK!

Send for Catalog 55
Universal RELAY CORP.
 42 WHITE ST., N.Y. 13, N.Y. • WAlker 5-6900

CIRCLE 954 ON READER SERVICE CARD

FOR RESEARCH — DEVELOPMENT & EXPERIMENTAL WORK

Over 10,000 different electronic parts; waveguide, radar components and parts, test sets, pulsers, antennas, pulse xmtrs, magnetrons, IF and pulse amplifiers, dynamotors, 400 cycle xmtrs, 584 ant. pedestals, etc.
PRICES AT A FRACTION OF ORIGINAL COST!
COMMUNICATIONS EQUIP CO
 343 CANAL ST., N. Y. 13, W.O. 6-4045
 CHAS. ROSEN (Formerly at 131 Liberty St.)

CIRCLE 950 ON READER SERVICE CARD

RADIO RESEARCH INSTRUMENT CO.

AUTO-TRACK & TELEMETRY ANTENNA PEDESTALS
 3 & 10 CM. SCR 584 AUTOTRACK RADARS
 AN/TPS-10 SEARCH, AN/TPS-10 HT. FINDERS,
 AN/FPN-32GCA, AN/APS-10 NAVIG. & WEATHER,
 AN/APS-15B PRECISION, AN/APG-35B PRECISION,
 AN/APS-31A SEARCH, DOZENS MORE
 .5-1-2 MEGAWATT HIGH POWER PULSERS.

RADIO RESEARCH INSTRUMENT CO.
 550 Fifth Ave., New York Judson 6-4691

RADAR SYSTEMS & COMPONENTS/ IMMEDIATE DELIVERY*

CIRCLE 951 ON READER SERVICE CARD

**electronics IS EDITED
 TO KEEP YOU
 FULLY INFORMED—
 a "well-rounded" engineer**

What's your *present* job in electronics? Do you work on computers? (electronics ran 158 articles on computers between July, 1961 and June, 1962!) Are you in semiconductors? (For the same period, electronics had 99 articles, not including transistors, solid-state physics, diodes, crystals, etc.) Are you in military electronics? (electronics had 179 articles, not including those on aircraft, missiles, radar, etc.)

In all, electronics' 28-man editorial staff provided more than 3,000 editorial pages to keep you abreast of all the technical developments in the industry. No matter where you work today or in which job function(s), electronics will keep you fully informed. Subscribe today via the Reader Service Card in this issue. Only 7½ cents a copy at the 3 year rate.

electronics

electronics

INDEX TO ADVERTISERS



Audited Paid Circulation

• AMP Incorporated	15	• Kepco, Inc.	67	Texas Instruments Incorporated Metals & Controls Division.....	97
Air Express	37	Loral Electronics Corp. General Products Div.....	71	Texas Instruments Incorporated Semiconductor-Components Division	10, 11
Arnold Engineering Co., The.....	86	Mallory and Co., Inc., P. R.....	68, 69	Thiokol Chemical Corp.....	6
• Boonton Radio Co. Div. of Hewlett Packard Co.....	36	McGraw-Hill Book Co.....	35	Tidewater Virginia Development Council	26
• Cannon Electric Co.....	9	Midwee	64	• Tung-Sol Electric, Inc.....	5
• Clairrex Corp.	32	Mitsumi Electric Co., Ltd.....	104	• Utica Drop Forge & Tool Division, Kelsey-Hayes Co.	78
• Clifton Precision Products Co., Inc....	75	Motorola Military Electronics Div....	16, 17	Wallace-Tiernan Inc. Harchem Product Development Dept.	100
Collins Radio Co.....	72	• Mullard Ltd.	14	West Penn Power.....	114
Consolidated Electrodynamics Corp..	92, 93	Nexus Research Laboratory Inc.....	106	• Williams & Co., C. K.....	76
• Corning Electronics, Div. of Corning Glassworks	63	• North Atlantic Industries, Inc.....	70		
Delco Radio	33, 34	OKI Electric Industry Co., Ltd.....	64		
DeVry Technical Institute.....	106	Origin Electric Co. Ltd.....	108		
duPont de Nemours & Co., Inc., E. I..	21, 83	• Polarad Electronic Instruments Div. of Polarad Electronic Corp.....	108		
Dymec A Division of Hewlett Packard Co...	40	Polariod Corp.	39		
Fansteel Metallurgical Corp.....	22, 23	• Potter Instrument Co., Inc.....	19		
• Filtrors Inc.	103	• Radio Corporation of America...4th Cover			
Formica Corp.	91	Radio Materials Co.....	13		
Fujitsu Ltd	107	• Reeves Instrument Corp. Sub. of Dynamics Corp. of America.	98		
General Electric Co. Silicone Products Dept.....	105	• Rixon Electronics, Inc.....	104		
Globe Industries Inc.....	89	• Sage Laboratories Inc.....	41		
• Hart Manufacturing Co.....	30	• Sanborn Company	38		
• Hewlett-Packard Company	2nd Cover, 27, 77	Saratoga Industries	106		
Hoffmann Electronics Corp.....	84, 85	• Schjeldahl Co., G. T.....	99		
Honeywell	94	Scientific-Atlanta, Inc.	95		
Houston Instrument Corp.....	96	Sperry Electronic Tube Div. Sperry Rand Corp.....	3rd Cover		
Hughes Aircraft Co.....	65	Sperry Microwave Electronics Co. Div. of Sperry Rand Corp.....	31		
Intercontinental Instruments Inc.....	42	Sprague Electric Co.....	4, 25		
• International Telephone and Telegraph Corp. Electron Tube Division.....	73	• Stevens-Arnold, Inc.	101		
I Triple E.....	38, 64, 87, 89	Synthane Corp.	38		
Johnson Company, E. F.....	89	Tektronix, Inc.	79		
		Texas Instruments Incorporated Industrial Products Group.....	29		

CLASSIFIED ADVERTISING

F. J. Eberle, Business Mgr.

EMPLOYMENT
OPPORTUNITIES110, 111, 112

EQUIPMENT
(Used or Surplus New)
For Sale 112

INDEX TO CLASSIFIED ADVERTISERS

Atomic Personnel Inc.....	112
Bristol Company, The.....	112
Columbia University	112
• Communications Equipment Co.....	112
Esso Research & Engineering Co.....	110
General Dynamics Electric Boat.....	110
Norden, Div. of United Aircraft Corp.	111
• Radio Research Instrument Co.....	112
• Universal Relay Corp.....	112
• See advertisement in the July 25, 1962 issue of Electronics Buyers' Guide for complete line of products or services.	

This Index and our Reader Service Numbers are published as a service. Every precaution is taken to make them accurate, but **electronics** assumes no responsibilities for errors or omissions.

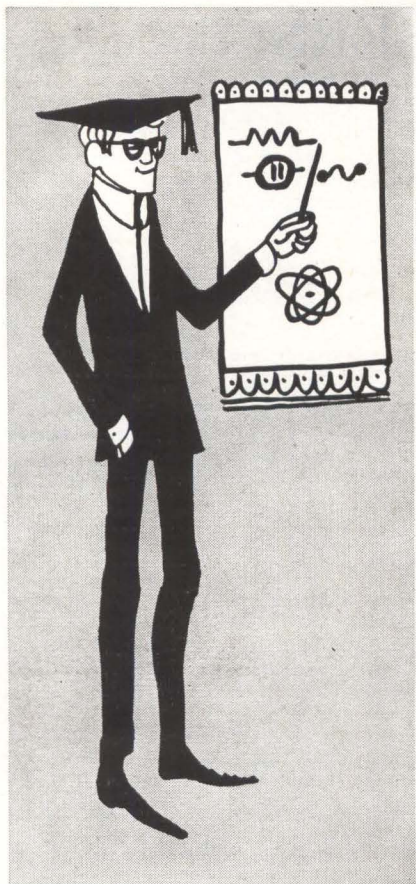

workability

(pre-production training)

WESTern PENNSylvania has a time-tested and proved-in-use plan by which employees—adaptable, productive people with a variety of industrial aptitudes—will be trained in advance for whatever skills are needed for YOUR particular operation at no cost to you. For details on this ability . . . and for complete information on 100% financing of plant space at low, low interest rates . . . and WESTern PENNSylvania's favorable tax climate, mail coupon, wire or call collect.

WEST PENN POWER

an operating unit of ALLEGHENY POWER SYSTEM



INDUSTRIAL SHELL BUILDINGS available at \$2.95 to \$3.25 a sq. ft. completed to your specs in 60-90 days.

WEST PENN POWER Phone: TEmple 7-3000
Area Development Department (Area Code 412)
Greensburg, Pennsylvania E 3-8-2

Please send me information on: Pre-production Training
 Favorable Tax Climate 100% Industrial Plant Financing Industrial Properties

Name _____

Title _____

Company _____

Address _____

City _____ Zone _____

State _____ Phone _____

electronics



Audit Bureau
of Circulations



Associated Business
Publications

Audited Paid Circulation

JAMES T. HAUPTLI

Advertising Sales Manager

R. S. QUINT:
Assistant Publisher Buyers'
Guide and Business Manager
DAVID CUNNIFF:
Promotion Manager
B. ANELLO:
Market Services Manager

RICHARD J. TOMLINSON:
Production Manager
GEORGE E. POMEROY:
Classified Manager
HUGH J. QUINN:
Circulation Manager

ADVERTISING REPRESENTATIVES

ATLANTA (9):
Michael H. Miller, Robert C. Johnson
1375 Peachtree St. N.E., Trinity 5-0523
(area code 404)

BOSTON (16):
William S. Hodgkinson, Donald R. Furth
McGraw-Hill Building, Copley Square,
Congress 2-1160 (area code 617)

CHICAGO (11):
Harvey W. Wernecke, Robert M. Denmead
645 North Michigan Avenue, Mohawk 4-5800
(area code 312)

CLEVELAND (13):
Paul T. Fegley
55 Public Square, Superior 1-7000
(area code 216)

DALLAS (1):
Frank Le Beau
The Vaughn Bldg., 1712 Commerce St.
Riverside 7-9721 (area code 214)

DENVER (2):
J. W. Patten
Tower Bldg., 1700 Broadway,
Alpine 5-2981 (area code 303)

HOUSTON (25):
Joseph C. Page, Jr.
Prudential Bldg., Halcombe Blvd.,
Riverside 8-1280 (area code 713)

LOS ANGELES (17):
Peter S. Carberry, Ashley P. Hartman,
W. C. Gries
1125 W. 6th St., Huntley 2-5450
(area code 213)

NEW YORK (36):
Donald H. Miller, Henry M. Shaw,
George F. Werner
500 Fifth Avenue, LO-4-3000
(area code 212)

PHILADELPHIA (3):
Warren H. Gardner, William J. Boyle
6 Penn Center Plaza, LOcust 8-4330
(area code 215)

SAN FRANCISCO (11):
R. C. Alcorn
255 California Street, Douglas 2-4600
(area code 415)

LONDON W1:
Edwin S. Murphy Jr.
34 Dover St.

FRANKFURT/Main:
Matthée Herfurth
85 Westendstrasse

GENEVA:
Michael R. Zeynel
2 Place du Port

"Headquarters for Business Information"

McGraw-Hill Technical and Business Publications

American Machinist/Metal-
working Manufacturing
Aviation Week and Space
Technology
Business Week
Chemical Engineering
Chemical Week
Coal Age
Construction Methods and
Equipment
Construction Daily
Control Engineering
Electrical Construction
and Maintenance
Electrical Merchandising Week
Electrical Newsletter
Electrical West

Electrical Wholesaling
Electrical World
Electronics
Engineering Digest
Engineering and Mining Journal
E & MJ Metal and Mineral
Markets
Engineering News-Record
Factory
Fleet Owner
Industrial Distribution
National Petroleum News
Nucleonics
Nucleonics Week
Platt's Oilgram News
Platt's Oilgram Price Service
Power

Product Engineering
Purchasing Week
Science Week
Textile World

Overseas only:
Automobile International
(English, Spanish)
Ingenieria Internacional
Construccion (Spanish)
International Management
(English, Spanish
Portuguese editions)
Metalworking Production
(Great Britain)

Available by subscription only — to qualified persons actively engaged in the field of the publication. For subscription rates and information describing the editorial coverage of any of the above publications, write to: Subscription Manager, Circulation Department, McGraw-Hill Publishing Company, 330 West 42nd Street, New York 36, N. Y.

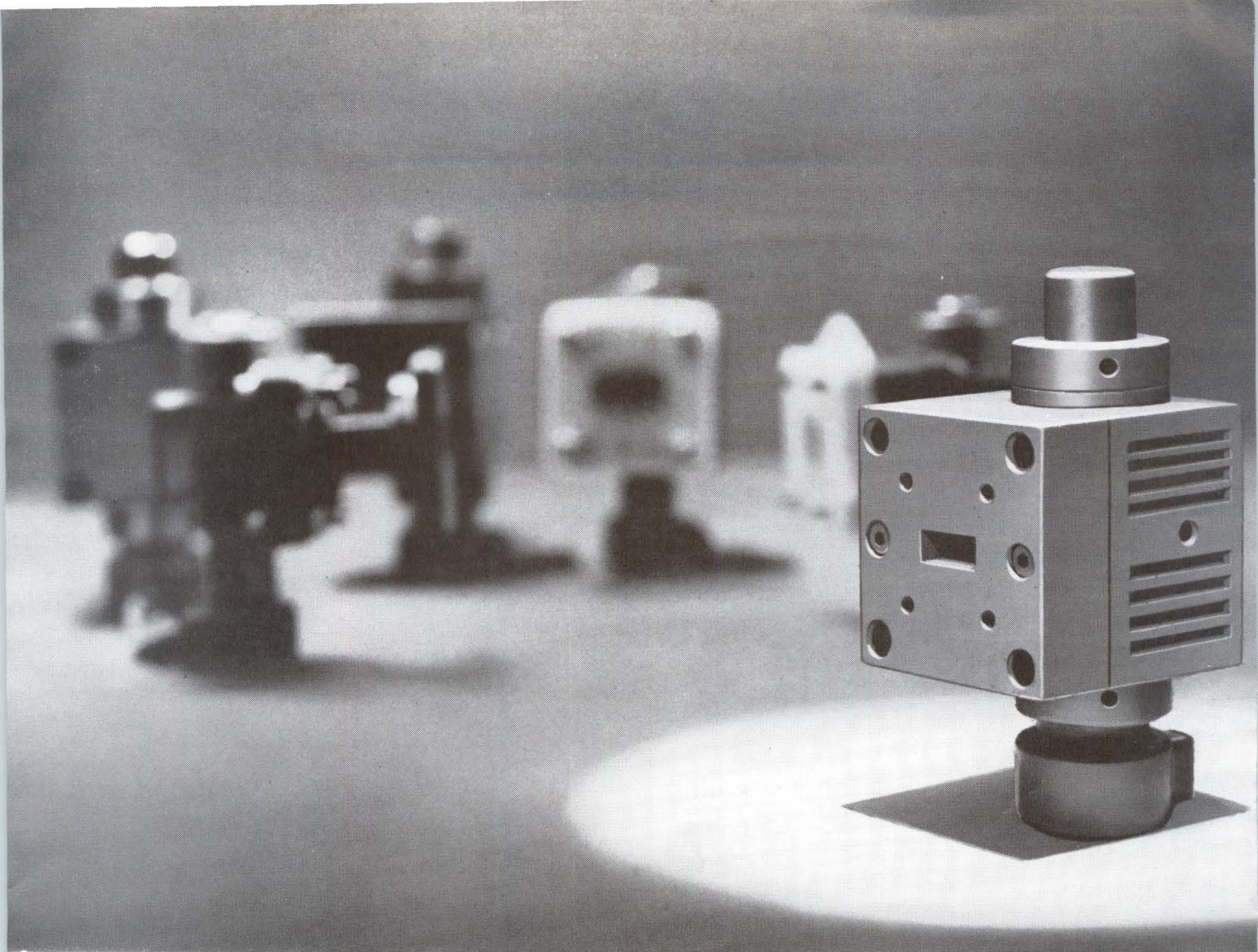

New SOV-2200 pumps paramps and masers at 35 Gc and delivers 500 mW of power. Operation at any frequency from 31 to 40 Gc is possible with this new oscillator family. Although miniaturized these Sperry oscillators have the frequency, high power, and stability of heavy-weight tubes.

New miniature, high-power oscillators push range to 40 Gc for paramp pumping

A new family of V band two-cavity klystron oscillators provides high power levels for parametric amplifier and maser pumping, doppler systems, and FM communications systems. These tubes cover the frequencies from 31 to 40 Gc. You now get off-shelf to 60-day delivery of two-cavity oscillators from Sperry Electronic Tube Division at any frequency from 12.5 to 40 Gc.

The unique combination of 500 mW power output at frequencies up to 40 Gc, exceptional AM stability, and small size is found only in Sperry's two-cavity design.

These Sperry miniaturized pump tubes weigh just 12 ounces — yet offer the performance formerly found only in much larger, heavier tubes.

The flat-topped "output power vs. beam voltage" mode shape results in outstanding amplitude stability, since variations in beam voltage and temperature produce only negligible variations in output power.

Sperry's two-cavity oscillators deliver power outputs ranging from .5 to 2 watts. Typical output at U band is 2 watts and at V band, 500 mW.

Use of two-cavity klystrons also permits considerable

system simplification, since equipment such as reflector power supply, automatic power leveler, and — in most applications — automatic frequency control can be eliminated.

For applications where outputs up to 300 mW and wide tuning ranges are required, ask about Sperry's tunable, low-voltage reflex klystron pumps.

A free technical booklet describing the entire Sperry line of paramp pump tubes — both two-cavity and reflex — is now available. For your copy, write Sperry, Sec. 189, Gainesville, Florida, or contact Cain & Co., Sperry's national representatives.

SPERRY

**ELECTRONIC
TUBE
DIVISION**

SPERRY RAND CORPORATION
GAINESVILLE, FLA. / GREAT NECK, N. Y.

CIRCLE 901 ON READER SERVICE CARD

Look
again
how
RCA's
DARK HEATER
benefits
you...

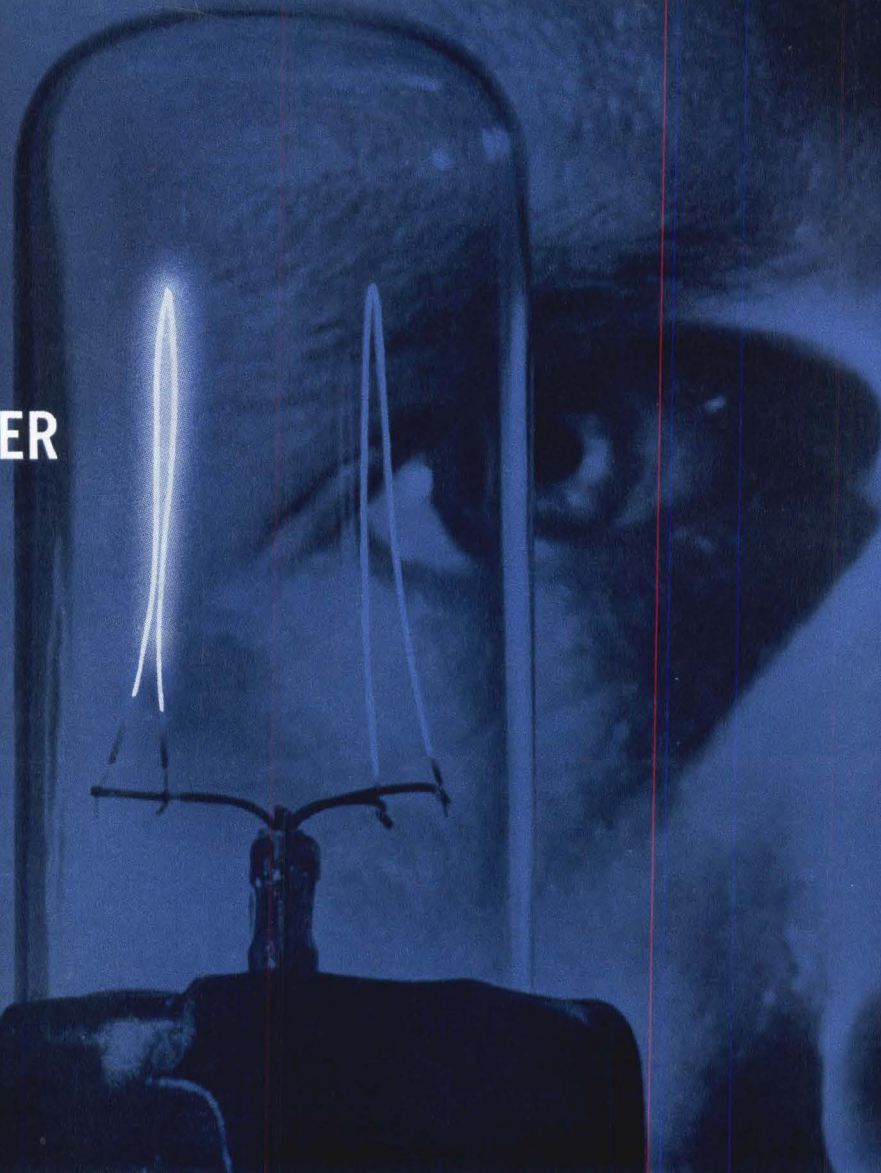

- cuts heater-associated tube defects by 20 to 1
- provides more stable tube characteristics over longer life spans

The filament at the right in the demonstration envelope is an RCA Dark Heater. Due to its superior thermal emissivity, the RCA Dark Heater produces the required cathode temperature at a heater temperature 200°K to 350°K below that of conventional heaters.

In a 500-hour accelerated heater-cycling life test, tubes with conventional heaters had 20 heater-associated defects per 100 tubes, while tubes with the RCA Dark Heater had only one! The tests were conducted at 143% of rated heater voltage (9 volts for a 6.3-volt type) and a heater-cathode voltage of 180 volts. The operating cycle was one minute on and two minutes off. These life tests are the equivalent of operation of a heater for 14,500 hours at normal heater voltage and they represent more than 250,000 tube-hours.

Features of the RCA Dark Heater which contribute to superior long-life performance include:

- **Exceptional Mechanical and Chemical Stability.** RCA's Dark Heater wire has an approximately 50% higher ultimate tensile strength when it operates at a temperature 350°K below the operating temperature of conventional heaters. Cooler operating

temperatures also minimize changes in heater shape during life. With smaller thermal fluctuations during "on-off" cycling, Dark Heater has less tendency toward recrystallization and burnout.

- **Heater-Current Stability on Life.** The Dark Heater maintains a remarkably stable current characteristic throughout life.
- **Reduced AC Heater-Cathode Leakage and Hum.** The Dark Heater reduces AC leakage and hum, particularly "spike" or pulse leakage currents. In addition, lower heater temperature reduces both AC and DC leakage from heater to cathode and heater emission to other tube electrodes.
- **Greater Safety Margin in H-K Voltage Ratings.** Cooler operation means greater safety margins in present H-K voltage ratings.

Dark Heater, now available in 231 popular O.E.M. types of RCA Receiving Tubes, is another RCA innovation to give you better performance and longer tube life. For full information on the Dark Heater, call your RCA Field Representative.

RCA ELECTRON TUBE DIVISION FIELD OFFICES
EAST: 744 Broad Street, Newark 2, New Jersey (201) 485-3900 • CENTRAL: Suite 1154, Merchandise Mart Plaza, Chicago 54, Illinois, (312) 527-2900 • WEST: 6801 E. Washington Blvd., Los Angeles 22, Calif., (213) RAYmond 3-8361 • 1838 El Camino Real, Burlingame, Calif. (415) OXford 7-1620



RCA ELECTRON TUBE DIVISION, HARRISON, N. J.

The Most Trusted Name in Electronics