

# electronics

A McGraw-Hill Publication 75 Cents

*(Photo at right)*

## READY TO LAUNCH

*Crystals probe Van Allen belt, p 42*

---

## AIR ROUTE SURVEILLANCE

*Reducing radar clutter, p 37*

---

## BANANA TUBE

*New color tv display, p 44*

---

## INFANTRY GUIDANCE

*Ultrasonic doppler system, p 48*

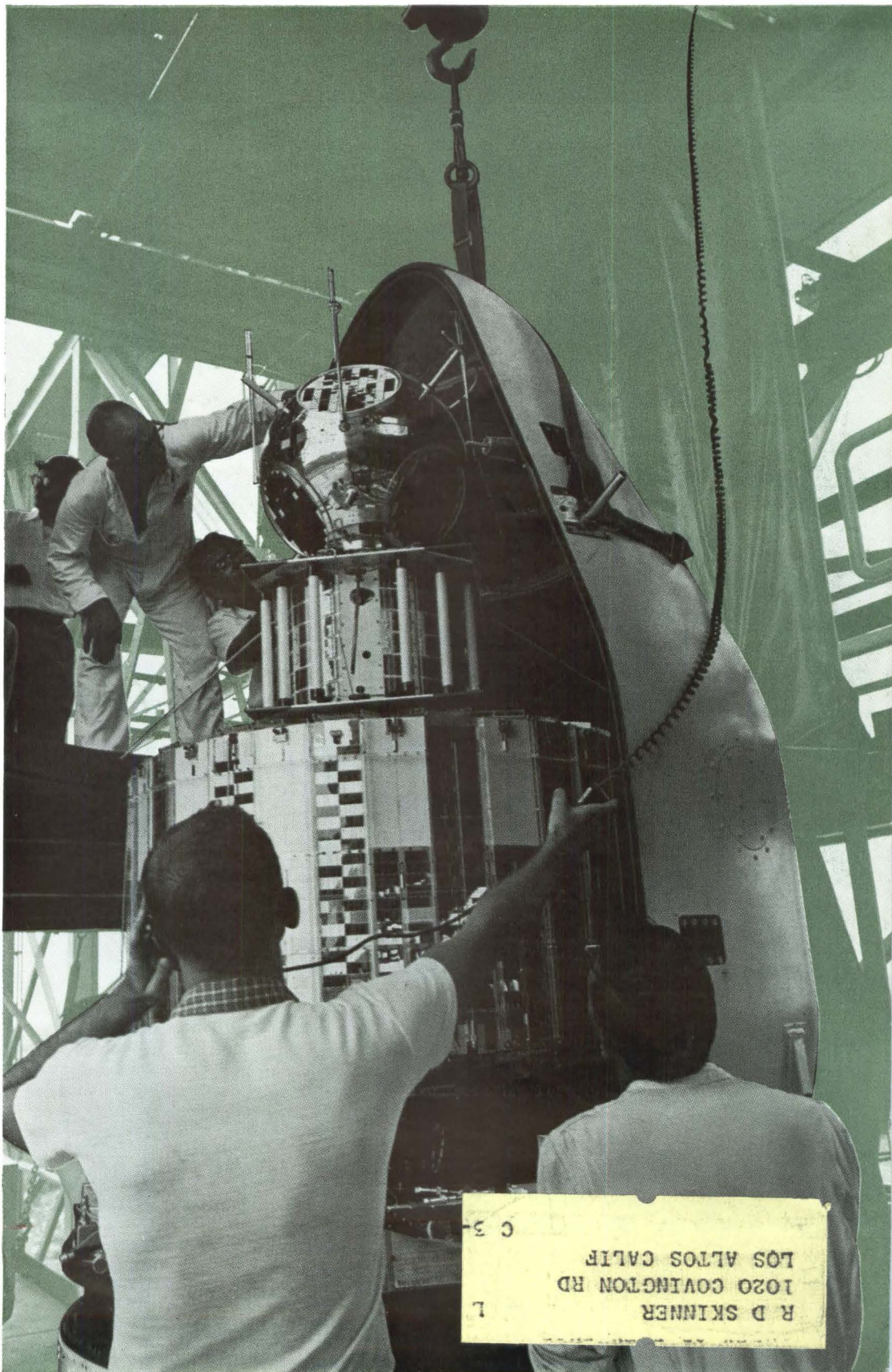

# No Balancing Required

**MAKES IMPEDANCE MEASUREMENTS  
AS FAST AS YOU CAN PLUG IN COMPONENTS**

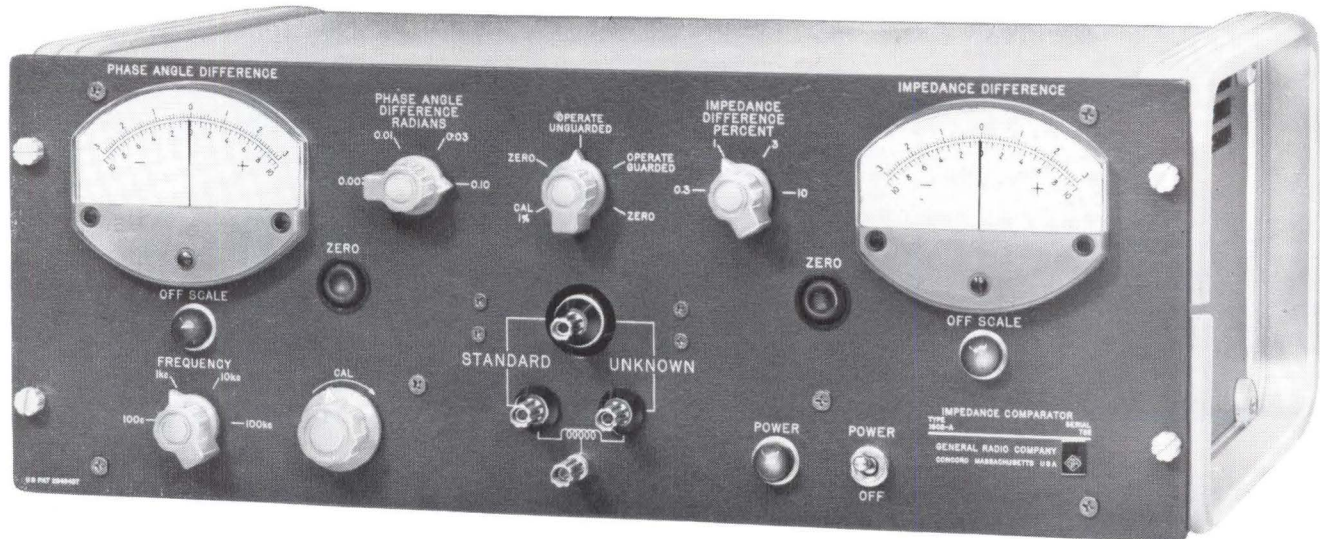

## IN THE LABORATORY:

- ★ Measures the effects of temperature, humidity, pressure, and time on components with high accuracy — provides continuous indication.
- ★ Rapidly compares quantities formerly requiring time-consuming techniques:
  - D of low-loss dielectric materials, D of inductors, Q or phase angle of wire-wound resistors or pots.
- ★ Measures transistor capacitances, balance of transformer windings, small impedance differences.

## ON THE PRODUCTION LINE:

- ★ Rapid matching, testing, and sorting of high-precision components, etched boards, subassemblies, and complex networks — manually or as an element of automatic sorting equipment.
- ★ Frequency characteristics of components.
- ★ Quick tracking tests of ganged pots and variable capacitors.

### SPECIFICATIONS IN BRIEF:

#### DIRECT READING METER RANGES

Impedance-Magnitude Difference:  $\pm 0.3\%$ ,  $\pm 1\%$ ,  $\pm 3\%$ ,  $\pm 10\%$  full scale.

Phase-Angle Difference:  $\pm 0.003\%$ ,  $\pm 0.01\%$ ,  $\pm 0.03\%$ ,  $\pm 0.1\%$  radian, full scale.

PRICE: Type 1605-A Impedance Comparator . . . \$800.

Type 1605-AH Impedance Comparator . . . \$925.

(3:1 increase in sensitivity over Type 1605-A).

#### HIGH ACCURACY

3% of full scale; i.e., for  $\pm 0.3\%$  Impedance-difference scale, accuracy is 0.009%.

#### WIDE RANGE OF INTERNAL TEST FREQUENCIES

100 cps, 1 kc, 10 kc, and 100 kc.

#### IMPEDANCE RANGE

R:  $2\ \Omega$  to  $20\ M\ \Omega$  C: 40 pf to 800  $\mu\text{f}$  L:  $20\ \mu\text{h}$  to 10,000 h

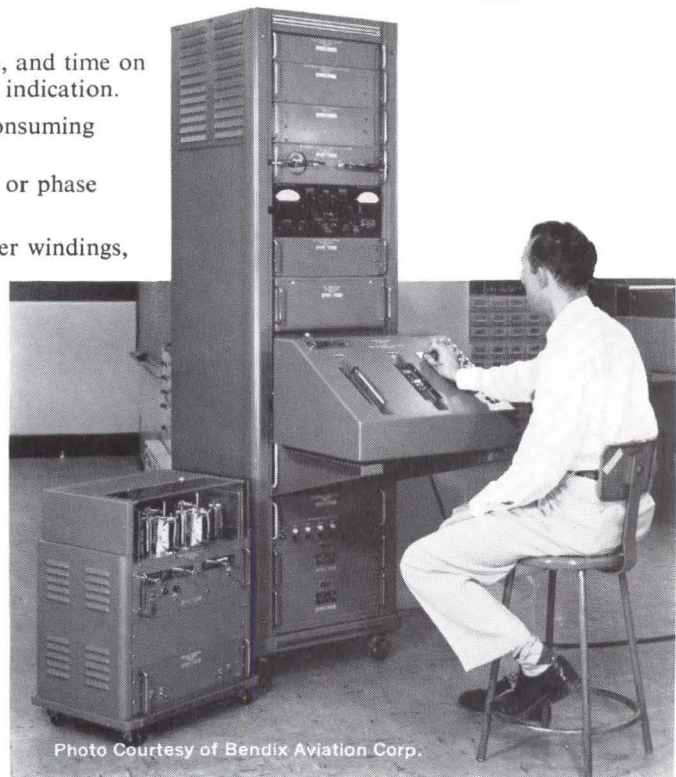

Photo Courtesy of Bendix Aviation Corp.

Used as the "brain" of this semi-automatic tester, manufactured by Bendix Aviation Corp., the Impedance Comparator enables complete check out of printed-circuit subassemblies. Comparator metering voltages (proportional to impedance magnitude and phase-angle differences) are compared against allowable tolerances.

Write for Complete Information

## GENERAL RADIO COMPANY

WEST CONCORD, MASSACHUSETTS

NEW YORK, Worth 4-2722  
District Office in Ridgefield, N. J.  
Whitney 3-3140

CHICAGO  
Oak Park  
Village 8-9400

PHILADELPHIA  
Abington  
Hancock 4-7419

WASHINGTON, D. C.  
Silver Spring  
Juniper 5-1088

SYRACUSE  
Syracuse  
Glenview 4-9323

SAN FRANCISCO  
Los Altos  
Whitecliff 8-8233

LOS ANGELES  
Los Angeles  
Hollywood 9-6201

ORLANDO, FLA.  
Orlando  
GArden 5-4671

IN CANADA  
Toronto  
CHerry 6-2171

# electronics

A McGraw-Hill Publication 75 Cents



W. W. MacDONALD, Editor

J. M. CARROLL, Managing Editor  
 SENIOR EDITORS: Samuel Weber, George W. Sideris. SENIOR ASSOCIATE EDITORS: William E. Bushor, Michael F. Wolff. ASSOCIATE EDITORS: Michael F. Tomaino, Sylvester P. Carter, William P. O'Brien, John F. Mason, Thomas Emma, Sy Vogel, Leslie Solomon, M. M. Perugini, George J. Flynn, Laurence D. Shergalis. ASSISTANT EDITORS: Nilo Lindgren, Stanley Froud, Stephen B. Gray, Roy J. Bruun, George V. Novotny, Leon H. Dulberger. REGIONAL EDITORS: Harold C. Hood (Pacific Coast, Los Angeles), Thomas Maguire (New England, Boston), Cletus M. Wiley (Midwest, Chicago). ART DIRECTOR: Harry Phillips; Howard R. Berry. PRODUCTION EDITOR: John C. Wright, Jr. EDITORIAL ASSISTANTS: Gloria J. Meurer, Bernice Duffy, Lorraine Rossi, Virginia T. Bastian, Lynn Emery, Laura W. Smith, Bette H. Snyder, Rosemary Abbruzzese, Judy Haskins. FOREIGN NEWS BUREAU: Director, John Wilhelm, Alyne Elias. London—John Shinn, Derek Barlow, Nicholas Landon. Bonn—Peter Forbath, James Morrison, Silke McQueen. Paris—Robert Farrell, Arthur Erikson. Milan—Gene DiRaimondo. Mexico City—Bruce Bendow. Rio de Janeiro—Leslie Warren. Moscow—Stewart Ramsey. Tokyo—Richard Hallaron, Charles Cohen, John Yamaguchi.

JAMES GIRDWOOD, Publisher

TRIPLE-HEADER—Three satellites: Transit IV (bottom), Injun I (middle) and Solar Radiation III (top) ready for launching in a Thor Able-Star rocket (RCA photo). *Injun I* carried five cadmium-sulfide energy-flux detectors described on p 42. After six months they are still working COVER

PLEASURE BOAT ELECTRONICS Stress Low Power Consumption, Operating Simplicity. Manufacturers seek \$12 million market in gear for yachtsmen. *Design details for new automatic direction finder and sonar are reported* 20

LAMINAR SUPERCONDUCTORS: New Tool for Cryogenic Electronics. Some of the effects observed when superconducting and normal metal films are stacked point the way to applications in computers and magnets. *New combinations of materials may free designers from restrictions on critical device temperatures* 26

LASER DANGERS. Experimenters should be wary. Exposure to direct or reflected laser beams can burn eyes. *Properties that make lasers dangerous also give physicians a new surgical tool* 27

RADIO SPECTRUM SHARING by Government and Civil Services. Here's how the Interdepartment Radio Advisory Committee and FCC divvy up frequencies between 25 Mc and 30 Gc. *Frequency sharing, up 10 percent in 10 years, will probably rise* 28

TEACHING MACHINE Paced by Students. Computer-based system lets pupils advance as fast as they can answer questions. *Future systems may teach 500 students different subjects* 32

AIR ROUTE SURVEILLANCE RADAR: How to Reduce Clutter. New system uses parametric r-f amplifier, high-angle coverage antenna and staggered-rep-rate moving-target indicator. *Here is a detailed case history of how to upgrade a radar system.* W. W. Shrader 37

LOW-ENERGY DETECTORS for Satellite Applications. Cadmium-sulfide crystals detect low-energy electrons and protons in the Van Allen radiation belts. *These particles would be stopped by the wall of a gas-type ionization chamber.* J. W. Freeman 42

BANANA TUBE: New Color Television Display. Red, blue and green phosphor stripes on elongated tube are scanned by three cylindrical lenses that rotate around it. *Tube is economical to produce. A white phosphor stripe can be added for monochrome display.* P. Schagen 44

Contents continued

Published weekly, with Electronics Buyers' Guide and Reference issue, as part of the subscription, by McGraw-Hill Publishing Company, Inc. Founder: James H. McGraw (1860-1948).

Indexed Annually in Buyers' Guide and Reference issue.

Title ® registered U.S. Patent Office; © Copyright 1962 by McGraw-Hill Publishing Co., Inc. All rights reserved, including the right to reproduce the contents of this publication, in whole or in part.

Executive, editorial, circulation and advertising offices McGraw-Hill Building, 330 West 42nd Street, New York 36, N. Y. Telephone Longacre 4-3000. Teletype TWX N.Y. 1-1636. Cable McGrawhill, N. Y. PRINTED IN ALBANY, N. Y.; second class postage paid at Albany, N. Y.

OFFICERS OF THE PUBLICATIONS DIVISION: Nelson L. Bond, President; Shelton Fisher, Wallace F. Traendly, Senior Vice Presidents; John R. Callahan, Vice President and Editorial Director; Joseph H. Allen, Vice President and Director of Advertising Sales; A. R. Venezian, Vice President and Circulation Coordinator; Daniel F. Crowley, Vice President and Controller.

OFFICERS OF THE CORPORATION: Donald C. McGraw, President; Hugh J. Kelly, Harry L. Waddell, Executive Vice Presidents; L. Keith Goodrich, Executive Vice President and Treasurer; John J. Cooke, Vice President and Secretary.

Subscriptions are solicited only from those actively engaged in the field of the publication. Position and company connection must be indicated on orders. Subscription rates: United States and Possessions, \$6.00 one year; \$9.00 two years; \$12.00 three years. Canada, \$10.00 one year. All other countries \$20.00 one year. Single Copies, United States and Possessions and Canada 75¢. Single copies all other countries \$1.50.

THE PUBLISHER, UPON WRITTEN REQUEST FROM ANY SUBSCRIBER TO OUR NEW YORK OFFICE, AGREES TO REFUND THAT PART OF THE SUBSCRIPTION PRICE APPLYING TO COPIES NOT YET MAILED.

Subscribers: Please address all correspondence, change of address notices, subscription orders or complaints to Fulfillment Manager, Electronics, at above address. Change of address notices should provide old as well as new address, including postal zone number if any. If possible, attach address label from recent issue. Allow one month for change to become effective.

Postmaster: Please send Form 3579 to Fulfillment Manager, Electronics, 330 West 42nd Street, New York 36, New York.



Audited Paid Circulation

**CONTENTS Continued**

**TUNNEL DIODE TESTER** With Low Duty Cycle. Pulser attached to curve tracer permits testing tunnel diodes at high reverse currents. *This technique makes it possible to measure series resistance conveniently.* L. M. Zappulla 47

**INFANTRY GUIDANCE** by Ultrasonic Doppler System. Unit for the individual foot soldier has ultrasonic doppler velocity meter, electronic compass and computer. *Rugged and lightweight, it can also be used by explorers, surveyors and forest rangers.* H. J. Galbraith 48

**NEON BULB** Provides Precise Oscillator Control. Difference in opposite-polarity signals from reference and variable oscillators develop control voltage. *Neon bulb and two diodes make a digital-to-analog converter.* J. Tewksbury 52

**DEPARTMENTS**

Crosstalk. *Security and Need-to-Know* 3

Comment. *Cryogenic Inductors, Potentiometer Tests* 4

Electronics Newsletter. *Maser May Reveal Submarines by Infrared Detection of Thermal Wake* 7

Washington Outlook. *Reorganization of Army Commands for Procurement and R&D Is Underway. Details of 1963 Budget* 12

Meetings Ahead. *Automatic Control Congress* 34

Research and Development. *Protecting Transistors from Transients* 58

Components and Materials. *Precision Potentiometer Uses Carbon Film* 66

Production Techniques. *Converging Strips Speed Module Assembly* 74

New Product Design. *Multiplier Phototube Supply Feeds Six or More Circuits* 88

Literature of the Week 106

People and Plants. *Resitron Launches Expansion Program* 108

Index to Advertisers 117

## Security and Need-to-Know

THE INDUSTRY-DEFENSE DEPARTMENT team, or "marriage" as it is sometimes referred to by the military, is without doubt an enduring romance. But, as in any strong alliance, dark moments do crop up. Get either side off for a confidential chat and they may sing like canaries, describing inequities perpetrated by the other.

Each side could, and has, listed grievances that fill volumes. Many of them are valid. But divorce is an irrational solution even to contemplate. The bond is, and must be, permanent. Fortunately for both sides and the nation as a whole, there is frequent reflection, resulting in revision of rules, regulations and responsibilities—all with an eye toward greater compatibility.

Some problems are due to simple misunderstanding. Adherence to the rules could save considerable grief. One situation, often voiced by industry as a grievance, may well fall into this category. "Security clearance requirements and the tedious need-to-know stipulation create an unfair handicap for companies new to government business."

Most clearance problems arise from poor understanding of the system. A company with no clearance hears about an industry briefing, calls up the government agency and asks to be invited. By this time it is too late to be cleared for the meeting. To obtain company clearance, the president, vice-president, secretary and treasurer must be cleared. (In small companies fewer than four men may hold down these four jobs.) While being cleared—Air Force clearance takes five to seven weeks—a capabilities survey is made of the company to determine the areas in which it is qualified to submit bid proposals. Once the above is accomplished, the company is as eligible as old-guard defense companies. Agency briefings provide the same information to all invited companies. If any company has further questions it can request a later, private briefing.

Companies newly interested in getting into the defense business feel that companies with long records of contractual work are in a more advantageous position. "They get more information because of their need-to-know status." There are more misunderstandings that crop up. Most

of them can be avoided by visiting a regional security office and planning in advance.

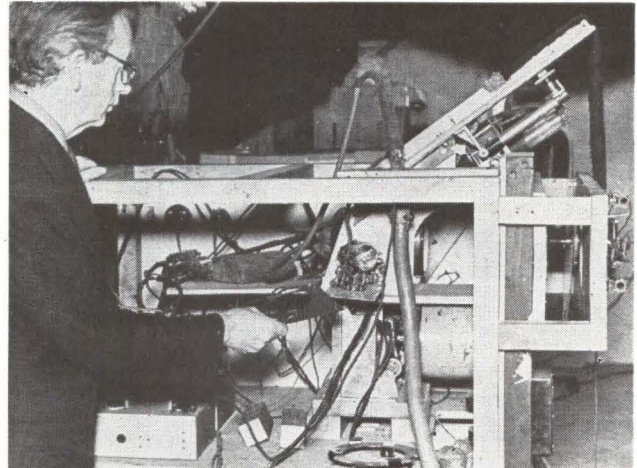

HISTORY REPEATS—Just over a quarter century ago an EMI-Marconi engineering group contended with a development organization headed by inventor John Logie Baird, to persuade the British Broadcasting Corporation to adopt one or the other of their television systems for the forthcoming public tv service. The EMI-Marconi equipment was all-electronic and not long out of the development labs. Baird's equipment had been demonstrated some ten years earlier, was fairly well debugged, but used electromechanical principles involving a rotating scanner disk to display the picture.

EMI-Marconi's electronic system won the day. In 1935, BBC commenced regular public television broadcasting, providing a prototype for the tv services that were rapidly inaugurated all over the world.

Despite his setback, Baird continued with his inventions and in 1941 developed a scheme for stereoscopic presentation of color tv (as shown in this ancient photograph unearthed from ELECTRONICS' morgue). However, like his original black and white system, the color version used electromechanical techniques and received no wide acclaim.

We introduce this background material because an article in this issue: The Banana Tube—New Color TV Display, by P. Schagen of Mullard Ltd., describes a simplified approach to color television. Existing color tubes require close-tolerance manufacturing processes and consequently are expensive compared to black and white tubes. However, the Mullard system uses an inexpensive tube, but—you guessed it—requires a rotating optical system to convert the tube's display into a recognizable picture.

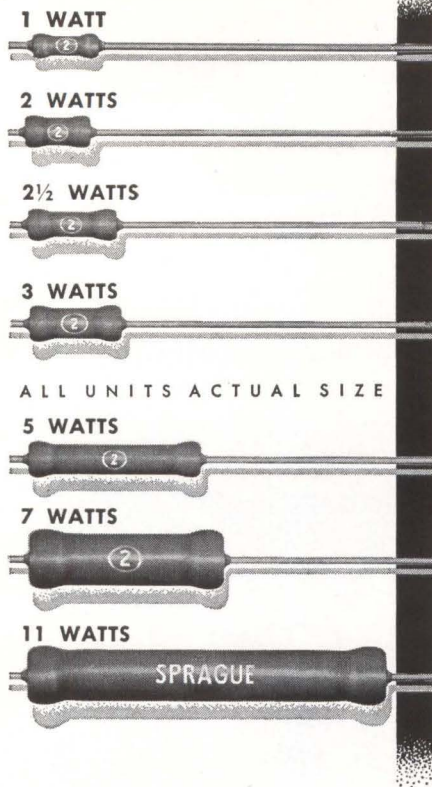

## NEXT TIME ... USE TINY Blue Jacket® WIREWOUND RESISTORS

*Sprague builds reliability... efficiency... economy right into miniaturized Blue Jackets with these important features:*

- \* All-welded end-cap construction with special vitreous-enamel coating for total protection against humidity, mechanical damage, heat, corrosion gives long-term dependability under severe environmental conditions
- \* Available in resistance tolerances as close as  $\pm 1\%$
- \* Low in cost... quick and easy to install

Tiny axial-lead Blue Jackets are specially designed for use with conventional wiring or on printed boards in miniature electronic assemblies. Write for complete technical data in Sprague Engineering Bulletin 7410B.

**SPRAGUE ELECTRIC COMPANY**  
35 Marshall Street, North Adams, Mass.



## COMMENT

### Cryogenic Inductors

The article by Mr. A. Hemel, *Cryogenic Inductors May Become Power Source* (p 96, Nov. 10, 1961), presents an interesting application of superconductivity.

In his example of possible energy storage on a practical scale, however, Mr. Hemel uses a figure of 100,000 amperes through a one-henry solenoid. This seems very improbable of physical realization, since a superconductor capable of carrying such a current, if it could be made at all, could not in practice be wound into a one-henry inductance. Perhaps he is using the 100,000 figure from recent results of current densities obtained of 100,000 amperes per square centimeter.

A typical one-henry solenoid might be wound of ten-mil wire and carry 50 amperes, reducing the theoretical energy stored to 0.35 kilowatt hours, using the  $W = 1/2 Li^2$  relation. This is hardly enough stored energy to propel the 200-horsepower vehicle Mr. Hemel describes for more than about six seconds.

WILLIAM E. BARBOUR, JR.  
President

Magnion, Inc.  
Cambridge, Mass.

### Author Hemel replies:

Mr. Barbour is correct in assuming that the 100,000-ampere figure is based on the recently obtained current densities of 100,000 amperes per square centimeter.

His comment that this cannot be wound into a one-henry superconductive coil fails to carry an explanation as to the reason for this conclusion. The problem seems primarily one of keeping the size down to a practical volume, rather than that of a fundamental impossibility.

Mr. Barbour's comparison with "a typical one-henry solenoid" leaves some questions. What makes the ten-mil coil so "typical" and why must the vehicle coil be so in such an untypical application? The six-second capacity would also apply if we tried to drive automobiles on model-airplane fuel tanks.

My last comment does not refer to Mr. Barbour's letter directly but to the field in general. Since the

article was written, some rapid strides have been made in the development of superconductive materials, as referred to on page 24 of your December 1 issue [*Cryogenics Spurs Magnet R&D*] and my letter to *Comment* (p 6, Dec. 22). These describe the recent predictions that superconductivity can be maintained in fields of 500 kilogauss, which exceeds the 88-kg field that I referred to by a factor of over five. Since the energy storage capability of a coil tends to be proportional to the square of the critical field ( $W = \frac{1}{2} LI_{max}^2$  where  $I_{max} = N\phi_{max}/L$ ), it appears that a 0.04-henry vanadium-gallium inductor would be as effective as the one-henry niobium-tin unit, because of its higher current capacity.

The closing paragraph of the article noted that extensive research and experimentation would be required to determine the feasibility of cryogenic inductive energy storage. The recent advances are quite surprising and encouraging, both in their scope and rate, and perhaps some more definite conclusions may be reached sooner than would have otherwise been expected.

A. HEMEL

Motorola Inc.  
Chicago, Illinois

### Potentiometer Tests

In the article by Mr. J. W. Fulton, *Comparison Method Speeds Potentiometer Tests* (p 76, Nov 24, 1961), the author is not entirely correct when he refers to Fig. 1A and states that the potentiometers must have identical resistance. They can be any value with their tap or end resistances in the same proportion. The one restriction is that their electrical angles must be identical.

GEORGE KIRIAZIDES  
Litton Industries, Inc.  
Mt. Vernon, New York

### Author Fulton agrees with Reader Kiriazides and continues:

In my original manuscript, I stated that the potentiometers must be identical. I was thinking of testing by comparing two identical potentiometers, one of which is considered a standard. The manuscript was revised to read that they must have identical resistance. This meaning was not intended.

# ON THE SHELF— ARNOLD CORES IN WAREHOUSE STOCK FOR IMMEDIATE DELIVERY

*Let us handle your inventory problems and save you time and money on your magnetic core requirements.*

Extensive stocks of four types of Arnold cores in the most popular sizes have been set up in our Marengo, Illinois and Fullerton, Calif. plants. Subject of course to temporary exhaustion of stock by prior sales, these cores will be shipped *the same day* on orders received at the warehouse by 12:00 noon. When cores are out of stock at the nearest plant, we may be able to ship within 24 hours from

the other.

Arnold core products covered by this warehouse stock program include: 1) Silectron C, E and O cores in 2, 4 and 12-mil tape. 2) Type 6T aluminum-cased cores of Deltamax, Square Permalloy and Supermalloy, in 1, 2 and 4-mil tape. 3) Mo-Permalloy powder cores, both temperature-stabilized and unstabilized types, ranging down to "cheerio" sizes. 4) Iron powder toroids, threaded cores and insert cores.

All four products are available

in a wide range of selection, for your convenience and economy in ordering either prototype design lots or regular production quantities. • Stock lists, bulletins, etc. are available—write for information. *The Arnold Engineering Company, Marengo, Ill.*

2998

ADDRESS DEPT. E-1



**ARNOLD**  
SPECIALISTS in MAGNETIC MATERIALS

BRANCH OFFICES and REPRESENTATIVES in PRINCIPAL CITIES • Find them FAST in the YELLOW PAGES

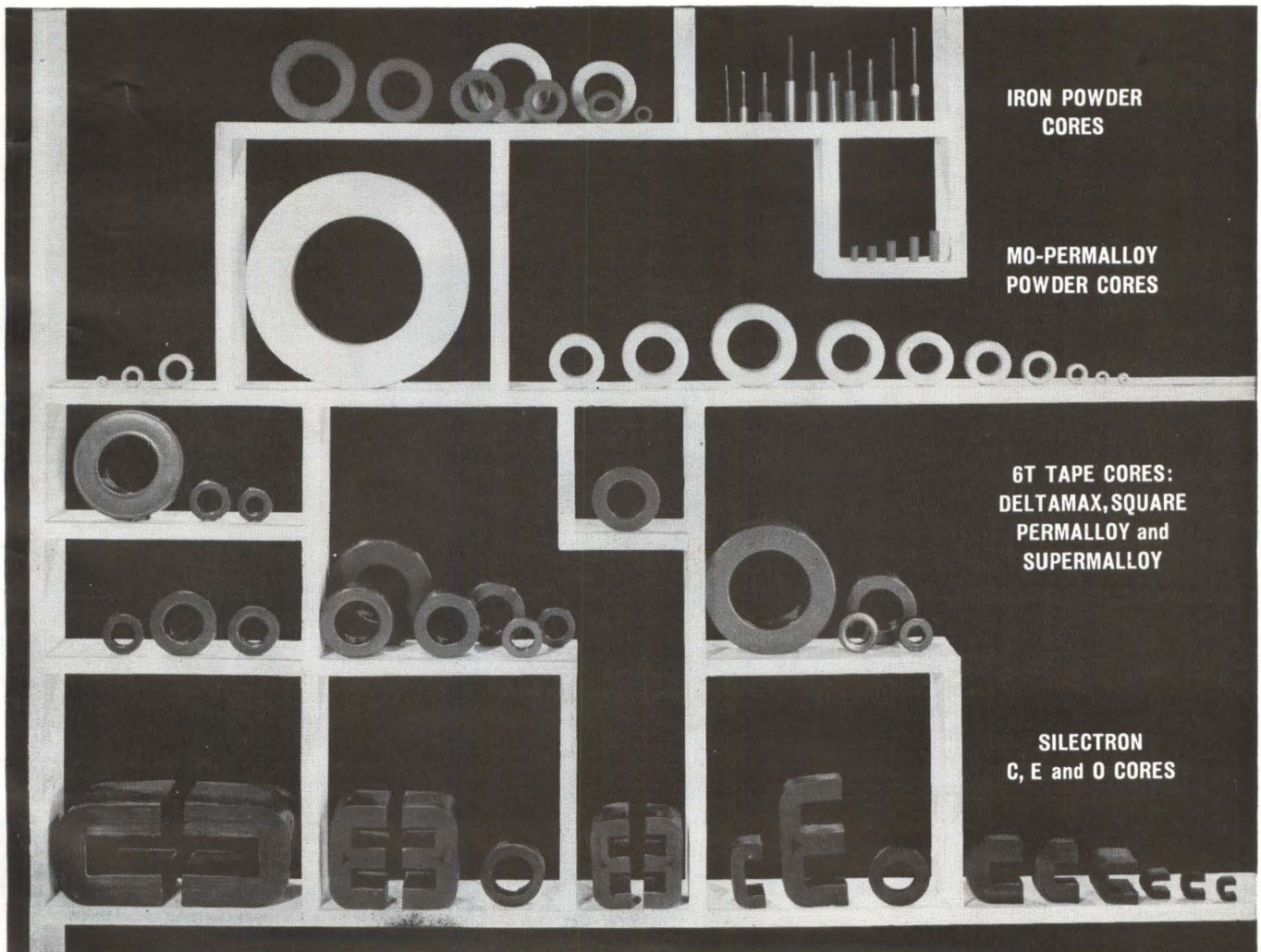



## **NEW EIMAC TWT COVERS THREE BANDS!**

Eimac's new EM-1060 TWT will operate in X-band. And C-band. *And* S-band. In fact, it's the only TWT available today with such a wide frequency range—2.5 to 11 Gc! And in all three bands, it provides a nominal output power of one watt and a gain of over 30db. It's just one of the many new advanced TWT's coming your way from Eimac. For more information write: Microwave Marketing, Eitel-McCullough, Inc., San Carlos, California.





# ELECTRONICS NEWSLETTER

## Airborne Radiometer May Find Submarines

LOS ANGELES—An extremely low-noise, wide-band maser amplifier, used as the first r-f stage in a correlative Dicke-type radiometer, may be the answer to successful round-the-clock all-weather detection of submarines from airplanes covering thousands of square miles.

Under development at Electro-Optical Systems in Pasadena, the system shows promise of eliminating obstacles heretofore blocking practical surveillance of both conventional and nuclear subs by infrared techniques.

It has been known for some time that a submerged craft forms a thermal and gravity wake, and that effective temperature differences between the wake and adjacent ocean surface have been measured at infrared frequencies. Up till now certain tactical conditions and weather situations have precluded using such techniques for operational surveillance, it was reported.

Details of the system will be presented at a confidential session on undersea warfare and sonar to be held during the upcoming (Feb. 7-9) National Winter Convention on Military Electronics here.

## Ruby-Sapphire Laser Operates Continuously

CONTINUOUS OPERATION of a laser with a trumpet-shaped, hybrid crystal was reported by D. F. Nelson and W. S. Boyle, of Bell Telephone Labs, at the annual Physics Show in New York this week.

The crystal is grown from a sapphire seed, producing the flared end, and is doped to produce the narrow, ruby end. Oscillations in the ruby generate coherent light with a wavelength of 6,934 Å.

White light from an 850-w mercury arc lamp (effective components are violet and green) enters the flared end, is reflected from the opaque-coated end of the ruby, and emerges as the laser beam from the flared sapphire. Light intensity multiplies sixfold in each direction of the round trip through the crystal. The crystal is cooled to liquid nitrogen temperature.

The lamp's image is focused into the crystal by two mirrors. The

emerging beam is picked off by a mirror set at a 45-deg angle. Since this concerns only one end of the crystal, external components can be easily introduced—a magnet coil around the crystal, for example.

## FCC Denies Petitions for A-M Stereocast Standards

WASHINGTON—FCC this month again denied petitions for rulemaking leading to adoption of standards for a-m stereo broadcasts. Southwestern Sales Corp., Tulsa, and Kahn Research Laboratories, Freeport, L.I., had asked the commission to reconsider a denial last September. The earlier petitions were filed by Philco, RCA and Kahn. FCC says it is watching f-m stereo development closely and will act on a-m stereo if it becomes convinced of a need for a-m service.

## West Ford Team Wants Second Dipole Belt Try

MIT LINCOLN LAB researchers have reportedly written off the first Proj-

ect West Ford dipole package launched three months ago and will seek permission to try again.

Among experiments waiting for an orbiting dipole belt is Dicon (Digital Communications through Orbiting Needles), designed to test the West Ford path (California to Massachusetts) as a high-capacity digital data link. Dicon would measure and record errors in a variety of modulation signals. Perturbations are expected from doppler shift and spread, and multipath delay. Frequency-shift keying will be the basic modulation technique.

Radar information indicates the first package broke in two without dispensing any dipoles.

## Character Systems Read Tape, Type and Flimsy

WASHINGTON—Character recognition machines, experiments and theories were explored last week at a symposium sponsored by the Office of Naval Research and National Bureau of Standards. Among the new systems:

National Cash Register's wide-tolerance optical system for reading business machine journal tapes. A width-coding technique describes character tops and bottoms in binary numbers. Data is stored, can be edited or arranged.

Burrhoughs Control Instruments division's type page reader. Images are converted to video signals by a flying-spot scanner. Characters are recognized by matching patterns with prearranged patterns in a magnetic core matrix.

Rabinow Engineering's cycloid

## Twenty-Channel Back Seat Driver

THERE IS NOTHING LIKE A DAME to get the attention of bomber pilots, reasoned the designers of a voice interruption priority system (Vips) now being produced for Air Force B-58 Hustlers.

Vips is a 20-channel logic and tape playback system that automatically announces prerecorded warnings on flight hazards in the order of their relative danger. It is made by Northrop's Nortronics division and is credited with averting a bomber crash during flight tests.

Messages are spoken in a "low-pitched, well modulated" woman's voice, to distinguish warnings from routine crew talk. Flight tests showed this gets a pilot's attention in three seconds while warning lights take 12 seconds, on the average.

document handler. It processes flimsy (paper used for waybills) at high speed. Rabinow said that anything printed or typewritten can now be read; handwritten numerals will be read in two years and cursive writing in five to 10 years.

## Four Japan-U.S. Computer Licensing Groups Forming

TOKYO—Competition in the Japanese computer market is likely to get hot this year. Four agreements between Japanese and U. S. manufacturers are underway.

Hitachi says it will complete an RCA model 301 before summer, calling it model 3010, and expects licensing agreements to be approved by summer. Subject to government approval, Mitsubishi Electric and General Precision have established Mitsubishi Precision. Toshiba with Remington Rand and Oki Electric with IBM also plan to make business computers.

Hitachi's 3010 is reportedly aimed at competition with IBM's 1401. Price of the 3010 is expected to be \$416,666.

## Major Chemical Company Enters Instrument Field

E. I. DUPONT DE NEMOURS & CO. said last week that it is establishing a new Instrument Products division to manufacture and market chemical processing instruments. It will start with process stream analyzers made under contract fabrication. Other plans are being studied, but manufacturing decisions and plant locations have not been determined. DuPont has been having specialized instruments made for its own use.

## Steelmaker Tries Computer Control of Blast Furnace

BLAST FURNACE NO. 5 at Inland Steel Company's Indiana Harbor Works will be tied to a computer in research aimed at applying computer controls to furnace operation. Ultimate goal is automatic process control that would enable the computer to keep one jump ahead of operat-

ing problems and make corrections.

The furnace, which produces 1,700 tons of iron daily, has been fitted with \$100,000 in instrumentation to scan 20 variables a second. IBM, cooperating in the project, supplied the computers. A 1620 punched card system was used initially. This month, it was replaced with a special 1710 system, made up of a modified 1620 and a 1711 data converter.

Inland doubts automatic control would reduce its manpower requirements. Increased production would require more men to charge and tap the furnaces and technicians to serve the instrumentation.

## Tackle Telemeter Tells How Rough Football is

MINIMUM STANDARDS for football headgear may result from a Northwestern University research helmet which got its initial tryout at the All-Star game in Los Angeles this month.

Linebacker Joe Schmidt, of the losing Eastern team, wore a helmet equipped with an accelerometer and a miniature transmitter. Impact data was received on the sidelines. Everything worked fine, except Schmidt spent much of the game on the bench.

Northwestern will add an electroencephalogram to the helmet and use it again in spring grid practice. The one-direction accelerometer used in the bowl game will be replaced with one measuring force in any direction.

## High-Flying Photoscanner Will Measure Airglow

YESTERDAY was the kick-off date for a project to measure light emission in the upper atmosphere. Finding out what causes airglow is, among other things, expected to help explain radio propagation problems. An Ebert-type scanning spectrophotometer, launched 180 miles up in an Astrobee rocket, will telemeter data. The project is jointly sponsored by Northeastern University, Boston, which built the instrumentation, and Air Force Cambridge Research Lab.

## In Brief . . .

WRIGHT MFG. CO., Phoenix, is making small, thermoelectric refrigerators, for line or battery power, using bismuth telluride elements and two transistors.

SPERRY PHOENIX has delivered to Army an all-weather, automatic landing system for helicopters.

FOREIGN SALES include Hughes' Taran-I fire control system to Switzerland for its Mirage-III-S fighter aircraft; two radio stations costing \$3 million, from Collins Radio, for NATO use in Norway; 14 weather radars, from Raytheon, to Sweden.

PROJECT RELAY will use three microwave transmitters supplied by Radiation at Stanford. Beckman Instruments will develop a miniature prototype gas chromatograph for JPL's Surveyor moon probe.

MILITARY EQUIPMENT contracts include \$3.8 million to Autonetics for Able portable gyrocompasses; \$1.2 to General Precision for simulators and navigation computers; "several million dollars" to Cubic Corp. for aerospace tracking; \$1.8 million to American Electronic Labs for pulse analyzers, other gear; \$623,000 to Servomechanisms for airspeed computers.

OTHER CONTRACTS are \$1.7 million to Adler Electronics for Army radio sets; \$1.1 million to Granger Associates for 70 h-f antennas and 60 multicouplers, to be installed at air bases; \$873,000 to Edo for Navy airborne weapons modifications and fabrication.

DONNER DIVISION of Systron-Donner, gets a \$1.5 million order for Polaris components, including units which automatically ignite engines during underwater launch.

COMPONENTS CONTRACTS include \$450,000 to Electronic Specialty for switches and other parts of the F-105; \$569,000 to Guidance Technology for aircraft vertical gyros; \$500,000 to Yardney Electric for silver-zinc batteries for F-105; \$224,222 to Applied Research for broadband amplifiers.



**FORE!** We had golf pro Bud Holscher take his best shots at a standard Hoffman 1N429 zener. Then we hooked the very same zener into a 6-volt DC circuit. It worked perfectly, of course. And, no wonder. This straight-from-the-bin unit is built to take many times the impact required by current military specifications. It's the same device that has achieved a 99.49% per 1000 hours Survival Rate Factor after two million component operating hours of testing. Our 1N429 stands up in every way, like all Hoffman semiconductor devices.



We specialize in devices for control, regulation and power. You can buy them with confidence that they'll work and keep on working. Confidence that they'll be available when and where needed. That's why so many of the most successful electronics designers keep coming back to Hoffman—again and again and again. Chances are you'll do the same. Try us. Call your nearest Hoffman distributor or sales office today.

**Hoffman** / **ELECTRONICS CORPORATION**  
*Semiconductor Division*

1001 N. Arden Dr., El Monte, Calif. • CUMberland 3-7191 • TWX: El Monte 9735

CIRCLE 9 ON READER SERVICE CARD

a pleasure  
to measure  
with these...



5512A, 300 KC



5532A, 1.2 MC

# 4 NEW SOLID STATE

Measure frequency, period, ratio, quickly, accurately. Compact, easy-to-use instruments provide continuous display, no "blinking"! Solid-state dependability! 0.1 volt

All the advantages of solid-state design are now yours in these new  $\Phi$  solid state counters—offered at prices comparable to those of today's vacuum tube counters. And you get the *plus* advantages of greater readability, faster measurements, easier routine maintenance, rack-and-stack convenience of the new  $\Phi$  universal module instrument cabinets.

Offered in four models, these new counters have maximum counting rates of 300 KC or 1.2 MC, with a choice of Nixie or columnar readouts. The high-intensity neon readouts are stacked in compact columns for faster, easier reading. On the in-line readouts,  $\Phi$ -pioneered standard incorporation of the new long-life, wide-viewing Nixies gives you many extra hours of lamp life and heretofore unknown readability even at extreme angles. Polarized screen provides maximum readout brilliance with freedom from reflections.

A unique display storage feature of these new counters produces a continuous visual readout of the most recent measurement, even while the instrument is making a new measurement. Only if the new count differs from the previous count will the display change, in which case it will shift directly to the new reading. The fatigue and error possibility of a "blinking" display is eliminated. The storage feature may be disabled with a rear panel switch.

The counter's "inactive time" (when not making a new measurement) is independent of gate time and adjustable from 0.2 to 5.0 seconds, thus permitting a higher sampling rate.

Counter	Max. Counting Rate	Registration	Period and Multiple Period	
			Range	Accuracy
5212A	300 KC	5 digits columnar	2 cps to 300 KC	$\pm$ one count $\pm$ time base accuracy $\pm$ trigger error/periods averaged
5512A	300 KC	5 digits Nixie		
5232A	1.2 MC	6 digits columnar	2 cps to 1.2 MC	$\pm$ 1 $\mu$ s $\pm$ time base accuracy $\pm$ trigger error/periods averaged
5532A	1.2 MC	6 digits Nixie		

High sensitivity permits low level measurement without accessories, and multiple period average measurement (to 100,000 periods) gives higher ac-



Note clean, compact, easy-to-service physical arrangement of new  $\Phi$  solid-state counters.



5212A, 300 KC

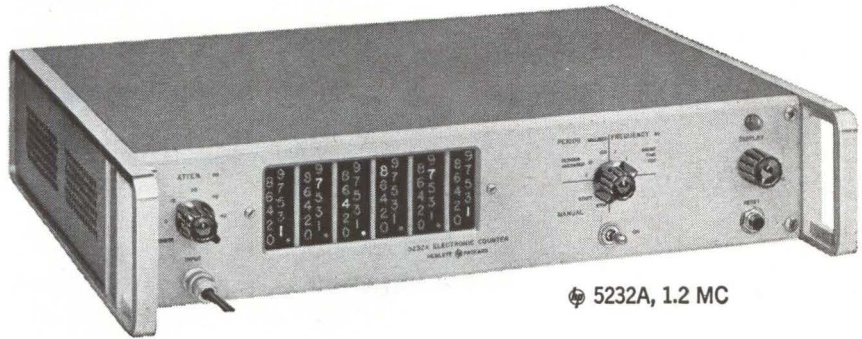

5232A, 1.2 MC



# COUNTERS!

sensitivity! Higher sampling rate! Unique low frequency accuracy! Operation  $-20^{\circ}$  to  $+65^{\circ}$  C! Prices comparable to vacuum tube counters!

Average Measurement		Frequency Measurement				Ratio Measurement			Price
Reads in	Periods Averaged	Range	Accuracy	Reads In	Gate Time	Reads	Range	Accuracy	
Milli-seconds or microseconds with positioned decimal	1, 10, $10^2$ , $10^3$ , $10^4$ , $10^5$	2 cps to 300 KC	$\pm 1$ count $\pm$ time base accuracy	KC with positioned decimal	10, 1, 0.1, 0.01 sec.	$(f_1/f_2) \times$ period multiplier	$f_1$ : 100 cps to 300 KC (1 v rms into 1,000 ohms)	$\pm 1$ count of $f_1 \pm$ trigger error of $f_2$	\$ 975.00
							$f_2$ : same as period		1,175.00
		2 cps to 1.2 MC					$f_1$ : 100 cps to 1.2 MC (1 v rms into 500 ohms)		1,300.00
							$f_2$ : same as period		1,550.00

accuracy in lower frequency ranges, even for noisy signals. Self-check is provided for both frequency and period measurement modes.

Only  $3\frac{1}{2}$ " high, these counters are housed in the new modular cabinets ideal for both bench use and easy rack mounting. Routine maintenance is simple with snap-out decade/readout units and circuit cards. Readout drive directly from photoconductors eliminates a complete stage of complex circuitry, to effect genuine cost and reliability advantages. Compact design and construction and servicing ease are illustrated at the left.

Solid state design and construction gives you the advantages of low heat dissipation with minor heating effect on adjacent equipment, fast warm-up, low power consumption and new standards of reliability.

The new counters include a four-line BCD code output. This output, with assigned weights of 1-2-2-4 ("1" state positive with respect to "0" state), is available for systems use or to operate devices such as the 562A Digital Recorder. Controls include Input Attenuation, Display, Reset and Function.

Call or write your representative or call us today for information and a demonstration!

Data subject to change without notice. Prices f.o.b. factory.



## HEWLETT-PACKARD COMPANY

1051 Page Mill Road  
Cable "HEWPACK"

Palo Alto, California, U.S.A.  
Davenport 6-7000

Sales representatives in all principal areas

## HEWLETT-PACKARD S. A.

Rue du Vieux Billard No. 1  
Cable "HEWPACKSA"  
Geneva, Switzerland  
Tel. No. (022) 26. 43. 86

CIRCLE 11 ON READER SERVICE CARD

# WASHINGTON OUTLOOK

**NEW ARMY ORGANIZATION** will have a big impact on the electronics industry.

Contractors and would-be contractors selling electronic and other equipment to the Army will deal with one agency, the Material Development and Logistics Command. This goes for research and development, procurement and production of communications, radar, automatic data processing, combat surveillance equipment, missiles, munitions, aircraft, vehicles and other general equipment.

The plan still has to be okayed by Congress but odds are it will be. It's part of Defense Secretary McNamara's drive to centralize control at the Pentagon. This particular move has been in the works several months.

Downgraded will be the contracting functions of the Signal and Ordnance Corps as well as other Army technical services: Quartermaster, Chemical and Transportation Corps, laboratories, arsenals, proving grounds, regional contracting offices and other field installations of the Army Signal and Ordnance Corps and the other technical services will be absorbed into MDLC.

## NEW ARMY BUYERS

**THIS IS ALL** part of a trend. In the Air Force, research and development and production functions have been combined in the Air Force Systems Command. And to consolidate management of common-use supplies for all three services there is a Defense Supply Agency (ELECTRONICS, p. 28, Jan. 19). While DSA will handle common-use electronic parts for all services, MDLC will handle electronic end items and major components peculiar to the Army.

An Army Combat Development Command will also be created in the shakeup. It will take over from the technical services and the Continental Army Command development of organizational and operational doctrine, requirements, war gaming, field experimentation and cost effectiveness studies.

## DEFENSE SUPPLY AGENCY

**KENNEDY ADMINISTRATION'S** defense budget follows the trend of all Pentagon budgets of recent years. It earmarks an increasing share of military spending for electronics.

By conservative estimate at least \$6.2 billion worth of new orders for both R&D and production of electronic equipment will be placed in fiscal year 1963, starting July 1. This compares with at least \$5.9 billion this fiscal year.

This estimate presumes that one quarter of all military R&D and production will go for electronics. Additional sums not included in the \$6.3 billion figure will go for electronics out of the \$11.6 billion operations and maintenance fund.

## KENNEDY BUDGET

**THE NEW BUDGET** allots \$6.4 billion for aircraft production, compared to \$6.8 billion this year; \$4.1 billion for missile production, compared to \$3.9 billion; \$2.9 billion for shipbuilding, \$1/2 billion more than this year, and \$4.2 billion for other military production—same as this year. "Pure" electronics and communications drop from \$1.5 billion to \$1.3 billion.

Polaris, Minuteman and Skybolt missile output will be stepped up. The Army's Nike Zeus anti-ICBM system will continue in R&D; no production funds yet. Six more Polaris submarines will be built. The third Ballistic Missile Early Warning System site will be completed. An emergency manual backup system for the Sage air defense control system is authorized.

R&D funds for civilian space programs jump to \$2.96 billion over fiscal 1962's \$1.4 billion. Plus there's an \$85 million supplemental request for the 1962 program. About 25 percent of space R&D usually goes to electronics. NASA's budget includes \$1.6 billion for manned space flight development, including Gemini and Apollo and Saturn and Nova boosters. Electric propulsion R&D money will go from \$17.5 million in fiscal 1962 to \$30.6 million in 1963.

## WHERE THE MONEY GOES

# DEVELOPED

FOR A MAJOR COMPUTER MANUFACTURER

This magnetic head developed for high frequency analog recording for use at intermediate tape speeds.

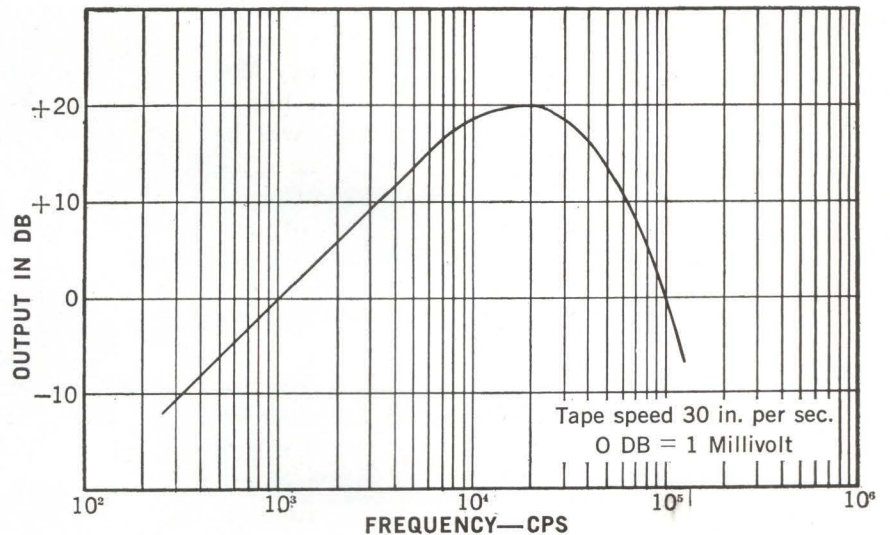

- Devoted exclusively to the manufacture of magnetic heads
- Complete facilities for production runs
- Laboratory facilities for special heads
- Thorough testing and documentation of data
- Proven design
- Entire range of magnetic heads

For further information call or write:

**iem**

international electro-magnetics, inc.  
Box 7, North Chicago, Illinois DEXter 6-1440

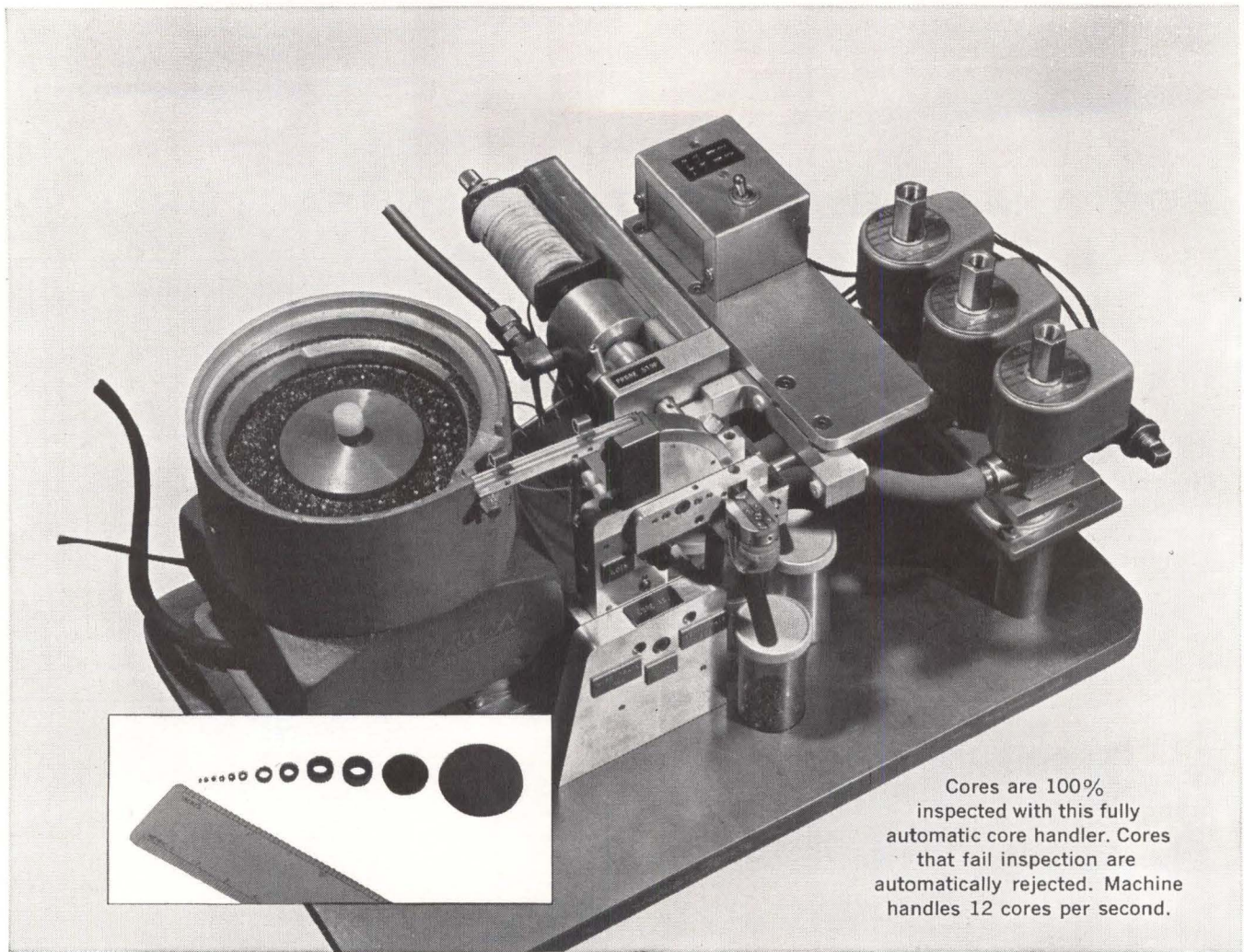

Cores are 100% inspected with this fully automatic core handler. Cores that fail inspection are automatically rejected. Machine handles 12 cores per second.

## New ultra-speed memory cores extend computer design limits

Indiana General's GC Division offers computer designers five new memory cores with increased capabilities for higher computer speeds, better performance.

These new cores are the most recent products of General Ceramics' advanced memory technology. This know-how, combined with the latest testing and manufacturing facilities plus 100% quality control, assures you of cores of utmost reliability. Control begins with mechanical and electrical testing of each individual core and con-

tinues with both visual and electrical inspection at all stages of assembly. Advanced techniques such as ultrasonic cleaning, automatic electrical testing, and other advanced electronic functional tests, provide that extra edge of reliability which GC customers have come to expect.

Cores are available with an AQL of .015 if ordered as 100% tested or 6.5 AQL if untested. For full details, write Memory Products Department, General Ceramics, Keasbey, New Jersey.

TYPICAL OPERATING CHARACTERISTICS OF NEW GC CORES AT 25° C

Type	Size (OD)	Response		I read I write (ma)	Pulse Rise Time $t_r$ ( $\mu$ sec)	I partial Write (ma)	Pulse Duration $t_d$ ( $\mu$ sec)	Switching Time $T_s$ ( $\mu$ sec)	Peaking Time $T_p$ ( $\mu$ sec)
		Undisturbed ONE Voltage $uV_1$ (mv)	Disturbed ZERO Voltage $dV_z$ (mv)						
MC161, 162	F764 (050)	150	10	700	0.2	350	1.0	0.60	0.34
MC163, 164	F764 (050)	185	12	830	0.2	415	2.0	0.5	0.3
MC165, 166	F764 (050)	100	5	410	0.5	205	4.0	1.12	0.68
MC167, 168	F764 (050)	75	4	330	0.5	165	4.0	1.42	0.78
MC169, 170	F394 (080)	170	19	620	0.2	310	4.0	1.07	0.50



INDIANA GENERAL CORPORATION

GENERAL CERAMICS DIVISION • KEASBEY, NEW JERSEY

® FERRITES, MEMORY PRODUCTS and TECHNICAL CERAMICS



*Crystallizing Ideas into Products*

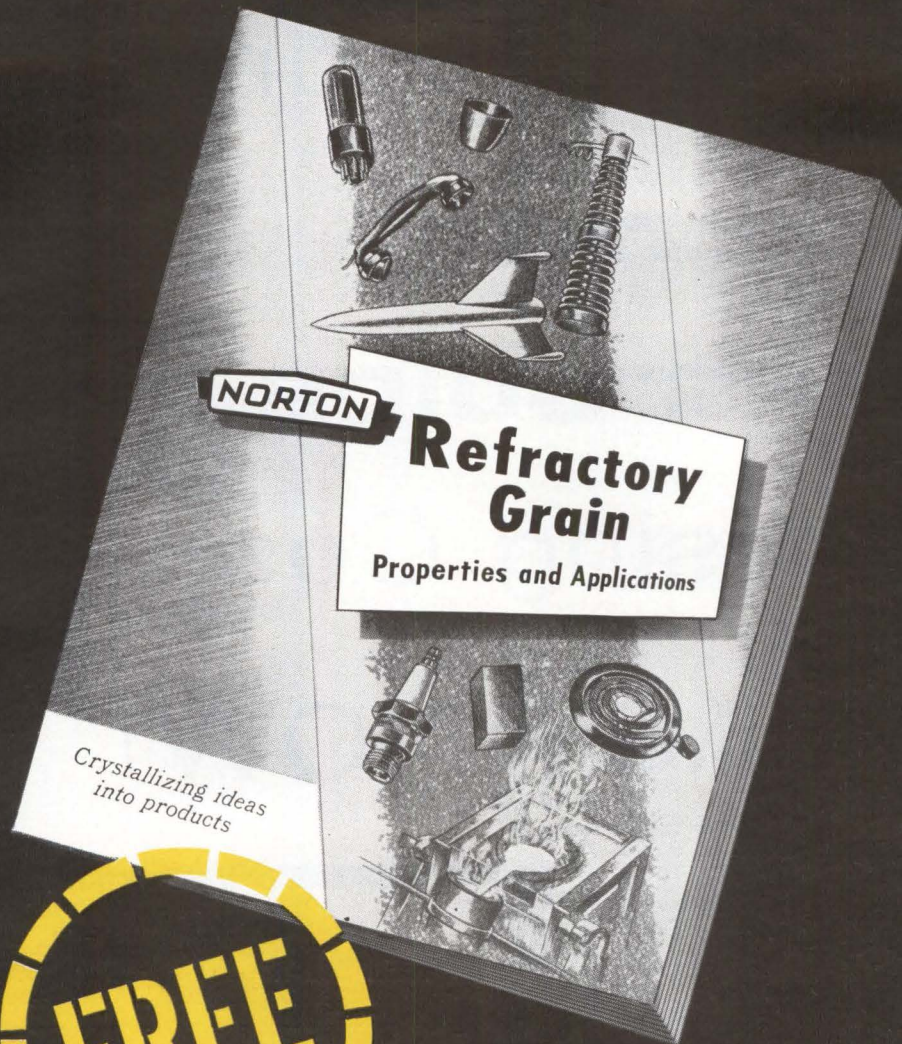

**FREE**

...and this book  
tells you how!

Does your processing, present or planned, call for materials that will stand up under temperatures as high as 4000°F. — or under the toughest mechanical, chemical, electrical and radio-active conditions?

Norton high purity refractory materials are meeting those requirements for many applications, industrial and scientific, protecting equipment ranging from foundry furnaces to space vehicles.

The large, well illustrated reference book shown above tells you all about

these materials . . . what they are made of, how they react, and what they can do for *you*. CRYSTOLON\* silicon carbide, ALUNDUM\* aluminum oxide, MAGNORITE\* magnesium oxide, NORBIDE\* boron carbide, fused stabilized zirconia and other Norton refractory developments are fully described.

For years this booklet has provided information on materials that help solve processing problems. For the facts you need, write for your free copy of "Norton Refractory Grain." NORTON COMPANY,

Refractories Division, 680 New Bond Street, Worcester 6, Massachusetts.

\*Trade Marks Reg. U.S. Pat. Off. and Foreign Countries.

**NORTON**

**REFRATORIES**

Making better products...  
to make your products better

# Save 7% of Your electronics BUYERS' GUIDE Advertising Costs ACT NOW!

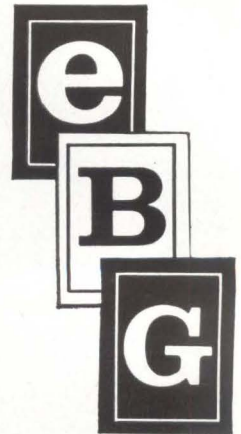

Order your advertising for the 1962 electronics BUYERS' GUIDE now. Study these exceptional discounts. You can earn up to 10% in discounts. You will see four distinct ways to save money. Here is how the "Early Bird" discount structure works:

In addition to volume discounts for Multiple Page, run-of-press, advertising, a discount of 7% on the earned rate will be allowed on ads of 1/2 page or more, provided insertion order is received by February 15, 1962, and plates are supplied to the publisher by April 25, 1962.

In addition to the volume rates for inserts, a discount of 7% of those rates will be allowed providing insertion order is received by February 15, 1962, and inserts are supplied to the publisher by May 25, 1962. See your local advertising representative, listed on the last page of this issue for complete details.

Multiple Page Discounts	
2 pages .....	earn 3%
4 pages .....	earn 4%
6 pages .....	earn 6%
8 pages .....	earn 7%
12 pages .....	earn 8%
16 pages .....	earn 9%

Special rates for furnished inserts	
2 pages .....	per page \$715
4 pages .....	682
6 pages .....	654
8 pages .....	616
12 pages .....	600
16 pages .....	583
20 pages .....	566
24 pages .....	550
28 pages .....	533
32 pages .....	517
over 32 pages .....	489

(Orders and complete plates to be sent to 330 West 42nd Street, New York 36, N. Y. Inserts to be shipped to National Publishing Co., Lanston Building, 24th and Locust Street, Philadelphia 1, Pennsylvania. Marked: Electronics Buyers' Guide.)

## electronics BUYERS' GUIDE & Reference Issue



A McGraw-Hill Publication / 330 West 42nd Street, New York 36, N. Y.

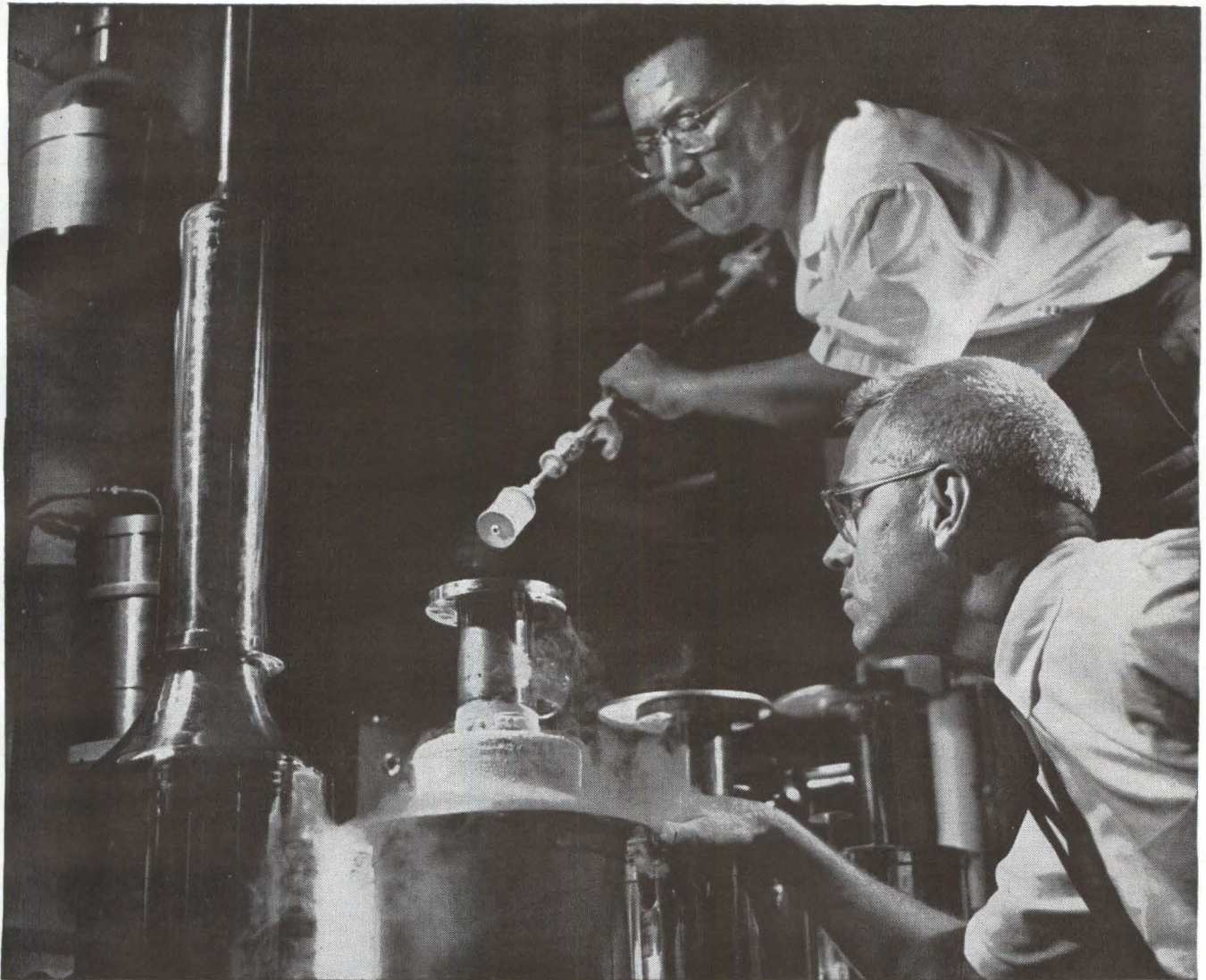

**The Making of a Magnet.** Bell scientists test new superconducting electromagnet, the small cylindrical object being removed from helium bath at minus 450 degrees F. An early experimental design produced a field strength over 65,000 gauss.

## OUT OF SOLID STATE SCIENCE COMES A POWERFUL NEW MAGNET

Bell Telephone Laboratories' creation of a powerful superconducting electromagnet once again illustrates the role of materials research in the advancement of communications.

It has long been known that certain materials called superconductors have a zero electrical resistance at temperatures near absolute zero. A solenoid of superconductive wire carrying a large current should be capable of producing an extremely powerful magnetic field without the bulky power equipment that is needed for conventional electromagnets.

A formidable obstacle blocked the way, however. The strong magnetic field tended to destroy the wire's superconductivity.

Bell Laboratories scientists studying superconductors—as part of their endless search for new materials for communications—were led to the discovery of a number of alloys and compounds having exceptional superconductive properties. One of these materials, a

compound of niobium and tin, was found to possess a startling ability to retain its superconductivity in intense magnetic fields of over 100,000 gauss. Bell scientists went on to show how the brittle, intractable material could be made into a wire and hence wound to make an extremely powerful electromagnet.

By finding a low-cost way to create enormously powerful magnetic fields, Bell scientists have brought closer new applications of magnetism in communications. Intense magnetic fields provide an invaluable tool in research, and offer an attractive means for containing hot plasma in thermonuclear experiments.

The new magnet is another example of how Bell Laboratories research not only works to improve Bell System communications but also benefits science on a broad front.



**BELL TELEPHONE LABORATORIES**

World center of communications research and development

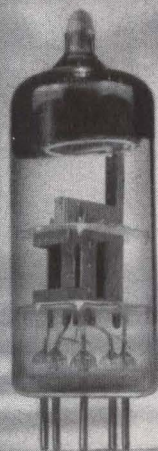

# 6GK5 V.H.F. TRIODE

Frame-Grid semi-remote cut-off triode for use as an r.f. amplifier in television receivers.

## ANOTHER MULLARD FRAME-GRID TUBE

Increased gain, reduced microphonics, and better controlled characteristics — these are the advantages you get when you specify Mullard frame-grid television tubes.

### CHARACTERISTICS

$V_a$	135	V
$I_a$	11.5	mA
$V_g$	-1.0	V
gm	15	mA/V
ra	5.4	k $\Omega$
$\mu$	78	
$r_{g1}$ (f=200 Mc/s)	275	$\Omega$
$V_g$ for 100:1 reduction in gm	-4.2	V

### SUPPLIES AVAILABLE FROM:

IN THE U.S.A.  
International Electronics Corporation  
81 Spring Street, New York 12, N.Y.  
Worth 6-0790

IN CANADA  
Rogers Electronic Tubes & Components  
116 Vanderhoof Avenue, Toronto 17, Ontario,  
Hudson 5-8621

\*Mullard\* is the trademark of Mullard Limited



# Mullard

ELECTRONIC TUBES

BRITAIN'S FIRST CHOICE FOR FIRST EQUIPMENTS  
MULLARD OVERSEAS LTD, MULLARD HOUSE, TORRINGTON PLACE, LONDON, ENGLAND



## WHAT'S YOUR TRANSFORMER PROBLEM?

Research in advanced applications? Optimizing performance/cost trade-off? Extreme reliability for military use? Audio, cathode ray, chokes, driver, filament, geofomers, toroids, hermetically sealed, instrumentation, pulse isolation, subminiature, micro-miniature, modulation, power, step-down, or transistor models? Triad solves thousands of transformer problems in all areas. Triad Transformer Corporation, 4055 Redwood Ave., Venice, Calif., or 305 N. Briant St., Huntington, Ind. Take the tough ones to Triad...and the easy ones too.

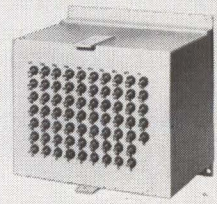
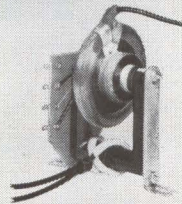
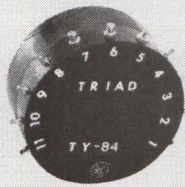

TRIAD TRANSFORMER CORP.  
A DIVISION OF LITTON INDUSTRIES



# Pleasure Boat Electronics Stresses Low

By LAURENCE D. SHERGALIS  
Associate Editor

NEW YORK—Improved accuracy, easier operation, lower power consumption and prices within range of weekend boaters were the sales features of new electronics equipment displayed at the National Motor Boat Show last week. Manufacturers hope for a \$12 million market in radiotelephones, depth sounders, direction finders and other communications, navigation and control gear for pleasure boats.

Among newer systems is a direction finder that automatically aims its loop antenna at a station and indicates direction on a remote compass. The set has been manufactured by CME Mfg. Co., San Diego, and is now to be made and sold by Raytheon. Covering a frequency range of 190 Kc to 2.8 Mc, its bearing accuracy is  $\pm 3$  degrees for signals exceeding 100 microvolts per meter.

A signal received by the loop antenna is amplified and fed to a 90-deg phaser. Thus the r-f signal is in phase with—or out of phase with—the signal received by the sense antenna. The degree of phase shift depends upon loop orientation.

Phaser output is fed in phase to grids of balanced modulator  $V_2$ . This tube is heavily biased by  $R_2$ . The signal is passed by one plate or the other as their respective grids are driven positive to overcome a bias by the 18 volt, 115-cps modulating voltage from  $T_4$ .

Center-tapped antenna trans-

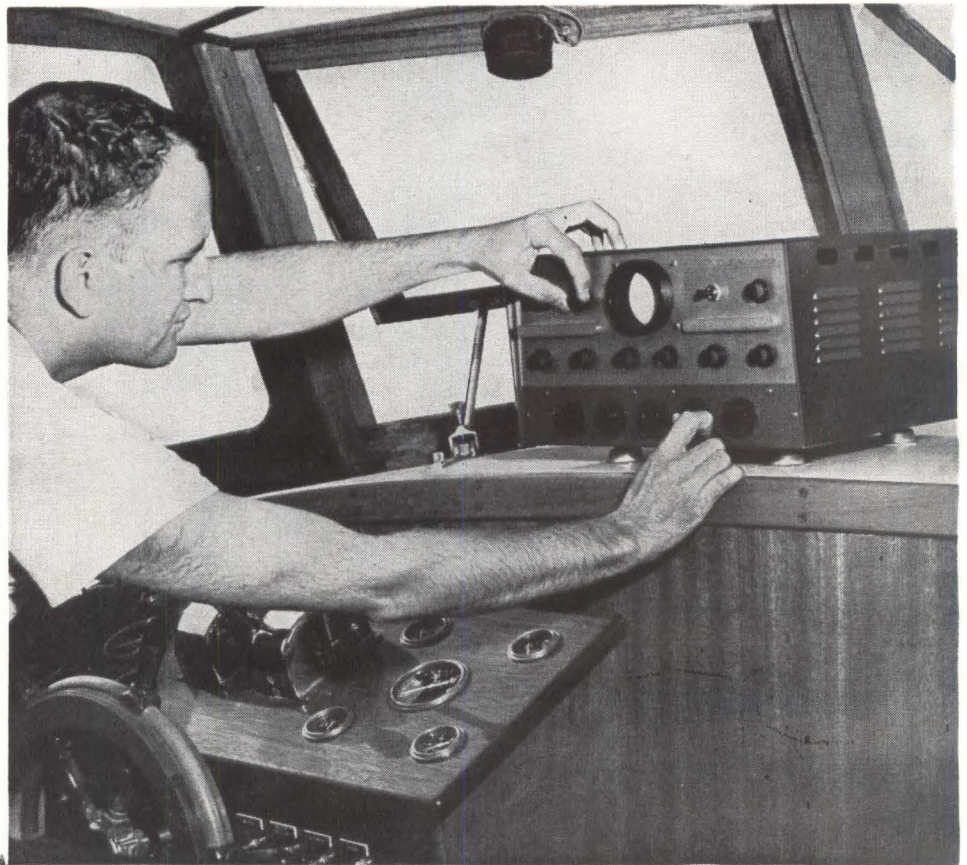

Loran by Electro-Nuclear Apparatus Co. is typical of navigation equipment now available to pleasure boat owners

former leads are tied to the plates of  $V_2$ . The balanced modulator shifts the signal from one side to the other, resulting in 180-degree phase reversal at 115 cps.

Signals from the modulator and sense antenna are combined in the r-f amplifier. When the two signals are in phase, the result is additive;

if not, they cancel. The action results in an r-f signal amplitude modulated at 115 cps. After going through the mixer and i-f amplifiers, the signal is detected by  $V_6$ . Here the demodulated 115-cps signal is in phase or out of phase with the 115-cps signal applied to  $V_2$ , depending on loop orientation.

After amplification in the triode section of  $V_6$ , the signal is filtered and fed into voltage amplifier  $V_7$ , and then the servo amplifier and one winding of the two-phase antenna drive motor. This signal leads or lags voltage applied to the other winding, depending on loop displacement from null. The motor rotates until null is reached.

Bendix announced a new depth sounder that can distinguish weak targets on or near the bottom from strong bottom echos. Generally, weak target echos, such as from fish lying on the bottom, are buried

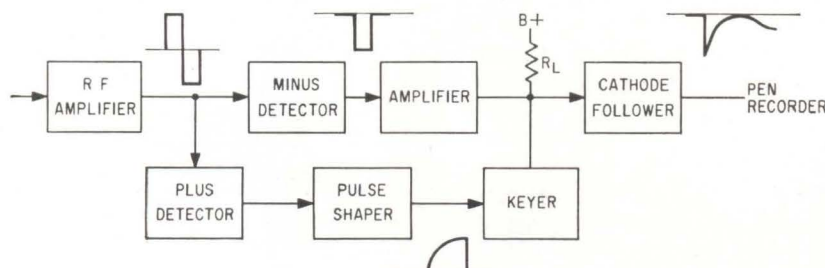

Bendix sonar uses ratio of resistances in the plus and minus detectors to determine pulse amplitude at which keyer is triggered

# Power Consumption, Operating Simplicity

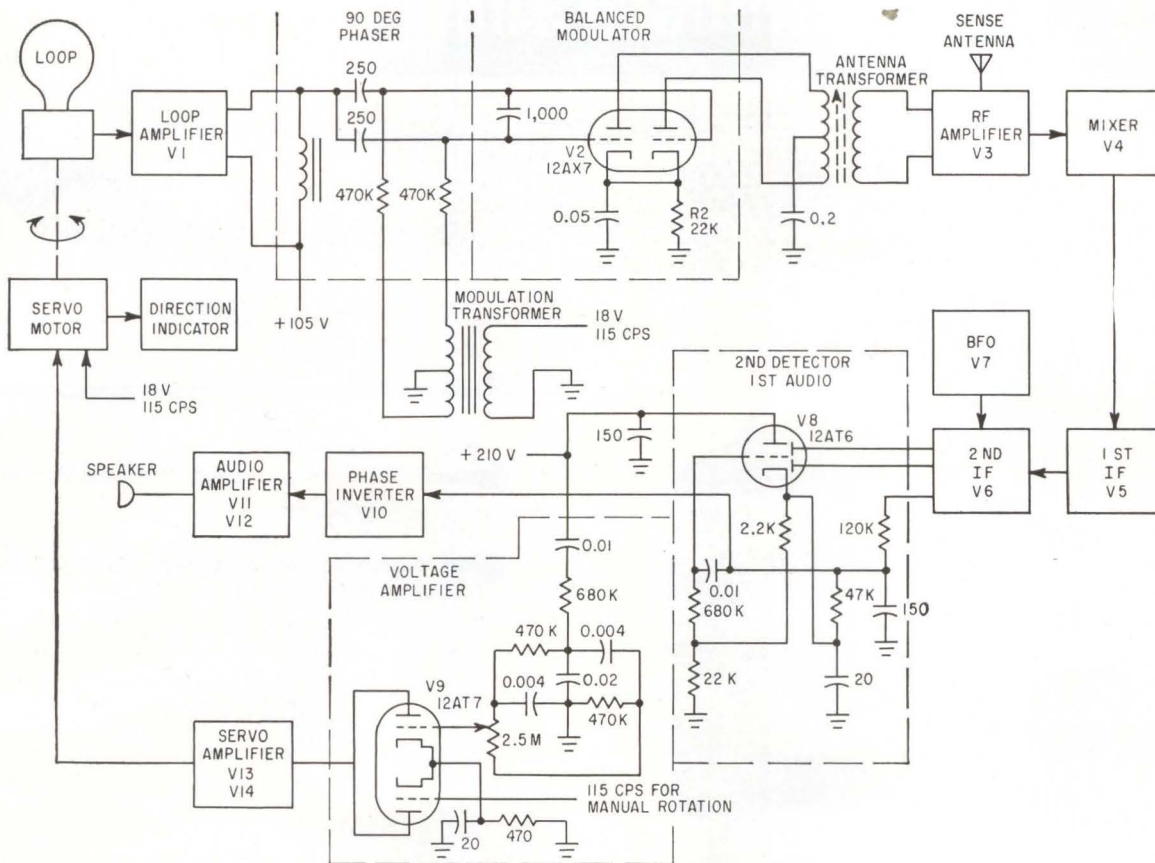

Error signals from the servo amplifier of Raytheon's direction finder are fed back to two-phase loop servo motor to correct for displacement from null position

in the bottom pulse return.

The circuit illustrated produces a sharp pulse on strong signals, but reproduces a weak signal return as received. A 50-Kc square-wave return is amplified and fed to two diodes called plus and minus detectors. Output from the plus detector is shaped as shown and actuates the keyer tube. Both the keyer tube and the amplifier of the negative pulse share the same load resistor  $R_L$ . The action is that of a summing d-c amplifier and results in the sharp negative pulse going to the cathode follower and the pen recorder.

Weak signal returns are passed by the minus detector and amplifier, but will not actuate the keyer in the positive detector circuit. Therefore, the weak return is reproduced as received. The chart trace shows a thin, well defined line indicating depth, while a fish on or near the

bottom is seen as a separate echo.

Most marine direction finders and receivers are now equipped to receive Consolon coastal navigation stations. These stations transmit coded signals in highly directional patterns, enabling the vessel to locate itself on a line radial from the station without a loop direction finder. Counting the series of dots or dashes from signals from two such stations and then referring to a chart gives the navigator an accurate fix.

Electro-Nuclear Apparatus Co., Baltimore, introduced a consol reader that digitally counts characters on two type 6909 tubes. During the transition period when the characters change from dot to dash, the device can distinguish characters that the average listener cannot make out.

The reader incorporates a narrow-band receiver with a band-

width of 2 Kc at 200 Mc, with an i-f of 45 Kc. Selectivity is also improved by a chopper-type beat oscillator. The dc from the detector is interrupted at about 600 cps to give a constant tone that does not vary with tuning. The tone is obtained at the zero beat.

Edo Corp. displayed their deep depth sounder with range to 36,000 feet. A cathode-ray tube display gives instantaneous readings to about 600 feet.

Transistor radiotelephones, Ioran and small radar rounded out the lines of equipment shown.

Several Japanese items were displayed by U. S. importers. An automatic direction finder, sold by Intercontinental Communications Corp., features a nonrotating loop with a goniometer for scanning. Four crystal positions enable the operator to tune four stations and obtain a fix within 20 seconds.

# THE WORLD'S FASTEST GOLD CATHODE TRIGGER TUBE

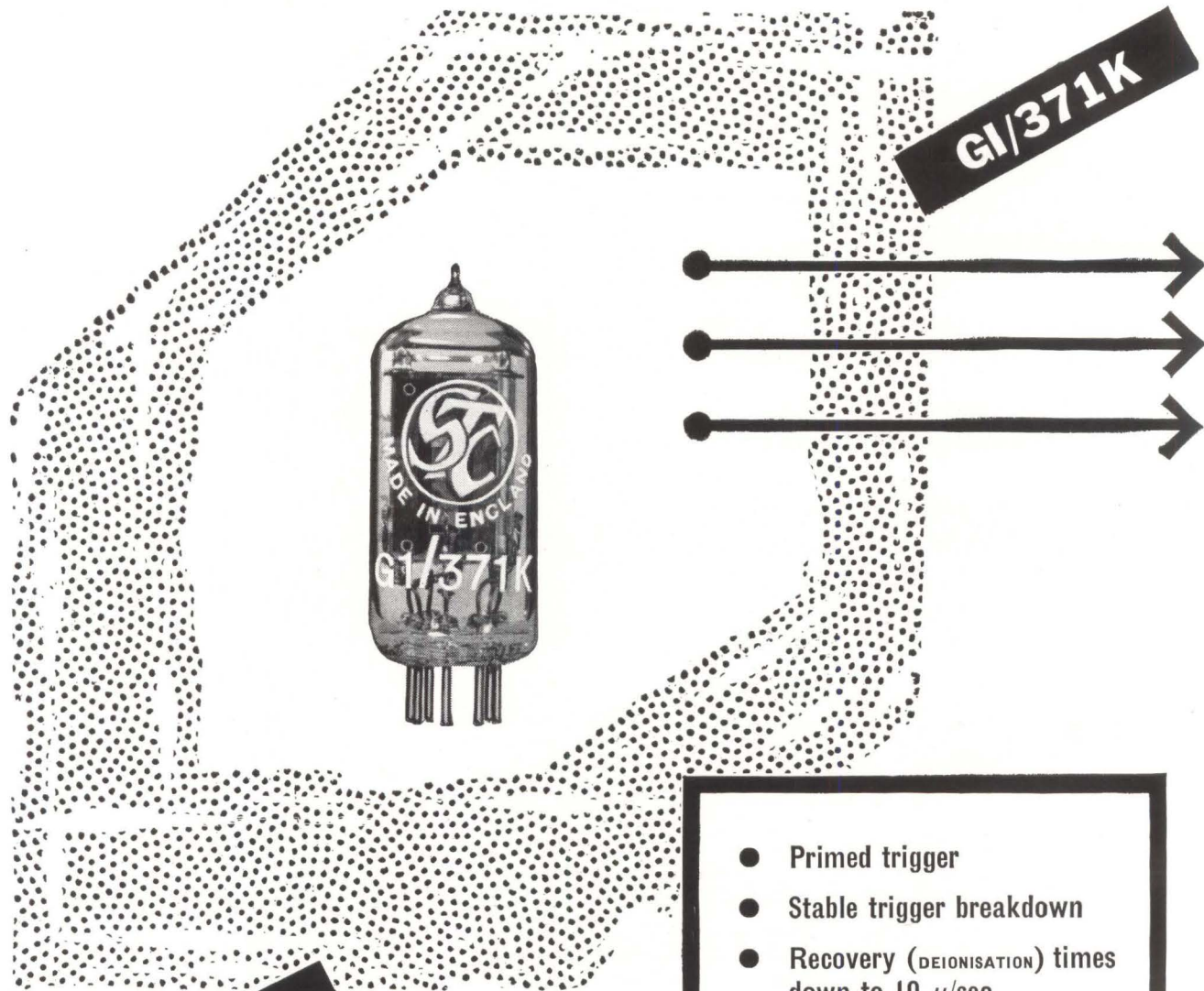

GI/371K

CV2224

Write for new  
application  
report  
MS/118

- Primed trigger
- Stable trigger breakdown
- Recovery (DEIONISATION) times down to 10  $\mu$ /sec
- Ring counter operation up to 100 kc/s
- Suitable for use on rectified 200/250V. mains supply.

ITT



62/16MS

*Standard Telephones and Cables Limited*

VALVE DIVISION: BRIXHAM ROAD · PAIGNTON · DEVON · ENGLAND





Even non-technical personnel can

# COMPLETE AN HOUR'S ALIGNMENT WORK IN FIVE MINUTES

with these direct-reading automatic

## NOISE FIGURE METERS

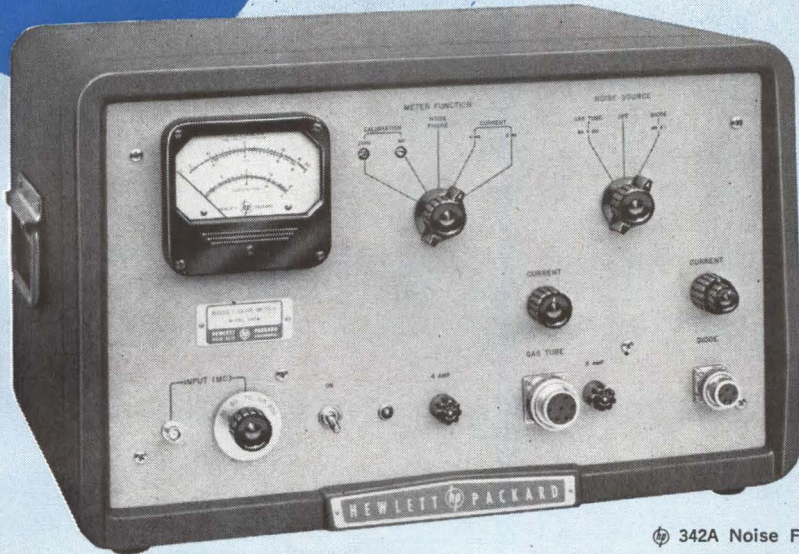

Ⓟ 342A Noise Figure Meter

Easy-to-use Ⓟ 340B and 342A Noise Figure Meters save you time and cut costs in the alignment of receivers, IF strips, rf amplifiers. With these instruments that read directly in noise figure\*, true receiver performance usually can be improved over the best adjustment previously possible. (A 3 db improvement in receiver noise figure is equivalent to doubling transmitter output.) These Ⓟ Noise Figure Meters simplify accurate alignment and speed routine equipment maintenance to provide you with peak performance from your high sensitivity rf and microwave equipment.

\*Ratio between total of a known quantity of broadband input noise plus receiver noise, and receiver noise only.

Equally important, these Ⓟ noise figure systems are indispensable tools for minimizing noise in critical front end stages of rf equipment under development. By measuring noise figure, the effects of component arrangement and selection are instantly apparent. This makes possible the optimum . . . designing to noise figure . . . the real criterion of receiver performance.

For information on noise figure measurement theory and practice, request Ⓟ Journal, Vol. 9, No. 5, and Vol. 10, No. 6-7.

### SPECIFICATIONS Ⓟ 340B NOISE FIGURE METER

**Frequency Range:** Depends on noise source used  
**Noise Figure Range:** 3 to 30 db, indication to infinity with waveguide noise source; 0 to 15 db, indication to infinity with IF noise source  
**Zero Offset:** Permits low values to be read on sensitive external meter  
**Accuracy (excluding source accuracy):** ±0.5 db, 10 to 25 db; ±1 db, 3 to 10 db, 25 to 30 db with waveguide source; ±0.5 db, 0 to 15 db with IF source  
**Input:** -60 dbm to -10 dbm (noise source on)  
**Input Frequency:** 30 and 60 MC, others between 10 and 70 MC on special order  
**Bandwidth:** 1 MC minimum  
**Input Impedance:** 50 ohms, nominal  
**AGC Output:** Nominally 0 to -6 v  
**Recorder Output:** Maximum of 1 ma into maximum of 2,000 ohms to operate recorder or remote meter  
**Dimensions:** 20¾" x 12¾" x 14½" (cabinet), 19" x 10½" x 13¾" (rack mount)  
**Price:** Ⓟ 340B, \$715.00 (cabinet); Ⓟ 340BR \$700.00 (rack mount).

### Ⓟ 342A NOISE FIGURE METER

(same as 340B except):  
**Input Frequency:** 30, 60, 70, 105 and 200 MC. 30 MC plus any four frequencies between 38 and 200 MC on special order. Frequency selector switch.  
**Price:** Ⓟ 342A, \$815.00 (cabinet); Ⓟ 342AR, \$800.00 (rack mount)  
**Use these Ⓟ Noise Sources with Ⓟ 340B or 342A:**  
Ⓟ 343A VHF Noise Source, 10 to 600 MC, \$100.00  
Ⓟ 345B IF Noise Source, 30 or 60 MC, \$100.00  
Ⓟ 347A Series Waveguide Noise Sources, all frequencies 2.6 through 18.0 GC, \$200.00 to \$300.00  
Ⓟ 349A UHF Noise Source, 400 to 4,000 MC, \$325.00  
Data subject to change without notice. Prices f.o.b. factory.

### HEWLETT-PACKARD COMPANY

1501 PAGE MILL ROAD, PALO ALTO, CALIFORNIA  
AREA CODE 415, DA 6-7000

Sales and service representatives in all principal U. S. areas;  
Europe, Hewlett-Packard S.A., Rue du Vieux Billard No. 1, Geneva;  
Canada, Hewlett-Packard (Canada) Ltd., 8270 Mayrand St., Montreal

7541

# New Subminiature Resistors Get Approval

KANSAS CITY, MO.—Electra Manufacturing Company recently announced approval of their new micro-size metal film and carbon film precision resistors. A company official states that these subminiature precision resistors are now ready for the Electronics Industry to be used in new designs where precision and size are critical. As one engineer aptly described it, in commenting on

their size, "If it weren't for the leads, you would never believe they were resistors — *much less, precision resistors*". The Type DC 1/10X and Type MFS 1/20 are available in 1/10 watt carbon film and 1/20 watt metal film, the company spokesman said. Complete information is available on request by writing to Electra Manufacturing Company, 4051 Broadway, Kansas City 11, Mo.

## MFS 1/20 METAL FILM RESISTOR

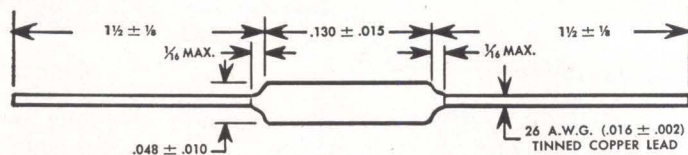

Resistance Range:  
Tolerance:  
Dissipation at 125° C:  
Temperature Coefficient:

30 ohms to 100 K  
± 1%  
1/20 Watt  
T-0: ± 150 PPM/°C  
T-2: ± 50 PPM/°C  
Electra's R-5 Coating  
Tag

Encapsulation:  
Marking:

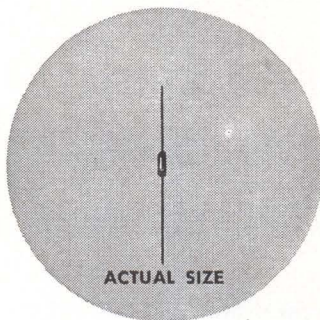
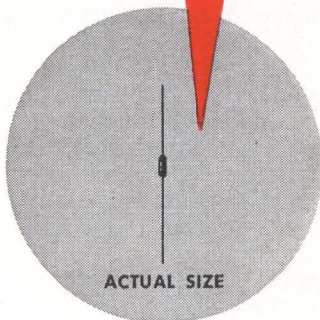

## DC 1/10 X — CARBON FILM RESISTOR

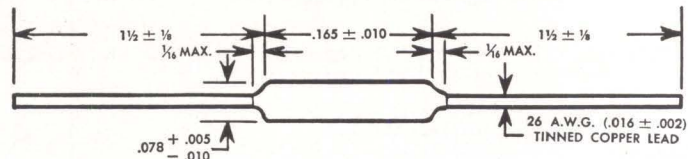

Resistance Range:  
Tolerance:  
Dissipation at 70° C:  
Temp. Coefficient:  
Encapsulation:  
Marking:

10 ohms to 301 K  
± 1%  
1/10 Watt  
Max. .05%/°C  
Electra's R-5 Coating  
Tag or Color Band



## ELECTRA MANUFACTURING COMPANY

4051 Broadway • Kansas City, Missouri

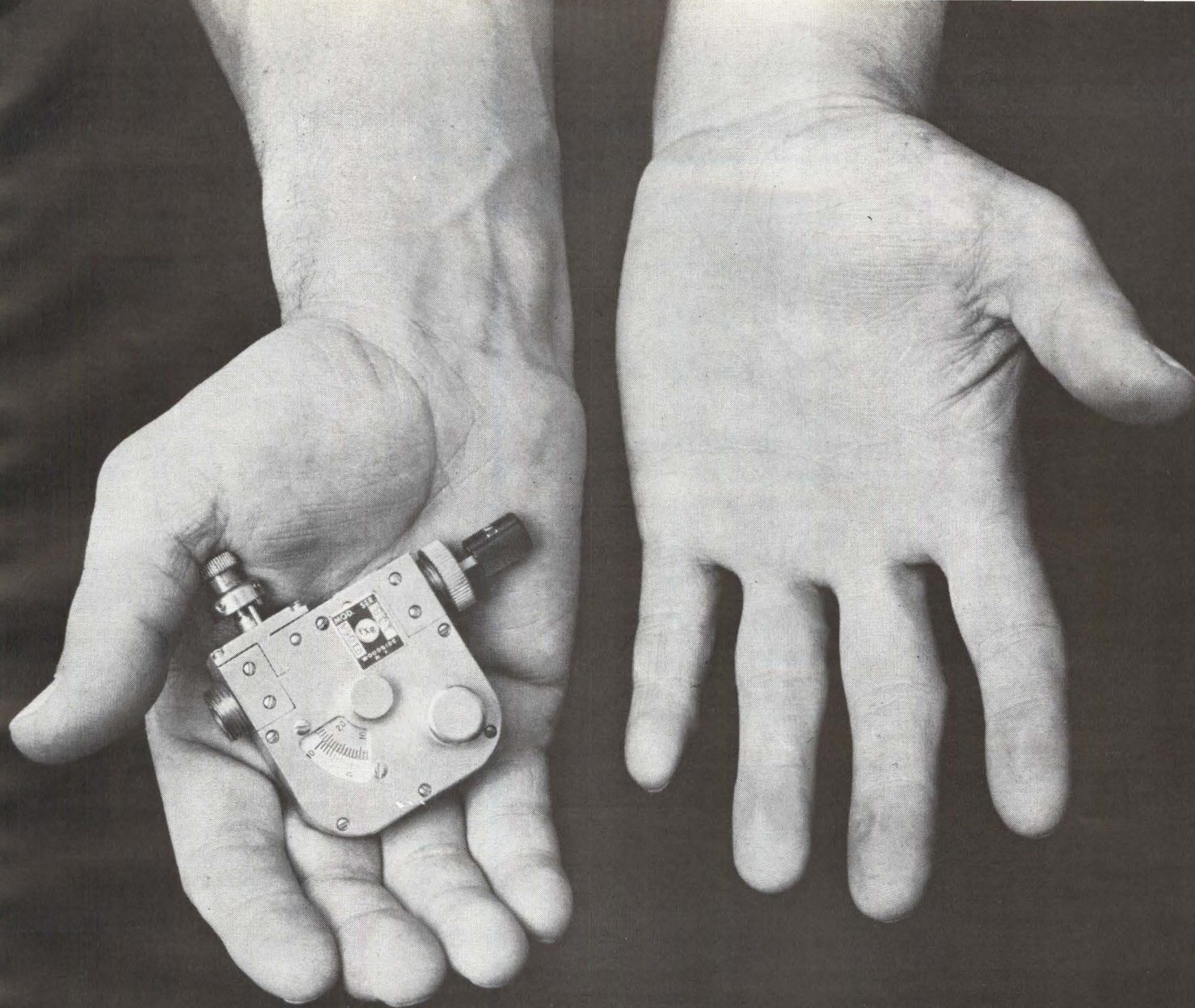

## *Wanted:* 2 & 3 mm oscillators to power FXR's 90 to 220 Gc components

FXR has on hand *today, in stock*, a complete line of microwave components for tomorrow's 2 & 3 mm systems. And by complete line, we mean frequency meters, precision attenuators, E/H tuners, harmonic generators, phase shifters, bends, twists, slotted sections, transitions — in short, everything needed to set up a test system in the 90 to 220 Gc range.

But what about the 2 & 3 mm oscillators needed to drive these test systems? We've the answer to that. While waiting for these 2 & 3 mm oscillators you, too, can use the FXR harmonic generators for test purposes to double and triple the frequencies of existing oscillators. This

design and production availability of 2 & 3 mm components is a further addition to FXR's comprehensive line of microwave components and test instruments.

Staying a band ahead is a point of pride with FXR engineers. FXR's leadership in the mm bands is typical of equally advanced developments in other areas of microwave engineering, including high power electronics. For example, the FXR engineering group which delivered the world's first 50 megawatt S-band trans-

mitter is now producing even more advanced types. Whether in microwave components, test instruments, sub-systems or high power electronics, FXR is known for its ability to *deliver* the last word in microwave technology today.

May we help you in your next microwave project? Write today for literature covering your particular field of interest. FXR, 25-26 50th Street, Woodside 77, New York. Telephone: Area Code 212, RAvenswood 1-9000.

# FXR

THE RF PRODUCTS AND MICROWAVE DIVISION  
AMPHENOL-BORG ELECTRONICS CORPORATION

CIRCLE 25 ON READER SERVICE CARD

# LAMINAR SUPERCONDUCTORS

## Applications in Computers and Magnets Expected for This New Tool in Cryogenic Electronics

By MICHAEL F. WOLFF  
Senior Associate Editor

STUDIES OF TUNNELING in superconducting thin films have sparked interest in laminar devices. Now researched primarily for their own scientific interest, laminar superconductors may find applications in cryogenic electronics, particularly for computers and magnets.

A laminate is formed by superimposing superconductor and normal metal films. In direct contact they influence each other so that the normal metal behaves like a superconductor while the superconductivity of the other metal is somewhat inhibited. The composite device has superconducting properties of its own. For example, the superconductor's critical temperature (at which resistance drops to zero) is depressed.

Main significance of the laminates for cryogenic electronics is that by varying relative film thicknesses critical temperature may be varied over a wide range. This would permit a circuit designer to arbitrarily choose critical temperatures rather than be restricted to those of existing superconductors and their alloys.

In experiments at Arthur D. Little with lead-silver films, critical temperature has been varied from that of lead (7.2 K) to 1.8 K. Presumably, it could go to zero degrees. These experiments also demonstrate that the otherwise normal silver has an energy gap and is able to pass a supercurrent (as described by S. Shapiro at the 1961 NEREM). ADL experiments deposited silver on a glass substrate by vacuum evaporation. All obscuring physical phenomena such as formation of alloys and intermetallic compounds are eliminated so that only the electronic interaction occurs. The persistent-current circuit which tests for superconductivity in silver is shown.

While varying critical temperature might permit more flexibility in cryotron design, for example, it

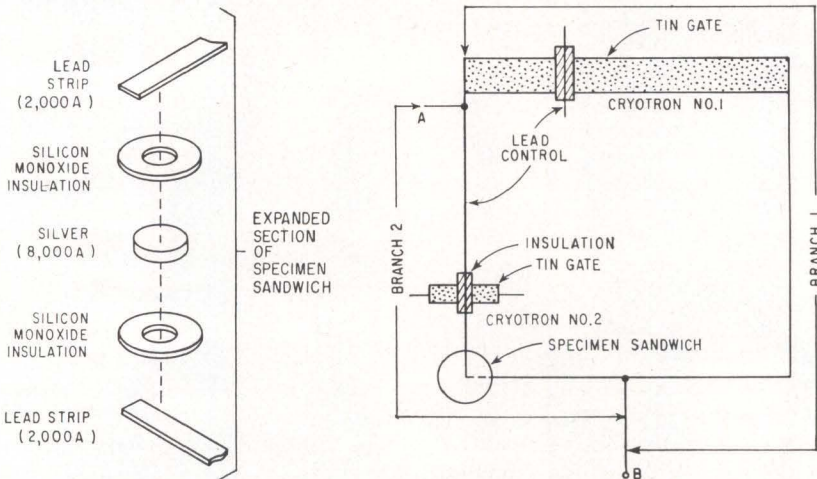

▲ With voltage across A and B, cryotrons 1 and 2 can switch current between branches 1 and 2 to find critical current needed to make ADL's lead-silver sandwich superconducting

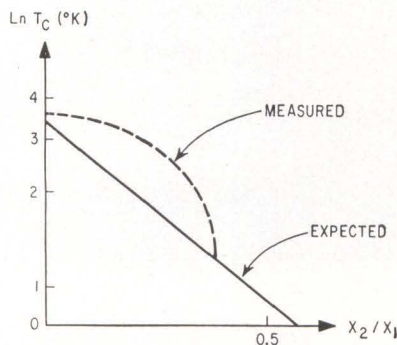

◀ Sudden drop in critical temperature  $T_c$  is seen in copper-tin junction made at Stevens Institute.  $X_1$  is tin thickness,  $X_2$  is copper thickness

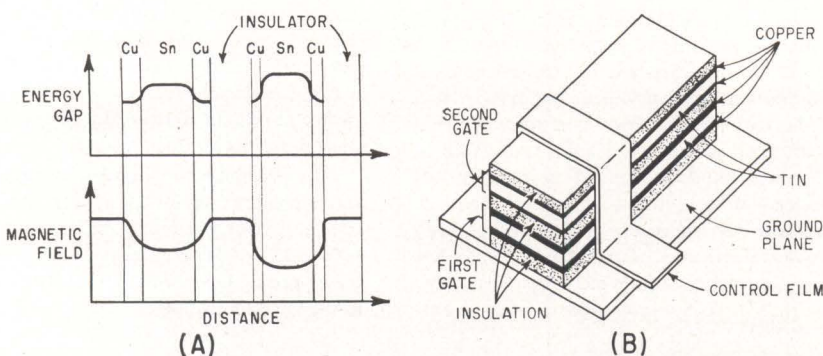

Variation of energy gap and magnetic field (A) with distance through gates of analog-to-digital converter (B) proposed by Stevens Institute

is not known yet whether a laminar junction would produce undesirable effects. Also, understanding of accompanying critical currents and critical magnetic fields is needed before laminar superconductors could be used.

Experiments by H. Meissner, of Stevens Institute of Technology, with tin-copper films have shown that with a very thin interposed oxide film critical magnetic field values are at least four times the expected value. Meissner anticipates that further study of the effect may enable construction of high-field superconducting magnets by a laminar process. His experiments also show an unexplained sudden drop in critical temperature.

Induced superconductivity has been observed in the contact of a thin potassium film and a bulk superconductor. J. Jacobs, of RIAS division of Martin-Marietta, reports a disappearance of contact resistance between two tin wires onto which potassium films have been evaporated.

Potential applications of laminar superconductors to cryogenic circuits lie in two areas. First, the device might be used, for example, in counting. An analog-to-digital converter could be built up as illustrated by the process studied at Stevens. As the control field is increased, succeeding stages become superconducting at points determined by the relative thicknesses of the films.

#### Other Laminar Uses

Laminar superconductors may also be useful in constructing superconducting circuits with definitive characteristics unchanged by time. Assuming no accompanying deleterious effects, a thin film of normal metal could be a diffusion barrier between two elements of a cryotron. Laminar junctions might also dissipate heat during switching and form superconducting contacts between cryotron decks.

Laminar junction techniques could control grain size and geometry of thin-film cryotron structures. For example, to eliminate high critical fields at edges of a thin film, the edges could be made electrically discontinuous by evaporating a superconductor onto a nucleating layer of a normal metal.

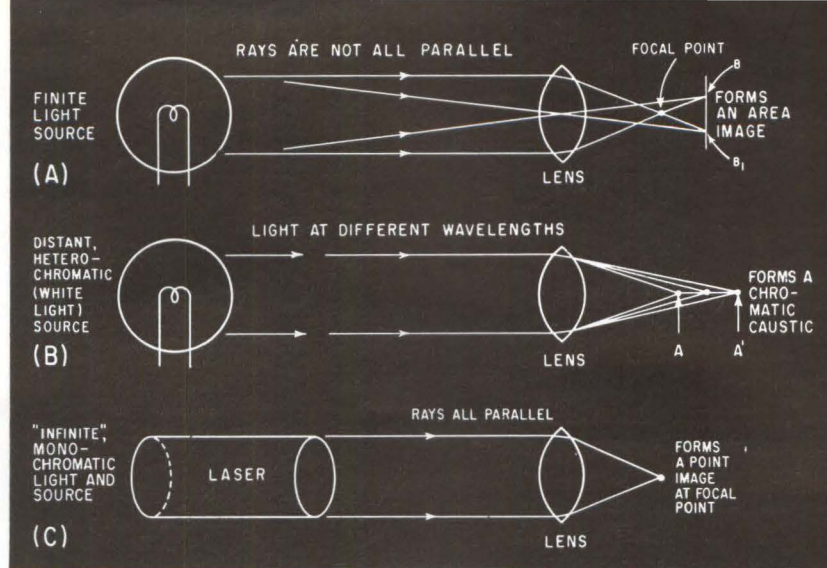

Use of lasers for surgery overcomes image spreading resulting from a finite light source (A) and chromatic aberration of heterochromatic light (B). Monochromatic laser beams act as an infinite source (C)

## How Dangerous Are Lasers?

By LEON H. DULBERGER

Assistant Editor

PHYSICIANS familiar with lasers generally agree that laser beams are potentially dangerous to unwary users. Safety precautions should be followed by experimenters to avoid eye injuries from thermal burns. High-intensity laser beams can damage an eye in a fraction of a second. Pigmented or dark portions of the eye readily absorb beam energy. Equally dangerous are beams reflected from an efficient mirror.

There have been reports of blindings of engineering personnel working with lasers, but no confirmations have been received to date. In two known cases, engineers noted images after viewing lasers three miles and one mile away. In the first case, the effect was gone in a few days; in the second, eye examination revealed no exposure.

One protective device suggested is a pair of thick, opaque goggles with a small hole at the lens centers. A beam must go through the hole to reach the eye. A cup shield around the edges would add to protection.

Should the beam enter the direct hole path, probably only the macula (the point of sharp focus on the retina) would be damaged. A victim could not focus sharply on an

object, but could still see light and dark and gross objects.

Objection to such goggles is that the limited field of vision might result in a general safety hazard. When safe exposure levels are known, narrow-band optical filters could be designed to attenuate the laser beam but pass sufficient light for vision.

Some lasers have emitted unexpectedly in the field because their circuit designs permitted the discharge capacitor to fire the flash tube after primary power was turned off.

Dr. Milton M. Zaret, a consulting ophthalmologist active in radiation hazards and laser eye surgery and safety, says that there is now no valid safety device other than avoiding the direct beam. He has led experiments at NYU Medical Center using a laser operating at 6,943 Å to test harmful effects and has reported thermal lesions in rabbits' eyes (*Science*, Nov. 10, 1961).

However, properly applied, laser beams are useful in eye surgery (*ELECTRONICS*, p 7, Jan. 5). Effectively coming from an infinite source and monochromatic, light from a laser can be precisely focused in three dimensions at the point of treatment. Both chromatic aberration and spot spreading common with broadband, finite light sources are overcome.

# Government and Civil Radio Share More Space

By THOMAS EMMA  
Associate Editor

RADIO SPECTRUM SPACE shared by government and nongovernment users in the frequency bands between 25 Mc and 30 Gc has increased 10 percent during the past 10 years. The shared frequencies are those which may be allocated to civilian users by the FCC, or to government services by IRAC (Interdepartmental Radio Advisory Committee).

Spectrum space allocated exclusively to government or nongovernment use has also shifted in balance during the 10 years. Government users of frequencies between 25 Mc and 30 Gc have gained the equivalent of 11.5 Mc of space since 10 years ago. Nongovernment users have given up the equivalent of 22 Mc to government services or to shared uses.

Net effect of these changes has been an almost equal division of nonshared space between government and nongovernment services.

Commission spokesmen and IRAC members think it unlikely that any major shifts in the balance between government and nongovernment spectrum use will be seen in the near future.

But there may be more frequency sharing. "Intelligent sharing is good frequency management," explains Fred Alexander, director of telecommunications for the Office of Emergency Planning.

Administration of government and nongovernment radio by two authorities has sometimes irritated users on both sides.

Nongovernment radio operators claim that government applicants for spectrum space sometimes use security regulations as a cover for obtaining the space they want. Members of FCC and IRAC both concede that hard feelings can result when a losing civilian applicant for the same space is not told how a government agency will use the frequency award.

Government radio users, on the

other hand, say that nongovernment services do not always make maximum use of the frequencies they have. Under fire at present is the uhf television band. FCC and IRAC agree, however, that most of the major differences are being worked out, pointing to the increased frequency sharing as evidence of cooperation.

In many cases, spectrum areas

assigned to government services also are used by nongovernment radio, W. E. Plummer, IRAC chairman, points out.

"The Federal Aviation Agency, for example, has many navigational frequencies that are used by commercial airlines and private flyers as much and maybe more than they are used by military aircraft.

"There are marine navigation

DIVISION OF RADIO FREQUENCY SPECTRUM BETWEEN GOVERNMENT AND NON GOVERNMENT USERS

Date and Band (Mc)	Government Mc	Government %	Nongovernment Mc	Nongovernment %	Shared Mc	Shared %
<b>March 1951</b>						
25-300	115,040	41.9	135,960	49.4	24,000	8.7
25-3,000	472,240	15.8	1,510,960	50.8	991,800	33.4
25-30,000	12,347,240	41.2	13,985,960	46.6	3,641,800	12.2
<b>April 16, 1958</b>						
25-300	113,165	41.2	137,305	49.9	24,530	8.9
25-3,000	571,565	19.2	1,295,305	43.5	1,108,130	37.3
25-30,000	13,444,565	44.9	13,987,305	46.6	2,543,130	8.5
<b>Sept. 18, 1961</b>						
25-300	110,340	40.2	132,985	48.3	31,675	11.5
25-3,000	765,540	25.8	1,180,985	39.7	1,028,475	34.5
25-30,000	13,405,540	44.7	10,935,985	36.5	5,633,475	18.8

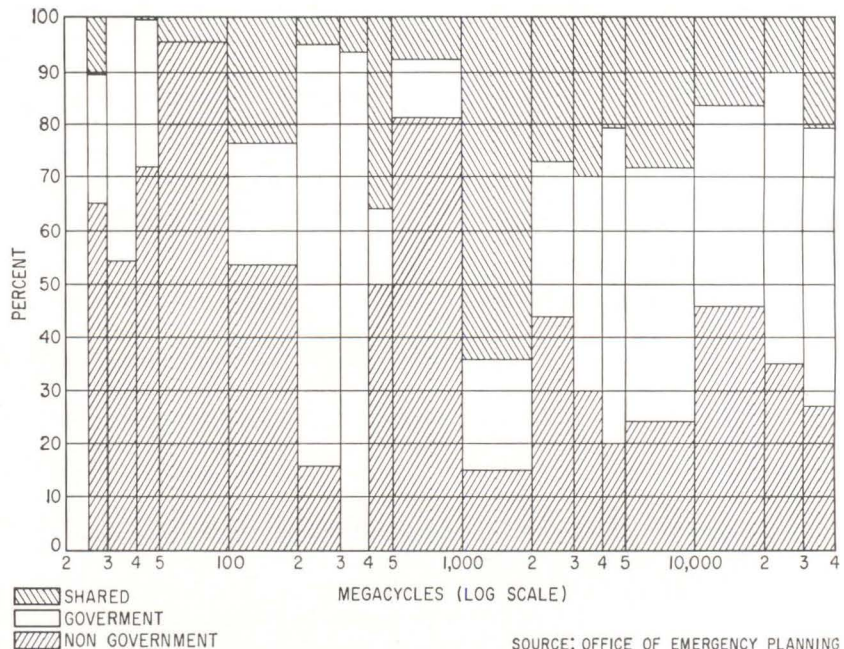

Percent of spectrum space that is used by government radio and civil radio, or is shared by government and civil radio

frequencies in the same position. Merchant ships, fishing vessels and pleasure boats get more use out of some of these than Navy and Coast Guard vessels. Yet these are government allocations."

#### IRAC'S HISTORY

*Interdepartment Radio Advisory Committee was organized in 1927 at the suggestion of Herbert Hoover, then Secretary of Commerce, to determine the best use of frequencies employed by government radio.*

*In 1951, an executive order directed IRAC to report to the newly-established Office of Telecommunications Advisor to the President. That office was transferred in 1953 to the Office of Civil and Defense Mobilization. IRAC now reports to the Director of the Office of Emergency Planning, as OCDM is now called.*

*IRAC has 12 members, a chairman, executive secretary and a liaison representative from FCC. It is composed of representatives of the State, Treasury, Army, Navy, Air Force, Interior, Agriculture, Justice and Commerce Departments, U. S. Information Agency, Federal Aviation Agency and National Aeronautics and Space Administration*

#### Report First Sales of New Input and Output Devices

AETNA INSURANCE CO. has bought the first of Farrington Electronics' new scanning systems which select specified data from a business document. It will be used to pick up information on insurance forms. Instructions to read or skip lines in documents are set up on interchangeable wiring panel. The information obtained is converted to computer language. Reading rate is 200 characters a second.

Telex reports the first order for its 300 lines a minute printout has been received from Advanced Scientific Instruments. The print mechanism uses d-c motor principles to drive hammers against the paper and character print drum. Each hammer slides in a magnet containing a coil. The print pulse in the coil sets up counter fields which drive the hammer forward.

(Advertisement)

### Magnetic Shift Registers Now Available At Sensible Prices

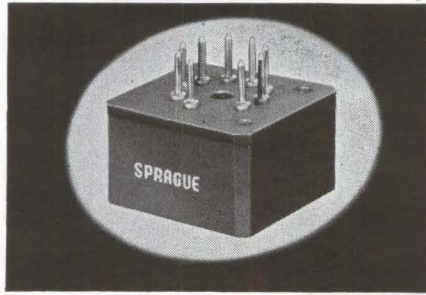

Sprague Electric Company's *Special Products Division* has scored another *first* by breaking the "\$5.00-per-bit" barrier. Magnetic Shift Registers for industrial control applications may now be obtained for less than the proverbial \$5.00 figure.

Inherently more reliable, more stable than costlier semiconductor alternates, these new encapsulated shift registers permit substantial savings in the design and production of your equipment without sacrificing quality or performance.

Sprague core-diode type shift registers employ high reliability components ruggedly assembled and epoxy encapsulated for long service. They are offered in a variety of package designs which have been developed to be compatible with all modern wiring techniques and equipment construction.

The cores used in Sprague magnetic shift register assemblies are all subjected to rigid switching tests which carefully control the basic parameters important to reliable operation in the final circuit application. Completed assemblies are 100% pulse-performance tested to insure strict adherence to engineering specifications.

Available in single-bit as well as multi-bit assemblies, with or without bit drivers, to meet your individual packaging requirements, Sprague Magnetic Shift Registers may well be the answer to some of your design problems.

For further information, or for application engineering assistance without obligation, write to Special Products Division, Sprague Electric Company, 35 Marshall Street, North Adams, Massachusetts.

CIRCLE 200 ON READER SERVICE CARD

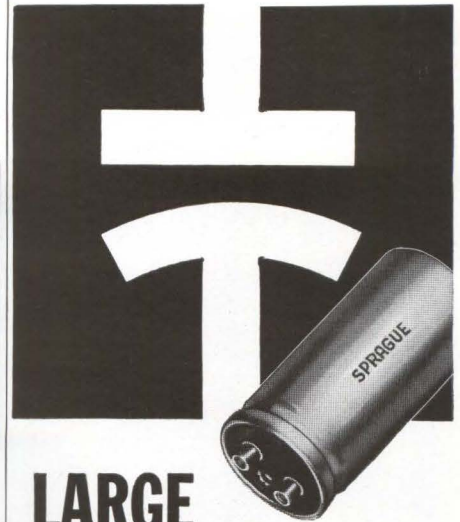

## LARGE VALUES OF CAPACITANCE

### IN SMALL PHYSICAL SIZE!

Sprague offers two series of "block-buster" electrolytic capacitors for use in digital power supplies and allied applications requiring extremely large values of capacitance.

Type 36D Powerlytic® Capacitors pack the highest capacitance values available in their case sizes. Intended for operation at temperatures to 65 C, maximum capacitance values range from 150,000  $\mu$ F at 3 volts to 1000  $\mu$ F at 450 volts.

Where 85 C operation is a factor, Sprague offers the Type 32D Compulytic® Series, the ultimate in reliable long-life electrolytics for digital service. These remarkably trouble-free units have maximum capacitance values ranging from 130,000  $\mu$ F at 2.5 volts to 630  $\mu$ F at 450 volts.

Both 32D and 36D Capacitors have low equivalent series resistance and low leakage currents, as well as excellent shelf life and high ripple current capability.

If you'd like complete technical data on Type 36D units, write for Engineering Bulletin 3431. For the full story on the "blue ribbon" Type 32D Series, write for Engineering Bulletin 3441B to the Technical Literature Section, Sprague Electric Company, 35 Marshall Street, North Adams, Massachusetts.



CIRCLE 29 ON READER SERVICE CARD 29



## ON THE DANGER OF BEING CLOSE

(a report  
from  
Delco Radio)

When electronic parts and circuits are crammed together, there's danger of coupling or regeneration between circuits. The smaller the package, the more critical the problem. ■ In development work on a small portable radio transmitter, Delco Radio engineers found that circuit coupling could be eliminated with the use of ferrite tuning cores and circuits totally enclosed in ferrite shields. ■ Also, ferrite gave each tuning coil a very high inductance and a wide tuning range with a high "Q". Significantly, it permitted a drastic reduction in the size of the coil, the core and the shield. ■ The finished product, an all-transistor transmitter, is no larger than a pocket radio and weighs only 11 ounces. The companion receiver is even lighter and smaller. ■ Both units are practical hardware, built of standard components to provide mobile, long-range communication today. For technical details, ask for Data Sheet 601. ■ Delco Radio may be able to solve your problem in miniaturization, digital modules or static power supplies, too. Write to Delco Radio Military Sales Dept., Kokomo, Ind.

Section of Single  
Sideband Transmitter,  
9x magnification

**DELCO**  
DEPENDABILITY  
**RADIO**  
RELIABILITY

Division of  
General Motors  
Kokomo, Indiana



# SMALL PART PROBLEMS ?

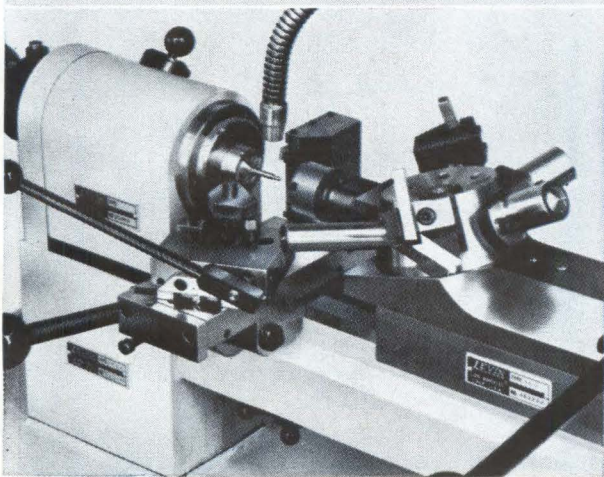

Shown above, an ACAF turret lathe set up to produce the small needle valve, illustrated, with a 0.0118" bleed hole. The self indexing turret is extremely sensitive for fine work. Speed regulation is continuously variable from 0 to 4000 r.p.m. with IR drop compensation.

**SEND FOR COMPLETE CATALOG**

**JEVIN** Heavy duty instrument lathes offer the best solution to small part lathe operations. 29 standard models for first and second operation work in 3/16", 5/16", and 1/2" collet capacities.

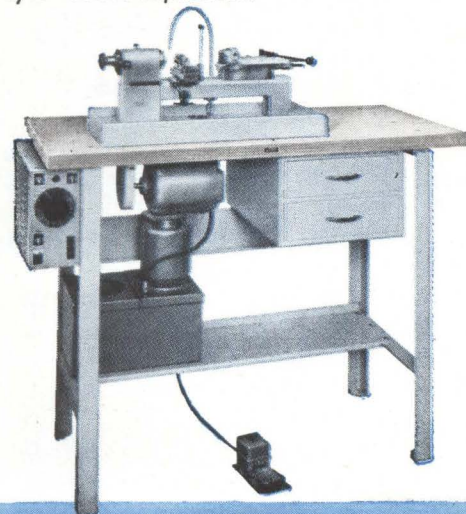

# JEVIN INSTRUMENT LATHES

LOUIS LEVIN & SON, INC.  
3573 Hayden Ave., Dept. E • Culver City, California

New York Representative and Showroom  
RUSSELL-HOLBROOK & HENDERSON, INC.  
292 Madison Ave., New York 17, N.Y.

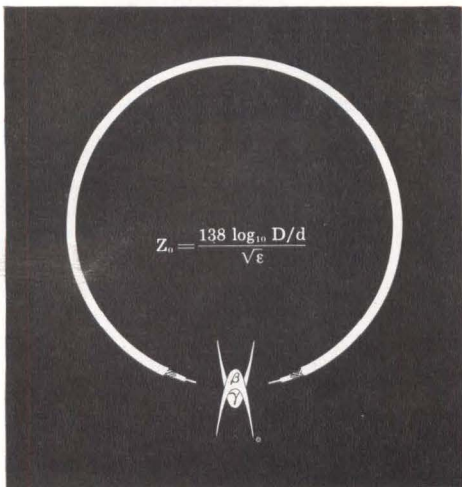

Miniature coaxial cables are designed for a particular characteristic impedance ( $Z_0$ ). The size of the cables is determined by the dielectric diameter (D), which depends upon the dielectric constant ( $\epsilon$ ) of the dielectric insulating material together with the center conductor diameter (d).

Heretofore, many miniature coaxial cables have used polytetrafluoroethylene dielectric ( $\epsilon=2.0$ ) and 30 AWG center conductors. While this helps to solve many problems of overall size it simultaneously created difficulties due to extremely small center conductors.

Raychem cables match the impedance ( $Z_0$ ) and overall diameter of the miniature coaxial cables but offer center conductors up to twice as large through the use of Rayfoam L, an irradiated, high-strength, unicellular, modified polyolefin, having a dielectric constant ( $\epsilon$ ) of only 1.5. The larger conductors overcome many of the problems previously incurred in miniature coaxial cables.

Rayfoam L is resistant to soldering temperatures, and its low specific gravity permits major weight reductions in miniature coaxial cables.



**RAYCHEM**  
CORPORATION

OAKSIDE AT NORTHSIDE  
REDWOOD CITY, CALIF.

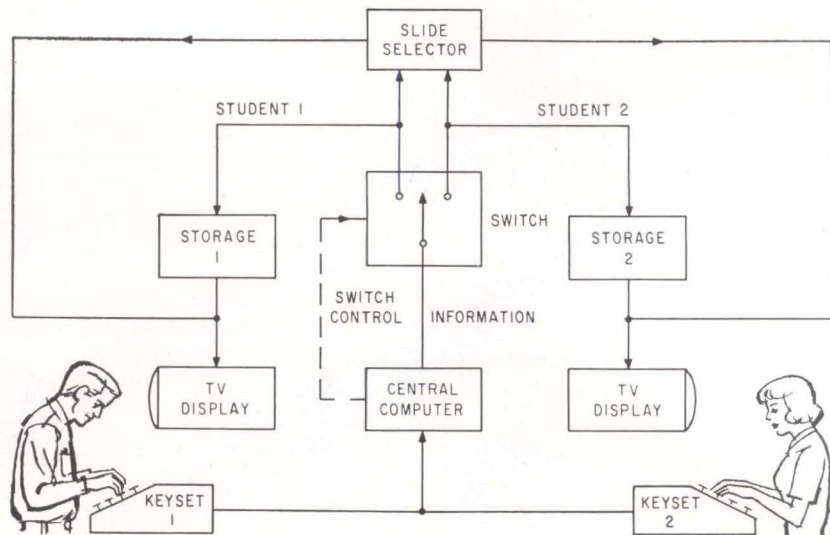

General organization of University of Illinois Plato II

## Pupils Pace Teaching Machine

FEEDBACK TEACHING machine called Plato (Programmed Logic for Automatic Teaching) developed at the University of Illinois, has simultaneously taught two students subjects as diverse as mathematics and French verb endings.

Plato uses the university's Illiac computer as a core. With a bigger, faster computer, up to 500 students could be taught at once. The system is being used to teach high school seniors computer programming, normally a college course. Development is supported by an Army-Navy-Air Force contract.

Keyboards select information displayed on a screen as a workbook. The keyboards are also used to change slides, or call up additional information when a student needs help. Material displayed on a tv screen is fed from storage tubes. Workbook capacity is 122 "pages", selected from slides viewed by through a photoelectric system.

If the student answers the question incorrectly, a bell rings and the page remains unchanged. With a "help" button, he can get additional details and the correct answer. Responses are recorded to report student performance or to indicate if lessons should be rewritten.

Quick students can set their own pace while slower students call up help slides. Future systems may insert additional problems or ques-

tions for students who are slow, make too many errors or require additional help.

### EDP Predicts Grades, Helps Pick Colleges

COMPUTER ANALYSIS of test scores is taking most of the guesswork out of selecting colleges for 70,000 high school seniors.

Under the American College Testing Program, individual grade averages during their college freshman year are predicted with a high degree of probability, E. F. Lindquist, R&D director, reported at an ACTP meeting in Chicago. Predictive indices are obtained for more than 160 colleges preferred by the students.

Increasing numbers of students will be brought into the program in coming years.

Lindquist, a professor at the State University of Iowa, reported on special data processing equipment developed at SUI's Measurement Research Center.

A high-speed photoelectric reader interlaces horizontal scans of both sides of test answer sheets in 100 microseconds. Answers are compared with correct answers stored in a memory drum and are analyzed in IBM 7070 and 1401 computers at a rate of 100 sheets a minute.

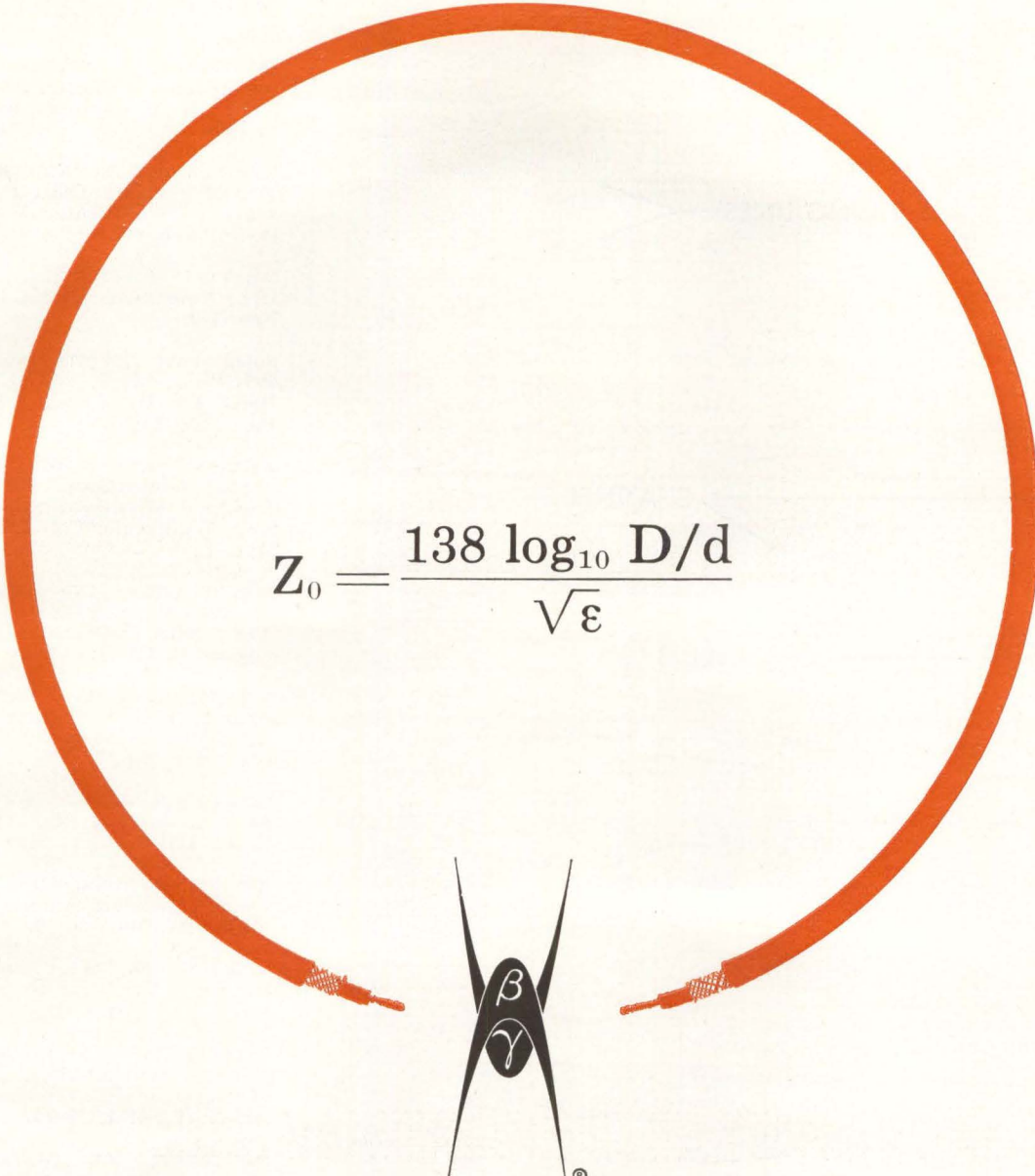
$$Z_0 = \frac{138 \log_{10} D/d}{\sqrt{\epsilon}}$$

**RAYCHEM**  
CORPORATION

**LEADER IN RADIATION CHEMISTRY  
FOR ELECTRONIC WIRE AND CABLE**

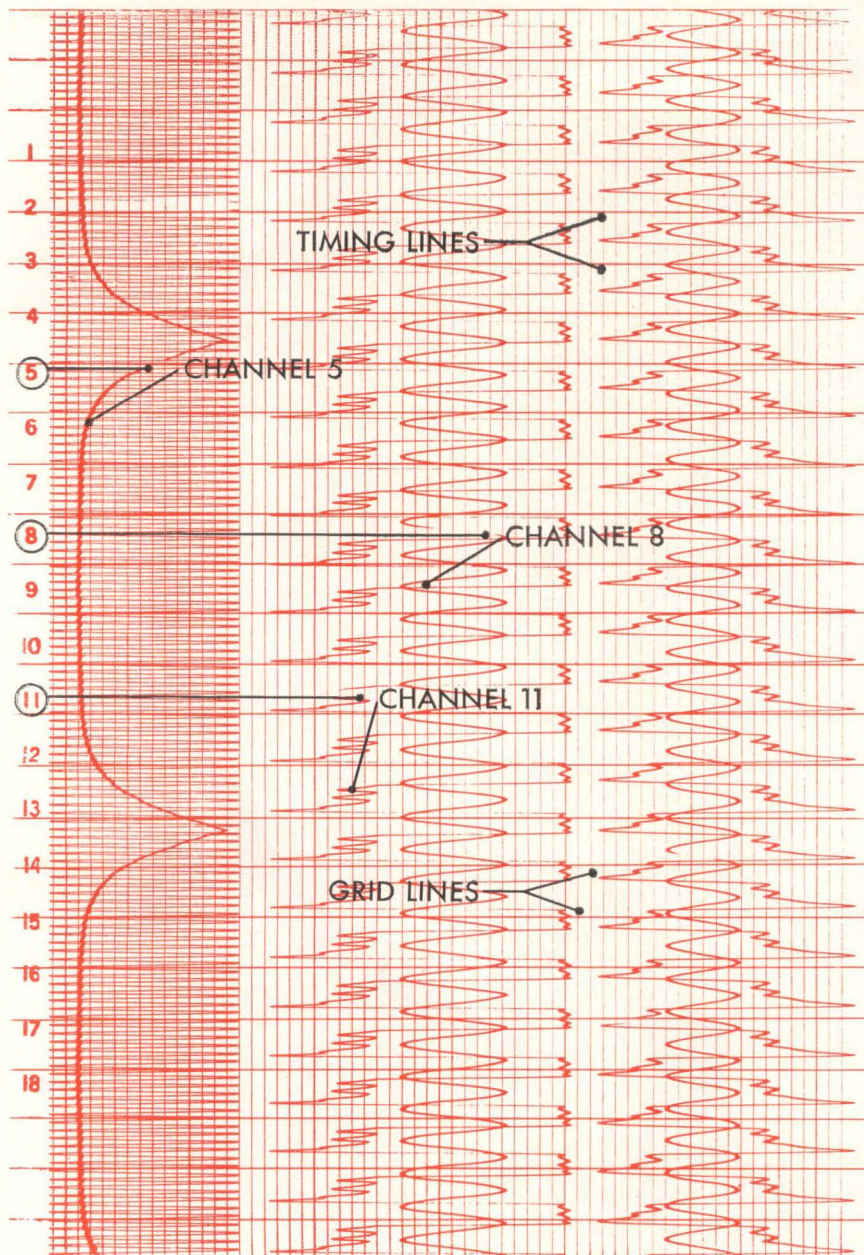

## wise for its size

Press a button. Then read what CEC's low-cost, portable (or rack mounted) Recording Oscillograph (5-124) has to say. Recording on 18 channels, it actually produces all record parameters at writing speeds up to 50,000 ips. The oscillogram tells all: full-length

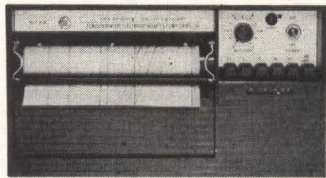

amplitude reference lines with 0.1-inch or 2 millimeter spacing, positive trace identification (including trace numbering), and full width timing lines. The 5-124 weighs only 40 lbs. Want one? Call your nearby CEC office or write for Bulletin CEC 5124-X24.

# CEC

Data Recorders Division

**CONSOLIDATED ELECTRODYNAMICS**  
PASADENA, CALIFORNIA • A SUBSIDIARY OF BELL & HOWELL

## MEETINGS AHEAD

**ELECTRICAL ENGINEERING Exposition** for Electrical-Electronics industry, AIEE; N. Y. Coliseum, N. Y. C., Jan. 29-Feb. 2.

**REDUNDANCY TECHNIQUES FOR COMPUTING SYSTEMS**, Office of Naval Research; Dept. of Interior Aud., Wash., D. C., Feb. 6-7.

**MILITARY ELECTRONICS**, PGMIL of IRE; Ambassador Hotel, Los Angeles, Feb. 7-9.

**SOLID STATE CIRCUITS**, Internat. Conf., PGCT of IRE, AIEE; Sheraton Hotel and U. of Penn., Philadelphia, Pa., Feb. 14-16.

**APPLICATION OF SWITCHING THEORY TO SPACE TECHNOLOGY** Symp., USAF, Lockheed Missiles & Space; at Lockheed, Sunnyvale, California, Feb. 27-Mar. 1.

**SCINTILLATION AND SEMICONDUCTOR COUNTER** Symp., PGNS of IRE, AIEE, AEC, NBS; Shoreham Hotel, Washington, D. C., Mar. 1-3.

**MISSILES & ROCKET TESTING** Symp., Armed Forces Communications & Electronics Association; Coca Beach, Fla., Mar. 6-8.

**EXTRA-HIGH VOLTAGE COMMUNICATION, CONTROL & RELAYING**, AIEE; Baker Hotel, Dallas, Tex., Mar. 14-16.

**IRE INTERNATIONAL CONVENTION**, Coliseum & Waldorf Astoria Hotel, New York City, Mar. 26-29.

**QUALITY CONTROL Clinic**, Rochester Soc for Q.C.; U. of Rochester, Rochester, N. Y., Mar. 27.

**ENGINEERING ASPECTS OF MAGNETO-HYDRODYNAMICS**, AIEE, IAS, IRE, U. of Rochester; U. of Rochester, Rochester, N. Y., Mar. 28-29.

**SOUTHWEST IRE CONFERENCE AND SHOW**; Rich Hotel, Houston, Texas, April 11-13.

**JOINT COMPUTER CONFERENCE**, PGEC of IRE, AIEE, ACM; Fairmont Hotel, San Francisco, Calif., May 1-3.

**HUMAN FACTORS in Electronics** PGHFE of IRE; Los Angeles, Calif. May 3-4.

**ELECTRONIC COMPUTERS** Conference, PGCP of IRE, AIEE, EIA; Marriott Twin Bridges Hotel, Washington, D. C., May 8-10.

### ADVANCE REPORT

**AUTOMATIC CONTROL** Congress, Internat. Fed. of Automatic Control; at Basle, Switzerland, during September 1963. Papers should deal with the following categories and topics: **THEORY**—discrete systems, stochastic systems, optimal systems, learning systems, systems reliability; **APPLICATIONS**—process dynamics, computer studies of on or off-line applications, optimizing or adaptive control applications; **COMPONENTS**—new and effective devices, measurement of the reliability of components. Authors should submit title and 200 word abstract to their national member organization of IFAC no later than Mar. 1, 1962.

# NEW MIL RESISTORS... from **OHMITE**



## "INSULATED" MIL-R-26C RESISTORS

### Wire-wound, Sealed in Silicone-Ceramic

**NEW MIL-R-26C AMENDMENT 2 IN BRIEF:** By means of this new amendment, specification MIL-R-26C is extended to include three sizes of *insulated, wire-wound* resistors with axial leads. The new insulated resistors meet all requirements of MIL-R-26C including a dielectric strength test (1000-volt, V-block) and an insulation resistance test (100-volt, V-block). Currently, tolerance is specified as 5%.

**INSULATED RESISTOR CONSTRUCTION:** A single layer of resistance alloy wire is wound on a ceramic core. Metal end caps, with axial leads attached by welding, are fitted snugly over each end of the core. A molded jacket of silicone-ceramic material completes the unit by sealing the entire assembly.

*Through research and advanced production know-how, Ohmite is able to introduce this advanced product line to meet the demanding new requirements of its Military and Industrial customers.*

Mil. Des.	Char.	Temp.	Watts	Resist. Range*	L ± .020"	D ± .020"
RW67	V G	350° C 275° C	6.5 5.0	0.10 to 3600 ohms	0.917"	0.323"
RW68	V G	350° C 275° C	11.0 8.0	0.10 to 8200 ohms	1.823"	0.343"
RW69	V G	350° C 275° C	3.0 2.5	0.10 to 910 ohms	0.542"	0.230"

\*MIL-R-26C limit for single-layer winding.

RESISTORS SHOWN TWICE SIZE



**Anticipating  
Industry's Needs  
In Quality  
Components**

*All Sizes and Values Available From  
Distributor or Factory Stock—  
Write for Bulletin.*

**OHMITE MANUFACTURING COMPANY**  
3610 Howard Street, Skokie, Illinois

Rheostats • Power Resistors • Precision Resistors • Variable Transformers • Tantalum Capacitors • Tap Switches • Relays • R.F. Chokes • Germanium Diodes • Micromodules

To Contractors and Subcontractors on U. S. Government Projects

# FAST SWITCHING PNP TRANSISTOR

Kilowatt Switching Capability—100 Nanoseconds

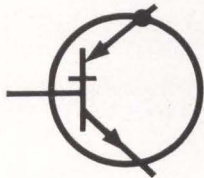

## 2N1765



TO-5 PACKAGE

The PNP 2N1765 is a 3-junction, 3-terminal diffused silicon transistor in a vacuum-tight enclosure suitable for fast, high-current, pulse switching. This device's rise time to 30 amperes is less than 100 nanoseconds. Turn off time is approximately 1 microsecond. It is operational at emitter currents to 50a with gate drives from 5ma to 2a.

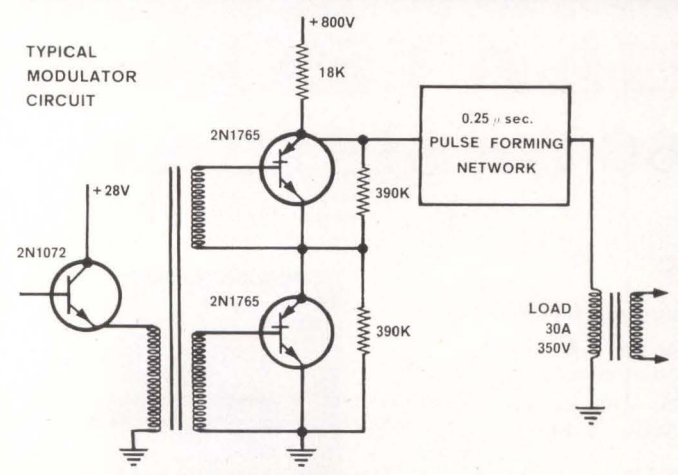

### MAXIMUM RATINGS AT 25 ° C

$I_{(on)}$  ..... 50a  
 $P_{(avg)}$  ..... 500mW

### ELECTRICAL CHARACTERISTICS

$BV_{(off)}$  (min) ..... 400V dc  
 $V_F$  (max) (@ 200 nsec) ..... 50V @ 30a  
 $t_d + t_r$  (max) (@  $i_F=50a$ ) ..... 125 nsec  
 $I_H$  (min) ..... 5mA

The 2N1765 transistor may be purchased in quantity from Western Electric's Laureldale Plant. For technical information, price, and delivery, please address your request to Sales Department, Room 102, Western Electric Company, Incorporated, Laureldale Plant, Laureldale, Pa. Telephone—Area Code 215—Walker 9-9411.

**LAURELDALE PLANT**  
 MAKER OF ELECTRON PRODUCTS

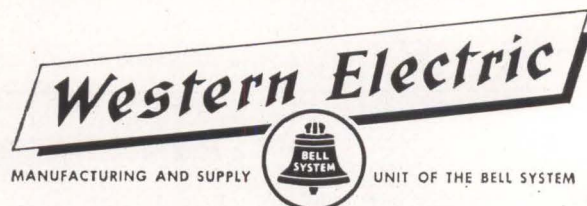

*Antenna for  
the ARSR-2  
air route  
surveillance radar*

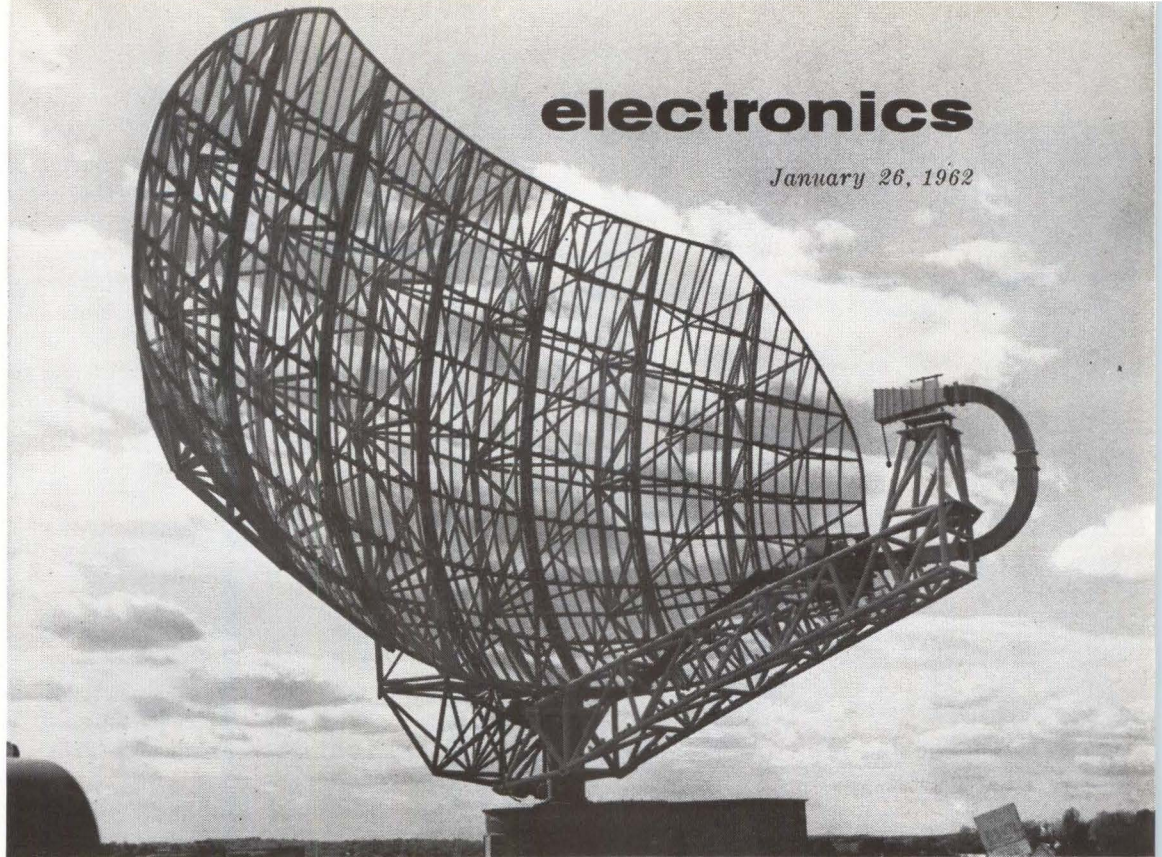

REDUCING CLUTTER IN

# Air Route Surveillance Radar

*Long-range, high-power system incorporates refinements that help the operator separate target indications from ground clutter, rain, birds and other undesirable signals*

By WILLIAM W. SHRADER, Raytheon Company, Wayland, Mass.

AS AIR TRAFFIC continues to grow in density, complexity and speed, the Federal Aviation Agency is gradually tightening up its traffic control system. To supplement the 32 ARSR-1A systems now in use the FAA has ordered 18 ARSR-2 systems. The first of these has been installed. When all 18 are in operation, the network will provide continuous radar surveillance along the nation's major airways. Each ARSR-2 system has a range of al-

most 200 nautical miles when watching a small jet airplane, such as a T-33, and covers over 150,000 square statute miles.

The advances offered by the ARSR-2 are a parametric r-f pre-amplifier for longer range, a high-angle coverage antenna for improved target-to-clutter signal ratio, and a staggered-repetition-period mti (moving target indicator) for eliminating moving-target blind speeds.

The ARSR-2 is a 5-megawatt, dual-channel, L-band system. All major parts except the antenna are duplicated to provide reliability. The standby channel can be maintained and tested while the operating channel is in use. An automatic performance monitor is built into the system to signal the operator if performance falls below preset limits. If a malfunction occurs in the operating channel, the operator can have the standby

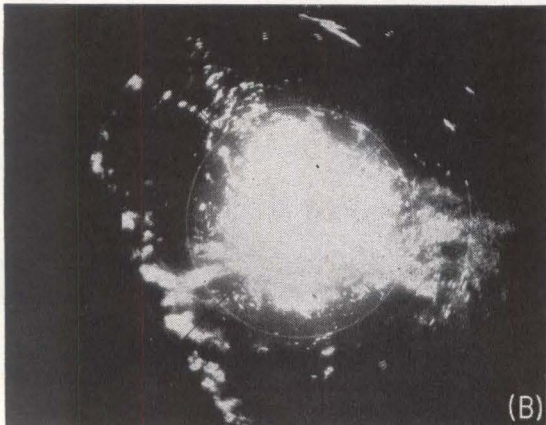
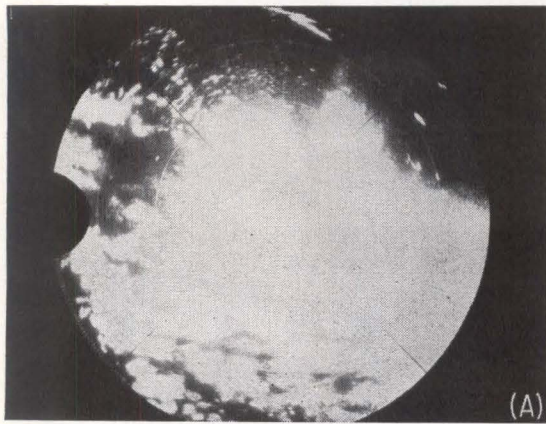

FIG. 1—Effect of some clutter-reducing techniques. Normal radar video (A); with circular polarization (B); using an mti receiver with circular polarization (C); and adding sensitivity time control (D)

channel on the air in less than 15 seconds. The FAA reports that operational availability of the ARSR-1A equipment is 99.5 percent. It is anticipated that the ARSR-2 will be at least as good.

A major problem as the performance of radar systems is improved is elimination of undesired targets. A radar system designed to detect a T-33 at a range of 200 nautical miles will also detect many targets of no interest. The operator uses a ppi (plan position indicator) to keep track of aircraft. Targets other than aircraft on the ppi detract from the usefulness of the system; the problem becomes more severe as the range performance is increased. Examples of unwanted targets are signals reflected from the ground, rain, birds, and insects, and interference from nearby radars. The ARSR-2 for example, will detect seagulls to 45 nautical miles.

A major portion of a high-performance radar is devoted entirely to eliminating unwanted signals from the display while retaining desired targets. The new antenna used on the ARSR-2 is incorporated to cope with this problem. The mti system attenuates signals reflected from stationary objects but permits moving targets to be displayed. The video integrator enhances weak signals and attenuates interference from other radar systems. The circular polarizer attenuates signals reflected from rain.

The sequence of ppi photographs

(Fig. 1) shows how some of the clutter-reducing techniques permit the use of the ARSR-2 under adverse weather and ground-clutter conditions. These pictures were taken during a severe thunderstorm. Since the camera shutter was left open for three revolutions of the radar antenna for each picture, aircraft targets appear as three closely spaced dots. The sequence was taken over a twenty-minute period so that the aircraft targets moved considerably between pictures. The ppi radius represents 40 nautical miles.

The first picture (Fig. 1A) shows normal radar video with linear polarization. Most of the airplane targets are obscured by signals reflected from the storm.

The second picture (Fig. 1B) shows the effect of circular polarization. The signal intensity from the storm is greatly attenuated, but signals reflected by ground clutter, such as the mountains shown in the picture at 11 o'clock, and 4 o'clock, are unaffected.

The third picture (Fig. 1C) shows the use of the mti receiver and circular polarization. The mountains in the second picture are now eliminated. In addition, all the ground clutter near the center of the picture is eliminated, although some signal return from the storm is still evident.

The fourth picture (Fig. 1D) shows the addition of stc (sensitivity time control) to the operating conditions of Fig. 1C. Aircraft

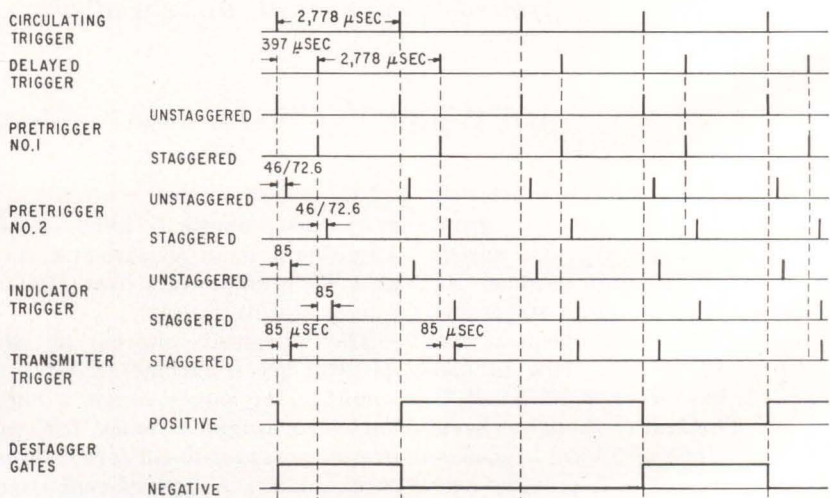

FIG. 2—Timing diagram shows how an incremental delay line is used to obtain three different pulse intervals. Average prf is 360 a second, with each pulse 2 microseconds long



targets are now visible over almost the entire display.

The mti system of the ARSR-2 incorporates a two-delay-line feedback canceller with pulse-to-pulse staggered repetition periods. The mti system filters out stationary targets while allowing moving targets to be displayed. With an airplane flying over a mountain, the mti system rejects the signal from the mountain but allows the airplane signal to be displayed if the airplane signal is at least 1/500 as strong as the mountain signal. This capability of the mti is known as scv (subclutter visibility). The ARSR-2 has an scv of 27db. Because the scv is finite, it is desired to have as high as possible a ratio of target signal to ground-clutter signal.

The response of an mti system to a moving target depends on the component of the target's velocity towards or away from the radar antenna. If the target is moving tangentially, it will not be displayed. If the target moves a multiple of one-half wavelength of the transmitted frequency nearer or farther from the radar system between pulses, it will not be seen by a fixed-repetition-period mti. The radial target velocities corresponding to a movement of one-half wavelength between pulses are known as blind speeds. Blind speeds for the ARSR-1A radar system occur at 80, 160, 240 . . . knots. By varying the interval between consecutive radar pulses, the number of blind speeds can be considerably reduced. The ARSR-2 utilizes three different pulse intervals in the ratio of 25 to 27 to 29. Blind speeds occur at 1,040 knots and its multiples.

The feedback in the dual canceller permits adjusting the mti response to slow-moving targets, and scan-modulated clutter. Varying the feedback affects the low-velocity response of the mti system; the feedback is adjustable from the master console, and the operator can optimize system response depending on the wind and antenna speed.

The three different pulse intervals are obtained by switching a single incremental delay line in and out of the bipolar video path. The radar pretrigger is circulated through the same delay line as the

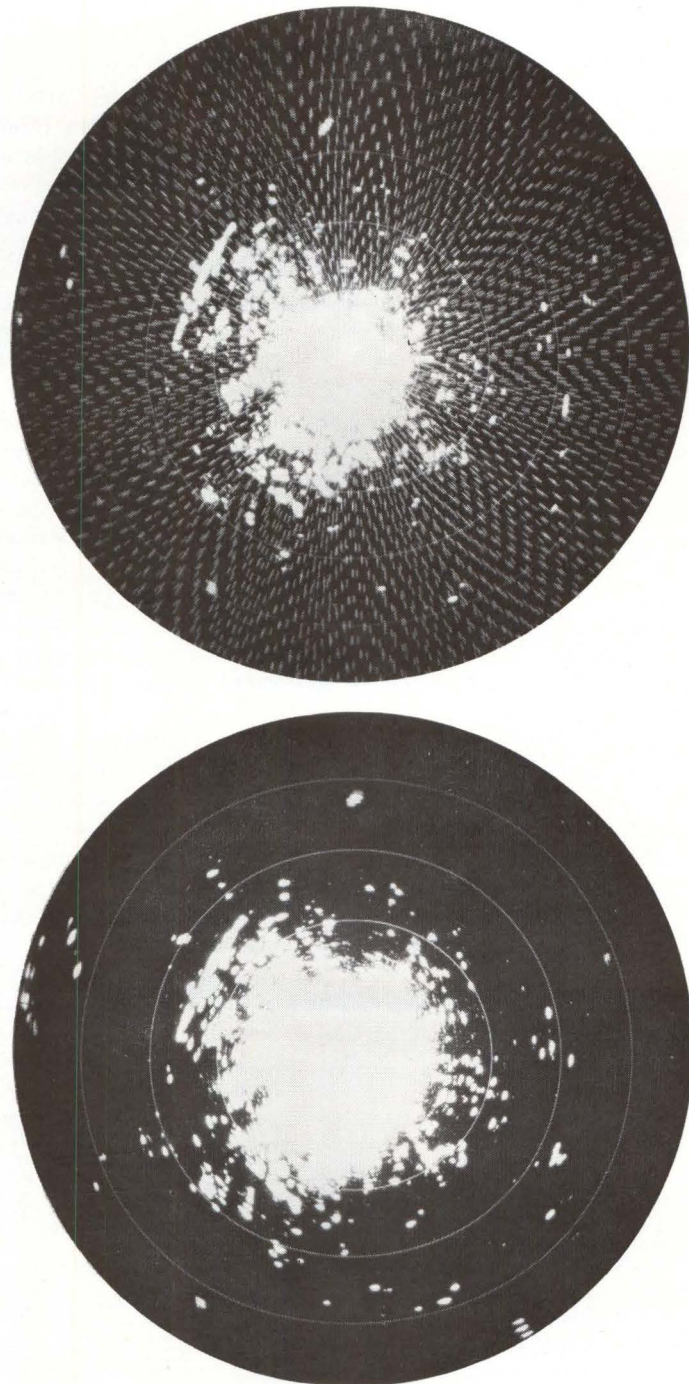

FIG. 3—Effect of delay-time video integrator. Normal video with random pulse interference (A); using video integrator (B)

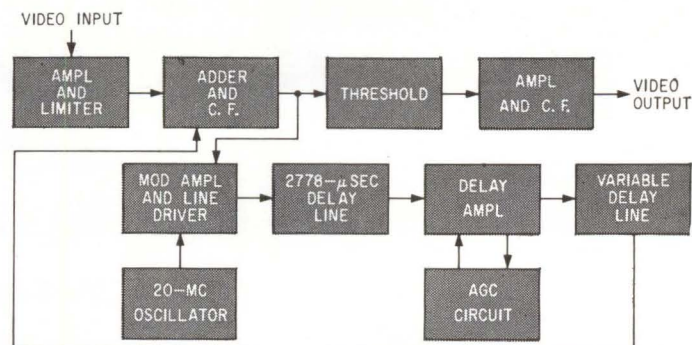

FIG. 4—Video integrator circuit for eliminating random pulse interference

bipolar video, thus ensuring complete compensation for time variations of the quartz delay lines such as caused by ambient temperature change.

The incremental delay line is switched in for two triggers out of every three. As can be seen from the timing diagram in Fig. 2, this results in one long interpulse period, one average period, and one short period. The video diode switches are operated at the appropriate instant to pass either the undelayed bipolar video or the bipolar video from the incremental delay line. Thus the bipolar video input to the dual canceller occurs at equal time intervals.

The system incorporates a delay-line video integrator for integrating normal video. The advantages of the video integrator are the elimination of random pulse interference and enhancement of weak target signals. The video integrator does not render detectable targets that would otherwise not be detected, but improves the peak-signal to rms-noise ratio, making it easier for the operator to distinguish between noise and targets on the ppi. Figure 3A shows normal video with a large amount of

random pulse interference. Figure 3B, taken immediately after, shows the effect of the video integrator. The random pulse interference is entirely eliminated. This is useful when the ARSR-2 is being operated near other radar systems operating on similar frequencies, or when friendly jamming missions are performed in the vicinity.

Figure 4 is the block diagram of the video integrator. The input to the video integrator, normal video, is limited to the peaks of noise and then enters the feedback loop. Amplitude modulation is used on the 20-Mc delay line carrier and the loop feedback factor is about 0.9. The output video is taken from the feedback loop, passed over a threshold to remove the majority of the integrated noise, and then sent to the ppi.

Small unwanted targets such as birds or insects plague the performance of a high-performance radar. These small targets, most noticeable in the mti video, are often referred to as angels, a name that was applied before the sources of these signals were known. A seagull and an airplane often appear the same on the ppi, and radar operators would sometimes ask the

pilot of an airplane flying towards what appeared as an angel on the ppi to identify the unknown target. The pilot would be unable to see a large bird flying a mile below him, and would report back to the radar operator that there were no targets near him. Thus the term, angels, developed.

Even though a bird and an airplane may appear the same on a ppi, the reflected signal from even a small jet airplane such as T-33 is over 200 times stronger than the reflected signal from a seagull. It is thus possible to turn down the receiver gain at short ranges so that birds will not be seen, but desired targets will still be visible. This is done with stc (sensitivity time control). The stc circuit, which varies receiver gain according to range, can be switched in at will by the operator.

On present radars with conventional antenna patterns, stc may solve one problem but create another—loss of desired targets at high elevation angles. The antenna pattern of the ARSR-2 permits the use of stc without the loss of desired targets.

Air route surveillance radars prior to the ARSR-2 have used antennas with a cosecant-squared pattern. This pattern results in antenna gain, above about 6 degrees elevation, being proportional to the square of the cosecant of the elevation angle. If the radar were used where there were no ground clutter signals and no undesired weak targets, this antenna pattern would be ideal, for it results in a constant-strength signal return from an airplane flying at constant altitude, whether the airplane is 10 miles or 100 miles from the radar system. Unfortunately clutter signals in the peak of the radar beam are much stronger at short ranges than at long ranges. Thus, with a cosecant-squared pattern and a target flying at constant altitude above 6 degrees elevation, the shorter the range, the lower the target-signal to clutter-signal ratio.

Since stc and mti both depend on maintaining an adequate target-signal to clutter-signal ratio, a special antenna pattern was derived for the ARSR-2 to do this.

The new antenna has a beam so shaped that relatively little energy is transmitted toward the ground

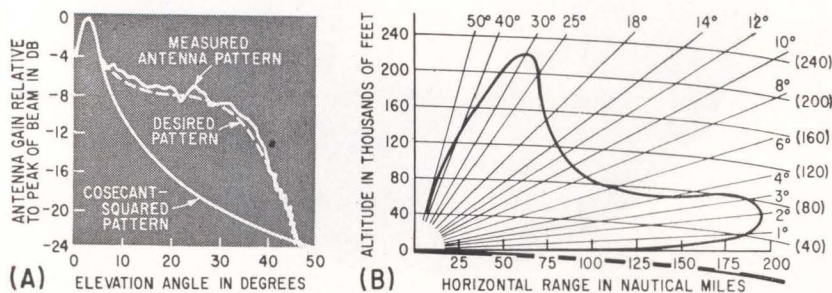

FIG. 5—Antenna elevation pattern for new antenna, compared to cosecant-squared pattern (A). Free-space coverage diagram (B)

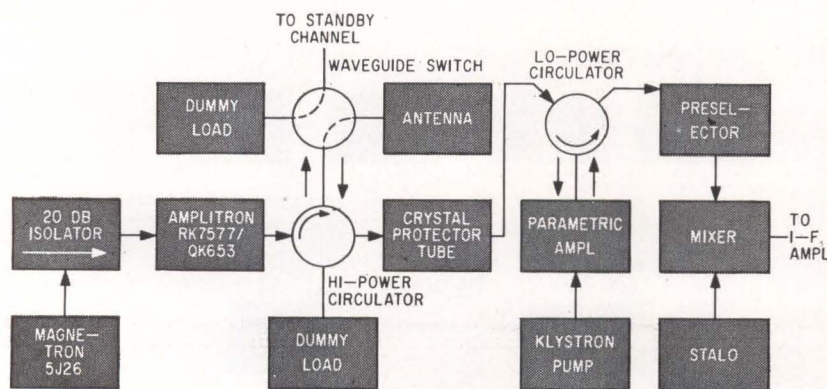

FIG. 6—Radio-frequency portions of the ARSR-2 radar system. Parametric amplifier has 10-Mc bandwidth

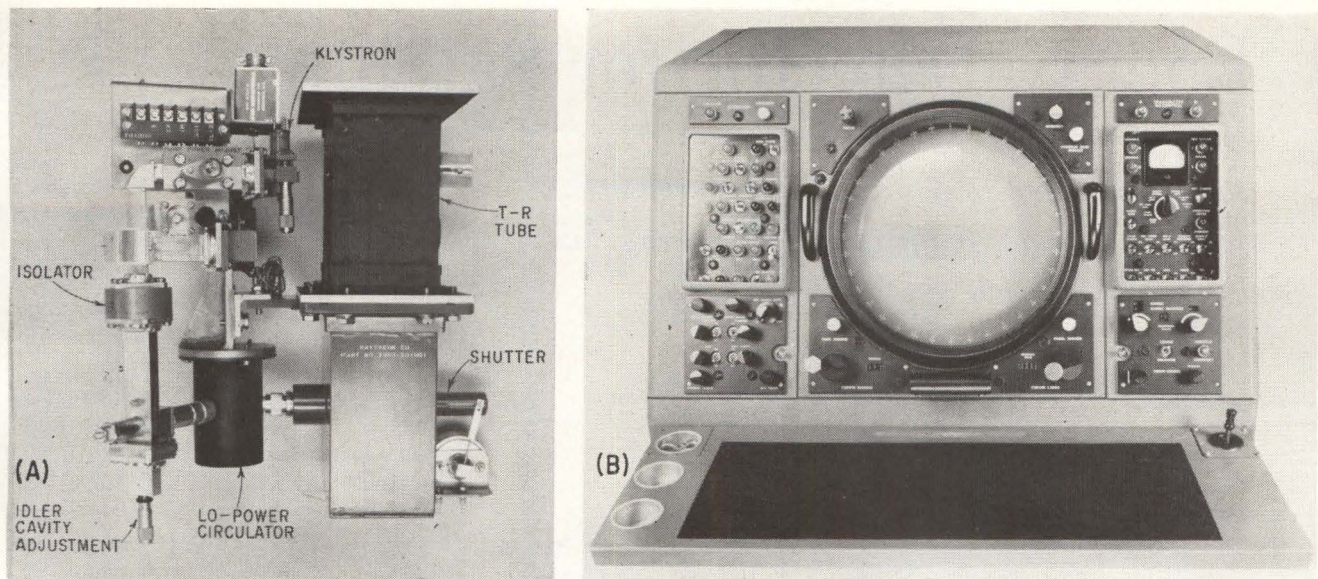

FIG. 7—Parametric amplifier, klystron and associated equipment, (A). A 5J26 tunable magnetron driving a QK653 Amplitron provides r-f power. (B) shows control console. 16-inch ppi has P7 phosphor. The system frequency range is 1,280 to 1,350 Mc

clutter, but just a few tenths of a degree above the ground there is almost peak transmitted energy. At high elevation angles, the antenna also transmits considerably more energy than a conventional system. The improvement thus gained in target strength relative to clutter strength gives the ARSR-2 better coverage at high elevation angles than previous air route surveillance radars. Comparison under assumed strong clutter conditions shows the ARSR-2 will provide coverage up to an elevation angle of 32 degrees on a small jet airplane, whereas the ARSR-1A would provide coverage up to only 12 degrees.

The measured antenna elevation pattern is shown in Fig. 5A. The dashed line superimposed on the elevation pattern is the pattern theoretically required to give the desired coverage. Also shown is a cosecant-squared pattern. The reflector required to achieve this pattern is 47 feet wide and 23 feet high.

The ARSR-2 free-space coverage diagram is shown in Fig. 5B and the antenna is shown in the lead photograph.

The controller at the master console can instantly switch from linear to circular polarization to reduce the radar signal from rain, thus making it possible to see targets otherwise obscured on the ppi. When the circular polarizer is used,

it automatically absorbs 99 percent of the received energy reflected from raindrops, but allows other received energy to enter the receiver. Thus the signal received from rain is attenuated by 20 db before entering the receiver, but signals received from aircraft are essentially unattenuated. Usually, the stc will prevent the remaining rain signal from being displayed. A controller at Boston's Logan International Airport says that if the circular polarizer won't eliminate the rain return, the rain is too heavy to fly an aircraft through.

The simplified block diagram in Fig. 6 indicates the major r-f portions of the ARSR-2. The magnetron peak power output is 500 kilowatts, and the Amplitron peak power output is 5 megawatts. The circulator and isolator each have slightly less than 1-db insertion loss. Peak power at the antenna is about 4 megawatts. The system incorporates a wide-band, nondegenerate, varactor parametric amplifier and the system noise figure, measured from the high-power circulator output to the i-f amplifier output, is 3.5 db.

The parametric amplifier uses a klystron pump at 11 gigacycles. Figure 7A shows an early version of the parametric amplifier attached to the end of the ARSR-2 waveguide run. This parametric amplifier has a bandwidth of 10 Mc and single-knob tuning. Only the idler

cavity needs to be retuned if the operating frequency is changed. The production models incorporate a parametric amplifier with 100-Mc bandwidth (wider than the radar operating band) and thus no tuning adjustments are necessary.

The master console, shown in Fig. 7B, has a 16-inch crt, an electronic cursor with bearing and range counters, complete controls for operation of the transmitter-receiver equipment, and panel lights to indicate deterioration in the selected channel's performance.

Each console has controls for setting the range at which mti video ceases and normal or integrated-normal video starts. In addition, gain controls are available on all consoles to provide a normal video background for mti video and to introduce map and beacon video data on the ppi as desired.

An electronic video mapper is supplied in duplicate with each system. The map is displayed on the ppi with the radar video. If the operator changes the range setting or decenters the display, the map changes to maintain correct relationship with respect to the radar pattern. An electronic cursor enables the operator to determine range and bearing between any two points on the display. Because the cursor is electronically generated, the display can be decentered or the range changed without affecting accuracy.

# Energy Detector for Satellites

*Cadmium sulfide detector for orbiting radiation satellites responds to the integrated energy flux of low-energy electrons and protons*

By JOHN W. FREEMAN Dept. of Physics and Astronomy,  
State Univ. of Iowa, Iowa City, Iowa

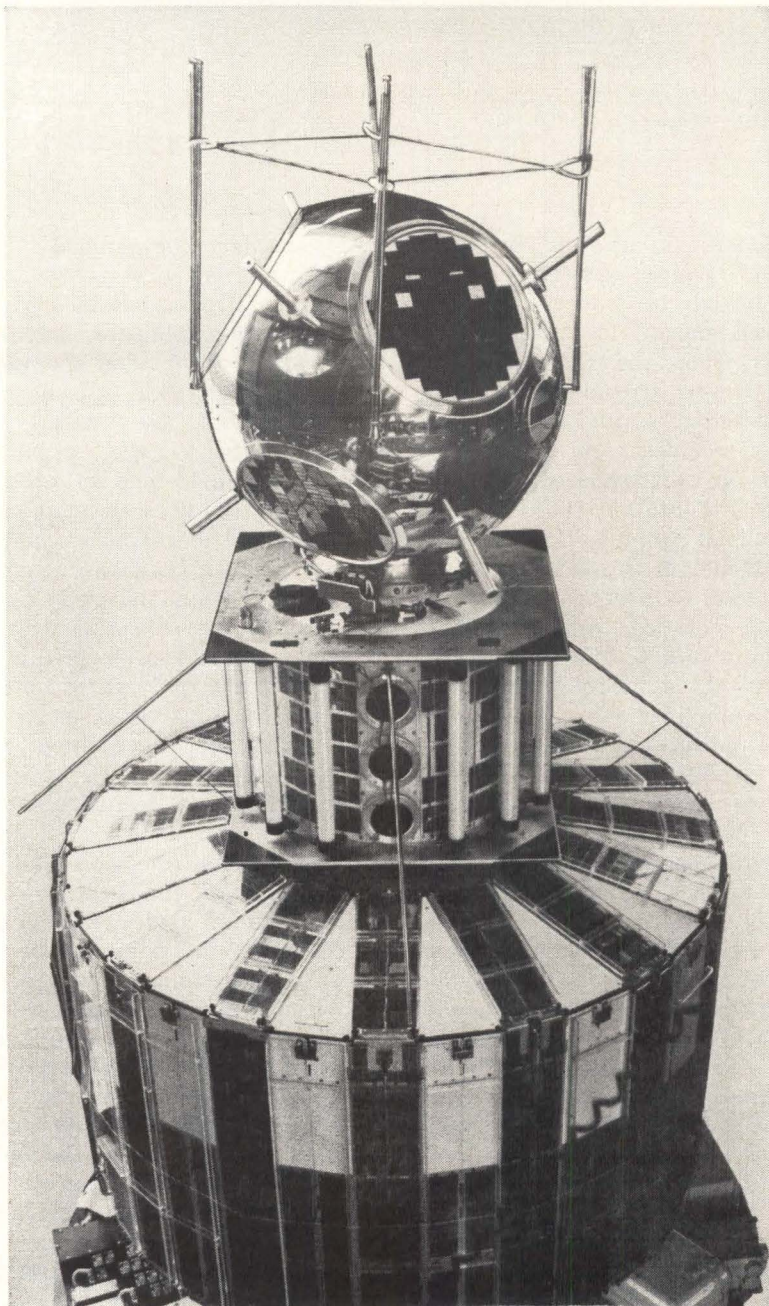

*Transit IVA (bottom), Injun I (middle) and Solar Radiation III (top) satellites during preflight checkout. Three dark circles on Injun I are electroluminescent panels for testing the cadmium sulfide detectors. The fluorescent lights test solar cell output (RCA Photo)*

SATELLITE STUDIES of Van Allen radiation zones require simple detectors capable of responding directly to the great flux of low-energy electrons and protons presumably present in these zones. Use of photoconductive crystals was suggested in 1959. Since then a detector usable in satellites and capable of responding to the integrated energy flux of high fluxes of low-energy charged particles has been developed. This detector is part of the detector complement of two presently orbiting radiation study satellites, Explorer XII and Injun I. It is scheduled for use in projects Ranger and Mariner.

In general, every insulator and semiconductor can be made more conductive by absorption of electron exciting radiation. Certain photoconductors such as CdS, PbS, CdSe, PbTe, PbSe, InSb, Si and Ge, show enhancement of conductivity under irradiation by electromagnetic radiation in or near the visible spectrum. The increased conductivity results from the excitation of electrons and holes into the conduction bands.

The excitation energy necessary to span the band gap depends on the material. Typical values range from a few ev for the visible-light sensitive photoconductors to a few tenths of an ev for the infrared sensitive detectors.<sup>1</sup> In fact, any form of ionizing radiation will induce the enhanced conductivity provided the necessary band-gap energy can be transmitted to the electrons. Recognition of this has led to interest in photoconductors as x-ray,  $\gamma$ -ray detectors and as low-energy charged-particle detectors.<sup>2,3</sup>

Practical features of such a radiation detector for satellite use are simplicity, light weight, low power drain and zero wall thickness. Whereas radiation detectors relying on gas ionization require a gas containment wall and high voltages, photoconductive crystal detectors can be left open. Hence these crystal detectors see particles that would be stopped in the wall of a gas type ionization chamber.

The detector is built around a

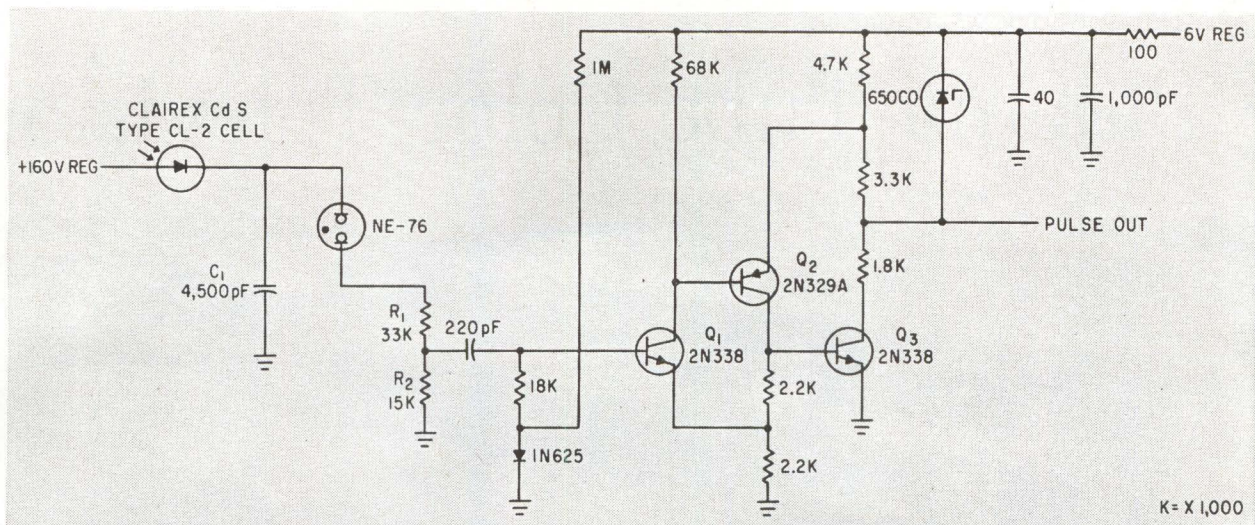

Capacitor  $C_1$  is adjusted to give 10-msec period at detector saturation

Clairex single crystal (cadmium sulfide) photocell. In the detector, the bare crystal is mounted in a lead shield situated behind a series of beam-collimating and light-baffling apertures that present a circular look aperture of approximately 12 degrees in angular diameter. Since the detectors have no physical obstruction between space and the crystal, they are sensitive to energy fluxes exceeding  $1 \text{ erg/cm}^2\text{-sec}$  consisting of electrons of energy  $200 \text{ eV} \leq E \leq 400 \text{ KeV}$  or protons of energy  $1 \text{ KeV} \leq E \leq 10 \text{ MeV}$ , or similar low-energy ions. Lower and higher energy electrons and protons are detected with decreasing efficiency.

Bremsstrahlung-produced x-rays are detectable with an efficiency at least an order of magnitude below that for their parent electrons. Small magnets are used with some detectors to remove low-energy electrons from the beam incident on the crystal and hence produce proton energy detectors. Corrections for external light sources are made by using an identical detector equipped with a transparent quartz window.

For a driving voltage of 100 v, typical CdS crystals yield currents of  $10^{-7}$  to  $10^{-9}$  amp for each  $\text{erg/cm}^2\text{-sec}$  energy absorbed in the crystal. For selected crystals a response-temperature coefficient of  $-0.25$  percent per degree centigrade is found for the temperature range  $-50 \text{ C}$  to  $50 \text{ C}$ .

The current resulting from the change in conductivity of the crystal with incident radiation is converted to pulse-code modulation

for telemetering and data handling. Conversion is by the neon glow-tube relaxation oscillator in the schematic. Current through the crystal determines the charging rate of capacitor  $C_1$  and hence the firing rate of the neon glow tube. Pulses from voltage divider  $R_1, R_2$  are inverted and shaped by the saturating bootstrap amplifier  $Q_2$  and used to drive an accumulation register. The size of  $C_1$  can be chosen to fit the telemetry system parameters.

The glow tube is NE 76 or NE 81. By selection of these lamps crystal currents as low as  $10^{-10}$  amp can be monitored. Frequency of the relaxation oscillator is nearly proportional to the radiation flux over a dynamic range of greater than  $10^4$ .

The detectors have added to the knowledge of the radiation environment of the earth and should see continued application.<sup>4</sup> The radia-

tion study satellite Injun I includes in its detector complement five CdS detectors. It was launched in June 1961 into a near circular orbit of apogee 1,012 Km and inclination 67 degrees.

Explorer XII, an eccentric orbit satellite built by NASA, includes three CdS detectors in its detector complement.

The work reported was assisted by NASA and the Office of Naval Research.

#### REFERENCES

- (1) R. H. Bube, "Photoconductivity of Solids", John Wiley and Sons, Inc., N. Y., N. Y., 1960.
- (2) W. J. Baird, Jr., "Effect of Gamma Radiation on Single Crystal Cadmium Sulfide" M.S. Thesis, Air Force Inst of Tech, Mar. 1958.
- (3) J. W. Freeman, "A Satellite Borne Cadmium Sulfide Total Corpuscular Energy Detector", M.S. Thesis, State University of Iowa, Feb. 1961.
- (4) J. W. Freeman, "Detection of an Intense Flux of Low-Energy Protons or Ions Trapped in the Inner Radiation Zone, State Univ. of Iowa Research Report 61-24.

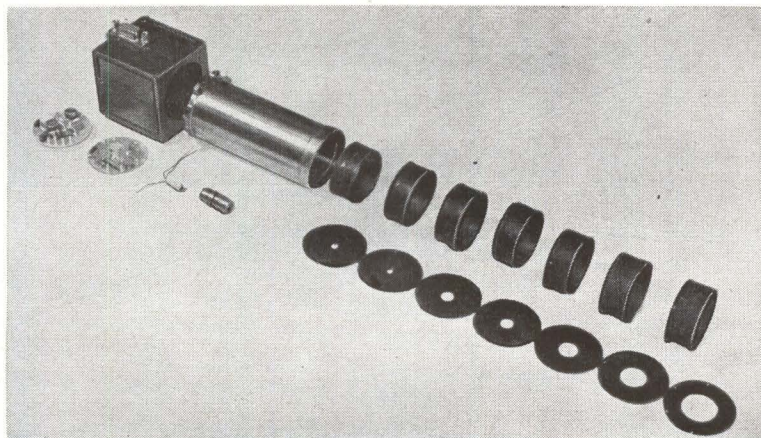

Detector photocell, electronics, lead shield and light baffle apertures

# Banana-Tube Color-Television

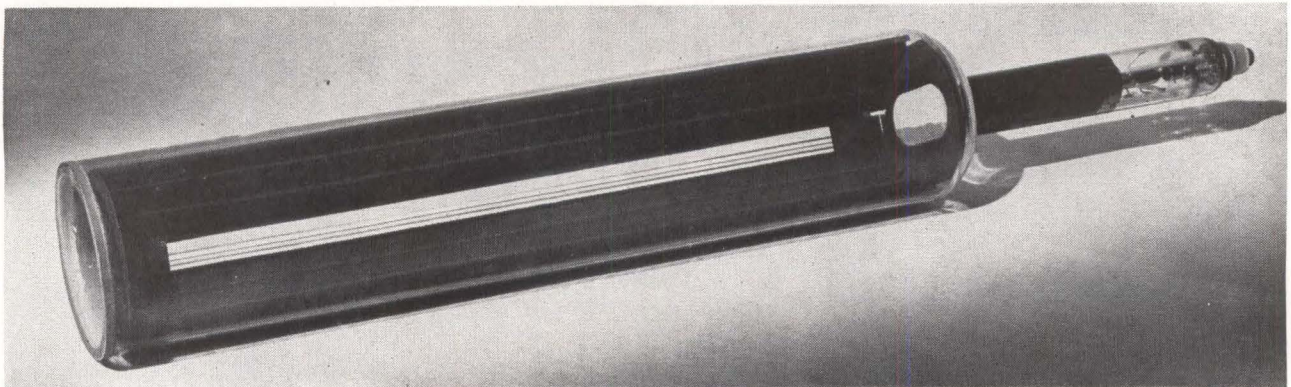

Banana tube with three phosphors for the primary colors and a fourth (white) for monochrome reception

By P. SCHAGEN

Mullard Research Laboratories,  
Mullard Ltd., London, England

THE RAPID expansion of monochrome television since the war has not been matched by a similar development in color television. This is partly due to the much more complex nature of the display device.

The shadow-mask tube, which at present is still generally accepted as

the best display element available, has some serious disadvantages which, despite a tremendous development effort, have not been completely overcome in the latest version of the tube.

The difficulties with this tube generally arise from its basic concept. The screen usually consists of an array of a large number of small phosphor elements, each of which luminesces in one of the primary

colors red, green or blue. Striking the correct phosphor elements with the appropriate intensities of electrons requires masks, grids or reflex elements inside the tube. These must be located with a high degree of accuracy in relation to the phosphors, which leads to complicated, and therefore expensive, manufacturing methods for color tubes.

A program was started in the Mullard Research Laboratories in 1955 to investigate the possibility of designing a color display system that could employ a much simpler color tube. This has led to the concept of the banana-tube display system.

The cathode-ray tube can be simplified by substituting for the two-dimensional array of phosphor elements a screen that has virtually only one dimension. The screen consists in this case of three narrow phosphor stripes, luminescing in the three primary colors. Each line is generated in the same position on this narrow screen.

Figure 1A shows a diagram of such a screen. The scanning beam, tracking along this screen for each line, can produce the three primary colors dot sequentially by introducing a spot-wobble motion across the three stripes as indicated.

Such a line-scan tube must then be combined with auxiliary moving components outside the tube to shift the apparent position of the line to produce the required field scan.

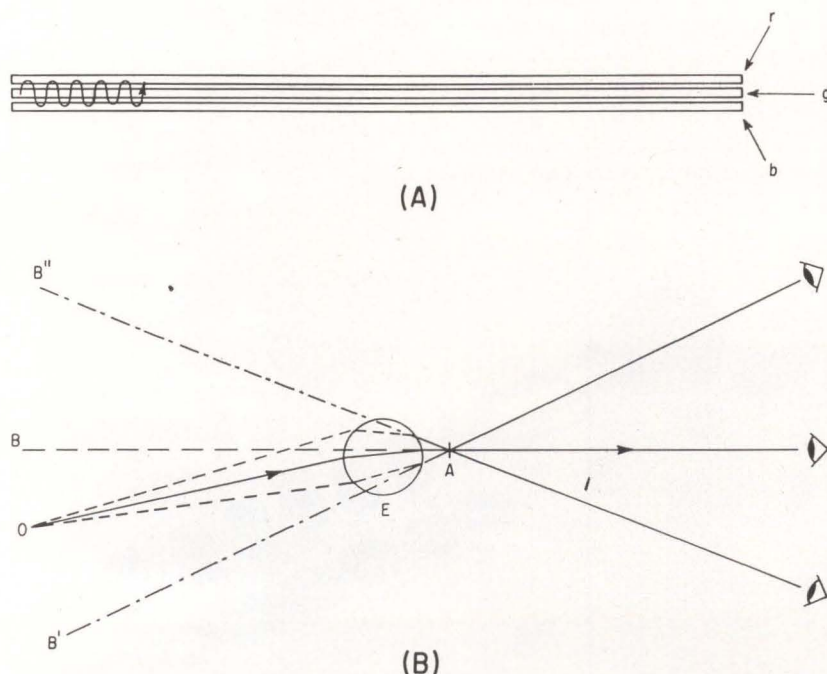

FIG. 1—Three-phosphor screen with scanning beam for banana tube (A); image formation with cylindrical lens (B)

# Display System

Three narrow strips of primary-color phosphors are painted lengthwise inside an elongated cathode-ray tube, around which rotates a drum with three cylindrical lenses to produce the field scan



Experimental model of banana-tube system displaying a color picture

For this purpose a direct-viewing system was chosen as the best solution, where the screen is viewed through a cylindrical lens. This avoids the severe loss of brightness and reduces the stringent requirements on geometrical accuracy of optical elements encountered with projection methods, thus leading to a brighter picture and cheaper optical elements.

Figure 1B illustrates the astigmatic image formation of line object *O* when observed through cylindrical lens *E* with its axis located horizontally. To an observer with his head in the upright position, the line will appear along axis *B* behind the lens, at a distance from the eye equal to the total optical path. The width of the observed line is reduced by a factor depending on the focal length of the lens in the vertical plane. If the observer moves up, the image appears to move down, and vice-versa. A vertical movement of the lens will produce a corresponding movement of *B*.

Figure 2A shows a simple way of obtaining a field scan by the movement of a cylindrical lens parallel to its axis. A drum carries three identical cylindrical lenses

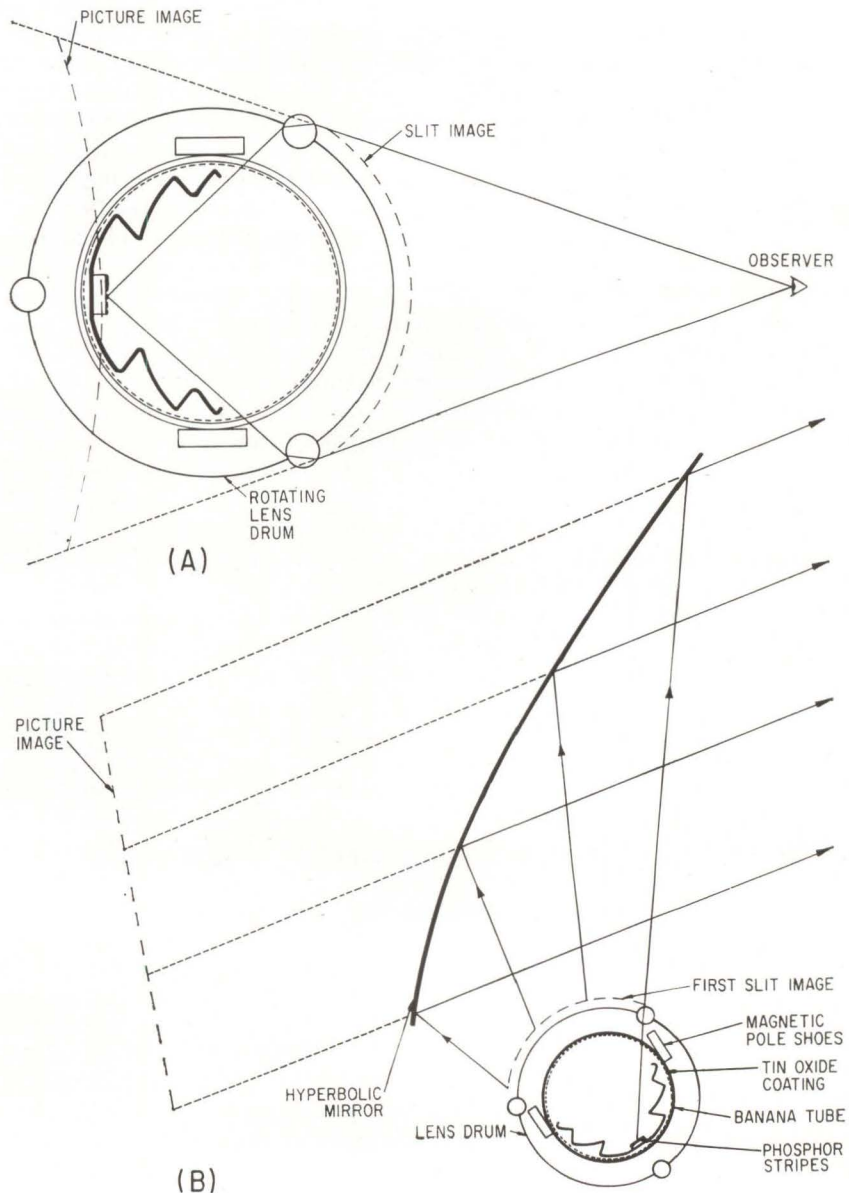

FIG. 2—Field scan system using cylindrical lens with banana tube (A); hyperbolic mirror magnifies picture vertically (B)

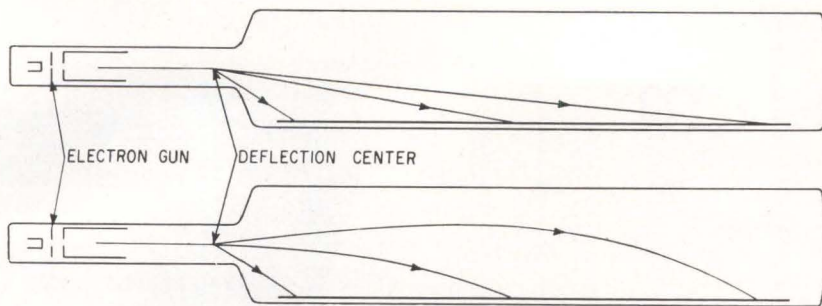

FIG. 3—Deflection of electron beam in line direction without (top) and with (bottom) magnetic field to improve resolution

that come into play successively as the drum rotates at constant speed.

A satisfactory picture with a good vertical angle of view can be obtained with this arrangement. The picture will, however, be slightly curved, and for a large picture size the drum becomes bulky, which increases the problems of wear and noise. The diameter of the drum can be kept reasonable by adding a stationary cylindrical optical element to magnify the picture in the vertical direction. This can either be a cylindrical lens or a mirror.

This arrangement has been adopted for a working model (Fig. 2B) that uses a cylindrical mirror with a hyperbolic cross-section, providing a vertical linear magnification of about a factor of two. The picture appears to lie behind the mirror at a distance that is again equal to the total optical path lengths and is almost perfectly flat.

By arranging the vertical image plane to coincide nearly with the horizontal one, minimum astigmatism and eye-strain result.

The vertical angle of view is somewhat restricted by the mirror, whereas the horizontal viewing angle is limited only by the width of the lenses and the mirror.

While the lens-drum provides an attractive solution to the problem from the mechanical point of view, it does require a completely unconventional design of cathode-ray tube, since this has to be placed inside the drum.

The lead photo shows a logical design, which is also suitable for production. Because of its geometry, and in analogy to the American apple tube for color display, this tube has been named the banana tube. The neck of the tube projects through an opening in one

of the end plates of the drum and has a focus coil, line-deflection coils and spot-wobble coils. With this tube geometry, the electron beam would approach the screen, and in particular the far end, at a shallow angle, which would cause an appreciable elongation of the spot and thus cause lack of resolution in the line-direction. A permanent magnetic field at right angles to the trajectory plane, and increasing in field strength toward the far end of the tube, curves the electron paths toward the screen (Fig. 3 bottom), which also improves focusing in the line direction.

Economically, a valid assessment is possible only when comparing fully-engineered home receivers. It is not possible to predict at present which modifications to the present banana-tube system would be desirable to make it into a successful home receiver.

A possible cost comparison for a 21-inch monochrome receiver, a banana-tube receiver and a shadow-mask tube receiver is in the ratio of 1:2:2.8.

The picture brightness is determined by several design characteristics of the system. Measurements on the present tubes show that a highlight brightness of 40 foot-lamberts is obtainable with a mean beam current of about 400  $\mu$ a for average picture material.

The basic resolution of the banana tube, as limited by the spot-size in the tube in its present form appears to be just adequate for a 405-line picture. Other factors, such as the frequency of color selection, tend to reduce this basic resolution, and a further improvement in spot size is therefore desirable.

A significant aspect of picture quality is the contrast, which is of prime importance for color pictures,

where loss of contrast causes a disturbing desaturation of the colors. The banana-tube display system has an advantage over any other direct-view display. Not only is the inherent contrast range in dark surroundings good (about 40:1), but ambient illumination has much less effect on the contrast than with other color tubes. This is because the picture is viewed as a virtual image against a black background, provided by the low-reflectivity exterior of the lens drum. This means the picture may be viewed in daylight or in a room with normal lighting.

Another advantage of the banana-tube is the inherent possibility of adding a white phosphor stripe to the screen structure, which can be scanned whenever a monochrome picture is received. A perfect black-and-white picture can thus be obtained.

Some of the less favorable features of the banana-tube display system are connected with the mechanical and optical parts of the system. These create problems of noise, jitter, flicker, dust accumulation and duration of reliable performance. Although these problems appear to be solvable in the laboratory, it is not possible now to predict whether they can be solved satisfactorily for a mass-produced home receiver.

The performance of the banana tube itself during life is also still uncertain. Due to the high mean loading of the screen, which is comparable to that in a projection tube, deterioration of phosphor efficiency is bound to take place at a more rapid rate than in conventional direct-viewing tubes.

The banana-tube display system as described has not outgrown the laboratory stage. Whether it will be applied in home color receivers is an open question.

#### BIBLIOGRAPHY

- P. Schagen, The Banana-Tube Display System, A New Approach to the Display of Colour Television Pictures, *Proceedings of the Institution of Electrical Engineers*, 108, Part B, Paper No. 3564, 1960.
- K. G. Freeman, Circuits for the Banana-Tube Colour-Television Display System, *ibid.*
- H. Howden, Mechanical and Manufacturing Aspects of the Banana-Tube Colour-Television Display System, *ibid.*
- B. A. Eastwell and P. Schagen, Development of the Banana-Tube, *ibid.*
- R. N. Jackson, Colorimetry of the Banana-Tube Colour-Television Display System, *ibid.*
- K. G. Freeman and B. R. Overton, Appraisal of the Banana-Tube Colour-Television Display System, *ibid.*



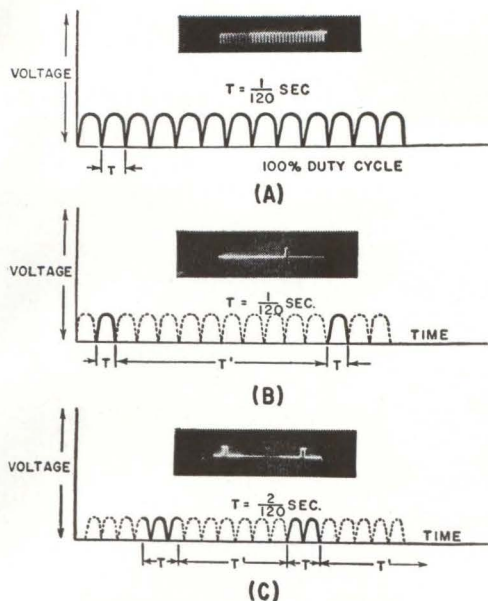

FIG. 1—Sweep output of conventional curve tracer (A); outputs with low duty cycle attachment (B) and (C)

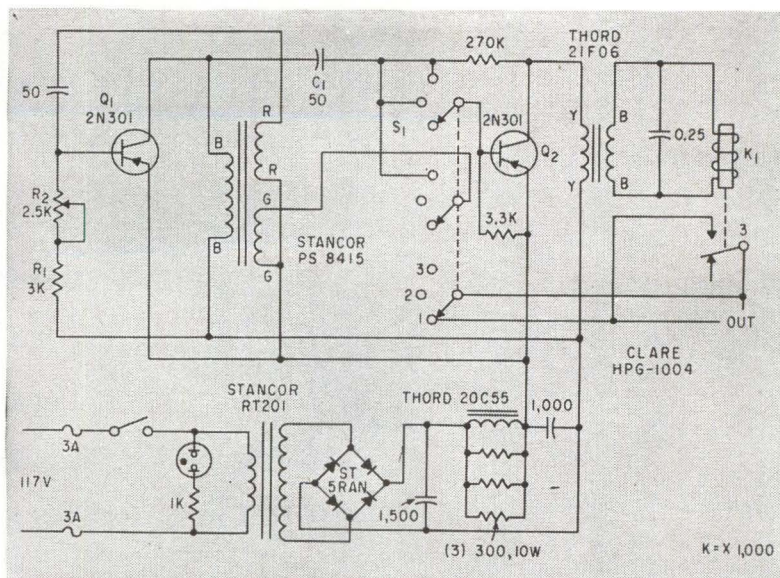

FIG. 2—Tester output goes in series with sweep-voltage output of conventional curve tracer. With switch in position 1, tester is out of circuit

## LOW DUTY CYCLE

# TUNNEL-DIODE TESTER

*Attachment to conventional curve tracer permits testing tunnel diodes at high reverse bias without danger of burnout*

By **L. M. ZAPPULLA**  
Electron Tube Division,  
RCA, Princeton, New Jersey

SERIES RESISTANCE, one of the most important tunnel-diode parameters, may be experimentally determined from the slope of the voltage-current curve of the diode at high reverse bias. Although this characteristic can be conveniently displayed on a transistor-curve tracer, the current at the required reverse bias can often overheat and destroy the diode. Therefore, the duty cycle of the display must be reduced so that the average current through the diode is limited to a safe level.

A typical curve tracer supplies a 120-cps full-wave rectified c-w sweep voltage. The tester switches the sweep voltage on and off at a reduced duty cycle. Each single pulse is 8.3 msec in duration, double pulses are of 16.6 msec duration. Figure 1A shows the sweep voltage

of an unmodified curve tracer while Fig. 1B and 1C show the low-duty cycle that results when the attachment unit is connected to the curve tracer.

If the time on is  $T$  and the time off is  $T'$ , the percent duty cycle is  $T/(T + T') \times 100$ . The single-pulse duty cycle can be varied from 4 to 7.6 percent by adjustment of the front panel repetition-rate control.

Much lower duty cycles can be obtained by increasing the value of  $R_1$  of Fig. 2. During experiments, duty cycles as low as one pulse every three or five seconds were obtained. The double-pulse duty cycle is fixed at 17.5 percent.

Transistor  $Q_1$ , an inductively coupled series-resonant feedback oscillator, has a frequency of oscillation determined by  $R_1$  and  $R_2$ . The output of  $Q_1$  is fed to driver amplifier  $Q_2$  through capacitor  $C_1$ . Transistor  $Q_2$  drives relay  $K_1$  that

switches the sweep voltage on and off through a two-wire shielded cable.

Switch  $S_1$  selects the mode of operation. In position 1, the unit is inoperative, and the curve tracer operates normally and a continuous trace is displayed. In position 2, the relay is closed once for each cycle of  $Q_1$ . The relay dwell time is 8.3 msec, which is the length of time per cycle that the output level of  $Q_2$  is above the actuating threshold of the relay. This timing permits the display of one cycle of the curve-tracer sweep voltage per cycle of  $Q_1$  and is independent of the frequency of  $Q_1$ . In position 3, the dwell time of the relay is doubled and two cycles of the sweep voltage are displayed for each cycle of oscillator  $Q_1$ .

The unit is connected to the curve tracer by placing the relay contacts in series with the sweep voltage output of the curve tracer.

# PORTABLE NAVIGATOR

*Self-contained navigator automatically calculates movements in range and azimuth from a known starting point to an accuracy of 1 percent without reference to remote base stations*

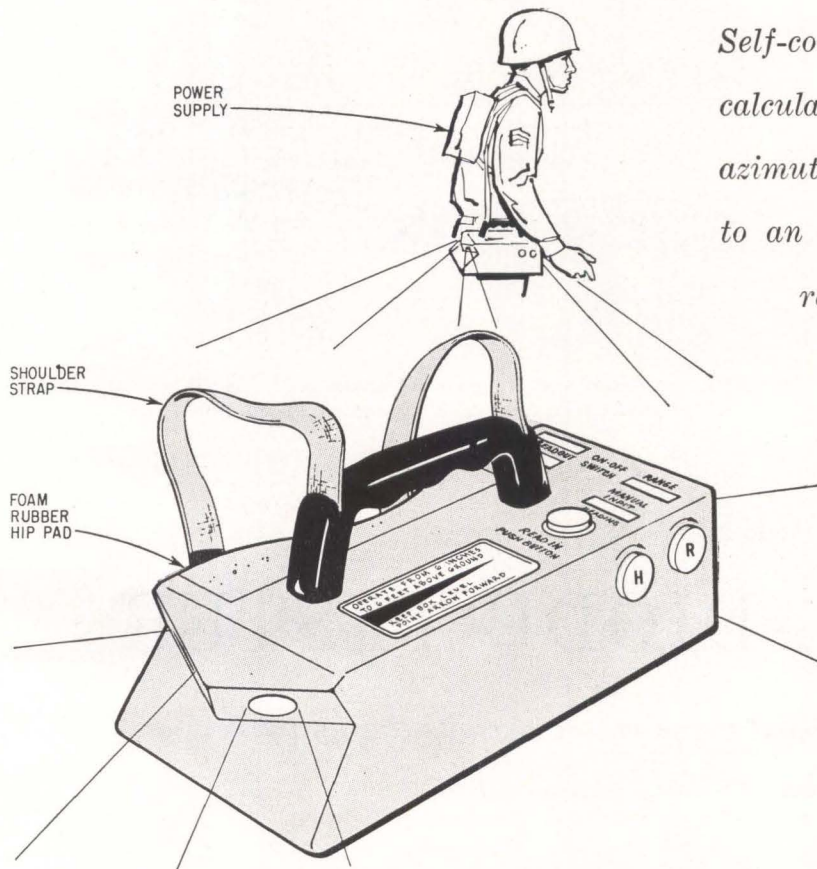

FIG. 1—Configuration of proposed navigator showing manual inputs and position of the three ultrasonic transducers

By HUGH J. GALBRAITH  
Motorola Systems Research  
Laboratory, Riverside, California

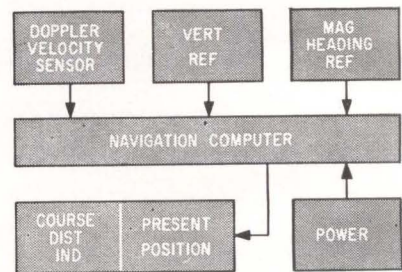

FIG. 2—Block diagram of navigator

EXCEPT for more accurate maps and better compasses, the foot soldier of today is little better off with regard to knowing where he is than were his predecessors of a hundred years ago. It is difficult to move across unfamiliar terrain, particularly under adverse conditions, and keep track of position, or reach a planned goal. It would seem advantageous to provide a practical navigation system for personnel.

This idealized backpack navigator would be of use not only to the military for both combat and training, but also to explorers, surveyors, firefighters, forest rangers, and law enforcement officers.

One approach to personnel navigation would be receipt of radio signals from a pair or more of base stations, such as Shoran, Loran, and

Decca. However, dependence on a base reference station impairs the overall reliability of the system. Failure of either the receiver or transmitter could hamper the mission. In addition, such a system would not be secure, and would be susceptible to jamming. The most reliable system would be one that is self-contained. Not tied to any central stations, it would be more flexible and have wider application.

An accuracy of 1 to 1.5 percent is felt sufficient for most navigational tasks assigned ground-based personnel. This accuracy would provide position fixing within less than half a city block after a circuitous trip of 5 miles.

Microminiaturization, incorporating solid state components is neces-

sary for size, weight and ruggedness. In battle or other field use, the navigator may be subject to rough handling, dirt and other contamination, moisture and temperature extremes. It is conceivable that underwater operation would be required and the package must be designed with this in mind. Although normally carried, the navigator might also be used near the ground, even pushed along through the mud. It should also be mountable on a vehicle. These considerations influence the design of the device, which normally operates from 3 inches to 6 feet above the surface.

The personnel navigator shown in Fig. 1 consists of three sections: a doppler velocity sensor, an all-electronic directional reference, and a lightweight digital computer-indi-

# FOR GROUND PERSONNEL

cator as shown in Fig. 2.

The phenomenon and theory of microwave doppler is well-known and well-covered in the literature. Its applications to aircraft and missiles are extensive, and work has been done on similar equipment for vehicular navigation. Much of the theory and development in this field were found directly applicable to the ultrasonic doppler system used in the personnel navigator.

Ultrasonic absorption, reflection, atmospheric attenuation, and the effects of temperature, humidity, and wind were investigated. It was found that a power of 1 to 2 watts is sufficient for a system being operated from 3 inches to 6 feet from the ground. Attenuation (120-140 db) is such that security is no problem and there is no possibility of jamming.

The pulsed system was chosen over c-w because of power and transducer requirements, and the reduction of isolation problems. The c-w system possesses some inherent advantages of simplicity, but was ruled out in this application because of weight and power considerations.

An operating frequency of 200 Kc was selected after consideration of atmospheric attenuation of ultrasonic waves, the magnitude of Doppler shift in the audio range, transducers available, and ease of transistor circuit fabrication. A pencil beam of 6 degrees or less conserves power and increases the accuracy of the velocity measurement.

To provide continuous horizontal velocity measurement during all types of motion (within certain pitch and roll limits) a 3-beam lambda configuration was chosen. The 72-degree looking angle of each beam is a compromise with respect to sensitivity, terrain bias, and power losses.

Figure 3 shows the velocity sensor. Each transducer consists of a single quarter-wavelength ferroelectric ceramic disk cemented to a metal backplate in an acoustically insulated mount. The frequency

tracker design is based upon the closed-loop frequency discriminator. However, the manner of instrumenting the discriminator technique, the feedback loop, and the output in digital (pulse train) form is considered unique and a patent application has been made. Figure 4 is a simplified diagram of operation of the frequency tracker.

Operation can be described by starting with the three voltage-controlled-oscillators  $f_A$ ,  $f_B$  and  $f_C$  shown in Fig. 3. Each low-power transistor vco is assumed to have an output sine-wave frequency of 200 Kc plus the appropriate Doppler shift for the corresponding beam. By a 3-way gate, each vco is connected to the transistor power amplifier for the indicated transmitting period, and at the same time the output of the amplifier is switched to the correct transducer. During transmission periods, a

third 3-way gate blocks transmitted energy from the preamplifier of the receiver to avoid overloading that might create a time lag in the receiver response. A dynamic compression or age circuit can be included in the preamplifier, which would also help maintain constant output with large variations in the return signal power due to altitude and terrain changes.

After the transmission period on one beam, the receiver is connected to the same transducer. The receiver consists of the transistor preamplifier and the filter-discriminator, which is fixed-tuned to the 200-Kc reference frequency and has filter passbands just above and below 200 Kc to accommodate the maximum range of the return doppler signal (approximately  $\pm 1,200$  cycles for zero to 10 fps velocity).

A single frequency is transmitted, but the return signal has a

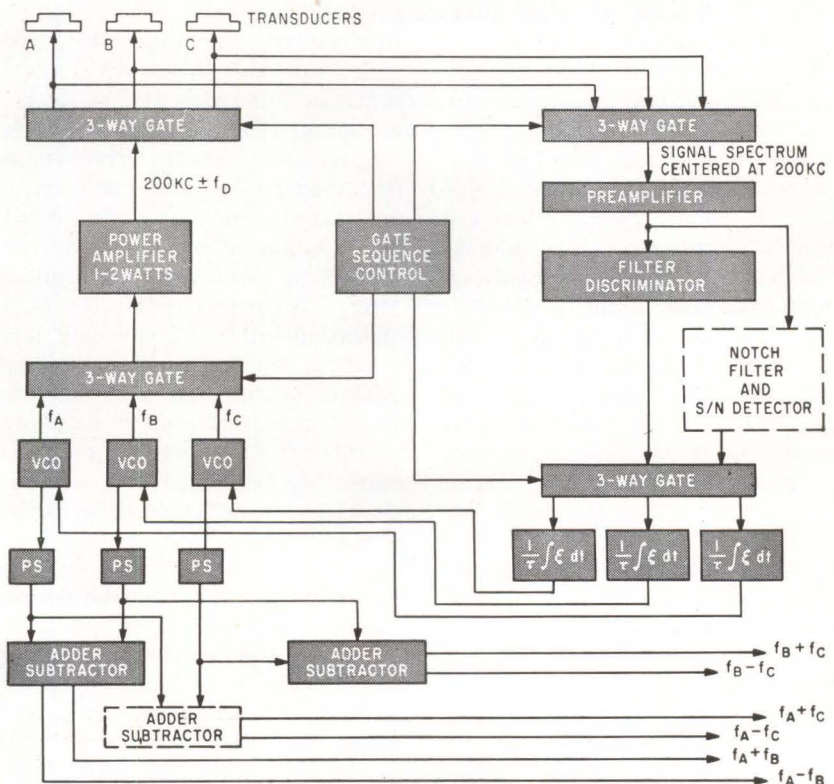

FIG. 3—Ultrasonic doppler sensor with three time-shared transducers

spectrum bandwidth upwards of 10 percent because of the doppler phenomena and the finite beam-width. The center of power of this signal spectrum is assumed to correspond to a single representative doppler frequency. The system operates in almost directly opposite fashion to conventional microwave doppler systems, which transmit at constant frequency and track a varying return frequency. Aside from the obvious difference in carrier frequency and in propagation mechanics, the feedback path in this tracking loop is closed externally through the propagation path and feedback action maintains the center frequency of the received signal constant.

A comparison of signal power present in the passbands of the two filters in the filter-discriminator yields a d-c error signal if the received signal is not centered at 200 Kc. The polarity of the error signal depends on whether the received signal is higher or lower than the reference frequency. The error signal is switched by the fourth 3-way gate to the proper integrating circuit that supplies a continuous control voltage to the corresponding vco for each beam.

The two adjacent passband filters can be either piezoelectric or magnetostrictive-driven electromechanical filters or crystal-lattice type filters, available in small packages for this frequency range. The long-term stability of the filter-discriminator is about  $\pm 500$  cycles. The error integrators can be either d-c or chopper-stabilized a-c transistor amplifiers. Their time constant or stability, along with the vco's, is of the order of several pulse periods (minimum of 25  $\mu$ sec), because of the propagation time delay between the transmitted signal, derivation of the error in the received signal frequency and the desirability of varying the vco frequency slowly. The error integrators or the vco's should not have frequency jitter over 5 cps, which is the minimum doppler frequency resolution corresponding to 0.1 foot per second in the cross-heading direction.

The tracking loop, from vco through propagation path and back through the filter-discriminator and error integrator, operates on a

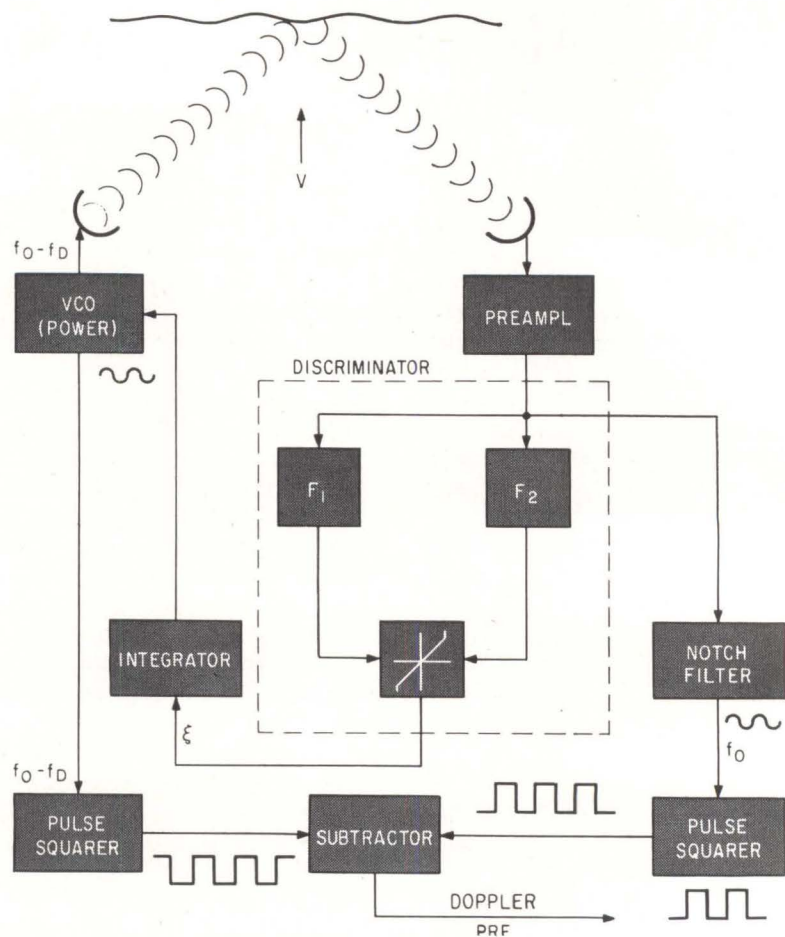

FIG. 4—Electronic doppler frequency tracker

time-shared, sampled-data principle. But the three vco's supply continuous outputs at 200 Kc plus or minus the respective doppler frequencies. These frequencies, smoothed by the integrator action, are available for continuous velocity and navigation computations. For preserving accuracy and limiting weight and power requirements, an operational-digital computing technique is employed. Sinewave outputs from the three vco's are converted to pulse trains by diode and transistor sine-wave clipping circuits (blocks labeled PS), having a positive and negative pulse output for each sine-wave cycle. Three pulse trains (prf's) taken by pairs, are added and subtracted to obtain sum and difference frequencies required in the solution of the doppler velocity equations. The adder-subtractor circuits are composed of diode gates that act in two ways. One set of gates in each circuit sums a pair of prf's by preventing time coincidence of any two pulses

and by allowing all of the incoming pulses to leave on a common line. The other set of gates permits only the excess or difference number of pulses between the two prf's to leave on a common line. The sum output prf is about 400 Kc, while the difference output prf can be from zero to about 220 pps.

Sense or polarity of the velocities measured by these sum and difference prf's is determined by comparing the relative prf magnitudes. In the case of the cross-heading component which may be either right or left (+ to the right), the outputs of the two vco's corresponding to the two rearward-looking beams (B and C) are compared. Since these two beams both experience the same downward shift in frequency due to a forward velocity in the along-heading direction, that beam having the highest frequency indicates a side velocity in its direction. Likewise, the frequencies of two beams on one side (A and B) can be compared to determine the

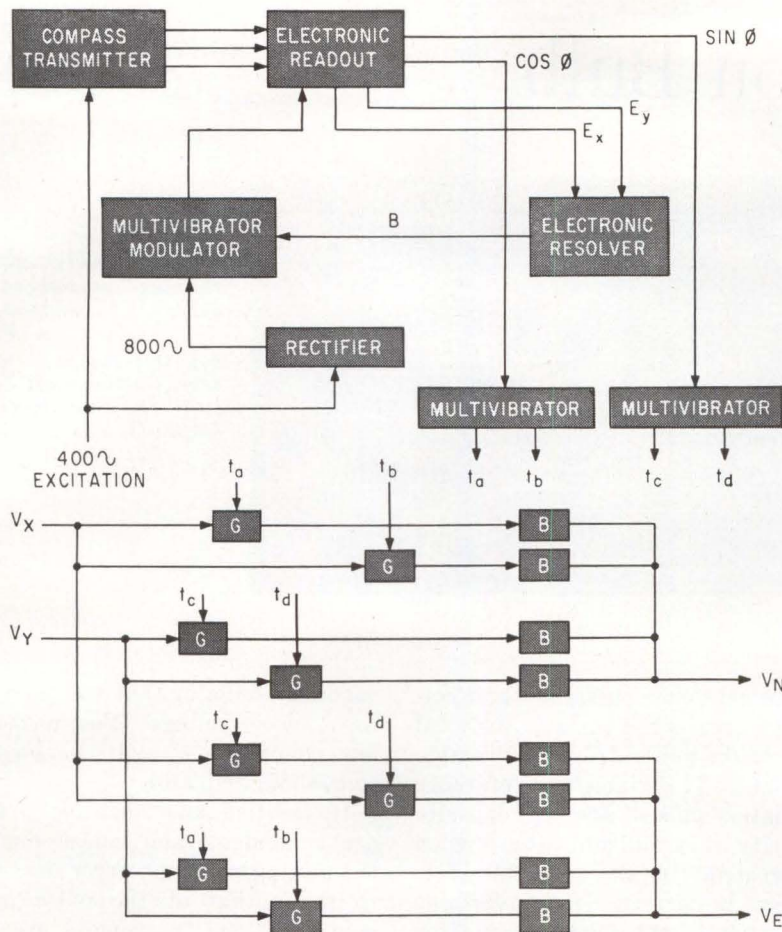

FIG. 5—Magnetic heading reference and velocity resolution

forward or reverse sense of the along-heading velocity component.

The adder-subtractor shown in dotted outline, Fig. 4, can be used to increase velocity computation accuracy by completely compensating for vertical velocity effects in the presence of pitch and roll, or if vertical velocity is desired as an additional output. Otherwise, only the four prf's— $f_A - f_B$ ,  $f_A + f_B$ ,  $f_B - f_C$ , and  $f_B + f_C$ —are necessary to compute the along-heading and cross-heading velocity components.

The gate frequency control consists of a free-running asymmetrical multivibrator that determines the transmit-receive periods and a two-stage binary counter supplying a count of three to sequentially switch from one transducer to the next. The gating pulses derived from these two transistor circuits then operate the four 3-way solid-state gates in synchronism.

The directional reference required to obtain north-south and east-west velocities from the veloc-

ity components measured along the body-fixed, non-directional, X and Y axes can be either a magnetic-slaved gyrocompass or an all-electronic magnetic heading reference. The latter heading reference was chosen to save weight and power.

Referring to Fig. 5, the compass transmitter is a pendulous field sensing element weighing less than one-half pound. The direction of the earth's magnetic field, as sensed and transmitted by a three-wire single-phase output, is read out by a combination of phase and amplitude sensing circuits. A 400 cps transistor oscillator supplies the excitation power to the compass transmitter and to a frequency-doubling rectifier.

The electronic readout consists of three 800 cps filters and transistor amplifiers, two transformers in a Scott-tee connection, two ring demodulators and two bridge rectifiers. Operating on the 800 cps voltages from the compass transmitter, the electronic readout produces bi-

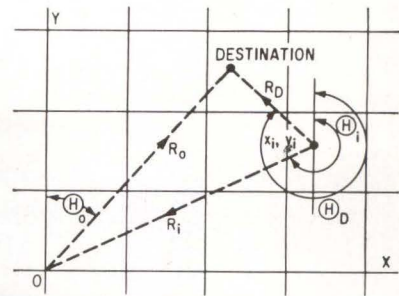

FIG. 6—Rho-theta initial and present position coordinates within a north-oriented grid

polar d-c voltages proportional to the sine and cosine of the magnetic heading.

The navigation computations include solution of the doppler velocity equations, resolution of the measured velocity components in the north-south and east-west directions, velocity integration to obtain distance traveled and present position, and if desired, the computation in rho-theta coordinates of the course and distance to a preset destination and/or the point of departure.

The present position computation as indicated in Fig. 6 is the integration or summing up of the north-south and east-west velocity pulse trains, and the addition of the distances to the grid coordinates of the point of departure. Indication of present position in X-Y grid coordinates will supply the minimum required navigation capability. It is easy for a human operator to estimate the course or bearing to a destination point, and the distance, when both his present position coordinates and those of the destination are known. In practice, regardless of the direction the man walked, the computer would indicate whether the magnitudes of the present position coordinates were increasing or decreasing in a manner to bring him to a desired end point. The man would only have to veer to the right or to the left, meanwhile noting the change in the indicated coordinate values, to establish an approximately correct line of travel, and then follow the heading with respect to north.

The work described here was done under contract with U. S. Army Signal Research and Development Laboratory.

# Oscillator Control Circuit Uses Neon Bulb

By JOHN TEWKSBURY  
Bendix Radio Division,  
Bendix Corp., Baltimore, Md.

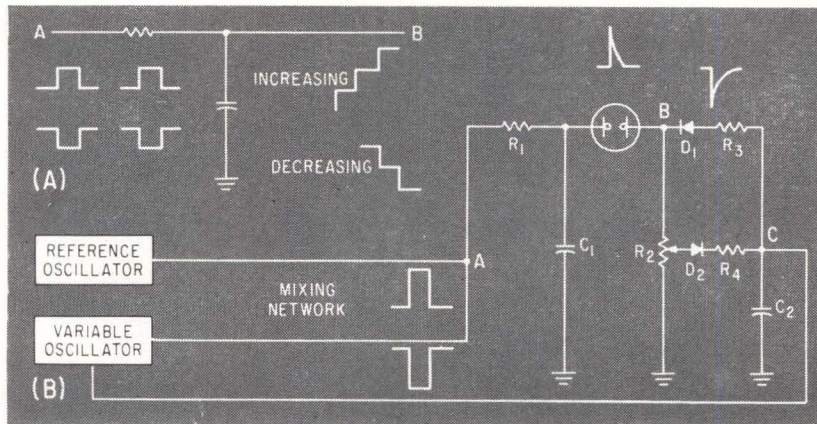

FIG. 1—Positive pulses produce positive-going staircase at integrator output (A) and negative pulses produce negative-going staircase. Symmetrical neon bulb (B) standardizes amplitude and duration of pulses

DIGITAL CONTROL of variable-frequency oscillators typically compares the number of cycles of the variable oscillator against a known standard such as a crystal oscillator. The error is usually cumulative and close control of the total number of cycles is maintained. A simple digital control circuit can be built with a symmetrical neon bulb. Signals from both reference and variable oscillator go through the same electrical components for the most part and component drift has little effect.

In the integrator circuit shown in Fig. 1A, pulses at A produce a staircase voltage at B. But all pulses must be of definite amplitude and duration, since it is pulse areas that determine output voltage.

A symmetrical neon bulb can insure standard pulses. If a pulse of either polarity is applied at A, Fig. 1B, capacitor  $C_1$  charges through  $R_1$ . The voltage across the neon bulb will increase to breakdown, then deliver a pulse at B, caused by discharge of  $C_1$  through  $R_2$ . When  $R_1$  is large compared to  $R_2$ , the charge delivered at B will be the same for either polarity of pulse.

The symmetry of the neon bulb pulse-forming circuit can be determined by applying a sinewave at A; the integral of the voltage at B will indicate the symmetry.

This circuit varies the amplitude

of the reference pulses so their collective area is the same as the total area of the pulses from the variable oscillator. If variable and reference oscillator pulses are of opposite polarity, they will add to zero when integrated, if the variable frequency is correct. If the variable oscillator is not correct, an error voltage will be developed.

Reference and variable oscillator outputs are first shaped and polarized as shown in Fig. 1B. They are then mixed and applied to the pulse-forming circuit. Since reference pulses are positive, and variable are negative, they can be separated. Reference pulses go through  $D_2$  and are attenuated by  $R_2$ .

For the circuit of Fig. 1B the reference oscillator frequency must be slightly above the upper limit of the variable oscillator. By adjusting  $R_2$  the total area of the reference pulses can be controlled with high precision. Attenuated reference pulses are then combined with negative variable oscillator pulses to produce an error voltage at C. For each setting of  $R_2$  there will be a specific frequency of the

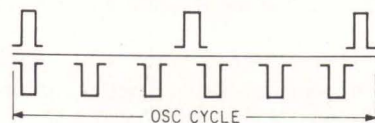

FIG. 2—Harmonic interference is reduced if initiator pulses are short compared to oscillator cycles

variable oscillator that will produce zero error voltage. Furthermore, any change in  $R_2$  will change the controlled oscillator.

If positive and negative pulses are coincident, and cancel out at the mixing point, an error develops in the output of the pulse integrator. If the frequencies are not related harmonically, the error voltage will be an a-c voltage and further integration will bring out the average error.

When the two pulse frequencies are harmonically related, the continuous cancellation of synchronous pulses can cause an error voltage even though the frequency is correct. Here the duration of the initiator pulses applied to the mixing network becomes important.

Assume 1,000 microseconds is the shortest duration of any cycle of either of the oscillators as shown in Fig. 2. If the initiated pulses are short as compared to this 1,000 microsecond period, the probability of interference is reduced.

When the initiator pulses are short compared to the cycle durations, the system will not permit phase locking of the oscillators but will allow the two to be harmonically related, provided they differ as to phase. The phase separation will depend upon the pulse widths and, to some extent, to the degree of relationship of the harmonics of the two frequencies.

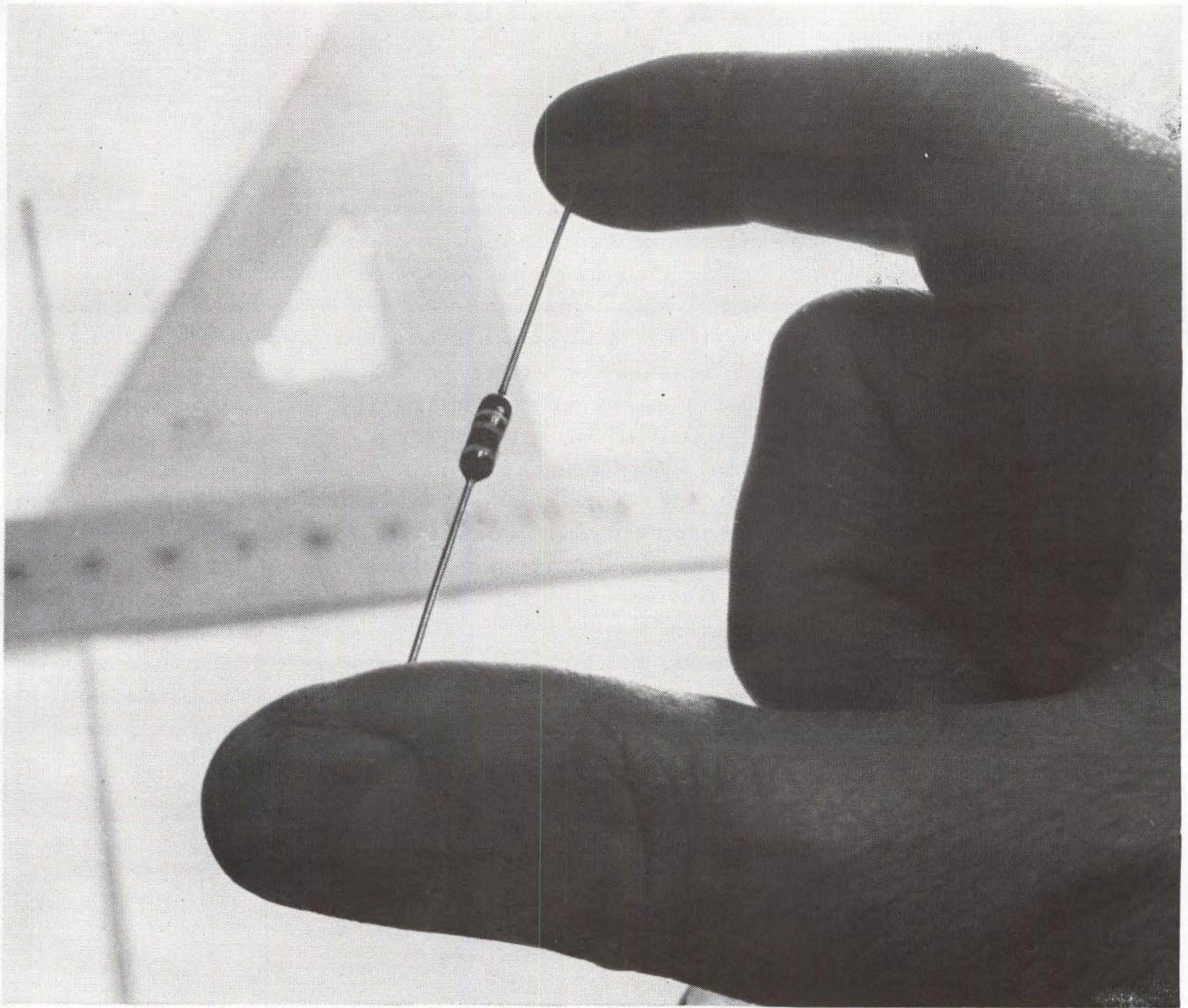

## Why more good circuits start with Corning C resistors

First, you get performance within precision parameters from general purpose C-style resistors.

Second, C resistors let you plan a circuit within *known* limits of total resistance change from nominal—as little as 5%. Our new Corning Design Tolerances, based on extended load-life tests, give you that assurance.

Third, you get this predictably high performance at low

cost. C resistors are priced competitively with composition types.

C resistors give you these design advantages uniformly because we control the composition of their materials, and the way those materials bond together, in a continuous process.

C resistors that meet MIL-R-22684 are available from your Corning distributor in four sizes and values.

Get data sheets, test reports, and a brochure, "The Story Behind the Corning C Resistor," by writing Corning Glass Works, 539 High Street, Bradford, Pa.

Type	Wattage	Resistance (ohms)		Nominal Dimensions	Design Tolerance Full power, 70°C.
		min.	max.		
C07, Mil Style RL07	¼	51	150K	.250" x .090"	5% plus purchase tolerance
C20, Mil Style RL20	½	51	150K	.375" x .138"	
C32, Mil Style RL32	1	51	470K	.562" x .190"	
C42S, Mil Style RL42	2	10	1.3 meg	.688" x .318"	

# CORNING

## Electronic Components

## TAKE A SECOND LOOK

IT'S THE 2N174—PART OF DELCO RADIO'S POWER TRANSISTOR FAMILY WHICH HAS PROVED ITS STUFF FOR YEARS IN HUNDREDS OF MILITARY AND INDUSTRIAL APPLICATIONS: MISSILES, COMMUNICATIONS, DATA PROCESSING, AND ULTRASONICS, TO NAME A FEW. THIS MULTI-PURPOSE PNP GERMANIUM POWER TRANSISTOR HAS THE HIGH PERFORMANCE AND VERSATILITY TO MEET OR EXCEED THE MOST RIGID ELECTRICAL AND ENVIRONMENTAL REQUIREMENTS. ( DESIGNED FOR GENERAL USE WITH 28-VOLT POWER SUPPLIES, THE 2N174 MAY ALSO BE USED WITH 12 VOLTS WHERE HIGHER RELIABILITY IS DESIRED. MAXIMUM EMITTER CURRENT—15 AMPERES, MAXIMUM COLLECTOR DIODE RATING—80 VOLTS, THERMAL RESISTANCE—BELOW  $.6^{\circ}\text{C}/\text{W}$  AND MAXIMUM POWER DISSIPATION—50 WATTS AT  $71^{\circ}\text{C}$ , MOUNTING BASE TEMPERATURE. THE 2N174'S LOW SATURATION RESISTANCE PROVIDES HIGH EFFICIENCY IN SWITCHING OPERATIONS. ( LIKE ALL DELCO TRANSISTORS, EVERY 2N174 MUST PASS AT LEAST A DOZEN ELECTRICAL AND ENVIRONMENTAL TESTS—BEFORE AND AFTER AGING—BEFORE IT LEAVES DELCO RADIO'S LABORATORIES. THIS 200 PERCENT TESTING, COMBINED WITH FIVE YEARS OF REFINEMENTS IN MASS PRODUCTION, MEANS CONSISTENT UNIFORMITY IN THE PRODUCT . . . AT A LOW PRICE. ( THE 2N174 IS JUST ONE OF MANY DEPENDABLE TRANSISTORS PRODUCED BY DELCO RADIO TO SUPPLY ALL YOUR TRANSISTOR NEEDS. FOR MORE DETAILS OR APPLICATIONS ASSISTANCE ON THE 2N174 OR OTHER DELCO TRANSISTORS, CONTACT YOUR NEAREST DELCO RADIO SALES OFFICE.

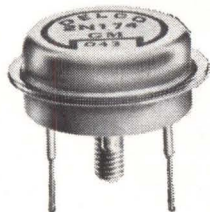
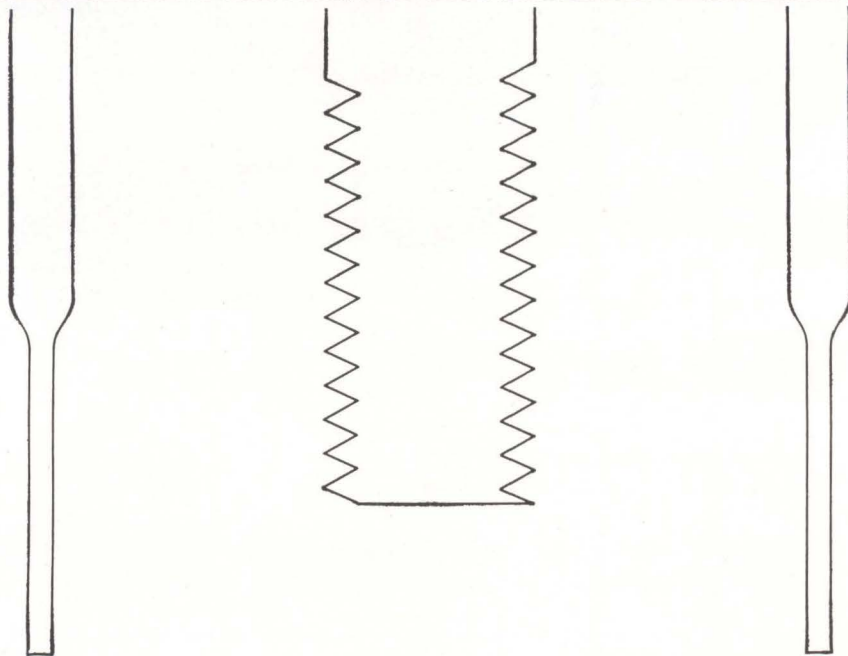

Union, New Jersey  
324 Chestnut Street  
MUrdock 7-3770

Santa Monica, California  
726 Santa Monica Blvd.  
UPton 0-8807

Chicago, Illinois  
5750 West 51st Street  
PORTsmouth 7-3500

Detroit, Michigan  
57 Harper Avenue  
TRinity 3-6560

DIVISION OF GENERAL MOTORS • KOKOMO, INDIANA

**DELCO**  
DEPENDABILITY  
**RADIO**  
RELIABILITY



**WELCOME,**  
**LITTLE ONE**



Just christened the Series CMP-100, this latest addition to the Mincom family is a little brother of Mincom's CM-100. Like the CM-100, it performs longitudinal recording with fixed heads up to 1.2 mc at 120 ips—but it's more compact and transportable, created by Mincom engineers to meet new and demanding dimensional specifications. This unique instrumentation system, with its predetection recording capabilities, may fit a special need at your facility. We'll introduce **CMP-100** formally at the March IRE Show in New York. See it at Booth 3243—or, write us today for information.

**Mincom Division** **3M**  
COMPANY

Los Angeles 25, California • Washington 4, D. C.

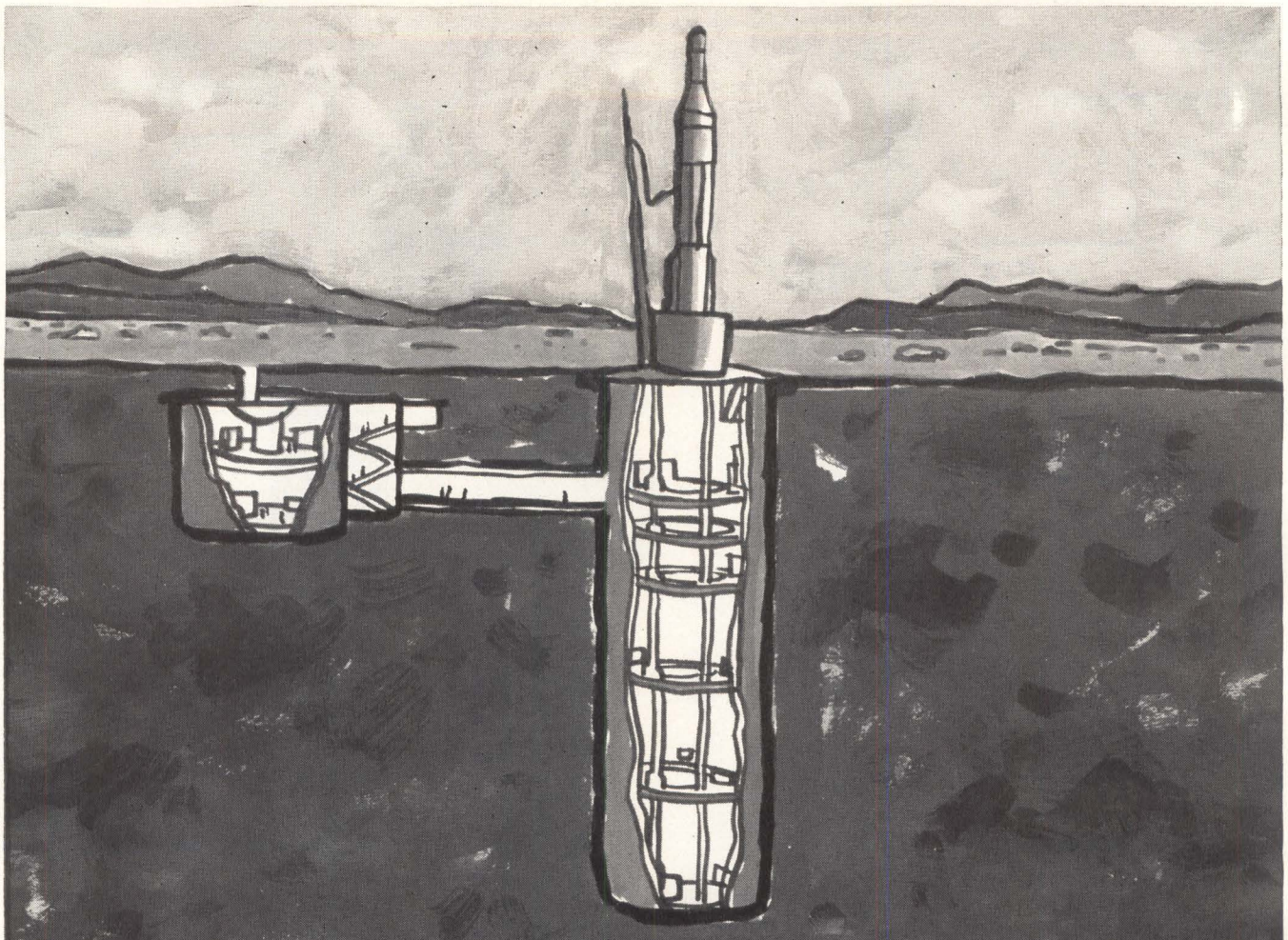

## DO YOU, JOHN DOE, SPECIFY GSE CABLES and ASSEMBLIES?

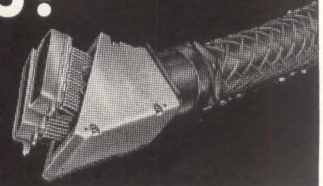
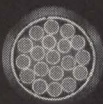

...and work on applications where oil, ozone, and weather resistance *really* count? You've plenty of company, John Doe. Other problems include the absolute necessity of good flexibility and stand-up to impact, bending, and twisting over an ambient temperature range from  $-65^{\circ}\text{F}$  to  $+160^{\circ}\text{F}$ —not to mention rough installations, reeling and unreeling over dry, rocky ground.

John, that reliability bit has more punch than we might think. Hitemp ground support cable and cable assemblies—CONFORMING TO MIL C-13777C—are precision-engineered for tough customers, like yours and mine. Applications? Power and transmission lines; ground support equipment cables for guided or ballistic missile launching pad; and test equipment cables for unmanned aircraft.

And how about this one, John? Hitemp has the whole

setup required to make complete, ready-to-use assemblies—all complying with "13777C". Modular units that save real money in original and installation costs, as well as long-term economy. This also includes the entire custom design routine—whatever you need.

Hitemp is a rare one, John. We can write to them about our problem, send for their "Condensed Catalog", and possibly even their engineering assistance. What can we lose?

### HITEMP WIRES CO.

a Division of Simplex Wire & Cable Co.

1200 SHAMES DRIVE, WESTBURY, NEW YORK  
1532 S. CALIFORNIA AVE., MONROVIA, CALIF.



# A NEW CONCEPT IN SCAN CONVERSION

from **G E C**

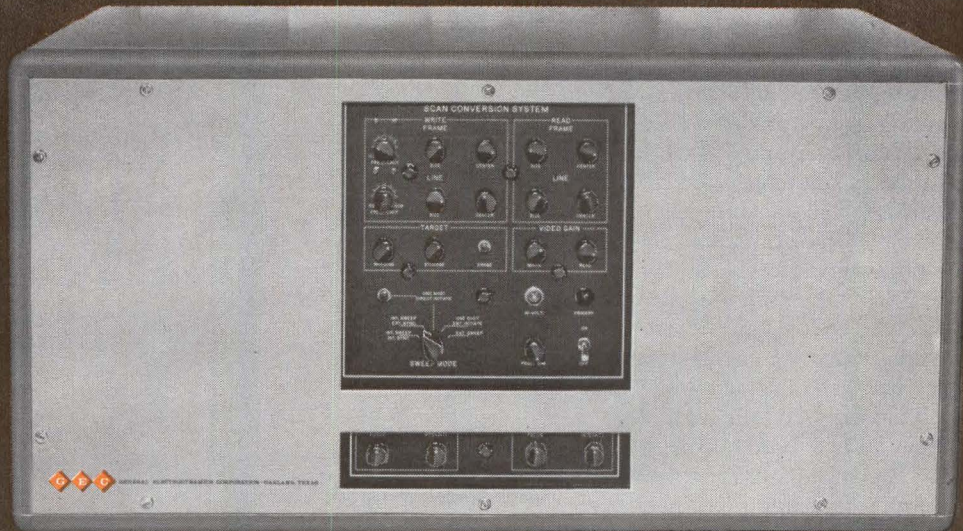

Now a low cost completely transistorized Scan Conversion unit is available which is capable of:

- ◆◆◆ TRANSLATION of video information from one scanning mode to another;
- ◆◆◆ STORAGE and INTEGRATION of video information;
- ◆◆◆ Expansion or reduction of bandwidth through TIME—COORDINATE TRANSFORMATION.

This completely transistorized, versatile system can be readily tailored to your specific needs through its plug-in printed circuits. For more information about conversion of radar PPI to TV, TV standards conversion or conversion of slow scan narrow band systems to standard TV or vice versa, contact GEC today.

*...advanced electronics at work*



January 26, 1962

**GENERAL ELECTRODYNAMICS CORPORATION**  
4430 FOREST LANE • GARLAND, TEXAS • BROADWAY 6-1161

CIRCLE 57 ON READER SERVICE CARD 57

# Protecting Transistors From Transients

By M. CARR WILSON  
Datex Corp., Monrovia, Calif.

TRANSIENT suppression method can provide considerable savings in total component costs. The circuit was designed to protect transistors from transient spikes caused by the interruption of relay current but is applicable to other inductances.

These inductive transients, usually many times supply voltage, can permanently damage transistors operating well within their normal ratings. The transistor usually breaks down between the collector and emitter through the base.

Many useful logic circuits combine the high speed of transistors with the power-handling capability of relays. This type hybrid logic is used in the Datex K-111 control chassis, but the transistors must be protected from transients without significantly slowing relay action.

## Suppression Methods

Transient suppression by resistive damping across the coil tends to sustain the magnetic field and prolong relay release time. However compromises have been reached between transient suppression and relay release time, including resistor-capacitor, diode and resistor-diode suppression. Since most transient energy occurs at low voltage, zener-diode reference suppression can short out the high voltage part without adding appreciably to relay release time.

When the transistor in the typical circuit at the top of the figure is abruptly cut off by closing the switch, current in the inductance is interrupted. Collector to emitter voltage is the sum of power supply voltage and back emf across the inductance. This total voltage must be kept below transistor breakdown voltage. Transistors are available with ratings as high as 75 or 80 volts. Thus with a 40-volt supply, shorting out the relatively small amount of energy in voltage spikes above 80 volts does not significantly

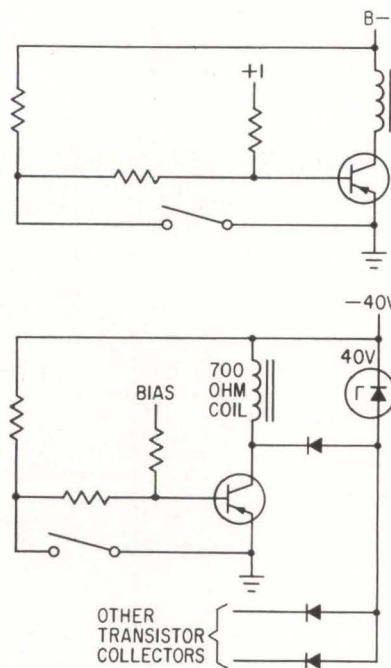

Closing switch in upper circuit cuts off transistor and interrupts inductor current, producing large transient that adds to supply voltage between collector and emitter. Circuit below shorts out voltage above a predetermined level

increase relay release time.

In the circuit at the bottom of the figure, the collector is referred to this reference level through a coupling diode. Collector and emitter potentials are about equal when the transistor is conducting, and the coupling diode does not conduct. When the transistor is cut off, collector voltage tends to approach the sum of supply and transient voltages. However the coupling diode conducts, preventing collector voltage from exceeding the reference.

Reference voltage can be established at emitter potential by a zener diode with breakdown voltage safely below 80 volts. It can also be referred to supply voltage, where breakdown voltage (difference between supply voltage and 80 volts) can be lower.

Several clamping diodes can use the same reference if zener dissipation is adequate for all transient current that may occur. If tran-

sients are to be suppressed in a single inductance, inverse rating of the coupling diode need only exceed supply voltage.

## Coupling Diode Ratings

If several inductances use the same reference and if the transistors are cut off rapidly and randomly, inverse voltage at a particular coupling diode can be total reference voltage. The higher voltage occurs because if a transistor remains saturated while another is switched off, the transient raises zener anode voltage to the reference level. The anode of the coupling diode in the saturated circuit is at reference while its cathode is close to emitter potential.

With a 40-volt supply and a 40-volt zener, during the transient spike reference voltage at the zener anode is 80 volts, which appears across the coupling diodes of all saturated transistor circuits. If switching rate is low, duration of this inverse voltage is short and peak inverse rating of the coupling diode must only exceed the reference level. However, if switching rate is high, the voltage is essentially continuous since an inductive spike is nearly always present. Thus the continuous inverse rating of the coupling diode must exceed the reference level.

## Servo System Controls Lunar Surface Analyzer

PRECISE control of deuterium gas pressure by a solid-state servo system has been achieved in a prototype instrument for identifying chemical elements of lunar and planetary surfaces. Design of the servo system has been a major part of a cooperative project to develop the surface analyzer. Participants are Aerospace Corp. and the Lawrence Radiation Laboratory of UCLA, which hope that the package will be landed on the moon as part of the Surveyor program.

To analyze the surface materials,

THE  
**kepco**



**BEST  
INVESTMENT  
IN  
POWER  
SUPPLIES**

0-30v dc/0-300 ma—\$119.00

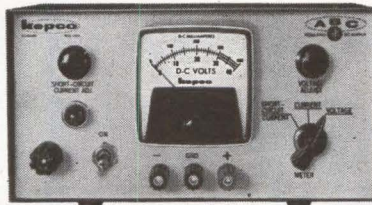

0-40v dc/0-500 ma—\$159.00

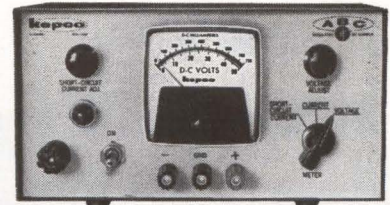

0-30v dc/0-300 ma—\$99.00



**OFF  
THE  
SHELF**

REAR VIEW FOR ALL MODELS

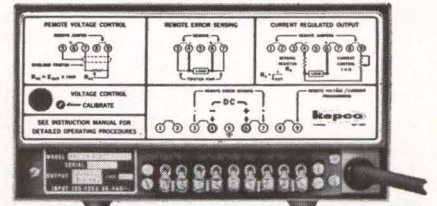

**TO YOUR  
BENCH**

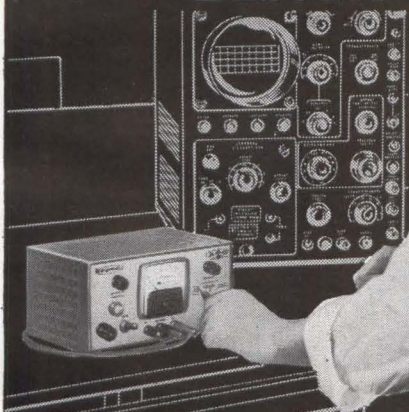

0-7.5v dc/0-2 amp—\$159.00

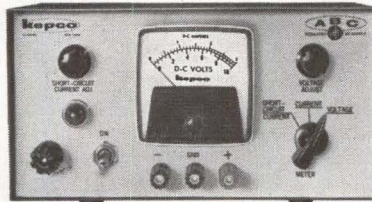

0-15v dc/0-1 amp—\$159.00



**OR SYSTEM**



MODEL	DC OUTPUT RANGE		DIMENSIONS			PRICE
	VOLTS	CURRENT	H	W	D	
ABC 30-0.3	0-30	0-300ma.	4¼"	8½"	5½"	\$ 99.00
ABC 40-0.5	0-40	0-500ma.	4¼"	8½"	9½"	\$139.00
ABC 7.5-2	0-7.5	0-2 amp	4¼"	8½"	9½"	\$139.00
ABC 15-1	0-15	0-1 amp	4¼"	8½"	9½"	\$139.00

For meter: add suffix "M" to Model No. and \$20.00 to price.  
Rack Adapter: Model RA-4 (for 2 units), RA-5 (for 1 unit) available at \$15.00 each.

- 0.05% Line/Load Regulation and Stability
- 0.5 mv (rms) Ripple
- Adjustable Overload Protection (Front Panel)
- Input 105-125v ac, 50-440 cps
- Low Price is achieved by high volume production without sacrifice in quality and reliability.
- Control Amplifier Terminals included for:
  - Remote Constant Voltage Programming
  - Remote Constant Current Programming
  - Remote Error Sensing
  - Complementary Tracking
  - Voltage Compliance Extension
  - Series or Parallel Slave Connections

**kepeco**  
inc.

WRITE FOR COMPLETE SPECIFICATIONS

131-48 SANFORD AVENUE • FLUSHING 52, N. Y.  
Area Code 212 IN 1-7000 • TWX # NY 4-5196

# 5 pulse channels you can adjust independently

Whenever you need a train of adjustable coded pulses for testing and aligning missile, beacon, or interrogation systems, the Polarad Model MP-1A offers the greatest pulsing capability in the smallest package.

Each channel of the five can be independently adjusted for pulse-width, and delay. Each pulse can be pulse-time modulated. Further, each channel provides an internal or external sync, internal time calibration markers, positive or negative triggers, and square wave output.

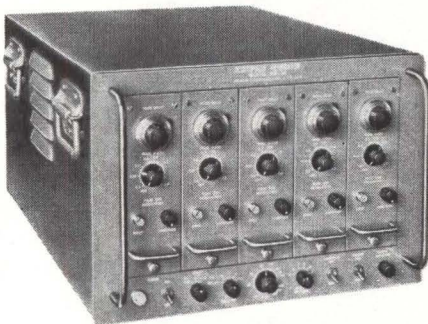

**Coded Multi-Pulse Generator Model MP-1A**

## SPECIFICATIONS

Pulse characteristics include:

Repetition rate	10 to 10,000 pulse groups per second
Width	0.2 to 2 microseconds
Delay	0 to 300 microseconds
Pulse spacing	to 0.1 microseconds between pulses
Rise and decay times	0.1 microsecond
Overshoot	Less than 10%
Amplitude	20 volts minimum into 100 ohms

**POLARAD**  
ELECTRONICS CORPORATION  
43-20 34th Street, Long Island City 1, N.Y.



high-energy pulsed neutrons are injected into the surface, exciting the nuclei of the unknown material. Following each pulse, de-excitation occurs and the nuclei emit gamma rays with energies that identify each element present.

Neutrons are obtained with a magnetic accelerator only a few inches long. The accelerating tube consists of an ion source, an accelerating gap, a tritium-impregnated target, a deuterium gas reservoir and a pressure sensor.

The ion source generates deuterium ions in square-wave pulses that are delivered to the accelerating gap, where they fall through an 80-Kv d-c potential. The ions impinge on the target, producing 5- $\mu$ sec bursts of 14-Mev neutrons.

Except for the reservoir, deuterium gas pressure would decrease during use. However, gas pressure

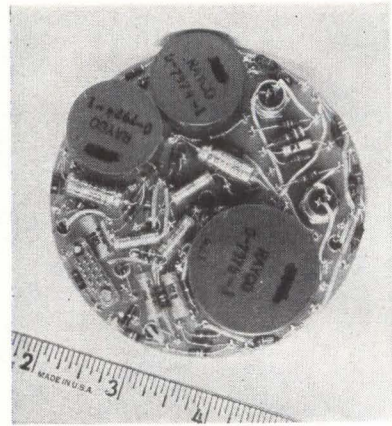

*Compact servo amplifier uses only solid-state components*

diagram in the figure is used to maintain gas pressure at 20 microns of mercury. A pressure sensor within the tube monitors gas pressure and provides an electrical signal that enables control of pressure. The servo amplifier provides an output to the reservoir heater that is proportional to pressure deviation.

### Pressure Error Signal

Two methods have been evaluated for obtaining a pressure error signal. In one method, thermistors are used in a Wheatstone bridge that is energized by a 5-Kc square-wave supply. Deviations in pressure unbalance the bridge providing a 5-Kc output proportional to pressure error. The 5-Kc supply is used to permit use of an a-c amplifier and thus avoid drift problems.

In the second method, a d-c voltage is provided to a 5-Kc solid-state chopper that is proportional to existing pressure, rather than pressure error. This method requires that a d-c bias voltage be provided proportional to desired pressure, which is compared with the actual pressure voltage in the chopper.

The all solid-state servo amplifier can provide up to about 4 watts output from an input of a few millivolts. The amplified error signal is fed to the synchronous converter. Because the converter is phase-sensitive, it provides a d-c output only when pressure is too high. This d-c voltage is used to bias two parallel-connected saturable reactors. The 5-Kc supply voltage is applied to the reactors, and the d-c control voltage determines the amount of power coupled through a transformer to the reservoir heater.

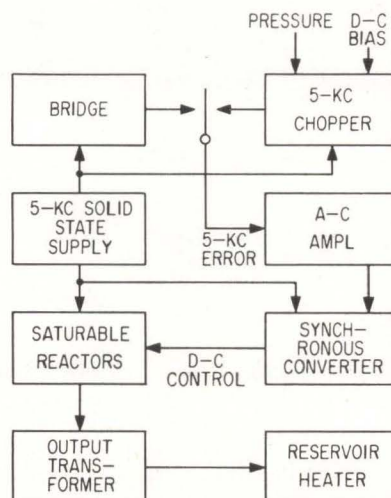

*Servo amplifier provides up to 4 watts output to reservoir heater from an input error signal of a few millivolts*

in the tube must be closely controlled to generate neutrons of the required energy and intensity to produce identifiable gamma rays. The servo system is used to control deuterium gas pressure.

The gas reservoir consists of deuterium-impregnated titanium wrapped in a tungsten wire heater element. The reservoir absorbs or emits gas depending on its temperature. Although this characteristic changes with age, gas pressure in the tube can be controlled by regulating heater current.

The control system in the block

# Three steps to rho

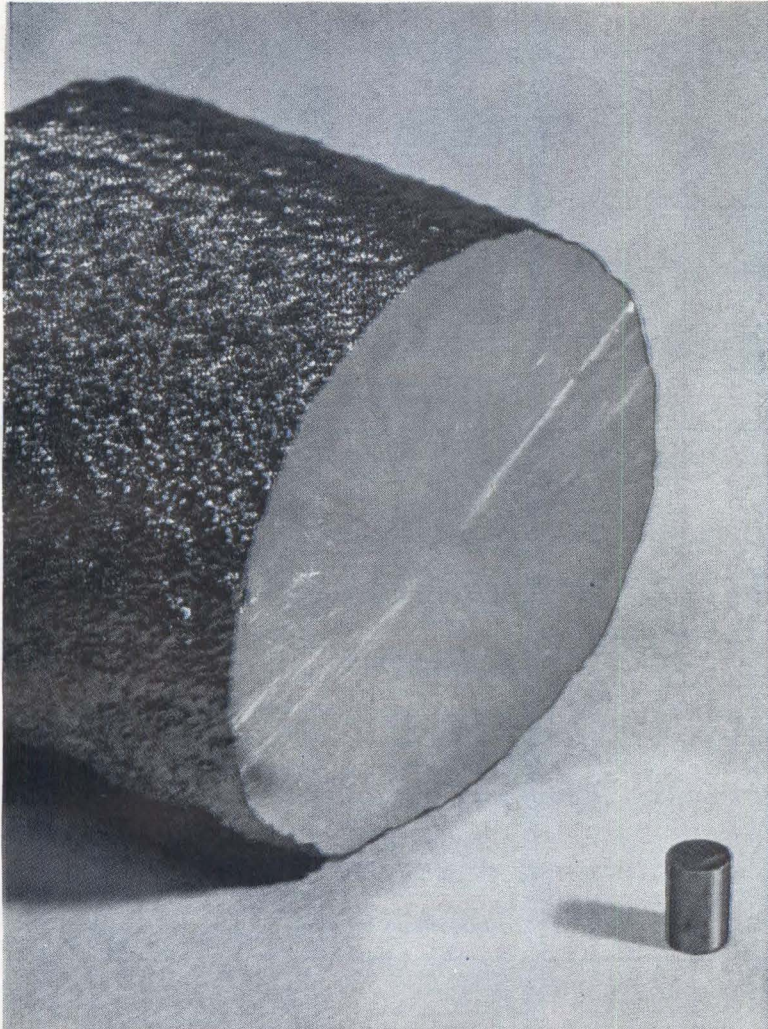

## Specify Dope-sil\* . . . for easy, consistent, on-target resistivity

If you use the Czochralski technique for growing single crystal silicon, you should consider this simple, three-step procedure for accurate, reproducible doping:

Step 1: Use nomograph to determine total atoms of dopant required.

Step 2: Select Dope-sil pellets containing the required total doping atoms. Dope-sil is the Dow Corning trademark for accurately pre-measured doping modules.

Step 3: Add the Dope-sil pellets to your pre-packaged Dow Corning hyper-pure silicon crucible charge.

And that's it! No need for long, involved calculations. No need for a delicate laboratory balance, the weighing of powders, grinding . . . other involved procedures.

How about accuracy? Resistivities are on-target . . . within closer tolerances than the accepted industry practice.

For more information on Dope-sil, on pre-packaged Dow Corning crucible charges, and copies of these easy-to-use nomographs, write Hyper-Pure Silicon Division, Dept. 4202.

\*Trademark for Dow Corning's doping modules

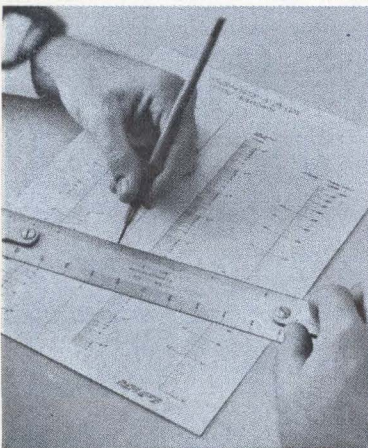

STEP 1

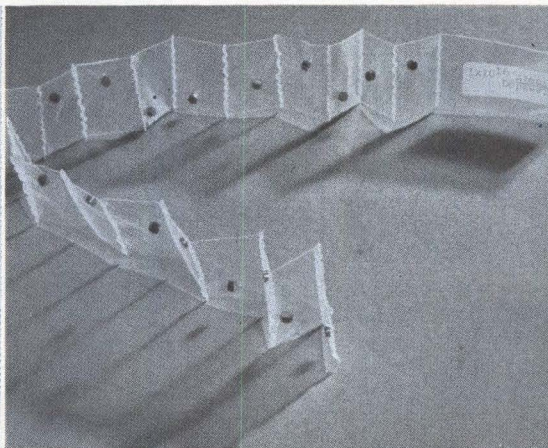

STEP 2

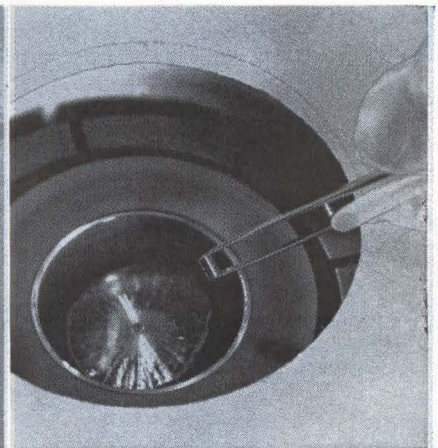

STEP 3

**Dow Corning CORPORATION**

HYPER-PURE SILICON DIVISION • HEMLOCK, MICHIGAN



# Reliability at low cost in power supplies...

● Many circuit refinements and improvements are made practical by the availability of (a) small size silicon rectifiers rated up to 800 volts at 500 to 750 milliamperes, and (b) compact high voltage silicon rectifier stacks with peak

inverse ratings to 10,000 volts. A dozen units of the first group and four of the latter are listed below. All are available at realistic cost and will increase reliability over tube supplies.

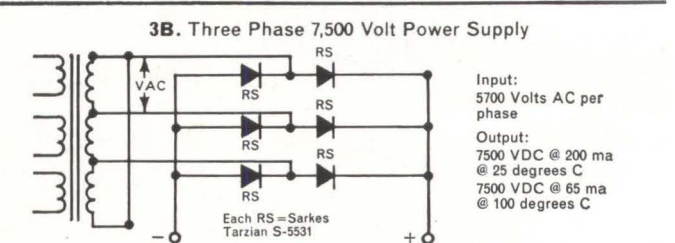
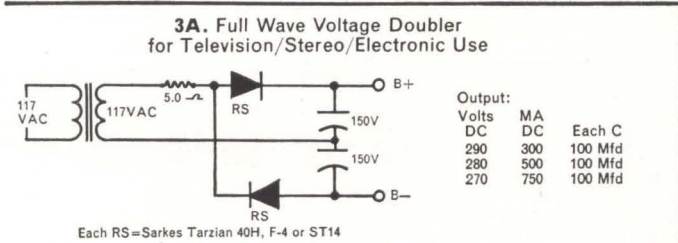
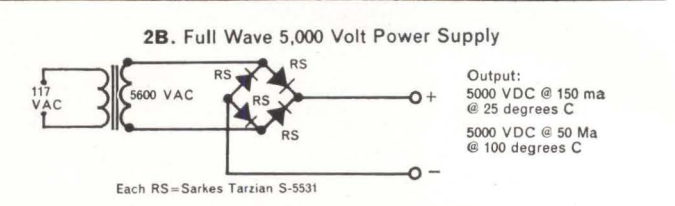
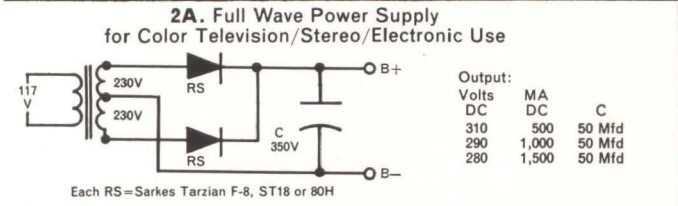
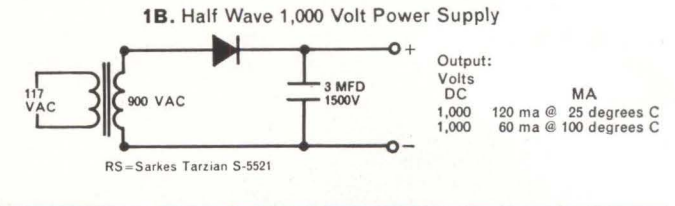
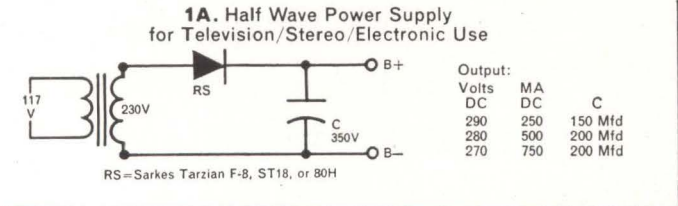

Three general circuits are shown for each of the two groups mentioned above to suggest some of the possibilities. For example: 1-A, a simple half-wave circuit operating off a 230 volt line or with a 1 to 2 step-up transformer, delivers between 270 and 290 volts with a capacitive input; 2-A, with two rectifiers

in a full wave circuit with a center tap transformer, delivers approximately 300 volts across a wide range of current ratings; and so on. Similarly the high voltage rectifiers let you design compact half wave and full wave supplies at moderate cost.

## SARKES TARZIAN LOW CURRENT RECTIFIERS

TARZIAN TYPE	MAX. PRV	MAX. RMS VOLTS	MAX. DC MA 55° C	MAX SURGE AMPS	DIMENSIONS
20H 40H 60H 80H	200 400 600 800	140 280 420 560	750 750 750 750	75 75 75 75	
F-2 F-4 F-6 F-8	200 400 600 800	140 280 420 560	750 750 750 750	75 75 75 75	
12 14 16 18	200 400 600 800	140 280 420 560	750 750 750 750	75 75 75 75	
S-5518 S-5521 S-5529 S-5531	1,000 3,000 4,000 10,000	700 2,100 2,800 7,000	200 150 50 25	20 15 5 5	

Whatever your application, let Tarzian engineers consider it for practical recommendation. Catalog available on request.



**SARKES TARZIAN, Inc.**  
World's Leading Manufacturers of TV and FM Tuners • Closed Circuit TV Systems • Broadcast Equipment • Air Trimmers • FM Radios • Magnetic Recording Tape • Semiconductor Devices  
**SEMICONDUCTOR DIVISION • BLOOMINGTON, INDIANA**  
In Canada: 700 Weston Rd., Toronto 9 • Export: Ad Auriema, Inc., New York



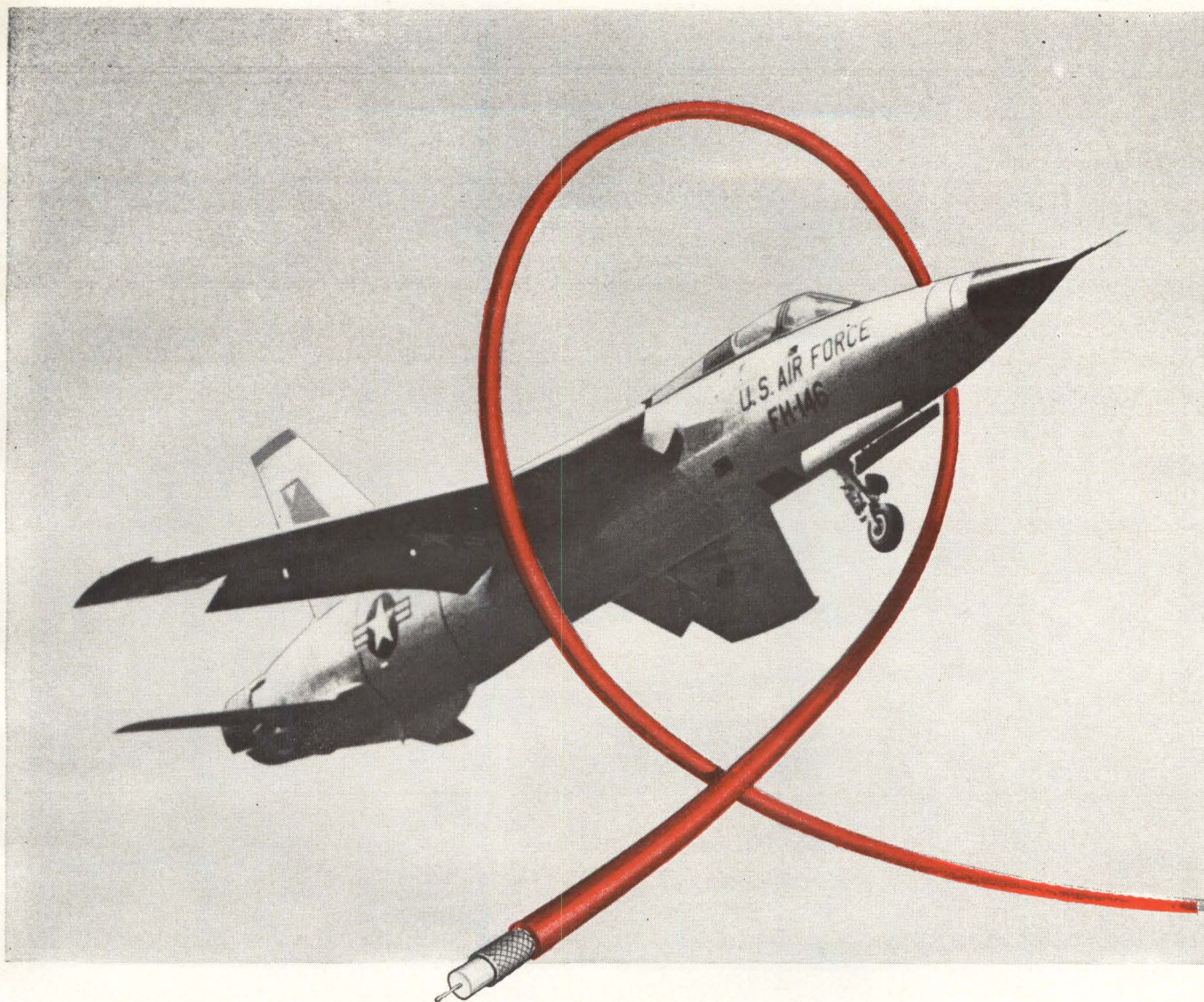

## Jackets of **TEFLON® FEP** on coaxial cables save space, weight...increase reliability

The multiple advantages of switching to coaxial-cable jacketing of a TEFLON FEP resin are clearly demonstrated in Republic Aviation Corporation's new F-105 Thunderchief fighter bomber. When the coax jackets in Communications, Interrogation, and Navigation electronic systems were switched from glass braid to FEP . . .

- weight savings of approximately 20 lbs. per plane were realized;
- over-all cable diameter was significantly reduced;
- system reliability was increased because of better abrasion resistance;
- snagging and fraying during installation were virtually eliminated.

And last, but far from least—in the quantities used by

Republic, the cost of coax jacketed with FEP resin was lower than that of the glass-braid construction.

Du Pont TEFLON FEP resin offers outstanding electrical properties over a wide range of temperatures and frequencies. Like the familiar TFE resins, FEP resin is inert to virtually all chemicals and solvents, and has excellent mechanical properties. Because FEP resin is melt-processible, it can be extruded in long, continuous lengths of jacketing and wire insulation.

Find out more about jacketing of FEP resin and the design advantages it offers *you*. Write to: E. I. du Pont de Nemours & Co. (Inc.), Dept. E-26, Room 2526 Nemours Bldg., Wilmington 98, Delaware. **In Canada:** DuPont of Canada Limited, P.O. Box 660, Montreal, Que.



**TEFLON®**  
FLUOROCARBON RESINS

*TEFLON is Du Pont's registered trademark for its family of fluorocarbon resins, fibers and film, including TFE (tetrafluoroethylene) resins and FEP (fluorinated ethylene propylene) resins.*

BETTER THINGS FOR BETTER LIVING . . . THROUGH CHEMISTRY

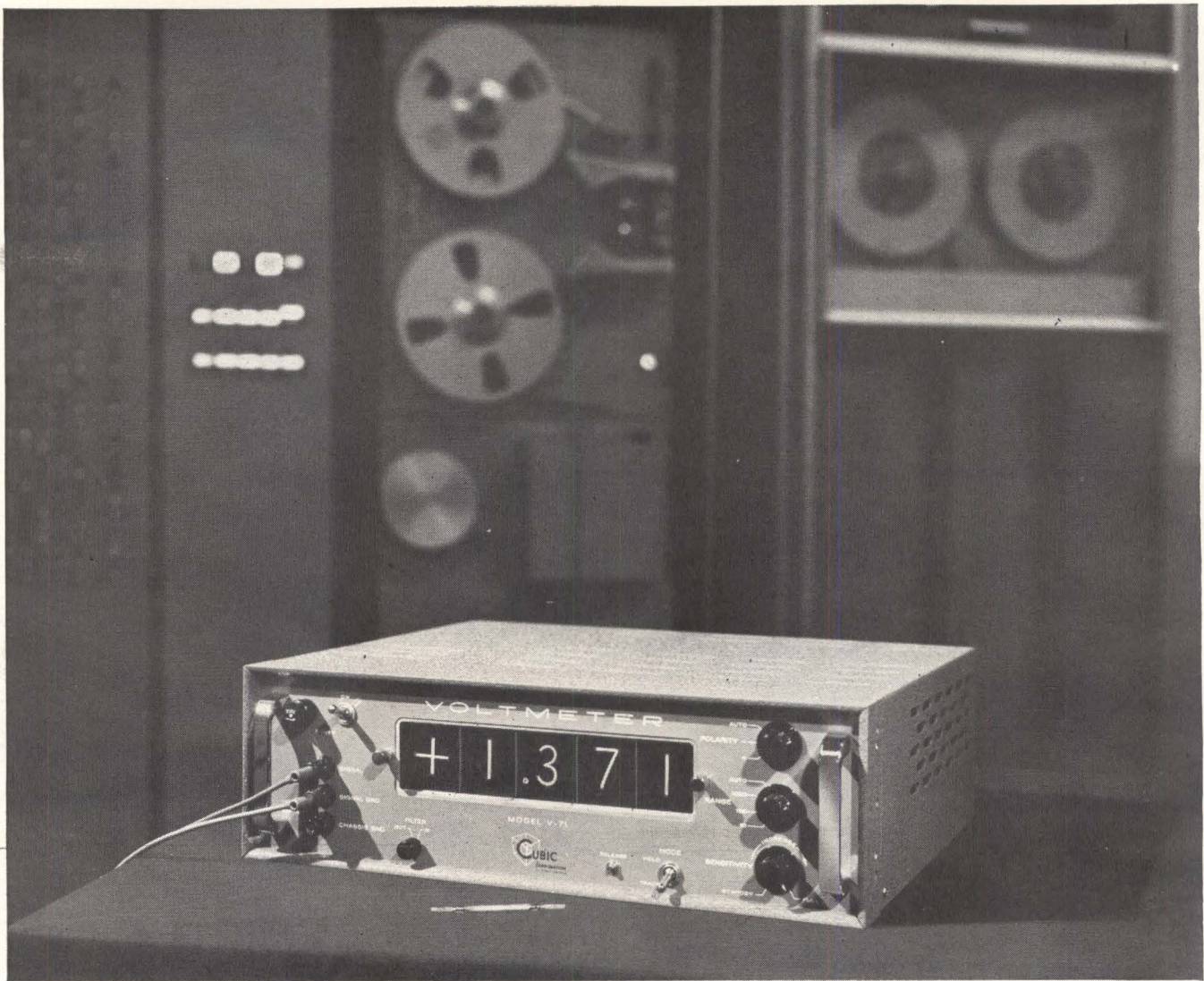

## The ideal systems DVM

■ Cubic announces the first reed relay digital voltmeter with automatic ranging and polarity. It's the perfect voltmeter for systems requiring rapid, continuous operation. The new Model V-71, shown above with a reed relay, gives you all these features:

**TEN YEARS WITHOUT PERIODIC MAINTENANCE:** Uses ultra-reliable reed relays sealed in glass, replacing stepping switches used in conventional DVMs. These relays have been life tested for more than 100 million operations without maintenance, equivalent to ten years normal use.

**AUTOMATIC RANGING AND POLARITY:** Automatically interprets incoming voltages and sets itself to the proper voltage range and polarity. No manual settings of any kind required.

**FIRST HIGH-SPEED, ACCURATE, LOW COST DVM:** Balance time only 500 milliseconds. Absolute accuracy of 0.01% plus or minus 1 digit. Price of the Cubic V-71 DVM is \$2,200.

**AUTOMATIC PRINT-OUT:** The V-71P print-out version offers automatic null detection at balance and 10-line decimal voltage level output for driving parallel printers. BCD coded outputs, available on special order. Price of the V-71P is \$2,800. For further information, address inquiries to Department A-103.



INDUSTRIAL DIVISION  
SAN DIEGO 11, CALIFORNIA • ROME, ITALY

OTHER OFFICES: LOS ANGELES, CALIFORNIA • ROME, ITALY (CUBIC EUROPA S.p.A.) • REPRESENTATIVES IN PRINCIPAL U.S. AND CANADIAN CITIES

# TWO SIGNIFICANT NEW TELEPHONE TYPE RELAYS

a cool, cool  
**COIL**  
AC MODEL  
(18°C. RISE AT  
115V 50/60 CY.)

a low-cost  
**SENSITIVE**  
20 MILLIWATTS  
DC MODEL

BOTH MADE BY  
**P&B**

\*\*\*\*\*  
*Like Janus, that ambivisioned  
Roman god, our Development  
Engineers look in all direc-  
tions to design superior relays  
for both AC and DC power.*  
\*\*\*\*\*

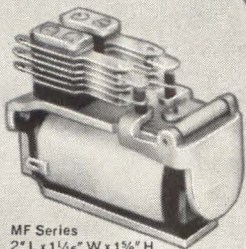

MF Series  
2" L x 1 1/16" W x 1 1/8" H  
(4 Form C)

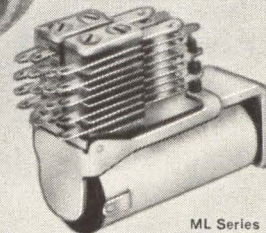

ML Series  
1 3/32" L x 3/4" W x 1 1/16" H  
(6 Form C)

## NEW AC TELEPHONE TYPE RELAY HAS LOW COIL TEMPERATURE RISE

Our MF relay has 30° to 40°C. less coil temperature rise than similar AC relays. *Advantages?* Consumes less current, usually requires less expensive circuit components (e.g. smaller transformers), and is generally more sensitive (2.3 VA) than mine-run AC telephone type relays. No need for expensive cooling devices, either.

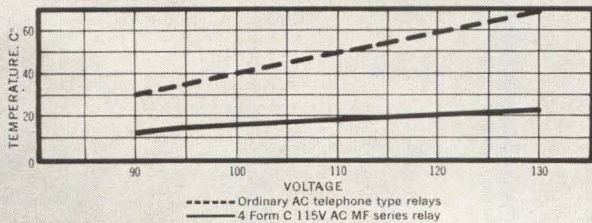

Will switch loads from dry circuit to 5 amperes, 115V AC resistive. Rated for continuous duty.

Write or call today for full information.

## NEW DC TELEPHONE TYPE RELAY CAN OPERATE IN TRANSISTOR CIRCUIT

Sensitive, small and inexpensive. These three qualities endear this relay to design engineers. Requiring only 20 milliwatts per movable at 25°C. ambient, the ML will operate in low-powered transistorized circuits.

Surprisingly, the ML sells for considerably less than similar competitive relays.

### ML SERIES ENGINEERING DATA

**GENERAL:**

**Life:** Contacts: 100,000 operations min. at rated load.

**Mechanical:** 10 million operations minimum.

**Temperature Range:** DC: -45°C. to +85°C. standard. (+105°C. avail. on spec. ord.)

**Enclosure:** Available hermetically sealed or dust covered.

**Terminals:** Pierced solder lugs standard. Available with printed circuit or taper tab No. 78 AMP terminals.

**CONTACTS:**

**Arrangements:** Up to 18 springs, (9 per stack). Bifurcated contact arms are available.

**Rating:** 3 amps at 115 volts AC resistive at standard power. Other ratings available with additional coil power.

**COILS:**

**Power:** DC: 20 milliwatts per movable arm minimum, 3 watts maximum @ +25°C.

**Resistance:** 33,000 ohms maximum.

**Duty:** Continuous.

P&B STANDARD RELAYS ARE AVAILABLE AT YOUR LOCAL ELECTRONIC PARTS DISTRIBUTOR



# POTTER & BRUMFIELD

DIVISION OF AMERICAN MACHINE & FOUNDRY COMPANY • PRINCETON, INDIANA  
IN CANADA: POTTER & BRUMFIELD, DIVISION OF AMF CANADA LIMITED, GUELPH, ONTARIO

# Precision Potentiometer Uses Carbon Film

RESOLUTION in precision carbon-film potentiometers is dependent on granular size of the film particles, rather on the spacing between wires. Low noise, highly sensitive potentiometers of this type have long life, can detect motions as small as 0.000005 in.

Basic and modified carbon film potentiometers are currently being used in the F-105's flight computer, nose wheel steering system, quadrature rejection system, fire control and automatic pilot equipment, as well as in ground based flight simu-

lators and checkout equipment.

Potentiometer construction for these systems use a carbon-film resistance element bonded to a high-temperature plastic base. These units, developed by Computer Instruments Corp., Hempstead, N. Y. offer linearity better than 0.2 per cent per inch of stroke. Resistance ranges are from 250 ohms to 200K ohms per inch, and life to 30 million strokes depending on circuit.

Currently claiming to be the only manufacturer of this type of potentiometer, Computer Instruments

Corp. supplies standard and specialized units to a number of sub-contractors, in addition to those supplied to the prime contractor, Republic Aviation.

The value of these Super Con P-111 pots shipped to date for the F-105's nose wheel system alone amounts to \$108,000. Two precision pots, used in each planes nose wheel steering system, give the pilot the instantaneous control needed for landing at 200 miles per hour. The nose wheel accounts for so much of the steering once the plane is down, that the pilot's ability to control the wheel's position means the difference between staying on the runway or plunging off the side.

Elements of the carbon-film potentiometers are shown in Fig. 1.

Excitation applied across the end terminals results in horizontal current flow as shown by the dotted lines in Fig. 1A. Points of equipotential are actually vertical, Fig. 1B, and these equipotential lines cannot cross each other, since one point cannot be at two different voltages. Unwanted negative slopes in the output are thus eliminated.

If wipers are included on all three wiper paths, A, B, and C, each will pick off the same potential if displaced equidistant from the end terminal. Equipotential lines are located perpendicular to the direction of travel of the wipers. Therefore, each wiper can pick up identical voltages, even though they are in different paths.

If the wipers are aligned at their point of contact with the film element, and their connection to the actuator staggered, each wiper will be of a different length. Since each will have a different resonant frequency, it is virtually impossible for a discontinuity to appear under vibration. Failure of one wiper will not cause total component failure.

Taps can be specified on either a voltage or mechanical displacement basis. Fig. 1C shows a zero width resistance tap on the potentiometer card. The width is virtually zero

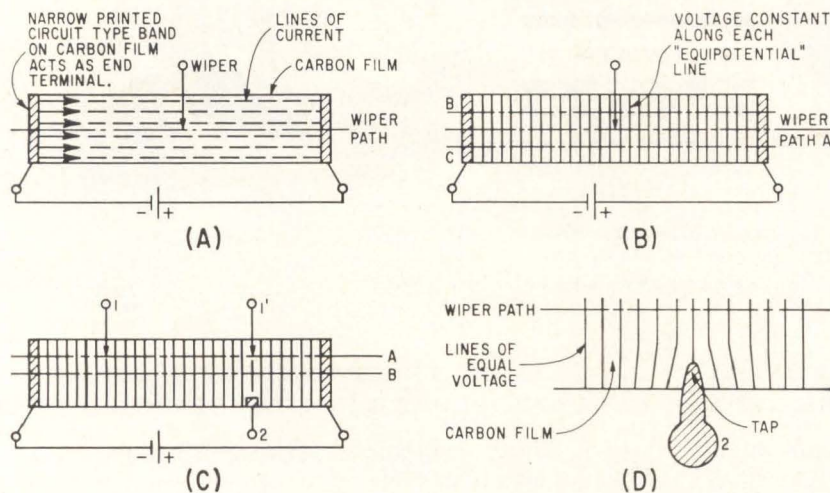

Fig. 1—Details of carbon film element (A) used in infinite resolution potentiometer shows wiper paths (B), resistance taps (C) and electrical configuration around tap (D)

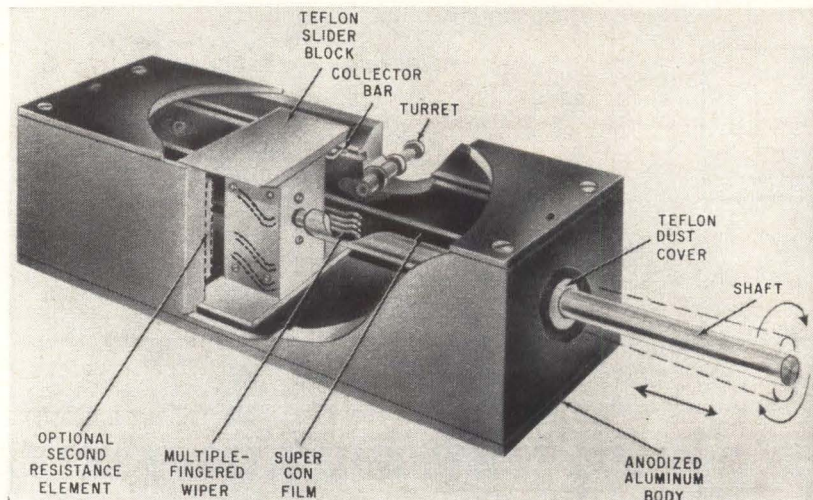
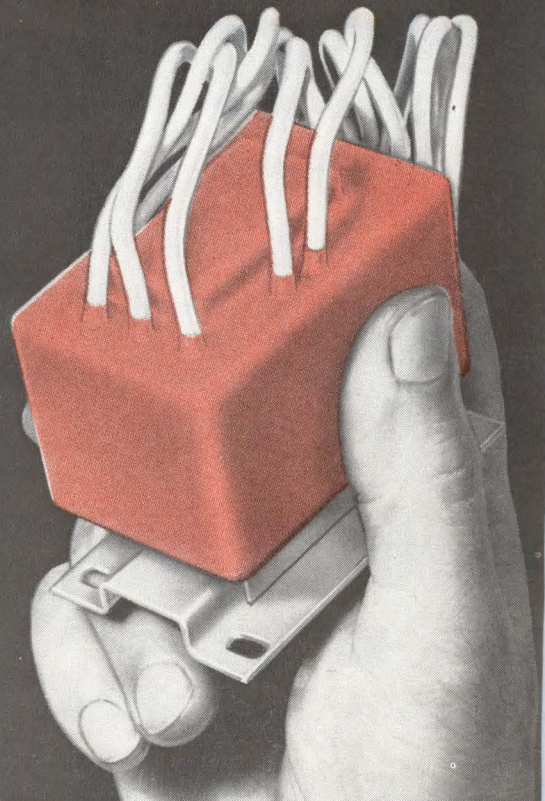

Fig. 2—Cross section view of the P-111 potentiometer

**Different potting and encapsulating problems require different solutions.** That's why General Electric offers a family of eight RTV and LTV silicones. LTV-602, for instance, is transparent, resilient and very easy to repair, curing in two hours. RTV liquid silicone rubber compounds offer good physical strength, resiliency and a selection of viscosities for impregnation, potting, conformal coatings or sealing.



## 8 fast cures for potting and encapsulating problems

*General Electric Silicones protect against temperature, moisture, ozone, thermal and mechanical shock*

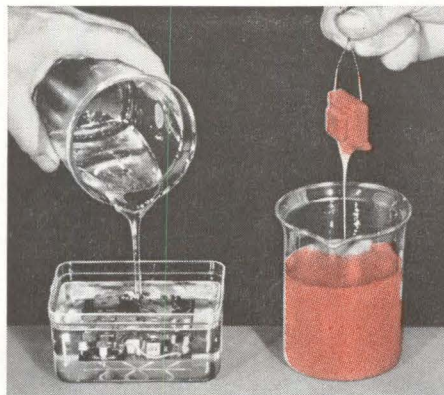
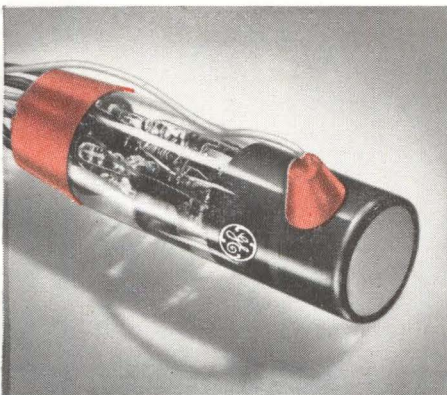

	COLOR	VISCOSITY POISES	CONSISTENCY
LTV-602	Clear	15	Easily Pourable
RTV-11	White	120	
RTV-20	Pink	300	Pourable
RTV-40	White	450	
RTV-60	Red	550	
RTV-77	White	8,000	Spreadable Thixotropic Paste
RTV-88	Red	10,000	
RTV-90	Red	12,000	Stiff Paste

**Why are G-E silicones used?** To protect against temperature extremes from  $-65^{\circ}\text{F}$  to  $600^{\circ}\text{F}$  . . . to provide a resilient, shock-absorbing cushion for delicate parts . . . for outstanding electrical properties . . . for their very low (0.2%) shrinkage . . . for their resistance to moisture, ozone and thermal shock.

**How are G-E silicones used?** By dipping, pouring, spraying or buttering. Cure times can be varied from minutes to hours, depending on catalyst used and the heat applied (from room temperature to  $125^{\circ}\text{C}$ ). They bond easily to properly primed surfaces, are easily removed from unprimed surfaces.

**Which is best for you?** G-E encapsulants vary in viscosity from a readily pourable liquid to a thick paste to fit special requirements. Applications range from deep impregnation of transformer coils to caulking of large equipment . . . from printed circuit encapsulation to making flexible molds.

Write for complete data. If you would like a free sample for evaluation, write on your business letterhead describing your proposed application. Section N164, Silicone Products Dept., General Electric Co., Waterford, New York.

GENERAL  ELECTRIC

CIRCLE 67 ON READER SERVICE CARD

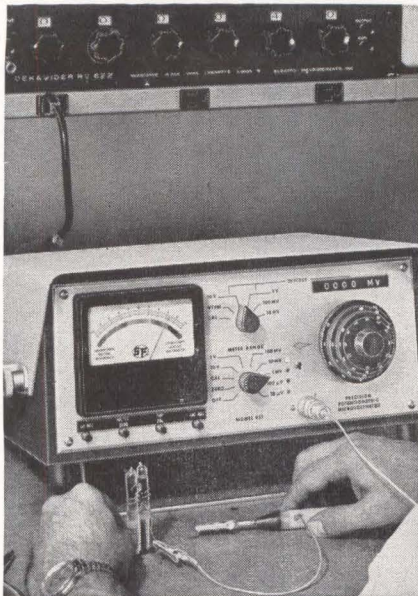

# .01% Accuracy

*-but we don't stop there*

This is Smith-Florence's new Standard Potentiometric Voltmeter, Model 951. Range, 1 microvolt to 1000 VDC.

Accuracy is .01% to 10v, .015% 10v to 1 kv.\* Smith-Florence will provide absolute accuracy curves on request.

High accuracy is not everything. Only Smith-Florence gives you all these features too:

- Solid state reliability
- Drift less than .5 microvolt/day
- Recorder and oscilloscope outputs
- Automatic decimal and range lights
- Reference consisting of special temperature compensated Zener plus standard cell
- Maximum residual thermal effect 0.2 microvolt

Price, \$2,495

For more details, and a demonstration, please call your Smith-Florence representative or write to us.

We'll also send you a helpful paper called "Basic Accuracy and High Precision Measurements" for the asking.

\*.005% precision 100v—1 kv divider used above 10v range.



**SMITH-FLORENCE INC.**

Overlake Industrial Park  
P. O. BOX 717  
REDMOND, WASHINGTON  
Phone: TUCKER 5-4389

since it is extremely far from any wiper path and it does not disturb the electrical configuration of the field set up around it, except in its immediate vicinity. This is shown in Fig. 1D, where the local disturbance of the equipotential lines is immediately adjacent to the tap. The wiper path is sufficiently far from the tap so as to cause no linearity error.

Construction features of the P-111 are shown in Fig. 2. A self-lubricating, precision-machined teflon slider block rides in lathe-like ways machined into case and sup-

type connections bonded to film. The entire connection is encapsulated for ultra reliability. No soldered connections or loose hanging lead wires are used.

Another feature of these pots that make them desirable for use in the F-105, as well as the F4H, A3J, and other land, water and underseas craft, is that non-linear functions can be successfully manufactured without compromising accuracy or resolution. Special techniques developed by company assure complete control of the film deposition required, whether non-

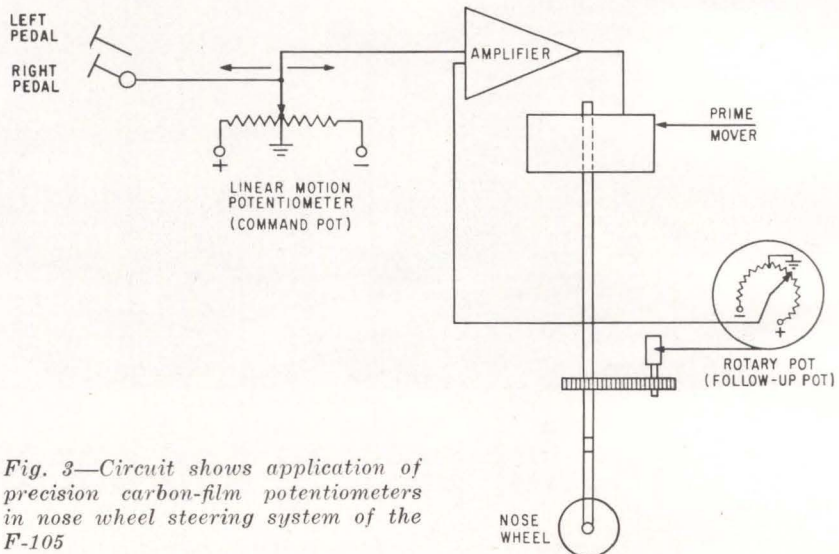

Fig. 3—Circuit shows application of precision carbon-film potentiometers in nose wheel steering system of the F-105

ports wiper rigidly at point of contact with film. Shock and vibration errors are thus eliminated. Tapered ways take up for wear. Wipers are displaced along an equipotential line. There is close proximity between the wiper location and the support for the wiper block. Many linear potentiometers rely on a bushing support where the shaft enters the housing. In the P-111 construction, there is no moment arm from the point of support.

The precious-metal, multiple-fingered wiper is welded to wiper mount. The film, bonded to plastic, presents a polished surface to wiper. An optional second resistance element is easily contained within the same case with no loss of accuracy, resolution or life. The collector bar is welded directly to terminal with no soldering or fragile lead wires used. Gold-plated turret terminates in printed circuit

linear or linear.

Figure 3 shows a typical installation of the pots in the nose wheel steering system of the F-105.

## New Capacitor for Micromodule

A SOLID electrolytic tantalum capacitor with extremely high capacitance values will be developed by General Instrument Capacitor Division for the Signal Corps' Micromodule Program. Contract was awarded to company by Radio Corporation of America, which heads the project, set up to develop complete miniature circuits composed of standardized building blocks elements of the same shape. The capacitance elements will operate at temperatures ranging from -80 C to 125 C without voltage deratings, at voltages up to and including 50 volts.



# Be practical

When the soldering gets tough, crimp. Because sometimes it just isn't practical to terminate connectors by soldering them.

Take connectors used in aircraft, for example. After a jet fighter is assembled to the point where connectors are ready to be terminated, working space has practically vanished. Under these conditions, soldered-on-the-job terminations are expensive and impractical.

That's probably why many airframe manufacturers and subcontractors have standardized on Amphenol "Poke R" connectors, especially when a MIL-C-5015

type connector is needed. "Poke R's" have removable, crimpable Poke-Home® contacts. Instead of soldering to contacts in a connector, Poke-Home contacts are crimped to wires *then* inserted into their proper connector location.

Besides conserving valuable assembly time, the Poke-Home method consistently produces more rugged, more reliable terminations.

Amphenol "Poke R" connectors are also widely used in land-based applications. An eastern computer manufacturer, for example, uses "Poke R" connectors not

only because they work better and are available with shielded contacts, but also because circuit changes can be easily made *after* connectors are installed. Anyone who has ever been forced to make circuit changes involving soldered terminations will recognize the value of removable contacts.

Complete technical data, including "Poke R" environmental resistance characteristics, is available from any Amphenol Sales Engineer. If you prefer, write Dick Hall, Vice President, Marketing, Amphenol Connector Division, 1830 S. 54th Ave., Chicago 50, Illinois.

\*T.M. Amphenol-Borg Electronics Corp.



**Connector Division /** Amphenol-Borg Electronics Corporation

# Relay News

from ELECTRICAL INDUSTRIES

## NEW **E-I** HERMETICALLY SEALED RELAY HEADERS

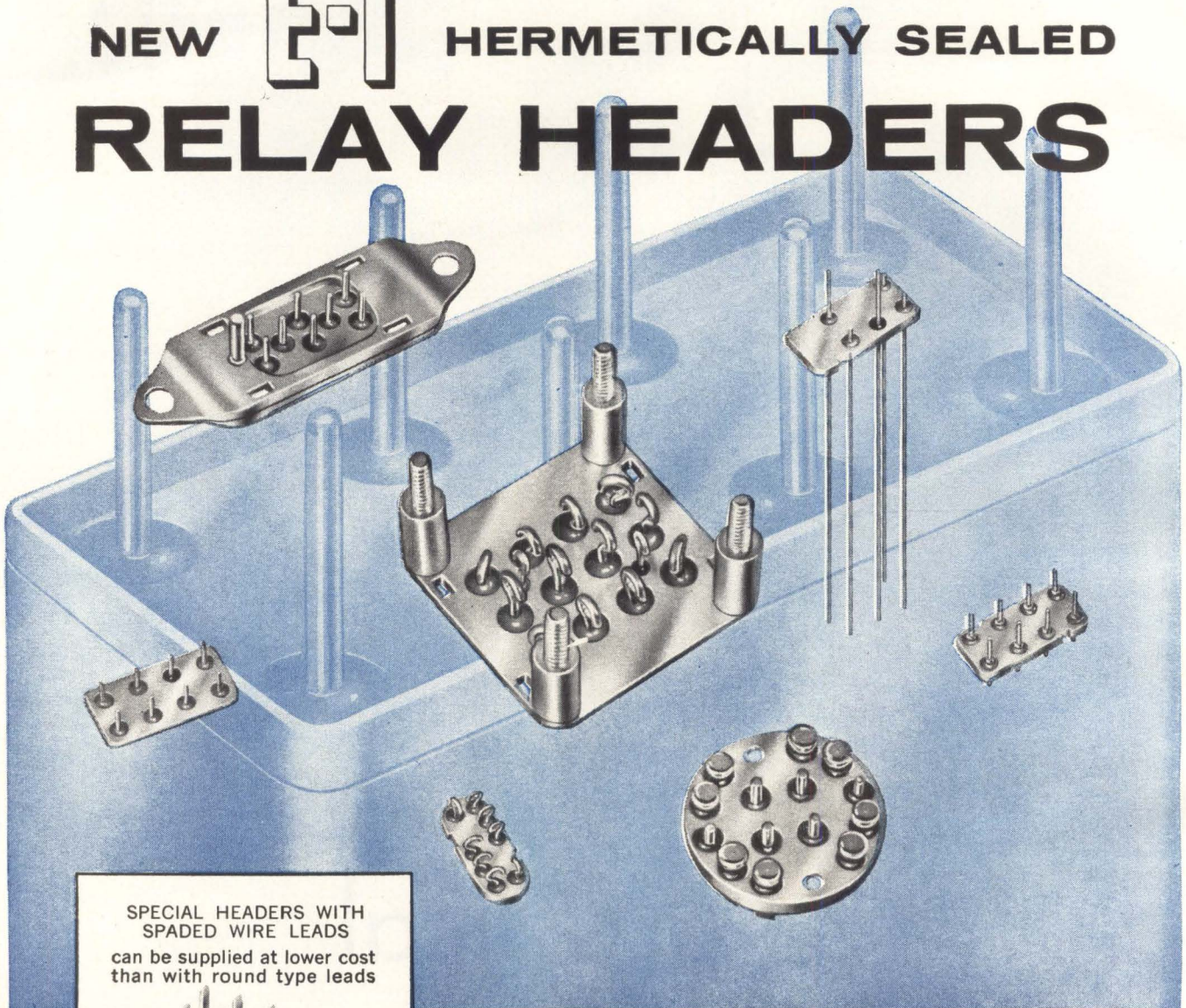

SPECIAL HEADERS WITH  
SPADED WIRE LEADS  
can be supplied at lower cost  
than with round type leads

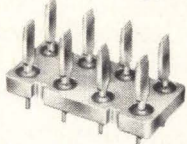

MODULAR TYPE HEADER  
SUITABLE FOR  
HELI-ARC WELDING

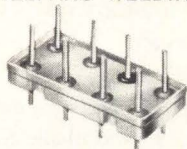

- Available in a Wide Range of Configurations
- Header Thicknesses down to .050 Inches
- Increased Torque Resistant Wire Available

E-I headers, featuring ruggedized compression seals, can be produced to your exact specifications to meet practically any type of relay application. In many cases, standard E-I tooling can be utilized at a considerable saving. Brazed contacts are available if required. Standard finishes available include hot solder dipped, electro-tin, nickel and gold. Special plating on order. Call or write E-I for quotations on your specific requirements!



### ELECTRICAL INDUSTRIES

691 CENTRAL AVENUE, MURRAY HILL, NEW JERSEY

*Division of Philips Electronics & Pharmaceutical Industries Corp.*

PATENTED IN CANADA, NO. 523,390; IN UNITED KINGDOM, NO. 734,583; LICENSED IN U. S. UNDER NO. 2561520



# FILTORS, INC. / RELAYS

PORT WASHINGTON, NEW YORK    Port Washington 7-8220, area code 516  
 In Canada: Filtors Division: Marsland Engineering Co., 154 Victoria St., Kitchener, Ont.

Filtors' new Miniwatt series relays... are 40-milliwatt microminiature relays that exhibit the performance characteristics normally associated with 250-milliwatt crystal-case relays. Miniwatt relays are especially useful in circuits where power is limited, packaging space is minimal, and environment is severe.

The motor in the Miniwatt relay series is a modified design of the famous Filtors' Sensi-Tork rotary relay motor. Because the Sensi-Tork motor delivers more torque per milliwatt input than any other microminiature relay motor, Filtors' 40-milliwatt relays deliver the contact pressures that assure reliable operation under severe vibration and shock: they are only slightly longer than standard crystal-case relays.

The Miniwatt Series relays are available in two configurations: the standard vertical mounting style (Series JV) and Filtors' new Pillbox mounting style (Series AV).

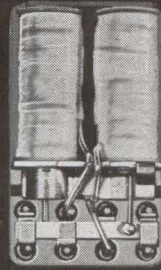

(actual size)

AMBIENT TEMPERATURE RANGE.....	-65°C to 125°C	SHOCK.....	50 G's for 11 milliseconds (100 G's available)
DIELECTRIC STRENGTH.....	1000 volts (500 volts between open contacts)	VIBRATION.....	10-55 cps, 0.06 inch amplitude; 55-3000 cps, 15 G's*
INSULATION RESISTANCE.....	1000 megohms minimum at 25°C	PICK-UP TIME.....	15 milliseconds maximum at nominal coil voltage at 25°C
CONTACT ARRANGEMENT.....	2-pole, double throw & 1-pole double throw	RELEASE TIME.....	15 milliseconds maximum
CONTACT RATING.....	2 amperes resistive at 28 vdc (dry circuit available)	ALTITUDE.....	100,000 feet
		DUTY.....	Continuous

\*ratings up to 30 G's available

## SMALL



CIRCLE 71 ON READER SERVICE CARD

*Opportunities for:*

# Aerospace Vehicles Engineers

The Aerospace Vehicles Laboratory of the Space Systems Division has openings for nearly one hundred engineers who have experience in stress, structures, propulsion, mechanisms, control systems, equipment installation or heat transfer which can be applied to advanced aerospace weapons systems or vehicles. The Aerospace Laboratory is concerned, as a result of SURVEYOR and other contracts, with lunar and space exploration, air to air missiles and ICBM defense systems. The openings are for both junior and senior mechanical engineers, electronic engineers, physicists and aeronautical engineers. Some of the openings are described below:

## Structures

**Senior Dynamicist.** Must be capable of performing advanced analysis in structural mechanics. Will be required to calculate response of complex elastic systems to various dynamic inputs including random excitation. Must be capable of original work in developing advanced analytical techniques.

**Loads Analyst.** To establish structural design criteria for advanced missiles and spacecraft. Should be capable of determining external airload and inertial force distributions.

**Reliability Analyst.** To perform statistical analysis of structural loads and strength properties for the purpose of establishing structural reliability criteria on a probability basis.

**Stress Analyst.** To perform advanced stress analysis of complex and redundant missile and spacecraft structures. Will be required to solve special problems in elasticity, plasticity, short time creep and structural stability.

**Design.** Experience is required in preliminary and final structural engineering and design, including preliminary stress analysis. A knowledge of the effects of extreme temperature environ-

ment and hand vacuum, plus a background in materials is desired.

## Heat Transfer

**Space Vehicle Heat Transfer.** Basic knowledge of radiation conduction and convection heat transfer with application to thermal control of space vehicles is required. Knowledge of spectrally-selective radiation coating, super-insulations and thermal vacuum testing is of particular value.

**Aerothermodynamicist.** Experience in hypersonic real gas dynamics, heat transfer, ablation; re-entry vehicle design, detection; shock layer, wake and rocket exhaust ionization; and anti-missile system requirements will be most useful.

## Equipment Installation

**Packaging and Installation Engineer.** To perform optimum packaging and installation design for missile and/or spacecraft units, considering amount and geometric shape of space available as well as weight and center of gravity distribution requirements. Must be capable of analyzing structural adequacy of unit under extreme environmental conditions.

## Controls

**Optical Devices.** Design, development, procurement and test operations are involved. Considerable experience in the field of optical devices for space applications such as star, horizon, sun and moon trackers.

**System Test.** To plan and supervise the operations of a flight control system laboratory. Air bearing tables and a wide variety of optical mechanical and electrical equipment are involved.

**Control System Analysis.** Requires engineers at various levels of experience including senior men capable of taking over-all project responsibility in the synthesis and analysis of control systems.

**Circuit Design and Development.** Experience in design and development of transistorized control system circuits, including various types of electronic switching and modulation techniques is required.

---

If you are a graduate mechanical engineer, electronic engineer, physicist or aeronautical engineer, with experience applicable to the above openings, please airmail your resume to: **Dr. F. P. Adler**, Manager, Space Systems Division, Hughes Aircraft Company, 11940 W. Jefferson Blvd., Culver City 20, California.

**WE PROMISE YOU A REPLY WITHIN ONE WEEK**

An equal opportunity employer.

Creating a new world with Electronics

**HUGHES**

HUGHES AIRCRAFT COMPANY  
SPACE SYSTEMS DIVISION

Newest...in the industry's  
most extensive line  
of rotary switches

# CENTRALAB SERIES 600

← 1<sup>9</sup>/<sub>32</sub>" →

# DIAMETER SWITCH

WITH 1<sup>1</sup>/<sub>2</sub>" STRUT CENTERS

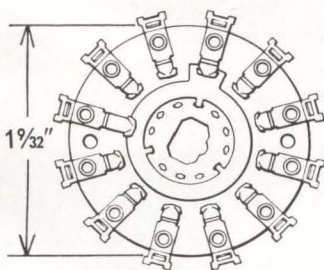
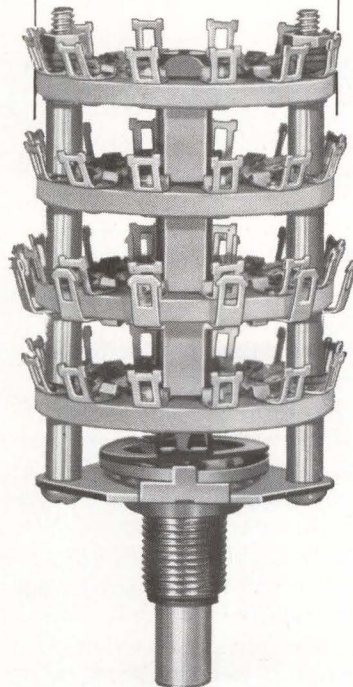

#### SPECIFICATIONS

**INSULATION:** 1500V RMS, Steatite, Grade L-5A, MIL-I-10  
1000V RMS, Phenolic, Type PBE, MIL-P-3115  
1500V RMS, Mycalex, Grade L-4B, MIL-I-10

**TORQUE:** Per MIL-S-3786A.

**CONTACT RESISTANCE:** 3 milliohms.

**CURRENT RATING:** 5.5 amps at 12 VDC.  
500 ma at 115 VAC.

**LIFE TEST:** 25,000 cycles minimum.

Designed to meet MIL-S-3786A, this switch is available with ceramic, phenolic or Mycalex sections. It can be supplied with adjustable or fixed stops with 30° or 60° indexing. The Series 600 switch has up to 12 terminals on each side of the stator of which 8 can be insulated.

Sample delivery is seven days. Production delivery, 4-5 weeks.

For detailed specifications, write for EP-1152.

Many types in stock at CENTRALAB distributors as Series PA-6000 Switches.

P-6209

# Centralab

THE ELECTRONICS DIVISION OF GLOBE-UNION INC.  
900A E. KEEFE AVENUE • MILWAUKEE 1, WISCONSIN  
In Canada: Centralab Canada Ltd., P.O. Box 400, Ajax, Ontario

ELECTRONIC SWITCHES • VARIABLE RESISTORS • CERAMIC CAPACITORS • PACKAGED ELECTRONIC CIRCUITS • ENGINEERED CERAMICS

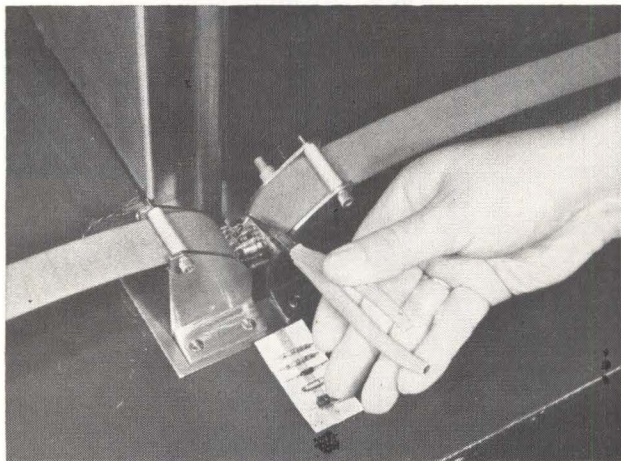

Two matched flexible strips, with printed circuits on the underside, come together at cordwood packing station

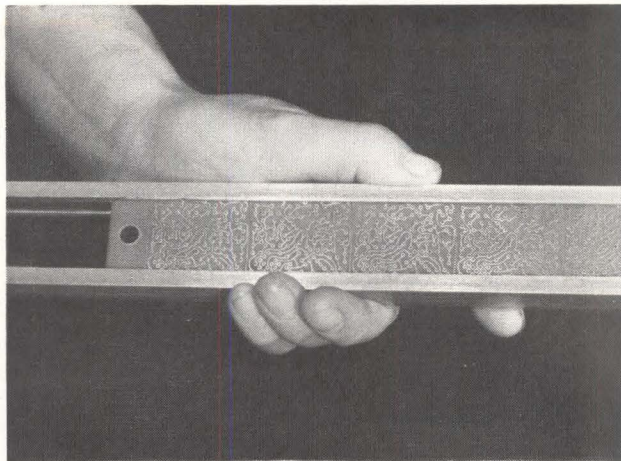

Module circuit is repeated as many times as is convenient on one side of each of the flexible strips

## Converging Strips Speed Module Assembly

By H. R. MILLIGAN

English Electric Aviation Ltd.,  
Luton Airport, Bedfordshire, England

A NEW METHOD of assembling high density, cordwood-stacked modules has been developed by English Electric Aviation Ltd. Called converging strip assembly, the method is claimed to be several times faster, even in its present, undeveloped form, than conventional U-channel assembly. An important advantage of the process is that it can be easily automated to any required degree. Rigidity of the assembled module allows flow-soldering to be used for speed; in addition, pre-assembly inspection techniques are simplified.

### High Density Circuits

Component densities of 250,000 to 300,000 per cubic foot can be attained using standard tubular components. Relatively unskilled labor can be used for assembly. In pilot tests a one by one by one-half inch module containing 70 components, including ten transistors and ten lead-through wires, was assembled in nine minutes at only the third run by the operator. Complimentary circuitry is printed and etched on the faces of two strips of flexible insulant (SRBP or glass

fiber) about 0.015 inches thick; the pattern is repeated at accurate intervals throughout the strip length and the strips are made as matched pairs.

Component wire holes and a feed and location hole are drilled or punched in the strip and then the strips are coated with solder. Components—of the cheap and easily available type—with lead wires cropped to correct length, are loaded into a magazine in a pre-arranged sequence dependent on module circuit pattern. Local screening within a module can be achieved with strips of plastic-insulated gauze inserted at the same time as other components.

The matched pair of strips is fed into the assembly machine where the leading edges of the strips engage converging guide slots. The strips are gradually brought together to a predetermined spacing as they are indexed through the fixture. At a point on the curvature where strip separation is suitable, components are inserted. As the strips converge further, components are drawn into correct position.

Holes in the boards are, as far as possible, drilled in definite rows so that only five or six components must be inserted at one position.

Component magazines, loaded with resistors, capacitors, transistors and other parts in definite rows (see sketch), are placed in the converging strips in a standard sequence. Light bulbs, located behind the strip guides in conjunction with light masks, light up only one row of holes at a time, thus the row being loaded is sharply defined. After each row is filled, the strips are moved along a definite distance until the next row of holes is lighted up and is in the loading position. This same procedure is repeated until the component magazine—or a section of the magazine if it holds parts for more than one module—is empty; the empty magazine section corresponds to a completed module and it is thus a partial check on the correctness of loading. All the modules in the strip are filled in the same way.

### Flow Soldering

As the loaded strips move through the machine they feed into a detachable magazine frame; the detachable frame holds the strip rigid for further processing. Next stage is flow soldering the component wires to the printed circuit pattern, which is completed while the modules remain held in the strip frame. During soldering, compo-

# Picture of sound being relayed under FREON<sup>®</sup> solvent

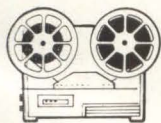

At recent national electronics shows we actually performed the demonstration depicted above. We taped a message, then connected the recorder's playback head to a high-fidelity amplifier. This we immersed in a tank of "Freon" for the entire duration of the show. Wires connected the output stage of the amplifier to a row of headphones. Show visitors listened to the message relayed under "Freon".

This demonstration was possible because "Freon" solvent is a superb dielectric and a selective cleaning agent. It cleans components or complete assemblies effectively without harm to metal parts, finishes, elastomers or plastic insulation.



Nothing cleans out oil, dirt, grease more efficiently. Its unique low surface tension gives deep penetration of tiny openings . . . keeps moving parts of missile

systems operating at tolerances as low as 0.00005 inch! And "Freon" cleans with safety. Nonflammable, nonexplosive, virtually nontoxic, it leaves no residue and can be recovered and used again and again for maximum economy.

Send for *free* 33 $\frac{1}{2}$  rpm demonstration recording made with the amplifier immersed in "Freon". Write on your company letterhead. If you have a specific cleaning problem, we'll be glad to arrange a visit by our representative. "Freon" Products Division, Room N-2420, E-1, E. I. du Pont de Nemours & Co. (Inc.), Wilmington 98, Delaware.



## FREON solvents



BETTER THINGS FOR BETTER LIVING . . . THROUGH CHEMISTRY

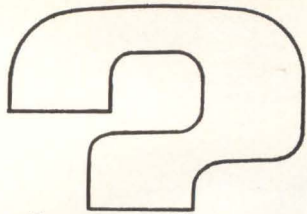

What do you need to know about



## PURE FERRIC OXIDES MAGNETIC IRON OXIDES

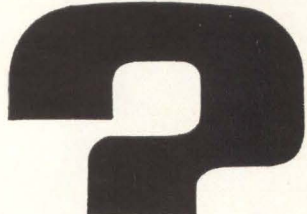

Since the final quality of your production of ferrites and magnetic recording media depends on the proper use of specialized iron oxides—you'll find it mighty helpful to have the latest, authoritative technical data describing the physical and chemical characteristics of these materials. This information is available to you just for the asking. Meanwhile, here are the highlights.

**PURE FERRIC OXIDES**—For the production of ferrites, both hard and soft, we manufacture a complete range of iron oxides having the required chemical and physical properties. They are produced in both the spheroidal and acicular shapes with average particle diameters from 0.2 to 0.8 microns. Impurities such as soluble salts, silica, alumina and calcium are at a minimum while  $Fe_2O_3$  assay is 99.5+%. A Tech Report tabulating complete chemical analysis, particle shape, particle size distribution, surface area, etc., of several types of ferric oxides, hydrated ferric oxide, and ferroso-ferric oxide is available.

**MAGNETIC IRON OXIDES**—For magnetic recording—audio, video, computer, and instrumentation tapes; memory drums; cinema film striping; magnetic inks; carbon transfers; etc.—we produce special magnetic iron oxides with a range of controlled magnetic properties. Both the black ferroso-ferric and brown gamma ferric oxides are described in a Data Sheet listing magnetic properties of six grades.

*If you have problems involving any of these materials, please let us go to work for you. We maintain fully equipped laboratories for the development of new and better inorganic materials. Write, stating your problem, to C.K. Williams & Co., Dept. 25, 640 N. 13th St., Easton, Pa.*

**WILLIAMS**  
COLORS & PIGMENTS

*Pigment  
Technology  
at its  
best*

E. ST. LOUIS, ILL. • EASTON, PENNA. • EMERYVILLE, CALIF.

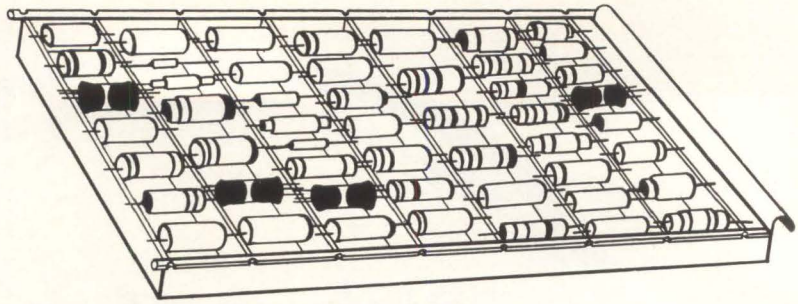

*Magazine holds components in pre-arranged order, with enough parts either for one module or a number of identical modules*

ment bodies reach a temperature of 60 to 65 C. After soldering, wires extending past the desired module thickness are cropped by a high-speed abrasive disc. For easy insertion, one lead is initially kept long and components are always inserted so that all the long leads appear on the same side of the module; thus only one side of the modules is normally cropped. If lead-through wires are needed, their long leads are inserted through the side that is left uncropped.

The completed module strip is then removed from the magazine and the modules are separated. Potting is done at this stage, if required; because component density is high, the quantity of potting resin required is below normal requirements.

Advantages of the system begin with the pre-loading of component magazines. After loading, the component magazines can be inspected easily, since components are visible. The magazines also minimize mistakes during insertion. Only one short row of holes is presented to the operator at one time and it is lit for easy identification. Any quantitative errors of component insertion then will be immediately apparent since there will either be an unfilled hole or a spare component remaining. Speed of assembly is greater, says English Electric, than with any other cordwood stacking method known to the company.

A module assembled in nine minutes by the converging strip method previously took well over an hour using U-channels. The technique makes high-density cordwood stacking comparable in cost to other, much lower density methods. Currently the process is being used for

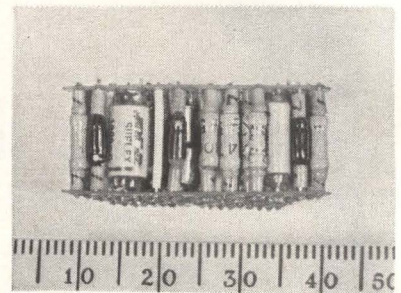

*Typical module uses conventional parts, still has high packing density*

one classified project where the quantities involved make a high degree of automation uneconomic. Production machines will be similar to the manual, lead-screw operated prototype rig used for testing. The major innovation on the production models will be the use of pneumatic indexing both for strips and component magazines. This means that when the operator indexes the strips, he also causes the component magazine to index, so the correct components for insertion are always presented for loading.

For other, mass-production applications, there are a number of refinements that can easily be incorporated. Thus, the component magazines can be loaded automatically from special hoppers, with automatic control being exercised with punched card techniques or by magnetic tape controlled gates. Another step toward further automation would be transfer lines from the module assembly machine to automatic soldering and finishing equipment; another automatic operation that is a distinct possibility is automatic component insertion. The increased automation of the process could be accomplished with only minor alteration of existing hardware.

**THIS  
IS A  
1 CUBIC FOOT  
COMPUTER!**

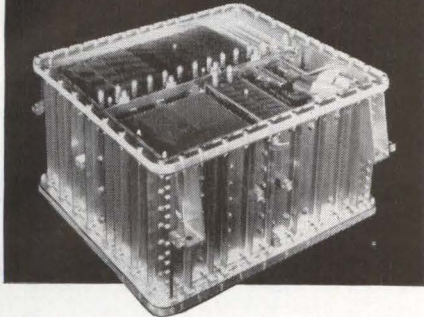

Innovations in high density packaging have compressed the performance of large, room-sized computers to "briefcase" dimensions at Univac. Example—a new Univac computer which measures just one cubic foot! Its thin film memory unit is an 8" cube, storing nearly 160,000 bits of memory. All other circuit components are commercially available items, ingeniously packaged and connected.

Univac continues to meet the challenge of the increasing demands for reliable miniaturization. Qualified personnel interested in both personal and professional advancement are invited to investigate the career opportunities now available on such programs.

*Immediate openings include:*

**RESEARCH ENGINEERS**

Attractive positions are now available for Research Engineers. These permanent assignments include circuit development work and the logical design of high speed computer elements.

- TRANSISTOR CIRCUIT DESIGNERS
- ELECTRONIC PACKAGING ENGINEERS
- SERVO-ENGINEERS
- ELECTROMECHANICAL ENGINEERS
- QUALITY CONTROL ENGINEERS
- PRODUCTION ENGINEERS
- RELIABILITY ENGINEERS
- STANDARDS & SPECIFICATIONS ENGINEERS

*Send resume of education and experience to:*

**R. K. PATTERSON, DEPT. T-1**

REMINGTON RAND  
**UNIVAC**

DIVISION OF SPERRY RAND CORPORATION

2750 West Seventh St., St. Paul 16, Minn.

*There are also immediate openings in all areas of digital computer development at our other laboratories. Inquiries should be addressed to:*

**F. E. NAGLE**, Dept. T-1  
REMINGTON RAND UNIVAC  
P. O. Box 500  
Blue Bell, Pa.

**D. CLAVELOUX**, Dept. T-1  
REMINGTON RAND UNIVAC  
Wilson Avenue  
South Norwalk, Conn.

*(An equal opportunities employer)*

# NEEDS AN OPERATOR

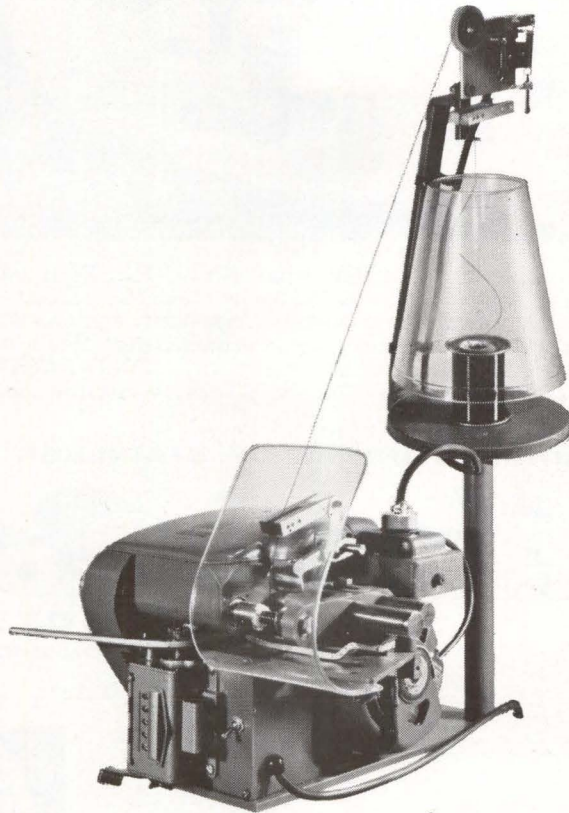

## to start it

Not much else to do. Watch it yourself ... in pleasure. See how the Leeson No. 115 Bachi Bobbin Winder saves an operator's time! See how it helps her change bobbins and start a new coil quickly, easily, *accurately*. No fumble to place wire in the wire guide—no needless motions. *Listen* to No. 115 ... you can hardly hear it. Watch for vibration ... you won't see any. Even at 10,000 rpm. No. 115 not only saves labor, reduces fatigue. It does more ... more accurately. For instance: set a dial ... the machine stops precisely at the number of turns desired. Another instance: turn a dial calibrated in 16ths of an inch, adjust traverse

infinitely from 0 to  $2\frac{3}{8}$  inches (to  $2\frac{3}{4}$  inches with special order machines). Adjust the wire guide pulley microscopically, compensate for differences in bobbin flange thickness. Obtain high speed up to 12,500 rpm, and with certain coils and wires, as high as 15,000 rpm. And this unusual machine not only winds spool wound coils: it also produces layer or form-wound coils. You can see No. 115 is compact. Our fact sheet and illustrated folder will show it has been designed sensibly so it is serviceable, that its components are extraordinarily efficient and durable, and it has the safeguards you want. Call your Leeson agent or write:



Leeson Corporation/Warwick, Rhode Island.

# Before you order . . . check NYLO-FAST® FASTENERS!

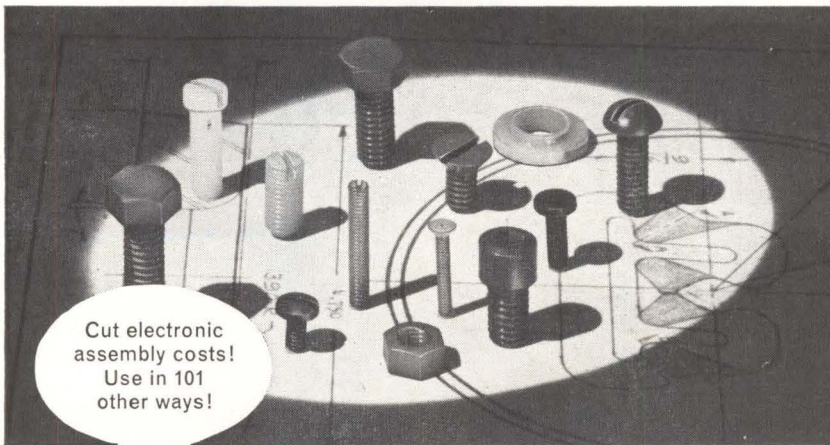

Cut electronic assembly costs!  
Use in 101 other ways!

Have you investigated what NYLO-FAST® Fasteners can do for you? They're colorful, strong — yet 1/6 the weight, chemical resistant, heat resistant, elastic, resilient, and non-conducting! You'll be surprised to discover how many ways NYLO-FAST® Fasteners can serve you—BETTER! Write for complete information.

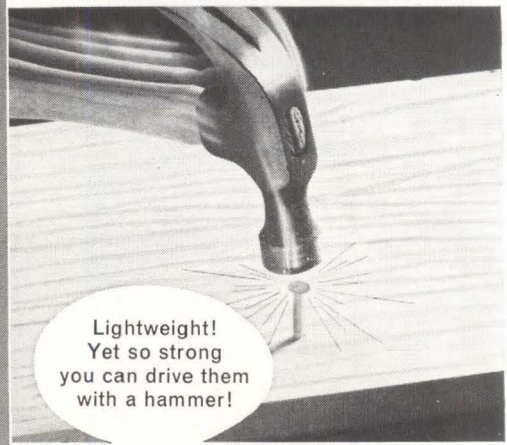

Lightweight!  
Yet so strong  
you can drive them  
with a hammer!

Immediate delivery from our large stocks which include Nylon, Delrin, Teflon, P.V.C., Lexan, etc. 10 different formulations! Write, wire, or telephone today for the facts!

**LEADING MANUFACTURERS OF STAINLESS STEEL AND NYLON FASTENERS!**

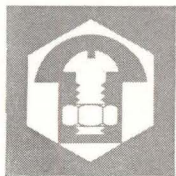

## Anti-Corrosive

**METAL PRODUCTS COMPANY, Inc.**

CASTLETON-ON-HUDSON 10, NEW YORK

CIRCLE 201 ON READER SERVICE CARD

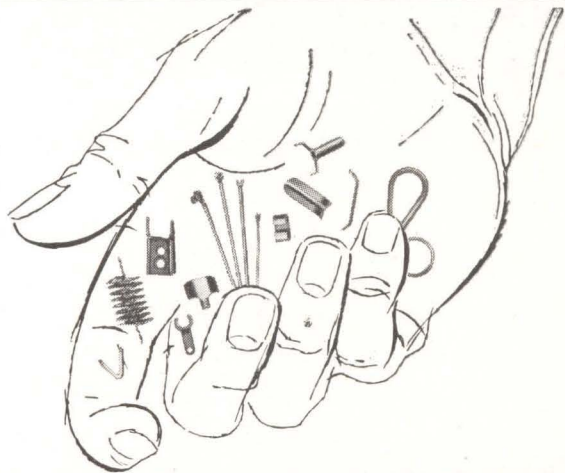

*We can show you SAVINGS!*

## PRECISION WIRE FORMS

Art Wire's high speed, automatic machines and production economies mean BIG SAVINGS for you . . . with guaranteed precision from the first to the millionth unit. Widest variety of wire components, made for today's automatic production, delivered on schedule to assure uninterrupted work flow.

Send a Sample or Blueprint for Estimates

**ART WIRE AND STAMPING CO.**

18 Boyden Place, Newark 2, N.J.

## Lepel

High Frequency

## INDUCTION HEATING EQUIPMENT

for

- BRAZING
- SOLDERING
- HARDENING
- ANNEALING
- MELTING
- BOMBARDING
- ZONE REFINING
- CRYSTAL GROWING
- PLASMA TORCH

### ELECTRONIC TUBE GENERATORS

Sizes: 1 Kw to 100 Kw output  
STANDARD UNITS  
Frequencies: 180 Kc to 600 Kc  
MEGACYCLE UNITS  
Frequencies: 3 Mc to 50 Mc  
DUAL FREQUENCY UNITS  
Frequencies: 180 Kc to 600 Kc  
and 3 Mc to 50 Mc  
SPARK GAP CONVERTERS  
Sizes: 2 Kw to 30 Kw input  
Frequencies: 400 Kc to 900 Kc

LEPEL LABORATORY SERVICE is offered without charge, to process your work samples and submit recommendations.

**Lepel**

WRITE FOR NEW LEPEL CATALOG

**HIGH FREQUENCY LABORATORIES, Inc.**

55th St. & 37th Ave., Woodside 77, N. Y. C.

Chicago Office for Sales & Service: 6246 W. NORTH AVE.

CIRCLE 202 ON READER SERVICE CARD

CIRCLE 79 ON READER SERVICE CARD →



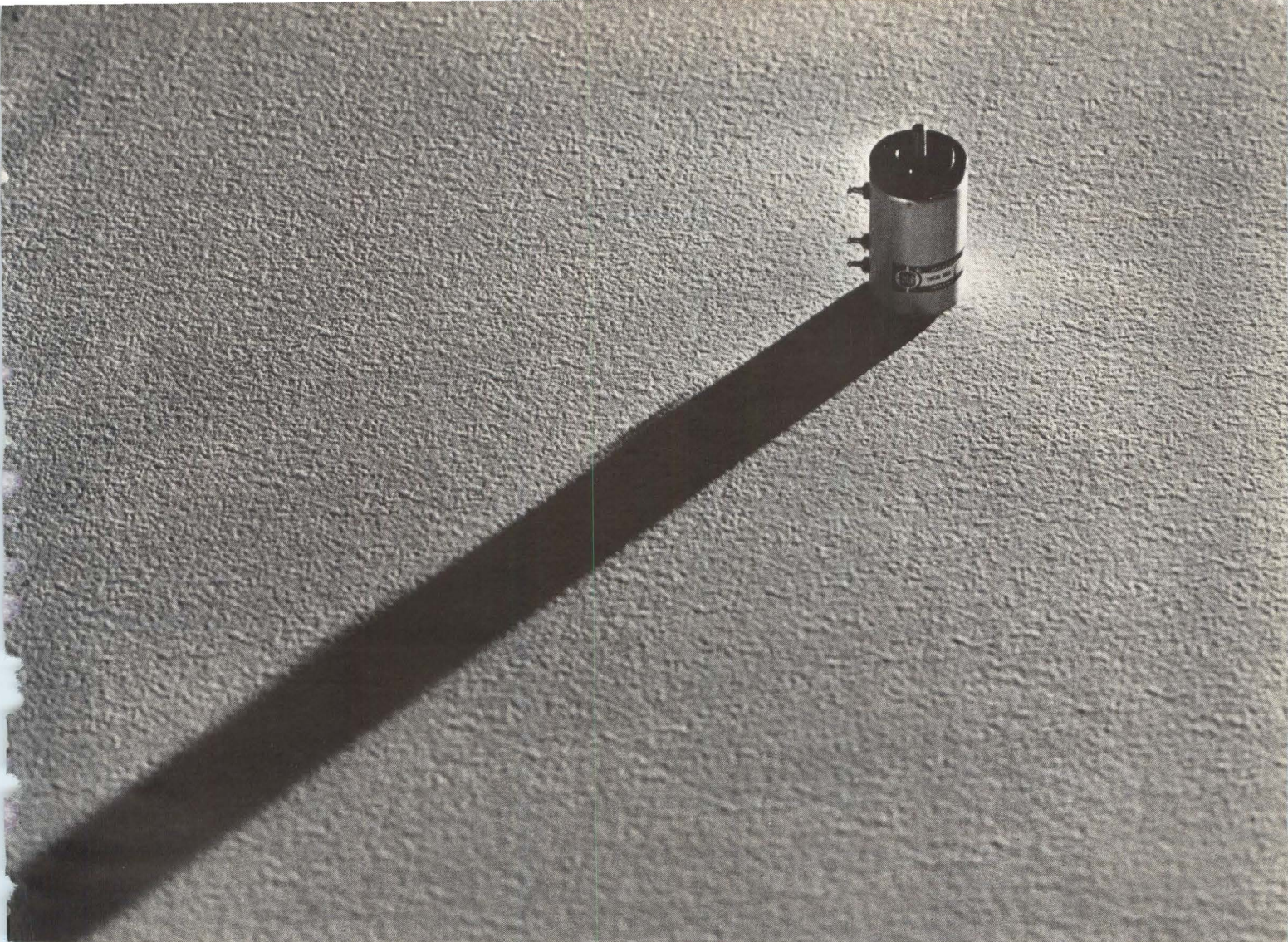

## How "complete" is a complete line?

Are you as confused about all this complete line talk as we are? What, for example, is a "complete" potentiometer line? This *should* include everything from the *cheap-and-dirty* kind you'll find on a bargain table-radio to the ultra-accurate precision type shown above. By such reckoning, our line of Borg Micropot<sup>®</sup> potentiometers is far from complete.

The Borg line is "complete" in a different way. Its range of sizes, ratings, and types makes it applicable to virtu-

ally every circuit requiring potentiometers with extreme accuracy, reliability and life expectancy along with small size, wide temperature ranges, and rugged resistance to shock, vibration and atmospheric contaminants.

In other words, the Borg Micropot line *is* a complete line—of precision units for precision applications. This is as true of the new 2100 series shown above as of the many other series in the Borg line. As true of single-turns as of

multi-turns. As true of commercial models as of military models.

There's a lot more to the Borg line than its completeness. It is *competitive*. Borg Micropot potentiometers are competitively priced, competitively distributed (through Amphenol Industrial Distributors), and competitively delivered. Find out for yourself. Contact your nearby Borg technical representative, Amphenol Distributor, or write to R. K. Johnson, Sales Manager.



### **BORG EQUIPMENT DIVISION**

Amphenol-Borg Electronics Corporation,  
Janesville, Wisconsin.

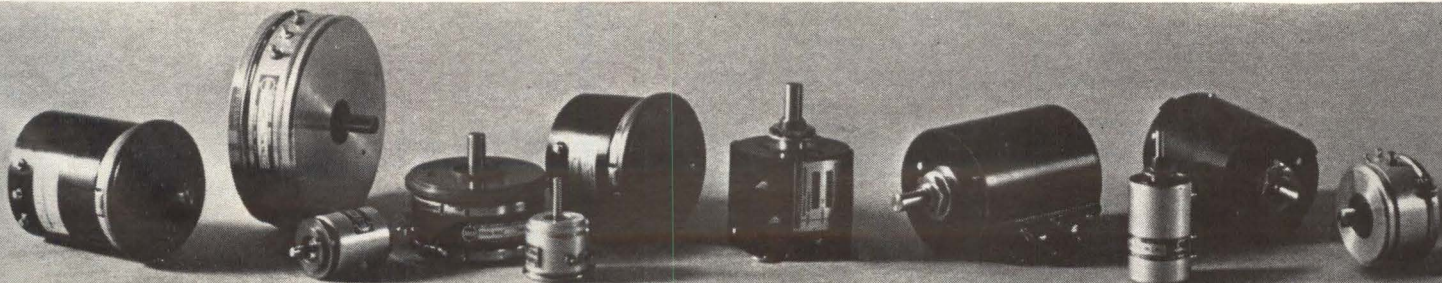

# TIME CAN BE MONEY SLIPPING AWAY

When time counts, it usually adds up to money! Profit-nibbling time lost.

In the case of pin and socket connections, add the uncertain reliability of other methods of terminating connections and you've got good reason to consider AMPin-cert\* Connectors with crimped, snap-in contacts.

AMPin-cert tape-fed, pin and socket contacts are precision crimped to leads on the AMP\* Automachine at rates of more than 1,600 per hour. High production rates, maximum reliability and low cost of semi-skilled labor combine with dependable connector performance for the lowest installed cost in the industry.

Make a simple, preliminary test. Check these AMPin-cert Connector features against whatever you're presently using:

- Compression crimping of leads to contact for maximum reliability backed by more than 20 years of AMP experience in solderless termination techniques
- Choice of five types of contacts
- Snap-in design contacts with cantilever beam construction for easy insertion

and dependable retention forces

- Choice of phenolic or diallylphthalate housings with or without cadmium plated aluminum shells in standard or environmentally sealed designs
- Wide variety of configurations and sizes and complete line of matching hardware and accessories.

Complete information will be sent upon request. Write today!

\*Trademark of AMP Inc.

# AMP INCORPORATED

GENERAL OFFICES: HARRISBURG, PENNSYLVANIA

AMP products and engineering assistance are available through subsidiary companies in: Australia • Canada • England • France • Holland • Italy • Japan • Mexico • West Germany

# MADE FOR EACH OTHER



**New From Continental ...  
a Complete Range of Connectors  
Designed for Wire-Wrapped Termination**

Shown here are three of the basic types of wire-wrap connectors now available from Continental in sizes and contact configurations to suit your requirements.

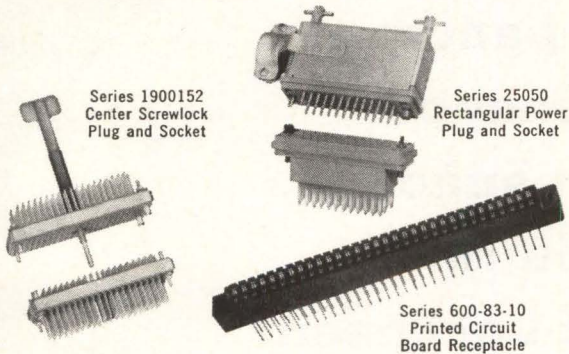

Continental's advanced connector engineering now drastically expands the number of applications in which you can take advantage of the high assembly speed, reliability and wiring density offered by automatic wire-wrapping techniques. Continental's comprehensive line of wire-wrap connectors now includes printed circuit, screwlock and terminal block types, with rectangular power connectors and other types available on order. All feature solid, sharp-edged brass terminations, gold plated over silver plate, accommodating three #20 AWG connections on each terminal. And—all include the Continental design features that spell maximum reliability in critical applications.

**DESIGNERS' DATA FILE.** If you're designing for wire-wrapped connections write for Continental's Con-Dex-File WR, Electronic Sales Division, DeJur-Amsco Corporation, Northern Boulevard at 45th St., Long Island City 1, New York (Exclusive Sales Agent), or call RAVENSWOOD 1-8000.

Wire-wrapping tool pictured above is product of Gardner-Denver Company

MICRO-MINIATURE • SUB-MINIATURE • MINIATURE • PRINTED CIRCUIT • RIGHT ANGLE PIN & SOCKET • CENTER SCREWLOCK

# CONTINENTAL CONNECTORS

CONTINENTAL CONNECTOR CORPORATION • WOODSIDE 77, NEW YORK

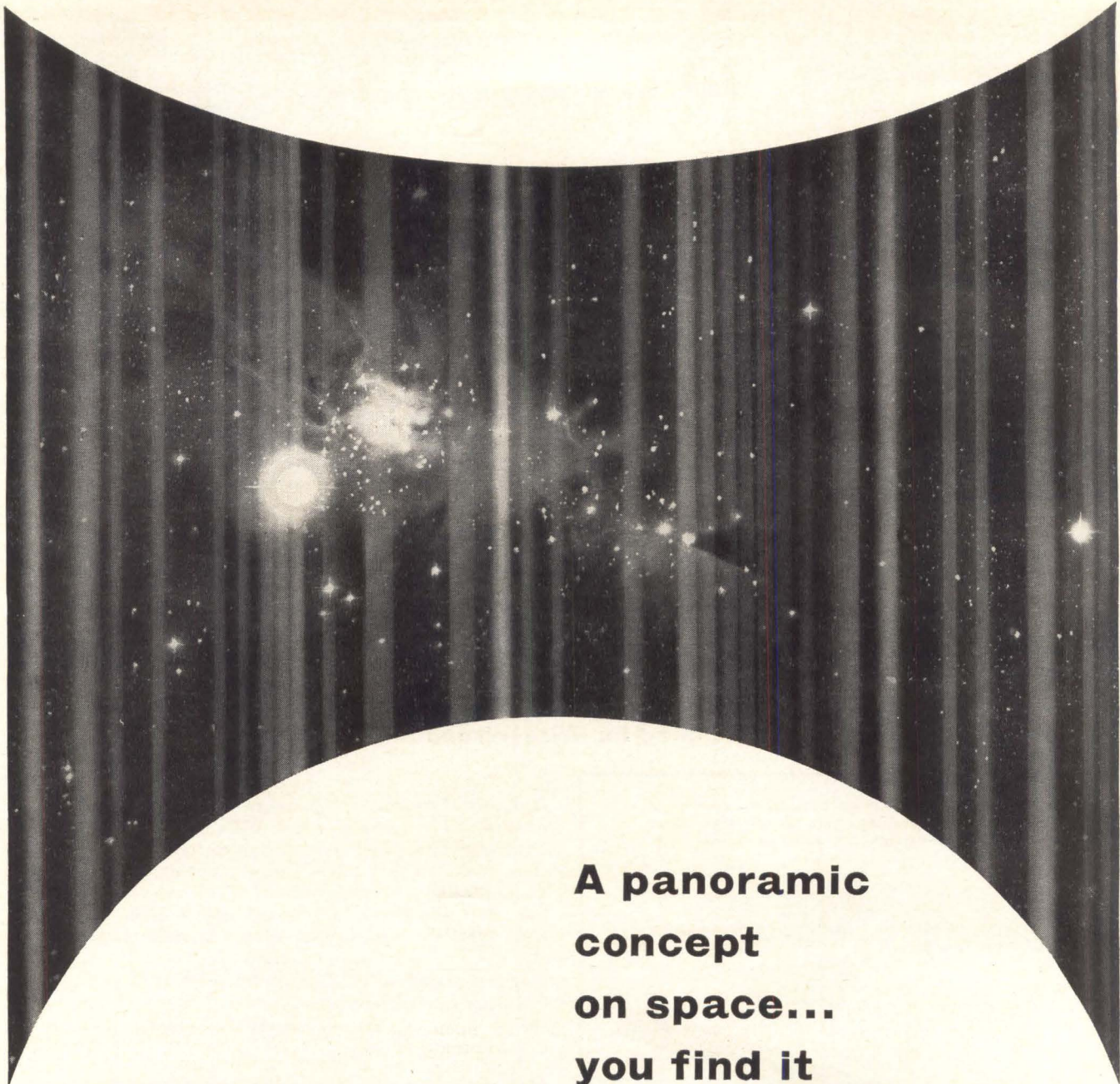

**A panoramic  
concept  
on space...  
you find it  
at Lockheed**

Long experience and proven capability give Lockheed a great advantage: perspective on space. This results in programs that cover the broad spectrum of aerospace dynamics; that present the most far-reaching technological problems; that offer endless creative challenge to Scientists and Engineers; that give them new concepts to explore—new goals to reach.

This far-ahead program in the concepts and vehicles of space creates a climate most favorable to advancement in the state of the art as well as in professional status.

**Scientists and Engineers** with an eye to a secure and

rewarding future will find these openings at Lockheed worthy of serious consideration: Aerodynamics; thermodynamics; dynamics; electronic research; servosystems; electronic systems; physics (theoretical, infrared, plasma, high energy, solid state, optics); electrical and electronic design; structural design (wing, empennage, fuselage); human engineering; reliability; wind tunnel design. Write today to Mr. E. W. Des Lauriers, Manager Professional Placement Staff, Dept. 1501, 2408 N. Hollywood Way, Burbank, California. An equal opportunity employer.

**LOCKHEED** CALIFORNIA COMPANY  
A DIVISION OF LOCKHEED CORPORATION

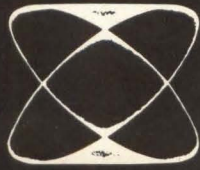

# THE SERVO CIRCUIT

Published by SERVO CORPORATION OF AMERICA

## TANK GUNNERS TAKE SHARP AIM

### Gun/turret control system zeroed in by SERVOSCOPE® servo system analyzer

Armored vehicle gun-elevating and turret-traversing control systems developed by Minneapolis-Honeywell's Ordnance Division, Minneapolis, are used in a number of different type Army, Marine Corps, and allied tanks.

Latest Honeywell design, a "dynamic gun/turret control system," provides for gyroscopic stabilization and control, effectively isolating the gun and turret from motion-induced rotational disturbances which tend to blur the gunner's view and affect orientation of the weapon.

Designed for fast, stable response, the closed loop control system permits the gunner to aim and fire at stationary and moving targets, as the tank rumbles over rough terrain, with a high probability of scoring first-round hits.

### SERVOSCOPE improves test accuracy, lowers development costs

Ordnance Division engineers credit the SERVOSCOPE® servo system analyzer with playing an important role in development of this latest M-H system.



SERVOSCOPE® was also used in the development and testing of armored vehicle turret components. Engineer, above, is shown analyzing stabilizer current using SERVOSCOPE.



Minneapolis-Honeywell Ordnance Division engineers using SERVOSCOPE® servo system analyzer to make dynamic analyses of new gyroscope-stabilized tank gun-elevating and turret-traversing control system.

The SERVOSCOPE was used to analyze transfer functions of open and closed loops and of damping and filter networks. Transient response and frequency response of systems and sub-systems components containing multi- and single-loop circuits could be observed.

Open loop frequency response measurements defined the characteristics of phase-correcting networks needed to achieve stable, closed-loop performance. Frequency response measurements were also used to verify filter network design. Closed loop transient and frequency response measurements tested total system performance.

The convenience of the SERVOSCOPE with its integral signal generator and phase shifter, note M-H engineers, simplified setup and operation. They also credit the servo system analyzer with improving test

accuracy and lowering development costs.

### Measures phase, gain, transient response

Using the SERVOSCOPE, an investigator can observe servo system phase, calculate gain, or measure transient response. Because the analyzer is a single, integral instrument, it can be used for final system inspection as easily as in design laboratory evaluation.

Fast direct setting and readout, coupled with high accuracy measurement, provides precise and rapid results. No calibration is required, making the analyzer immediately applicable to different problems.

Send for technical bulletin and free SERVOSCOPE Worksheets and Servo Slide Rule.



SERVO CORPORATION OF AMERICA • 111 New South Road • Hicksville, L.I., N.Y.

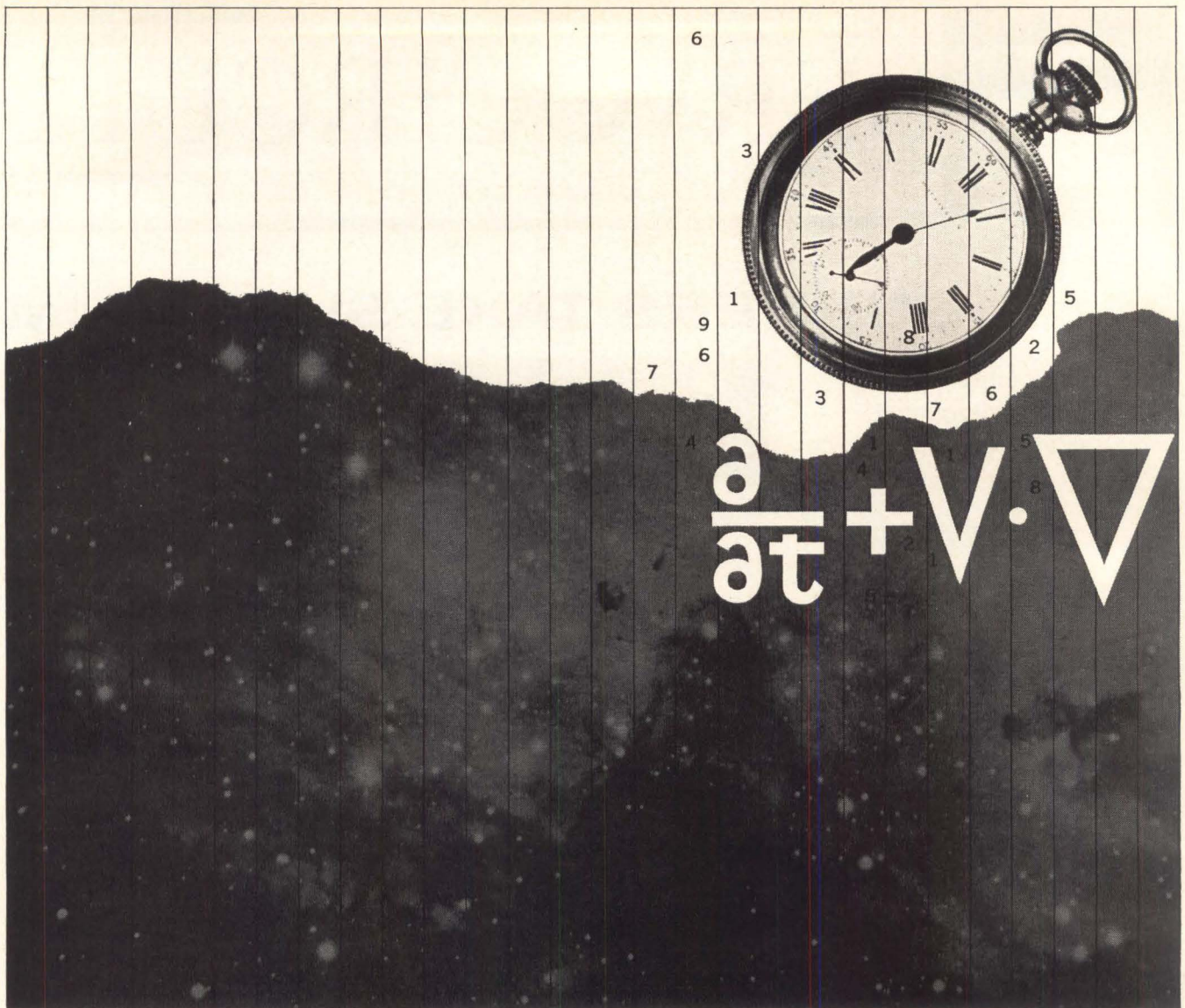

## purposeful imagination....in time

The men of Aerospace apply the full resources of modern science and technology in a timely manner to achieve the continued advances in ballistic missile and space systems basic to national security. Their mission includes stimulating the flow of the most advanced scientific information and objectively planning the technical management programs necessary to generate superior systems in the shortest possible time. □ Chartered exclusively to serve the United States Government in this effort and acting in partnership with the Air Force-science-industry team, the men of Aerospace contribute: advanced systems analysis and planning; theoretical and experimental research; general systems engineering and corresponding technical direction of programs. □ To aid in reducing the timetable of advanced systems, from concept through completed mission, more men with advanced degrees are needed at Aerospace Corporation, an equal opportunity employer. Dedicated interdisciplinary scientists and engineers who can contribute effectively are invited to contact Mr. George Herndon, Room 110, Aerospace Corporation, P. O. Box 95081, Los Angeles 45, California. □ Organized in the public interest and dedicated to providing objective leadership in the advancement and application of science and technology for the United States Government.

**AEROSPACE CORPORATION**  
 2400 EAST EL SEGUNDO BLVD., EL SEGUNDO, CALIFORNIA



## Eye-opening facts about miniature electrolytic capacitors

Many electronic designers and buyers already depend on iei for higher reliability capacitors and dependable service. If iei is a new name to you, here are the facts.

**iei** offers full polar, partial polar and non-polar construction in aluminum foil, 85° and 125° tantalum foil, tantalum wet slug and solid tantalum types. For many years iei has been the only company specializing in low-voltage, miniature electrolytic capacitors for transistor applications.

**iei** units cover the range from 3 to 150 WVDC, from 2 to 5000 mfd, and offer the greatest range of standard types and ratings.

**iei** 85° Tantalum Foil units are available in ten case sizes—5 MIL, 5 smaller with equal capacity—for optimum space utilization.

**iei** and local distributors stock standard values of these miniature electrolytic capacitors.

**iei** has prepared a new technical bulletin for specifying and buying personnel. Write for Form 2773 to International Electronic Industries, Box 9036-94, Nashville, Tennessee. A Division of Standard Pressed Steel Co.

**International Electronic Industries Div.**

**SPS**

*where reliability replaces probability*

# DESIGN AND APPLICATION

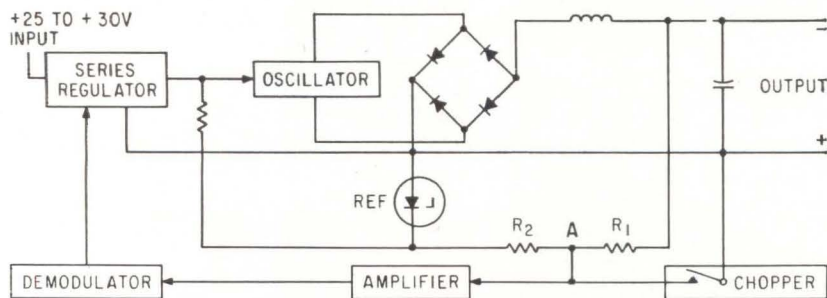

## Multiplier-Phototube Supply

CAN HANDLE SIX OR MORE CIRCUITS

RECENTLY released by Grafix, 2841 San Mateo Blvd., NE, Albuquerque, New Mexico, is the HVS-1000 multiplier-phototube power supply. This completely solid state chopper-stabilized inverter is shown in the schematic. The single-pole, single-throw solid-state chopper opens and closes point A to ground in synchronism with the demodulator and oscillator. The output voltage is divided down and compared to a reference voltage. Any voltage differ-

ence existing at point A will appear as an a-c voltage which is amplified, demodulated and used to control the series regulator. This unit can deliver 1,000 v at 6 ma; the regulation with input voltage variations between 25 and 32 v and  $\pm 33$  percent load variations is less than  $\pm 0.04$  percent. Ripple peak-to-peak is less than 0.05 percent; occupies 6 cubic inches and weighs 12 oz.

CIRCLE 301 ON READER SERVICE CARD

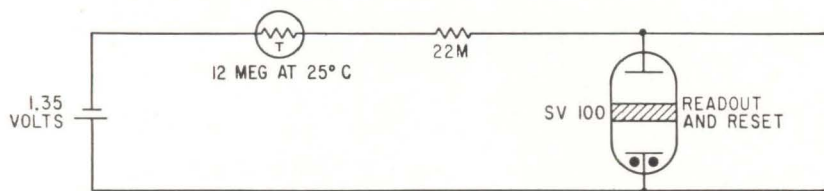

## Electrochemical Integrator

EITHER VISUAL OR ELECTRICAL READOUT

RECENTLY announced by Texas Research and Electronic Corporation, Meadows Building, Dallas, Texas, is the SV100 electrochemical integrator. This device is a miniature long-term current integrator whose charge capacity (time integral of current) is 0.05 coulomb. Voltage drop is 0 to  $\pm 100$  mv depending upon the integral value. The integral drift is approximately 3 micro-coulombs per day corresponding to a leakage or error current of  $3 \times 10^{-11}$  amperes. Readout may be either visual or electrical. Visual

readout is a color change in the integral compartment while the more accurate electrical readout is available because the voltage across the device is a function of the time integral of current. The slope of the output voltage can be positive or negative depending on the initial conditions established. The circuit shows a long-term integration application, in this case for climatological purposes. The temperature-sensitive element is a thermistor in series with a resistor chosen for best compromise between sensitiv-

ity and linearity of current change with temperature. The current in degree hours is determined by measuring the voltage across the integrator and a supplied calibration curve. This circuit will integrate 20 F to 100 F for one week to give average temperature within  $\pm 2$  F.

CIRCLE 302 ON READER SERVICE CARD

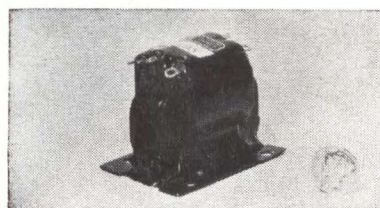

## Transformer

MICROMINIATURE

TRANSISTOR APPLICATIONS, INC., Somerville, Mass. The Firefly transformer is  $1\frac{3}{4}$  in. high,  $2\frac{1}{2}$  in. long and  $1\frac{1}{8}$  in. wide. It uses new developments in heat-dissipating techniques, optimized design, heat resistant materials and ultrahigh flux density cores. It is intended for use in aircraft, missiles, nuclear reactors and control equipment.

CIRCLE 303 ON READER SERVICE CARD

## Dielectric Impregnant

COLUMBIA TECHNICAL CORP., Woodside 77, N. Y. The HumiSeal type 1B21 is a dielectric impregnant designed for application as a coil dope over a wide range of frequencies.

CIRCLE 304 ON READER SERVICE CARD

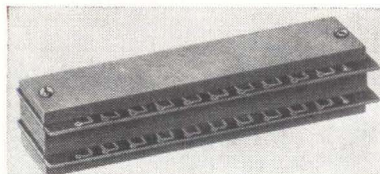

## Tapped Delay Lines

FULLY POTTED

ALLEN AVIONICS, INC., 255 E. 2nd St., Mineola, N.Y. The Quick Lines modular, tapped delay lines can be

CIRCLE 89 ON READER SERVICE CARD →



# BIGGER "EARS" FOR THE NAVY

**1 KILOWATT SEMICONDUCTOR AUDIO AMPLIFIERS TODAY  
100 KILOWATT SEMICONDUCTOR AUDIO AMPLIFIERS TOMORROW**

Today, the Boston Division of Honeywell is delivering one kilowatt linear audio amplifiers for driving sonar transducers to the United States Navy Underwater Sound Laboratory.

Tomorrow, using a new basic technique for producing a-c and d-c at high power levels, Honeywell is designing semiconductor amplifiers capable of hundreds of kilowatts of audio power.

Employing transistors in the switching mode, Honeywell engineers have developed a feedback system of pulse width modulation (patent pending) which produces more accurate linear amplification than any conventional method.

The new technique can be used wherever low power a-c or d-c is to be amplified from a different a-c or d-c power source and wherever amplitude of voltage or current must be controlled.

A method of creating bigger "ears" for the Navy is typical of the inventive thinking of Honeywell's Military Products Group. In the electronics area exciting new ideas are being explored in high power solid state audio amplifiers. These amplifiers are an important contribution to Honeywell's expanding sonar systems capability.

Write for information on Honeywell's capabilities in the electronics area to Minneapolis-Honeywell, Boston Division, Dept. 7, 1400 Soldiers Field Road, Boston 35, Mass., or call your local Military Products Group Office. Sales and Service offices in all principal cities of the world.

Challenging career positions for Electro-Mechanical Design Engineers, Circuit Design Engineers and Physicists are now available in the Boston Division. Write to Personnel Department.

*An equal opportunity employer*

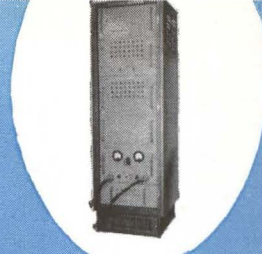

## Honeywell



*Military Products Group*

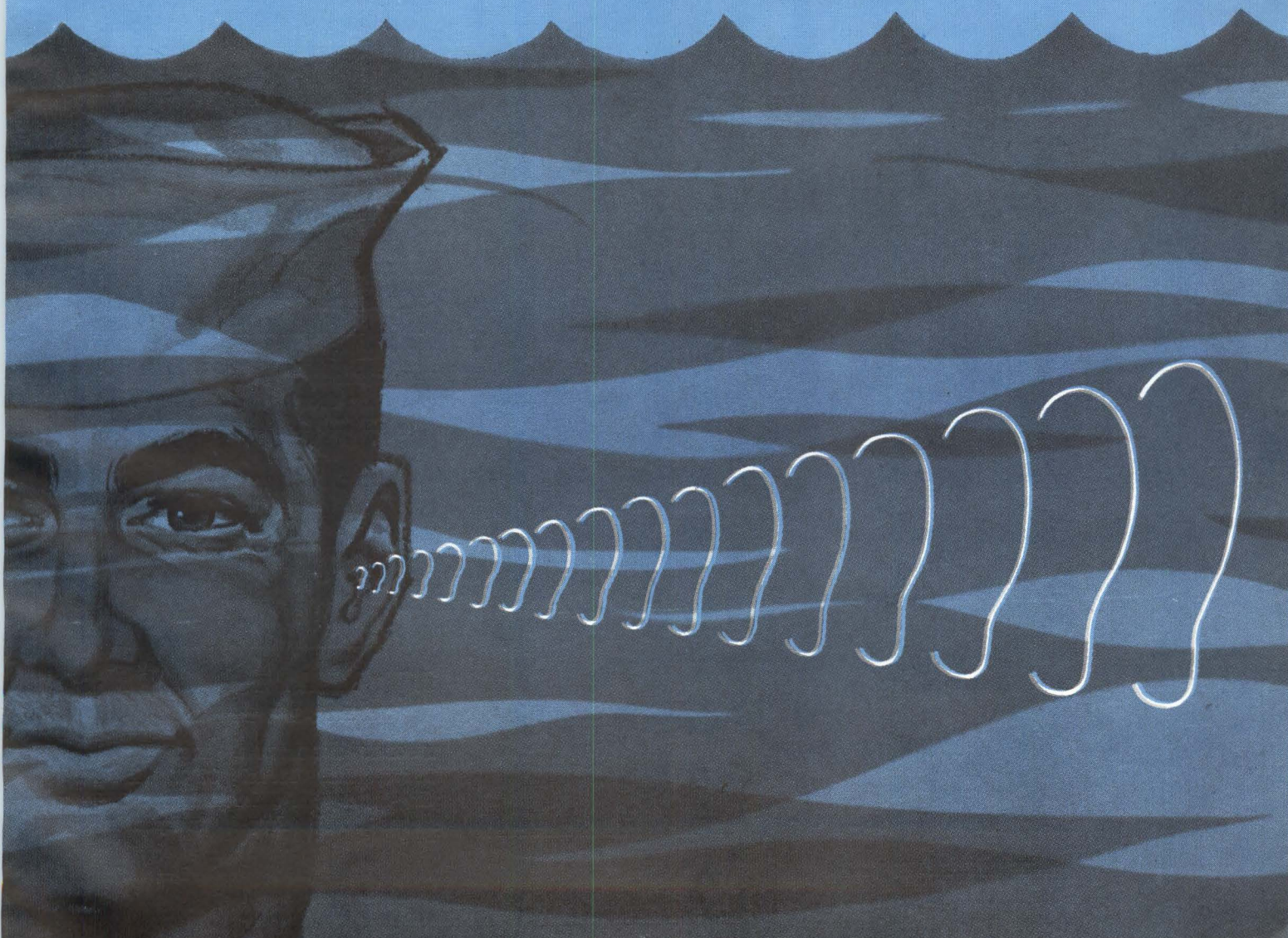

# THE *light* TOUCH

## IN AUTOMATION AND CONTROL

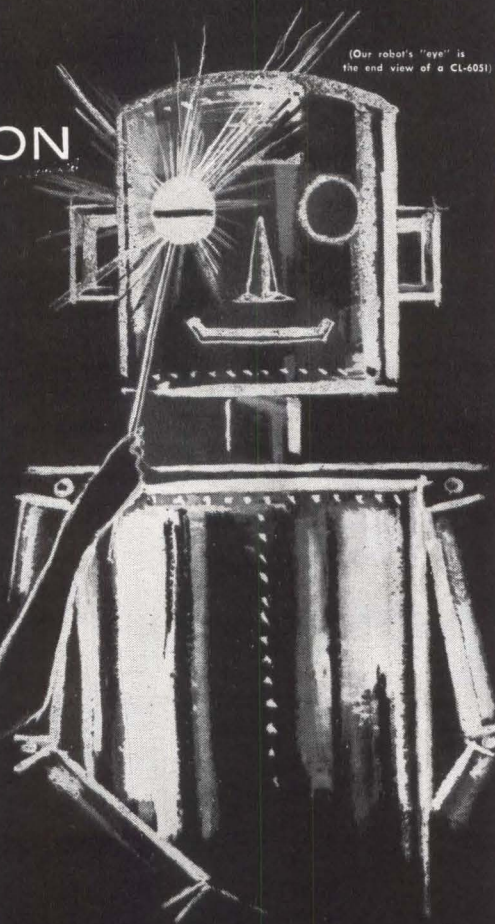

(Our robot's "eye" is the end view of a CL-6051)

Clairex Photoconductive Cells, like the human eye, are "windows to the world" of control system design. Our continually expanding line now includes the 5-1 series of hermetically sealed Cadmium Sulphide cells, employing a sensitive material formulation that matches the spectral sensitivity of the human eye! These are the first real "electronic eyes" and thus are particularly useful in applications involving human vision . . . such as Daylight Switches, Photography, and Automatic Brightness Control in Television Receivers.

 **CLAIREX**  
CORPORATION

and New Facilities . . . to meet Growing Needs  
8 WEST 30 STREET, NEW YORK 1, N. Y. • MU 4-0940

supplied in 100, 500 and 1,000 ohms impedance. Over 500 are available from stock with delays from 0.05 to 8  $\mu$ sec. Each section has the start and finish available so that lines can be terminated at any number of sections and tapped in as many places as desired. Units are constructed in 10 section modules, and by adding modules, lines with any number of sections can be constructed.

**CIRCLE 305 ON READER SERVICE CARD**

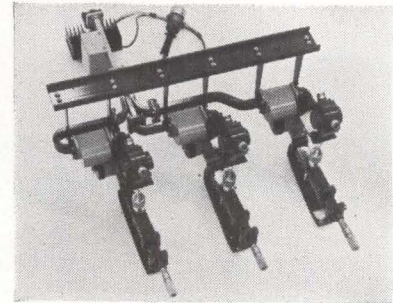

### Parametric Amplifier

PHASE STABLE

VARIAN ASSOCIATES, 611 Hansen Way, Palo Alto, Calif. The V-8353A phase stable parametric amplifier is a three-channel, non-degenerate, low-noise unit designed and packaged as a preamplifier for improving the performance of the AN/FPS-16 radar. Package includes all accessory equipment and components making possible the significant reduction of the noise figure, from 10.5 to 3.5 db.

**CIRCLE 306 ON READER SERVICE CARD**

### Coax Balanced Mixers

RLC ELECTRONICS, INC., 805 Mamaroneck Ave., Mamaroneck, N. Y. Line of coaxial balanced crystal mixers are available in 6 ranges for operation from 250 Mc to 7 Gc.

**CIRCLE 307 ON READER SERVICE CARD**

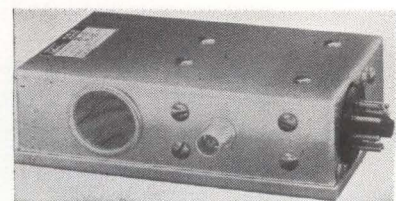

### C-W Oscillator

CRYSTAL-CONTROLLED

TELONIC INDUSTRIES, INC., Beech Grove, Ind. Model CP-11 is a plug-in, crystal-controlled unit that serves as a simple, inexpensive

source of c-w for the instrumentation or systems engineer requiring such signals. The oscillator is available in any frequency from 200 Kc to 75 Mc, with an accuracy of  $\pm 0.005$  percent. Basic circuitry consists of a series-fundamental or overtone crystal oscillator followed by an output amplifier that provides over 100 mw into 50 ohms.

**CIRCLE 308 ON READER SERVICE CARD**

### Variable Attenuators

MICROWAVE ASSOCIATES, INC., Burlington, Mass., announces four calibrated variable attenuators for power level adjustment in microwave equipment and lab test applications.

**CIRCLE 309 ON READER SERVICE CARD**

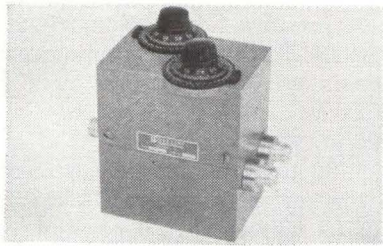

### Coaxial Diplexer

COMPACT UNIT

WAVELINE, INC., Caldwell, N.J. Model 90158, a 6-cavity coaxial diplexer tunes the range of 1.7 to 2.4 Gc. It accomplishes the diplexing function as an integral characteristic of a combined assembly. The device, designed to discriminate frequency difference, has two type N outputs available for low power receiver and transmitter connections, as well as type N input connector.

**CIRCLE 310 ON READER SERVICE CARD**

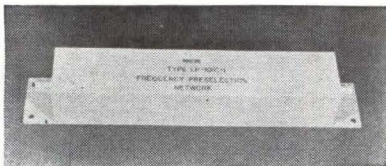

### Low-Pass Filter

100-W POWER RATING

ELECTRO INTERNATIONAL, INC., Box 391, Annapolis, Md., offers a low-pass antenna filter compatible with rfi control requirements. Type LP-101C is designed to pass all frequencies below 32 Mc with an insertion loss of 0.5 db or less. In the stop-band the attenuation curve

# Itek

## Crystal Filters do Wonderful Things

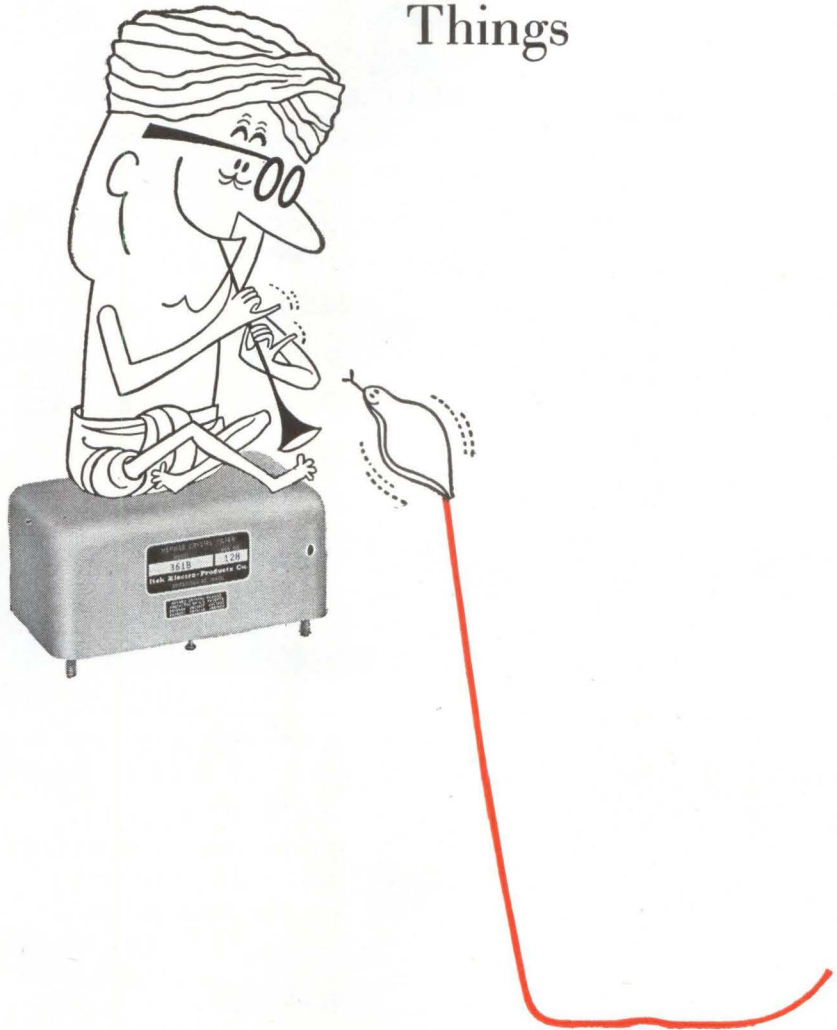

Charming a Doppler signal out of the clutter is a wonderful thing! Itek Crystal Filter 361B stops in the stopband, passes in the passband (with hardly a ripple), and slopes nearly straight up between the two. Similar Itek filters for single side band transmission and reception have been designed up to 40 megacycles.

Perhaps you don't need a Doppler crystal filter. But could you use the ingenuity that built one? Could Itek technical leadership help you?

Of course, the world's largest and most complete selection of stock crystal filters is available, too. Choose from more than 3,000 Itek-Hermes designs.

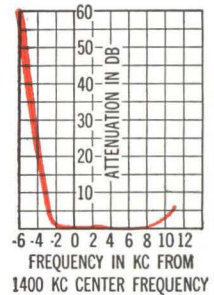

Write for free Brochure "WEESKACFAACP" or, *What Every Engineer Should Know About Crystal Filters At A Cocktail Party. You'll enjoy it.*

## Itek Electro-Products Company

75 CAMBRIDGE PARKWAY, CAMBRIDGE 42, MASS. A DIVISION OF

# Itek



**DEPENDABLE**

**TI Semiconductors & Components**

from your  
AUTHORIZED



**TEXAS INSTRUMENTS  
DISTRIBUTORS**

CIRCLE 203 ON READER SERVICE CARD

## MAKING ROOM AT THE TOP



See the 41 additional EICO instruments helpful for your lab and line work. Write for free catalog and name of neighborhood distributor.



Dept. E-1B  
3300 N. Blvd., L.I.C. 1, N. Y.  
Export Dept.: Roburn Agencies, Inc.  
431 Greenwich St., N. Y. 13, N. Y.

Add 5% in the West.

*EICO creates a new, professional lab quality test instrument series at moderate prices.*

**EICO®**

**AC VTVM & AMPLIFIER  
#250**

Kit \$49.95, Wired \$79.95

**VTVM:** 12 ranges from 1mv to 300v rms; response absolutely flat from 10 cps to 600 kc; input impedance 10MΩ shunted by 15μf; accuracy ±3% of full scale.

**Note:** Average responding meter calibrated in rms. Linear 0-1, 0-3 scales. Decibel scales based on 0db=1mw in 600Ω with 10db interval between ranges.

**AMPLIFIER:** 60db gain on 1mv range; response +0, -3db from 8cps to 800kc; output to 5V rms undistorted, variable down to zero by attenuator control at output; input impedance 10MΩ, output impedance 5KΩ; hum & noise -40db for signal inputs above 2mv.

**DESIGN QUALITY:** All frame-grid tubes; 60db frequency-compensated input attenuator ahead of cathode follower with 10db/step attenuator following; two-stage R-C coupled amplifier and full-bridge meter circuit in one overall feedback loop; no response adjustment required in amplifier circuit; single sensitivity adjustment; voltage-regulated power supply. 50/60 cycle operation.

**EICO MODEL 255 AC VTVM**  
Identical to Model 250 described above, but less amplifier facility. 50/60 cycle operation.  
Kit \$44.95      Wired \$72.95

rises sharply to better than 100 db at 50 Mc and provides a nominal attenuation of 100 db up to 10,000 Mc. Impedance is 52 ohms, input and output.

CIRCLE 311 ON READER SERVICE CARD

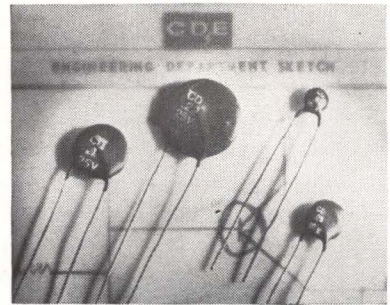

**Ceramic Capacitor  
SMALL SIZE**

CORNELL-DUBILIER ELECTRONICS, New Bedford, Mass. The 25-vdew type HCC TinyMike ceramic capacitor is available in four nominal ratings: 0.01-, 0.05-, 0.10- and 0.22-μf with capacitance tolerance of +80 percent and -20 percent. Minimum leakage resistance at +25 C will exceed 50 megohms at 5 v and 2 megohms at 25 v. Capacitor also features a low maximum power factor of 10 percent. It withstands life tests of 500 hr at rated voltage and 85 C.

CIRCLE 312 ON READER SERVICE CARD

## Gold/Tin Laminate

ALLOYS UNLIMITED, INC., 21-01 43rd Ave., Long Island City 1, N. Y. Five-layer gold/tin laminate enables a silicon diode to be bonded to the dumet stud of the conventional glass diode package in one operation.

CIRCLE 313 ON READER SERVICE CARD

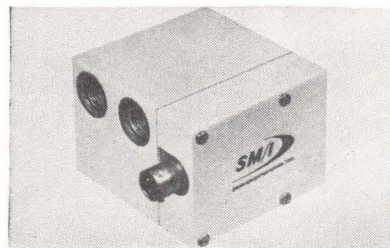

**Pressure Switch  
SOLID-STATE**

SERVOMECHANISMS/INC., 200 N. Aviation Blvd., El Segundo, Calif. Type TR2129 supplies a switch

closure or opening on either an increasing or decreasing pressure. Heart of the unit is a pressure transducer using a twisted Bourdon tube. By coupling the transducer with solid-state circuitry, SM/I has produced a pressure switch with either single or multiple switch points. A 60 psi unit will not chatter when subjected to 60 g vibration when the pressure input is only 0.5 percent away from the switch point. Switch is available for pressures from 0 to 1,000 psi, differential or absolute.

**CIRCLE 314 ON READER SERVICE CARD**



**Subcarrier Oscillator  
FOR TELEMTRY**

DORSETT ELECTRONICS, INC., P.O. Box 862, Norman, Okla. Transistorized low-level subcarrier oscillator for telemetry application is designed to accept signal inputs of  $\pm 10$  mv or 0 to +20 mv. A-c common mode rejection is 100 db minimum from d-c to 1,000 cps. D-C common mode rejection of 140 db minimum. Model MVO-20 is packaged in the Dorsett module two configuration (1.76 in. by 1.87 in. by 2.25 in.)

**CIRCLE 315 ON READER SERVICE CARD**

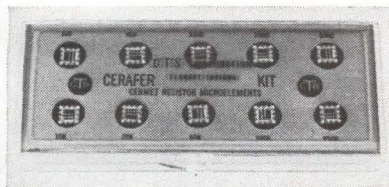

**Resistance Wafer Kit  
TEN MICRO-ELEMENTS**

CTS CORP., Elkhart, Ind. Kit containing 10 Cermet resistor microelements for use in micromodule experimentation is offered for \$20. The resistance wafers, called Cerafers, are rated from 100 to 250,000

January 26, 1962

# BALLANTINE Wide Band, Sensitive VTVM model 317

Price: \$495  
with probe



**Measures**  
**300  $\mu$ V to 300 V**  
**at Frequencies 10 cps to 11 Mc**

A stable, multi-loop feedback amplifier with as much as 50 db feedback, and 10,000 hour frame grid instrument tubes operated conservatively, aid in keeping the Model 317 within the specified accuracy limits over a long life. A million to one in voltage range and over a million to one in frequency coverage makes it attractive as a general purpose instrument for measurement of af or rf as well as the complete band. **All readings have the same high accuracy over the entire five inch voltage scales.** This is typical of all Ballantine voltmeters due to the use of individually calibrated logarithmic scales. The 317 may be used as a null detector from 5 cps to 30 Mc having a sensitivity of approximately 100  $\mu$ V from 10 cps to 20 Mc.

## SPECIFICATIONS:

- VOLTAGE:** 300  $\mu$ V to 300 V.
- FREQUENCY:** 10 cps to 11 Mc (As a null detector, 5 cps to 30 Mc).
- ACCURACY:** % of reading anywhere on scale at any voltage. 20 cps to 2 Mc — 2%; 10 cps to 6 Mc — 4%; 10 cps to 11 Mc — 6%.
- SCALES:** Voltage, 1 to 3 and 3 to 10, each with 10% overlap. 0 to 10 db scale.
- INPUT IMPEDANCE:** With probe, 10 megohms shunted by 7 pF. Less probe, 2 megohms shunted by 11 pF to 24 pF.
- AMPLIFIER:** Gain of 60 db  $\pm$  1 db from 6 cps to 11 Mc; output 2.5 volts.
- POWER SUPPLY:** 115/230 V, 50 — 400 cps, 70 watts.

Write for brochure giving many more details

— Since 1932 —

**B** BALLANTINE LABORATORIES Inc.  
Boonton, New Jersey

CHECK WITH BALLANTINE FIRST FOR LABORATORY AC VACUUM TUBE VOLTMETERS, REGARDLESS OF YOUR REQUIREMENTS FOR AMPLITUDE, FREQUENCY, OR WAVEFORM. WE HAVE A LARGE LINE, WITH ADDITIONS EACH YEAR. ALSO AC/DC AND DC/AC INVERTERS, CALIBRATORS, CALIBRATED WIDE BAND AF AMPLIFIER, DIRECT-READING CAPACITANCE METER, OTHER ACCESSORIES. ASK ABOUT OUR LABORATORY VOLTAGE STANDARDS TO 1,000 MC.

**CIRCLE 93 ON READER SERVICE CARD**

93

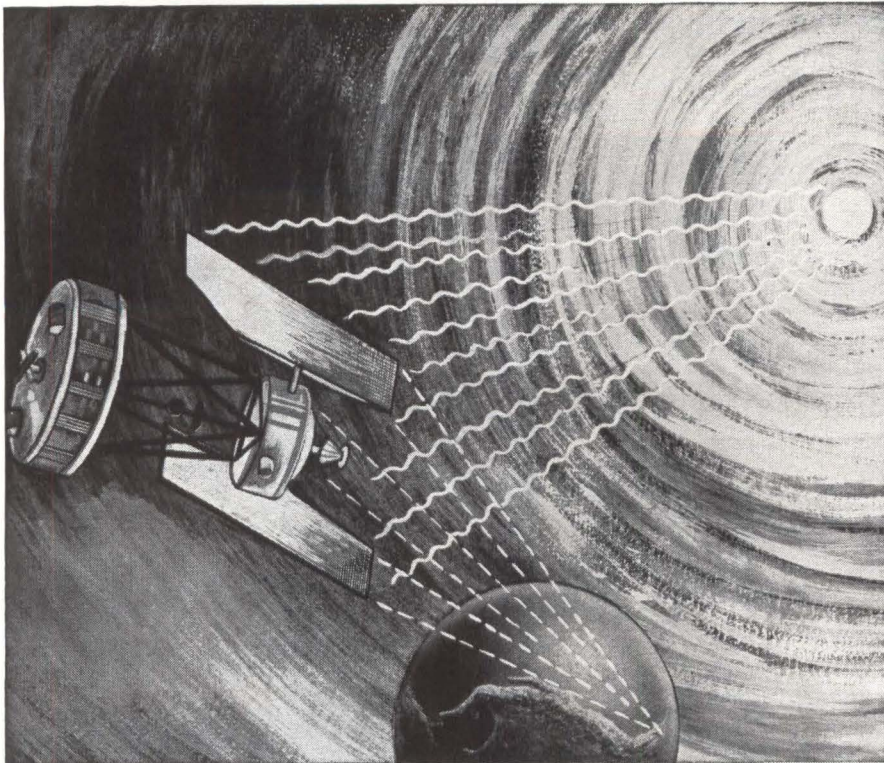

## How to "air condition" solar cells in space

*Bausch & Lomb optical/electronic/mechanical capabilities boost power-pack efficiency*

Silicon solar cells provide energy for space craft by converting solar radiation into electricity. Only about 10% of the sun's energy is utilized. The rest is unwanted heat that can reduce the efficiency of the cells and jeopardize the vehicle's instrumentation.

Bausch & Lomb solar cell coatings, by selective absorption and reflection, enable the solar power pack to achieve optimum efficiency. (See typical curves.) Count on B&L experience—in vacuum deposition of precision coatings on all kinds of cover glass substrates as well as on the cells themselves—to tailor the coating to specific requirements.

Write for technical reports on B&L capabilities in design, development and production. Bausch & Lomb Incorporated, Military Products Division, 61425 Bausch Street, Rochester 2, N. Y.

**BAUSCH & LOMB**

SINCE  1853

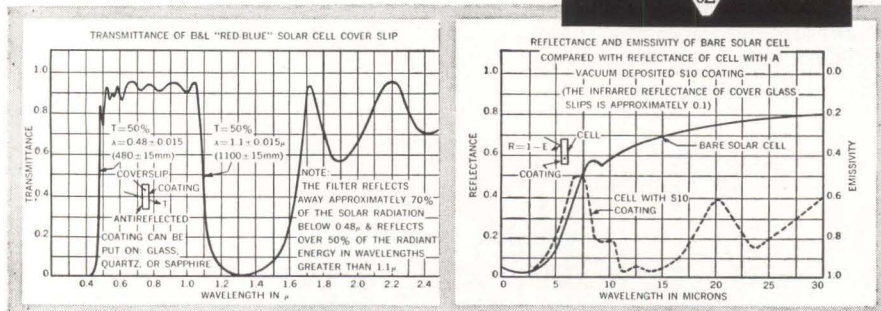

ohms,  $\pm 10$  percent, in short straight paths without resorting to lattice or grid patterns. Each wafer has two resistors of the same value on one side. Dimensions are 0.310 by 0.310 by 0.010 in. Cerafers feature high stability and reliability in extreme temperatures and environments.

CIRCLE 316 ON READER SERVICE CARD

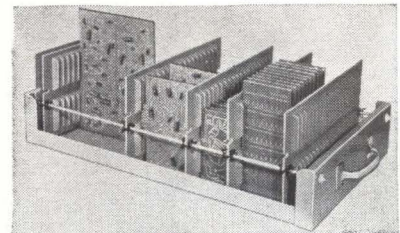

## Storage Tray FOR P-C BOARDS

HOLLIS ENGINEERING, INC., Pine St. Extension, Nashua, N.H. Storage tray for p-c boards is suitable for assembly line; no damage to edge circuitry or to mounted components; no falling out in transit. Adjustable from 1 in. to 19 in. boards,  $\frac{3}{8}$  in. to  $\frac{1}{4}$  in. thick. Sturdy lightweight steel with grey epoxy finish, with molded plastic dividers. Each kit consists of a tray and six dividers.

CIRCLE 317 ON READER SERVICE CARD

## Pulse Transformers

PCA ELECTRONICS, INC., 16799 Schoenborn St., Sepulveda, Calif., is manufacturing a series of Datatron pulse transformers, containing ferrite cores, for nsec pulse applications.

CIRCLE 318 ON READER SERVICE CARD

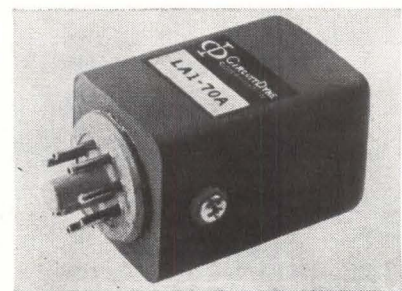

## A-F Inductor 10 TO 1 ADJUSTMENT

CIRCUITDYNE CORP., 480 Mermaid St., Laguna Beach, Calif. Model LA1 inductor element for use in a-f

systems features an adjustable inductance range of 10 to 1. It may be specified with any maximum inductance from 0.5 to 100 henries. Adjustment is guaranteed from above the maximum value to below both this value. Inductance is easily changed by an external adjusting screw which mechanically sets the specially designed core structures in the inductor.

**CIRCLE 319 ON READER SERVICE CARD**

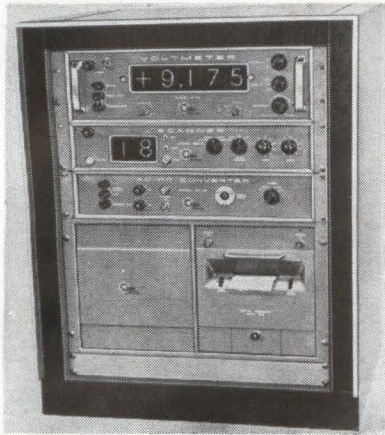

### Digital Package FOR LOGGING USES

CUBIC CORP., San Diego 11, Calif. The S-70, a standard digital instrument package for logging applications, consists of a V-70 digital voltmeter, a scanner and an 11-channel printer. The high-speed manual ranging data system will plug in any conventional a-c outlet and readout data at 100 channels per minute (0.01 percent accuracy). Package is designed for environmental test data recording, modular check-out and production check-out, where recorded data are necessary.

**CIRCLE 320 ON READER SERVICE CARD**

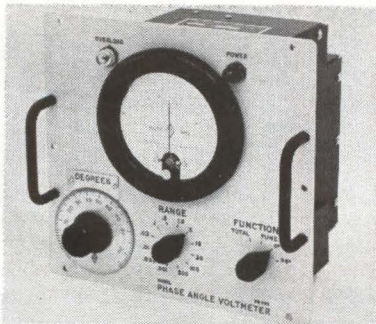

### Phase Angle Voltmeter ALL-TRANSISTORIZED

NORTH ATLANTIC INDUSTRIES, INC.,  
Terminal Drive, Plainview, New

January 26, 1962

# INFORMING THE ENGINEERING MIND

**electronics** is written and edited specifically to inform...and, more difficult, to keep informed...the engineering minds that ultimately pace and guide the vast electronics industry. To this end, the **electronics** editorial staff scours the nation and the world to report all important developments in the areas of research, design, production and management.

The result: *must reading* for anyone in these areas of the industry. Don't miss an issue; subscribe today, via the Reader Service Card in this issue, to

# electronics

# HICKORY BRAND TEFLON\* HOOK-UP WIRE

*Long, Continuous Lengths!  
Immediate Delivery!*

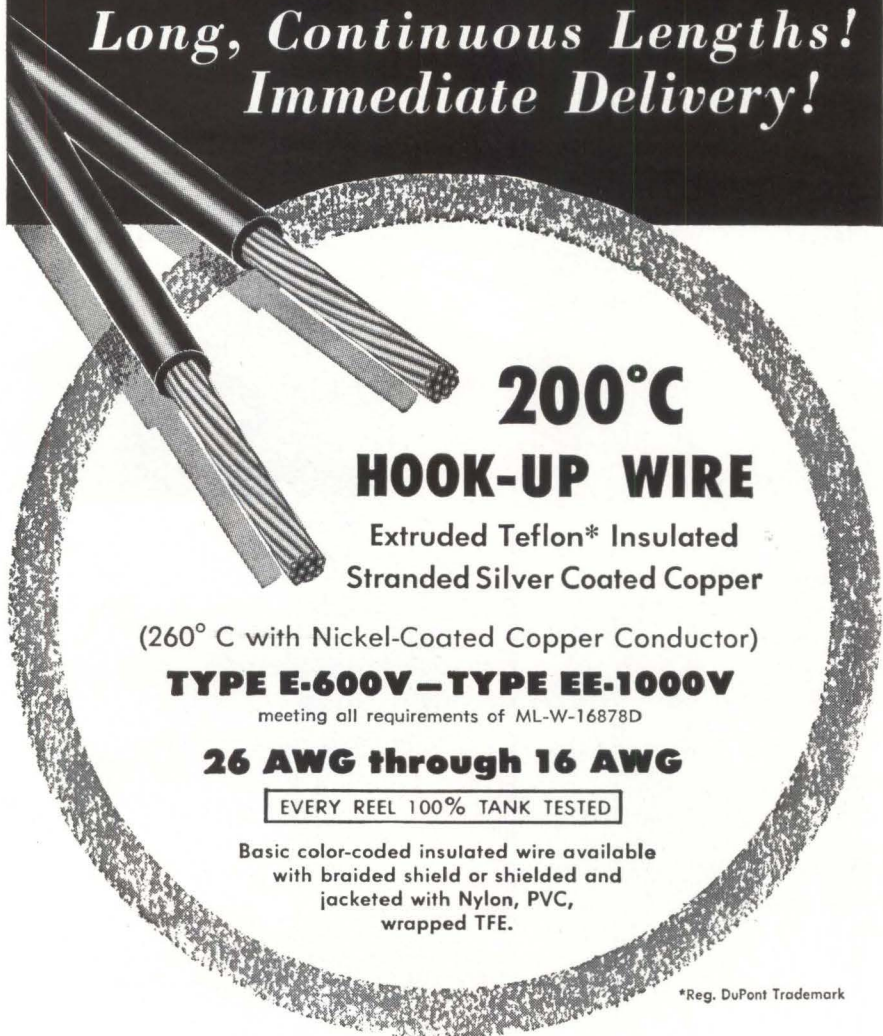

**200°C**

**HOOK-UP WIRE**

Extruded Teflon\* Insulated  
Stranded Silver Coated Copper

(260° C with Nickel-Coated Copper Conductor)

**TYPE E-600V - TYPE EE-1000V**

meeting all requirements of ML-W-16878D

**26 AWG through 16 AWG**

EVERY REEL 100% TANK TESTED

Basic color-coded insulated wire available  
with braided shield or shielded and  
jacketed with Nylon, PVC,  
wrapped TFE.

\*Reg. DuPont Trademark

**Multi-conductor Cable Constructions  
Designed to Meet Your Specific Requirements**



For prompt quotation, call or write  
**HICKORY BRAND**  
**Electronic Wires and Cables**

**SUPERIOR CABLE CORPORATION**  
P. O. Box 480-A • Hickory, N. C.

5805

96 CIRCLE 96 ON READER SERVICE CARD

York. VM-235 voltmeter combines the functions of an a-c voltmeter, phase meter, phase sensitive null indicator, power factor meter, and measures separately the in-phase and quadrature components of a signal. It features compact rugged design, suited for weapon system and ground support service.

CIRCLE 321 ON READER SERVICE CARD

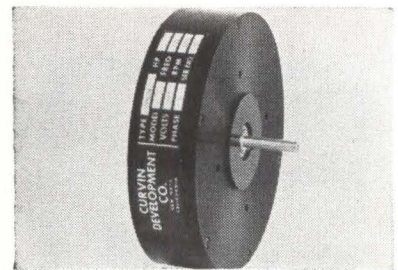

## Synchronous Motor 24-POLE, 2-PHASE

CURVIN DEVELOPMENT CO., 13735 Saticoy St., Van Nuys, Calif. Model 119 motor operates at frequencies up to 800 cps. The rotor combines p-m excitation with a squirrel cage induction rotor to provide for high efficiency of operation as well as good starting and damping characteristics. Stator is completely encapsulated in a fiberglass reinforced epoxy to insure maximum in reliability. Unit is rated at 0.03 h-p at 4,000 rpm, has a diameter of 5 1/4 in. and a length of 1 3/4 in.

CIRCLE 322 ON READER SERVICE CARD

## UHF Circulator

RANTEC CORP., Calabasas, Calif. Model CU-900 uhf L-band 3-port Y-junction circulator is available.

CIRCLE 323 ON READER SERVICE CARD

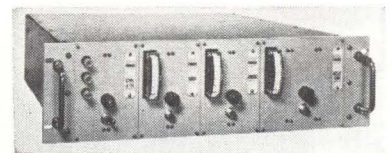

## BWO Power Supplies MODULAR DESIGN

MICRO-POWER, INC., 20-21 Steinway St., Long Island City 5, N.Y., offers power supplies for backward wave oscillators. Electrode supply modules are available with external d-c coupled rapid full range electronic control. Specifications: 0.002

electronics



percent line and 0.005 percent load regulation; 0.0001 percent rms ripple for manually controlled and 0.001 percent rms ripple for electronically controlled electrode supplies. Semiconductor diodes and transistors are used for reliability and small size.

**CIRCLE 324 ON READER SERVICE CARD**

## Switching Transistor

GENERAL ELECTRIC CO., Syracuse, N. Y. The 2N994 germanium epitaxial mesa transistor has a maximum total switching time of 80 nsec, a narrow beta range of 3 to 1.

**CIRCLE 325 ON READER SERVICE CARD**

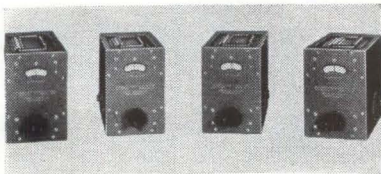

## Preselector Filters PACKAGED, TUNABLE

EMPIRE DEVICES, INC., Amsterdam, N.Y. Packaged, tunable microwave preselector filters, model PF-190, for four frequency ranges between 850-10,000 Mc are available. Units are recommended where high selectivity is desired. They permit separation of wanted signals from high amplitude interference for receivers or measuring instruments whose own selectivity is inadequate for the purpose. They are suited for use in labs, as instrument accessories, as well as for screen room and field applications.

**CIRCLE 326 ON READER SERVICE CARD**

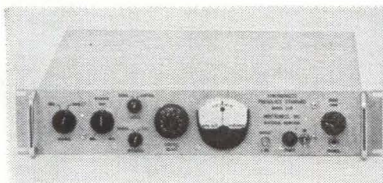

## Frequency Standard SYNCHRONIZED

MONTRONICS INC., 1212 West Main, Bozeman, Mont. Model 200 is a complete frequency standard system. The internal standard is always synchronized to the received signal. It provides 1 Mc output which will have a long term frequency accuracy of the transmitted signal and

**CIRCLE 97 ON READER SERVICE CARD** →

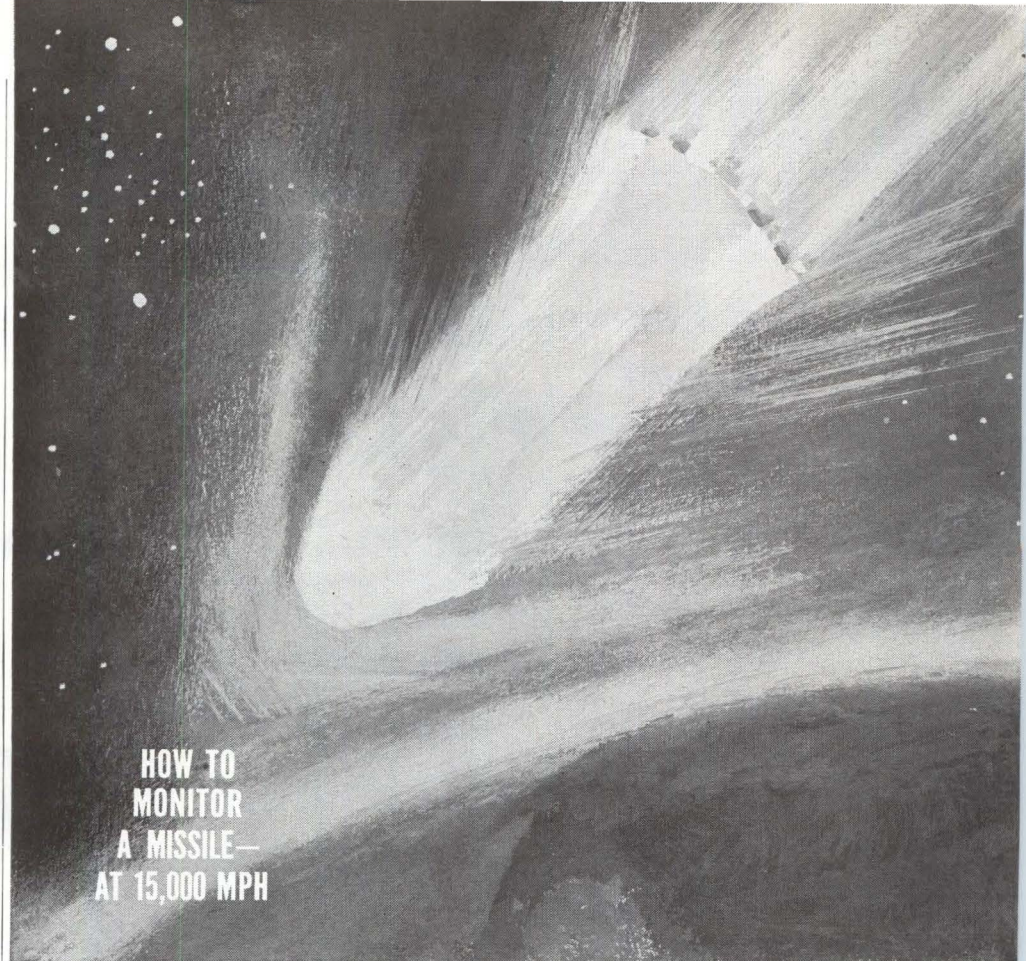

**HOW TO  
MONITOR  
A MISSILE—  
AT 15,000 MPH**

Spectacular as it is, a Titan take-off from Canaveral is only one end of the story. Moments after the shoot, nine thousand miles downrange, an airborne monitoring team is alerted to record the other end of the story as the re-entry vehicle plunges into the atmosphere at 15,000 mph.

Aboard the re-entry monitoring aircraft, a battery of photographic, photoelectric, and radiometric devices captures the dramatic end of the flight. A P.I. instrumentation tape recorder, operated by an Avco-Everett Research Laboratory monitoring team, is used to preserve on magnetic tape a precise record of important radiometric and time-sequence information... data which is essential in the development of advanced re-entry vehicles and in the country's anti-missile program.

One reason a P.I. recorder was selected for this program is that it provides full-size instrumentation performance in a fraction of the space. You'll be interested, if you record any type of scientific data, in other characteristics of P.I. recorders. For details, write for our current brochure.



Above — Photo of Titan missile re-entry. Below — Recorder installation aboard the monitoring aircraft. Photos courtesy of Avco-Everett Research Laboratory.



**PRECISION INSTRUMENT COMPANY**  
1011 Commercial Street • San Carlos • California  
Phone LYtell 1-4441 • TWX: SCAR BEL 30  
Representatives in principal cities throughout the world

# OFF THE SHELF DELIVERY OF ELECTRONIC COUNTERS!



## 3 ERIE MODELS YOU CAN COUNT ON...

*These 3 low cost Erie instruments have set reliability standards in digital measurement for many years.*

### MODEL 400 UNIVERSAL COUNTER-TIMER

A compact, versatile 100 KC instrument for counting, frequency measurement, period determination and time interval measurement. Count: 99,999; Crystal Stability: 0.001%; Sensitivity: 25 mv RMS; Frequencies: from 1 to 100,000 cps; Time Interval: in multiples of 10 from 10  $\mu$ sec. to 10 seconds; Period: 1 or 10 cycles of the input signal; Gate Times: 1 ms to 10 sec. in decade steps; Power: only 75 watts; Size: 19" W x 3 $\frac{1}{2}$ " H x 10" D; Weight: 15 pounds. Price: **\$695**

### MODEL 210 TIME INTERVAL COUNTER

A rugged, reliable instrument using crystal-controlled timing frequencies. Counts cyclic and random events from 0 to 50,000 pps; checks and calibrates relays, valves, actuators, etc; computes velocities of vehicles, projectiles and rotary equipment. Range: 100  $\mu$ sec. to 10 sec.; Accuracy:  $\pm 1$  count  $\pm 0.005\%$ ; Start-Stop Inputs: 6 to 120 volts, positive or negative slope; Power: only 50 watts; Size: 19" W x 3 $\frac{1}{2}$ " H x 5" D; Weight: 12 pounds. Price: **\$395**

### MODEL 130 FREQUENCY COUNTER

A general purpose, lightweight counter for counting cyclic or random events; tests and calibrates oscillators and wave filters; may be used as tachometer; measures vibration frequencies. Frequency Range: 1 to 50,000 cps; Accuracy:  $\pm 1$  count,  $\pm 0.1\%$  nominal; Input: High - 25 mv; Low - 1 volt; Gate Times: 0.1 and 1.0 sec. (10 sec. decade divider optional); Power: only 50 watts; Size: 19" W x 3 $\frac{1}{2}$ " H x 5" D; Weight: 12 pounds. Price: **\$395**

Complete technical specifications available on request.



ERIE-PACIFIC, DIVISION OF ERIE RESISTOR CORPORATION

12932 South Weber Way, Hawthorne, California • ORegon 8-5418 • TWX HAW CAL 4006

a normal short term accuracy, over a 15 minute interval, of 1 part in 10<sup>6</sup>. Sensitivity is 1  $\mu$ v at antenna terminals. Frequency: 18 or 20 Kc —front panel selected.

**CIRCLE 327 ON READER SERVICE CARD**

## Circuit Breaker

SYLVANIA ELECTRIC PRODUCTS INC., Ipswich, Mass. The Thermo-Break is a miniature, glass-encapsulated, temperature sensitive circuit breaker for the protection of shaded pole and permanent split winding types of electrical motors.

**CIRCLE 328 ON READER SERVICE CARD**



## Pulse Generator

WIDE-RANGE

GENERAL RADIO CO., West Concord, Mass. With the type 1217-B, pulses are either generated internally at pulse repetition rates from 2.5 to 500,000 cps, or triggered by external signals from d-c to 1 Mc. Main output pulses are simultaneous positive and negative 40-ma pulses, d-c coupled. Amplitude is adjustable from 0.1  $\mu$ sec to 1 sec, in seven decade ranges. Price is \$250.

**CIRCLE 329 ON READER SERVICE CARD**

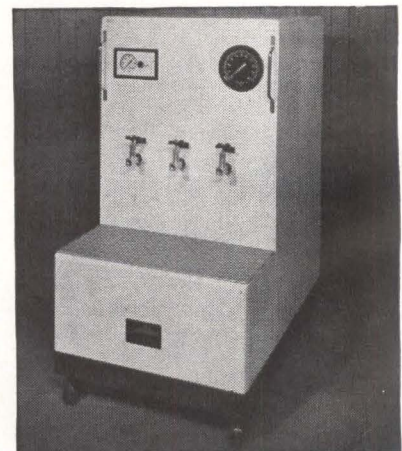

## Supply Tanks

LIQUID DIOXIDE

STANDARD CABINET CO., INC., 56 Washington Ave., Carlstadt, N.J. Line of mobile, low pressure liquid

dioxide supply tanks, with capacities of 300, 500 or 1,000 lb of CO<sub>2</sub>, are available on either a rental or an outright purchase. They are designed for applications requiring low pressure liquid CO<sub>2</sub> (300 psi) for rapid cooling or an inert atmosphere. In plants or laboratories, such uses include cooling of test chambers and of machining operations and shrink fitting of parts (missiles, etc.).

**CIRCLE 330 ON READER SERVICE CARD**

## D-C Relay

ALLIED CONTROL CO., INC., 2 East End Ave., New York 21, N.Y. A 4pdt microminiature d-c relay completes a standardized crystal can line.

**CIRCLE 331 ON READER SERVICE CARD**

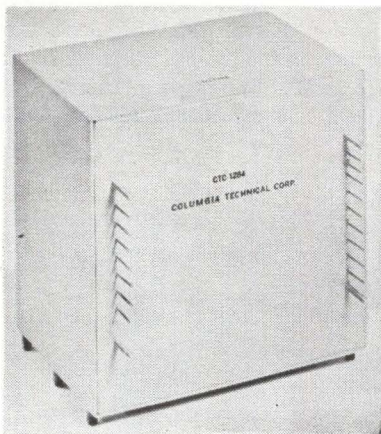

## Delay Line

### HIGH-DENSITY

COLUMBIA TECHNICAL CORP., Woodside 77, N.Y. Model 284 high-density, high delay-to-rise time ratio delay line contains three separate delay networks in a 44 cu. in. package. The total combined delay/rise time ratio is 120/1 including one line with a 80/1 ratio. Bandwidth of this delay line is 5 Mc. Temperature coefficient is 50 ppm/deg C. Attenuation is 0.1 db/ $\mu$ sec. It has a distortion of 3 percent. Unit is hermetically sealed and meets MIL environmental requirements.

**CIRCLE 332 ON READER SERVICE CARD**

## Tape Translator

MCDONNELL AUTOMATION CENTER, P. O. Box 516, St. Louis 66, Mo. The Interface model 73 tape translator can be used for connecting a

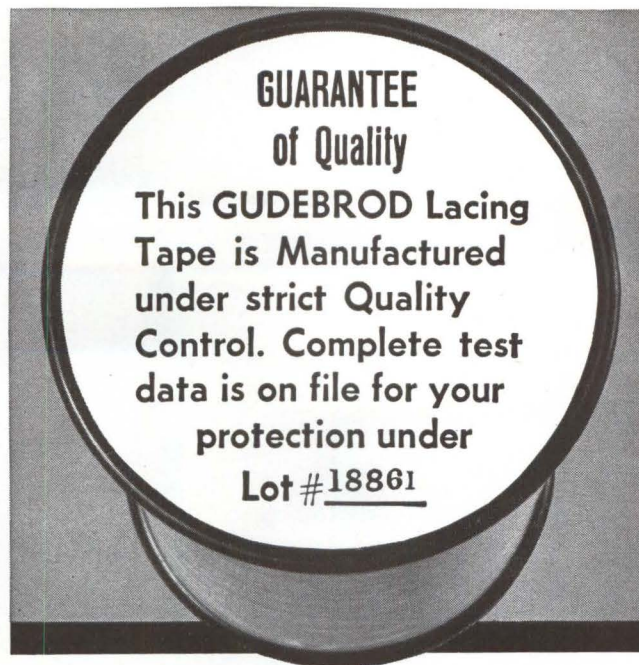

**GUARANTEE  
of Quality**  
This **GUDEBROD Lacing  
Tape** is Manufactured  
under strict Quality  
Control. Complete test  
data is on file for your  
protection under  
Lot # 18861

**THIS SEAL GUARANTEES YOU  
REAL LACING ECONOMY...  
increased production  
with fewer rejects!**

Always specify Gudebrod whether you use one spool of lacing tape or thousands because Gudebrod lacing tape is produced under strict quality control. Gudebrod checks and rechecks every lot of tape to insure that it meets the highest standards . . . higher standards than those required to meet MIL-T specifications.

Gudebrod helps increase your production because we carefully test, measure and maintain close tolerances on such characteristics as slip resistance, fray resistance, breaking strength, wax content, fungistatic effectiveness. These and other tests assure you that when Gudebrod lacing tape is used production increases. *Knots don't slip . . . harnesses stay tied . . . assemblies remain firm . . . there are fewer rejects!*

Whatever your lacing needs—Teflon\*, dacron†, glass, nylon, high temperatures, special finishes—Gudebrod makes it or will produce a tape to meet your special requirements. If you want a tape to meet 1500°F . . . Gudebrod Experimental Research Project 173 is the answer. If you want a tape that meets MIL-T-713A . . . Gudelace® (Style 18 Natural) is the answer.

**MAKE THE H-R TEST!** Write for samples of Gudelace or other Gudebrod lacing tapes and have them tested in your harness room. Compare a harness tied with a "Quality Controlled" Gudebrod tape and any other tape. This test will convince you that when you specify Gudebrod you specify *real* economy—increased production with fewer rejects.

Write for our free Technical Products Data Book. It explains Gudelace and other Gudebrod lacing tapes in detail.

\*Dupont's TFE fluorocarbon fiber.

†Dupont's polyester fiber.

## **GUDEBROD BROS. SILK CO., INC.**

Electronics Division  
225 West 34th Street  
New York 1, New York

Executive Offices  
12 South 12th Street  
Philadelphia 7, Pa.

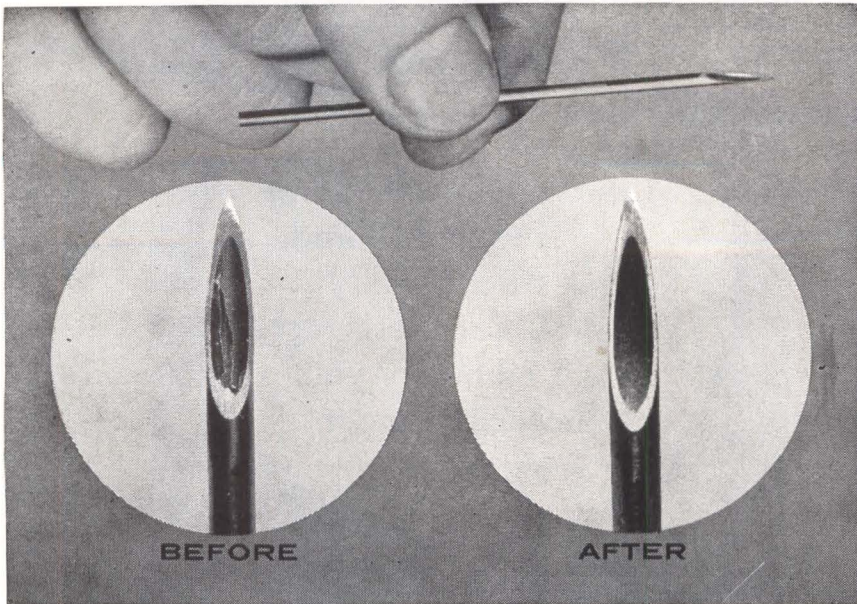

## Airbrasive deburring... increased production ten times... product improved

Vita Needle Company, Needham, Mass., is only one of many companies to experience a big boost in production through Airbrasive deburring.

One of the many seemingly impossible jobs that this unique industrial tool can do is to remove tiny, frequently inaccessible burrs from hard brittle materials. It will do it many times faster than other methods . . . including handwork with picks, probes and power tools. Equally important the Airbrasive will do the job with greater safety to the part and with less loss in dimension.

Vita Needle, for example, put deburring for the first time on a mass-production basis with Airbrasive . . . increased their output ten to twelve times . . . found that their product was cleaner, smoother, bur-free.

The secret of the Airbrasive is a superfine jet of abrasive particles that will cut hard, brittle materials without shock, heat or vibration . . . glass, germanium, tungsten, ceramics, ferrites and others. Low in cost, too. For under \$1,000 you can set up your own Airbrasive cutting unit.

Send us samples of your "impossible" jobs  
and let us test them for you at no cost.

SEND FOR  
BULLETIN 6006  
on complete information.

S. S. WHITE INDUSTRIAL DIVISION  
DEPT. EU, 10 East 40th St., N. Y. 16, N. Y.  
Telephone MU 3-3015 collect.



1172

for superfine cutting • deburring • cleaning

hard brittle materials

**S.S. White** INDUSTRIAL AIRBRASIVE

variety of digital tape transports to the IBM 7000 series computers.

**CIRCLE 333 ON READER SERVICE CARD**

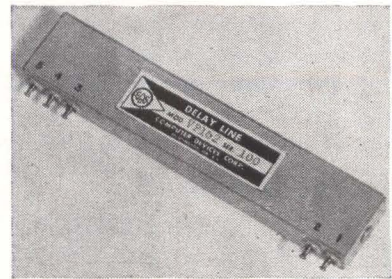

### Variable Delay Line INFINITE RESOLUTION

COMPUTER DEVICES CORP., 6 W. 18th St., Huntington Station, N.Y. Model VP-162 features infinite resolution over a delay variation from  $\frac{1}{2}$  to 7  $\mu$ sec and a rise time of 0.3  $\mu$ sec at full delay. It was designed for trigger and digital applications. Attenuation at full delay is 30 db and spurious response is less than 10:1. Price is \$100 in single quantity.

**CIRCLE 334 ON READER SERVICE CARD**

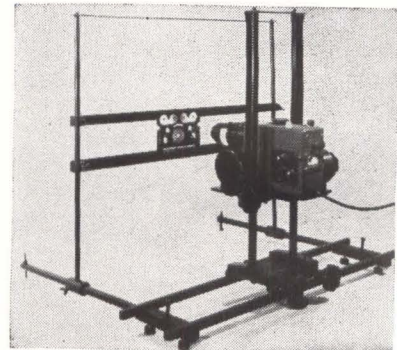

### Meter Mover INSTRUMENT MOUNT

HOFFMAN ENGINEERING CORP., Old Greenwich, Conn. The Meter Mover was developed for fast, accurate, stable and smooth positioning of photometers, pyrometers, cameras, microscopes and other instruments where infinitesimal precision measurements are required. The equipment permits 3 dimensional precision control measurements to 1/1,000th in. or better.

**CIRCLE 335 ON READER SERVICE CARD**

### Paper-Base Laminate

TAYLOR FIBRE CO., Norristown, Pa. Fireban 330 paper-base, phenolic resin laminate combines flame re-

# PRECISION GLASS FOR HIGH PERFORMANCE

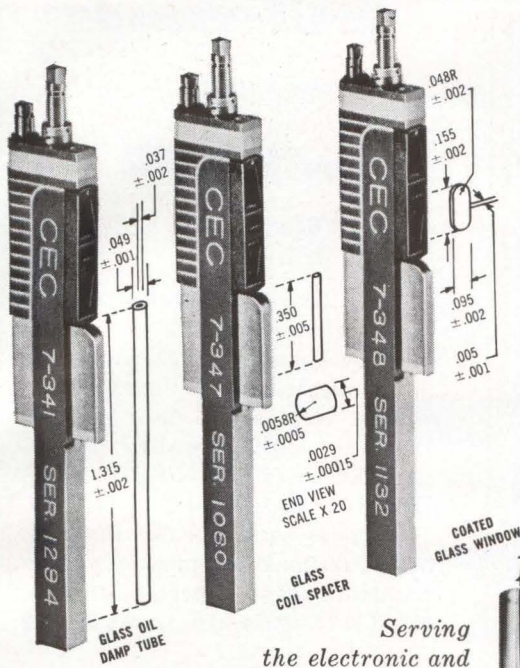

Serving  
the electronic and  
instrumentation field since 1953

EXCELLENCE of these Consolidated ElectroDynamics Corporation galvanometers is recognized the world over. Manufacturing them requires glass components to the exceptionally close tolerances illustrated.

T. H. GARNER COMPANY has produced parts to C.E.C.'s specs for 8 years. We at GARNER are proud of this long association — and our thousands of GLASS parts which have contributed to the outstanding performance of C.E.C. products.

Technical and production capabilities of T. H. GARNER COMPANY are available to you — to help solve your most difficult problems with PRECISION in GLASS. Write

## T. H. GARNER COMPANY

177 So. Indian Hill Blvd.  
Claremont, California  
NAtional 6-3526

CIRCLE 204 ON READER SERVICE CARD

# FAST ALL SOLID STATE DC AMPLIFIER

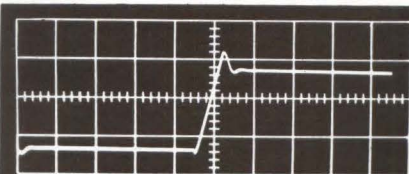

UNITY GAIN WAVEFORM  
REPRODUCTION  
10 KC OUTPUT • 5 VOLTS/CM  
10 MICROSECONDS/CM



\$195

## HALF USUAL COST

If you have applications requiring a miniature DC amplifier with fast frequency response, there's a good chance RIG's new DIFFERENTIAL OPERATIONAL AMPLIFIER MODEL A-2 can cut your amplifier costs 50% or more. Until now, only far higher priced transistorized amplifiers exhibited rise time characteristics comparable to the A-2. Check and compare these specifications:

OPEN LOOP GAIN — 100,000.  
GAIN-BANDWIDTH PRODUCT  
Short Circuit Stable — 200 KC. RISE TIME — Less than 10 microseconds at unity gain, and at gain of ten; less than 100 microseconds at gain of one hundred. DRIFT REFERRED TO INPUT — Less than two millivolts over 75°F to 120°F change of ambient; less than 100 microvolts over eight-hour period at constant temperature.

Request RIG-AMP Technical Bulletin for complete details.

ALSO AVAILABLE. Companion, plug-in Power Booster for use with Amplifier A-2 in driving heavy instrument systems, rotary amplifiers, and small DC servos.



**RIDGEFIELD  
INSTRUMENT GROUP**  
a Schlumberger division

Ridgefield, 5 Conn., P.O. Box 337, Idlewood 8-6571

# METALS for ELECTRONIC APPLICATION rolled ULTRA THIN

by OUR SPECIAL ROLLING  
TECHNIQUE

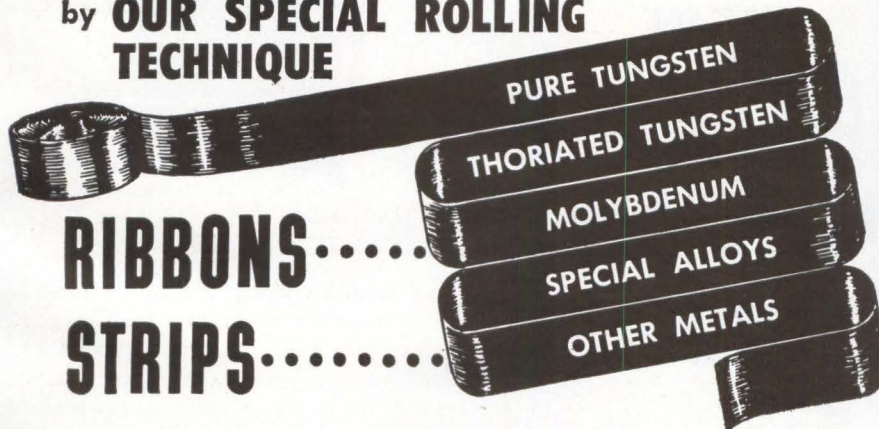

TOLERANCES CLOSER THAN COMMERCIAL STANDARDS

Note: for highly engineered applications—strips of TUNGSTEN and some other metals can be supplied

rolled down to .0003 thickness

- Finish: Roll Finish—Black
- Ribbons may be supplied in Mg. weights

Developed and Manufactured by

# H. CROSS CO.

363 PARK AVE.  
WEEHAWKEN, NEW JERSEY  
Tele. UN-3-1134

CIRCLE 205 ON READER SERVICE CARD

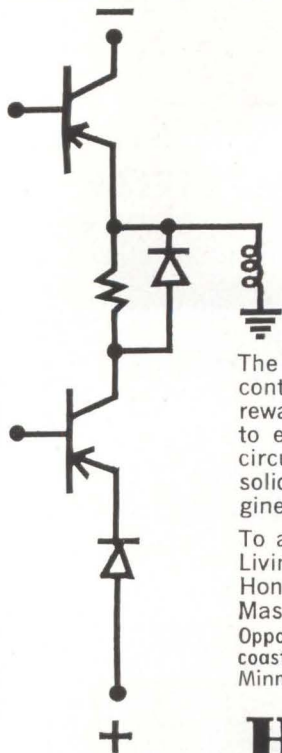

**CIRCUIT DESIGN ENGINEERS  
MANUFACTURING ENGINEERS  
SOLID STATE ENGINEERS  
ELECTRO-MECHANICAL  
DESIGN ENGINEERS**

The Boston Division of Minneapolis-Honeywell offers continued growth and stability within a dynamic and rewarding atmosphere. Qualified engineers are invited to explore the opportunities available in the fields of circuit design, electro-mechanical component design, solid state device engineering, and manufacturing engineering with members of our technical management.

To arrange an interview please contact: Mr. G. Ronald Livingstone, Dept. B, Boston Division, Minneapolis-Honeywell, 1400 Soldiers Field Road, Boston 35, Massachusetts.

Opportunities also exist in other Honeywell facilities coast to coast. Send resume to H. B. Eckstrom, Minneapolis-Honeywell, Minneapolis 8, Minnesota.

**Honeywell**



*Boston Division*

'An equal opportunity employer'

tardance with high electrical insulation and cold punching properties.  
**CIRCLE 336 ON READER SERVICE CARD**

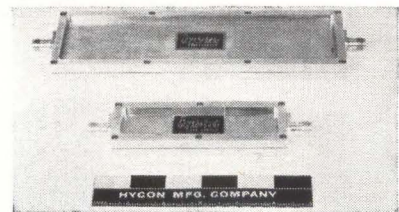

**Band Pass Filters  
TWO MODELS**

HYCON MFG. CO., 700 Royal Oaks Drive, Monrovia, Calif. The eight section shorted pi type band pass filter operates over octave bandwidths. Number of filter sections can be varied according to the characteristics required. Model HBP-1008, pass band 2-4 Gc; HBP-1009, pass band 4-8 Gc. Insertion loss, 1 db max. Attenuation, 30 db minimum below 85 percent of lower cutoff and above 110 percent upper cutoff frequencies.

**CIRCLE 337 ON READER SERVICE CARD**

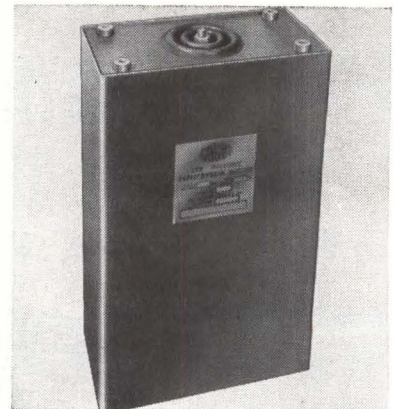

**Capacitors  
ENERGY DISCHARGE**

SANGAMO ELECTRIC CO., Springfield, Ill., announces energy discharge capacitors which are a basic element in impulse generators, hypersonic wind tunnels, laser equipments, magnetic forming, shock wave experiments, ion propulsion and other advanced projects.

**CIRCLE 338 ON READER SERVICE CARD**

**Delay Line**

GRAY & KUHN DIV. of Burnell & Co., 10 Pelham Parkway, Pelham, N. Y., offers a step variable delay line consisting of multi-section M-derived



**NEW  
MINIATURIZED  
COMMUTATING  
SWITCH**

- IDL "STANDARD" Performance and Flexibility in 1/3rd the Volume
- Satisfies 98% of all PAM and PDM Telemetry System Requirements
- Clamped Speed Regulator holds Pole Speed to 2%
- Phase-Lock Concept controls speed of 4 or more independent switches

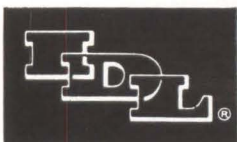

**INSTRUMENT DEVELOPMENT LABORATORIES, INC.**

**51 MECHANIC STREET, ATTLEBORO, MASS.**

# 1962 BUYERS' GUIDE TAKES THE FIRST BIG STEP TO INCORPORATE SIC\* NUMBERS IN PRODUCT LISTINGS

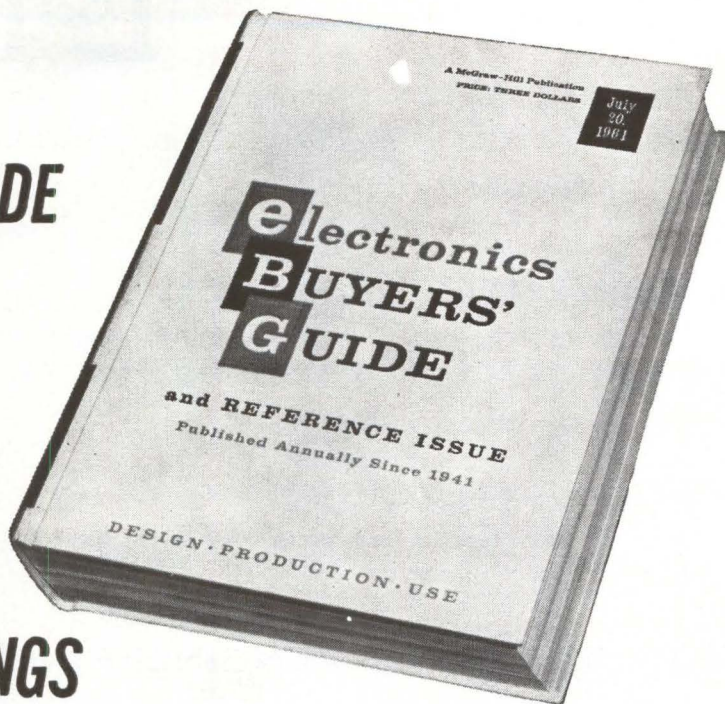

\*SIC (Standard Industrial Classification) codes are used by the U. S. Government, Bureau of the Census at the seven digit level to report statistics on individual products by industry.

Users of the BUYERS' GUIDE have come to expect pioneer service during its more than 20 years of existence. Editorial initiative keeps the BUYERS' GUIDE up to date on the products, materials and services of the entire industry; who makes what and where to buy it.

For the first time anywhere the 1962-63 **electronics** BUYERS' GUIDE and Reference Issue will include SIC numbers for those products which are clearly defined by the SIC. Statistics for marketing based on census figures are available only on products that can be precisely coded by SIC.

To date, neither private industry nor the Government has been able to define the 2,500 products, materials, services that comprise the electronics industry in a satisfactory 7-digit, SIC numbering system.

These first steps by the editors of the '62 BUYERS' GUIDE, taken with the assistance of the Bureau of the Census, Electronics Division of Business and Defense Services Administration, encourages the government, the industry and **electronics** to work together eventually to describe all the products of the industry.

This is only one of the many features that make electronics BUYERS' GUIDE your "best buy" for selling to the electronics industry. Reserve your advertising space now.

## **electronics** **BUYERS' GUIDE and Reference Issue**

**The Basic Buying Guide in Electronics Since 1941**

A McGraw-Hill Publication • 330 West 42nd Street • New York 36, N.Y.



*The Lincoln Laboratory program for ballistic missile range measurements and penetration research includes:*

## EXPERIMENTAL RESEARCH

Measurements and analysis of ICBM flight phenomena for discrimination and for decoy design purposes, including optical, aerodynamic and RF effects.

## SYSTEM ANALYSIS

Studies to apply research findings to advance the technology of ICBM and AICBM systems.

## INSTRUMENTATION ENGINEERING

Designing radar, optical and telemetry equipment with which to measure ICBM flight effects under actual range conditions.

## RADAR SYSTEMS RESEARCH

Extending the theory and application of radar techniques to problems of discrimination, countermeasures and performance in a dense-target environment.

## HYPERSONIC AERODYNAMICS

Study of the flow-fields around re-entering bodies for various body designs and flight conditions. Excellent computer facilities available.

## RADAR PHYSICS

Theoretical and experimental studies in radar back-scattering. Interaction of RF radiation with plasmas.

- *A more complete description of the Laboratory's work will be sent to you upon request.*

All qualified applicants will receive consideration for employment without regard to race, creed, color or national origin.

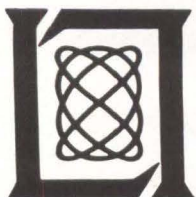

Research and Development  
**LINCOLN LABORATORY**  
Massachusetts Institute of Technology  
BOX 27  
LEXINGTON 73, MASSACHUSETTS

networks that provides equal input and output impedance, low distortion and high delay to rise time ratio.

**CIRCLE 339 ON READER SERVICE CARD**

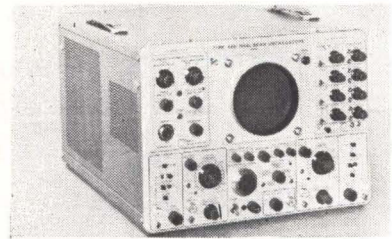

## Oscilloscope DUAL-BEAM

TEKTRONIX, INC., P.O. Box 500, Beaverton, Ore., announces type 565 dual-beam oscilloscope with two separate vertical and two separate horizontal systems, capability for delayed-sweep presentations and single-sweep applications. Characteristics include: sweep times from 1  $\mu$ sec/div to 5 sec/div in 21 calibrated steps with 10 $\times$  sweep magnification possible on all ranges for each independent sweep channel, calibrated delayed-sweep range from 0.5  $\mu$ sec to 50 sec, and triggering facilities for amplitude-level selection.

**CIRCLE 340 ON READER SERVICE CARD**

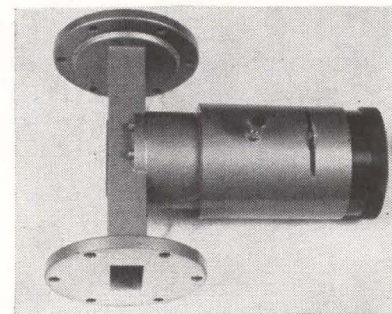

## Wavemeter TUNABLE UNIT

FREQUENCY ENGINEERING LABORATORIES, P. O. Box 504, Asbury Park, N. J. Model WC5882-1DR wave-meter is a tunable resonant cavity designed for the accurate measurement of microwave frequencies in the laboratory or in system maintenance applications. It is tunable over a range of 5,850 to 8,200 Mc and has an accuracy at room temperature of  $\pm 0.02$  percent. Loaded Q is 5,000 minimum; vswr, 1.1:1.

**CIRCLE 341 ON READER SERVICE CARD**



## PRODUCT BRIEFS

**TNC MULTIPURPOSE RECEPTACLES** gold-plated contacts and probe. General RF Fittings, Inc., 702 Beacon St., Boston 15, Mass. (342)

**CODING KEYBOARD** magnetic-mechanical. Information Products Corp., 156 Sixth St., Cambridge, Mass. (343)

**ALUMINUM/BORON ALLOY** for semiconductor industry. Alloys Unlimited, Inc., 21-01 43rd Ave., Long Island City 1, N. Y. (344)

**WEDGE-ACTION RELAY** low contact resistance. Electro-Tec Corp., 1 Henderson Drive., West Caldwell, N. J. (345)

**GATED COUNTER** solid state. Erie-Pacific, Division of Erie Resistor Corp., 12932 South Weber Way, Hawthorne, Calif. (346)

**SERVO MOTOR GENERATOR** weighs 27 oz. Kearfott Div., General Precision, Inc., 1150 McBride Ave., Little Falls, N. J. (347)

**PORTABLE SOURCE** of 110 v a-c power. Cornell-Dubilier Electronics Div., Federal Pacific Electric Co., Fuquay Springs, N. C. (348)

**SEMICONDUCTOR WAFER SCRIBER** saves time, cuts costs. Kulicke and Soffa Mfg. Co., 401 N. Broad St., Philadelphia 8, Pa. (349)

**SINGLE CRYSTAL GERMANIUM** for semiconductor applications. Semimetals, Inc., 172 Spruce St., Westbury, L. I., N. Y. (350)

**TWIN TETRODE** for ssb systems. Ampere Electronic Corp., 230 Duffy Ave., Hicksville, L. I., N. Y. (351)

**HYDROPHONE AMPLIFIER** ultra-low-noise. ACF Electronics Division, ACF Industries, Inc., Paramus, N. J. (352)

**FUSED FIBER OPTICS PLATES** for varied applications. Optics Technology, Inc., 248 Harbor Blvd., Belmont, Calif. (353)

**ELECTRONIC CAMERA** single frame. Abtronics, Inc., 64 South P St., Livermore, Calif. (354)

**OSCILLOSCOPE** fully transistorized. General Atronics, 1 Bala Ave., Bala-Cynwyd, Pa. (355)

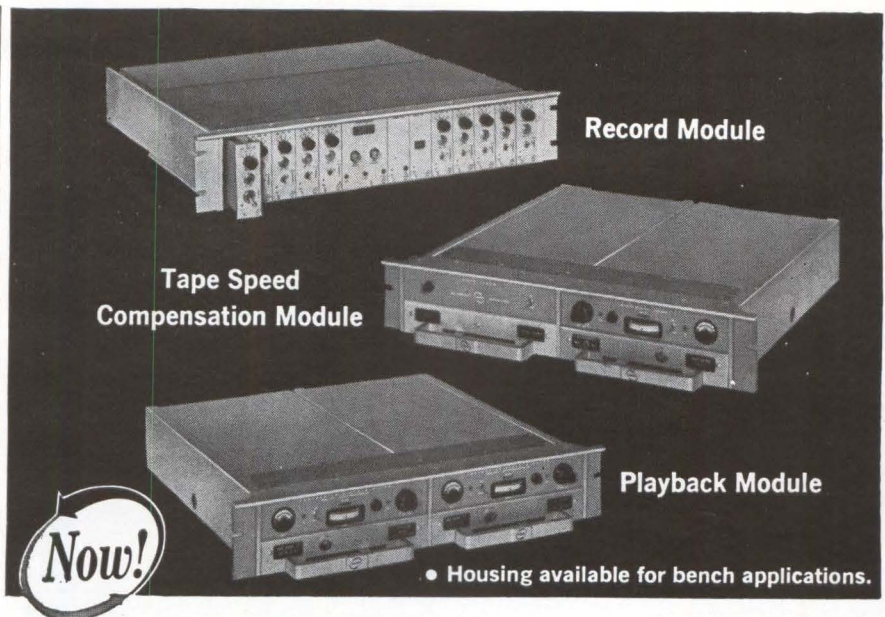

# 140 Channels of 2 kc data on 100 kc magnetic tape recorder!

—One example of UNIDAP Data System capability!

- Permits magnetic recording and playback of multichannel, constant-bandwidth, time-correlated research data.
- Unique frequency translation and multiplexing techniques permit optimum use of recorder bandwidth capabilities.
- Physically and electrically interchangeable modules make custom system assembly easy.
- Compatible with existing DCS analog and digital equipments.

UNIDAP—a new concept... complete systems-engineered modular capability for acquisition, storage and playback of multichannel static and dynamic research data! Completely transistorized! Operator can modify system characteristics to adapt to the recorded data. Entire system automatically compensated to eliminate effects of wow and flutter. Modules can be interconnected at will using program boards. System can be expanded to meet future requirements and adapt to improved recorder capabilities.

Three systems are available immediately; others will follow:

**MARK 1**.... All standard IRIG channels are available. Also, center frequencies to 1 mc with deviations to 40%.

**MARK 500**... Simultaneous continuous FM magnetic recording of 1 to 10 channels of 500 cps intelligence data plus reference frequency on single tape track of 50 kc bandwidth recording capability.

**MARK 2000**.. Similar to Mark 500. Records 1 to 10 channels of 2000 cps on 200 kc bandwidth track.

• All above are nominal 1% accuracy systems, subject to terminal equipment employed. • Full range of accessory calibration and test equipment available.

If you're concerned with magnetically recorded data for any purpose, you'll want to know more about UNIDAP's unique capabilities. For more information, address: Dept. E-1-7.



**DATA-CONTROL SYSTEMS, INC.**  
*Instrumentation for Research*

Los Angeles • Santa Clara • Wash., D. C. • Cape Canaveral  
Home Office: E. Liberty St., Danbury, Conn. • Pioneer 3-9241

# Literature of

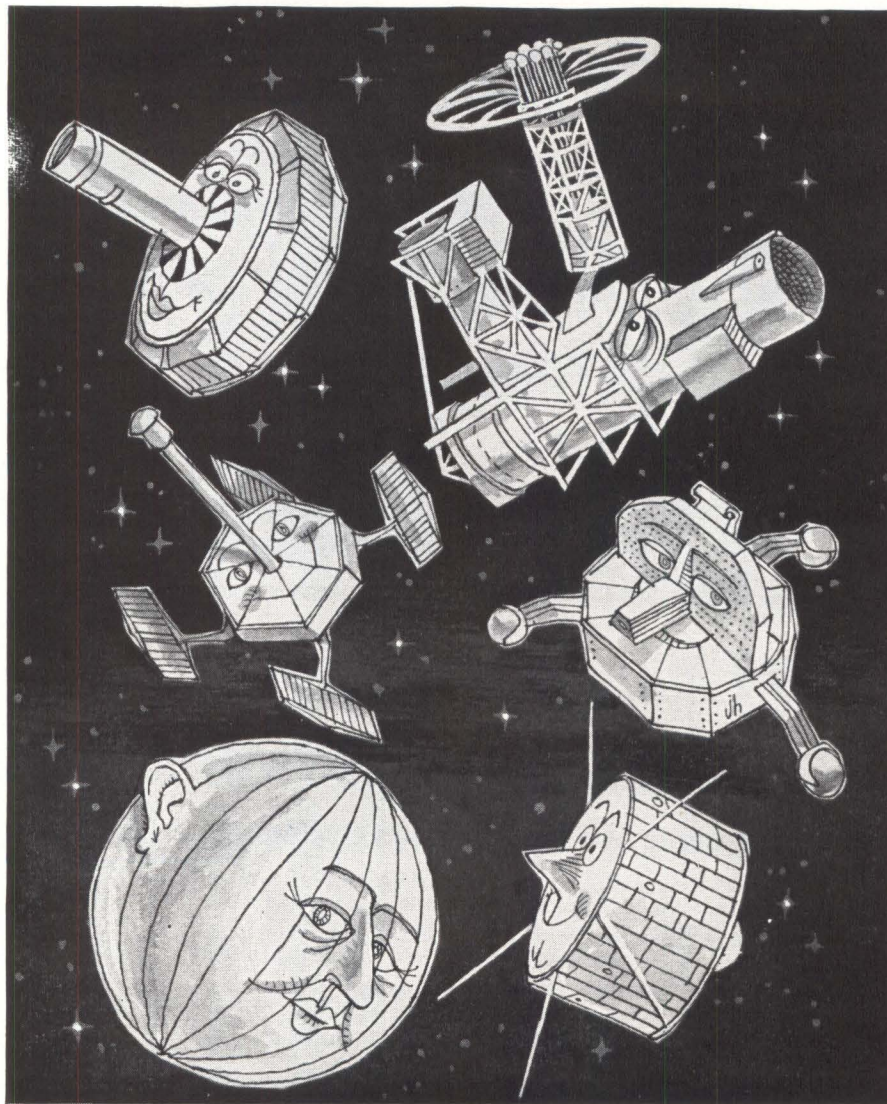

## Six Different Languages... NEMS-CLARKE® 1440 Receiver Interprets Them All!

This hard-working navigational telemetry receiver is already monitoring Transit, Traac, Echo, S3, S16, Stratoscope. It is an exceptionally stable Phase-Lock Receiver with a tuning range of 130-140 mc. The 1440 is particularly suited for the forthcoming S-27 Orbiting Astronomical Observatory.

Nems-Clarke 1440 provides outputs for video, spectrum display, frequency monitor and signal strength recorder. Its four panel mounted meters indicate tuning, output, deviation and signal strength during operation. The receiver is for standard rack mounting.

Write for Data Sheet C-006, Vitro Electronics, 919 Jesup-Blair Drive, Silver Spring, Maryland. A Division of Vitro Corporation of America.

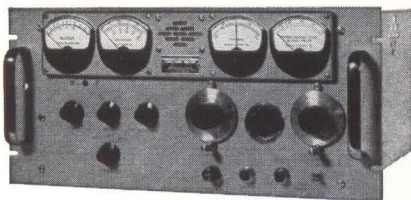

**Vitro ELECTRONICS**

### Specifications:

1. Type of Reception.....FM
2. Tuning Range.....130-140 mc
3. Noise Figure.....6 db maximum
4. IF Bandwidth —
  - Wide Band .....100 kc at 3 db points
  - Narrow Band ..... 50 kc at 3 db points
5. Phase-Lock Detector.....linear to better than 1% over bandwidth of  $\pm 50$  kc
6. Video Output .....adjustable
7. Video Frequency
  - Response.....400 cps to 15 kc
8. Sensitivity.....0.3 v peak to peak per kc of deviation, minimum

**UNIVERSAL PHOTOMETER** Eldorado Electronics, 2821 Tenth St., Berkeley 10, Calif. Model 201 universal photometer, a general purpose instrument with wide application in the field of light measurement, is described and illustrated in a 2-page bulletin. (356)

**GERMANIUM** Amco Sales, a division of American Metal Climax, Inc., 1270 Ave. of the Americas, New York 20, N.Y. Booklet describes properties, performance and processes used to produce germanium dioxide, as reduced germanium metal, zone-refined intrinsic germanium, and various germanium compounds. (357)

**P-C BOARD RETAINERS** The Birtcher Corp./Industrial Division, 745 S. Monterey Pass Rd., Monterey Park, Calif. Data sheet describes PCB-Tainers for  $\frac{1}{16}$  and  $\frac{3}{32}$  p-c boards that will hold up  $\frac{1}{2}$  lb of circuitry/components under 30 g shock in modules and provide an excellent ground and thermal path. (358)

**INSTRUMENTS** Forster/Hoover Electronics, Inc., P.O. Box 1003, Ann Arbor, Mich., has published a 12-page illustrated electronic instruments handbook. (359)

**POWER OUTPUT TRANSFORMER** Polyphase Instrument Co., Bridgeport, Pa. Bulletin 77F covers a 400 cps power output transformer that drives matching power filter for high efficiency. (360)

**PULSED OPERATION LASER** Kollman Instrument Corp., Elmhurst 73, N.Y. Bulletin describes the PistoLaser AL-001, a pulsed operation laser designed for portability, convenience and safety. (361)

**BU/ORD RESOLVERS** Kearfott Division, General Precision, Inc., Little Falls, N.J. Catalog sheet describes size 11 resolvers designed to meet MIL-R-21530. (362)

**DIGITAL VOLTMETER** Kin Tel Division of Cohu Electronics, Inc., 5725 Kearny Villa Road, San Diego 12, Calif. Data sheet 19-113 presents specifications, applications, design and wiring of a militarized digital voltmeter. (363)

**PLUG-IN CHOPPER** Solid State Electronics Co., 15321 Rayen St., Sepulveda, Calif., announces litera-

# the Week

ture describing model 65 transistorized plug-in chopper with transformer coupled isolating drive capable of being driven from 400 cycle line. (364)

**CURRENT PULSE GENERATOR** Rese Engineering Inc., A & Courtland Sts., Philadelphia 20, Pa. Brochure describes model 1300A high speed programmed current pulse generator. (365)

**POWER SUPPLIES** Micro-Power, Inc., 20-21 Steinway St., Long Island City 5, N.Y., has available a data and selection guide for modular power supplies designed for microwave tubes. (366)

**POWER TRANSISTORS** Tung-Sol Electric Inc., One Summer Ave., Newark 4, N.J., an information folder and specification guide for power transistors. (367)

**TRANSFORMER WINDER/TENSION** Geo. Stevens Mfg. Co., Inc., Pulaski Road at Peterson, Chicago 46, Ill. Catalog sheet covers the model 910 heavy duty foil and core transformer winder and the model T-910 tensioning platform. (368)

**TRANSISTOR SERVO AMPLIFIERS** Diehl Mfg. Co., FINDERNE Plant, Somerville, N.J., has published catalog sheets on its line of transistor servo amplifiers and associated solid state power supplies. (369)

**TRANSIENT VOLTAGE SUPPRESSORS** Sarkes Tarzian, Inc., 415 N. College Ave., Bloomington, Ind. Catalog covers Klipvolt transient voltage suppressors that reduce silicon rectifier failure. (370)

**ROTARY VACUUM SEAL** MRC Mfg. Corp., Orangeburg, N.Y., has published a bulletin on the model V4-100 rotary vacuum seal for all speeds up to 2,000 rpm. (371)

**BUSINESS PUBLICATION READING** McGraw-Hill Publishing Co., Company Promotion Dept., 330 W. 42nd St., New York 36, N.Y., has prepared a booklet that tells how to go about reading a business publication in order to obtain the greatest benefit in the least amount of time. (372)

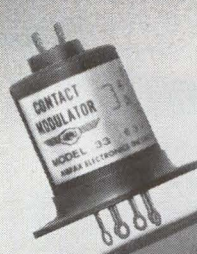

## WORLD'S LOWEST NOISE\* CHOPPER

### AIRPAX MODEL 33

\*The induced or stray noise appearing between each contact and ground does not exceed 0.6 microvolts RMS across 100 ohms at 60 CPS.

"Noise" is the residual voltage between either fixed contact and ground across a resistance, with the chopper operating and no signal applied.

#### CHARACTERISTICS

DRIVE.....	6.3 volts at 60 CPS
DWELL.....	175 degrees, average
PHASE.....	25 ± 10 degrees
BALANCE.....	Within 15 degrees
CONTACT ACTION.....	SPDT BBM

MODEL 33 is 3/4" in diameter and has a seated case height of 1 3/16" to top of terminals.



CAMBRIDGE DIVISION, CAMBRIDGE, MARYLAND

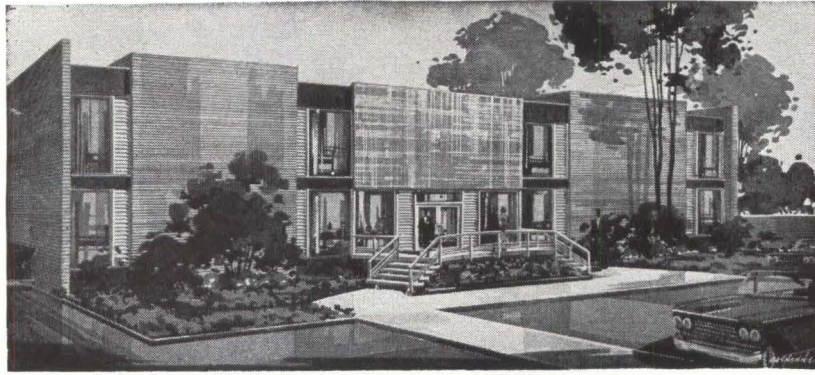

## Resitron Launches Expansion Program

RESITRON LABORATORIES, INC., Santa Monica, Calif., manufacturer of high-voltage, high-vacuum relays, vacuum capacitors, image converters, x-ray tubes and related devices, has launched a \$350,000 expansion program.

A new 30,000 sq ft plant in Los Angeles will increase the company's total plant space five-fold next month. It will increase engineering and production facilities and provide a complete laboratory for research and development work. This expansion, management believes, will enable the firm to further accelerate sales. Sales in 1961 are estimated at \$500,000 to \$600,000 compared with \$180,000 in 1960.

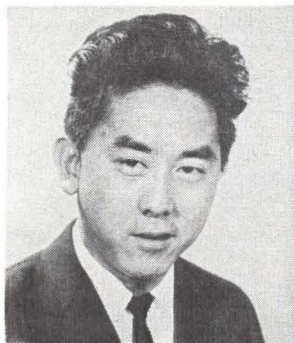

### Electronic Memories Hires Goda

APPOINTMENT of Ben T. Goda as senior staff engineer for Electronic Memories, Inc., Los Angeles, Calif., is announced.

Electronic Memories is engaged in the development, design, and manufacture of ferrite memory

Victor E. DeLucia, president, says the expansion is necessary to meet the increased demand and provide additional manufacturing space for recently developed products, including a variable vacuum capacitor, a high-vacuum rotary switch and a titanium sputter pump called TiVAC.

Resitron has invested several thousands of dollars in tooling for the variable high-vacuum capacitor. It is compatible in equipments which use the company's high vacuum relays. Patent applications are in process. It is anticipated that sales of the capacitor will account for 20 percent of the company's business in the coming year.

cores and core memory systems for civilian and military applications.

Prior to joining EMI, Goda was employed by Telemeter Magnetics, Inc., as an engineering section head from 1956 through 1961.

### National Semiconductor Expands Operation

NATIONAL SEMICONDUCTOR CORP., Danbury, Conn., has acquired 13,000 sq ft of additional space in its main office building. Expanding operations to the third floor represents a 50 percent increase in production facilities, according to Bernard J. Rothlein, president.

Rothlein, marking 2½ years of operation in Danbury, noted that

since May, 1959, National Semiconductor has grown from a small nucleus of eight founding scientists housed in a single 11,000 sq ft plant, to a fully integrated organization of 300 employees in two buildings totaling 40,000 sq ft.



### TRW Appoints New President

J. D. WRIGHT, chairman and chief executive officer of Thompson Ramo Wooldridge Inc., Los Angeles, Calif., has announced the resignation of Dean E. Wooldridge, president of the company since November 1958, and the appointment of H. A. Shepard (picture), TRW board member and vice president, general manager, as his successor. The change becomes effective February 1.

Wooldridge will continue to serve the company as a board member of both TRW and Space Technology Laboratories, Inc., a subsidiary of TRW.

The policy-making group of the company will now consist of J. D. Wright, chairman; Simon Ramo, vice chairman; and H. A. Shepard, president.

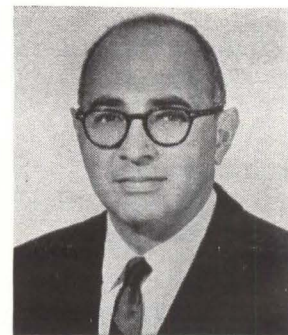

### Radiation Inc. Elects Morris to Board

ALBERT J. MORRIS, president of Radiation at Stanford, was recently

# NEW DEVELOPMENT BENDIX® 3-AMP DAP



Designers can count on the new Bendix 3-amp DAP® power transistor series for greater efficiency in switching and audio applications. These diffused-base units offer low input resistance, outstanding gain characteristics, and high collector-to-emitter voltages. And every unit is "Dynamically Tested", an exclusive Bendix quality control process that assures uniform reliability. Dimensions conform to JEDEC TO-37 outline with collector electrically connected to case. Write to Holmdel, N. J., for details.



MAIN OFFICE: Holmdel, N. J.—Ph: SH 7-5400 • NEW ENGLAND OFFICE: 114 Waltham St., Lexington, Mass.—Ph: VO 2-7650 • DETROIT OFFICE: 12950 West 8 Mile Rd., Detroit 37, Mich.—Ph: JO 6-1420 • MIDWEST OFFICE: 1915 N. Harlem Ave., Chicago, Ill.—Ph: 637-6929 • WEST COAST OFFICE: 117 E. Providencia Ave., Burbank, California—Ph: VI 9-3961 • CANADIAN AFFILIATE: Computing Devices of Canada, P.O. Box 508, Ottawa 4, Ont. • EXPORT OFFICE: Bendix International, 205 E. 42nd Street, New York 17, N.Y. • STOCKING DISTRIBUTOR: Contact nearest sales office for local distributor.

Absolute Maximum Ratings:	V <sub>CE</sub> Vdc	V <sub>CEO</sub> Vdc	V <sub>CB</sub> Vdc	I <sub>C</sub> Adc	P <sub>C</sub> * W	T <sub>stg</sub> °C	T <sub>j</sub> °C
B-1013	60	30	60	3	5	-65 to +110	110
B-1013A	100	60	100	3	5	-65 to +110	110
B-1013B	200	100	200	3	5	-65 to +110	110

\*P<sub>C</sub> is the maximum average power dissipation. It can be exceeded during the switching time.



ACTUAL SIZE

**Bendix Semiconductor Division**



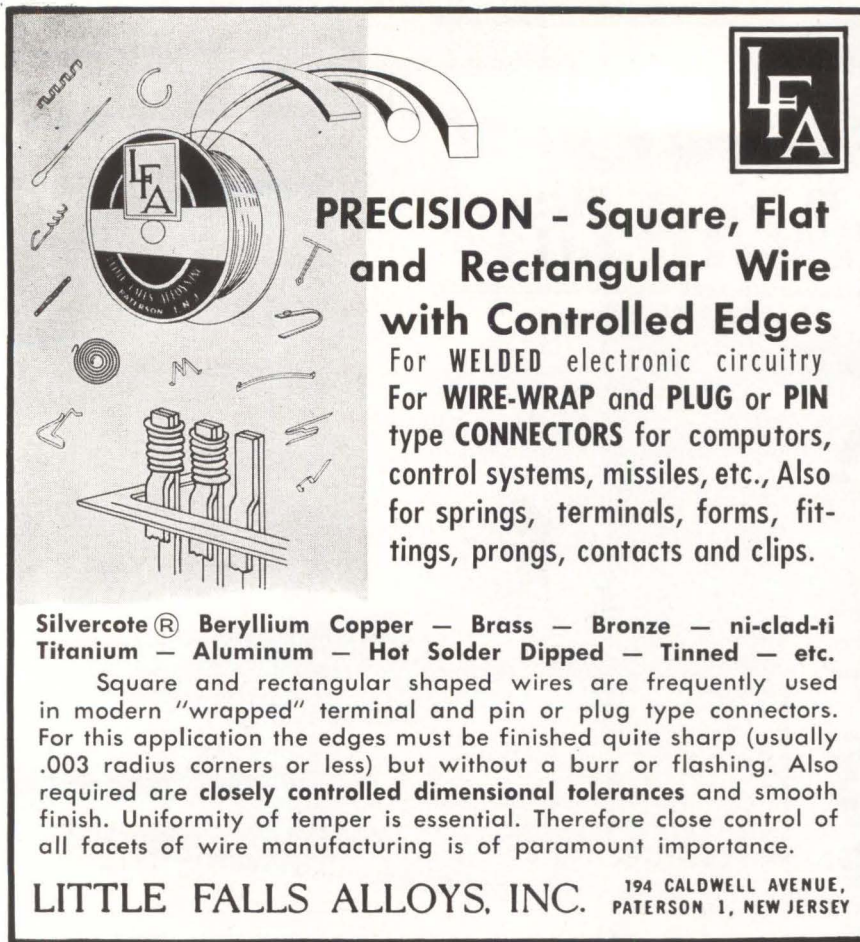

**PRECISION - Square, Flat and Rectangular Wire with Controlled Edges**

For WELDED electronic circuitry  
For WIRE-WRAP and PLUG or PIN type CONNECTORS for computers, control systems, missiles, etc., Also for springs, terminals, forms, fittings, prongs, contacts and clips.

Silvercote® Beryllium Copper — Brass — Bronze — ni-clad-ti Titanium — Aluminum — Hot Solder Dipped — Tinned — etc.

Square and rectangular shaped wires are frequently used in modern "wrapped" terminal and pin or plug type connectors. For this application the edges must be finished quite sharp (usually .003 radius corners or less) but without a burr or flashing. Also required are closely controlled dimensional tolerances and smooth finish. Uniformity of temper is essential. Therefore close control of all facets of wire manufacturing is of paramount importance.

**LITTLE FALLS ALLOYS, INC.** 194 CALDWELL AVENUE, PATERSON 1, NEW JERSEY

CIRCLE 207 ON READER SERVICE CARD



**5 MEGACYCLES 5th OVERTONE**

Primarily for Frequency Standard Use Under Rigorous Environmental Conditions.



**Aging:**  $1 \times 10^{-9}$ /day. **Frequency Change:** Less than  $1 \times 10^{-9}$  under vibration of 10 to 200 cps at 10 G, and under 100 G shock when tested per MIL-STD 202A Method 202A. **Frequency Range:** From 4.966 mc to 6.133 mc. Write for literature to James Knights Company, Sandwich, Illinois.

110 CIRCLE 110 ON READER SERVICE CARD

elected to the board of directors of Radiation Inc., Melbourne, Fla.

The Radiation subsidiary which Morris now heads specializes in the design and manufacture of high-power electronic equipment.

### Theta Instrument Hires Yaeger

WILLIAM O. YAEGER has joined Theta Instrument Corp., Saddle Brook, N.J., as project engineer. In this position he will be responsible for design and development of instruments and components that the company produces for the aerospace ground equipment field.

Prior to joining Theta, Yaeger was assistant project engineer at the Bendix Corp. working on special purpose transistorized circuitry, servomechanisms and amplifiers, and digital projects.

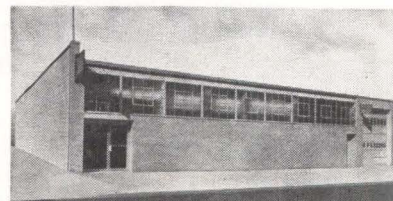

### Set Up New Company In New York City

FREQUENCY ELECTRONICS, INC., Astoria, N.Y., was recently formed to develop and manufacture frequency and time control systems and related devices.

The company now occupies a new 8,000 sq ft building, fully equipped for research, development and manufacture.

Martin B. Bloch and John Ho, formerly with Bulova Electronics, are president and chief engineer, respectively, of the new firm.

### Electrons Elevates Two Executives

ELECTRONS, INC., Newark, N.J., a subsidiary of the General Railway Signal Co., Rochester, N.Y., has promoted Earle K. Smith from executive vice president to president, and Herbert W. Chamberlain from president to chairman of the board.

Chamberlain has been president since 1960. Smith joined Electrons

Write for our catalogue

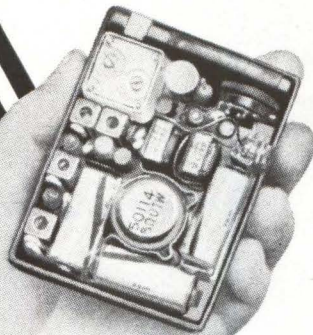

Good parts work best!

Intermediate Frequency Transformer IFT



POLYVARICON Variable Capacitor



The high standards of MITSUMI electronic components are insured by a fully-automated assembly system, and double-checked by rigid quality controls. Mitsumi Electric Company is Japan's largest manufacturer of components for radio, television and communications equipment.

**MITSUMI PARTS**

**MITSUMI ELECTRIC CO., LTD.**

Komae, Kitatama, Tokyo



CIRCLE 208 ON READER SERVICE CARD

# RESOLVER NEWS!

## VERNITRON .05% ACCURACY PRECISION RESOLVERS DELIVERED ON REGULAR PRODUCTION BASIS

60 THROUGH 10,000 CYCLES

ALL SIZES—8 through 23  
ALL STANDARD TYPES—Computing, Data Transmission, Phase Shifters and Sweep  
ALL ENGINEERED & MANUFACTURED TO: MIL-R-14346

ALL AVAILABLE WITH

- Thru-Bore Design
- High Reliability Exclusive Brush Block
- Stainless Steel housings, shaft, bearings
- High voltage capabilities between stator and compensator windings (on feedback units)

A major break-through, made possible by VERNITRON specialization in precision synchro and resolver design and manufacture.



WRITE, WIRE, PHONE NOW for complete price, delivery and specification data; ask for NEW VERNITRON Condensed Catalog.

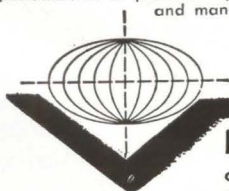

**VERNITRON CORPORATION**

THE QUALITY NAME IN PRECISION SERVO COMPONENTS

606 Old Country Rd., Garden City, N. Y.—Pioneer 1-4130 • TWX: G-CY-NY-1147  
WEST COAST PLANT: 1742 So. Crenshaw Blvd., Torrance, Cal.—FAirfax 8-2504 • TWX: TNC-4301

CIRCLE 209 ON READER SERVICE CARD

January 26, 1962

## MESUR-MATIC'S GO/NO-GO TRANSFORMER TESTER

Mesur-Matic's Model TT-1-P56 is designed for precision evaluation of 50 and 60 cycle power transformers in the 1 to 1000 VAC range. Under actual operating conditions, each winding is tested against every other winding and the frame to pre-set inspection tolerances. The voltage accuracy of each secondary and tap is individually indicated by GO/NO-GO lights.

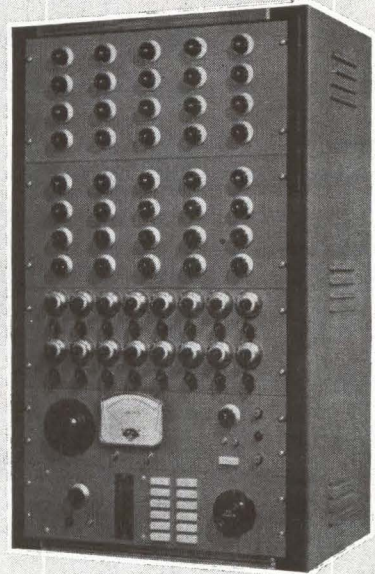

The GO/NO-GO system makes it possible to establish inspection tolerances to extremely precise limits and yet utilize non-technical operator personnel. Errors of interpretation are completely eliminated by means of the flashing red and green lights which clearly indicate either a "GO" (within tolerance) or a "NO-GO" (out of tolerance) condition. Mesur-Matic also makes available testers for RF and audio transformers and 400, 800 and 1200 cycle power transformers.

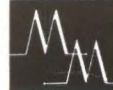

**MESUR-MATIC ELECTRONICS CORP.**  
BRADFORD, NEW HAMPSHIRE

CIRCLE 111 ON READER SERVICE CARD 111



## NEW GAS DISCHARGE INDICATION TUBE FOR SMALL SIGNALS

Designed specifically for display indicator use in transistorized electronic equipment, the TG121A glow discharge tube offers important advantages over neon indicators and miniature incandescent lamps. Of prime importance is the fact that it can be switched on and off by an input signal of a few volts and thus can be operated directly by ordinary transistor output voltage without amplification. Since it is a cold cathode device there is no heating problem such as is encountered with miniature lamps, even when many are used. This advantage coupled with its small size (length 18mm, diameter 8mm) makes it ideal for miniaturized equipment. Characteristics are stable and life is practically limitless. Detailed specifications and application information are available from our representatives listed below.



**FUJI TSUSHINKI SEIZO K.K.,**  
TOKYO, JAPAN

Represented by:

■ The Nissho American Corporation □ New York 5, 80 Pine St., WH 3-7840 □ Chicago 3, 140 S. Dearborn St., CE 6-1950 ■ The Nissho Pacific Corporation □ San Francisco 4, 120 Montgomery St., YU 2-7901 □ Los Angeles 14, 649 S. Olive St., MA 7-7691

CIRCLE 112 ON READER SERVICE CARD

4 4 44 4 4 4 4 4 4

**TODAY YOU MUST SELL ALL FOUR!**

*Design, Production, and Management. Put your advertising where it works hardest...*

Is your advertising selling the same four key buyers your salesmen call on? Competition demands it! Only advertising in electronics reaches and sells the electronics man wherever he is: in *Research,*

*Design, Production, and Management. Put your advertising where it works hardest...*

in **electronics**

in 1930. Prior to becoming executive vice president in 1960, he had been chief engineer and then vice president.

### Helweg Advances At Farrington

FARRINGTON MFG. CO., Needham Heights, Mass., recently promoted Theodore W. Helweg to head up two operating subsidiaries.

Helweg has been appointed vice president and general manager of Farrington Electronics, Inc., Alexandria, Va., and of Farrington Business Machines Corp., New Bedford, Mass.

### PEOPLE IN BRIEF

Thomas L. Phillips, v-p of Raytheon and g-m of its Missile & Space div., elected executive v-p. James E. Densmore leaves Jet Propulsion Laboratory to become director of the projects office of the Advanced Electronics and Information Systems div. of Electro-Optical Systems, Inc. Charles E. Roessler, Jr., formerly with Pressure Products Industries, now production mgr. at Omnitronics, Inc. Louis Gerold and George B. McClellan are promoted to assistant v-p's of Hazeltine Electronics div. General Time Corp. transfers H. S. Marchisello to its Haydon div. as chief industrial engineer. Shahen A. Hovanessian, previously with California Research Corp., joins TRW Computers Co. as a process analyst. Arthur H. Smith, a v-p of Midwest Technical Development Corp., elected a director of the firm. Harry Sello takes new assignment for Fairchild Semiconductor as head of production and technical activities for its Italian affiliate (Societa Generale Semiconduttori). Philip N. Hess, ex-General Electric Co., named senior scientist in charge of crossed field research at Litton Industries' Electron Tube div. research laboratory. Adler Electronics, Inc., adds two principal engineers to the Systems Engineering dept. of the Military Products div.: James Van Horn and Thomas S. Murphy, formerly with Westinghouse Electric Co. and ITT Laboratories, respectively.



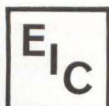

115/60-BER-12/600, in case

### 50 amp power supplies 0.1% regulation

Model	Output Voltage*	Ripple	Delivery	Price
115/60-BER-12/600	12	1 mv, rms	From stock	\$ 945
230/60-BER-28/1400	28	2 mv, rms	Less than 30 days	\$1750

\*Output voltage adjustable over  $\pm 17\%$  range.

These supplies have magnetic circuit breakers for overload protection, metered outputs, and remote sensing capability. Optional features include modifications for parallel operation and remote programming. Available for 19-inch racks or in case mountings.

Write for complete specifications on these and many other EIC power supplies.

### ELECTRODYNAMIC INSTRUMENT CORPORATION

Subsidiary of Reed Roller Bit Company

JA 6-3761 • 1841 Old Spanish Trail • Houston 25, Texas

CIRCLE 210 ON READER SERVICE CARD

# New! MINIATURE AXIAL FANS

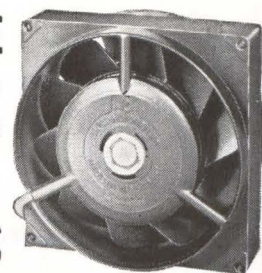

## with up to 4 times greater cooling efficiency!

Characteristic	PAMOTOR Model 1000	Conventional Fan
Type of Motor	induction (capacitor-type squirrel cage)	shaded-pole
Housing	die cast warp-free Zymec	plastic
Output @ 60 cps (0 back pressure) (.25" back pressure) (.3" back pressure)	125 cfm 75 cfm 50 cfm	100 cfm 20 cfm 0
Output @ 50 cps (0 back pressure) (.25" back pressure)	100 cfm 62.5 cfm	75 cfm 5 cfm
Operating Temp. Range	-55°C to +85°C	-18°C to +44°C

The PAMOTOR Model 1000 Miniature Fan is completely interchangeable with conventional units now in use (4 1/8" center-to-center mounting holes). But the similarity ends there.

check this comparison chart!

The Model 1000 Fan meets MIL-T-5422E, Class 2 Environmental specifications. Inside-outside rotating motor design gives flywheel effect, resulting in constant, quiet fan speed. Large surface sleeve bearings mean minimum maintenance, maximum reliability.

For complete specifications and name of nearest stocking distributor, write to:

### PAMOTOR, Inc.

312 Seventh Street • San Francisco 3, Calif.

CIRCLE 211 ON READER SERVICE CARD

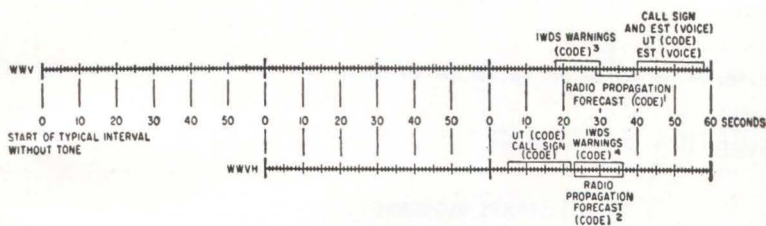

## PRIMARY STANDARDS

Whether you want to pace a city's clocks or time the transit of an artificial satellite, you'll find the standard time intervals and frequencies broadcast by the National Bureau of Standards of vital assistance.

You'll find a complete run-down on this NBS service in your 1961 **electronics Buyers' Guide** and Reference Issue, plus information on how you can obtain NBS calibration of practically any secondary standard, from resistance to the complex elements of the tensor permeability matrix.

Wealth of information like this makes your 1961 **EBG** a primary reference volume in the electronics field. You'll find new uses for it every day.

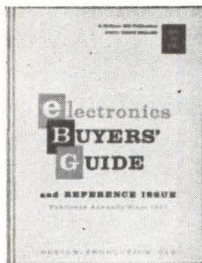

### electronics BUYERS' GUIDE and Reference Issue



The Basic Buying Guide in Electronics since 1941

## ON PW BOARDS...

# STOP COSTLY COMPONENT PREPARATION

### WITH DYNASERT



Cards or reels of components are loaded into self-feeding raceways and prepared for insertion *automatically*... The Dynasert Component Inserting Machine does all the work! Components are inserted accurately, uniformly at high rates of speeds. Operators are easily trained, changes made from one board or component type to another in seconds. Let us show you how Dynasert can actually pay for itself on only a few hundred insertions per week. Send for Facts. Dynasert Dept., United Shoe Machinery Corp., Boston, Mass.

### United

# DYNASERT®

US1-72

CIRCLE 113 ON READER SERVICE CARD

# electronics

## WEEKLY QUALIFICATION FORM FOR POSITIONS AVAILABLE

### ATTENTION: ENGINEERS, SCIENTISTS, PHYSICISTS

This Qualification Form is designed to help you advance in the electronics industry. It is unique and compact. Designed with the assistance of professional personnel management, it isolates specific experience in electronics and deals only in essential background information.

The advertisers listed here are seeking professional experience. Fill in the Qualification Form below.

#### STRICTLY CONFIDENTIAL

Your Qualification form will be handled as "Strictly Confidential" by ELECTRONICS. Our processing system is such that your form will be forwarded within 24 hours to the proper executives in the companies you select. You will be contacted at your home by the interested companies.

#### WHAT TO DO

1. Review the positions in the advertisements.
2. Select those for which you qualify.
3. Notice the key numbers.
4. Circle the corresponding key number below the Qualification Form.
5. Fill out the form completely. Please print clearly.
6. Mail to: D. Hawksby, Classified Advertising Div., ELECTRONICS, Box 12, New York 36, N. Y. (No charge, of course).

COMPANY	SEE PAGE	KEY #
A C SPARK PLUG Electronics Div. of General Motors Corp. Milwaukee, Wisconsin	65*	1
DALMO VICTOR CO. Div. of Textron, Inc. Belmont, California	116	2
ESQUIRE PERSONNEL SERVICE INC. Chicago, Illinois	116	3
GENERAL DYNAMICS/ASTRONAUTICS San Diego, California	33, 34*	4
GRUMMAN AIRCRAFT ENGINEERING CORP. Bethpage, L. I., New York	115	5
HARVARD UNIVERSITY Cambridge, Massachusetts	92*	6
I T T KELLOGG Communications Systems Division Chicago, Illinois	93*	7
LOCKHEED CALIFORNIA CO. A Div. of Lockheed Aircraft Corp. Burbank, California	84	8
MICROWAVE SERVICES INTERNATIONAL, INC. Denville, New Jersey	116	9
MINNEAPOLIS HONEYWELL Boston Division Boston, Massachusetts	102	10
PAN AMERICAN WORLD AIRWAYS INC. Guided Missiles Range Div. Patrick AFB, Florida	14*	11
PHILCO WESTERN DEVELOPMENT LABS. Palo Alto, California	90*	12
REMINGTON RAND UNIVAC Div. of Sperry Rand Corp. St. Paul, Minnesota	77	13

CONTINUED ON PAGE 116

(cut here)

(cut here)

### electronics WEEKLY QUALIFICATION FORM FOR POSITIONS AVAILABLE

Personal Background

NAME .....  
HOME ADDRESS .....  
CITY ..... ZONE ..... STATE .....  
HOME TELEPHONE .....

### Education

PROFESSIONAL DEGREE(S) .....  
MAJOR(S) .....  
UNIVERSITY .....  
DATE(S) .....

### FIELDS OF EXPERIENCE (Please Check)

12662

- |  |  |                                       |
|--|--|---------------------------------------|
| <input type="checkbox"/> Aerospace           | <input type="checkbox"/> Fire Control        | <input type="checkbox"/> Radar        |
| <input type="checkbox"/> Antennas            | <input type="checkbox"/> Human Factors       | <input type="checkbox"/> Radio—TV     |
| <input type="checkbox"/> ASW                 | <input type="checkbox"/> Infrared            | <input type="checkbox"/> Simulators   |
| <input type="checkbox"/> Circuits            | <input type="checkbox"/> Instrumentation     | <input type="checkbox"/> Solid State  |
| <input type="checkbox"/> Communications      | <input type="checkbox"/> Medicine            | <input type="checkbox"/> Telemetry    |
| <input type="checkbox"/> Components          | <input type="checkbox"/> Microwave           | <input type="checkbox"/> Transformers |
| <input type="checkbox"/> Computers           | <input type="checkbox"/> Navigation          | <input type="checkbox"/> Other .....  |
| <input type="checkbox"/> ECM                 | <input type="checkbox"/> Operations Research | <input type="checkbox"/> .....        |
| <input type="checkbox"/> Electron Tubes      | <input type="checkbox"/> Optics              | <input type="checkbox"/> .....        |
| <input type="checkbox"/> Engineering Writing | <input type="checkbox"/> Packaging           | <input type="checkbox"/> .....        |

### CATEGORY OF SPECIALIZATION

Please indicate number of months experience on proper lines.

	Technical Experience (Months)	Supervisory Experience (Months)
RESEARCH (pure, fundamental, basic)	.....	.....
RESEARCH (Applied)	.....	.....
SYSTEMS (New Concepts)	.....	.....
DEVELOPMENT (Model)	.....	.....
DESIGN (Product)	.....	.....
MANUFACTURING (Product)	.....	.....
FIELD (Service)	.....	.....
SALES (Proposals & Products)	.....	.....

CIRCLE KEY NUMBERS OF ABOVE COMPANIES' POSITIONS THAT INTEREST YOU

1 2 3 4 5 6 7 8 9 10 11 12 13 14 15 16 17 18 19 20 21 22 23 24 25

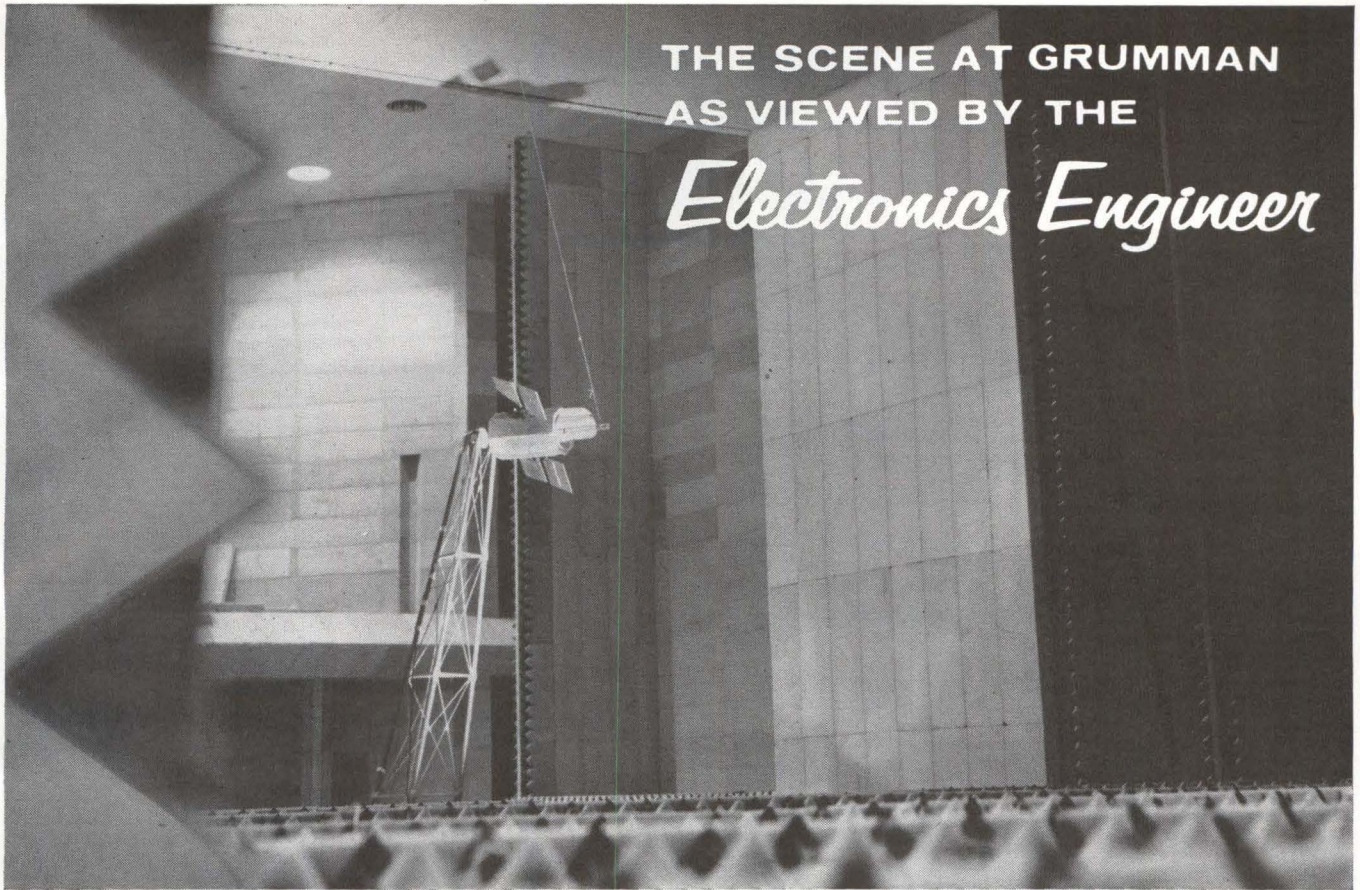

THE SCENE AT GRUMMAN  
AS VIEWED BY THE

## *Electronics Engineer*

### *...The Blue Room*

A unique attraction at Grumman's Electronic Systems Center is the "Blue Room", or Anechoic Chamber, designed for echo-free indoor radio frequency testing. This lofty chamber, 110 feet long by 40 feet wide by 25 feet high, is the largest indoor Anechoic Chamber in the United States devoted to aero-space antenna work. It gets the name, "blue room", from the fact that it is completely lined and baffled with four-inch-thick blocks of pale blue plastic foam containing wave-absorbing cones. Specific care has been taken in design to insure over 40 db. reduction of reflections at all frequencies from 1000 MC to at least 40 KMC. The "blue room" is just one of the many advanced facilities at Grumman available to the electronic engineer.

Long-range planning in Grumman's electronics programs include study activities, design and production of vehicles and systems ranging from ASW through space technology. Electronic engineers who can contribute to these programs are urged to consider the following positions:

**Radar Development Engineers**—BSEE with a minimum of 4 years experience in the analysis, design and development of airborne radar systems. Should be capable of analyzing the radar system with the end view of integrating the equipment into a complex weapons system. Will fully participate in laboratory and flight development programs conducted in the finest facilities available in a professional atmosphere.

**ECM Engineers** — BSEE or BS in Physics with a minimum of 3 years experience in the fields of radar systems, passive and/or active counter-measures systems, and ECCM systems. Work involves the development of ECM systems and the integration of ECM equipment with navigation and digital computer systems. Background in digital computers and programming is desirable but not essential.

**Communications Systems Engineer**—Electronic Engineers with thorough knowledge of communications techniques who wish to extend their technical background to new challenging areas. An important phase of this effort will be extensive laboratory development programs in our new Electronics Systems Center using the finest of equipment and facilities. BSEE with a minimum of 3 years experience.

**Digital Computer Systems Engineer**—BSEE with a minimum of 4 years experience in the analysis design and development of digital computers. Will participate in the integration of digital computer into a complex weapons system. A significant part of the effort will be devoted to extensive laboratory and flight development programs.

To arrange an immediate interview, send your resume to Mr. W. Brown, Manager Engineering Employment, Dept. GR-76  
(U. S. citizenship required)



# GRUMMAN

AIRCRAFT ENGINEERING CORPORATION  
Bethpage • Long Island • New York

All qualified applicants considered regardless of race, creed, color or national origin.



A leader in . . .

Design, Development and Manufacturing of

- MICROWAVE ANTENNAS SYSTEMS & COMPONENTS
- ELECTRONIC SYSTEMS
- MAGNETIC INSTRUMENTATION SYSTEMS
- SERVO CONTROL SYSTEMS

Invites . . .

Qualified Engineers and Scientists to explore the challenging opportunities created by increased business volume and facility expansion.

Experienced Engineers and Physicists will find stimulating assignments, career growth opportunities based on performance, and the opportunity to make significant individual contributions toward major state of the art advances in the areas indicated above.

Liberal employee benefits which include Insurance, Stock Plan, Profit-Sharing and Educational assistance, combine with the natural advantages of Northern California suburban living to offer an ideal environment in which to work and live.

For further information, please write, sending a copy of your resume to:

Technical Employment



1515 Industrial Way  
Belmont, Calif.

"an equal opportunity employer"

**Electronic Instrument Technicians**  
The Oak Ridge National Laboratory  
Operated by  
**UNION CARBIDE NUCLEAR COMPANY**  
at  
Oak Ridge, Tennessee  
Has openings for

Highly skilled electronic instrument technicians to work with electronic engineers in the development, installation and maintenance of electronic systems. Digital data handling, transistorized pulse height analyzers, analog and digital computer systems are only a few examples.

Minimum high school education, with additional training in electronics and at least three years' experience in installation and maintenance of complex electronic systems. Entrance rate \$3.10 per hour; \$3.16 per hour after six months. Reasonable interview and relocation expenses paid by Company.

Excellent Working Conditions and

Employee Benefit Plans  
An Equal Opportunity Employer  
Send detailed resume to:

Central Employment Office  
**UNION CARBIDE NUCLEAR COMPANY**  
Post Office Box M Oak Ridge, Tennessee

## MICROWAVE COMMUNICATIONS ENGINEERS

Ankara - Teheran - Karachi  
Bangkok - U. S.

Work involves engineering, supervision of installation, operation and maintenance of microwave communications systems.

College Degree Mandatory

## MICROWAVE COMMUNICATIONS TECHNICIANS

Must be qualified by education and experience to inspect installation, operate and maintain microwave communications systems to insure quality and performance standards.

Technical or trade school training mandatory.

Families May Accompany

Usual Overseas Benefits

Send detailed resumes to:

P-7950, Electronics  
645 N. Michigan Avenue, Chicago 11, Ill.

### COMMUNICATIONS APPLICATION ENGINEER

Analysis of advanced electronic communication systems including radio, carrier, telephone, microwave: Must have design and marketing experience with commercial and military users.

EE degree, 5 yrs. exp. min.  
Send Resume to:  
Microwave Services International Inc.  
Consulting Engineers  
Route 46 Denville, N. J.

### RESUMES

Resumes by Richton, the dynamic, dignified approach to best jobs. Expertly prepared, professionally written, custom printed. Complete analysis and evaluation with or without personal visit. Free bonus features. Nationwide service. Free literature. The Richton Company, Dept. F, 1020 Broad St., Newark, N. J.

# electronics

## WEEKLY QUALIFICATIONS FORM FOR POSITIONS AVAILABLE

(Continued from page 114)

COMPANY	SEE PAGE	KEY #
SPACE TECHNOLOGY LABS., INC. A Sub. of Thompson-Ramo-Wooldridge Los Angeles, California	91*	14
UNION CARBIDE NUCLEAR CO. Oak Ridge, Tennessee	116	15
UNIVERSITY OF MICHIGAN Ann Arbor, Michigan	92*	16
P-7950	116	17

\* These advertisements appeared in the 1/19/62 issue.

### PROJECT MANAGER

TO \$18,500 PER YEAR

To manage multimillion dollar electro-mechanical materials handling system development and implementation programs. Responsibilities will begin during contract negotiation and continue through and finalize in re-negotiation of contract costs. All expenses assumed by client.

ESQUIRE PERSONNEL SERVICE, INC.  
202 South State St. Chicago 4, Illinois

### SEARCHLIGHT SECTION

(Classified Advertising)  
BUSINESS OPPORTUNITIES  
EQUIPMENT - USED or RESALE

### NEW INDUSTRY WANTED

Community Has Cash To Help locate industry in western Kentucky lake area. No gimmick! Plenty of water, labor, sites, gas, power. 100% plant financing. For more details call or write, West Hopkins Industries, Box 245, Dawson Springs, Ky.

# EFFECTIVE ENGINEER RECRUITMENT ADVERTISING DEPENDS ON ENGINEERING READERSHIP

Where your recruitment program calls for qualified engineers in the electronics industry, there is no more efficient method of reaching them than through the pages of the publication they pay to read.

## electronics

Classified Advertising Division

Post Office Box 12

New York 36, N. Y.

# INDEX TO ADVERTISERS



## Audited Paid Circulation

• AMP Incorporated .....	80	Minnesota Mining & Mfg. Co.	
• A P M Corp. ....	117	Mincom Division .....	55
• Aerospace Corporation .....	86	• Mitsumi Electric Co., Ltd. ....	111
• Airpax Electronics, Inc. ....	107	• Mullard Ltd. ....	18
• American Machine & Foundry Co.		Norton Company .....	15
• Potter & Brumfield Div. ....	65	• Ohmite Mfg. Co. ....	35
• Amphenol-Borg Electronics Corp.		Parmotor Inc. ....	113
• Connector Division .....	69	• Polarad Electronics Corporation	60
• Anti-Corrosive Metal Products Co.,		• Potter and Brumfield, Div. of American	
• Inc. ....	78	• Machine & Foundry Co. ....	65
• Arnold Engineering Co., The. ....	5	• Precision Instrument Co. ....	97
• Art Wire & Stamping Co. ....	78	• Radio Corporation of America ... 4th Cover	
• Ballantine Laboratories, Inc. ....	93	• Raychem Corp. ....	32, 33
• Bausch & Lomb, Inc. ....	94	• Remington Rand Univac	
• Bell Telephone Laboratories .....	17	• Div. of Sperry Rand Corp. ....	77
• Bendix Corporation		• Ridgefield Instrument Group. ....	101
• Semiconductor Division .....	109	Sarkes Tarzian Inc. ....	62
• Borg Equipment Division, Amphenol-		• Servo Corporation of America. ....	85
• Borg Electronics Corp. ....	79	• Smith Florence, Inc. ....	68
• Centralab, The Electronics		• Sperry Electronic Tube Div.	
• Div. of Globe-Union Inc. ....	73	• Sperry Rand Corp. .... 3rd Cover	
• Clairrex Corp. ....	90	• Sprague Electric Co. ....	4, 29
• Consolidated Electrodynamics Corp.	34	• Standard Telephones & Cables Limited	22
• Continental Connector Corp. ....	83	• Superior Cable Corp. ....	96
• Corning Glass Works, Electronic		Texas Instruments Incorporated	
• Components .....	53	• Semiconductor & Components. ....	92
• Cross Co., H. ....	101	• Triad Transformer Corp.	
• Cubic Corp. ....	64	• A Div. of Litton Industries. ....	19
Data-Control Systems, Inc. ....	105	United Shoe Machinery Corp. ....	113
• DeJur-Anseco Corporation .....	83	• Vernitron Corporation .....	111
• Deleo Radio .....	30, 54	• Vitro Electronics .....	106
• Dow Corning Corp. ....	61	Western Electric, Laureldale Plant. ....	36
• duPont de Nemours & Co., Inc. E. I. 63,	75	• White, S. S. ....	100
• Eitel-McCullough, Inc. ....	6	• Williams & Co., C. K. ....	76
• Electra Mfg. Co. ....	24		
• Electrical Industries, Inc. ....	70	CLASSIFIED ADVERTISING	
• Electrodynamic Instrument Corpora-		F. J. Eberle, Business Mgr.	
• tion .....	113	EMPLOYMENT OPPORTUNITIES. 115, 116	
• Electronic Instrument Co., Inc. (EICO)	92	BUSINESS OPPORTUNITIES .....	116
• Electronic Measurements Co., Inc. ....	118	INDEX TO CLASSIFIED ADVERTISERS	
• Erie Pacific,		Dalmo Victor Company,	
• Div. of Erie Resistor Corp. ....	98	• Div. of Textron, Inc. ....	116
• FXR, A Div. of Amphenol-Borg Elec-		• Esquire Personnel Service Inc. ....	116
• tronics Corp. ....	25	• Grumman Aircraft Engineering Corp. ....	115
• Filitors, Inc. ....	71	• Microwave Services International Inc. ....	116
• Fuji Tsushinki Seizo, K. K. ....	112	• Union Carbide Nuclear Co. ....	116
Garner Co., T. H. ....	101	• See advertisement in the July 20, 1961 issue	
• General Electric Co.		of Electronics Buyers' Guide for complete line of	
• Silicone Products Dept. ....	67	products or services.	
• General Electrodynamics Corporation	57	This index and our Reader Service Numbers are pub-	
• General Radio Co. .... 2nd cover		lished as a service. Every precaution is taken to make	
• Gudubrod Bros. Silk Co., Inc. ....	99	them accurate, but ELECTRONICS assumes no	
• Hewlett-Packard Company .....	10, 11,	responsibilities for errors or omissions.	
• Hilemp Wires Inc. ....	56		
• Hoffman Electronics Corp. ....	9		
• Hughes Aircraft Co.			
• Space Systems Div. ....	72		
• Indiana General Corp. ....	14		
• Instrument Development Laboratories,			
• Inc. ....	102		
• Itek Electro-Products Co. ....	91		
• International Electro-Magnetics, Inc.	13		
• International Electronic Industries,			
• Inc. ....	87		
• Kepeco, Inc. ....	59		
• Knights Company, James. ....	110		
Leesona Corp. ....	77		
• Lepel High Frequency Laboratories,			
• Inc. ....	78		
• Levin and Son, Inc., Louis. ....	31		
• Lincoln Laboratory .....	104		
• Little Falls Alloys Inc. ....	110		
• Lockheed California Co.,			
• Div. of Lockheed Corp. ....	84		
Mesur-Matic Electronics Corp. ....	111		
• Minneapolis-Honeywell			
• Boston Division .....	89, 102		

GREAT HISTORICAL LEAKS



## BETTER WITH A HEXSEAL\*

HEXSEALS are modular external seals. They fit onto switches, potentiometers, circuit breakers and lighted push-buttons.

We also make:

- SEELSKREWS\*
  - SEELBOLTS\*
  - SEELRIVITS\*
  - SEELTHREDS\*
- } SELF-SEALING HARDWARE

APM PRODUCTS MEET ALL APPLICABLE MIL SPECS.

Our list of modular seals is just too long for this ad. Let us send you our Catalog No. 359B.

\*Trade Mark

Write or call: MISS RIVA SOLINS  
**APM HEXSEAL CORPORATION**  
 41 Honeck Street, Englewood, N. J.  
 LOwell 9-5700

# 0 TO 1500 V COMPLIANCE

## with ELECTRONIC MEASUREMENTS



MODEL C638A

## CONSTANT CURRENT POWER SUPPLIES

You'll find a whole new world of application in Electronic Measurements Constant Current Power Supplies. Take the husky Model C638A shown here. It'll deliver up to 1500 V dc at any output current from a few microamperes up to 100 ma. There are other features too... a modulation input, programmability, less than 0.01%+1  $\mu$ a ripple... and the all-important voltage control that lets you set the maximum voltage compliance.

For complete information ask for Specification Sheet 3072B.

### BRIEF SPECIFICATIONS

MODEL	RANGE		VOLTAGE COMPLIANCE (MINIMUM)
	MIN.	MAX.	
C612A	1 $\mu$ a	100 ma.	100 V
C631A	1 $\mu$ a	100 ma.	300 V
C638A	1 $\mu$ a	100 ma.	1500 V
C624A	2.2 $\mu$ a	220 ma.	100 V
C632A	2.2 $\mu$ a	220 ma.	300 V
C629A	2.2 $\mu$ a	300 ma.	50 V
C633A	2.2 $\mu$ a	300 ma.	300 V
C620A	5 $\mu$ a	500 ma.	50 V
C621A	5 $\mu$ a	500 ma.	100 V
C613A	10 $\mu$ a	1 AMP	50 V
C614A	10 $\mu$ a	1 AMP	100 V

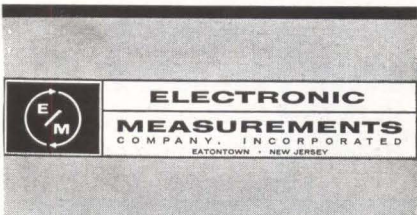

## electronics



Audit Bureau  
of Circulations

Associated Business  
Publications

Audited Paid Circulation

**JAMES T. HAUPTLI**

Advertising Sales Manager

**R. S. QUINT:**  
Assistant Publisher  
Business Manager  
**FRED STEWART:**  
Promotion Manager  
**B. ANELLO:**  
Marketing Service Manager

**RICHARD J. TOMLINSON:**  
Production Manager  
**GEORGE E. POMEROY:**  
Classified Manager  
**HUGH J. QUINN:**  
Circulation Manager

### ADVERTISING REPRESENTATIVES

**NEW YORK (36):**  
Donald H. Miller, Henry M. Shaw, George F. Werner  
500 Fifth Avenue, OXford 5-5959  
**BOSTON (16):**  
William S. Hodgkinson, Donald R. Furth  
McGraw-Hill Building, Copley Square,  
Congress 2-1160  
**PITTSBURGH (22):**  
David M. Watson  
Four Gateway Center, Express 1-1314  
**PHILADELPHIA (3):**  
Warren H. Gardner, William J. Boyle  
6 Penn Center Plaza, LOcust 8-4330  
**CHICAGO (11):**  
Harvey W. Wernecke, Robert M. Denmead  
645 North Michigan Avenue, Mohawk 4-5800  
**CLEVELAND (13):**  
Paul T. Fegley  
55 Public Square, Superior 1-7000  
**SAN FRANCISCO (11):**  
R. C. Alcorn  
255 California Street, Douglas 2-4600  
**LOS ANGELES (17):**  
Peter S. Carberry, Ashley P. Hartman  
1125 W. 6th St., Huntley 2-5450

**DENVER (2):**  
J. W. Patten  
Tower Bldg., 1700 Broadway, Alpine 5-2981  
**ATLANTA (9):**  
Michael H. Miller  
1375 Peachtree St. N.E., Trinity 5-0523  
**HOUSTON (25):**  
Joseph C. Page, Jr.  
Prudential Bldg., Holcomb Blvd.,  
Jackson 6-1281  
**DALLAS (1):**  
Frank Le Beau  
The Vaughn Bldg., 1712 Commerce St.  
Riverside 7-9721  
**LONDON W1:**  
Dennis McDonald  
34 Dover St.  
**FRANKFURT/Main:**  
Stanley R. Kimes  
85 Westendstrasse  
**GENEVA:**  
Michael R. Zeynel  
2 Place du Port

"Headquarters for Business Information"

### McGraw-Hill Technical and Business Publications

American Machinist/Metal-  
working Manufacturing  
Aviation Week and Space  
Technology  
Business Week  
Chemical Engineering  
Chemical Week  
Coal Age  
Construction Methods and  
Equipment  
Construction Daily  
Control Engineering  
Electrical Construction  
and Maintenance  
Electrical Merchandising Week  
Electrical Newsletter  
Electrical West

Electrical Wholesaling  
Electrical World  
Electronics  
Engineering Digest  
Engineering and Mining Journal  
E & MJ Metal and Mineral  
Markets  
Engineering News-Record  
Factory  
Fleet Owner  
Industrial Distribution  
National Petroleum News  
Nucleonics  
Nucleonics Week  
Platt's Oilgram News  
Platt's Oilgram Price Service  
Power

Product Engineering  
Purchasing Week  
Science Week  
Textile World

Overseas only:  
Automobile International  
(English, Spanish)  
Ingenieria Internacional  
Construccion (Spanish)  
International Management  
(English, Spanish  
Portuguese editions)  
Metalworking Production  
(Great Britain)

Available by subscription only — to qualified persons actively engaged in the field of the publication. For subscription rates and information describing the editorial coverage of any of the above publications, write to: Subscription Manager, Circulation Department, McGraw-Hill Publishing Company, 330 West 42nd Street, New York 36, N. Y.

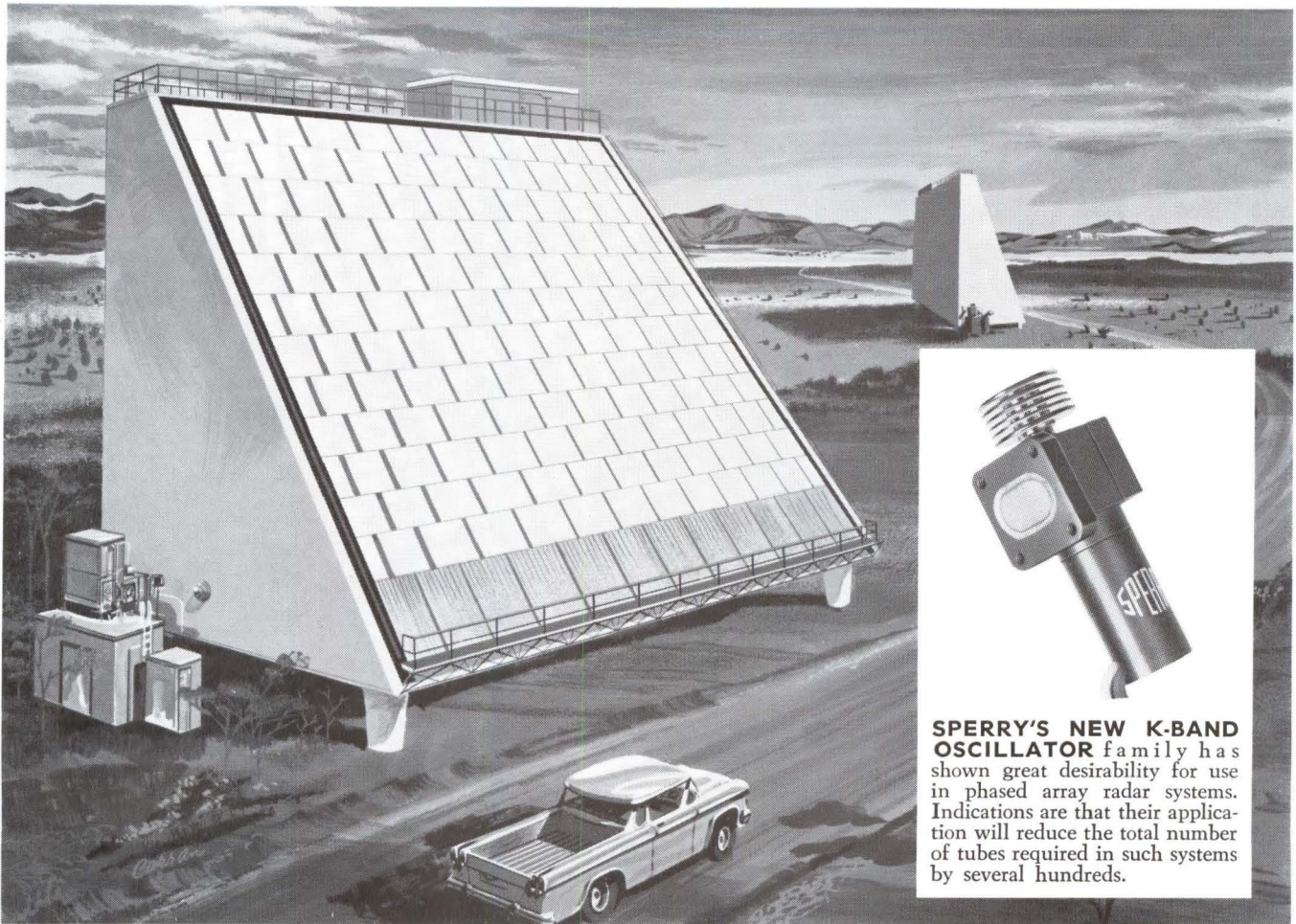

**SPERRY'S NEW K-BAND OSCILLATOR** family has shown great desirability for use in phased array radar systems. Indications are that their application will reduce the total number of tubes required in such systems by several hundreds.

## Production-ready K-band oscillators deliver 600 mW over a 20 Mc bandwidth

A new family of K-band two-cavity oscillators is now production-ready at Sperry Electronic Tube Division, Sperry Rand Corporation, Gainesville, Florida.

The new tubes show particular promise for parametric amplifier pumping applications because of their inherent amplitude stability and high power output levels at K-band frequencies (18-26.5 Gc). Depending on voltage mode of operation, power levels from 200 to 600 mW are available. While the lower level is highly promising for single amplifier pumping, the higher outputs offer tremendous possibilities in applications where several amplifiers must be pumped simultaneously. In fact, one tube—operating on the mode which delivers 600 mW minimum power output—will pump 10 or more parametric amplifiers.

### COMPONENT SAVINGS POSSIBLE

The capability of these new tubes to pump several parametric amplifiers will greatly reduce the number of tubes required in many systems. In phased array radars, for example, a net saving of several hundred tubes may result when a switching network is coupled with multiple pumped parametrics.

### DESIGN ECONOMIES REALIZED

Dramatic reductions in system design costs are indicated when the new Sperry Tubes are used in doppler radars, FM communications systems, and other K-band applications. Operating in a flat-top mode these tubes have an amazing 20 Mc bandwidth. This characteristic permits tremendously increased latitude in the specification of other parts. The system designer, freed from the tedious necessity of closely matching components, works more quickly, more efficiently, and more economically.

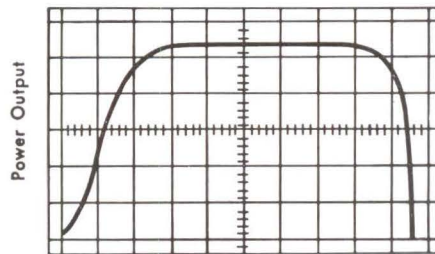

A typical main mode, adjusted for optimum flat-top operation

### FREE K-BAND BROCHURE

A NEW, FREE BROCHURE DESCRIBES THE CAPABILITIES OF THE NEW SPERRY K-BAND OSCILLATOR FAMILY IN GREATER DETAIL. FOR YOUR COPY, WRITE TO SPERRY ELECTRONIC TUBE DIVISION, SEC. 112, GAINESVILLE, FLORIDA.

Since the new Sperry family is ready for volume production, you can start specifying them *now*. Unit price is \$2,995. Cain & Co., which represents Sperry Electronic Tube Division nationally, has a salesman near you. He'll be happy to help you work out the details. Call him today!



GAINESVILLE, FLA. / GREAT NECK, N. Y.  
SPERRY RAND CORPORATION

RCA Announces 2N1905, 2N1906

# NEW HIGH-SPEED HIGH-LINEARITY POWER TRANSISTORS

- 50 watts dissipation at 25°C
- 10 amps collector current
- new flat-flange case

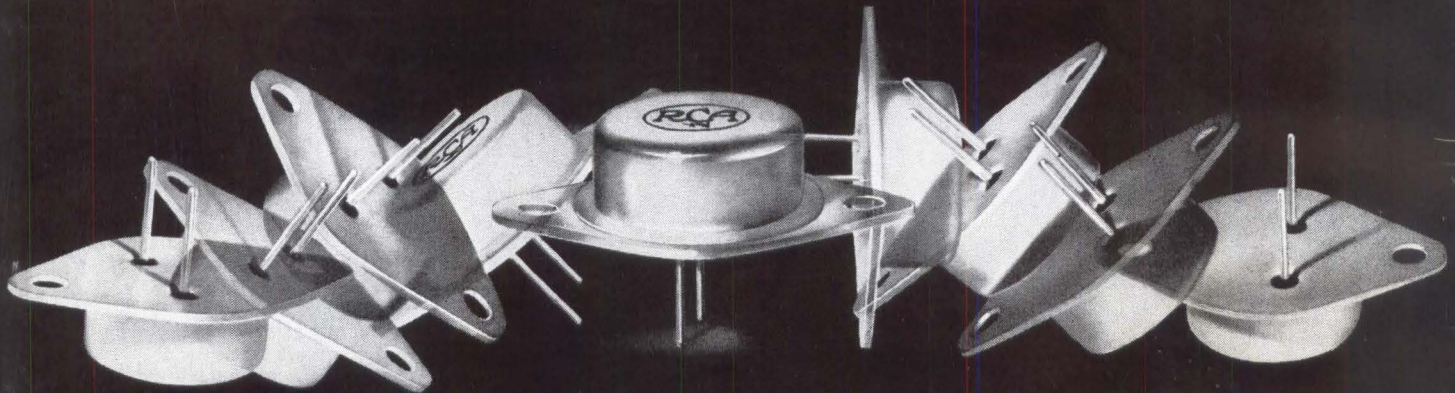

Two new low-priced p-n-p drift-field power types, RCA 2N1905 and 2N1906 offer high-power, high-speed performance that now makes these transistors practical for a broad, new range of applications

Now, out of RCA's pioneering background in drift-field transistor development, comes another significant advance...new low-cost, high-power drift-field transistors available in large quantities. These new germanium types feature high power and high current plus:

**HIGH SPEED**...extremely short rise and fall times at high values of  $I_C$ ...less than 1  $\mu$ sec.

**HIGH MINIMUM DC BETA**...50 for 2N1905, 75 for 2N1906.

**LINEAR GAIN CHARACTERISTIC** over entire collector-current range made possible by RCA's diffused-collector, graded-base construction.

**BROAD APPLICATION**...Mechanically interchangeable with present TO-3 packages...especially useful in high-power, high-speed switching circuits...in dc-to-dc converters, inverters, data-processing equipment, ultrasonic oscillators and in large-signal, wide-band, linear amplifiers.

**HIGH TYPICAL GAIN-BANDWIDTH PRODUCT**—7.5 Mc.

**LOW BASE RESISTANCE** for high power sensitivity.

**LOW PRICE**...Also available in large production quantities.

**EXTRA RELIABILITY**...Welded construction, elimination of eyelet-type pin insulators, greater uniformity of characteristics from unit to unit.

**IMPROVED HEAT TRANSFER**...Flat-Mounting-Flange case with smooth bottom surface provides uniform, total-flange contact with chassis. Mounting flange serves as the collector electrode. Thermal Resistance is 1.5°C/watt max.

Call your RCA representative today for full price and delivery information. For further technical data, write RCA Semiconductor and Materials Division, Commercial Engineering, Section A-19-NN-4, Somerville, N.J.

	MAXIMUM RATINGS, ABSOLUTE MAXIMUM VALUES	
	2N1905	2N1906
Collector-To-Base Voltage	-60	-100 volts
Collector-To-Emitter Voltage With Base Open	40	40 volts
Emitter-To-Base Voltage	-1	-1 volt
Collector Current	10	10 amp.
Base Current	3	3 amp.
Transistor Dissipation For Mounting-Flange Temperature Up to 25°C	50	50 watts
Temperature Range: Storage	-55 to +100°C	
Operating (Junction)	-55 to +100°C	

Available Through Your  
RCA Distributor



The Most Trusted Name in Electronics  
RADIO CORPORATION OF AMERICA

RCA SEMICONDUCTOR & MATERIALS DIVISION FIELD OFFICES... EAST: Newark, N. J., 744 Broad St., HU 5-3900 • (Camden-Philadelphia Area) Erlton, N. J., 605 Marlton Pike, HA 8-4802 • Syracuse, N. Y., 731 James St., Rm. 402, GR 4-5591 • Baltimore, Md., EN 9-1850 • NORTHEAST: Needham Heights 94, Mass., 64 "A" St., HI 4-7200 • SOUTHEAST: Orlando, Fla., 1520 Edgewater Dr., Suite #1, GA 4-4768 • EAST CENTRAL: Detroit 2, Mich., 714 New Center Bldg., TR 5-5600 • CENTRAL: Chicago, Ill., Suite 1154, Merchandise Mart Plaza, WH 4-2900 • Indianapolis 5, Ind., 2132 East 52nd St., CL 1-1405 • Minneapolis 16, Minn., 5805 Excelsior Blvd., WE 9-0676 • WEST: Los Angeles 22, Cal., 6801 E. Washington Blvd., RA 3-8361 • (San Francisco area) Burlingame, Cal., 1838 El Camino Real, OX 7-1620 • Seattle 4, Washington, 2250 First Ave. S., MA 2-8350 • SOUTHWEST: Dallas 7, Tex., 7905 Carpenter Freeway, ME 1-9720 • GOV'T: Dayton, O., 224 N. Wilkinson St., BA 6-2366 • Washington, D. C., 1725 "K" St., N.W., FE 7-8500.