

electronics

A McGraw-Hill Publication 75 Cents

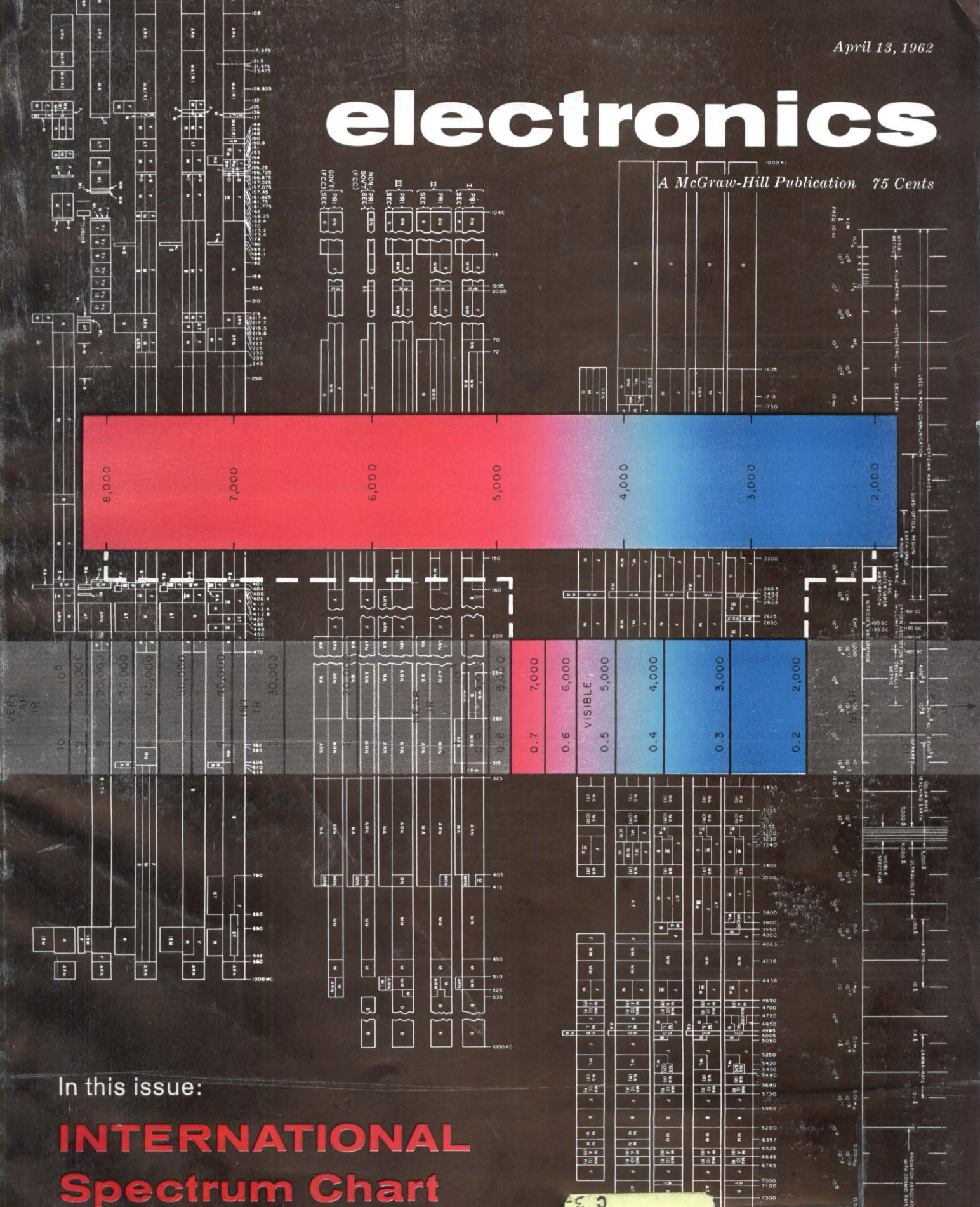

In this issue:

INTERNATIONAL Spectrum Chart

R D SKINNER
 1020 COVINGTON RD
 JALIF

ANOTHER ADVANCED MICROWAVE TUBE DEVELOPMENT
FROM RAYTHEON'S SPENCER LABORATORY



SPACE-CAPSULE COMPACTNESS of new voltage-tunable oscillator is evident in this actual-size photo. S-band M-BWO has high efficiency, light weight, needs only conduction cooling.

Newest wideband, versatile M-BWO breaks watts-per-pound record

QKA 995—TYPICAL OPERATING CHARACTERISTICS

	Sole tuning	Anode tuning
Frequency Range (Mc).....	2700-3200	2200-3200
Power Output	50 watts min.	30-60 w
Anode Voltage	1200 V	600-1400 V
Anode Current.....	115 ma	115 ma
Sole Voltage	350-750 V	500 V
Accelerator Voltage.....	600 V	600 V
Efficiency	50%	50%
Diameter	less than 4.5 in.....	
Weight	3.5 lbs.....	
Cooling	Conduction.....	

3½-pound voltage-tunable oscillator delivers 50 watts min., features low-voltage tuning

Raytheon's newest all metal-ceramic QKA 995 is the smallest and most efficient M-BWO yet developed. This extremely rugged voltage-tunable oscillator requires no external RF package. Its size, weight and sturdy construction make it ideally suited for airborne, missile and space applications.

Bandwidth is as great as 2200 to 3200 Mc depending on mode of tuning. Either anode or sole voltage can be varied to tune tube.

Write today for complete technical details on this and other Raytheon microwave oscillators. Address Raytheon Company, Microwave and Power Tube Division, Waltham 54, Massachusetts.

RAYTHEON

RAYTHEON COMPANY

MICROWAVE AND POWER TUBE DIVISION

CIRCLE 257 ON READER SERVICE CARD

electronics

A McGraw-Hill Publication 75 Cents



W. W. MacDONALD, Editor

J. M. CARROLL, Managing Editor
 SENIOR EDITORS: Samuel Weber, George W. Sideris. SENIOR ASSOCIATE EDITORS: William E. Bushor, Michael F. Wolff. ASSOCIATE EDITORS: Michael F. Tomaino, Sylvester P. Carter, William P. O'Brien, John F. Mason, Thomas Emma, Sy Vogel, Leslie Solomon, George J. Flynn, Laurence D. Shergalis. ASSISTANT EDITORS: Nilo Lindgren, Stanley Froud, Stephen B. Gray, Roy J. Bruun, George V. Novotny, Leon H. Dulberger. REGIONAL EDITORS: Harold C. Hood (Pacific Coast, Los Angeles), Thomas Maguire (New England, Boston), Cletus M. Wiley (Midwest, Chicago). ART DIRECTOR: Harry Phillips; Howard R. Berry. PRODUCTION EDITOR: John C. Wright, Jr. EDITORIAL ASSISTANTS: Gloria J. Meurer, Bernice Duffy, Lorraine Rossi, Virginia T. Bastian, Lynn Emery, Laura W. Smith, Bette H. Snyder, Rosemary Abbruzzese, Judy Haskins, Ann Mella. FOREIGN NEWS BUREAU: Director, John Wilhelm, Alyne Elias. LONDON—John Shinn, Derek Barlow, Nicholas London. Bonn—Peter Forbath, James Morrison, Silke McQueen. Paris—Robert Farrell, Arthur Erikson. Milan—Gene DiRaimondo. Mexico City—Bruce Bendow. Rio de Janeiro—Leslie Warren. Moscow—Stewart Ramsey. Tokyo—Richard Halloran, Charles Cohen, John Yamaguchi.

JAMES GIRDWOOD, Publisher

ARTIST'S CONCEPTION of international spectrum chart. Background shows portions of international electromagnetic spectrum from 1,000 Kc to 10 Mc, 10 Kc to 1,000 Kc and 100 Mc to 1,000 Mc and the over-all spectrum from vlf to cosmic rays. *Superimposed is spectrum from far infrared to far ultraviolet with expanded visible spectrum above.* See p 37 COVER

DIGITAL COMMUNICATIONS System to Test Space Path. Orbiting needle belt will be used as relay. *To overcome interference and fading, 16 pairs of frequencies are employed* 20

MHD ENGINE Uses Traveling Wave Principle. Reports at magnetohydrodynamics symposium include one on engine with time-varying magnetic field. *Other engines have attained efficiencies of 50 to 60 percent* 26

"AFTERBURNER" Improves Plasma Engine. *Lorentz-force accelerator requires moderate magnetic field* 27

CENTAUR Tries Two Telemetry Firsts. Tv will monitor action in fuel tank. *NASA says use of 540 channels is a new high* 28

REMOTE VIEWER Has Screen Worn Like a Monocle. *Tv or radar image is superimposed on viewing background.* 30

TABLE OF FREQUENCY ALLOCATIONS based on international regulations and corrected as of December 1961. This 30 by 22-in. chart covers all three regions of the world with special emphasis on government and nongovernment allocations in the U. S. *The chart also presents the useful optical spectrum, sound spectrum and map of the three ITU regions* 37

MAGNETOSTRICTIVE DELAY LINES: What Designers Should Know About Them. Reviews design and operation of longitudinal and torsional types with emphasis on latter. Discusses commercially available lines and gives pointers on how to build your own. *These lines are finding increasing use in missiles, aircraft navigation, radar, sonar, data processing and automatic control.* 55
 By A. Rothbart and A. J. Brown

MICROMINIATURE CRYSTAL OSCILLATOR Using Wafer Modules. A 10-Mc crystal-controlled oscillator with electronic temperature control occupies 1.5 cu in. *Temperature control circuit uses thermistor; oven heater current is controlled by pulse width modulator.* 60
 By M. Lysobey

Published weekly, with Electronics Buyers' Guide and Reference issue, as part of the subscription, by McGraw-Hill Publishing Company, Inc. Founder: James H. McGraw (1860-1948).

Indexed Annually in Buyers' Guide and Reference issue.

Title ® registered U.S. Patent Office; © Copyright 1962 by McGraw-Hill Publishing Co., Inc. All rights reserved, including the right to reproduce the contents of this publication, in whole or in part.

Executive, editorial, circulation and advertising offices McGraw-Hill Building, 330 West 42nd Street, New York 36, N. Y. Telephone Longacre 4-3000. Teletype TWX N.Y. 1-1636. Cable McGrawhill, N. Y. PRINTED IN ALBANY, N. Y.; second class postage paid at Albany, N. Y.

OFFICERS OF THE PUBLICATIONS DIVISION: Nelson L. Bond, President; Shelton Fisher, Wallace F. Traendly, Senior Vice Presidents; John R. Callahan, Vice President and Editorial Director; Joseph H. Allen, Vice President and Director of Advertising Sales; A. R. Venezian, Vice President and Circulation Coordinator; Daniel F. Crowley, Vice President and Controller.

OFFICERS OF THE CORPORATION: Donald C. McGraw, President; Hugh J. Kelly, Harry L. Waddell, Executive Vice Presidents; L. Keith Goodrich, Executive Vice President and Treasurer; John J. Cooke, Vice President and Secretary.

Subscriptions are solicited only from those actively engaged in the field of the publication. Position and company connection must be indicated on orders. Subscription rates: United States and Possessions, \$6.00 one year; \$9.00 two years; \$12.00 three years. Canada, \$10.00 one year. All other countries \$20.00 one year. Single Copies, United States and Possessions and Canada 75¢. Single copies all other countries \$1.50.

THE PUBLISHER, UPON WRITTEN REQUEST FROM ANY SUBSCRIBER TO OUR NEW YORK OFFICE, AGREES TO REFUND THAT PART OF THE SUBSCRIPTION PRICE APPLYING TO COPIES NOT YET MAILED.

Subscribers: Please address all correspondence, change of address notices, subscription orders or complaints to Fulfillment Manager, Electronics, at above address. Change of address notices should provide old as well as new address, including postal zone number if any. If possible, attach address label from recent issue. Allow one month for change to become effective.

Postmaster: Please send Form 3579 to Fulfillment Manager, Electronics, 330 West 42nd Street, New York 36, New York.



Audited Paid Circulation

CONTENTS continued

- TUNNEL-DIODE GATE Has Subnanosecond Rise Time. Gate circuit consists of a balanced bridge. Two different outputs are obtained when tunnel-diode is switched between stable states. *Circuit is useful as pulse-height discriminator in nuclear instrumentation.* By F. W. Kantor 62
- ANALOG TECHNIQUE Derives Correlation Functions. General purpose analog computer with a pair of electronic storage tubes can compute autocorrelation or cross-correlation functions of time-varying signals. *Power spectral density function is also available since it is a Fourier transform of the correlation function.* By N. D. Diamantides 65
- RAISING INPUT IMPEDANCE of Transistor Amplifiers. Negative feedback is applied to emitter and positive feedback to base of input transistor. *Varying value of positive-feedback resistor varies input impedance.* By J. J. Tiemann 68
- LOW-COST PULSE GENERATOR. A transistor is added to single neon-tube relaxation oscillator. Transistor overcomes limitation of difference in neon-tube ignition and extinction voltages. *Oscillator covers a range of 0.05 to 7,000 cps.* By R. D. Ryan 70

DEPARTMENTS

- Crosstalk. *Guest Editor. Mileage at IRE Show* 3
- Comment. *Bionics Models. Not a Ring Counter* 4
- Electronics Newsletter. *Space-Tracking System Scheduled for Expansion* 7
- Washington Outlook. *Industry Objections to New Trade Bill May Result in Changes* 12
- Meetings Ahead. *National Conference on Tube Techniques* 32
- Research and Development. *Biasing Adds Life to Electrostatic Recording* 74
- Components and Materials. *Ferrite Cup Cores* 80
- Production Techniques. *Control Pulse Polarity for Weld Strength* 86
- New Products Design and Application. *Ultrastable Oscillator. Microsignal Amplifier* 94
- Literature of the Week 116
- Index to Advertisers 132

CROSSTALK

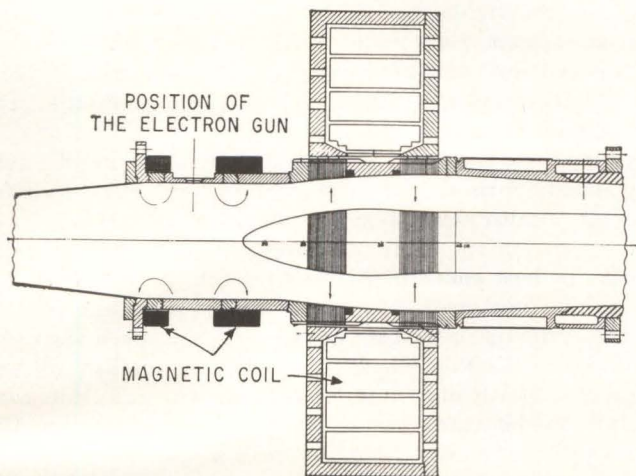

GUEST EDITOR. The rapidly expanding fields of electric propulsion, energy conversion, plasma diagnostics and communications, and controlled thermonuclear fusion research linked by the thread of magnetohydrodynamics (MHD) is of considerable interest to our industry. The potential impact, both technological and financial, is incalculable at present.

Best guess is that MHD research will generate numerous advances in hardware (measuring and control instrumentation), in space systems (longer range and more maneuverability), in defense (coping with the plasma sheath surrounding reentry vehicles), and in theory (electron optics, cosmology, and the action of magnetic fields upon gases).

But, let's face it, MHD is still a fairly esoteric field and keeping up with developments is hard work. Not that we are shirkers—we ran a three-part series on plasma engineering last year (p 47, July 14; p 33, Aug. 4; p 29, Sept. 1) and have had numerous articles and news items before and since then.

So we were delighted to learn that an acquaintance of one of our editors was chairman of the program committee of a national symposium on MHD and would be willing to cover the conference for us. The report, by George W. Sutton, a visiting professor at MIT, appears on page 26. Sutton is on leave of absence from GE, where he started an MHD power conversion program in 1958.

One of the interesting papers at the conference was a report by Bela Karlovitz on attempts

made during 1932 to 1947 to develop an MHD generator. The engine, illustrated at left, did work, but its power output was too small. This is one problem that present-day experimenters seem well on their way to solving.

SHOELEATHER. Most everybody on our staff spent a day or so at the IRE Show last month. And most of us were content to dismiss the topic of mileage covered with the comment, "My feet hurt."

But not Assistant Editor Gray. He turned in a technical note:

Floor 1: 1.75 miles
Floor 2: 1.50 miles
Floor 3: 0.75 mile
Floor 4: 0.60 mile
Total: 4.60 miles

Mileage was recorded by a pedometer set for a 30-inch stride. However, Gray adds, since a 30-inch stride was difficult to achieve in the crowded aisles of the Coliseum and since the pedometer didn't register on-feet time spent in talking, a finagle factor must be applied. The factor depends on whether one wishes to maximize ("Boss, I really wore out my shoes covering that show") or minimize ("Doesn't take long for an experienced editor").

Not included in the total mileage are the steps at both ends of a bus trip to the Waldorf-Astoria to attend a technical session and then, because taxis were scarce and it was the nicest day in a month, walking back to the office: 2.1 miles.

Coming in Our April 20 Issue

SWEPT FREQUENCY. Of increasing import because of the design flexibility that they permit are frequency-independent antennas. Next week, J. D. Dyson, of the University of Illinois, gives a lucid account of the development of these antennas and an outline of some of the problems yet to be overcome.

Another article, interesting for its humane as well as its engineering overtones, is a description by C. D. Valz, of the U. S. Bureau of Fisheries, of an underwater electric fence. The fence guides salmon to prevent them getting trapped in hydroelectric power turbines.

Other reports include a tunnel diode switching-time tester, by J. E. Gersbach and I. Lieber, of IBM, and preventing gaseous breakdown in microwave systems, by R. M. White and R. H. Stone, of GE.

CALIBRATED Thermistor Mounts

For Greater Accuracy
in Power Measuring Systems



Model 675-A

Coaxial Thermistor Mount

The Model 675-A is a 200 ohm thermistor mount for use in the 100 to 4000 mc range. Its extremely long thermal time constant virtually eliminates effects of ambient temperature changes. Calibration factor is supplied to an accuracy of 2% at 400, 1000 and 1500 mc.

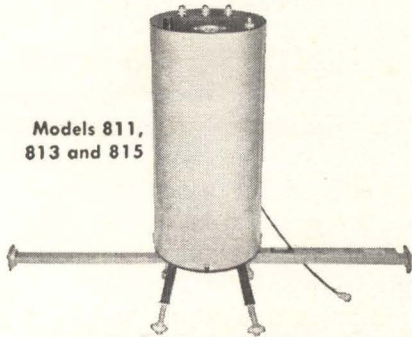

Models 811,
813 and 815

X-Band Power Standard

This 200 ohm thermistor mount-coupler-temperature chamber combination operates over any specified 200 mc band between 8.2 and 11.2 kmc. The thermostatically controlled constant temperature chamber eliminates effects of ambient temperature changes. An NBS test report is supplied giving the calibration factor to an accuracy of 1%.

Precision Power Bridges

Weinschel Engineering also manufactures precision power bridges for use with these thermistor mounts. These bridges give accuracies to 0.1% of substituted power.

For complete specifications:
Write for Weinschel Bulletin #386

WEINSCHEL
ENGINEERING

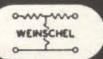

10503 METROPOLITAN AVENUE
KENSINGTON, MARYLAND
Tel.: 949-0141 (Area Code 301)
TWX: KENS 446
In California: 631 Wilshire Blvd.
Santa Monica
TWX: SMON 7185

COMMENT

Bionics: Models

One point I wish more people would make (though I think it would have been out of place in ELECTRONICS) is that when we make models, of the nervous system for example, we are limited by (at least) two factors: (1) the problem we are interested in and (2) the level of technology. Both of these being obvious, why insist? I think I can make my point clearer by analogy.

Art fakes that pass the best connoisseurs of one generation are easily detected by the ordinary interested amateur of the next. Not because there has been an elevation of taste or knowledge, but because the counterfeiter has provided only those elements in the picture which his contemporaries are looking for as "characteristic" of X, the artist he is faking.

The next generation sees how bad the counterfeit is, because it will be obsessed by something else, and will see as important some other characteristic of X. The counterfeiter cannot know and probably does not care what will obsess the next generation and so in these aspects will reveal himself, exposing the fraud.

When *we* think of the eye as an encoder rather than the optical instrument of 19th century physiology, do we do so because the eye is *really* one rather than the other, or because "encoder" better describes the answers to the questions *we* ask about the eye?

In both cases we are model-making and by its nature a model is incomplete, telling us as much or more about the interests of its creator than it does about the object it was constructed to explain.

The second point is only a different aspect of the first.

Lucretius described the motion of the stars in terms of a water wheel, which seems to have been introduced into the Mediterranean area during his lifetime (always include a classical reference for tone) and *we* describe the brain as a computer. If there are people still around 2,000 years from now, will his model seem any more primitive than ours?

I am not trying to denigrate what's being done in bionics, only trying to say that there should be a more conscious realization on the part of the people who are model-making (I realize this is only one part of bionics) of what it is they are doing.

There is such a neat illustration from moth behavior that I can't help quoting it, though it is only tenuously connected with the proceeding:

A moth flies by orienting himself with respect to light rays, that is, a moth "wanting" to go at a particular angle will fly so that the light rays incident on his receptors are all cut at this same angle. Now this works very well when the light source is infinitely distant, as the sun or moon, and the light rays consequently parallel. But when the light source is a candle or bulb, the rays diverge from a point and the locus that cuts each of these radii at the same angle will be a logarithmic spiral, either into the flame or out into space. Human beings, being more versatile, seem to be doing both at once.

Rereading the letter, I see I did not say that I liked the Bionics articles. It doesn't go without saying; I did.

LEONARD GREENSTONE
San Francisco, California

Not a Ring Counter

Congratulations to your editors on a good job of condensing my report to the article, Magnetic-Core Ring Counter Needs No Drive (p 52, Mar. 23).

However, the title is incorrect. This circuit is not a ring-counter as commonly used. A ring-counter circuit accepts a series of input pulses and separates them in successive stages to provide sequenced output pulses or a single output pulse for each *n* input pulses. My circuit does not use any input pulses. It is an oscillator, which generates its own pulses and provides an output of timed and sequenced pulses suitable for triggering other circuits.

J. M. MARZOLF
U. S. Naval Research Laboratory
Washington, D. C.

For the 10TH year...

LAMBDA OFFERS THE STRONGEST PROOF OF TROUBLE-FREE POWER SUPPLY PERFORMANCE

Every Lambda power supply sold since 1953 has been backed by Lambda's 5-year guarantee, which covers workmanship and materials (except for tubes and fuses). Any Lambda power supply sold today is guaranteed to perform to specifications until 1967.

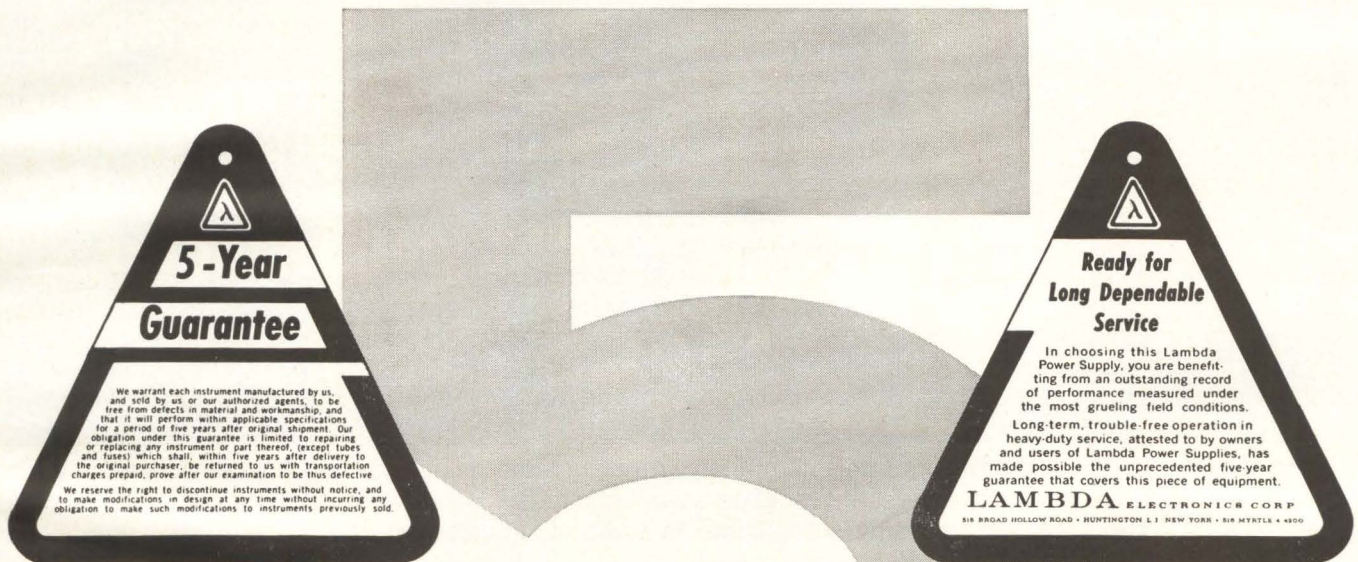

5-Year Guarantee

We warrant each instrument manufactured by us, and sold by us or our authorized agents, to be free from defects in material and workmanship, and that it will perform within applicable specifications for a period of five years after original shipment. Our obligation under this guarantee is limited to repairing or replacing any instrument or part thereof, except tubes and fuses) which shall, within five years after delivery to the original purchaser, be returned to us with transportation charges prepaid, prove after our examination to be thus defective.

We reserve the right to discontinue instruments without notice, and to make modifications in design at any time without incurring any obligation to make such modifications to instruments previously sold.

Ready for Long Dependable Service

In choosing this Lambda Power Supply, you are benefiting from an outstanding record of performance measured under the most grueling field conditions. Long-term, trouble-free operation in heavy-duty service, attested to by owners and users of Lambda Power Supplies, has made possible the unprecedented five-year guarantee that covers this piece of equipment.

LAMBDA ELECTRONICS CORP
515 BROAD HOLLOW ROAD • HUNTINGTON L. I. NEW YORK • 516 MYRTLE 4-4200

YEAR GUARANTEE

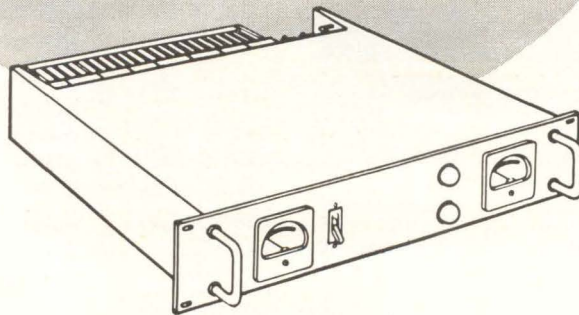

Send for Catalog on LAMBDA'S wide range line of regulated transistorized power supplies



LAMBDA ELECTRONICS CORP.

515 BROAD HOLLOW ROAD • HUNTINGTON, L. I., NEW YORK • 516 MYRTLE 4-4200

Western Regional Office: 230 North Lake Avenue, Pasadena, California • Phone: Code 213, MUrray 1-2544
New England Regional Office: 275 Boston Post Road, Marlboro, Massachusetts • Phone: Code 617, HUrtle 5-7122
Middle Atlantic District Office: 515 Broad Hollow Road, Huntington, L. I., New York • Phone: Code 516, MYrtle 4-4200

Use it on the bench—carry it anywhere!

New High Stability Oscillator

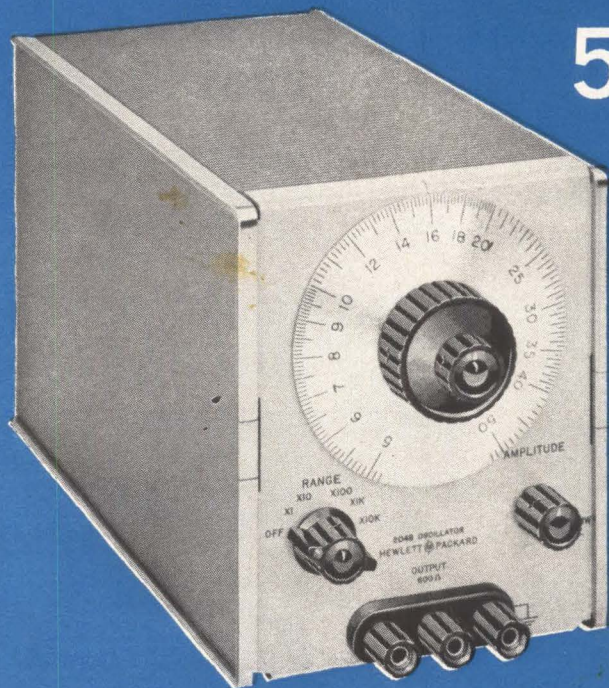

hp 204B Portable Oscillator

5 cps to 500 KC

Unique frequency,
amplitude stability
in this compact,
light weight, solid
state oscillator!

The unusual stability of the new  204B combines with solid state design and battery operation to give you one of the most useful, reliable, versatile oscillators available today. Because the 204B is fully transistorized, internal heat is small and warmup drift is negligible. In addition to battery operation, the 204B is operable on ac, with an ac power pack available at extra cost.



Frequency stability over the entire 5 cps to 500 KC range is better than $\pm 0.03\%/^{\circ}\text{C}$ from 0° to 55°C . Amplitude stability over rated frequency range and output levels is better than $\pm 0.1\%$ over 8 hours of operation at constant line voltage and temperature*; better than $\pm 0.2\%$ for line voltage changes of $\pm 10\%$; better than $\pm 0.1\%/^{\circ}\text{C}$, $0-55^{\circ}\text{C}$.

Output of the 204B is fully floating, isolated from both power line ground and chassis. Balanced and unbalanced loads, and loads referenced either above or below ground, can be driven by this versatile oscillator.

Low impedance circuits drive the 600 ohm output, effectively isolating the oscillator stage.

SPECIFICATIONS

Frequency Range:	5 cps to 500 KC, 5 ranges, 5% overlap, vernier control
Dial Accuracy:	$\pm 3\%$
Frequency Response:	$\pm 3\%$ with rated load
Output Impedance:	600 ohms
Output:	10 mw (2.5 v rms) into 600 ohms; 5 v rms open circuit
Output Control:	Continuously variable bridged "T" attenuator with at least 40 db range
Distortion:	Less than 1%
Noise:	Less than 0.05%
Power Source:	4 battery cells at 6.75 v each, 7 ma drain, life at least 300 hours
Power Accessory Available:	AC power supply can be installed in place of batteries. Optional at extra cost.
Dimensions:	6 - 3/32" x 5 - 1/8" x 8". 6 lbs.
Price:	 204B, \$275.00

Designed in the new  instrument module packaging, the 204B is only 6-3/32" high, 5 1/8" wide and 8" deep; weighs just 6 pounds! A new rack mount adapter holds three 204B oscillators or other  instruments of the new modular design.

*On battery operation, stability -1% during battery depolarization, less than 30 minutes.



HEWLETT-PACKARD COMPANY

1501A Page Mill Road
Cable "HEWPACK"

Palo Alto, California, U.S.A.
DAvenport 6-7000

Sales representatives in all principal areas

HEWLETT-PACKARD S. A.

Rue du Vieux Billard No. 1
Cable "HEWPACKSA"

Geneva, Switzerland
Tel. No. (022) 26.43.36

ELECTRONICS NEWSLETTER

Space-Tracking System Expansion Planned

WASHINGTON—National Aeronautics and Space Administration plans to spend \$158.4 million in fiscal year 1963 to beef up its tracking and data acquisition system, in preparation for a schedule that will produce at least 40 major space launchings annually by 1964. If Congress approves NASA's request, the money will be spent on:

Five new tracking stations costing, in all, \$33.6 million; stations, not yet located, for the Gemini and Apollo manned space programs, \$18.1 million; and for additional equipment at existing stations, \$75 million. The rest of the money will be spread among other tracking and data acquisition projects.

The five new station locations are: Goldstone, Calif., \$14.1 million; Rosman, N. C., \$3 million; Woomera, Australia, and Johannesburg, South Africa, \$5 million each; a Far Eastern station, \$6.5 million. Where the station in the Far East will be located hasn't been decided. A NASA team is scouting possible sites.

Phased Array Radar Ordered for Spadats

MULTIMILLION-DOLLAR contract to develop and test a phased array radar system to detect hostile satellites has been awarded Bendix's Radio division by the Air Force. When fully developed, the radar would become part of Spadats, the Space Detection and Tracking System (p 32, Nov. 24, 1961). The radar reportedly will be located in Florida so it can watch the equator.

NAB Conventioneers See Four-Color tv Camera

CHICAGO—RCA showed an experimental fourth-color tv camera last week at the National Association of Broadcasters convention. A 4½-in. image orthicon, used in combination with three 1-in. chroma vidicons, is reported to supply the luminance needed for the sharp definition of four-color printing.

The bigger image orthicon is also used in a new monochrome

camera that, RCA says, improves picture resolution, signal-to-noise ratio and gray scale rendition. A single zoom lens is used to avoid color balance problems, to reduce camera dollying and to facilitate remote control.

GE displayed a 4½-in. image orthicon studio camera that is convertible to a 3-in. tube for operating economy. The company's video switcher switches in a vertical blanking interval to eliminate transients for improved picture quality.

Next Window to Heaven A Big Venetian Blind?

STANFORD Radio Astronomy Institute is making a study, under a \$222,000 grant from National Science Foundation, of radio telescope designs that would provide better resolution at lower cost. A proposed design is an echelon antenna resembling a huge venetian blind.

The "slats" would be independently tiltable, concave-faced elements with thin sheet metal surfaces, each 30 ft wide and 2,400 ft long. Sixty elements would have a total area of 90 acres, requiring a ground area of 130 acres—more space than Stanford has on its own antenna farm.

One advantage would be that while the telescope was being used, elements could be lengthened, new ones built or remote ones added.

Hardened Antenna Rams Through Bomb Debris

DALLAS—Collins Radio has designed, to civil defense specifications, a retractable antenna for back-up voice communications after an atomic attack. The antenna is in

Interrogator-transponder tech-

Air Collision Avoidance System Is Under Study

LATEST ACTION by the Federal Aviation Agency in its long hunt for a system to prevent impending mid-air collisions: a \$300,000 contract to Sperry Gyroscope to study a proposed system.

If successful, the system would predict collision courses between aircraft. An escape maneuver would be fed the autopilot. This would be done fast enough to avoid a crash with a third plane if the maneuver is made in a high-density air traffic area.

Interrogator-transponder tech-

Conelrad System to Be Superseded?

CHICAGO—A new national emergency communications network will be announced soon to supersede Conelrad, FCC Commissioner Robert Bartley reported at the NAB convention.

No firm announcement can be made at present, he said, because the system falls in the classified area of U. S.-Canadian relations.

Operated largely by private broadcasters, the new net would give the President direct access to radio communications from at least five locations in each state.

The FCC believes the government should pay for equipment required to set up the new civil defense network in privately owned stations, Bartley said

a steel crib that fits into an underground concrete silo. Before the antenna is extended, a ram with a 5-ton thrust rises to clear away any rubble.

The antenna, a monopole, operates at 3 to 30 Mc without inductive loading or impedance matching devices. Instead, height is adjusted so it is $\frac{1}{4}$ wavelength at the operating frequency. Height is sensed by a dual-selsyn system that measures passage of a cable attached to the top of the telescoping element. Full height is 76 ft.

One peaceful use was suggested by Collins. Modified, it could be used on ships that have to pass under low bridges.

Superconducting Magnet Goes in Telstar Maser

BOSTON—A maser using a superconducting magnet is being built by British Post Office engineers for the Telstar and Relay experimental satellite receiver under construction at Goonhilly Downs, England (p 26, Feb. 6).

Meanwhile, at the U. S. station in Andover, Me., the 340-ton horn antenna was checked out successfully. It picked up a signal bounced from a target six miles away.

This receiver uses a traveling-wave ruby maser. A closed-cycle system to provide a continuous supply of liquid helium to its dewar is being built by A. D. Little.

FAA Tries Weather Net, Cockpit Voice Recorders

EXPERIMENTAL weather warning network, for short period forecasting at airports, is being studied at the Federal Aviation Agency's National Aviation Facilities Experimental Center, Atlantic City, N. J.

Digital data equipment, including 13 trailer-installed, semiautomatic weather stations linked to a central recording and control console, has been delivered to the center. The equipment was built by Datex Corp., under contracts totaling \$842,000.

The unmanned mobile units will be stationed around an airport. Planes could be told earlier to land at alternate fields when the local

weather conditions change.

The center is also evaluating cockpit voice recorders with magnetic cartridges in crash-proof housings. These would aid in determining crash causes. Four prototypes of one recorder have been delivered by United Data Control, Inc., under a \$31,533 contract, and others are being designed by Lockheed Aircraft Service Co., Fairchild Camera and Instrument Corp. and Spec Tool Co.

British Announce Pay Tv System Using Wire Lines

LONDON—Marconi's Wireless Telegraph, Ltd., has developed a closed-circuit wireline pay tv system for PayVision, Ltd.

The customer is connected into a wideband coaxial network by a program selector box plugged into the antenna socket. When he selects a program, with pushbuttons and by turning a key, the purchase information is telemetered back along the line to a central office.

Marconi says the technique will allow the network to carry up to 20 programs without the use of "on air" channels. Three channels will be offered initially. Programs can be transmitted in color or black and white.

Japanese and American Joint Venture OK'd

TOKYO—Japan's Foreign Investment Council last week approved a joint venture here by General Precision and Mitsubishi Electric. Authorized capital is \$4.05 million. Mitsubishi is contributing capital and manufacturing facilities, will own 60 percent of the new company. General Precision will contribute know-how and technical assistance and will own 40 percent.

The company, to be known as Mitsubishi Precision, Inc., will produce all General Precision products except tv and certain industrial control equipment. It will have exclusive manufacturing rights in Japan and marketing rights throughout the free world. Manufacturing will be done at Mitsubishi Electric facilities until a new plant under construction near Tokyo is completed.

In Brief . . .

AFTER SEVERAL years of testing, Navy is going ahead with Ampex's pilot landing aid tv system to monitor and direct aircraft landings on carriers. Ampex has \$270,000 contract.

MINNEAPOLIS-HONEYWELL has announced a magnetic tape system for computers that reads and writes 186,000 decimal digits a second. It is compatible with company's slower-speed units.

AVCO will study advanced target discrimination techniques for Nike Zeus, under Bell Labs contract.

PHILIPS, The Netherlands, is raising its capital to 822 million guilders with a stock issue for 137 million guilders.

ELECTRO NUCLEAR Systems Corp. has \$85,000 Navy contract for R&D on display system to present digital information in real time and in variety of colors.

ALUMINIUM LTD. will link its plants in Canada, U. S. and England with an ITT automatic data exchange.

AIR FORCE has given GE an additional contract for \$4.8 million for production of Advent communications satellite vehicles.

MAJOR MISSILE contracts include \$3.6 million to Ford Motor for Shillelagh R&D; \$1.9 million to Martin for Pershing simulator components; \$1.5 million to Sylvania for communications at Atlas bases; over \$1 million to Guidance Technology for spring-driven gyros for Bullpup.

AUTONETICS has a \$1.5 million contract from Minneapolis-Honeywell for computers and guidance equipment for DynaSoar.

NATIONAL CO. has a \$2.4 million Air Force contract for troposcatter communications equipment.

HUGHES has ordered a \$1 million space simulation chamber from Clauser Technology.

NOW
AVAILABLE
WITH WELDABLE
LEADS

**RUGGED END-CAP
CONSTRUCTION FOR
LONG TERM STABILITY**

**EXCEPTIONAL RESISTANCE
TO MOISTURE
AND MECHANICAL
DAMAGE**

**SURPASS MIL-R-10509
PERFORMANCE
REQUIREMENTS**

AVAILABLE IN
REEL PACKING
FOR AUTOMATED
PWB INSERTION

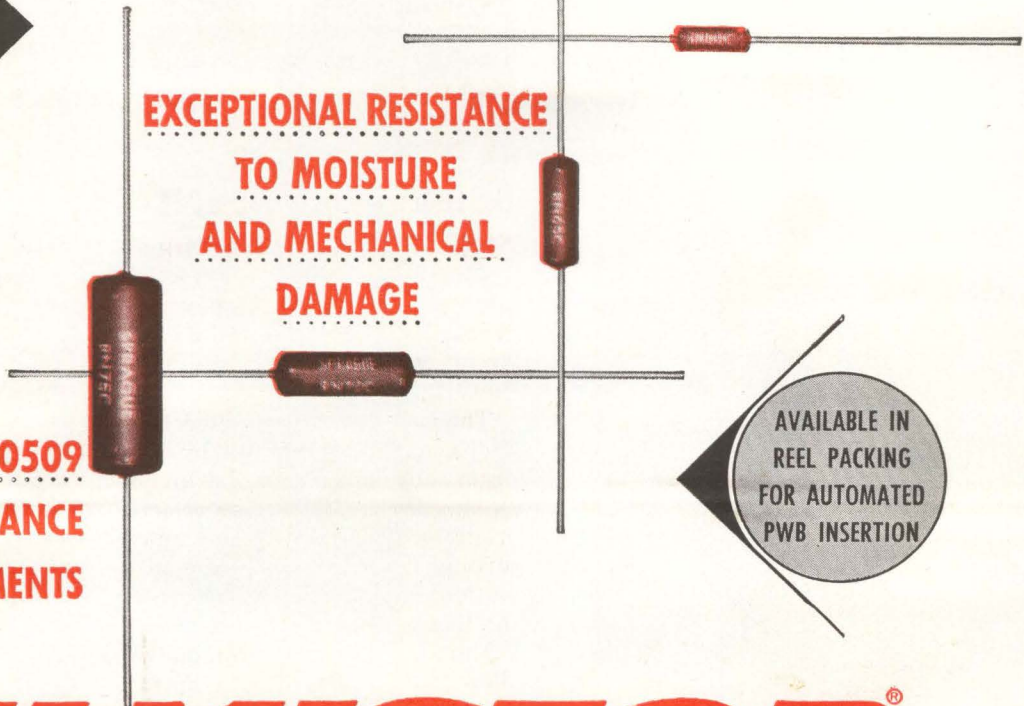

FILMISTOR[®] **METAL FILM RESISTORS**

**OFFER 5 DISTINCT
TEMPERATURE
COEFFICIENTS TO
MEET ALL CIRCUIT
REQUIREMENTS**

Providing close accuracy, reliability and stability with low controlled temperature coefficients, these molded case metal-film resistors outperform precision wirewound and carbon film resistors. Prime characteristics include minimum inherent noise level, negligible voltage coefficient of resistance and excellent long-time stability under rated load as well as under severe conditions of humidity.

Close tracking of resistance values of 2 or more resistors over a wide temperature range is another key performance characteristic of molded-case Filmistor Metal Film Resistors. This is especially important where they are used to make highly accurate ratio dividers.

Filmistor Metal Film Resistors, in 1/8, 1/4, 1/2 and 1 watt ratings, surpass stringent performance requirements of MIL-R-10509D, Characteristics C and E. Write for Engineering Bulletin No. 7025 to: Technical Literature Section, Sprague Electric Co., 35 Marshall Street, North Adams, Mass.

*For application engineering assistance write:
Resistor Division, Sprague Electric Co., Nashua, New Hampshire.*

SPRAGUE COMPONENTS

RESISTORS
CAPACITORS
MAGNETIC COMPONENTS
TRANSISTORS

INTERFERENCE FILTERS
PULSE TRANSFORMERS
PIEZOELECTRIC CERAMICS
PULSE-FORMING NETWORKS

HIGH TEMPERATURE MAGNET WIRE
CERAMIC-BASE PRINTED NETWORKS
PACKAGED COMPONENT ASSEMBLIES
FUNCTIONAL DIGITAL CIRCUITS

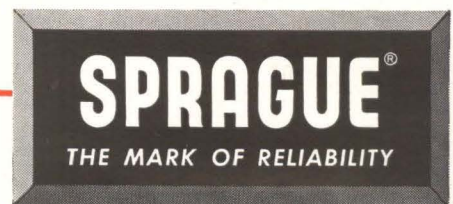

'Sprague' and '®' are registered trademarks of the Sprague Electric Co.



The computer analysis shows we're

Purchasing would have been more expensive than it looked. It took a computer—sharing honors with IBM's new Capital Investment Computer Program—to get the right answer.

This program helps your computer answer many problems such as: Shall you replace or repair existing equipment...which line of research is most apt to pay off...will expansion pay out...shall we buy or make...which new ideas are worth backing...?

Using the Investor's Method (Rate of Return on Investment) the new program directs the computer in printing out the probable results of each proposed investment, gives you a uniform, accurate guide to better, more profitable use of your company's money.

The Capital Investment Computer Program is written in FORTRAN language; you can run it, for example, on the low-cost IBM 1620 Data Processing System. Why not call your local IBM Representative for complete details?



better off making those parts...



■ *Repair or replace?* Feed all the facts into the computer. CIP helps it pull them together, evaluate them, helps you choose the best alternative.



■ *Which line of research?* This requires knowledge of all the facts. CIP provides a uniform guide to help you make the right decision.

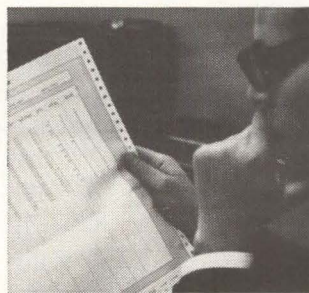

■ *Make or buy?* CIP helps you correlate all the facts such as: materials availability, effect on taxes. Decisions come quicker, easier.

IBM[®]
DATA PROCESSING

WASHINGTON OUTLOOK

ELECTRONIC INDUSTRIES ASSOCIATION supports "in principle" the objectives of the new trade bill, H.R. 9900, but "strongly opposes" many of its major provisions, Robert C. Sprague, of Sprague Electric, chairman of EIA's Imports Committee, told the House Ways and Means Committee last week. He cited these specific objections:

Unprecedented economic authority is given the President, who could reduce tariffs without review or veto by Congress; there is no guarantee that tariffs and other concessions will be negotiated under rules assuring true reciprocity—elimination of such restrictions as quotas, extra taxes and import licenses, imposed by other countries; escape clause and peril point protective procedures to safeguard industry are practically eliminated; subsidy approach to help companies hurt by imports is impractical and objectionable.

CONTROVERSIAL SECTIONS of the trade bill, constantly criticized during the hearings, may be resolved by compromises or more precise language before the House committee sends the bill to the floor sometime next month. Here are some potential changes:

H.R. 9990 makes it much tougher than present laws for a company injured by imports to get a hearing for higher tariffs. Entire industries must be affected and a company needs a strong case. Many congressmen think it unfair to vastly increase tariff-cutting powers and then limit a company's chance for import protection. An escape clause may be added.

The President could in five years eliminate tariffs on a product if the U. S. and European Common Market control 80 percent of trade in that product. The committee may set more precise limitations and directives on what products are affected.

Industrial witnesses fear government negotiators, if inexperienced in an industry's problem, may make disastrous concessions. The committee may require an industry advisor on the negotiating team whenever that industry's products are up for possible tariff cuts.

Language in the "trade adjustment" section may be spelled out more carefully, with modifications in the power to subsidize industries injured by imports.

ALMOST UNQUALIFIED SUPPORT for H.R. 9900 was given by Charles F. Adams, Raytheon president. By reducing European tariffs, considerable business can be gained there, he said, and to get tariffs down, the President must have ample authority to negotiate. Adams was concerned about giving the President so much power, but thought that effective restrictions could place U. S. negotiators "in a sort of strait jacket." He suggested this dilemma could be at least partially solved by the use of industry advisors on the negotiating team.

PRESSURES ARE BEING GENERATED to have the Pentagon order major system components directly from producers instead of allowing prime contractors to buy them from subcontractors. How this might be done hasn't yet been proposed. Origin of the pressures is the much-publicized inquiry by the Senate Investigations Subcommittee probing the alleged "pyramiding" of profits on missile work.

EIA LISTS
TRADE LAW
PROTESTS

TARIFF
POWERS
MAY BE
REDUCED

INDUSTRY
ADVISORS
PROPOSED

PENTAGON
PURCHASES?

NOW RCA OFFERS 3 MEMORY STACK TYPES TO SOLVE YOUR MEMORY DESIGN PROBLEMS

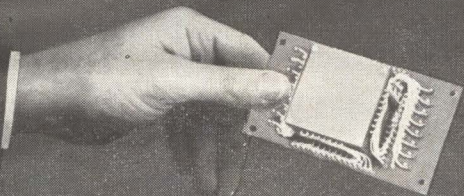

1. WIDE TEMPERATURE RANGE STACK—
256 words, 8 bits per word... with
RCA 233M1 cores, covers 120° tem-
perature range... 4½" x 2½" x 1½"

2. TEMPERATURE CONTROLLED STACK—
4096 words, 32 bits per word...
stable over 0° to 55°C range ±2°C
... 5" x 6.3" x 6"

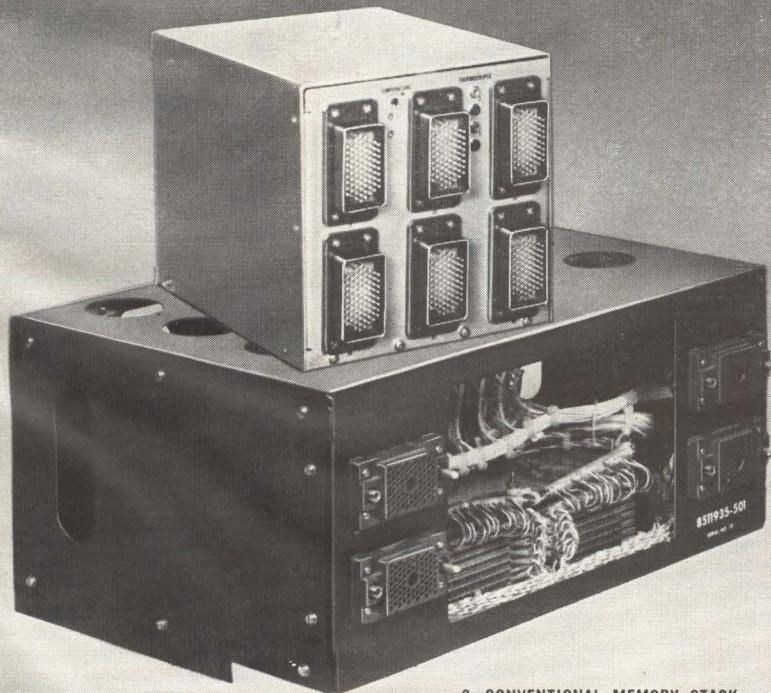

3. CONVENTIONAL MEMORY STACK—
10,000 words, 14 bits per word

RCA now adds Memory Stacks utilizing temperature-stable ferrite cores to its broad line of temperature-controlled stacks and conventional, non-temperature-controlled types.

Now you can make RCA Semiconductor and Materials Division your Headquarters for ferrite memory stacks packaged virtually any way you specify.

1. Wide-Temperature-Range Stacks. New RCA temperature-stable ferrite core 233M1 permits the construction of planes and stacks that require no peripheral temperature-control equipment. In those applications where small size, minimum weight and reduced peripheral equipment are required, these devices can achieve vital space and cost savings.

2. Temperature-Controlled Stacks. RCA Memory Stacks, temperature-controlled within $\pm 2^\circ\text{C}$, are designed to meet MIL Specifications. Available in standard or high density packages, these stacks can be utilized where specifications call for conventional core operation over extreme temperature ranges.

3. Conventional Memory Stacks. RCA conventional memory stacks may be used where temperature is not a critical problem, but where RCA's high quality and reliability are required at lowest possible cost.

RCA Memory Stacks are available in sizes from 256 words x 8 bits to 16,384 words x 32 bits, with cores from .030" to .080" O.D. for system speeds as fast as 1 μsec . Stacks can be supplied in a wide range of configurations and operating characteristics to meet your design needs. In addition, you can specify from a broad range of plane designs from *new* molded epoxy to phenolic, printed-circuit, or aluminum types designed to meet MIL specifications.

Reliability: RCA ferrite memory stacks can be designed and built to meet your stringent environmental specifications for shock and vibration. All RCA stacks are 100 percent dynamically tested to assure the utmost dependability under actual operating conditions.

Service: Your local RCA Semiconductor and Materials Division field representative is prepared to provide a completely coordinated application service, covering transistors, tunnel diodes and other semiconductor diodes, ferrite cores and memory systems. Call him today. For further technical information, write RCA Semiconductor and Materials Division, Commercial Engineering, Section D-19-NNF-2, Somerville, N. J.



The Most Trusted Name in Electronics

Visit the R.C.A. Exhibit at
the Spring Joint Computer Conference

A new concept in line voltage regulation in the KVA range...

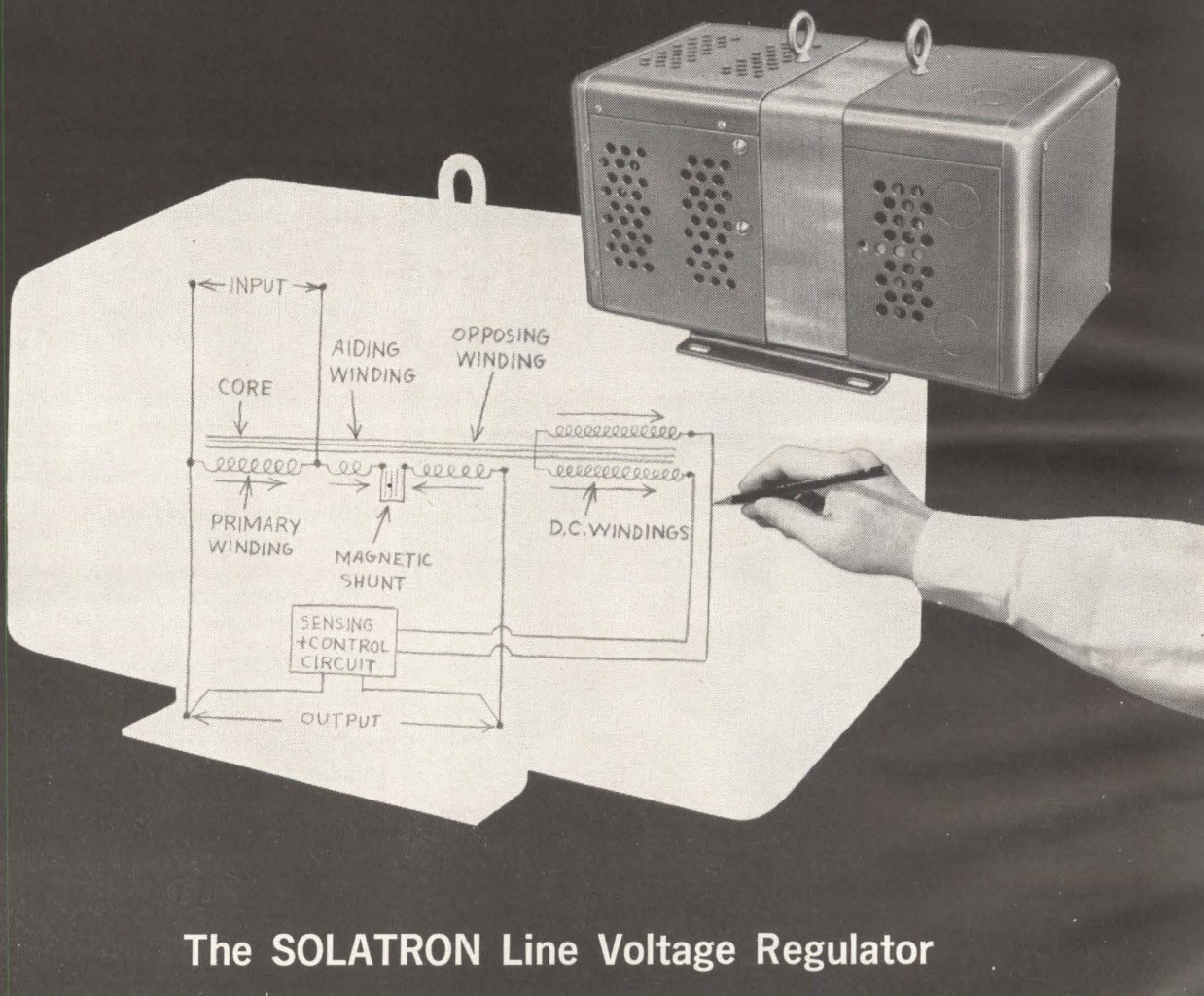

The SOLATRON Line Voltage Regulator

Sola now has developed a new uncomplicated breed of line voltage regulators. *Up to 10 times faster than mechanical regulators*, the new SOLATRON Line Voltage Regulator features no moving parts, lower operating cost per KVA, and is maintenance free!

Designed to cover the 3-100 KVA range, the SOLATRON Line Voltage Regulator offers corrective action the instant output departs from nominal . . . long before voltage even approaches boundaries of the regulation envelope! Output holds *stable* in the face of leading and lagging power factors. Efficiency — 95% at full load.

For more information on the new SOLATRON Line Voltage Regulator, send requests, on company letterhead, direct to our factory address.

- **EXCELLENT REGULATION** — $\pm 1\%$ from nominal, for any combination of line, load, and frequency change within specified parameters.

- **FAST RESPONSE** — practically instantaneous; even under extreme conditions, return to nominal will never exceed 10 cycles.

- **ULTRA-COMPACT** — Over-all dimensions for the 5 KVA measure approximately $8\frac{1}{4} \times 8\frac{1}{4} \times 16\frac{1}{4}$ ".

- **COMPLETE FLEXIBILITY** — designed for horizontal or vertical mounting; standard NEMA markings and color coding.



Division of
Basic Products Corporation

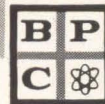

SOLA ELECTRIC CO.
1717 Busse Road
Elk Grove Village, Ill.
HEmpstead 9-2800
IN CANADA,
Sola-Basic Products Ltd.,
377 Evans Avenue,
Toronto 18, Ontario

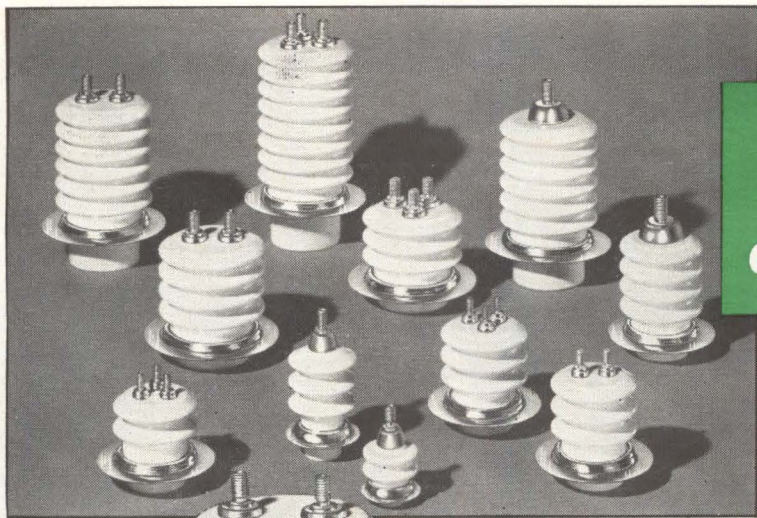

ALITE[®]

CERAMIC-TO-METAL SEALS

*Standard Bushings
or Special Designs*

FROM ONE COMPLETELY INTEGRATED SOURCE

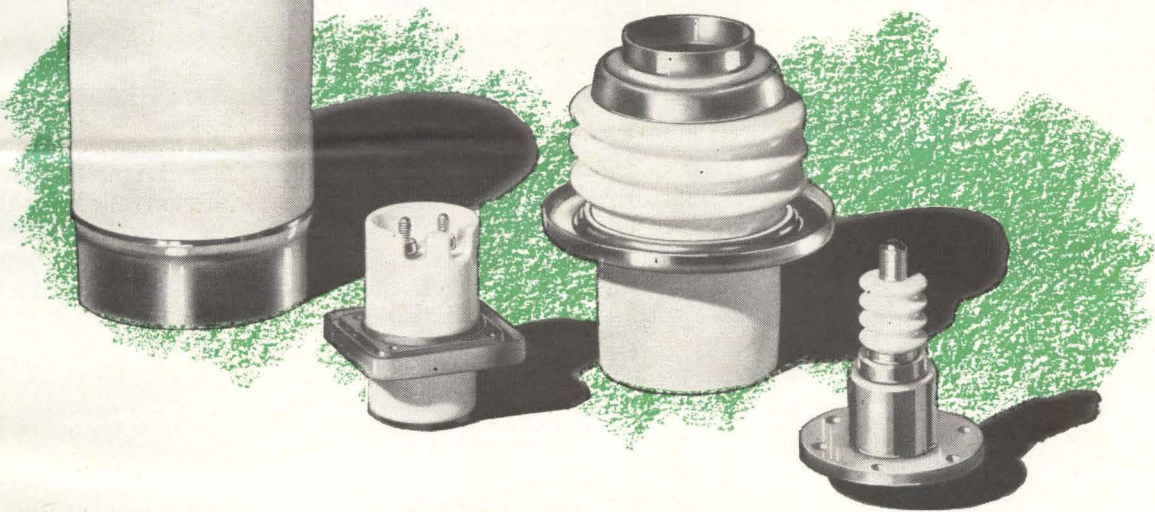

ALITE — with its completely equipped facilities for producing high quality, vacuum-tight, ceramic-to-metal seals — is geared to meet all your requirements for high alumina ceramic-metal components. From design to finished assembly, every manufacturing step — including formulating, firing, metalizing and testing—is carefully supervised in our own plant. Result: effective quality control and utmost reliability.

Hermetic seals and bushings made of high alumina Alite are recommended for electromechanical applications where service conditions are extremely severe or critical. Alite has high mechanical strength and thermal shock resistance. It maintains low-loss characteristics through a wide frequency and temperature range. It resists corrosion, abrasion and nuclear radiation. Its extra-smooth, hard, high-fired glaze assures high surface resistivity.

To simplify design problems and speed delivery, Alite high voltage terminals, feed-throughs and cable end seals are available in over 100 standard sizes. However, when specifications call for special units for unusual applications, you can rely on expert assistance from Alite engineers to help you take full advantage of Alite's superior properties.

Write us about your specific requirements today:

WRITE FOR HELPFUL FREE BULLETINS

Bulletin A-8 gives useful comparative data. Bulletin A-40-R describes Alite facilities and complete line of Alite Standard Bushings.



ALITE DIVISION

U. S. STONEWARE

BOX 119

ORRVILLE, OHIO

**NOW IN
PRODUCTION**

AT
Melabs

**An
all-solid-state
microwave
power source
with high
stability**

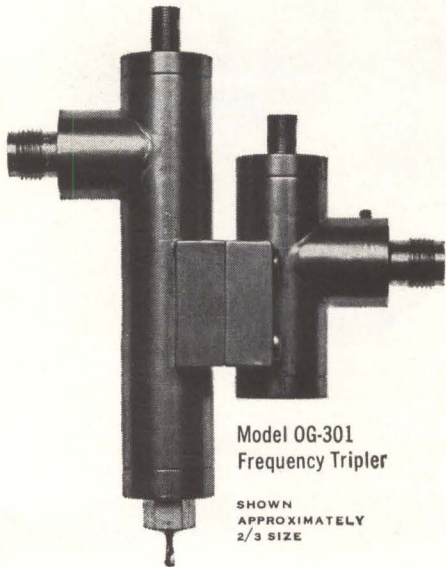

Model OG-301
Frequency Tripler

SHOWN
APPROXIMATELY
2/3 SIZE

Applications:

*Stable local oscillators for
microwave communications and
radar systems ...*

Paramp pump of high stability ...

*Power source for telemetry
transmitters ...*

*General signal source of
limited power ...*

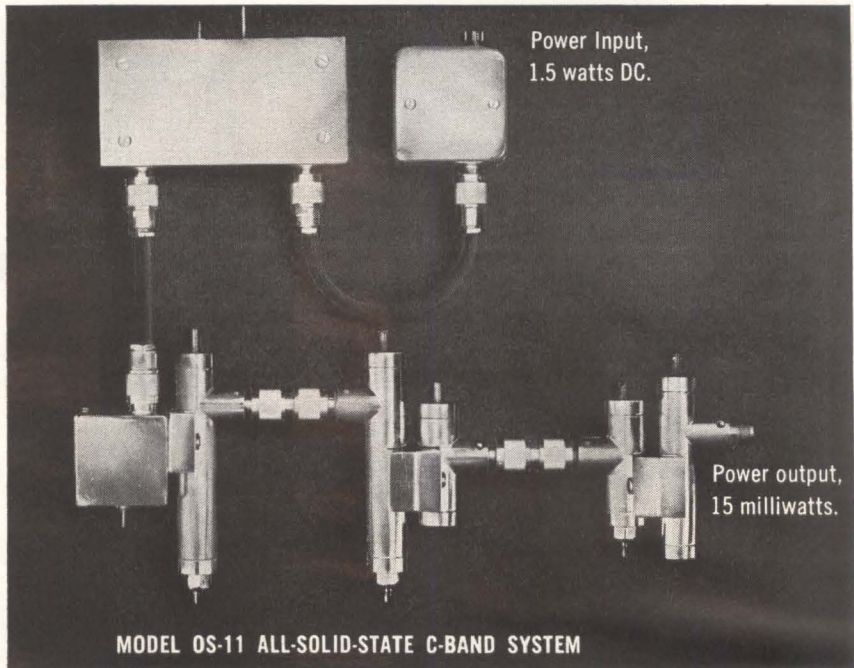

MODEL OS-11 ALL-SOLID-STATE C-BAND SYSTEM

MELABS is now in current production on a new, entirely solid-state microwave power source of advanced design. Circuitwise, a transistorized, highly stable quartz crystal controlled oscillator in the 80 megacycle range drives a chain of varactor frequency multipliers to produce useful, stabilized power in the 6-8 Gc band! This outstanding new equipment offers important advantages not obtainable with klystron oscillators. For example:

- Stability is limited only by that of the driving source which operates at lower VHF frequencies where precision quartz crystals are entirely feasible.
- Varactor diodes used throughout the multiplier chain are self-biased requiring no additional bias supplies. The transistorized crystal oscillator operates from a 24-28 volt DC voltage source.
- No tube replacement problem—greatly reduced supervision and maintenance. Semi-conductor elements used throughout have extremely long life.
- All cavities are capable of being laboratory tuned (with instruments) over a 25% frequency range and the input and outputs of all cavities are matched to a 50 ohm source.
- Small in size. (C-Band chain occupies only about 30 cu ins.)

The entire solid-state system listed below (or the individual multiplier) is available per listed frequency and power on a 30 day delivery basis. Power figures shown are for this specific chain.* The fixed-tuned multipliers can be specified at any frequency within the indicated tuning range.

MODEL	FUNCTION	TUNING RANGE INPUT FREQ.	POWER INPUT	TUNING RANGE OUTPUT FREQ.	POWER OUTPUT	CONVERSION LOSS
OS-11	C-Band LO	70-90mc	1.5W DC	5.67-7.29 Gc	15mW	16 db
OG-301	Tripler	70-90mc	0.6W	210-270mc		2 db
OG-302	Tripler	210-270mc	0.38W	630-810mc		3 db
OG-303	Tripler	630-810mc	0.19W	1890-2430mc		5 db
OG-304	Tripler	1.89-2.43 Gc	60mW	5.67-7.29 Gc	15mW	6 db

*Higher powers, depending upon the input drive power and the specific varactors used, can be supplied on special order.

Your inquiries invited

Melabs

3300 HILLVIEW AVENUE / STANFORD INDUSTRIAL PARK / PALO ALTO, CALIFORNIA

TELEPHONE: DA 6-9500. AREA CODE: 415. TWX: PAL AL 138

DEPT
B9

Employment opportunities at Melabs are exceptional for ambitious engineers and physicists; write in confidence.

AN EQUAL OPPORTUNITY EMPLOYER

Circuit Fabricators get Proven, Consistent RELIABILITY

using . . .

SCHJEL-CLAD LAMINATIONS

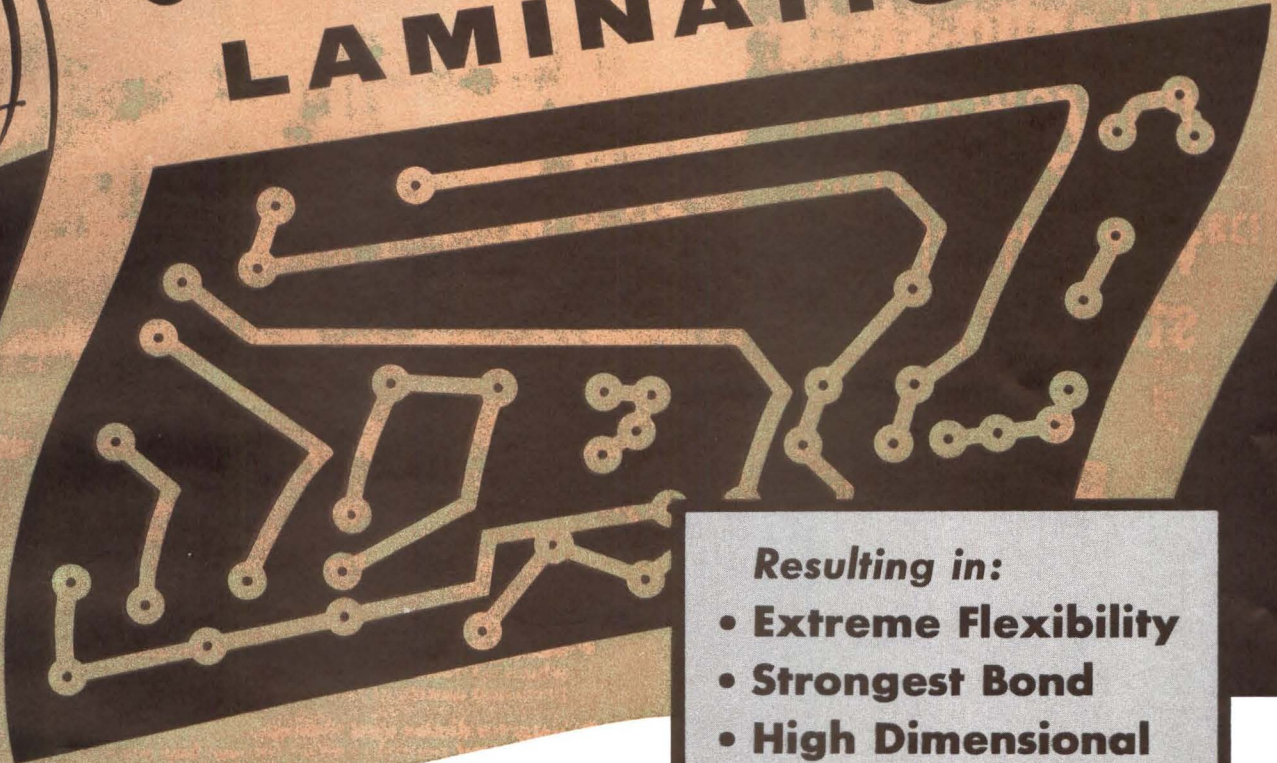

Resulting in:

- Extreme Flexibility
- Strongest Bond
- High Dimensional Stability

If you're using flexible printed circuitry now or have tried in the past with little success, Schjeldahl's Schjel-Clad Copper Mylar lamination offers you the strongest bond and the purest finished product.

With Schjel-Clad Copper Mylar, all inherent characteristics of Mylar and copper are maintained. The "creep" factor is very low; circuits don't shift. The bond is uniform, eliminating air bubbles and "fish eyes" in the final product.

The bonding agent is Schjel-Clad, a special thermo-setting Schjeldahl adhesive which assures high purity and high bonding strength in the lamination. Low distortion of circuits etched on Schjel-Clad Copper Mylar is proof of its dimensional stability. It can be etched by the use of standard etching materials and also can be exposed to chlorinated cleaning solvents for short periods of time without damage.

AVAILABILITY

Schjeldahl's Copper Mylar is available in various composites from 10 mil Mylar laminated to 5 oz. copper to 1/2 mil Mylar on 1 oz. copper.

*du Pont trademark for its polyester film

This material is available with copper on both sides of Mylar, or Mylar on both sides of copper. There are a number of **circuit fabricators** who are familiar with Schjel-Clad. A listing is available on request. **The applications listed below show a number of uses or proposed uses of Schjel-Clad:**

- | | | |
|----------------------|-------------------|-----------------------|
| Computers | Business Machines | Printed Wiring |
| Aircraft | Switchboards | Circuitry |
| Television and Radio | Automobiles | Shielding |
| Transformers | Memory Systems | Harnessing and Wiring |

G. T. SCHJELDAHL CO., Northfield, Minnesota
 Attn.: Carl R. Bergquist, LAMINATING DIVISION

Please Rush more information on Schjel-Clad
 Send me a sample SIZE: _____ x _____
 THICKNESS: _____
 Call me immediately

Mr. _____
 Company _____
 City _____ State _____

PUTTING
TOMORROW'S
MATERIALS
TO WORK
TODAY



G.T. Schjeldahl Co.
 NORTHFIELD, MINNESOTA • PHONE: NIAGARA 5-5635

yes

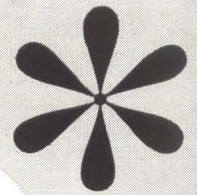

actual size



Gamewell made a sector pot with .0006" wire. This subminiature sector pot is wound with .0006" wire at over 1000 turns per inch. Required winding length tolerance is only .005". ■ Here's one example of the hundreds of "special" pot design requests that Gamewell is answering with an unqualified YES. ■ Find out what Gamewell YES service — Your Engineered Specials service — can do for you. Write to Gamewell today for the complete facts. ***your engineered specials service**



THE GAMEWELL COMPANY, POTENTIOMETER DIVISION, 1615 CHESTNUT STREET, NEWTON UPPER FALLS 64, MASSACHUSETTS. A SUBSIDIARY OF E. W. BLISS COMPANY.

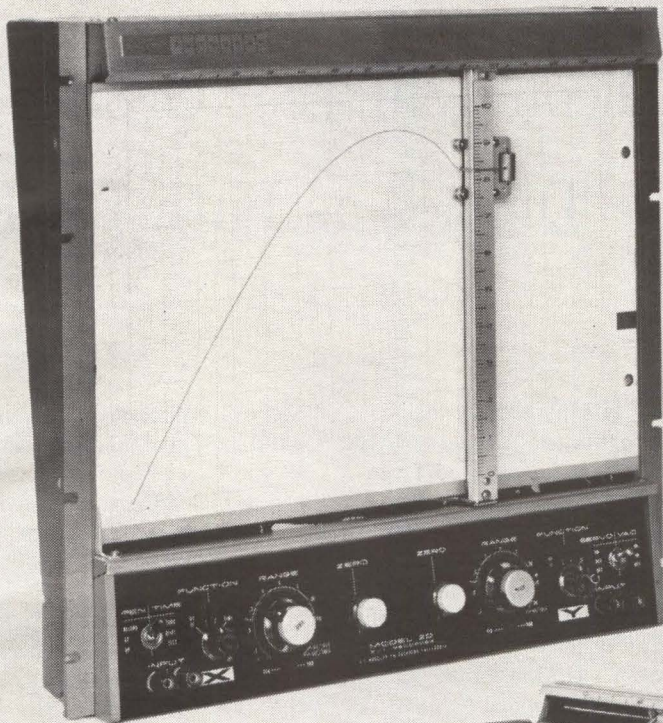

Moseley 2DR, compact, rack mounting

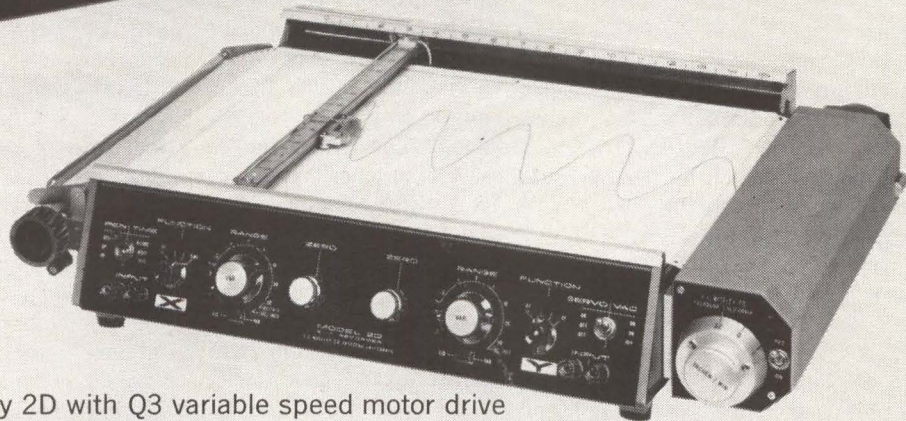

Moseley 2D with Q3 variable speed motor drive

MOSELEY X-Y T* RECORDERS

MODEL 2D 11" x 17" series AUTOGRAF RECORDERS are offered in 9 different units, tailored to your exact need.

MODEL 2D (Bench type) and 2DR (Rack type). Versatile series leaders feature dc and ac inputs, X-axis time basis, continuous electronic reference, and facilities for a built-in magnetic curve follower. 2D, \$2450; 2DR, \$2525.

MODEL 2D-2 and 2DR-2. Include all standard features of 2D, 2DR except ac input facility. 2D-2, \$2050; 2DR-2, \$2125.

MODEL 2D-3 and 2DR-3. Specially designed for operation with ± 100 volt external computer reference supply. Include alternate built-in electronic reference, omit time base and ac signal input features.

MODEL 2D-4 and 2DR-4. Low cost versions with reduced accuracy for basic dc signal recording. Furnished without time base, ac input, or curve follower facilities.

MODEL 2D-5. Combines all features of Model 2D with Type F-2 Photo-Electric Line Follower. Records, reproduces a function signal with desired transport delay simulation.

No other 11" x 17" Recorder offers all these standard features

- ½ mv/in. Sensitivity each axis
- 16 Calibrated dc Ranges Plus Stepless Control (Vernier)
- Potentiometric Input at Maximum Sensitivity Range
- Built-in X-Axis Time Base
- Electronic Reference
- Full Scale Zero and Full Scale Zero Offset
- Self Contained Vacuum System for Paper Holdown
- Optional AC Input
- Optional Roll Chart Capabilities
- Operates with Both Magnetic and Optical Curve and Line Followers

*Built-in time base

F. L. MOSELEY CO.

409 N. Fair Oaks Avenue • Pasadena, California



The old and the new: 60-ft precision parabolic antenna for orbital scatter experiments stands next to idle troposcatter antenna

Dicon Will Test Orbiting Dipoles as Path for Data

BOSTON—One experiment awaiting resumption of Project West Ford (ELECTRONICS, p 7, Mar. 16) is Dicon (Digital Communications through Orbiting Needles). Dicon is designed to demonstrate applicability of the West Ford channel as a high-capacity digital data link and to measure performance under a variety of modulation signals.

Ready at MIT Lincoln Lab's field site at Camp Parks, Calif., is a transmitter with 33 frequency oscillators. A 35-channel receiver has been built at the Millstone Hill station, in Westford, Mass. Dicon has 32 information channels. The 33rd transmitter oscillator is for synchronization pulses. Of the three extra receiver channels one is for timing and two are for frequency control.

Dicon's maximum data rate is 50,000 bits/sec, using 20 μ sec pulses for each digit and cycling through as many as 16 pairs of frequencies to avoid intersymbol interference due to multipath and to combat selective fading.

It is expected that the principal sources of signal corruption in the West Ford channel will be multipath delay and Doppler shift and spread. The receiver uses the 33rd or sync frequency to compensate for changes in Doppler shift and path length.

For any given information digit, a rectangular r-f pulse is transmitted by using one of a pair of frequencies, depending on whether the digit is ZERO or ONE. A receiver channel tuned to each of the two frequencies measures the energy received. That channel detecting the larger energy is judged to be

the one containing the signal.

The information signal at the transmitter can be derived from a fixed 16-bit word, which is used for error-rate measurements; from a standard 60-wpm teletypewriter through code-matching logic; from digital voice-encoding equipment; or from any other live source transmitting at a suitable rate.

The basic Dicon word contains 17 pulse intervals of identical duration, called bauds after the traditional unit of telegraph signal speed. The first baud contains the sync frequency; and the remaining 16 contain selections from the data frequency pairs. Baud lengths vary from a minimum of 20 μ sec to a maximum of 2.56 msec by factors of two.

The transmitter, which generates fsk-type modulation, consists of 33 oscillators for transmitting data and sync bauds and a digital control for selecting the appropri-

ate oscillator outputs during each baud interval. Modulation is generated in a band of about 4 Mc, centered at 8 Mc, and then translated up to the intermediate frequency of 60 Mc, at which it is fed to the r-f exciter.

In the Dicon receiver the signal obtained from the r-f receiver is centered at $60 + f_D$ Mc, where f_D is the Doppler shift. It is converted to a signal of the same bandwidth but centered at 8 Mc, the band in which it was generated. At this point the signals are at the correct center frequencies for the bank of channel receivers.

Acquisition is performed by frequency searching for the sync signal. The frequency control loop is opened and the frequency of the variable frequency oscillator is controlled by a locally-generated triangular sweep waveform. Sweep range and rate are adjustable. If the time tracking circuit detects

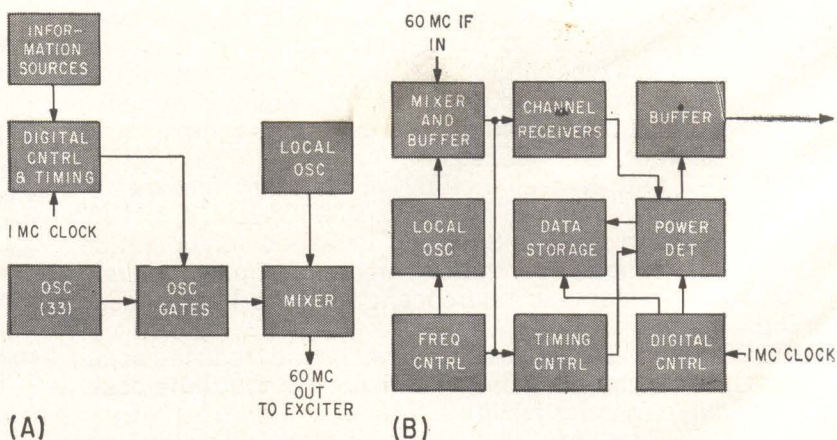

Fsk-modulated transmitter (A) and receiver (B). Receiver is designed to recover signal and measure errors

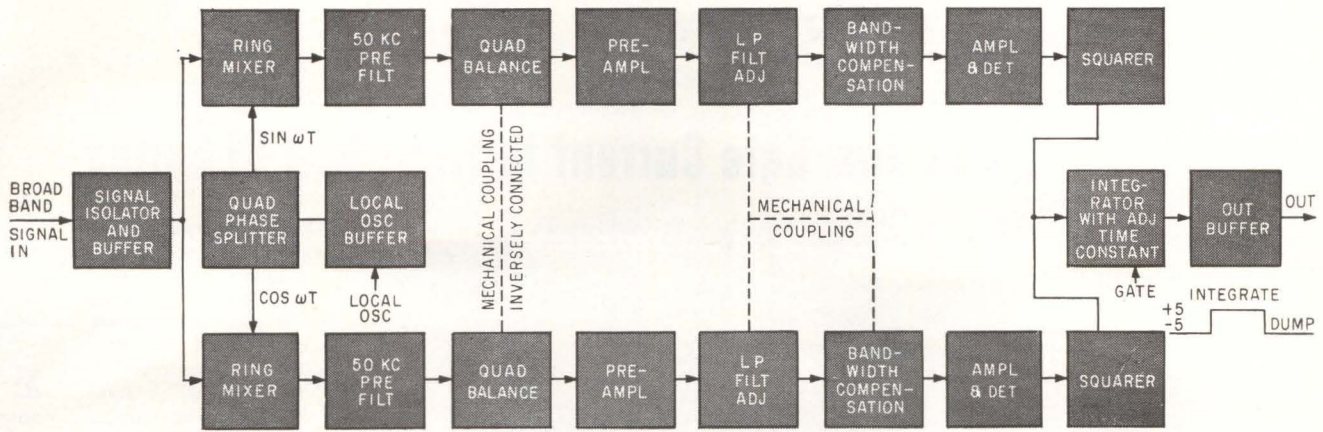

Preselection of channel receivers is accomplished in a group of 35 bandpass filters external to the receivers

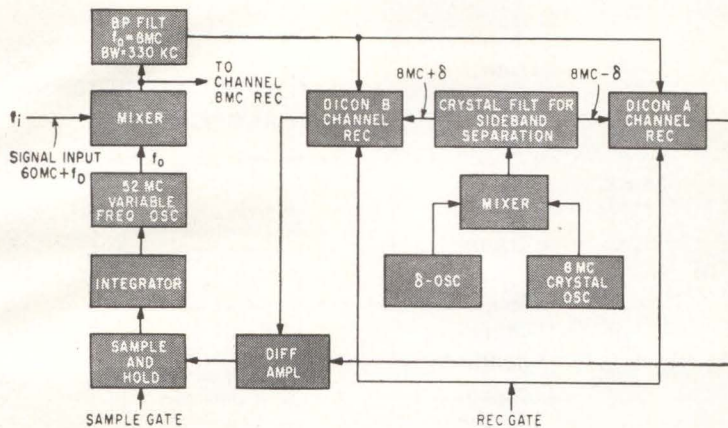

Dicon frequency-tracking circuit. Frequency discriminator section at right measures the energy difference in two equal and adjacent frequency bands

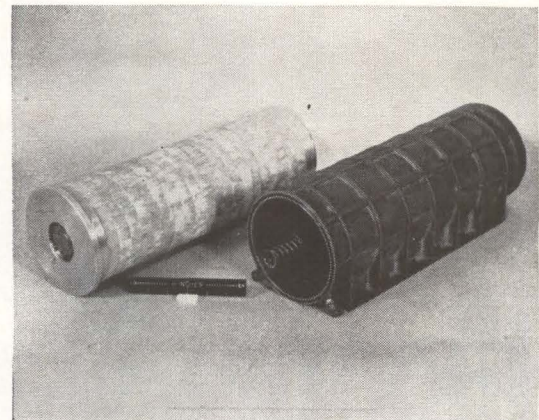

Dipole dispenser used in first trial. New dispenser will be instrumented to disperse fibers on command and monitor dispersal

the presence of the sync pulse, it generates a signal which is fed back to the frequency tracking circuit. This feedback signal interrupts the search mode of the variable frequency oscillator and closes the frequency control loop, thereby enabling automatic frequency control.

The Dicon system uses agc to keep the output of the sync receiver constant, as required by the digital integrator, and simultaneously to maintain a satisfactory signal level at the inputs to the 32 channel receivers. The receivers are designed to measure r-f energy within a given bandwidth, manually adjustable, and during a selected interval of time, controlled by an externally generated gate.

The power detector and bit decision section sample the receiver at the proper times and transmit to the data-processing equipment the

sequence of received binary digits. Decisions are based on energy measurements.

The channel receiver outputs are selected by a set of 32 analog gates, controlled by logic levels. The frequency assignment and frequency selection plugboards determine the sequence in which the gates are

LUNAR SUBSTITUTE

After the first West Ford trial failed because the dipole dispenser did not spin and disperse the dipoles, Dicon was tested using the moon as a relay. Digital data was transmitted at 50,000 bits a second. Tests with live teletypewriter signals have not approached the system's capacity. Highly redundant and correspondingly reliable transmissions were made at rates of 780 bits a second, equivalent to about 21 channels

opened. Sixteen channel receivers are tuned to frequencies designating ONES and these are connected to the 16 gates that make up the ONE selector. Depending upon the mode of operation, one, two, or four gates may be open at a time. The gate outputs feed through averaging resistors to the high impedance input of a voltage follower. Closed gates have a high impedance and do not affect the average. The 16 ZERO channels are connected to the ZERO selector in the same way. The outputs of the two voltage followers are subtracted in a difference amplifier whose output voltage is between -10 and +10 volts. The absolute value of this voltage depends on the signal-to-noise ratio, and its polarity determines the decision of the output bit.

This description was abstracted from a Lincoln Laboratory report edited by N. L. Dagget.—TM

20 ua Max. Gate Current to Fire - New C7 Series



silicon

controlled rectifier

The extreme triggering sensitivity of the new General Electric C7 series opens important new application areas for low current Silicon Controlled Rectifiers, including timing and time delay circuits, voltage limit detectors, high gain static switching, and logic circuits. Because of the high surge capability (15A) of the C7, you can make smaller squib firing systems without sacrificing design margin, and the maximum holding current level of 1 ma is particularly useful in many programming, control, and logic circuits.

In addition to the C7, General Electric offers two other levels of gate sensitivity in the TO-5 package: the C5 series (200 ua max. gate current to fire) and the 2N1595-99 series (10 ma max. gate supply current to fire). Your G-E Semiconductor Products District Sales Manager can give you complete technical information on these TO-5 packaged SCR's. Or write Rectifier Components Department, Section 16067, General Electric Company, Auburn, New York. In Canada: Canadian General Electric, 189 Dufferin St., Toronto, Ont. Export: International General Electric, 159 Madison Avenue, New York 16, New York.

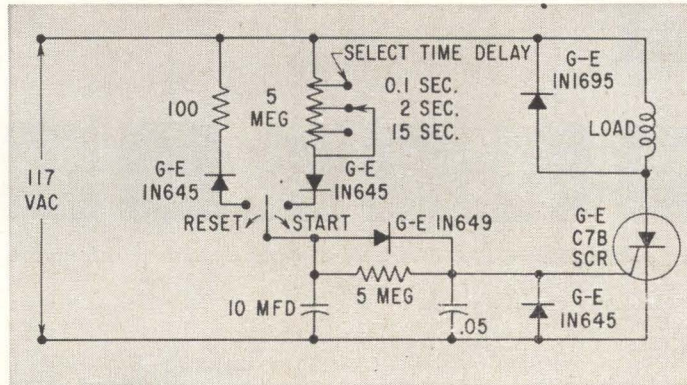

TYPICAL TIMING CIRCUIT FEATURING:

- completely static operation
- operates directly from standard 117 volt AC line
- instantaneous reset
- negligible temperature effects
- handles up to 1 ampere load at standard line voltages
- circuits also available for DC supplies
- accurate, repeatable timing from milliseconds to more than a minute

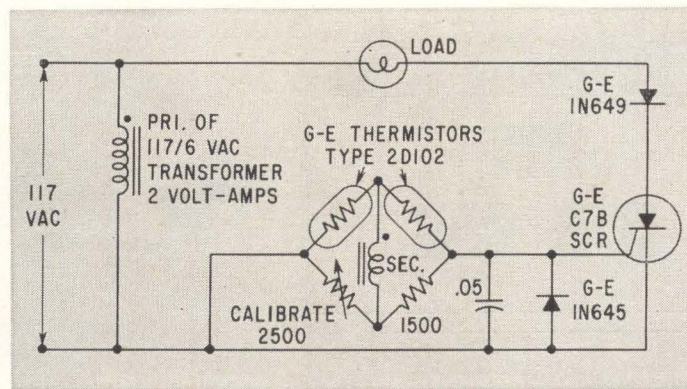

TYPICAL SENSING/SWITCHING CIRCUIT APPLICATIONS:

- constant temperature controls
- differential temperature controls
- flow controls
- light level controls
- position controls
- proximity switches
- alarm system
- radiation detectors
- liquid level controls
- stress detectors

AVAILABLE THROUGH YOUR AUTHORIZED G-E SEMICONDUCTOR DISTRIBUTOR

GENERAL  **ELECTRIC**

حياة طويلة

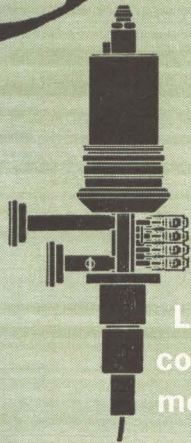

This Arabic script means "Long Life." For people who deal with complex microwave problems, "long life" means Varian klystrons—pulse, CW, reflex.

Simplicity of design, ruggedness, and precision manufacture make possible these histories: On Spruce Mountain, Nevada, a VA-220 reflex oscillator klystron was installed in 1956 in a TV transmission system. It has been operating unattended for more than 33,000 hours. Near the Arctic Circle, VA-842 super-power klystrons were installed in 1960 in a classified radar network. Eight tubes had reached 10,000 hours operation by December, 1961. In Norway, VA-800C CW amplifier klystrons were installed in 1958 in HOTLINE, a link in a NATO troposcatter system. Six tubes are still going after 10,000 hours; one has reached 20,000 hours. If your microwave system design calls for tubes that *last*, contact Tube Division.



VARIAN associates

PALO ALTO 1, CALIFORNIA

Varian Subsidiaries: BOMAC LABORATORIES, INC. • S-F-D LABORATORIES, INC. • SEMICON ASSOCIATES, INC.
VARIAN ASSOCIATES OF CANADA, LTD. • SEMICON OF CALIFORNIA, INC. • VARIAN A. G. (SWITZERLAND)

CIRCLE 23 ON READER SERVICE CARD

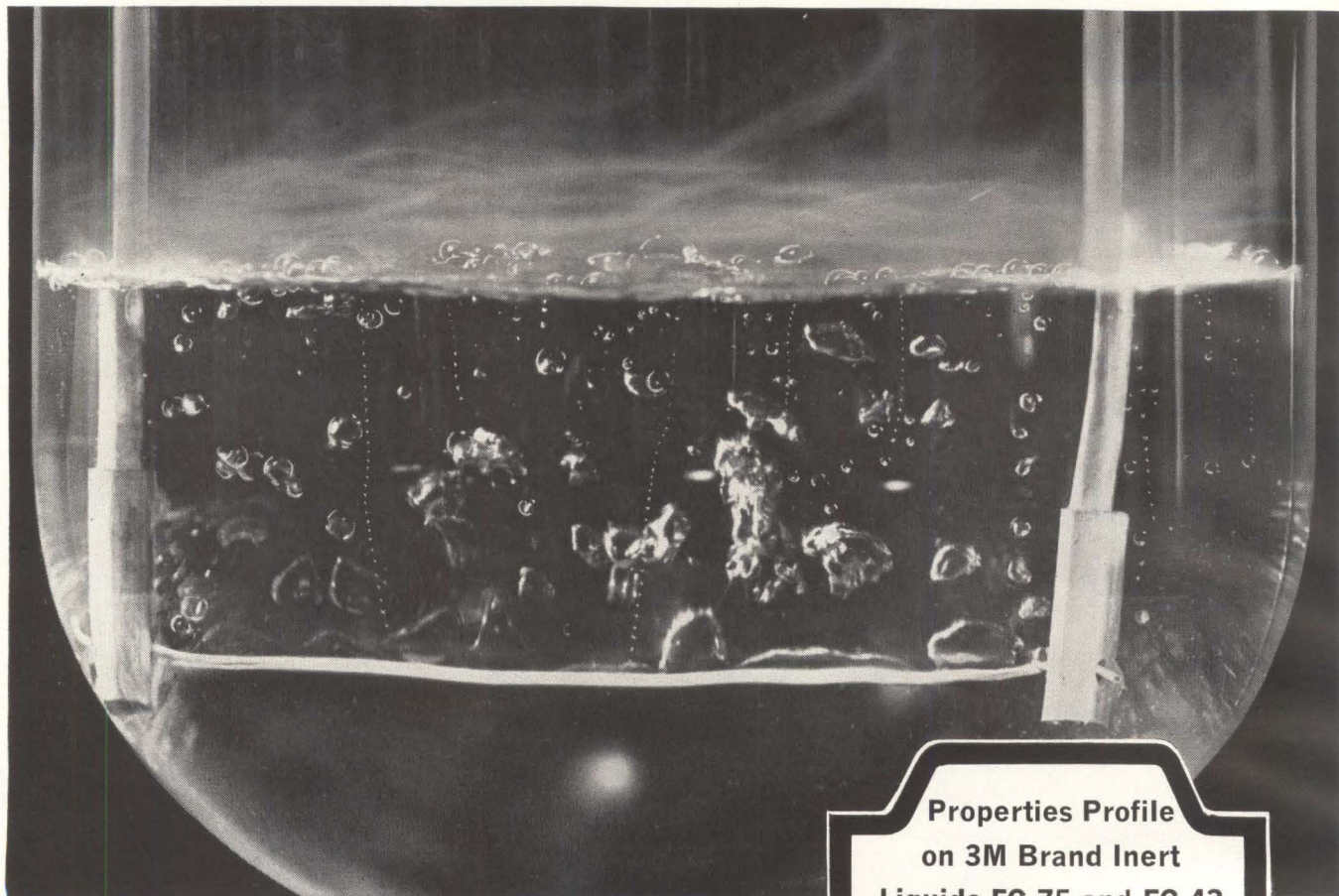

Heat Fluxes (150-500 watts/in.²) no problem when FC-75 cools components!

Using Inert Fluorochemical Liquid FC-75 as a heat transfer medium for cooling electronic gear, designers can practically eliminate hot-spot problems. Heat fluxes—from 150 to 500 watts per square inch, for example—can be handled by this coolant with minimal changes in temperature of components.

FC-75's low boiling point (214°F) permits a high heat transfer rate by evaporation, as illustrated above. Hot spots in a component part attain a temperature above the boiling point of the FC-75, then remain relatively constant. Because of the rapid transfer of heat from the component by the boiling FC-75, burn-out dangers are minimized.

FC-75, as well as its companion product FC-43, are at their best when equipment is specifically designed around their remarkable cooling abilities. FC-75 can remove up to 10 times more heat than such coolants as transformer oil. Thus new designs using FC-75 can drastically reduce the size of electronic units. Design space-savings up to a factor of six have been achieved.

FC-75 is stable up to 750°F and is completely compatible with most materials. It is non-explosive, non-flammable, non-toxic, odorless, and non-corrosive. Unimpaired by arcing, it heals itself in either the liquid or vapor state. Because of its thermal stability, no sludges are formed. Write for further information, and for specific application details.

Properties Profile on 3M Brand Inert Liquids FC-75 and FC-43

ELECTRICAL PROPERTIES

	FC-75	FC-43
Electrical Strength	35KV	35KV
Dielectric Constant (1 to 40 KC @ 75°F)	1.86	1.86
Dissipation Factor (1000 cycles)	<0.0005	<0.0005

TYPICAL PHYSICAL PROPERTIES

	FC-75	FC-43
Pour Point	<-100°F	-58°F
Boiling Point	212°F	340°F
Density	1.77	1.88
Surface Tension (77°F) (dynes/cm)	15	16
Viscosity		
Centistokes (77°F)	0.65 Min.	2.74
Thermal Stability	750°F	600°F
Chemical Stability	Inert	Inert
Radiation Resistance	25% change @ 1 x 10 ⁸ rads	25% change @ 1 x 10 ⁸ rads

For more information on FC-75 and FC-43, write today, stating area of interest to: 3M Chemical Division, Dept. KAX-42, St. Paul 1, Minn.

Now measure MTBF in 1000's of hours!

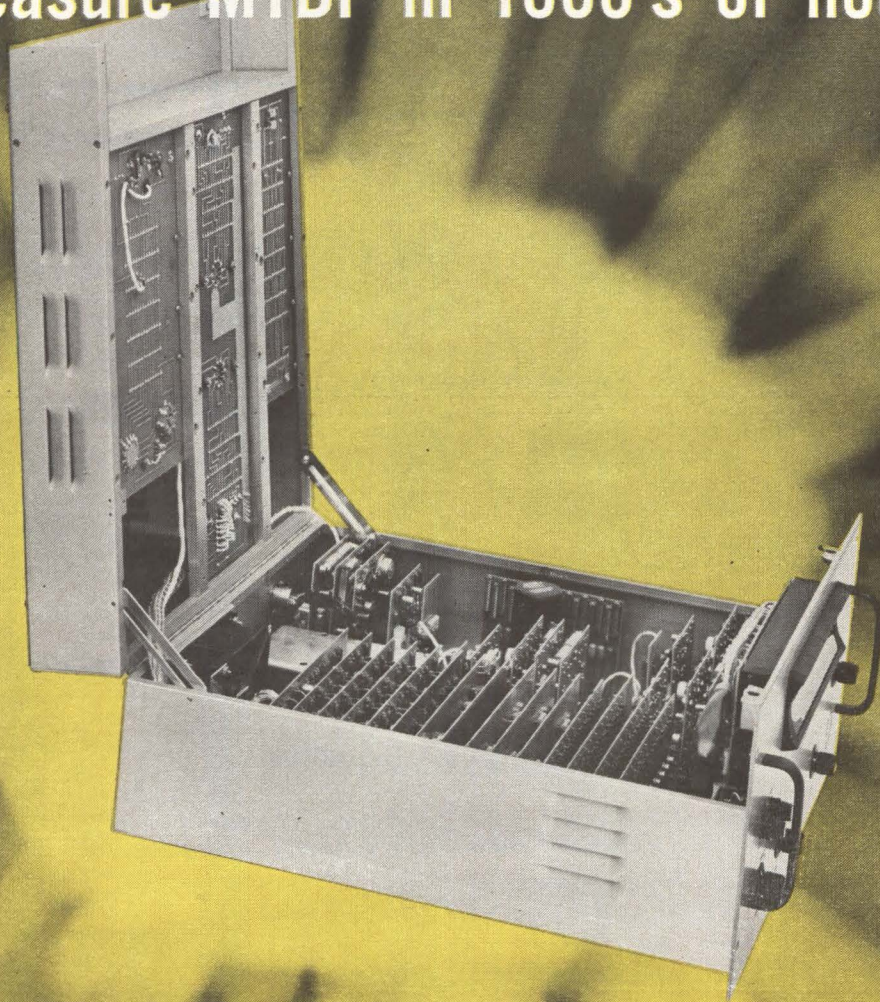

These 7 **Eitronic** design concepts set a new standard for digital instrument reliability

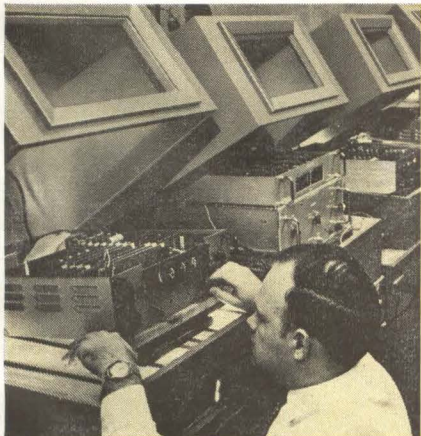

Accelerated aging, equivalent to 100 hours of actual use, eliminates 98% of possible component failures

All-Electronic Switching—Eitronic logic is all solid state. No rotating elements, no metal fatigue, no contacts to clatter and wear. Just cool, silent, reliable operation.

Conductance Adder Logic—Eitronic logic operates continuously without errors or downtime due to wear. Varying voltages are quietly tracked. Operator reads *exact* voltages instantly.

Zener Diode Reference—Long term tests prove that the temperature controlled, twin-bridge zener diode reference is stable to 0.005% for *months*. This stability gives real meaning to Eitronic accuracy.

Careful Component Selection—The costlier, high quality components used in Eitronic instruments are carefully selected based upon the findings of our own component evaluation tests. Completed circuit boards are then rigorously tested numerous times during assembly.

Conservative Circuit Design—Eitronic circuits are conservatively rated to assure reliable performance in the most demanding applications, including continuous, 24-hour operation.

Modular Internal Design—The modular approach permits exhaustive "pyramid" testing of components and assemblies during manufacture to assure field reliability.

Unique Mechanical Design—Use of an exclusive "fliptop" design permits multiple measuring functions within a single package. Heat sinks coupled with built-in cooling devices insure component operation within rated temperature tolerances.

Your EI field engineer will be pleased to demonstrate any of the models in the Eitronic Series: Single and multiple function instruments capable of measuring AC volts, DC volts, DC ratios and resistance in either 4 or 5 digit models.

Electro Instruments, Inc.

8611 BALBOA AVENUE, SAN DIEGO 11, CALIFORNIA

Engineers: Challenging opportunity now available. Contact Mr. Harvey Fleming.

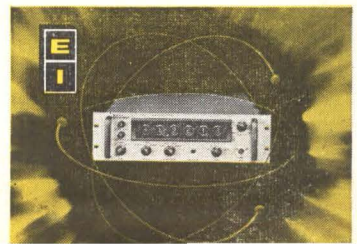

MHD Engine Uses Traveling Wave

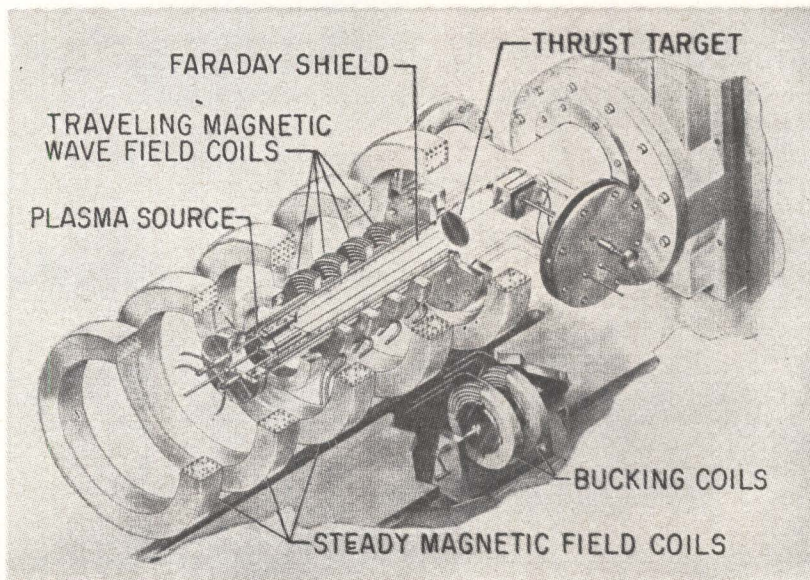

Traveling magnetic wave plasma engine under development at National Aeronautics and Space Administration's Lewis Research Center

Efficiency of developmental magnetohydrodynamic device is now only three percent, compared to 50 to 60 percent for pulsed-type accelerators

By GEORGE W. SUTTON

Associate Professor of Mechanical Engineering, (Visiting)*, Massachusetts Institute of Technology

ROCHESTER—New data on applications of magnetohydrodynamics to flight and power conversion highlighted the recent Third Annual Symposium on the Engineering Aspects of Magnetohydrodynamics. Sponsored by the AIEE, Institute of the Aerospace Sciences, IRE and University of Rochester, the symposium featured a round table discussion on high current particle beams and sessions on flight applications, energy conversion, diagnostics and communications, and fusion. It drew approximately 300 engineers and scientists.

At the session on flight applications, R. E. Jones and R. W. Palmer, of NASA's Lewis Research Center, presented measurements of energy efficiency of up to 3 percent and specific impulse of 1,000 in a traveling-wave engine. The engine has four 150-Kc field coils mounted coaxially around a discharge tube (see figure). They provide a time-varying magnetic field which induces currents in the ionized gas that result in a repulsive force to accelerate the plasma. A new engine is being designed to give higher efficiencies.

A novel MHD engine was described by David Miller, of GE's Space Science laboratory. Gas is

*On leave of absence from GE Space Science Laboratory

Multipole Toroid Confines Plasma

TECHNIQUE that may solve some key problems in controlled thermonuclear fusion was described at the recent American Power Conference in Chicago by D. W. Kerst, of General Dynamics. Kerst suggested that a toroidal multipole structure developed by T. Ohkawa of the General Atomic division should be able to contain a high plasma pressure.

In the toroidal multipole structure (see sketch) internal conductors are used to form a simple multipole magnetic field that will confine the plasma. The system is similar to a stellarator (ELECTRONICS, p 29, Sept. 1, 1961) without a circumferential field through the plasma. It reportedly overcomes the drift problems associated with stellarators and other toroidal systems.

Stellarators use external conductors. Using internal conductors

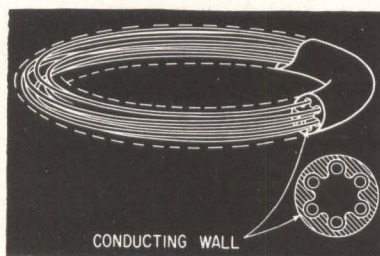

Transparent view of multipole structure developed at General Atomic

in the toroidal multipole system will pose construction problems different from those of stellarators. But the problems are not expected to be serious obstacles to this confinement method.

The work was carried out under a joint General Atomic-Texas Atomic Energy Research Foundation program on controlled thermonuclear reactions.

admitted into the high magnetic field end of a magnetic mirror, and then ionized and heated by electron cyclotron resonance. The diverging magnetic lines act as a nozzle for the electrons. The ions are then accelerated by the resulting space charge.

Two papers on pulsed-type accelerators, by Michel Maes, of Rocket Research Corp., and Per Gloersen, of GE's Space Science Laboratory, indicate specific impulses of 5,000 to 10,000 at 50 to 60 percent efficiencies have been achieved for runs up to several days with little component problems.

W. T. Hogan, of the MIT Magnetogasdynamics Laboratory, described experiments on a crossed-field Lorentz-force accelerator in a shock tube. Using a megawatt of power, Hogan was able to triple the gas velocity to 12,000 meters a second, with an efficiency of 60 percent.

The round table discussion centered on high energy ion beams, used for ion propulsion and to inject plasmas into magnetic mirrors for studies of controlled thermonuclear fusion. All agreed that in laboratory experiments beam neutralization was no problem, but there is still disagreement as to whether this may be a problem for an ion engine that is used in outer space.

John Luce, of Aerojet General, and Russell Meyerand, Jr., of United Aircraft, showed that the Langmuir-Childs limitation on current can be circumvented by injecting electrons with the correct energy which neutralizes the space-charge effect. In the Penning-type discharge under development by Meyerand, (*ELECTRONICS*, p 47, July 14, 1961) ion reflectors at the forward end can be used to increase the efficiency when used as an ion propulsion engine.

Several investigators described recent work with duoplasmatron (Von Ardenne) ion sources. T. Forrester, of Electro-Optical, pointed out the geometric similarity of the duoplasmatron to an ion engine which uses a porous tungsten plate as the ionizing source. Forrester claimed that with a porous tungsten ionizer there is no upper limit to the beam current, while with the duoplasmatron, beam currents up to $\frac{1}{2}$ amp have been achieved at 600

Kv, with a goal of 10 amps.

The early history of experiments on MHD power generation was given by Bela Karlovitz, of Combustion and Explosive Research, who described his work from 1932 to 1947 at Westinghouse. The generator design was extremely sophisticated even by today's standards, but the power generated was small because of insufficient ionization of the gas. The present ionization technique is thermal ionization which is obtained by increasing the combustion temperature by preheating and oxygen enrichment; using this technique, T. R. Brogan, of Avco Research Laboratory has generated 600 kilowatts for a short time. A materials test stand is being built for use in solving materials problems. Although the overall thermal efficiency is predicted

to be 52.5 percent, a study by J. J. W. Brown, of GE, showed that the capital cost is too high to make MHD power economic at present, but according to Brogan cost estimates cannot yet be made.

A different method of achieving sufficient ionization was described by E. J. Sternglass, of Westinghouse. Here the working gas selected has a low electron deionization time and ionization is achieved by high energy electron beams. This is similar to the technique unsuccessfully tried by Karlovitz.

Successful operation of a Hall generator was reported by L. P. Harris, of GE Research Lab. In a Hall generator, Hall current is tapped off and fed to the load instead of the Faraday current as in most generators. Performance agreed with theoretical predictions.

"Afterburner" Improves Plasma Engine

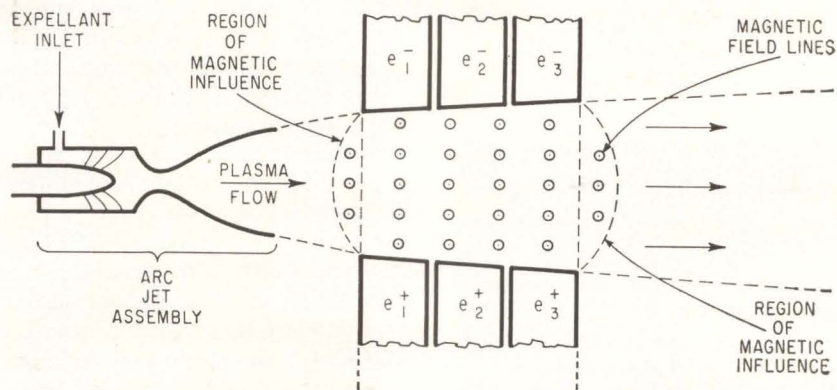

Accelerator increases thrust of plasma stream

ADDING a magnetogasdynamics accelerator to a thermal arc jet plasma generator may result in a practical space propulsion engine having a thrust of 1 to 10 pounds, reports Northrop's Space Propulsion and Power Lab. The plasma generator's propulsion performance is increased by converting electrical input immediately into kinetic energy instead of thermal energy.

At present, the plasma generator works at about 50 percent efficiency in heating a propellant gas with a continuous electrical discharge before expanding it through a nozzle.

The accelerator acts like an afterburner on a turbojet engine, to attain higher velocity thrust.

Conducting gas from the generator is exposed to currents between electrode pairs perpendicularly oriented to gas flow and an applied magnetic field. A Lorentz force on the plasma, in a direction paralleling flow direction, increases thrust by increasing plasma pressure.

High thrust levels at high efficiency, are obtained with high electrode currents and moderate magnetic fields. Thrust and efficiency were found to increase with

magnetic flux until flux reaches almost three kilogauss. Further increases in magnetic flux sharply lower thrust and efficiency.

Forty percent of the accelerator's energy input is figured as going into increasing the kinetic energy of the plasma gas, 30 percent heats the electrodes and 30 percent dissociates or ionizes the plasma.

Cooling the electrodes may make the accelerator an efficient, long-life propulsion device (aluminum electrode holders acted as heat sinks).

During studies of electrode discharge characteristics, electrode current was observed to actually pass through the plasma stream even though the main plasma core was a half inch from electrode surfaces. This implies that the luminous core is surrounded by a conducting sheath of outwardly diffused electrons. Existence of the conducting sheath was verified by measuring gap conductance and electrode drag as a function of electrode spacing.

Effect of electrode configuration on discharge stability, thrust and efficiency was studied using one inch-square pure tungsten bars. Arranging bars in a staircase pattern and using a serrated cathode were found to improve stability.

NASA Tries Telemetry Firsts

RECORD IN MISSILE telemetry is planned for the first Centaur launch vehicle test. The big booster was scheduled for firing atop an Atlas at Cape Canaveral this week.

Some 540 channels of information—a new high, NASA says—were to be radioed back from the rocket during its 15-min, 1,175-mi flight down the Atlantic Missile Range. In addition, the first known attempt was to be made to receive and record tv images of an internal vehicle function.

Of the 540 telemetry channels, about 400 are devoted to the upper stage of the vehicle. The 140 booster measurements are primarily to record engine and guidance functions, plus standard vibration, bending and temperature measurements.

Most top stage instruments gather data on engine sequencing, autopilot operation and the reaction of a partial tank of hydrogen at zero gravity. A "Christmas tree," in the hydrogen tank will indicate fuel movements. The tree is a metal skeleton extending the length of the tank. Each of its limbs is equipped with liquid sensors.

A small, cylindrical tv camera mounted in the tank bulkhead monitors hydrogen reaction. It takes a picture every two seconds. The signal transmitted to ground is recorded on tape, then converted to tv and motion pictures for study. A 100-Kw strobe lights each exposure.

The inertial guidance system is primarily a four-gimbal platform stabilized by three gyros, plus a general purpose digital computer with a 2,560-word memory. Autopilot commands are computed by position, velocity and acceleration data comparisons with precalculated mission requirements. The autopilot steers the vehicle through the engine gimbals until sustainer engine cutoff.

After first stage separation, the autopilot is responsible for second stage flight control. It accepts signals from the guidance system and initiates such events as engine

starts and payload separation (the latter does not occur in this first test). During coast periods the guidance system is cut off, except for a timer.

Minneapolis-Honeywell designed the inertial guidance system and built the stabilized platform. Librascope provided the guidance computer; Texas Instruments, the telemetry; Hallamore Electronics, the tv camera, and Bell Aerospace, the H₂O₂ attitude controls.

Centaur is being developed by General Dynamics/Astronautics under technical direction of Marshall Space Flight Center.

At present, R&D flights are scheduled for Centaur through 1963. Later flights will launch a variety of spacecraft including NASA's Mariner interplanetary probes and Surveyor lunar soft-landing craft and the Army's Advent synchronous-orbit communications satellite.

Centaur will place some 8,500 lb into a low earth orbit, send some 2,300 lb on an escape trajectory to the moon, or about 1,300 lb to Venus and Mars. The vehicle stands about 105 ft, is ten ft in diameter, and weighs about 150 tons at liftoff. The first U.S. liquid hydrogen-fueled rocket, it is expected to provide 40 percent more thrust than hydrocarbon-fueled rockets.

British May Use UHF-Tv In Line Standard Change

CHICAGO—Impending move by BBC to obtain more tv channel space by using uhf is sharing top priority with a change in line standards from 405 to 625, Sir Harold Bishop, director of engineering for BBC, told broadcast engineers at their annual conference here last week.

"We are on the verge of expansion, and it is now or never," Bishop said. A government committee has urged Britain to line up with the 20 organizations and 16 countries using the 625-line standard within the Eurovision system.

This change would mean replacement of 12 million existing 405-line receivers, he said. The 8-Mc chan-

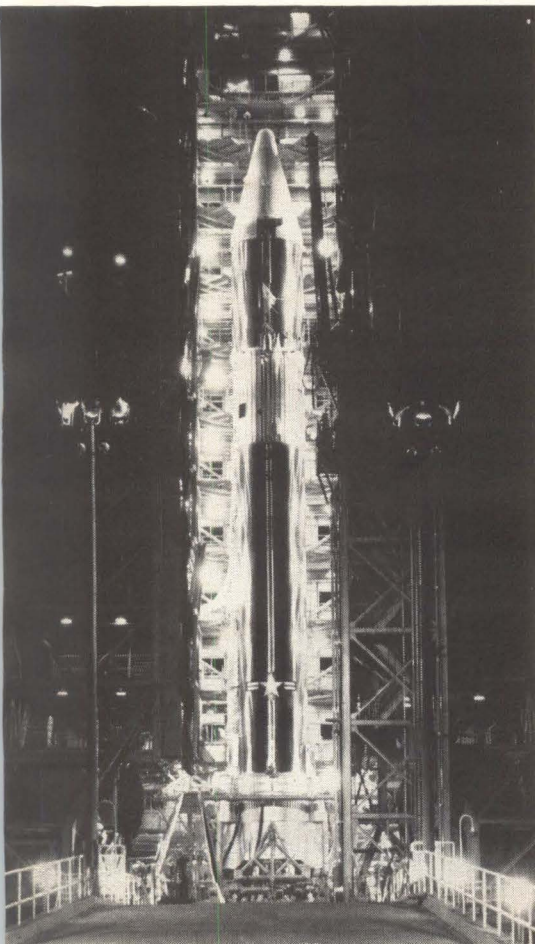

◀ Centaur sits atop modified Atlas at Cape Canaveral

nel width required for the higher standard won't leave enough room in the vhf band for both commercial and BBC national coverage. Channel allocations at uhf will be needed to maintain national coverage after the change, Bishop said.

The uhf band promises to provide space for four national programs. BBC plans to extend field trials, using two and possibly three uhf transmitters. Four uhf channels were allocated London under the Stockholm plan.

Expecting trouble, particularly in color transmission and differential fading, the British believe the current New York FCC trials should use at least two transmitters—with appropriate channel spacing—to find out the extent of interference from second channel and other sources.

The British are continuing test transmissions and industry has made great strides in color receiver designs, Bishop said. But it may be three years before the nation starts full development of color tv.

Bishop described the U.S. f-m stereo system as excellent. He saw "a considerable future" for stereo in Britain. Despite the predominance of television, public interest in radio is growing there, he said.

Harbor Radar-Tv



Under an experimental Coast Guard program, radar view of New York harbor is transmitted over uhf-tv channel 47. System uses a Raytheon storage tube which gives a persistent trace of moving ships. Craft in harbor equipped with tv set can determine their own position by maneuvering and watching their trace

**How one
electronic
watchman
reports
on 256
check points
ten times
a second**

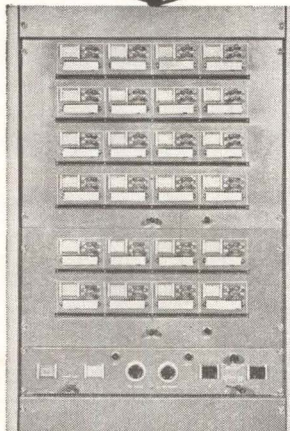
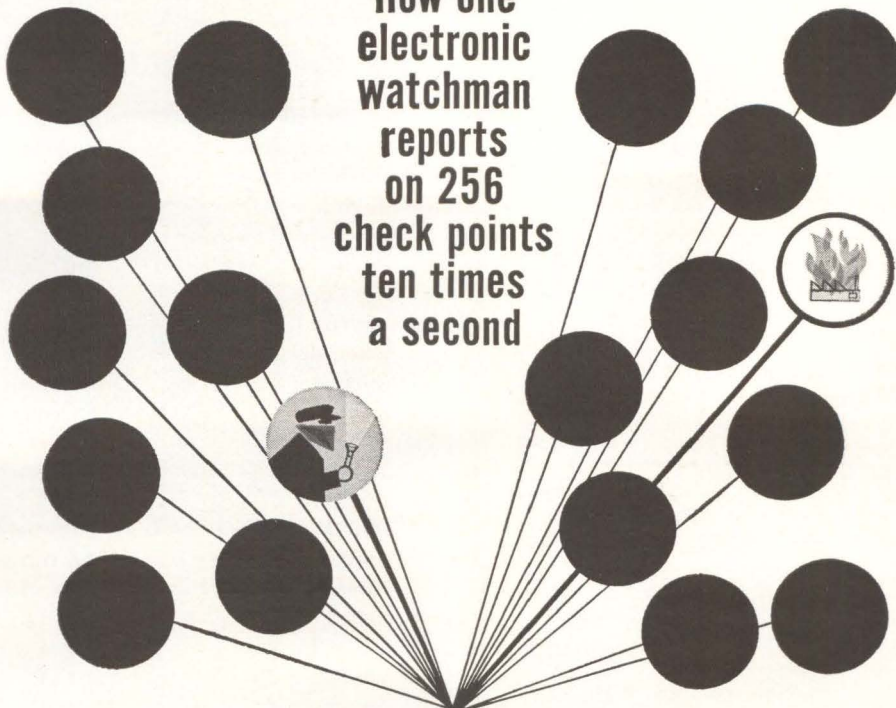

MARC systems help ADT® guard \$62 billion worth of American property

It hasn't been so long since the territory a night watchman could cover was determined by how fast he could walk. But today, with systems combining solid-state electronics and multiplexing, there's literally no limit to the number of points which can be supervised from one central station.

In the newest fire and burglar alarm systems available from American District Telegraph Company, for example, the central station operator can supervise conditions at numerous points many miles apart. He can monitor their security status, detect incipient fires, and guard against burglary and holdup, with better efficiency and reliability than a "live" watchman.

ADT systems now use MARC remote supervisory equipment similar to that supplied to pipelines, railroads, and other communication system users. MARC equipment, manufactured by Moore Associates, is available in off-the-shelf coder and decoder units which operate around-the-clock, utilizing telephone, VHF, microwave, or carrier communications links. All-solid-state design insures reliable, maintenance-free operation. Each decoder unit, handling information from 8 to 256 check points, occupies only a few inches of rack space.

Moore Associates offers a the development and manufac-
plex equipment to meet specific

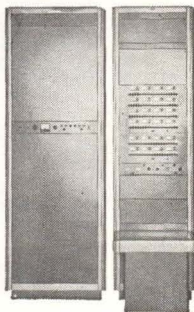

unique experience and capability in
ture of specialized time-division multi-
customer requirements. Write today for
details.



MOORE ASSOCIATES INC.
893 American Street, San Carlos, Calif.

SPRAGUE PIEZO- ELECTRIC CERAMIC ELEMENTS

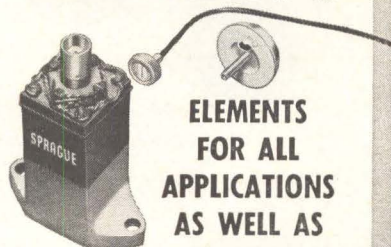

**ELEMENTS
FOR ALL
APPLICATIONS
AS WELL AS
COMPLETE**

**TRANSDUCER ASSEMBLIES
FOR MOST APPLICATIONS,
SUCH AS UNDERWATER
SOUND AND
VARIOUS ORDNANCE AND
MISSILE DEVICES.**

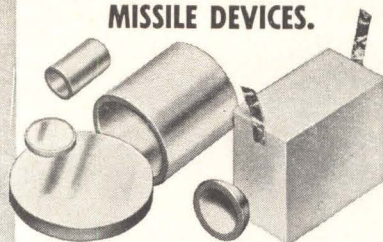

Sprague-developed mass production and quality-control techniques assure lowest possible cost consistent with utmost quality and reliability. Here too, complete fabrication facilities permit prompt production in a full, wide range of sizes and shapes.

Look to Sprague for today's most advanced ceramic elements—where continuing intensive research promises new material with many properties extended beyond present limits.



**YOUR INQUIRIES
ARE INVITED**

**WRITE FOR
LITERATURE**

SPRAGUE ELECTRIC COMPANY
35 Marshall Street, North Adams, Mass.

SPRAGUE®
THE MARK OF RELIABILITY

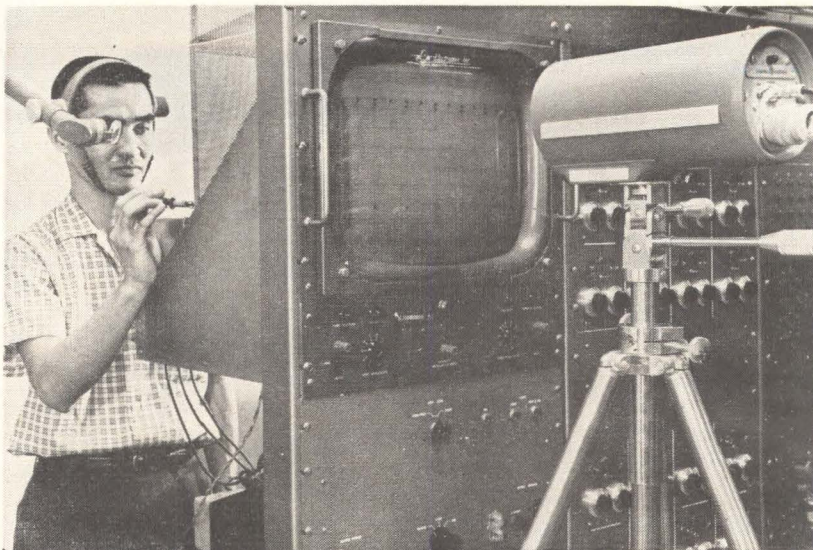

Engineer wearing viewer can adjust equipment in rear while tv camera watches the front

Tv Screen Is Worn Like a Monocle

NEW YORK—Remote viewing device that allows the wearer to watch any kind of cathode-ray tube picture and his surroundings at the same time was demonstrated here last week by Hughes Aircraft.

The headpiece consists of a L-shaped housing containing a miniature crt and a mirror to deflect the image onto a transparent eyepiece. Dichroic filters in the eyepiece selectively filter background illumination, so the image can be seen in normal lighting. Minimum operating brightness is 25 ft-lamberts, Hughes said.

The apparent diameter of the image can be adjusted up to 8 ft at a distance of 20 ft. The viewer weighs 30 oz. Earphones can be

added for audio reception.

Image sources may be radar, instrument or computer data, or any scene that can be transmitted by closed-circuit tv.

Hughes listed a number of potential military, aviation, industrial and space applications: as a walk-around radar monitor for aircraft traffic controllers, supplying military personnel with personalized briefings or sections of complex battle displays; remote viewing of instruments, instructing assemblers of complex equipment, and so on.

Communications Company Sells a Computer System

DALLAS—Collins Radio, which announced recently it would enter computer field (p 7, Jan. 12), has sold its first data communications switching system to Aeronautical Radio, Inc., for \$2 million.

System will handle routine and priority messages in ground radio station network operated by ARINC for major airlines, which includes 105 multiparty telegraph lines. Major parts of system are dual solid-state data processors and random access message files, magnetic tape handlers for message storage, and control console.



Viewer is transparent

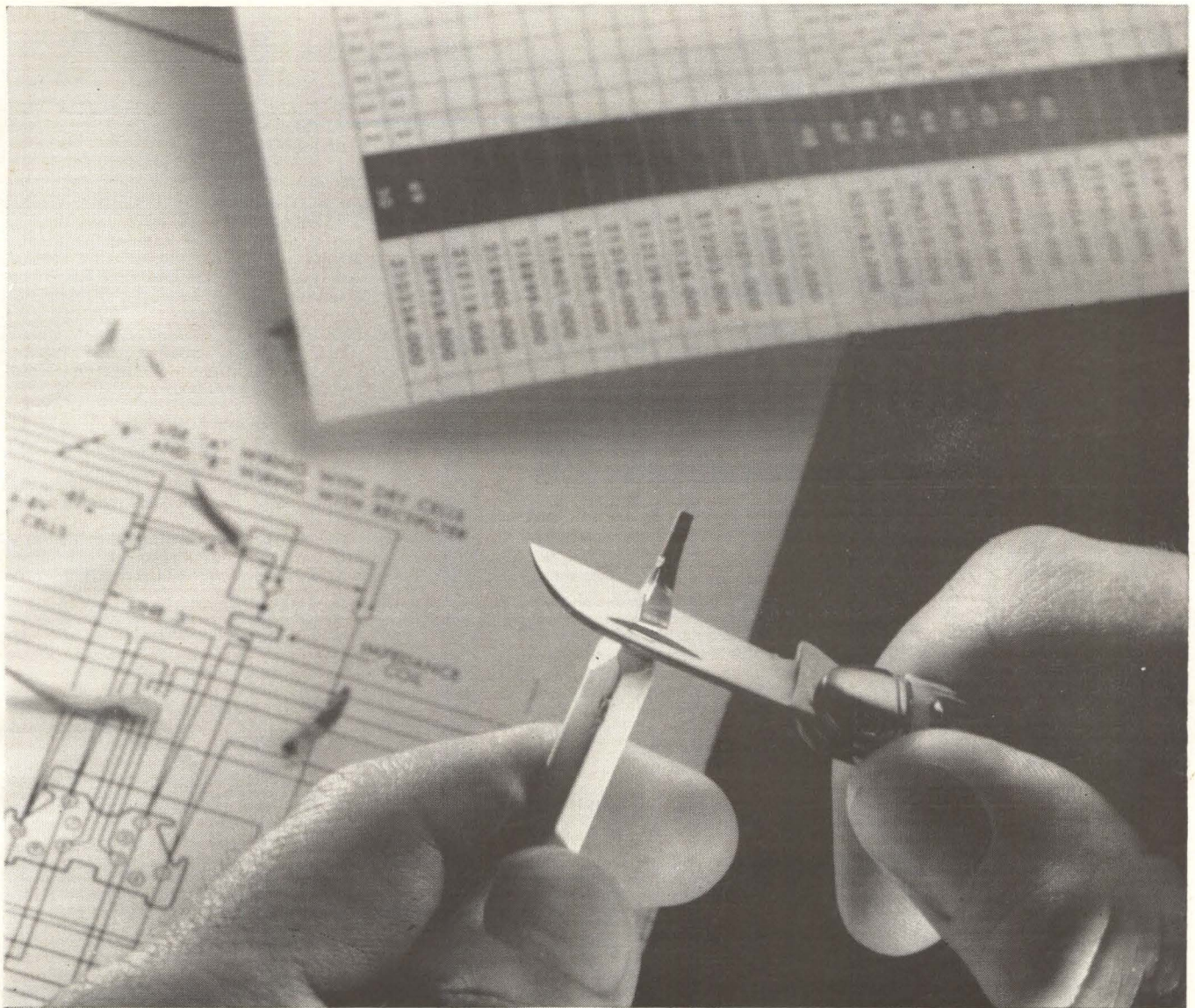

Sorry, but your resistor specs just went out of date

Now Corning supplies total ΔR less than 3% with no derating

Start a design with known limits of resistance deviation as tight as that and you can specify other components with more certainty and more freedom.

Drop an amplifier stage? Use broader tolerance, cheaper tubes or transistors?

That's what our new *Corning Design Tolerances* are all

Model	Resistance (ohms)	Corning Design Tolerance
NF (Meets Mil-R-10509D)	60 65 100 to 100K 100 to 348K	3%
N (Meets Mil-R-10509D)	60 65 70 10 to 133K 10 to 499K 10 to 1 meg.	3%
C (Meets Mil-R-22684)	20 32 42S 51 to 150K 51 to 470K 10 to 1.3 meg.	5% (plus purchase tolerance of either 2% or 5%)

about. They give you a percent deviation from nominal that includes the purchase tolerance, maximum ΔR due to TC, and maximum load-life drift. They're based on extended performance at full power and 70°C. ambient for over 30,000 hours.

We've assigned them to resistors that cover the 10 ohm-1 meg. range: the fusion-sealed NF, the precision N, and the low-cost, high-performance general purpose C. They're available fast, and at factory prices, from your local Corning distributor.

A new folder, "Design Tolerances for Tin Oxide Resistors," gives you full information. Write for a copy to Corning Glass Works, 539 High St., Bradford, Pa. . . . and sharpen your pencil.

CORNING

Electronic Components

Here is

'SCOPE RECORDING VERSATILITY



... for ANY 5" Oscilloscope

for IMMEDIATE PRINTS
—2 Polaroid Land* Cameras

New MULTIPLE EXPOSURE MODEL SM-209



A special sliding mount for the well-known Polaroid Land Camera Back, lets the SM-209 take 1 to 9 evenly-spaced trace exposures on a single print. All camera adjustments are made without removing the camera from the scope. Has 1 to 1/100 second shutter and f:1.9 Wollensak "Oscillo-Raptar" lens for perfect corner definition. Price: \$365.

SINGLE EXPOSURE MODEL SM-200A

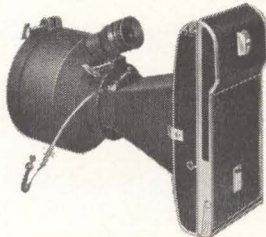

Here is fast, truly economical single-trace recording in easy-to-use form. Like the SM-209 all adjustments are readily accessible. Model SM-200A at \$345., has f:1.9 Wollensak "Oscillo-Raptar" lens and 1:0.9 image ratio.

for CONTINUOUS RECORDING
—1/2" to 12,000" per minute . . .



SM-100 Camera mounted on ETC Model K-470 . . . from ETC's extensive oscilloscope line.

The ultimate in highly accurate scope recording, the Model SM-100 takes single frame or moving film recordings over a wide speed range using 400 ft. magazine (1,000 ft. capacity available) of 35 mm film or paper (perforated or unperforated). Has binocular viewing, f:1.5 lens, 1 to 1/100 second shutter speeds, built-in tachometer, magnetic film brake, and glow lamp that provides timing marks on film edge. Price: \$1195., including tripod and case.

Write for Details on Any Type.

High-speed drum cameras, film & paper processing equipment, and custom-designed cameras can also be furnished

*T.M., Polaroid Corp.

electronic tube & instrument division

of General Atronics Corporation

1200 E. MERMAID LANE, PHILADELPHIA 18, PENNA.

(formerly Electronic Tube Corporation)

MEETINGS AHEAD

AEROSPACE SYSTEMS RELIABILITY SYMPOSIUM, IAS; Salt Lake City, Utah, April 16-18.

MICROWAVE MEASUREMENTS LECTURES, IRE-PGMT&T; Babson Institute, Wellesley, Mass., April 18, 25.

IONIZATION RADIATION, HEALTH ASPECTS OF, Institution of Electrical Engineers (British); Savoy Pl., London, April 25.

FREQUENCY CONTROL SYMPOSIUM, U. S. Army Signal Research and Development Laboratory; Shelburne Hotel, Atlantic City, N. J., April 25-27.

WESTERN SPACE AGE INDUSTRIES & ENGINEERING EXPOSITION/CONFERENCE, sponsored by various business and governmental organizations; Cow Palace, San Francisco. April 25-29.

PULP & PAPER INSTRUMENTATION SYMPOSIUM, Instrument Society of America; Jacksonville, Fla., April 26-27.

MOTION PICTURE & TELEVISION ENGINEERS CONVENTION AND EQUIPMENT EXPOSITION, SMPTE; Ambassador Hotel, Los Angeles, April 29-May 4.

MANNED SPACE FLIGHT SYMPOSIUM, IAS; Chase Hotel, St. Louis, Mo., April 30-May 2.

INSTRUMENTAL METHODS OF ANALYSIS SYMPOSIUM, Instrument Society of America; Daniel Boone Hotel, Charleston, W. Va., April 30-May 2.

SPECTROSCOPY SYMPOSIUM, Society for Applied Spectroscopy; Conrad Hilton Hotel, Chicago, April 30-May 3.

JOINT COMPUTER CONFERENCE, IRE-PGEC, AIEE, ACM; Fairmont Hotel, San Francisco, Calif., May 1-3.

HUMAN FACTORS IN ELECTRONICS, IRE-PGHFE; Lafayette Hotel, Long Beach, Calif., May 3-4.

POWER INSTRUMENTATION SYMPOSIUM, ISA; Hotel Texas, Fort Worth Tex., May 6-9.

COMPUTER CONFERENCE, Michigan State University; at the University, East Lansing, Michigan, May 7-8.

ELECTRONIC COMPONENTS CONFERENCE, IRE-PGCP, AIEE, EIA; Marriott Twin Bridges Hotel, Washington, D. C., May 8-10.

WESTERN ELECTRONICS SHOW AND CONFERENCE, WEMA, IRE; Los Angeles, Calif., Aug. 21-24.

ADVANCE REPORT

NATIONAL CONFERENCE ON TUBE TECHNIQUES. Advisory Group on Electron Devices in the Office of the Director of Defense Research and Engineering; Western Union Auditorium, NYC. Sept. 19-21. May 15 is the deadline for submission of one-page abstracts (single-spaced) to: Mr. David Slater, NY University Engineering Research Division, Electron Device Group, 346 Broadway—8th Floor, New York 13, N. Y. The program will cover all phases of electron tube making techniques, processes, and materials.

Here's a new "twist" for the specialized application:

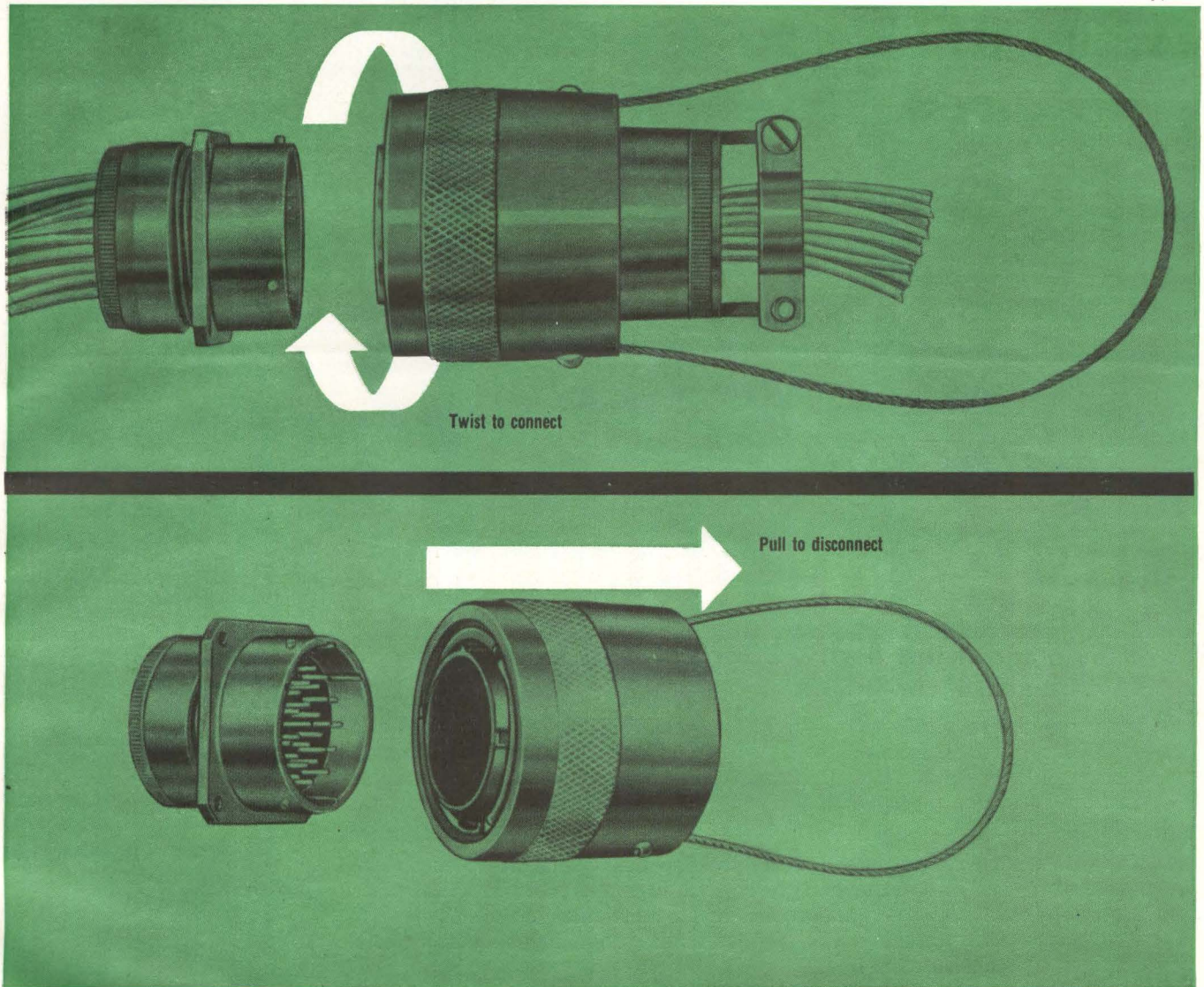

Bendix "TWIST / PULL" Pygmy Electrical Connector

This new Bendix® Pygmy® Electrical Connector uniquely combines positive coupling and pull-to-disconnect features. It is connected by a twist; disconnected either by hand or, remotely, by lanyard.

Complete intermateability with PT receptacles is achieved through use of standard Pygmy PT plug shells, five-key polarization, and three-point bayonet lock coupling. The "twist/pull" design assures inter-facial sealing and meets the performance requirements of MIL-C-26482.

Resilient inserts assure extreme vibration resistance and provide support for size 20 or 16 gold-plated Pygmy contacts of either the solder or removable crimp type. Plating options for the aluminum shell components are: cadmium with an olive drab chromate after treatment, or alumilite hard anodic coating.

Write us at Sidney, New York, for your copy of our informative technical bulletin SL-102, giving complete information on shell sizes and arrangements, as well as helpful design and dimensional data.

Scintilla Division



Canadian Affiliate: Aviation Electric, Ltd., 200 Laurentien Blvd., Montreal 9, Quebec. Export Sales & Service: Bendix International, 205 E. 42nd St., New York 17, N. Y.

April 13, 1962

CIRCLE 33 ON READER SERVICE CARD

33



Hathaway

DRIREED CONTACT

a magnetic switch designed for the most extreme environmental conditions...

It withstands temperatures of -54°C to $+125^{\circ}\text{C}$. External vibrations at 35g to 2000 cps. Shock forces have no effect on contact operation. Reliability features like these are why Hathaway Drireeds were specified for Transit, Titan, Advent, Surveyor—and a variety of other ground and space applications requiring excellent performance in critical environments.

The glass-sealed contact has high natural frequency and offers exceptional speed of operation. Cantilever type contact bars are precious metal plated for low contact resistance and sealed in an inert nitrogen atmosphere for insurance against contamination. Symmetrical design holds thermo-electric voltages to an absolute minimum.

And in the Drireed, environmental capabilities are matched by longevity. These are life ratings no other contact can provide: 5,000,000 operations at full load; 25,000,000 operations at half load; 1,000,000,000 operations at dry circuit. While reliability has been increased, contact mass has been decreased. This is the Drireed shown actual size:

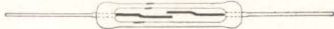

TYPICAL SPECIFICATIONS

Closed Contact Resistance: 0.04 to 0.09 ohms (including approximately 0.02 ohms lead resistance). **Contact Capacitance:** Less than 1 micro-microfarad. **Closure Time of Contacts:** 200 to 600 microseconds including bounce, after application of sufficient magnetic force to cause actuation. **Natural Frequency of Contact:** 2700 to 3200 cycles per second.

If your application is more demanding than most—if you want to design a smaller and better product—we'd like to tell you more about the Drireed line. Write or phone us at the address below, or see your local Hathaway representative.

Hathaway

INSTRUMENTS, INC.

A SUBSIDIARY OF THE LIONEL CORPORATION
5800 EAST JEWELL AVENUE, DENVER 22, COLORADO



Skyline 6-8301
TWX DN 656

Foreign Representation by: Terminal Radio International, Ltd., 3 West 61st St., New York 23, N. Y.

Typical products from Hathaway that utilize the Drireed to give the ultimate in reliability, life, and miniaturization.



DRIREED MINIATURE RELAY, Form A



DRIREED RELAY, Form C

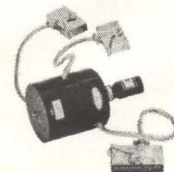

DRIREED SHUTTER CONTROLLED COMMUTATOR, Type RSC

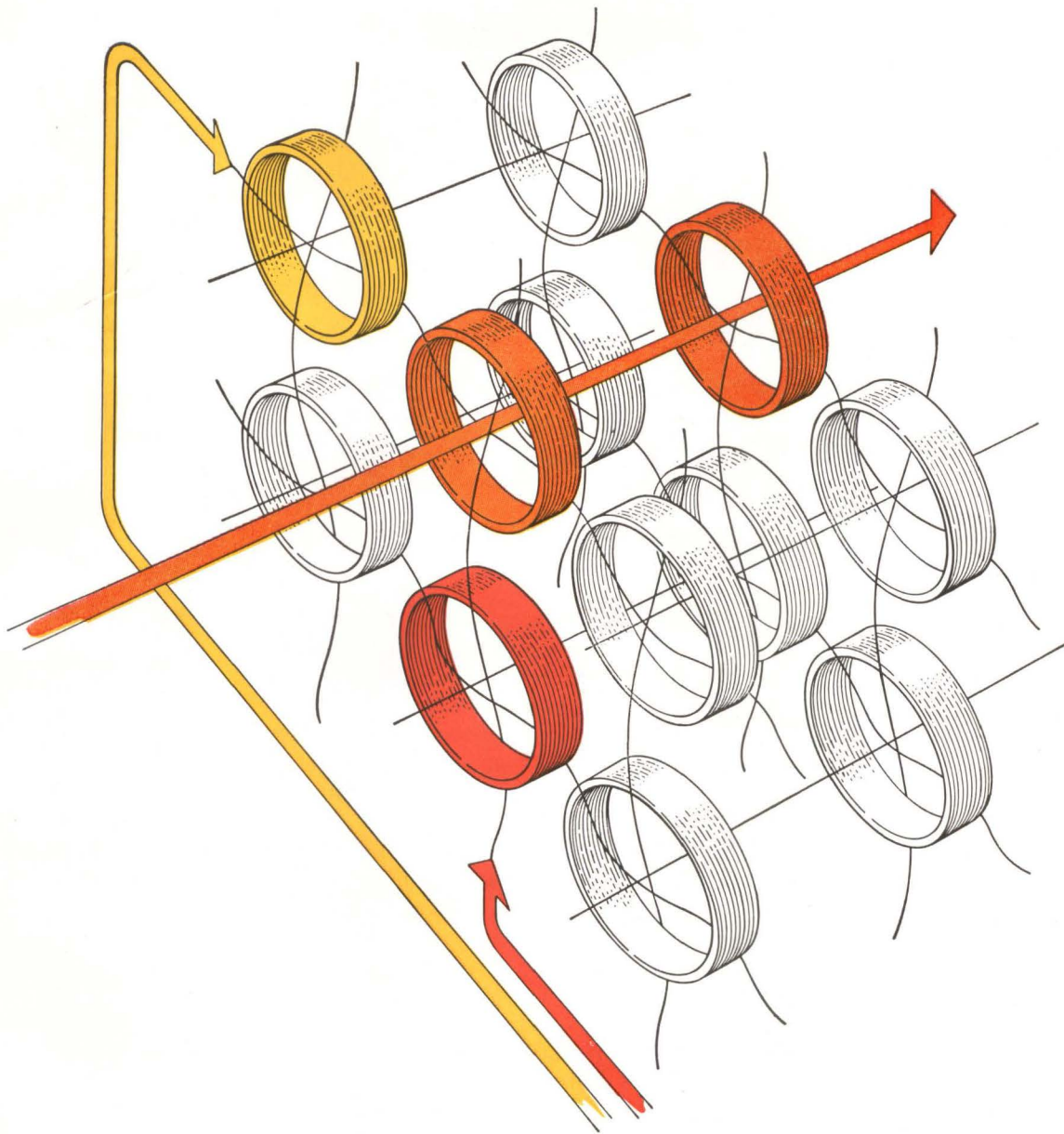

STANDARDIZED COMMERCIAL COINCIDENT CURRENT MEMORY SYSTEMS

Daystrom Military Electronics Division is now making available a series of new standardized coincident current memory "packages". Designed for commercial data processing systems, the CCM memories present features as: highly reliable all-solid-state circuitry; high component density which results in sizes up to 30% smaller than presently available units; and cycle times as fast as 3.5 μ sec. These commercially-priced CCM's provide the data systems engineer with a variety of packaged, modular core storage memories flexible enough to fit a vast number of design needs. Daystrom's CCM's are available as random access, sequential/interlaced, or sequential/non-interlaced. Word lengths of 8, 16, and on up to 64 bits, and capacities up to 4096 words are offered. The construction of these memories is modular, and many special features may be incorporated without major design change. Daystrom CCM systems reflect our extensive experience in the design of military digital machines such as the Navy's NORC memory and memories for the 465L global command and control network for SAC, in addition to our commercial one μ sec memory series. They represent a considerable advance in the field of commercial memories. Send for technical data.

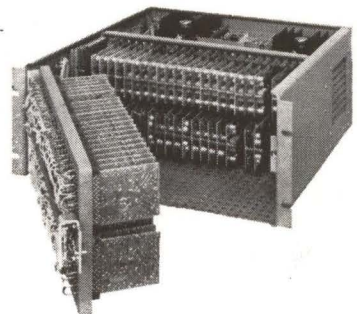

DAYSTROM, INCORPORATED
 MILITARY ELECTRONICS DIVISION
 ARCHBALD, PENNSYLVANIA

the common denominator behind each success:

SERVOSCOPE®

servo system analyzer

The *Atlas*... the *Minuteman*... take virtually any major missile program
... The *B-52-H*... the *F-104*... all the important aircraft developments
... The *M-60* or any other tank... Plants and projects throughout the world—
most likely including your own...

From missiles to manufacturing—wherever servo systems must be tested
and evaluated quickly, accurately, dependably—there is one common
denominator: the SERVOSCOPE® servo system analyzer. SERVOSCOPE stands
in the shadow of each success.

To the engineer working with missiles, weapons systems, airborne gear, ground
support equipment, instrumentation, navigation equipment, computers,
controls... SERVOSCOPE is an accepted part of the program. Understandably so.

From the simplest to the most complex electronic, electrohydraulic,
electromechanical, and electropneumatic servo system, they find, SERVOSCOPE
provides them with reliable answers in a hurry. By measuring the changes
in phase, gain, and transient response which occur when signals of various
frequencies are fed to the design, the investigator can safely evaluate
the behavior pattern of the system to meet ultimate operating conditions.

SERVOSCOPE is always set to take on new problems immediately.
And it's so easy to operate, that even a new man will be plotting Nyquist,
Bode, and Nichols diagrams after only a few minutes' familiarization.
(You'll even see SERVOSCOPE being operated right on the production line.)

If you've never tried the SERVOSCOPE, never seen what it can do,
prove it to yourself. Ask for a demonstration. There's a Servo office or
representative in your area.

- A free set of SERVOSCOPE WORKSHEETS or a Servo calculator, as well as technical literature will be sent you on request.



SERVO CORPORATION OF AMERICA

111 New South Road • Hicksville, L. I., N. Y. • WELLS 8-9700

Sales and service offices coast to coast

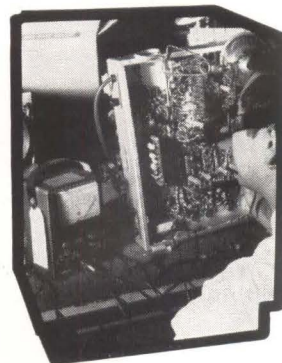
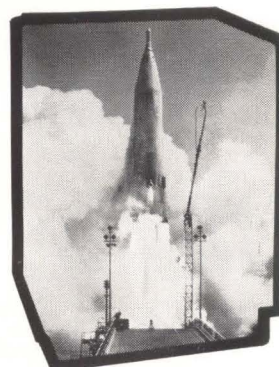
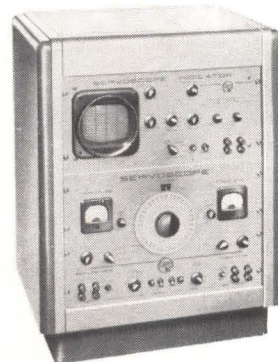

FOR ALL WIDE-BAND CIRCUITS :



TV, RADAR, VHF-RADIO

**LABORATORY
WOBBULATOR
411 A**

MAIN CHARACTERISTICS

Frequency range : 0 to 320 Mcs in 3 sub-ranges.

Wobulation amplitude : from 0 to ± 25 Mcs, according to frequency.

Marker (patented) : continuous scaling every 1 and 10 Mcs.

Output voltage : 0,1 V R.M.S. on a 75 Ω load ; constant level within ± 1 dB.

2 attenuators :

- by steps of 10 dB from 0 to 70 dB ;
- by steps of 2 dB from 0 to 10 dB.

Built-in oscilloscope :

- High sensitivity : 15 mV/cm
- Sine-wave sweep.

**RIBET
DESJARDINS**

For detailed specifications on this instrument, or on any other RIBET-DESJARDINS products, apply to :

MEASURE & CONTROL DEPARTMENT, 13-17, RUE PERIER, MONTROUGE (SEINE) FRANCE
TEL. ALÉ. 24-40 + - CABLE ADDRESS : PILACELECT - MONTROUGE

Agencies throughout the world :
North America [Canada] : ELECTROLINE TELEVISION EQUIPMENT INC. Room 114, 5757 Decelles Avenue - MONTREAL
Other areas : addresses sent on request

NEW INSTRUMENTS EXHIBITED AT THE I.E.A. SHOW — LONDON — 28 MAY - 2 JUNE 1962.

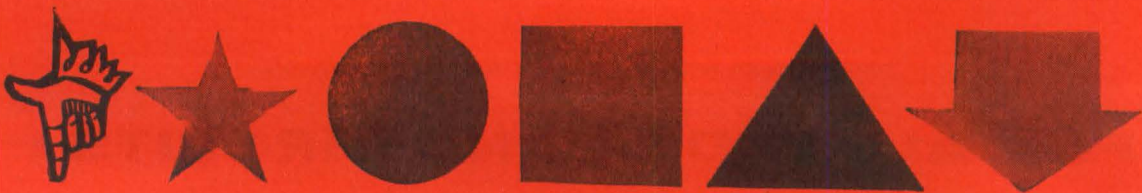



compare

NEW PHILCO 2N2400 SERIES MADT'S*
WITH ANY COMPARABLY PRICED SWITCHES!



Much higher avalanche voltage
for improved reliability—free-
dom from latching.

Higher Beta for improved de-
sign margins.



Lower V_{SAT} requires less dissi-
pation—easier circuit design.

Tighter V_{BE} spreads mean
more design flexibility—more
fan-in and fan-out.

Lower C_{ob} means faster switch-
ing at low currents.

Higher f_T .

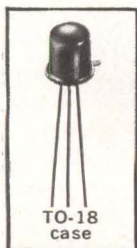
MAXIMUM RATINGS:	PHILCO 2N2400	2N711	PHILCO 2N2401	2N711A	PHILCO 2N2402	2N711B
V_{CBO}	-12 v	Same	-15 v	Same	-18 v	Same
V_{CES}	-12 v	Same	-15 v	-14 v	-15 v	Same
V_{CEO}	-7 v	NONE	-10 v	-7 v	-12 v	-7 v
V_{EBO}	-1 v	Same	-1.5 v	Same	-2 v	Same
Dissipation	150 mw	Same	150 mw	Same	150 mw	Same
ELECTRICAL CHARACTERISTICS:						
I_{CBO} ($V_{CB} = -5v$)	3 μ a max	Same	1.5 μ a max	Same	1.5 μ a max	Same @-10 V_{CB}
h_{FE} ($V_{CE} = -0.5v$, $I_C = -10ma$)	30 min	20 min	50 min	25 min	60 min	30 min
h_{FE} ($V_{CE} = -0.5v$, $I_C = -50ma$)			40	40@-0.7 V_{CE}	50	40@-0.7 V_{CE}
$V_{CE(SAT)}$ ($I_C = -10ma$, $I_B = -0.4ma$)	0.22v max	0.50v max	0.20v max	0.30v max	0.20v max	0.25v max
$V_{CE(SAT)}$ ($I_C = -50ma$, $I_B = -2ma$)			0.30v max	0.55v max	0.25v max	0.45v max
V_{BE} ($I_C = -10ma$, $I_B = -0.4ma$)	0.27 min 0.36 max	0.34 min 0.50 max	0.27 min 0.36 max	0.34 min 0.50 max	0.27 min 0.36 max	0.34 min 0.45 max
V_{BE} ($I_C = -50ma$, $I_B = -2ma$)			0.38 min 0.48 max	0.45 min 0.75 max	0.38 min 0.48 max	0.45 min 0.70 max
C_{ob} ($V_{CB} = -5v$, $I_E = 0$, $f = 4mc$)	4.0 pf max	7.5 pf max	4.0 pf max	6.0 pf max	4.0 pf max	6.0 pf max
f_T ($V_{CE} = -7v$, $I_C = -10ma$)	150 mc min	Same @-5 V_{CE}	200 mc min	150 mc min @-5 V_{CE}	250 mc min	150 mc min @-5 V_{CE}
t_{on} (max)	75 nsec	100 nsec	75 nsec	Same	75 nsec	Same
t_s (max)	140 nsec	200 nsec	120 nsec	Same	100 nsec	Same
t_r (max)	130 nsec	150 nsec	110 nsec	Same	100 nsec	Same



*Micro Alloy Diffused-base Transistor

New Philco 2N2400, 2N2401 and 2N2402 high-speed low-cost switching transistors are available in production quantities. Your local Philco Industrial Semiconductor Distributor offers off-the-shelf delivery today.

For complete data and applications assistance, write Dept. E41362.

PHILCO

A SUBSIDIARY OF *Ford Motor Company*

LANSDALE DIVISION, LANSDALE, PA.



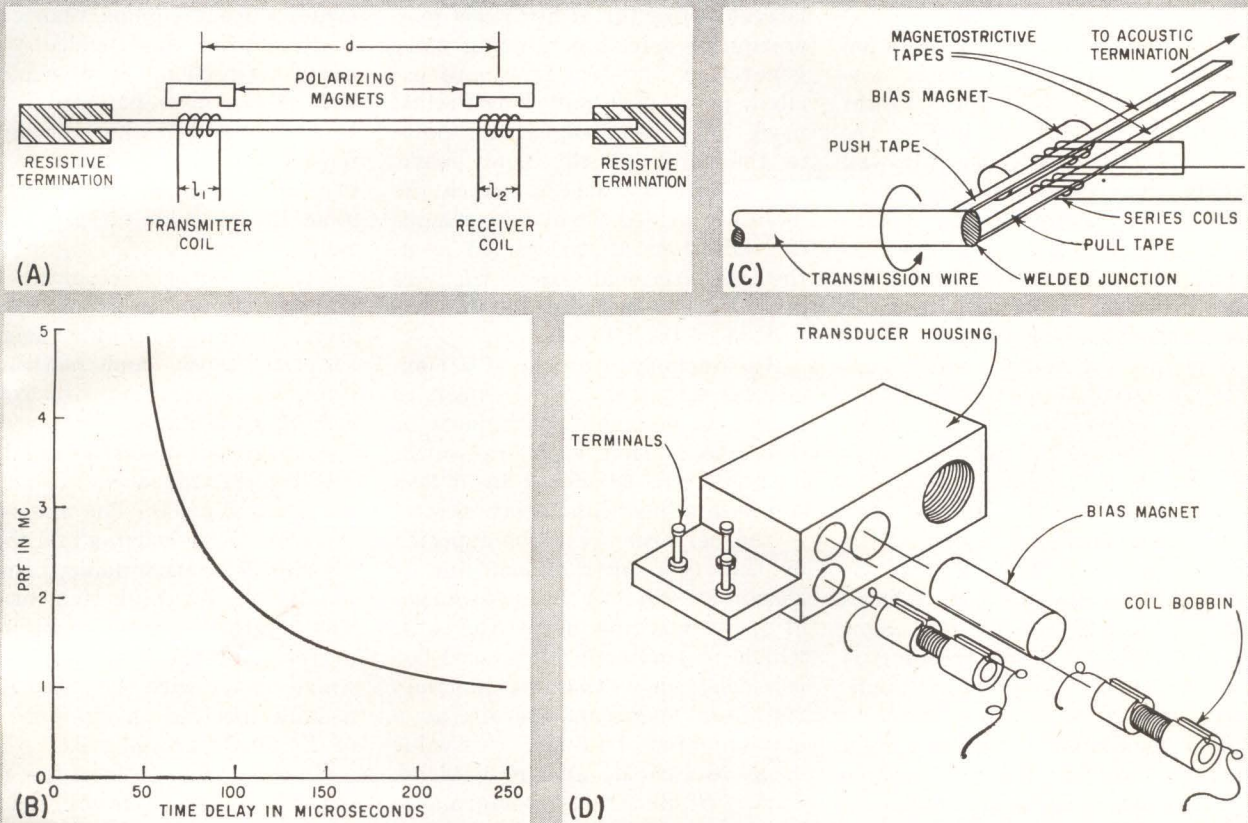

FIG. 1—Basic magnetostriction delay line (A), pulse repetition frequency against time delay in the longitudinal mode (B), longitudinal to torsional mode converter (C) and typical transducer assembly (D)

WHAT DESIGNERS SHOULD KNOW ABOUT

Magnetostrictive Delay Lines

New designs are resulting in increased use of this component. Performance and design features of some commercially available longitudinal and torsional magnetostrictive delay lines are explained

By ARTHUR ROTHBART, Consulting Engineer, New York
 ALAN J. BROWN, Airborne Instruments Lab., Deer Park, New York

IMPROVED performance and reliability of magnetostrictive delay lines have resulted in their increasing military and commercial use in missiles, aircraft navigation, radar, sonar, data processing and automation. This trend has been particularly evident in the small digital computer where the advantages of this type of pulse storage—economy, temperature stability, high

operating speed and expandable capacity—have enabled magnetostrictive delay lines to displace magnetic drums and cores.

This article will present information on performance and design features of some commercially available longitudinal and torsional magnetostrictive delay lines.

The early development work on magnetostrictive delay lines was concerned solely with the straight longitudinal line shown in Fig. 1A. To avoid pulse dispersion, thin-wall tubing, thin tapes and fine wires were used as the media of propagation. Multiple tapes and bundles of fine wires were used to achieve high magnetic efficiency in wide-band transducer operation.

The limiting factor, which controls the resolution of such a line, is the effective length of magnetic field under the transducer coils.¹ To obtain maximum delay-line resolution, this field should be short with minimum flux fringing at the ends. Although the coils can be fitted into ferrite cups, which theoretically sharply define the edges of the field, too much fringing is still present in the practical application.

The maximum pulse repetition frequency of presently available straight longitudinal lines is shown in Fig. 1B as a function of time delay. Lines less than 50 μ sec long can be made to operate at a prf as high as 5 Mc.² Since the digital bit rate can be made twice the prf by using non-return-to-zero techniques,³ a digital bit rate of 10 Mc is possible for such a line. As the delay time is increased above 50 μ sec, the maximum prf decreases because of dispersion, becoming 1 Mc at 250 μ sec. However, a 250- μ sec line will have an overall length of four feet. If this line is coiled to save space, the dispersive effects are accentuated, with a consequent decrease in the maximum prf.

The delay-line manufacturer prefers to supply straight longitudinal lines up to a 100- μ sec delay. Beyond this point, coiled delay lines which operate in a nondispersive torsional mode are available. Torsional lines are used to a much greater extent. The one great advantage of the longitudinal line is that it is much easier to build efficient magnetostrictive transducers

for longitudinal rather than for torsional operation. However, with a longitudinal-to-torsional mode converter⁴, shown in Fig. 1C, it is possible to obtain the advantages of longitudinal transducer operation with torsional propagation. This converter operates as a bilateral device for either pulse generation or detection. During pulse generation, the two tapes are excited in a push-pull longitudinal mode by an applied current pulse to the coils. As the tapes move, they rotate the wire to which the tapes are welded. To avoid mechanical reflections at the welded joint, the cross-sectional area of the wire must have a definite relationship to that of the tapes.

An assembly drawing of a commercial torsional line is shown in Fig. 2. A desirable convenience of this line is that each transducer assembly can be moved by a lead screw to adjust time delay.

The performance to be expected of this type of torsional line is shown in Fig. 3A by two curves of prf versus time delay. Curve A, which is pertinent up to a 1,000 μ sec delay, shows that lines less than 200 μ sec long can operate at a maximum prf of 1.5 Mc. This value drops to 1.25 Mc at a millisecond. Curve B illustrates performance from 1 to 10 milliseconds of delay. At 3 milliseconds, the maximum prf is 1 Mc. The prf drops to 600 Kc at 5 milliseconds, and 400 Kc at 10 milliseconds.

The factor which limits the prf of the shorter lines is the pulse widening or stretching effect of the mode converter. The factors controlling the performance of the longer lines are the small amount of dispersion present even in a torsional mode, and the resistive losses introduced both by the wire

supports and the finite mechanical Q of the wire.

The push-pull transducer technique using thin magnetostrictive tapes, which is a necessary feature of the mode converter in the torsional line, has been applied to the straight longitudinal line to obtain larger output signals than can be realized in single-ended transducer operation. The maximum prf of the push-pull longitudinal line is about 2 Mc, high enough for most applications. Therefore, some degree of standardization is possible in the manufacture of both types of lines.

The advantages resulting from standardization in transducer design, specifications for magnetostrictive tapes, and methods of acoustic termination are reduced cost of manufacture, improved performance, and increased reliability.

A typical transducer assembly is shown in Fig. 1D. The material of the transducer housing and the coil bobbins is a machinable dielectric, unaffected by high temperature. The length of the undercut section of the bobbin containing the coil, which varies with the rated prf, is usually specified in standard sizes of 25, 50, 75 or 100 mils.

To avoid the effects of flux fringing at the ends of the coil, the mean coil diameter should be as small as possible. Accordingly, the bobbin hole diameter need only be large enough to pass the specified tape width. In practice, the hole size may vary from 20 to 30 mils. To insure tight magnetic coupling between the coil and the tape, the bobbin thickness next to the coil is held to 5 mils. With the same end in view, the coils are wound with No. 50 AWG wire to keep the coil height to a minimum. The wire should have a polyurethane coating that is easy to strip.

For the torsional and the short longitudinal lines, two types of tape materials are commonly used. One type is Grade-A Nickel, which is 99-percent pure. The other type is an alloy of nickel with small amounts of manganese and silicon, known as R-63 alloy, which is usually specified for delay lines in which large variations in output amplitude with temperature cannot be tolerated. Since the temperature coefficient of delay of

PRACTICAL WINDING DATA

Delay (in μ sec)	Diameter (in inches)		Flat Spi- ral	Vertical Helix
	Mean	Inner		
Below 500	5	4	x	
500-1,000	6	5	x	
1,000-2,000	8	6	x	
2,000-3,000	10	8	x	x
Above 3,000	10	—		x

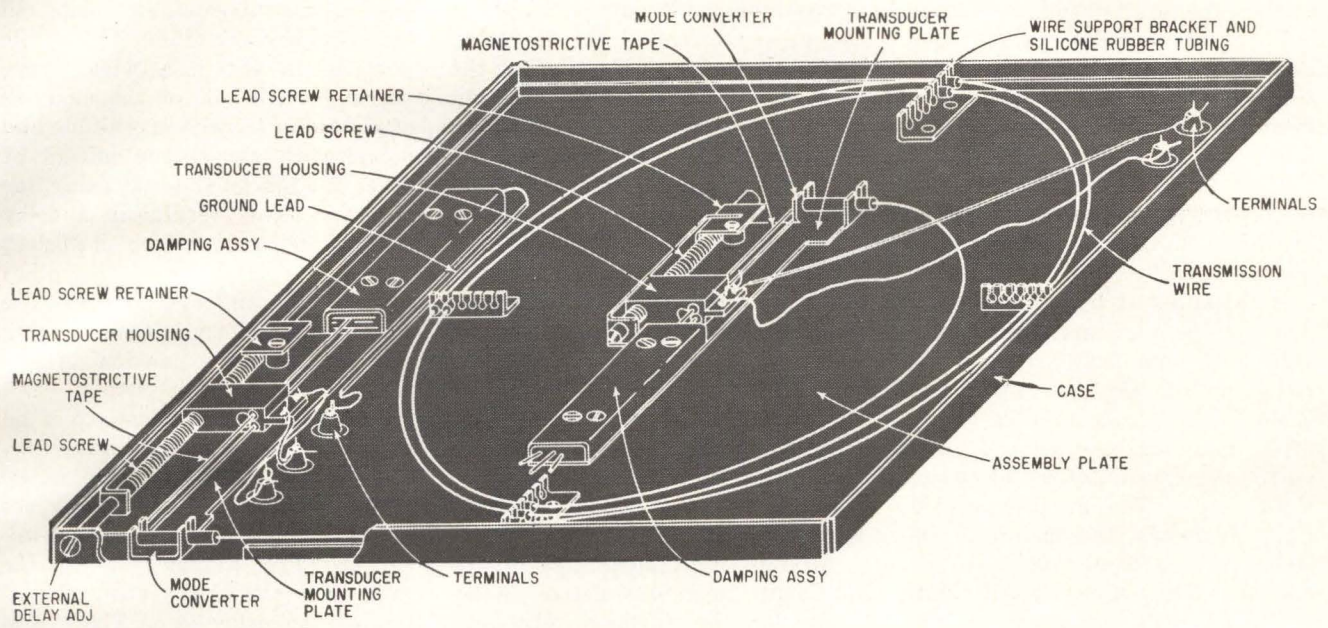

FIG. 2—Typical commercially available torsional delay line. Each transducer can be moved with a lead screw to adjust time delay

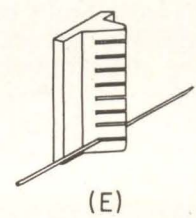
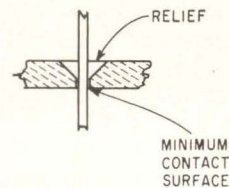
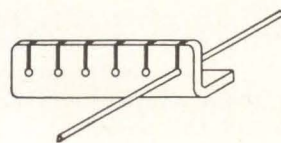
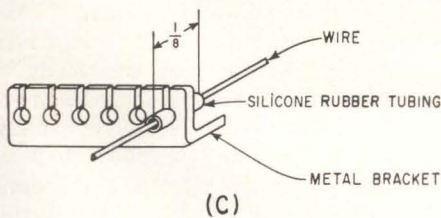
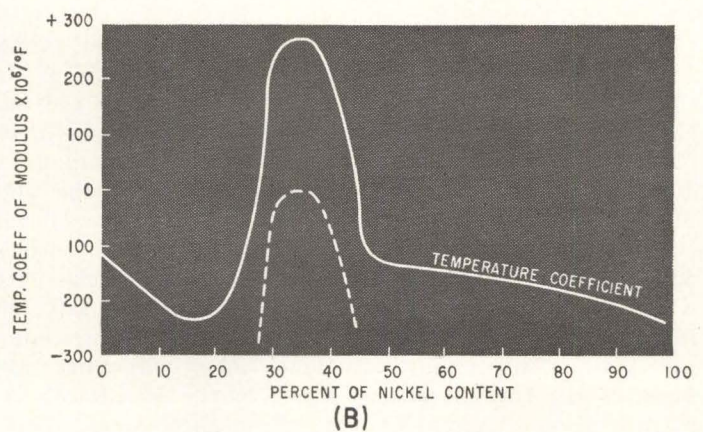
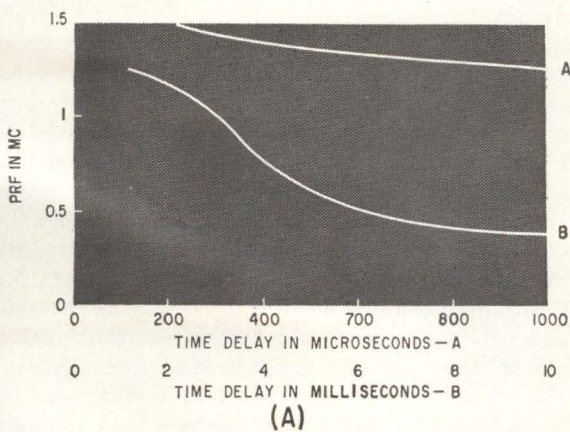

FIG. 3—Pulse repetition frequency against time delay in the torsional mode (A), temperature coefficient of the modulus of elasticity (B), simple wire support (C), general-purpose polyethylene support (D) and molded rubber support (E)

these two materials is 160 ppm/degree C, they cannot be used for the longer longitudinal lines. Tapes of a constant-modulus alloy, such as Ni-Span C, can be substituted at the expense of output amplitude.

Tapes are usually ordered from the supplier in a half-hard conditions as a compromise between high mechanical Q and ease of handling. However, to achieve the highest possible magnetostrictive coefficient, the tape sections underneath the transducer coils are flame annealed.

A thickness of two mils is specified for the tape material to provide good frequency response by reduction of eddy current losses. Instead of a single tape, 2, 3 or 4 tapes may be welded to form a single set with a desired cross-sectional area. The use of multiple tapes increases the magnetic efficiency in wideband transducer operation. The choice of tape width is a compromise between the high prf obtained with narrow tapes and the high output obtained with wide tapes. The actual tape widths in a practical delay line may vary between 10 and 20 mils. The most common width for a prf of 1 Mc is 15 mils.

An important design problem in magnetostrictive delay lines is that of obtaining minimum reflections from the tape ends. Reflection coefficients better than 20 to 1 can be realized in production without undue care. A practical technique for damping the ends of the tapes is illustrated in Fig. 4.

A rectangular piece of $\frac{1}{8}$ -in. silicone rubber, $1\frac{1}{2}$ -in. long and $\frac{3}{4}$ -in. wide, is placed down on the damping area on the transducer mounting plate. Then, the individual tapes of the bottom set are separated to form a narrow V. A piece of two-mil Teflon ribbon, $\frac{3}{4}$ -in. long and $\frac{1}{2}$ -in. wide, is folded lengthwise over the tapes, at an angle to avoid the possibility of coherent reflections. The Teflon-enclosed tapes are then placed over the bottom piece of silicone rubber. Another piece of rubber is placed over the tapes to form a sandwich. The same procedure is repeated for the top set of tapes. The entire assembly is then clamped by a top metal plate.

The Teflon provides a hard termination that absorbs almost all

the transmitted acoustic energy. The rubber acts as a soft termination in combination with the Teflon to provide a tapered mechanical resistance. Since mechanical energy is contained uniformly throughout the cross-section of the material, and damping occurs only at the periphery, the use of tapes (having a low ratio of cross-sectional area to periphery) results in more efficient damping of the mechanical signal than can be achieved by wires or tubes.

Besides the mode converter, there are a number of major design features in commercial torsional lines which have no counterparts in longitudinal lines. These features are the characteristics of the wire material and its heat treatment, the form and diameter to which the wire is wound, and the wire supports.

An important advantage of the torsional magnetostrictive delay lines over other forms of ultrasonic delay lines is their stability of delay with large variations in temperature. This stability is obtained by using wires composed of materials in which the modulus of elasticity is independent of temperature. These materials belong to a group of constant modulus alloys, which contain nickel and iron in the proper proportion. Figure 3B is a curve⁵ of the temperature coefficient of the modulus of elasticity for nickel-iron alloys of different percentages. This curve shows that the alloys containing 27- or 44-percent nickel have zero temperature coefficients of the modulus of elasticity. Since these percentages are critical, a small amount of chromium added to the alloy will shift the peak of the curve downwards as shown by the dashed curve. This addition provides a flat composition range of zero coefficient alloys, and is the basis of the constant modulus alloys known as Iso-elastic and Elinvar. In these alloys, the thermal coefficient of the modulus of elasticity is determined solely by chemical composition and may differ from one batch of material to another due to commercial variations in melting and alloying. This class of alloys is unsuitable for wire delay lines.

However, if a small amount of titanium is added to a nickel-iron

alloy of the proper proportion, the effective nickel content of the alloy can be controlled by heat treatment. During the heat treatment, nickel is precipitated out of the alloy as an intermetallic compound of nickel and titanium. Thus, it is possible to obtain a wire whose thermal coefficient of the modulus of elasticity has the magnitude and polarity to cancel the effects of other factors on thermal delay-line stability. This results in a delay line whose temperature coefficient of delay is nearly zero. The other factors affecting overall delay are the change in delay in the end tapes and the linear expansion of the wire.

Another advantageous effect on delay-line performance occurs during heat treatment. As the nickel precipitates, the alloy becomes hard, thus increasing its mechanical Q. The higher the Q, the greater is the bandwidth and output of the delay line. These precipitation-hardening constant modulus alloys are known as the nickel-iron-titanium alloys. If chromium is added to an alloy of this type to make the heat treatment less critical, the alloy known as Ni-Span C is obtained. However, chromium acts as a damping agent to lower the Q of the wire.

Heat treatment may be accomplished either in a furnace or by passing an electric current through the wire. The electrical process is superior from both an economic and an engineering point of view. Since the average delay-line manufacturer cannot afford the expense of operating his own furnace, he must send his wire to an outside facility for treatment, thus losing control over the operation. By contrast, an electrical facility can be installed in the manufacturer's own plant for less than \$2,000.

Another point to consider is that the wire must be naturally straight⁴ before heat treatment to obtain nondispersive delay-line performance. Since the wire usually arrives from the supplier on 9-in. diameter spools, straightening must be done mechanically if the wire is to be heat treated in a furnace. Where heat treatment is accomplished electrically, straightening can be achieved by stretching the wire in a straight line during heating. For normal electrical

heat treatment, the process may be carried out in air without damaging the surface or finish of the treated wire. A mild oxide coating, usually not detrimental to delay-line performance, will form on the wire.

The choice of wire diameter is a compromise between delay-line resolution and output. The finer the wire, the less will be the dispersion and the better the resolution. The larger the wire, the higher will be the output. Practical wire diameters in commercial delay lines may vary from 10 to 30 mils. The most common choice for a prf of 1 Mc is 20 mils.

Only Ni-Span C and nickel-iron-titanium wires are used commercially because of the usual requirements for extreme thermal stability. Its lower mechanical Q restricts the use of Ni-Span C to lines with a delay of less than 2 milliseconds at a prf of 1 Mc. On the other hand, lines using nickel-iron-titanium wires have been built with delays greater than 3 milliseconds at the same prf.

Where temperature stability is not required, the higher Q of commercial piano wire makes its use attractive as a standard against which to compare the performance of the other materials. The temperature coefficient of delay of piano wire is about 125 ppm/degree-C.

The form (flat spiral or vertical helix), and the diameter of the coiled wire are functions of the delay length and the prf. To obtain the high resolution and performance required in digital operation, the winding diameter should be large to avoid the problems associated with wire support reaction. If the wire is wound on too small a diameter, undesirable effects may occur because of the excessive forces exerted on the wire by the supports. These are: introduction of mechanical discontinuities causing reflections that will degrade the signal-to-noise ratio; increase of resistive mechanical loading that will attenuate the signal and reduce the bandwidth; and possible deformation of the wire beyond its elastic limit, forcing the natural radius of curvature of the wire to assume a finite value with introduction of dispersion.

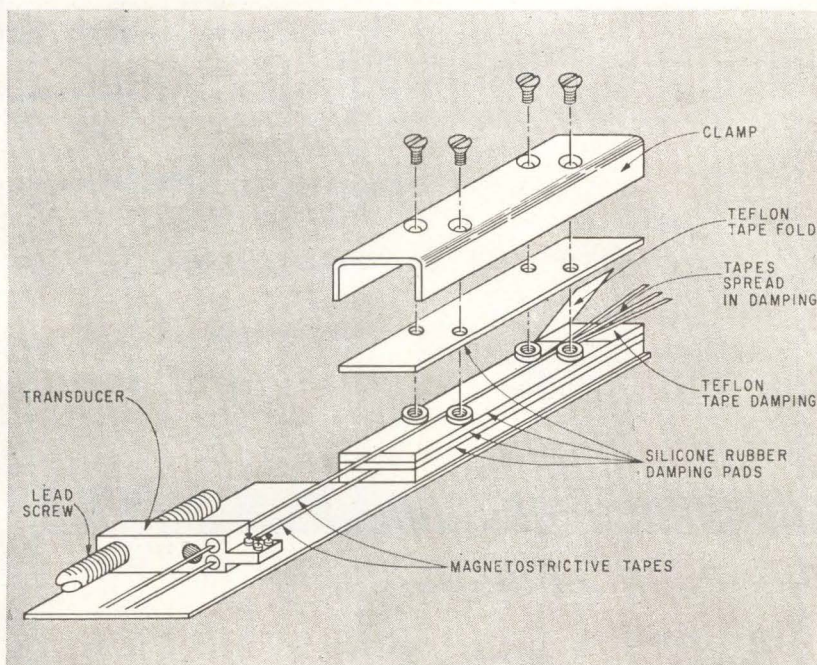

FIG. 4—Acoustic termination dampens ends of tapes

Practical minimum winding diameters and standard winding forms are listed in the table.

The wire supports should cause minimum absorption or reflection of the mechanical pulse at the point of support. The contact surface between the wire and the support should be a minimum. A knife-edge support is not used since the materials suitable for knife-edge support are hard enough to cause mechanical discontinuities. A rigid fixed support should not be used because the wire will tend to flex about the point of support under shock and vibration, thus generating undesirable noise.

A support of a soft material in which the wire is loosely retained has been found most suitable. A simple and effective support of this type is shown in Fig. 3C. The wire is threaded through a short length of silicone rubber tubing held in a slightly undersized hole in a metal bracket.

This support is suitable for extreme environmental conditions, and for the longer lines operating at the higher prf's.

For high-volume production of commercial lines where cost is a factor, a support molded from general-purpose polyethylene as shown in Fig. 3D, is satisfactory. The wire hole is recessed to minimize the contact surface between the

polyethylene and the wire. This support is not recommended for shock and vibration.

These two supports are suitable for windings that are either flat spirals or vertical helices.

Under conditions of volume production, high density packaging, and shock and vibration, the molded rubber support shown in Fig. 3E, can be specified. Because of difficulty in molding the wire slots, these supports may be used only with windings of a vertical helix.

Because of the rapid growth in the use of magnetostrictive delay lines, there has been insufficient time for industry to agree on standard definitions and measurement procedures for such delay line parameters as resolution, signal-to-noise ratio, input impedance, terminating impedance and attenuation figure.

REFERENCES

- (1) A. Rothbart and L. Rosenberg, A Theory of Pulse Transmission Along a Magnetostrictive Delay Line, *IRE Trans on Ultrasonics Engineering*, PGUE-6, p 32, Dec. 1957.
- (2) R. C. Williams, Theory of Magnetostrictive Delay Lines for Pulse and Continuous Wave Transmission, *IRE Trans on Ultrasonics Engineering*, PGUE-7, p 16, Feb. 1959.
- (3) A. Rothbart, A Non-Return to Zero (NRZ) Mode of Operation for a Magnetostrictive Delay Line, *Proc IRE (Correspondence)*, 48, p 1,486, Aug. 1960.
- (4) G. G. Scarrott and R. Naylor, Wire-Type Acoustic Delay Lines for Digital Storage, *Proc. IEE*, 103, B, suppl. 3, p 497, March 1956.
- (5) H. A. Wilson Co., Union, New Jersey.

Microminiature

Designing with micromodules permits compact packaging with close thermal coupling for precise frequency stability

By MORRIS LYSOBEY
Surface Communications Division,
Radio Corporation of America,
Camden, New Jersey

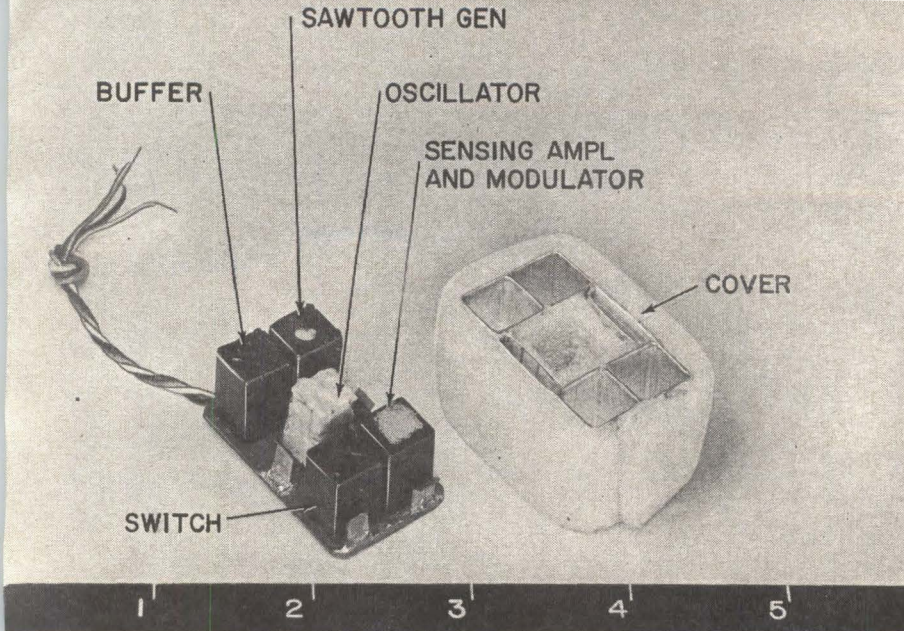

FIG. 1—In this laboratory model, the oscillator cavity is part of the heat-sink enclosure for the rest of the modules

MICROMODULE COMPONENTS are used in a quartz crystal oscillator for use in military single-sideband equipment, communications devices, missile tracking, telemetering and sound ranging equipment. The oscillator has low power drain (600 mw at room temperature), fast warm-up time, miniature size and weight and meets specified military requirements. Short and long-term stability is 1.8×10^{-7} per day. The five-module assembly including oscillator module cavity measures only $0.7 \times 0.85 \times 1.4$ inches. It can be made as small as 1.5 cu. in. including insulating foam and outer cover.

A laboratory model, Fig. 1, probably will not be the final physical form, but indicates what can be achieved in size and power consumption. The measured stability

of 1.8×10^{-7} per day with presently available micro-element crystals may be improved one and a half orders of magnitude by using microelement crystals now under development.

Because of the extreme compactness that can be accomplished with micromodules, the heater and temperature sensing elements were actually built into the module. This design approach insures close thermal coupling between the heat source and temperature controlled mass and would not have been possible using conventional components. Higher gain in the temperature control amplifier was possible and heater power requirement were reduced.

The operating temperature of the crystal is about 80 C and the maximum anticipated operating ambient

was 70 C; therefore the amount of controlled heater power was further reduced by heat sinking the power dissipating controller modules, thus effectively reducing the temperature differential between the temperature controlled oscillator module and the outside.

The controller circuit accepts readily available micromodular components. It uses, with one exception, 2N404 transistors throughout, has high gain and low output transistor dissipation as a result of improved rise and fall times of the switching pulse. Total power consumption measured at room temperature with no special thermal insulation is 600 mw.

The crystal, Fig. 2, is a 10-Mc fundamental mode unit in a micro-element form. Collector voltage of 2N706 is kept low and is stabilized by D_1 , a Zener diode. D_2 is a voltage sensitive capacitor used for fine frequency adjustments with a variable voltage divider, R_1 (Fig. 2). Output of the oscillator is decoupled from the following buffer-amplifier stages by a capacitive voltage divider.

Temperature is controlled using a pulse-width modulator. In this control the output transistor is switched between on and off states at a fixed repetition frequency. On-time within the cycle is varied depending on power demand. In the circuit, Fig. 3, Q_3 and Q_4 are an

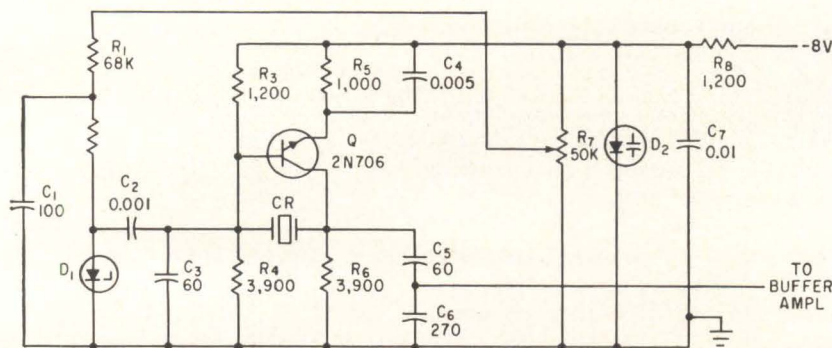

FIG. 2—Crystal used in this 10-Mc oscillator is a 10-Mc fundamental mode unit in wafer form

Crystal Oscillator Using Wafer Modules

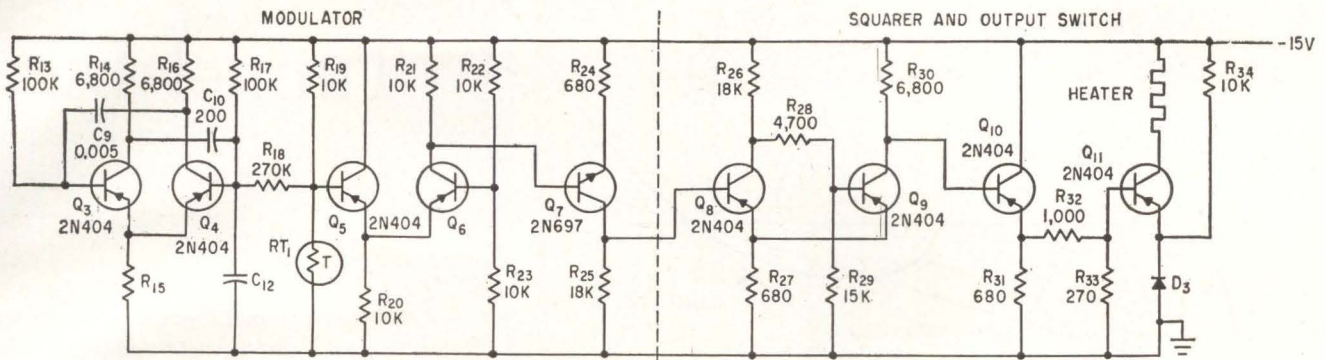

FIG. 3—Thermistor in the modulator, left, senses temperature variation and establishes conduction time of the temperature sensing amplifier Q_5 and Q_6 .

asymmetric, free-running multi-vibrator whose output is integrated by C_{12} ; Q_5 and Q_6 with a thermistor and resistors R_{10} , R_{22} and R_{23} produce a temperature-sensitive amplifier arrangement.

Following the modulator is an additional stage of amplification and a four-transistor switch. To improve the switching waveforms and reduce dissipation in the switch proper, Q_{11} is preceded by a squarer and emitter follower, Q_8 , Q_9 and Q_{10} respectively. Diode D_3 in the emitter circuit of Q_{11} holds it in cutoff until Q_{10} starts conducting. If a portion of the multivibrator output is applied to the base of Q_5 , the control loop functions as follows: depending on the preset heater temperature (as sensed by the thermistor placed in close proximity) the conduction time of the temperature sensing amplifier, (pick-off point on the slope of the sawtooth input and therefore the ON time of the output switch) will be established to keep error at a minimum.

In design, most consideration was given to thermal properties such as power consumption, warm-up time, ambient reduction capabilities of the temperature control and the frequency characteristics. Power is consumed by the heater to maintain the required oven temperature, and by the circuit elements. Heater power will change with changing ambient tempera-

ture. The power, however, used by circuit elements changes little.

Thermal warm-up is the time from the moment the unit is switched on to the point where the preset oven temperature is first approached. Outwardly it will manifest itself in a rapid decrease of the heater supply current.

Ambient reduction factor is a measure of temperature control quality with changing ambient temperature as: $A_R = S_R / Q_R$ where S_R is controller sensitivity measured in watts of heater power change per ohm of sensing resistor change (translated into equivalent ambient temperature change), and Q_R is oven quality factor measured as heater power increment per degree C over temperature rise. The calculated value holds only for the condition that both S_R and Q_R re-

main constant within the interval of interest.

Reversible and irreversible frequency changes take place in operation. The former are mainly due to operational and environmental conditions; the latter are caused by internal crystal parameter changes. Frequency changes with changing supply voltage and changing ambient can be considered reversible; frequency reverts back after removal of the cause of the shift. Long-term frequency drift is caused by internal changes of the resonator and is irreversible. Results of checks of frequency drift and the effect of voltage variation are shown in Fig. 4.

To detect frequency changes of the order of parts in 10^8 , a secondary frequency standard is required. A 100-Kc signal with certified stability of 10^{10} parts per day was used in all frequency measurements.

In the packaging of the oscillator, care was necessary in the arrangement and thermal layout of the temperature-sensitive frequency-determining elements. Because of the low power, the problem of heat leaks and thermal gradients becomes prominent. This is alleviated by close thermal coupling of the heat source and heated elements (using heavy thermal shunts wherever possible) and minimization of lead and other direct losses.

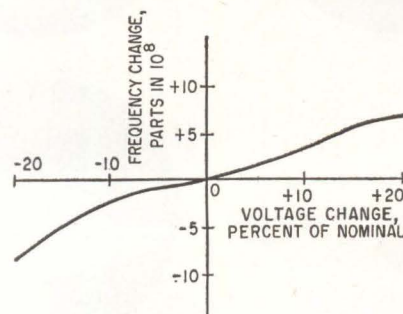

FIG. 4—Variation of oscillator frequency with changing supply voltage is a reversible characteristic

Tunnel-Diode

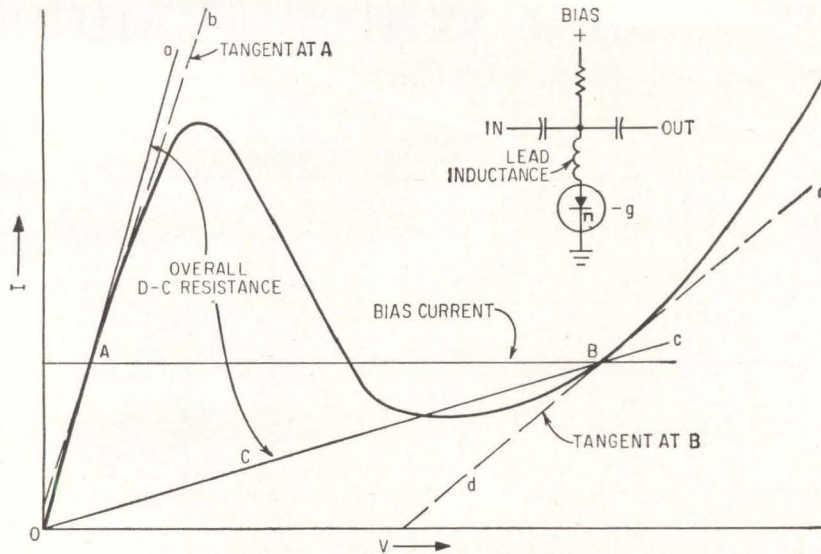

FIG. 1—Conventional tunnel diode circuit (inset) with output taken as a voltage pulse and a typical curve

Application of tunnel-diode switching between stable states to signal gating and data storage may produce computers with clock rates in excess of 500 Mc

By **FREDERICK W. KANTOR,**
Integrated Research and
Technology, Inc., New York, N. Y.

A BIASED tunnel diode can be forced to switch between two stable states corresponding to two different voltages (Fig. 1.) Presently it is necessary to load the tunnel diode with some form of output indicator to determine the state of the diode; this load generally increases the switching time.

As shown in Fig. 1, the tunnel diode is biased to the current represented by line AB and switches between states A and B. The d-c resistances of these two states are represented by lines a and c drawn to them from the origin. Small-signal a-c impedances are represented by the tangents to the curve at points A and B respectively. Characteristics of these a-c impedances corresponding to A and B show that the a-c impedance is not necessarily the same as the d-c resistance and that the small-signal

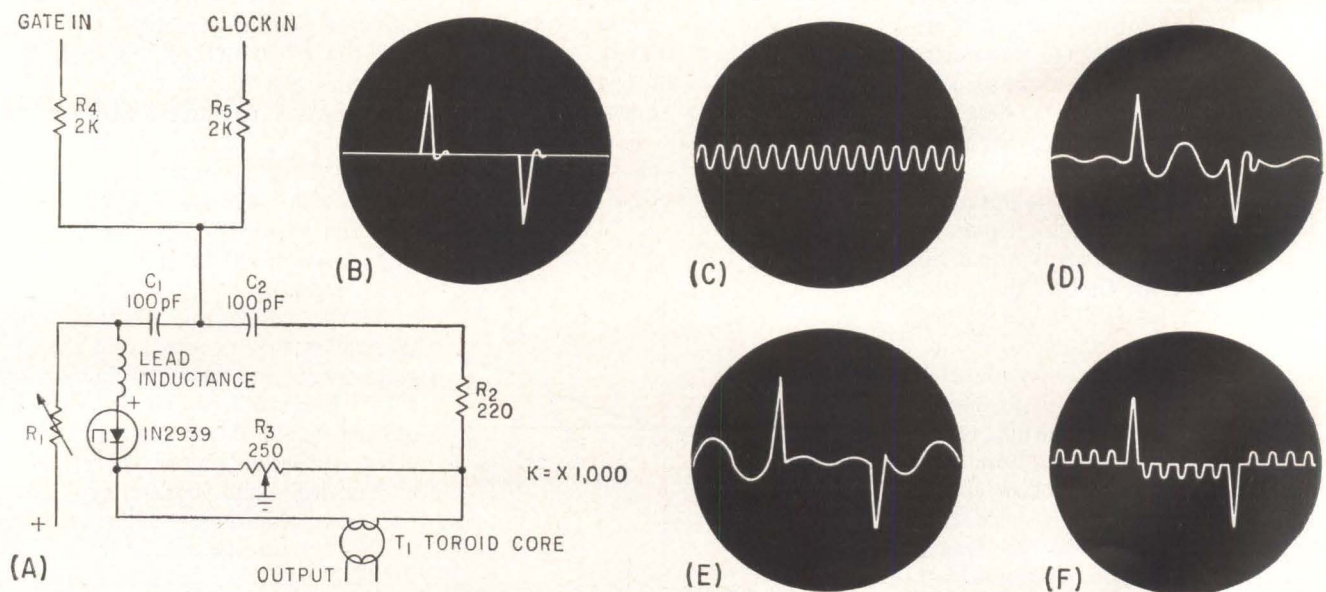

FIG. 2—Bridge test circuit (A) with double pulse gate (B), 300 Mc clock (C), output with R_3 balanced for low-impedance state (D), output with R_2 balanced for high-impedance state (E) and pulse inversion with pulse signals replacing sine-wave clock (F).

Gate Has Subnanosecond Rise Time

impedance of state *B* can be made as high as desired (the tangent to the curve can be made as close to horizontal as necessary) by choice of bias current. The ratio of the small-signal impedances can be large and the state determined by observing these impedances.

The first test circuit was the a-c bridge shown in Fig. 2 using a tunnel diode as one arm. Potentiometer R_1 provides bias for the diode, which is d-c blocked from the inputs by C_1 . Capacitor C_2 was added to preserve the symmetry of the bridge, with R_2 completing the symmetrical arm. Potentiometer R_3 is a carbon-film unit for balance adjustment while R_4 and R_5 were added to separate the two signal sources. Transformer T_1 was 1:1 wound on a ferrite toroid and was added to permit one side of the output to be grounded for observation on an oscilloscope.

The bias was adjusted so that a current slightly above the valley-point current passed through the tunnel diode. With this bias, a small-signal impedance ratio of about five to one was obtained. Some difficulty was encountered

with instability when the ratio was made higher, but for test 5:1 sufficed. The rest of the circuits were also adjusted to an impedance ratio of about 5:1 between states. A 0.1-v peak-to-peak 300-Mc clock signal was fed in and the bridge was balanced with R_2 . A double pulser was used to produce first a positive and then a negative gating pulse, which were shortened with shorted cable. Pulses of approximately 2-v amplitude and about 1-nanosecond long were used for gating or changing the state of the tunnel diode. How much of this voltage appeared across the tunnel diode is not known because stray capacitance may have produced additional coupling. Both test circuits were breadboards. The test traces obtained with R_3 set for balance in the low-impedance state of the tunnel diode are shown in Fig. 2. Figure 2B is the pair of gating pulses as seen from the output, Fig. 2C is the clock signal which was gated and Fig. 2D is the output of the gate circuit. Potentiometer R_3 was then set for balance in the high-impedance state and the output in Fig. 2E was obtained.

The circuit was then operated with R_3 adjusted to a point between the balance positions for the two states. Thus, a change in state of the tunnel diode produced an inverted output. The sine-wave clock unit was replaced with a pulse input; Fig. 2F shows the output. Inversion is obtained because with the tunnel diode in one state the bridge is unbalanced one way, and with the tunnel diode in the other state the bridge is unbalanced towards the other arm.

A second test circuit, shown in Fig. 3, was built to use the change in impedance directly without a

bridge. Resistor R_1 provides the bias, R_2 is used to separate the sources and C_1 provides d-c blocking. The gate and clock, measured

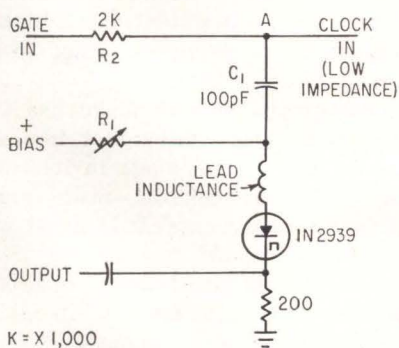
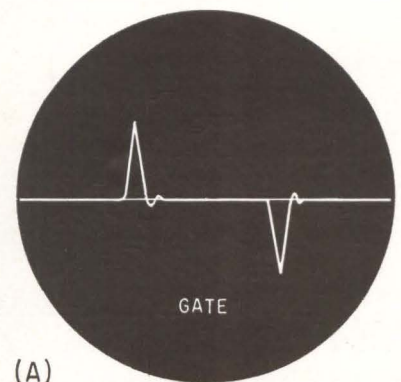
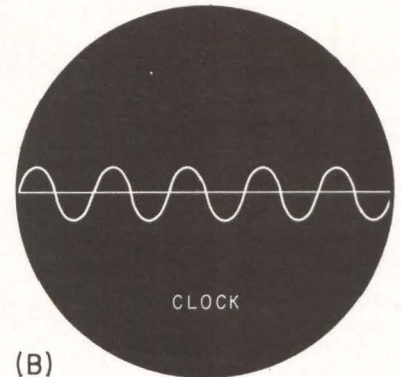

FIG. 3—Using the impedance of a tunnel diode as part of a voltage divider



(A)



(B)

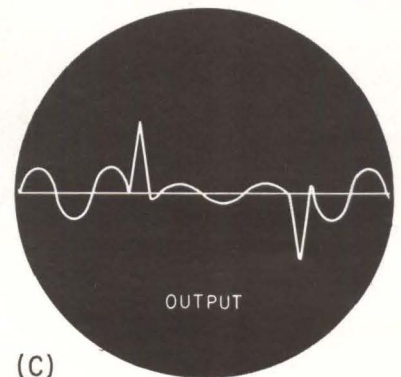

(C)

FIG. 4—Gate (A) and clock (B) measured at A of Fig. 3. Output is shown at (C)

at A, and the output, are shown in Fig. 4. The gating voltage at A was about 1 v, and the clock voltage was 0.1 v peak-to-peak. With the bias adjusted, the ratio between the output with the tunnel diode in the low-impedance state to the output with the tunnel diode in the high-impedance state was better than 3:1.

Several refinements on the orig-

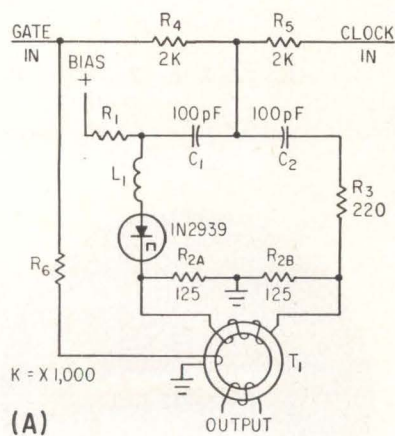

(A)

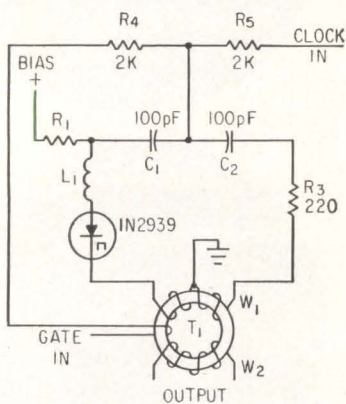

(B)

FIG. 5—First modification of bridge to cancel output spike (A) and second modification (B). Lead inductance L_1 is important in switching time

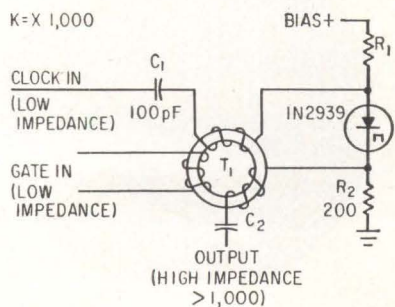

FIG. 6—Modification of voltage divider configuration to reduce gate spike in output

inal bridge circuit were tried. The principal difficulty with the bridge circuit was that the gating pulse appeared in the output. This was corrected in two ways by the circuits shown in Fig. 5. In Fig. 5A, a portion of the gate signal is fed to a wire threading the output toroid so that the output spike is cancelled. Resistors R_{2A} and R_{2B} replace potentiometer R_3 of Fig. 2. Because the impedance of the tunnel diode can be varied by varying bias current, the bridge can be balanced by selection of R_1 , as well as by selection of R_3 . In Fig. 5B, R_3 of Fig. 2 has been replaced by a tapped winding on the toroid and R_6 of Fig. 5A has been eliminated by threading the gate input through the output toroid. Winding W_1 and W_2 were kept in a 1:1 ratio, and the number of turns on both was adjusted so that the flux produced by the spike after it had passed through the circuit was cancelled by the flux produced by the gate input threading the core. Thus, the output did not have a spike. Balance was obtained by adjusting R_3 and bias was adjusted for stable switching.

The bridge circuit can be used as a gate when it is balanced in one of the two states. A piece of cable can be connected to the gate input, shorted at the far end and terminated at the near end, to act as a delay line and pulse inverter. This produces a precisely controlled gate. The state of the bridge can be used to control the polarity of output pulses. The output can be stepped up at the output toroid and directed by two diodes into two different outputs. Thus the state of the tunnel diode can be used to direct an input to either of two outputs, similar to a spdt switch.

This gate offers several advantages for work in nuclear instrumentation. The tunnel diode in the gate acts as a pulse height discriminator simplifying the circuit. The gate has a fast rise time. Although no satisfactory measurement of the rise time was obtained it is less than one nanosecond with the minimal triggering pulse and is smaller for larger pulses. Because of the discriminator action, the rise time is good for minimal drive pulses which is important in nuclear in-

strumentation where an accurate gate is required even when input pulses are sloppy. The device can be used for pulse direction, thereby replacing several discriminators and gates.

The circuit of Fig. 3 was modified to obtain the circuit of Fig. 6. Resistor R_1 provides bias which is d-c blocked from the input by C_1 . The clock input has a low impedance, so it is possible to use it in series with the secondary of toroid T_1 . A tertiary winding cancels the gating spike which would otherwise appear in the output. The output can be fed to a discriminator so that total blocking of the smaller signal is obtained. This gate acts as a discriminator for its gate control pulses and has a rise time faster than the bridge because the tunnel diode is not loaded at all during switching.

One application of this gate is as a memory with extremely fast readout. Since readout consists of measuring the impedance of the tunnel diode, readout speed is limited only by the rate of propagation of the signal along the wires leading to and from the tunnel diode. Because the readout is nondestructive there is no cycle time. The discriminating action of the tunnel diode should make it possible to use matrix arrays with an addressing system similar to that used for core read in.

Tunnel diodes operated in a chain for counting are usually switched from a low-impedance state to a high-impedance state. This means that to get to the next tunnel diode, a pulse has to travel through one or more high-impedance diodes. It may be possible to make considerably longer chains of tunnel diodes if they are started in a high-impedance state and switched to a low-impedance state.

All of the devices make use of the fact that small-signal impedances of a tunnel diode in its two stable states can be made significantly different. This mode of operation should be feasible for other negative-resistance devices, notably superconducting thin films separated by 50 angstroms or so of insulation. This mode of operation may make possible computers with clock rates in excess of 500 Mc.

Correlation Functions

Fast and accurate technique for computing autocorrelation functions of time-varying signals is based on general-purpose analog computer and storage tubes, provides a practical method of solving random-signal problems

By N. D. DIAMANTIDES

Goodyear Aircraft Corp.,
Akron, Ohio

CORRELATION FUNCTIONS are familiar to statisticians, who have been concerned for many years with measuring the dependence of one set of numbers upon another. Originally, the use of correlation functions was confined exclusively to real data. No attempts were made to go from the real, or time, domain into a frequency domain by transform relationships. Thus, while engineers were analyzing frequencies and power spectra with Fourier series and complex Fourier integrals, statisticians were noting properties of correlation functions. The two concepts, however, were not associated.

Under certain conditions, power spectral density functions and correlation functions are Fourier transforms of each other, except for a constant factor. The two concepts are significant in communications and automatic controls. Both communications and automatic controls operate on, or through, statistical signals that carry information and commands between a mechanistic system and its environment. Both must overcome other statistical signals that enter the system as undesirable but unavoidable disturbances.

The classical definition of the cross-correlation function between two signals, $f_1(t)$ and $f_2(t)$, that are functions of time, t , is

$$R(\tau) = T \xrightarrow{\text{lim}} \infty \frac{1}{2T} \int_{-T}^T f_1(t)f_2(t+\tau)dt \quad (1)$$

where τ is a displacement along the time axis and $2T$ is the length of time over which averaging of the product $f_1(t) \cdot f_2(t + \tau)$ is done.

When $f_1(t) = f_2(t) = f(t)$, Eq. 1 becomes the autocorrelation function of $f(t)$,

$$R(\tau) = T \xrightarrow{\text{lim}} \infty \frac{1}{2T} \int_{-T}^T f(t)f(t+\tau)dt \quad (2)$$

The correspondence between $R(\tau)$ and the power-spectral or cross-spectral density, $F(j\omega)$, is given by the Fourier pair

$$F(j\omega) = \int_{-\infty}^{\infty} R(\tau)e^{-j\omega\tau} d\tau \quad (3)$$

$$R(\tau) = \frac{1}{2\pi} \int_{-\infty}^{\infty} F(j\omega)e^{-j\omega\tau} d\omega \quad (4)$$

This quality is reflected in any analysis of dynamic systems in that they may be studied in either the time domain or frequency domain. The frequency domain procedure is

advantageous because of its long standing in the analysis of control loops, particularly of the linear type. Measurements in the frequency domain are easy to make when dealing with sinusoidal inputs, and the instrumentation is simple and available.

Special analyzers are needed, however, to deal with situations in which the signals are random rather than deterministic. Available analyzers, while they provide direct calculation of cross-spectra, have serious shortcomings. It is difficult to predict what an analyzer will do, because the result is affected by the transfer characteristic between the paired inputs as well as by the nature of the inputs themselves. When dealing with random processes, the first step—which seems to have been bypassed in the cases of most machines avail-

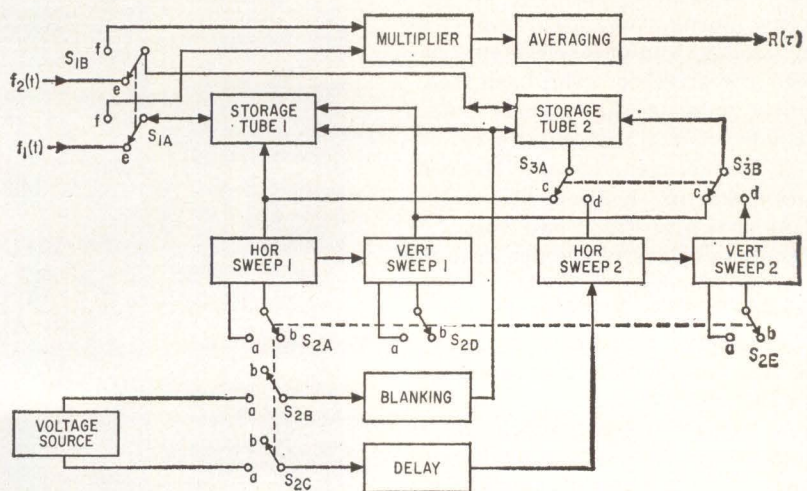

FIG. 1—Autocorrelator amplifiers are of the operational type that satisfy analog computer requirements

able—is to determine what the analyzer is doing. This means that it is necessary to classify the machine data with respect to input processes, to input processes transmitted through known linear networks, and to input processes through known nonlinear networks.¹

Classification of machine data with respect to input processes through nonlinear networks often is impossible since the equivalent nonlinear network of most systems under study usually is unknown. Hence, spectral data often may be obtained more conveniently and accurately, by correlation and Fourier transformation. The process of lagged multiplications and averaging need not be arduous and little time is required.

Any technique for the evaluation of correlation functions has to be founded on the definition given by Eq. 1 or its equivalent

$$R(\tau) = T \xrightarrow{\text{lim}} \infty \frac{1}{T} \int_0^T f_1(t) f_2(t+\tau) dt \quad (5)$$

This indicates that the measurement requires: (1) shifting the time axis to generate $f_2(t + \tau)$, (2) multiplying, and (3) averaging.

It is necessary to implement a reliable memory in which the functions $f_1(t)$ and $f_2(t)$ can be stored and read out for the formation of the lagged product in the integrand of Eq. 5. Steps must be taken to overcome the self-generation of process errors, which usually plagues conventional correlator storage mechanism, and to avoid the lengthy computation time associated with existing machine designs. A memory unit with an electronic storage tube used as part of an analog computer system has been investigated. The basic feasibility premises for such a system include adequate amplitude resolution in the memory and compensation for any nonlinearities.

As shown in Fig. 1 and 2 the two signals to be correlated are brought into the memory unit as voltages varying in time. They are made to modulate the writing beams of the storage tubes while the beams scan the storage matrices. Memorization begins when switch S_1 is turned to position e , connecting the modulating voltages $f_1(t)$ and $f_2(t)$ to the control grids. This initiates the sweep generator and applies

the sweep to the deflection coils.

If a 3-inch storage tube and a raster-type scan are used, a stored, square-shaped image of an area $A = 2 \times 2$ inch can easily be accommodated. By assuming that the length of the signal is T seconds and that the highest frequency component of interest is N cps, the number of cells that should be stored distinctly over the area A can be obtained by application of the basic theorem of information theory (according to which the signal must be sampled at a rate equal to $2N$). The resolution required, then, is $2NT/A$ cells per square inch. Since the resolution of available storage tubes is 200 lines per linear inch or 200×200 cells per square inch,

$$\frac{2NT}{A} = 4 \times 10^4 \text{ cycles per sq. in.} \quad (6)$$

that is

$$NT = 8 \times 10^4 \text{ cycles} \quad (7)$$

Thus, a control system having a band pass of $N = 50$ cps may be tested for as long as $T = 1,600$ sec = 26.6 min.

Since the signal will be stored in $200\sqrt{A} = 400$ lines and since write-in will occur during the spot's travel in both directions

along the horizontal axis, a triangular sweep will be required

$$f = \left(\frac{400}{2}\right) \left(\frac{1}{T}\right) = \frac{200}{T} \text{ cps} \quad (8)$$

Therefore, $f = 0.125$ cps. Precise timing of the sweep is necessary to ensure accurate generation of the time offset, τ , that enters basic Eq. 5.

This may be accomplished by the circuits shown in Fig. 1. The basic element is a three-amplifier triangular-wave generator, the output voltage of which is a train of triangular pulses of repetition frequency

$$f = \frac{R_4}{4R_3} \text{ cps} \quad (9)$$

and of peak-to-peak amplitude

$$V = \frac{2R_2}{R_1} E \quad (10)$$

The train is initiated as soon as switch S_{2A} frees output integrator 3. Thus, to store signals $f_1(t)$ and $f_2(t)$, switch S_3 is kept in position e while switch S_1 is in position e . Starting switch S_{2A} , S_{2B} , S_{2C} is turned to position a , initiating the horizontal sweep for both storage tubes and timer integrator 9, which closes the relay that applies a blanking voltage to both beams at

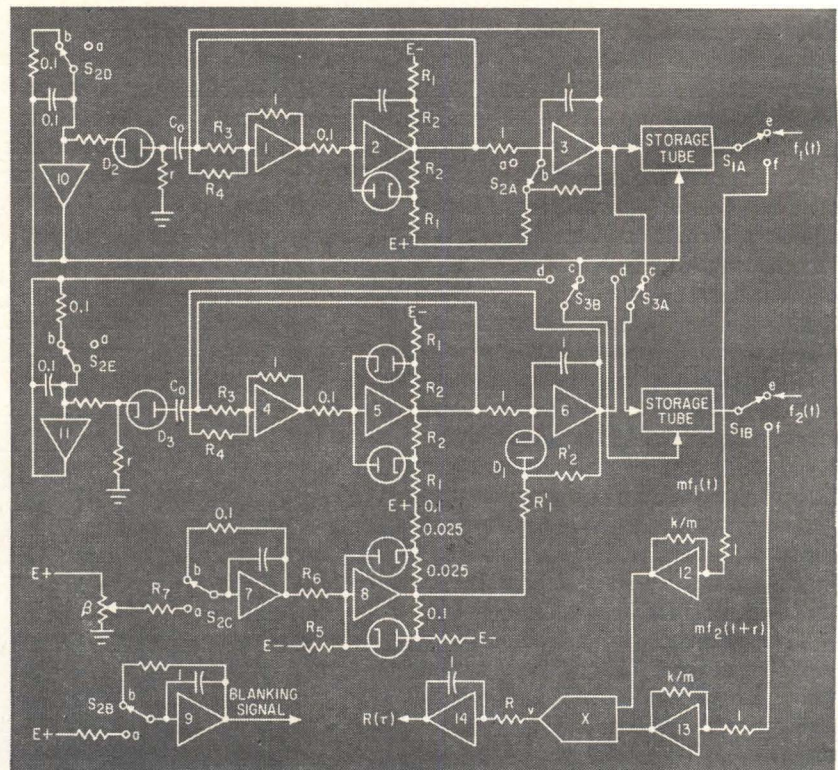

FIG. 2—Autocorrelator storage tube can be the Westinghouse WX-4293

the end of time T . Switch S_{2A} , S_{2B} , S_{2C} is then returned to position b . Throughout the interval T the signals $f_1(t)$ and $f_2(t)$ are being stored in the tube matrices.

To read the stored signals into the multiplier, switch S_1 is turned to the f position, which puts the storage tubes in the read-out mode. Switch S_3 is turned to the d position, which connects a second triangular wave generator to one of the tubes. At this stage, switch S_{2A} , S_{2B} , S_{2C} is turned to a to start horizontal sweep 1, as before, while sweep 2 is delayed by an interval τ . The delay of sweep 2 is accomplished as follows: the output of amplifier 8, because of the voltage $E+$ fed into it, is maintained at -50 v; this keeps diode D_1 in its conducting state and biases output integrator 6 to the voltage indicated in Eq. 10, or

$$V = 50 \frac{R'_2}{R'_1} \quad (11)$$

As S_{2C} frees integrator 7, the integrator output starts to increase linearly with time as

$$\frac{\beta E}{R_7 C} t$$

where β is the potentiometer setting.

The circuit is so adjusted that when $t = \tau$, the boundary condition

$$\frac{\beta E}{R_7 R_6 C} \tau = \frac{E}{R_5} \quad (12)$$

is met; at this instant, amplifier 8 flips to its second stable state of $+100$ -volt output. Thus, diode D_1 is cut off and sweep 2 is initiated after a delay τ , which from Eq. 12 is

$$\tau = \frac{R_6 C}{\beta R_5} R_7 \quad (13)$$

By varying β , the desired offset, τ , is obtained.

The successive values of τ and their range are dependent on the characteristics of the system that produces the signal for which the power spectrum is desired. If an appreciable amount of energy is generated by the system at a maximum frequency of N cps, the correlation computation process must be capable of specifying the system's performance at N cps. Since a periodic function can be completely determined by two measurements per cycle at the highest frequency, the spacing between the

successive values of τ should be at least

$$\tau_{i+1} - \tau_i = \frac{1}{2N} \text{ sec} \quad (14)$$

To maintain the fine detail in the power spectrum, however, it is necessary to use high values of the maximum delay, τ_m . The maximum resolvable detail, ΔN , in the power spectrum is related to the maximum time lag, τ_m , of the correlation by

$$\Delta N = \frac{1}{2\tau_m} \quad (15)$$

This relationship can be grasped readily by recalling that when measuring the difference between two single-frequency oscillators, it is necessary to wait longer periods as the frequencies become closer together because the periods of the beats become longer as the two frequencies approach one another.

Once τ_m has been decided upon, the interval of integration T should, as a general rule, be

$$T > 15\tau_m \quad (16)$$

If T is too small, the autocorrelation function usually does not converge smoothly to its asymptote.

The same triangular wave generators that produce the horizontal sweeps are made to generate the vertical sweeps. Advantage can be taken of the fact that the outputs of amplifiers 2 and 5 are square waves of constant amplitude. A differentiating circuit, *rc*, following each amplifier will produce a pulse of constant strength every time the corresponding square wave switches polarity. Through a polarity-discriminating diode, D_2 or D_3 , pulses corresponding only to the end of each horizontal sweep step up, by a preassigned quantum, the outputs of integrators 10 and 11, which feed the vertical deflection coils.

In this way precisely timed horizontal and vertical sweeps are generated. If m is the associated attenuation factor, the signals $mf_1(t)$ and $mf_2(t + \tau)$, as read out of the storage tubes, are amplified in amplifiers 12 and 13 (having gains k/m) and are sent to the multiplier. The outputs of the multiplier then will be

$$v = \frac{k^2}{k_0} f_1(t)f_2(t + \tau) \quad (17)$$

where k_0 is its gain factor.

After integration, the desired correlation function point (that which corresponds to the selected delay τ) is obtained as the output $P(\tau)$ of end integrator 14

$$P(\tau) = \frac{k^2}{k_0 R} \int_0^T f_1(t)f_2(t + \tau) dt \quad (18)$$

Hence, from Eq. 5 and 18

$$R(\tau) = \frac{k_0 R}{k^2 T} P(\tau) \quad (19)$$

Repetition of the procedure for the successive values τ_i of τ , as required by Eq. 14 and 15, will yield $R(\tau)$ with the desired accuracy.

The read-out time of the functions $f_1(t)$ and $f_2(t)$ may be made much shorter than the original signal length T . This may be implemented by reducing all capacitor values of the circuit by the same factor, say n , during read out; this will automatically speed up the computation of each point $R(\tau_i)$ by the same factor. The limiting element for such a speed-up will be the frequency response of the multiplier, since the bandwidth of the signals $f_1(t)$ and $f_2(t)$ is also augmented by a factor n .

A correlator of adequate accuracy and speed may be built around general-purpose analog computer equipment provided that a storage tube of sufficient grey-level resolution is available. Preliminary estimates indicate that the computation time of the correlation function will be about 0.5 min per correlation point and may be reduced further if a dynamic storage analog computer is used, thus allowing on-line operation.

The described technique features convenience and speed surpassing other methods that use storage equipment involving mechanical motion; it is immune to the shortcomings of conventional spectrum analyzers in that it does not require any classification of the machine in regard to the effect of the tested system on its input signals. Thus, the only critical factor to be considered with this approach is the amplitude resolution of the storage tubes. Electronic type storage tubes presently available are capable of resolving about one hundred levels.

REFERENCE

- (1) L. J. Seltzer, D. T. McRuer, Survey of Analog Cross-Spectral Analyzers, Technical Report 59-241, Wright Air Development Center, Dayton, Ohio, 1959.

Transistor Amplifier With

Circuit uses both positive and negative feedback; these can be balanced to obtain desired input characteristics. Unit is suitable for mounting in microphone case

By J. J. TIEMANN
General Electric Research
Laboratory, Schenectady, N. Y.

A SMALL, SELF-CONTAINED amplifier with a high input impedance and low output impedance can be useful when used with a high-impedance microphone. Whenever stray pickup or other interference is a problem, such an amplifier can be placed in the microphone case to raise the power level of the signal above that of the interference.

The transistor amplifier here presented has an input impedance of over 1 megohm, a bandpass from 10 cps to 100 Kc and a power requirement of 1.3 ma at 9 volts.

A number of compromises must be faced in the design of a transistor amplifier. One of the most serious of these is thermal stability against noise figure. Thermal

stability can be obtained by increasing the bias current until it is large compared to the leakage currents at the highest operating temperature, but this sacrifices the noise figure and the operating economy of the circuit.

In this amplifier, thermal stability at low bias current was obtained by including a d-c amplifier to regulate the bias supplied to the amplifying transistors. In this way, bias currents of the same order as the leakage currents can be used while still maintaining large operating temperature range. A capacitive input coupling was anticipated, and the second amplifier stage is directly coupled to the first; this eliminates all transformers, and consequently a large bandwidth is obtained. For the amplifier to have good low frequency response, it must have a long input time

stant. To accomplish this without raising the input capacitance above that of a piezoelectric microphone (about 0.01 mfd) the input impedance must be high. This was accomplished by combined use of positive and negative feedback. The negative feedback is applied to the emitter of the first transistor so that the emitter-base junction impedance is raised. The positive feedback is applied to the base. The positive feedback is equivalent to connecting a negative conductance across the base of the input transistor, and by adjustment a value can be found that nearly cancels the positive conductances. This cancellation must be independent of temperature if the amplifier is to have an input impedance that is independent of temperature. The use of thermistors would upset the balance between negative and positive conductance.

Ignoring the positive feedback path and concentrating on the negative feedback loop, the diagram can be simplified to Fig. 1B. Bias resistances and the load resistance have been ignored since their effect is equivalent to a decrease in the current gain of the transistors.

If a voltage is applied to the base of the first transistor, a current

$$i = \frac{V - V_e}{R_{be}} \quad (1)$$

will flow across the emitter junction. When R_{be} is the slope of the V-I characteristic of the emitter-base diode at the operating point, V is the applied voltage and V_e is the corresponding voltage at the emitter terminal. This current is multiplied by $\beta_1\beta_2$ by the cascaded transistors and, with the current flowing in the first transistor, pro-

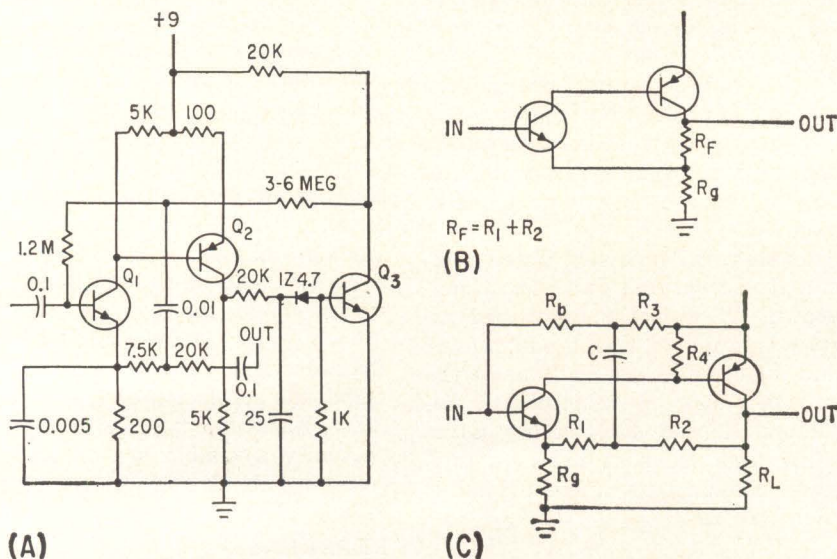

FIG. 1—Schematic diagram of amplifier, (A). The parameters given are chosen for the following transistors: Q_1, Q_2 —2N1086A; Q_3 —2N414. Feedback loops are illustrated in (B) and (C)

Adjustable Impedance and Gain

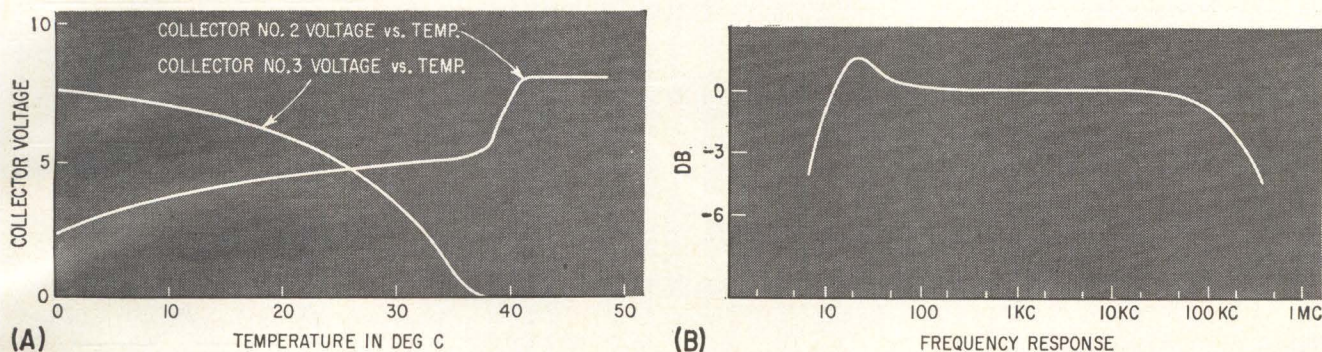

FIG. 2—Variation of output transistor voltage and the compensating transistor voltage against temperature, (A); frequency response characteristic of the amplifier, (B)

duces an IR drop across R_g of

$$V_e = ([1 + \beta_1] + \beta_1\beta_2)iR_g \quad (2)$$

if both $\beta_1 \gg 1$ and $\beta_2 \gg 1$, neglect the contribution of the first transistor and combine Eq. 1 and 2

$$V_e = \beta_1\beta_2 \left(\frac{V - V_e}{R_{be}} \right) R_g \quad (3)$$

Solving for V_e ,

$$V_e \left(1 + \frac{\beta_1\beta_2 R_g}{R_{be}} \right) = \beta_1\beta_2 \frac{R_g}{R_{be}} V$$

or

$$V_e = \frac{\alpha'}{1 + \alpha'} V \quad (4)$$

where

$$\alpha' = \frac{\beta_1\beta_2 R_g}{R_{be}}$$

is the voltage feedback ratio.

When $\alpha' \gg 1$, $V_e \approx V$, and the output voltage gain is

$$A = \frac{R_F + R_g}{R_g} \quad (5)$$

which can be varied by varying R_F/R_g . The input impedance is

$$Z_i \equiv \frac{V}{i} = \beta_1\beta_2 R_g \quad (6)$$

and if $\beta_1\beta_2 \gg 1$ it can be large.

Return now to the complete circuit and consider the positive feedback.

The overall current gain from

the base of T_1 to the collector of T_2 is

$$K = \frac{R_{cb}}{R_{cb} + Z_1} \times \beta_1 \times \frac{R_4}{R_4 + Z_2} \quad (7)$$

where R_{cb} is the collector-base resistance of the first transistor and Z_1 and Z_2 are the base input impedances of T_1 and T_2 respectively. If R_3 is much larger than all other resistances, the loop gain for the positive feedback is then, assuming C is large

$$G_L \cong K \left(\frac{R_L}{R_1 + R_2 + R_g} \right) \frac{R_1}{R_b} \quad (8)$$

The input impedance will be infinite if $G_L = 1$. This reduces to

$$\frac{R_2}{R_1} = K \frac{R_L}{R_b} \text{ for the case } K \gg 1 \quad (9)$$

This condition is independent of R_g ; thus the gain can be varied without upsetting the input impedance by varying R_g .

The operation of the temperature compensating circuit is straightforward. The R-C combination filters out the audio frequency component, and any excess voltage over the breakdown voltage of the zener diode causes current to flow in Q_3 . This in turn causes the collector voltage to drop, and consequently less bias is delivered to Q_1 . This will decrease the current in Q_3 , and hence the operating point will return to the knee of the zener diode characteristic.

The amplifier in Fig. 1C can be

adjusted for a wide variety of operating conditions. The output impedance can be raised or lowered by raising or lowering R_L . The voltage gain can be varied by varying R_g or R_g and R_2 . For best results, the voltage gain should be kept below one half of the voltage gain with no feedback. The preferred value is around $\frac{1}{4}$ the open loop gain. Having determined R_L , R_2 and R_g , the bias resistor R_3 can be set by observing the voltage at the collector of Q_3 . This voltage should be 5 volts when the temperature of the amplifier is at the center of its operating range.

When this value has been set, the input impedance can be raised by inserting the positive-feedback resistor R_1 . This resistor must be chosen precisely; a simple method is to apply a square wave at the input and watch the droop on an oscilloscope as R_1 is gradually raised. At some point R_1 will become too large, and the amplifier will oscillate. Leave that value of resistance in the circuit and shunt it with another resistor. Gradually raise the value of the shunt until the adjustment is complete. This procedure is more accurate than picking a single resistor.

Figure 2 summarizes the performance of the amplifier by showing how the output voltage varies with temperature, and the flatness of the frequency response curve.

Low-Cost Pulse Generator

Neon tube and transistor relaxation oscillator can cover

0.05 to 7,000 cps with less than 1-ma current drain

By REGINALD D. RYAN,

School of Physiology, University of
New South Wales, Sidney, Australia

ONE of the simplest and cheapest negative-resistance devices is the common neon tube. A relaxation oscillator using the neon tube is shown in (A). One limitation is the 20-v difference between ignition and extinction voltages, which also may vary appreciably between various neons.

An advantage possessed by the neon tube compared with other and more expensive negative resistance devices such as the four-layer diode, is the low current (less than $5 \mu\text{a}$) prior to breakdown. This permits R_1 , Fig 1A, to have values as high as 10 megohms giving very-low-frequency operation with relatively small value charging capacitors.

An improved circuit is obtained by adding a transistor as shown in (B). Here, the neon tube operates as a low-current switch driving Q_1 to completely discharge capacitor C_1 through diode D_1 and current limiting resistor R_2 . Diode D_1 should be silicon to insure low leakage current during the charging period. Duration of the discharge pulse is determined by C_2 and R_3 and must be long enough to allow C_1 to be discharged. Diode D_2 is cut off during the discharge to prevent premature extinction of the neon tube but it clamps C_1 and C_2 in parallel during charge period. To a first approximation, period between pulses is $T \cong 0.6 R_1 (C_1 + C_2)$. Sawtooth amplitude is equal to ignition voltage and circuit sta-

bility is mainly determined by this voltage. A low impedance 100-v output pulse is available at Q_1 collector. The average supply current is a fraction of 1 ma.

The circuit can operate over the range of 0.05 to 7,000 cps with the lower limit being set by available low-leakage capacitors. A number of interdependent factors are involved in determination of maximum frequency. They are glow discharge maintaining current, deionization time, average neon current and transistor switching time. With an NT-2 and 2N398, the practical limit is approximately 7,000 cps. Since average neon current is about $20 \mu\text{a}$, an operating life in excess of 10,000 hours can be expected.

The circuit in (C) forms part of a stimulator for neurophysiology research. An increased sawtooth amplitude, greater than ignition voltage, is obtained by returning the neon tube to a lower voltage than the transistor emitter. The neon tube is then biased in the reverse direction at the start of the sawtooth. Collector breakdown is now the limiting parameter of sawtooth amplitude. Larger sawtooth excursion improves timing stability by decreasing percentage effects of variations in ignition voltage.

BIBLIOGRAPHY

- E. M. Boone, "Circuit Theory of Electron Devices," p 175, John Wiley, New York, 1953.
General Electric Miniature Lamp Dept., leaflet, Glow Lamps as Circuit Control Elements.

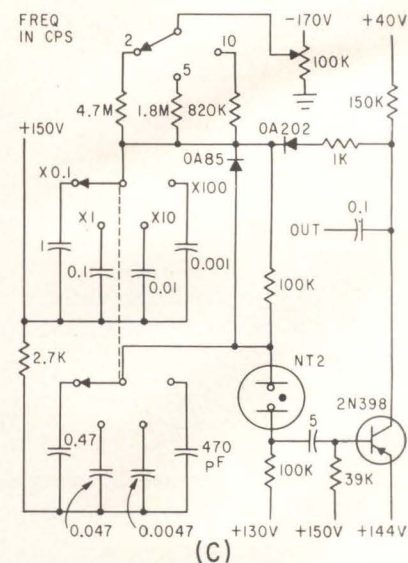
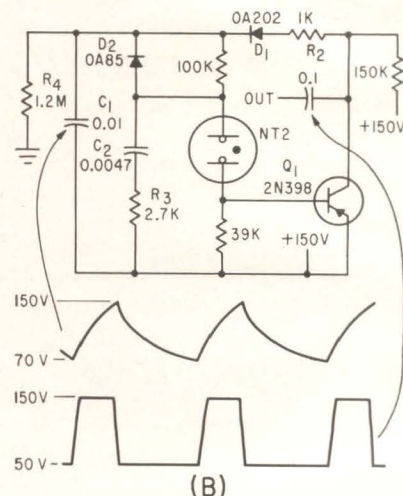
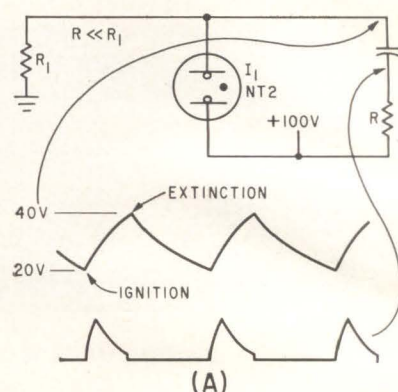

Simple neon tube relaxation oscillator with associated waveforms (A), transistor-neon tube 100-cps pulse generator (B) and a practical pulse generator covering the range from 0.2 to 2,500 cps as used in a neurophysiology stimulator (C)

814. High-Resolution Analog Recording from Frequency Counters

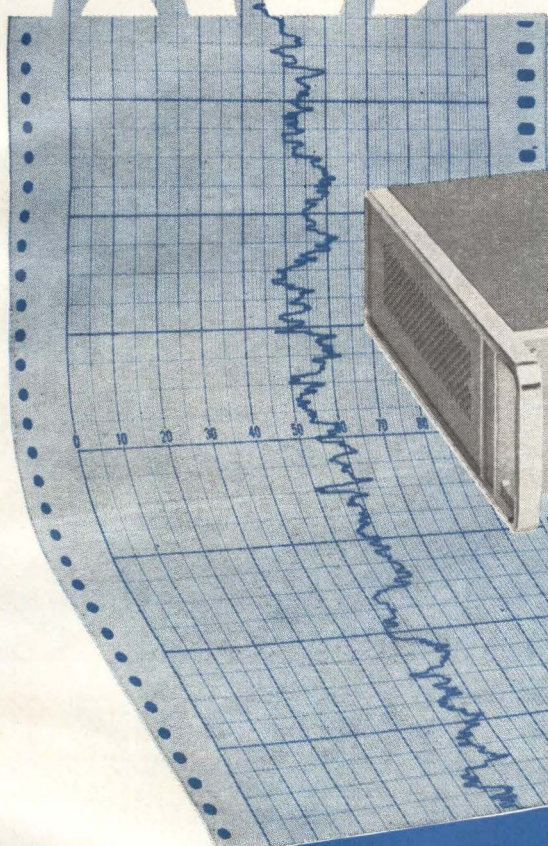

New **hp** 580A Solid State Digital/Analog Converter

With the new **hp** 580A Digital/Analog Converter you can get resolution to 1 part in 10^8 or better in making X-Y or strip chart recordings from the output of your electronic counter, digital voltmeter or other device providing the proper 4-line BCD output code.

The converter, for example, can be used with any of the new **hp** solid state counters, with **hp** and Dymec vacuum tube counters equipped with output kits, and with other vacuum tube and solid state instruments. It provides outputs for both potentiometer and galvanometer recorders, and includes controls for calibration of the recorders.

Any three successive digits (or the righthand two) may be chosen for analog output, and selection of the least significant digits produces analog records of extreme resolution and accuracy. For example, recording three righthand digits of nine-column data results in resolution of 1 part in 10^8 . Automatic zero-shift keeps the record "on-scale" at all times.

The solid state **hp** 580A accepts 4-line data, which is transferred to storage binary units within the converter on command from the counting source. The stored data is then translated and weighted to provide the proper analog output voltage or current.

SPECIFICATIONS

Accuracy:	0.5% of full scale
Potentiometer Output:	100 mv full scale
Galvanometer Output:	0 to 1 ma into 5,000 ohms or less
Driving Source:	Parallel entry 4-line BCD, 1-2-2-4 (9 digits max.) having a swing of 4 to 75 v about a source reference
Command Pulse:	Positive or negative pulse, 20 μ sec or greater in width, 6-40 v amplitude
Transfer Time:	2 msec
Size:	16 $\frac{3}{4}$ " wide, 3 $\frac{1}{2}$ " high, 11 $\frac{1}{2}$ " deep; 15 lbs.
Price:	\$525.00

Data subject to change without notice
Price f.o.b. factory.



HEWLETT-PACKARD COMPANY

1501 Page Mill Road, Palo Alto, California, U.S.A.
Cable "HEWPACK" Davenport 6-7000
Sales representatives in all principal areas

HEWLETT-PACKARD S. A.

Rue du Vieux Billard No. 1, Geneva, Switzerland
Cable "HEWPACKSA" Tel. No. (022) 26. 43. 36

7366

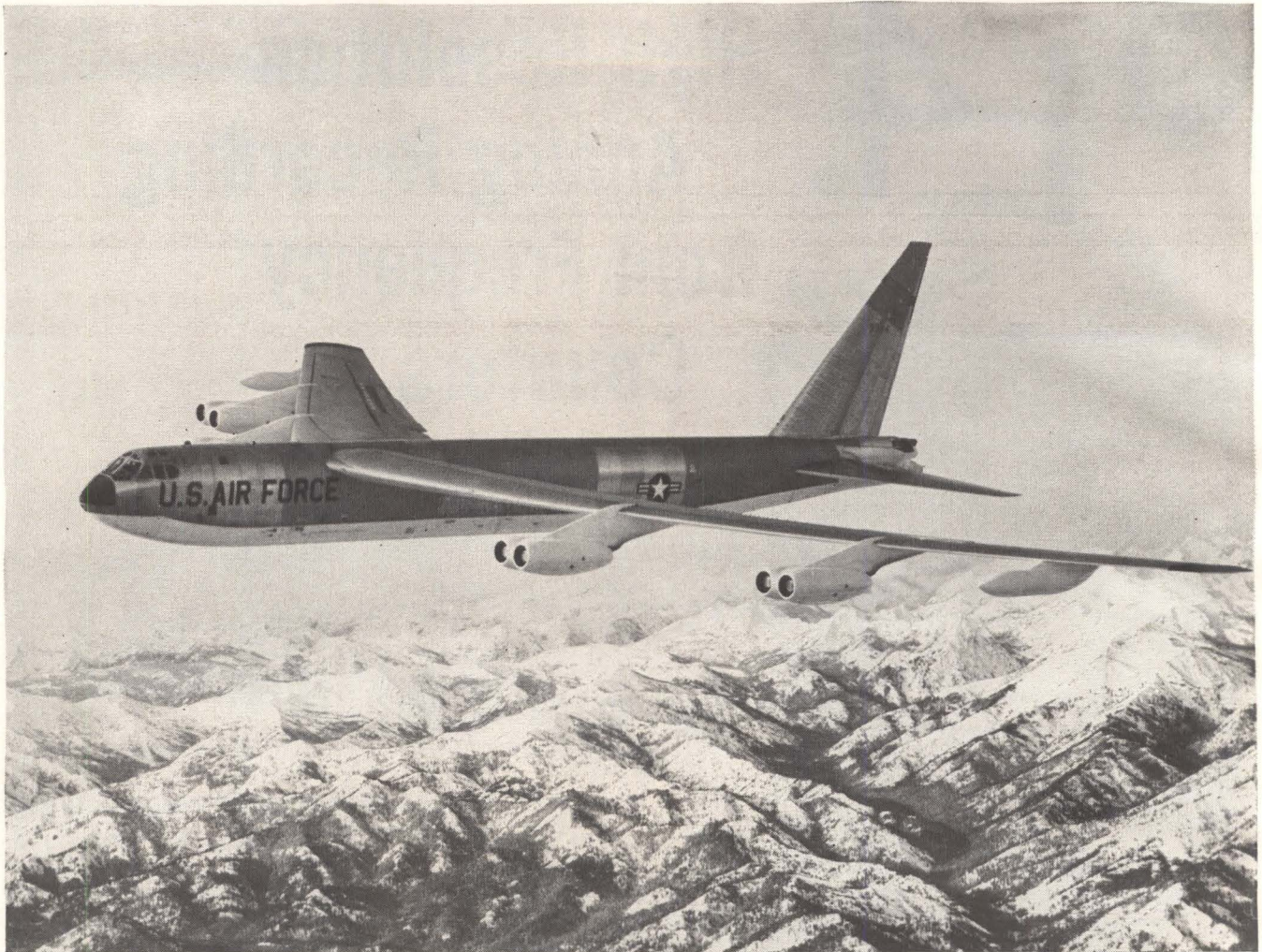

THE HEAT IS OFF THE B-52

General Electric silicone dielectric fluids keep electronic gear running cool and efficiently — indefinitely

We've taken the heat out of the B-52. We've done the same for the B-47, B-57, and B-66. We can do the same for you.

Shown here is the HALLICRAFTERS Company

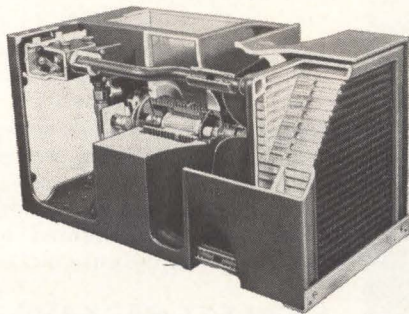

If you need the heat taken off your electronic components, get the full story on G-E silicone dielectric fluids. Write: General Electric Company, Silicone Products Department, Section N462, Waterford, N. Y.

heat exchanger, HD-406, now being used to cool electronic counter measures equipment in all of the above Air Force bombers.

G-E silicone dielectric fluid SF-97 is used as a coolant and dielectric in this equipment. This coolant has excellent electrical properties, and eliminates pressurization requirements at high altitudes.

SF-97 also maintains *consistent* viscosity: requires minimum pumping power. It operates over a wide temperature range, (down to -65°F), cooling reliably and efficiently. Possesses excellent thermal and oxidative stability.

G-E silicone dielectric fluids are used in capacitors, pulse transformers, in air-borne and land-based radar units, and in many systems where heat transfer and dielectric properties are necessary.

GENERAL  ELECTRIC

How much better is MOTOROLA'S 2N960 Series Epitaxial Mesa?

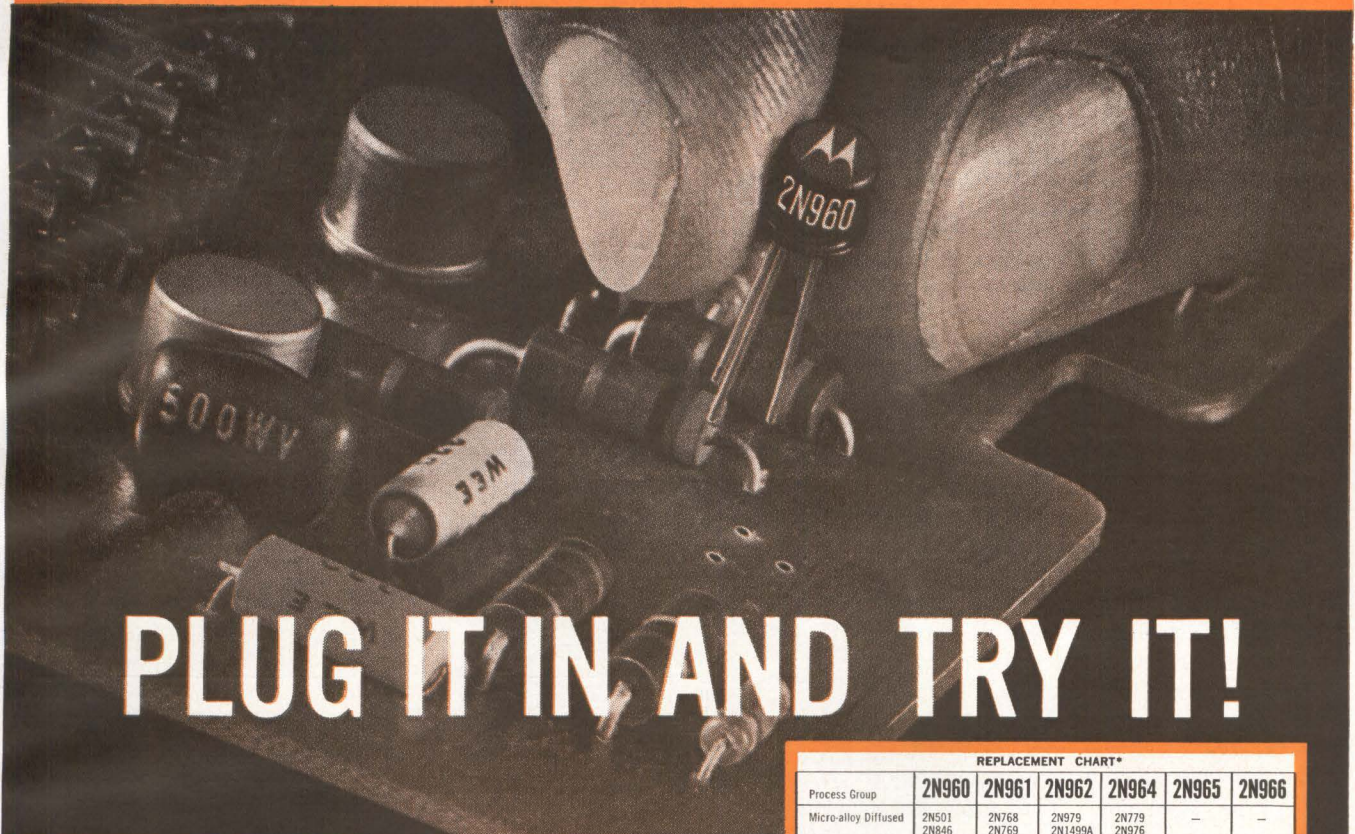

PLUG IT IN AND TRY IT!

Is it true that Motorola's germanium, epitaxial, 2N960 switching series will supplant nearly all other germanium micro-alloy, drift, mesa, and other transistor types for high-speed switching applications? And is it true that the Motorola series is even faster and performs better than advertised? The best way to find out is to try it!

Use the adjacent Replacement Chart and Specifications as a guide, and try any of these six remarkable new Motorola devices in your circuits. Judge for yourself what the advantages are. Samples are available from your local Motorola District Office. Ask also about Motorola's low prices — in many cases, they are considerably lower than those for old type devices.

Some of the Published Advantages of the Motorola 2N960 Series:

- faster switching time
- guaranteed minimum Beta over a wide current range . . . specified at 10, 50, and 100 mA
- low saturation even at 100 mA
- rugged Motorola mesa construction
- the most comprehensive and conservative published specifications of any similar switching transistors
- proven reliability from the world's largest manufacturer of germanium epitaxial transistors

Process Group	2N960	2N961	2N962	2N964	2N965	2N966
Micro-alloy Diffused	2N501 2N846 2N984	2N768 2N769	2N979 2N1499A 2N1500	2N779 2N976 2N982 2N983	—	—
Mesa	2N705 2N710 2N711B 2N781	2N711 2N711A	2N782	2N795 2N934 2N994 2N1301	2N796 2N1683	2N1300 2N794
Micro-alloy	2N1122A	2N1122	2N1411 2N1427	—	—	2N393
Alloy	2N583	—	—	2N582 2N584	—	—
Drift	—	2N643 2N644 2N645	2N602 2N1450	—	2N609	2N603

*Interchangeability of types shown is on the basis of performance in most switching circuit applications.

	2N960	2N961	2N962	2N964	2N965	2N966	UNITS
$f_{\beta E}$ (MIN) 10, 50, 100 mA	20	20	20	40	40	40	—
V_{CE} (SAT) MAX @ 10 mA	.20	.20	.20	.18	.18	.18	Volts
@ 50 mA	.40	.40	.40	.35	.35	.35	Volts
@ 100 mA	.70	.70	.70	.60	.60	.60	Volts
f_T (MIN) $I_C=20$ mAdc $V_{CE}=1.0$ Vdc	300 mc all types						
Q_T (MAX) $I_C=10$ mAdc $I_B=1$ mAdc	80	80	90	80	80	90	pc
$I_C=100$ mAdc $I_B=5$ mAdc	125	125	150	125	125	150	pc
τ_{RE}	0.6 nsec typical all types						
τ_{FE}	0.5 nsec typical all types						
All types have 150 mW dissipation in free air, 300 mW at 25°C case temperature							



For more information on this important new mesa series, contact your Motorola District Office, or call or write: Motorola Semiconductor Products Inc., Technical Information Department, 5005 East McDowell Road, Phoenix 8, Arizona.

MOTOROLA DISTRICT OFFICES:
Belmont, Mass. / Burlingame, Calif. / Chicago / Cleveland / Clifton, N. J. / Dallas / Dayton / Detroit / Garden City, L. I. / Glenside, Pa. / Hollywood / Minneapolis / Orlando, Fla. / Phoenix / Silver Spring, Md. / Syracuse / Toronto, Canada.



MOTOROLA
Semiconductor Products Inc.

A SUBSIDIARY OF MOTOROLA, INC.

1882

5005 EAST McDOWELL ROAD • PHOENIX 8, ARIZONA

Biasing Adds Life to Electrostatic Recordings

PERMANENT electrostatic recordings can be provided by charging that penetrates into an insulating material. Such records can have storage life of hundreds of years and can be played back hundreds of times with little loss of signal. The recording methods said to provide these advantages were described at the IRE Convention in a paper by D. E. Richardson, J. J. Brophy and H. Seiwatz of Armour Research Foundation and J. E. Dickens and R. J. Kerr of E. I. du Pont de Nemours and Company.

Early experiments indicated the desirability of charge injection in which equal charges of opposite polarity were produced at points opposite each other through the plastic film recording medium. Bias and signal voltages are applied to a knife-edge electrode and resilient backing electrode between which the tape is drawn. The tape is played back by passing it between similar electrodes, as shown in Fig. 1A.

Little charge is injected into the tape until bias exceeds a threshold. Applying a reverse-polarity prebias before the tape reaches the bias and signal electrodes measurably improves s/n and other properties. With no signal, correct prebias and

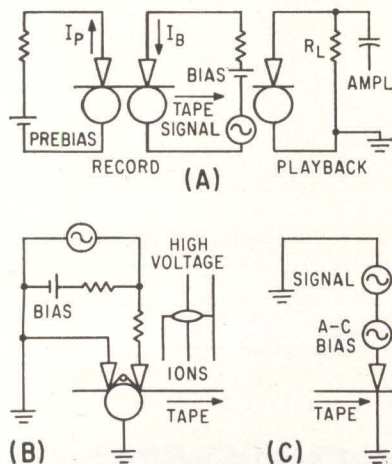

FIG. 1—Prebias (A) improves s/n and circuit (B) establishes equal prebias and bias currents and also neutralizes tape. A-c bias (C) has similar effect

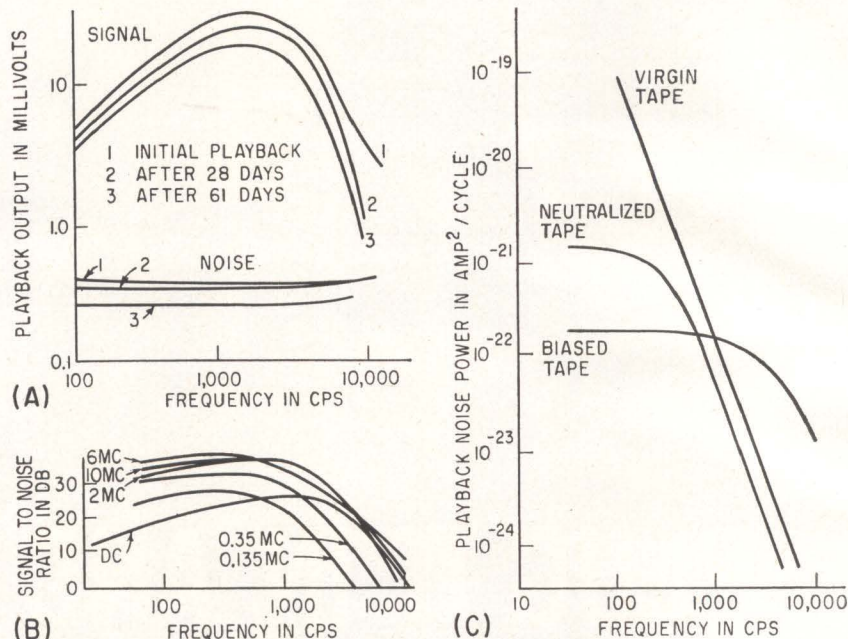

FIG. 2—Playback output is shown (A) for 22-ips record initially and after 28 and 61 days. Affect of a-c bias (B) is shown for 7.5-ips record, while noise of virgin, neutralized and biased tape played back at 11-ips is shown at (C)

bias potentials produce an essentially neutral tape. Applying a signal produces a corresponding charge pattern, which can be erased by subsequent re-recording.

In experiments, maximum s/n and record life and minimum playback distortion were obtained with equal prebias and bias currents. Voltage from the single source in Fig. 1B is divided to produce generally equal prebias and bias currents. Typical bias is 1,500 v d-c and signal level is 100 v rms.

During playback, the signal charges induce potentials in the electrodes that can be amplified. Signal magnitude depends on R_L in Fig. 1A and is about 40 mv for a 10-megohm load. Typical frequency response is shown in Fig. 2A with noise for a 10-cps to 20-Kc bandwidth taken immediately before and after each signal point on adjacent parts of the tape.

A-c bias applied at a single pair of opposed knife-edge electrodes as in Fig. 1C has a similar effect. As shown in Fig. 2B, s/n is larger

than for d-c bias and apparently there is less second-order distortion. After both recording and playback, an atmospheric ion bath neutralizes net charge on the tape produced by triboelectric charging and by the recording process. The ion bath, applied each time the tape passes the electrodes, improves permanence and greatly reduces print-through between layers during storage. It is produced by a high-voltage corona discharge from pointed electrodes between the recording electrodes and the take-up spool in Fig. 1B. A bath between the feed reel and the electrodes can also be used but is often unnecessary.

The low-frequency noise component of virgin tape in Fig. 2C is presumably caused by triboelectric charging during handling and spooling and is greatly reduced by ion neutralization. The reproducible noise of neutralized tape can be interpreted in terms of a stable random array of charged spots produced by air breakdown at the tape

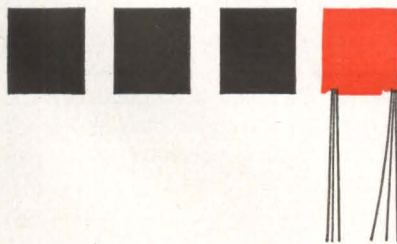
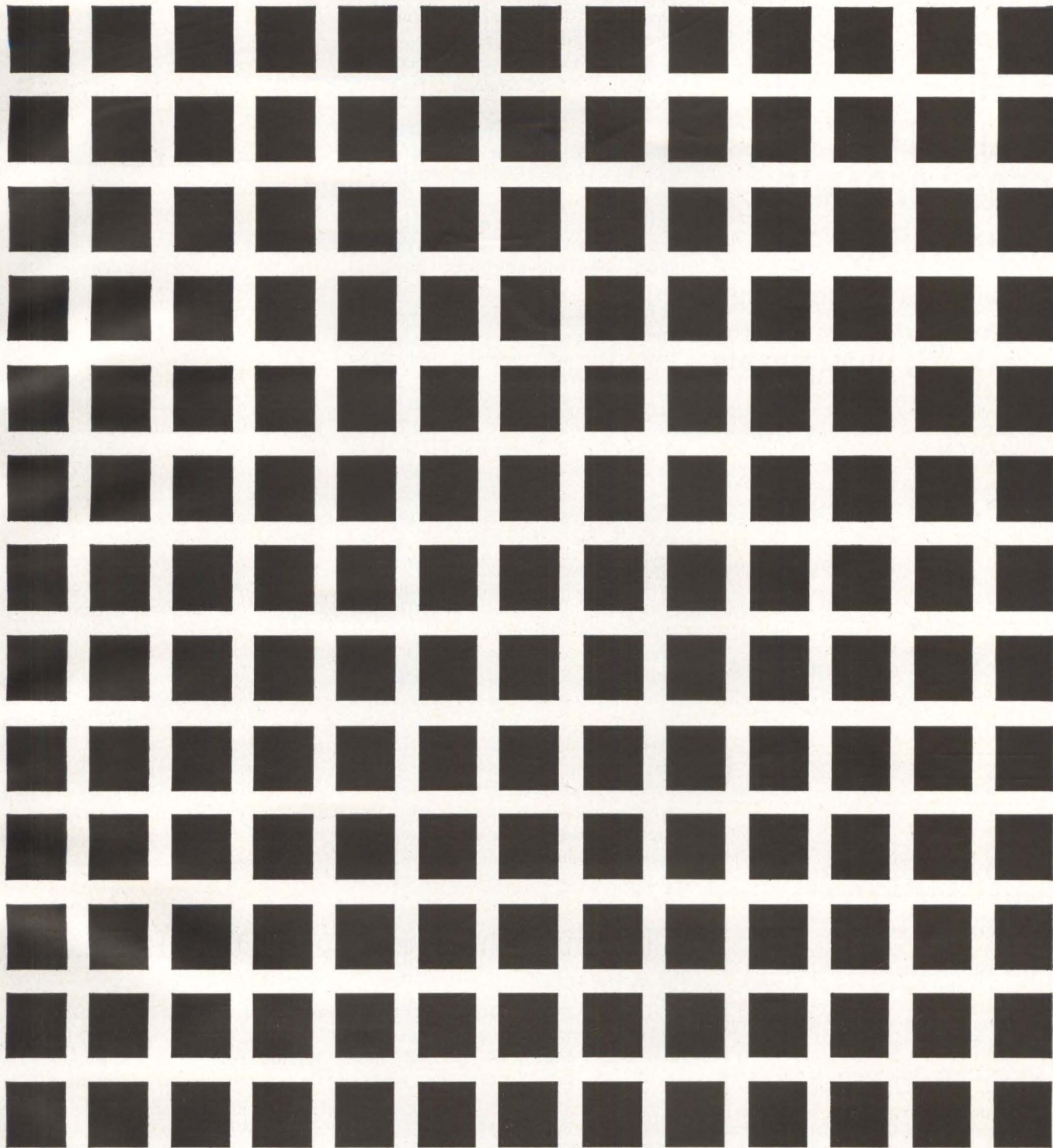

The amazingly light and small Red Spec is representative of the outstanding miniature transformers designed by Triad. All are built in compliance with military specifications. Many offer performance in excess of normal requirements because Triad designs transformers to the often more stringent parameters of advanced electronic systems. An example is the Custom Model 11965. Designed for a highly sophisticated inertial guidance system, it has endured over 100 temperature cycles to date without failure. Many such models, originally custom designed for special military and industrial applications, are now stocked. For system-engineered miniature transformers, write 4055 Redwood Avenue, Venice, California, or 305 North Briant Street, Huntington, Indiana.



TRIAD TRANSFORMER CORP.

PRODUCT
NEWS
FROM



HIGH-RELIABILITY CEROL® CERAMIC CAPACITORS

provide extremely high capacity units in ranges previously unattainable

Hi-Q Cerol capacitors are rolled ceramic capacitors in the high capacitance range of paper and plastic film dielectrics, but in much smaller physical sizes and with superior electrical characteristics. A major breakthrough in design and construction, Cerol provides extremely high capacity ceramic units in ranges previously unattainable.

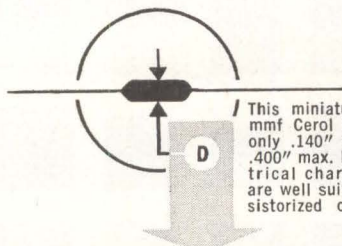

This miniature 100,000 mmf Cerol capacitor is only .140" max. O.D. x .400" max. length. Electrical characteristics are well suited for transistorized circuits.

TYPE CR89 - 50 VDCW		
VALUE	D MAX IN.	L MAX IN.
.1 MFD	.140	.400
.25 MFD	.210	.495
.5 MFD	.260	.495
1.0 MFD	.260	.690
2.0 MFD	.350	.690

PROVEN APPLICATIONS—Designed for general applications in by-pass coupling, filtering, and blocking circuits, Cerol capacitors offer excellent electrical characteristics for critical applications in decoupling and pulse circuits, where low series resistance at high frequencies together with extremely small sizes are required.

SPECIFICATIONS—Three voltage ranges are available: Type CR90 rated at 100 VDCW @ 85°C, and derated to 50 VDCW @ 125°C; Types CR89 and CR91 rated at 50 VDCW and 200 VDCW respectively @ 85°C, and derated by 50% at 125°C. When tested using Cerol ratings, these capacitors will meet or exceed applicable requirements of MIL-C-11015B.

IMMEDIATE AVAILABILITY—Hi-Q Cerol capacitors are available for immediate delivery in production quantities.



COMPLETE TECHNICAL DATA—Write, wire or phone today for our latest catalog sheet.

AEROVOX CORPORATION

Hi-Q Division, Olean, New York

Technical Leadership - Manufacturing Excellence

surface caused by triboelectric charging. This charge pattern is altered by prebias and bias.

Recorded noise can be analyzed in terms of a random array of much smaller charged spots produced by the recording process. The spots correspond with the observed spot-like character of gas discharge at the electrodes during recording. Although wideband noise of biased tape exceeds that of neutralized tape, low-frequency noise is much reduced.

Resolution is influenced by and can be analyzed in terms of effective width of recording and playback electrodes. For the simple knife-edge playback electrode, minimum wavelength is about 0.7 mil. Resolution is improved by a close fitting electrostatic shield on each side of a center pickup electrode. The tape region that induces signals in the active electrode is restricted so that resolution is equal to the distance between the shields. The capacitive loading effect of the shields can be reduced by driving them with a cathode follower.

Gas discharge at the recording electrodes seems to be associated with resolution limits. The finite size of charged spots produced in d-c bias recording and the spread of discharge away from the knife edge tend to limit wavelength. Ambient atmosphere is also known to affect resolution.

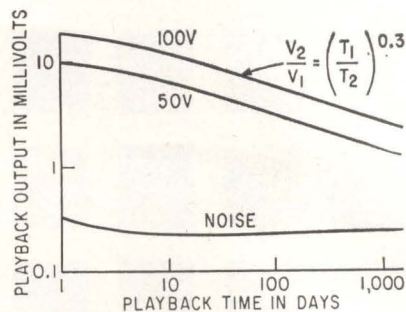

FIG. 3—Permanence is shown for electrostatic recordings made with equal prebias and bias currents after room storage

Long record life is attributed to charge distribution in the tape. Typical signal and noise decay in tape stored under ambient conditions is shown in Fig. 3. After an initial period, noise increases somewhat, possibly because of noise print-through. Signal decay can be represented approximately by a power law with an exponent of 0.3 on this curve. This exponent has been as large as 0.7 for recordings made under adverse conditions such as unequal prebias and bias currents. Tapes stored in dry air have had exponents as low as 0.07 or a life of hundreds of years.

Ion treatment apparently affects playback life. Suitably neutralized records can be played back hundreds of times with relatively little signal loss.

Cadmium-Sulfide Solar Battery Is Flexible

EXPERIMENTAL CADMIUM-SULFIDE solar battery can be rolled up. Such batteries might be carried into orbit in a satellite and then unrolled to intercept maximum sunlight. The battery promises a four-fold increase in power-to-weight ratio, and its cost may be only a small fraction of the cost of present solar batteries.

The first experimental batteries were produced by Harshaw Chemical Co. under contract to the Flight Accessories Laboratory, Aeronautical Systems Division. The work was monitored by the Aeronautical Research Laboratory, U. S. Air Force Office of Aerospace Research.

The solar battery is an unex-

pected dividend of an ARL basic research program begun in 1952 involving compound semiconductors. Purer and larger cadmium sulfide crystals had been grown and studies were being conducted to learn more about their fundamental structure. Progress was made in several directions and in one case led to awarding an applied research contract to Harshaw Chemical for the design of solar cells having higher efficiency and higher power-to-weight ratios.

Since the photovoltaic effect occurs at a thin surface barrier, an effort was made to produce cadmium-sulfide thin-film barriers supported on a light-weight substrate. Although a number of problems have



**When safety
counts ...**

IMPERIAL Ungar

Imperial...bright new way to effectively boost your overall plant safety program. Ungar 3-Wire grounded safety cord sets in matched colors make this the safest soldering iron ever created. Specify the revolutionary "operator-safe" Imperial with complete confidence when you order soldering irons!

IMPERIAL Ungar *Accepted standard of the electronic industry*

UNGAR ELECTRIC TOOLS E-4-62
 Electronic Division of Eldon Industries, Inc.
 P. O. Box 1007, Hawthorne, California
Please send me free full-color IMPERIAL brochure!

NAME _____ TITLE _____
 COMPANY _____
 ADDRESS _____
 CITY _____ STATE _____

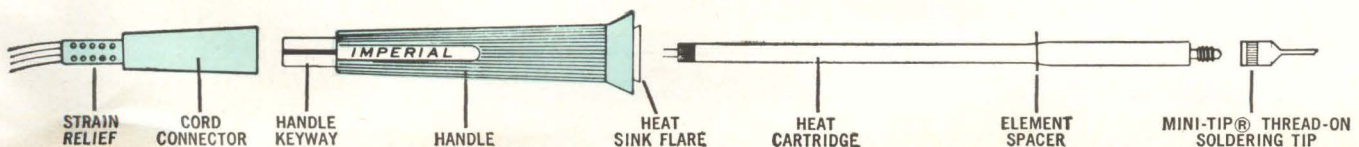

Does Your Manpower Spend

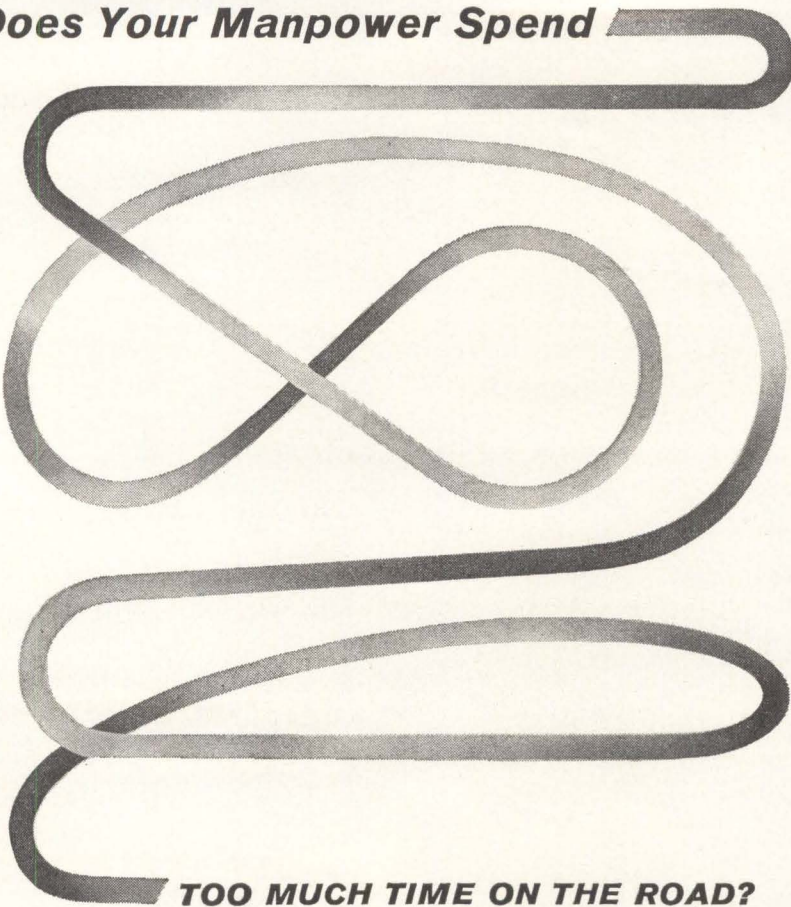

TOO MUCH TIME ON THE ROAD?

cover a
market of over
60 million
in minutes

When manpower scatters, every minute counts—because in minutes, you can cover a market of millions. Location of manpower is the key—that's why America's industrial leaders recognize Georgia as the BIG WHEEL in their sales and delivery pattern.

Facilities provide:

- 29 rail carriers—13 main lines—7 railway systems
- 100 fixed-route motor carriers
- 6 major airlines—372 daily flights (Atlanta alone)
- 2 deepwater ports served by 100 steamship lines
- 2 inland barge terminals now in operation

Do you enjoy these competitive advantages?

**GEORGIA
DEPARTMENT
OF
COMMERCE**

100 State Capitol
Atlanta, Georgia

FREE—Opportunity Reports prepared by Georgia Tech industrial research specialists. Write for list of projects, or for any specific industry.

Dept. E-4

NAME _____

ADDRESS _____

CITY _____ STATE _____

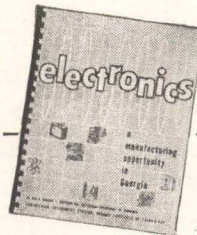

been encountered and the research is continuing, films were developed that it was practical to bend. The significance of such solar batteries for space applications was apparent.

Battery Efficiency

Measured efficiency of the solar batteries in their present state of development depends on area. Efficiency for large areas is about 1 percent. For small area, efficiency is about 5 percent, compared to about 10 percent for the best single-crystal silicon cells in use in satellites or 8 percent for the best single-crystal cadmium-sulfide cells made in the laboratory.

Power-to-weight ratio of the new solar batteries at the large-area 1-percent efficiency is about equal to that of present cells. However, preliminary estimates of manufacturing costs are from 25 to 75 percent lower. It is believed that weight of the film cells can be reduced to half. This weight reduction combined with a large-area efficiency of only 2 percent improve power-to-weight ratio by a factor of four. In addition, cost of the film solar battery would only be a small fraction of present solar batteries.

Battlefield Laser Will Measure Target Range

LASER-RANGER is being developed for battlefield use. Operation is similar to conventional radar except that a narrow, high-intensity light beam is used instead of microwaves.

The lightweight system, under development at the Orlando Division of the Martin Company, will be used to pinpoint targets such as tanks and artillery. The laser ranger is intended for use in conjunction with antitank weapons.

Light is generated by a crystal laser, and the system is said to enable highly accurate measurements of range. The 35-pound unit is attached to a tripod and can easily be carried by a soldier. To measure range, the portable device about the size of a breadbox is set up on the tripod. With the laser-ranger aimed at the target, a button is pressed and range is indicated directly on a panel meter.

Speaking of Packaging Density!

Dunco

TYPE FC-1 DC RELAYS

DP-DT HERMETICALLY SEALED, 26.5 VOLTS DC

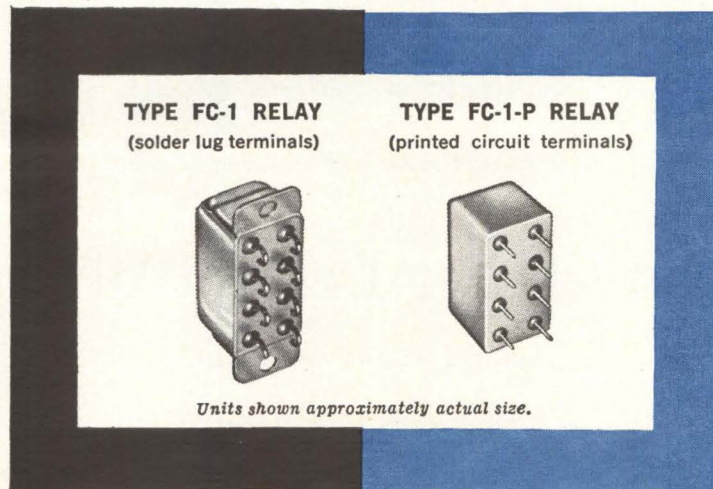

1/2 the size of crystal cans

Here are all the performance and operating capabilities of conventional crystal can relays in just half the size! Only 0.400" high (less terminals), Dunco Type FC-1 relays may also be used as direct replacements for side terminal crystal can types as used in printed circuits. And, they'll need $\frac{2}{3}$ less mounting area!

Designed especially for missile and ground support equipment, Type FC-1 relays are tested in accordance with MIL-R-5757D. Their all-welded internal construction eliminates solder flux contamination. This, combined with hermetic sealing in controlled atmospheres, repeated cleaning operations during assembly, and the use of nongassing materials insure reliable contact performance at loads ranging from dry circuit conditions to 2 amps, resistive.

Write for Data Bulletin FC-1.

Address: Struthers-Dunn, Inc., Pitman, N. J.

STRUTHERS-DUNN

PIONEERS OF SPACE AGE RELAY RELIABILITY



Member, National Association of Relay Manufacturers

Sales Engineering Offices in: Atlanta • Boston • Buffalo • Charlotte • Chicago • Cincinnati • Cleveland
Dallas • Dayton • Denver • Detroit • High Point • Kansas City • Los Angeles • New York • Orlando • Pittsburgh
St. Louis • San Diego • San Francisco • Seattle. Canadian Licensee: Renfrew Electric Co., Toronto, Ontario, Canada.
Export Department: 1505 Race St., Philadelphia 2, Pa., U.S.A.

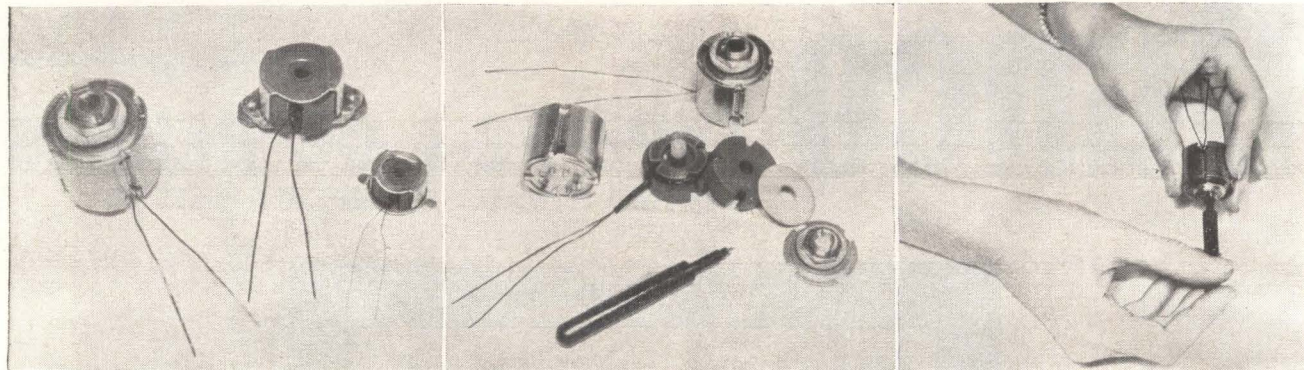

Choice of the class of pot core is easy to determine. It is simply based on the inductance tolerance desired, if possible by adjusting the number of turns on the coil vs the cost of having it built into the core itself

Pot Cores Offer Design Advantages

By C. J. KUNZ, JR.
Chief Engineer
Ferroxcube Corp., of America
Saugerties, New York

IN THE LAST DECADE, with the advent of ferrite materials and the possibility of molding an almost infinite variety of magnetic core configurations, there has evolved a simple, inexpensive, compact inductive core shape known as a pot core. Performance advantages, which are not common in the older style U, E or toroid form. These include improved temperature stability, ease of inductance adjustment, adjustment to 0.02% of a desired inductance value and inherent 40 to 50 db magnetic shielding between side-by-side units.

These advantages, as well as the low losses and high frequency application potential of the ferrite material, are common in all devices, whether it be a filter component, tuned circuit, loading coil, delay line component, transformer, or just an inductive unit.

The complete assembly consists of two ferrite pieces and a coil, usually wound on a plastic bobbin, which is inserted in the space provided in the center of the ferrite. Simple modifications of this consist of using a self-supporting coil and/or one ferrite pot core and a ferrite cover plate. The assembly is relatively simple and the coils used in such a unit can be wound at minimum cost on inexpensive

multi-coil winding machines.

Inductance Value Variations

All magnetic materials are made to permeability tolerance of $\pm 20\%$. Higher accuracy is obtained by modifying turns on the coil. Precision and temperature stability is improved by inclusion of an air gap in magnetic path.

Resultant flux and possible values are explained by Fig. A. The flux that would flow thru a reluctance, R , as a result of a constant applied magnetic driving force. The resultant flux and possible values it may have as the result of variations in R , due either to material variation or temperature instability, give a picture of the tolerance one might expect on the inductance. Looking at Fig. A, p 83, it is clear that if the core reluctance R_1 has a tolerance of $\pm 20\%$, then the flux and inductance will also have this same tolerance, $\pm 20\%$. For the sake of discussion, let's associate a number, 1,000 with R_1 . This means R_1 can be any value between 800 and 1,200. Now, if an air gap is introduced in the circuit, Fig. B, and has a fixed constant value, R_2 —say equal to 5,000, then the total reluctance, which is $R_1 + R_2$, can have values between 5,800 and 6,200. This is equivalent to R_{total} equal to 6,000 ± 200 or $\pm 3.3\%$. To go to the extreme of compensation, we could theoretically adjust the air gap value to exactly offset the variations in R_1 .

That is, if R_1 were 800, we could make $R_2 = 5,200$, or if R_1 were 1,200, we could make $R_2 = 4,800$. All values in between 800 and 1,200 for R_1 , would likewise have a suitable value of R_2 , which in effect could make R_{total} equal to 6,000 $\pm 0\%$. On paper then, we have shown the possibility of completely compensating for material variations from one unit to the next or from one material batch to another. Temperature instability is, in effect, the same as a tolerance on R_1 . It should be evident that since the air gap reluctance R_2 is temperature independent, that although we cannot go to the extreme of perfect compensation for the temperature variation, we can reduce the temperature dependence in the same ratio as we reduced the tolerance in Fig. B from $\pm 20\%$ to $\pm 3.3\%$. In pot core manufacture, the air gap is introduced by recessing the center post. This is done in a subsequent grinding operation after the basic core has been completely formed.

Considering things now from the practical point of view, it is obvious that the reluctance of the air gap, R_2 , cannot be added to the core without some tolerance. The magnitude of what tolerance one might reasonably expect depends on the magnitude of the physical length of the air gap and the degree of precision that one can measure and maintain in the grinding operation. Practical considerations, therefore,

NEW Simpson PANEL METERS

New 1½" Wide-Vue

Another new member in this popular family. Needs only 3.1 sq inches of panel area. Supplied in DC, AC (rectifier), and VU types. Colors are standard black or your choice. Self-shielded core magnet type movements. *Forty-seven stock ranges in six types . . . Model 1212C, DC; Model 1214C, AC and VU.* This very popular style of meter is also stocked in 2½", 3½", and 4½" sizes. *See your electronic distributor for the many stock ranges.*

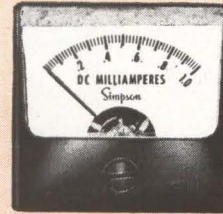

All Meters Shown 60% Actual Size

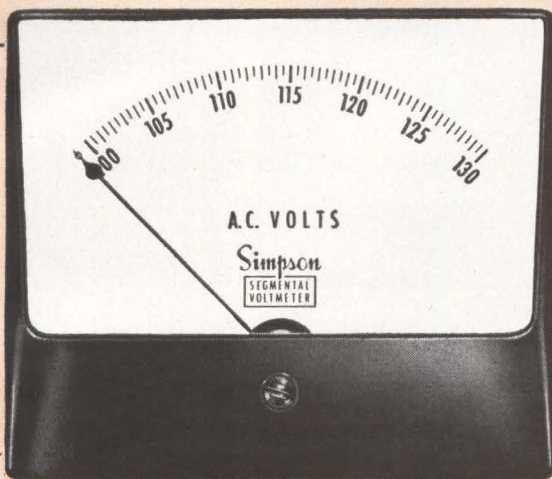

Wide-Vue Case Style

Segmental (Expanded Scale) AC Voltmeters - 3½" and 4½"

Stock meter reads 100 to 130 AC volts. Other ranges supplied on special order. Frequency range is 20-2,000 cps. Accuracy is $\pm 0.5\%$ of center scale value at 25°C and 60 cps sine wave. Self-shielded core type movement; rectangular cases. Stock units are 3½" Model 1347C (Wide-Vue Style), 4½" Model 1349C (Wide-Vue Style), and 4½" Model 49C. *See your electronic distributor.*

1% and 2% DC Meters From Stock

Rectangular 6" cases. Mirror scales on 1% meters. Self-shielded core movement or external magnet type depending on range. Order Model 1150-E and specify either 1% or 2% accuracy. Milliammeters and microammeters stocked in both accuracies; voltmeters, millivoltmeters, and ammeters stocked in 2% only. *See your electronic distributor.* For other than stock ranges, send us your specifications.

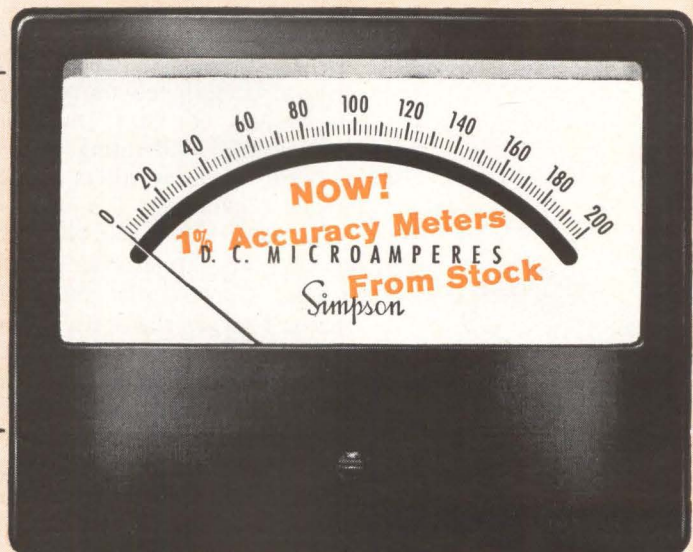

Write on Company Letterhead for Completely NEW 88-Page Catalog and Engineering Manual No. 18. Gives Comprehensive Listings on All Simpson Panel Meters.

Simpson

INSTRUMENTS THAT STAY ACCURATE

SIMPSON ELECTRIC COMPANY
5203 West Kinzie Street, Chicago 44, Ill.
Phone: EStbrook 9-1121 (Area Code 312)
In Canada: Bach-Simpson Ltd., London, Ontario

tiny rheostat

rated at $12\frac{1}{2}$ watts, 40°C

...and a very sizeable 8 watts at 125°C

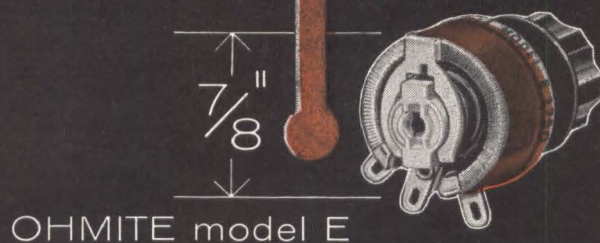

■ Here's real power in a small package for operation at elevated temperatures where units with organic materials fail. All ceramic and metal in construction, the Model E rheostat is designed to operate at a maximum hot spot temperature of 340°C without charring, shrinkage, or deterioration. Full rating is $12\frac{1}{2}$ watts at 40°C , but even at 125°C , there is still a sizeable 8-watt rating for units through 5000 ohms.

The Model E is wire-wound, yet measures only $\frac{7}{8}$ " in diameter—no larger than many one and two-watt potentiometers. Construction and materials are the same as for Ohmite's larger rheostats. Each turn is permanently fixed and insulated on a solid ceramic core by Ohmite-developed vitreous enamel or Ohmicone silicone-ceramic coating (above 5000 ohms).

Thirty-one resistance values from 1 to 15,000 ohms (linear) are stocked in both unenclosed and enclosed styles for immediate delivery from your distributor or the factory. Units with tapered windings, tandems, and many other variations are available on order. Write for Stock Catalog 30, which lists all 11 sizes of Ohmite rheostats from $12\frac{1}{2}$ to 1000 watts.

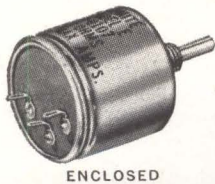

ENCLOSED



UNENCLOSED

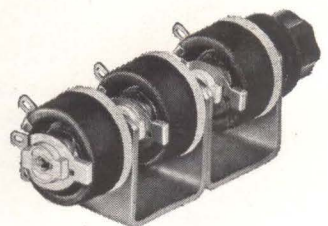

TANDEM



OHMITE

MANUFACTURING COMPANY
3610 Howard Street, Skokie, Illinois

RHEOSTATS • POWER RESISTORS • PRECISION RESISTORS • VARIABLE TRANSFORMERS •
TANTALUM CAPACITORS • TAP SWITCHES • RELAYS • R. F. CHOKES • GERMANIUM DIODES

And Rated "Superior" by Users...

OHMITE Germanium DIODES

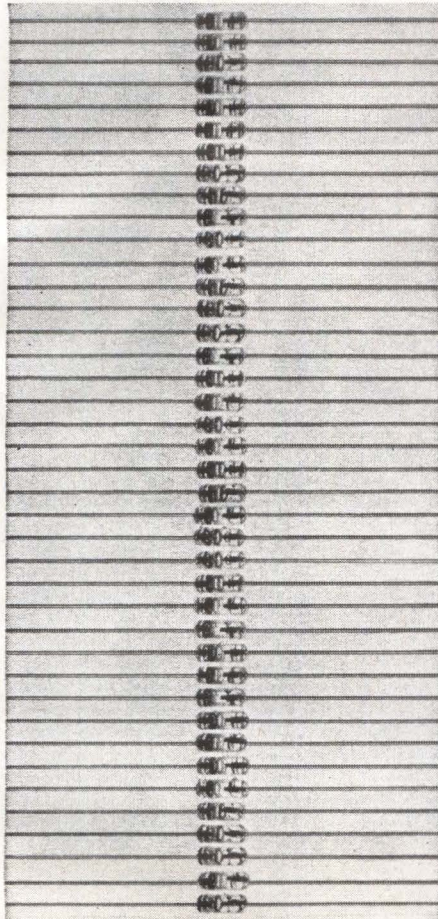

Discover, as other users have, how Ohmite achieves unusual reliability through manufacturing quality control.

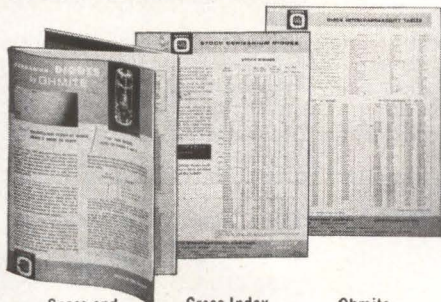

Specs and Listings,
BULLETIN 158

Cross Index
to 24 Makes,
BULLETIN 1002

Ohmite
Stock Diodes,
BULLETIN 164

**SEND FOR
A SET**

Ohmite Mfg. Co.
3610 Howard St.
Skokie, Illinois



CIRCLE 83 ON READER SERVICE CARD
April 13, 1962

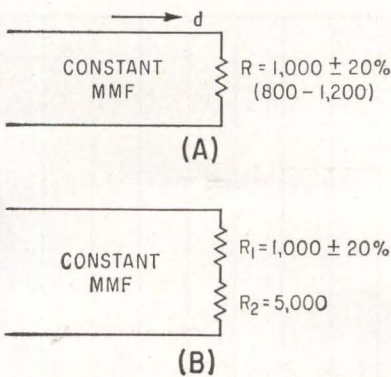

Flux through a reluctance

lead to three classes of pot cores, each progressively more precise in magnetic quality and equally slightly more expensive to manufacture and purchase.

In the non-adjustable category, (fixed inductance) one can purchase three classes or groups of cores. Class 1 is a group of cores with no added air gap. The tolerance on effective permeability is usually $\pm 20\%$, which is the material tolerance. The pot core pair usually has an effective permeability slightly lower than the material permeability. This slight reduction is the result of the "inherent" air gap that is always present when two parts are mated together. One has some selection on available effective permeability by his choice of basic material usable in the frequency range of interest. The core size is primarily dictated by the required inductance.

Gapped Pot Cores

In mechanically pre-adjusted or gapped pot cores. Class II, all cores are gapped (center post recessed) to a fixed dimension, plus or minus some mechanical allowance. With this class of cores, tolerances on effective permeability usually run from 5 to 10%. Cores are available in a range of fixed gap lengths and can be selected on the basis of the permeability or inductance desired with a given number of turns on the coil. Core size is then selected on the basis of winding volume needed for the given number of turns of a certain size wire. In effect, this gives the designer one more degree of freedom, since he can now select the material on the basis of characteristics other than permeability. Class III is a group of pre-adjusted

or gapped pot cores. In this group, each core is tested as it is recessed. The amount of grind is varied to account for material variation. The pot cores are segregated and prepared for sale as mated pairs. In this way, magnetic tolerances can be reduced to as little as 2%. This group is likewise sold in ranges of effective permeabilities in different materials and gives the designer the same benefits as Class II.

Finally, there is one more general category of pot cores, called adjustable pot cores (inductance can be varied by a tuning mechanism). In this category, which includes Class III above, a threaded adjusting slug is provided with suitable mounting hardware to allow up to $\pm 10\%$ variation on the mean value of effective permeability and inductance. In this configuration, a ferrite slug is inserted in the center hole of the pot core pair and effectively spoils to some extent the effect of the air gap in the center post.

It is important to note that this adjustable variety of cores is not solely for circuit applications where adjustment is necessary or desired. They are more often used in fixed inductor applications, the adjustment merely facilitates attaining a precised value of inductance. Units with this arrangement can be adjusted, disassembled and re-assembled to an inductance accuracy of 0.02%. These units in commercial applications allow use of a wider tolerance and, consequently, less expensive associated capacitors. For example, in a resonant circuit of a filter, which might ordinarily require a 1% capacitor to go with a 1% toroid inductor to give a required tuning accuracy, a 5% capacitor could be used with an adjustable pot core and the combination tuned to resonance to within .014%. Not only can the adjustment accuracy be improved, but the complete tuned circuit, considering the cost of the precision capacitor and the cost of winding and adjusting a toroid inductor, will be considerably less expensive.

Frequently, engineers are to some extent at a loss in selecting proper core material, class of cores, size of gap, and size of pot core. This is not surprising, since the number of variables involved leads to a large selection of cores.

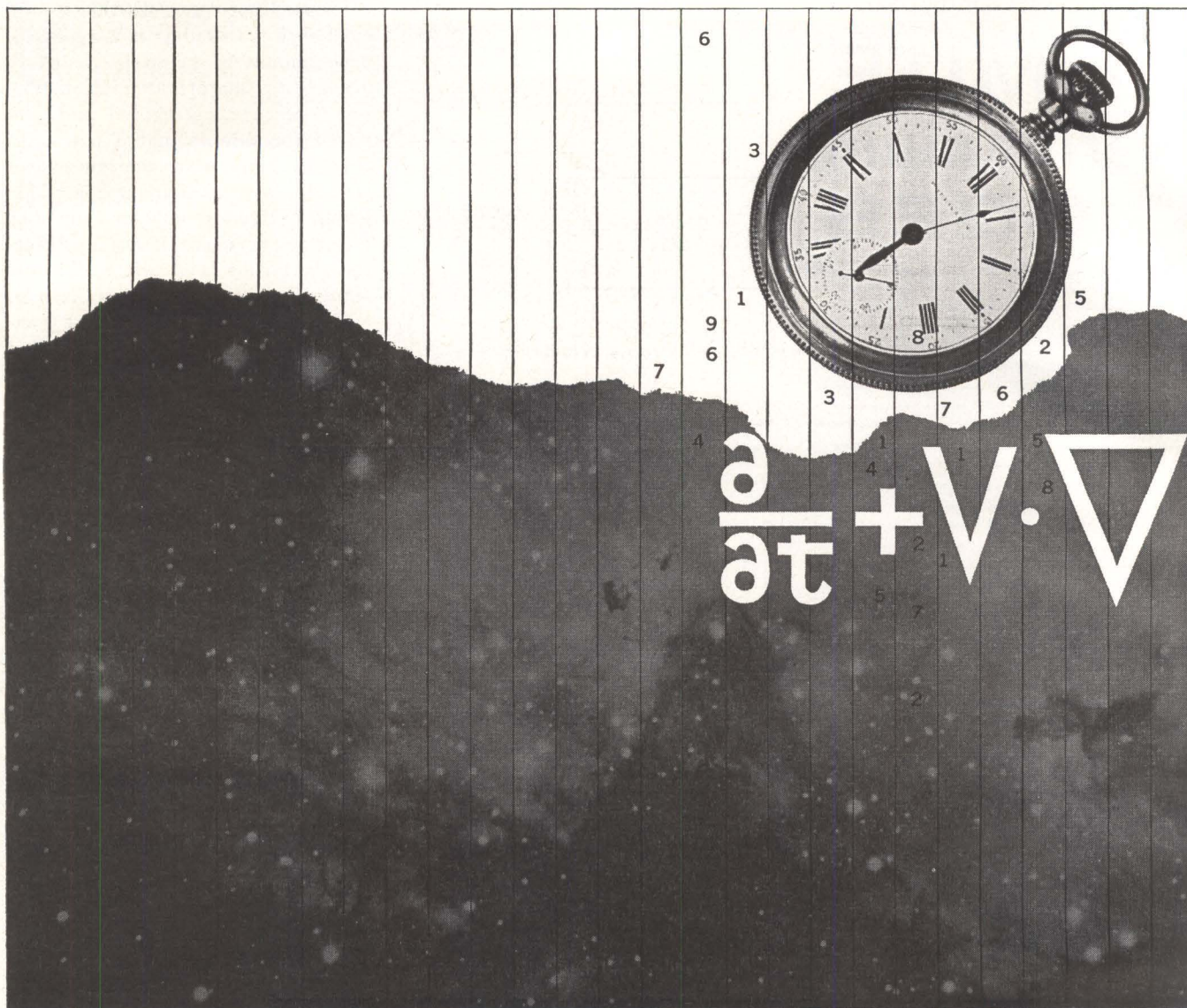

purposeful imagination....in time

The men of Aerospace apply the full resources of modern science and technology in a timely manner to achieve the continued advances in ballistic missile and space systems basic to national security. Their mission includes stimulating the flow of the most advanced scientific information and objectively planning the technical management programs necessary to generate superior systems in the shortest possible time. □ Chartered exclusively to serve the United States Government in this effort and acting in partnership with the Air Force-science-industry team, the men of Aerospace contribute: advanced systems analysis and planning; theoretical and experimental research; general systems engineering and corresponding technical direction of programs. □ To aid in reducing the timetable of advanced systems, from concept through completed mission, more men with advanced degrees are needed at Aerospace Corporation, an equal opportunity employer. Dedicated interdisciplinary scientists and engineers who can contribute effectively are invited to contact Mr. George Herndon, Room 110, Aerospace Corporation, P. O. Box 95081, Los Angeles 45, California. □ Organized in the public interest and dedicated to providing objective leadership in the advancement and application of science and technology for the United States Government.



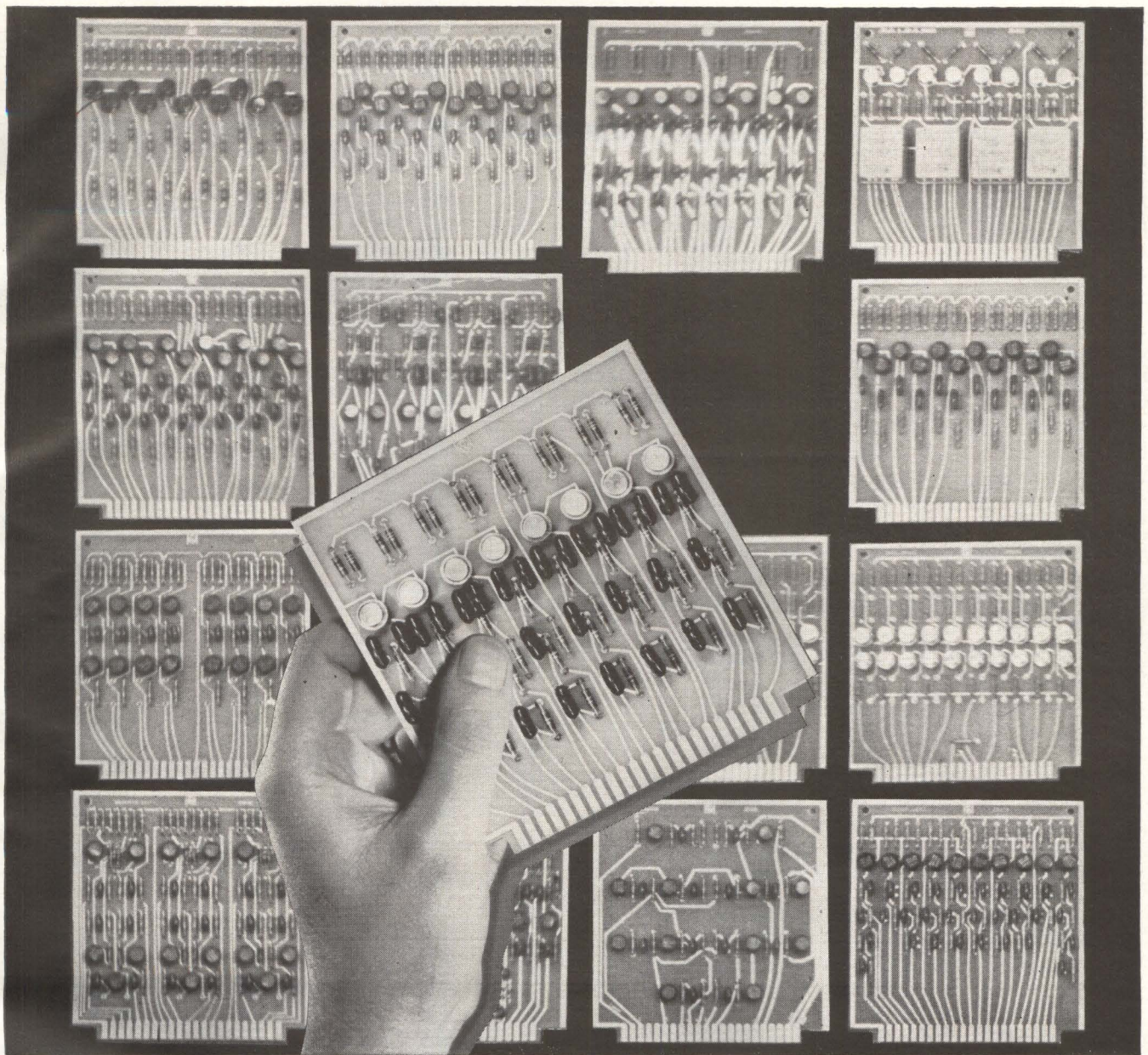

Take this 1 mc Solid State Printed Circuit, for example...

Intermountain Branch of Curtiss-Wright Electronics Division designed and manufactured it to meet exacting standards of quality, reliability and performance in a wide variety of digital logic systems. These precision built 1 mc units are available in a broad selection of standard "off-the-shelf" circuits, or Intermountain will custom design and manufacture solid state printed circuits and systems to your specifications.

- Double sided, gold, plated through holes
- Lower cost multi-circuit packaging
- Meet all specifications in accordance with Mil. Std. 275A

Write for information and prices on standard units, or a quotation on your specific requirements.

NEW—MAXPAK® Digital Modules are welded, high density modules, encapsulated in HEATCON® high conductive plastic. Offer substantial savings in space and weight, flexibility and reliability at modest cost. Standard units available, or your circuits can be packaged to specification. For complete information, write: Advanced Miniaturized Electronics, Inc., 55 Kearney Rd., Needham Heights, Mass.

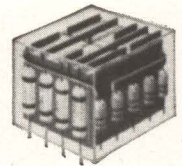

Electronics Division Intermountain Branch
Curtiss Wright

CORPORATION

P.O. Box 10044 Albuquerque, New Mexico

Phone: 345-1661 TWX: AQ-69

Control Pulse Polarity for Weld Strength

By JOHN SOSOKA,
Weldmatic Div.,
Unitek Corp.,
Monrovia, Calif.

FOR HIGH RELIABILITY welding with single-pulse welders, electrode polarity must be considered, since it can be as important as proper energy and pressure settings.

Stored energy welding has become increasingly popular because of the high degree of control it allows. This, in combination with a relatively short weld cycle, allows many dissimilar materials to be joined. But welding dissimilar materials usually presents the problem of electrode polarity.

Welded electronic modules are typical of the type of application where polarity must be carefully controlled. The great variety of lead materials on the components results

in a number of dissimilar material combinations. This situation combined with the need for high reliability demands strict polarity control.

Tests show that the direction of flow of the welding current through some combinations of dissimilar materials have a dramatic effect on the quality and strength of the bond. The data shown in the table is typical of polarity-sensitive combinations of material. Simply reversing the direction of the welding current reduces the strength of some bonds by 50 percent. If the operator reverses the material between the electrodes, or if a welder is installed with the equipment polarity reversed, only a partial weld of uncertain consistency will result.

Operator error is the major problem because it is apt to be random. Thus it is imperative that the op-

erators be made aware of polarity effects and that proper polarity be clearly specified in their instructions. This is especially true where similar electrode materials are used for both electrodes.

The problem of improper polarity can easily be avoided once its significance is recognized. Since most stored energy welders are unipolar it is only necessary to check the direction of the welding pulse, which can be done with an oscilloscope if the power supply terminals are not marked positive and negative. To check pulse polarity with an oscilloscope, a nonconductive material can be used between the electrodes.

Another method of establishing polarity of the equipment is to weld a material combination known to be polarity sensitive. The materials should be welded in one direction and then with the polarity reversed. For simplicity, both electrodes should be of the same material. The welded samples can then be pull-tested to determine which polarity

HOW ELECTRODE POLARITY AFFECTS WELD STRENGTH

Non-polarity-sensitive material combination

Nickel wire (0.025 in. dia.) cross-wire welded to nickel ribbon (0.010 × 0.031 in.)

Electrode Force in pounds	Weld Energy in watt-seconds	Average Pull Strength in pounds (Torsional shear test)		Percentage of Normal Pull Strength with Polarity Reversed.
		Normal Polarity Nickel Ribbon (-)	Reverse Polarity Nickel Ribbon (+)	
8	10	18.4	18.0	98
8	12	17.6	17.3	98
8	14	16.9	16.6	98
8	16	16.4	15.9	97

Polarity sensitive material combination

Tinned-copper wire (0.026 in. dia.) cross-wire welded to nickel ribbon (0.010 × 0.031 in.)

Electrode Force	Weld Energy	Average Pull Strength		Percentage of Normal Pull Strength with Polarity Reversed
		Normal Polarity Nickel Ribbon (-)	Reverse Polarity Nickel Ribbon (+)	
7	32	12.9	6.3	49
7	34	12.4	8.4	68
7	36	13.3	7.5	56
7	38	12.3	2.6	21

Large Size PC Board

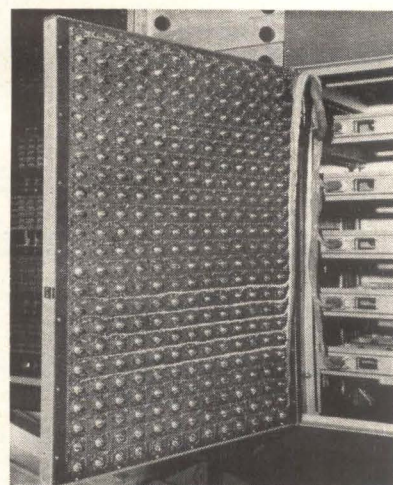

One of the world's largest printed circuit boards is used at the Bremerton Naval Yard, Bremerton, Washington in a read-out panel for an acoustic tone analyzer. The board, 41 by 31 inches, was manufactured by Automated Controls Co., Alderwood Manor, Washington, using ¼-inch thick Formica XXXP-36 laminate, holds 290 light sockets

CAPACITORS OF MYLAR[®]

SAME PRICE RANGE

AS PAPER

BUT WITH EXTRA RELIABILITY

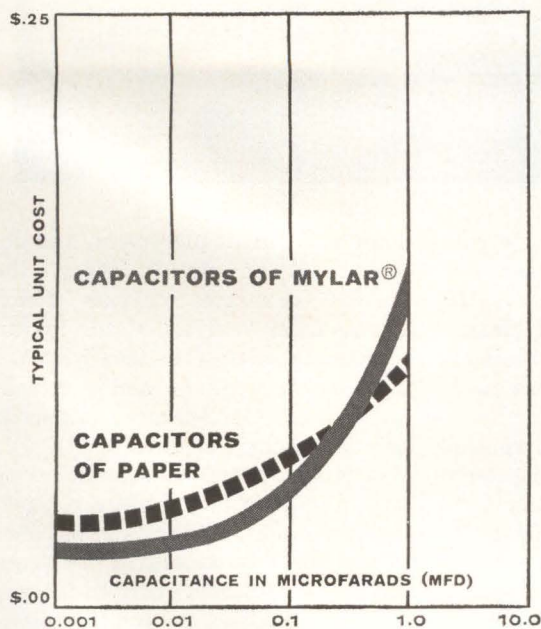

You may not realize it, but you can benefit from the higher dielectric strength, moisture resistance and reduced size of capacitors of "Mylar"^{*} polyester film without paying a premium price. An industry study of manufacturer prices shows THAT OVER A RANGE OF SIMILAR CAPACITANCES AND RATINGS, UNITS OF "MYLAR" COMPARE CLOSELY IN COST WITH THOSE OF PAPER.

According to a recent survey, few engineers are aware of this close price comparison . . . although they recognize the outstanding properties of "Mylar". Look into it yourself. Before specifying capacitors for your design, get this free booklet study with performance facts and price charts. Write: Du Pont Co., Film Dept., Wilmington 98, Delaware.

*Du Pont's registered trademark for its polyester film.



REG. U.S. PAT. OFF.

BETTER THINGS FOR BETTER LIVING . . . THROUGH CHEMISTRY

April 13, 1962



CIRCLE 87 ON READER SERVICE CARD

87

TOUGH

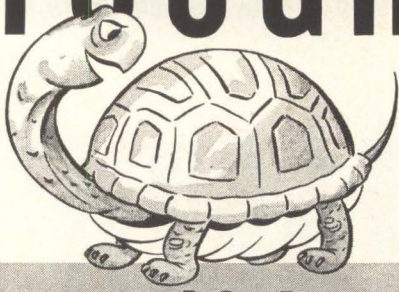

... AS A TURTLE'S BACK

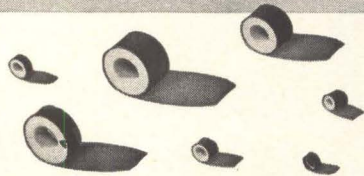

**ARMAG*-PROTECTED
DYNACOR®
BOBBIN CORES
AT NO EXTRA COST!**

Tough-as-tortoise-shell Armag armor is an exclusive Dynacor development. It is a thin, non-metallic laminated jacket for bobbin cores that replaces the defects of nylon materials and polyester tape *with very definite advantages*—and, you pay no premium for Armag extra protection.

Tough Armag is suitable for use with normal encapsulation techniques on both ceramic and stainless steel bobbins. It withstands 180°C without deterioration—is completely compatible with poured potted compounds—has no abrasive effect on copper wire during winding—fabricates easily to close-tolerance dimensions—inner layer is compressible to assure tight fit on bobbin—does not shrink, age or discolor.

Write for Engineering Bulletins DN 1500, DN 1000A, DN 1003 for complete performance and specification data covering the wide range of Dynacor low cost Standard, Special and Custom Bobbin Cores—all available with Armag non-metallic armor.

*TRADEMARK

SPRAGUE®
THE MARK OF RELIABILITY

SPRAGUE ELECTRIC COMPANY
35 MARSHALL ST. • NORTH ADAMS, MASS.

resulted in the strongest welds.

Polarity effects have been somewhat slighted primarily because of the tremendous increase of stored energy welding in the electronics industry, and the use of capacitor discharge welding for the fabrication of welded circuits. The phenomena is unique with single-pulse welding and is not a problem with a-c resistance welding. In a-c resistance welding a number of cycles are usually used and polarity cannot be controlled.

Evidence to date indicates that the polarity effect is the result of either a semiconductor effect at the

interface or the result of an electrical potential between the materials being welded. Since the voltage applied across the materials during the weld is only a few volts, either of these effects could account for the polarity phenomena.

In some cases, the preferred polarity cannot be used. During the weld, a voltage is generated across the interface of the conductors being welded and if this voltage is applied incorrectly to a semiconductor device, it can damage it. The effects of having to use the wrong polarity can be somewhat offset by increasing weld energy.

Where Computers Come From

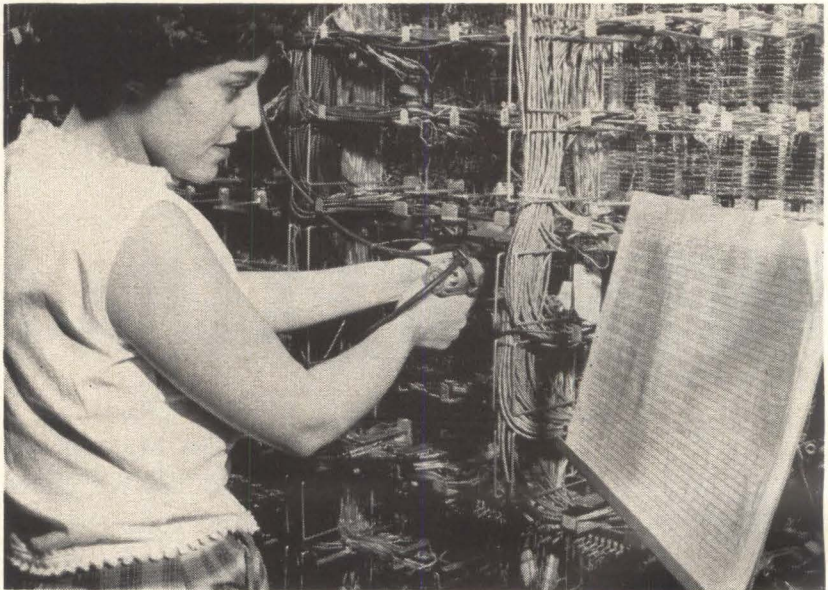

MACHINE GENERATION of wiring specifications and production-line instructions is becoming one of the most valuable benefits of design automation principles, particularly in the manufacture of circuit packages for large computers.

Among examples of "computers breeding computers" is the technique used at the Electronic Data Processing Division of Minneapolis-Honeywell in Brighton, Mass. There the Honeywell D-1000, a first-generation computer, turns out wiring specifications and production instructions for manufacture of units of the Honeywell 800 and 400 computers.

From basic inputs such as statements of the purely logical design of a unit, skeletal information as to

logic and circuit placement, and descriptions of circuit types, the D-1000 generates outputs which range from analysis of the logical design to wiring instructions for production workers and punched-card decks to operate automatic wirewrapping machinery.

Initially, the D-1000 produces on tape the logic files, universal package-type files, and allocation files. From these is generated the engineering wire list, or "backboard file," which is the source of production documents, ring-out documents (for verification of wiring from and to correct pins) and quality control documents. It also produces documents that show wire runs.

For wire-wrapping machines, the design automation technique gen-

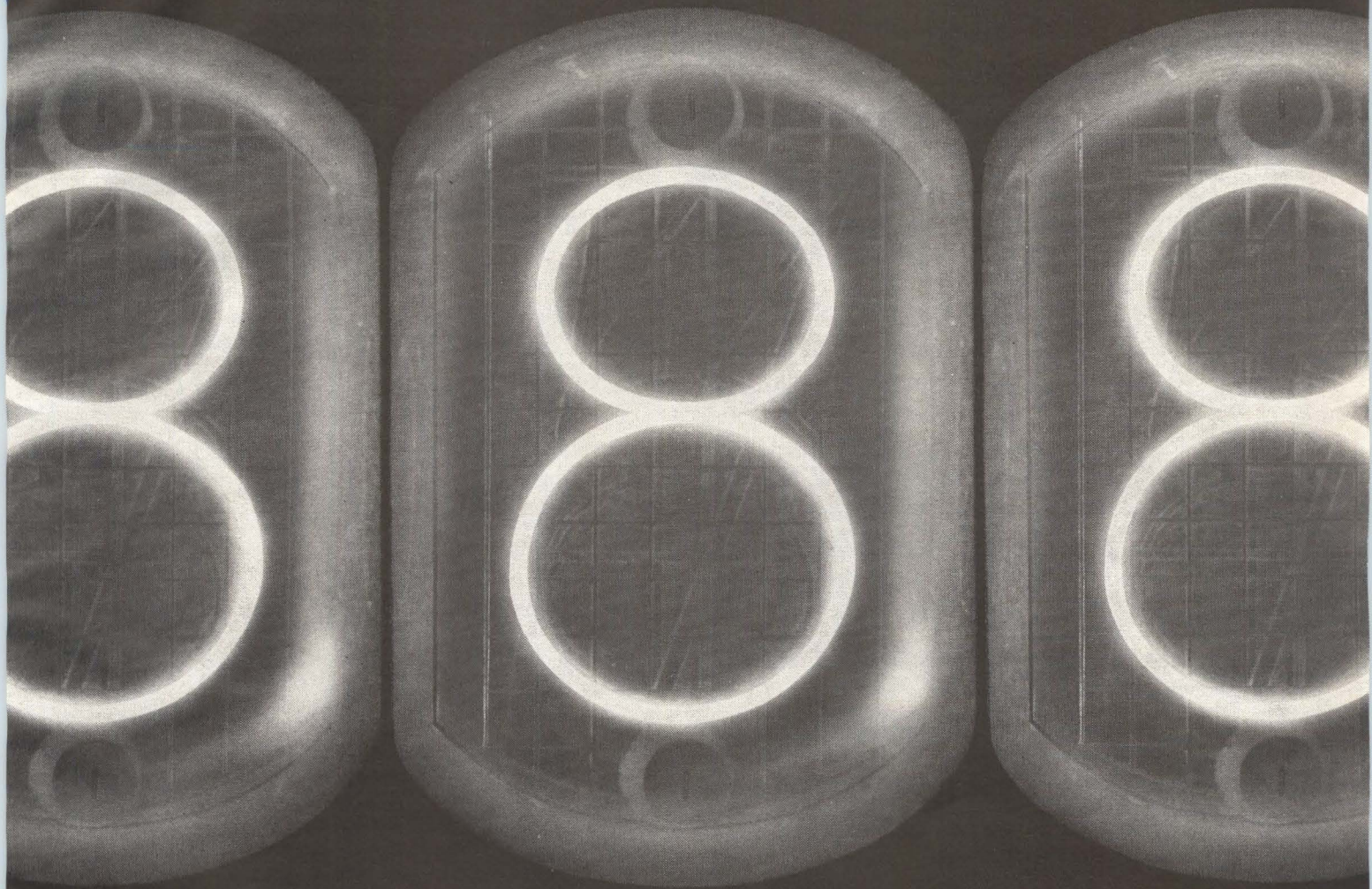

the new rectangular NIXIE[®] tube

There's a new addition to the Nixie Tube Line . . . the Rectangular Nixie Indicator Tube. This latest advance in Nixie Tube design provides a major reduction in the over-all width and depth of the readout, but the same character size is maintained.

To the design engineer this means: Greater freedom for equipment miniaturization • Design flexibility, including the use of smaller drive circuits • The ability to add features without increasing space.

And the new Rectangular Tube retains all of the advantages which have made Nixie Tubes industry's most popular readout . . . longest life, lowest cost, smallest size (now smaller than ever!), and greatest readability. Write today for complete technical information on the entire line of Nixie Indicator Tubes . . . including the new Rectangular Nixie Tube.



REGULAR
CYLINDRICAL



NEW
RECTANGULAR

ANOTHER ELECTRONIC CONTRIBUTION BY
Burroughs Corporation
ELECTRONIC COMPONENTS DIVISION
PLAINFIELD, NEW JERSEY



HOW CHEAP IS "CHEAP"?

"Why should we buy from you when we can get the 'same thing' from other suppliers at a lower price?"

In selecting a supplier of lacing tape (or any component), price and compliance with specifications are not the only criteria. But too often, manufacturers ignore the other factors involved and consequently lose money.

For example, in a \$15,000 piece of equipment there may be only 15 cents worth of Gudebrod lacing tape. It costs \$75 to work this tape. It may be possible to buy the same amount of tape from other suppliers for 2 or 3 cents less . . . it "will meet the specs" according to these suppliers. But one of our customers recently pointed out why he still specifies only Gudebrod lacing tape in such cases.

"We tried buying some cheaper tape that 'met the specs.' Within a few months our production was off by 50% . . . boy, did the production people really scream about that tape. And our labor costs doubled . . . our costing people really flipped!

"Another thing, why should we risk the possible loss of thousands of dollars when the original material cost difference is only a few cents. Once you put cheaper tape on and something goes wrong after the equipment is finished . . . you've had it. No, thank you! We learned our lesson! We buy Gudebrod lacing tape!"

Whether your firm uses one spool of lacing tape or thousands, there are four advantages in specifying Gudebrod for all your lacing requirements:

1. *Gudebrod lacing tape guarantees increased production!*
2. *Gudebrod lacing tape guarantees reduced labor costs!*
3. *Gudebrod lacing tape guarantees minimal maintenance after installation!*
4. *Gudebrod guarantees quality!* On every spool is a lot number and seal which guarantees that all Gudebrod lacing tape is produced under strict quality control. Our standards are more exacting than those required for compliance with Mil-T.

Our Technical Products Data Book explains in detail the complete line of Gudebrod lacing tapes for both civilian and military use. For your copy write to Mr. F. W. Krupp, Vice President, Electronics Division

GUDEBROD BROS. SILK CO., INC.

Electronics Division
225 West 34th Street
New York 1, New York

Executive Offices
12 South 12th Street
Philadelphia 7, Pa.

erates flow charts and the do-list for wrapping sequence.

Production instructions can be updated in a matter of hours to incorporate substantial engineering changes, affecting either manual wiring by production workers or changes in the automatic wire-wrapping sequence.

Production engineers have access to the wiring files, enabling them to make minimal changes to a package already under construction without effecting programming changes all the way back to basic logic files. Production supervisors say instruction sheets generated by machine enable girls to tackle wiring jobs with only one week of training.

Use of ring-out documents have proven so effective that 98 percent of wiring errors are caught before computer systems go to dynamic test.

For automatic wire-wrap, the computer program processes data so as to produce the most efficient operation in terms of path configuration, color, length, number of wraps on pin, etc. Also, production designers can determine how to minimize total wire length in a given run.

The present system concentrates on the problem of backboard wiring interconnections. Expansion of the system will enable machine processing to go inside the package, or outside to the major unit complex.

Wire Stripper Raises Insulation to Cut It

BOEING'S Aero-Space Div., Seattle, Wash., has developed a stripper that avoids danger of wire damage. The tool raises a section of insulation and cuts it without touching the wire. The technique prevents a small nicks or cut strands, which could induce wire failure under vibration.

Two mechanical jaws, a fraction of an inch apart, grasp the insulation firmly. Pushed together, the jaws slide the insulation along the wire and raise it. When the jaws meet, they cut through the insulation and complete the action.

Boeing has made several prototypes, now is studying marketing possibilities.



1048

2 3 4 5 6 7 8.9 0 4 1
 3 4 6 7 8 9 0.1 2

703190007067.0
 801200122211.4
 6724508886008
 804543584330.2
 3402670083830
 5055049963733
 245004050522.0
 500747505747.0
 986650577088.8
 644300666002.4
 356005662404.0
 340888862048.3
 678006060636.0
 377800004009.9
 130002036065.3
 725600650054.2
 336700040672.7
 566688887185.8
 754321111230.0
 765008760321.1
 760503211103.5
 133674570767.5
 642505872730.2
 256020562606.0
 256077246531.5
 777260333704.4
 350044552044.0
 350651603608.0
 732770605665.3
 542367660674.3
 865456543456.7
 863168853146.7
 542127757934.9
 545588550302.4
 876543345678.6
 578058607293.3
 673673158273.2
 684668584899.8
 123456789876.5
 987654321234.5
 236084063344.4
 579644789644.7
 405993036906.4
 808686804809.9
 568579369756.8

**Data processing design problem:
 FOOLPROOF FIGURES**

Thanks to the figures above, designed by the NCR Electronics Division, computer systems can now read "on sight" the printed output of cash registers and business machines. As a result, data processing systems have a key to greater speed, efficiency and economy.

A unique double code within the figures eliminates the problem of incorrect readings. This code, by making the characters self-checking, also permits important reductions in the cost and complexity of the reading equipment. Even though ink splashes, skew and weak print conspire constantly to "fool" the system, infallible recognition is now possible with relatively simple equipment — at laboratory speeds to 11,000 characters per second!

CAREERS NOW OPEN IN THESE COMPUTER AREAS:

- SOLID STATE CIRCUIT DESIGN
- TRANSISTOR CIRCUITRY
- SYSTEMS ENGINEERING
- SYSTEMS TEST ENGINEERING
- PRODUCT ENGINEERING
- PRODUCT DESIGN ENGINEERING
- RESEARCH ENGINEERING

Please send resume to Norval E. Powell, Director of Industrial Relations. Interviews may be arranged for the Spring Joint Computer Conference in San Francisco, May 1-3.



The National Cash Register Company
 ELECTRONICS DIVISION
 1401 E. El Segundo Blvd., Hawthorne (Los Angeles), Calif./Phone PL 7-1811

Large production gives you low prices!

— that's why...

Over 100 O.E.M.s
have standardized
on

AMPERITE

Thermostatic DELAY RELAYS

2 to 180 Seconds

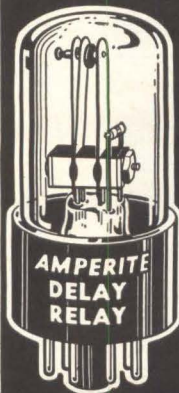

Actuated by a heater, they operate on A.C., D.C., or Pulsating Current.

Hermetically sealed. Not affected by altitude, moisture, or climate changes. SPST only—normally open or closed.

Compensated for ambient temperature changes from -55° to $+80^{\circ}$ C. Heaters consume approximately 2 W. and may be operated continuously. The units are rugged, explosion-proof, long-lived, and—inexpensive!

TYPES: Standard Radio Octal, and 9-Pin Miniature . . . List Price, \$4.00.

Also—Amperite Differential Relays: Used for automatic overload, under-voltage or under-current protection.

PROBLEM? Send for Bulletin No. TR-81

BALLAST REGULATORS

Amperite Regulators are designed to keep the current in a circuit automatically regulated at a definite value (for example, 0.5 amp.) . . . For currents of 60 ma. to 5 amps. Operate on A.C., D.C., or Pulsating Current.

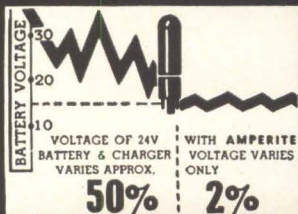

Hermetically sealed, they are not affected by changes in altitude, ambient temperature (-50° to $+70^{\circ}$ C.), or humidity . . . Rugged, light, compact, most inexpensive . . . List Price, \$3.00.

Write for 4-page Technical Bulletin No. AB-51

AMPERITE

561 Broadway, New York 12, N. Y. . . . CAnal 6-1446

In Canada: Atlas Radio Corp., Ltd., 50 Wingold Ave., Toronto 10



TKK INDUSTRIAL MOTORS

Lowest Drain, Minimum Noise,
Longest Life — at Low Cost

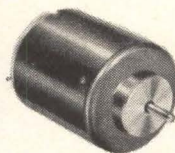

RM-170 T

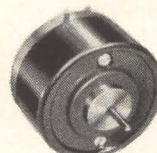

FM-250 R

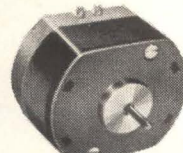

FM-250 N

APPLICATIONS

- * Tape-recorders
- * Record-players
- * Clocks
- * Shavers
- * Music Boxes
- * Cinecameras
- * Turntables
- * Automations
- * Other Appliances

type	voltage (D.C.)
RM-170 T models	1.5 ~ 3.0 V
RM-170 S models	1.5 ~ 6.0 V
RM-170 SC models	3.0 ~ 12 V
FM-250 N models	1.5 ~ 4.5 V
FM-250 R models	1.5 ~ 6.0 V

Large orders executed reliably and on schedule by the world's largest factory specializing in D.C. magnetic low current motors (Output: up to 2½ million units per month!) Your detailed inquiry is invited — your satisfaction guaranteed.

MABUCHI SHOJI K.K.

37, Kabuto-cho 2-chome, Nihonbashi, Chuo-ku, Tokyo, Japan
C.P.O. Box 1084, Tokyo Cables: "NIHONKAKOCO TOKYO"

CIRCLE 200 ON READER SERVICE CARD



Around the world it's **KEW**



MODEL F-98



MODEL EW-16



MODEL P-22



MODEL VR-2P



MODEL VO-38



MODEL TK-20A



MODEL FL-202

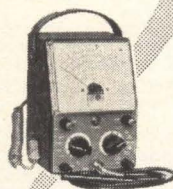

MODEL PV-200

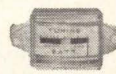

MODEL TR-A

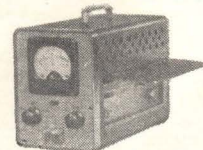

SWR & RF WATTMETER

KYORITSU ELECTRICAL INST. WORKS, LTD.

No. 120, Nakane-cho, Meguro-ku, Tokyo, Japan

Cable Address: "KYORITSUKEIKI TOKYO"

Tel: (717) 0131 ~ 5 • 0151 ~ 3

CIRCLE 201 ON READER SERVICE CARD

electronics

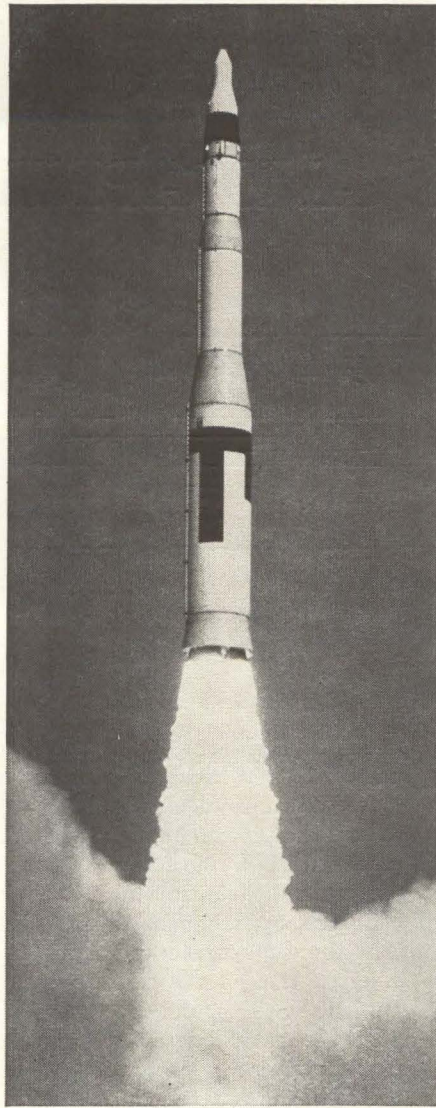

BOEING OPENINGS FOR ELECTRONIC/ELECTRICAL ENGINEERS

Boeing's Aero-Space Division, holder of major contracts on such advanced space programs as SATURN, DYNA-SOAR and MINUTEMAN, has a number of immediate, long-range openings offering professional challenge, and in many instances, unique ground-floor opportunities in newly-formed divisional organizations.

ELECTRONIC/ELECTRICAL engineering assignments are available in many areas, including the design of electronic equipment, the development of improved design techniques, electronic parts, electronic packaging techniques and the design and development of improved electronic systems.

Salaries are commensurate with all levels of education and experience. Minimum requirements are a B.S. degree in any

applicable scientific discipline. Most of the assignments are in the uncongested Pacific Northwest, offering outstanding family living and recreational advantages.



Send your resume, today, to Mr. Carl Anderson, The Boeing Company, P.O. Box 3707-ECG, Seattle 24, Washington. The Boeing Company is an equal opportunity employer.

P.S. Seattle is the scene, April 21 to October 21, of the science-oriented Century 21 World's Fair. The Fair's Boeing-sponsored Spacearium in the Science Pavilion offers simulated flights through outer space. Fair visitors are invited to stop in at the Boeing Professional Employment Information Center, near the Fair's Science Pavilion entrance.

BOEING

Divisions: Military Aircraft Systems • Transport • Vertol • AERO-SPACE • Industrial Products—Boeing Scientific Research Laboratories

DESIGN AND APPLICATION

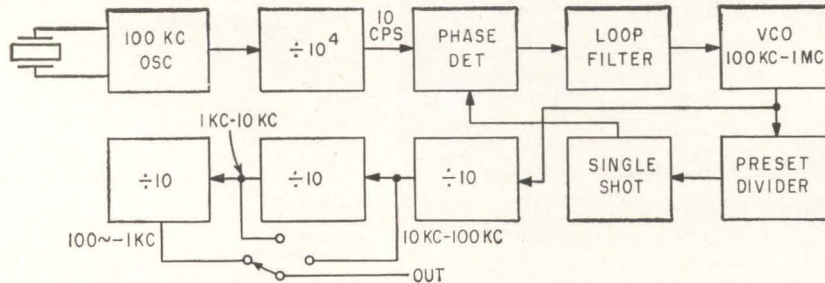

Ultra Stable Oscillator

5 DIGIT SETABILITY

MANUFACTURED by Hull Instruments, 1128 Mission St., South Pasadena, Calif., is the Decalock Oscillator having a frequency range from 0.001 to 999.99 Kc with 5 digit setability and a long term stability of up to 1 part in 10^9 or better. The output is a sine wave with 0-1 v rms or a square wave having 0-10 v rms. It can be used for rapid generation of precise calibration points without the use of a frequency counter. The circuit, shown in the sketch, is basically a phase-coherent frequency multiplier where the input to the loop is a crystal-controlled frequency. The divider is a five decade preset counter preset by

knobs on the front panel. The output of the crystal oscillator is divided down to derive a reference frequency source that is compared to the output of a vco divided by some preset factor. Synchronization of the two comparison frequencies requires that the vco operate at a frequency equal to that of the reference multiplied by a preset factor. Five digit accuracy and setability of the preset divider is then reflected directly in the vco output. Long term stability is a direct function of the reference source. Short term stability of one part in 10^5 is fixed due to noise in the apc loop.

CIRCLE 301 ON READER SERVICE CARD

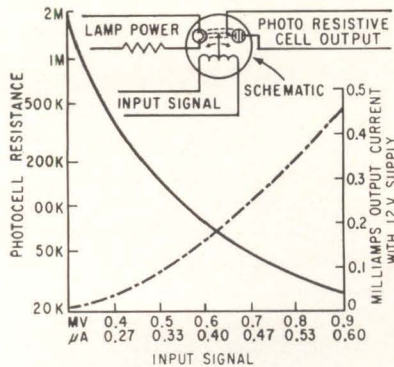

Microsignal Amplifier

WORKS ON LIGHT

ANNOUNCED by F & M Scientific Corp., Starr Rd and Rt 41, Avondale, Pa., is the model 210 micro-

signal amplifier-converter that can be used as either a d-c to d-c amplifier or a d-c to a-c converter. The unit is recommended for all applications where a low-level d-c must be converted and/or amplified. The sketch shows the operating principles. The pointer of a sensitive d-c meter cuts a light beam falling on a photoresistive cell, changing the resistance of the secondary circuit. There is complete isolation between input and output. With 12 v d-c on the photocell, current amplification is over 1,000. Noise level is less than $2\mu\text{v}$ equivalent input with drift less than $5\mu\text{v}$ over four hours. Reproduceability is better than $5\mu\text{v}$ and the device has a time

constant of about one second. Input resistance is 1,500 ohms and basic sensitivity is about 2×10^{-14} watts.

CIRCLE 302 ON READER SERVICE CARD

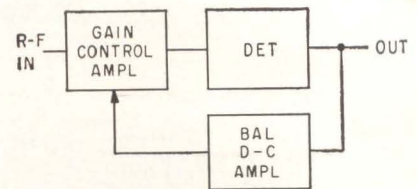

Logarithmic Amplifier

400 KC TO 100 MC

RECENTLY announced by Jerrold Electronics Corp., 15th and Lehigh, Philadelphia 32, Pa., is the model LA-5100 r-f precision log amplifier covering the range between 400 Kc and 100 Mc with dynamic ranges to 90 db. As the sketch shows, the amplifier consists of a nine stage bandpass amplifier, d-c automatic gain control amplifier and detectors for output meter and external oscilloscope use. The system develops the required gain in a precise logarithmic manner to permit total response characteristic of the device under test to be linearly displayed in db on a conventional d-c oscilloscope. There are four calibrated ranges. These are: a linear range equivalent to a 20 db calibrated range, a 0 to 40 db, 0 to 60 db and a 0 to 80 db. Adjustment of linear gain permits uncalibrated linear viewing of the response characteristic down to 80 db. The other ranges are internally calibrated, and have an associated expander function to permit uncompressed or linear viewing of the top 5 db of each range.

CIRCLE 303 ON READER SERVICE CARD

Polycarbonate Resin

GENERAL ELECTRIC CO., 1 Plastics Ave., Pittsfield, Mass. Giving in-

33 REASONS WHY SHALLCROSS MINIATURE SERIES SWITCHES OFFER SUPERIOR PERFORMANCE

UNEQUALED VERSATILITY

1. 24 OR 32 POSITION WAFERS
1 TO 32 POSITIONS SHORTING (SINGLE POLE)
1 TO 16 POSITIONS NON-SHORTING (SINGLE POLE)
2. 4 INDEXING ANGLES SHORTING ($11\frac{1}{4}^\circ$, 15° , $22\frac{1}{2}^\circ$ OR 30°) AND 2 INDEXING ANGLES NON-SHORTING ($22\frac{1}{2}^\circ$ OR 30°)
3. 1, 2, 3 OR 4 POLES PER DECK
4. ADJUSTABLE STOPS
5. UP TO 24 DECKS OR 70 POLES PER SWITCH
6. BUSHING AND TANG (3 BUSHING LENGTHS AVAILABLE) OR TWO HOLE MOUNTING
7. CLUSTER ARM ROTORS FOR PROGRESSIVELY SHORTING OR OPENING ELECTRICAL CIRCUITS WHEN REQUIRED
8. SPRING RETURN ACTION FOR ROTATION IN EITHER OR BOTH DIRECTIONS FROM REST POSITION (UP TO FOUR POLES)
9. DUAL CONCENTRIC SHAFT VERSIONS FOR INDEPENDENT SWITCHING OF 2 SWITCH GROUPS ON ONE SHAFT
10. PRINTED CIRCUIT MOUNTING AVAILABLE FOR LAST DECK
11. REMOVABLE DETENT FOR MOTOR DRIVEN OPERATION
12. AVAILABLE PREWIRED TO REDUCE FINAL ASSEMBLY TIME AND COSTS
13. AVAILABLE WITH GOLD PLATED CURRENT CARRYING PARTS TO REDUCE CONTACT RESISTANCE AND CORROSION EFFECTS
14. AVAILABLE WITH SHAFT SEALS FOR HERMETIC SEAL APPLICATIONS
15. LOCKING MECHANISMS TO PREVENT ACCIDENTAL SWITCH ROTATION (OPTIONAL ACCESSORY)
16. ADAPTABLE TO SOLENOID OPERATION
17. COMPLETE ACCESSORIES (DIALS; KNOBS, REAR MOUNTING BRACKETS AND MISCELLANEOUS HARDWARE)

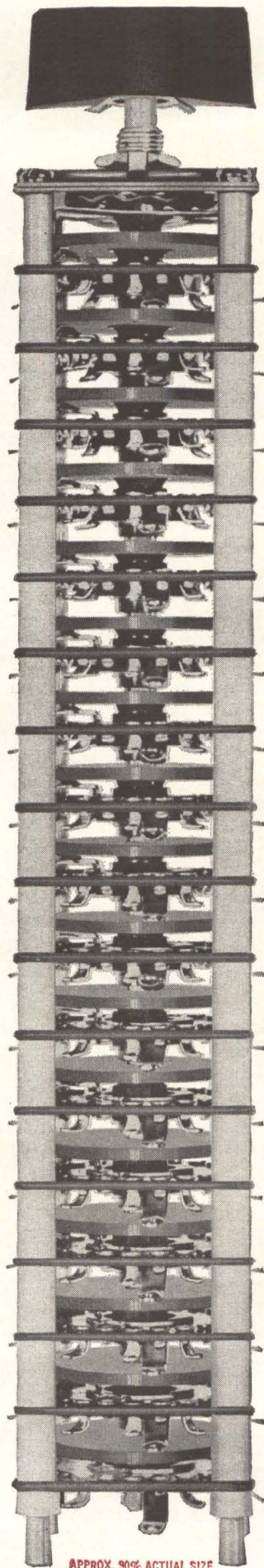

APPROX. 90% ACTUAL SIZE

HIGH QUALITY ELECTRICAL FEATURES

1. INITIAL CONTACT RESISTANCE 2 MILLIOHMS OR LESS
2. CONTACT RESISTANCE STABILITY 1 MILLIOHM FOR 20,000 OPERATIONS
3. INSULATION RESISTANCE OVER 1000 MEG-OHMS BETWEEN CONTACTS
4. NEGLIGIBLE THERMAL EMF (SIMILAR METALS FOR ALL CURRENT CARRYING PARTS)
5. COMPLETELY ISOLATED SHAFT

HIGH QUALITY MECHANICAL FEATURES

1. POSITIVE INDEXING
2. UNCOMPROMISED MATERIAL QUALITY (COIN SILVER TERMINALS AND CONTACTS, SILVER ALLOY ARMS AND COLLECTOR RINGS, GLASS FIBRE EPOXY LAMINATE WAFERS, PASSIVATED STAINLESS STEEL SHAFTS MOUNTING PLATES AND DETENT ASSEMBLIES (MILITARY APPROVED))
3. SELF CLEANING WIPING ACTION
4. MULTIPLE LEAF WIPER ARMS WITH "FLOAT" TYPE WIPING ACTION FOR MAXIMUM CONTACT RESISTANCE STABILITY
5. INTEGRAL CONTACTS AND TERMINALS TO ELIMINATE MECHANICAL JOINTS

COMPACTNESS

1. 1.015" BACK PANEL DEPTH FOR SINGLE DECK SWITCH AND ONLY $\frac{1}{16}$ " FOR EACH ADDITIONAL DECK
2. OVER 650 CIRCUITS CAN BE SWITCHED IN ONLY 38 CUBIC INCHES
3. LIGHT-WEIGHT CONSTRUCTION (79 GRAMS SINGLE DECK SWITCH AND 30 GRAMS EACH ADDITIONAL DECK)

ATTRACTIVE CONVENIENCE FEATURES

1. EXTENDED TERMINAL LUGS FOR EASY WIRING
2. IDENTIFICATION MARKINGS FOR COMMON TERMINALS AND NUMBER ONE CONTACTS
3. INDIVIDUAL "AIR TIGHT" VINYL PACKAGES FOR DUST AND CORROSION FREE STORAGE

**PROTOTYPE SERVICE 1-5 DAYS
PRODUCTION QUANTITIES 1-2 WEEKS**

FOR COMPLETE SPECIFICATIONS ON THIS SWITCH SERIES, MARK READER SERVICE CARD OR REQUEST SHALLCROSS L45-A-1 L45-B

Shallcross

INSTRUMENTS • RESISTORS • SWITCHES • ATTENUATORS • DELAY LINES

reliability

...based
on
experience

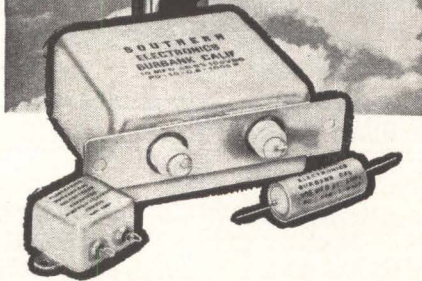

ultra-high precision capacitors

Southern Electronics high-precision capacitors are demonstrating their **proven reliability** today in twelve different missiles, analog computers, and many radar and communications applications.

SEC high-precision capacitors utilize polystyrene, providing .01% tolerances, and mylar and teflon to meet .5% requirements. They show excellent stability characteristics over an extended temperature range, and tolerances are unaffected even at extreme high altitudes.

The unusual accuracy, stability and reliability of **SEC capacitors** are the result of engineering experience concentrated on the design and manufacture of precision capacitors only, plus rigid quality control standards subjecting each capacitor to seven inspections during manufacture, plus final inspection.

Our engineering experience enables us to meet **your** size requirements, while holding to exact capacitance and tolerance specifications.

SEC capacitors are manufactured in a wide range of capacitance to meet your needs from 100 mmfd. to any higher value, and meet or exceed the most rigid MIL-SPECS.

Write today for detailed technical data and general catalog.



SOUTHERN ELECTRONICS Corporation

150 WEST CYPRESS AVENUE
BURBANK, CALIFORNIA

creased miniaturization, Lexan polycarbonate resin is specified for the dielectric body of microminiature 3 amp connectors which feature simplified wire termination, low contact resistance and low noise.

CIRCLE 304 ON READER SERVICE CARD

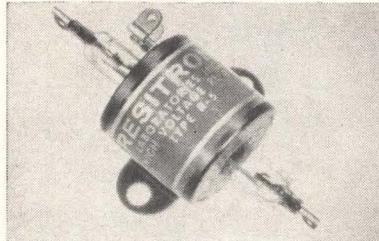

High Vacuum Relay MINIATURIZED

RESITRON LABORATORIES, INC., 2908 Nebraska Ave., Santa Monica, Calif. The Minivac R-5 is capable of switching up to 5,000 v d-c and of handling up to 1,000 v-a. It is actuated by means of a 26.5 v d-c coil. Max length is 2 in. and it is $\frac{3}{4}$ in. in diameter. It weighs 1 oz and is suited for airborne applications and for instrumentation where high reliability is required.

CIRCLE 305 ON READER SERVICE CARD

R-F Connectors TRIAXIAL

GREMAR MFG. CO., INC., 7 North Ave., Wakefield, Mass. Designed for use with triaxial r-f cables, these connectors are a solution to ground loop problems by providing a double shielding and prevent random r-f noise in electronic equipment.

CIRCLE 306 ON READER SERVICE CARD

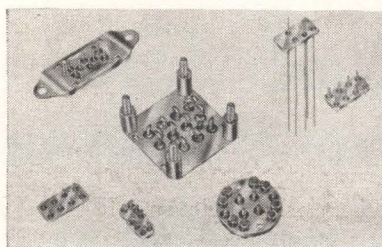

Relay Headers HERMETICALLY SEALED

ELECTRICAL INDUSTRIES, 691 Central Ave., Murray Hill, N. J. These headers, featuring rugged compres-

sion seals, can be produced to exact specifications to meet practically any type of relay application. Brazed contacts are available if required. Standard finishes available include hot solder dipped, electro-tin, nickel and gold. Special plating on order. Special headers featuring spaded wire leads, can be supplied at lower cost than round types. Spaded pins are precision formed.

CIRCLE 307 ON READER SERVICE CARD

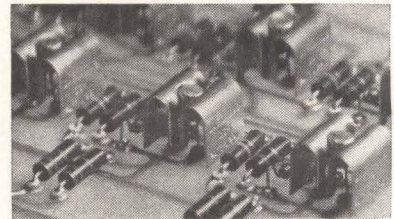

Heat Sink FOR P-C APPLICATION

DAEDALUS CO., 21901 DeLaGuerra St., Woodland Hills, Calif. Part No. CS-1 Clipsink is designed for the TO-18 transistor case. Being a single piece copper stamping, it provides extensive cooling surface within a small volume. Design permits the use of pure copper of the highest thermal conductivity. The CS-1 requires p-c board space of $\frac{1}{2}$ in. by $\frac{1}{2}$ in. with a total height of less than $\frac{1}{8}$ in. Completed assembly is proof against extreme conditions of shock and vibration. In still air the CS-1 lowers external thermal resistance of the transistor to less than 50 C/w; in moderately moving air, to less than 15 C/w.

CIRCLE 308 ON READER SERVICE CARD

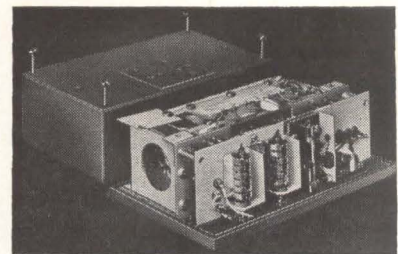

Airborne Oscillator CRYSTAL CONTROLLED

REEVES HOFFMAN DIVISION, Dynamics Corp. of America, Carlisle, Pa. Model S-1397 is a highly rugged oscillator that will withstand acceleration of 11 g, shock of 20 g, vibration at 5 g from 1 to 500 cps, altitude up to 55,000 ft and oper-

ating temperature in the range from -55°C to 100°C . It contains an oven-controlled crystal and transistor oscillator, plus cathode follower and grounded grid amplifier.

CIRCLE 309 ON READER SERVICE CARD

Quartz Crystal GLASS MOUNTED

BLILEY ELECTRIC CO., Union Station Building, Erie, Pa. In primary standards, this glass mounted, optically polished, gold-plated fifth overtone quartz crystal at 2.5 Mc provides a stability of 1 part in 10^9 with aging of only 5 parts in 10^{10} . Known as Bliley type BG11AH-5, the average Q is 4,500,000.

CIRCLE 310 ON READER SERVICE CARD



Test Set DIRECT READING

DYNATRAN ELECTRONICS CORP., 178 Herricks Road, Mineola, N.Y. Model 1818A provides direct readings of the 100 Mc gain for both *nnp* and *pnp* transistors; also provides direct readings of the gain bandwidth product up to 1,000 Mc. Instrument features a high impedance 100 Mc current source and a very low impedance 100 Mc collector load. Price is \$840.

CIRCLE 311 ON READER SERVICE CARD

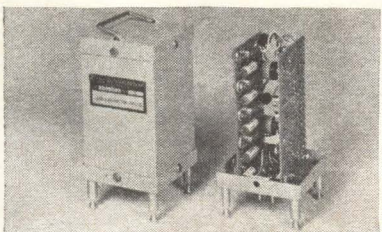

Signalling Device HIGH-SPEED

RIXON ELECTRONICS, INC., 2121 Industrial Parkway, Montgomery In-

April 13, 1962

FOR PROJECT MERCURY THE TERMINAL COMMUNICATION EQUIPMENT IS ROANWELL

-Because high intelligibility between sender and receiver is a necessity in space communications.

Since 1948 Roanwell has manufactured and supplied high quality **Headsets, Handsets, and Noise-Cancelling Microphones** for use in aircraft, submarines, with ship-to-shore single sideband systems, sonar and doppler radar, and underwater mine detectors. Roanwell terminal communication equipment is used in most of the missile and space programs such as Project Mercury, X15, the Atlas, Minuteman, Saturn, Jupiter, Pershing and Redstone.

Roanwell's high reputation in this field comes from specialized technical "know-how," manufacturing integrity and product adaptability that permits us to meet our customers' most rigid specifications. For reliable terminal communication equipment, contact Roanwell. Write for catalog

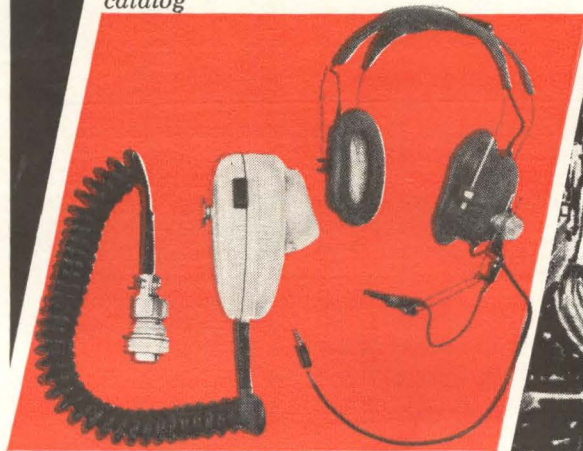

Prime authority in electro-acoustic devices

ROANWELL CORPORATION

ROANWELL BUILDING
180 Varick Street, New York 14, N. Y.
212 YUkon 9-1090 TWX NY1-478



CIRCLE 97 ON READER SERVICE CARD

97

FOR TIME FOUR

ALL FOUR IRIG FORMATS ON ONE COMPACT CHASSIS WITH EECO 811 TIME CODE GENERATOR

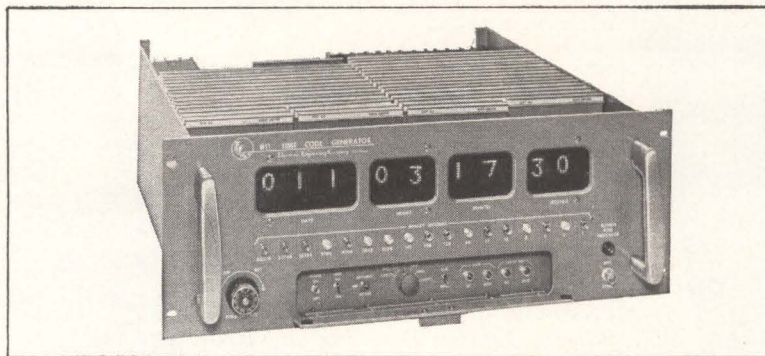

EECO 811 IRIG FORMATS

	A	B	C	D
Time Code Format	34 Bit BCD Code identifying days, hours, minutes, seconds and 1/10 seconds and a 17-bit binary code identifying time of day in seconds.	30 Bit BCD Code identifying days, hours, minutes, seconds and a 17-bit binary code identifying time of day in seconds.	23 Bit BCD Code identifying days, hours and minutes.	16 Bit BCD Code identifying days and hours.
Code Frame Length	0.1 second	1 second	1 minute	1 hour
Code Scan Rates	1000 pps	100 pps	2 pps	1 ppm
Code Carrier Frequency	10 kc	1 kc	1 kc or 100 cps (switch selection)	1 kc or 100 cps (switch selection)

An all solid state, card construction, precision "metronome" for the most demanding range or laboratory instrumentation. Supplies all four serial IRIG time-code formats with an accuracy of better than 1 second a month. Frequency stability is 1×10^{-8} per day at laboratory temperatures; 3×10^{-5} per day throughout entire operating range of -20°C to $+55^{\circ}\text{C}$. Parallel code output. 10 pps and 1 pps synchronizing pulses. Synchronizing pulse for controlling external control element scanner. Both digital and resolver time shift for fast, accurate synchronization with WWV or other time standard. Operates on 115v ac $\pm 10\%$, 50-400 cps, 1 amp, with power supply on same chassis.

Specify small (7" x 19" x 17"), light (32 pounds) EECO 811 Time Code Generator as the heart of your instrumentation and be assured of accurate time correlation. Investigate EECO's new reduced prices on various models of timing equipment.



Electronic Engineering Company of California

1601 E. Chestnut Avenue, Santa Ana, California • KImberly 7-5501. P. O. Box 58

Representative in Western Europe and Israel: Electronic Engineering S.A., C.P. 142, Fribourg, Switzerland

EE 1-36R

dustrial Park, Silver Spring, Md. The SCR601 semiconductor relay is a high-speed, solid state switch for controlling signal currents in teletypewriter and similar circuits. Its complete freedom from mechanical adjustment eliminates expensive service and maintenance costs. Its absence of radio interfering radiation makes it useful in many applications where a mechanical relay's interference was intolerable.

CIRCLE 312 ON READER SERVICE CARD

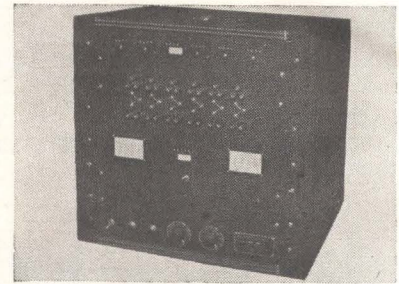

Relay Tester

DRY-CIRCUIT

FLEETWOOD LABORATORIES INC., 35 Rockwood Place, New Rochelle, N. Y. Models R-5 and R-6 feature cycling speeds down to 2 and up to 300 cycles per minute. When requested, two-phase cycling of relay coils is provided, so that latching or bi-polar relays may be tested. Sensitivity can be as high as 80 μv , so that contact resistance down to 80 ohms at 1 μa of current may be detected, in model R-6. Also featured are quiet operation and automatic shutdown in case of miss detection.

CIRCLE 313 ON READER SERVICE CARD

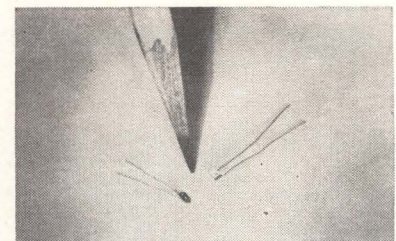

Thermistors

VARIED SHAPES

GULTON INDUSTRIES, INC., 212 Durham Ave., Metuchen, N. J., offers wafer, disk, washer, rod and bead configuration thermistors. They are supplied in resistances from 1 ohm to 1,000 megohms and in a range

of temperature coefficients of resistance from -3.4 percent per deg C to -6.8 percent per deg C. The wafer type is used in missile and satellite applications. Smallest wafer presently made by the company is 0.6 in. square.

CIRCLE 314 ON READER SERVICE CARD

Silicon Rectifiers

INTERNATIONAL RECTIFIER CORP., 1521 E. Grand Ave., El Segundo, Calif. Ten flangeless diffused junction rectifier types provide 2 amp d-c output, voltage range from 50 to 1,000 v prv.

CIRCLE 315 ON READER SERVICE CARD

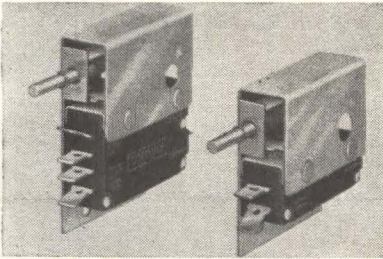

Snap-Acting Switches

D-P AND S-P

UNIMAX SWITCH, Ives Road, Wallingford, Conn. Low-cost snap-acting switches, with ratchet-drive plunger mechanism that gives alternate-stroke operation, provide convenient, single-button control of loads up to 15 amp 125/250 v a-c and up to $1\frac{1}{2}$ h-p at 250 v a-c. Both dpdt and spdt switches are available in this design, which is suitable for manual, mechanical, or solenoid operation.

CIRCLE 316 ON READER SERVICE CARD

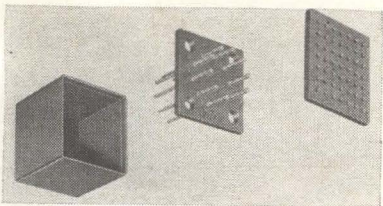

Module Case Header & TERMINAL BOARD

GRAYHILL MOLDTRONICS, INC., 229 Burlington Ave., Clarendon Hills, Ill., offers the 3B2143 miniature module case with mating 3B2040-1 Deci-board, or 3YY2039 header

CIRCLE 99 ON READER SERVICE CARD →

P. I. recorder stars in command performance aboard Discoverer/Agna

Upon command, an instrumentation tape recorder goes into instant action aboard the Agna satellite used in the Air Force's Discoverer program. After recording way-out scientific data, the 100-ounce recorder brings it down to earth in a hurry by playing back eight times as fast as it records. And by recording in one direction, playing back in the other, the recorder bypasses the usual rewind function . . . not only saving time and payload weight, but also permitting a simplicity in design which insures extreme reliability. ■ This remarkable instrument, the 3-channel Precision PS-303L, is a veteran performer on the orbital circuit and has contributed significantly to the Discoverer program.

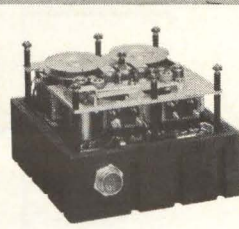

PS 303L Recorder

Despite the fact that it was designed* to function under extreme environmental conditions, it offers performance capabilities comparable with those of much larger, earth-bound recorders. Frequency response, for example, is 5 kc at a recording frequency of only $1\frac{1}{2}$ ips. ■ When your next project involving data acquisition is ready for orbit, we suggest you investigate the P.I. approach to the problems involved.

The P.I. concept of full-size performance in a fraction of the space is already saving important dollars in hundreds of applications, from monitoring missiles to recording infra-red, from gathering geophysical shock data to simulating radar signals. Write today for the current P.I. brochure.



PRECISION INSTRUMENT

1011 Commercial St., San Carlos, Calif. LYtel 1-4441 TWX: SCAR BEL 30
Representatives in principal cities throughout the world

*for Lockheed Missiles & Space Company, Sunnyvale, California

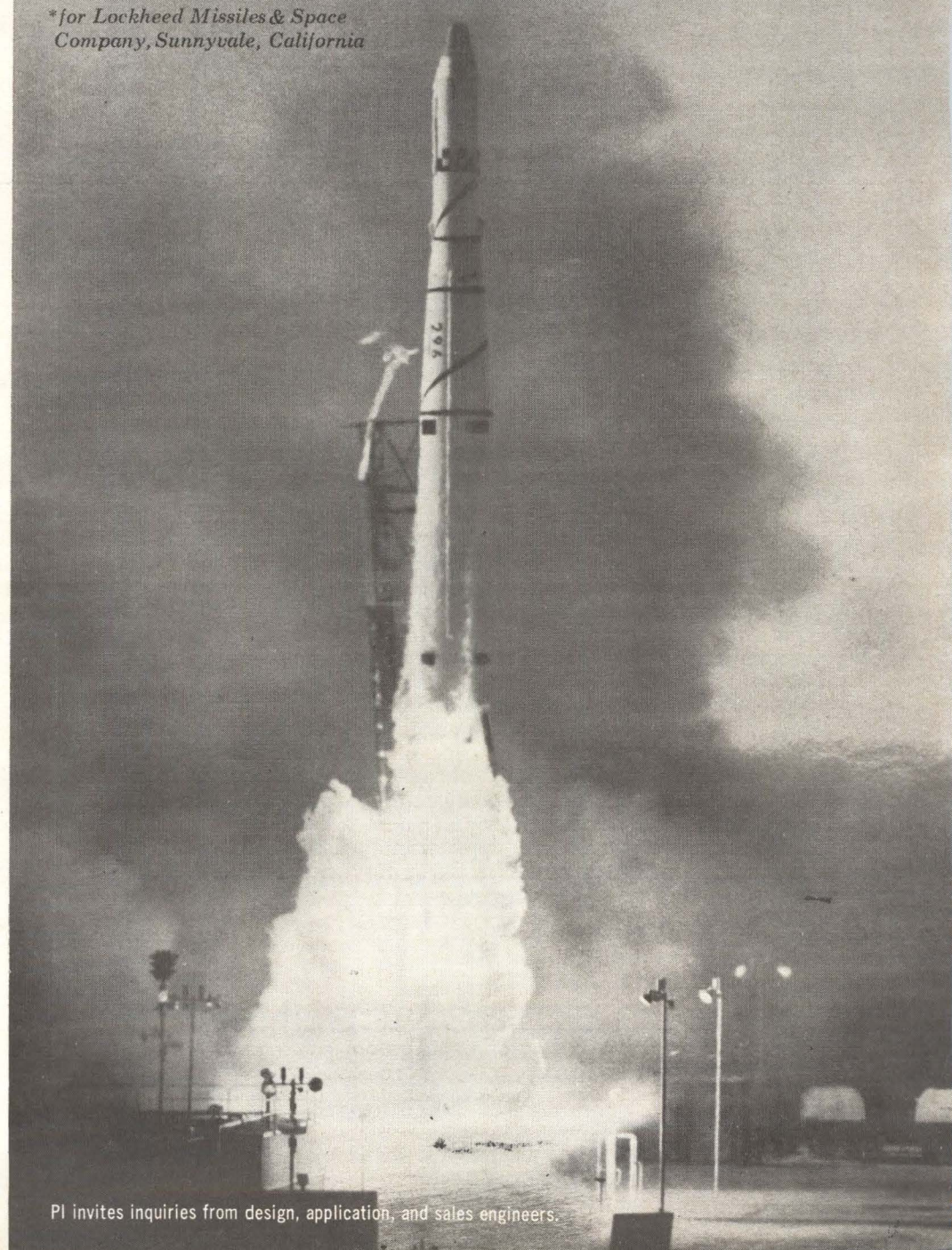

PI invites inquiries from design, application, and sales engineers.

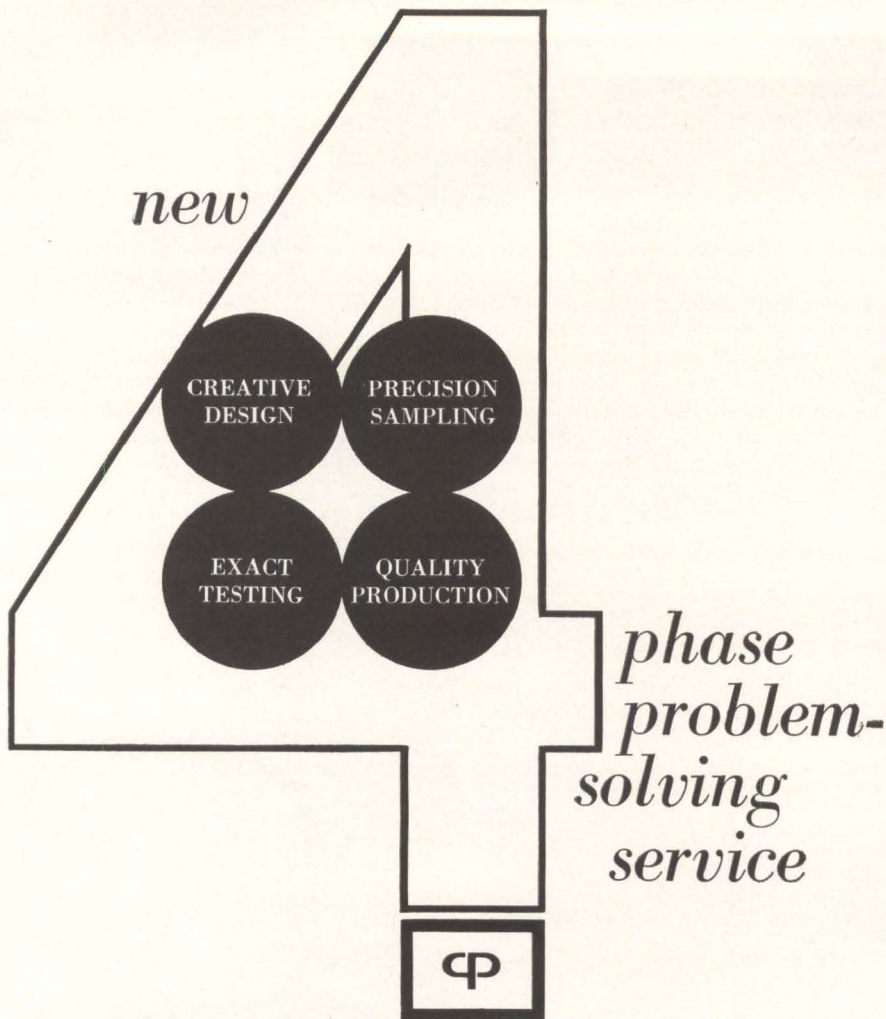

CP Electronics specialists provide a 4-phase service for electromagnetic component design, engineering and manufacturing. Specialized service in new product development is the key to achieving the full capabilities of your end products or sub-assemblies. Electromagnetic components must be custom-designed and produced to meet your individual specifications. At CP, years of experience in the development of power and audio amplification components have led to close engineering that converts design into high-quality components with specific tolerances. The all-new CP Electronics Research and Development Laboratory at West Lafayette, Indiana stands ready to serve you, as do CP's complete testing and production facilities. For the custom components you require . . . for greater depth in new product, new technique engineering . . . investigate CP's 4-phase problem-solving service soon!

Write for actual examples of how CP's 4-phase problem-solving service has worked for others. For example, each year CP's facilities account for large-scale manufacturing of laminated iron-cored transformers and inductors with open, encapsulated or hermetically sealed construction and insulation allowing temperature ratings to 130° C. These are utilized at both power and audio frequencies with versions available for pulse transformer applications where pulse widths are in the microsecond range and PRF in the audio range.



CP ELECTRONICS, INC.

(FORMERLY COLUMBUS PROCESS COMPANY, INC.)

COLUMBUS, INDIANA • PHONE 812-372-4471

- Manufacturers of Electro-Magnetic Components for Audio Amplification
 • Telemetering • Radio, TV, HiFi, Stereo • Civilian Broadcast Equipment
 • Specialty Power Supplies

Case is 0.750 deep over all by 0.840 square. Header is available with either 9 or 10 pins. Header pins are on a 0.468 circle of centers for a standard 9-pin miniature tube socket for plug-in applications. The Deci-board has 49 flash covered holes on 0.100 in. grid. All that is required is to punch out the desired holes, and the remainder stay sealed.

CIRCLE 317 ON READER SERVICE CARD

Dielectric Sheets

CUSTOM MATERIALS, INC., Alpha Industrial Park, Chelmsford, Mass., has available Custom High-K 707S, copper clad dielectric sheets with a range of dielectric constants from 2.5 to 25.

CIRCLE 318 ON READER SERVICE CARD

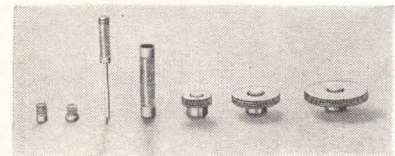

Bellows Contacts

HIGHLY RELIABLE

SERVOMETER CORP., 222 Main Ave., Passaic, N. J., offers a line of bellows contacts that serve as noninductive springs for electronic assemblies, provide repeatability for any number of re-assemblies, and have low microwave resistance and d-c electrical resistance. Manufactured of nickel metal, they are 24 carat gold surface plated 0.00004 in. thick, providing excellent contact and microwave characteristics.

CIRCLE 319 ON READER SERVICE CARD



Digital Voltmeter

HIGH STABILITY

DYMEC, a Division of Hewlett-Packard Co., 395 Page Mill Road, Palo Alto, Calif. The DY-2401A integrating digital voltmeter features fully floated and guarded input and measuring circuitry, in combina-

tion with an integration process to provide an effective 140 db common mode rejection at all frequencies, including d-c. The integrating technique provides an average reading of the input voltage over a selected, crystal-controlled sample period. Price is \$3,950.

CIRCLE 320 ON READER SERVICE CARD

Electronic Counter

BECKMAN INSTRUMENTS, INC., Berkeley Div., 2200 Wright Ave., Richmond 3, Calif. Model 8370, a 10 Mc counter, displays digital data in electroluminescence. Price is \$2,175.

CIRCLE 321 ON READER SERVICE CARD

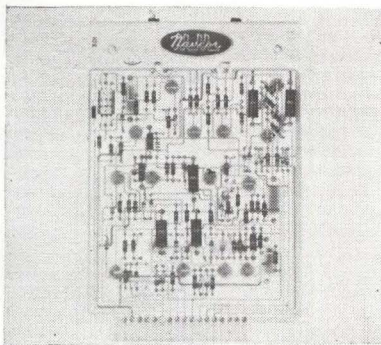

Gated Clock

BUILDING MODULE

NAVIGATION COMPUTER CORP., Valley Forge Industrial Park, Norristown, Pa. As the heart of a 0.1 percent analog-to-digital converter, model 301 contains a gated 100 Kc oscillator, a master reset generator, gating to provide set and reset strobe pulses, and a sign flip-flop. Price is \$183.

CIRCLE 322 ON READER SERVICE CARD

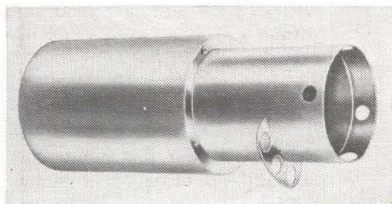

Magnetic Shield

FOR DISPLAY TUBES

MAGNETIC SHIELD DIV. Perfection Mica Co., 1322 N. Elston Ave., Chicago 22, Ill., has developed a Netic Co-Netic magnetic shield for close fit and retrofit display tube applications. All exposed edges of the dual lamina shield are completely sealed

April 13, 1962

DOUBLE
THROW
DRG-DTH

HAMLIN
magnetic reed
SWITCHES



SEE IT! HEAR IT!



FREE CARD

with magnet
and switch

the largest selection
ever offered...

The use of magnetic reed switches has been increasing by leaps and bounds, and Hamlin engineers have set the pace with the greatest selection. All standard varieties, of course, plus...

- DRM-001 High Voltages (up to 5000 V)
- DRG-DTH Double Throw (Form C)
- DRR-5 Heavy Duty (up to 50 V amp.)
- DRS-5 Heavy Thrust (in-rush to 15 amp.)
- HRC-1 No-Bounce (Mercury wetted)

and many more designed for special requirements... **YOUR** specifications. Send for literature.

HAMLIN INC

Dept. EL • LAKE AND GROVE STREETS • LAKE MILLS, WISCONSIN

MINIATURE DRY REED SWITCHES

MRG-15 with 10¹⁵ insulation resistance. Illustration same size — for miniaturization and long life.



ELECTROLYTIC POTENTIOMETERS

EP Series for gravity sensing in gyroscope correction devices. Extremely accurate.



MERCURY SWITCHES

Many design ideas. Super-sensitive. Huge selection, variety combinations. Custom design on request.

YOUR SOURCE FOR *Engineered* SWITCHES

CIRCLE 103 ON READER SERVICE CARD 103

NEW 1/2" SQUARE METAL FILM TRIMMER POTENTIOMETER

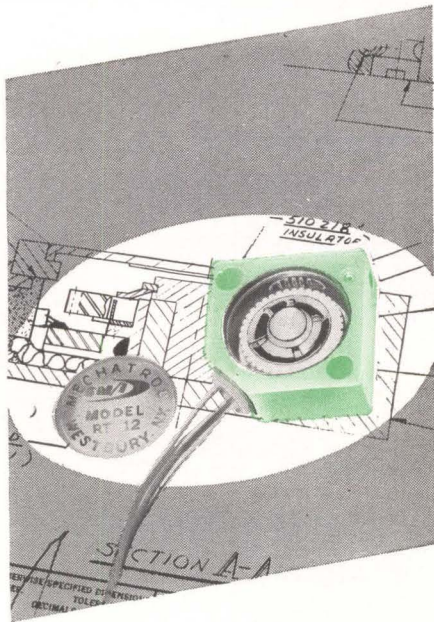

Engineered for:

- Low Cost
- Infinite Resolution
- Low Temperature Coefficient
- High Temperature Performance
- Conformance to Mil-R-22097 A

Data Sheets
Available

CALL OR WRITE FOR DETAILS



SERVOMECHANISMS/INC.

MECHATROL DIVISION

NEW YORK—Home Office
1200 Prospect Avenue
Westbury, New York
Area Code 516—EDgewood 3-6000
TWX WBRY 359

CALIFORNIA—Branch Office—Mechatrol of Calif.
200 North Aviation Boulevard
El Segundo, California
Area Code 213—ORegon 8-7841
TWX HAWCAL 4262

by a new fusion process. The sealed edges prevent electroplating solution from collecting between the laminates, eliminating possibility of corrosive activity starting at a future date.

CIRCLE 323 ON READER SERVICE CARD

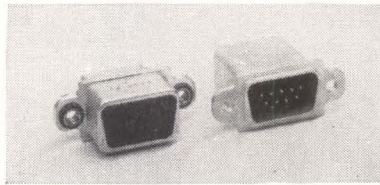

Subminiature Plug

MEETS MIL-C-8384

CANNON ELECTRIC CO., 3208 Humboldt St., Los Angeles 31, Calif. The DEDR is a sealed version of the rectangular D subminiature plugs, and is sealed by a grommet that is cemented to the insulator. This eliminates need for potting, and the crimp snap-in contacts can be easily installed or replaced without damaging the seal, thus cutting installation and maintenance time. Contacts are a copper alloy with a gold or silver plating, and are spaced on 0.108 in. centers.

CIRCLE 324 ON READER SERVICE CARD

Gold Alloy Preforms

ALPHA METALS, INC., 56 Water St., Jersey City 4, N. J., has available a new series of Au/Ge and Au/Si alloys in washers, disks, rectangles and spheres.

CIRCLE 325 ON READER SERVICE CARD



Dual Power Supply

SOLID STATE

MODERN DESIGN, Div. of H. C. Schloer Inc., Vestal, N. Y. The 121D provides two independent outputs of either 12 or 15 v d-c at 1 amp in a package of approximately 7 by 7 by 4 1/2 in. The desired voltages are obtained by inserting the proper circuit-regulating card for

VITREOSIL® PURE FUSED QUARTZ

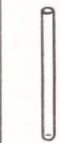
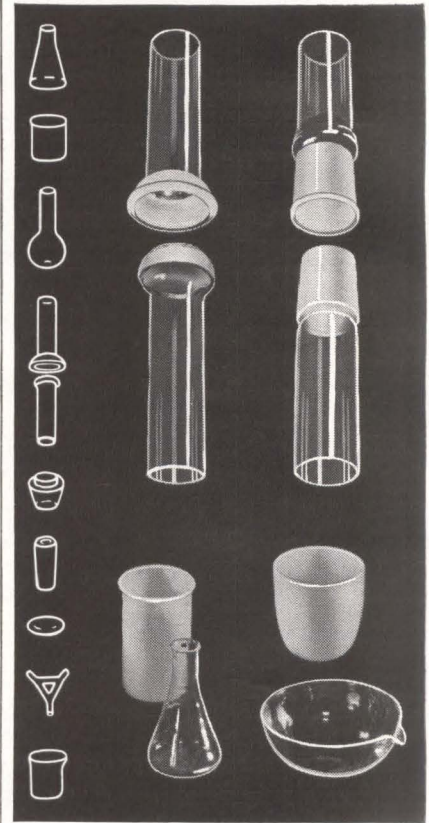

For use in Production of Semi-Conductor Metals

VITREOSIL pure fused quartz can take temperatures in excess of 1000°C and is unaffected by more acids than glass, platinum, or porcelain. Comes in tubes, rods, sheets, and blocks for lenses, laboratory and industrial ware, special fabrication etc. Our know how enables us to hold close tolerances; and metal to quartz seals are a production item.

SPECTROSIL®, the purest form of quartz known, is recommended where the optimum is required in semi-conductor work. Spectrosil has unique qualities in purity, transparency and homogeneity — fabrication the same as Vitreosil — in clear only.

For more details see Chemical Engineering Catalog, Electronic Engineers Master, or write for our 32 page catalog.

**THERMAL AMERICAN
FUSED QUARTZ CO.**

RT. 202 & CHANGE BRIDGE RD.
MONTVILLE, NEW JERSEY

CIRCLE 202 ON READER SERVICE CARD

electronics

each output. Simple to remove and install, the glass epoxy cards speed trouble-shooting and offer maximum maintenance ease. Module is designed for I-v transistor and solid state computer applications and is packaged for easy access to components.

CIRCLE 326 ON READER SERVICE CARD

Pulse Counter

PRESIN CO., INC., 2014 Broadway, Santa Monica, Calif. Model F108 electromagnetic pulse counter has a life of 1 billion steps and a maximum counting rate of 100 pulses per sec.

CIRCLE 327 ON READER SERVICE CARD

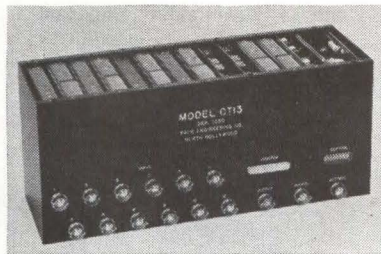

Subcarrier Oscillator

MODULAR SYSTEM

PACE ENGINEERING CO., 13035 Saticoy St., N. Hollywood, Calif. Model CT 13 universal subcarrier oscillator system accepts inputs from a number of transducers and other input devices for f-m/f-m telemetry. Use of modular construction with plug-in function cards minimizes the complications and cost in problems involving a variety of physical measurements.

CIRCLE 328 ON READER SERVICE CARD

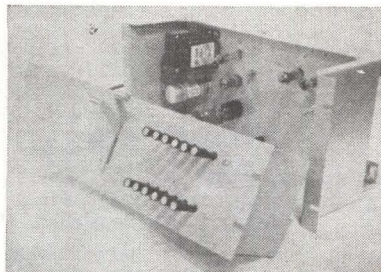

Switcher-Fader

FOR C-C TV USE

NASSAU LABORATORIES, 29 Haven Ave., Port Washington, N. Y. Model SF-1, switcher-fader is capable of

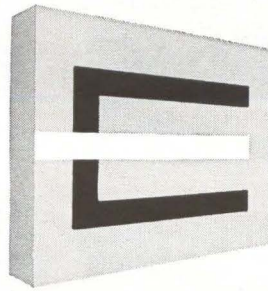

ESTERLINE ANGUS

*Whatever you need to record, you need reliable instruments**

***Dependable, trouble-free performance over a wide range of applications has won for Esterline Angus instruments the highest reliability rating in the industry.**

Let this broad experience work for you in recording Microamperes, DC; Milliamperes, DC; Amperes, AC and DC; Volts, AC and DC; Watts, AC and DC; KVA, KVAR; Frequency, Events, Speed, Position, Motion, Pressure, Vacuum, or whatever *your* needs may be.

Put your confidence, also, in typical new Esterline Angus designs and applications shown below. You'll find them to be versatile, compact, reasonably priced, and—above all—*reliable*.

New "602" Two-channel Recorder • Simultaneously records two variants on adjacent 2"-sections of single 6"-wide chart. Applications: checking current and voltage, quality determination of arc welds, records of input vs. output.

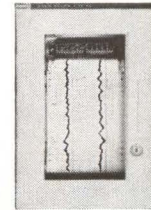

New Analog-Event Recorder • One instrument does the work of two . . . simultaneously records analog data and up to 8 channels of event information on single 6"-wide chart. Applications: wind speed and direction, substation bus voltage and breaker operation, rate of production (speed) and conveyor operation.

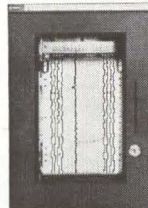

New "620" Event Recorder with Tempen • Writes without ink, using electrically-heated styluses. Simultaneously records "when," "how long" and "how many" on as many as 20 channels. Applications: productive and non-productive time of any or all machines in a plant, circuit breaker action, qualitative analysis, missile performance.

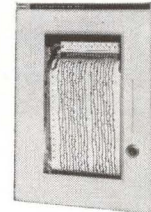

New Expanded Scale Voltmeter • Provides increased readability of voltage records as upper ¼ of voltage range is expanded to fill upper 80% of chart span. Applications: checking voltage regulation, voltage records, trouble-shooting.

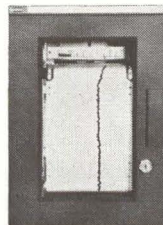

Available in portable, wall, flush and projection mounting switchboard cases. Contact your nearby EA representative for more detailed information. You'll find him listed in Yellow Pages under Recording Instruments—Industrial and Scientific. Or write us direct, telling us the special data you wish to record:

ESTERLINE ANGUS

Instrument Company, Inc., Box 596E, Indianapolis 6, Indiana

Excellence in graphic recording for over 50 years

TEST AND CHECK-OUT TEMPLATE MAKES COMPLEX EQUIPMENT SEEM SIMPLE

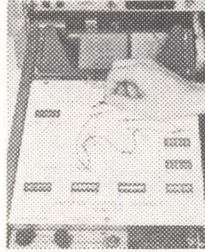

The Problem:

Verification of proper operation of modern electronic equipment can be a very formidable problem. Status lamps and indicators, automatic check-out routines and operator training programs are employed with varying degrees of success. Lamps and check-out routines require additional equipment which is frequently quite sophisticated and complex itself, to monitor and confirm proper performance. Personnel turnover and other problems make training programs of any complexity an expensive and uncertain solution. There has been a need for a simple, foolproof check-out system which does not add to the equipment complexity or require special training for its use.

The Solution:

The illustration shows a test or check-out template for the Sebit-24 Data Modem. The Sebit-24 is laid out with permanent test points for strategic circuit locations along the top of the individual circuit modules. There are approximately 300 such points to provide for complete and detailed check-out and analysis. The test template controls access to those points which provide key information for a particular check-out and graphically shows the oscilloscope pattern which represents normal operation. By following the arrow from point-to-point the performance can be verified and improper performance isolated. Various templates can be employed for progressively more complex procedures without requiring any special knowledge of the system other than the use of the templates.

The application of this technique to a variety of electronic equipment is a current program at Rixon. A letter or phone call will make our experience available to you.

RIXON

ELECTRONICS, INC.

TELEPHONE: 622-2121 TWX: S-SPG 213

2121 INDUSTRIAL PARKWAY MONTGOMERY INDUSTRIAL PARK SILVER SPRING, MARYLAND

CIRCLE 203 ON READER SERVICE CARD

continuous, heavy broadcasting operation. In application, it permits the director to change the transmitted picture from one camera to another in a smooth fade or lap-dissolve without interference, without picture interruption and with full control of picture level. All fades go to black when no picture is present. Unit contains illuminated push buttons for selection of the cameras to be switched.

CIRCLE 329 ON READER SERVICE CARD

Pressure Controller

MICRO GEE PRODUCTS, INC., 6319 W. Slauson Ave., Culver City, Calif. Model 57Q is an all solid-state pressure controller that combines both electronic and pneumatic servo loops into a compact control instrument.

CIRCLE 330 ON READER SERVICE CARD

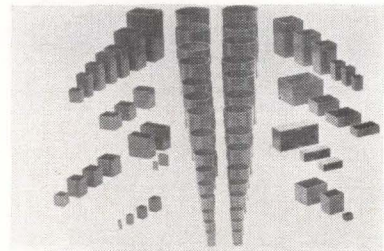

Plastic Cups

FOR ENCAPSULATION

ELECTRONIC PRODUCTION & DEVELOPMENT, INC., 501 N. Prairie Ave., Hawthorne, Calif., offers a line of EC high temperature resistant plastic cups. All are compression molded using flameproof glass-fiber filled diallyl-phthalate material approved under MIL-M-19833-GDI-30F.

CIRCLE 331 ON READER SERVICE CARD

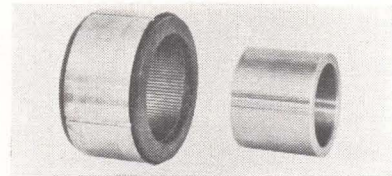

Torque Motor

THREE PHASE

CURVIN DEVELOPMENT CO., 13735 Saticoy St., Van Nuys, Calif. Model 120, a 60 cycle 3 phase torque motor, produces stall torque in excess

EICO® PUTS THE BEST IN CREATIVE ELECTRONICS INTO YOUR HANDS



Send for **FREE** Catalog

28 pages of professional electronic equipment in kit and wired form—for Lab . . . Line . . . Home

EICO, 3300 N. Blvd., L.I.C. 1, N. Y. E-4A
 Send free 32-page catalog & dealer's name.
 Send new 36-page Guidebook to HI-FI for which I enclose 25¢ for postage & handling.

Name _____
 Address _____
 City _____ Zone _____ State _____

EICO® 3300 N. Blvd., L.I.C. 1, N. Y.
 Export Dept., Roburn Agencies
 431 Greenwich St., N. Y. 13, N. Y.

VARIABLE CONDENSER

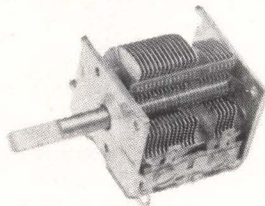

3 types; AM, AM-FM, FM.
 2 gang, 3 gang, 4 gang.

PLASTIC INSULATED VARIABLE CONDENSER

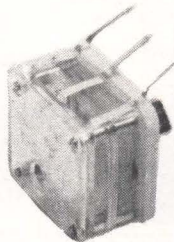

Square Sizes:
 15mm., 17mm.,
 20mm., 21mm.,
 24mm.,
 Single band,
 2 band, 3 band
 and for FM only.



SANKAISHA CO., LTD.

Cable address: SANESUVARICON TOKYO
 1425, 4-chome, Higashinakano, Shinagawa Ku, Tokyo, Japan.

CIRCLE 204 ON READER SERVICE CARD

of 10 lb ft. It is 7½ in. in diameter by 4½ in. long and has a 4 in. diameter hole through the rotor. It is a 32 pole induction motor with a no load speed of approximately 225 rpm.

CIRCLE 332 ON READER SERVICE CARD

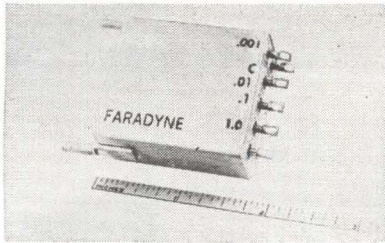

Multiple Capacitor

HERMETICALLY SEALED

GULTON INDUSTRIES, INC., 212 Durham Ave., Metuchen, N. J., announces a Faradyne Mylar capacitor with values of 1 µf, 0.1 µf, 0.01 µf and 0.001 µf within a single unit. Tolerance on these values within one unit is ±0.25 percent. Use of the Faradyne unit in oscilloscopes and other instruments can eliminate the need for employing potentiometers, which are usually required to adjust to the desired RC constant.

CIRCLE 333 ON READER SERVICE CARD

Coil Winder

FULLY AUTOMATED

GEO. STEVENS MFG. CO., INC., Pulaski Rd. at Peterson, Chicago 46, Ill. Model 518-RW, a 6 station indexing machine, winds multilayer coils as well as single layer coils, close, space wound, linear or non-linear coils.

CIRCLE 334 ON READER SERVICE CARD

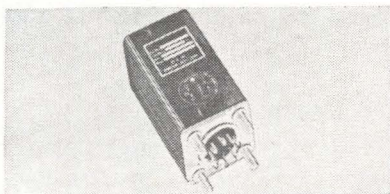

Voltage Sensor

STUD MOUNTED

HI-G, INC., Bradley Field, Windsor Locks, Conn. Standard line of voltage sensors will accommodate a voltage to be sensed of 17 v d-c to

April 13, 1962

AIRPAX

MICRO-MIDGET

LOW NOISE

CHOPPERS

Electrical noise, always a problem in highly sensitive circuits, has been brought to an irreducible minimum by these micro-midget electromechanical choppers. Even at high impedance levels, the noise is down in the random noise level region. Chopper life is at least two thousand hours and the units withstand 100 G shock.

The miniaturization achieved in these electromechanical choppers was not merely a matter of shrinking all parts — a completely new operating principle was designed and developed by Airpax. The manufacturing processes require the ultimate in precision, yet when encased, these choppers have all of the ruggedness and stability of larger types.



MODEL 30



MODEL 33



MODEL 36

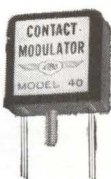

MODEL 40



MODEL 43



MODEL 46

- Model 30, a natural for printed circuits, weighs only 9 grams. Size: 21/64" x 21/32" x 5/8".
- The drive coil leads are brought out the top of the Model 33 can, further reducing the possibility of noise pickup.
- The center-tapped 60 CPS drive coil of the Model 36 facilitates transistor drive in totally transistorized circuits.
- Model 40, employing 400 CPS drive is well-suited for printed circuit and transistorized uses.
- Model 43 noise (chopper plus system) does not exceed 0.56 uv at 100 ohms load, 400 CPS! Capacitive coupling — too small to measure.
- Model 46, for use in 400 CPS transistor drive circuits, has a maximum noise level of 0.65 uv at 100 ohms load, 400 CPS.



CAMBRIDGE DIVISION • CAMBRIDGE, MARYLAND

ALL MODELS
AVAILABLE
IN
PRODUCTION
QUANTITIES!

CIRCLE 107 ON READER SERVICE CARD

107

This announcement is neither an offer to sell nor a solicitation of an offer to buy these securities. The offer is made only by the Prospectus.

\$50,748,200

Litton Industries, Inc.

3½% Convertible Subordinated Debentures

Due April 1, 1987

(To Bear Interest from April 9, 1962)

Convertible into Common Stock at \$160 per share to and including April 1, 1972, and at increasing prices thereafter.

The Company is offering to the holders of its Common Stock and its outstanding Convertible Securities the right to subscribe for the Debentures, subject to the terms and conditions set forth in the Prospectus. The Subscription Offer will expire at 3:30 P.M., Eastern Standard Time, on April 9, 1962. The several Underwriters may offer Debentures pursuant to the terms and conditions set forth in the Prospectus.

Subscription Price 100%

Copies of the Prospectus may be obtained in any State only from such of the several Underwriters, including the undersigned, as may lawfully offer these securities in such State.

Lehman Brothers	Clark, Dodge & Co. <small>Incorporated</small>
Blyth & Co., Inc.	The First Boston Corporation
Eastman Dillon, Union Securities & Co.	Glore, Forgan & Co.
Goldman, Sachs & Co.	Harriman Ripley & Co. <small>Incorporated</small>
Lazard Frères & Co.	Kidder, Peabody & Co. <small>Incorporated</small>
Merrill Lynch, Pierce, Fenner & Smith <small>Incorporated</small>	Carl M. Loeb, Rhoades & Co.
Stone & Webster Securities Corporation	Smith, Barney & Co. <small>Incorporated</small>
Dean Witter & Co.	White, Weld & Co. <small>Incorporated</small>
	Paribas Corporation

March 26, 1962.

33 v d-c, accuracy $\pm 2\frac{1}{2}$ percent of specified value over temperature range, drop-out or release voltage within $\frac{1}{2}$ v of actual pull-in, operate and release time 10 millisecond over temperature range. Temperature range -65 to +125 deg operating, to +150 deg storage; vibration 20 g to 2,000 cps; shock 50 g for 11 ± 1 millisecond; insulation resistance 1,000 megohms.

CIRCLE 335 ON READER SERVICE CARD

Voltage Regulators

THE SUPERIOR ELECTRIC CO., Bristol, Conn. The EMS series Stabiline automatic voltage regulators are available for single or three phase duty with ratings from 25 to 275 Kva.

CIRCLE 336 ON READER SERVICE CARD

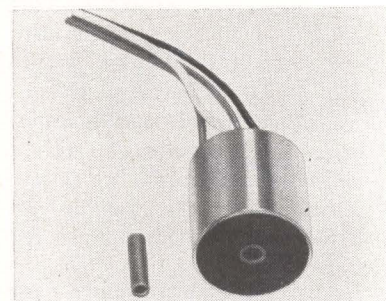

Transformer

DIFFERENTIAL TYPE

SANBORN CO., 175 Wyman St., Waltham 54, Mass. Series of linear displacement transducers, with infinite resolution, high accuracy and sensitivity, includes a built-in carrier system. Model 7 DCDT-050, first in the series, has a rated displacement range of ± 0.050 in. Entire unit weighs approximately 0.8 oz, occupies less than $\frac{1}{2}$ cu in. and is hermetically sealed. D-C output is 1.6 v max. Price is \$99.

CIRCLE 337 ON READER SERVICE CARD

Coil Forms

FOR PRINTED CIRCUITS

CAMBRIDGE THERMIONIC CORP., 445 Concord Ave., Cambridge 38, Mass., has three new horizontal coil forms for i-f and r-f printed circuits. Designated parts 2533-4 and -5, these internally threaded, grade L-5 silicone-impregnated, ceramic coil forms are designed with

Is your advertising selling the same four key buyers your salesmen call on? Competition demands it! Only advertising in electronics reaches and sells the electronics man wherever he is: in Research,

TODAY YOU MUST SELL ALL FOUR!

Design, Production, and Management. Put your advertising where it works hardest...

in **electronics**

In Electronic Components,
The Least Costly
Can be Vital!



USE LTCO LACING CORDS and TAPES

The Largest Line...The Most Advanced Types



Valuable Literature! New Linen Thread Company catalog, "Lacing Cords and Tapes for Electronics," can help you save money, eliminate hazards. It tells you how to save up to 500% with LTCO X-Type Nylon Lacing Cord, gives data you need on other Specification Lacing Cords and Tapes made by LTCO in Nylon Linen, Teflon, Cotton, Dacron.



Write Dept. 16D for your copy
THE LINEN THREAD CO., INC.
Blue Mountain, Alabama • Est. 1784

CIRCLE 205 ON READER SERVICE CARD

Eisler

A NAME TO REMEMBER IN
MACHINERY FOR ELECTRONICS

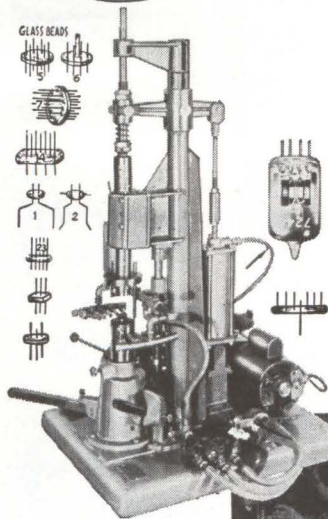

At left: No. 105-BSTI Single position Button Stem and Wafer making machine — Designed for small production runs on special tube parts, or for laboratory use. Produces button stems up to 1 1/4" diameter.

Illustrated below: An Eisler precision Vertical Spot Welder designed exclusively for welding of electronic components. Available in sizes from 1/2 to 7 1/2 KVA.



Write us today
for full
particulars!

EISLER ENGINEERING CO., INC.

Charles Eisler Jr., President

751 So. 13th St., Newark 3, N.J.

CIRCLE 207 ON READER SERVICE CARD

April 13, 1962



Exclusive Representatives

ARISTO-CRAFT
DISTINCTIVE MINIATURES

MIDGET DC MOTORS
for Consumer Products



LOW DRAIN, QUIET, LONG LIFE—LOW COST!
PRODUCTION— UP TO 2,500,000 PER MONTH
INFORMATION, SAMPLES, PRICES—RIGHT IN U.S.A.

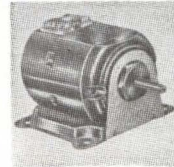

World's Leading Line

Large or small orders shipped on schedule. Over 30 sizes & types from 1 1/2 to 12 volts. We make modifications to fit your needs.

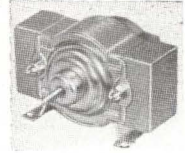

CER-MAG PER-MAG
APPLICATIONS: TAPE RECORDERS, RECORD PLAYERS, CLOCKS, SHAVERS, MUSIC BOXES, MOVIE CAMERAS, TURNTABLE, AUTOMATION, APPLIANCES, TOYS, ETC.
Write or Phone for Catalog, Specifications & Quotations Stating Use.

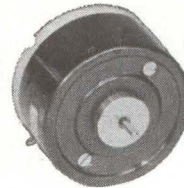

FM-250R

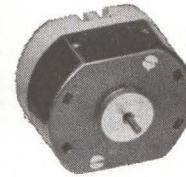

FM-250N



RM-170T

Supplying Midget Motor Needs for Over 25 Years

ARISTO-CRAFT DISTINCTIVE MINIATURES (Dept. E462)
314 FIFTH AVE., N. Y. 1, N. Y. — BRyant 9-9034

CIRCLE 206 ON READER SERVICE CARD

CONANT

where stability
and miniaturization
are primary

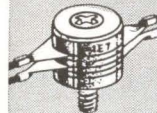

**SEMICONDUCTORS
COPPER OXIDE
AND SELENIUM**

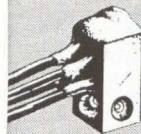

**INSTRUMENT RECTIFIERS
RING MODULATORS
HIGH-VOLTAGE RECTIFIERS
VOLTAGE REGULATORS
SWITCHED RECTIFIERS
CHOPPERS**



**SPECIAL PURPOSE UNITS
LIST PRICES FROM 42c**

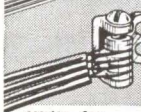

5 COPPER OXIDE CELL STYLES FROM .080" to .500" DIA. ACTIVE AREAS .0012 to .125 SQ. IN.

SELENIUM CELL SIZES FROM .080" round TO 2" SQUARE. .020" TO .045" THICK.

Write for
Free Bulletins
Dept. 20

CONANT LABORATORIES
LINCOLN, NEBRASKA

CIRCLE 109 ON READER SERVICE CARD

109

GREEN PANTOGRAPH ENGRAVERS

- ELIMINATE DELAYS!
- KEEP YOUR OPERATING COSTS WHERE THEY SHOULD BE!



PORTABLE 40-POUND BENCH MODEL 106

*You Make
Your Own
Engraved
Nameplates!*

Here is a speedy, economical 2 or 3-dimensional engraver used by thousands of dollar-conscious companies. It features 5 positive, accurate pantographic ratios; ball bearing spindle with 3 speeds up to 14,000 rpm. Is supplied with one copy carrier that accepts all standard master type sizes. Will actually work up to 10" by any width. Height of pantograph and position of cutter are continuously adjustable.



MODEL D-2 HEAVY-DUTY 2-DIMENSIONAL

Pantograph for milling, drilling and engraving.

Vertical adjustment of copy table automatic with Pantograph. Features: unobstructed on 3 sides to take large work; micrometer adjustment for depth of cut; ball bearing construction throughout; spindle speeds up to 26,000 rpm for engraving or machining, vertical range over 10"; ratios 2 to 1 to infinity — master copy area 26" x 10"

NEW

MODEL D2-201 PNEUMATIC ATTACHMENT

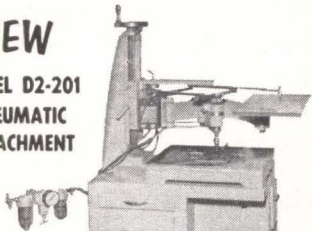

for use with Model D2 Pantograph Engraver to rapidly drill holes in printed circuits by tracing templates. Drills as many as 100 holes per minute. Equipped with foot switch, spindle air cylinder, regulating valve and pressure gauge; filter and oiler. It's ready to use as soon as it's attached to an air compressor.

Write or call for full
details and prices.

GREEN INSTRUMENT COMPANY, INC.

Dept. 63, 295 Vassar St.,
Cambridge 39, Mass. Tel. Eliot 4-2989

mounting pins to fit 0.040 in. diameter holes.

CIRCLE 338 ON READER SERVICE CARD

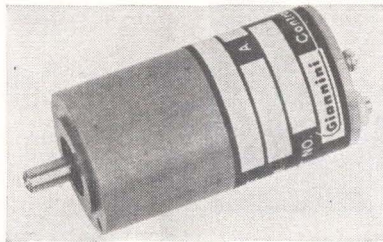

D-C Servo Motor MINIATURIZED

GIANNINI CONTROLS CORP., 1600 S. Mountain Ave., Duarte, Calif. Miniature d-c servo motor is designed for applications ranging from timing devices to the motor portion of an integrating accelerometer used in missile programs. O-d measurement is $\frac{3}{4}$ in. and length is $1\frac{3}{4}$ in. Unit develops 1 oz-in. of stall torque and a no-load speed of 22,000 rpm. Insulation system is rated at 155 C and a minimum life of 500 hr is normal.

CIRCLE 339 ON READER SERVICE CARD

Ultrasonic Welder

SONOBOND CORP., subsidiary of Aeroprojects Inc., West Chester, Pa. New version of the Sonoweld model W-600-TSR ultrasonic welder is utilized to weld closures of electronic packages in a totally controlled atmosphere. A solid state joining process is used.

CIRCLE 340 ON READER SERVICE CARD

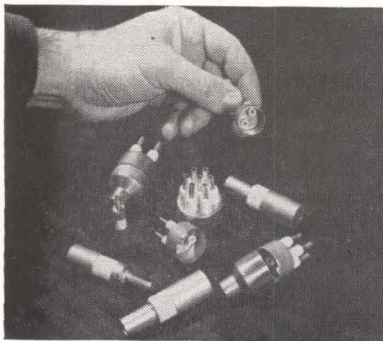

Cable End Seals

CERAMIC-TO-METAL

ADVANCED VACUUM PRODUCTS, INC., 440 Fairfield Ave., Stamford, Conn., offers a line of ceramic-to-metal cable end seals for use with min-

YOU ARE THERE!

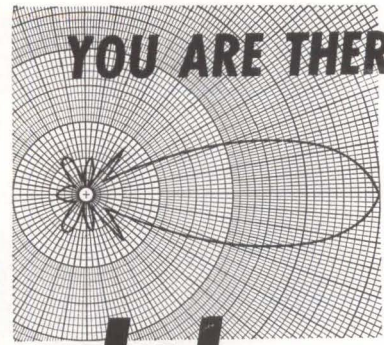

with **telrex**

"BEAMED-POWER" ANTENNAS

NOW MAILING! PL88 — technical data, pricing bulletin describing Advanced-design commercial and citizen-band base-station antennas and accessories. Includes Tower, Rotator, "Baluns," Masting and Transmission line data, plus nice-to-have-around "info." Request your copy, today; no obligation.

WORLD RENOWNED AND RESPECTED
PERFORMANCE -6 to 1500 MC.



ASBURY PARK 25, NEW JERSEY, U.S.A.
CIRCLE 210 ON READER SERVICE CARD

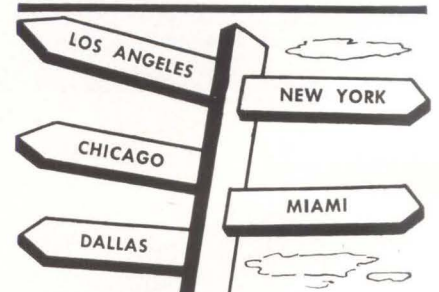

**IMMEDIATE DELIVERY
ANYWHERE
IN THE
NATION**



ELECTROLYTIC AND PAPER TUBULAR CONDENSERS

"35 YEARS OF PROVEN
DEPENDABILITY"

COSMIC CONDENSER CO.

853 WHITTIER STREET, BRONX, N. Y.
LUdlow 9-3360

CIRCLE 211 ON READER SERVICE CARD
electronics

eral-insulated cable. Because of special processing techniques and use of high-purity alumina, the seals can withstand temperatures to 1,500 F, and pressures as high as 5,000 psi. All seals are subjected to rigorous testing with a mass spectrometer for a maximum permissible leak rate of 10^{-8} cc of helium per sec. They are rated at 1,000 to 2,500 v, 20 to 60 amp, with terminal torque ratings of 15 to 35 in.-lb.

CIRCLE 341 ON READER SERVICE CARD

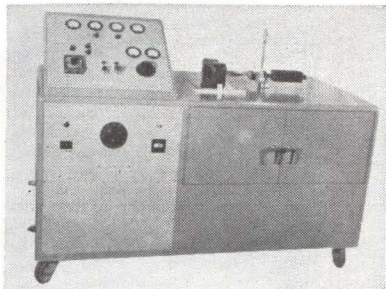

Pulse Modulator HEAVY-DUTY

BURMAC ELECTRONICS CO., INC., 142 South Long Beach Road, Rockville Centre, L. I., N. Y. Model 504 pulse modulator will pulse various types of transmitting tubes to $2\frac{1}{2}$ megawatts peak drive power. Unit has an output of 0-35 Kv peak at up to 70 amp peak with provision to match load impedances of 500 to 1,000 ohms. Pulse widths are 0.5, 1 and 3 μ sec.

CIRCLE 342 ON READER SERVICE CARD

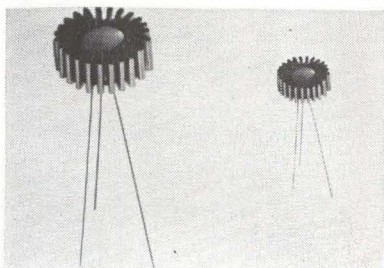

Transistor Cooler ONE SIZE FITS ALL

INLAND CERTIFIED ELECTRONICS, 323 W. Washington Blvd., Pasadena, Calif., announces a transistor cooler that fits all TO size transistors from 0.335 in. to 0.400 in. Sixty-three different sizes of coolers were formerly required. Designed for p-c board mounting, the 4 sq in. of

April 13, 1962

NEW LEAK DETECTOR



... with a built-in protection valve

A pressure surge or burst is no problem to CEC's new 24-120A Leak Detector. The secret: a unique, dual-purpose safety and throttle valve. Let seals in the component being tested fail—let the operator err—and the valve slams shut automatically before pressure in the detector rises above the safe operating limit. Result: a few moments pause to restore vacuum, instead of a major delay... and longer filament life. Portable, versatile, low cost, 24-120A is so sensitive it spots and measures leaks as small as 5×10^{-11} atm cc/sec fast. If a leak is your problem—be it in pressurized or evacuated components, in lab, field, shop, or production line, get the whole story. Call your CEC office, or write for Bulletin CEC 24120-X21.

CEC

Analytical & Control Division

CONSOLIDATED ELECTRODYNAMICS
PASADENA, CALIFORNIA • A SUBSIDIARY OF BELL & HOWELL

CIRCLE 111 ON READER SERVICE CARD 111

0 TO 1500 V
compliance

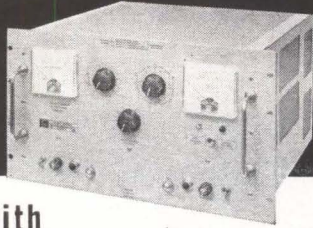

with
**ELECTRONIC
MEASUREMENTS
constant-current
POWER
SUPPLIES**

You'll find a whole new spectrum of application in Electronic Measurements Constant-Current Power Supplies. Take the husky Model C638A shown here. It'll deliver up to 1500 V DC at any output current from a few microamperes up to 100 MA. There are other features too... a modulation input, programmability, less than 0.01% +1 μ a ripple... and the all-important voltage control that lets you set the maximum voltage compliance.

For complete information ask for Specification Sheet 3072C.

BRIEF SPECIFICATIONS

MODEL	CURRENT RANGE		VOLTAGE COMPLIANCE	
	MIN.	MAX.	MAX.	MIN.
C612A	1 μ a	100 ma.	260 V	100 V
C631A	1 μ a	100 ma.	420 V	300 V
*C638A	0.5 μ a	100 ma.	2100 V	1500 V
C624A	2.2 μ a	220 ma.	260 V	100 V
C632A	2.2 μ a	220 ma.	420 V	300 V
*C636A	2.2 μ a	220 ma.	735 V	600 V
C629A	2.2 μ a	300 ma.	205 V	150 V
C633A	2.2 μ a	300 ma.	420 V	300 V
C620A	5 μ a	500 ma.	110 V	50 V
C621A	5 μ a	500 ma.	160 V	100 V
C613A	10 μ a	1 AMP	115 V	50 V
C614A	10 μ a	1 AMP	170 V	100 V
*C628A	10 μ a	1 AMP	215 V	150 V
*C630A	10 μ a	1 AMP	280 V	200 V
*C625A	22 μ a	2 AMP	150 V	75 V
*C626A	22 μ a	2 AMP	190 V	100 V
*C615A	22 μ a	3 AMP	125 V	50 V
*C618A	22 μ a	3 AMP	170 V	100 V

* Voltage limiting control standard. Optional on all other models.

† For current vs. voltage compliance curves, request Specification Sheet 3072C.



**ELECTRONIC
MEASUREMENTS
COMPANY, INCORPORATED**
EATONTOWN, NEW JERSEY

cooling area not only provides greater cooling efficiency, but also serves as a transistor retaining device.

CIRCLE 343 ON READER SERVICE CARD

Snap-Action Switch

CONTROL PRODUCTS, INC., 280 Ridge-dale Ave., East Hanover, N.J., offers a snap-action switch for use in precision pressure switches in aircraft, missiles and similar applications requiring temperature range of -80 F to 180 F.

CIRCLE 344 ON READER SERVICE CARD

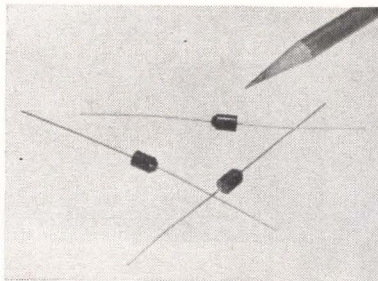

Silicon Rectifiers

EPOXY-ENCAPSULATED

COMPUTER DIODE CORP., 250 Garibaldi Ave., Lodi, N. J. Eleven new low-leakage, high-current, epoxy-encapsulated silicon rectifiers include three EIA types and eight CODI specials. All are double sealed, of an all-welded construction, and are polarized for automatic insertion.

CIRCLE 345 ON READER SERVICE CARD



**Digital Voltmeter
AND RATIOMETER**

COHU ELECTRONICS, INC., Kin Tel Div., 5725 Kearny Villa Road, San Diego 12, Calif. Model 551, which uses mercury-wetted relays, measures d-c between 0.0000 and ± 999.99 v, ratios between ± 0.00001 and 999.99 v. D-C measurements are made in less than 0.3 sec and displayed on a built-in projection readout. Printer drive circuit ac-

**COMPUTER
RESEARCH
ENGINEERS &
LOGICAL
DESIGNERS**

Rapid expansion of the Computer Laboratory at Hughes-Fullerton has created several attractive professional opportunities for qualified Computer Research Engineers and Logical Designers. These positions require active participation in broad computer R & D activities in connection with Army/Navy computer systems and new large-scale, general-purpose computers. These multiple processor computers utilize advanced solid-state circuitry, gating and resolution times in the millimicrosecond regions; combine synchronous and asynchronous techniques for maximum speed and reliability.

These professional assignments involve broad areas of logical design, programming and system conception. Fields of interest include:

- Distributed computers ■ Advanced arithmetic processing techniques ■ Mechanized design
- Asynchronous design techniques ■ Utilization of parametrons in computers ■ Studies in the utilization of multiple processor computers.

These professional assignments involve such R & D areas as:

- Solid state digital circuitry involving millimicrosecond logic
- Microwave carrier digital circuits
- Sub-microsecond core memory
- Thin film storage techniques
- Functional circuit concepts
- Micro-miniaturization concepts
- Tunnel diodes ■ Microwave parametrons ■ Circuit organization for maximal-speed computing.

Located in Southern California's Orange County (the nation's fastest growing electronics center), Hughes-Fullerton offers you: a stimulating working environment; private or semi-private offices; long-term stability.

CALL COLLECT TODAY!
For complete information on these challenging assignments, call us collect today! Ask for:

**Mr. J. E. TENNEY at:
TROjan 1-4080, ext. 3741.**

Or, airmail resume to: HUGHES-FULLERTON R & D, P. O. Box 2097, Fullerton 1, California.

An equal opportunity employer.



HUGHES AIRCRAFT COMPANY

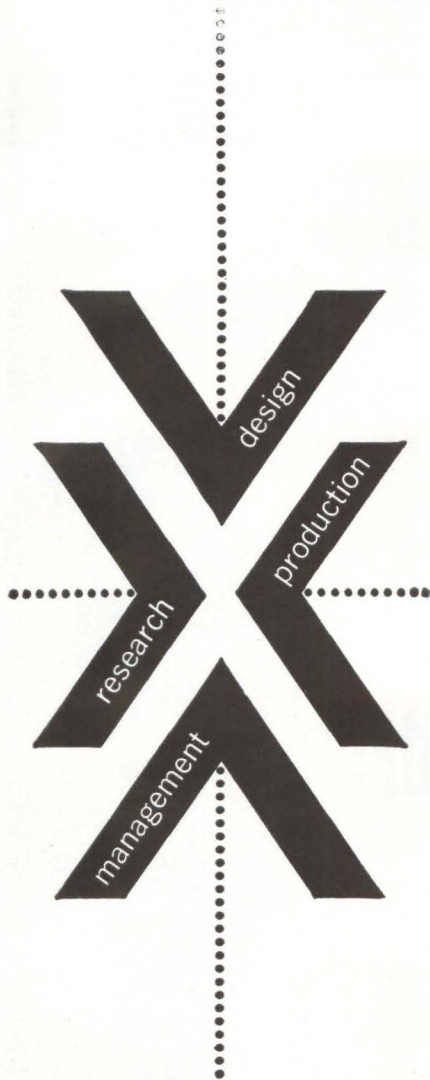

**it's read
more
by all 4!**

electronics magazine covers engineering and technically interpreted market trends every week. Government, military and economic developments, new applications, and technical data you'll want to file and keep. Subscribe now and read it first (don't be low man on a routing slip). Mail the reader service card (postpaid) to **electronics**, the magazine that helps you to know and to grow! Rates: three years for \$12; one year for \$6; Canadian, one year for \$10; foreign, one year for \$20. Annual **electronics** BUYERS' GUIDE (single issue price \$3.00) included with every subscription.

subscribe today to
electronics

April 13, 1962

Dilemma: true RMS-measuring instruments are low-impedance, delicate, and damage-prone devices. Increase their sensitivity and they slow down. VTVMs, conversely, measure true RMS of pure sine waves only.

Resolution: trio/lab's superb combination of high impedance, sensitivity, and overload immunity — the new Model 120 AC Voltmeter. The trick is turned by driving a laboratory-standard electro-dynamometer by an ultra-linear, high-impedance amplifier, gain-stabilized by negative current-feedback to better than 0.1%.

Results: 0.25% true RMS accuracy, 10MV-500V full-scale sensitivity, 50-2,000 CPS frequency range — regardless of time, temperature, or line fluctuations. Convenience and peace of mind for you, too: the Model 120 reads out *directly* from a 7" edge-indicating, mirror-backed scale; it can be overloaded only by malicious mischief.

Put this original concept in instrumentation — derived from trio/lab's 8 pioneering years in producing "build-ins" — to work for you. \$985 ships the portable Model 120-1, or the rack-mounted 120-7, from stock.

Secondary-Standard Accuracy

$\frac{1}{4}\%$ true RMS-direct reading

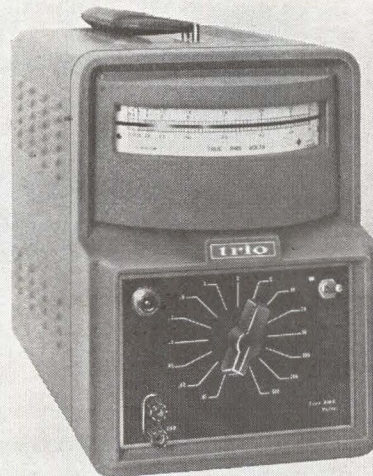

TRIO LABORATORIES, INC., PLAINVIEW, L. I., NEW YORK
OVERBROOK 1-0400, AREA CODE 516, TWX HKVL 1166

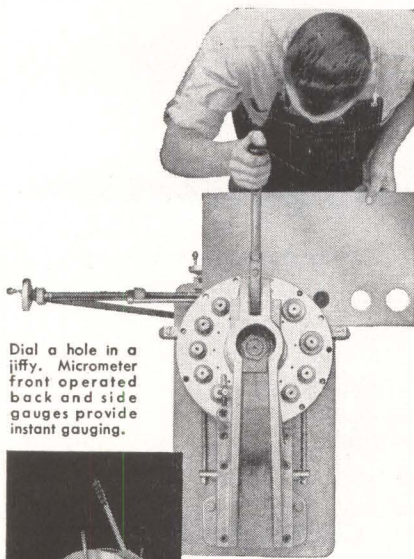

Dial a hole in a jiffy. Micrometer front operated back and side gauges provide instant gauging.

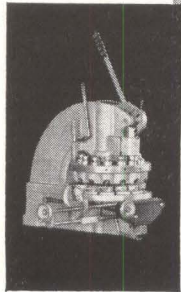

new
**Di-Acro
turret
punch
press**

Accurate Burr-Free Punching at 12 Rotating Stations

The new Di-Acro 4 Ton Turret Punch Press provides rapid, close tolerance punching of round, square, oval and rectangular holes from $\frac{1}{16}$ " to 2".

Rotating turrets provide rapid indexing for single or sequence punching. Precision hole location quickly obtained with Micro-twin gauges. Punches sheet metals up to 16 gauge mild steel, fibreboard, asbestos, paper, cork, leather, rubber, plastic and other sheet materials.

Dies are mounted in turrets—always handy. Standard clearance between punch and die is .002". Choice of 6 other clearances at no charge. The Di-Acro Turret Punch Press is safe, simple to operate—requires little maintenance.



Consult the Yellow Pages of your phone book under Machinery, Machine Tools for the name of your Di-Acro distributor or write us for catalog describing this and other Di-Acro machines.

pronounced die-ack-ro

DI-ACRO CORPORATION

434 Eighth Ave. • Lake City, Minn.



114 CIRCLE 114 ON READER SERVICE CARD

cessories permit recording all measurements on an external digital printer. Price is \$4,150.

CIRCLE 346 ON READER SERVICE CARD

Gearhead Motor

GLOBE INDUSTRIES, INC., 1784 Stanley Ave., Dayton 4, O. Type CLC gearhead motors are 2.88 in. in diameter, produce 1/40 h-p output, with typical max output 120 in. lb torque at 15 rpm synchronous speed.

CIRCLE 347 ON READER SERVICE CARD

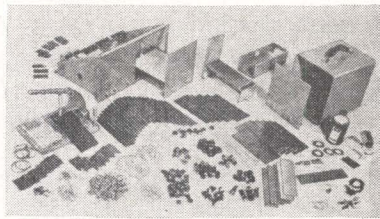

Construction Kit

FOR PROTOTYPE WORK

ALDEN PRODUCTS CO., 117 N. Main St., Brockton, Mass. Kit No. 37 includes all the circuitry mounting and packaging components needed to assemble various combinations of a functionally subdivided rack module and a rugged, quick access, portable instrument. It utilizes the best Alden circuit mounting techniques and an introduction to the plug-in unit construction system.

CIRCLE 348 ON READER SERVICE CARD

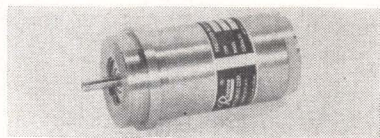

Synchros

HIGH PRECISION

REEVES INSTRUMENT CORP., Garden City, N. Y. Thirty-second accuracy Size 23 synchros conform to MIL-S20708A. Series includes both transmitters and control transformers; and can be supplied for either a 60- or 400-cycle input. The transmitters have an extremely low output impedance, thus enabling one transmitter to drive a number of control transformers without degrading system performance.

CIRCLE 349 ON READER SERVICE CARD

Miniature connectors with minimum voltage drop

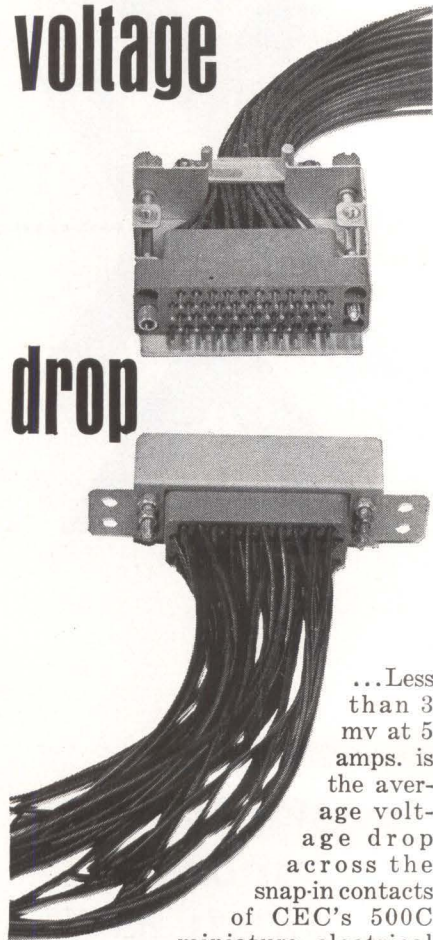

...Less than 3 mv at 5 amps. is the average voltage drop across the snap-in contacts of CEC's 500C miniature electrical connectors. This low contact resistance makes these rectangular connectors ideal for dry circuit applications. Designed to exceed MIL-C-8384A requirements, they are available in a range of 14 to 200 contacts—with mounting hardware for flush or surface installation, right-angle or straight cable entrance and guide pin or jackscrew mating. ■ For more data, call your nearby CEC office or write for Bulletin CEC4010-X2.

CEC

Data Recorders Division

CONSOLIDATED ELECTRODYNAMICS

PASADENA, CALIFORNIA

A SUBSIDIARY OF BELL & HOWELL

CIRCLE 212 ON READER SERVICE CARD

electronics

PRODUCT BRIEFS

SILICON CONTROLLED RECTIFIER rated at 3 and 5 amp d-c. Sarkes Tarzian, Inc., 415 N. College Ave., Bloomington, Ind. (350)

WIREWOUND POTENTIOMETER high-power, small size. Bourns, Inc., 1200 Columbia Ave., Riverside, Calif. (351)

MICRO ZENER DIODES 2.7 to 18 v. TRW Electronics/Pacific Semiconductors, Inc., 12955 Chadron Ave., Hawthorne, Calif. (352)

REGULATED POWER SUPPLY 300-5,000 v d-c. Kilovolt Corp., 238 High St., Hackensack, N. J. (353)

GLASS EPOXY LAMINATE for p-c applications. Formica Corp., 4614 Spring Grove Ave., Cincinnati 32, Ohio. (354)

TRANSISTOR OSCILLATOR low profile. Monitor Products Co., Inc., 815 Fremont Ave., South Pasadena, Calif. (355)

MAGNETOSTRICTIVE DELAY LINE operates at 4 Mc. Computer Control Co., Inc., 983 Concord St., Framingham, Mass. (356)

CONDUCTOR PAINT silver-filled. Epoxy Products Div., Joseph Waldman & Sons, 137 Coit St., Irvington 11, N. J. (357)

VERSATILE TEST STAND designed for printed circuits. Circuit Structures Lab, P.O. Box 36, Laguna Beach, Calif. (358)

CERAMIC COMPOSITION features a low loss tangent. Gulston Industries, Inc., 212 Durham Ave., Metuchen, N. J. (359)

COMMUNICATIONS SWITCH space-saving, 24-position. Chicago Dynamic Industries, Inc., 1725 Diversey Blvd., Chicago, Ill. (360)

INSTRUMENT COUNTER rated at 3,000 rpm intermittent. Durant Mfg. Co., 1912-A N. Buffum St., Milwaukee 1, Wis. (361)

TRIMMER RESISTOR infinite resolution. Weston Instruments Div., Daystrom, Inc., 614 Frelinghuysen Ave., Newark 14, N. J. (362)

GERMANIUM TRANSISTORS 15 amp collector current. Tung-Sol Electric Inc., 1 Summer Ave., Newark 4, N. J. (363)

CUSTOM IRON CORES *to your specifications*

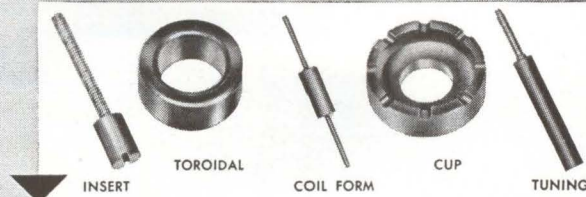

for
Military,
Micromodular
and Special
Applications

Never a problem in meeting Mil. Specs., when your "blue print" specifies Iron Cores from Permacor*. Also, iron core environmental testing facilities available.

The Original
Engineered
Economy
Iron Cores
for
Commercial
and Military
Applications



Ours alone . . . ENGINEERED ECONOMY® IRON CORES at low cost from stock. Over 14 types for most threaded and insert applications. As the world's largest producers of iron cores, we have the biggest, most expert engineering staff for designing, producing and recommending those custom iron cores that are best for your jobs.

Complete
Engineering
Service . . .

PERMACOR

The Iron Core Division of
Radio Cores, Inc.

We welcome
your inquiries.

9540 Tulley Avenue, Oak Lawn, Illinois • Phone: GArden 2-3353

*Trade Mark

CIRCLE 213 ON READER SERVICE CARD

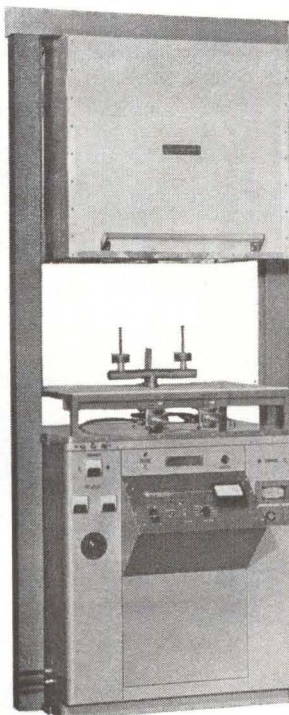

MODEL BD-70-15

CLEAN-OIL FREE HIGH VACUUM - 10⁻⁹ TORR Electron Tube Exhaust System



ION PUMPING CONCEPT IS UTILIZED IN A COMPLETELY NEW SERIES OF TUBE EXHAUST EQUIPMENT

THE MODEL BD-70-15 PUMPING SYSTEM IS EXPRESSLY DESIGNED TO RELIABLY PROCESS SPECIAL PURPOSE ELECTRON TUBES

System Features:

- 15 liter/sec. Ion Pump
- 2 cfm Mechanical Roughing Pump
- Stainless Steel Exhaust Manifold
- High Vacuum Valving for Roughing System and Gas Backfilling
- Tube-Bake-out Oven with Hoist

Write or Call today for Complete Details

Sales Agents in Principal Cities

BON-DE ELECTRONIC LABORATORIES, INC.

361 Rantoul St., Beverly, Mass.

WA 2-1106

components and systems

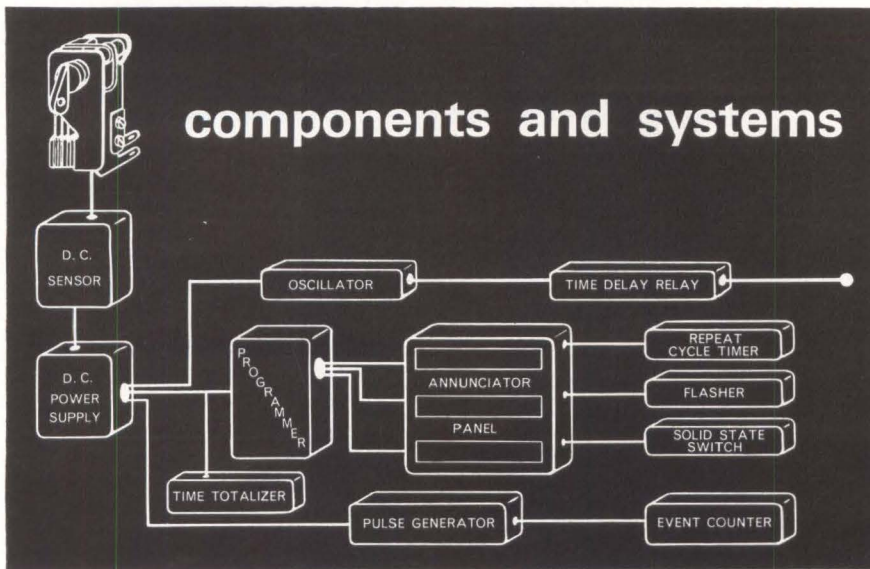

Research and development of today's products for tomorrow's standards make WHEATON a leader in airborne and ground support equipment. An extensive line of high reliability components—timers, sensors, programmers, elapsed time indicators, power supplies, annunciator panels, solid state and electro-mechanical devices—allow WHEATON to offer controls and systems of unsurpassed quality. An engineering representative is available to assist you with your applications.

WHEATON

Engineering Division
HURLETRON, INC.

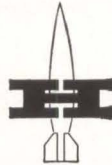

920 Manchester Road, Wheaton, Illinois

CIRCLE 214 ON READER SERVICE CARD

Coto-Coils for Contact Capsules

TYPE	DC-V	Ohms	Nom. Watts	Nom. Amp/Turns
S	6	100	.40	250
	12	360		
	24	1400		
M	6	50	.70	250
	12	175		
	24	820		
T	6	100	.35	125
	12	400		
	24	1600		
	48	2800		
U	6	150	.24	125
	12	600		
	24	2500		

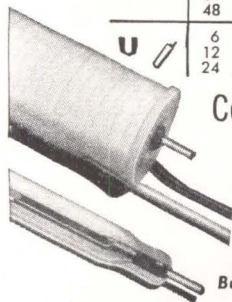

Coil Windings

WIRE SIZES
#6 to #56
CLASSES
A, B, F and H

Write for
Bulletin and Prices

Since 1917 Coto-Coil has wound all types of coils for every application. Complete design and engineering service is available.

Coto-Coils

COTO-COIL CO., INC.,
65 Pavilion Avenue
Providence 5, R. I.

116 CIRCLE 116 ON READER SERVICE CARD

INDUSTRY FINDS COLORADO RICH!



• Companies "prospecting for plant sites"...find rich new benefits in Colorado. Pleasant Living, a product of Colorado's magic climate attracts and holds the most competent personnel. Industry's westward migration has made Colorado the transportation hub serving the vast new markets west of the Mississippi. "Site-see" Colorado now...right at your desk.

SEND FOR FREE EXECUTIVE PORTFOLIO "INDUSTRIAL COLORADO." Newly completed 9-booklet portfolio on Colorado's industrial sites, assets, opportunities and weekend vacation wonderland. All inquiries held confidential.

COLORADO
DEPARTMENT OF DEVELOPMENT
70 State Capitol Denver 2, Colorado

CIRCLE 215 ON READER SERVICE CARD

Literature of

TRANSFER MOLDING Hull Corp., Hatboro, Pa., has available a technical paper entitled "Transfer Molding—past, Present and Future." (364)

CONTROL KNOBS National Radio Co., Melrose 76, Mass. Data sheet CO-9 covers a wide variety of commercial knobs. (365)

F-M TAPE SYSTEM Sanborn Co., 175 Wyman St., Waltham 54, Mass. A single-page bulletin describes a 7-channel f-m tape system. (366)

DIGITAL LOGIC MODULES Scientific Data Systems, 1542 Fifteenth St., Santa Monica, Calif., has published a brochure on an integrated line of all-silicon semiconductor digital logic modules. (367)

ACCELERATORS High Voltage Engineering Corp., Burlington, Mass., offers a booklet on Tandem Van de Graaff accelerators. Request copy on organization letterhead.

RECTIFIER POWER UNITS Syntron Co., 241 Lexington Ave., Homer City, Pa. An 8-page bulletin outlines a line of selenium and silicon rectifier power units. (368)

P-C CONNECTORS Continental Connector Corp., 34-63 56th St., Woodside 77, N. Y., offers a printed circuit connector catalog covering its entire line. (369)

POWER TRANSFORMERS Tektran Inc., 2905 N. Leithgow St., Philadelphia 33, Pa. Two recent bulletins describe silicon rectifier power transformers. (370)

CAPACITOR TEST REPORT Vitramon, Inc., P. O. Box 544, Bridgeport, Conn. Brochure of 16 pages contains summary test data on porcelain capacitors to high reliability specification S-1002. (371)

TEFLON Tri-Point Industries, Inc., 175 I. U. Willets Rd., Albertson, L. I., N. Y., has issued a 24-page technical manual-catalog on Teflon forms and products. (372)

COOLING DEVICE Dynacool Mfg. Co., P. O. Box 132, West Hurley, N. Y. Bulletin contains illustration, specifications and prices for the Power 500S series cooling device. (373)

SIGNAL ANALYZER Raydata Corp., 1078 E. Granville Rd., Columbus

electronics

the Week

24. O. Bulletin describes model 41 signal analyzer for industrial and laboratory measurements. (374)

PRESSURE MONITOR Datametries Inc., 87 Beaver St., Waltham 54, Mass. A bulletin covers the type 25 pressure monitor. (375)

HIGH VOLTAGE CHOPPER Solid State Electronics Co., 15321 Rayen St., Sepulveda, Calif., has issued a data sheet on the model 150 silicon transistor electronic chopper. (376)

DIGITAL MODULES Computer Control Co., Inc., 983 Concord St., Framingham, Mass., has published 28-page S-PAC digital module catalog S-1. (377)

MATERIALS EVALUATION Materials Testing Laboratories Div., Magnaflux Corp., 7300 W. Lawrence, Chicago 31, Ill. Bulletin outlines the materials evaluation services available from MTL's nationwide network of 15 laboratories. (378)

POWER TRANSISTORS Kearfott Div., General Precision, Inc., Little Falls, N. J. Three catalog sheets cover 7 types of *pn*p germanium alloy junction power transistors. (379)

ELECTROMAGNETIC RELAYS Potter & Brumfield, Princeton, Ind. A catalog features a complete line of electromagnetic relays. (380)

PCM GROUND STATION Epsco, Inc., 275 Massachusetts Ave., Cambridge 39, Mass., offers a 28-page brochure on its universal pcm ground station, model PCG-UN1. (381)

COMPUTER POWER SUPPLIES Kearfott Div., General Precision, Inc., Little Falls, N. J. A 2-page catalog sheet contains application data for computer power supplies. (382)

TRIMMING POTENTIOMETERS Daystrom, Inc., Potentiometer Division, Archbald, Pa., offers a technical data sheet on the 200 series Square-trim subminiature trimming potentiometers. (383)

SOUND MEASUREMENT H. H. Scott Instrument Division, 111 Powder Mill Rd., Maynard, Mass., has available an 8-page brochure on sound measuring and analyzing instruments. (384)

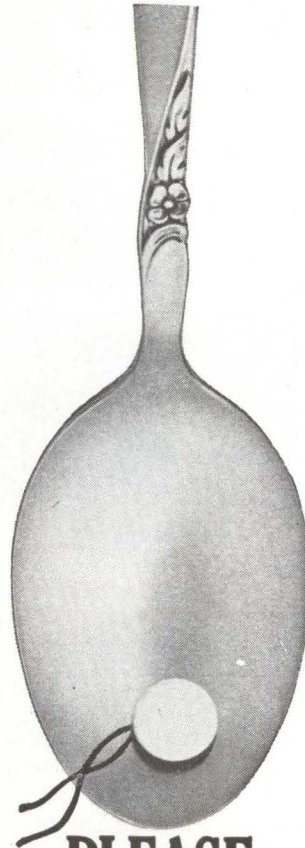

**PLEASE
DON'T
SWALLOW
OUR
MOTOR**

...IT'S HIDING BEHIND THE ASPIRIN. Actually, we set out to build an easy-to-read tiny timer...but we first had to build an aspirin-sized motor to drive it. This assignment might have been a headache for a sorcerer, but A. W. Haydon did it. And there is something magical about these micro-miniature elapsed time indicators and companion events counters. ■ This digital elapsed time indicator has many outstanding features: size is only $\frac{1}{2}$ " square x $\frac{1}{16}$ " long...weight .75 ounce...

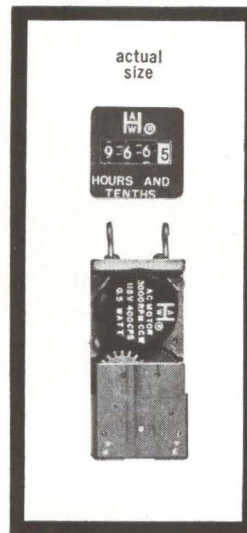

meets all mil specs...temp. range -54 to $+125^{\circ}\text{C}$...vibration to 2000 cps at 20 G...choice of two ranges (hours to 9999, tenths to 999.9)...power input .5 watt, max. In fact, the complete data outweighs the equipment. Send for our heavyweight literature on the 19200 ETI right now. ■ Electrical or electronic, the A. W. Haydon Company works wonders in time. For electronic requirements call Culver City. For electro-mechanical devices call on our wizards in Waterbury.

AWH HAYDON
THE COMPANY
235 NORTH ELM STREET WATERBURY 20, CONNECTICUT



GPE To Open Research Center

A RESEARCH CENTER for aerospace sciences will be opened this year as part of the advanced research program of General Precision Equipment Corp., Tarrytown, N. Y. The 80,000 sq ft center is under construction at Kearfott Division, Little Falls, N. J. Its purpose is to centralize research activities of the division.

The 1962 completion date was announced by J. W. Murray, chairman of the board, and D. W. Smith, president, in the annual report to stockholders. "Current backlog and new business booked after the close of the year indicate increased sales for 1962," they said. "We expect 1962 net profits to show improvement over those of 1961."

Reporting that investment in research and development had con-

tinued at a high level in 1961, the corporation said that past research in navigational aids and precision components alone had resulted in more than \$500 million sales in the past few years.

The new center will be devoted in part to basic materials research that can result in new products. Overall, the corporation expects its research programs to yield many developments that will contribute to future growth.

These programs include projects in stellar navigation, space-vehicle computers and instrumentation, miniaturization, optical masers and electronic flight simulation. Others are specialized radar devices, infrared systems, explosive ordnance and propellants, bionics and micro-circuitry.



Aerospace Research Hires Schissler

L. ROBERT SCHISLER has been appointed to the staff of Aerospace Research, Inc., Newton, Mass. He

will be primarily involved in the design and fabrication of rocket receivers at very low frequencies for use in probing the ionosphere.

Schissler was formerly with Simplex Wire and Cable as a research scientist.

Stern Accepts Executive Post

MARVIN STERN, 39-year old deputy director of defense research and engineering, Department of Defense, in charge of weapon systems, is resigning to become corporate

vice president for research for North American Aviation, Inc., Los Angeles, Cal. A mechanical engineer with a doctorate in mathematics, Stern has been at the Pentagon since August 1960, was previously General Dynamics' corporate staff executive for research and development.



Tamar Electronics Appoints Whiteside

GEORGE A. WHITESIDE has been appointed vice president and general manager of Wiancko Engineering, a division of Tamar Electronics, Inc., Anaheim, Calif.

Prior to his new post at Tamar, Whiteside was the assistant to the vice president of the Armament and Flight Control Division of Autonetics.



Electra Mfg. Co. Names Butler

GEORGE D. BUTLER, formerly vice president of marketing for International Resistance Co., has become president of Electra Manufacturing Co., Kansas City, Mo. Electra, which employs approximately 850

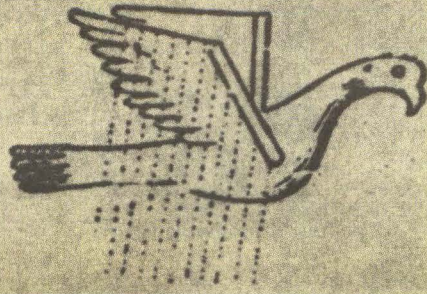

Archytas of Tarentum (428-347 B.C.), Greek philosopher and mathematician, is credited with being almost the first to bring mathematics to human uses. His invention of a wooden pigeon that actually flew is an example of his ingenuity in this respect. Though we do not know today what means Archytas used to make the wooden bird fly—whether it was a heavier-than-air machine or whether it utilized gases—the concept was definitely original and successful.

THE WOODEN PIGEON OF ARCHYTAS OF TARENTUM

ORIGINAL



The space-saving square design for a potentiometer is an original Daystrom contribution. Our patented Squaretrim® started a trend throughout the industry . . . a trend that increases every year. Moreover, Daystrom's original wire-in-the-groove winding process for the resistance element has resulted in exceptional reliability. Add our unusually prompt delivery, and it's obvious why more engineers specify Squaretrims than all other square trimming pots combined. Send for catalog of over 2000 standard models.

THE SQUARETRIM® SUBMINIATURE POTENTIOMETER

DAYSTROM, INCORPORATED
POTENTIOMETER DIVISION
ARCHBALD, PENNSYLVANIA • LOS ANGELES, CALIFORNIA

ALLMETAL

Immediate Shipment

FROM ENDLESS STOCKS of

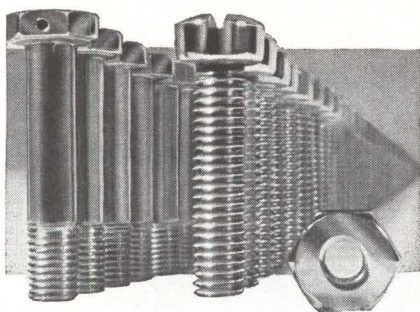

STAINLESS STEEL FASTENERS

AN-MS-COMMERCIAL



Your order, large or small, filled "fast" from the world's largest stock of stainless steel fasteners. AN, MS, Commercial specifications in stock. Rigid quality control, mass production economies. Special stainless steel fasteners also manufactured to your exact requirements on extremely short notice. Just send blueprint or specs for quotation. Full range of raw material, on hand, assures prompt service.

WRITE • WIRE • PHONE

FOR QUOTATION OR SHIPMENT
ASK FOR CATALOG

ALLMETAL®

Screw Products Company, Inc.
MANUFACTURERS OF STAINLESS FASTENERS SINCE 1929

821 Stewart Avenue, Garden City, L.I., N.Y.
Phone: Pioneer 1-1200 TWX GCY 603

Midwest Division
6424 W. Belmont Avenue, Chicago 34, Illinois
Phone: Avenue 2-3232 TWX CG 3185

West Coast Division—Office and Warehouse
5822 West Washington Blvd., Culver City, Calif.
Phone: Webster 3-9595 TWX LA 1472

people, produces electronic components for industrial computers and control equipment for military electronics and for the aerospace industry.

Butler is director of the Precision Potentiometer Manufacturer's Association.



Eveleth Assumes New Position

JASON F. EVELETH has been appointed chief engineer of the Ultra-Sonic Delay Line division of Andersen Laboratories, Inc., West Hartford, Conn. Andersen Laboratories manufactures components and systems used by 3D radar, man-in-space, DEW line, computer and nuclear activities.

For the past five years Eveleth has been associated with the Corning Glass Works.



Acton Laboratories Names MacMullen

ALEXANDER MACMULLEN has been named manager of instrumentation engineering at Acton Laboratories, Inc., Acton, Mass., subsidiary of Bowmar Instrument Corp., Fort Wayne, Ind. He will be responsible for design and development of the company's line of instruments for measurement of voltage, impedance, phase and delay, as well as

WHITNEY JENSEN

ESTABLISHED 1910

HERE IS OUR LATEST!

No. 441 HAND NOTCHER



CAPACITY
1" NOTCH
20 GA. MILD STEEL

ONE OF THE GREATEST SMALL HAND TOOLS EVER DEVELOPED FOR SHEET METAL WORKERS EVERYWHERE

FEATURES

Upper blade has concave face, producing a shearing cut to exact depth of notch selected. No "pushing-away," as by a straight blade.

Both upper and lower blade are removable and replaceable.

Standard models have 90° or 45° notch. Special angle and coping blades and jaws available on special order.

Lower jaw has ample clearance for punchings to drop out.

Spring-return handles are coated with molded-on non-slip plastic.

Sharp tip on upper blade locates depth of notch accurately to prick, scribed line, or mark.

Guide shoulders on lower jaw assure correct cut relative to edge of sheet.

WHITNEY METAL TOOL CO.
722 FORBES ST., ROCKFORD, ILLINOIS

CIRCLE 218 ON READER SERVICE CARD

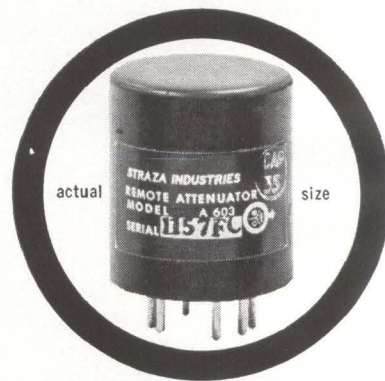

MINIATURIZATION BREAK-THRU!

A compact passive device to replace expensive follow-up servos 20 times its size!

REMOTELY-CONTROLLED ATTENUATOR

... **COMPACT!** Just 1 in x 7/8 in, the A-603 replaces servos, variable mu vacuum tube circuits or other complex circuitry generally required for remote control purposes.

... **VERSATILE!** No interaction between control and signal. Permits unlimited length of unshielded 0 to 6 v, ac or dc control wires. Used for attenuation of high or low impedance ac or dc signals, phase shifting, variable filter, AGC control, etc.

... **EXTRA LONG LIFE!** Passive circuit elements, no moving parts, improved heat dissipation.

... **LOW COST!** \$25.00. Immediate delivery.

STRAZA INDUSTRIES

790 Greenfield Dr, El Cajon, California
Hickory 2-3451

CIRCLE 216 ON READER SERVICE CARD
electronics

special components for space and industrial applications.

MacMullen formerly was a manager of the communications design section at Raytheon Co. and a project engineer with Radio Free Europe.



Rudenberg Joins Arthur D. Little

H. GUNTHER RUDENBERG has joined Arthur D. Little, Inc., Cambridge, Mass., as a member of the senior staff of the research and development division. In this post he will be concerned with the development of the new generation semiconductor devices, and related research and engineering problems.

Previously Rudenberg was director of research at Transitron Electronic Corp., a post he held since the founding of the firm in 1952.



Connor Accepts Additional Post

PHILLIP R. CONNOR, JR., president of Space-Tone Electronics Corp., Washington, D. C., has been elected board chairman of Solar Systems, Inc., North Hollywood, Calif. Space-Tone recently took over active management of Solar Systems, Inc.

Solar Systems is engaged in research and development work on solar cells and solar equipment, elec-

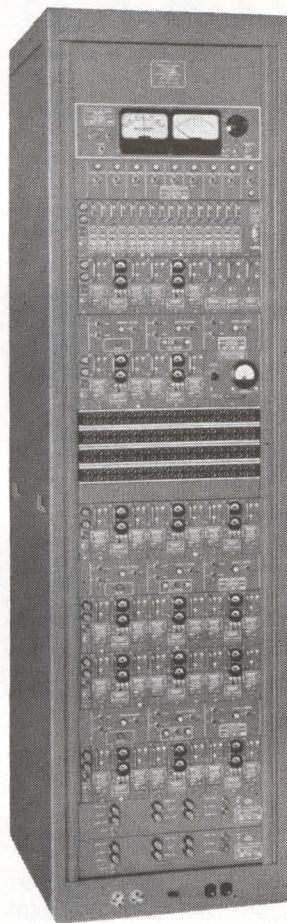

NEW BETTER-THAN-EVER RELIABILITY

for long-distance point-to-point communications



NORTHERN RADIO

NEW 16-CHANNEL TRANSISTORIZED VOICE FREQUENCY DIVERSITY CARRIER TELEGRAPH TERMINAL TYPE 235 MODEL 3 MIL DESIGNATION AN/FGC-61A

ADVANCE

... All units militarized: components and design approved by U.S. Military.

... Converters have equalized gain and adjustable time delay in each channel for better diversity performance and interchangeability.

... Switching Panels provide "local" or "remote" selection of 2-channel or 4-channel diversity modes.

... Combiners have adjustable gains in each channel, for complete switching flexibility, and the combining follows an ideally modified square law function for both 2-channel space or frequency and 4-channel space plus frequency diversity.

... Keyers have adjustable "threshold" sensitivity control and simplified input circuit selection.

... Dotter and Delay Indicator provides test keying signal source for keyers and delay equalizers in all channels.

Write for complete literature.

Pace-Setters in Quality Communication Equipment.

NORTHERN RADIO COMPANY, inc.
147 WEST 22nd ST., NEW YORK 11, NEW YORK

In Canada: Northern Radio Mfg. Co., Ltd., 1950 Bank St., Billings Bridge, Ottawa, Ontario.

CIRCLE 217 ON READER SERVICE CARD



TWO AFFILIATED COMPANIES PROVIDE A SINGLE SOURCE FOR SEMICONDUCTOR CLAD METALS & PARTS



Clad Metal Combinations

- Tin Clad Nickel
- Lead-Tin-Antimony Clad Nickel Iron
- Tin-Lead Clad Nickel
- Gold-Antimony Clad Molybdenum
- Gold-Antimony Clad Nickel Iron

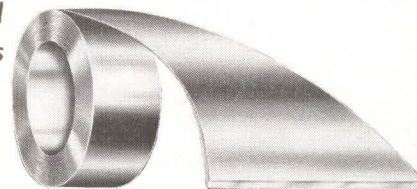

Single or Double clad in continuous coils
NEW COMBINATIONS BEING DEVELOPED DAILY

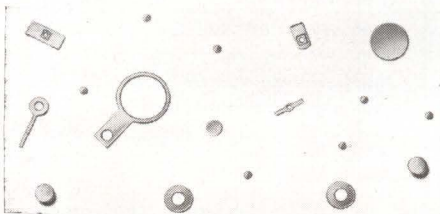

Precision Parts Fabrication

Long experience with the electronics and allied industries plus exceptional tooling facilities qualify to meet semiconductor parts requirements at low cost with complete conformity.

SPECIFY BOTH L & G AND G F

For Alloys and Clad Metals

For Precision Parts

LEACH & GARNER COMPANY / GENERAL FINDINGS INC.

For complete information on materials and parts write 52 Pearl Street, Attleboro, Massachusetts

SALES OFFICES: NEW YORK • CHICAGO • LOS ANGELES

NOW! Miniature CLIP-ON NUT

...self-locking nut
in popular 4-40
thread size!

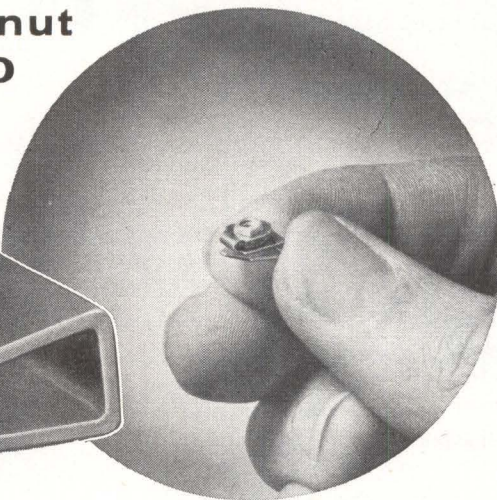
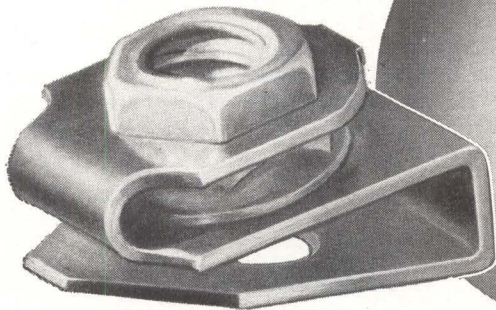

Replaces standard anchor nut to eliminate costly riveting. No tools required. As integral part of a sub-assembly, it eliminates additional drawings, part numbers and installation in final assembly traditional with conventional anchor nuts. Reduces inventory; simplifies design changes, field rework, repairs. Meets MIL-N-25027—120,000 psi class.

Write for bulletin.



MONADNOCK MILLS • SAN LEANDRO, CALIFORNIA
SUBSIDIARY OF UNITED-CARR FASTENER CORP., BOSTON, MASS.

OFFICES: ATLANTA, BOSTON, CHICAGO,
CLEVELAND, DALLAS, DETROIT, LOS ANGELES, NEW YORK, PHILADELPHIA, SYRACUSE
CIRCLE 219 ON READER SERVICE CARD

DIGITAL CLOCKS

Up to 86,400 contact combinations per day in Decimal or Binary Coded Decimal form for Programming . . . Process Control . . . Test Data Logging . . . Computer Systems.

Time in increments of minutes, tenth minutes, or seconds. Time of day (12 hour or 24 hour) — Count Down or Elapsed Time configurations.

Easy to read, single or multiple displays. Output compatible with printers, typewriters, card punches, etc. Special models. For details write:



PARABAM

DIVISION OF **HF** HOUSTON FEARLESS CORPORATION
12822 Yukon Avenue, Hawthorne, Calif./OSborne 9-3393

electronics

Editorial Opportunity

IT DOESN'T HAPPEN OFTEN, but **electronics**, "bible of the industry" and a McGraw-Hill publication, has an opening for an Assistant Editor.

Ideally, the man we are looking for and to whom a post on our New York staff could be a long-term challenge, would have an electrical engineering degree or technical equivalent, practical experience in our field and a demonstrated aptitude for editing, writing, reporting. He probably lives somewhere in the metropolitan area and therefore would have no relocation problem.

Write The Editor, **electronics**, 330 W. 42nd St., New York 36, stating experience, aspirations and past earnings. Mark the envelope "Confidential" and it will be kept that way.

tronic systems and solid propellant cooling systems for missiles.

Autometric Names Abraham Mann

APPOINTMENT of Abraham Mann as head of the electronics department of Autometric Corp., New York City, has been announced.

Mann is concurrently a member of the staff of the Polytechnic Institute of Brooklyn, where he teaches graduate courses in electrical engineering. He was formerly manager of the electronics department, system development section, Bulova Research and Development Laboratories.

PEOPLE IN BRIEF

Peter L. Fetterolf leaves Minneapolis Honeywell to join Potter Instrument Co., Inc., as assistant to the manufacturing mgr. **Ralph L. McCreary**, formerly with Collins Radio Co., named mgr. of the Motorola Inc. Systems Research Laboratory. He succeeds **John F. Byrne** who has been appointed mgr. of advanced technical plans for the company's Military Electronics div. **Grant D. Christensen**, previously with General Dynamics Corp., now mgr. of engineering services of McDonnell Aircraft Corp. **L. J. Bonis** moves up from executive v-p to president of Ilikon Corp. **Robert H. Borders**, ex-Hallicrafters Co., named executive v-p and elected to board of directors of Schaevitz Engineering. **John F. Jewett** promoted to assistant director of engineering of the eastern operation of Sylvania Electronic Systems. **Richard C. Hahn**, formerly with The Victoreen Instrument Co., joins CBS Laboratories as mgr., program development., Acoustics and Magnetics Branch. **Thomas R. Bristol** advances to assistant to the mgr., display devices dept., for Litton Industries' Electron Tube Div. **John M. Klaarenbeek**, ex-Hurletron, Inc., appointed quality assurance mgr. of Babcock Relays. **Irving J. Gabelman** elevated to director of advanced studies of Rome Air Development Center. **Roy E. Wendahl** advances to executive v-p of Hughes Aircraft Co.

electronics

WEEKLY QUALIFICATION FORM FOR POSITIONS AVAILABLE

ATTENTION: ENGINEERS, SCIENTISTS, PHYSICISTS

This Qualification Form is designed to help you advance in the electronics industry. It is unique and compact. Designed with the assistance of professional personnel management, it isolates specific experience in electronics and deals only in essential background information.

The advertisers listed here are seeking professional experience. Fill in the Qualification Form below.

STRICTLY CONFIDENTIAL

Your Qualification form will be handled as "Strictly Confidential" by ELECTRONICS. Our processing system is such that your form will be forwarded within 24 hours to the proper executives in the companies you select. You will be contacted at your home by the interested companies.

WHAT TO DO

1. Review the positions in the advertisements.
2. Select those for which you qualify.
3. Notice the key numbers.
4. Circle the corresponding key number below the Qualification Form.
5. Fill out the form completely. *Please print clearly.*
6. Mail to: D. Hawksby, Classified Advertising Div., ELECTRONICS, Box 12, New York 36, N. Y. (No charge, of course).

COMPANY	SEE PAGE	KEY #
ALLSTATES DESIGN & DEVELOPMENT CO., INC. New York, New York	100*	1
ATOMIC PERSONNEL, INC. Philadelphia, Pennsylvania	126	2
BOEING COMPANY Seattle, Washington	93	3
DELCO RADIO Div. of General Motors Corp. Kokomo, Indiana	24*	4
EITEL-McCULLOUGH INC. San Carlos, California	71*	5
ESQUIRE PERSONNEL SERVICE INC. Chicago, Illinois	126	6
FAIRCHILD STRATOS Aircraft & Missiles Div. Hagerstown, Maryland	80, 81*	7
GENERAL ELECTRIC COMPANY Light Military Electronics Dept. Utica, New York	126	8
INTERNATIONAL BUSINESS MACHINES CORP. Poughkeepsie, New York	127	9
LOCKHEED CALIFORNIA CO Div. of Lockheed Aircraft Co. Burbank, California	74, 75*	10
LOCKHEED-GEORGIA CO. Div. of Lockheed Aircraft Co. Atlanta, Georgia	20*	11
MARTIN COMPANY Orlando Div. Orlando, Florida	100*	12
MICROWAVE SERVICES INTERNATIONAL, INC. Denville, New Jersey	100*	13
MOTOROLA, INC. Chicago, Illinois	101*	14
NATIONAL CASH REGISTER CO. Dayton, Ohio	124, 127	15
NATIONAL CASH REGISTER CO. Electronics Division Hawthorne, California	91	16

CONTINUED ON PAGE 126

(cut here)

(cut here)

electronics WEEKLY QUALIFICATION FORM FOR POSITIONS AVAILABLE

Personal Background

NAME

HOME ADDRESS

CITY ZONE STATE

HOME TELEPHONE

Education

PROFESSIONAL DEGREE(S)

MAJOR(S)

UNIVERSITY

DATE(S)

FIELDS OF EXPERIENCE (Please Check)

41362

- | | | |
|--|--|---------------------------------------|
| <input type="checkbox"/> Aerospace | <input type="checkbox"/> Fire Control | <input type="checkbox"/> Radar |
| <input type="checkbox"/> Antennas | <input type="checkbox"/> Human Factors | <input type="checkbox"/> Radio-TV |
| <input type="checkbox"/> ASW | <input type="checkbox"/> Infrared | <input type="checkbox"/> Simulators |
| <input type="checkbox"/> Circuits | <input type="checkbox"/> Instrumentation | <input type="checkbox"/> Solid State |
| <input type="checkbox"/> Communications | <input type="checkbox"/> Medicine | <input type="checkbox"/> Telemetry |
| <input type="checkbox"/> Components | <input type="checkbox"/> Microwave | <input type="checkbox"/> Transformers |
| <input type="checkbox"/> Computers | <input type="checkbox"/> Navigation | <input type="checkbox"/> Other |
| <input type="checkbox"/> ECM | <input type="checkbox"/> Operations Research | <input type="checkbox"/> |
| <input type="checkbox"/> Electron Tubes | <input type="checkbox"/> Optics | <input type="checkbox"/> |
| <input type="checkbox"/> Engineering Writing | <input type="checkbox"/> Packaging | <input type="checkbox"/> |

CATEGORY OF SPECIALIZATION

Please indicate number of months experience on proper lines.

	Technical Experience (Months)	Supervisory Experience (Months)
RESEARCH (pure, fundamental, basic)
RESEARCH (Applied)
SYSTEMS (New Concepts)
DEVELOPMENT (Model)
DESIGN (Product)
MANUFACTURING (Product)
FIELD (Service)
SALES (Proposals & Products)

CIRCLE KEY NUMBERS OF ABOVE COMPANIES' POSITIONS THAT INTEREST YOU

1 2 3 4 5 6 7 8 9 10 11 12 13 14 15 16 17 18 19 20 21 22 23 24 25

*Demanding Assignments for
Engineers at*



Reconnaissance Systems Laboratories
on the
SAN FRANCISCO PENINSULA

SYSTEMS ENGINEERS. System analysis and synthesis in new programs at Sylvania's RSL offer a broad spectrum of challenging problems involved in reconnaissance systems including: feasibility studies, conception and definition of optimized system solutions to basic operational requirements; application and development of advanced techniques; specification of constituent subsystems; human factors engineering; operations research; system performance analyses. A minimum of 5 years experience is required in progressive assignments in system analysis and synthesis and integration of subsystems. Should have background in receiving systems in the HF through millimeter bands. Advanced degree preferred.

DESIGN ENGINEERS. The design groups in RSL have openings for engineers at all levels with design and development background in one or more of these areas: receivers, RF components, DF equipment, antennas, magnetic tape recorders, teletype equipment, displays, data transmission, data converters and computers. Opportunities for both technical specialists and supervisors.

SENIOR RELIABILITY ANALYSIS ENGINEERS Positions requiring systems analysis, test design, availability and effectiveness studies, proposal writing, major reliability reports. Must have BS in EE or Physics with knowledge of fundamentals of calculus or probability; a minimum of 4 years of senior responsibility in reliability engineering involving implementation of reliability programs.

THE REWARDS. Work in a compact and growing laboratory which offers the creative engineer the opportunity to grow with an expanding organization. Take advantage of the individual recognition and advancement opportunities of a small organization (approximately 500 employees) with the security, benefits and diversified opportunities of a large corporation. Enjoy the ideal Northern California climate in relaxed suburban communities with excellent schools and recreational facilities for you and your family. Live within 40 minutes of cosmopolitan San Francisco. Realize the advantages of being close to leading universities (Stanford is just five miles from the Laboratory).

*Complete information may be obtained by writing, in confidence, to
Roger Harlan at:*

SYLVANIA ELECTRONIC SYSTEMS — WEST
SYLVANIA RECONNAISSANCE SYSTEMS LABORATORIES
P. O. Box 188, Mountain View, California



An equal opportunity employer.

7703



RESEARCH

**SOLID STATE
PHYSICS**

New programs in semi conductor and thin films research have created ground floor opportunity for qualified and vigorous research scientists in NCR's expanding research and development effort. Our interest is not temporary; rather it is an element of the stable long range viewpoint that has led to 78 years of leadership in the field of business equipment and systems. Perhaps you qualify to become a part of this respected organization.

*Openings in our Physical
Research Department include:*

Ph.D in physics, with at least five years experience in semi conductor component research and development, a theoretical understanding of semi conductor (silicon and germanium) physics, research and development experience in the semi conductor device fabrication techniques such as diffusion, alloying, masking etching, and in particular be familiar with the epitaxial formation of multilayer semi conductor structures.

Assignment involves technical leadership for a program in molecular electronics which will first be concerned with the investigation and exploitation of the epitaxial technique to determine its limitation and capabilities as related to the fabrication of functional semi conductor structures.

Ph.D in physical chemistry with three years of experience in the areas of electro-chemistry, preferably as applied to the formation of thin magnetic films. He should be familiar with the process of electro-deposition as related to magnetic materials and alloys, and have considerable understanding of magnetic theory, processes of crystal nucleation and growth as they are related to the formation of metallic electro-deposited films. It is also desirable to have technical familiarity with x-ray and electron diffraction examination and analysis methods, so that these skills may be brought to bear on the problem of the relationships of film composition and crystalline structure to the magnetic characteristics of electro-deposited films.

Ph.D in physical chemistry, with approximately 5 years experience and theoretical understanding of the problems of materials preparation, structural and compositional analysis and interpretation, and methods of materials evaluation. Particular emphasis should include solid state materials, such as semi conductors, magnetic materials, superconductors, and dielectrics.

To investigate these and other openings, write to:

Technical Placement
The National Cash Register Company
Main and K Streets
Dayton 9, Ohio

An Equal Opportunity Employer

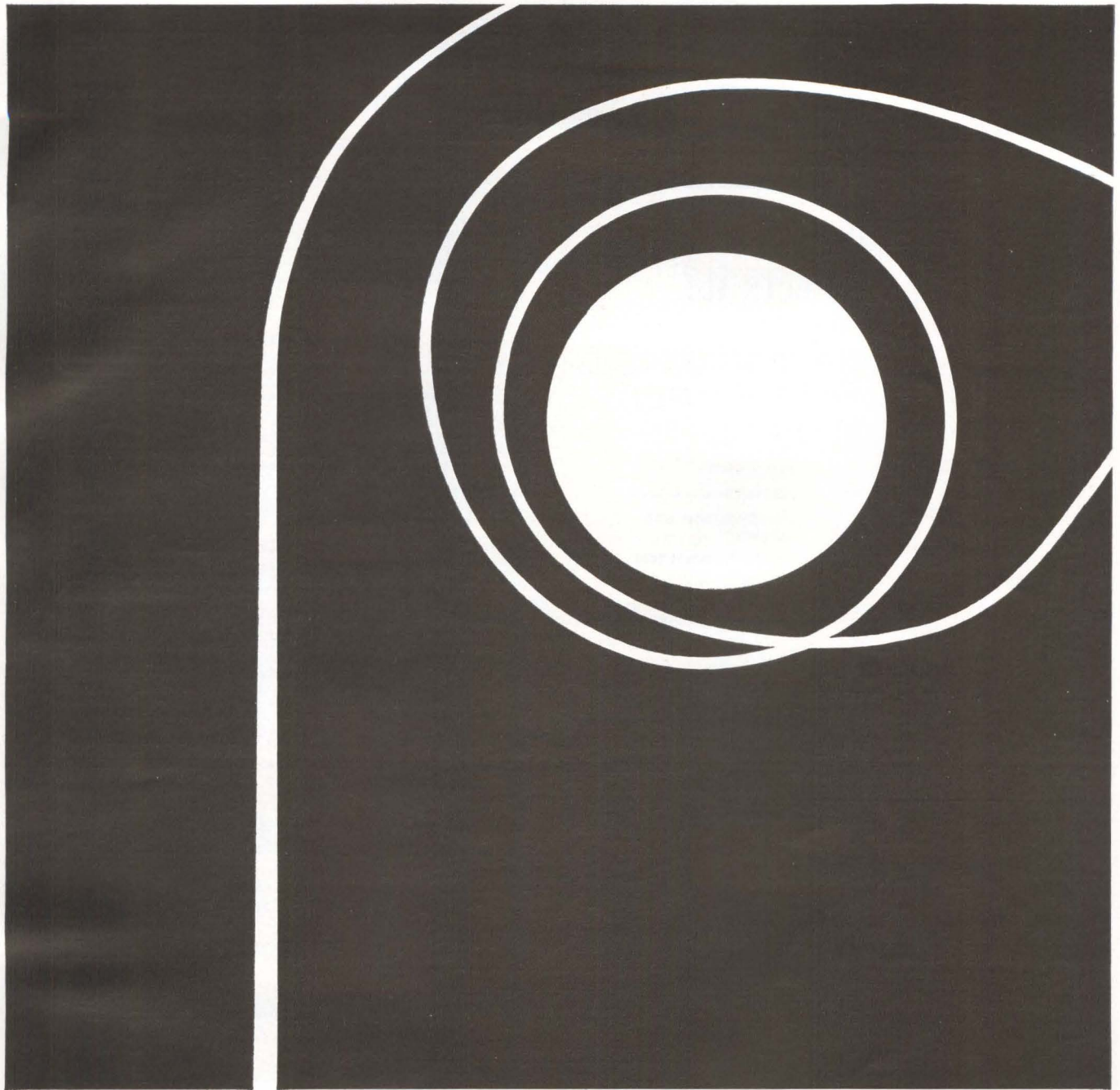

CHALLENGE FROM THE GROUND UP

At Philco Western Development Laboratories, specialists in communications sciences, space sciences and mathematical analysis begin each new space age program with analysis of mission requirements. Advance techniques in communications and control are applied to development of system demands, specifications for systems and sub-systems, and development specifications. These program-oriented efforts lead to development fabrication and test, and, finally, to installation, checkout and operation of equipment. Career opportunities for holders of B.S. or advanced degrees (electronics, mathematics, physics) offer start-to-finish challenge at Philco WDL, whose achievements include work on Discoverer, Midas, Advent and Courier programs.

Write in confidence for information on how you can find your career at Philco WDL, with the additional rewards of ideal living on the San Francisco Peninsula and professional and monetary advancement commensurate with your own ability. Requirements include U. S. Citizenship or current transferable Department of Defense clearance. Address Mr. Patrick Manning, Department E4.

PHILCO **WESTERN DEVELOPMENT LABORATORIES**
A SUBSIDIARY OF
Ford Motor Company, 3875 Fabian Way, Palo Alto, California
an equal opportunity employer

7756

Looking for more responsibility immediately... and a starting salary that reflects it?

General Electric's Light Military Electronics Department is seeking highly competent engineers to fill immediate technical leadership and consulting openings in the following program areas:

- | | |
|-------------------------------------|------------------------------------|
| Space Vehicle Guidance Systems | Command Guidance & Instrumentation |
| Missile & Satellite Computers | A.E.W. & Control |
| Microelectronics | Electronic Countermeasures |
| Space Detection & Surveillance | Space Communications & Telemetry |
| Navigation & Communication Systems | Undersea Warfare Systems |
| Silicon Crystal Circuit Development | Thin Films |
| | Automated Test Equipment |



LIGHT MILITARY ELECTRONICS DEPARTMENT



THESE ARE SAMPLES OF THE IMMEDIATE OPENINGS:

- ▶ **TRANSISTOR CIRCUIT DESIGN**
...on computers utilized in airborne early warning system.
- ▶ **LEAD EE**
...to integrate logic and circuit design efforts on space vehicle guidance equipment.
- ▶ **CIRCUIT DEVELOPMENT AND APPLICATION ENGINEER**
...should be capable of doing work in the following areas: a) Paper design & synthesis of complex circuitry such as is found in airborne electronics; b) Analysis of complete systems to determine and design those portions capable of being micro-miniaturized; c) Advise and consult with product line electronic design engineers; d) Prepare proposals.
- ▶ **DATA PROCESSING CONSULTING ENGINEER**
...involves computer design, including logic and logic organization, basic computer circuit design, memory storage circuits and devices, overall computer systems synthesis. Also includes direct leadership of D/A projects for advance design techniques, consultation with design engineers on product line design problems, assistance in preparation of technical proposals, participation as panel member in design reviews, leadership of technical symposia in your design field.
- ▶ **SYSTEMS ANALYST**
...includes missile flight test and analysis regarding guidance systems and computation; orbital trajectory analyses; overall system, sub-system and error analysis.
- ▶ **COMMUNICATION ENGINEER**
...for design studies and analyses regarding command control systems for space applications.
- ▶ **SPACE NAVIGATION OR GUIDANCE ENGINEER**
...to conduct systems studies regarding integrating hardware, e.g., developing stellar, radio or inertial navigation or guidance systems to perform specific missile function.
- ▶ **MICROWAVE ENGINEER**
with 3 to 5 years' antenna and microwave design experience to design radar and missile antennas, and microwave components.
For a careful review of your qualifications, and a prompt reply, forward your resume today in strictest confidence. Address: Mr. R. Zukowski, Div. 69-WO., Light Military Electronics Dept., General Electric, French Road, Utica, New York.

An Equal Opportunity Employer

Engineering or Science Graduates to be trained as
INSTRUMENT SALES ENGINEERS with

The Bristol Company

Leading manufacturer of automation equipment and control systems requires men, preferably 25 to 35 years old, to sell high quality, nationally accepted products to wide variety of industrial markets.

Openings in various areas of the country. Successful applicants take comprehensive three-months course at headquarters. Salary and expenses

All replies confidential; every inquiry answered. Write: Charles F. Johnson, Mgr. of Sales Training

The Bristol Company

Waterbury 20, Conn.

COMPUTER APPLICATIONS SPECIALIST
\$12,000 Per Year

Will investigate application for special purpose analog and digital computers and data processing equipment. Analyze requirements and prepare proposals and estimates. Staff opportunity. Company client assumes all expenses.

ESQUIRE PERSONNEL

202 South State St. Chicago 4, Ill.



MANUFACTURERS' REPRESENTATIVES

IN THE ELECTRONIC INDUSTRY

SAMUEL K. MACDONALD, INC.
manufacturers representatives over 25 years
1531 SPRUCE STREET, PHILA. 2, PA.

Territory: Pennsylvania • New Jersey
Delaware • Maryland
Virginia • West Virginia
District of Columbia

Other Offices:
Pittsburgh
Baltimore
Washington, D.C.



E.E.'s

For professional, individualized fee-paid service write for confidential application.

A national employment agency for the Nuclear & Scientific Fields.

ATOMIC PERSONNEL, INC.
Suite 1207L, 1518 Walnut St., Phila. 2, Pa.

ADDRESS BOX NO. REPLIES TO: Box No.
Classified Adv. Div. of this publication.
Send to office nearest you.
NEW YORK 36: P. O. Box 12
CHICAGO 11: 645 N. Michigan Ave.
SAN FRANCISCO 11: 255 California St.

SELLING OPPORTUNITY WANTED

Sales Representation—Competent Staff of Professional Engineers available to represent aircraft & equipment manufacturers in Texas, Oklahoma, Kansas and Missouri. Facilities resume upon request. RA-8515, Electronics.

EMPLOYMENT OPPORTUNITIES

The advertisements in this section include all employment opportunities — executive, management, technical, selling, office, skilled, manual, etc. Look in the forward section of the magazine for additional Employment Opportunities advertising.

— RATES —

DISPLAYED: The advertising rate is \$40.17 per inch for all advertising appearing on other than a contract basis. Contract rates quoted on request. An advertising inch is measured 7/8" vertically on a column—3 columns—30 inches to a page. Subject to Agency Commission.
UNDISPLAYED: \$2.70 per line, minimum 3 lines. To figure advance payment count 5 average words as a line.
Box numbers—count as 1 line.
Discount of 10% if full payment is made in advance for 4 consecutive insertions.
Not subject to Agency Commission.

electronics

WEEKLY QUALIFICATIONS FORM FOR POSITIONS AVAILABLE

(Continued from page 123)

COMPANY	SEE PAGE	KEY #
PHILCO WESTERN DEVELOPMENT LABS. Palo Alto, California	125	17
SCOPE PROFESSIONAL PLACEMENT CENTER Waltham, Massachusetts	100*	18
SIMMONDS PRECISION PRODUCTS INC. Tarrytown, New York	100*	19
SNELLING & SNELLING Boston, Massachusetts	100*	20
SYLVANIA MOUNTAIN VIEW OPERATIONS Mountain View, California	124	21

* These advertisements appeared in the 4/6/62 issue.

NCR

ADVANCED
DEVELOPMENT

INTEGRATED ELECTRONICS

A new program has started in the development of Integrated Circuits for computers and business machines. Circuits both in thin films and in semiconductor blocks will be designed, made, and evaluated. Novel circuits, applications, and processes will be sought. This program will provide growth opportunities along technical or managerial lines for imaginative experienced individuals. Backgrounds are desired in thin films, semiconductors, or logic design. Specific openings comprise:

● **SOLID STATE PHYSICS**

To design and confirm integrated circuit structures

● **ELECTRONICS**

To design and evaluate integrated circuits

● **LOGIC**

To specify and evaluate integrated circuits in logical applications

● **PROCESS**

To establish and improve processes in thin film and semiconductor technology such as evaporation, diffusion, contacting, surface treatment, epitaxy, etc.

In addition to unexcelled facilities and opportunities, NCR offers many unusual and unexpected benefits both in living and working climate. Purposeful effort, long range planning, and good management backed with 78 years of systems experience underline the stimulating program of research and development now emerging at NCR. To be considered for what may be your ground floor opportunity, write to:

T. F. Wade, Technical Placement,
The National Cash Register
Company, Main & K Streets,
Dayton 9, Ohio

An Equal Opportunity Employer

ENGINEERS FOR

IBM

INDUSTRIAL ENGINEERING

IBM is currently introducing new concepts into the basic fundamentals of . . .

INDUSTRIAL ENGINEERING

Through COMPUTER UTILIZATION, the following programs take on new meaning . . .

- **Work Sampling for Group Measurement**
- **Predetermined Time Standards**
- **Method Improvement Studies**
- **Indirect Work Measurement Using Statistical Techniques**
- **Plant Capacity and Manpower Planning**

If you have a B.S. or M.S. in Industrial Engineering, Electrical Engineering, Mechanical Engineering, or Industrial Management, and are interested in this new, growing industrial engineering division, please write, outlining your background and interests, to . . .

Gary A. Bosket
Dept. 554Q2
IBM Data Systems Div.
South Road
Poughkeepsie, N. Y.

INTERNATIONAL BUSINESS MACHINES CORPORATION

IBM

IBM is an Equal Opportunity Employer

SPECIAL PURPOSE TUBES

OA2.....	.80	4-65A.....	10.00	25Z6WGT.....	1.50	725A.....	10.00	5751WA.....	2.00
OA2WA.....	2.00	4-125A.....	20.00	26Z5W.....	1.50	726A.....	5.00	5763.....	1.75
OA3.....	.85	4-250A.....	32.50	FG-27A.....	20.00	726B.....	5.00	5777.....	150.00
OB2.....	.60	4-400A.....	30.00	28D7W.....	3.50	726C.....	8.50	5778.....	150.00
OB2WA.....	2.00	4-1000A.....	85.00	FG-32.....	6.50	802.....	3.50	5783.....	2.25
OB3.....	.70	4A10.....	10.00	35T.....	10.00	803.....	3.50	5787.....	2.50
OC3.....	.50	4B31.....	12.50	35TG.....	1.50	804.....	15.00	5796.....	8.00
OD3.....	.30	4C35.....	15.00	FP-54.....	100.00	805.....	7.50	5800/VX-41.....	7.50
C1A.....	7.50	4CX250B.....	30.00	FG-57.....	6.00	807.....	1.35	5803/VX-55.....	5.00
1AD4.....	1.50	4D32.....	15.00	HK-60/1641.....	1.50	807W.....	1.75	5814A.....	1.35
1B24A.....	12.50	4E27.....	10.00	HY-69.....	3.00	808.....	2.50	5829.....	1.00
1B35A.....	3.00	4J32.....	100.00	BL-75.....	3.00	809.....	5.00	5830/FG41.....	100.00
1B63A.....	10.00	4J34.....	100.00	TG-77.....	7.50	810.....	15.00	5836.....	50.00
1C/3B22.....	5.00	4J50.....	100.00	HF-100.....	10.00	811.....	2.50	5837.....	50.00
CIK.....	7.50	4J52.....	35.00	100TH.....	12.00	811A.....	4.00	5840.....	2.50
1P21.....	32.50	4PR60A.....	50.00	100TL.....	12.00	812A.....	4.75	5845.....	6.00
1P22.....	8.00	4X150A.....	15.00	FG-105.....	25.00	813.....	12.50	5852.....	5.00
1P25.....	10.00	4X150D.....	15.00	F-123A.....	5.00	814.....	3.50	5876.....	8.50
1P28.....	15.00	4X150G.....	25.00	FG-172.....	25.00	815.....	2.50	5879.....	1.25
1Z2.....	1.50	4X250B.....	25.00	211.....	2.50	816.....	2.25	5881/6L6WGB.....	2.50
2-01C.....	12.50	4X250F.....	30.00	212E.....	25.00	826.....	3.50	5884.....	4.00
2A1A.....	7.50	5B1A.....	9.50	FG-235.....	40.00	828.....	12.50	5894.....	18.85
2B23.....	20.00	5C22.....	17.50	242C.....	10.00	829B.....	9.50	5915.....	1.00
2BP1.....	8.50	5CP1A.....	9.50	244A.....	3.50	832.....	2.50	5915/SU4W6.....	4.00
2C36.....	22.50	5CP7A.....	9.50	245A.....	3.50	832A.....	7.50	5933/807W.....	2.50
2C39A.....	9.75	5D21.....	7.50	249B.....	10.00	833A.....	37.50	5948/1754.....	100.00
2C39B.....	15.00	5J26.....	50.00	249C.....	5.00	834.....	7.50	5949/1907.....	50.00
2C40.....	7.50	5J1.....	7.50	250R.....	10.00	836.....	2.50	5963.....	1.10
2C42.....	3.00	5L1.....	7.50	250TH.....	25.00	837.....	1.00	5965.....	8.5
2C43.....	7.50	5R4G.....	1.10	251A.....	50.00	838.....	1.00	5976.....	50.00
2C46.....	5.00	5R4WGA.....	5.00	254A.....	3.50	842.....	7.50	5992.....	5.00
2C50.....	4.00	5R4WGB.....	6.00	FG-258A.....	75.00	845.....	7.50	5993.....	5.00
2C51.....	1.50	5R4WGY.....	2.75	259A.....	3.50	849.....	35.00	6002/QK221.....	250.00
2C52.....	1.50	5R1A.....	9.50	262B.....	5.00	851.....	1.90	6005/6AQ5W.....	1.50
2C53.....	7.50	5Y3WGT.....	1.25	267B.....	5.00	866A.....	5.00	6012.....	4.00
2D21.....	.50	5Y3WGTB.....	3.00	271A.....	12.50	869B.....	50.00	6021A.....	2.00
2D21W.....	1.00	6A C7W.....	2.00	274A.....	3.50	872A.....	7.50	6027/2M2A.....	100.00
2E22.....	2.50	6AC7WA.....	2.00	283A.....	3.50	874.....	1.25	6032.....	10.00
2E24.....	2.5	6AG5WA.....	1.50	287A.....	3.50	884.....	.85	6037/QK243.....	50.00
2E26.....	2.50	6AG7Y.....	1.00	QK-28B.....	250.00	885.....	.85	6045.....	1.15
2J42.....	75.00	6AK5W.....	1.25	HF-300.....	35.00	889A.....	150.00	6072.....	1.50
2J51.....	50.00	6AK5 (WE).....	.75	300B.....	5.00	891.....	200.00	6073.....	1.50
2J55.....	90.00	6AL5W.....	.60	304TH.....	35.00	913.....	2.50	6074.....	1.75
2K22.....	25.00	6AN5.....	1.75	304TL.....	35.00	920.....	2.50	6080.....	3.35
2K25.....	35.00	6AN5WA.....	3.50	307A.....	3.50	927.....	1.50	6080WA.....	5.00
2K26.....	35.00	6AQ5W.....	1.00	310A.....	3.50	931A.....	3.50	6080WB.....	12.50
2K29.....	30.00	6AR6.....	.85	311A.....	3.50	1000T.....	80.00	6082.....	2.50
2K30.....	50.00	6AS6W.....	1.00	313C.....	1.50	R1130B.....	10.00	6087/SY3WGTB.....	3.00
2K33A.....	200.00	6AS7G.....	2.50	323A.....	6.00	1500T.....	150.00	6101/6J6WA.....	1.50
2K34.....	75.00	6AU6WA.....	1.25	328A.....	3.50	1611.....	2.00	6115/OK351.....	50.00
2K35.....	200.00	6B4G.....	3.35	329A.....	4.50	1614.....	2.75	6130/3C45.....	6.50
2K39.....	150.00	6BA6W.....	.75	336A.....	2.50	1616.....	1.00	6136/6AU6WA.....	1.25
2K41.....	50.00	6BE6W.....	1.50	337A.....	3.50	1620.....	4.00	6146.....	3.00
2K42.....	125.00	6BH6W.....	2.75	347A.....	1.00	1624.....	1.00	6159.....	3.50
2K43.....	175.00	6BL6.....	20.00	348A.....	4.50	1625.....	.50	6161.....	35.00
2K44.....	125.00	6BM6.....	25.00	349A.....	3.50	1635.....	2.00	6166/6AG5WA.....	1.50
2K45.....	20.00	6BM6A.....	30.00	350A.....	3.50	1846.....	50.00	6189/12AU7WA.....	1.50
2K47.....	150.00	6C4W.....	2.50	350B.....	2.50	1855.....	250.00	6197.....	1.75
2K48.....	50.00	6C4WA.....	1.00	352A.....	8.50	2050.....	1.25	6201/12AT7WA.....	1.85
2K50.....	100.00	6C21.....	17.50	354A.....	12.50	ZB-3200.....	100.00	6202/6X4WA.....	1.50
2K54.....	10.00	6D4.....	1.50	355A.....	12.50	5578/C6L.....	3.50	6211.....	.75
2K55.....	15.00	6F4.....	3.50	371B.....	2.50	5545.....	20.00	6216.....	3.00
2K56.....	50.00	6G1.....	10.00	388A.....	2.00	5550.....	30.00	6233.....	100.00
2P21.....	40.00	6G1/A.....	15.00	393A.....	5.00	5552/FG235.....	50.00	6236.....	125.00
2X2A.....	1.00	6G1/K.....	20.00	394A.....	3.00	5553/FG258.....	75.00	6248.....	500.00
3A5.....	.75	6J4.....	1.50	395A.....	2.25	5557/FG17.....	5.00	6263.....	9.00
3A1P.....	3.50	6J4WA.....	2.50	396A/2C51.....	1.50	5558/FG32.....	6.50	6264.....	9.00
3B24W.....	3.00	6J6W.....	.60	398A/5603.....	3.00	5559/FG57.....	6.00	6265.....	9.00
3B24WA.....	5.00	6J6WA.....	1.00	401A/5590.....	1.00	5560/FG95.....	20.00	6265/6BH6W.....	2.75
3B25.....	2.50	6K4.....	2.00	403B/5591.....	3.00	5561/FG104.....	40.00	6299.....	37.50
3B26.....	2.25	6L6GAY.....	.75	404A/5847.....	7.50	5586.....	150.00	6316/BL800A.....	100.00
3B28.....	3.00	6L6WGA.....	1.50	407A.....	3.75	5586.....	2.25	6322/BL25.....	15.00
3B29.....	5.00	6L6WGB.....	2.50	408A/6028.....	3.25	5642.....	2.00	6336.....	8.75
3BP1A.....	5.00	6Q5G.....	2.50	409A/6A56.....	1.00	5643.....	3.00	6336A.....	12.75
3C/4B24.....	4.00	6SJ7WGT.....	1.25	410R.....	75.00	5647.....	3.50	6344/QK235.....	500.00
3C22.....	25.00	6SK7W.....	.75	416B/6280.....	30.00	5651.....	.75	6352.....	7.50
3C23.....	4.00	6SK7WA.....	2.00	417A/5842.....	9.50	5654/6AK5W.....	1.50	6385.....	6.00
3C24/24G.....	7.50	6SL7WGT.....	1.00	418A.....	9.50	5656.....	5.00	6390.....	125.00
3C33.....	7.50	6SN7W.....	.50	420A/5755.....	5.00	5663.....	1.00	6394.....	10.00
3C45.....	3.50	6SN7WGT.....	1.00	421A/5998.....	7.50	5665/C16J.....	35.00	6438.....	5.00
3CX100A5.....	17.50	6SN7WGTA.....	2.50	429A.....	6.50	5667.....	125.00	6463.....	1.00
3D21A.....	2.50	6SU7GT.....	.85	GL-434A.....	7.50	5670.....	1.00	6485.....	1.50
3D22.....	8.00	6V6GTY.....	1.00	450TH.....	40.00	5672.....	1.35	6517/QK358.....	500.00
3DP1A.....	5.00	6X4W.....	.75	450TL.....	40.00	5675.....	8.50	6533.....	5.00
3E29.....	7.50	6X4WA.....	1.50	575A.....	15.00	5678.....	1.25	6542.....	5.75
3GP1.....	1.50	6XS5WGT.....	1.00	578.....	5.00	5686.....	2.25	6550.....	3.00
3J1.....	7.50	6X4WA.....	1.50	KU-610.....	5.00	5687.....	5.00	6807.....	20.00
3J1A.....	9.50	6X4WA.....	1.50	NL-623.....	8.50	5691.....	1.50	7034/4X150A.....	15.00
3J21.....	35.00	6X4WA.....	1.50	631-P1.....	5.00	5692.....	2.50	7044.....	1.50
3J31.....	50.00	6X4WA.....	1.50	673.....	15.00	5693.....	3.50	7580.....	35.00
3JP1.....	5.00	6X4WA.....	1.50	676.....	30.00	5696.....	.75	8002R.....	25.00
3K21.....	125.00	6X4WA.....	1.50	677.....	40.00	5720/FG33.....	17.50	8005.....	7.50
3K22.....	125.00	6X4WA.....	1.50	678.....	40.00	5721.....	110.00	8008.....	7.75
3K23.....	200.00	6X4WA.....	1.50	701A.....	5.00	5725/6A56W.....	1.50	8013A.....	5.00
3K27.....	150.00	6X4WA.....	1.50	703A.....	1.50	5726/6AL5W.....	.75	8014A.....	30.00
3K30.....	100.00	6X4WA.....	1.50	707B.....	2.50	5727/2D21W.....	1.25	8020.....	4.50
3K31.....	9.75	6X4WA.....	1.50	NL-710.....	9.75	5728/FG67.....	10.00	8025A.....	7.50
3RP1.....	7.50	6X4WA.....	1.50	715C.....	15.00	5749/6BA6W.....	.75	9003.....	2.00
3WP1.....	12.50	6X4WA.....	1.50	719A.....	12.50	5750/6BE6W.....	1.50	9005.....	3.00
		6X4WA.....	1.50	721B.....	5.00	5751/12AX7W.....	1.35		
		6X4WA.....	1.50	723A/B.....	3.50				

ALL TUBES ARE NEW, INDIVIDUALLY CARTONED, FULLY GUARANTEED

western engineers

Orders for less than \$10 cannot be processed

ELK GROVE, CALIFORNIA
SUPPLIERS OF ELECTRON TUBES SINCE 1932

Prices are FOB shipping point

• MAGNETRON PULSER •

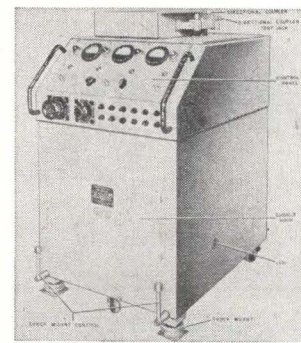

Made special to test, pulse and age magnetrons type 4J50, 4J78 and similar. Can be easily modified to test any magnetron up to 500 KW input. Variable repetition rates and power output. Power input 115V, 50-1000 cycles. Unit size: 30" x 48" x 28"—mounted on casters. Packed in new original factory cases.

SPECIAL PRICE .. \$1,950.00

only a fraction of manufacturers cost

Of interest to manufacturers and users of magnetrons . . . laboratories . . . and airlines.

LIBERTY ELECTRONICS, INC.

582 Broadway New York 12, N. Y.
Phone: WAlker 5-6000 Cables: TELSERSUP

CIRCLE 461 ON READER SERVICE CARD

CAPACITORS

MFD VOLTS	PRICE	MFD VOLTS	PRICE
.001 75KV	80.00	† 2 6000V	

ELECTRONIC

WAR TERMINATION INVENTORIES

WRITE OR WIRE FOR INFORMATION ON OUR COMPLETE LINE OF SURPLUS ELECTRONIC COMPONENTS. ALL PRICES NET F.O.B. PASADENA, CALIFORNIA

C&H SALES CO.

2176-E East Colorado St.
Pasadena 8, California
Murray 1-7393

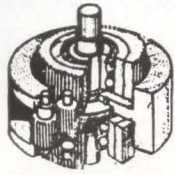

SIMPLE DIFFERENTIAL WITH BALL-BEARING SUN GEARS

The 1:1 reverse ratio spur gears are 48-tooth, 32 pitch brass with 3/16" available face. On one side, the shaft is 23.64" dia. for 11/16" and has a pin hole, then increases in dia. to .377" for the remaining 3/16" of length. On the other side, the shaft is .377 dia. 1/4" lg. 2-13/16" dia. is required to clear the body. Stock no. A6-115 each \$15.00

1/100 SECOND TIMER, INTERVAL, 115 VAC, 60 CYCLE

mfgd. by Standard Electric Time Co. accuracy ± .005 sec. w/DC clutch first hand speed — 1 FPS—totalizes 60 seconds short hand smallest graduations .01 sec. 115 VAC, 60 ohms, brake solenoid 27.5 VDC dial—white background w/black characters clock motor to close set of contacts at one second intervals contact rating 1 amp, 28 VDC, non-inductive. Manual reset, outside dim. 3 3/4" sq. in. PRICE \$25.00 EACH



400-CYCLE MOTOR GENERATOR, PU-20

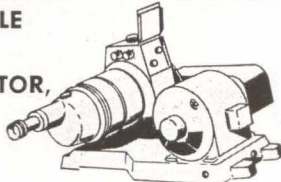

The generator assembly consists of a 1400-watt, 120-volt, 400-cycle inductor-alternator and a 400-watt, 27-volt D.C. generator. The alternator rotor and the D.C. generator armature are mounted on a common shaft, which is dual-belt-driven by a 3-H.P., 1750-R.P.M., 115/230-volt, single-phase 60-cycle electric motor. Weatherproof output box is mounted on top of the stator shell. It contains a rheostat, adjustable resistor, two pin jacks for plugging in an A.C. voltmeter. Size: 28" W., 33" L., 18" H. Weight, approx. 250 lbs. Price \$175.00

8-DAY ELAPSED-TIME SURPLUS AIRCRAFT CLOCK



Here's an accurate time-control center that'll help you win your next rally. It not only tells you the date and time of day right to the second, it's a stop watch that gives you elapsed time in seconds, minutes, and hours! The 24-hour clock simplifies adding and subtracting elapsed time for your navigator. Manufactured by Elgin Watch Co. to exacting military specifications, it will remain accurate in spite of road bumps and vibrations. Uses no electrical connections. Does the job of high-cost equipment. Jeweled/Sweep Second Hand/Luminous Hands and Numerals/25-Hour Dial/Black Face and Plastic Case/3/16" Mounting. Cost the Government \$185.00

Only \$39.95 Postpaid

SPERRY VERTICAL GYRO

Part #673073, Motor 115 volts, 3 phase, 400 cycle, 8 watts, 20,000 RPM. 3-minute runup, synchro pickoffs, roll 360°, pitch 85°. Synchro excitation 26 volts, 400 cycle, 150 m.a. Vertical accuracy ± 1/2". Weight 3 1/2 lbs. Approx. dim. 5 1/4" L., 4 1/2" W., 4 1/4" H. Price \$35.00



VARIABLE SPEED BALL DISC INTEGRATORS (All Shafts Ball Bearing Supported)

No. 145 Forward & Reverse 2 1/2"-.021" Input shaft spline gear 12 teeth 9/32" dia. 3/4" long. Output shaft 15/64" dia. x 15/32" long. Control shaft 11/32" x 3/4" long. Cast aluminum construction. Approx. size 3" x 3" x 2 1/4" \$17.50

No. 146 Forward & Reverse 4-0-4. Input shaft 5/16" dia. x 3/4" long. Output shaft 15/64" dia x 9/16" long. Control shaft 11/64" dia. x 11/16" long. Cast aluminum construction. Approx. size 4 1/2" x 4 1/2" x 4". \$18.50 ea.



SMALL DC MOTORS

(approx. size over 3/4" x 1 1/4" dia.)
5067043 Delco 12 VDC PM 1" x 1" x 2", 10,000 rpm. \$7.50

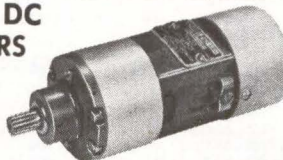

- 5067126 Delco PM, 27 VDC, 125 RPM, Governor Controlled 15.00 ea.
- 5069600 Delco PM 27.5 VDC 250 rpm 12.50
- #5069625 120 rpm, mfr. Delco, 27 VDC governor controlled \$15.00
- 5069230 Delco PM 27.5 VDC 145 rpm 15.00
- 5068750 Delco 27.5 VDC 160 rpm w. brake 6.50
- 5068571 Delco PM 27.5 VDC 10,000 rpm (1x1x2") 5.00
- 5069790 Delco PM, 27 VDC, 100 RPM, Governor Controlled 15.00 ea.
- #5069800 575 rpm, mfr. Delco, 27 VDC, PM reversible governor controlled, equipped with 27 VDC clutch \$17.50
- 5072735 Delco 27 VDC 200 rpm governor controlled. 15.00
- 5BA10A118 GE 24 VDC 110 rpm 10.00
- 5BA10AJ37 GE 27 VDC 250 rpm reversible 10.00
- 5BA10AJ52 27 VDC 145 rpm reversible 12.50
- 5BA10AJ50, G.E., 12 VDC, 140 rpm 15.00
- 5BA10FJ401B, G.E. 28 VDC, 215 rpm, 10 oz. in., 7 amp. contains brake 15.00
- 5BA10FJ421, G.E. 26 VDC, 4 rpm, reversible, 6 oz. in., .65 amp 15.00

400 CYCLE PM GENERATOR

115/200 volts A.C. 1- or 3-phase, 200 watts. 4,000 r.p.m. Approx. dimensions: 4 1/2" dia.; 3" long; 1/2" shaft, AN connector. \$75.00

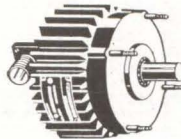

DIRECTIONAL INDICATOR, TYPE C5C



Mfr. Summers Gyroscope Company. 115 volt A.C., 400 cycle, 3 phase. Contains direct reading gyro with caging mechanism and power failure indicator. Hermetically sealed case. 5" dial, 0 to 360° PRICE \$22.50

MINNEAPOLIS-HONEYWELL RATE GYRO (Control Flight)



Part no. JG7005A, 115 volts A.C., 400 cycle, single phase potentiometer take off resistance 530 ohms. Speed 21,000 r.p.m. Angular momentum 2 1/2 million, CM²/sec. Weight 2 lbs. Dimensions 4-7/32 x 3-29/32 x 3-31/64. Price \$22.50

SELSYNS- SYNCHROS

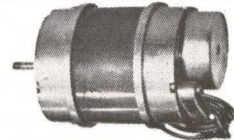

- 1CT cont. Trans 90/55V 60 cy..... \$27.50
- 1DG Diff. Gen. 90/90V 60 cy..... 34.50
- 1F Syn. Mtr. 115/90V 60 cy..... 34.50
- 1G Gen. 115V 60 cy..... 34.50
- 1HDG 37.50
- 1HCT 37.50
- 1SF Syn. Mtr. 115/90V 400 cy..... 12.50
- 23TR4 torque receiver..... 34.50
- 23TR6 torque receiver..... 37.50
- 23CT6 control transformer..... 37.50
- 23CX6 control transmitter..... 37.50
- 23TX6 torque transmitter..... 37.50
- 7DG differential generator..... 37.50
- 2J1F1 Gen. 115/57.5V 400 cy..... 7.50
- 2J1F3 Gen. 115/57.5V 400 cy..... 10.00
- 2J1FA1 Gen. 115/57.5V 400 cy..... 7.50
- 2J1G1 57.5/57.5V 400 cy..... 5.00
- 2J1H1 Diff. Gen. 57.5V 400 cy..... 7.50
- 2J5D1 Cont. Trans. 105/55V 60 cy..... 17.50
- 2J5F1 Cont. Trans. 105/55V 60 cy..... 17.50
- 2J5H1 Gen. 115/105V 60 cy..... 17.50
- 2J15M1 Gen. 115/57.5V 400 cy..... 17.50
- 5CT Cont. Trans. 90/55V 60 cy..... 34.50
- 5D Diff. Mtr. 90/90V 60 cy..... 34.50
- 5DG Diff. Gen. 90/90V 60 cy..... 34.50
- 5F Syn. Mtr. 115/90 VAC 60 cy..... 34.50
- 5G Syn. Gen. 115/90VAC 60 cy..... 34.50
- 5HCT Cont. Trans. 90/55V 60 cy..... 37.50
- 55DG Diff. Gen. 90/90V 400 cy..... 12.50
- 6DG Diff. Gen. 90/90V 60 cy..... 25.00
- 6G Syn. Gen. 115/90VAC 60 cy..... 42.50
- 7G Syn. Gen. 115/90VAC 60 cy..... 42.50
- C56701 Type 11-4 Rep. 115V 60 cy..... 20.00
- C69405-2 Type 1-1 Transm. 115V 60 cy..... 20.00
- C69406 Syn. Transm. 115V 60 cy..... 20.00
- C69406-1 Type 11-2 Rep. 115V 60 cy..... 20.00
- C78248 Syn. Transm. 115V 60 cy..... 20.00
- C78410 Repeater 115V 60 cy..... 20.00
- FPE 49-7 Diehl servo motor, 115 volts, 60 cycle, 10 watts..... 30.00

400 CYCLE, 3 PHASE GENERATOR BY MASTER ELECTRIC

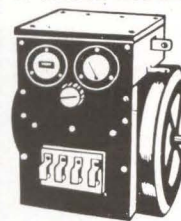

Type AG, frame 364Y, 7.5 kw, 3428 rpm, pf .95 Star connected 120/208 3 phase, 22 amps. Delta connected 120 volt single phase 6 amps. Self excited. Complete with control box, voltage regulator, AC voltmeter and frequency meter. Shaft 1" dia., 2" long; overall dim. of unit: 21" x 18" x 20". Price \$395.00 each

SENSITIVE INTEGRATING GYROS



This is the famous HIG Gyro which is being used in missile guidance systems, radar stabilization and fine control systems. Government cost approximately \$1500. PRICE \$50.00

400 CYCLE PM GENERATOR

Mfgd. by T K M Electric Corp. Model #A-12 120/208 volts, 400 cycle, 1 or 3 phase, 1 kva, pf 0.8, rpm 8,000. Approx. dim. 6" x 5 1/2". Internal spline drive. Price \$100.00

HONEYWELL VERTICAL GYRO MODEL AG7044A17



115 volts, 400 cycles, single phase, 35 watts. Pitch and roll potentiometer pickoffs 890 ohms, 40 volts max. AC or DC. Speed 20,000 rpm, ang. momentum 12,500,000 gm-cm²/sec. Erection system 27 VAC, 400 cycles, time 5 min. to 1/2°; caging mechanism operates on 24 VDC. \$49.50

DIRECTIONAL GYRO

Mfg. Sperry Part #66519 115 VAC 400 N 3 phase

\$35.00 ea.



SPECIALIZING **R & D** RESEARCH & DEVELOPMENT EQUIPMENT

MICROWAVE ANTENNAS



3 CM ANTENNA ASSEMBLY:
Uses 17" paraboloid dish, operating from 24 vdc motor. Beam pattern: 5 deg. in both Azimuth and elevation. Sector Scan: over 160 deg. at 35 scans per minute. Elevation Scan: over 2 deg. Tilt. Over 24 deg.\$27.50

3 cm. Horn: 1"x1/2", with twist and 180 deg. bend. With di-electric window\$7.50

AT49/APR - Broadband Conical, 300-3300 MC, Type N Feed.\$5.95

Discone Antenna, AS 125/APR, 1000-3200 mc. Stub supported with type "N" connectors.\$6.95

AS14A/AP, 10 CM pick up dipole assy, complete w/length of coax and "N" connectors.\$4.50

AS46A/APG-4 Yagi Antenna, 5 element array. \$8.95

30" Paraboloid Reflector Spun Aluminum dish 10 1/2" Focus\$4.85

18" PARABOLOID DISHES, spun aluminum. Focus approx. 8 inches.\$3.95

APS-4, 3 cm. antenna. Complete. 1 1/4" dish. Cutler feed dipole directional coupler, all standard 1" x 3/8" waveguide. Drive motor and gear mechanisms for horizontal and vertical scan. complete.\$27.50

PULSE NETWORKS

G.E. #6E3-5-2000-50P2T, 6KV "E" circuit, 3 sections 5 microsecond, 2000 PPS 50 ohms impedance.\$4.00

G.E. #3E (3-84-810) (8-2-24-405) 50 P4T: 3KV "E" CKT Dual Unit; Unit 1, 3 sections, 0.84 Microsec. 810 PPS, 50 ohms imp; Unit 2, 8 sections, 2.24 microsec. 405 PPS, 50 ohms imp.\$3.75

H-616 10 KV, 2.2 usec., 375 PPS, 50 ohms imp. \$8.50

H-615 10KV, 0.85 usec., 750 PPS, 50 ohms imp. \$8.50

H-605: 25KV, "E" CKT, 1.5 usec., 400 PPS, 50 Ohms Impedance, 5 sections.\$47.50

7-5E3-1-200-67P, 7.5 KV "E" Circuit, 1 Microsec. 200 PPS, 67 ohms impedance 3 sections.\$4.00

7-5E4-16-60, 67P, 7.5 KV "E" Circuit, 4 sections 16 microsec. 60 PPS, 67 ohms impedance.\$6.00

7-5E3-3-200-67P, 7.5 KV, "E" Circuit, 3 microsec. 200 PPS, ohms, imp, 3 sections.\$7.00

X BAND-1" x 1/2" WAVEGUIDE

90 degree elbows. "E" or "H" Plane 2 1/4" radius \$5.50

ROTARY JOINT (APS-6) Sperry PT #658275, 180 deg. rotation, choke-to-choke. Has "Built-in" Di-Coupler, 20 DB, with "N" Takeoff.\$12.50

PARABOLOID DISH, 18" diam, Spun Aluminum, 8" Focus, For AN/APS-6.\$3.95

3 CM. DIPOLE and Feed Assembly. (May be used with above dish) 8 inches long.\$5.00

FLEXIBLE SECTION 9 in. long, Cover-to-Cover \$4.00

3 CM. DIPOLE FEED, 15" L for APS-15.\$8.50

Cross-Guide Directional Coupler, UG-40 output flange. Main Guide is 6" Long, with 90 Deg. "E" Plane bend at one end, and is fitted with Std. UG 39/UG 40 flanges. Coupling figure: 20 db Nominal.\$12.50

Bulkhead Feed-thru Assembly.\$9.75

Pressure Gauge Section with 15 lb. gauge.\$7.50

ADAPTER, waveguide to type "N" UG 81-U, p/o TS 12, TS-13, Etc.\$6.50

I.F.F. 1 KW Pulsed Output Pkg. Tunable 154-186 mc. adj. modulating pulses 4-10 micro sec. comp. 115 60 cy ac pwr. supply. Video output receiver. New w/tubes.\$200.00

Dipole Array for above.\$10.00

COMMUNICATIONS EQUIP CO.

All merch. guar. Mail orders promptly filled. All prices F.O.B. N.Y.C. Send M.O. or Chk. Only shipping chgs. sent C.O.D. Rated Concerns send P.O.

COAXIAL R.F. FILTERS

F-29/SPR-2, Hi-Pass, with 1000 mc. Cut-off, Type "N" input and output, 50 Ohms Z.\$5.00

F-4/SPR-1, Hi-Pass, with 300 mc cut-off, Type "N" input and output, 50 Ohms Z.\$5.00

ANTENNA PEDAAL SCR 584

Full azimuth and elevation sweeps 360 degrees in azimuth, 210 degrees in elevation. Accurate to 1 mil. or better over system. Complete for full tracking response. Angle acceleration rate: AZ, 9 degrees per second squared EL, 4 degrees per second squared. Angle slewing rate: AZ 20 degrees per sec. EL 10 degrees per sec. Can mount up to a 20 ft. dish. Angle tracking rate: 10 degrees per sec. Includes pedestal drives, selcons, potentiometers, drive motors, control amplifiers. Excellent condition. Ideal for missile & satellite tracking, antenna pattern ranges, radar systems, radio astronomy, any project requiring accurate response in elevation and azimuth. 1/2" x 1/2" Complete description in McGraw-Hill Radiation Laboratory Series, Volume 1, page 284 and page 209, and Volume 26, page 233.

Price on request.

ELECTRONICS

TS 12, AP complete with waveguides #1 & #2 units - P.O.R. CF-2 CARRIER 6"x2"x18"\$75.00

400 MC RADAR, complete set w/indicators, control boxes, XMTR, RCVR, connectors, less 2 cables\$57.50

WE HAVE OVER 100,000 THERMAL RELAYS IN 40 TYPES P.O.R.

PULSE EQUIPMENT

MIT. MOD. 3 HARD TUBE PULSER: Output Pulse Power 144 KW (12 KV at 12 Amp). Duty Ratio: .001 max. Pulse duration: 5, 1.0, 2.0 microsec. Input voltage: 115 v, 400 to 2400 cps. Uses: 1-713, 4-89-B, 3-72's, 1-73. New. Less Cover-\$60.00

ASD Modulator Units. mfd. by Sperry. Hard tube pulser delivers Pk. pulse of 144 kv. Similar to Mod. 3 unit. Brand new, less tubes.\$52.50

Airborne RF head, model A1A, delivers 50 Kw peak output at 9000 mc, at .001 duty. Complete with pulser unit and all tubes. Used, excel.\$85.00

PULSE TRANSFORMERS

Westinghouse 4P37: Primary: 50 ohms imp. 750 v. Sec. 15 kv. 1000 ohms imp. Bifilar filament trans. built in, delivers 12.6 v at 2.5 amp. (pri. 115 v. 400 cy.)\$17.50

RAYTHEON WX 4298E: Primary 4KV., 1.0 USEC. SEC: 16KV-18 AMP DUTY RATIO: .001 400 CYCLE FIL TRANS. "BUILT-IN"\$22.00

WECO: KS 9948: Primary 700 ohms; Sec: 50 ohms. Plate Voltage: 18 KV. Part of APQ-13.\$7.50

K-2745 Primary: 3.1/2.8 KV, 50 ohms Z, Secondary: 14/12.6 KV 1025 ohms Z. Pulse Length: 0.25/1.0 usec @ 600/600 PPS, Pk. Power 200/150 KW. Bifillar: 1.3 Amp. Has "built-in" magnetron well.\$15.00

K-2461-A. Primary: 3.1/2.6 KV-50 ohms (line), Secondary 14/11.5 KV-1000 ohms Z. Pulse Length: 1 usec @ 600 PPS, Pk. Power Out: 200/130 KW. Bifillar: 1.5 Amp. Fitted with magnetron well \$17.50

FOR R & D EXPERIMENTS SUPPLIES

Visit and see over 10,000 different Electronic Parts and assemblies. Hundreds of Wave Guide Parts. We welcome your phone inquiries.

343 CANAL ST., N. Y. 13, N. Y.
(Formerly 131 Liberty St.)
CHAS. ROSEN, Worth 6-4045

CIRCLE 466 ON READER SERVICE CARD

Wilgreen

can deliver Amphenol Bendix Cannon CONNECTORS FITTINGS & CLAMPS

We stock more than 5,000,000 MS/AN CONNECTORS of 50,000 variations! IN PRODUCTION QUANTITIES we sell BELOW "O.E.M." PRICE and offer IMMEDIATE "OFF-THE-SHELF" DELIVERY!

FREE . . . Send for latest brochure and list price chart

WILGREEN INDUSTRIES, Inc.
102 Warren Street, New York 7, N. Y.
Worth 4-2490-1-2 Wire: FXK

CIRCLE 467 ON READER SERVICE CARD

HERSHEL SPECIALS



BUTTERFLY CONDENSERS

YOUR CHOICE

\$4.95

TYPE A 4 1/4" Dia. Type A-104-330 MC-Antenna Type



TYPE B 4 3/8" Dia. Type B-135-485 MC

These units make the finest tuners for Ultra-high frequency transmitters, receivers, frequency meters, and oscillators.



TYPE C 2 1/2" Dia. Type C-100-1000 MC-Use 306A8 tube



TYPE D 2 1/2" Dia. Type D-300-1000 MC-Clip Top Xial Dev.

TERMS: Cash with order or 25% DOWN-BALANCE C.O.D. ALL PRICES NET F.O.B. DETROIT

TYLER 8-9400

HERSHEL RADIO CO.

5247 GRAND RIVER Detroit 8, Michigan

CIRCLE 468 ON READER SERVICE CARD

GET IT from GOODHEART!

MEASURE E, I, R TO 4-FIGURE ACCURACY
and with ZERO current drawn from ckt being measured. Voltage: Direct reading, Potentiometric method. W supply 110V AC. L & N 3-dial Kelvin 20 K ohm Voltage Divider, accuracy .01%, plus .01% resistors for Divider connection as Wheatstone Bridge, plus 0-center uAmmeter, plus exact instructions, theory & practical data, Divider & Potentiometer. You supply cheap batteries for 3-figure accuracy or standard cell for 4 figures. This is a \$1055.00 Test Set! All for only. **\$79.50**

West. Elect. KS-10375 Null Voltage Test Set, 0-250 V, made by L & N, is 4-dial 100 K ohm Voltage Divider, accuracy 1 part in 100,000, with sensitive L & N galvanometer and convenient switching. \$199.50

WESTON STANDARDIZING POTENTIAL XFMR
Mod. 311 Type 3. Adjust 120 v 50-125 cy to wdg 1 to read 150.0 v on your meter at wdg 3. Get 1 1/2, 2, or 3, 15 & 30 v at wdg 2, accurate 0.1%, to 500 ma. Regular \$461.50, **\$199.50**
Only.

MIL SPEC SILICON DIODES IN250A
Unused, contract termination. 200 PIV 20A at 150 deg. C, 1/2-2 volt, hex base. Max 1 1/2 v dc 5 m reverse, 250 A 1/2-cy surge. Regular \$100.00. Buy postpaid at only. **\$2.50**

PRECISION PHASE METER AN/URM-67
Phase Monitor ME-63/U in chest w/cords. Inputs 20-20,000 cy 2-30 v peak, reads 0-360 deg. Same as Control Electronics Co. Model 120. Actual cost \$1420.00. Like new, **\$275.00**
only.

HANDY-DANDY 3-PH 400 CY INVERTER
Ideal for labs, instrument checkout, breadboard as-semblies, etc. Eclipse-Pioneer #12142-1-A, In: 271 v dc 22A. Out: 3 ph 115 v 400 cy 250 VA I.O PF. V & freq. regulated. Only 9 1/4" lg, 6 1/4" h. Very cheap. Check out grid, w/mating plug. **\$24.50**
14 lbs fob San Diego, only.

GRAPHIC RECORDERS AND AMPLIFIERS
Brush BL-262, 2-channel elect, wrtg, rack mtd, sensitivity 1.1 mm/v, 1450 ohms, 16 v rms FS. Switch selects 8 chart speeds from 1 to 250 mm/second. Regular \$350.00. Early price, check new. \$395.00

Brush BL-202, same penmotors, 2 chan. portable, ink wrtg, gear-shifted S, 25, 125 mm/sec. Regularly \$875.00, checked, ready to use. \$295.00

Same for electric wrtg/pwr supply.\$295.00

Easterline-Angus portable Type AW, spring-wound chart drive, 2 1/2-0-2 1/2 ma dc, checked OK. \$175.00

Est.-Angus ditto 1 ma dc full scale, new. \$250.00

Est.-Angus ditto except 20 pens record 24 v dc events with 400 ohm actuators, new, only. \$150.00

Gen. Radio 715AM DC Amplifier, new, only. \$97.50

Sanborn #154-100B rack-mtg 4-chan. recorder, elect. wrtg, plus time marker. Multiple chart-speed choice. Checked and certified 100% OK. \$450.00

Sanborn #150-2900V, 2-chan. DC amplifier. \$175.00

Penmotors only, similar in shape to Brush BL-902A, less penholders, unknown make, appear exc. \$49.50

NEW COMPLETE MAGNETOMETER AN/ASQ-3
Osc. 0-3 & Converter CV-1 in case CY-4; Head (with orienters) DT-2; Dynamotor Assly. DY-6; Control C-8; Indicator ID-5 (is a 1/2-0-1/2 ma dc meter, may be paralleled by a recorder if desired); set of plugs; and 160-page Handbook, Input 28 v dc 10A, starting surge 70A. At max. sensitivity, 5 gammas produce 1/2 ma dc. In Mfr's packing, clean and fresh as day it left the factory. Ship wt 25 1/2 lbs. **\$349.50**
fob Phila., Pa.

Add for Recorder RD-4/ASQ, new \$200.000

RADIO RECEIVER AND/OR SPECTRUM ANALYZER
AN/APR-4 rcvr is the 11-tube 30 mc if etc. for its plug-in tuning units; has 5-meter, 60 cy pwr sply, Pan., Video & Audio outputs, AM, Checked, aligned with heads for 38-1000 mc, **\$164.00**
Pwr plug & Handbook, fob Los Ang.

Add \$59.50 for 1-2.2 kmc; and \$175.00 for 2-2.4 kmc; add \$150.00 for 30 mc Fanadator RDP; add \$79.50 for Test Oscillator TS-47/APR (40-3000 mc ± 1%, CW, AM, Pulsed, w/built-in 60 cy sply).

0.1% SORENSEN LINE VOLTAGE REGULATOR
#5000S holds setting 110-120 v to 0.1% despite line changes 95-130 v 1 ph 50/60 cy & load changes 0-5 kva. Max. harmonics 3%. Recovery 0.15 seconds. Regular \$695 less spares, New. **\$349.50**
w/spares, 285 lbs fob Utica, N.Y.

2 KVA SOLA CONSTANT-VOLTAGE XFMR
Input 95-125/190-250 v 50/60 cy 1 1/2. Sec. 115.0 v ± 1%, 0-17.4 A, New. 260 lbs **\$89.50**
fob Harrisburg, Pa. only

Convert above output to 230.0 v ± 1% with Westinghouse 5 kva autotransformer, new, **\$45.00**
fob Los Angeles, add only.

STODDARD NOISE/FIELD STRENGTH METER
NMA-5A(TS-587/U) complete, certified OK. **\$499.50**
w/Handbook, uncalibrated, fob Los Angeles

TRIM ANTENNAS TO EXACT IMPEDANCE
Navy OCK rf bridge is same electrically as Gen. Radio's \$620.00 #916AL, has all accessories. Aer-O-Com's \$425.00 Artificial Antenna DA-200 cranks up to exact L, C & R to trim antennas up to 200 W Po. Combination OCK & DA-200, both like new, \$1045.00 value. **\$370.00**
fob Los Angeles for only.

STANDARD SIGNAL GENERATOR BARGAIN
Navy LAE 2 new, like new, 520-1300 mc ± 1%, AM, CW, Pulse, calibrated V0 1 uv to 1 v ± 2 1/2 & 1%, Pulse delay 3-300 usec, duration 2-30 usec, rate 60-2500 pps. **\$89.50**
FOB San Diego, only.

BECKMAN/BERKELEY COUNTERS, 1/2 PRICE
554-F1, 5 rows, 0-100,000. Time base 1.1, 1.10 sec. Schmidt triggering. Exc. **\$325.00**
cond., fob Los Angeles only.

7360 Universal EPUT Time Interval, 6 rows, 0-1 mc. Time 1 usec to 10 million sec. Trigger slope selection. Exc. cond., **\$625.00**
ready to use, fob Los Angeles only.

R. E. GOODHEART CO.
P. O. Box 1220-E Beverly Hills, Calif.

ANTENNA PEDESTAL SCR 584-MP 61B

Full azimuth and elevation sweeps 360 degrees in azimuth, 210 degrees in elevation. Accurate to 1 mil. or better over system. Complete for full tracking response. Angle acceleration rate: AZ, 9 degrees per second squared EL, 4 degrees per second squared. Angle slowing rate: AZ 20 degrees per sec. EL, 10 degrees per sec. Can mount up to a 20 ft. dish. Angle tracking rate: 10 degrees per sec. Includes pedestal drives, selsyns, potentiometers, drive motors, control amp/dynes. Excellent condition. Quantity in stock for immediate shipment. Ideal for missile & satellite tracking, antenna pattern ranges, radar system, radio astronomy, any project requiring accurate response in elevation and azimuth.
Complete description in McGraw-Hill Radiation Laboratory Series, Volume 1, page 284 and page 209, and Volume 26, page 233.

2 MEGAWATT PULSERS

(A) 31 KV at 60 amps .002 Duty Cycle Ideal for 5J26 at 500KW 5C22 Thyr. \$950.
(B) 30 KV at 70 amps .001 Duty Cycle 5C22 Thyr. \$1250 w/pulse trans.

MIT MODEL 9 PULSER 1 MEGAWATT— HARD TUBE

Output pulse power 25 KV at 40 amp. Max. duty ratio: .002. Uses 6C21 pulse tube. Pulse duration .25 to 2 microsec. Input 115 volts 60 cycles AC. Includes power supply in separate cabinet and driver. Fully guaranteed as new condition. Full Desc. MIT. Rad. Lab. Series "Pulse Generators."

500 KW PULSER

5C22 Hyd Thyr Modulator. 22KV at 28 Amps. W/HV & Fil Supplies. 3 pulse length rep rates: 2.25 usec 300 pps. 1.75 usec 550 pps. .4 usec 2500 pps. 115V 60 cy. Will deliver nominal 225 KW X Band using 4J50 magnetron.

MIT MODEL 3 PULSER

Output: 144kw (12kv at 12amp.). Duty ratio: .001 max. Pulse duration: .5 1 and 2 micro sec. Input: 115v 400 to 2000 cps \$325 ea. Full desc. Vol. 5 MIT Rad. Lab. series pg 140.

L BAND RF PKG.

20KW peak 990 to 1040MC. Pulse width .7 to 1.2 micro sec. Rep rate 180 to 420 pps. Input 115 vac. Incl. Receiver \$1200.

SCR 584 RADARS AUTOMATIC TRACKING

3 CM & 10 CM. Our 584s in like new condition, ready to go, and in stock for immediate delivery. Ideal for telemetry, research and development, missile tracking, satellite tracking, balloon tracking, weather forecasting, anti-aircraft defense practical air support used on Atlantic Missile Range, Pacific Missile Range, NASA Wallaps Island, A.B.M.A. Write us. Fully Desc. MIT Rad. Lab. Series, Vol. 1, pps 207-210, 228, 284-286.

AN/TPS—1D RADAR

500 kw. 1220-1359 mcs. 160 nautical mile search range P.P.I. and A. Scopes, MTI. thratron mod. 5J26 magnetron. Complete system.

AN/TPS 10D HEIGHT FINDER
250 KW X-Band. 60 & 120 mile ranges to 60,000 feet. Complete.

AN/APS—15B 3 CM RADAR

Airborne radar. 50uw output using 725A magnetron. Model 3 pulser. 30 in. parabola stabilized antenna. PPI and "A" scope. Complete system. \$1200 each. New.

10KW 3 CM. X BAND RADAR

Complete RF head including transmitter, receiver, modulator. Uses 2J42 magnetron. Fully described in MIT Rad. Lab. Series Vol. 1, pps. 616-625 and Vol. II, pps. 171-185 \$375. Complete Radar System \$750.

10 CM. WEATHER RADAR SYSTEM

Raytheon, 275 KW output S band. Rotating yoke P.P.I. Weather Band. 4, 20 and 80 mile range. Price \$975. complete. Has picked up clouds at 50 miles. Weight 488 lbs.

CARCINOTRON

Type CM 706A Freq. 3000 to 4000 mcs. CW. Output 200 Watts minimum. New, with full guarantee.

VA-800 KLYSTRON

1.7 to 2.4 KMC. (continuously turnable). 10 KW. CW. 50 db Gain output UG-435 A/U Flange \$975 each.

R RADIO RESEARCH
INSTRUMENT CO.
550 FIFTH AVE., NEW YORK
JUDSON 6-4691

CIRCLE 470 ON READER SERVICE CARD

SEARCHLIGHT SECTION

RATES

DISPLAYED

The advertising rate is \$27.25 per inch for all advertising appearing on other than a contract basis. Contract rates quoted on request. AN ADVERTISING INCH is measured $\frac{7}{8}$ inch vertically on one column, 3 columns—30 inches—to a page. EQUIPMENT WANTED or FOR SALE ADVERTISEMENTS acceptable only in Displayed Style.

UNDISPLAYED

\$2.70 a line, minimum 3 lines. To figure advance payment count 5 average words as a line.

PROPOSALS, \$2.70 a line an insertion. BOX NUMBERS count as one line additional in undisplayed ads.

DISCOUNT OF 10% if full payment is made in advance for four consecutive insertions of undisplayed ads (not including proposals).

SMALL AD but BIG STOCK

of choice test equipment
and surplus electronics

Higher Quality—Lower Costs
Get our advice on your problem

ENGINEERING ASSOCIATES

434 Patterson Road — Dayton 19, Ohio

CIRCLE 471 ON READER SERVICE CARD

MICROWAVE ANTENNAS

6' Spun aluminum dish. Parabolic. Andrews #2006 W/T4 Mounting brackets, de-icer and dipole radiator. New crated for export. \$100.00 complete. One hundred available. Also Rigid Line, Hangers & Fittings.

SIERRA WESTERN ELECTRIC
1401 Middle Harbor Road Oakland 20, Calif.
TE-2-3527

CIRCLE 472 ON READER SERVICE CARD

FREE...CATALOG BARRY ELECTRONICS

512 BROADWAY WALKER 5-7000
NEW YORK 12, N.Y. TWX- NY 1-3731

CIRCLE 473 ON READER SERVICE CARD

Your Inquiries to Advertisers
Will Have Special Value . . .

—for you—the advertiser—and the publisher, if you mention this publication. Advertisers value highly this evidence of the publication you read. Satisfied advertisers enable the publishers to secure more advertisers and—more advertisers mean more information on more products or better service—more value—to YOU.

Advertisement

INTERESTING TO NOTE . . .

NEW YORK, N. Y. Feb. 1962:—

Universal Relay Corp., 42 White St., New York 13, N. Y. announces the publication of their 52 page Spring 1962 catalog. With publication of the catalog, they inform their customers that "normal inventory includes over 1,500,000 relays in approximately 30,000 types. In most cases stock is sufficient to give immediate delivery of production quantities.

This catalog is, therefore, not just a listing of items available 'on order' but, by and large, it is an indication of in-stock items (either as complete units or as ready to assembly components).

The average shipment is made within 48 hours. Where coils and frames require assembly, or relays require special testing or adjustment, shipments are made within one week to ten days.

Universal is completely equipped to assemble, adjust and thoroughly test any type of relay. Assembly and test facilities have been imitated by some relay manufacturers.

A personal interest is taken in every order. This interest is maintained as the order is processed. And, it continues even after the customer receives the merchandise until he makes sure that it satisfies his needs.

All merchandise is guaranteed, subject to customers' inspection and approval, and may be returned within 30 days for replacement or credit.

The catalog is full of items to fill everyday relay requirements".

Catalog E-162 may be obtained by writing directly to:

UNIVERSAL RELAY
CORP.

42 White Street, New York 13, N. Y.
WALKER 5-6900

CIRCLE 474 ON READER SERVICE CARD

*Acoustical Components
of Superior Quality*

JAPAN PIEZO supplies 80% of Japan's crystal product requirements.

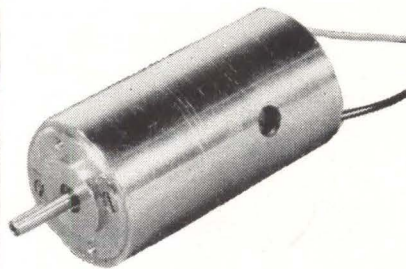
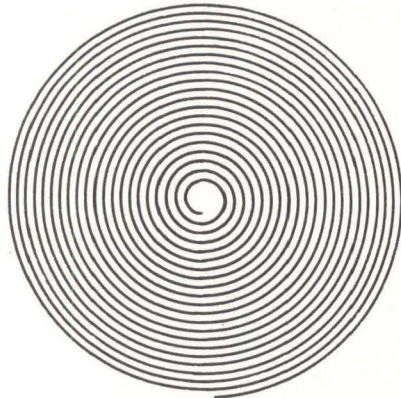

**PHONOGRAPH
MOTOR — DC
PM — 31-1**

9V, 2,500RPM: No-load current, 35 mA; load current, 80 mA. Starting torque, 13 g-cm; load torque, 5 g-m. Size: 2.4 cm x 4.6 cm. Weight: 100 gm.

Write for detailed catalog on our complete line of acoustical products including pickups, cartridges, microphones, record players and many associated products.



**JAPAN PIEZO
ELECTRIC CO., LTD.**

Kami-renjaku, Mitaka, Tokyo, Japan

INDEX TO ADVERTISERS



Audited Paid Circulation

Aerospace Corporation	84	Gamevell Co., The	18
Aerovox Corp.	76	General Electric Co. Rectifier Components Dept.	22
• Airpax Electronics, Inc.	107	Silicone Products Dept.	72
• Allmetal Screw Products Co., Inc.	120	• General Findings, Inc.	121
• Amperite	92	Georgia Dept. of Commerce.	78
Aristo-Craft	109	• Green Instrument Co., Inc.	110
		• Gulebrod Bros. Silk Co., Inc.	90
Beattie-Coleman Inc.	133		
• Bendix Corporation Scintilla Division	33	• Hamlin, Inc.	193
Boeing Co., The	93	Hathaway Instruments, Inc.	34
Bon-De Electronic Laboratories, Inc.	115	• Hayden Co., A. W.	117
• Brush Instruments, Div. of Clevite Corp.3rd Cover		• Hewlett-Packard Company	71
Burroughs Corporation Electronic Components Div.	89	Hughes Aircraft Co.	112
		IBM	10, 11
CP Electronics, Inc.	100		
Colorado Dept. of Development.	116		
Conant Laboratories	109	• Japan Piezo Electric Co., Ltd.	132
Consolidated Electrodynamics Corp.111, 114			
Corning Electronic Components	31		
Cosmic Condenser Co.	110	• Kyoritsu Electrical Instruments Works, Ltd.	92
• Coto-Coil Co., Inc.	116		
• Curtiss-Wright Corp.	35		
		• Lambda Electronics Corp.	5
Daystrom Incorporated, Military Electronics Div.	35	Lehman Bros.	108
• Daystrom Incorporated, Potentiometer Div.	119	• Leach and Garner, Co.	121
Di Acro Corp.	114	Linen Thread Co., Inc., The.	109
duPont de Nemours & Co., Inc. E. L.	87		
Dynacor, Inc., A Sub. of Sprague Electric Co.	88	Mabuchi Shoji K. K.	92
		Melabs	16
Eisler Engineering Co., Inc.	109	Minnesota Mining & Mfg. Co. Chemical Div.	24
Electro Instruments, Inc.	25	Monadnock Mills	122
Electronic Engineering Co.	98	Moore Associates Inc.	29
• Electronic Instrument Co., Inc. (EICO)	106		
Electronic Measurements Co., Inc.	112		
Electronic Tube & Instrument Div. of General Atronics Corp.	32		
Esterline-Angus-Instrument Co., Inc.	105		
		• See advertisement in the July 20, 1961 issue of Electronics Buyers' Guide for complete line of products or services.	

• Moseley Co., F. L.	19
Motorola Semiconductor Products Inc.	73
National Cash Register Co.	91
• Northern Radio Co., Inc.	121
• Ohmite Mfg. Co.	82, 83
Parabam	122
• Philco Corporation	54
Precision Instrument Co.	99
• Radio Cores, Inc.	115
• Radio Corporation of America	13, 4th Cover
• Raytheon Company	2nd Cover
• Ribet-Desjardins	53
• Rixon Electronics Inc.	106
Roanwell Corp.	97
Sankaisha Co., Ltd.	106
Schjeldahl Co., G. T.	17
• Servo Corporation of America.	36
Servomechanisms, Inc. Mechatrol Div.	104
Shallcross Mfg. Co.	95
Simpson Electric Company	81
• Sola Electric Co.	14
• Southern Electronics Corp.	96
Sprague Electric Co.	9, 30
Straza Industries	120
Struthers-Dunn	79
Telrex Laboratories	110
Thermal American Fused Quartz Co., Inc.	104
Triad Transformer Corp.	75
• Trio Laboratories, Inc.	113
Unger Electric Tools	77
U. S. Stoneware	15
Varian Associates	23

• Winschel Engineering	4
Wheaton Engineering Div. Hurlertron, Inc.	116
Whitney Metal Tool Co.	120

MANUFACTURERS' REPRESENTATIVES
MacDonald Inc, Samuel K. 126

CLASSIFIED ADVERTISING
F. J. Eberle, Business Mgr.

EMPLOYMENT OPPORTUNITIES 124-127

SPECIAL SERVICES 128

EDUCATIONAL 128

EQUIPMENT
(Used or Surplus New)
For Sale 128-131

INDEX TO CLASSIFIED ADVERTISERS

Atomic Personnel Inc.	126
• Barry Electronics	131
Bristol Company	126
• C & H Sales Company	129
• Communications Equipment Co.	130
• Engineering Associates	131
Esquire Personnel	126
Grantham Schools Inc.	128
General Electric, Light Military Electronics Dept.	126
• Goodheart Co., R. E.	130
Hershel Radio Co.	130
International Business Machines Corp.	127
• Liberty Electronics Inc.	128
Lifschultz Fast Freight	128
• Monmouth Radio Laboratories	128
National Cash Register Company.	124, 127
Philco Western Development Laboratories	125
• Radio Research Instrument Co.	131
Sierra Western Electric Cable Co.	131
Sylvania Mountain View Operations.	124
• Universal Relay Corp.	131
• Western Engineers	128
• Wilgreen Industries Inc.	130

• See advertisement in the July 20, 1961 issue of Electronics Buyers' Guide for complete line of products or services.

This Index and our Reader Service Numbers are published as a service. Every precaution is taken to make them accurate, but ELECTRONICS assumes no responsibilities for errors or omissions.

Use the POLAROID® 10,000 SPEED Land Film

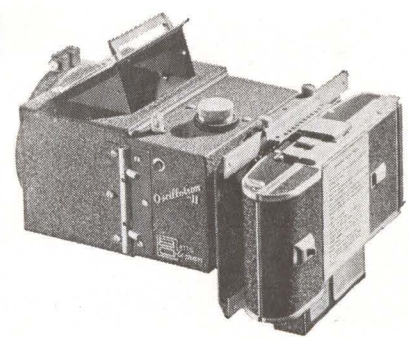

in the new BEATTIE-COLEMAN MARK II OSCILLOTRON

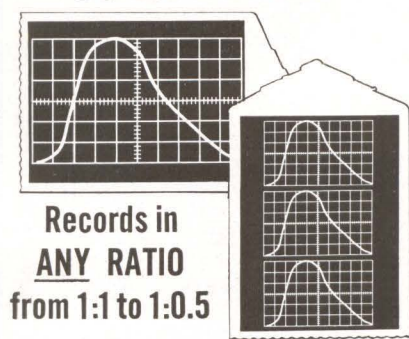

Records in
ANY RATIO
from 1:1 to 1:0.5

Here's the most versatile oscilloscope camera ever made. Especially designed for new 10,000 speed Polaroid Land Type 410 film that records pulses of extremely short duration. Prints in 10 secs. Easily change ratios from 1:1 to 1:0.5 without extra lenses. External focusing. Flat field lens. Electric shutter eliminates cable release. Direct viewing port or hood. Records up to 13 traces on one frame. Dark slide on Polaroid Land Camera back. Records written data on film. Fits any 5" scope. Attractively priced. Send for catalogs on all B-C Oscillotron models now.

"Polaroid"® by Polaroid Corporation



**BEATTIE-COLEMAN
INC.**

1004 N. OLIVE ST., ANAHEIM, CALIFORNIA

Notice to subscribers . . .

**RECENT INQUIRY
DELAYS DUE TO
CHANGE OVER
TO SPEEDY,
SAME-DAY SERVICE**

Processing of **electronics** reader inquiry cards has been transferred recently to high-speed computers at a new location.

During the transfer, some delays occurred, and your cards did not reach the advertisers with our usual promptness.

Should you experience a delayed response to recent inquiries, it was occasioned by the change over process, and is in no manner the fault of the advertiser.

We are back on schedule, servicing all cards on a current daily basis.

electronics



Audit Bureau
of Circulations

Associated Business
Publications

Audited Paid Circulation

JAMES T. HAUPTLI

Advertising Sales Manager

R. S. QUINT:
Assistant Publisher Buyers'
Guide and Business Manager
FRED STEWART:
Promotion Manager
B. ANELLO:
Market Services Manager

RICHARD J. TOMLINSON:
Production Manager
GEORGE E. POMEROY:
Classified Manager
HUGH J. QUINN:
Circulation Manager

ADVERTISING REPRESENTATIVES

NEW YORK (36):
Donald H. Miller, Henry M. Shaw,
George F. Werner
500 Fifth Avenue, LO-4-3000
(area code 212)

BOSTON (16):
William S. Hodgkinson, Donald R. Furth
McGraw-Hill Building, Copley Square,
Congress 2-1160 (area code 617)

PHILADELPHIA (3):
Warren H. Gardner, William J. Boyle
6 Penn Center Plaza, LOcust 8-4330
(area code 215)

CHICAGO (11):
Harvey W. Wernecke, Robert M. Denmead
645 North Michigan Avenue, MOhawk 4-5800
(area code 312)

CLEVELAND (13):
Paul T. Fegley
55 Public Square, Superior 1-7000
(area code 216)

SAN FRANCISCO (11):
R. C. Alcorn
255 California Street, DOuglas 2-4600
(area code 415)

LOS ANGELES (17):
Peter S. Carberry, Ashley P. Hartman
1125 W. 6th St., HUNtley 2-5450
(area code 213)

DENVER (2):
J. W. Patten
Tower Bldg., 1700 Broadway,
Alpine 5-2981 (area code 303)

ATLANTA (9):
Michael H. Miller, Robert C. Johnson
1375 Peachtree St. N.E., TRinity 5-0523
(area code 404)

HOUSTON (25):
Joseph C. Page, Jr.
Prudential Bldg., Holcomb Blvd.,
Jackson 6-1281 (area code 713)

DALLAS (1):
Frank Le Beau
The Vaughn Bldg., 1712 Commerce St.
Riverside 7-9721 (area code 214)

LONDON W1:
Dennis McDonald
34 Dover St.

FRANKFURT/Main:
85 Westendstrasse

GENEVA:
Michael R. Zeynel
2 Place du Port

"Headquarters for Business Information"

McGraw-Hill Technical and Business Publications

American Machinist/Metal-
working Manufacturing
Aviation Week and Space
Technology
Business Week
Chemical Engineering
Chemical Week
Coal Age
Construction Methods and
Equipment
Construction Daily
Control Engineering
Electrical Construction
and Maintenance
Electrical Merchandising Week
Electrical Newsletter
Electrical West

Electrical Wholesaling
Electrical World
Electronics
Engineering Digest
Engineering and Mining Journal
E & MJ Metal and Mineral
Markets
Engineering News-Record
Factory
Fleet Owner
Industrial Distribution
National Petroleum News
Nucleonics
Nucleonics Week
Platt's Oilgram News
Platt's Oilgram Price Service
Power

Product Engineering
Purchasing Week
Science Week
Textile World

Overseas only:
Automobile International
(English, Spanish)
Ingenieria Internacional
Construccion (Spanish)
International Management
(English, Spanish
Portuguese editions)
Metalworking Production
(Great Britain)

Available by subscription only — to qualified persons actively engaged in the field of the publication. For subscription rates and information describing the editorial coverage of any of the above publications, write to: *Subscription Manager, Circulation Department, McGraw-Hill Publishing Company, 330 West 42nd Street, New York 36, N. Y.*

verify
 events
 permanently
 in
 milliseconds

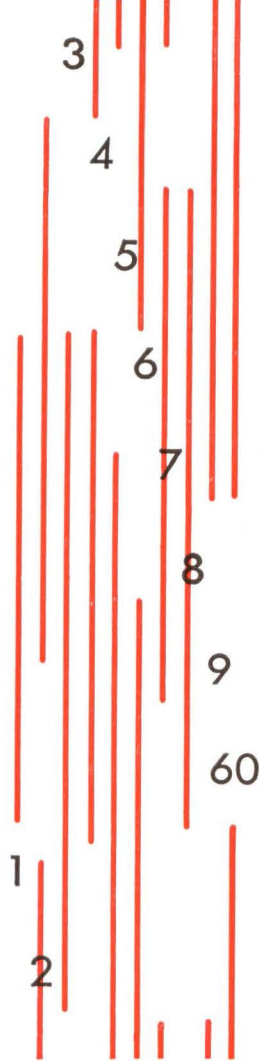

Brush Operations Monitors' response to signals is virtually instantaneous—less than 4 milliseconds. Multiple high-speed events are clearly defined from start to stop, on a common time base—and at rates up to 500 per second. Portable 30 channel or rack-mounting 100 channel models record sharp reproducible traces with fixed-stylus electric writing that provides the utmost in reliability. "Built-in" transistor switching to eliminate relays is optional. No direct writing recording system can match the capabilities of Brush Operations Monitors for industrial and military analysis and control. Write for complete specifications and application data.

brush INSTRUMENTS
 DIVISION OF
 CLEVITE CORPORATION
 37TH AND PERKINS CLEVELAND 14, OHIO

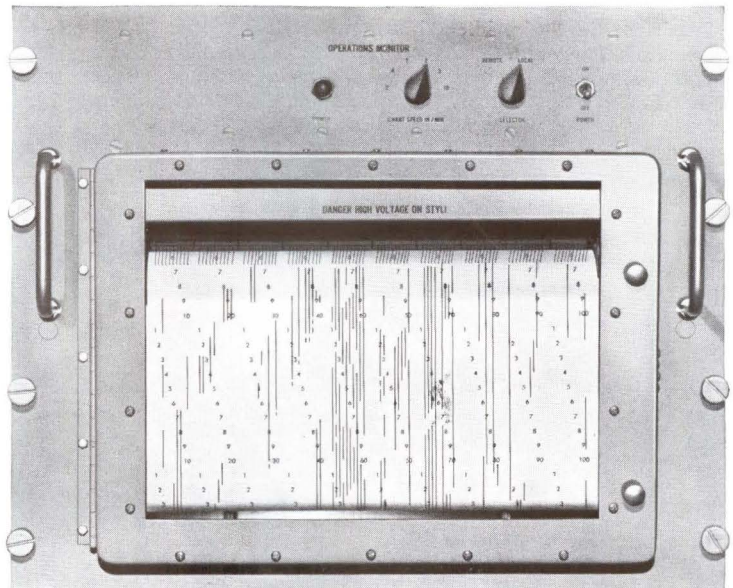
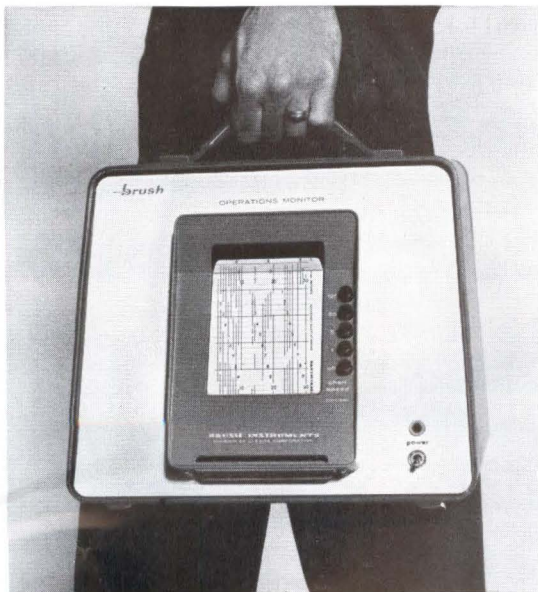

CIRCLE 256 ON READER SERVICE CARD

Higher Circuit Performance
Lower Component Cost

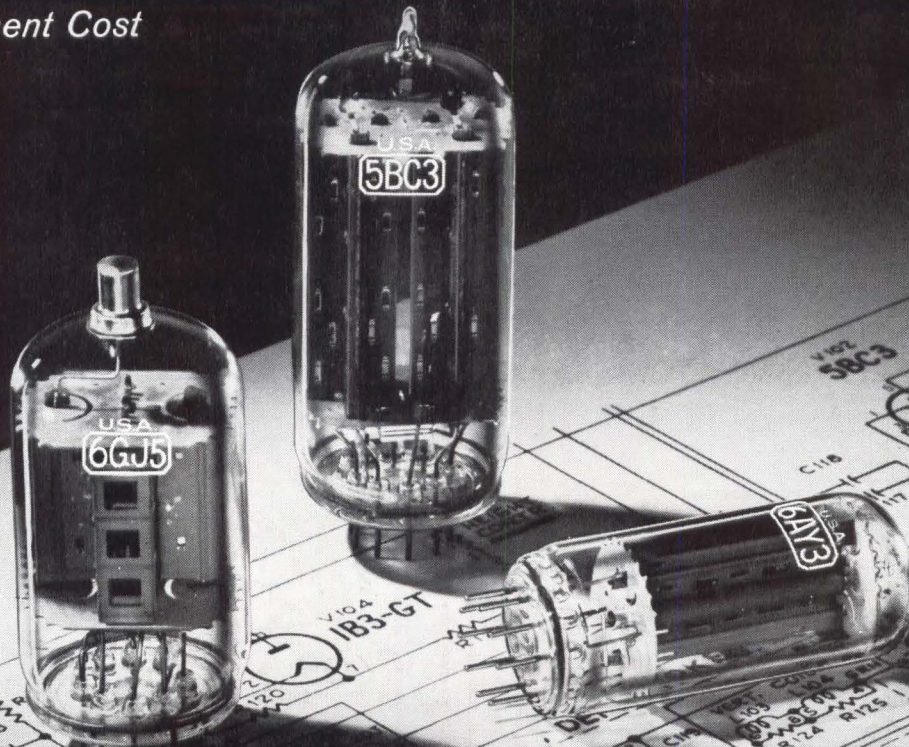

Major Manufacturers of TV, Audio and Hi-Fi Equipment Are Switching to NOVAR...*what about you?*

8 LEADING MANUFACTURERS HAVE ALREADY USED HALF A MILLION NOVAR TUBES IN TV, AUDIO AND HIGH-FIDELITY EQUIPMENT
14 MORE LEADING MANUFACTURERS WILL USE NOVAR TUBES IN THEIR NEW SET MODELS

Why? Because the 9-pin, integral-base novar design offers *better performance at lower cost* than comparable tubes, regardless of base configuration, previously manufactured with octal base and T-9 or T-12 envelopes. With so many important manufacturers swinging over to low-cost, high-performance novar, you won't want to miss out on the unique advantages of novar design, namely:

Larger internal lead diameter—provides strong cage support and high thermal conductivity for very effective heat dissipation.

Wider spacing between pins (0.172")—minimizes the possibility of voltage breakdown; hence greater reliability.

Pin length of 0.335"—assures firm retention of tube in socket.

Pin circle diameter of 0.687"—large enough to permit use of both T-9 and T-12 envelopes.

RCA "Dark Heater"—operating about 350°K below the temperature

of conventional heaters, "Dark Heater" assures longer tube life and improved stability and reliability.

These novar tube types are commercially available:

For TV damper service: RCA-6AY3, 12AY3, 17AY3; RCA-6BH3, 17BH3, and 22BH3; RCA-6DW4 (color and black-and-white).

For TV horizontal-deflection amplifier service: RCA-6GT5, 12GT5 and 17GT5; RCA-6GJ5, 12GJ5 and 17GJ5.

For use in hi-fi amplifiers: RCA-7868.

For rectifier use in TV sets, hi-fi audio equipment and radio power supplies: RCA-5BC3.

For additional information on any novar tube type, call your RCA Field Representative or write Commercial Engineering, RCA Electron Tube Division, Section D-19-DE-3, Harrison, N.J.



The Most Trusted Name in Electronics

RCA ELECTRON TUBE DIVISION—FIELD OFFICES . . . EAST: 744 Broad Street, Newark 2, New Jersey, HUmboldt 5-3900 • MIDWEST: Suite 1154, Merchandise Mart Plaza, Chicago 54, Illinois, WHitehall 4-2900 • WEST: 6801 E. Washington Boulevard, Los Angeles 22, California, RAYmond 3-8361