

electronics®

MILLIMETER COMPONENTS

Latest frontier in microwave, p 33

CHECKING ON JET ENGINES

Computer Samples 36 parameters, p 38

WHAT'S NEW IN TV SETS?

Tubes and circuits set the pace, p 47

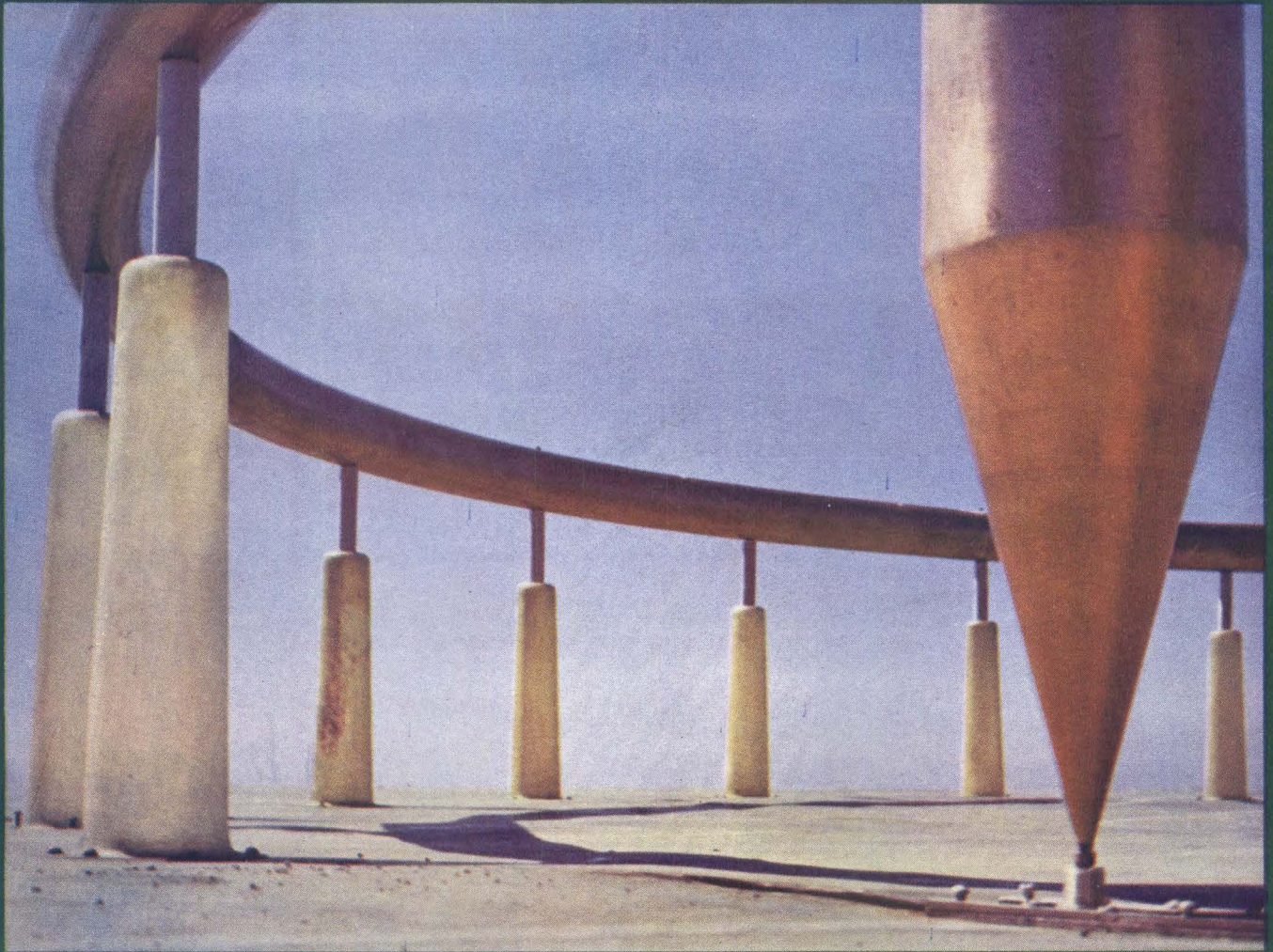

(photos show)

HULA-HOOP ANTENNA

Girth makes up for lack of height, p 44



R D SKINNER
 1020 GOVINGTON RD
 LOS ALTOS CALIF
 SUPV DEV
 C 3
 L

The versatile new  310A High Frequency Wave Analyzer separates an input signal so that the fundamental, harmonics or intermodulation products can be determined and analyzed. Any signal component between 1 kc and 1.5 mc may be selected for measurement. Additionally, a front panel Mode switch lets the 310A function as an efficient tuned voltmeter for accurately measuring relative or absolute signal levels, as a signal source for selective response measurements, and as either an AM receiver or carrier reinsertion oscillator for demodulating sideband signals.

High sensitivity of 10 μ v full scale, and the wide dynamic range of 75 db allows measurements of weak harmonic components down to 1 μ v or strong signals up to 100 v. A switch above the input attenuator can be flipped from Absolute to Relative to permit signal readings at any arbitrary point on the meter for simplifying relative-strength measurements for harmonic components.

Three passbands, selected with a front panel control, increase the versatility of the 310A even more. The 200 cps passband discriminates between harmonics for exact identification. The 1 kc passband simplifies calculations of noise power per cycle bandwidth. The 3 kc passband admits carrier channel signals for evaluation and is wide enough to pass intelligible voice signals, but contributes so little noise that even the 10 μ v range can be used. Rapid drop-off of 24 db per octave on either side of the band's cutoff frequency assures accurate readings.

The 310A is extremely easy to use. To prevent ambiguity of reading, proper voltage range, corresponding

to full scale sensitivity, is automatically shown on an illuminated display on a 15-place front panel range scale indicator. Frequency tuning is continuous and linear over the entire range with no bandswitching. Frequency can be easily read from a 4-place digital type dial which has a resolution of better than 200 cps over the entire band, any setting being accurate to \pm (1% + 300 cps).

An AFC control has a dynamic hold-in range of \pm 3 kc (at 100 kc) with response rapid enough to lock signals with drift rates in excess of 100 cps/second.

Outputs include restored frequency, which permits accurate measurement of the input frequency of the signal to which the 310A is tuned, plus a dc output for driving a recorder.

The output from the BFO is a derived sine wave that corresponds to the tuning indicator's setting, and it can be used effectively to make selective or narrow-band response tests on such as filter circuits and transmission systems. The BFO and tuned voltmeter are simultaneously controlled by the frequency indicator, tracking together, and can be conveniently used as a self-contained measuring system—the BFO output fed through a device under test, then back to the tuned voltmeter input for comparative analysis.

A carrier reinsertion oscillator is included to provide for the demodulation of single sideband signals, either normal or inverted. The demodulated signal is available for aural or recording purposes.

Call your nearby Hewlett-Packard representative today for a demonstration of this remarkable new instrument.

ANALYZER

SPECIFICATIONS

| | |
|--|--|
| Frequency Range: | 1 kc to 1.5 mc (200-cps passband); 5 kc to 1.5 mc (1,000-cps passband); 10 kc to 1.5 mc (3,000-cps passband) |
| Frequency Accuracy: | \pm (1% + 300 cps) |
| Frequency Calibration: | Linear graduation, 1 division per 200 cps |
| Selectivity: | Three IF passbands; 3 db points at \pm 100 cps for 200 cps passband; \pm 500 cps for 1,000 cps passband; \pm 1,500 cps for 3,000 cps passband. Drop off is 24 db/octave from 3 db points. Mid-passband indicated by rejection 1 cps wide |
| Voltage Range: | 10 μ v to 100 volts full scale |
| Voltage Accuracy: | \pm 6% full scale |
| Dynamic Range: | Greater than 75 db |
| Input Resistance: | Determined by input attenuator; 10K ohms on most sensitive range; 30K ohms on next range; 100K ohms on other ranges |
| Automatic Frequency Control: | Dynamic hold-in range is \pm 3 kc, minimum, at 100 kc. Tracking speed is approximately 100 cps/sec for signal as low as 70 db below zero db reference on range attenuator |
| Restored Frequency Output: | Restored signal frequency maximum output is at least 0.25 volts across 135 ohms with approximately 30 db of level control provided. Output impedance, approximately 135 ohms |
| BFO Output: | 0.5 volt across 135 ohms with approximately 30 db of level control provided |
| Recorder Output: | 1 ma dc into 1,500 ohms or less for single-ended recorders |
| Receiver Function (Aural or Recording Provision): | Internal carrier reinsertion oscillator is provided for demodulation of either normal or inverted single sideband signals. AM signal also can be detected |
| Power: | 115 or 230 volts \pm 10%, 50 to 1,000 cps; approx. 16 watts |
| Dimensions: | 16 $\frac{3}{4}$ " wide, 10 $\frac{1}{2}$ " high, 18 $\frac{3}{8}$ " deep. Hardware furnished converts panel to 10 $\frac{1}{4}$ " x 19" rack mount. 44 lbs. |
| Price: | \$2,000.00 |

Data subject to change without notice. Price f. o. b. factory.

**HEWLETT
PACKARD
COMPANY**

1501 Page Mill Road, Palo Alto, California, Area Code 415, DA 6-7000
Sales and service representatives in all principal areas; Europe, Hewlett-Packard S.A., 54-54bis Route des Acacias, Geneva; Canada, Hewlett-Packard (Canada) Ltd., 8270 Mayrand Street, Montreal



8121

CIRCLE 900 ON READER SERVICE CARD

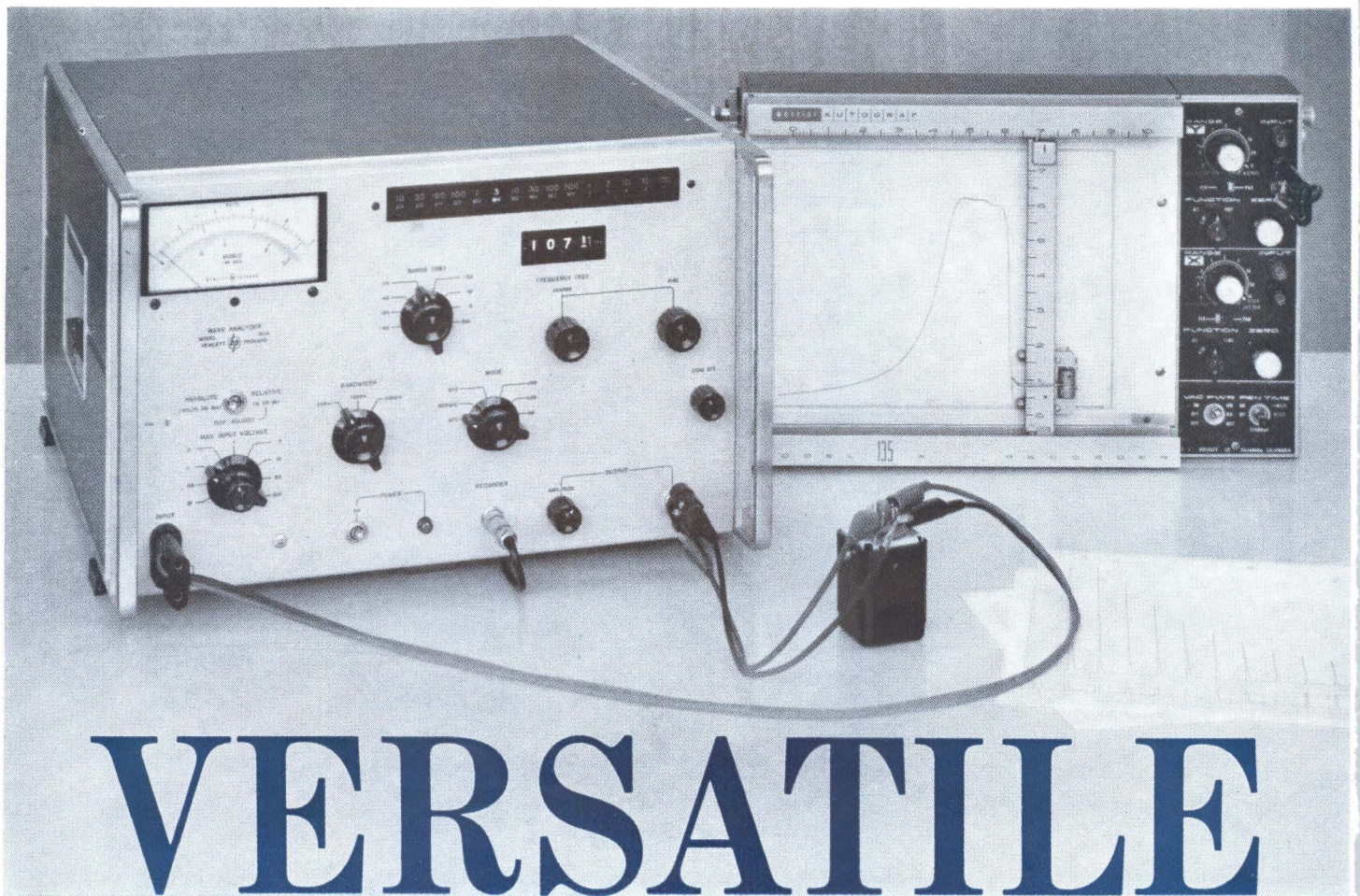

VERSATILE

Curve on recorder shows frequency response of filter under test in 1 mc range; recording on table shows odd order harmonics of square wave:

With the NEW hp 310A:

- Analyze complex audio and rf waveforms
- Measure frequency response of filters and amplifiers
- Measure multi-channel carrier waves
- Make long line telephone measurements
- Measure transmission line characteristics
- Analyze sonar signals

Check these features:

- Covers 1 kc to 1.5 mc, three passbands
- High sensitivity of 10 microvolts full scale
- Wide dynamic range, over 75 db
- Continuous linear tuning, no frequency range switching
- Digital frequency readout
- Automatically tracks drifting signal
- Restored frequency output
- Carrier reinsertion oscillator
- All solid state with plug-in board construction
- High input resistance

ver·sa·tile

(vûr'sætĭl), *adj.* 1. capable of or adapted for turning with ease from one to another of various tasks, subjects, etc.; many-sided in abilities.

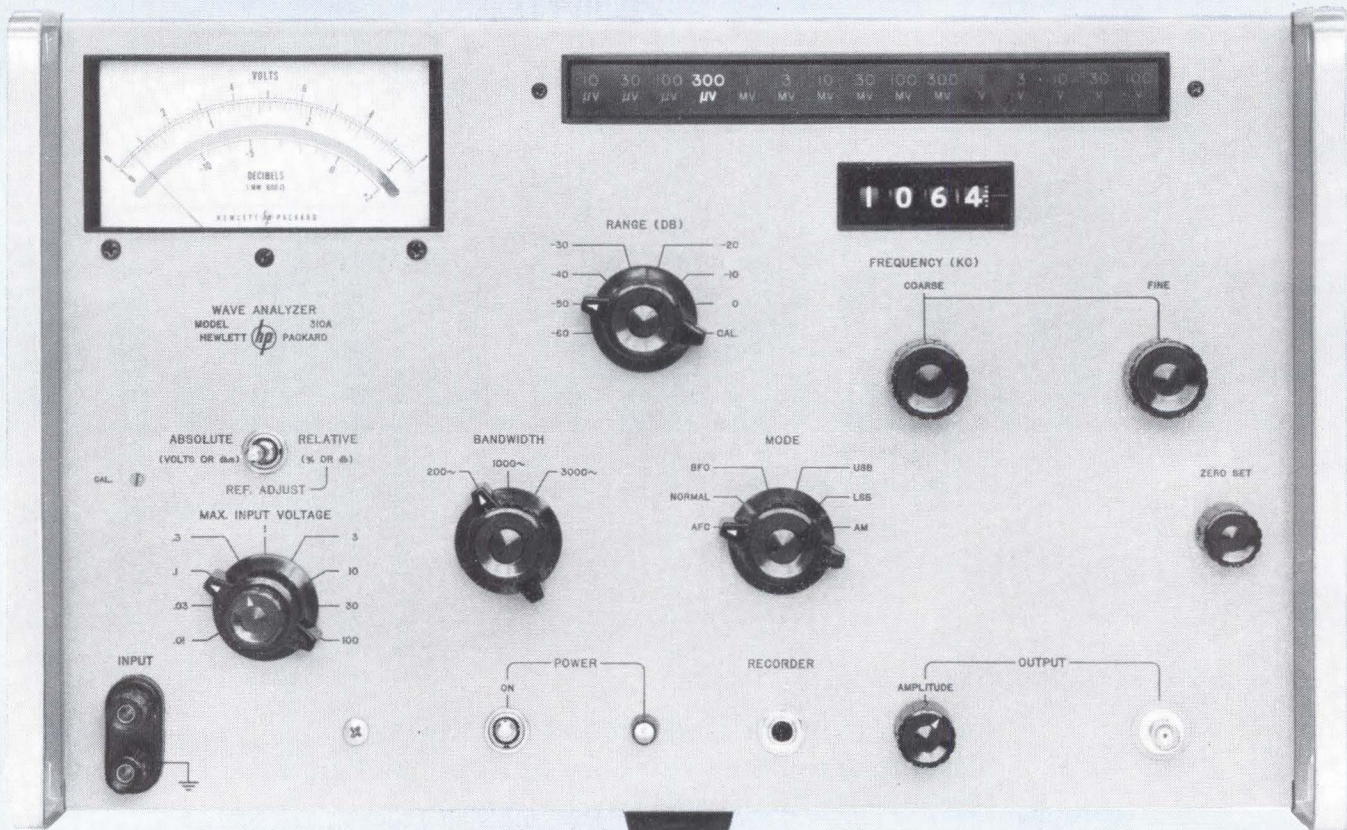

Count the capabilities of
this high sensitivity, high frequency
New hp 310A
Wave Analyzer

TURN THE PAGE for details on the usefulness of the 310A for analyzing complex audio and rf waveforms—measuring frequency response of filters and amplifiers—making multi-channel carrier measurements—making long line telephone measurements—analyzing transmission line characteristics—analyzing sonar signals...

electronics

A McGraw-Hill Publication 75 Cents



W. W. MacDONALD, Editor

J. M. CARROLL, Managing Editor
SENIOR EDITORS: Samuel Weber, George W. Sideris. **SENIOR ASSOCIATE EDITORS:** Michael F. Wolff, John F. Mason. **ASSOCIATE EDITORS:** Michael F. Tomaino, Sylvester P. Carter, William P. O'Brien, Sy Vogel, Leslie Solomon, George J. Flynn, Laurence D. Shergalis, George V. Novotny, Leon H. Dulberger. **ASSISTANT EDITORS:** Nilo Lindgren, Stanley Froud, Stephen B. Gray, Roy J. Bruun, Barry A. Briskman. **REGIONAL EDITORS:** Harold C. Hood (Pacific Coast, Los Angeles), Thomas Maguire (New England, Boston), Cletus M. Wiley (Midwest, Chicago). **ART DIRECTOR:** Howard R. Berry. **ASSISTANT ART DIRECTOR:** John C. Wright, Jr. **EDITORIAL ASSISTANTS:** Lorraine Rossi, Virginia T. Bastian, Lynn Emery, Ann Mella, Lorraine Werner, Alice M. O'Brien. **FOREIGN NEWS BUREAU:** Director, John Wilhelm; Alyne Elias, Betsy Wilson. **LONDON—**John Shinn, Derek Barlow, Nicholas Landon. **BONN—**Richard Mikton, Silke McQueen. **BRUSSELS—**Peter Forbath. **PARIS—**Robert Farrell, Arthur Erikson. **MILAN—**Marc A. Messina. **MEXICO CITY—**Bruce Bendow. **RIO DE JANEIRO—**Leslie Warren. **MOSCOW—**Stewart Ramsey. **TOKYO—**Richard Halloran, Charles Cohen, John Yamaguchi.

W. W. GAREY, Publisher

DDRR ANTENNA—Directional discontinuity ring radiator operates in 2 to 4-Mc range and is only about two feet high. Box at left houses motor-driven vacuum capacitor for tuning. *Northrop antenna makes up in circumference the efficiency it loses with height. See p 44* COVER

SOVIETS PLANNING Transmissions from Mars. Tass report indicates that they will try to receive data from their Mars probe over a distance of 150 million miles. *Here are diagrams showing the probe's configuration and equipment* 18

PEST CONTROL: Sound Offers a Better Way. Sound can kill some insects, lure others to their death, chase rats and birds. *But before practical sound systems can be developed, engineers will have to become familiar with the characteristics of pests* 24

RADIO PLOTS High-Altitude Nuclear Blasts. Expanding plasma reveals much about size and altitude. *Distinctive shape of electromagnetic pulses enable observers to tell the difference between a blast and a whistler or sferic* 28

TELSTAR I COMES ALIVE—Telstar II Slated for Launch. By working with a duplicate of the radiation-disabled command circuit, engineers learned how to trick it into working again on Telstar I. *Telstar II will have more protection from space-radiation damage* 30

NEW MILLIMETER COMPONENTS AND TECHNIQUES. Although microwave engineers have always found the millimeter region intriguing, its use was restricted because high-power generators were unavailable. Recently new tubes have become available that fulfill this need. Now research turns to design of other components. *This article deals with harmonic generators, detectors, filters and wavemeters.*
 By J. W. Dees and A. P. Sheppard, Martin 33

UNIQUE COMPUTER SYSTEM Monitors Aircraft Engines. Performance monitor for multi-engined jets scans 36 parameters automatically and presents, on a simple display panel, only those of the worst-performing engine. *System requires digital computer, analog-to-digital and digital-to-analog converters and stepping motor.*
 By S. J. DiPaolo, Bendix 38

SIMPLE MAGNETIC STRIP Keeps Tape Running True. Tracking error and skew can raise hob with magnetic-tape recordings. *But a d-c strip recorded down the center of the tape and picked up by a special head can easily supply a signal to correct such displacement.*
 By B. R. Gooch, Ampex 42

Published weekly, with Electronics Buyers' Guide as part of the subscription, by McGraw-Hill Publishing Company, Inc. Founder: James H. McGraw (1860-1948).

Title ® registered U.S. Patent Office; © copyright 1963 by McGraw-Hill Publishing Co., Inc. All rights reserved, including the right to reproduce the contents of this publication, in whole or in part.

Executive, editorial, circulation and advertising offices: McGraw-Hill Building, 330 West 42nd Street, New York 36, N. Y. Telephone Longacre 4-3000. Teletype TWX N.Y. 212-640-4646. Cable McGrawhill, N. Y. PRINTED IN ALBANY, N. Y.; second class postage paid at Albany, N. Y.

OFFICERS OF THE PUBLICATIONS DIVISION: Shelton Fisher, President; John R. Callahan, Vice President and Editorial Director; Joseph H. Allen, Vice President and Director of Advertising Sales; A. R. Venezian, Vice President and Circulation Coordinator; Daniel F. Crowley, Vice President and Controller.

OFFICERS OF THE CORPORATION: Donald C. McGraw, President; Hugh J. Kelly, Harry L. Waddell, Executive Vice Presidents; L. Keith Goodrich, Executive Vice President and Treasurer; John J. Cooke, Vice President and Secretary.

Subscriptions are solicited only from those actively engaged in the field of the publication. Position and company connection must be indicated on orders. Subscription rates: United States and Possessions, \$6.00 one year, \$9.00 two years, \$12.00 three years. Canada: \$10.00 one year. All other countries \$20.00 one year. Single Copies, United States and Possessions and Canada 75¢. Single copies all other countries \$1.50.

THE PUBLISHER, UPON WRITTEN REQUEST FROM ANY SUBSCRIBER TO OUR NEW YORK OFFICE, AGREES TO REFUND THAT PART OF THE SUBSCRIPTION PRICE APPLYING TO COPIES NOT YET MAILED.

Subscribers: Please address change of address notices, subscription orders or complaints to Fulfillment Manager, Electronics, at above address. Change of address notices should provide old as well as new address, including postal zone number if any. If possible, attach address label from recent issue. Allow one month for change to become effective.

Postmaster: Please send Form 3579 to Fulfillment Manager, Electronics, 330 West 42nd Street, New York 36, New York.



Audited Paid Circulation

CONTENTS continued

HULA-HOOP ANTENNAS: A New Trend? At first height meant everything in antennas—early experimenters used to say that if London had an Eiffel Tower, France and England could communicate by radio. Then came electrically short antennas but a price had to be paid in efficiency. *Now these hoop antennas make up in circumference what is lost in height.*
By J. M. Boyer, Northrop 44

CONSUMER ELECTRONICS: New Tubes and Circuits. The radio-tv business may benefit from frame-grid tube design, semi-remote-cutoff i-f amplifiers, comparative intermodulation studies of tube and transistor tv tuners. *Proposed partial d-c restoration uses d-c coupling on low-key scenes only.*
By L. Solomon 47

REFERENCE SHEET: How to Choose Transistors for Low Noise. Three equations and a chart do the trick. *The chart plots gain and operating frequency against alpha cutoff and can be used for screening transistor types for possible use.*
By J. L. Wilkerson, Hughes 50

DEPARTMENTS

Crosstalk. *We Need Bombers Too* 3

Comment. *Engineering Shortage. Comic-Strip Technology* 4

Electronics Newsletter. *Air Force Receives Funds to Continue Nuclear Engine Project* 7

Washington Outlook. *Polaris Deal Clouds Future of Mobile Mid-Range Ballistic Missile* 12

Meetings Ahead. *Audio Engineering West Coast Convention* 31

Research and Development. *Three-Dimensional CRT Uses Atomic Resonance* 52

Components and Materials. *Ultrasonic Rotary Drive May Open up Many New Applications for Rotary Devices* 56

Production Techniques. *Sintering Toughens Printed Circuits* 60

New Products. *Temperature Measurements at a Distance* 62

Literature of the Week 72

People and Plants. *Transistor Increases Plant Area* 74

Index to Advertisers 87

We Need Bombers Too

INDUSTRY is taking a beating from the Department of Defense—a beating it does not deserve.

President Kennedy recently made the remarkable statement that Skybolt represents "... in a sense, a kind of engineering that's beyond us." Harold Brown testified at length last March to the House Committee on Appropriations that practically everything needed for the RS-70 airplane was beyond us, especially the radar. Brown is Director of Defense Research and Engineering. He is one of the prime military advisers to Secretary of Defense McNamara, and hence to President Kennedy.

In reflecting on the long list of technical achievements industry has presented to the Department of Defense in the past, one wonders why Kennedy and McNamara and Brown have so little faith in its ability to come through again. Significantly, however, the DOD's lack of faith seems to appear when the project at hand has to do with the manned bomber—a weapon system they have repeatedly said was being replaced by the ICBM.

Beyond the annoyance of being accused of not being able to deliver the goods, the tactic results in a far more serious condition. Once Brown has made a pronouncement that radar is too difficult for mach-3 planes, few dare to suggest that it isn't—no one who wants to do business with the Defense Department at any rate. McNamara buys the verdict, and the attitude becomes a fact. As a result, state-of-the-art progress grinds to a halt.

McNamara and Brown have made it clear in pages and pages of congressional testimony that they are not enthusiastic about the manned bomber. They apparently work on the theory that ICBM's in silos and submarines are all we need. Anything else is redundant.

On April 4, 1962, McNamara told the Senate Armed Services Committee that if nuclear arms were ever banned by international agreement, and conventional armaments had to be delivered at great distance, the B-70 would still be too expensive a vehicle to deliver it. "It would be much cheaper to deliver by ICBM," he told Senator Cannon.

The senator reminded the defense secretary

that ICBM's can't carry too much weight, and that the B-70 is designed to be recoverable. "It is," McNamara agreed, "but it is still terribly expensive."

McNamara is apparently able to ignore the fact that more than 3,200 V-2 rockets equipped with 2,200-lb conventional warheads were fired at England during the war, and that the results were not decisive.

McNamara's attitude seems more that of a cost accountant than of a military planner. He theorizes on what "should be" an adequate deterrent force, weighs it against cost, and then throws out nearly everything else. Working on this theory, he fails to feed into his computer the human, psychological and random factors that inevitably play an important—and sometimes decisive—role in any military crisis. In fact, he apparently often fails to feed any military considerations at all into the military problem.

The strategic value of the bomber is widely known. Pages and pages of congressional testimony from experienced generals have documented this. But there is also a psychological value the bomber possesses. Regardless of the fact that the B-52 would take from six to eight hours to get half way around the world while a missile could make the trip in 30 minutes, the knowledge that the U.S. has already started to act, that its striking force is off the ground and on the way can be an emotional blockbuster. Distant aggressors would have several hours to reexamine their position.

ICBM's waiting in silos and submarines are obviously a deterrent, too. But they are not a deterrent that has been set in motion. They are as inactive at the moment of crisis as they are months before in more tranquil times. To push the button and start them off cancels their deterrent value and turns them into war.

The military is well aware of the value of bombers. Congress—which was pushed into the improbable roles of military strategist and scientific wizard and, to the surprise of many, has acquitted itself well—sees the need for bombers. But a powerful clique in the DOD will not readily deviate from its theory. It is a rigid viewpoint, and one that may well lead to disaster.

our stock answer is YES

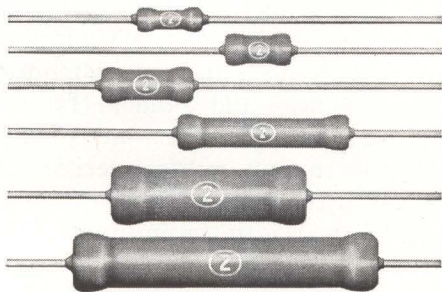

ALL UNITS ACTUAL SIZE

ALL AXIAL LEAD BLUE JACKET RESISTORS

in 1, 2, 3, 5, 7 and 10-watt
power ratings are carried in
factory stock for immediate
delivery. Place your order now
with your nearest Sprague
District Office or Sales
Representative. Key
Sprague Industrial Distributors
carry most popular ratings
in local stocks.

SPRAGUE ELECTRIC COMPANY
35 Marshall Street, North Adams, Mass.

SPRAGUE®
THE MARK OF RELIABILITY

COMMENT

Engineering Shortage

With interest I read your articles, Who's Minding The Stockroom (p 3), and Here's A Way Colleges Can Tap A Major Source Of Business Help (p 16), with the undertitle, Initiative Lies With Colleges, in the Nov. 2 issue. May I contribute to lift the editorial out of its theoretical sphere?

Our college was established 1937. During the 25 years of its existence, 429 radiotechnicians and radio engineers, an average of about 17 per year, graduated from our courses.

We have a "potential market" of 300 freshmen, leading to from 10 to 50 electronic engineers per year. To reach this we only need "capacity," that is, financial means.

We are a thriving, professional, conservative country with keen willingness and interest to work and cooperate in international activities, with all our sympathies on the Western side. We are a dedicated, thriving, professional college with all the know-how to serve the Western and the American world with our "engineering products."

Where are you? If your engineering shortage is as bad as advertised, then: Where is the American company that is willing to invest in our supply of direct or future requirement in engineering manpower, either for its domestic or overseas interests?

J. L. J. VAN DER WERFF
Radio Technical College
Haarlem, Netherlands

New Logic Formula

I was greatly surprised to see in the *Comment* section of your Nov. 23 issue (p 4), letters to the editor in regard to a new logic formula. [See also *Comment* on p 4, Nov. 2 and Nov. 30.]

Over 20 years ago my brother and I devised a little technique to test our mathematical wit. It included such problems as adding *talk* and *yell* to equal *shout*, or *life* plus *look* equals *time*, or, a real doozey, *rubber* minus *check* equals *bounce*.

In 1956 I tried to promote this

idea with the *Detroit Free Press* as a gimmick for promoting circulation. In my presentation to the *Free Press* I remember using "*Free + Press = Best.*" After a series of meetings they turned it down, because they thought it would be too difficult for the average layman.

I still do not think there is any logical mathematical equation to be used in solving these problems. I think it is more a matter of perseverance and determination.

ARTHUR C. JACOBSON
Director

Advertising & Public Relations
Tamar Electronics, Inc.
Anaheim, California

Comic-Strip Technology

In view of your stated editorial aim to keep ahead and abreast of the important subject of microelectronics (p 3, Sept. 28, 1962), I thought you might be interested in the fact that even the comic strips now recognize the significance of this new technology.



The enclosed strip is the first instance I can recall where modern electronic technology is described in realistic engineering jargon. It's also the first comic-strip application of microminiaturization.

JACK SKILOWITZ
Hartsdale, New York

Reader Skilowitz has forgotten Dick Tracy's fabled wristwatch radio, which was the forerunner of microminiaturized equipment, although the innards have never been revealed.

The illustration is from the Dec. 12 episode of "Johnny Hazard," by Frank Robbins, and is used by permission of King Features Syndicate.

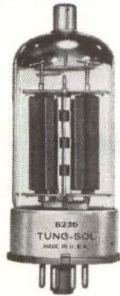

8236 High dissipation, high pervance pentode with full ratings up to 30 Mc. Typical ICAS operation is 60 watts dissipation, 200 watts input, 140 watts output.



8032 13.5 volt heater version of 6146 for mobile application. Other tubes in the 6146 family are 6883 and 6159 with 12.6 and 26.5 volt heaters respectively, "W" ruggedized versions, and a 6146A with controlled output at low end of heater voltage range.



6146 Beam power tube operable to 175 Mc. Typical ICAS operation at 60 Mc is 20 watts plate dissipation, 90 watts input, 70 watts output.



6907 UHF Twin Tetrode operable to 600 Mc. Typical operation at 465 Mc is 15 watts total plate dissipation, 40 watts input, 25 watts output.



6360 Miniature Twin Tetrode operable to 200 Mc. Typical ICAS operation is 12 watts total plate dissipation, 30 watts input, 18 watts output.



5894 UHF Twin tetrode operable to 500 Mc. Typical ICAS operation at 250 Mc is 40 watts total plate dissipation, 135 watts input, 95 watts output.

TUNG-SOL TRANSMITTING TUBES COVER THE RF SPECTRUM

Here are efficient twin tetrodes and beam power tubes that provide more power per stage to simplify transmitter and transceiver design, make equipment more compact and lower initial costs and maintenance. □ Tung-Sol transmitting tubes are specifically designed to provide the optimum power input, dissipation and output required for RF power amplifiers and oscillators and frequency multipliers, and AF power amplifiers and modulators in HF, VHF and UHF mobile and fixed station communications transmitters. □ Tube types in the series provide a full range of characteristics, suitable for every class of operation: telephony or telegraphy, SSB or AM, FM or PM modulation, in commercial, amateur, military or citizens' band service. □ Fully detailed information will be promptly supplied upon request. Tung-Sol Electric Inc., Newark 4, New Jersey. TWX: 201-621-7977

 **TUNG-SOL®**

EECo G-Series Circuit Applications - Number 4

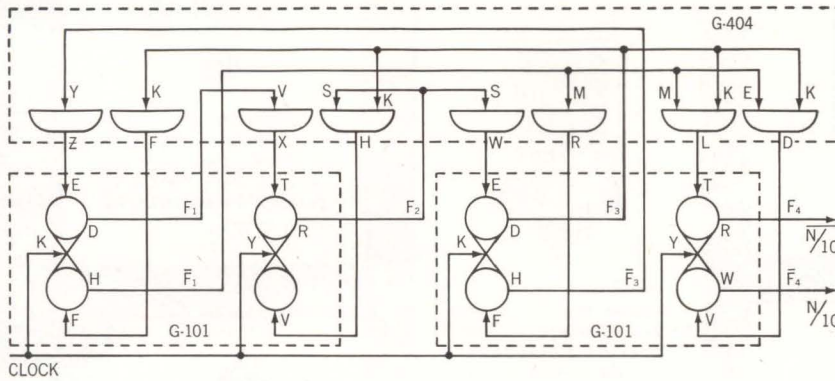

Set-Reset Logic:

$$\begin{aligned} F_{1S} &= F_3 & F_{3S} &= F_2 \\ F_{1R} &= F_3 & F_{3R} &= \overline{F_1} \\ F_{2S} &= F_1 & F_{4S} &= \overline{F_1}F_3 \\ F_{2R} &= F_2F_3 & F_{4R} &= F_1F_3 \end{aligned}$$

Note:

No clock term is necessary because G-101 flip-flops are internally steered.

Input (Trigger):

Amplitude: 6-volt p-p negative pulses at rise times to 20 nanoseconds.
Frequency: 0 to 10 Mpps

Output:

Signal Levels: -6VDC = "1", 0VDC = "0"
False Level (worst-case) Load: 40 ma, each output
Rise Time: 20 nanoseconds maximum
Fall Time: 50 nanoseconds maximum

Power Required:

-12VDC @ 190 ma maximum
-6VDC @ 66 ma maximum
+6VDC @ 12.4 ma maximum

EECo Modules Required: Two G-101 dual JK flip-flops, one universal logic C G-404 circuit

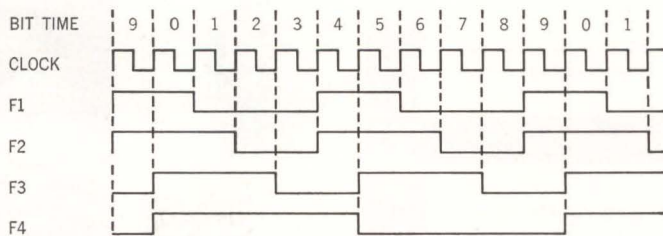

A 10 MPPS DECADE SCALER—AND MORE

USE IT AS AN N/10 COUNTER WITH SYMMETRICAL OUTPUTS:

Synchronous decade scaler shown operates at input frequencies to 10 Mpps. Outputs F4 and $\overline{F_4}$ are symmetrical square waves. Also, since F4 and $\overline{F_4}$ have no logic load, they have full drive capability (40 ma each).

USE IT AS AN N/5 COUNTER:

Because the first three stages complete a counting cycle for every group of five input clock pulses, they may be used as an N/5 counter if the fourth stage is deleted.

USE IT AS A SOURCE OF DELAYED CLOCK PULSES:

Output waveforms of second and third stages are identical, but third-stage output is delayed one clock time. Pairs of signals such as these are useful for timing systems requiring two or more clocks for logic propagation.

AND MORE:

These are just a few applications for this 10 Mpps scaler—and for EECo's new G-Series extended-service digital-circuit modules. Perhaps others will be of interest to you. Write, wire, or phone today for details. Ask for the new G-Series catalog or a call from one of our experienced staff of applications engineers.

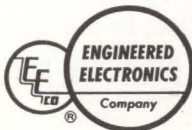
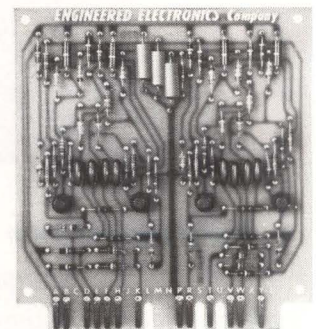

ENGINEERED ELECTRONICS Company

1441 East Chestnut Avenue, Santa Ana, California
Telephone: 547-5651 Cable Address: ENGELEX

Nuclear Missile Project Gets New Funds

WASHINGTON—Defense Department has given the Air Force \$19 million to continue development of Project Pluto. Goal of the project is a nuclear ramjet engine that could power a supersonic cruise missile. The money was allocated from this year's defense budget. DOD had been withholding the funds.

The additional money, said an Air Force spokesman, will provide for development work "beyond the Tory 2C tests" (Tory 2C is a flight-type reactor for ground tests).

One project tied to Pluto that could lead to substantial electronics development is Slam. Slam is a series of studies for a supersonic, low-altitude missile. The missile would reportedly have an intercontinental range and fly at a speed of Mach 3.

Telephone Installers Vote Against Hoffa

WESTERN ELECTRIC installers of electronic equipment dealt Jimmy Hoffa and his Teamsters Union a major setback last week in Hoffa's plan to organize the communications and electronics industries (p 24, Dec. 21). In the first big representational election in these fields, the installers gave their present union, the Communications Workers of America, 11,388 votes and the Teamsters 4,000. Interest ran so high that 94 percent of those eligible voted.

Beam Compression Raises Mm Power

ORLANDO, FLA.—New scheme for millimeter-wave generation was proposed this week at IRE conference here on millimeter and sub-millimeter work.

Intense magnetic fields can compress an electron beam and achieve circuit densities as high as 2,500 amps/cm², said E. A. Ash, of Standard Telecommunications Labs, England. A generator has been built

and an output of 2 watts at 4 mm achieved. Higher outputs are expected.

It was also revealed by the Martin Co. that a new frequency standard using a molecular beam technique is nearing completion. Accuracy is expected to be 1 part in 10¹⁰ at 300 Gc.

Work is being done under a Signal Corps contract. One remaining problem is getting a high enough vacuum for operation.

Skybolt Phase-Out Plans Due Monday

AIR FORCE will submit plans, on Monday, to the Department of Defense for phasing out the Skybolt missile program. DOD requested the Air Force to do this after formally killing the project on December 31.

Douglas Aircraft, prime contractor for Skybolt, will lay off about 4,000 employees within the next 30 days. Northrop, the guidance contractor, will lay off about 2,000.

Despite DOD's swift action before Congress convened (January 9), Congress is expected to revive the Skybolt issue, if not the missile

itself. Congressmen expressed alarm over what appears to be "the demise of the Air Force," and also over their constitutional authority in the government.

Relay's Power Supply OK, Another Trouble Develops

RELAY'S power supply problem corrected itself last week but nobody knew why. According to one educated guess, moisture had been causing a transistor to malfunction; when the moisture went away, so did the trouble.

With the satellite producing enough power for transmission purposes for the first time since it was launched Dec. 13, scientists initiated a series of communications tests. A tv test pattern was transmitted across the Atlantic, but almost immediately command difficulties were encountered. In an effort to overcome this, scientists this week were altering the sequence of commands. Again, no one knew why the command circuits were behaving erratically.

Relay's return to at least partial service gave the United States two

Strike-Bound Papers Eye Typesetting Computers

COMPUTERS that punch tape for the automatic setting of type hit the newspaper field in a big way last week, promising huge savings, increased efficiency and even more complications in the already thorny relationship between the publishers and International Typographical Union.

The *Los Angeles Times* recently put an automated typesetting system into operation. Heart of the process is an RCA 301 computer. The *West Palm Beach (Fla.) Post-Times* is getting a similar system, and a third computer system, using an IBM 1620, is almost set at Oklahoma City newspapers. None of these papers has a contract with the union.

RCA said many other newspapers, including some in New York City, are interested in its system. New York papers were shut down a month ago by a printers' strike. A major obstacle to settlement, it was reported, is a union demand for control over automated equipment in the composing room.

The *Los Angeles Times* system sets up lines of type directly from a reporter's typewriter, makes editing changes and corrections, and decides where split words are to be hyphenated

communications satellites now transmitting from outer space (see Telstar story, p 30).

Radar Spectrum Analyzer Pinpoints Wind speeds

BOSTON—New spectrum analyzer has enabled wind speeds to be measured by radar to an accuracy of less than $\frac{1}{2}$ mph by Air Force Cambridge Research Laboratory.

The analyzer and doppler techniques were developed by Roger Lhermitte, of AFCRL. The analyzer is designed for 3-cps bandwidths spaced 14.7 cps apart in a comb array. On the C-band doppler radar, this spacing is equivalent to increments of 0.4 meter/sec in radial velocity. Horizontal wind can be measured at all heights.

Improved radars and data processing techniques promise to provide a system that could measure winds in fair weather as well as foul and detect clear-air turbulence, an aircraft hazard. The present system's observations are limited to snowy and rainy weather.

Defense and Space Group Organized at Burroughs

BURROUGHS CORPORATION announced last week that various facilities and activities have been placed in a corporate-wide operation called the Defense and Space Group.

Included in the team are Burroughs Laboratories, and the Defense and Space Systems Management, Military Electronic Computer, Military Field Service and Control Instrument divisions, Defense and Space Systems Marketing, and Contracts Administration.

Irven Travis, president of Burroughs Laboratories and corporate vice president, will service as the group executive.

Underwater Laser Techniques Studied

BOSTON—Ceramic material is being used instead of mirrors to concentrate ruby laser beams and to deflect laser output to accomplish raster scan. The techniques are being developed by Hans Udo

Von Schultz, director of engineering at U.S. Sonics Corp., Cambridge, for application to underwater laser when and if such a device emerges. Von Schultz said he is working on developing a blue or green laser for underwater use.

RCA and Philco Settle, Philco to Make Color Tv

RCA AND PHILCO reached an out-of-court agreement last week on their dispute over rights to patents in the color television, transistor and data-processing fields. Philco is withdrawing its \$150 million damage suit against RCA, and RCA its countersuit for \$174 million.

The agreement provides that RCA will receive nonexclusive licenses under all present Philco and Ford Motor Co. United States patents and patent applications relating to radio-purpose apparatus (including color tv), transistors and data processing equipment. These licenses will run for the full lives of the patents. RCA will also be able to use any domestic color-tv patent granted to Philco in the next five years. For these rights, it is paying Philco \$9 million.

In return, RCA will make available to Philco and its parent company, Ford Motor Co., all its color tv patents issued up to Oct. 28, 1958. Later patents will be available to Philco under regular license fees.

Reportedly, Philco will begin manufacturing color-tv sets this year. Philco plans to begin by assembling RCA components, then to produce sets with Philco-produced components.

NASA in the Market for A Really Big Satellite

NASA WILL RECEIVE proposals next Friday for an erectable satellite to study micrometeoroids and to gain experience in designing manned and unmanned space systems. The satellite is to weigh more than two tons and have a surface area of more than 2,000 square feet. It is to be launched during the eighth and ninth Saturn booster test flights.

In Brief . . .

MARINER II lost contact with earth Tuesday after traveling 54.3 million miles. The antennas probably turned away from earth.

RAYTHEON last week received two Navy contracts totaling \$55 million for production of Sparrow III missiles and allied services. Army gave Raytheon a \$46.8-million order for Hawk missile equipment.

TEXAS INSTRUMENTS has a production order from Litton Industries for silicon integrated circuits. They'll be used in AN/ASA-27 radar computer indicators for Navy's W2F-1 early-warning aircraft.

ELECTRO - MECHANICAL RESEARCH will produce telemetry pcm ground stations for NASA's world-wide range of tracking stations, under \$7.4-million contract. Automatic checkout subsystems will be included. EMR will also supply spacecraft data transmission, on board recording systems and associated ground checkout equipment to McDonnell Aircraft for Project Gemini.

TELETYPEWRITER SYSTEM used by Westinghouse Electric now has a computer to control automatic routing of messages between 300 locations.

BENDIX has won a \$19.4-million contract from Army for Pershing missile guidance and control equipment, and a \$7.1-million Army award for fighter aircraft equipment.

SYLVANIA is awarded another \$19.3-million order for Army communications equipment, making total contract \$33 million.

HOFFMAN ELECTRONICS will produce 600 Tacan transceivers for Air Force under a \$1.9-million contract.

HAMMARLUND MANUFACTURING is to design and produce 200 ssb, compatible a-m radiotelephones for the Coast Guard.



**SPRAGUE HYREL® ST
SOLID TANTALUM CAPACITORS
Meet Minuteman Goal April, 1962**

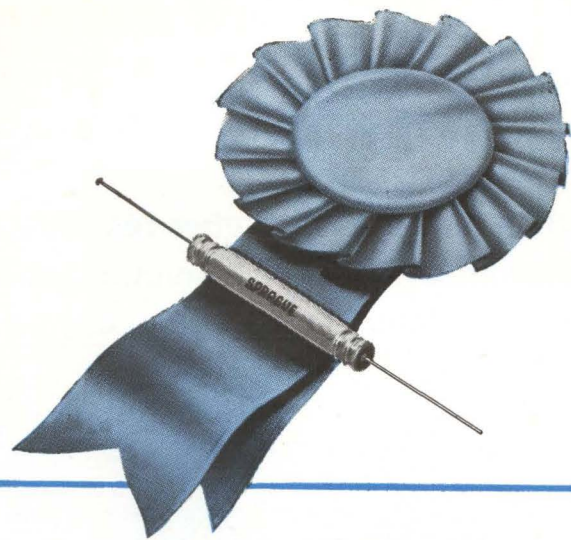

**...AND NOW HYREL® FT
FOIL TANTALUM CAPACITORS
NOVEMBER, 1962**

SPRAGUE HYREL® FT FOIL TANTALUM CAPACITORS SURPASS MINUTEMAN PROJECT GOAL!

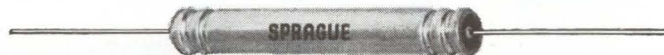

**SPRAGUE successfully meets 2nd of two Minuteman targets,
having previously achieved solid tantalum capacitor goal**

**Failure Rate Goal of .001%/1000 hrs.*
has been bettered by wide margin!**

Sprague HYREL FT Foil Tantalum Capacitors have exceeded Minuteman's component development objective, attaining a use condition failure rate of .00045% per 1000 hours in recently completed tests. Sprague's qualification to the Minuteman Foil Tantalum Capacitor Specification, like its earlier qualification to the Minuteman Solid Tantalum Capacitor Specification, is unrestricted and "across-the-board."

Backing this performance is Sprague's record of pioneering

*at 60% confidence level by accelerated qualification tests.

in highly reliable capacitors, which earned the opportunity to participate in the Air Force's Minuteman Component Development Program at Autonetics, a division of North American Aviation, Inc.

All of the special processes and quality control procedures that make HYREL FT Foil Tantalum Capacitors so reliable can now help improve the dependability of your military and aerospace electronic equipment. A tantalum capacitor engineer will be glad to discuss the application of these capacitors to your projects. Write to Mr. C. G. Killen, Vice-President, Industrial and Military Sales, Sprague Electric Co., 35 Marshall St., North Adams, Mass.

SPRAGUE COMPONENTS

CAPACITORS

TRANSISTORS

MAGNETIC COMPONENTS

RESISTORS

MICROCIRCUITS

INTERFERENCE FILTERS

PULSE TRANSFORMERS

PIEZOELECTRIC CERAMICS

PULSE-FORMING NETWORKS

TOROIDAL INDUCTORS

HIGH TEMPERATURE MAGNET WIRE

CERAMIC-BASE PRINTED NETWORKS

PACKAGED COMPONENT ASSEMBLIES

FUNCTIONAL DIGITAL CIRCUITS

ELECTRIC WAVE FILTERS

SPRAGUE®
THE MARK OF RELIABILITY

'Sprague' and '®' are registered trademarks of the Sprague Electric Co.

Prize Crop of Precision Potentiometers

With smaller cases, higher resistances, better linearity, finer resolution, and higher operating temperatures than any other line.

Now you can obtain a 25 to 39% increase in total resistance together with standard linearity as low as 0.2% and resolution as fine as 0.01% — in a potentiometer that's shorter than any competitive unit. Our 10-turn Model 3500, for example, is just 1" long, a full 1/2" shorter than units available elsewhere. The secret: new design techniques including a thin-wall molded plastic case that lets us put a 20%-longer resistance element in a shorter package.

The new case also improves heat dissipation, thus increasing power-handling ability and raising the maximum operating temperature 20°C above that of poten-

tiometers available elsewhere. Sealed against humidity, these units exceed steady-state requirements, and most can even be specified to meet MIL-STD-202B, Method 106 (cycling humidity). Reliability is further enhanced by the virtually indestructible Bourns Silverweld® termination.

Units are individually inspected and subjected to the stringent double-check of the Bourns Reliability Assurance Program. Prices are competitive and delivery is immediate. Write today for complete technical data. AVAILABLE OFF THE SHELF AT FACTORY PRICES FROM DISTRIBUTORS ACROSS THE NATION.

Exclusive Silverweld® termination — an indestructible fused bond between terminal and resistance wire — eliminates chief cause of precision potentiometer failure.

Double slip-ring contact provides wider contact area and a double safety margin for vibration and shock.

Molded, high-temperature plastic housing enables standard model to meet steady state humidity spec. of MIL-STD-202B, Method 103.

20%-longer resistance element provides better resolution, cooler operating temperature, and higher total resistance.

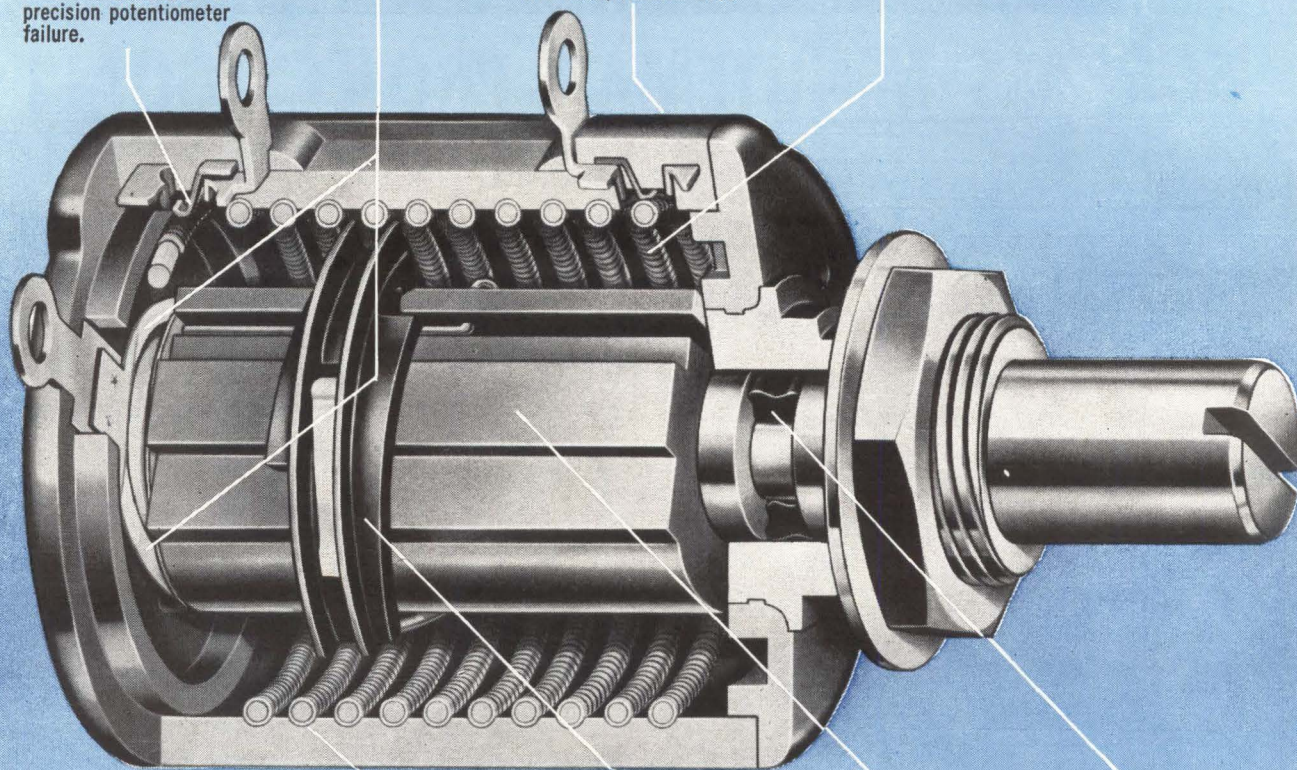











Element grooves molded within plastic housing ensure perfect helix for resistance element.

Large slider block provides greater wiper stability, eliminates rocking.

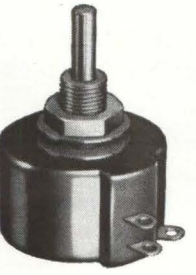
Special close-tolerance rotor almost completely eliminates backlash.

Quad ring ensures Mil-Spec. resistance to humidity.

This cutaway of Model 3500 shows the typical high-quality construction to be found in all Bourns precision potentiometers, although some features may vary from model to model.

| | | | | | |
|--|---|--|--|---|--|
| Model 3500—$\frac{7}{8}$" , 10-turn Now: standard linearity of 0.2% | | | Model 3700—$\frac{1}{2}$" , 10-turn Now: drastically reduced to only \$19.60 each (100 pcs.) | | |
|  | Length (body) Standard linearity Standard resistances Power rating Humidity Max. operating temp. Resolution | 1.00" $\pm 0.2\%$ 500 Ω to 125K 2.0W @ 70°C MIL-STD-202B, Method 103 (steady state)† 125°C 0.01 to 0.03% |  | Length (body) Standard linearity Standard resistances Power rating Humidity Max. operating temp. Resolution | 1.00" $\pm 0.25\%$ 500 Ω to 100K 1.0W @ 70°C MIL-STD-202B, Method 103 (steady state)† 125°C 0.020 to 0.060% |
| Model 3520—$\frac{7}{8}$" , 5-turn Length, .678"—resistances to 75K | | | Model 3600 KNOBPOT®* Potentiometer— $\frac{3}{4}$ ", 10-turn Potentiometer, dial, and knob all in one—operates at 125°C | | |
|  | Length (body) Standard linearity Standard resistances Power rating Humidity Max. operating temp. Resolution | .678" $\pm 0.3\%$ 200 Ω to 75K 1.5W @ 70°C MIL-STD-202B, Method 103 (steady state)† 125°C 0.015 to 0.070% |  | Length (body) Standard linearity (dial accuracy) Standard resistances Power rating Humidity Max. operating temp. Resolution (Also available without dial) | 1.00" $\pm 0.5\%$ 1K to 100K 1.5W @ 25°C MIL-STD-202B, Method 103 (steady state) 125°C .011 to .035% |
| Model 3510—$\frac{7}{8}$" , 3-turn Length, .549"—resistances to 50K | | | URNS-COUNTING DIALS Easy-to-read dials requiring only 1" of panel space are available for all Bourns precision potentiometers (except KNOBPOT units, which incorporate their own dials). Easily mounted—no extra panel holes needed, can be set to less than .1% of total travel. Locking device (optional) positively prevents shift in setting. Anodized finish, black or clear. | | |
|  | Length (body) Standard linearity Standard resistances Power rating Humidity Max. operating temp. Resolution | .549" $\pm 0.3\%$ 200 Ω to 50K 1.0W @ 70°C MIL-STD-202B, Method 103 (steady state)† 125°C 0.028 to 0.100% |  | | |
| | | | KNOBPOT POTENTIOMETER MIL-SPEC COLOR ACCESSORIES Meeting color requirements of MS-91528B and MIL-STD-242 (ships). | | |
| | | |     | | |
| | | | COLORED SNAP-RINGS for color-coding panels or imparting high style to equipment. COLORED MIL-SPEC SLIP-OVER KNOBS for function, for style. Standard 1" MIL-Spec diameter. LOCKING DEVICE (BRAKE) to prevent accidental jarring of settings. STAINLESS STEEL SKIRTS to add a touch of glamour. | | |

All units shown actual size

*U. S. Pat. No. 3,069,646

†Optional feature meets MIL-STD-202B, Method 106 cycling humidity

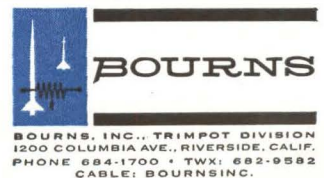

Manufacturer: Trimpot® potentiometers; transducers for position, pressure, acceleration. Plants: Riverside, California; Ames, Iowa; and Toronto, Canada.

WASHINGTON OUTLOOK

POLARIS DEAL CLOUDS FUTURE OF MMRBM

PLANS TO SUPPLY Britain and NATO with Polaris missiles makes the Air Force's Mobile Mid-Range Ballistic Missile (MMRBM) project more uncertain, say Pentagon sources.

The overriding rationale for the project is that MMRBM would be the nuclear deterrent weapon sought by so many in NATO. It seems very unlikely that NATO would get two different strategic weapons.

Air Force wants MMRBM as a tactical weapon to replace Mace. But the Pentagon's top echelon has virtually ruled out that mission.

BUT NATO MAY NEVER GET POLARIS FORCE

POLARIS AGREEMENT is still so fuzzy that some Washington observers doubt NATO will ever build up a nuclear deterrent force.

So many crucial questions—number of missiles, sales terms, deployment, relationship between British and NATO Polaris forces, multinational command and control, etc.—are still to be ironed out that skeptics think the Nassau agreement was essentially a political face-saving maneuver for Prime Minister MacMillan.

Behind the skepticism is the Kennedy administration's dislike of nuclear proliferation and its desire for U. S. control of the Western deterrent force. Skepticism is bolstered by the extended timetable for a British Polaris force—some seven years off—and difficulties Britain faces in paying for nuclear submarines.

AIA PLANS TO AID DEPRESSED AREA FIRMS

AEROSPACE INDUSTRIES ASSOCIATION's voluntary plan to channel military subcontracts to firms in areas with high rates of unemployment has the government cheering. Pentagon officials concede their own program to encourage defense business in depressed areas is hard to enforce, so they are particularly keen about AIA's plan.

AIA's program includes electronic devices able to meet military specs, and high-reliability and close-tolerance electromechanical components. It does not include "common, readily available, and highly competitive product lines" because AIA feels such items have a "low yield of opportunity" for subcontracting. The Defense Department will give AIA's 18 major prime contractor members information on qualified companies.

CIVILIAN R&D TAX CREDIT?

WHITE HOUSE SOURCES indicate that President Kennedy may ask Congress to allow a special tax credit for money spent by companies on research equipment and facilities. The Treasury department is working on such a proposal. The administration is looking for ways to stimulate research and, hence, business in the so-called civilian economy—building, transportation, education, etc.

SATELLITE SPIES ON SOVIET R-F

PENTAGON WON'T COMMENT on reports that it has a new satellite, dubbed Ferret, that can monitor Soviet radar and radio traffic. However, of 71 military satellites launched from the West Coast through November 24, 1962, only 38 have been identified as Discoverers. Another 33 were a mixture of Discoverer, Samos, Midas and Ferret satellites, say informed sources. Launched into polar orbit carrying it over Russia, Ferret picks up coded and scrambled transmissions, then relays them to U.S. listening posts.

Proved through 9,000,000 cycles



SUSPENSION TYPE METERS

- NO PIVOTS ▪ NO JEWELS
 - NO HAIR SPRINGS
- thus NO FRICTION

FACTS MAKE FEATURES

1 No pivots . . . no jewels . . . no hair springs . . . thus NO FRICTION.

2 Greater SENSITIVITY and REPEATABILITY

3 RUGGED and ACCURATE. Highly resistant to extreme shock. Accurate to 2% of full scale deflection (coming from line production at 1½% maximum tolerance. Greater accuracy available on special order!) Famous Triplet patented Bar Ring Construction.

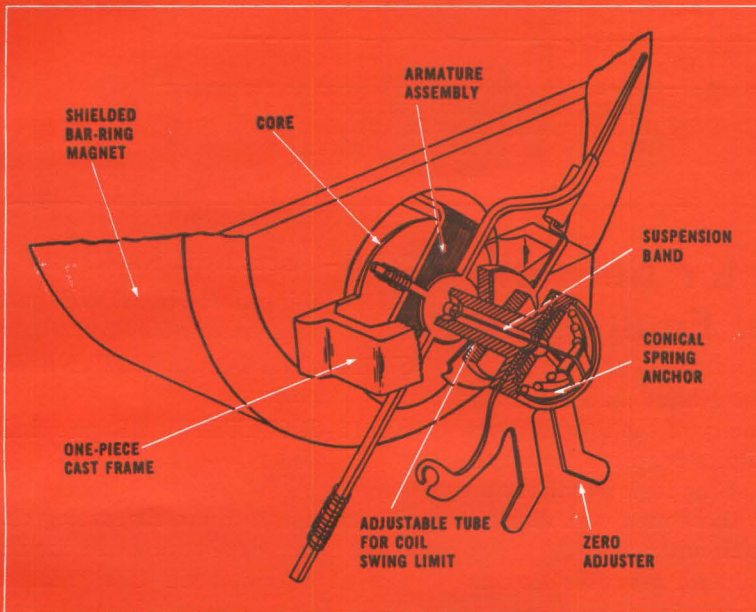

1½ TIMES ACTUAL SIZE

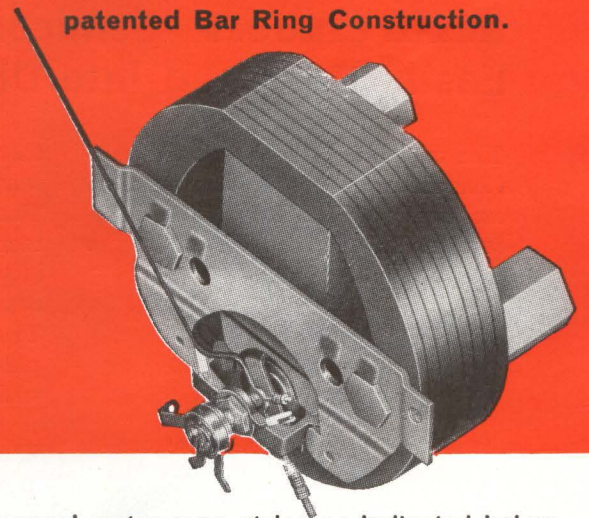

This improved new suspension type movement comes in standard panel meter case styles as indicated below. Meters can be used with almost negligible current drain. Especially applicable to transistor and similar circuits. Their high overload capacity prevents harm from surges many times normal full scale current. These instruments feature a short, very thin, narrow band kept tightly suspended on special spring terminals, which support the coil with its moving counter parts. The Triplet spring is conical in shape, the suspension wire being looped over and fastened to the top cone section. This allows freedom of action for the twisting suspension and added protection against severe shocks. As in all Triplet products, attention to detail makes for longer instrument life.

THE TRIPLET ELECTRICAL INSTRUMENT COMPANY, BLUFFTON, OHIO

8 CASE STYLES—11 MODELS—SIZES 2½" THROUGH 8"



MANUFACTURERS OF PANEL AND PORTABLE INSTRUMENTS; ELECTRICAL AND ELECTRONIC TEST EQUIPMENT



NEW CIRCUITS FOR SOLVING YOUR DESIGN PROBLEMS

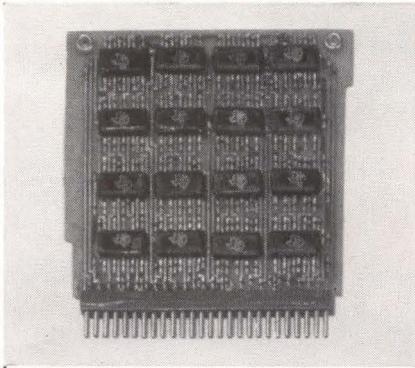

Right: 16-stage shift-register block diagram incorporates 16 SN510 or SN511 semiconductor networks. Inset photo shows actual-size shift-register card built from the logic diagram.

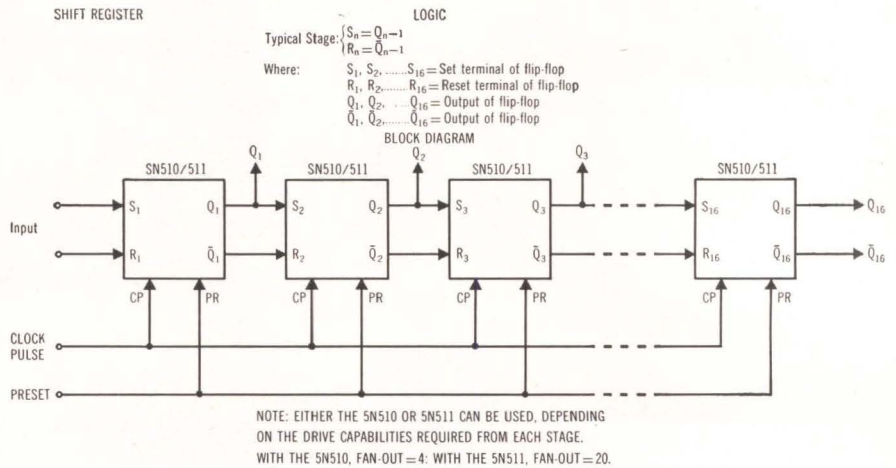

SOLID CIRCUIT[®] Semiconductor Networks Easily Designed Into Digital Equipments

The typical digital logic configurations shown on this page are made up exclusively of **SOLID CIRCUIT** semiconductor networks from Texas

Instruments. Notice the straightforward simplicity of the logic layouts. The techniques required for implementation of the logic equations are identical to those used with discrete-component circuits.

TI semiconductor networks are complete electronic circuits fabricated within a single block of silicon, and are hermetically sealed within a 1/4" x 1/8" x 1/32" package. Each "Series 51" digital network performs the functions of up to 31 transistors, diodes, resistors, and capacitors.

More and more circuit designers are turning to TI semiconductor networks for improved reliability, reduced size and weight, lower power requirements, and — in most cases — significant cost savings.

"Series 51" semiconductor networks are available today in six off-the-shelf logic circuits:

- SN510—R-S FLIP-FLOP/COUNTER
- SN511—R-S FLIP-FLOP/COUNTER with emitter-follower outputs
- SN512—6-input NOR/NAND gate
- SN513—6-input NOR/NAND gate with emitter-follower output
- SN514—Dual 3-input NOR/NAND gate
- SN515—EXCLUSIVE OR gate (half adder)

In addition to these six catalog circuits, hundreds of customized circuits can be obtained via TI's "Master Slice" design concept. This technique consists of depositing your special interconnection pattern on standard diffused-silicon slices. Since there is only a single special step in the design process, your customized variations can be quickly produced at surprisingly economical prices.

A comprehensive applications report on "Series 51" semiconductor networks is now available. This report contains design rules applicable to networks, a number of additional examples of logic implementations, and simple breadboarding techniques. For your copy, write to Department 606-1, Dallas.

*Trademark of Texas Instruments Incorporated

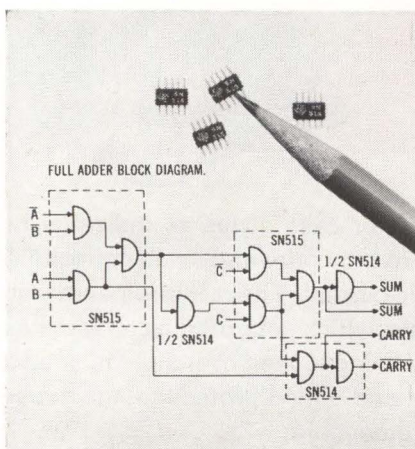

Two SN514 and two SN515 semiconductor networks form a full adder. Inset photo shows the four TI networks used to perform this frequently encountered logic function.

Transistorized UHF Tuner Features Low Noise, High Gain

A low-noise, highly efficient UHF tuner using 2N2415 transistors has been developed by Texas Instruments. Full design data will be made available to interested manufacturers.

The circuit was designed for use as a UHF television tuner, but is adaptable to other uses. The photo shows (left to right) the tuned RF amplifier, the oscillator, and the mixer. Output is 45 mc.

On test, the tuner indicated a typical noise figure of 7 to 9 db, compared with 10 or 12 db for comparable vacuum-tube circuits. Gain was 3 to 9 db — a substantial increase over the 6 db loss usually obtained from tube circuits in the 470- to 890-mc band. Stability was excellent. At 935 mc, temperature fluctuations from 25°C to 50°C caused the local oscillator frequency to vary only 600 kc, and

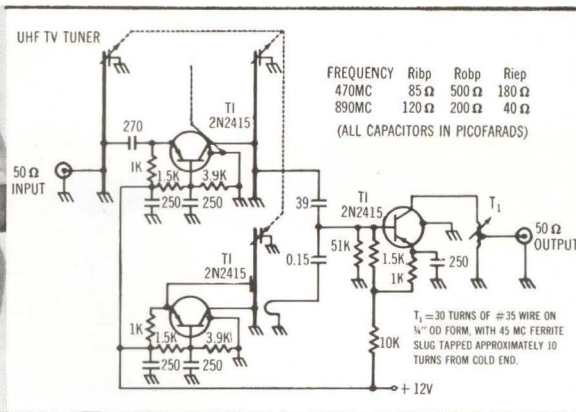
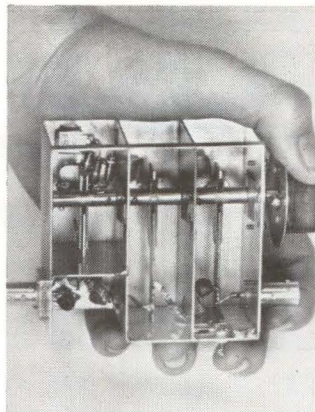

Circuit diagram for transistorized UHF Tuner. Input is tunable from 470 to 890 mc. Output is 45 mc. Power requirement

is only 18 ma at 12 volts. Mixer emitter current is 0.1 ma.

supply-voltage changes of 10 percent caused frequency variances of only 400 kc.

The TI 2N2415 transistors in this circuit have a f_{max} of 3 Gc, the highest in the industry. Transistor noise figures through the UHF range are the lowest available today. A typical noise

figure at 200 mc is 2.4 db. Collector-base time constant is unusually low — three picoseconds. Ruggedness of construction is confirmed by 100-percent centrifuge testing. For data sheets on Texas Instruments 2N2415 transistors, write to Department 606-2, Dallas.

120-Watt DC-DC Converter Operates From -55° to +125°C

This 120-watt, 10-kc, dc-to-dc converter circuit operates dependably over a wide range of ambient temperature conditions and includes built-in momentary short-circuit protection. The self-starting converter has input current of 5 amps, over-all efficiency of 85 percent, and output ripple of 0.6 volts maximum. Output shown is 400 volts, but this can easily be modified. Texas Instruments 2N1722 or 2N1724 transistors are used. These devices exhibit typical 2.5 μ sec total switching times and have a guaranteed minimum f_T of 10 mc — important characteristics for dc-dc converters, wide-band audio amplifiers, transient-sensitive d-c power regulators, and a host of other applications.

The 2N1722 and 2N1724 high-frequency silicon power transistors are produced by TI's triple-diffused mesa process. The result is an optimization

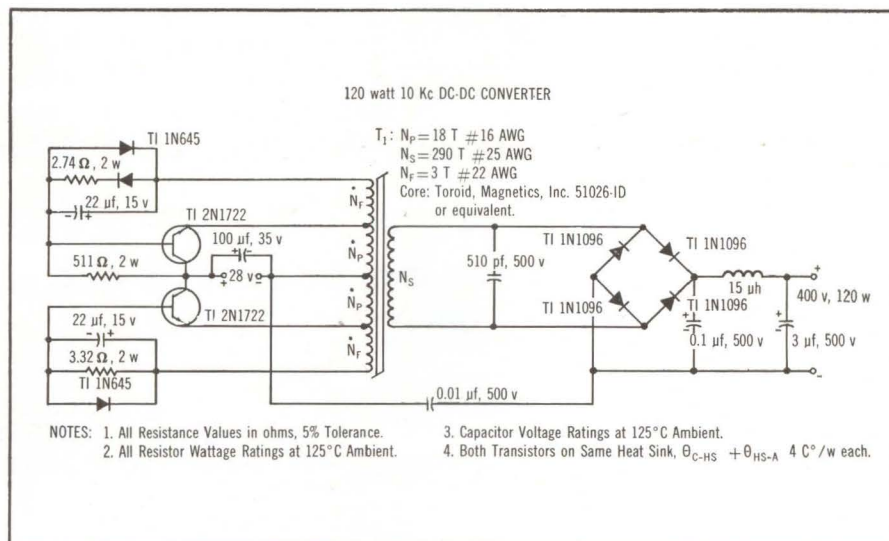

between high collector-emitter breakdown voltage (BV_{CEO}) and low saturation resistance. Low-contact resistance offers unusually high efficiency. Oxide passivation of the emitter-base junction surface reduces and stabilizes leakage current.

These TI silicon transistors offer the best performance available today in

applications requiring 50 watts at 100°C case temperatures. For data sheets on Texas Instruments 2N1722 or 2N1724 transistors, write to Dept. 606-3, Dallas.

Except for TI's semiconductor networks, TI cannot assume any responsibility for any circuits shown or represent that they are free from patent infringement.

SEMICONDUCTOR-COMPONENTS
DIVISION



TEXAS INSTRUMENTS
INCORPORATED
13500 N. CENTRAL EXPRESSWAY
P. O. BOX 5012 • DALLAS 22, TEXAS

19645

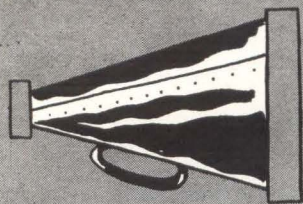

ANNOUNCING FOR 1963

a tremendous
electronics BUYERS' GUIDE Issue

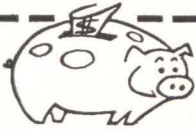

NEW LOW CATALOG RATES ALLOW SUFFICIENT SPACE FOR YOU TO PROVIDE COMPLETE BUYING INFORMATION ON YOUR ENTIRE PRODUCT LINE



Take complete advantage of marketing's
MAGIC COMBINATION

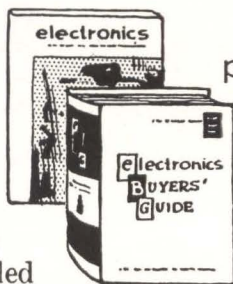

electronics every Friday – to create preference for your products...

The 1963 **BUYERS' GUIDE** to make product preference pay off in buying action

For 22 years of sales-minded

effectively and economically than ever before. Your **electronics** representative has full information on how this can be accomplished. Look at these new eBG catalog rates:

this combination has worked magic for thousands companies. It will work for you in 1963 more

CATALOG ADVERTISING RATES PER PAGE:

Without "EARLY BIRD" Discounts

| Space Used | Rates | Space Used | Rates |
|------------------|--------------|-------------------|----------------|
| 1 page | \$900 | 12-15 pages | \$545 per page |
| 2-3 pages | 740 per page | 16-19 pages | 495 per page |
| 4-5 pages | 670 per page | 20-23 pages | 465 per page |
| 6-7 pages | 630 per page | 24 or more | 440 per page |
| 8-11 pages | 590 per page | | |

FOR THE SAME PRICE AS 1962, FROM 33% TO 60% MORE SPACE!

Rates with "EARLY BIRD" Discounts

| | | | |
|------------------|----------|-------------------|----------|
| 1 page | \$837.00 | 12-15 pages | \$506.85 |
| 2-3 pages | 688.20 | 16-19 pages | 460.15 |
| 4-5 pages | 623.10 | 20-23 pages | 433.45 |
| 6-7 pages | 585.90 | 24 or more | 409.20 |
| 8-11 pages | 548.70 | | |

"EARLY BIRD" Closing Dates (For Discounts)

Reservations for space Feb. 15th / Copy to set April 16th / Complete plates April 25th

ACT NOW!



For Complete Information, Contact Local Sales Offices Listed on the Last Page of This Issue

Moseley
Model 680 series
solid state
recorders

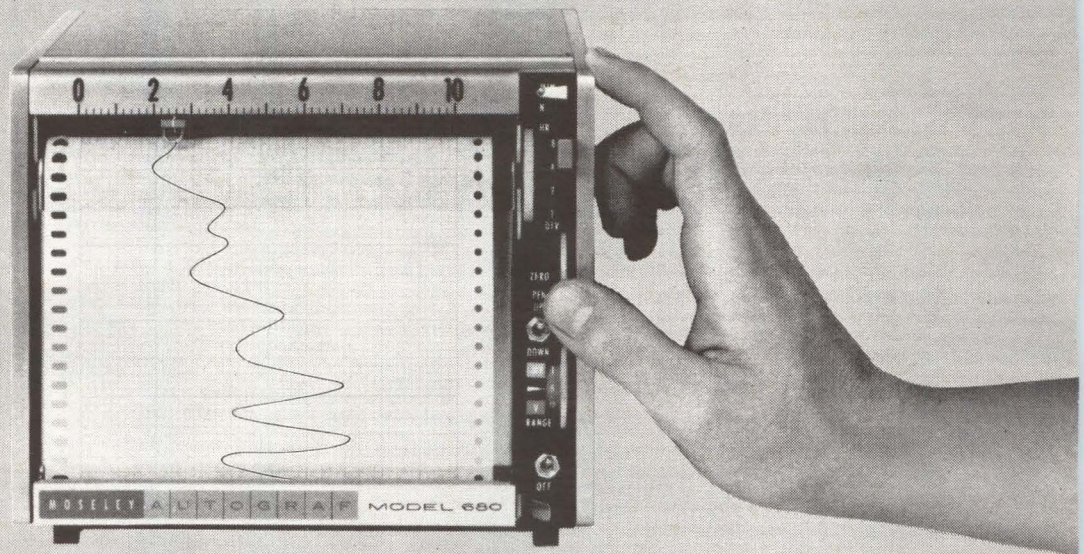

Ultra-compact 6" Strip-Chart Recorder

Low-power cool and reliable

Instant load, tilt-front chart carriage; dual mode paper take-up or tear-off

Ten calibrated input ranges from 1 millivolt/inch

Eight instantly selected chart speeds

Clean, disposable plug-in ink cartridge with start bulb. Inkless writing modes optional

Drives output-potentiometers, limit switches, digitizers

Any mounting—rack, table; or industrial panel in sealed, rugged, locked case

Also thermocouple, milliammeter, single range dual-speed models, 1 mv full scale models

SPECIFICATIONS

| | |
|------------------------------------|-----------------|
| Full scale balance time | 0.5 second |
| Accuracy | 0.2% full scale |
| Power | 10 watts |
| Weight | 10 pounds |
| Zero set and remote pen lift | |
| Input isolated 500 volts to ground | |
| Zener reference voltage | |
| All solid state circuitry | |
| Plug-in modular construction | |

| | Model | Price |
|--------------------------|-------|-------|
| Multi-Range, Multi-Speed | 680 | \$750 |
| Single Range, Dual Speed | 681 | 625 |
| Thermocouple Recorder | 682 | 675 |
| Milliammeter Recorder | 683 | 625 |

F. L. MOSELEY CO.
409 N. Fair Oaks Ave., Pasadena, California
an affiliate of Hewlett-Packard





ASTRONOMICAL photographs, made at 30-second intervals, show the spaceship and its boosters (arrows) against a star background at distances of about 120,000 miles from earth. Photos were used to plot Mars-1's initial trajectory (Sovfoto)

Soviets Planning Transmissions

Tass report indicates they plan to transmit over 150 million miles

WHAT TECHNIQUES will the Soviets use to transmit data and photos from their Mars probe when it arrives at the planet late in May after a seven-month journey?

There was no specific information in the progress report and description of Mars-1 recently published in Moscow by Tass. But there were a few clues:

- Radio equipment includes L, S and X-band systems (32, 8 and 5-cm wavelengths)

- The craft carries a directional parabolic antenna with a diameter of about 7 feet. An unfolded mesh provides more than half the diameter

- Transmissions will be made at longer intervals, up to 15 days apart, as the craft gets farther from earth. This will provide more time for battery recharging, presumably overcoming radiation degradation of the solar cells. Data is stored between transmissions.

Tass' discussion of the spacecraft's orbit, and an accompanying sketch indicate that the probe will be some 150 million miles from earth when it reaches Mars. Also, the Russians say that one purpose of the flight is to reliably maintain communication over "distances of tens and hundreds of kilometers."

There is no theoretical reason why this can't be done, if transmissions are made in a tight beam at high power. From the clues listed above, this seems to be the plan.

The alternative, waiting until Mars-1 returns to earth, would multiply reliability and solar-cell degradation problems. The probe is traveling faster than earth, but because its orbit around the sun is

longer, the Tass sketch indicates, it would take four years for it to catch up with earth again.

The probe will pass some 120,000 to 140,000 miles from Mars on its present trajectory. Plans were to correct the course to bring the probe within 600 to 7,000 miles of the planet. As of last month, when the craft had gone some 5 million miles, the course had still not been corrected.

However, Tass stated that communications were good and that all systems were functioning.

CONFIGURATION—Mars-1 is divided into two sections. One, called the orbital compartment, houses in-flight equipment. A planetary compartment contains the scientific instrumentation. The craft is 11 feet long, 3.6 feet in diameter and weighs almost one ton. Including solar cell panels and radiators, it is 13 feet wide.

An optical orientation system keeps the solar panels pointed toward the sun and maintains the craft's attitude with respect to the sun, a given star and the planets. On-board equipment is automatically controlled. Commands are radioed from ground.

RADIO SYSTEMS — Radio and telemetry systems are designed to transmit to earth coded information on equipment operation, scientific measurements and trajectory

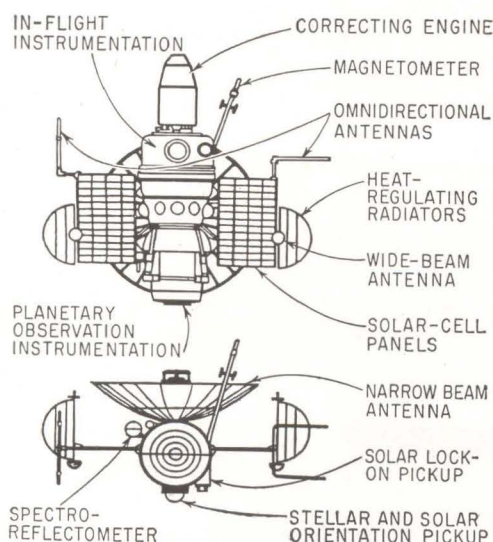

CONFIGURATION of Soviet Mars probe is detailed in these diagrams published last month in Moscow

LIFE ON MARS?

NASA plans to send a probe to Mars in 1966 to investigate whether there is life on the planet. The spacecraft would land a package on the planet. The package would analyze soil samples to determine whether bacteria or biological substances are present. This would provide a more positive answer than the spectrophotometer experiment aboard the Soviet Mars probe

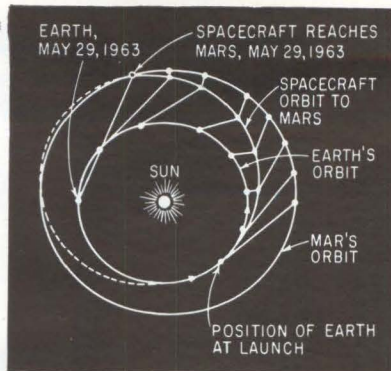

ORBITS of Mars probe and of the planet Mars projected on the plane of earth's orbit. Spacecraft will take about 16 months for a complete orbit around the sun

from Mars

information acquired by the optical system. Distances to the spacecraft, its speed and orbital coordinates are computed at ground stations from data received.

Three radio systems are used, with wavelengths of 1.6 m, 32 cm, and 5 cm and 8 cm. Apart from telemetering, the 1.6-m system is used to maintain communication with earth if the orientation system fails (this was not further explained, but apparently the omnidirectional antennas are for the 1.6-m system).

EXPERIMENTS—Research equipment includes, according to Tass:

- Phototelevision for photographing Mars' surface
- Spectrophotometer for detecting organic cover on the planet
- Spectrograph for studying ozone absorption strips in Mars' atmosphere
- Magnetometers for detecting magnetic fields in space and around Mars
- Radiation measuring equipment, including gas-discharge and scintillation gages, and traps for registering low-energy protons, electrons and positive ions. These will be used to analyze space radiation and to determine if Mars has a radiation belt
- Radio telescope to study space radiation in the 150-m and 1.5-Km wavelengths
- Micrometeorite pickups.

Gas pressure inside the spacecraft is kept at about 850 mm of mercury. Temperature ranges from 20 C to 30 C. Temperature is regulated by a heat-exchange system that circulates liquid through the hemispherical radiators. The bands on the radiators are coatings that absorb varying amounts of solar heat, to provide heating and cooling sections.

Missile-Watching Tv



AIR-GROUND TV developed by Cubic Corp. and Cohu Electronics enables ground observers to monitor missile launches. Airborne portion consists of camera and transmitter each weighing about 5 pounds. Receiver has horizontal line resolution of 700 lines

"Nothing is impossible to diligence and skill"

Samuel Johnson

These are the trademarks of some of our customers—each an important contributor to a dramatically growing industry. We at Potter pledge our diligence and skills to this growth through a constantly expanding program of research and development.

POTTER

**Model LP-1200
High Speed
Printer adds
new versatility**

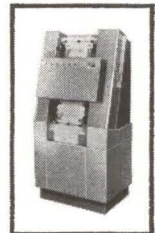

to modern computer systems. This high-performance, extremely reliable printer provides speeds of 1000 lines per minute with a maximum of 160 columns. An optional Format Control feature permits multi-page forms or books to be printed with completely flexible horizontal or vertical format and up to five carbons.

The Potter LP-1200 reflects the engineering-knowledge gained from extensive experience and research in high-speed printing. Solid-state modular electronics enhance reliability and sturdy, simple mechanical design readily adapts to meet customer requirements.

Three models are available: LP-1200—160 (160 columns), LP-1200—132 (132 columns) and LP-1200—80 (80 columns). Write for specifications.



Manufacturers of:
• Digital Magnetic Tape Systems
• Perforated Tape Readers
• High Speed Printers
• Data Storage Systems

POTTER INSTRUMENT CO., INC.
Sunnyside Boulevard • Plainview, New York

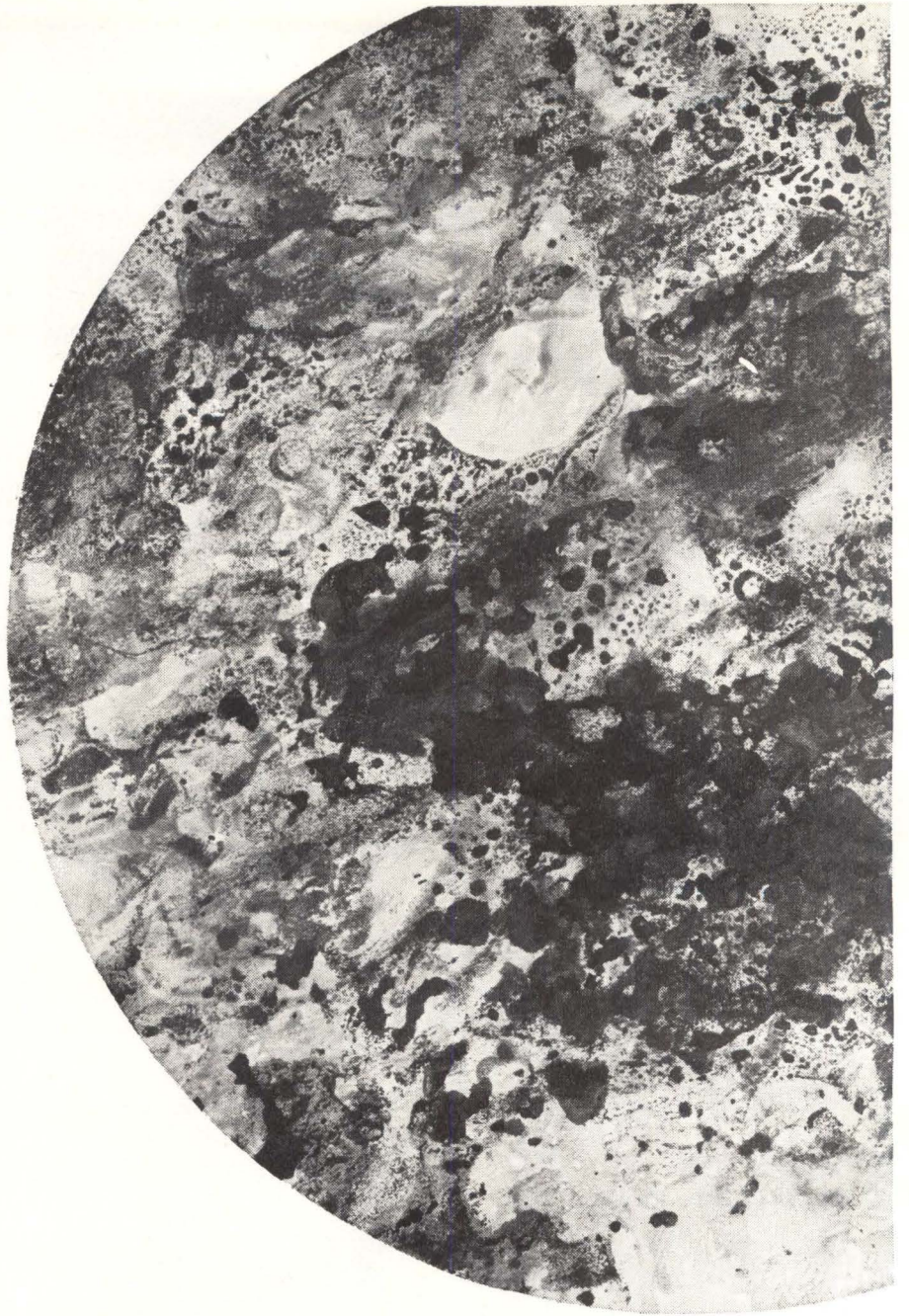

IF TODAY'S REALITY

IS TOMORROW'S MYSTERY.

What we know today is insignificant alongside what we will know tomorrow, and Philco Western Development Laboratories' advanced technology leads the way to better solutions for bigger problems . . . and to your career. With its space age achievement a matter of record in some of the Nation's most important satellite programs, Philco WDL extends a penetrating probe into the mysteries of tomorrow's universe: Cosmic ray and ruby laser optics, solid state microwave electronics, microwave miniaturization, signal detection techniques, deep-space communications. These are advanced fields being explored today at Philco WDL. Your career there can be as successful as your adventuring spirit. Tomorrow's space age problem is today's task at WDL.

Write in confidence for information on how you can find your career at Philco WDL, with the additional rewards of ideal living on the San Francisco Peninsula and professional and monetary advancement commensurate with your own ability. Requirements include B.S. or advanced degree (electronics, mathematics, physics), U. S. Citizenship or current transferable D.O.D. clearance. Address Mr. Patrick Manning, Department E-111.

PHILCO

A SUBSIDIARY OF
Ford Motor Company

WESTERN DEVELOPMENT LABORATORIES

3875 Fabian Way, Palo Alto, California

an equal opportunity employer

7759

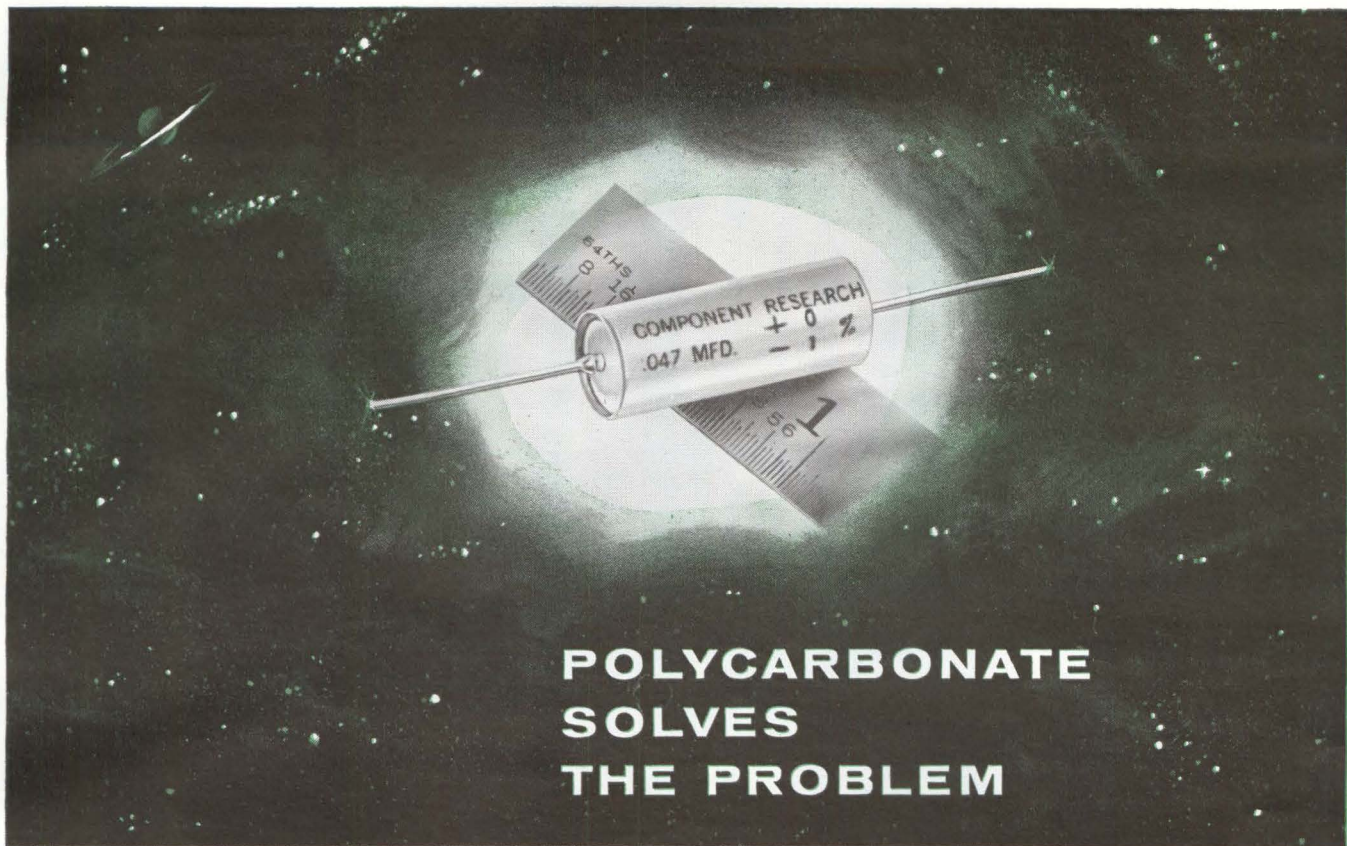

POLYCARBONATE SOLVES THE PROBLEM

COMPONENT RESEARCH CO., INC., Los Angeles, manufactures precision and special-purpose capacitors for vital space age applications requiring maximum reliability—for satellite guidance systems, miniaturized computers and lightweight power supplies.

As developed by Component Research, these compact capacitors have high dielectric strength, low temperature coefficient of

capacitance, and low dielectric loss over a wide temperature range. Natvar Polycarbonate Film, manufactured specifically for this type of capacitor, is used because of its outstanding dielectric properties over this wide range.

If you are presently manufacturing to maximum reliability standards, or are planning to, it will pay you to investigate Natvar Insulations.

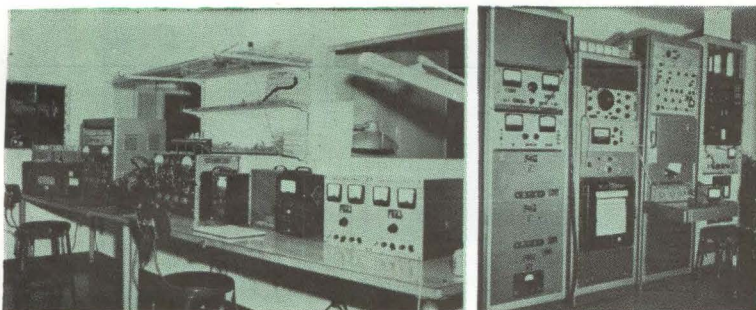

Typical test equipment in use at Component Research, capable of testing performance characteristics of capacitors under simulated flight conditions.

NATVAR CORPORATION

FORMERLY THE NATIONAL VARNISHED PRODUCTS CORPORATION

201 RANDOLPH AVENUE • WOODBRIDGE, NEW JERSEY

Telephone: Area Code 201—Fulton 8-8800 • TWX: 201-381-8056 • Cable Address: NATVAR: RAHWAY, N. J.



PRODUCTS: Varnished cambric • Varnished canvas and duck • Varnished silk and special rayon • Varnished papers—rope and kraft Varnished, silicone varnished and silicone rubber coated Fiberglas* • Slot cell combinations, Aboglas® • Teraglas® • Acryliglas** Isoteraglas** • Epoxy coated glass • Isoglas® • Isolastane® sheet, tape, tubing and sleeving • Vinyl coated and silicone rubber coated Fiberglas tubing and sleeving • Extruded vinyl tubing and tape • Styroflex® flexible polystyrene tape • Polycarbonate film and tape

We will be very happy to supply information on any of our products on request. *TM (Reg. U. S. Pat. Off.) OCF Corp. **TM Reg. Applied for.

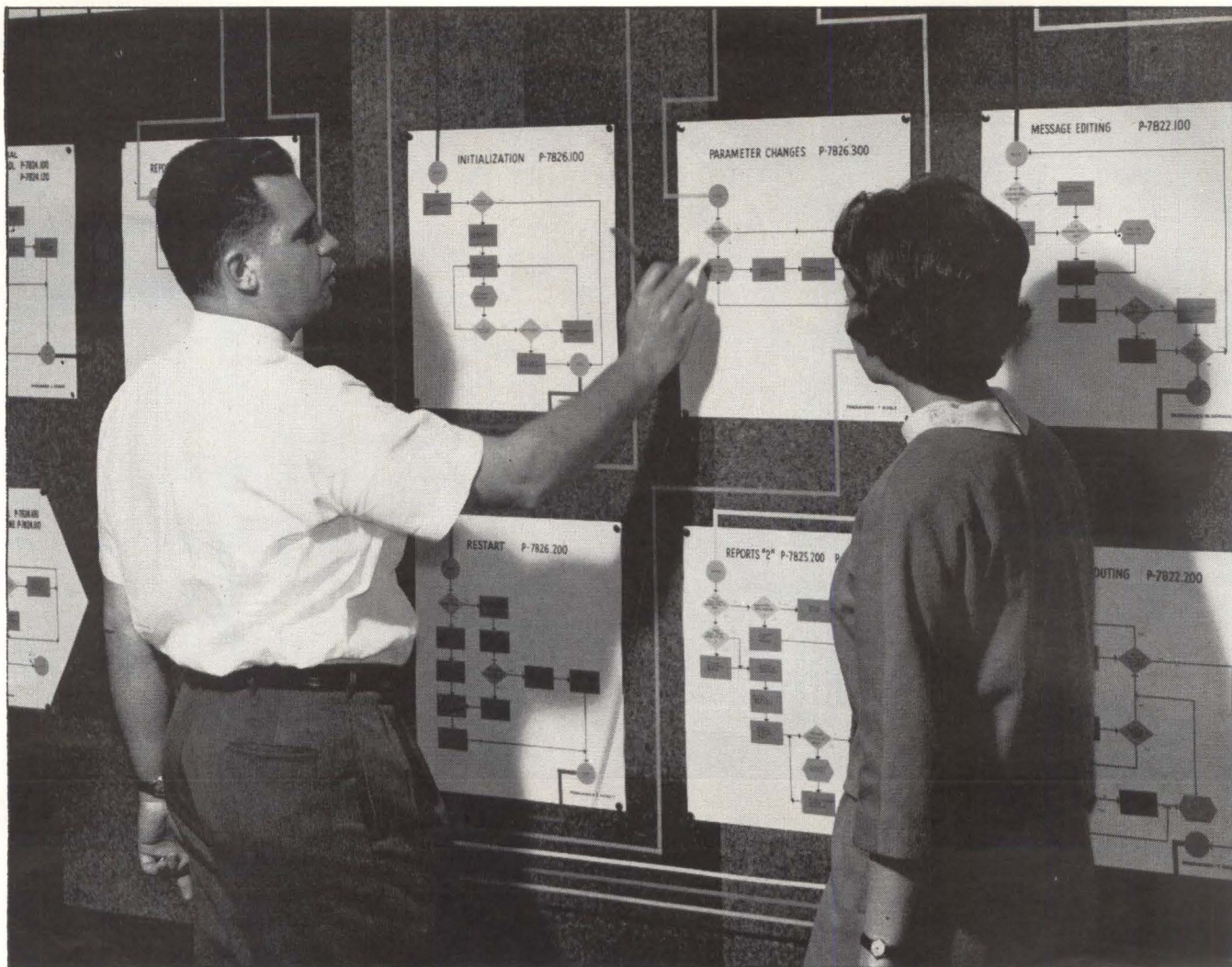

If you're a data processing specialist...

YOU SHOULD BE AT COLLINS

Why? Because Collins is taking an entirely new approach—the Microprogramming Technique—to computer design. We're using this technique in combining communication functions—message switching, priority routing, data transmission and conversion—with conventional computer data processing applications. This new Collins concept of what a computer can do opens up a whole new field to programmers. You'll be able to experiment and explore. You'll have the opportunity to actually participate in logical design. You'll be looking for new ways to use this computer system, new applications in which it can be used, new product development ideas. Talk about ground floor opportunities! We've already sold and are installing these systems in airline and railroad communication networks. But the surface has just been scratched. If you have at least three years of programming experience, a degree in E.E., Math or Business Administration, we'd like to talk with you. The listings at right tell you what fields are open and where to write.

Microprogrammers
(Logic Designers)

Applications Programmers
(Customer's Problems)

Software Programmers
(Business & Scientific Problems)

Diagnostic Programmers
(Automatic Fault Location)

Operating Systems



Send your reply,
marked Dept. E.L. to:

E. D. Montano
Information Science Center
Collins Radio Company
Newport Beach, California

L. R. Nuss
Collins Radio Company
Cedar Rapids, Iowa

C. P. Nelson
Collins Radio Company
Dallas, Texas

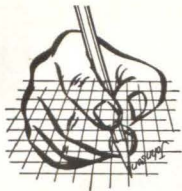

Time after time engineers specify Johnson sockets!

Whatever the choice . . . a miniature 7-pin steatite wafer—or a low-loss Kel-F socket for high power transmitting tubes . . . time and time again design and development engineers specify Johnson tube sockets! All sockets have been categorized under a socket standardization program, reducing the number of variations in each socket type. Standardized specifications and immediately available stock shortens delivery cycles — permits the selection of a Johnson socket for almost any application!

Kel-F Series—Molded of low dielectric loss-factor Kel-F plastic—designed for use with high power transmitting tubes such as the 4X150A, 4X250B, 7032, etc. Available in many designs—with or without low inductance screen grid by-pass capacitors, mounting saddle, or steatite chimney.

Bayonet Types—include Medium and Heavy Duty Medium, Jumbo and Super Jumbo 4-pin types.

Steatite Wafer Types—available in 4, 5, 6, 7, and 8 pin standard sockets, as well as Super Jumbo 4 pin, Giant 5 and 7 pin models and VHF Septar Sockets for tubes with E.I.A. Base No. E7-20 and E7-2.

Miniature Types—all steatite, available in Standard Wafer Type or Shield Base Type for 7 pin miniatures with E.I.A. Base No. E7-1.

Special Purpose Types—include sockets for tubes such as the 204A and 849, the 833 and 833A, 152TL, 304TL, 750TL, 1500T, 2-2000A, 5D21, 705A and other special purpose tubes.



E. F. JOHNSON COMPANY
3002 TENTH AVENUE S.W. • WASECA, MINNESOTA

STANDARD INDUSTRIAL, MILITARY TUBE SOCKETS

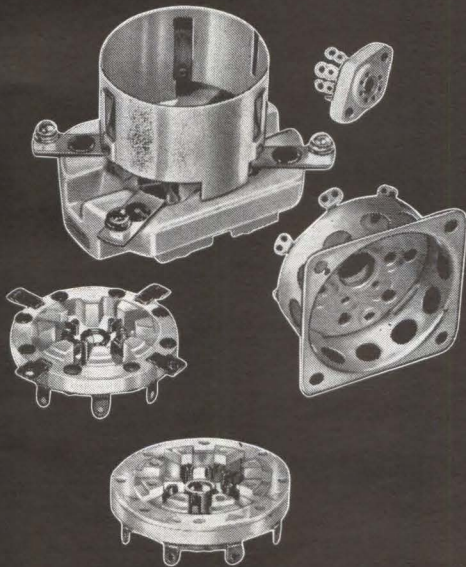

DETAILED COMPONENTS CATALOG AVAILABLE
—Write today on company letterhead!

- CAPACITORS • TUBE SOCKETS • CONNECTORS • PILOT LIGHTS
- INSULATORS • KNOBS AND DIALS • INDUCTORS • HARDWARE

CIRCLE 200 ON READER SERVICE CARD

January 11, 1963

Large production gives you low prices!
— that's why . . .

Over 100 O.E.M.s
have standardized
on

AMPERITE

Thermostatic DELAY RELAYS

2 to 180 Seconds

Actuated by a heater, they operate on A.C., D.C., or Pulsating Current.

Hermetically sealed. Not affected by altitude, moisture, or climate changes.

SPST only—normally open or closed.

Compensated for ambient temperature changes from -55° to $+80^{\circ}$ C. Heaters consume approximately 2 W. and may be operated continuously. The units are rugged, explosion-proof, long-lived, and—inexpensive!

TYPES: Standard Radio Octal, and 9-Pin Miniature . . . List Price, \$4.00.

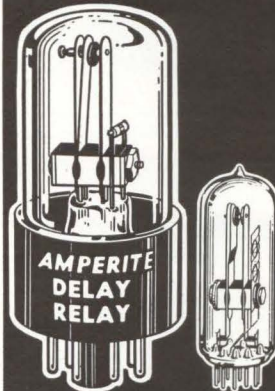

Also — Amperite Differential Relays: Used for automatic overload, under-voltage or under-current protection.

PROBLEM? Send for Bulletin No. TR-81

BALLAST REGULATORS

Amperite Regulators are designed to keep the current in a circuit automatically regulated at a definite value (for example, 0.5 amp.)

. . . For currents of 60 ma. to 5 amps. Operate on A.C., D.C., or Pulsating Current.

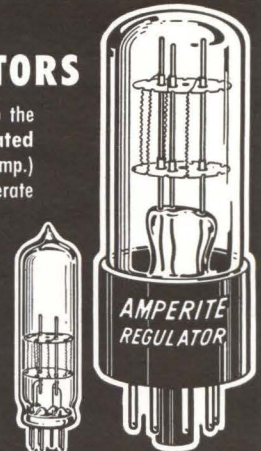
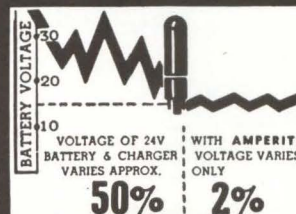

Hermetically sealed, they are not affected by changes in altitude, ambient temperature (-50° to $+70^{\circ}$ C.), or humidity . . . Rugged, light, compact, most inexpensive . . . List Price, \$3.00.

Write for 4-page Technical Bulletin No. AB-51

AMPERITE

561 Broadway, New York 12, N. Y. . . . CAnal 6-1446
In Canada: Atlas Radio Corp., Ltd., 50 Wingold Ave., Toronto 10

CIRCLE 23 ON READER SERVICE CARD 23

SOUND: A Better Way to Control

By HUBERT and MABLE FRINGS
University of Hawaii, Honolulu

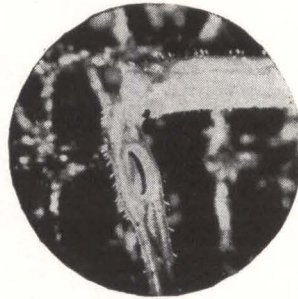
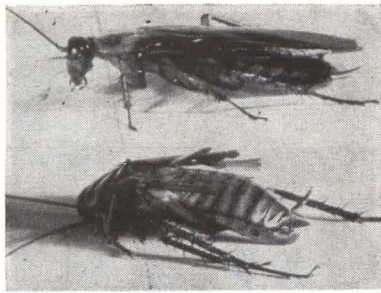

COCKROACH before and after exposure to 30 seconds of sound at 6 Kc and 160 db (left). Body is bloated by heat and wings are torn. At right is ear of katydid, on its front leg

*Bugs, rats, birds:
sound can kill some,
chase others away*

WHY SHOULD WE RELY almost exclusively on chemicals to control pests? Newer electronic tools give us other agencies, among the most promising of which are sounds.

Man has always used high-intensity noises to chase animals. It is easier and safer to make loud noises electronically than with hands, voice or guns. Unfortunately, most pests are higher animals, and soon learn to ignore meaningless noises.

Very-high-intensity sounds (160 db and higher) can destroy animals, but the power costs make these impractical. Nor does ultrasonic sound mysteriously affect animals. Unless it is powerful enough to cause physical damage, and so is economically impractical, ultrasound must be heard by animals to affect them. Many insects and some mammals can hear ultrasonic sounds; birds generally cannot.

A promising method for attracting or repelling pests uses recorded communication signals. These signals, the language of the animals, are tape-recorded and played back to the animals to influence their behavior. This does not require unusual equipment, and so is economically practical.

CONTROLLING RATS—Mice and rats are so destructive that they warrant major concern.

They can hear ultrasonic sound, at least an octave and a half higher than man. So, sounds inaudible to man could influence their behavior. This would be a tremendous advan-

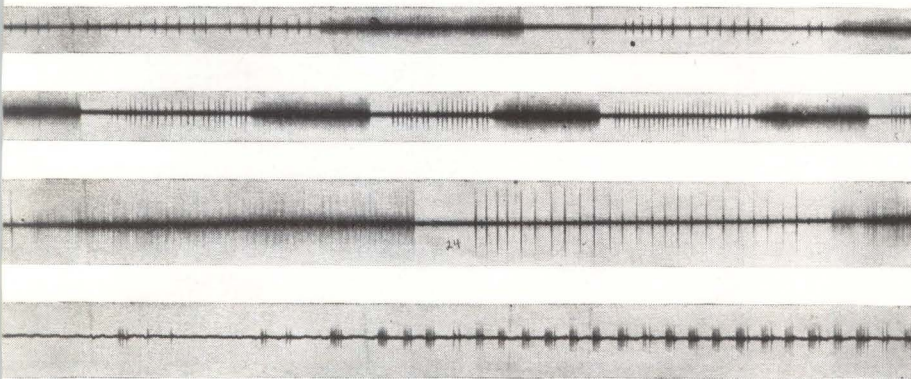
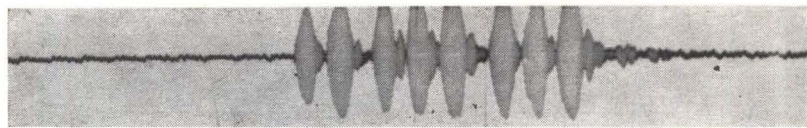

INSECT SOUND PATTERNS. Reading from top are chirp of snowy tree cricket, grasshopper song at cool and warm temperatures, grasshopper song at recording speed of 25 mm/sec and at 500 mm/sec



CROWS ARE CALLED by the authors (inset photo) by broadcasting recordings of the crows' assembly call. In the background photo, a large flock of starlings fly out of their tree roost when a recorded distress call is broadcast

Pests

tage if acoustical controls are used near homes or stores.

Rats and mice in the laboratory can be thrown into epileptic fits by certain sounds, chiefly ultrasonic. In these fits, mice may die. Wild rodents, which need not stay in an area, would probably leave rather than suffer. At least one electronics company is working on this.

Rodent communication signals seem to be mostly ultrasonic. If we understood these, we might use them to attract or repel the pests.

Ultrasound, however, creates some interesting engineering problems. The higher the frequency, the more sound travels like light, and the greater the possibility of sound shadows. Filling a building with sound to control rodents means a major job of loudspeaker placement. Also, microphones, recorders and loudspeakers able to handle frequencies above 25 Kc are expensive.

CHASING BIRDS — Many birds get in man's way, particularly as civilization offers them new foods and homes.

Birds are notably sound-oriented, and it is with them that practical acoustical control was first achieved. In 1954, we showed that starlings could be chased from roosts by broadcasting to them recordings of their own distress call. Later experiments with other birds that are considered pests suggest that recorded communication signals can be the basis of effective controls.

Germany and France have set up laboratories to study acoustical controls for pest birds. In the United States, the work has lagged. Recently, however, Gordon Boudreau, an Arizona engineer who took out time from engineering to study bird behavior, has developed controls for some agricultural pests using recorded communication signals.

Undoubtedly many species of birds could be controlled by recorded distress or alarm calls. Biologically, the problems center around finding proper times and methods of application. Electronically, there are also problems.

Bird sounds, particularly alarm

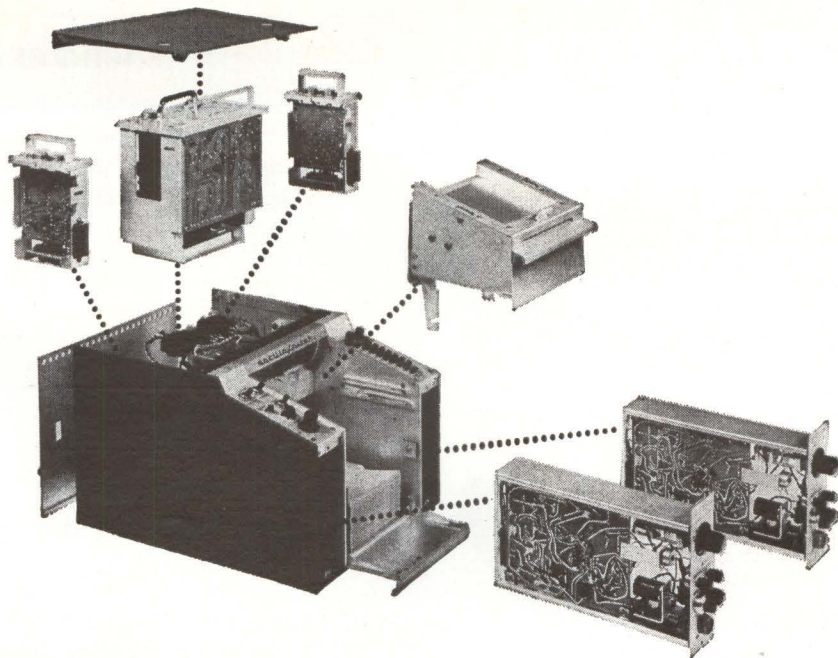

All the features you want in a medium frequency recorder

The *oscillo/riter** recorder incorporates all the features you want for top performance, convenience and reliability. Modular construction and all transistorized electronics provide complete accessibility and maximum reliability; interchangeable

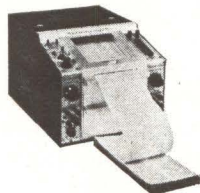

able amplifiers handle more recording jobs; extended frequency response; top panel push buttons select 8 chart speeds from 1 mm/sec to 250 mm/sec; choice of roll or Z-fold chart paper, interchangeable ink or heat writing with Texas Instruments exclusive rectilinear recording system. Write for full information.

*A trademark of Texas Instruments Incorporated.

INDUSTRIAL
PRODUCTS
GROUP



TEXAS INSTRUMENTS
INCORPORATED
P. O. BOX 66027 HOUSTON 6, TEXAS

SENSING • RECORDING • TESTING • DIGITIZING INSTRUMENTS
THE INSTRUMENTS OF TEXAS INSTRUMENTS

566

CIRCLE 201 ON READER SERVICE CARD

How to Prepare EFFECTIVE ENGINEERING PROPOSALS by Emerson Clarke

THIS NEW BOOK DESCRIBES HUNDREDS of job-tested time and money saving ways to produce better technical proposals and more of them. It's also an invaluable reference—one that the engineer and scientist will rely on for every proposal.

\$6.95

Available at technical booksellers, or directly from TW Publishers—postpaid world-wide. (Illinois residents add 4% tax.)

ADDRESS TECHN. BOOK DEPT.



TW Publishers Box 152 River Forest, Illinois

INSTRUMENT SERVOS

for measurement, remote display, data conversion, control, computation

North Atlantic's Series 7000 and 8000 Instrument Servos are designed to meet exacting requirements in airborne, ground support and industrial applications. Types available to accommodate most input signals, and providing a wide range of visual, shaft position and signal outputs.



| MODEL | OUTPUT | ACCURACY (% full scale) |
|----------|---|--|
| SBI-7000 | single pointer dial | $\pm 0.2\%$ to $\pm 0.5\%$ |
| | linear dial, single pointer | $\pm 0.2\%$ to $\pm 0.5\%$ f.s. numerator |
| SBI-7070 | dual pointer; coarse and 10:1 vernier | $\pm 0.1\%$ |
| SBI-8000 | single or dual pointer, counter-pointer | $\pm 0.1\%$ to $\pm 0.5\%$ |
| SBI-7080 | counter or counter-pointer | $\pm 0.1\%$ to $\pm 0.5\%$ |
| SBI-7090 | digital encoder | $\pm 0.1\%$ |
| SBI-8010 | 1/8" dia. shaft | $\pm 0.1\%$ to $\pm 0.5\%$ with 15 oz. in. load |
| SBI-8020 | 0-999 decimal counter | $\pm 0.05\%$ to $\pm 0.1\%$ |
| SBI-8050 | pointer and subdial vernier | $\pm 0.05\%$ to $\pm 0.1\%$ |

Specifications are for typical production models.

For complete data request SFC-1

NORTH ATLANTIC
industries, inc.
TERMINAL DRIVE, PLAINVIEW, L.I., NEW YORK
Telephone: OVerbrook 1-8600

ENGINEERING ZOOLOGY

Professor Frings and Mable Frings, both zoologists, have for some time been attempting to interest engineers in aiding naturalists to develop sound systems for pest control.

The biggest stumbling block, they have found, is not that engineers aren't willing—it is that engineers usually know too little about pests and propose impractical equipment.

They submitted this article to *ELECTRONICS* hoping that it would help bridge the gap between what naturalists want to do and what electronic equipment can now do

notes, are of short duration and sudden onset. Most persons, in first recording them, overload badly, because they fail to realize that the slowly responding v-u meter averages a transient sound starting at high intensity and rapidly dying away. When sounds must be broadcast over large distances, one must have high power and still have fidelity—the message must get across to the birds. Generally, the sound cannot be left on continuously, but must be turned on and off at irregular intervals. A great deal of electronic spadework is needed.

KILLING INSECTS—By far, the greatest economic potential in pest control lies with insects, our chief competitors for everything we want. Among a few of the insects for which acoustical controls seem possible, are: grasshoppers, roaches, flies, mosquitoes, moths, beetles, bugs and plant lice, and ants.

We have indexed more than 2,200 papers dealing with insects and sounds. This shows the interest in fundamental work on acoustical behavior of insects. But the gaps in our knowledge are tremendous. There are over 80,000 species of flies and 250,000 of beetles alone.

Few attempts have been made at insect control with sound. In 1945, it was shown that male mosquitoes were attracted by recordings of female wing sounds and could then be killed. Unfortunately males do not bite man, and even killing 99.999 per cent of the males is useless. The few that are left can fertilize enough females to more than repopulate the whole area.

INSECT SOUNDS—Insects produce sounds chiefly for sexual attraction and recognition, so recordings could probably be used to

attract or repel insect pests.

These sounds are often of high frequency, many times ultrasonic, and almost invariably of a transient nature, with high initial intensity dying away rapidly. They are generally produced by rubbing teeth over scrapers. The pulse rates may be 50 to 500 a second.

These sounds, particularly when ultrasonic, create special recording and broadcasting problems. Most microphones and loudspeakers tend to smooth them out. Obviously, a loudspeaker should have no inertia at all, but only a corona type meets this requirement.

The size or shape of the loudspeaker may also be important. Female mosquitoes, for instance, are almost point sources of sound, even though the sound is of very low frequency. Loudspeakers to broadcast this to other mosquitoes to study their reactions are large. Little wonder that mosquitoes fail to respond to them. On the human scale, this is like having a blindfolded man try to localize a sound played through a loudspeaker the diameter of New York City.

In many cases, insects respond to artificial sounds. Sometimes these resemble natural sounds; sometimes they do not. It is certain that, in the normal communication sounds of insects, much is redundant. Here the biologist and physicist should combine talents to find important parameters of sound signals, so artificial sounds might be used.

We seem to know so much about acoustical behavior of animals, yet still have so little in practical pest control to show for it. With newer developments in electronics, however, provided interested biologists and electronics experts can be brought together, there could be interesting developments.

MORE VERSATILE THAN EVER

"SPEEDIVAC"

MULTIPLE
VAPOR
SOURCE

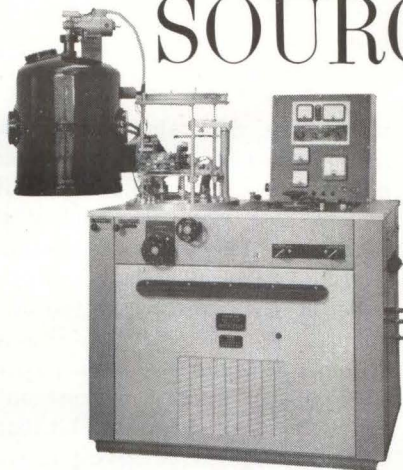

VACUUM
COATING
UNIT

Following are listed some of the special features supplied as standard fittings in the EDWARDS 19E6 evaporator.

Stainless Steel Bell Jar, Viton Gasketing, Six Position Vapor Source, Substrate Heater, Motor Driven Rotary Substrate Holder, Glow Discharge Cleaning, Ultimate Vacuum with LN² trap 2 x 10⁻⁷ Torr.

Fast reliable pump downs are, of course, a feature of all EDWARDS evaporators.

Write for your free technical reprints, written by members of our research staff on "Thin Films and Ultra High Vacuum Techniques."



MICRO-CIRCUIT JIG AND MASK CHANGER

The micro-circuit jig is complete with a six-position vapor source, enabling six 2" square substrates to be coated with six different materials using six different masks.

The jig is also provided with two substrate heaters, one to preheat the substrate to 150°C. and the second to raise the temperature of the substrate in the evaporation position to 300°C. Resistance monitor pick-up points are provided and separate resistance monitor and automatic source shutter can be provided.

Standard EDWARDS patented glow discharge cleaning rings are supplied with the jig, along with the rotating six-position vapor source.

The accuracy of registration of each successive mask in contact with a given substrate is within $\pm 0.001"$.

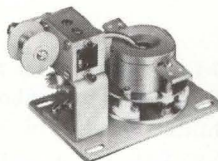

ELECTRON BOMBARDED VAPOR SOURCE

Designed as an inexpensive vapor source for depositing thick films of material containing Ni, Fe or Co. The source is complete with a wire feed mechanism and handwheel assembly for continuous controlled evaporation by feeding wire to the vapor source from the handwheel mounted externally on the coating unit. A complete power supply to operate the source is also available complete with interlocks to the vacuum system.



MARK II MODULATED BEAM PHOTOMETER

The "Speedivac" Modulated Beam Photometer provides a method of controlling the optical thickness of films deposited by evaporation or sputtering by indicating the changing optical characteristics of the films as their thickness increases. The instrument measures the reflection from or the transmission through coated glass surfaces as a function of wavelength. Both these quantities can be measured alternately if two light sensing elements are used.



CRYOGENIC CIRCULATING UNIT

The unit has been designed primarily for use with the coil trap fitted to the 19E series evaporators. It provides continuous circulation of liquid gas with minimum loss.

The system consists of a liquid gas circulation pump with variable speed control and a 12 litre Dewar mounted on a mobile trolley. Valves are fitted for convenient introduction of a dry gas.

WE WILL BE AT BOOTHS 105, 106, AND 107 IN THE BUFFALO ROOM OF THE STATLER HILTON FOR THE 11TH ANNUAL PHYSICS SHOW IN NEW YORK JANUARY 23-26, 1963

EDWARDS HIGH VACUUM INC. / 3279 GRAND ISLAND BLVD., GRAND ISLAND, N.Y.
MANUFACTURERS OF THE MOST COMPLETE LINE OF HIGH VACUUM COMPONENTS AND SYSTEMS

HOW RADIO CAN PLOT High-Altitude Nuclear Blasts

Expanding plasma reveals much about size and altitude

SEATTLE, WASH.—Recordings made by Boeing engineers during high-altitude nuclear explosions over Johnston Island from July through November shed new light on the electromagnetic waves associated with nuclear blasts.

The EM pulse from a high-altitude explosion may easily be distinguished from a sferic or a whistler by its distinctive shape. The main pulses shown in the scope photos probably result from a magnetohydrodynamic wave while the small signal that triggered the scopes was a direct voltage or current that either traveled through the earth or along the ionosphere.

A system for locating and recording EM signatures of high-altitude blasts can provide an important adjunct to the seismometer networks already discussed (*ELECTRONICS*, p 26, Jan. 4, 1963).

According to a report by W. E. Spencer, hydrodynamic wave theory may explain the main part of the signal. Immediately after detonation of a nuclear device, the hot weapon debris is a highly ionized vapor or plasma. This plasma expands widely and causes violent distortion of the earth's magnetic field. The distortion propagates away from the burst as a hydrodynamic wave. At lower levels, where it interacts with the denser atmosphere, it may be detected as an ordinary electrical wave or as a magnetic disturbance.

Also after a nuclear detonation the ionosphere D layer effectively lowers. The change in electron density in the ionosphere may cause a change in potential in the atmosphere separate from the hydrodynamic wave.

INSTRUMENTATION—The antenna used for the first shot was a

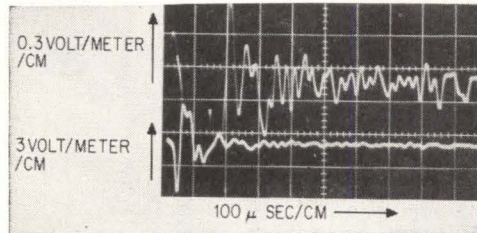

FIRST BLAST—megaton bomb hundreds of kilometers high, July 9, 1962, at 0200 PST

20-foot-square wire mesh suspended about 5 meters above a grounded counterpoise. The antenna output was fed to a cathode follower, filtered with a passband of 500 cps to 50 Kc.

The antenna used for the succeeding shots was a 6-foot-square mesh 6 meters above ground. Antenna output was sent to a cathode follower, filtered with a passband of 500 cps to 500 Kc. A tape recording was kept of the countdown.

PROCEDURE—Scope triggering was a positive trigger on a positive slope. The sensitivity was set so that spurious signals as whistlers and sferics would trigger the scope no oftener than about twenty seconds apart.

The first four shots were recorded with no trouble; however, shot number 5 was not recorded. The scopes triggered but the oscillogram showed that a sferic or whistler had been received instead of the EM pulse. During this shot the countdown station did not fade as in the preceding experiments.

DISCUSSION—The signal of shot number 1 shows a negative-going pulse with an amplitude of about 5 v/meter followed by a wave damped both in amplitude and frequency. This shot is probably limited in amplitude by the frequency response of the equipment.

The passband of the later shots was broader and showed a narrower spike with a higher ampli-

tude. The first shot, which was detonated above the ionosphere, showed a negative spike leading while those detonated below the ionosphere showed a positive-going leading spike. The last shot may have been detonated in the ionosphere.

Shots 2, 3 and 4 show a positive first pulse of about 8 microseconds, followed by a negative kickback, then three quick positive pulses of the same amplitude. About 200 microseconds after the traces begin there is another low-amplitude pulse. This occurs also in shot number 1.

On all four received shots the scopes triggered about 30 microseconds before the arrival of the main spike of the EM pulse. Part of the EM pulse may have traveled by a

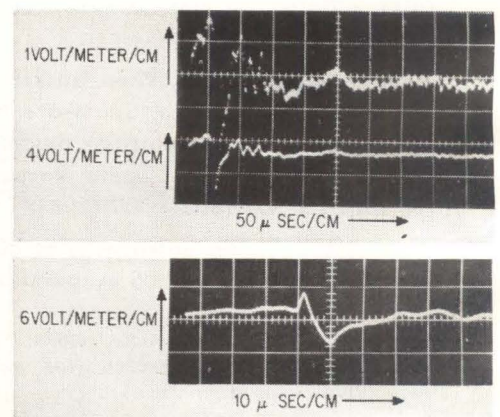

LATEST RECORDING—submegaton bomb tens of kilometers high, Nov. 1 1962, at 0410 PST. Full trace and expanded portion of lower trace



shorter route making enough signal available to trigger the scopes. Since a positive slope, positive trigger was used as a trigger, it is possible that a negative slope, negative trigger might have triggered the scopes even earlier.

Rotatable Waveguide Aids Astronomers

ROTATABLE waveguide horn is helping University of Michigan astronomers find and measure new sources of polarized radio waves in space.

Such data collected from deeper space sources may help explain enormous energies inside certain radio galaxies, according to Prof. Fred Haddock.

A precision rectangular waveguide proportionately dimensioned to 8 Gc was mounted at the focus of Michigan's radio telescope. Maximum reception was achieved by aligning the horn with the plane of the incoming radio waves.

Polarization is created by radiation-emitting electrons spiraling around lines of force in the magnetic field of a galaxy, Haddock said. Polarization shows up as regular sinusoidal waves on the graph of the incoming radiation, when rotational position of the horn is changed.

Calculations determining orientation of the field as it appears on earth can help determine the shape of distant galactic magnetic fields.

TYPE FC-406 5-AMPERE, 6P-DT



... for real Space-Age
RELIABILITY

Dunco

AIR FRAME RELAY

An inherently dependable design . . . assembled under contaminant-free, super-clean conditions . . . gives the Dunco FC-406 the ultimate reliability demanded by the most critical aerospace applications.

Components of the FC-406 are repeatedly cleaned during manufacture, assembled in white rooms and hermetically sealed in inert atmospheres to assure long, fully dependable operation under minimum current, rated load, and severe overload conditions.

Designed primarily for air frame use to MIL-R-6106C, the FC-406 design is also adaptable to MIL-R-5757D applications. A dual coil magnet operating a balanced armature assures resistance to vibration and shock. Bifurcated contacts are used to improve contact life and to insure minimum-current reliability.

Optional mounting and terminal styles as well as self-contained rectifiers for 115V ac coil operation are available. For full details, ask for Data Bulletin FC-406. Address: Struthers-Dunn, Inc., Pitman, N.J.

STRUTHERS-DUNN

Member, National Association of Relay Manufacturers

Sales Engineering Offices in: Atlanta • Boston • Buffalo • Charlotte • Chicago • Cincinnati • Cleveland
Dallas • Dayton • Denver • Detroit • Kansas City • Los Angeles • Memphis • New York • Orlando
Pittsburgh • St. Louis • San Diego • San Francisco • Seattle. Canadian Licensee: Renfrew Electric
Co., Toronto, Ontario, Canada. Export Department: 1505 Race St., Philadelphia 2, Pa., U.S.A.

MONROE

A DIVISION OF LITTON INDUSTRIES

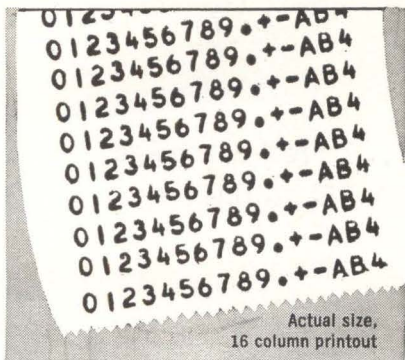

1040 Lines Per Minute Solid State Printer 4 Line Coded Input

MONROE DATA/LOG[®] MC 10-40

4 COLUMNS \$1570.

8 COLUMNS \$1760.

12 COLUMNS \$1950.

16 COLUMNS \$2140.

- Printing rate: 1040 printed lines per minute, 17.3 per second
- Input character code: Any 4 line coded input
- Column capacity: 4, 8, 12, or 16 columns
- Printable characters per column: 15 printing positions and blank
- 0 through 9 plus 5 special characters (+, -, decimal, A and B are standard)
- Character pitch: 10 characters per inch
- Line spacing: 6 or 3 printed lines to the inch
- Paper: 2 1/4" width, roll or folded
- Ribbon: 2" wide, 30 yards long, nylon black only
- Mounting: Rack or self enclosed
- Dimensions: 12 1/4" high, 19" wide
- Construction: Modular, solid state, printed circuit boards
- Power input: 95 to 130 volts, 60 cps
- Self-contained regulated power supply
- Option: Register available for columns parallel, bits parallel, pulse input
- Transfer time: 2 microseconds or less.

Warranty: One year's parts and maintenance by Monroe, on yearly maintenance contracts thereafter.

DELIVERY: 30 DAYS

Electronics Components Division
Monroe Calculating Machine Co., Inc.
60 Main Street, San Francisco, California

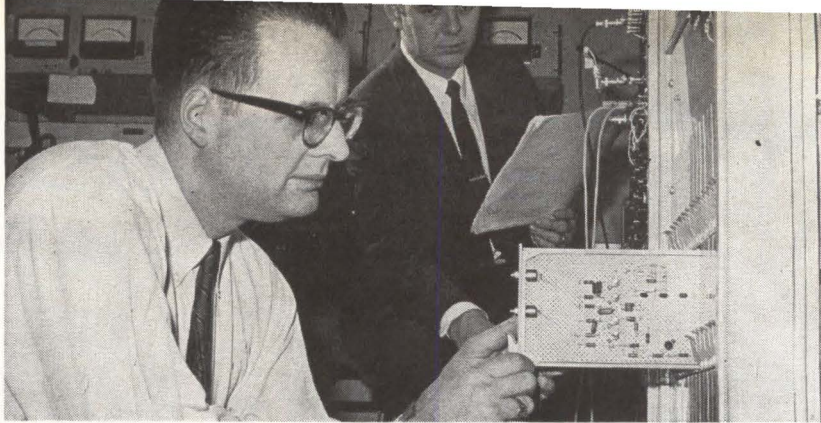

SPECIAL CIRCUIT goes into command encoder to generate trick signal

Trick Revives Telstar

Codes overcome damage from radiation; second Telstar to be launched

JUST A FEW DAYS after AT&T announced plans to launch Telstar II, engineers at Bell Telephone Laboratories got Telstar I's command circuit working again last week, making tv and communications transmission possible again. Trick codes were used to fool the decoder and reactivate Telstar I after a month of silence.

Radiation encountered by the satellite was about 100 times greater than expected and high energy electrons caused a surface ionization effect in silicon transistors in the zero-gate circuit of the decoder. The effect causes leakage current to increase when there is normal voltage across silicon transistors and the transistors are irradiated; diodes and germanium transistors are not affected. If either the radiation or the voltage is reduced, leakage current falls again but may remain higher than it was initially.

When Telstar failed, Bell Labs engineers subjected a duplicate decoder to radiation and located three or four possible failure modes. In the satellite code, a ONE is a long pulse and a ZERO a short one. The trick codes were created by sneaking a dip in a long pulse through the ONE gate and getting a decoder to accept it as a ZERO.

Initial attempts to reactivate Telstar over South Africa, where radiation was lowest, were not suc-

cessful, but the third trick code succeeded in commanding a switch to turn. Periods of circuit exercise and rest were then used to dissipate the surface ionization charge and the satellite eventually returned to normal operation.

TELSTAR II—One of the objectives of Telstar II, said AT&T, will be to learn how to extend satellite life by overcoming radiation damage.

A modified Thor Delta rocket, more powerful than the booster for Telstar I, will be used by NASA to launch Telstar II this spring. The added rocket power will give Bell Labs two options for reducing radiation damage to Telstar II:

- The satellite can be placed in a higher orbit, exposing it to less of the high-energy radiation of the inner Van Allen belt. Last fall, a 6,000-mile-high orbit was being considered (ELECTRONICS, p 7, Oct. 5, 1962)

- More shielding can be used. Special attention will be given to protecting the command circuit.

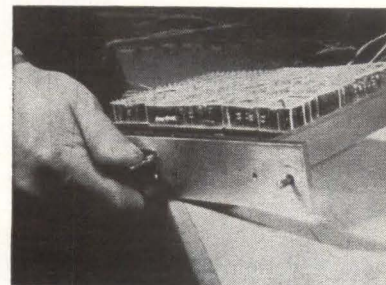

DECODER like this in satellite was disabled by radiation

MEETINGS AHEAD

RELIABILITY & QUALITY CONTROL SYMPOSIUM, IRE-PGRQC, AIEE, ASQC, EIA; Sheraton Palace Hotel, San Francisco, Calif., Jan. 21-24.

INSTITUTE OF ELECTRICAL & ELECTRONICS ENGINEERS WINTER GENERAL MEETING & EXPOSITION, IEEE; Statler and New Yorker Hotels, New York City, Jan. 27-Feb. 1.

MILITARY ELECTRONICS WINTER CONVENTION, IRE-PGMIL; Ambassador Hotel, Los Angeles, Calif., Jan. 30-Feb. 1.

QUANTUM ELECTRONICS INTERNATIONAL SYMPOSIUM, IRE, SFER, ONR; Unesco Building and Parc de Exposition, Paris, France, Feb. 11-15.

INFORMATION STORAGE AND RETRIEVAL SYMPOSIUM, American University; International Inn, Washington, D. C., Feb. 11-15.

ELECTRICAL & ELECTRONIC EQUIPMENT EXHIBIT, ERA, ERC; Denver Hilton Hotel, Denver, Colo., Feb. 18-19.

SOLID STATE CIRCUITS INTERNATIONAL CONFERENCE, IRE-PGCT, AIEE, University of Pennsylvania; Sheraton Hotel and U. of P., Philadelphia, Pa., Feb. 20-22.

PACIFIC COMPUTER CONFERENCE, AIEE; California Institute of Technology, Pasadena, Calif., March 15-16.

BIONICS SYMPOSIUM, United States Air Force; Biltmore Hotel, Dayton, Ohio, Mar. 18-21.

IEEE INTERNATIONAL CONVENTION, Institute of Electrical and Electronics Engineers; Coliseum and Waldorf-Astoria Hotel, New York, N. Y., March 25-28.

ENGINEERING ASPECTS OF MAGNETO-HYDRODYNAMICS SYMPOSIUM, IRE-PGNS, AIEE, IAS, University of California; UCLA, Beverly, Calif., April 10-11.

OHIO VALLEY INSTRUMENT-AUTOMATION SYMPOSIUM, ISA, et al; Cincinnati Gardens, Cincinnati, Ohio, April 16-17.

CLEVELAND ELECTRONICS CONFERENCE, IRE, AIEE, Case Institute, Western Reserve University, ISA; Hotel Sheraton, Cleveland, April 16-18.

INTERNATIONAL NON-LINEAR MAGNETICS CONFERENCE, IRE-PGEC, PGIE, AIEE; Shoreham Hotel, Washington, D. C., April 17-19.

ADVANCE REPORT

AUDIO ENGINEERING WEST COAST CONVENTION, IRE, *Acoustical Society of America*; Hollywood Roosevelt Hotel, Hollywood Boulevard, Los Angeles, California, March 13-15. Send 25-50 word abstract as soon as possible to: John K. Hilliard, AES Spring Convention, LTV Research Center, Western Division, 1859 South Manchester Avenue, Anaheim, Calif. A wide variety of topics will be covered including: f-m stereo broadcasting; microphones and earphones; loudspeakers; audio applications in the space age; uses of audio in oceanography; language laboratory and teaching machines; requisites of modern telephony; use of audio by power utility companies; communications systems using audio frequencies; disk recording and reproduction.

January 11, 1963

VOLTRON ANNOUNCES A FUNDAMENTAL ADVANCE IN THE CALIBRATION ART

The VOLTRON-GALMAN
AVERAGE VALUE TRANSFER STANDARD

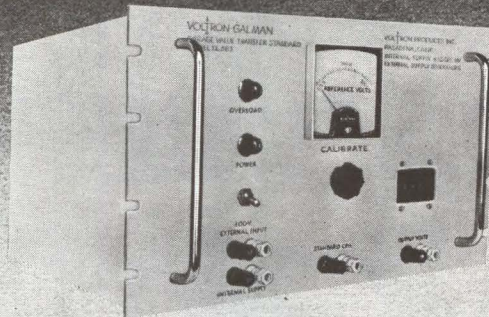

WITH } $\pm 0.01\% \pm 1$ MV absolute ACCURACY
 } $\pm 0.001\%$ REPEATABILITY
 } 10 MV RESOLUTION

Based on the unique Voltron-Galman Operational Rectifier configuration (patent applied for), this instrument permits rapid, positive calibration of digital voltmeters, transducers, analog data channels, and related average-sensing equipments, at secondary-standard levels of accuracy, with COMPLETE CONFIDENCE. Rectifier non-linearities, harmonic effects, and frequency distortion are all rendered negligible by this exclusive new circuit. This device responds to TRUE-FULL-WAVE-RECTIFIED-AVERAGE VALUES — it does not employ peak-sensing or RMS-sensing.

The Voltron-Galman circuit is as fundamental and as readily standardized for average values as the well-known Hermach thermal standard configuration is for RMS values. Performance levels are comparable.

Model 12.583, shown above, generates 0-300 volts, in 10 MV steps, at low impedance, at discrete frequencies between 50 and 3000 cps; distortion <0.1%. An unsaturated standard cell is the primary reference.

The Model 12.583 is COMPLETELY SELF-CONTAINED, including not only an ultra-stable oscillator, precision toroidal dividers, and operational rectifier, but also a standard cell, normalizing and standardizing networks, and a null-indicating galvanometer. No auxiliary equipment is required.

VOLTRON
PRODUCTS, INC.
1020 So. Arroyo Parkway, Pasadena, California

We have prepared a complete technical exposition of the theory of operation of this new circuit, including performance specifications. May we send you a copy?

MICRO-DRILLING PROBLEMS?

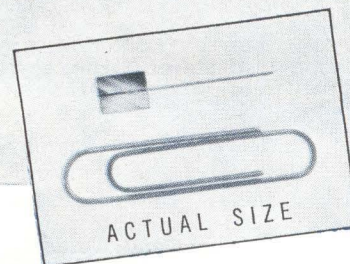
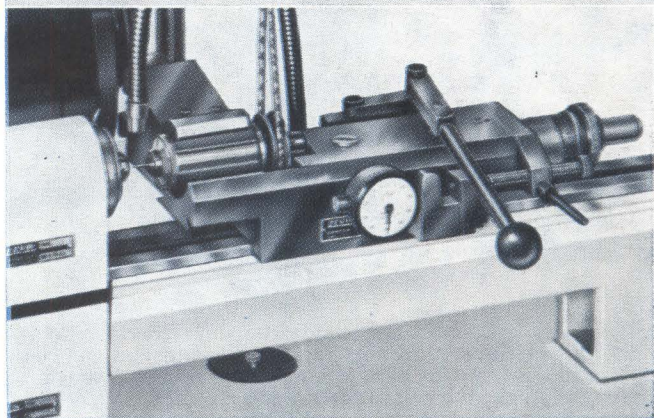
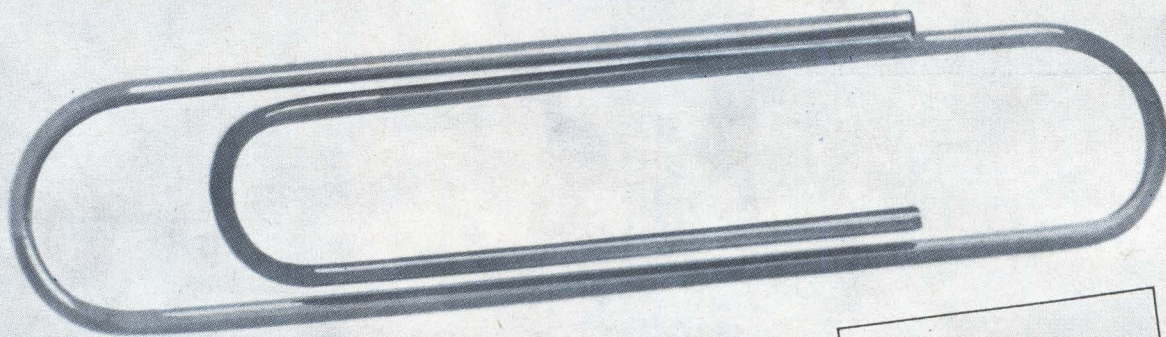
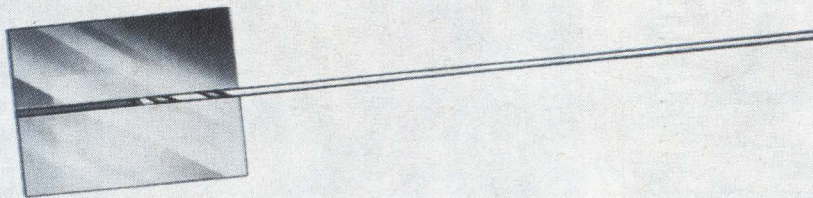

JEVIN micro-drilling machines are the best answer for precision drilling of orifices, bushings, and similar devices, with hole diameters in the range from 0.001" to 0.125". The drilling spindle can be shifted to drill up to ¼" off center if desired.

Shown above, an ACDO micro-drilling machine set up for drilling the miniature bushing illustrated, with a 0.0114" hole 0.250" long. Maximum run out on either end of the hole does not exceed 0.00020" T.I.R. separate motors and controls are used on the headstock and drilling spindles. Both are continuously variable from 0 to 4000 RPM with dynamic braking on each and IR drop compensation on the headstock spindle motor. The headstock is driven by a ¼ HP motor and the drilling spindle by a ⅛ HP motor.

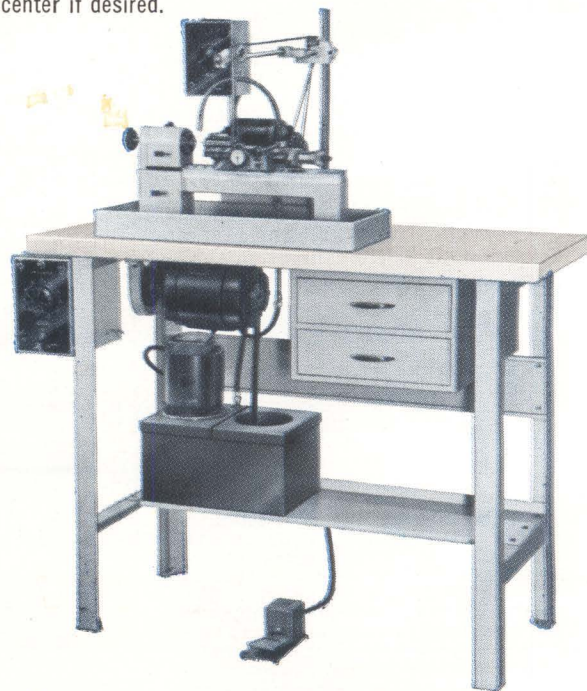

JEVIN[®]

LOUIS LEVIN & SON, INC.
3573 Hayden Ave., Dept. A, Culver City, California

New York Representative and Showroom
RUSSELL-HOLBROOK & HENDERSON, INC.
292 Madison Ave., New York 17, N.Y.

ATMOSPHERIC ATTENUATION OF MM ENERGY

Water vapor, oxygen and other gases severely attenuate mm waves. One effort at Martin-Orlando is to determine by experiments the limitations imposed by atmospheric attenuation at altitudes lower than 50 kilometers. Work is also going on to develop a molecular-beam frequency-control system that uses a 394-Gc rotational transition in H₂S. The expected stability is one part in 10¹² or better. This work is sponsored by the USASRDRL under contract No. DA-36-039-SC87321

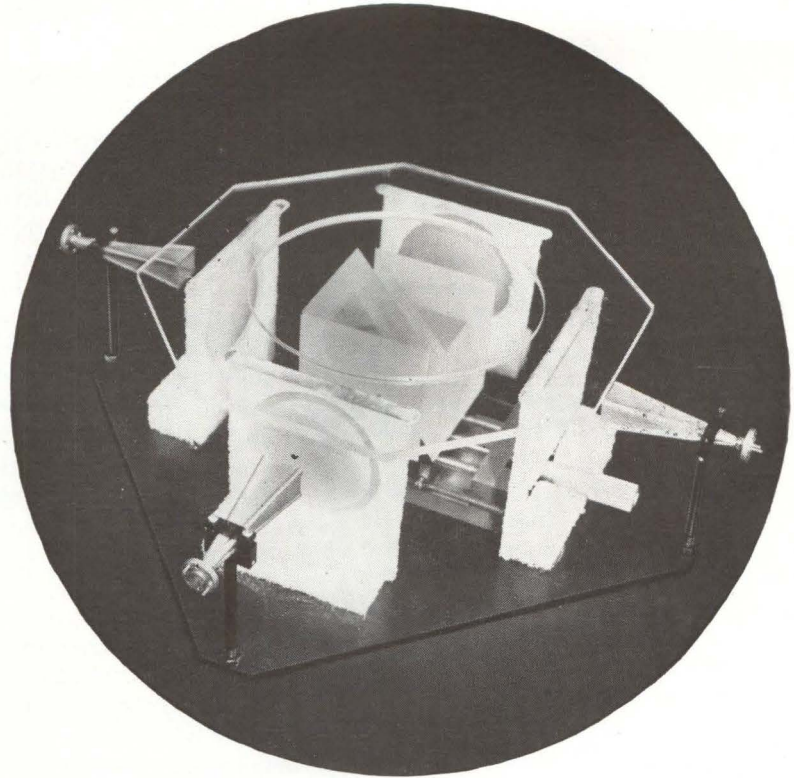

MM WAVE directional coupler—see Fig. 5 on p 36

New Millimeter Components and Techniques

Practically every electronic function that can be performed at lower frequencies can now be duplicated at frequencies above 100 Gc. Among devices described are harmonic generators, detectors, filters and wavemeters

By J. W. DEES and A. P. SHEPPARD, Martin Company, Orlando, Florida

UNTIL RECENTLY, millimeter and submillimeter (mm and submm) wavelengths have been used only as research tools in microwave spectroscopy because mm and submm sources had too little power for systems applications. The picture has changed: reflex klystrons operating at frequencies up to 140 Gc with tens of milliwatts output

have been developed; backward-wave oscillators operating at 200 Gc have been built; carcinotron tubes can be purchased with upper frequency limits greater than 300 Gc; magnetrons are available that operate up to nearly 100 Gc with peak power outputs of 10 Kw.

The advent of such generators has stimulated work on mm sys-

tems. Components and techniques have also been developed.

HARMONIC GENERATION—Although mm tubes are commercially available to above 300 Gc, it is often difficult to obtain models operating above 100 Gc because of government priorities and low research budgets. Harmonic generation has

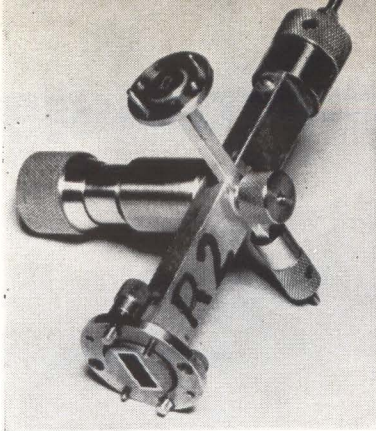

CROSSED WAVEGUIDES and a crystal inside comprise the heart of this harmonic generator—Fig. 1

been an effective method for frequency coverage in the 100 to 500-Gc region. Typically, the harmonic generator is driven by a reflex klystron operating in the 10 to 100-Gc region. The multipliers that have been used successfully are of the crossed-waveguide run-in type shown in Fig. 1. These multipliers have fundamental input waveguides ranging from RG-52/U (8 to 12 Gc) to RG-99/U (60 to 90 Gc) and have harmonic output waveguides ranging up to RG-139/U (220-325 Gc). With driving tube outputs from 20 to 100 mw, signals up to 486 Gc

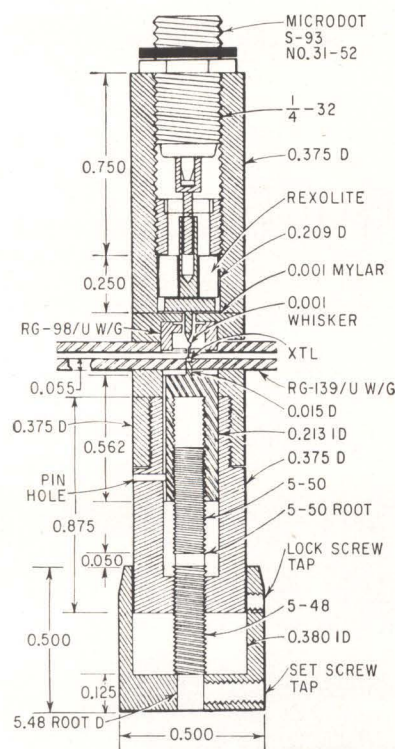

CROSS-SECTION of harmonic generator shows construction, which is similar to that of Fig. 1, but not identical—Fig. 2

have been obtained from these devices with sufficient power for molecular-spectroscopy measurements (on the order of microwatts). Harmonics as high as the twentieth have been obtained with the lower frequency input units while the fourth harmonic has been observed from the higher frequency input units. Conversion losses vary from 15 to 25 db for the second harmonic to 5 db per harmonic for harmonics > the seventh.

Mechanical construction for these units is based on a fine-thread differential screw arrangement that provides minute adjustment of the crystal-tungsten cat-whisker contact made directly inside the waveguide.¹ Figure 2 shows some of the mechanical specifications that are needed on one of the higher frequency units. The differential screw advances the crystal 0.0008 inch per revolution. Extremely light contact pressures are necessary in the mm region to reduce the capacitance shunting the contact junction and the contact is critical. The size of all parts is reduced, in comparison to other units, to be compatible with the smaller waveguides. A Microdot connector replaces the larger BNC type used in lower-frequency models. Since the whisker and crystal supporting post structures appear as waveguide-to-coaxial-line transitions, a combination coaxial and radial line choke is designed around these structures to prevent losses due to leakage through these terminals. An r-f choking arrangement, although frequency sensitive, should reduce losses at the design frequencies resulting in optimum performance for narrow-band applications such as molecular spectroscopy. It is necessary that the coaxial and radial line dimensions of these r-f chokes be such that higher-order modes will not be propagated since these can be excited by slight discontinuities and cause improper choking actions. This necessity imposes severe mechanical and constructional limitations as the frequency of operation increases.

CRYSTAL MATERIALS — The crystal materials are disk shaped and range in thickness from 0.005 to 0.025 in. and from 0.015 to 0.0625 in. in diameter. In the past these crystals have been soldered to the

post. This required a metallic backing that was made by plating and metal evaporation. Since many crystals are obtained in bulk configurations, crystal preparation is required: slicing, dicing, polishing, backing, etching, soldering and grinding. More recently, silver conductive epoxy has been used to attach the crystals to the post, eliminating the need for plating or backing and soldering. Growing a crystal layer directly on the metal post may eliminate all such crystal preparations and permit the determination of the optimum crystal thickness. This can be controlled in the growing process to a fraction of a micron.

Silicon, and irradiated or bombarded silicon², have been employed in the multipliers and detectors. Ten other crystal materials have been mounted by the silver epoxy method and are being investigated for harmonic generation, mixing and detection applications in the mm region. Among the more promising types are gallium arsenide, indium antimonide (InSb), indium arsenide, and gallium antimonide. For point-contact diodes the upper operating frequency limit is³

$$f_{\max} = \frac{1}{2\pi R_s C_b} \propto \frac{1}{a} \left(\frac{Nb^2}{e} \right)^{1/2}$$

where a = radius of contact, b = mobility, e = dielectric constant, N = carrier concentration, R_s = series resistance, and C_b = barrier capacitance.

The maximum attainable frequency is directly proportional to the crystal mobility. At liquid nitrogen (N_2) temperatures the mobility of InSb increases tremendously and has been given⁴ as $3 \times 10^5 \text{ cm}^2\text{v}^{-1}$ with $N = 5 \times 10^{17}/\text{cm}^3$. Assuming $e = 16e_0$, $a = 4$ microns, $R_s = 8 \times 10^{-3}$ ohm and $C_b = 0.235 \text{ pF}$, $f_{\max} = 8.5 \times 10^{13} \text{ cps}^5, 6, 7$. Thus, InSb at liquid N_2 temperatures may extend the operation of crystals across the gap between the infrared and microwave regions.

Several different sizes, shapes and materials have been evaluated as cat whiskers in mm harmonic generators. Among the materials investigated were tungsten, beryllium copper and phosphor bronze. A statistical evaluation of a large number of run-ins indicates that tungsten and beryllium copper of less than 1.5 to 2.0 mils diameter

and hooked, rather than straight, gives the best results. Where long cat whiskers (over $\frac{1}{2}$ in. length) could be used no difference in performance could be attributed to the shape (hooked or straight). Phosphor bronze gave poor results.

BIAS EFFECTS—Biasing a crystal harmonic generator consists of passing a d-c current through the contact junction and usually causes a drastic change in the crystal's impedance and nonlinear characteristics. The bias current can be supplied from an external bias supply or a self-biasing current can result with low crystal load impedances and reasonably high fundamental driving power. Self-bias currents flow in the forward direction and are determined and limited by the input power level and crystal load impedance; higher forward current or reverse current must be applied from an external source. Biasing techniques have been tested under many conditions, including forward and reverse bias over a wide range of current (up to several ma), with varying input power levels, tuning conditions and crystal load impedances. It is usually necessary to retune after applying bias.

While significant increases in harmonic output can be obtained using bias, the effect of bias is a function of the specific run-in conditions. Sometimes where no improvement or a degradation of the harmonic signal occurred with bias, repointing the whisker, or using another whisker run-in, resulted in an increased output with bias. It is best to try a variety of biasing

techniques for each situation, since no one technique will enhance operation for all cases; in some instances, using no bias will give an improvement.

An increase in harmonic output as high as 18 db has been observed when using bias on a harmonic generator operating at a fundamental frequency of 33 Gc. In a few cases it has been possible to improve one harmonic relative to others using various biasing techniques, although little data have been taken on this characteristic because of the need for and lack of a sufficient variety of filters in the millimeter-wave region.

Possible ways to improve harmonic generators are:

- using a semiconductor cat whisker

- growing the crystal to controlled thicknesses directly on the post
- evaluating various crystal types
- providing individual and independent tuning for the fundamental, second harmonic and the desired output harmonic^{8, 9, 10},
- providing an element in the fundamental guide that selectively reflects harmonic power back to the junction, and to the harmonic output waveguide.

A novel suggestion⁹ for generating mm waves in a point-contact crystal waveguide configuration is shining a laser beam on the crystal junction, thereby mixing the beam components, or modes, of the laser beam in the crystal junction and producing difference outputs at mm wavelengths.

DETECTORS — Techniques for making detectors are the same as for multipliers in that a crystal cat-whisker contact is made in a straight waveguide section, using a differential screw as in Fig. 2. These detectors have performed at frequencies to 500 Gc. The run-in units should be useful at even shorter wavelengths. Among other devices under investigation for detecting mm energy are bolometers¹¹ and a photoconductive free-carrier absorption detector¹².

Bolometer mounts in RG-99/U up to RG-139/U waveguide using Wollaston wire in sizes from 5 microns to 50 microns in di-

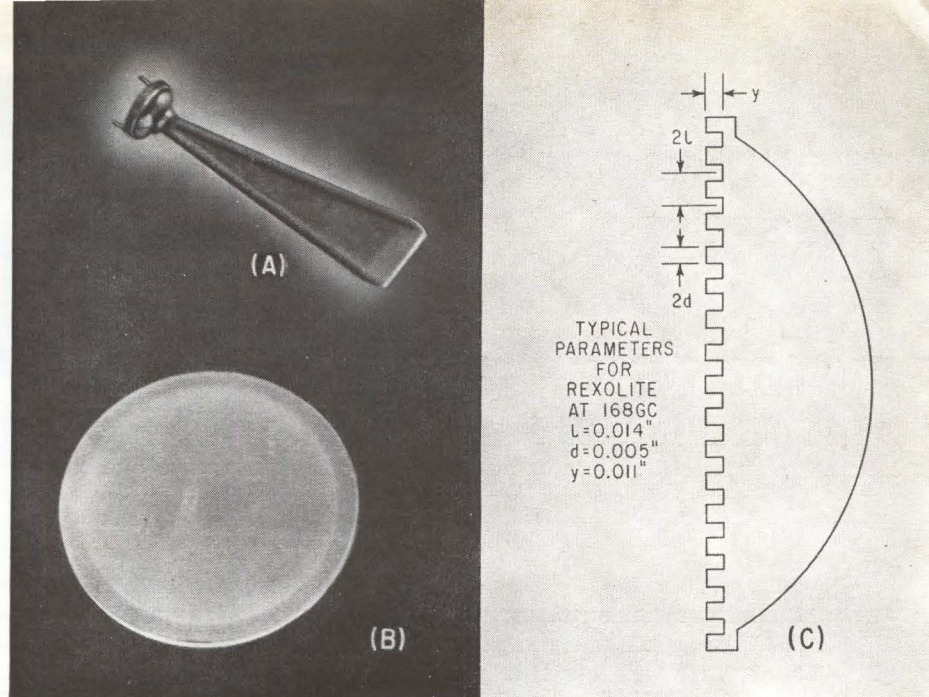

HORN and LENS (A) and (B) operate at mm wavelengths. Corrugations in lens (C) improve matching of the lens dielectric to air—Fig. 4

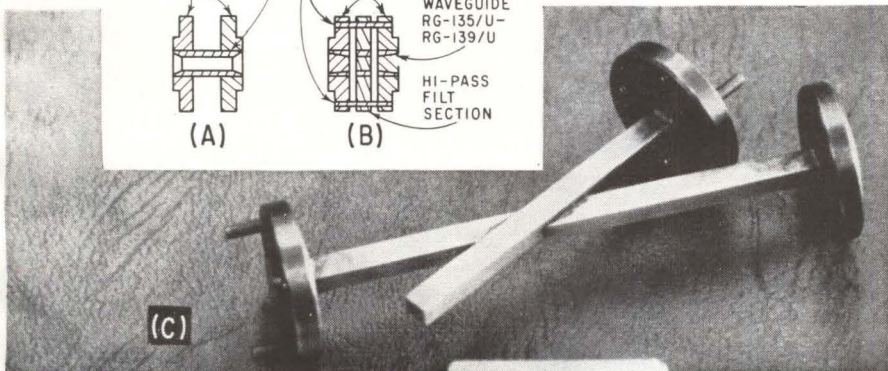
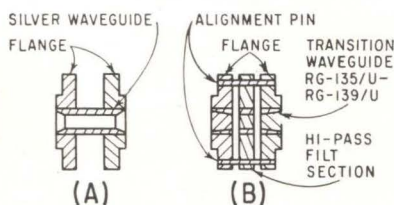

WAVEGUIDE FILTER in (A) is swaged, as are the two end pieces of the 3-piece waveguide filter (B). A Bethe-hole directional coupler is shown in (C)—Fig. 3

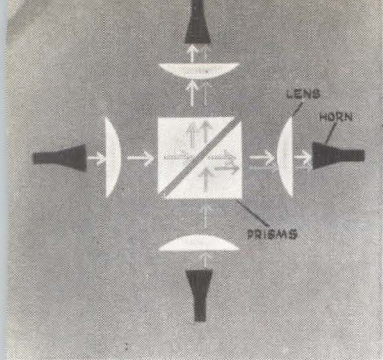

DIRECTIONAL coupler splits power equally between two output ports—Fig. 5

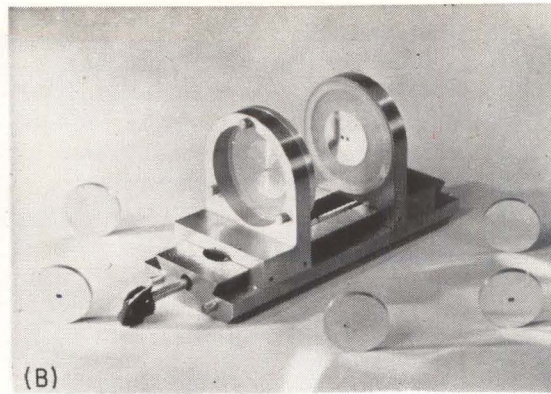
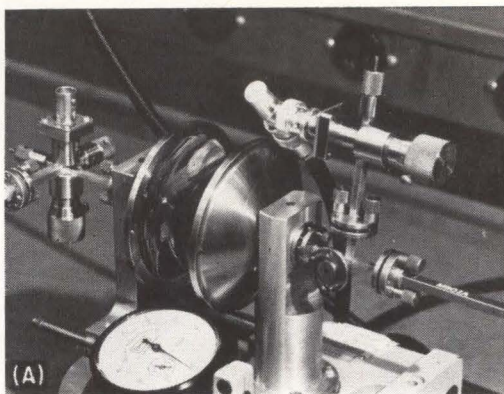

INTERFEROMETER plates of (A) are spherical. Broached plates (B) show how energy is coupled—Fig. 6

ameter offer possibilities. Superconducting bolometers, which are operated at extremely low temperatures near the threshold point of superconductivity, are also under consideration. A ferroelectric bolometer under development at Electronic Communications, Inc. shows promise as a mm power-measuring device. It uses the heating effect of mm-wave energy on a ceramic mixture of 35-percent lead titanate and 65-percent strontium titanate. This ceramic mixture¹³ is extremely lossy at mm wavelengths and its dielectric constant changes rapidly with temperature. By using the ferroelectric material arranged in a waveguide so that it forms the dielectric of a parallel-plate capacitor, the parallel-plate capacitance will be a function of the r-f input power.

The photoconductive free-carrier absorption detectors must operate at a few degrees Kelvin. Indium antimonide of high purity appears to be suitable for this type detector¹². A change in the conductivity of the material occurs when energy of the correct frequency is absorbed. Low temperatures are necessary to prevent thermal ionization of the *n*-type impurities. High magnetic fields are also required to prevent impurity level broadening. In addition, the photo-injection of carriers by excitation of carriers across the energy gap of a superconductor in a combination of thin films of metal to metal-oxide barrier to superconductor (M/B/S) can lead to an exceedingly sensitive detector of mm radiation¹⁴.

The Goly cell is a useful detector of energy at frequencies above 100 Gc although efficient coupling into the cell is difficult.

Superheterodyne detection using harmonic mixing has been successfully employed at 168 Gc.

In radiometry applications, harmonic mixing has been used at frequencies above 200 Gc¹⁵.

FILTERS AND COUPLERS —

High-pass or band-pass filters are required for mm power measurements harmonic peaking and bias investigation. Some band-pass filtering action can be accomplished by quasi-optical techniques such as using frequency-sensitive Fresnel-zone lenses. The simplest type is the high-pass "waveguide beyond cut-off" filter but fabrication problems are severe. A waveguide with a cutoff at 368 Gc would have inside dimensions of 0.008 × 0.016 in. and would require tapers up to some larger size, such as RG-135/U (0.0255 × 0.051 in.). Squeezing short sections of fine silver waveguide and swaging end openings of waveguides as small as 0.008 × 0.016 in. (by forcing a tapered mandrel into the waveguide opening) has been attempted with only moderate success. Aluminum mandrels that can be etched out after electroforming are being considered but grinding aluminum to such small sizes with tapers and close tolerances is difficult. High-pass filters with cut-off frequencies at 73.8, 115.7, 150 and 170 Gc have been realized using the swaging technique (Fig. 3A).

The swaging technique often results in an irregular inside surface for the straight center section, whose length determines the cut-off slope and maximum attainable attenuation at any frequency in the stop band. Such irregularities increase the insertion loss in the pass-

band to such an extent that the filter becomes useless. This problem can be overcome by using the three-piece construction shown in Fig. 3B. Here, the transition is confined to the flange thickness, and the high-pass filter section is confined to a flange whose thickness, that is, length of filter section, can be varied. Pins are used to align the three pieces. Total filter length, including transitions, is about $\frac{3}{8}$ inch. The swaging operation is restricted to the transitions and does not affect the center section. Making the transition separately provides access to both ends of the transition waveguide for deburring and finishing. The three pieces are held together with small screws, and the alignment pins are removed to provide access for the guide pins of the mating flanges.

A Bethe-hole directional coupler (Fig. 3C), constructed in RG-135/U waveguide, gives 30-db coupling. This unit uses a 0.013 in. coupling hole with a 0.001 in. common-wall thickness and an included angle of 28 degrees. Tests at 168 Gc have shown the coupling to be as predicted. Round-hole cross-guide couplers have also been designed above 100 Gc. As with the Bethe-hole coupler, however, tight coupling is not possible with normal design parameters.

HORNS AND LENSES—Both pyramidal and optimum-gain-pyramidal horns have been fabricated by electroforming copper on a stainless-steel mandrel constructed to have the desired aperture and waveguide input. Horns having inputs of RG-139/U and a gain of 30 db have been built successfully. Pattern measurements have been made

by probing the far-field and performance is in agreement with low-frequency observations.

Lenses are used with the horns to obtain maximum transfer of energy. Both delay-type hyperboloid lenses¹⁶ and Fresnel-zone lenses¹⁷ have been used. The Fresnel-zone lens consists of circular grooves machined in a dielectric and is simpler to fabricate than the delay-type lens. Due to size limitations imposed by the zone diameter associated with a required focal length and operation frequency, it is sometimes necessary to use the hyperboloid. Figure 4 shows a horn (A) and lens (B). Matching the air to dielectric interface has been successfully solved at mm wavelengths by parallel corrugations machined directly in the dielectric as shown in Fig. 4C¹⁸.

A Rexolite prism duplexer¹⁹ has been built at 245 Gc (Fig. 5 and photo on page 33). Initial tests indicate that equal power division between two output ports is obtained with suitable prism separation just as easily with this device as with the hybrid ring used at lower frequencies.

WAVEMETERS — Useful wavemeters in the 100- to 200-Gc region have been built by constructing right circular cylinders operating in the TE_{11n} modes²⁰.

INTERFEROMETERS — Many high-Q resonant cavities become prohibitively small at frequencies higher than 100 Gc. The Fabry-Perot interferometer^{21, 22, 23}, however, serves satisfactorily as a high-Q mm resonator since the size of the structure may be determined in part by external requirements. The geometry of the Fabry-Perot interferometer may take several forms. The most widely known form uses highly reflective plane parallel plates whose surfaces are flat to about $1/1,000 \lambda$. Another geometry uses spherical plates (Fig. 6A), also highly reflective, which are separated by their common radius of curvature. This is called the con-

focal condition and is less critical to align than the plane-parallel-plate interferometer. It is convenient, at mm wavelengths, to use semiconfocal interferometers where one spherical and one flat plate are separated by half the radius of curvature of the curved plate.

Coupling to the interferometer cavity may be accomplished by direct waveguide iris input and output as shown by the plate of Fig. 6B, which have been broached for RG-135/U. Coupling may also be accomplished by making the plates

REFERENCES

- (1) W. C. King and W. Gordy, *Phys Rev*, **93**, p. 407, 1954.
- (2) R. S. Ohl, P. P. Budenstein and C. A. Burrus, *Rev Sci Instr*, **30**, p. 765, 1959.
- (3) C. T. McCoy, Present and Future Capabilities of Microwave Crystal Receivers, *Proc IRE*, **46**, p. 61, Jan. 1958.
- (4) F. A. Cunnell and E. W. Saker, Properties of the III-V Compound Semiconductors, "Progress in Semiconductors, Vol. 2", p. 35, John Wiley, New York, 1957.
- (5) D. A. Wright, Compound Semiconductors, *Electronic Eng*, **31**, p. 659, Nov. 1959.
- (6) H. C. Torrey and C. A. Whitmer, "Crystal Rectifiers", McGraw-Hill, New York, 1948.
- (7) B. Strain, U of Illinois, private discussions.
- (8) J. J. Gallagher, J. W. Dees and R. G. Strauch, Quarterly Progress Reports, "Excitation and Detection Techniques for MM Wave Transitions", Contract No. DA-36-039-SC87321 (U. S. Army Signal Supply Agency, Fort Monmouth, N. J.), Martin Co., Orlando, Fla., July 1, 1961 through July 1, 1962.
- (9) F. S. Barnes, U. of Colorado, private discussions.
- (10) T. Utsunomiya, T. and S. Yuan, Theory, Design and Performance of Maximum-Efficiency Variable-Reactance Frequency Multipliers, *Proc IRE*, **50**, pp. 57-65, Jan. 1962.
- (11) United States Atomic Energy Commission Report No. 9, Quarterly Progress Report, "Research and Investigation Leading to Methods of Generating and Detecting Radiation in the 100 to 1000 Micron Range of the Spectrum", Ultra-microwave Section, E. E. Research Lab., Univ. of Illinois, Urbana, Ill., Contract No. AF (11-1)-392, 15 June 1958.
- (12) E. H. Putley, "Impurity Photoconductivity in n-type InSb", *Proc Phys Soc*, **76**, p. 802, Nov. 1960. Also see B. V.

as gratings²¹ as illustrated by the insert in Fig. 7; many semiconfocal interferometers use this type of coupling. Resonator Q's approaching 100,000 have been obtained. To measure such high Q's it is necessary to use a stabilized source such as obtained by phase-locking²¹ the klystron that drives the harmonic generator.

Acknowledgments are due R. E. Cupp and R. A. Miesch, who conducted many of the tests on these components and to J. J. Gallagher for many helpful discussions.

- Rollin, Detection of Millimeter and Submillimeter Wave Radiation by Free Carrier Absorption in a Semiconductor, *Proc Phys Soc* **77**, p. 1102, May 1961.
- (13) University of Michigan, Ann Arbor, Mich., Final Report, "Investigation of Microwave Properties of Ferroelectric Materials", Dept. of Electrical Engineering, March 1959.
 - (14) E. Burstein, D. N. Langenburg, B. N. Taylor, Superconductors as Quantum Detectors for Microwave and Submillimeter Wave Radiation, *Phys Rev Lett*, **6**, p. 92, Feb. 1, 1961.
 - (15) M. Cohn, F. Wentworth, F. Sobel and J. Wiltse, 1962 NAECON Proc., p. 537.
 - (16) G. C. Southworth, "Principles and Applications of Waveguide Transmission", p. 413, 473, D. VanNostrand Company, Inc., New York, N. Y., 1956.
 - (17) King, Rodgers, Sobel, Wentworth, and Wiltse, Electronic Communications, Inc., Research Div., Timonium, Md., "Quasi-Optical Components and Surface Waveguides for the 100 to 300 kmc Frequency Range", Scientific Report No. 2, (AFCRL-TN-60-115T), Contract AF 19 (604)-5475, Nov. 1960.
 - (18) E. M. T. Jones, T. Morita, S. B. Cohn, *Trans IRE*, AP-3, **31**, 1956.
 - (19) Royal Radar Establishment, Report No. 3020, R. G. Garnham, 1958.
 - (20) Radiation Laboratory Series, Vol. 11, p. 327.
 - (21) W. Culshaw, "High Resolution Millimeter Wave Fabry-Perot Interferometer", *IRE Trans of PGMTT*, **MTT-8**, No. 2, p. 182-188, Mar. 1960.
 - (22) A. G. Fox and T. Li, *Bell Syst Tech J*, **25**, p. 453, 1961.
 - (23) G. D. Boyd and J. P. Gordon, *Bell Syst Tech J*, **25**, p. 489, 1961.
 - (24) J. J. Gallagher, J. W. Dees, R. G. Strauch, R. E. Cupp, "Generation of Phase Locked Millimeter Waves for Frequency Control", Proc. 16th Annual Frequency Control Symposium, p. 305-327, Atlantic City, N. J., U. S. Army Signal Research and Development Laboratory, Apr. 25-27, 1962.

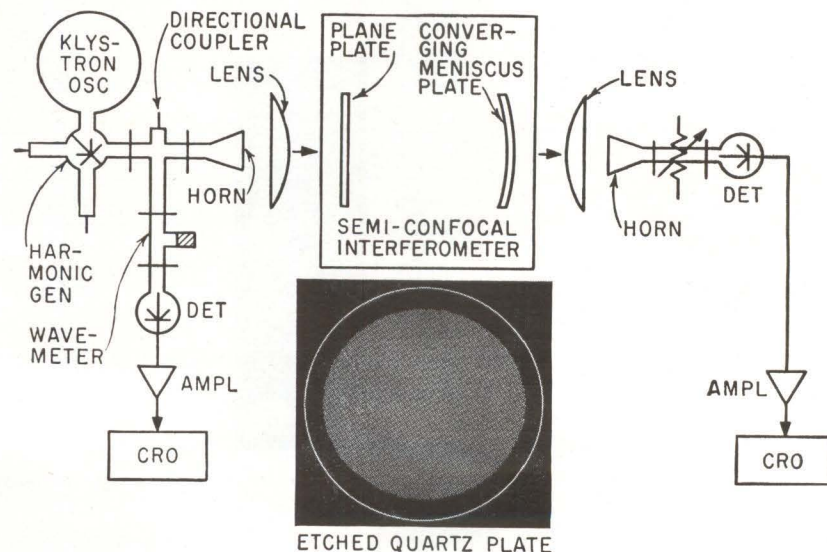

SEMICONFOCAL INTERFEROMETER (A) uses plane and concave plates that have gratings such as the photo-etched plate shown in the inset—Fig. 7

Unique Computer System Monitors Aircraft Engines

New system for multiengine aircraft cuts engine instrument panel complexity by two-thirds, improves efficiency

By S. J. DIPAOLO, Eclipse-Pioneer Division, Bendix Corp., Teterboro, New Jersey

REDUCING visual scanning time of an aircraft instrument panel is accomplished by using a computer to scan 36 engine performance parameters and to display those that represent the poorest performing engine on a simple display panel. Outputs of all of the critical engine instruments are fed into a digital computer, along with air speed, altitude and ambient temperature. Twelve indicators in the

display show torque output of each engine and eight engine performance parameters. The computer selects the worst of each of these eight parameters for display.

Movable indicators, set by the computer, show optimum operating settings of torque and turbine inlet temperature for flight conditions. Variable markers, set by the computer, indicate acceptable operating conditions. Off-limit operation

is indicated by numbered lights.

Figure 1 shows the inputs of the engine parameters and inputs of ambient flight conditions from an air data computer. Outputs are display indications, Fig. 2, and an analog voltage proportional to total fuel flow. Each engine may be monitored separately if desired.

DIGITAL COMPUTER—This is a compact solid-state computer using

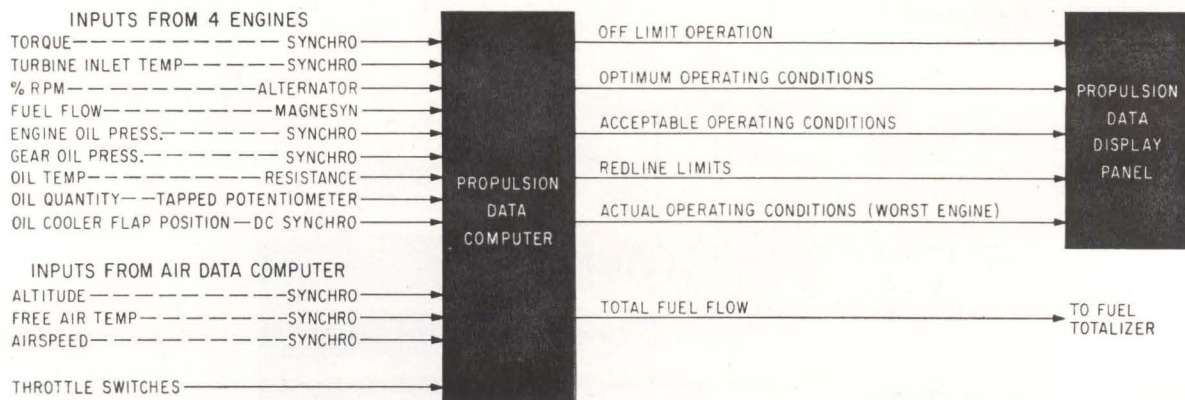

COMPUTER accepts engine and air data, left, and presents only the most critical data for display—Fig. 1

AUTOMATION IN THE AIR

In flying modern multiengine jet aircraft, the crew is required to monitor nearly 650 instruments, controls and warning lights. Any way to make the job easier is welcomed. In this computer-controlled system described, 36 conditions of engine performance of a four-engine turbo-prop aircraft are reduced to only ten indicators. During a typical flight, this system relieves the crew of using as many as 20 different charts to calculate how engines should be operating

a clock frequency of 409.6 Kc derived from an optical memory. The clock frequency represents $2^{10} \times 400$ cps and permits using 10-stage counters and registers and also allows synchronizing the computer with the aircraft power-supply frequency. A computer block diagram, Fig. 3, shows inputs applied to a switching matrix which, controlled by the input control section, sequentially scans each input transducer for 10 milliseconds, 4 cycles of the aircraft power. Two cycles are allotted for switching transient settling time, and on the third cycle an analog-to-digital conversion takes place. A comparison is then made to determine if this input is above or below a safety limit stored in the diode memory and whether this engine is the worst case of the four engines for the parameter. An input exceeding a safety limit will cause the numbered cold-cathode discharge lamp to flash above the indicator for the parameter.

The input representing the worst

case of the four engines will, under control of the engine-display section, cause the output switching matrix to connect the transducer to the worst engine to a follow-up servo in the indicator display panel. The positions of the red-line markers are controlled by the performance monitor section, which processes inputs from switches located on the throttle quadrant, a timer and several of the inputs. Logic functions such as "reduce the turbine inlet temperature red line from 977 C. to 932 C. when the engines have been operated at full throttle for 35 minutes" determine the red-line positions.

The inputs of the air-data computer, fuel flow and turbine inlet temperature are used with the optical memory to set optimum torque and acceptable turbine inlet temperature values on the indicators. The optical memory has a 3-inch diameter glass disk as a storage medium with eleven tracks of information recorded photographically. Data is read out using 11 phototransistors each with individual cascaded emitter followers driving monostable multivibrators. Disk illumination is provided by four bulbs whose outputs are mixed by fiber optics for maximum reliability since the memory is de-

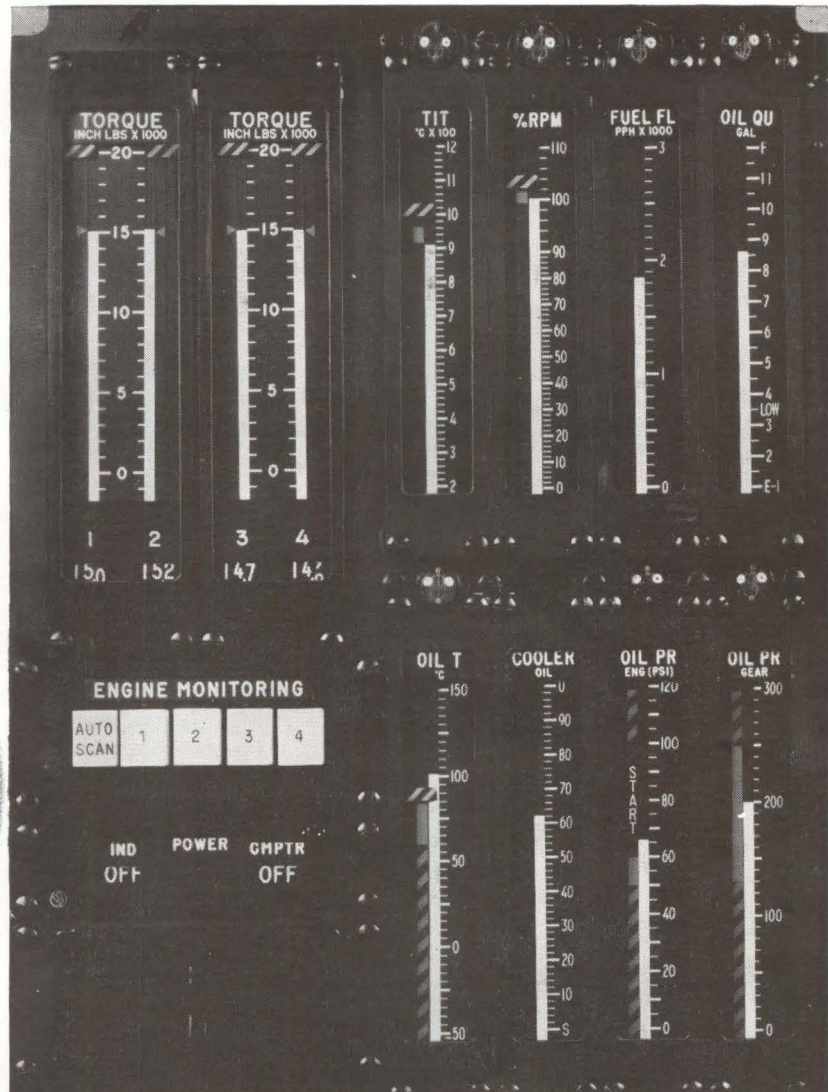

PANEL DISPLAY shows torque for each of the four engines and only the worst parameters during each scan cycle—Fig. 2

signed to operate with only two-bulb illumination. Scanning and computing is at $2\frac{1}{2}$ times a second.

A-D CONVERTER—Three-phase inputs from synchros, Magnesyns and potentiometers are converted from analog voltages into digital pulse trains by the analog to digital converter, Fig. 3. Input of the converter is a Scott tee transformer whose two outputs have magnitudes proportional to $\sin \theta$ and $\cos \theta$, where θ is the mechanical shaft position of the transducer. These signals are converted into phase-shifted signals of constant amplitude through an operational amplifier and an R-C summing network. The amplifier feedback network is an R-C combination whose impedance is equal to the input summing network impedance, and also has $\omega RC = 1$ where ω is the transducer excitation frequency. The output of the operational amplifier is

$$E_o = \frac{-Ke}{2} \sqrt{\theta - \frac{\pi}{4}}$$

where K is the transformation ratio of the transducer and Scott tee transformer.

The output signal is then applied to a tunnel-diode zero-crossing detector whose output is a negative-going pulse with 0.1- μ sec rise time. This detector has an accuracy of better than 0.1 percent for an input frequency of 400 cps over a tem-

perature range of -55 to 125 C.

To obtain a pulse width proportional to mechanical shaft position, the output signals from the Scott tee are applied to reference signal selector circuits that determine the signal whose magnitude is largest. The selector uses one of two zero-crossing detectors, depending on whether a positive going or negative going zero crossing is required since the two references are 180 deg out of phase. The selector produces an output pulse to set a gating flip-flop. The arrival of the phase-shifted signal from the transducer's section will reset the flip-flop. Its output gates a NAND circuit whose other input is a clock train from the optical memory. The output of the NAND is a pulse train proportional to the transducer shaft position.

In analog-to-digital conversion of a variable resistance input from the oil-temperature probe, the probe is connected as one leg of a bridge circuit excited from a 400-cps source. The output of the bridge is fed to two operational amplifiers into opposite inputs of the R-C summing network. A reference voltage is fed into the other two inputs. Outputs of the two operational amplifiers are used with zero crossing detectors to set and reset a flip-flop that controls the gating of clock pulses.

STEPPER MOTOR — Computer outputs of optimum torque and ac-

ceptable turbine inlet temperature are 225-pps pulse trains that drive stepper motors in the display panel. The complete stepper motor loop, Fig. 4A, consists of a stepper motor in the vertical-scale indicator that drives the marker as well as a feedback synchro. The synchro signal is converted into a digital pulse train that counts up a register. The register has previously been counted backward an amount proportional to the desired position of the indicator marker. As the synchro pulse train is counted in, an error count is accumulated in the register.

This count is shifted serially into an error register in the stepper motor drive, Fig. 4B. Also associated with the error count is polarity information that is transferred to a sign flip-flop at the same time. There is a separate stepper motor drive section for each of the five stepper motors. The shift-enable pulse that allows the error count to be shifted is applied also to an inverter, the output of which is applied to NAND gate 1. When shifting occurs the NAND gate is disqualified; when the shift enable signal goes low the NAND allows the 225-pps oscillator to count down the error register and simultaneously count into a two-stage ring counter. The direction of count of the ring counter is controlled by the sign flip-flop. When the error register reaches a zero count, the output of NAND gate 2 will go low, disqualify NAND 1 and stop the count.

The outputs of the ring counter are applied sequentially to the windings of the stepper motor through power NANDs that are qualified by the output of flip-flop 1. When zero count is reached, the output of NAND 2 also sets a monostable multivibrator that will set flip-flop 1 approximately 100 milliseconds later. This transition will disqualify the power NANDs and remove power from the stepper motor windings thus minimizing power consumption and heat dissipation within the indicators. The ring counter will remain in its last state until a new error signal is counted down, thus insuring that sequence of motor-winding excitation is maintained.

D-A CONVERTER—The output

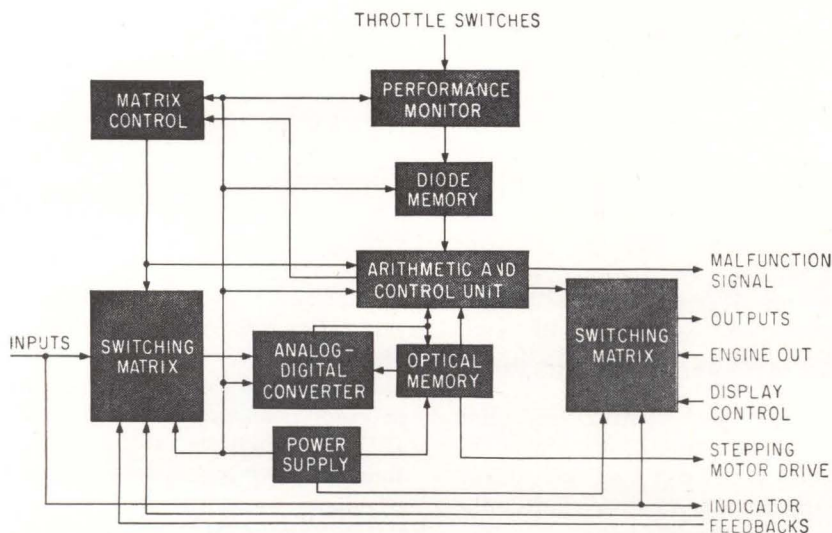

PROPULSION DATA COMPUTER uses an optical memory with data recorded on a glass disk. This stored data sets optimum torque indicators for flight conditions—Fig. 3

representing total fuel flow for four engines is converted from binary coded digital information into a 400-cps analog signal and applied to a fuel-flow totalizer servo. Pulse trains from the analog-to-digital conversion of each engine transmitter are accumulated in a counter and after accumulation are transferred in parallel to the digital-to-analog converter. The converter consists of a storage register, bilateral transistor switches, resistance lattice and Darlington output stage. The state of each flip-flop stage determines whether the excitation voltage E_s is connected to the lattice or not. The resistance lattice may be represented by Fig. 5A. It may be shown that

$$E_0 = \frac{E_s}{1,024} \sum_{n=1}^{10} \delta_n (2^{n-1})$$

where $\delta_n = 1$ if the flip-flop is set and $\delta_n = 0$ if the flip-flop is not set. The number of the flip-flop stage is n . The Darlington circuit provides for a high input impedance load on the lattice network, Fig. 5B. For a 10-stage register the digital-to-analog converter has an accuracy of 0.1 percent.

POWER SUPPLY — Eleven supplies are contained in approximately 180 cubic inches. A three-phase transformer powers ten banks of silicon rectifiers arranged in a six-phase star. Nine transistor voltage regulators deliver 103 watts d-c to the loads. The tenth power supply delivers 38 watts, unregulated. A subharmonic oscillator operating from a single phase delivers 15 watts at 200 cps to power the Magnesyns.

Long-term voltage stability is achieved by low-temperature-coefficient resistors in a high-loop-gain differential amplifier that drives a Darlington power amplifier.

Specifications for the propulsion data system were prepared by CWO George Fels and Mr. Paul Blore of the Flight Control Branch, Flight Vehicle Division of the Directorate of Operational Support Engineering, Aeronautical Systems Division. Development of this concept into a flyable prototype system has been sponsored under U.S. Air Force contract AF33(600)41462.

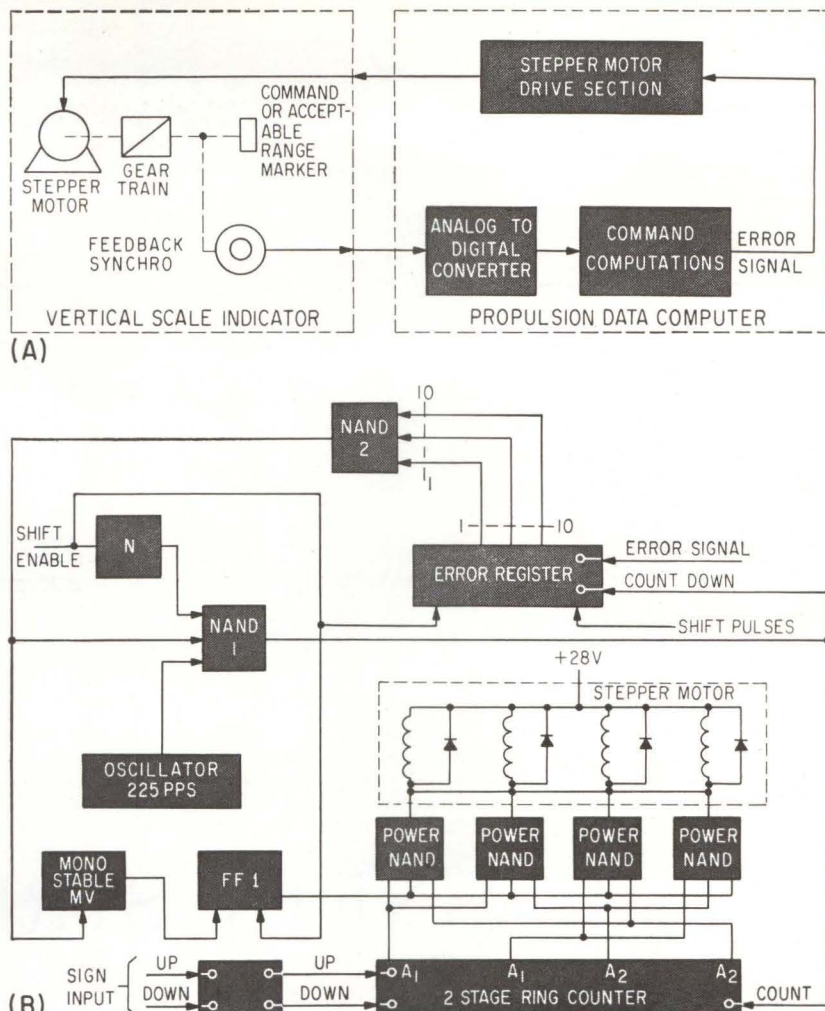

STEPPER MOTOR loop (A) and detail of stepper motor drive (B)—Fig. 4

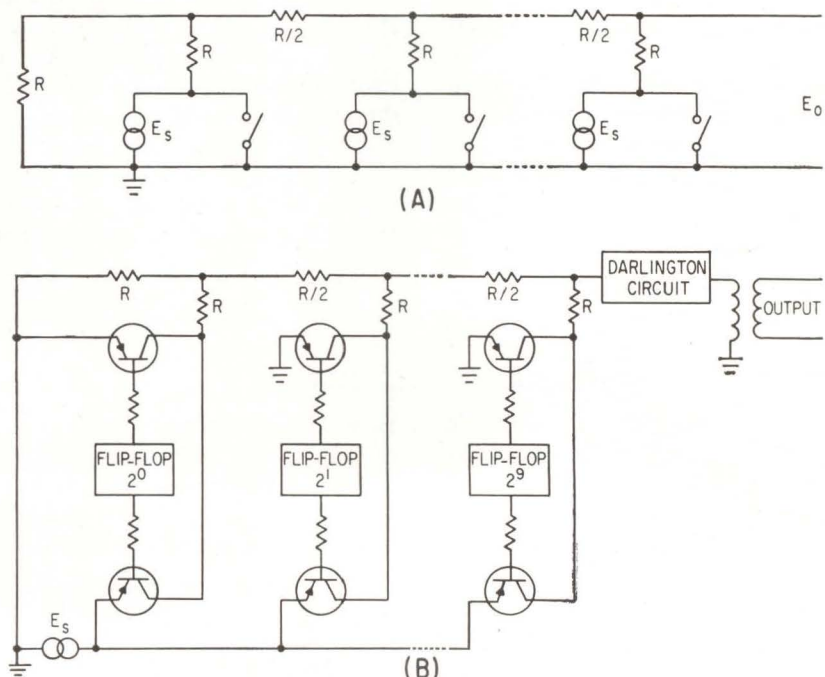

DIGITAL-TO-ANALOG converter equivalent circuit (A) and a portion of the actual circuit (B) whose output is an analog voltage representing fuel flow—Fig. 5

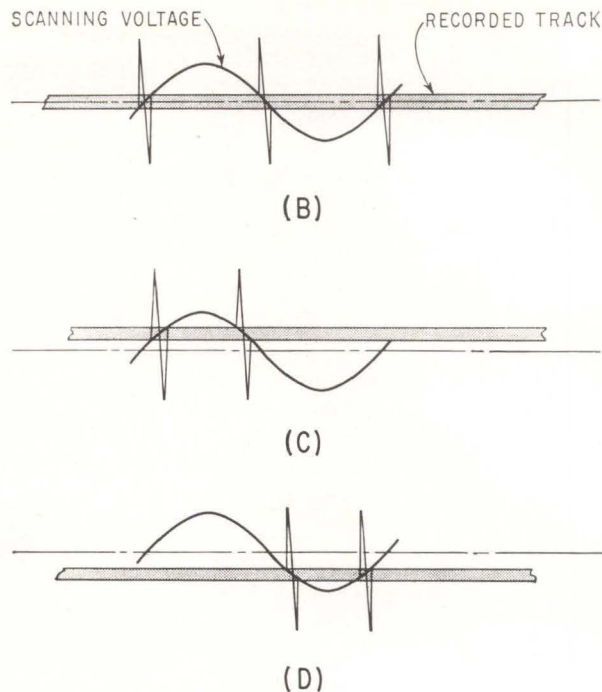
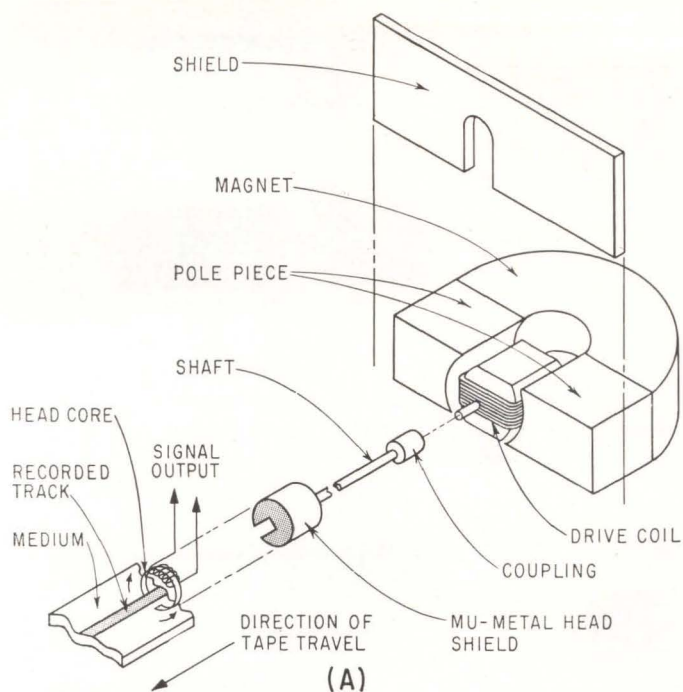

SCANNING HEAD mechanical arrangement (A) produces one pulse period when recorded track is in center of scan (B), another when track is above scan center (C) and a third when below scan center (D). The track is recorded by applying a d-c voltage to a conventional recording head—Fig. 1

MAGNETIC STRIP Keeps Tape

MAGNETIC TAPE tracking error and instantaneous skew can be determined by several methods. Usually, these are complex and leave no permanent record.

By applying d-c to the tape-transport record head and recording a magnetic strip down the tape, then scanning this track in the transverse direction with a conventional ring-type playback head, a voltage proportional to track displacement can be generated. This voltage can

be displayed for immediate observation or recorded for future use.

VIBRATING HEAD — The drive coil of the galvanometer motor shown in Fig. 1A is excited by a 60-cps sinusoidal voltage. As the head mechanically scans across the d-c recorded track, pulses are generated at the crossover points.

When the track is in the center of the head scan, the periods between output pulses are equal as

shown in Fig. 1B. When the recorded track is moved from the scan center, a difference in period results as shown in Fig. 1C and 1D.

Because the tape is scanned transversely by the head, a transverse (gap parallel to tape) orientation of the record head prevents a phase reversal of the output pulses as the recorded track is displaced from scan center as shown in Fig. 2.

Linearity is proportional to the ratio of maximum displacement of the tape and the peak-to-peak amplitude of the mechanical scan. A scan amplitude of approximately twice maximum displacement provides a usable value. For example: a total displacement of 10 mils requires a scan amplitude of 20 mils. The head may be driven by any moving-coil transducer having sufficient torque to overcome friction imposed by medium being scanned and adequate mechanical movement to accomplish desired scan amplitude.

ELECTRONICS — As shown in Fig. 3, both the pickup-head drive coil and the signal detector are sup-

TAPE TRACKING ERRORS

During design of magnetic tape transports, it is necessary to determine amount of tracking error and instantaneous tape skew. Mechanical methods using optical instruments are subject to reading errors and provide no permanent record. Other techniques include recording separate in-line tracks and measuring

time delay between reproduced signals. This method gives positive results but requires multiple recording heads and electronics to match.

The scanning head technique uses minimum equipment to provide both instantaneous readout and a signal that can be recorded

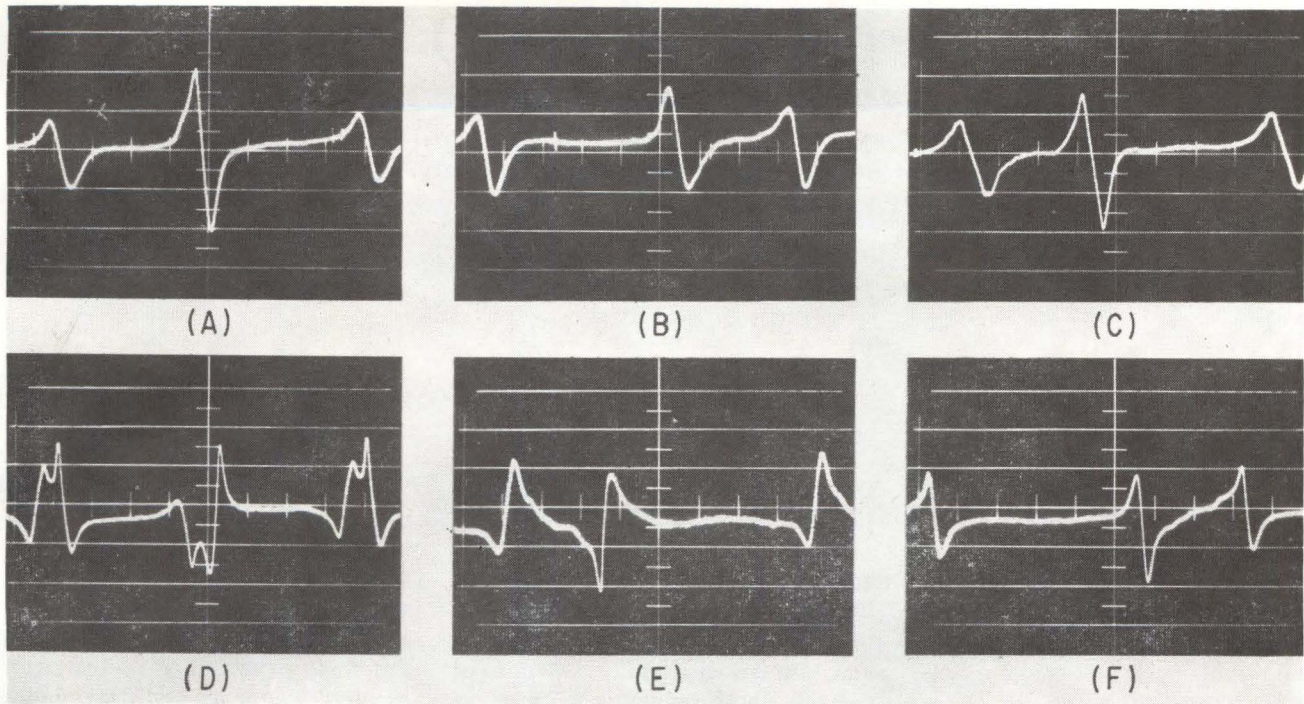

PLAYBACK HEAD output pulses with transverse orientation of record head showing recorded track in center of scan (A), below scan center (B) and above scan center (C). Pulses with longitudinal orientation of record head showing track in center of scan (D), above scan center (E) and below scan center (F)—Fig. 2

Running True

By BEVERLEY R. GOOCH, Ampex Corporation, Sunnyvale, California

plied from a common 60-cps source, therefore they are in phase. The pickup head signal is amplified; positive peaks are removed by a clipper limiter; and the resulting signal drives a one-shot multivibrator. The multivibrator removes amplitude variations caused by tape irregularities and contact losses.

The positive-going output pulses from the multivibrator have a period proportional to the recorded track position, and drive silicon-transistor switch Q_1 to place a charge on C_1 at the crossover points of the recorded track and scan voltage.

Because detector and scan voltages are in phase, when the re-

corded track is moved to the positive portion of the scan voltage, a positive charge is placed on C_1 . Conversely, when the recorded track is moved to the negative portion, C_1 acquires a negative charge. Amplitude and polarity of the charge, or output voltage, are proportional to the relative position of the recorded track and scan voltage.

Duration of the switching pulse is adjusted so that applied voltage across C_1 does not decrease appreciably during interval between pulses.

Due to low leakage resistance of the silicon transistor, discharge time of C_1 is long so that if one pulse is missed or a dropout occurs, the output signal will remain ap-

proximately at the same potential until another pulse is received. If no additional pulses are received, the output drops to zero.

Detector output is fed to a difference amplifier having a d-c microammeter connected between the cathodes. When measuring tracking errors, the vibrating head is adjusted to the center of the recorded d-c track while the tape is stationary. When the tape is set in motion, tracking error can be read from the meter and recorded if desired.

Capacitor C_2 can be used to provide any needed additional damping if a more average reading is required. The meter scale is calibrated to read track displacement in mils.

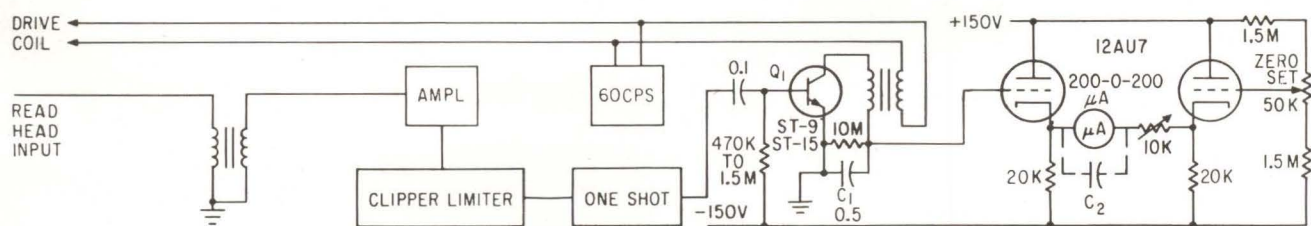

PICKUP HEAD signals are amplified, clipped and trigger a multivibrator. Pulses are detected and measured by a vtvm. An external recorder can be connected between vtvm cathodes—Fig. 3

Hula-Hoop Antennas:

When antenna height is reduced by loading, efficiency deteriorates rapidly. Here is a system of antenna height-reduction where circumferential aperture is substituted for antenna portions lost

TODAY, when the military needs reliable world-wide communications, long waves have again assumed great importance. This trend has revived interest in the electrically short antenna.

While important for long-wavelength applications, the short-height antenna is also valuable in mobile and portable communications systems in the high-frequency bands where the vertical extent of a resonant quarter-wave antenna is mechanically impractical.

SHORT ANTENNA—A naturally resonant, vertical antenna such as the grounded quarter-wave radiator is a colinear aperture. Its properties are ideal for general communications, providing an omnidirectional radiation pattern with most signals delivered at low angles. At full height, its radiation resistance is far greater than any electrical-loss resistance in the conductors. Even when operated over soil, the vertical's characteristics permit excellent radiation efficiency, even with simple wire radial ground networks.

When the height of this classical antenna is sharply reduced and electrical resonance restored by a conjugate reactor, its performance deteriorates severely. Fortunately, excellent theoretical contributions¹ on reduced electrical size antennas and modern supergain theory² show the reason for this effect. Reduction of physical height removes a portion of the colinear aperture of the vertical antenna. Loss of colinear aperture means loss of radiation resistance, resulting in less input power coupled to space. Loss in wire ground planes is severe in low-frequency radiator use.

When dealing purely with a co-

linear aperture, loss of electrical height means less efficiency.

DDRR ANTENNA—In the directional-discontinuity ring-radiator (DDRR) antenna,³ circumferential aperture is substituted for the colinear portion lost in height reduction. Using normalized dimensions and, assuming that an antenna is desired whose height is 2.5 electrical degrees at the operating wavelength, it is specified that no lumped inductive elements be used to achieve electrical resonance to reduce electrical loss. Radiation efficiency must be within 2 to 3 decibels of a full quarter-wave vertical antenna erected over the same

ground plane.

A circular array with a circumference of one full electrical quarter wavelength results in an antenna diameter of 28 electrical degrees. To attain an in-phase electric distribution over this circumferential aperture means using a center-fed radial waveguide like the flat top antenna. Study of a 28-degree diameter electric array by techniques such as those developed by Chireix,⁴ shows that even with a 90-degree shift in phase around the aperture, an omnidirectional radiation pattern in the horizon plane will result. To establish a circular array a conductor one-quarter wavelength in length is conductively joined to the

HOOP WITH A PURPOSE

Low-frequency antennas require either long wires supported by tall masts, or vertical tower radiators 60 to 300 feet. Here is an antenna that looks like a child's hula-hoop and has performance characteristics closely approaching those of a full quarter-wave vertical.

The DDRR antenna (this week's cover) offers a height reduction of up to thirty-to-one over verticals now in use and can range in size from 6-inches to 5,000 feet in diameter and 2-inches to 300 feet in vertical height.

A model of this new antenna only 2-feet high, recently equaled the performance of a 60-foot vertical radiator

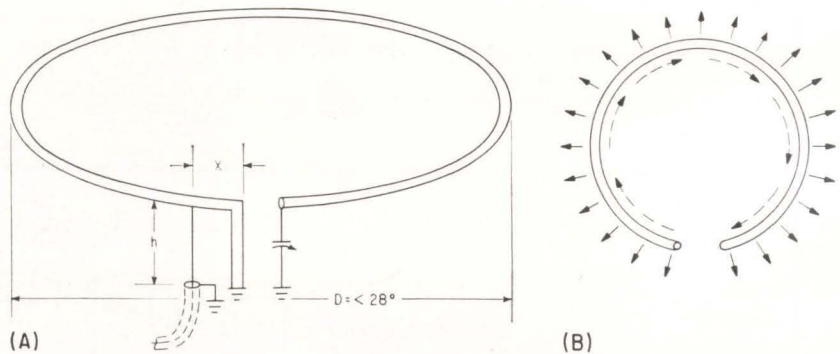

RING TRANSMISSION LINE showing feed and tuning, if required (A) and current in ring element (B)—Fig. 1

A Coming Trend?

By J. M. BOYER

Chief, Radio Physics Group,
Northrop Ventura, Van Nuys, Calif.

top of a 2.5-degree high vertical element and bent around in the horizon plane at this height to form a circle as shown in Fig. 1A. If a generator is connected across the slot formed by the circular conductor and the ground plane, an energy wave can be launched in this curved boundary region.

When a change of direction occurs in any electromagnetic waveguide system, higher order modes are established.⁵ If this discontinuity takes place in a completely closed system such as rectangular waveguide, the equivalent circuit of the discontinuity will contain only reactive components because no power is lost in radiation. If, however, the fields are not confined, but extend beyond the guide boundaries, the discontinuity equivalent circuit contains resistive and reactive components. Field line fringing or extension effect is present in dielectric waveguides and open-wire transmission lines.

The constant-height ring-conductor just described forms a single-wire transmission line with the ground-plane surface. It runs a straight path rather than in a curve, this close-spaced line produces little radiation as shown by King.⁶ This condition is true, to a

first order, because the TEM mode exists over the length of this line, with discontinuities occurring only at the ends.

If the same single wire line is bent into a curve, however, a wave launched at its input terminals encounters a different set of conditions. The bent waveguide is a constant series of directional discontinuities. Thus, the launched wave radiates continuously in a direction transverse to the line-axis throughout its entire length. Radiation occurs from two sources; a horizontally polarized wave is launched from the current-flow in the ring element itself, but is cancelled because of the antisymmetric current relation in the image plane. At the same time, vertically polarized radiation takes place from the higher-order modes established by the direction discontinuity. The launched wave radiates as it moves around the ring until it meets the far end. The energy still remaining at this point reflects, radiating on its path back to the generator. Thus, the DDRR antenna might well be called a leaky-waveguide radiator, with radiation being integrated over its entire circumferential boundary or aperture.

The DDRR antenna produces

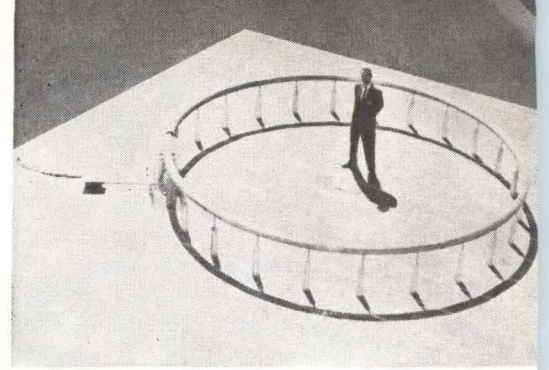

(A)

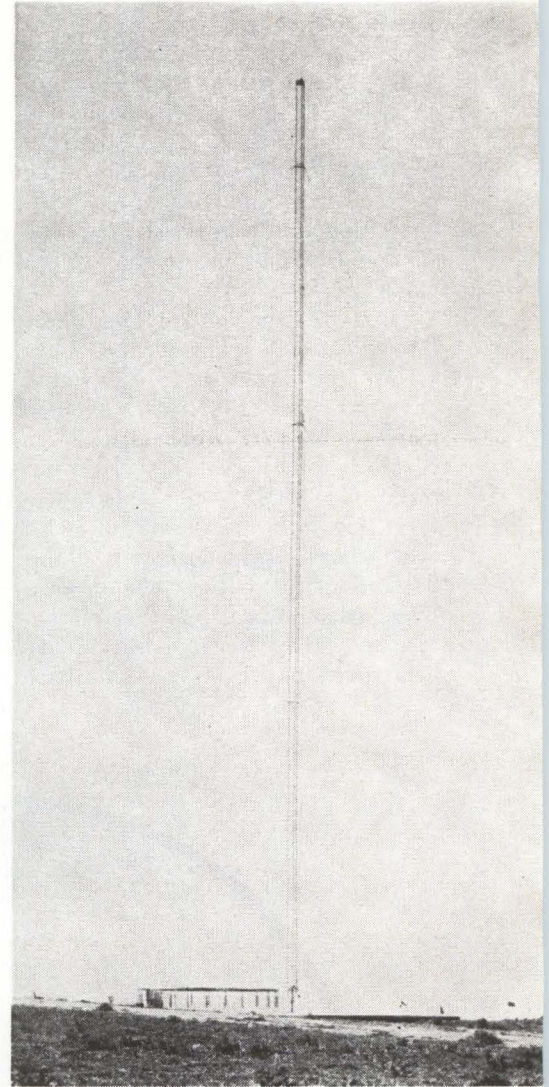

(B)

MODEL of the DDRR antenna operating between 2 and 4 Mc (A) and the same antenna compared to a quarter-wave vertical (B)—Fig. 3

typical dipole doughnut radiation pattern when its diameter is not large in wavelength. Chireix analysis quickly explains the omnidirectional azimuth plane pattern. In the elevation plane, the zenith null must occur due to the out-of-phase relationship of parallel current components on the ring element and the typical antisymmetric distribution of electric lines of force around

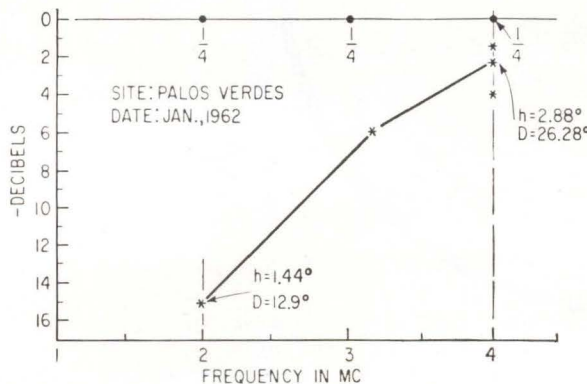

AVERAGE GAIN versus frequency of a DDRR antenna compared to a full, quarter-wave vertical radiator with same counterpoise—Fig. 2

the circular aperture as shown in Fig. 1B.

Although the ring-type-DDRR antenna design simplifies low-height radiator structure by eliminating the large current sheet found in the flat top model, it has other advantages. Unlike the flat top, the DDRR design is naturally resonant when the diameter of the aperture is approximately 28 electrical degrees. Resonance is relatively unaffected by the height h above the ground plane if kept well below 90 degrees. When size limitations restrict the diameter to less than 28 degrees, electrical resonance can be restored with a low-loss air or vacuum capacitor connected from the open end of the ring to the ground plane.

The DDRR design permits direct connection of transmission lines across the aperture and ground plane. Any line from 36 to 500 ohms may be used if dimension X is varied to suit its characteristic impedance. Thus, the impedance-matching network required with other short height designs is eliminated, together with attendant electrical loss and additional restriction of bandwidth. When point X has been determined to conform with

the transmission line, a DDRR antenna may be capacitively tuned over at least a 2:1 frequency range without input vswr exceeding the 2:1 limit.

PERFORMANCE—No single antenna design is a panacea for the problems of communications, but the performance and flexibility of the DDRR antenna, represents a significant improvement.

Figure 2 shows typical gain variation of a simple DDRR antenna over a 2:1 frequency band. The magnitudes are the average for many field-strength comparisons to full quarter-wave vertical antennas taken at steadily increasing range over a combination land and sea path, where distances ranged from 1 to 132 miles in both a North and South path. The model used was small electrically, being only 12.9 degrees in diameter and 1.44 degrees high at the 2-Mc limit and 26.28 degrees in diameter and 2.88 degrees high at 4 Mc. This antenna appears in Fig. 3A. At the same frequency limits, the comparison test antenna was a one-foot, triangular cross-section tower, 110 feet tall, at 2 Mc and 68 feet high at 4 Mc. as shown in Fig. 3B.

Operation was over rocky soil, using 90 radials each one-half wave long. Tests were made under the special call KM2XOP by authority of the FCC. Tuning of the test antenna over the entire frequency range was completely remote, using a servo actuated Jennings vacuum variable capacitor adjusted from the transmitter console 500 feet away; vswr was under 2:1 in 50-ohm coaxial cable at all frequencies.

MOBILE USE—At higher frequencies, the DDRR has proven a convenient and efficient device for mobile communications. A mobile model designed for use between 26.5 and 31 Mc is 27 inches in diameter and projects only 3½ inches above the vehicle roof. The horizontal radiation pattern of the DDRR and that of a full quarter-wave whip antenna on the same vehicle are shown in Fig. 4. Departure from a perfect omnidirectional pattern for both antennas is due to the nonsymmetrical ground plane geometry provided by the metal skin of the car. In addition to increased efficiency, the antenna possesses other important advantages for the mobile service. At high road speeds, there is no signal-flutter effect from the DDRR antenna. This wind effect is severe in vertical antennas cut for the same frequency range. Also, the simple DDRR design used in the mobile service acts as a sharp band-pass filter centered on the operating channel. Thus, better isolation from adjacent-channel interference is achieved during reception than with conventional designs. Being directly grounded to the car frame, an automatic static drain to ground is provided for static charge induced by fog, dust and precipitation, affording improved receiver signal-to-noise ratio.

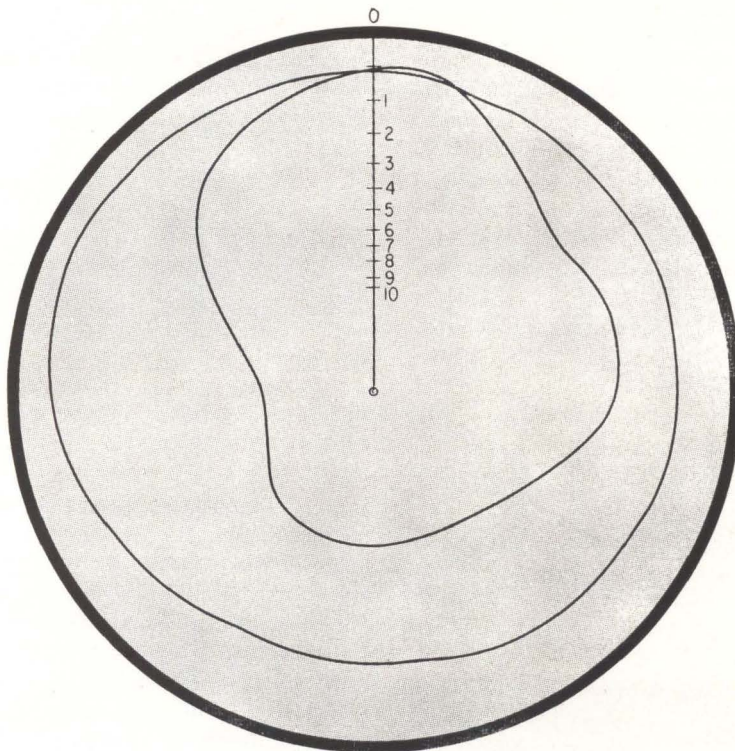

POLAR PLOT of a vehicular quarter-wave whip (inner) and that of a DDRR antenna (outer)—Fig. 4

REFERENCES

- (1) L. J. Chu, Physical Limitations of an Omnidirectional Antenna, *J. App. Phys.*, Dec. 1944.
- (2) S. A. Schelkunoff, Advanced Antenna Theory, John Wiley & Sons, p 44-48.
- (3) J. M. Boyer, Radio Antenna, U.S. Patent.
- (4) H. Chireix, Antennas a Rayonnement Zenithal Réduit, *L'Onde Elec.*, Vol. 15, p 440-446, 1936.
- (5) T. Moreno, Microwave Transmission Design Data, Dover Pub. Co., p 162.
- (6) R. P. King and J. E. Storer, Radiation Resistance of a Two-Wire Line, *Proc IRE*, p 1408-1412, Nov. 1951.

NEW TUBES AND CIRCUITS

FOR CONSUMER ELECTRONICS

Developments in frame-grid tubes including a video i-f amplifier, cross-modulation characteristics of transistor and tube tv tuners and a novel approach to d-c restoration were presented at the Radio Fall Meeting

By LESLIE SOLOMON Associate Editor

SOME of the latest developments in circuits and electronic devices for the home-entertainment industry were given at the Radio Fall Meeting, sponsored by the EIA Engineering Department with participation by IRE professional groups, and held in Toronto, Canada between November 12 and 14, 1962.

Subject matter ranged from component and system reliability through new developments in vacuum tubes, semiconductors and associated circuits.

NEW I-F TUBE — Advances in video i-f amplifiers have been made through use of frame-grid tubes. However, they still operate on the same principles as their predecessors and suffer from the same basic deficiencies. It is believed that this is due to method of applying agc voltage¹.

At present, semiremote-cutoff pentodes are extensively used in agc controlled amplifiers. Semiremote characteristics are obtained by having a number of widely spaced turns or windows in the middle of the control grid. Usually, 20 to 30 percent of the normal operating current flows through these windows. Because of low amplification factor in this region, window current is inefficient and contributes little to total transconductance at low signal levels. Furthermore,

a heavy concentration of current density through the control-grid windows results in overheating screen-grid laterals facing the openings. Because of this, maximum screen dissipation must be set at a lower value.

To control gain in a typical i-f amplifier, effective transconductance must be reduced by negative feedback. Tube input capacitance can be kept constant by using a cathode resistor. Unfortunately, when an unbypassed resistor is used, effective transconductance is also reduced.

If a tube gets gassy, or has grid emission, and agc voltage is applied to the control grid through a relatively high resistance, voltage generated across this resistance can

cause instability or a possible runaway condition.

Another difficulty arises from the movement of operating point towards cutoff as signal level increases. If signal amplitude is greater than amount of grid base between bias point and cutoff, the signal will be limited and any a-m stripped off. Thus extensive control of transconductance transfer characteristics is necessary in production of semiremote-cutoff pentodes.

Cross section of the new 6GK7 is shown in Fig. 1. The screen grid gives triode amplification of 80 and an L-shaped connector is used between grid 2 support and the stem to provide built-in inductance for screen grid regeneration. Since a high degree of suppression is used in this tube, a large number of electrons cannot reach the plate and are forced back to the cathode.

To prevent these electrons from being picked up on the screen grid laterals, an electrode combining the functions of shield and beam plate is placed between suppressor and screen grids. This electrode is at screen-grid potential.

Figure 2 shows a typical i-f stage using the 6GK7. Circuit operation is based on dual-control properties of the tube. Amplification is controlled by varying amount of negative voltage applied to suppressor. As agc bias increases, electrons find

EYEGLOSS TV?

During a discussion on microelectronics, it was mentioned that microminiaturization could lead to really small consumer products such as eyeglass-mounted tv and earpiece-type radios.

After local newspapers in Toronto reported on some of the Radio Fall Meeting sessions, a number of people called trying to find out where they could buy a hang-on-the-glasses tv.

As none of the manufacturers present could offer any, here is a market for some enterprising engineer with small fingers and lots of patience

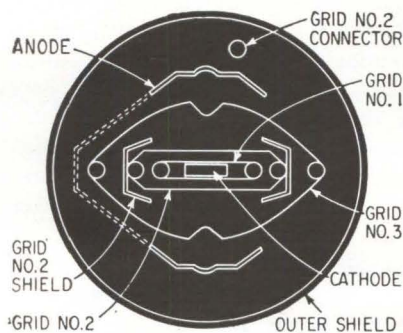

CROSS SECTION of new 6GK7 frame-grid, sharp-cutoff pentode—
Fig. 1

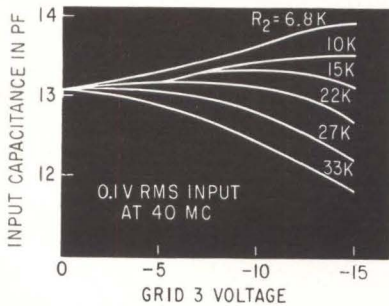
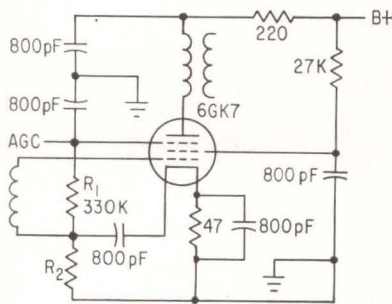

VIDEO *i-f* amplifier showing how *age* is applied. Curve shows changes in input capacitance with variation of R_2 —Fig. 2

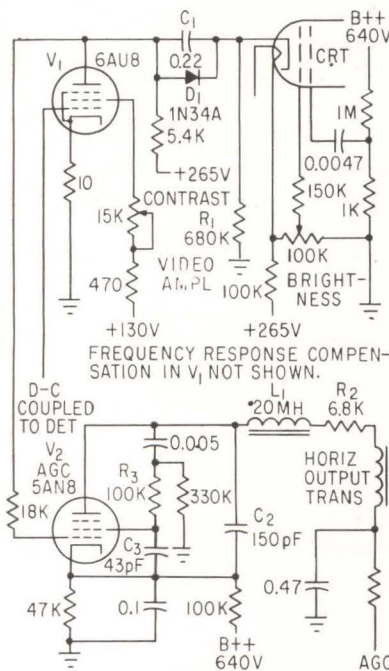

COMPOSITE *a-c/d-c* video coupling and keyed *age* produces nearly ideal picture signal—Fig. 3

it more difficult to penetrate the suppressor and plate current, therefore transconductance decreases. Electrons that cannot reach the plate are deflected to the screen shields. Application of *age* to the suppressor allows the control grid to be returned to ground through a low-resistance path and gas or grid-emission currents cannot cause instability.

Main function of suppressor grid is to divide cathode current between plate and screen grid according to amount of *age* voltage. If d-c potential of control and screen grids are kept constant, and electrons returning from suppressor are prevented from entering and changing space-charge conditions in the control grid-to-cathode region, cathode current will remain independent of *age* applied to suppressor. Cathode current and control grid bias remains reasonably constant and control grid bias is always set so that modulation clipping cannot occur.

Since the control grid does not have a window, the tube can also be used as a sharp-cutoff pentode. When used without *age*, suppressor is returned to +15 v to reduce space charge suppression and increase transconductance.

CROSS MODULATION—The active element chosen for the r-f stage of a receiver front end should have good cross-modulation characteristics under various *age* conditions as well as at maximum gain. Cross modulation tests between tubes and transistors in a typical vhf tv tuner indicate that transistors are between 1½ and 2 times worse than tubes. However, by using small-value degenerative emitter resistors, the transistor can be made as good as the best tubes. By using a 56-ohm unbypassed emitter resistor and forward *age*, cross modulation of a T-2028 microalloy diffused transistor is equal or better than the best tube tuners over the entire *age* range². The data also indicates no substantial difference between cross modulation of silicon or germanium transistors.

Analyses that cover h-f operation predict that transistor cross modulation should decrease at higher frequencies. However, all data taken to date at tv frequencies indicate the reverse to be true. All

the analyses ignore nonlinearities contributed by collector junction or the collector depletion layer. This may account for the observed discrepancy. Also, it has not been possible to get good agreement between predicted and observed variation of cross modulation with operating point. This may result from neglect of collector contribution.

The table compares tuners with four different tube complements. Measurements were made at both channel 6 and channel 13 with the undesired signal approximately 6 Mc higher than the desired one. The undesired signal level at which 1-percent cross modulation occurs is measured at the tuner input and referred to 75 ohms. It appears that number listed for average tube tuners is the current state of the art.

Transistor tuners using madt's showed that structure had little effect on performance. The table also shows typical transistor performance when two different silicon types were used in the r-f stage in place of germanium types. For convenience, the mixer and local oscillator were not changed as it has been established that the major portion of cross modulation occurs in the r-f stage. In all cases, interstage bandwidth between r-f and mixer was identical and operating points adjusted for best compromise of gain, noise figure and cross modulation.

The data indicates that tube tuners are 1½ to 2 times better with respect to cross modulation, that there is little difference between germanium and silicon cross modulation and that the noise figure of germanium devices is better than present-day tubes.

Cross modulation is intimately related to nonlinearity of the active element. One method of reducing this effect is to externally linearize the device by an unbypassed emitter resistor. For each change in resistance, the input circuit was rematched for best compromise between gain, noise and cross modulation. Gain was unaffected at both high and low frequencies by emitter resistors as large as 100 ohms. The resistor improved cross modulation characteristics with accompanying degradation of noise figure. Resistors between 40 and 50 ohms lead to performance charac-

teristics about equal to those of average tube tuners. Inclusion of the resistor does not alter normal forward age characteristic.

D-C RESTORATION—For many years, most monochrome tv sets produced in the U.S. were of the a-c coupled crt type, making no use of the signal d-c component. Although picture quality was somewhat impaired by incorrect reproduction of the gray tones in many type of scenes, these sets found good public acceptance.

Field tests failed to show clear-cut differences in performance when a-c coupled receivers were compared to receivers in which d-c coupling was used. It is believed that a substantial improvement in picture quality may be obtained when black level is carefully stabilized both at transmitter and receiver.

Perfect d-c restoration is costly due to regulation effects on the horizontal scanning and high-voltage system. Many set manufacturers use a compromise partial d-c coupling.

An ideal compromise system curve could be obtained with d-c coupling in low-key (dark) scenes and a-c coupling at higher-key scenes³. Such a circuit, with back-porch keyed age is shown in Fig. 3. Here, diode D_1 has been added across coupling capacitor C_1 . When the transmitter fades to black, and the brightness control is properly adjusted, crt beam current is zero. Consequently, D_1 conducts. Since the voltage drop across the diode when conducting in the forward direction is negligible, diode current will be that value that causes the voltage drop across R_1 to equal the d-c voltage at the plate of video amplifier V_1 . For low-key scenes, the video amplifier remains d-c coupled to the crt through D_1 , although voltage drop across R_1 is now total of diode current and beam current. As the scene goes to white, the beam current increases and less current from the video amplifier is required through the diode. An average value of scene key is reached at which average crt beam current is sufficient to cause drop across R_1 (due to beam current alone) to equal amplifier plate voltage. When this value is reached, no current flows through the diode.

TABLE—TRANSISTOR VERSUS TUBE TV TUNERS

| COMPLEMENT | | | PERFORMANCE | | | | | |
|--------------------|-------|-------|-------------|------------|--------|-----------|---------|--------|
| R-F | Mixer | L-O | Power gain | Channel 13 | | Channel 6 | | |
| | | | | (1% CM) | NF | PG | (1% CM) | NF |
| 3GK5 | 6CG8 | | 30 | 5.5 mv | 6.0 db | 39 | 8 mv | 5.5 db |
| 6DS4 | 6CG8 | | to | 8.1 | 5.5 | to | 17 | 4.5 |
| 3CY5 | 6BR8 | | 31 | 9.0 | 6.2 | 41 | 25 | 5.9 |
| 6GK5 | 6CG8 | | db | 7.0 | 5.8 | db | 10 | 4.8 |
| Average Tube Tuner | | | 30 db | 7.4 | 5.9 | 40 db | 15 | 5.2 |
| T2028 | T2029 | T2030 | 30 db | 4.7 | 4.8 | 38 | 10 | 4.6 |
| 2N917 | T2029 | T2030 | 25 | 6.0 | 7.0 | 35 | 6.5 | 5.6 |
| 2N918 | T2029 | T2030 | 27 | 5.0 | 7.0 | 37 | 12 | 5.7 |

With further increase in scene key, diode remains nonconductive and the circuit is a-c coupled. The beam current produces sufficient drop across R_1 to keep the diode back biased.

Use of sync tips as the reference level in recovering d-c signal component has certain problems. To maintain proper black level, amplitude of signal between sync tip and reference black level must be constant. Some changes could occur from switching between channels with resulting signal differences. In a receiver where the age signal is taken at a point following the contrast control, the age circuits holds the sync tips at constant potential at the video amplifier plate but changes in video amplitude result in black level shift as the contrast control is varied.

One answer is to reference age to blanking level rather than sync tips and cause the age tube to conduct during back porch interval and not during sync. In the circuit shown in Fig. 3, keying pulses are applied to both plate and screen of age tube V_2 . The pulse applied to the plate is delayed slightly by R_2 , L_1 and C_2 . The screen pulse is further delayed by R_3 and C_3 .

Since both plate and screen are keyed, relative timing of the two pulses determines time of plate-current flow. With proper delay, age is referenced to back porch (blanking level) rather than to sync tips.

In Fig. 3, assume the brightness control adjusted for low-key scenes and then there is an increase in

scene brightness. The resulting increase in beam current causes a decrease in boosted voltage (B^{++}) and a corresponding decrease in crt grid 2 potential. This drop in potential causes a decrease in crt cutoff potential. Thus for a high-key scene, black level would be below cutoff with an uncompensated circuit and dark shades of gray (near black) would also be below cutoff and show up as black.

When scene brightness is increased in the compensated circuit, a decrease in boosted voltage (B^{++}) also causes a decrease in cathode potential of the age tube. This drop causes more age voltage, which in turn reduces the voltage developed by the video detector and as a result, the black level i-f signal at the video amplifier plate is at a less-positive potential than when a lower keyed signal was received. The net result is that the compensating age circuit can be designed to cause the black level of the video signal to track with changes in crt cutoff potential resulting from boosted voltage variations.

REFERENCES

- (1) M.E.Ulug, Novel Tube and Circuit Designs for Automatic Gain Controlled Broad Band Intermediate Frequency Amplifiers, RQ62EE18, Canadian General Electric Co. Ltd., Toronto, Canada.
- (2) C.D. Simmons and J.Specialny, Application Report 775, Cross Modulation in Transistor Tuners, Philco Lansdale Div., Lansdale, Pa.
- (3) S.P.Ronzheimer, DC Restoration—A New Approach, Hazeltine Research, Inc., Chicago, Ill.

DEFINITION OF TERMS

- r_b = base series resistance
- R_s = source resistance
- r_e = emitter resistor
- B_o = common-emitter current gain (hf_e)
- F = noise figure ratio
- I_e = emitter current
- f_α = alpha cutoff frequency
- α_o = common-base current gain

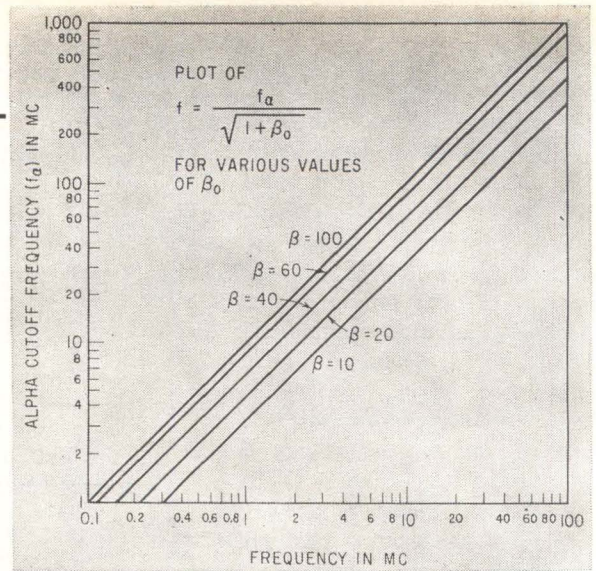

HOW TO CHOOSE

Transistors for Low Noise

By JOHN L. WILKERSON

Hughes Aircraft Co.,
Los Angeles, California

THE GUESSWORK in choosing the proper transistor for low-noise circuits is eliminated by the method outlined here.

Since noise figure is a function of emitter current—and there is an emitter current that gives minimum noise—a transistor with optimum noise figure can be chosen based on emitter-current characteristics.

The method consists of finding an expression for the noise figure, differentiating it with respect to emitter current, and setting the result to zero. The solution is the best emitter current for least noise.

NOISE EQUATIONS—The expression for a common-emitter or common-base T-circuit is²

$$F = 1 + (r_b + \frac{1}{2}r_e/R_s) + (R_s + r_b + r_e)^2/2r_eR_s\beta_o \quad (1)$$

The approximate relationship

$$r_e \cong 26/I_e \quad (2)$$

where $kT/q = 26 \times 10^{-3}$ at room temperature, defines the noise figure in terms of equivalent-circuit parametering to zero leads to optimum emitter current.

$$F = 1 + (r_b/R_sI_e) + (R_s^2 + 2r_bR_s + r_b^2)I_e/52R_s\beta_o \quad (3)$$

and plotting it, a saucer-shaped curve results that is a function of emitter current; it increases at low or high emitter currents.

Differentiating Eq. 3 with respect to I_e and equating to zero leads to an optimum emitter current.

$$I_{e(opt)} = \left[\frac{52r_b\beta_o}{R_s^2 + 2R_sr_b + r_b^2} \right]^{1/2} \quad (4)$$

For most transistors, the optimum current is between 0.1 and 1.0 ma². The source resistance that gives the lowest noise figure—found by differentiating Eq. 3 with respect to R_s —is about 1,000 ohms². Equation 4 establishes the optimum emitter current when r_e and β_o are known. Source resistance R_s may be assumed near 1,000 ohms for comparison.

If a circuit's gain and frequency are given, the

transistor's alpha cutoff (f_α) frequency and minimum current gain (β_o) for optimum noise performance can be selected. The relationship between noise figure and frequency leads to³

$$F = 1 + \frac{r_b + \frac{1}{2}r_e}{R_s} + \frac{(1 - \alpha_o)(r_e + r_b + R_s)^2 \left[1 + \frac{f^2}{f_\alpha^2(1 - \alpha_o)} \right]^{1/2}}{2r_eR_s\alpha_o} \quad (5)$$

The plot of measured noise figure against frequency indicates that at lower frequencies (below 1 Kc) the noise figure rises with a slope of 3 db/oct and remains flat for higher frequencies. Then, as the frequency reaches $\sqrt{1 - \alpha_o} f_\alpha$ (or $f_\alpha/\sqrt{1 + \beta_o}$, in terms of β_o) the slope rises to 6 db/oct. This fact can be conveniently used to plot a curve of the corner frequency, 3-db breakpoint, f , as a function of the alpha cutoff frequency with β_o as a parameter for the family of curves. These curves are used to select f_α when the maximum frequency to be amplified is known.

Example: Find a transistor to operate at 10 Mc with a gain of 40.

Solution: Enter 10 Mc in the horizontal axis, and read f_α in the vertical scale for $\beta_o = 40$, or 62 Mc.

Equation 3 shows that the noise figure is directly proportional to r_b and inversely proportional to β_o . Usually, transistor specifications are given in terms of hybrid (h) parameters that are easily converted to find the base resistance.

$$r_b = h_{ie} + \frac{h_{re}(1 + h_{fe})}{h_{oe}} \quad (6)$$

Using Eq. 6 and the graph, the number of possible transistors is narrowed down to a few; further calculation as to the approximate magnitude of the noise figure may be computed based on Eq. 4, with $R_s = 1,000$ ohms; also, Eq. 3 may be used.

REFERENCES

- (1) William R. Bennett, "Electrical Noise", McGraw-Hill Book Co., N. Y., 1960, Chap. 2, 3, 5 and 8.
- (2) E. G. Nielson, "Behaviour of Noise Figure in Junction Transistors", *Proc. IRE*, Vol. 45, pp 957-963, 1957.
- (3) M. Schwartz, "Information Transmission, Modulation, and Noise," McGraw-Hill Book Co., N. Y., 1959, p 457.

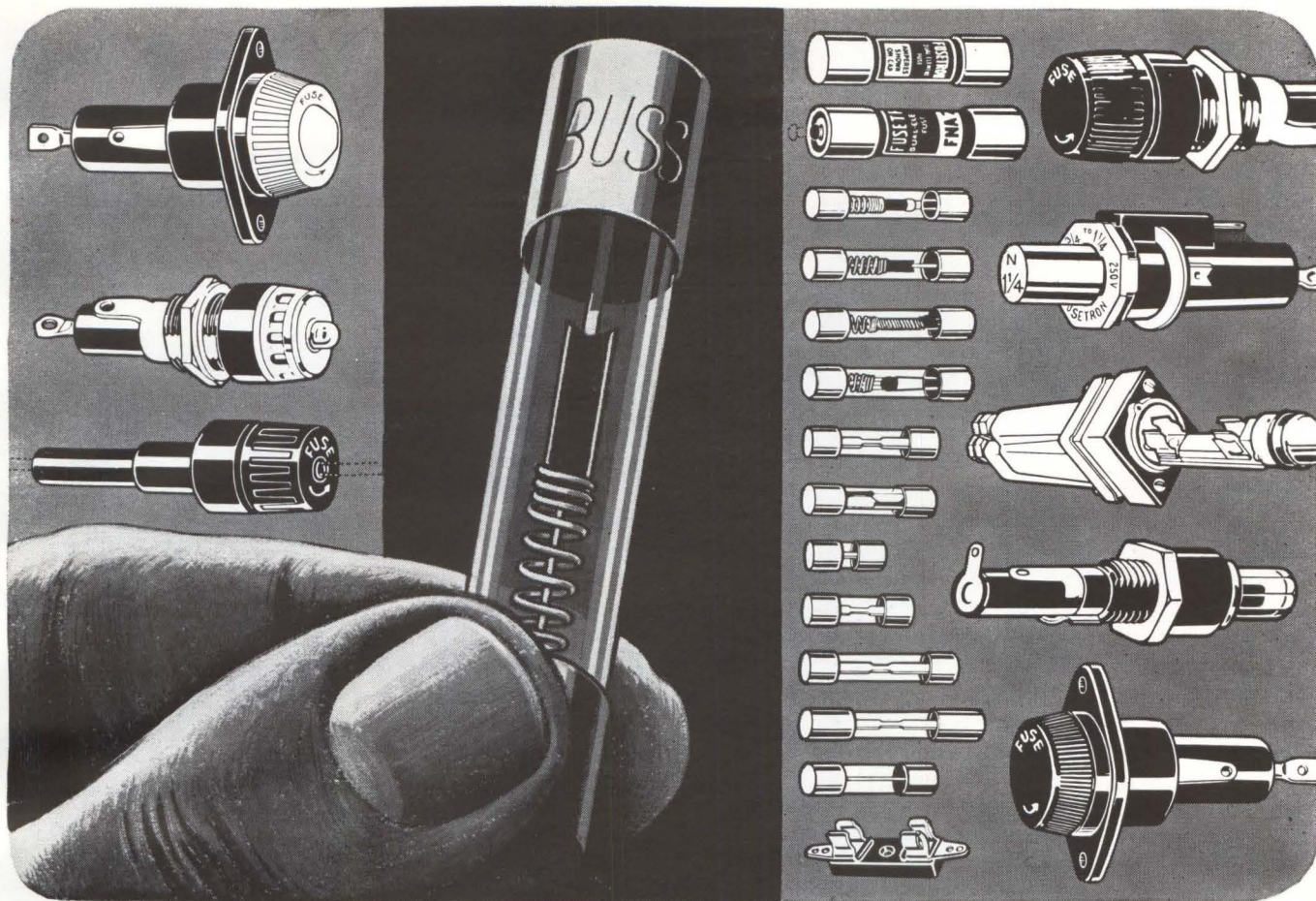

For Every Electrical Protection Need

there's a safe and
dependable **BUSS** or
FUSETRON Fuse!

BUSS fuse engineers have consistently pioneered the development of new fuses to keep pace with the demands of the Electronic industry. Today, the complete line includes:

Single-element fuses for circuits where quick-blowing is needed;—or single-element fuses for normal circuit protection;—or dual-element, "slow-blowing" fuses for circuits where harmless current surges occur;—or indicating fuses for circuits where signals must be given when fuses open. Fuses range in sizes from 1/500 amperes up— and there's a companion line of fuse clips, blocks and holders.

If you have a special protection problem

The world's largest fuse research laboratory, plus the experience gained by solving many, many electrical protection problems is on call to you at all times. Our engineers work with yours and can help you save engineering time and trouble.

For more information, write for BUSS bulletin SFB.

BUSS: The complete line of fuses and fuse mountings of unquestioned high quality.

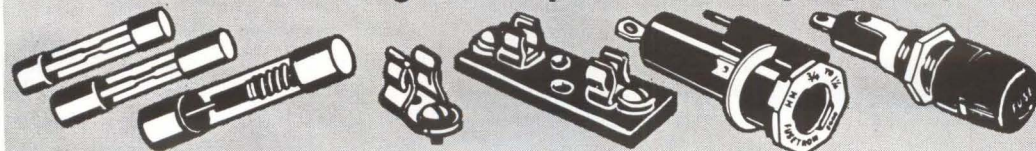

BUSSMANN MFG. DIVISION
McGraw-Edison Co.
St. Louis 7, Mo.

Three-Dimensional CRT Uses Atomic Resonance

Multiple excitation of mercury vapor may lead to true solid display

By RALPH ZITO, JR.

Missile and Space Vehicle Dept.,
General Electric Co.,
Philadelphia, Pa.

TO PRODUCE A VISUAL image in three-dimensional space, several conditions must be met: the image space must be transparent to visible radiations and at the same time have such properties that it is possible to cause a small spot of light, a near-point, to appear in its interior. The location of this near-point source must be controllable by some external means.

It appears that a threshold or multiple-excitation phenomenon of some sort is required, in which no visible light is produced at a given limited region of the image space until a minimum excitation level is reached or until two or more stimuli are present.

Under certain conditions, atomic resonance radiation of a gas lends itself to such an application. Step-wise excitation of mercury vapor at low pressure is applicable, in principle, to obtaining an isolated, visible region of fluorescence in space. Figure 1A illustrates the basic method.

Step-wise excitation of mercury vapor was first investigated early in this century.^{1,2} A resonance tube containing mercury vapor at room temperature was illuminated by the characteristic spectral lines of mercury from a mercury arc, and it was observed that most of the stronger mercury lines were given off by the mercury resonance tube as fluorescence. For any of the visible lines to appear, it was necessary that the mercury 2,537-Å line be present in the light from the arc. Further investigation has led to relatively good understanding of the mercury resonance radiation.



THREE-DIMENSIONAL DISPLAY using threshold excitation of mercury vapor, in artist's conception

Energy levels pertinent to the three-dimensional display problem are illustrated in a partial energy level diagram, Fig. 1B.

DISPLAY MECHANISM—Excitation 1 is a beam of ultraviolet light, wavelength $\lambda_1 = 2,537$ Å. On absorption, this beam raises the normal ground-state atoms of the mercury vapor from the 6^1S_0 level to the excited or resonance level 6^3P_1 . Mercury atoms in this state reradiate energy at the same wavelength, 2,537 Å. If the vapor is at very low pressure and no foreign gases are present, most of the energy absorbed from beam 1 by the 6^1S_0 atoms is given off as resonance reradiation by these atoms returning from the 6^3P_1 to the 6^1S_0 level. When an atom is excited into the resonance state, it eventually loses or gives up its energy of excitation, by one of two mechanisms: (1) collision with other mercury atoms, foreign atoms or molecules, or walls of chamber, and (2) re-radiation of energy to ground state.

If the pressure is low enough and

the mean free atomic path long enough, most of the energy is given off as reradiation. Reradiation will take place all along the path of the beam 1; therefore it is imperative that beam 1 be outside the visible portion of the spectrum.

As shown in Fig. 1B, absorption of 4,358-Å photons will raise the 6^3P_1 atoms to the 7^3S_1 level. From this upper level, the further excited atoms may radiate 4,358, 4,047, and 5,461 Å in returning to the 6^3P_1 , 6^3P_0 , and 6^3P_2 levels respectively. The fluorescence of the 5,461-Å line is of particular interest: due to the shape of the human eye response curve, the 4,358 and 4,047-Å lines are at the low extremes of human visibility, whereas the green 5,461-Å line is almost at the peak of the curve. The display chamber can be designed to depend on the absorption of 4,047 Å instead of 4,358 Å to arrive at the 7^3S_1 level for the green fluorescence. Hence excitation number 2 is at wavelength $\lambda_2 = 4,047$ Å. The addition of a foreign gas such as nitrogen into the chamber creates 6^3P_0 atoms by colli-

Simplex Electronic Cables . . .

Float at Sea

Eliminate Hosing Problems

Link Rockets to Ground Control

Many inner space projects require cable that will not sink to the ocean floor. To meet such requirements, Simplex has designed and produced special cables with built-in flotation. If desired, cables can be designed with plastic tubes to be used as gas, pneumatic or hydraulic lines.

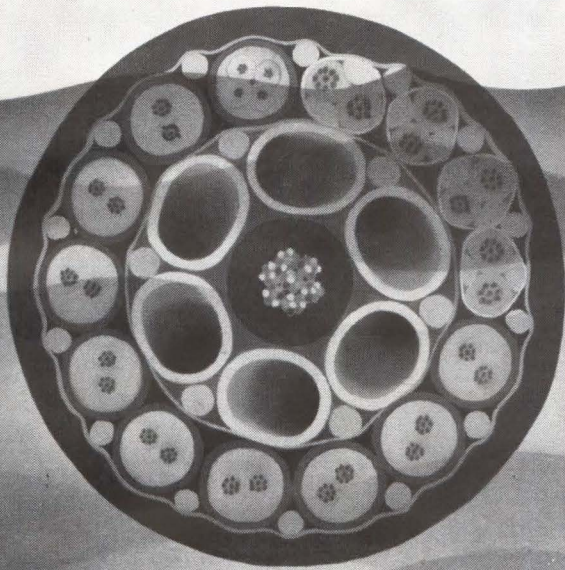

For the growing number of installations where hosing of water through a cable could cause serious trouble, Simplex offers a "non-hosing" cable construction. Cables with this construction contain a special filler compound which eliminates wicking action even if the cable jacket is damaged.



Umbilical cables manufactured by Simplex are used to connect rockets to their sites before firing. Essential characteristics of these cables include flexibility, exceptional reliability, resistance to mechanical damage and chemical attack by exotic fuels.

There's a Simplex electronic cable to meet virtually every existing application involving the transmission of power, control and communications. And Simplex has unique capabilities for solving any problems you may encounter in these areas. For further information, write Department 365, Simplex Wire & Cable Co., Cambridge, Mass.



Simplex
WIRE & CABLE CO.

EXECUTIVE OFFICES: Cambridge, Mass.

Plants at Cambridge, Mass., Portsmouth, N.H.,

Westbury, L.I., Monrovia, Calif.

CIRCLE 53 ON READER SERVICE CARD



R-F FILTERS

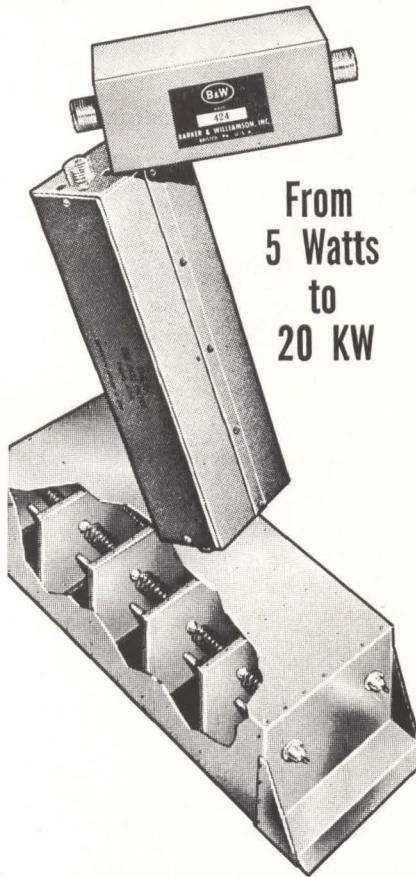

From
5 Watts
to
20 KW

- Spurious frequencies radiated by HF radio transmitters can be effectively suppressed with B & W filters.
- Our Models 425 (52 ohms) and 426 (75 ohms) handle a kilowatt, start cut-off at 40 mc, provide 85 db attenuation through the TV bands.
- Our Model 424 for transmitters under 100 watts provides 60 db suppression through the TV bands.
- 10, 15 and 20 KW units have been manufactured to customers' specifications.
- If you have "spurious" and "harmonic" problems, B & W can provide a solution.

BARKER & WILLIAMSON, Inc.
Radio Communication Equipment Since 1932
BRISTOL, PENNSYLVANIA • Stillwell 8-5581

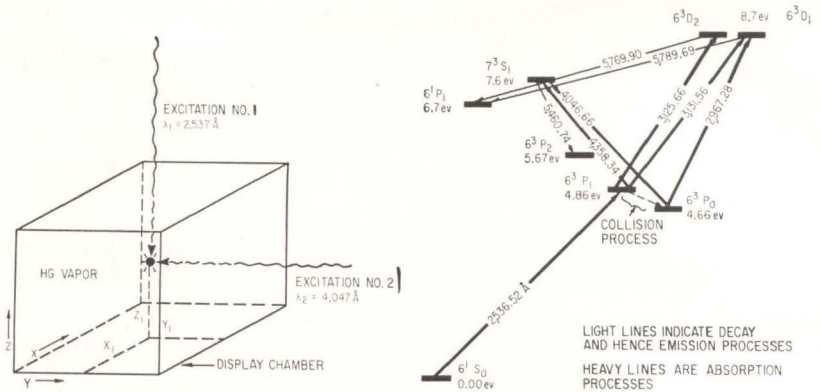

DUAL EXCITATION in space of mercury vapor, (A); mercury energy level diagram showing pertinent states of atom excitation, (B)—Fig. 1

sion with the resonance 6^3P_1 atoms. The reason for this substitution is the longer lifetime of these "metastable" 6^3P_0 atoms and consequently a higher rate of adsorption of 4,047 than 4,358Å for the same intensities of beams 1 and 2.

As a summation, it may be said now that beam 1 (2,537Å) upon passing through the chamber, is absorbed by the ground-state Hg atoms and raises them to the resonance 6^3P_1 level. Collisions of 6^3P_1 level Hg with N_2 molecules result in the creation of 6^3P_0 atoms which may then partly absorb beam 2 (4,047Å). The passage of beam 2 through the chamber causes no change in the Hg vapor energy states unless 6^3P_0 atoms are present in its path. Unless there are 6^3P_0 atoms present, Hg vapor is completely transparent to this wavelength. Thus, at the region of inter-

(1) Intensity of the source of light from within the 3-D chamber is determined by the intensities of excitations 1 and 2 and the line widths, the absorptivity $K\lambda_1$ and $K\lambda_2$ and the lifetimes of the 6^3P_1 and 6^3P_0 states.

(2) Uniformity of source intensity throughout the chamber volume for given values of beams 1 and 2 depends largely upon the attenuation of beam 1 as it penetrates the chamber, since absorption occurs all along its length.

(3) Resolution and size of the chamber fluorescence will depend largely upon the degree of collimation and cross section of the two excitations, the diffusion rate of 6^3P_0 atoms as compared with their half life and secondary effects such as 2,537Å scattering because of re-radiation of excited Hg vapor.

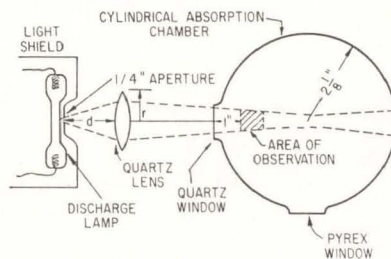

EXPERIMENTAL DISPLAY layout shows actuating beam focused into chamber through quartz glass window at left—Fig. 2

section of the two beams, 7^3S_1 Hg atoms are created by the absorption of 4,047Å and one observes the green radiation of 5,461Å by the decay process of 7^3S_1 atoms to the 6^3P_2 state.

Among the factors important for achieving a 3-D display device the following are listed in terms of the resonance mechanism:

EXPERIMENTAL DISPLAY — With an experimental display chamber, a diffuse source of green fluorescence was produced. The absorption chamber was illuminated by a slowly convergent unfiltered beam entering the quartz window as shown in Fig. 2. The brightness figure of 6×10^{-6} lumens/cm² is a light output readily visible in a semi-darkened room. Comparison of this result with the figure of 2 lumens/sq. ft as an acceptable brightness for a cathode-ray-tube presentation indicates that a factor of about 300 in amplification of fluorescence is needed.

REFERENCES

- (1) C. Fuchtbauer, Excitation of Mercury Spectral Lines, *Phys Z.*, **21**, p 635 1920.
- (2) R. W. Wood, Controlled Optical Transfers in Optically Excited Mercury Atoms, *Proc Roy Soc* **106**, p 679, 1924.
- (3) M. L. Pool, Measurement of the life of the metastable mercury atom, *Phys Rev* **33**, p 22, 1929.

Of interest to engineers and scientists

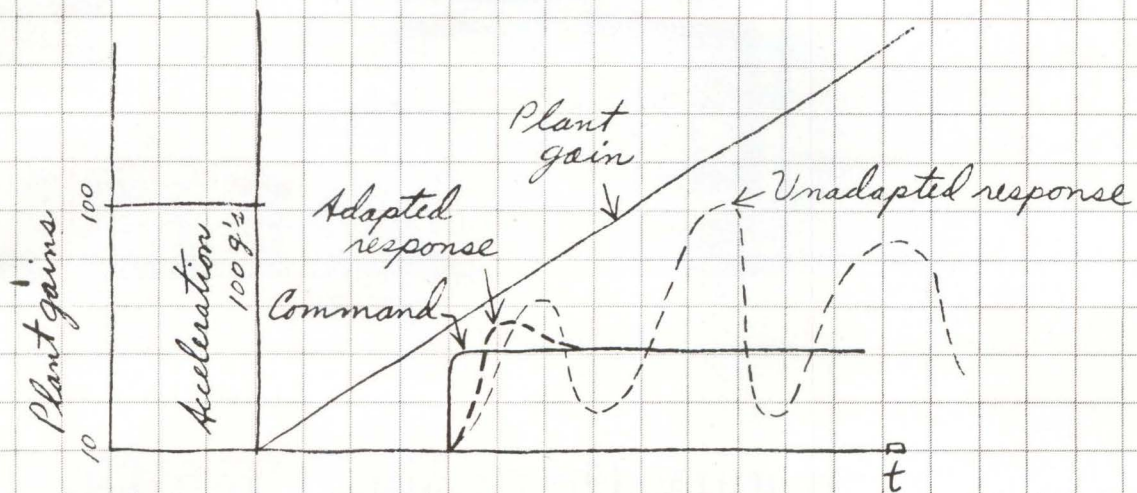

ADAPTIVE FLIGHT CONTROLS

... among the more than 500 R&D programs under way at Douglas

Douglas is developing adaptive control systems for a wide range of vehicles from atmospheric anti-ICBM missiles to space craft designed for interplanetary missions.

Digital and analog computers are being employed to process vehicle flight parameters and vary control system parameters to obtain optimum response. Adaptive schemes use advanced mathematical techniques (e.g.—the second method of Liapunov). Complete non-linear system simulation is accomplished on the analog to digital—digital to analog facility.

Hot gas servo systems and high pressure (6-20,000 psi) light weight hydraulic servos are currently in the process of being developed for use with this program.

Of career interest to engineers and scientists

The foregoing is only one of many areas in which Douglas offers stimulating assignments

which will lead to professional advancement.

Expanded research activity plus a wide range of vital current aerospace programs like Saturn S-IVB and Zeus allow Douglas to offer superior career opportunities in a great variety of disciplines. There are prime openings at all degree and experience levels, including many for executive personnel.

Send us your resume or fill out and mail the coupon. Within 15 days from the receipt of your letter, we will send you specific information on opportunities in your field at Douglas.

Mr. W. C. Ames J-152
Douglas Missile & Space Systems Division
3000 Ocean Park Boulevard
Santa Monica, California

Please send me full information on professional opportunities in my field at Douglas.

Name _____

Engineering or scientific field _____

Address _____

City _____ State _____



MISSILE & SPACE SYSTEMS DIVISION

An equal opportunity employer

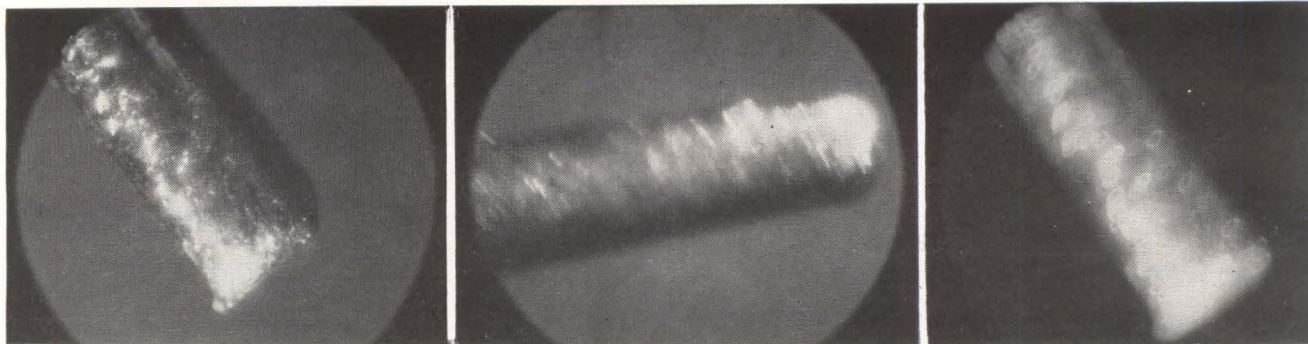

PHOTOMICROGRAPHS of ultrasonic tool tip. Tip is shown prior to being energized (left), when set in longitudinal motion (center), and when tip is set in elliptical motion, (right). Bright points of light reflected in motionless tip show up as linear streaks and as elliptical rings. End of flat tip measures about 0.020 inch by 0.080 inch—Fig. 1

Ultrasonic Rotary Drive May Open Up Many New Applications for Micro Devices

Small diameter shafts can be driven at extremely high rotational speeds

By LEWIS BALAMUTH
Cavitron Ultrasonic, Inc.,
Long Island City, New York

IN MANY USES of ultrasonic vibrators, accidental phenomena arise which produce rotational motions. For example, in observing an ultrasonic impact grinder operating with its flow of abrasive slurry, a ball of the wet abrasive climbs up the side of the vibrating tool which spins there in apparent defiance of gravity.

The fact that a vibrator is cyclic in its motion and that rotational motion is also cyclic is undoubtedly the underlying cause of most of the "vibration-into-rotation" transformations commonly seen.

This article deals with background of the development of some new vibration-into-rotation transformations. Details of adaptations of this new principle are also presented.

DEVICE—This type of ultrasonic vibrator comprises a nickel lamination stack transducer coupled through a Monel, stainless steel, or

beryllium copper transmission line to a bent tool at the output end. Nominal operating frequency is 25 Kc. The stack is windowless, so that the coil, whose alternating magnetic field excites the stack, sur-

rounds it without coming into contact with it. This is of the utmost advantage where it is required to change the vibrators quickly or where rotation of the entire tool is desired. A handpiece is composed

WHAT MICRO ROTOR CAN DO

THIS WEEK ELECTRONICS examined an ultrasonic rotor principle, whose applications in the microworld of electronics and electromechanical devices seems to be limited only by the creative ingenuity of designers of both solid-state components and tiny rotary gear mechanisms.

Not only is it possible to drill micron-sized holes in electronic materials and components, but rotary motion developed from vibrational energy may be applied to servodrives, tiny control circuits, and drives in sophisticated aerospace systems where temperature extremes would normally create problems for conventional drives.

Principle allows shafts or tool stems, whose diameters are in the range of three millimeters or less to rotate at speeds in the order of ten-thousand to several-hundred-thousand revolutions per minute.

Rotor drive can be made to vibrate along its axis. Further, a cluster of driving shafts can be designed to operate electro-mechanical drives. A similar cluster of driving shafts can also be used as a drill for shaping and polishing a series of tiny holes in very hard materials such as germanium, silicon, ferrite, barium titanate, tungsten carbide, diamond, or laser crystals.

Developed as a high-speed dental drill, the principle should be further explored by engineers familiar with microelectronic technology

of a housing on which is wound a coil of copper wire. Coil is shielded from the operator's hand by means of a plastic sheath of high dielectric strength. The cable which connects the handpiece to the generator source of alternating high frequency current contains not only conductors but also a water line to provide for cooling of the handpiece. Water cooling is generally recommended, from experience, when the input power to the handpiece is of the order of 30 watts.

Elliptical vibrations have been repeatedly observed microscopically for various bent tips developed for dental use. Figure 1 shows photomicrographs of bent tips illustrating the motions.

In the dental uses of these tips, the effect of the elliptical vibrations was chiefly twofold. In the first place drilling rates were materially increased for elliptical vibrations as compared with linear vibrations of like magnitude. In the second place patient comfort was enhanced, due to the large friction reducing effect.

CONVERSIONS—Having established the necessary background, the vibrator-into-rotation conversion possibility of elliptical or circular vibrations will be explained.

First, it was often observed that a small ball of abrasive slurry would mount the side of the tip and spin at about a quarter inch from the vibrating output end. Secondly, cavitation spray from a bent tip showed a clear nodal region of flexural motion, Fig. 2.

The next developmental step was to use this motion to drive a shaft so as to have a high speed drill of small diameter suitable for dental and industrial use.

Continuous variation of rotational speed is obtained by controlling the length of the driving stroke of the cyclic vibrations. Other advantages are: instant starting and stopping, silent operation, good cutting torque, torque control, and the absence of fluid drive avoids unwanted spray.

In practice it has been found that such reciprocation at high frequency greatly reduces the grinding sound when drilling brittle materials. At the same time enhanced material removal rates are also

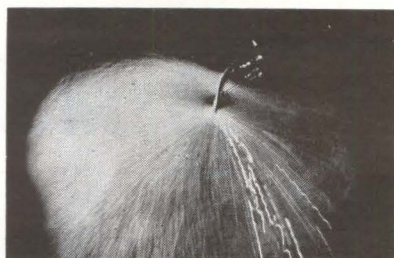

CAVITATION spray from a bent tip shows a clear nodal region of flexural motion—Fig. 2

found. For glass, preliminary studies show increased rates of material removal using carbide burrs, of from 4 to 50 times those found with the same drill without the high-frequency reciprocation.

PRINCIPLE—Simple explanation of rotor is this:

Driving force for rotor is applied to a circular shaft by generating rapidly-repeating ovaloid or elliptical cyclic motion strokes at the driving tip of a transducer assembly. Each stroke is a wiping action that can be compared to the foot motions of a lumberjack trying to maintain his balance on a rolling log.

Drive shaft may be rotated at theoretical rotative speeds expressed by this formula:

$$N = \frac{S}{D} f$$

where N is the number of revolutions per second of the tool stem; S is the length of the driving stroke of the high-frequency cyclic vibrations; D is the diameter of the circular shaft at the driving area; and f is the number of cyclic vibrations per second executed by the driving tip.

If diameter of shaft (D) is one-eighth of a millimeter, and the transducer assembly generates 40,000 ovaloid or elliptical motions cycles per second (f), at the driving surface of its driving element with a driving stroke (S) of one-twentieth of a millimeter or two thousandths of an inch, the tool shaft would be rotated at a theoretical speed (N) of approximately 960,000 revolutions per minute.

Methods and means for driving small diameter shafts at high rotational speeds discussed in this article were developed by author working in cooperation with Claus Kleesattel and Arthur Kuris.

True Torque Control

NO MORE SCRATCHED FIXTURES

ELECTRONIC COMPONENT MANUFACTURER USES CLECOMATIC* BECAUSE . . .

(1) Fragile cabinets were being marred by old fastening methods. The Model 10RSA-10 CLECOMATIC with the automatic start/stop feature has eliminated damaged screw heads, scratched cabinets and cracked surfaces.

(2) Air tool operates only while driving the fastener. Wasted air is eliminated. Parts wear drastically reduced.

If you have a trouble spot on your production line, call your nearest CLECO Representative. He can help you.

*Fully warranted for one year by the GOLDEN CIRCLE guarantee



A DIVISION OF REED ROLLER BIT COMPANY P. O. Box 2541 • Houston, Texas



High performance Mallory batteries

Exploring new ideas in self-powered products . . . instruments, portable radios, depth finders, cameras? The new generation of premium-performance Mallory batteries can help you make your product smaller, more reliable, more convenient to use . . . more appealing to your customers. One or more of these Mallory developed battery systems may provide the extra touch your product needs.

Transistorized AC Voltmeter, by Radiation Electronics, is small, compact, multi-range . . . applicable to audio and r-f measurements. Power supply is two Mallory TR-135R Mercury Batteries, selected for constant voltage output, long life, small size.

Pocket-size Radiation Monitor, made by Nuclear Corp. of America, small as a pack of cigarettes, gives audible signal and meter read-out of radiation intensity. Transistorized circuit with 25 ma. drain operates 40 hours continuously from a Mallory TR-133 Mercury Battery.

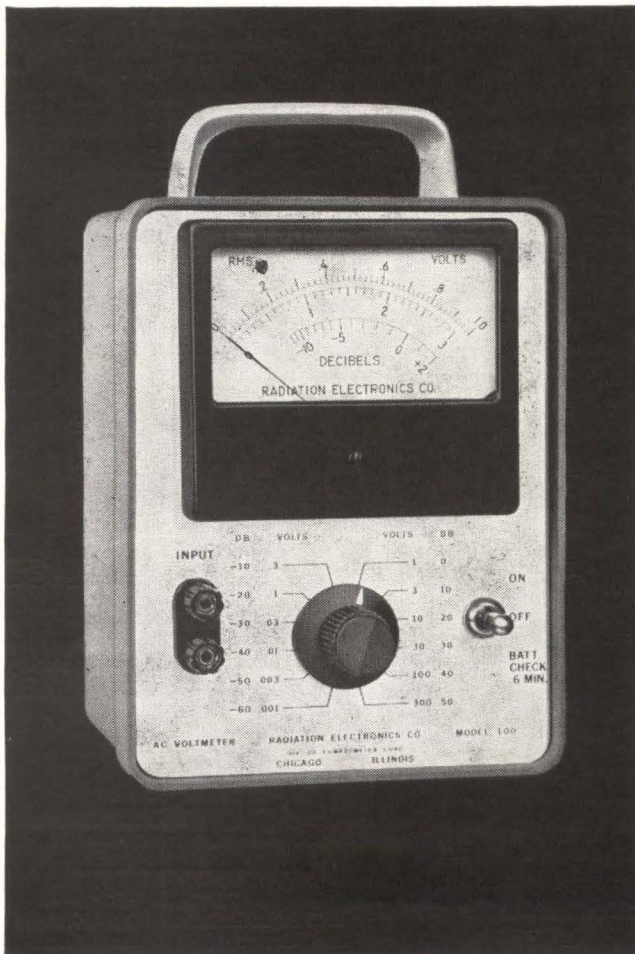

add sales power to cordless products

Mallory Mercury Batteries, best for low and medium drain circuits, have 3 to 4 times more capacity, life and energy/volume than conventional batteries. Precise output voltage, $\pm 1/2\%$ at no load, is suitable as secondary standard. Flat voltage discharge is ideal for transistor circuitry. Shelf life is 5 years or more. In sizes as small as an aspirin tablet.

Mallory Manganese Batteries . . . new alkaline system for medium and high drains. Dependability, service and shelf life exceeded only by Mallory Mercury Batteries. In all standard cell configurations.

Rechargeable Mercury Batteries . . . new kind of secondary cell with primary capacity. Holds its charge a year or more. Self-vented, non-leaking. Supplied with self-regulating solid-state charging circuit.

Solidion® Solid State Batteries . . . the first completely "dry" battery; high voltage, small size, for microampere drains. Shelf life upwards of 10 years.

Mercury-zinc carbon batteries . . . long-life system for cordless clocks, electronic timepieces and other low drain uses.

Write or call today for data and a consultation with one of our application engineers.

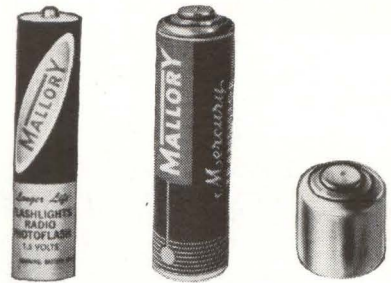

Mallory Battery Company
North Tarrytown, N.Y.

a division of



Mallory Battery Company of Canada Limited,
Clarkson, Ontario; Mallory Batteries, Ltd.,
Crawley, England

Radar Sentry sounds warning to motorists when a traffic radar beam is intercepted. Compact 13-ounce unit, made by Radatron, Inc., is mounted under the sun visor. Two Mallory Mercury Batteries provide over 1000 hours of service life.

Stethotracer made by Don Bosco Electronics, Inc., detects, demodulates audio or modulated r-f signals and amplifies 1000X for electronic trouble-shooters. Uses penlight Mallory Manganese Battery whose "long life provides reliability for our products."

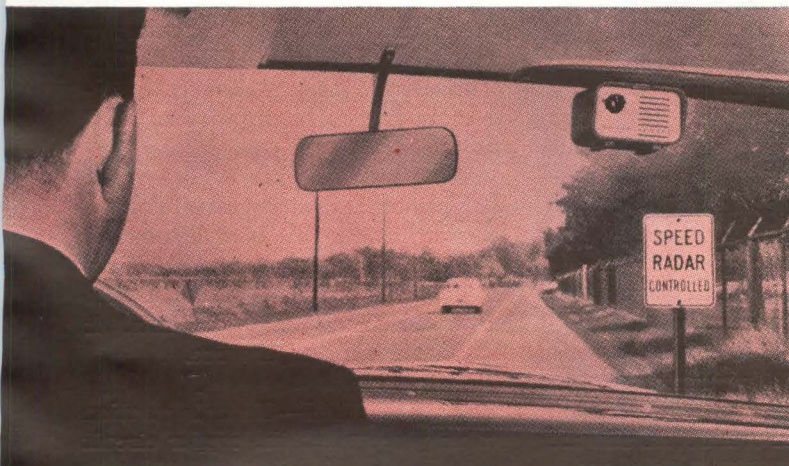

Sintering Toughens Printed Circuits

Increased flexibility, economy and process simplification claimed

By P. R. WHITE and R. F. JACK
Bell Telephone Laboratories
New York, N. Y.

NEW TECHNIQUE, in which sintered copper conductors are mechanically bonded to a plastic substrate, holds promise of making highly durable and reliable circuits that can be economically manufactured. Conductors are formed in flat metal circuit-configuration dies. Circuit grooves hold powdered copper for pressing and sintering operations. Then, the circuit die is placed as an insert in a plastic molding die. During molding, the sintered circuit is mechanically bonded to a plastic base and is subsequently released from the circuit die.

PROCESS — The sintered-circuit process consists of these basic steps:

- (1) The die's circuit grooves are filled with copper powder.
- (2) A thin rubber mat is placed over the metal die.
- (3) The copper powder is compressed through the rubber at approximately 50,000 psi.

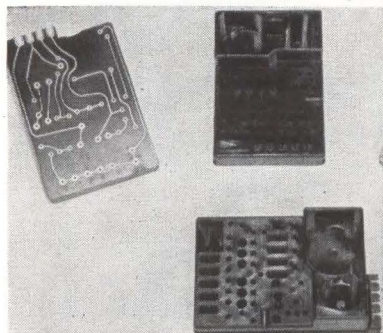

SINTERED-COPPER conductors for E6 telephone repeater provide the first full-scale trial of sinter technique

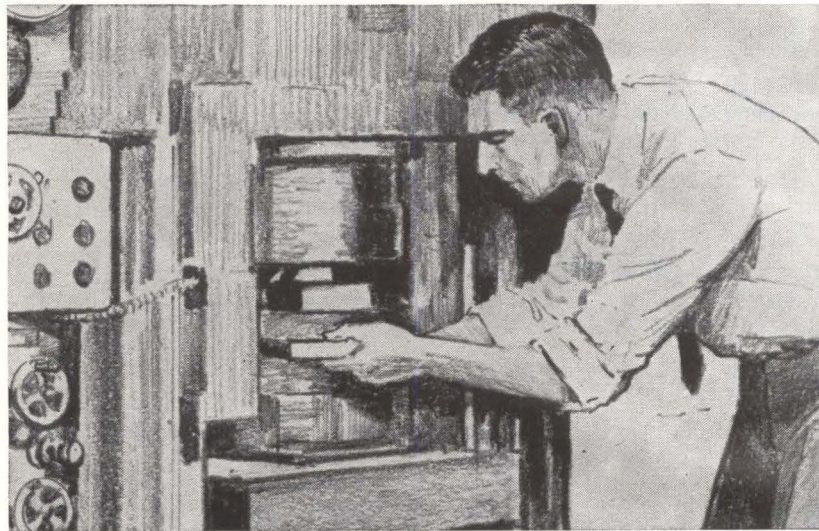

POWDERED COPPER is compressed at 50,000 psi into circuit-groove die prior to sintering in a reducing atmosphere. Rubber mat is used directly over circuit die

- (4) The pressed powder circuit is sintered in place in the metal die in a furnace for approximately 15 minutes at 930 degrees F in a reducing atmosphere.
- (5) The molded assembly is formed by pressure-molding an insulating material, such as plastic, to the sintered-copper circuit while still in the die.

Circuit grooves should be no less than 0.025-inch deep. Cross-section of grooves should have a draft angle of about 5 degrees to help release the circuit from the die after molding. Bottom corners of grooves can be sharp or rounded, but there should not be any undercuts.

During the pressing step, the copper powder is compacted to almost one-half of its original thickness in the grooves. The copper powder, which is forced against the polished circuit grooves forms smooth conductor surfaces. The back of the copper powder in contact with the rubber mat is left rough and slightly porous to provide for the strong mechanical bond between sintered conductors and the

molded plastic base. During the first stage of the molding step, the plastic penetrates under 50,000 psi pressure into the interstices of the rough sintered copper. Since the bond is mechanical, the back of these conductors can be oxidized during the molding operation without having any detrimental effect on the bond. With certain plastics, an oxidized copper surface may actually increase the bond strength. Thermoplastic as well as thermosetting molding compounds can be used for the insulating substrate.

Although conductors could be made by using much lower pressures, they would not be as strong nor as conductive as desired. The conductivity of the sintered conductors is equivalent to that of 2 oz. copper foil.

The pressed copper is sintered in any atmosphere that will reduce the copper oxides at 930-degrees F. After 15 minutes in the 930-degree F heat zone, the die is pulled into a water-cooled chamber until it reaches room temperature.

PRECAUTIONS—Sintering action takes place when the copper circuit

Problem for you:

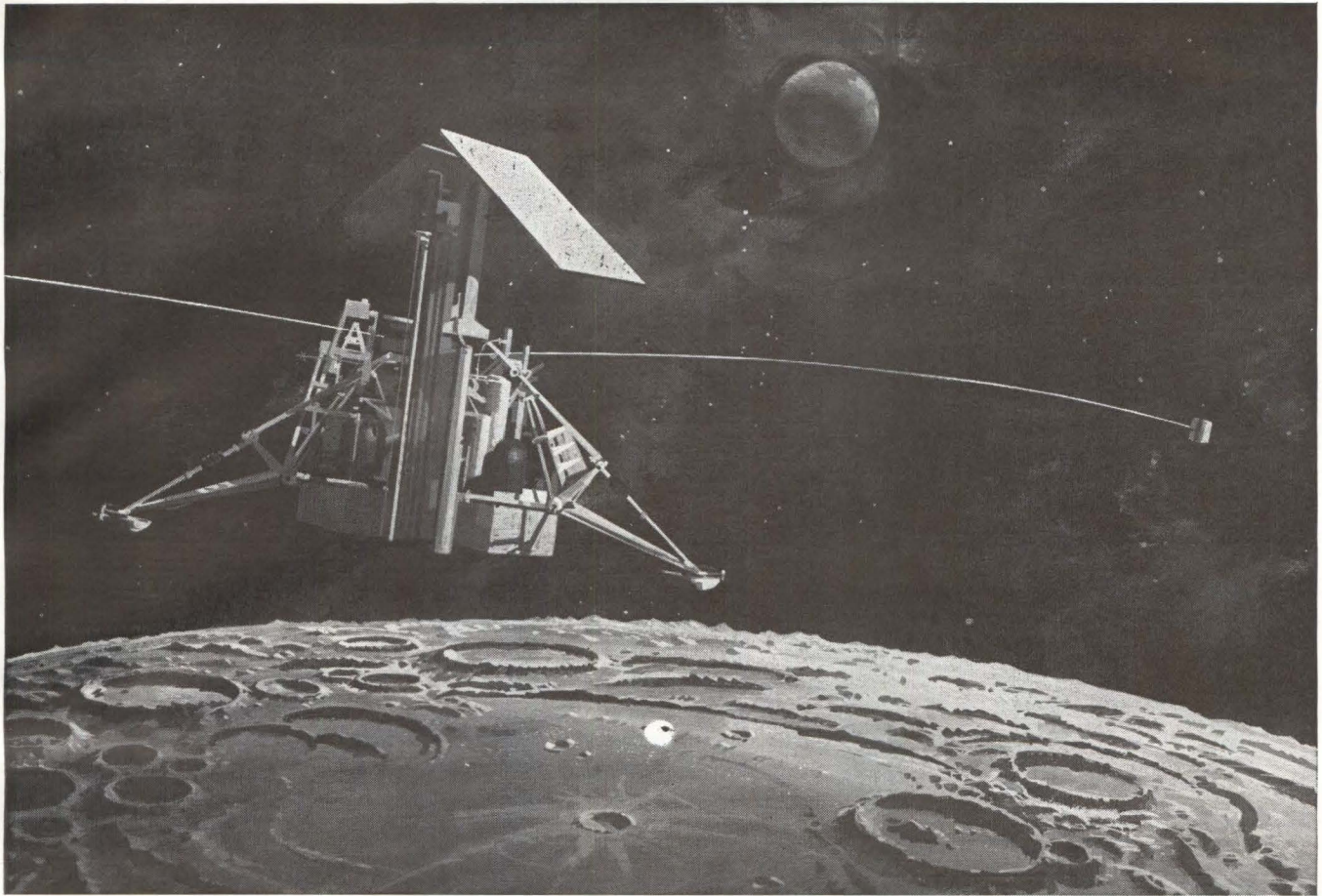

Soft land this vehicle on the moon

This spacecraft is SURVEYOR, one of the many important projects now under way at Hughes. It will "soft" land on the moon sometime in 1964. Its mission: to pierce and analyze the moon's surface; to transmit back to earth high quality television pictures; and to measure the moon's magnetic and radiation characteristics. To accomplish these demanding objectives, Project Surveyor requires the talents of many imaginative junior and senior engineers and physicists to augment its outstanding staff. A degree from an accredited university and U.S. citizenship are required. Experience in Aerospace Vehicles is preferred but not necessary. A few of the openings include:

CONTROLS ENGINEERS. Concerns airborne computers and other controls related areas for: missiles and space vehicles, satellites, radar tracking, control circuitry, control systems, control techniques, transistorized equalization networks and control servomechanisms.

CIRCUIT DESIGNERS. Involves analysis and synthesis of systems for: telemetering and command circuits for space vehicles, high efficiency power supplies for airborne and space electronic systems, space command, space television, guidance and control systems, and many others.

INFRARED SPECIALISTS. To perform systems analysis and preliminary design in infrared activities for satellite detection and identification, air-to-air missiles, AICBM, infrared range measurement, air-to-air detection search sets, optical systems, detection cryogenics and others.

SYSTEMS ANALYSTS. To consider such basic problems as: requirements of manned space flight; automatic target recognition requirements for unmanned satellites or high speed strike

reconnaissance systems; IR systems requirements for ballistic missile defense. Inquire today. Please airmail your resume to:

Mr. Robert A. Martin,
Head of Employment,
Hughes Aerospace Divisions,
11940 W. Jefferson Blvd.,

Culver City 10, California.

We promise a reply
within one week.

creating a new world with electronics

HUGHES

HUGHES AIRCRAFT COMPANY
AEROSPACE DIVISIONS

An equal opportunity employer.



AM·FM Tuner Unit

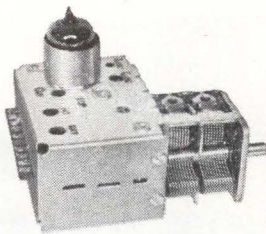

AM SEC. CAPACITY: MAX. 377FF
: MIN. 12PF
TUBE: 6AQ8, 12DT8, 17EW8

PLASTIC VARIABLE CONDENSER

Square Size:
1 5 mm., 1 7 mm.,
2 0 mm., 2 1 mm.,
Single band
2 band, 3 band
and for FM only.

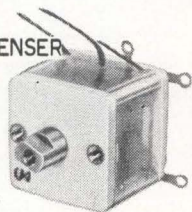

SANKAISHA CO., LTD.

Cable address: SANESVARICON TOKYO
1425, 4-chome, Higashinakanobu,
Shinagawa-ku, Tokyo, Japan.

CIRCLE 202 ON READER SERVICE CARD

electronics

Editorial Opportunity

IT DOESN'T HAPPEN OFTEN, but **electronics**, "bible of the industry" and a McGraw-Hill publication, has an opening for an Assistant Editor.

Ideally, the man we are looking for and to whom a post on our New York staff could be a long-term challenge, would have an electrical engineering degree or technical equivalent, practical experience in our field and a demonstrated aptitude for editing, writing, reporting. He probably lives somewhere in the metropolitan area and therefore would have no relocation problem.

Write **The Editor, electronics**, 330 W. 42nd St., New York 36, stating experience, aspirations and past earnings. Mark the envelope "Confidential" and it will be kept that way.

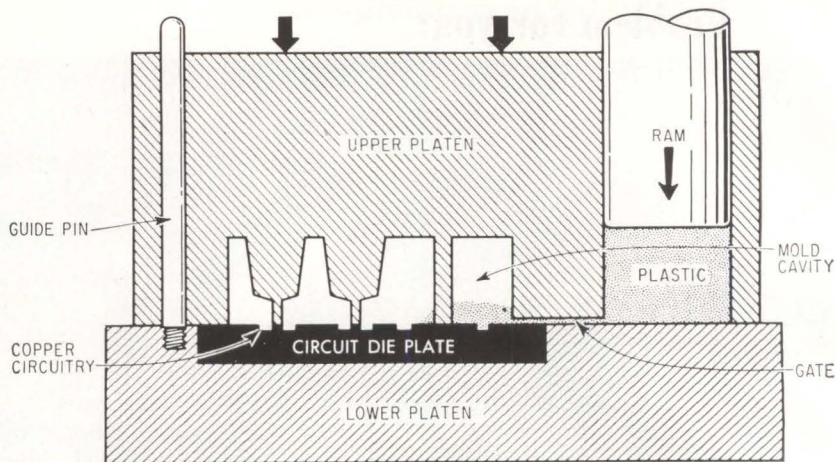

PLASTIC INSULATING material is pressure-molded to sintered copper circuit while it is still in die

gets above 750-degrees F. However, a large part of the total furnace heating time is used in getting the mass of the die up to this temperature. Cycle time may be reduced by induction heating or by using a high-temperature preheat zone.

The longer the copper is sintered and the higher the temperature, the more dense and more ductile the conductors become. If the temperature is too high, however, the metal die may soften. Therefore since the cost of dies is not usually very high, a continuous belt furnace is recommended for taking the dies through the controlled atmosphere and then through a cooling environment set at a desired temperature.

Conductors produced by this process are raised approximately 0.025 inch from the surface of the molded plastic. They can therefore be readily cleaned by mechanical cleaning methods such as rubbing with steel wool, glass fiber brushes, wire or rubber wheels, abrasive paper. The rubber wheel appears to be the most feasible method. They should not be cleaned by chemical methods because ionic contaminants may be trapped in the conductors.

ADVANTAGES — After cleaning, the boards are fluxed with a non-corrosive rosin flux and solder-coated by floating them on top of a 60:40 tin-lead solder bath at 475-degrees F. The excess molten solder can then be readily shaken off. Since the bond is mechanical and the thermosetting plastic is not very susceptible to degradation during the short time at this soldering tem-

perature, the boards can be soldered and resoldered several times without affecting the circuit or the bond.

A further advantage is that circuit dies can be designed so all component lead wire holes are molded into the assembly. No drilling or punching will be required. This can be done by having a small pin in the center of the land area contact a tapered pin in the plastic-molding die.

AUTOMATION—The process can be readily automated. Since only the desired copper circuit is bonded to the insulating base, no unwanted material has to be removed by chemical etches or matching. This means that the high-resin content on the surface of the molded plastic base is retained and that this surface is not contaminated by any chemical etchants.

APPLICATIONS — Sintered circuits will be particularly effective where assemblies may have to be repeatedly resoldered and subjected to high mechanical stresses and high operating temperatures.

By placing special inserts in the grooves prior to filling with copper powder it is possible to obtain wear resistant contacts and even permit the conductors to go around corners.

Where mechanical details such as cavities to hold components, guides for attachment to other apparatus or identification markings are desired in addition to the circuit, this process will find extensive application.

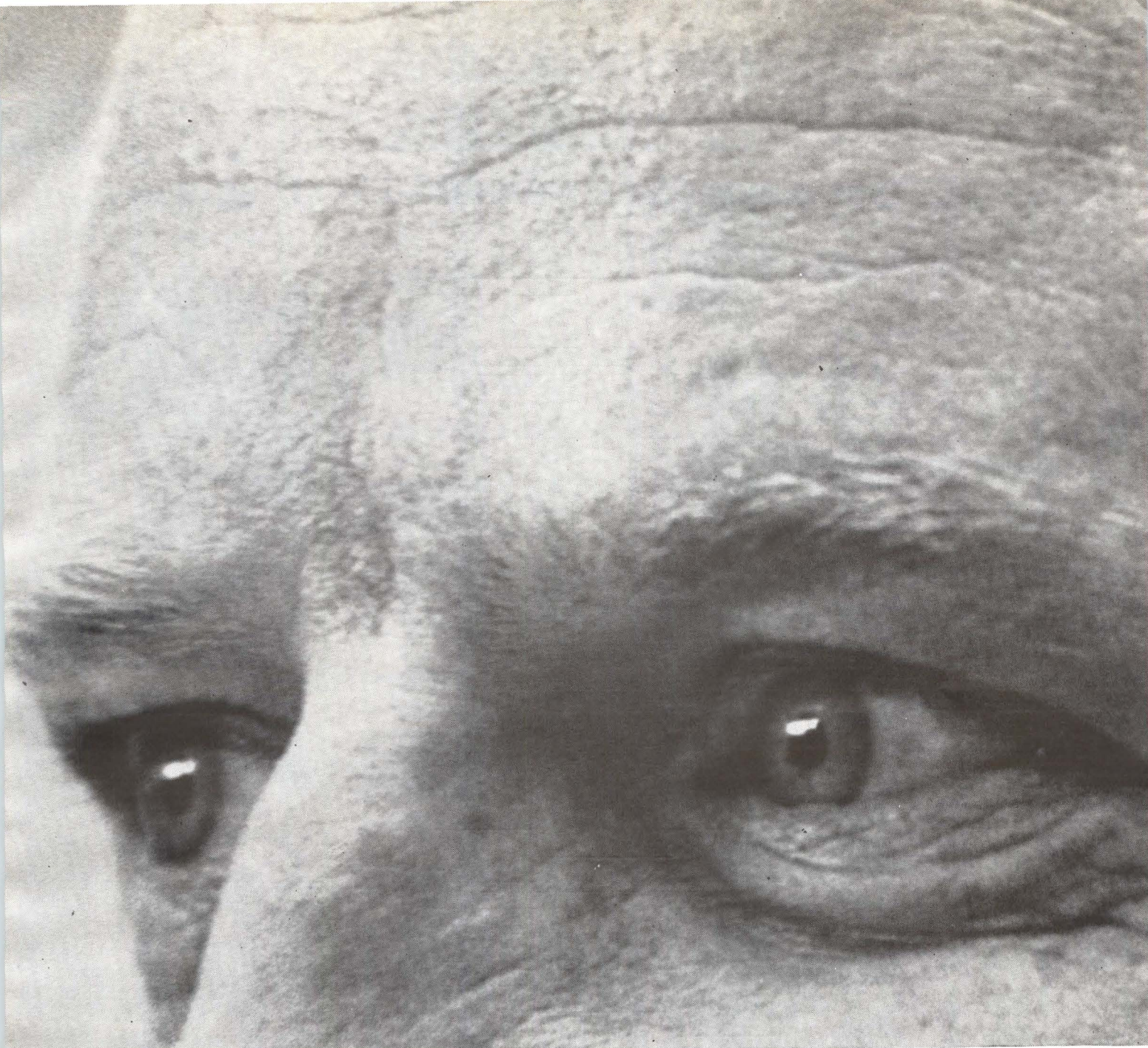

The moment of insight is a private thing.

It can happen anytime, anywhere. Somewhere in the mind the barrier to a solution crumbles. Everything suddenly slips into place. It can't be forced or commanded. But it comes about most often in a climate of mutual respect and recognition. This is the kind of climate you'll find at Northrop.

You'll also work in a climate of constant professional challenge at Northrop. We have more than 70 active projects in work, and we're always evaluating new lines of inquiry. Present programs cover such fields as interplanetary navigation and astro-inertial guidance, aerospace deceleration and landing, man-machine and life support systems for space, automatic checkout and failure prediction systems, laminar flow control techniques, undersea technology and world-wide communications.

Why not get in touch with us, and talk things over? Write to Dr. Alexander Weir, Northrop Corp., Beverly Hills, California, and tell us your field of interest. You'll receive a prompt reply.

NORTHROP
AN EQUAL OPPORTUNITY EMPLOYER

Temperature Measurement at a Distance

Portable unit measures 1,250 to 5,500 F between 3 inches and 50 feet

ANNOUNCED by Pyrotel Corp., 225 Valley Place, Mamaroneck, New York, the model PY15 infrared pyrometer is a portable, self-contained battery-operated instrument used to indicate temperature of hot surfaces between 1,250 and 5,500 F at distances dependent on the physical size and temperature of the target. Available span is 100 to 2,000 F. The distance will range from 3 inches for a small object to 40 to 50 feet for a larger one. The direct view optics has a normal field of view of 1.5 degrees, and accuracy is ± 2 percent of tem-

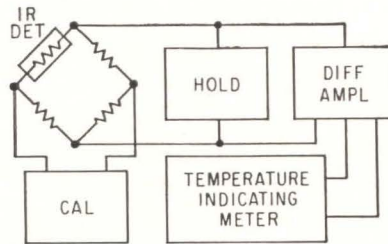

perature (black body calibration). As shown in the sketch, the circuit consists of an infrared detector in a bridge connected to a differential amplifier driving a temperature-calibrated meter. An electronic holding circuit maintains the meter reading for approximately 20 seconds after removal from the target area. A calibration circuit permits meter calibration after ex-

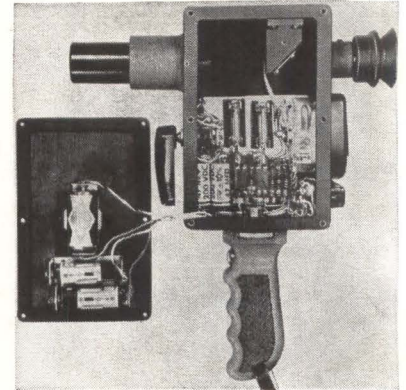

tended use. The unit is $3 \times 4 \times 6$ inches and weighs $3\frac{1}{4}$ lb. An optional pistol-grip handle may be attached to the tripod mounting socket at the base.

CIRCLE 301, READER SERVICE CARD

Generator Features 300-Mc-Wide Sweep

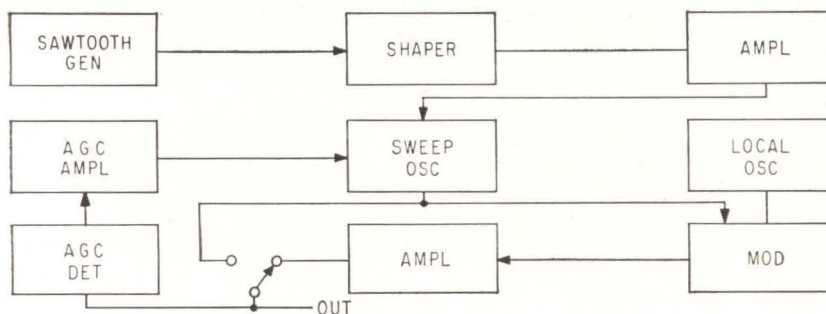

DEVELOPED by Kay Electric Co., Maple Ave., Pine Brook, New Jersey, the model 121-A multi-sweep generator covers the frequency range between 0.5 and 1,100 Mc in frequency sweeps up to 300 Mc wide. Vhf range is from 500 Kc to 300 Mc and uhf range is 180 to 1,100 Mc. Output impedance is 50 ohms with 0.5 v rms level, flat within ± 0.25 db and harmonic distortion is better than 30 db down. The device uses both fundamental and beat frequency oscillator techniques and center frequency and sweep width are continuously variable. As shown in the sketch, output is derived from an oscillator

whose output level is maintained within close tolerances by an agc system. The sweep circuits also develop sawtooth waveshapes and blanking voltages to provide zero reference displays. Internal sweep can be varied down to 15 cps or locked to the line. External sweeps can be used for rep rates down to 1 cps and lower or up to 20 Kc and higher. (302)

Oscillator's Phase Locks To VLF Standard Signal

NEW from RMS Engineering, Inc., 486 Fourteenth St., N.W., Atlanta

13, Georgia, the model SFC-1 vlf phase tracking servo is an electro-mechanical device for continuously measuring accumulated phase difference between two vlf signals (12 to 25 Kc), one of which is derived from a 100 Kc local frequency standard. A synchro transmitter can be coupled to the device to control frequency of the local standard. Output readout is a five-digit counter calibrated in μ sec. Potentiometer output is also available to drive conventional 1 ma recorder with 100 μ sec full scale deflection. Phase tracking accuracy is 1 μ sec and speed is 10 μ sec per minute. As shown in sketch (p 67) the error signal is derived from phase comparison and shifts the phase of the 100 Kc local standard. Accumulated phase shift is displayed on a counter. The servo loop is automatically opened when the received reference signal falls below a predetermined level. A front-panel lamp indicates this condition. The device can also supply a vlf signal phase-locked to the reference signal picked up on the receiver. Such

MR. RELAY *by Allied Control*

1. I SEE
ASTOUNDING
THINGS ABOUT
YOUR SON,
T-154.

TELL ME!
WHAT'S HIS
FUTURE GOING
TO BE?



2. FIRST, HE'LL
HAVE AN
AMAZINGLY
LONG LIFE.

THAT'S FINE.
WHAT ELSE?

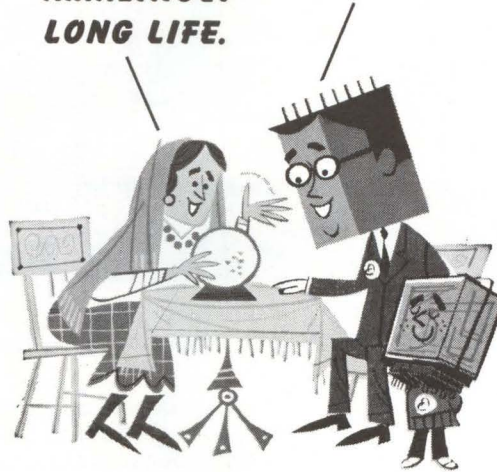

3. WELL, HE'LL BE
THE CHAMPION
IN THE BANTAM
WEIGHT
DIVISION.

SURE, HE'S
SMALL BUT
RUGGED.

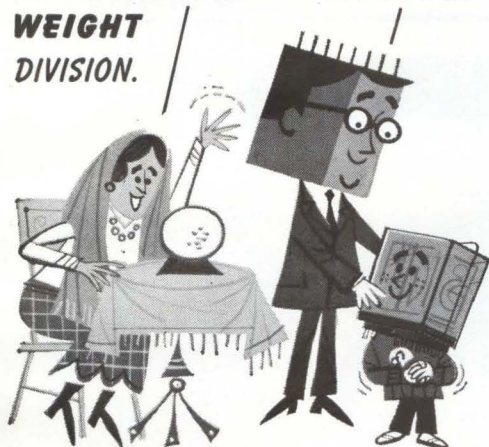

4. GOSH, WHAT A
VISION! I SEE A
BIG T-154 AND
A SMALL \$.

NATURALLY, T-154'S
ABILITIES ARE GREAT.
HE OFFERS SO MUCH
FOR SO LITTLE.



There are *many more* good reasons why the Allied T-154 "cradle" relay has a BIG future. The T-154 is versatile . . . especially suited for long life applications. It features no internal wiring; contact arms are extended to form combination solder and plug-in terminals. The T-154 is simple to install because it mates with easy-to-plug-in solder and printed circuit-type sockets. And this popular relay is sensitive, too . . . down to 50 milliwatts for 1C. Want the T-154 fast? Just call your nearest Allied distributor. Also, write for Allied's complete 4-page Cradle Relay Bulletin which contains a helpful socket guide.

©1962 BY ALLIED CONTROL COMPANY, INC.



AL-226-T

January 11, 1963

| OPERATING CONDITIONS | |
|-----------------------------|---|
| Contact Rating: | Available with low level, 2 or 5 ampere contacts for resistive loads up to 29 volts d-c |
| Contact Arrangement: | Up to six pole double throw |
| Ambient Temperature: | -55°C to +71°C Higher temperature available |
| Operate Time: (at +25°C) | 15 milliseconds maximum at nominal coil voltage |
| Release Time: (at +25°C) | 8 milliseconds maximum at nominal coil voltage |
| Weight: | From 0.80 to 1.0 ounces maximum |

ALLIED CONTROL COMPANY, INC.

2 EAST END AVENUE, NEW YORK 21, N. Y.



CIRCLE 65 ON READER SERVICE CARD

65

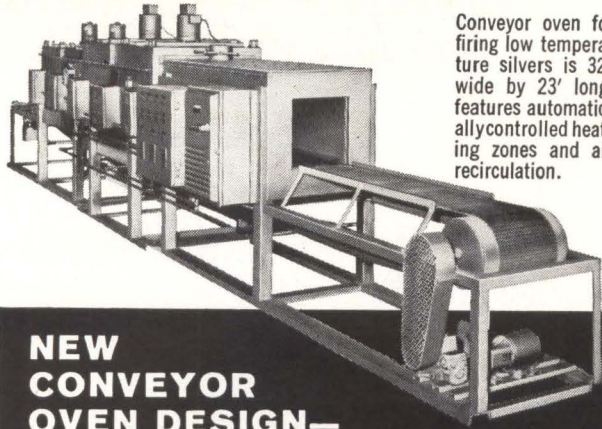

Conveyor oven for firing low temperature silvers is 32" wide by 23' long, features automatic-allycontrolled heating zones and air recirculation.

NEW CONVEYOR OVEN DESIGN— INCREASES PRODUCTION— CUTS COSTS

Exclusively from Trent—a design that gives you fast uniform automatically controlled heat not possible with conventional conveyor units.

You get custom designed heating based on your speed, temperature, gradient and production requirements. The use of standard components assures economy in both operation and maintenance. Discuss your needs with a qualified Trent Engineer or write for Bulletin 75-TD.

201R



203 Leverington Ave., Philadelphia 27, Pa.
Electric & Gas Heated Industrial Equipment

in Canada: Pioneer Electric Eastern Ltd., Toronto

CIRCLE 203 ON READER SERVICE CARD

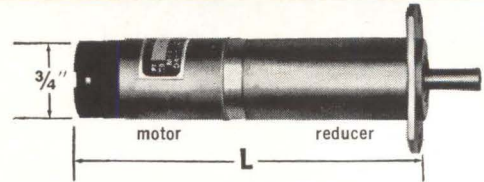

NEW 3/4" GEARHEAD MOTOR

Now you can get up to 300 oz. in. torque from a precision miniature gearmotor only 3/4" in diameter. Globe's new SD permanent magnet d.c. motor with integral planetary gearhead provides 19 standard ratios, wound for 4 to 50 volts. Armatures can be wound to produce any speed-torque combination within the capacity of the motor. Can meet environmental and other applicable portions of MIL-8609. Request Bulletin SDG from Globe Industries, Inc., 1784 Stanley Ave., Dayton 4, Ohio.

| Speed Reduc. Ratio | Max. Cont. Torque In. Oz. | L | Speed Reduc. Ratio | Max. Cont. Torque In. Oz. | L |
|--------------------|---------------------------|-------------------------------|--------------------|---------------------------|-------------------------------|
| 14.58 | 3.0 | | 733 | 100 | |
| 22.03 | 4.5 | 2 ³ / ₄ | 1108 | 150 | 2 ⁶ / ₄ |
| 33.28 | 7.0 | | 1853 | 200 | |
| 55.66 | 10 | | 2799 | 300 | 3 ¹ / ₆ |
| 84.11 | 14 | 2 ⁵ / ₂ | 4230 | 300 | |
| 127.1 | 21 | | 6391 | 300 | |
| 192 | 30 | | 10689 | 300 | |
| 321 | 45 | 2 ⁶ / ₄ | 16150 | 300 | 3 ¹ / ₄ |
| 485 | 70 | | 24403 | 300 | |
| | | | 36873 | 300 | |

GLOBE

GLOBE INDUSTRIES, INC.

CIRCLE 204 ON READER SERVICE CARD

CURTISS-WRIGHT ELECTRONICS...

adding a new dimension to the capability of man

C-141 FLIGHT CREW TRAINER simulates complete aerodynamic performance including the effects of cargo drops. It represents a significant improvement in radio aid capacity—utilizing 320 stations (instead of the usual 6) which can be prepared for global missions eliminating previously required manual changes as the "flight" progressed. Closed circuit TV permits the instructor to monitor the flight path. As with other Curtiss-Wright simulators, attention is paid to all factors affecting realism and human engineering.

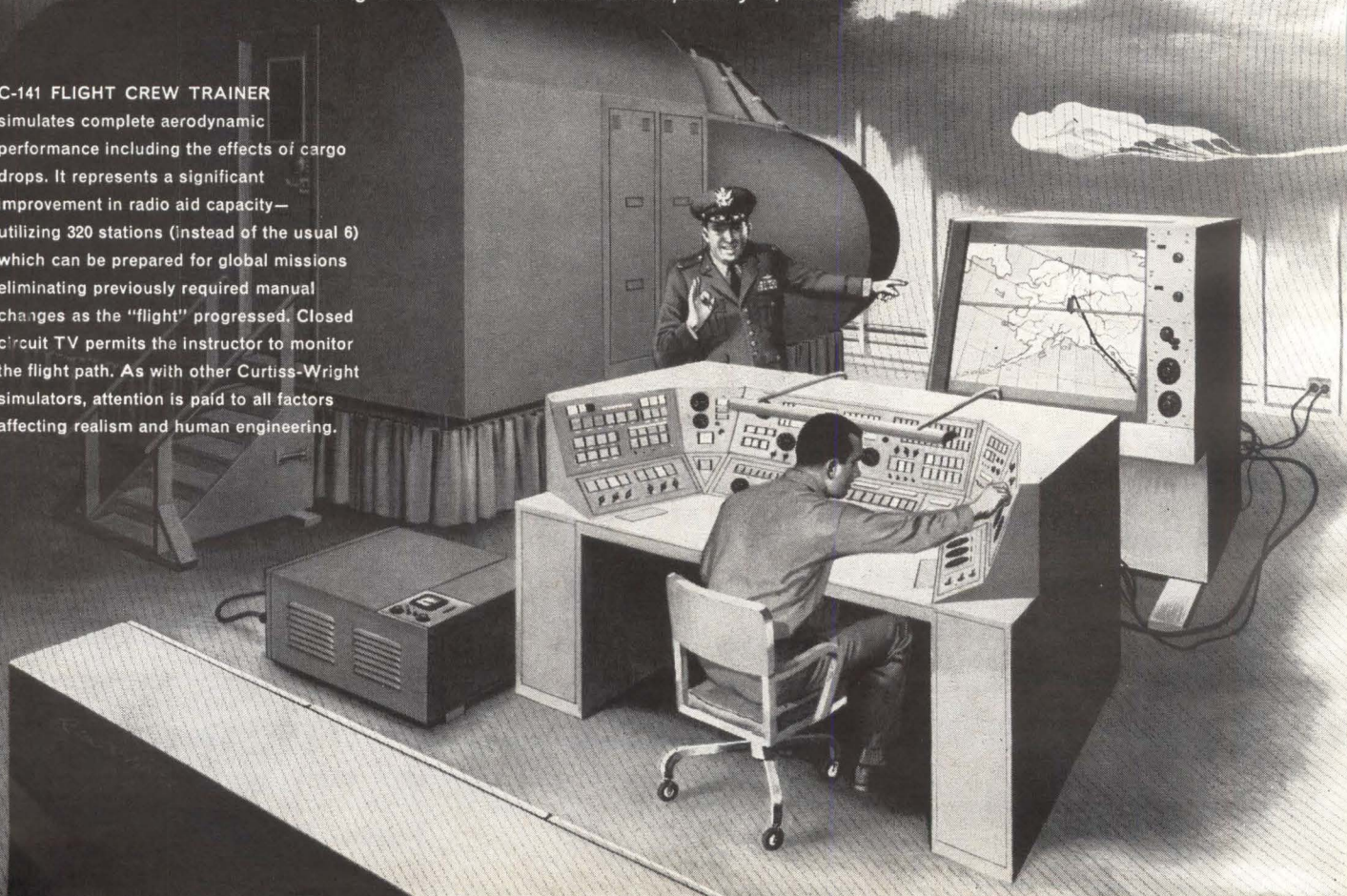

phase-locked signals are cleaner than the received signals and can

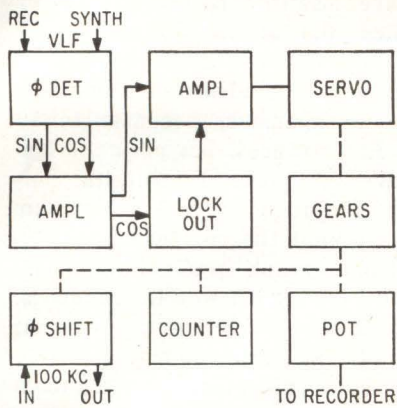

be used to synchronize clocks or can be multiplied up to higher frequencies.

CIRCLE 303, READER SERVICE CARD

Converting Finger Pressure to D-C

MANUFACTURED by Measurement Systems, Inc., 140 Water St., South Norwalk, Connecticut, the model 433 hand control is a two-axis, stiff-

stick transducer that translates finger pressure into d-c output voltages in linear proportion to applied pressure up to 2 v for 10 lb pressure. A force exerted on the control stick produces a deflection of a few thousandths of an inch to unbalance a pair of a-c impedance bridges. Unbalance voltages are amplified and demodulated to produce output voltages of 0.2 v per pound of force at 10,000 ohms output impedance. Human engineering studies have shown that an operator has better control of finger pressure than that of displacement. Pressure on a stiff-stick control produces no noticeable deflection such as occurs on a handwheel or joystick control. Characteristics al-

so include infinite resolution, zero backlash and instantaneous response. In a typical application, the hand control permits single operator control of a tracking radar antenna mount, with device output voltages producing proportional azimuth and elevation angular rates of the antenna mount. (304)

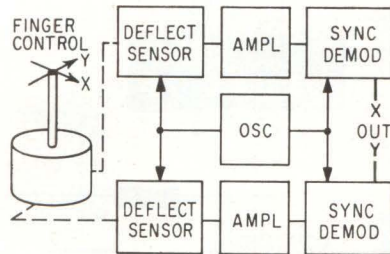
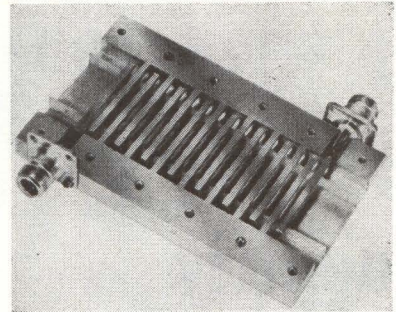

Bandpass Filters Feature Low Loss

RECENTLY announced by Melabs, 3300 Hillview Avenue, Stanford Industrial Park, Palo Alto, California, are a series of bandpass filters with center frequencies between 100 Mc

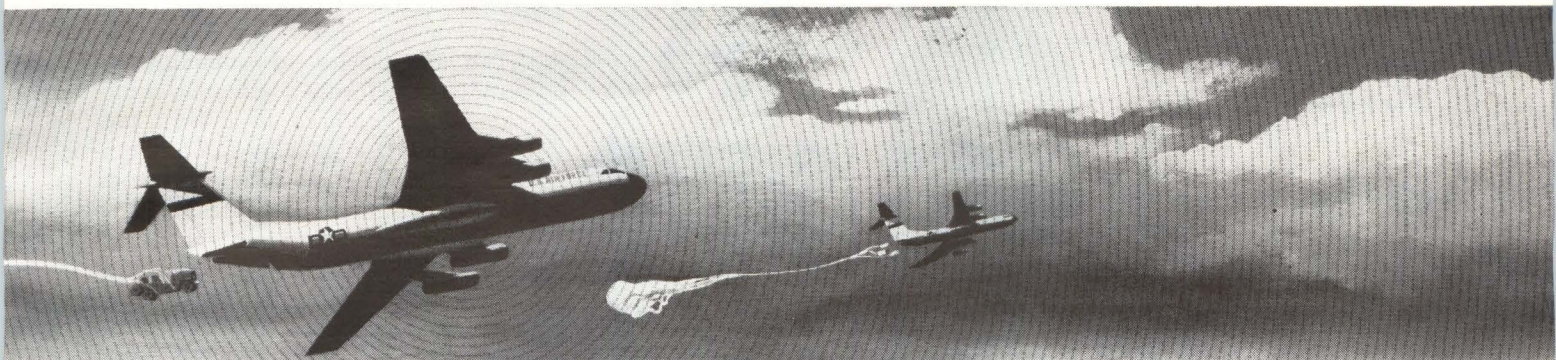

PROJECT IN POINT:

this C-141 crew thinks it has just completed an equipment drop

Simulation reflects the ultimate in the application of science and technology. It is the electronic bridge from research to reality. At Curtiss-Wright, electronic simulation systems orient men and machines to missions for many military and industrial programs.

Project in Point: Under contract to the Air Force, Curtiss-Wright today is producing a fully digital flight crew trainer that matches the high performance characteristics of the new Lockheed C-141 turbofan transport. This flight simulator is the first to use a general purpose, all-digital computer.

The C-141 is being developed as a "10-year aircraft" with built-in capability to accommodate newer power plants as they become available. This flexibility in the

giant transport's design is matched by the Curtiss-Wright simulator. Because it is fully digital, the simulator can be updated easily to reflect performance changes at minimal expense and down-time.

Advanced activities like this have created immediate opportunities at Curtiss-Wright Electronics Division for solid state circuit designers, digital computer programmers and others experienced in the application of real-time digital computation to the most challenging problems in simulation.

For complete information, please write Mr. D. Gene Kelly, Manager of Professional Placement, Curtiss-Wright, Electronics Division, East Paterson, New Jersey. An equal opportunity employer.



ELECTRONICS DIVISION
CURTISS - WRIGHT CORPORATION

35 MARKET STREET, EAST PATERSON, N. J.

ask
MARKEM
to show you
how to
identify
your products
completely
— at
least
cost

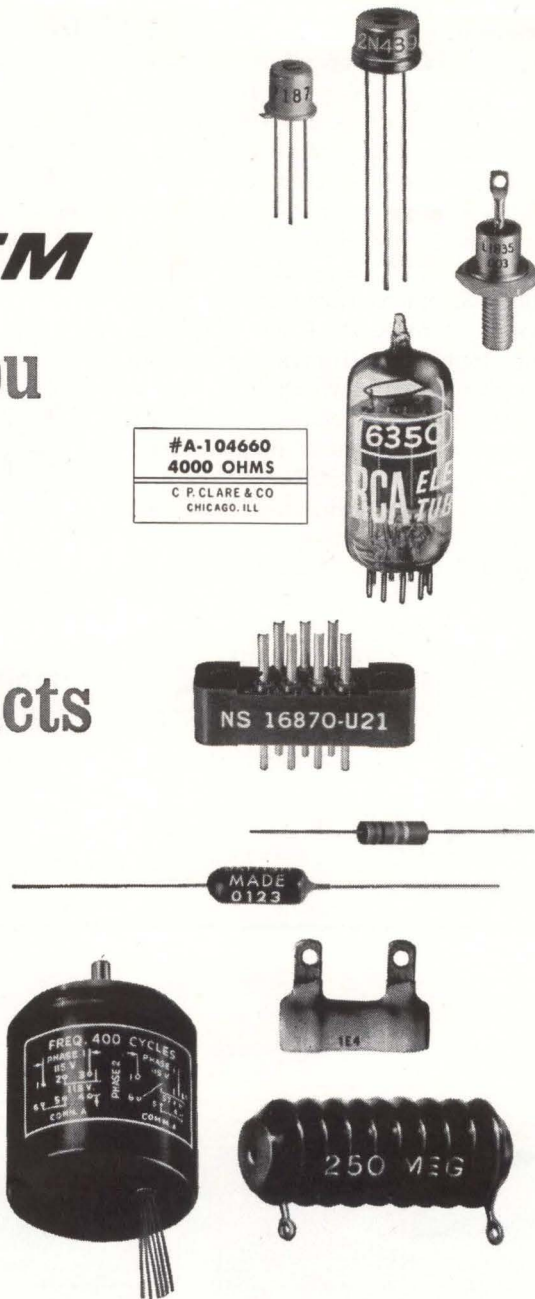

#A-104660
4000 OHMS
C. P. CLARE & CO
CHICAGO, ILL.

NS 16870-U21

MADE
0123

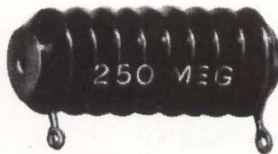
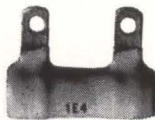

Whether your electrical and electronic products range from subminiature and microminiature components to large panels and "packages", you can identify them *all* completely and clearly, at production speeds, with economical Markem methods engineered to your particular requirements. For example: methods to mark odd shapes, sizes and surfaces with your complete, detailed legend, using quick-change type flexibility and ink to meet military specifications and withstand unusual environmental conditions—and above all, with savings in time and money—are offered by Markem, one responsible source for the entire process. For a complete in-plant analysis of all your product identification processes—or a practical answer to a specific problem—call in your local Markem Technical Representative. Markem Machine Co., Electronics Division, Keene 5, N. H.

12-page catalog on request. Please use inquiry card.



MARKEM

HELPS YOUR PRODUCT SPEAK FOR ITSELF

and 12 Gc, bandwidth capability from 1 percent to greater than an octave, loss in a 12-section filter of typical 0.3 to 0.7 db and phase tracking between units better than 2 degrees. Models are available without spurious responses to 50 Gc. Ratings are 1 Kw peak and 100 w average power. Interdigital construction using coupled rectangular bars permit the low insertion loss. The photograph (p 67) shows model FL-13 having a 1 to 2 Gc bandpass, loss of 0.5 db and uses a 16-section interdigital arrangement.

CIRCLE 305, READER SERVICE CARD

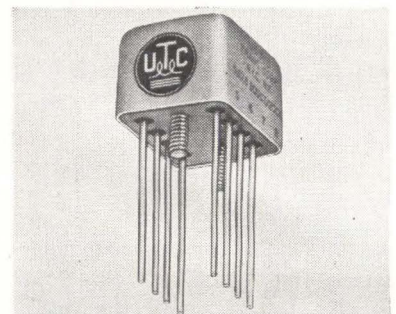

Audio Transformers and Split Inductors

UNITED TRANSFORMER CORP., 150 Varick St., New York 13, N. Y. The FH series of subminiature audio transformers and split inductors is manufactured and guaranteed to MIL-T-27A by full environmental testing and has been proven for ruggedness and reliability. The transformers have an operating level of 100 mw with an impedance range of 50 ohms to 20,000 ohms, and a response of less than 2 db over a broad a-f range. The inductors allow either series or parallel connections with ranges from 15 μ h at 64 ma, 1.5 ohms to 2.4 henries at 2 ma, 160 ohms. (306)

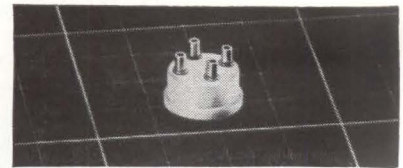

Transistor Holder Saves Space

SEAELECTRO CORP., 139 Hoyt St., Mamaroneck, N.Y. The RTC-400T-L2 Teflon - insulated transistor holder provides gold-plated brass

lugs extending only 0.070 in. below the Teflon body for associated circuitry connections. Four connections are provided on a 0.200 in. pitch circle. Unit is a reverse design, whereby the component is mounted against the shoulder of the Teflon body. The major diameter is 0.325 in. and the minor diameter is 0.290 in. The holder is inserted into the metal chassis in the usual Press-Fit fashion. It may be used on chassis thicknesses up to 0.093 in. Overall height of socket is 0.225 in. (307)

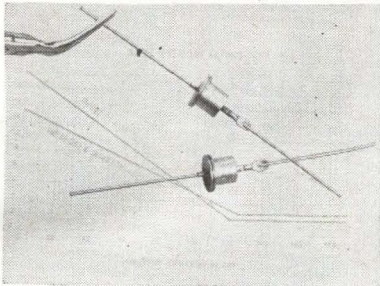

Silicon Rectifiers Are Low Current Type

TUNG-SOL ELECTRIC INC., One Summer Ave., Newark 4, N. J. Reverse current ratings at 125 C on types 1N1487 through 1N1492 range from 0.3 to 0.4 ma with prv ratings from 100 to 600 v. Max rectified current at 25 C is 750 ma. Full cycle average forward voltage drop at full load is 0.6 v. One cycle surge current at 60 cps for all the units is 15 amperes peak. The rectifiers have an operating temperature range from -65 C to +150 C. They are all of standard JEDEC DO-1 construction. (308)

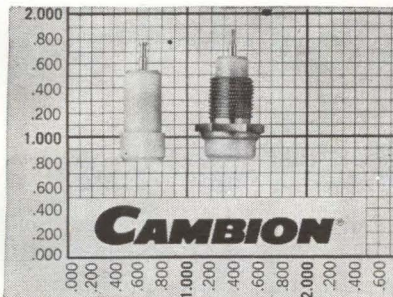

Gold-Plated Jacks Are Nylon-Insulated

CAMBRIDGE THERMIONIC CORP., 445 Concord Ave., Cambridge 3, Mass., adds two new jacks to its line. Both

Time-tested Standard of the Resistor Industry!

EVANOHM[®]

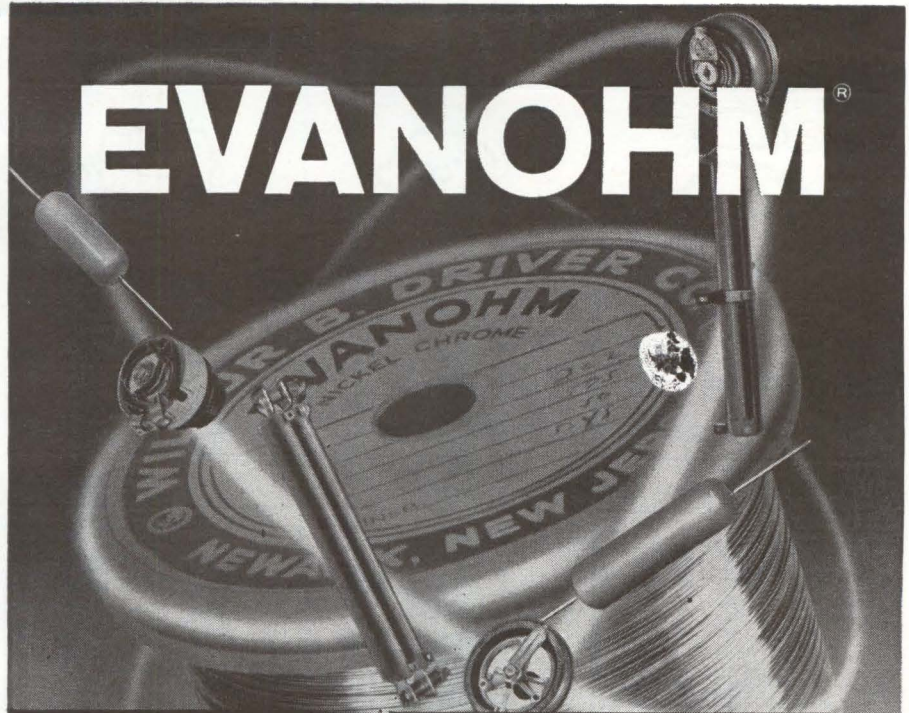

SPECIFICATIONS

Nominal composition
75% Nickel
20% Chromium
2.5% Aluminum
2.5% Copper

Specific resistance 20°C
800 ohms/cm²
134 microhm cm

Coefficient of linear expansion 20° to 100°C
.000014/°C

Specific gravity
8.10 gm/cc

Pounds per cubic inch
.293

Magnetic attraction
None

Average tensile strength
180,000 psi

Thermal conductivity
0.152 W/cm/°C

Mean thermal EMF vs copper 0°C to 100°C
1 μV/°C

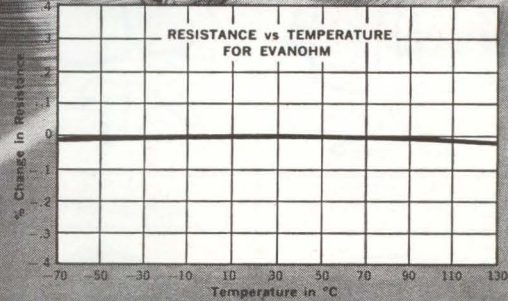

Specify EVANOHM for exceptional stability over wide temperature ranges. This WBD precision resistance alloy provides high specific resistance, low temperature coefficient and low thermal EMF to copper. It is especially recommended for high reliability applications . . . resistors, precision instruments, missiles and critical equipment. Available in bare wire, enameled or insulated.

FINE WIRE ALLOYS IN A FULL RANGE OF RESISTIVITIES

| ALLOY | Nominal Composition | Resistivity (ohms/cm ²) | T.C. of Resistance (ohms/ohm/°C, 20-100°C) | Specific Gravity gms/cc |
|------------------------------------|---------------------------|-------------------------------------|--|-------------------------|
| Evanohm [®] | 75 Ni-20 Cr-2.5 Al-2.5 Cu | 800 | ±.000005† (-65° to 125° C.) | 8.10 |
| Tophet A [®] | 80 Ni-20 Cr | 650 | .000085 | 8.412 |
| Tophet [®] C | 61 Ni-15 Cr-bal. Fe | 675 | .00013 | 8.247 |
| Cupron [®] (Constantan) | 55-Cu-45 Ni | 294 | ±.000020 | 8.90 |
| Balco [®] | 70 Ni-30 Fe | 120 | .0045 | 8.46 |
| Ballast [®] (Pure Nickel) | 99.7 Ni | 48 | .0060 | 8.90 |
| 30,60,90,180 Alloys | Cu-Ni | 30-180 | .00130 - .00018 | 8.90 |

†.002" and finer



Call or write for EVANOHM brochure to—

WILBUR B. DRIVER COMPANY
NEWARK 4, NEW JERSEY — Telephone: HUmboldt 2-5550

In Canada: Canadian Wilbur B. Driver Co., Ltd., 50 Ronson Drive, Rexdale (Toronto)

PRECISION RESISTANCE, ELECTRONIC AND MECHANICAL ALLOYS FOR ALL REQUIREMENTS

SUPERIOR SUPPLIES CATHODES FOR EVERY ENGINEER'S REQUIREMENTS

| | | |
|---|---|--|
|  |  |  |
| I want high-purity nickel | I want round shape | I want square shape |
|  |  |  |
| I want king size | I want active | I want passive |
|  |  |  |
| I want all-purpose | I want high strength | Which kind do you want? |

Whatever kind of cathodes you need, Superior can supply them. For all sizes of receiving tubes, transmitting tubes, special purpose tubes. Seamless, WELDRAWN,® Lockseam,* lapseam. Choice of over 25 different alloys. Shaped, beaded or tabbed. Disc cathodes in standard, miniature and subminiature sizes. Quality is unmatched. Fast delivery. Write for selector guide. Superior Tube Co., 2500 Germantown Avenue, Norristown, Pa. *Manufactured under U.S. patents

Superior Tube 

The big name in small tubing
NORRISTOWN, PA.

Johnson & Hoffman Mfg. Corp., Mineola, N.Y.

—an affiliated company making precision metal stampings and deep-drawn parts

have inside diameters of 0.082 in. and mate with $\frac{1}{2}$ in. long standard phone-tip plugs with tip diameters of 0.080 in. Part 2202 is a clip-mount jack with a 0.312 in. mounting diameter and an above-board height of 0.730 in. Part 2209 is a thread-mount jack with a $\frac{3}{32}$ stud thread and an above-board height of 0.829 in.

CIRCLE 309, READER SERVICE CARD

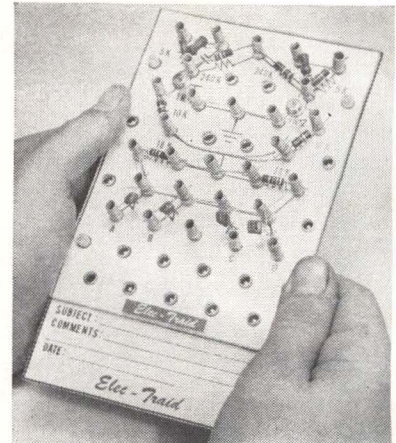

Circuit Cards For Experimental Use

ELECTRONIC TRAINING AIDS CO., P. O. Box 53, Cambridge 41, Mass. A versatile experimental breadboarding device, the Koil-Kard was designed for the construction of high frequency semiconductor circuits. Gold plated helical springs are threaded into the Kard as required providing reliable solderless connections. Feed-through springs are also supplied for those who wish double-sided circuits. Each spring terminal will accept up to 5 leads as well providing top or bottom dual and single banana plugs. Accessory items such as plug-in transistor sockets are available. (310)

Multiplexer Provides Variable Sample Rate

ALPHA-TRONICS CORP., 2626 South Peck Road, Monrovia, Calif. Welded and encapsulated construction of the SSM-101-30 provides 30 channels of high level multiplexer data in less than 15 cu. in. Extremely high signal to ground isolation and low noise as well as variable sampling rates is provided by

transistor switching and sequencing circuitry. Sample and non-sample multiplexer input impedance is maintained at a constant level to insure constant transducer loading. Dynamic output impedance is less than 500 ohms. (311)



Preamplifier Module Features Low Noise

H. H. SCOTT, 111 Powder Mill Road, Maynard, Mass. Type 1420 is designed for system and special test equipment requirements. Gain is greater than 20 db. Frequency response less than 1 cps to 2.5 Mc (± 0.2 db). Equivalent input noise is less than $17 \mu\text{v}$ broadband; input impedance, 10 megohms $+ 20 \mu\text{F}$; rise time, $0.3 \mu\text{sec}$; max output, 20 v rms; distortion, less than 0.2 percent at 10 v output; power required, $+ 180$ v d-c at 5 ma, $+ 6$ v d-c at 1 amp. (312)

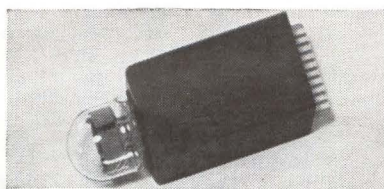

Nixie Driver Has Binary Decode

ELECTRONIC CONTROL PRODUCTS, U.S. Highway 22, P.O. box 286, Dunellen, N.J. The Bidex driver is a binary decode Nixie driver. It is a plug-in module measuring $3\frac{3}{8}$ long, $1\frac{1}{4}$ high, $1\frac{1}{4}$ wide. It is designed for those applications involving the parallel transfer of information in the various binary codes into digital display. The silicon diode matrix may be supplied as 1-2-2-4 binary coded decimal, 1-2-4-8 straight binary (decodes 0 through 9 only), or a decimal repeat Gray Code. The 1-2-4-8 straight binary may be used for octal coded decimal systems. (313)

January 11, 1963



EMCOR® II Modular Enclosures hold the answer to your enclosure problems

Your imagination creates the custom look for your equipment with EMCOR II Modular Enclosures. EMCOR II Enclosures have basic points of modification which provide each customer with product individuality. Select recessed, flush or extended panel mountings; choice of trim or grillwork extrusions; nameplate style variations, double width frames, pontoon bases and side panels—all designed to give you custom type enclosures without the cost of custom fabrication. A few of the many EMCOR II Enclosure configurations are shown above. Contact your local Ingersoll Products Sales Engineering Representative or write for full details.

REQUEST NEW
EMCOR II
LITERATURE



EMCOR—The Original Modular Enclosure System By
INGERSOLL PRODUCTS
Division of Borg-Warner Corporation
1000 W. 120th ST. • DEPT. 1242 • CHICAGO 43, ILL.

CIRCLE 71 ON READER SERVICE CARD 71



If you are manufacturing your own magnetic components profitably, we welcome the competition. However, most companies who manufacture their own components are doing so as a sideline. They believe they're saving money.

But there are always "hidden" costs in making your own parts. In many instances, your sideline operation hurts your over-all profit and loss statement because you are operating outside your specialty. The time, money and effort put into your sideline could actually be more wisely invested in your main business, where you are the expert.

At Aladdin Electronics, we have no sideline business. All of our time and effort is devoted to the research, development, engineering and production of pulse and wide-band transformers, inductors, micromodule and microelement components.

If you use magnetic components in your business, tell us about it. Then let us show you how to save money by buying instead of making.

where the magic of magnetism is a science...™

nashville 10, tennessee phone: 242-3411, code 615
twx: 615-244-1534

Aladdin[®]
electronics

Literature of the Week

NICKEL-CADMIUM CELLS Gulton Industries, Inc., 212 Durham Ave., Metuchen, N. J. Hermetically sealed nickel-cadmium cells are described in bulletin V0114.

CIRCLE 314, READER SERVICE CARD

VOLTMETER B&K Instruments, Inc., 3044 W. 106th St., Cleveland 11, O., offers a two-page specification sheet on the model 2410 RMS audio voltmeter. (315)

FUSED RESISTANCE DECADE Matronic Instrument Co., P. O. Box 304, Newark, Del. Two-page bulletin illustrates and describes model 1400 fused resistance decade. (316)

H-V CAPACITORS Chicago Condenser Corp., 3255 W. Armitage Ave., Chicago, Ill., has released a catalog sheet listing type CMP space saving high voltage capacitors. (317)

D-C MOTOR The A. W. Haydon Co., 232 North Elm St., Waterbury 20, Conn. Technical brochure SP9-4 covers model K5801 high-torque, high-accuracy chronometrically governed d-c motor. (318)

DELAY LINE ESC Electronics Corp., 534 Bergen Blvd., Palisades Park, N. J., has issued a mailing piece on the series 800 Trimline miniature trimmer delay line. (319)

DIODE INTERCHANGEABILITY TABLES Ohmite Mfg. Co., 3645 Howard St., Skokie, Ill. Bulletin 803 lists close to 900 germanium diodes in alpha-numerical order along with the equivalent Ohmite numbers. (320)

D-C AMPLIFIER Dana Laboratories, Inc., 630 Young St., Santa Ana, Calif. Data sheet 8 describes model 2200 solid-state, low-level, wideband, differential d-c amplifier. (321)

DIGITAL EQUIPMENT Abacus, Inc., 1718 21st St., Santa Monica, Calif. Three-sheet foldout describes a line of digital modules, as well as custom digital systems. (322)

RFI FILTERS Hopkins Engineering Co., P.O. Box 191, San Fernando, Calif. Catalog describes 11 typical categories of rfi filter design solutions comprising more than 2,000 different designs. (323)

ENVIRONMENTAL EQUIPMENT Cincinnati Sub-Zero Products, Inc., 3930 Reading Road, Cincinnati 29, O. Twelve-page guide describes environmental equipment for modular testing of electronic components parts. (324)

ENCAPSULATING SILICON RECTIFIERS Epoxy Products Inc., 133 Coit St., Irvington, N. J. Information bulletin No. 4 describes a new technique for encapsulation of silicon rectifiers. (325)

MODULAR DISCRIMINATOR SYSTEM Data-Control Systems, Inc., Danbury,

Conn. A set of three specification sheets describe model GFD-5 sub-carrier discriminator and associated GFD-5/TU tuning units and GFD-5TU/L low pass filters. (326)

C-C TV CAMERAS General Electric Co., Schenectady 5, N. Y. Three brochures describe a complete line of compact vidicon cameras for closed-circuit tv applications. (327)

SPACE SIMULATION NRC Equipment Corp., 160 Charlemont St., Newton 61, Mass., has published an 8-page facilities bulletin entitled "Space Conquest Through Vacuum." (328)

AMPLIFIER AND POWER SUPPLY Massa Division of Cohu Electronics, Inc., 280 Lincoln St., Hingham, Mass. Two-page bulletin describes the 60 db amplifier and preamplifier power supply, model M-185. (329)

SUBMINIATURE TOROIDS Johnson Electronics, Inc., P. O. Box 7, Casselberry, Fla. Components catalog describes a variety of subminiature toroids available in a wide range of standard inductance values. (330)

VIDEO TAPE EDITING Minnesota Mining and Mfg Co., 2501 Hudson Rd., St. Paul 19, Minn. Articles on the use of splicing tape and marking pens in video tape editing are featured in the second issue of "Video Tape Playback". (331)

ROTARY SWITCH Disc Instruments, Inc., 3014-B So. Halliday St., Santa Ana, Calif., offers a bulletin containing design and construction information, specifications, dimensions and ordering information on model 10 Rotary switch. (332)

MERCURY - WETTED - CONTACT RELAYS Automatic Electric, Northlake, Ill., has available a 16-page catalog describing its line of mercury-wetted-contact relays. (333)

SLIP-RING CAPSULE Kollmorgen Corp., Northampton, Mass. Technical bulletin 326 describes a miniature 20-circuit slip-ring capsule. (334)

INDICATOR LAMP Transistor Electronics Corp., Box 6191, Minneapolis 24, Minn. Catalog sheet describes new solid-state indicator lamp with replaceable incandescent lamp. (335)

GLASS/EPOXY LAMINATES The Mica Corp., 4031 Elenda St., Culver City, Calif. Brochure details Micaply standard and thin grade glass/epoxy laminates available with and without copper cladding of various weights. (336)

MODULES AND CIRCUITS Burroughs Corp., Plainfield, N. J. A 40-page brochure No. 405 presents the latest modules and circuit information on the BEAM-X module line. (337)

TRANSFORMERS Marcus Transformer Co., Inc., Rahway, N. J. Catalog contains complete data on a line of dry and liquid-filled transformers through 10,000 Kva. (338)

COIL FORMS National Radio Co., 37 Washington St., Melrose, Mass., announces bulletin CO-8 which catalogs its line of coil forms. (339)

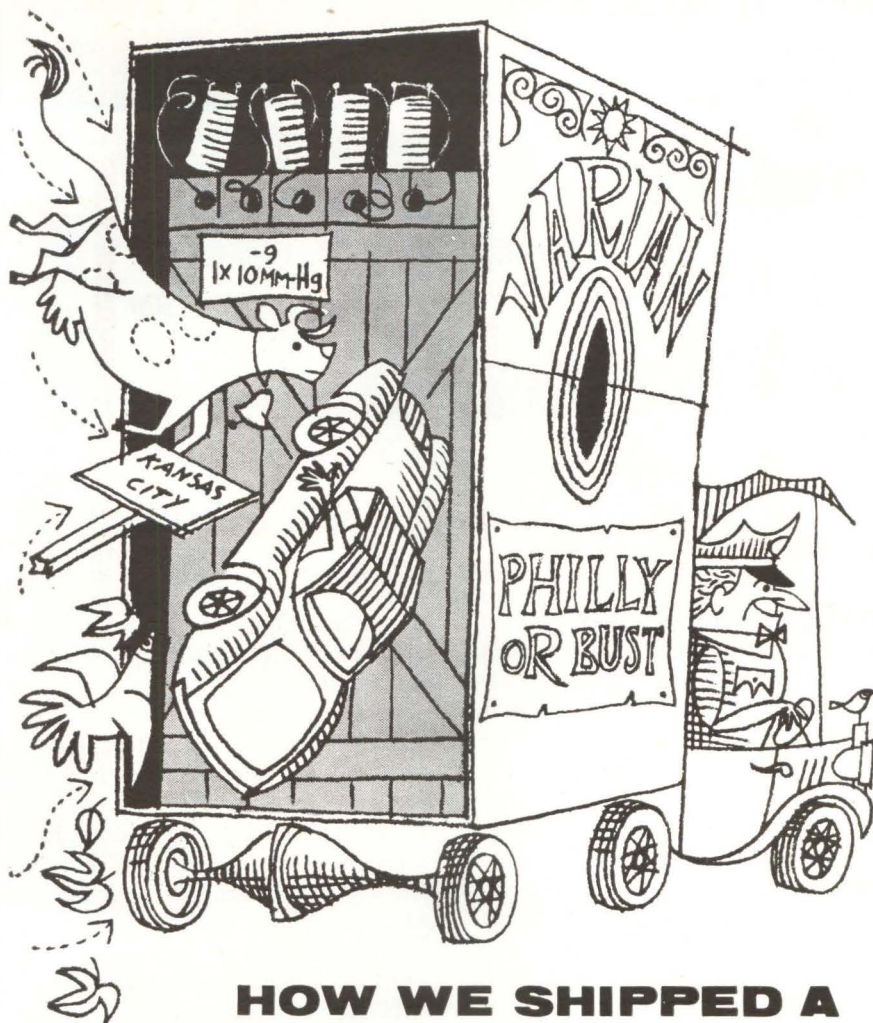

HOW WE SHIPPED A VACUUM IN A MOVING VAN

Or, 10^{-10} mm Hg from Palo Alto to Philadelphia

Customer of ours in Philadelphia recently bought a Varian VacIon® pump system for some thin-film work. Bought a 1,000-litre/second pump, a couple of VacSorb® roughing pumps, and some other delightful hardware from our catalog.

We packed the whole shebang into a moving van. In the spirit of high adventure, we hooked the system up to four 12-volt battery-operated VacIon pump power supplies.

Off went the van, with the system pumping merrily away on the 10^{-10} mm Hg scale. One week and 3,000 miles later, we opened the doors of the truck. Yep! There was that sweet little system, still operating somewhere below 10^{-9} mm Hg.

Our point? Proven capability under adverse conditions is always a good sales point. If this coast-to-coast success story doesn't help prove VacIon pumps are the best you can buy, then we're sending on the wrong wavelength.

Dependable Varian VacIon pumps (whether they're little 0.2 litres/second appendage pumps or monster 10,000 litre/second systems) will give you exact rated pumping speeds. When you want them. For as long as you want them.

Clean vacuums? Far as we can tell, an ion-getter pump is the only way to get an absolutely pure vacuum. Modesty almost forbids our mentioning that we *invented* VacIon diode-type pumps. You'll get the world's cleanest vacuum with a VacIon all-electronic pump. No wandering organic molecules—just clean, clean vacuums. That we'll guarantee.

Since we're in the mood, here's something else we'll guarantee. If your Varian VacIon pump doesn't perform *exactly* the way we said it would, we'll replace it. Or give your money back. We ask only that you install the pump according to the excellent recommendations of our noteworthy vacuum specialists.

Do we have a deal?

VACUUM
PRODUCTS
DIVISION

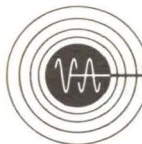

VARIAN associates

PALO ALTO 1, CALIFORNIA



Tansitor Increases Plant Area

TANSITOR ELECTRONICS, Inc., Bennington, Vermont, has recently completed its fourth plant expansion in seven years of operation.

The firm was established in 1955 by its current owner and president, A. F. Torrisi, for the manufacture of tantalum capacitors. It presently employs over 300 persons. Latest expansion increases Tansitor's plant area nearly 80 percent, bringing the total to 35,000 square feet.

Included is a 13,500-square foot structure (closest to swimming and skating pond in photo), connected

to the main building by a new combination corridor-cafeteria. This addition provides a 100-percent increase in manufacturing area for foil, wire-anode, and sintered-anode units. It also provides a three-fold increase in research and development area, and houses new equipment supplementing the existing facilities for environmental testing of capacitors.

Another part of the expansion is an 1,800-square foot building (at extreme left) in which chemical operations have been consolidated.



ITT Appoints Graham Area Manager

APPOINTMENT of John J. Graham (picture), a vice president, as area general manager-North America for International Telephone and Telegraph Corp. has been announced by Harold S. Geneen, president.

In North America, Graham will be responsible for the U.S. Commercial Group, which he has headed since April 1962, and the U.S. De-

fense Group, which is headed by vice president Charles M. Mooney.

Geneen said the consolidation of ITT's manufacturing, marketing, research, and service operations in the U.S. and Canada under one management will accelerate the company's rate of growth in North America, facilitate the integration of newly acquired companies and product lines, and provide a focal point for serving U.S. defense requirements.

Graham joined ITT in December, 1961, as vice president and executive assistant to the president.

Applied Technology Hires Hennies

STUART R. HENNIES, formerly with E-H Laboratories, Inc., has joined Applied Technology, Inc., Palo Alto, Calif., as senior engineer. He will

be involved in the development of advanced electronic reconnaissance, active countermeasures and microwave telemetry equipment.



Elect Edward Klein Mepco President

EDWARD L. KLEIN has been elected president, chief executive officer and a member of the board of directors of Mepco, Inc., Morristown, N. J., an affiliate of Consolidated Electronics Industries Corp. He was formerly executive vice president of the company.

Mepco manufactures high reliability resistors and allied components for the electronics industry.



Geoghegan Moves Up At Dearborn

EAMONN D. A. GEOGHEGAN has been named vice president of engineering at Dearborn Electronic Laboratories, Inc., Orlando, Fla. He will head up all engineering activity relating to the Dearborn line of missile reliability capacitors, radio frequency interference filters, and pulse forming networks.

Geoghegan started his career 35 years ago with RCA. His experience includes a variety of positions in engineering and management with various other companies. In 1951 he joined General Instrument Corp. and was named vice president of

If your plant
belongs in
FLORIDA

Plant City

is the most
STRATEGIC
LOCATION

LOCATION — In the center of Florida — closer to all Florida markets — served by two railroads, major truck lines; only minutes from deep-water port and international airport.

LAND — Low cost sites in city-owned industrial park. Large acreage also available.

LABOR — Excellent local labor market.

LIVING — Established community with all educational, civic, and cultural advantages.

All correspondence in strict confidence.

SEND FOR INDUSTRIAL SURVEY

Dick Prewitt, General Manager

INDUSTRIAL DEVELOPMENT COMMITTEE

P.O. Box 1509-E

Plant City, Florida

City MOST Convenient to ALL Florida

CIRCLE 205 ON READER SERVICE CARD

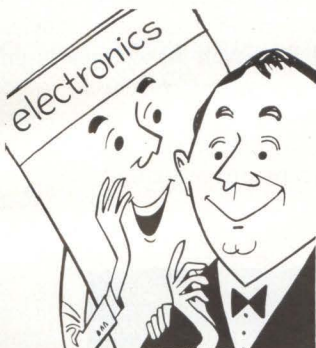

electronics
IS EDITED
TO KEEP YOU
FULLY INFORMED
— a "well-rounded"
engineer

What's your *present* job in electronics? Do you work on computers? (**electronics** ran 158 articles on computers between July, 1961 and June, 1962!) Are you in semi-conductors? (For the same period, **electronics** had 99 articles, not including transistors, solid-state physics, diodes, crystals, etc.) Are you in military electronics? (**electronics** had 179 articles, not including those on aircraft, missiles, radar, etc.)

In all, **electronics'** 28-man editorial staff provided more than 3,000 editorial pages to keep you abreast of all the technical developments in the industry. No matter where you work today or in which job function(s), **electronics** will keep you fully informed. Subscribe today via the Reader Service Card in this issue. Only 7½ cents a copy at the 3 year rate.

electronics

January 11, 1963

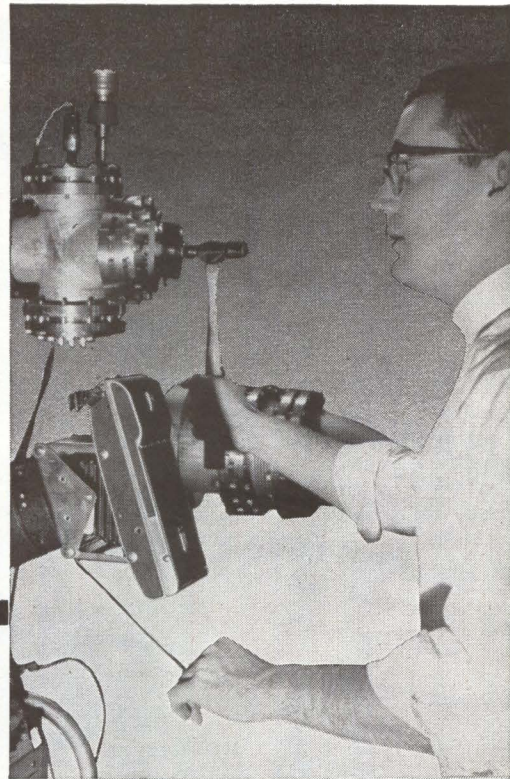

In the above experiment, the engineer is punching a hole in a thin foil window at the end of a twenty foot long vacuum system. An oscilloscope detects the operation of silicon controlled rectifiers triggered by signals from gages spaced at intervals down the vacuum pipe. The velocity of propagation of the shock wave down the pipe is calculated directly from the system dimensions and the time intervals measured from the oscilloscope trace. This velocity is three times the speed of sound.

This information is needed for the design of a fast acting high vacuum gate valve to protect the delicate accelerator components from damage in the event of a vacuum failure.

This experiment is just one of the many challenging problems under investigation at High Voltage Engineering Corporation, the foremost leader in the research, development and manufacture of particle accelerators.

Engineers and Scientists with experience in the following fields are invited to investigate career opportunities:

PULSE CIRCUITRY
CONTROL SYSTEMS
STABILIZATION SYSTEMS
MAGNETIC FIELD
MEASURING DEVICES

PLEASE CONTACT:

Mr. Louis O. Ennis, P.O. Box 98, Burlington, Mass.

**HIGH VOLTAGE
ENGINEERING CORP.**



Burlington, Massachusetts

An Equal Opportunity Employer

alpha 7.003924

Precision temperature sensing elements require
PLATINUM WIRE
of highest purity, homogeneity,
and reproducibility . . .
Write for latest brochure

SIGMUND COHN Mfg. Co. Inc.
121 South Columbus Ave.,
Mount Vernon, N. Y.

Since  1901

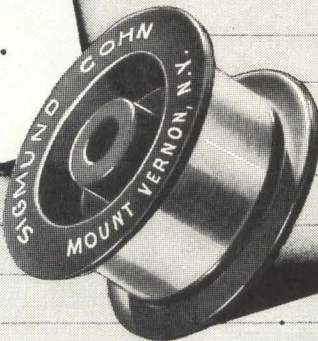

SIGMUND COHN CORP. OF CALIFORNIA • 151C NORTH MAPLE STREET, BURBANK, CALIFORNIA

CIRCLE 206 ON READER SERVICE CARD

Write for our catalogue

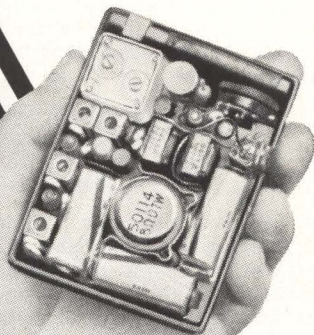

**Good
parts
work
best!**

Intermediate
Frequency
Transformer
IFT



The high standards of MITSUMI electronic components are insured by a fully-automated assembly system, and double-checked by rigid quality controls. Mitsumi Electric Company is Japan's largest manufacturer of components for radio, television and communications equipment.

MITSUMI PARTS

MITSUMI ELECTRIC CO., LTD.
Tokyo, Osaka, New York



POLYVARICON
Variable
Capacitor



engineering of its Capacitor division.

In 1960, he accepted the position of chief engineer of Dearborn Electronic Laboratories, Inc.



Allied Research Elects Carter

JOHN H. CARTER (picture) has been elected president and chief executive officer of Allied Research Associates, Inc., Concord, Mass. He succeeds Gen. Roscoe C. Wilson (USAF Ret.) who continues as board chairman.

Carter joined Allied Research Associates last April as executive vice president. Previously he had been vice president of Itek Corp. and president of Itek Laboratories.

Allied Research Associates is engaged in applied research, aerospace and weapon systems development, and advanced scientific instrument manufacturing.

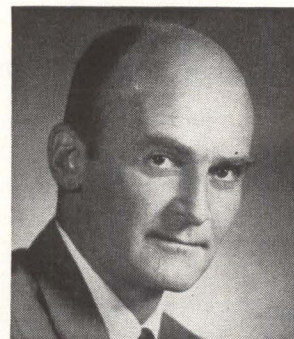

Sprague Organizes New Department

ORGANIZATION of a new Microelectronics Engineering department in the Engineering Laboratories of the Sprague Electric Co., North Adams, Mass., has been announced.

The department will be headed by Norton Cushman who has occupied various executive and engi-

neering positions since joining the company in 1952. In his new post, he will be responsible for development and pilot production of silicon based microcircuits and for augmenting the company's production capabilities in vapor deposition of thin film active and passive elements.



Microwave Associates Appoints Christian

MICROWAVE ASSOCIATES, INC., Burlington, Mass., announces the appointment of James W. Christian as project engineer in the Waveguide Systems division. His primary responsibility will be directing the new microwave strip transmission line components activity. In addition, he will concentrate his engineering experience in the areas of design, development and packaging of waveguide components and assemblies.

Prior to this appointment, Christian was a project engineer in the Instrument division of Laboratory for Electronics, Boston, Mass.



Kollsman Motor Names Reiter

ELI REITER has been named as electronic and servo sub-systems manager for Kollsman Motor Corp., Dublin, Pa., a subsidiary of Stand-



CAN A YOUNG MAN FROM A BIG COMPANY FIND HAPPINESS WITH A DYNAMIC SMALLER FIRM IN THE SUBURBS?

Don't tune in tomorrow. Think about it today.

Syntronic is a "small" firm (and proud of it) in need of a vigorous young (under 30) graduate electrical engineer to handle expanding product development. We're not sure our man is currently with a "big company," but we'd definitely want him to have a few years seasoning under his hat. Can he find happiness with us? Well, consider . . .

THE LEADING COMPANY in its field . . . Deflection Yokes, Focus Coils, Electro-Mechanical Magnetic Components.

ENGINEER-ORIENTED management accustomed to working side-by-side with the engineering staff.

14-YEAR-OLD GROWTH PATTERN built on sound economics and unparalleled customer loyalty.

OPPORTUNITY TO DELVE into the entire electron-optical system of various electron beam tubes . . . to originate and develop new wrinkles in components for CRT's, Vidicons, Image-Orthicons, Image Storage Tubes, Daylight Storage Tubes, Image Converter Tubes, Color Tubes, Beam Welders, and Beam Cutting Tubes.

ALL THE INDEPENDENCE your own initiative can handle—with plenty of engineering help when you need it.

THE VARIETY of developing various phases of several different components for many outstanding customers.

A GOOD SALARY with an attractive profit sharing plan which permits you to grow with the company.

CHICAGO'S PLEASANT western suburbs (20 miles from the loop) in which to work and live.

Syntronic is, in short, a group of DEFLECTION YOKE SPECIALISTS who enjoy hard work in an atmosphere largely free from protocol. If you can picture yourself as catching fire in such an atmosphere, we'd like to know all about you. Send all details directly to Dr. Henry Marcy, President.



syntronic INSTRUMENTS, INC.
100 Industrial Road, Addison, Illinois
Phone: Kingswood 3-6444

DYNAMICS

INSTRUMENTATION AMPLIFIERS

—fully isolated from
the power line.
through use of double
shielding techniques
and integral
power supplies

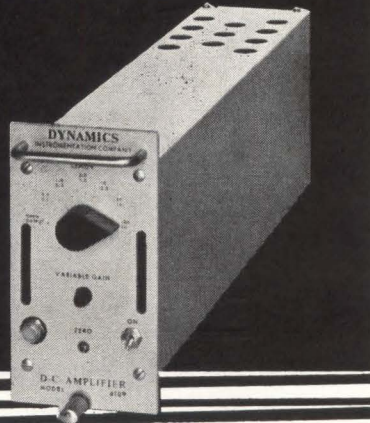

MODEL 6109—dc amplifier. Unit meets low-noise and low-drift requirements for driving galvanometers—meets other pertinent requirements, including:

Voltage gain: 0.1 through 100 in 7 steps, continuously variable between steps.
Noise: less than 20 microvolts rms, referred to input.
Frequency response: DC to 30 kc.
Output capability: ± 10 v, ± 100 ma (simultaneously).
DC drift: less than 0.1% of full scale output.
Small size: 2 $\frac{7}{8}$ " W x 5 $\frac{1}{4}$ " H x 13 $\frac{1}{2}$ " D.

Instrument is compatible with many other Dynamics amplifiers and signal conditioners for use in standard 6-channel, rack mounting module.

Write for literature on Model 6109, or on the entire line.

DYNAMICS
INSTRUMENTATION COMPANY
583 Monterey Pass Road, Monterey Park, Calif.
Phone: CUMberland 3-7773

CIRCLE 207 ON READER SERVICE CARD

SUBJECT: *More New Shielded Coil Forms*

USE: *RF Coils, Chokes, Filters, Transformers*

FREQ: *To 200 MC.*

SOURCE: *Micrometals*

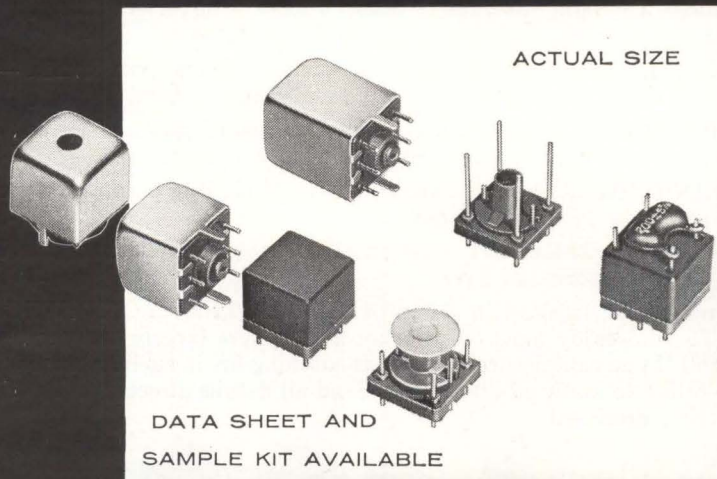

MICROMETALS

72 E. MONTECITO AVE., SIERRA MADRE, CALIFORNIA
MURray 1-9025

78 CIRCLE 78 ON READER SERVICE CARD

ard Kollsman Industries, Inc.

Reiter was associated previously with Westinghouse Electric Corporation's Missile Ground Control Group, and with the Defense Electronics Products division of RCA, Camden, N. J.

PEOPLE IN BRIEF

Julian S. Hernandez, formerly with Data Sensors, named chief applications engineer at Fairchild Controls west coast plant. **Edward F. Mullen**, previously with Daystrom, Inc., appointed application mgr. for the Berkeley div. of Beckman Instruments, Inc. **D. G. Cowden** promoted to engineer in charge-industrial and military crt's for Sylvania's Electronic Tube div. **Anthony A. Tiezzi** moves up to corporate director of quality assurance and reliability of the Sprague Electric Co. He succeeds **Walter W. Clark**, who has been named asst. to the president for quality assurance. **Robert O. Maze** advances to director of engineering for Minneapolis-Honeywell's Ordnance div. Ampex Corp. ups **Robert J. Weismann** to mgr. of manufacturing for the video and instrumentation div. **Jerome Schwartz** promoted to asst. chief engineer in the Electronics div. of Channel Master Corp. **Peter F. Lefort**, ex-Sperry Gyroscope, named sales mgr., Electron Tube and Device div. of Microwave Associates, Inc. **John T. Lesko**, from Eaton Mfg. Co. to Electric Products div. of Vickers, Inc., as production mgr. **R. P. Bennett**, formerly with Cornell Dubilier Electronics, now a consultant to the Electronics div. of Electric Motor & Transformer Co. Inc. **Walter F. Horstman** leaves GE to join Continental Wire Corp. as senior product development engineer. **Mark Van Buskirk**, with Mallory for 28 years, appointed sales engineer at The Mallory Capacitor Co. headquarters. **Irwin Wallman**, recently with Huyck Systems Co., named project mgr. on the engineering staff of GAP Instrument Corp. **Vance Elkins, Jr.** advances to product mgr., process control computers, at Electronic Associates, Inc.

electronics

electronics

WEEKLY QUALIFICATION FORM FOR POSITIONS AVAILABLE

ATTENTION: ENGINEERS, SCIENTISTS, PHYSICISTS

This Qualification Form is designed to help you advance in the electronics industry. It is unique and compact. Designed with the assistance of professional personnel management, it isolates specific experience in electronics and deals only in essential background information.

The advertisers listed here are seeking professional experience. Fill in the Qualification Form below.

STRICTLY CONFIDENTIAL

Your Qualification form will be handled as "Strictly Confidential" by ELECTRONICS. Our processing system is such that your form will be forwarded within 24 hours to the proper executives in the companies you select. You will be contacted at your home by the interested companies.

WHAT TO DO

1. Review the positions in the advertisements.
2. Select those for which you qualify.
3. Notice the key numbers.
4. Circle the corresponding key number below the Qualification Form.
5. Fill out the form completely. Please print clearly.
6. Mail to: Classified Advertising Div., ELECTRONICS, Box 12, New York 36, N. Y. (No charge, of course).

| COMPANY | SEE PAGE | KEY # |
|--|----------|-------|
| ATOMIC PERSONNEL INC. Philadelphia, Penna. | 84 | 1 |
| COLLINS RADIO COMPANY Cedar Rapids, Iowa | 22 | 2 |
| CURTISS WRIGHT CORPORATION Electronics Division Paterson, N. J. | 66, 67 | 3 |
| DOUGLAS AIRCRAFT CO. Missile & Space Systems Division Santa Monica, California | 55 | 4 |
| GENERAL ELECTRIC CO. Apollo Support Department Daytona Beach, Florida | 83 | 5 |
| GRUMMAN AIRCRAFT ENGINEERING CORP. Long Island, New York | 81, 82 | 6 |
| HARVARD UNIVERSITY Cambridge 38, Mass. | 153* | 7 |
| HIGH VOLTAGE ENGINEERING CORP. Burlington, Mass. | 75 | 8 |
| NASA MANNED SPACECRAFT CENTER Houston 1, Texas | 80 | 9 |
| NATIONAL CASH REGISTER COMPANY Dayton, Ohio | 84 | 10 |
| NAVY DEPT. (BUREAU OF SHIPS) Washington 25, D. C. | 152* | 11 |
| NORTHROP CORPORATION Beverly Hills, California | 63 | 12 |

(Continued on page 84)

(cut here)

electronics WEEKLY QUALIFICATION FORM FOR POSITIONS AVAILABLE

(cut here)

(Please type or print clearly. Necessary for reproduction.)

Personal Background

NAME

HOME ADDRESS

CITY ZONE STATE

HOME TELEPHONE

Education

PROFESSIONAL DEGREE(S)

MAJOR(S)

UNIVERSITY

DATE(S)

FIELDS OF EXPERIENCE (Please Check)

- | | | |
|--|--|---------------------------------------|
| <input type="checkbox"/> Aerospace | <input type="checkbox"/> Fire Control | <input type="checkbox"/> Radar |
| <input type="checkbox"/> Antennas | <input type="checkbox"/> Human Factors | <input type="checkbox"/> Radio-TV |
| <input type="checkbox"/> ASW | <input type="checkbox"/> Infrared | <input type="checkbox"/> Simulators |
| <input type="checkbox"/> Circuits | <input type="checkbox"/> Instrumentation | <input type="checkbox"/> Solid State |
| <input type="checkbox"/> Communications | <input type="checkbox"/> Medicine | <input type="checkbox"/> Telemetry |
| <input type="checkbox"/> Components | <input type="checkbox"/> Microwave | <input type="checkbox"/> Transformers |
| <input type="checkbox"/> Computers | <input type="checkbox"/> Navigation | <input type="checkbox"/> Other |
| <input type="checkbox"/> ECM | <input type="checkbox"/> Operations Research | <input type="checkbox"/> |
| <input type="checkbox"/> Electron Tubes | <input type="checkbox"/> Optics | <input type="checkbox"/> |
| <input type="checkbox"/> Engineering Writing | <input type="checkbox"/> Packaging | <input type="checkbox"/> |

11163

CATEGORY OF SPECIALIZATION

Please indicate number of months experience on proper lines.

| | Technical Experience (Months) | Supervisory Experience (Months) |
|-------------------------------------|-------------------------------|---------------------------------|
| RESEARCH (pure, fundamental, basic) | | |
| RESEARCH (Applied) | | |
| SYSTEMS (New Concepts) | | |
| DEVELOPMENT (Model) | | |
| DESIGN (Product) | | |
| MANUFACTURING (Product) | | |
| FIELD (Service) | | |
| SALES (Proposals & Products) | | |

CIRCLE KEY NUMBERS OF ABOVE COMPANIES' POSITIONS THAT INTEREST YOU

1 2 3 4 5 6 7 8 9 10 11 12 13 14 15 16 17 18 19 20 21 22 23 24 25

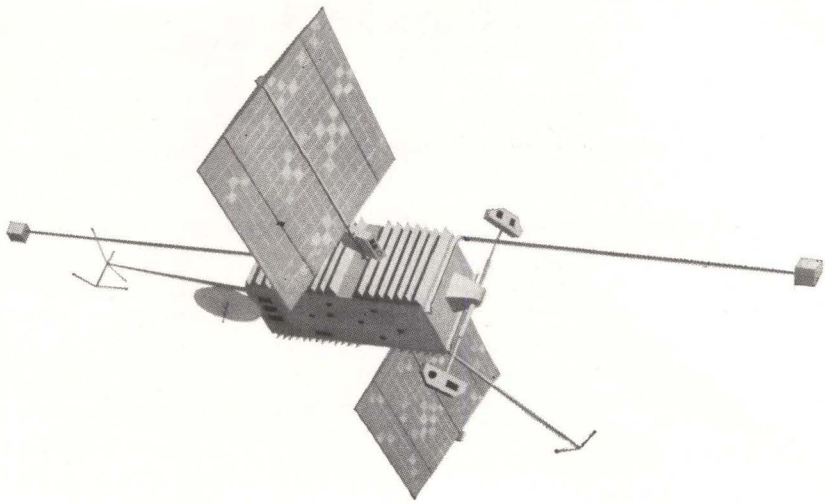

OGO EGO POGO

Meet OGO, the curious-looking object you see above. Actually, OGO is the family name; it stands for Orbiting Geophysical Observatory. There are two members of the OGO family: EGO (Eccentric Geophysical Observatory) and POGO (Polar Orbiting Geophysical Observatory).

EGO's purpose is to gather and transmit data on energetic particles and other geophysical phenomena. It will be launched into an eccentric orbit by an Atlas-Agena B vehicle from Cape Canaveral late next year.

POGO will be boosted into a polar orbit by a Thor-Agena B from the Pacific Missile Range in early 1964. Its assignment will be to send back information about the atmosphere and ionosphere, particularly over the North and South Poles.

If you are an engineering or science graduate with one or more degrees from an accredited college or university and appropriate experience, you may qualify for participation in history-making projects such as these.

Right now NASA Manned Spacecraft Center in Houston, Texas, has several key openings. They include:

- Electrical or Electronics Engineers, with experience in radar RF systems, telemetry or other missile tracking systems;
- Senior Electronic Engineers to analyse and recommend instrumentation programs;
- Flight Systems Engineers, experienced in the use of analog and digital computers, to solve flight operations and other research and development problems;
- Aerospace Engineers, experienced with flight simulators in the training of test pilots and flight personnel. Pilot experience is also desirable.

Send a complete resume to: Mr. J. Galloway, Dept. SHC, NASA Manned Spacecraft Center, Houston 1, Texas.

Positions filled under USCS Ann. 252B. An Equal Opportunity Employer.

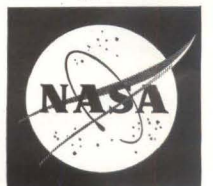

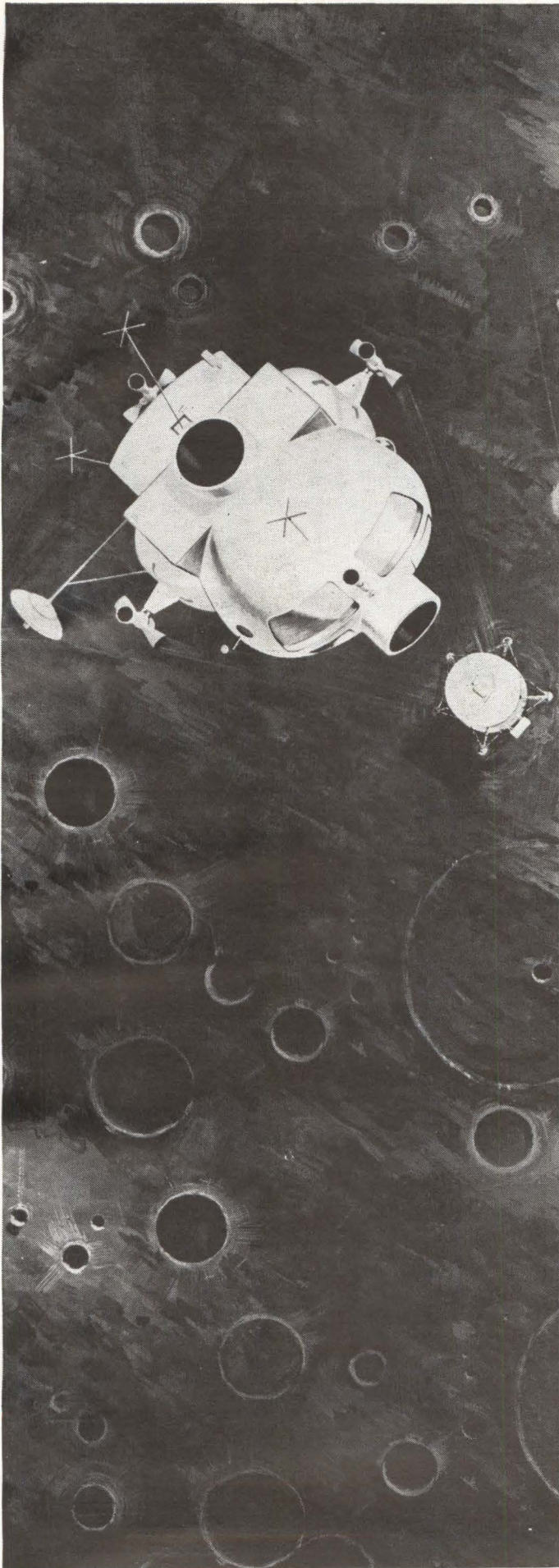

LUNAR LANDING AND RENDEZVOUS PROGRAM OFFERS ENGINEERS & SCIENTISTS THE GREATEST TECHNICAL CHALLENGE OF OUR TIMES

The selection of Grumman to design, develop and fabricate the NASA Lunar Excursion Module (LEM) which will be used to achieve the Apollo program's goal of landing astronauts on the moon, opens a new chapter in the conquest of space. Boosted by a three-stage Saturn C-5 vehicle, the Apollo spacecraft will enter lunar orbit and LEM will separate from the spacecraft to begin its epoch-making descent to the lunar surface.

Later, it will launch itself back into orbit and rendezvous with the Apollo Command and Service Modules permitting the lunar astronauts to return to earth, while the LEM is jettisoned into lunar orbit.

The Lunar Excursion Module and other space programs at Grumman are creating unprecedented professional opportunities at the company. Make 1963 a year of personal achievement in an endeavor that ranks among the greatest of all times. Current requirements are detailed on the next page. We invite your inquiry on the attached inquiry form or by personal resume to Mr. W. Brown, Manager Engineering Employment, Dept. GR76.



GRUMMAN

AIRCRAFT ENGINEERING CORPORATION

Bethpage · Long Island · New York

(An Equal Opportunity Employer)



GENERAL ELECTRIC TO SUPPORT NASA IN FORMULATING DESIGNS AND EQUIPMENT FOR CHECKOUT OF THE APOLLO SYSTEM

The National Aeronautics and Space Administration has assigned to General Electric a major role in designing and developing integrated, automatic checkout and test equipment for the APOLLO program, in addition to supporting NASA in overall reliability of the entire system. High level specialists and systems people are being drawn from many components of the company to contribute to the design and development of computerized semi-automatic and automatic checkout systems. Additional highly qualified engineers and scientists are needed now.

Assignments at HUNTSVILLE, ALABAMA and CAPE CANAVERAL, FLORIDA

Engineering experience required in
SYSTEMS and SUB-SYSTEMS CHECKOUT and TEST PLANS, DESIGNS and OPERATIONS

Electrical ■ Electronics ■ Mechanical ■ Conversion and Guidance ■ Propulsion ■ Instrumentation and Communications ■ Telemetry ■ Pyrotechnic ■ Vehicle Systems ■ Systems Specifications and Designs ■ Digital Command Systems ■ PCM ■ Computers ■ Display ■ Analog and Digital Simulation ■ Test Simulation ■ Vibration Analysis ■ Space Mechanics ■ Operational Support Systems.

If you have experience in any of the listed areas, write us today (include salary requirements). Your inquiry will be held in strict confidence. Write to: Mr. P. W. Christos, Professional Placement, Section 69-WF, Apollo Support Department, General Electric Co., Administration and Engineering Bldg., Daytona Beach, Florida.

APOLLO SUPPORT DEPARTMENT

GENERAL  ELECTRIC

An Equal Opportunity Employer

NCR

WHERE OPPORTUNITY AND TALENT DEVELOP

few companies offer stability and challenging work as found at NCR. Consider these positions now open:

ADVANCED PLANNING: Technical specialists in various areas find challenging opportunities with our Advanced Planning Group for military or commercial development. Speech recognition, data reduction, or optics background are but a few of the interesting areas of work involved. Some positions require project manager potential or experience.

INTEGRATED ELECTRONICS: Career openings exist in Physical Research and Development Program requiring experience in the areas of thin films and solid state circuitry. Most openings demand advanced education at the MS or Ph.D. level plus capability for individual contribution and potential management responsibility.

SYSTEMS ENGINEER: Responsible positions in commercial or military groups providing outstanding opportunity for the senior man desiring to work with advanced concepts in digital system design. MSEE preferred or BS with 5-10 years experience.

CIRCUIT DESIGNER: Experience in transistor circuit design and evaluation plus a BSEE degree provides the background for opportunity in areas of work related to computer and peripheral unit development. Other openings are related to design improvement of established lines together with factory follow up.

ELECTROMECHANICAL DESIGNER: The changing nature of our product line and the corporate Total Systems concept provides outstanding potential for the above average designer to work in areas of high speed mechanisms. Other openings require experience with small part mechanical design.

OTHER OPENINGS: Cover a broad field of activity with specialties including computer programming, operations research, technical library systems, new product development (technical and marketing background.)

Send your personal letter to: T. F. Wade, Technical Placement, The National Cash Register Company, Dayton 9, Ohio
An equal opportunity employer.



E. E.'s
for FEE-PAID Positions
WRITE US FIRST!
Use our confidential application for professional, individualized service . . . a complete national technical employment agency.
ATOMIC PERSONNEL, INC.
Suite 1207L, 1518 Walnut St., Phila. 2, Pa.

EMPLOYMENT OPPORTUNITIES



The Advertisements in this section include all employment opportunities—executive, management, technical, selling, office, skilled, manual, etc. Look in the forward section of the magazine for additional Employment Opportunities advertising.

Positions Vacant Civil Service Opportunities
Positions Wanted Selling Opportunities Wanted
Part Time Work Selling Opportunities Offered
Employment Agencies
Employment Services
Labor Bureaus

— RATES —

DISPLAYED: The advertising rate is \$40.17 per inch for all advertising appearing on other than a contract basis. Contract rates quoted on request.

An advertising inch is measured 7/8" vertically on a column—3 columns—30 inches to a page.
Subject to Agency Commission.

UNDISPLAYED: \$2.70 per line, minimum 3 lines. To figure advance payment count 5 average words as a line.

Box numbers—count as 1 line.

Discount of 10% if full payment is made in advance for 4 consecutive insertions.
Not subject to Agency Commission.

electronics

WEEKLY QUALIFICATIONS FORM FOR POSITIONS AVAILABLE

(Continued from page 79)

| | |
|---|---------|
| PAN AMERICAN WORLD AIRWAYS INC Guided Missiles Range Div. Patrick Air Force Base, Fla. | 151* 13 |
| PHILCO WESTERN DEVELOPMENT LABORATORIES Palo Alto, Calif. | 20 14 |
| ROME AIR MATERIEL AREA (AFLC) Griffiss Air Force Base, Rome, N. Y. | 153* 15 |
| SPACE TECHNOLOGY LABORATORIES INC. Sub. of Thompson Ramo Wooldridge Inc. Redondo Beach, Calif. | 15* 16 |
| U. S. ARMY Harry Diamond Laboratories Washington, D. C. | 152* 17 |
| U. S. A. F. INERTIAL GUIDANCE Maintenance and standards Calibration Center, Newark Air Force Station Newark, Ohio | 85 18 |

* These advertisements appeared in the Jan. 4th issue.

PROFESSIONAL SERVICES

GIBBS & HILL, Inc.
Consulting Engineers
Systems Engineering
Operations Research • Development
Field Studies • Design • Procurement
Power • Transportation • Communications
Water Supply • Waste Treatment
393 Seventh Avenue New York 1, N. Y.

FOR MORE INFORMATION About Classified Advertising

Contact the McGraw-Hill Office Nearest You

| | |
|--|------------------|
| ATLANTA, 9 1375 Peachtree St., N.E. | TRinity 5-0523 |
| BOSTON, 16 O. Davis Copley Square | COngress 2-1160 |
| CHICAGO, 11 W. J. Higgins 645 No. Michigan Avenue | MOhawk 4-5800 |
| CLEVELAND, 13 1164 Illuminating Bldg. | SUperior 1-7000 |
| DALLAS, 7 F. LeBeau 1712 Commerce St., Vaughn Bldg. | Riverside 7-9721 |
| DENVER, 2 J. Patten 1700 Broadway, Tower Bldg. | ALPine 5-2981 |
| DETROIT, 26 856 Penobscot Bldg. | WOodward 2-1793 |
| HOUSTON, 25 J. Page Prudential Bldg., Holcombe Blvd. | Riverside 8-1280 |
| LOS ANGELES, 17 R. McGinnis 1125 W. 6th Street | HUntley 2-5450 |
| NEW YORK, 36 H. T. Buchanan, D. Hawksby 500 Fifth Avenue | LOngacre 4-3000 |
| PHILADELPHIA, 3 Wm. B. Sullivan-R. Lewis Six Penn Center Plaza | LOcust 8-4330 |
| PITTSBURGH, 22 J. Williams 4 Gateway Center | EXpress 1-1314 |
| ST. LOUIS, 8 J. Crowe 7751 Carondelet Avenue | PARkview 5-7285 |
| SAN FRANCISCO, 11 J. A. Hartley 255 California Street | DOuglas 2-4600 |

CAREER OPPORTUNITIES FOR ENGINEERS AND SCIENTISTS

With the U S A F INERTIAL GUIDANCE MAINTENANCE AND STANDARDS CALIBRATION CENTER

This newly-activated Air Force facility near Newark, Ohio, has a vital role in the defense of our country. That role is to assure accuracy . . . Accuracy in the calibration standards used throughout the Air Force and accuracy in the inertial guidance systems of the ATLAS, TITAN, MINUTEMAN and HOUND DOG.

STEP INTO YOUR NATION'S FUTURE IN ONE OF THESE CHALLENGING ASSIGNMENTS.

ELECTRONIC ENGINEER. Inertial Guidance engineering studies; advanced planning in development of inertial guidance maintenance capabilities; engineering studies for advanced aircraft; direct inter-disciplinary engineering functions into the integrated areas of electronic, electrical and optical sub-systems of the inertial guidance systems; provide engineering capability to foremen and technicians engaged in the trouble-shooting, repair and testing of inertial guidance systems and components; solve difficult and unusual problems in the field of metrology in connection with the National Bureau of Standards working in—"The most advanced standards laboratory in the world."

ELECTRICAL ENGINEER. Determine quality and performance of electrical aspects of inertial guidance systems after repair or overhaul; interpret manifestations of design changes and relate their significance to repair technicians; provide engineering assistance to procurement activities during repair contract negotiations; evaluate facility repair capability in light of manufacturer's design changes; conceive theories and plans for application of unique test equipment; research and application of Versatile Automatic Test Equipment (VATE).

MECHANICAL ENGINEER. Ultra-precision instrumentation in ultra-modern mechanical standards laboratory; travel to contractor's plants for purpose of interpreting technical requirements, obtaining technical information and determining similarity of the equipment and the repair process; provide engineering direction in set up and maintenance of test equipment; provide engineering assistance in determining equipment specifications; support foremen and technicians engaged in trouble-shooting and repair of inertial guidance systems and components.

If you have experience in the areas listed above, there is a position for you at the Newark Air Force Station, located thirty miles east of Columbus, Ohio. Salaries range up to \$11,150 per year. Graduate personnel with accredited degrees are desired.

Advantages include:

- Professional Environment
- Individual Responsibility
- Variety of Challenging Assignments
- New and Growing Organization
- Opportunity for Rapid Advancement
- Civil Service Career Status
- Excellent Leave Benefits
- Retirement Program
- Life and Health Insurance
- Work Stability
- Relocation Expenses

To arrange interview, interested applicants should send Federal Employment Application (Form 57 available at Post Office) to:

Mr. Charles A. Bradshaw
2802 Inertial Guidance and
Calibration Group
Newark Air Force Station
Newark, Ohio

An Equal Opportunity Employer

SPECIAL PURPOSE TUBES

| | | | | | | | | | |
|-------------|--------|------------|--------|----------|--------|------------|--------|--------|--------|
| OA2 | .80 | 4-125A | 20.00 | 100TH | 12.00 | 816 | 2.00 | 5836 | 50.00 |
| OA2WA | 1.50 | 4-250A | 35.00 | 100TL | 12.00 | 826 | 5.00 | 5837 | 50.00 |
| OA3 | .85 | 4-400A | 35.00 | FG-105 | 25.00 | 829B | 17.50 | 5840 | 2.50 |
| OA5 | 5.75 | 4-1000A | 95.00 | FG-172 | 25.00 | 829B | 10.00 | 5842 | 7.00 |
| OB2 | .70 | 4AP10 | 10.00 | HF-200 | 15.00 | 832A | 7.50 | 5845 | 6.00 |
| OB2WA | 1.50 | 4B31 | 15.00 | 212E | 50.00 | 833A | 37.50 | 5847 | 7.55 |
| OB3 | .75 | 4C35 | 12.50 | 242C | 10.00 | 836 | 2.50 | 5852 | 5.00 |
| OC3 | .50 | 4CX250B | 30.00 | 244A | 3.50 | 837 | 1.50 | 5876 | 9.50 |
| OD3 | .50 | 4CX1000A | 125.00 | 249B | 8.50 | 842 | 7.50 | 5879 | 1.15 |
| C1A | 7.50 | 4D32 | 15.00 | 249C | 6.50 | 845 | 12.50 | 5881 | 2.50 |
| IAD4 | 1.75 | 4E27 | 10.00 | 250R | 10.00 | 849 | 75.00 | 5886 | 3.50 |
| IB24 | 7.50 | 4J32 | 100.00 | 250TH | 25.00 | 851 | 50.00 | 5893 | 10.00 |
| IB24A | 17.50 | 4J34 | 100.00 | 251A | 75.00 | 866A | 2.00 | 5894 | 19.85 |
| IB35A | 3.50 | 4J50 | 100.00 | 259A | 5.00 | 869B | 75.00 | 5899A | 2.00 |
| IB59/R1130B | 10.00 | 4J52 | 35.00 | 262B | 4.00 | 872A | 5.00 | 5915 | 1.00 |
| IB63A | 10.00 | 4J62 | 150.00 | 267B | 5.00 | 884 | 1.25 | 5933 | 3.50 |
| 1C/3B22 | 5.00 | 4J63 | 150.00 | 271A | 10.00 | 885 | 1.00 | 5948 | 150.00 |
| 1D21/SN4 | 6.00 | 4J64 | 150.00 | 274A | 3.50 | 889RA | 150.00 | 5949 | 100.00 |
| CIK | 7.50 | 4PR60A | 50.00 | 279A | 200.00 | 891R | 300.00 | 5963 | 1.00 |
| IP21 | 30.00 | 4X150D | 12.50 | 283A | 3.50 | 892R | 300.00 | 5964 | .85 |
| IP22 | 8.00 | 4X150A | 12.50 | 287A | 3.50 | 913 | 12.50 | 5965 | 8.5 |
| IP25 | 10.00 | 4X150F | 20.00 | QK-288 | 200.00 | 927 | 2.00 | 5976 | 50.00 |
| IP28 | 15.00 | 4X150G | 25.00 | HF-300 | 35.00 | 931A | 5.00 | 5993 | 5.00 |
| 1Z2 | 2.50 | 4X250B | 25.00 | 300B | 5.00 | 1000T | 100.00 | 5998 | 5.00 |
| 2-01C | 12.50 | 4X250F | 30.00 | 304TH | 35.00 | VC-1257 | 500.00 | 6005 | 1.50 |
| 2A1P1A | 8.50 | 5ABP1 | 20.00 | 304TL | 38.85 | VC-1258 | 15.00 | 6012 | 4.00 |
| 2B23 | 20.00 | 5AHP7A | 25.00 | 310A | 3.50 | K-1303 | 35.00 | 6021A | 2.00 |
| 2BP1 | 10.00 | 5BP1A | 9.50 | 311A | 3.50 | 1500T | 200.00 | 6028 | 2.75 |
| 2C36 | 22.50 | 5C22 | 17.50 | 313C | 1.50 | 1603 | 3.50 | 6032 | 50.00 |
| 2C39 | 5.00 | 5CP1A | 9.50 | 323A | 6.00 | 1614 | 2.25 | 6045 | 1.15 |
| 2C39A | 10.00 | 5J26 | 75.00 | 328A | 4.50 | 1620 | 4.00 | 6072 | 1.25 |
| 2C39B | 15.00 | 5LP1A | 20.00 | 329A | 4.50 | 1624 | 1.00 | 6073 | 1.50 |
| 2C40 | 7.50 | 5R4GY | 1.25 | 336A | 2.50 | 1625 | .50 | 6074 | 1.50 |
| 2C42 | 4.00 | 5R4WGA | 4.00 | 337A | 3.50 | 1629 | .50 | 6080 | 3.35 |
| 2C43 | 7.50 | 5R4WGB | 6.00 | 348A | 4.50 | 1645A | 4.00 | 6080WA | 5.00 |
| 2C50 | 4.00 | 5R4WGY | 2.00 | 349A | 3.50 | 1846 | 50.00 | 6080WB | 10.00 |
| 2C51 | 1.50 | 5RP1A | 35.00 | 350A | 3.50 | 1850A | 300.00 | 6081 | 25.00 |
| 2C53 | 7.50 | 5UP1 | 12.50 | 350B | 2.50 | 2000T | 350.00 | 6082 | 3.35 |
| 2D21 | .65 | 5Y3WGT | 1.25 | 352A | 8.50 | 2050 | 1.35 | 6087 | 2.50 |
| 2D21W | 1.25 | 6AC7W | 1.00 | 354A | 12.50 | ZB-3200 | 150.00 | 6101 | 1.50 |
| 2E22 | 3.00 | 6AG5WA | 1.50 | 355A | 12.50 | 5516 | 7.50 | 6115A | 65.00 |
| 2E24 | 3.50 | 6AG7Y | 1.00 | 393A | 5.00 | 5528/C6L | 3.50 | 6130 | 6.50 |
| 2E26 | 2.50 | 6AK5W | 1.25 | 394A | 3.00 | 5545 | 25.00 | 6136 | 1.50 |
| 2J42 | 75.00 | 6AL5W | .60 | 403B | 3.00 | 5550 | 35.00 | 6146 | 3.00 |
| 2J51 | 50.00 | 6AN5 | 1.75 | 404A | 7.50 | 5551/FG271 | 50.00 | 6159 | 3.50 |
| 2J55 | 100.00 | 6AN5WA | 3.50 | 407A | 3.75 | 5552/FG235 | 60.00 | 6161 | 35.00 |
| 2J66 | 200.00 | 6AQ5W | 1.00 | 408A | 2.75 | 5553/FG258 | 125.00 | 6163 | 15.00 |
| 2K22 | 25.00 | 6A57G | 2.50 | 410R | 75.00 | 5556/PJ8 | 20.00 | 6164 | 45.00 |
| 2K25 | 8.50 | 6AU6WA | 1.25 | GL-414 | 80.00 | 5557/FG17 | 5.00 | 6186 | 1.60 |
| 2K26 | 35.00 | 6B4G | 3.35 | 416B | 20.00 | 5558/FG32 | 10.00 | 6189 | 1.60 |
| 2K28 | 25.00 | 6BA6W | .75 | 417A | 7.50 | 5559/FG57 | 10.00 | 6197 | 1.75 |
| 2K29 | 25.00 | 6BF7W | 2.00 | 418A | 7.50 | 5560/FG95 | 20.00 | 6199 | 35.00 |
| 2K30 | 50.00 | 6BL6 | 20.00 | 420A | 5.00 | 5561/FG104 | 40.00 | 6201 | 1.75 |
| 2K33A | 175.00 | 6BM6 | 20.00 | 421A | 7.50 | 5586 | 100.00 | 6202 | 1.50 |
| 2K34 | 100.00 | 6BM6A | 30.00 | 422A | 10.00 | 5590 | 1.00 | 6211 | .75 |
| 2K35 | 200.00 | 6C4W | 2.50 | 423A | 4.00 | 5591 | 3.00 | 6213 | 2.50 |
| 2K39 | 125.00 | 6C21 | 25.00 | 427A | 4.00 | 5603 | 3.00 | 6216 | 3.00 |
| 2K41 | 35.00 | 6F4 | 5.00 | 429A | 6.50 | 5608A | 5.00 | 6236 | 125.00 |
| 2K42 | 150.00 | 6GJ | 10.00 | 432B | 7.00 | 5636 | 2.25 | 6263 | 9.00 |
| 2K43 | 175.00 | 6J4 | 1.75 | GL-434A | 10.00 | 5641 | 2.00 | 6279 | 17.50 |
| 2K44 | 125.00 | 6J4WA | 2.50 | 450TH | 50.00 | 5642 | 2.25 | 6280 | 30.00 |
| 2K45 | 20.00 | 6J6W | .75 | 450TL | 40.00 | 5647 | 3.50 | 6291 | 35.00 |
| 2K47 | 150.00 | 6J6WA | 1.00 | CK-503AX | 1.00 | 5651 | 1.00 | 6292 | 40.00 |
| 2K48 | 60.00 | 6L4 | 3.00 | 575A | 15.00 | 5654 | 1.50 | 6293 | 4.50 |
| 2K50 | 100.00 | 6L6GAY | 1.25 | 578 | 5.00 | 5656 | 5.00 | 6299 | 40.00 |
| 2K54 | 15.00 | 6L6WGA | 1.50 | NL-615 | 7.50 | 5665 | 40.00 | 6303 | 65.00 |
| 2K55 | 15.00 | 6L6WGB | 2.00 | NL-623 | 10.00 | 5667 | 125.00 | 6316 | 100.00 |
| 2K56 | 50.00 | 6Q5G | 2.50 | 631-P1 | 5.00 | 5670 | 1.00 | 6328 | 7.50 |
| 2X2A | 1.25 | 6SJ7WGT | 1.25 | 677 | 15.00 | 5672 | 1.35 | 6336 | 8.75 |
| 3A5 | 1.00 | 6SK7W | 1.00 | 677 | 50.00 | 5675 | 9.50 | 6336A | 12.75 |
| 3AP1A | 12.50 | 6SL7WGT | 1.25 | BL-696 | 35.00 | 5678 | 1.50 | 6350 | 1.25 |
| 3B4 | 2.50 | 6SN7W | .75 | 701A | 5.00 | 5684 | 9.50 | 6363 | 90.00 |
| 3B24W | 3.00 | 6SN7WGT | 1.00 | 707B | 2.50 | 5685 | 15.00 | 6364 | 130.00 |
| 3B24WA | 5.00 | 6V6GTY | 1.00 | NL-710 | 10.00 | 5686 | 2.25 | 6385 | 10.00 |
| 3B25 | 2.50 | 6X4W | .75 | 715C | 15.00 | 5687 | 1.50 | 6390 | 125.00 |
| 3B26 | 3.50 | 6X5WGT | 1.00 | 719A | 12.50 | 5691 | 5.00 | 6394 | 12.75 |
| 3B28 | 3.00 | 7MP7 | 22.50 | 721B | 5.00 | 5692 | 3.50 | 6442 | 25.00 |
| 3B29 | 5.00 | 10KP7 | 15.00 | 723A/B | 3.50 | 5693 | 3.50 | 6476 | 10.00 |
| 3BP1A | 7.50 | 12AT7WA | 1.25 | 725A | 10.00 | 5696 | 1.00 | 6485 | 1.50 |
| 3C22 | 25.00 | 12AU7WA | 1.50 | 726A | 5.00 | 5718 | 1.50 | 6528 | 12.75 |
| 3C23 | 5.00 | 12AX7W | 1.35 | 726B | 5.00 | 5721 | 100.00 | 6550 | 3.50 |
| 3C24/24G | 5.00 | 12AY7 | 1.00 | 726C | 10.00 | 5725/6AS6W | 1.50 | 6655 | 40.00 |
| 3C45 | 3.50 | 12GP7 | 25.00 | 750TL | 112.50 | 5726 | .75 | 6807 | 25.00 |
| 3CX100A5 | 15.00 | X-13 | 150.00 | NL-760 | 25.00 | 5727 | 1.25 | 6816 | 40.00 |
| 3D21A | 5.00 | C16J | 25.00 | BL-800 | 75.00 | 5728/FG67 | 20.00 | 6877 | 12.50 |
| 3E29 | 7.50 | HK-24 | 5.00 | 802 | 7.50 | 5734 | 15.00 | 6883 | 3.50 |
| 3GP1A | 12.50 | 25T | 7.50 | 803 | 5.00 | 5749 | 1.00 | 6888 | 2.00 |
| C3J | 7.50 | 26Z5W | 1.50 | 804 | 15.00 | 5750/6BE6W | 1.75 | 6896 | 350.00 |
| 3J21 | 35.00 | 28D7W | 3.50 | 805 | 7.50 | 5751WA | 1.50 | 7391 | 47.50 |
| 3J31 | 100.00 | FG-32 | 10.00 | 807 | 1.50 | 5755 | 5.00 | 7521 | 100.00 |
| 3K21 | 125.00 | 35T | 7.50 | 807W | 2.50 | 5763 | 1.75 | 7580 | 35.00 |
| 3K22 | 125.00 | 35TG | 3.75 | 808 | 2.50 | 5777 | 150.00 | 8000 | 18.85 |
| 3K23 | 200.00 | FP-54 | 150.00 | 809 | 4.75 | 5778 | 150.00 | 8002R | 35.00 |
| 3K27 | 150.00 | FG-57 | 10.00 | 810 | 18.85 | 5783 | 2.25 | 8008 | 6.00 |
| 3K30 | 100.00 | RK-60/1641 | 1.50 | 811 | 3.00 | 5787 | 2.50 | 8013A | 5.00 |
| 3KP1 | 9.75 | HY-69 | 3.00 | 811A | 4.75 | 5800 | 7.50 | 8014A | 25.00 |
| 3RP1 | 7.50 | 75TH | 18.85 | 812A | 4.75 | 5803 | 5.00 | 8020 | 6.00 |
| 3WP1 | 12.50 | 75TL | 18.85 | 813 | 12.50 | 5814A | 1.35 | 8025A | 5.00 |
| 3X2500A3 | 150.00 | KU-99 | 12.50 | 814 | 4.50 | 5819 | 40.00 | 9003 | 2.00 |
| 4-65A | 12.00 | HF-100 | 10.00 | 815 | 3.50 | 5829 | 1.00 | 9005 | 3.50 |

ALL TUBES ARE NEW, INDIVIDUALLY CARTONED, FULLY GUARANTEED

western engineers

TELEX or TWX:
916-681-3061
Telephone:
916-685-9582

ELK GROVE, CALIFORNIA
SUPPLIERS OF ELECTRON TUBES SINCE 1932

Prices FOB
Min order \$10

CIRCLE 950 ON READER SERVICE CARD

SEARCHLIGHT SECTION

Classified Advertising

BUSINESS OPPORTUNITIES

EQUIPMENT - USED or RESALE

DISPLAYED

The advertising is \$27.25 per inch for all advertising other than on a contract basis. AN ADVERTISING INCH is measured 7/8" vert. on a column, 3 cols.—30 inches—to a page. EQUIPMENT WANTED or FOR SALE ADVERTISEMENTS acceptable only in Displayed Style.

RATES

\$2.70 a line, minimum 3 lines. To figure advance payment count 5 average words as a line. BOX NUMBERS count as one line additional. DISCOUNT of 10% if full payment is made in advance for four consecutive insertions.

UNDISPLAYED

"TAB" TEST INSTS & EQUIPMENT! "TAB" Tested Guaranteed Reconditioned

BALLANTINE #300 Electronic Voltmtr/RMS Sensitive AC/VTVM, HiGain! Wide Freq! Hi-Stability! 1Mv to 100 volts/10 to 150,000 cps/ Reads AVG/SW Calibrated RMS/AC Volts & Decibels/2% Acy Op 115Vac/60Cys. SPECIAL LIMITED QTY!...\$125

BALLANTINE #304 WIDE BAND VTVM 30Cys to 5.5 Mcs 1Mv to 1V (Less Probe)...\$90

BALLANTINE #316 "INFRAFRONIC" Peak to Peak VTVM .02 to 200V at .05 to 30,000 Cps/3%Acy Wide Range! Mtr Flutter Free! Hi-Stability! Op 115V/60cys. SPECIAL LIMITED QTY...\$195

INSTRUMENT ELECTRONICS #253 ELEC. VTVM & AMPLIFIER, RMS/Voltmtr, 10to300,000Cys, Reads 1.5Mvto500V & -70 to +40DB in 12 steps Over 3 Bands, InpR+7Meg/15Mmf/2% Op 115v/60cys. SPECIAL LIMITED QTY...\$150

INSTRUMENT ELECTRONICS #45 ELECTRONIC VTVM & AMPLIFIER, RMS/Voltmtr 10 to 150,000 cys, Reads 0.5Mv to 500V & DB, Inpt R = 2Meg/15Mmf/2% Op 115V/60cys. SPECIAL LIMITED QTY...\$125

BOONTON Q METER #170A/30 to 200 Mcs Op 115V/60 cys. SPECIAL...\$225

N.Y.T. #312 DECADE INDUCTOR STANDARD .01 to 1 Henry in .01&.1/Steps 2x10 pos...\$66

DONNER #3730 Electronic Function Multiplier Dual Channel Hi Acy 1/4%...\$342

DONNER #3720R Fraction Cyclic Reset Generator .06to20cps in 5 pos. Manual & Automatic...\$108

"FP" Radiographing Pressure Gauge (15PSI)...\$115

"FP" Radiographing Pressure Gauge (75PSI)...\$115

RUBICON LAB GALVOMTR M/Lgt 5-0-5Microamps...\$61

FRAHM #FCDB5/400cy Freq Meter op 15 & 115V...\$23

Standard Timer #MST500 Gal 1/1000-30@.002 Secds...\$66

FXR #N410A Wavemtr, Direct Reading Freq 1.00to4.00KMC/Sec Acy/0.08%...\$225

RCA VTVM 195A Volt ohmyst...\$25

RCA WV-75A LAB Senior VoltOhmyst...\$40

RCA VTVM 84A Ultra Sens Microammeter .001 to 1000 Microamps...\$61

Electronic Meas #200B Rack Mtg Pwr Supply 0-325VDC@125Ma/1%Reg; Fil/6.3VAC@6A& Mts...\$90

ROGER WHITE #GPSIC Noise Source...\$66

"TAB" 111E Liberty St. "TAB"
N. Y. 6, N. Y., U.S.A.

Send 25¢ for Catalog

Phone Rector 2-6245

CIRCLE 951 ON READER SERVICE CARD

LIFSCHULTZ FAST FREIGHT



PIGGYBACK

TO BOTH COASTS

TRUCKLOAD RATES

TO BOTH COASTS

•We welcome your inquiry.

PROMPT
DAILY
PICKUP
and
DELIVERY

**FASTEST
TO BOTH COASTS!**

CIRCLE 952 ON READER SERVICE CARD

FREE Catalog OF THE WORLD'S FINEST ELECTRONIC GOV'T SURPLUS BARGAINS



HUNDREDS OF TOP QUALITY ITEMS — Receivers, Transmitters, Microphones, Inverters, Power Supplies, Meters, Phones, Antennas, Indicators, Filters, Transformers, Amplifiers, Headsets, Converters, Control Boxes, Dynamotors, Test Equipment, Motors, Blowers, Cable, Keys, Chokes, Handsets, Switches, etc., etc. Send for Free Catalog—Dept. E-3

FAIR RADIO SALES
2133 ELIDA RD. • Box 1105 • LIMA, OHIO

CIRCLE 953 ON READER SERVICE CARD

FREE...CATALOG TUBE & COMPONENT BARRY ELECTRONICS

512 BROADWAY Walker 5-7000
NEW YORK 12, N. Y. TWX- NY 1-3731

CIRCLE 954 ON READER SERVICE CARD

SMALL AD but BIG STOCK

of choice test equipment and surplus electronics

Higher Quality—Lower Costs
Get our advice on your problem

ENGINEERING ASSOCIATES

434 Patterson Road — Dayton 19, Ohio

CIRCLE 955 ON READER SERVICE CARD

POTTING APPLICATORS MANUAL AND DISPOSABLE

6cc 12cc 30cc

FOR POTTING, ENCAPSULATING, AND SEALING OF MINIATURE COMPONENTS
PHILIP FISHMAN CO.
7 CAMERON ST., WELLESLEY 81, MASS.



CIRCLE 956 ON READER SERVICE CARD

FOR RESEARCH — DEVELOPMENT & EXPERIMENTAL WORK

Over 10,000 different electronic parts: waveguide, radar components and parts, test sets, pulsers, antennas, pulse xmfrs, magnetrons, IF and pulse amplifiers, dynamotors, 400 cycle xmfrs, 584 ant, pedestals, etc.

PRICES AT A FRACTION OF ORIGINAL COST!

COMMUNICATIONS EQUIP CO.

343 CANAL ST., N. Y. 13, WO 6-4045
CHAS. ROSEN (Formerly at 131 Liberty St.)

CIRCLE 957 ON READER SERVICE CARD

RADIO RESEARCH INSTRUMENT CO.

AUTO-TRACK & TELEMETRY ANTENNA PEDESTALS 3 & 10 CM. SCR. 584 AUTOTRACK RADARS. AN/TPS-10 SEARCH. AN/TPS-10 HT. FINDERS. AN/PPN-32GCA. AN/APS-10 NAVIG. & WEATHER. AN/APS-15B PRECISION. AN/APQ-35B PRECISION. AN/APS-31A SEARCH. DOZENS MORE. 5-1-2 MEGAWATT HIGH POWER PULSERS.

RADIO RESEARCH INSTRUMENT CO.
550 Fifth Ave., New York Judson 6-4691

RADAR SYSTEMS & COMPONENTS/ IMMEDIATE DELIVERY

CIRCLE 958 ON READER SERVICE CARD

CATALOGS

Let us send you FREE brochure "How to Produce a Successful Catalog".

FREE Analysis and recommendations — if you send your present catalog to:

THE M. B. PEARLMAN COMPANY
280 Madison Avenue, New York 16, N. Y.

CIRCLE 959 ON READER SERVICE CARD

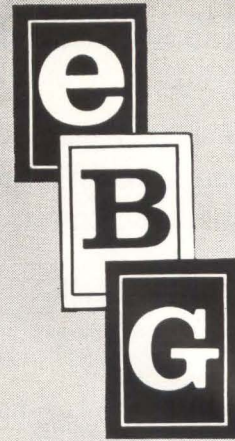

Make sure you know your electronics BUYERS' GUIDE

Review THE CONTENTS PAGE

● PRODUCT LISTINGS, streamlined by engineers for engineers.

● COMPANY STATISTICS: number of employees, product lines, names of key people, dollar volume.

● EDITORIAL INDEX to electronics for July 1961 through June, 1962.

● ABSTRACTS of Feature Articles in the current Editorial Index.

eBG

**HAS MUCH FOR YOU
BE SURE TO USE IT
ALL... REVIEW
THE CONTENTS PAGE**

INDEX TO ADVERTISERS



Audited Paid Circulation

| | | | |
|--|--------|--|--------|
| Aladdin Electronics..... | 72 | Sankaisha Co., Ltd..... | 62 |
| • Allied Control Company, Inc..... | 65 | Simplex Wire and Cable Co..... | 53 |
| • Amperite | 23 | Sprague Electric Co..... | 4, 9 |
| | | Struthers-Dunn Inc. | 29 |
| Barker & Williamson, Inc..... | 54 | • Superior Tube Co..... | 70 |
| Bourns Inc. | 10, 11 | • Syntronic Instruments, Inc. | 77 |
| • Bussmann Mfg. Co. Div. of McGraw Edison Co..... | 51 | T W Publishers..... | 25 |
| | | Texas Instruments Incorporated Semiconductor-Components Division | 14, 15 |
| Cleco Div. of Reed Roller Bit. Co..... | 57 | Texas Instruments Incorporated Industrial Products Group..... | 25 |
| • Cohn Corp., Sigmund..... | 76 | Trent Inc. | 66 |
| Collins Radio Co. | 22 | Triplett Electrical Instrument Co..... | 13 |
| • Curtiss-Wright Corp. | 66, 67 | • Tung-Sol Electric, Inc..... | 5 |
| | | • United Shoe Machinery Corp..... | 87 |
| Douglas Aircraft Co. | 55 | | |
| • Driver Co., Wilbur B. | 69 | Varian Associates | 73 |
| Dynamics Instrumentation Co. | 78 | Voltron Products Inc..... | 31 |
| | | | |
| Edwards High Vacuum Inc..... | 27 | | |
| • Engineered Electronics Co. | 6 | | |
| | | | |
| Florida Industrial Development Com- mittee | 75 | | |
| | | | |
| Globe Industries Inc. | 66 | | |
| Graphic Systems, Inc..... | 87 | | |
| Gries Reproducer Corp..... | 88 | | |
| | | | |
| • Hewlett-Packard Co..... Inside front cover | | | |
| High Voltage Engineering Corp..... | 75 | | |
| Hughes Aircraft Co. Aerospace Divisions | 61 | | |
| | | | |
| • Ingersoll Products, Div. of Borg-Warner Corp..... | 71 | | |
| | | | |
| Johnson Company, E. F..... | 23 | | |
| | | | |
| Kintel Div. of Cohu Electronics Inc...3rd cover | | | |
| | | | |
| Levin and Son, Inc., Louis..... | 32 | | |
| | | | |
| Mallory and Co., P. R..... | 58, 59 | | |
| Markem Machine Co..... | 68 | | |
| Meller Co., Adolf..... | 88 | | |
| Micrometals | 78 | | |
| Mitsumi Electric Co., Ltd..... | 76 | | |
| Monroe Calculating Machine Co., Inc. | 30 | | |
| • Moseley Co., F. L..... | 17 | | |
| | | | |
| • Natvar Corp. | 21 | | |
| • North Atlantic Industries, Inc..... | 26 | | |
| Northrop Corp. | 63 | | |
| | | | |
| Philco, Western Development Labs.... | 20 | | |
| • Potter Instrument Co., Inc..... | 19 | | |
| | | | |
| • Radio Corporation of America...4th cover | | | |

CLASSIFIED ADVERTISING

F. J. Eberle, Business Mgr.

| | |
|--|--------|
| PROFESSIONAL SERVICES | 84 |
| EMPLOYMENT OPPORTUNITIES...80-84 | |
| SPECIAL SERVICES | 86 |
| EQUIPMENT (Used or Surplus New) For Sale | 85, 86 |

INDEX TO CLASSIFIED ADVERTISERS

| | |
|---|--------|
| Atomic Personnel Inc..... | 84 |
| • Barry Electronics | 86 |
| • Communications Equipment Co..... | 86 |
| • Engineering Associates | 86 |
| • Fair Radio Sales..... | 86 |
| Fishman Co., Philip..... | 86 |
| General Electric Apollo Support De- partment | 83 |
| Grumman Aircraft Engineering Corp. | 81, 82 |
| Lifschultz Fast Freight..... | 86 |
| NASA Manned Spacecraft Center..... | 80 |
| National Cash Register Company..... | 84 |
| Pearlman Company, M. B..... | 86 |
| • Radio Research Instrument Co..... | 86 |
| • TAB | 86 |
| • Western Engineers | 85 |
| U. S. A. F. Newark Air Force Station.. | 85 |

• See advertisement in the July 25, 1962 issue of Electronics Buyers' Guide for complete line of products or services.

This Index and our Reader Service Numbers are published as a service. Every precaution is taken to make them accurate, but **electronics** assumes no responsibilities for errors or omissions.

'On PW Boards'

DYNASERT
COMPONENT
INSERTING
MACHINE
CAN PAY
FOR ITSELF

**IN A YEAR
or less!**



BY DYNASERT
BY HAND

With only a few hundred PW boards a week, when Dynasert automatically feeds, prepares and inserts components, direct labor is cut to a fraction. Insertion rates go up to ten times faster, model changeovers made in seconds, boards are neater, more dependable, easier to solder tightly. Result: Savings that can return the cost of Dynasert in six months' to a year's time, plus more accurate and uniform insertions.

Send for the facts and figures. Dynasert Dept., United Shoe Machinery Corp., Boston, Mass.

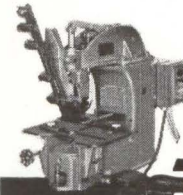

United
DYNASERT®

CIRCLE 208 ON READER SERVICE CARD

How To Get Things Done Better And Faster

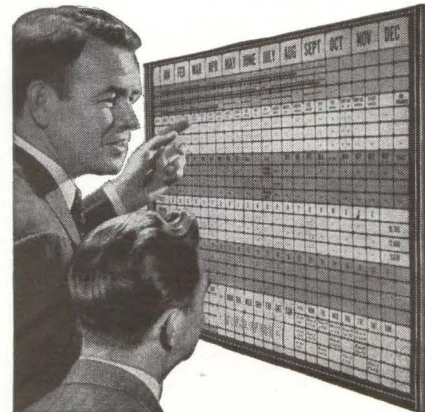

BOARDMASTER VISUAL CONTROL

- ☆ Gives Graphic Picture—Saves Time, Saves Money, Prevents Errors
- ☆ Simple to operate—Type or Write on Cards, Snap in Grooves
- ☆ Ideal for Production, Traffic, Inventory Scheduling, Sales, Etc.
- ☆ Made of Metal. Compact and Attractive. Over 750,000 in Use

Full price **\$4950** with cards

FREE 24-PAGE BOOKLET NO. C-30
Without Obligation

Write for Your Copy Today

GRAPHIC SYSTEMS
YANCEYVILLE, NORTH CAROLINA

CIRCLE 87 ON READER SERVICE CARD

87

FASTENERS FROM

GRC

DIE CAST ZINC ALLOY

ZINC ALLOY
ROUND HEAD
THUMB NUTS

Wing Nuts



Cap Nuts



Thumb Nuts



Thumb & Wing Screws



MOLDED NYLON & DELRIN

Screws



Hex Nuts



Washers



Screw Insulators

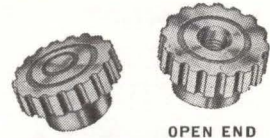

CLOSED END
with EXCLUSIVE WIDE GRIP

GRC THUMB NUTS feature extra-large round heads with deep fluted edges for firm, comfortable grip . . . smooth, rustproof, corrosion resistant surfaces. Smart design adds sales appeal.

Available with open and closed ends in a wide variety of sizes . . . Head Diameters: 1/2" to 1 1/8" . . . Thread Sizes: #4 to 7/16". GRC's exclusive methods—die casting zinc alloy or molding Nylon and Delrin fasteners in one high speed automatic operation—assure high quality at lowest possible cost.

Write, wire, phone TODAY for SAMPLES, prices, your copy of GRC's NEW INDUSTRIAL FASTENER CATALOG



GRIES REPRODUCER CORP.

World's Foremost Producer of Small Die Castings
151 Beechwood Ave., New Rochelle, N. Y.
Phone: (914) NEW Rochelle 3-8600

CIRCLE 209 ON READER SERVICE CARD

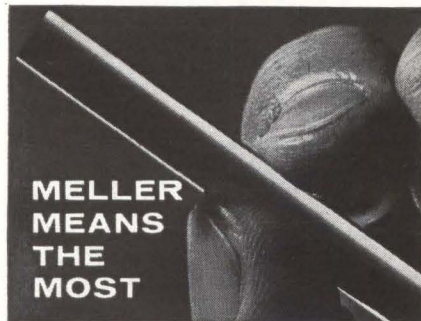

**MELLER
MEANS
THE
MOST**

Crystals of all types and sizes,
guaranteed to laser!

In stock, hundreds of single crystals. All configurations (plain flat and parallel ends, TIR configuration, Brewster's angle). Optically corrected for lowest threshold, narrowest beam divergence. Extra slow grown and annealed for minimum strain.

- NEW glass crystals w/2.0% Nd³⁺
- NEW NPSI super-uniform ruby crystals
- Ruby rods up to 12" long • CaWO₄ w/.5% Nd³⁺ up to 5" long • SrF₂ w/.1% Sa²⁺ • BaF₂ w/.5% Nd³⁺, or .1% U³⁺ • CaF₂ w/.5% Nd³⁺, or .1% Sa²⁺, or .05% Dy²⁺, or .1% U³⁺.

For full specifications and prices, contact Adolf Meller Company, Box 6001, Providence 4, R. I. Tel: DEXter 1-3717 (Area Code 401).

MELLER

**SAPPHIRE
PRODUCTS**

Synthetic Sapphires • Ruby Lasers & Masers
Alumina Powder

88 CIRCLE 88 ON READER SERVICE CARD

electronics



Audit Bureau
of Circulations



Associated Business
Publications

Audited Paid Circulation

JAMES T. HAUPTLI

Advertising Sales Manager

R. S. QUINT:
Assistant Publisher Buyers'
Guide and Business Manager
FRED STEWART:
Promotion Manager
B. ANELLO:
Market Services Manager

RICHARD J. TOMLINSON:
Production Manager
GEORGE E. POMEROY:
Classified Manager
HUGH J. QUINN:
Circulation Manager

ADVERTISING REPRESENTATIVES

- ATLANTA (9):
Michael H. Miller, Robert C. Johnson
1375 Peachtree St. N.E., Trinity 5-0523
(area code 404)
- BOSTON (16):
William S. Hodgkinson, Donald R. Furth
McGraw-Hill Building, Copley Square,
Congress 2-1160 (area code 617)
- CHICAGO (11):
Harvey W. Wernecke, Robert M. Denmead
645 North Michigan Avenue, Mohawk 4-5800
(area code 312)
- CLEVELAND (13):
Paul T. Fegley
55 Public Square, Superior 1-7000
(area code 216)
- DALLAS (1):
Frank Le Beau
The Vaughn Bldg., 1712 Commerce St.
Riverside 7-9721 (area code 214)
- DENVER (2):
J. W. Patten
Tower Bldg., 1700 Broadway,
Alpine 5-2981 (area code 303)
- HOUSTON (25):
Joseph C. Page, Jr.
Prudential Bldg., Halcombe Blvd.,
Riverside 8-1280 (area code 713)
- LOS ANGELES (17):
Peter S. Carberry, Ashley P. Hartman,
W. C. Gries
1125 W. 6th St., Huntley 2-5450
(area code 213)
- NEW YORK (36):
Donald H. Miller, Henry M. Shaw,
George F. Werner
500 Fifth Avenue, LO-4-3000
(area code 212)
- PHILADELPHIA (3):
Warren H. Gardner, William J. Boyle
6 Penn Center Plaza, LOcust 8-4330
(area code 215)
- SAN FRANCISCO (11):
R. C. Alcorn
255 California Street, Douglas 2-4600
(area code 415)
- LONDON W1:
Edwin S. Murphy Jr.
34 Dover St.
- FRANKFURT/Main:
Matthée Herfurth
85 Westendstrasse
- GENEVA:
Michael R. Zeynel
2 Place du Port

"Headquarters for Business Information"

McGraw-Hill Technical and Business Publications

American Machinist/Metal-
working Manufacturing
Aviation Week and Space
Technology
Business Week
Chemical Engineering
Chemical Week
Coal Age
Construction Methods and
Equipment
Construction Daily
Control Engineering
Electrical Construction
and Maintenance
Electrical Merchandising Week
Electrical Newsletter
Electrical West

Electrical Wholesaling
Electrical World
Electronics
Engineering Digest
Engineering and Mining Journal
E & MJ Metal and Mineral
Markets
Engineering News-Record
Factory
Fleet Owner
Industrial Distribution
National Petroleum News
Nucleonics
Nucleonics Week
Platt's Oilgram News
Platt's Oilgram Price Service
Power

Product Engineering
Purchasing Week
Science Week
Textile World

Overseas only:
Automobile International
(English, Spanish)
Ingenieria Internacional
Construccion (Spanish)
International Management
(English, Spanish
Portuguese editions)
Metalworking Production
(Great Britain)

Available by subscription only — to qualified persons actively engaged in the field of the publication. For subscription rates and information describing the editorial coverage of any of the above publications, write to: Subscription Manager, Circulation Department, McGraw-Hill Publishing Company, 330 West 42nd Street, New York 36, N. Y.

electronics



**BEHIND THIS CURTAIN HIDE THE ONLY ICBMs NOT
WATCHED BY KINTEL CLOSED CIRCUIT TV SYSTEMS**

5725 Kearny Villa Road, San Diego 12, California • Phone 277-6700 (Area Code 714)

COHU
ELECTRONICS, INC.
KINTEL DIVISION

CIRCLE 901 ON READER SERVICE CARD

Super-clean area of the "White Room," where every TWT assembly operation is performed.

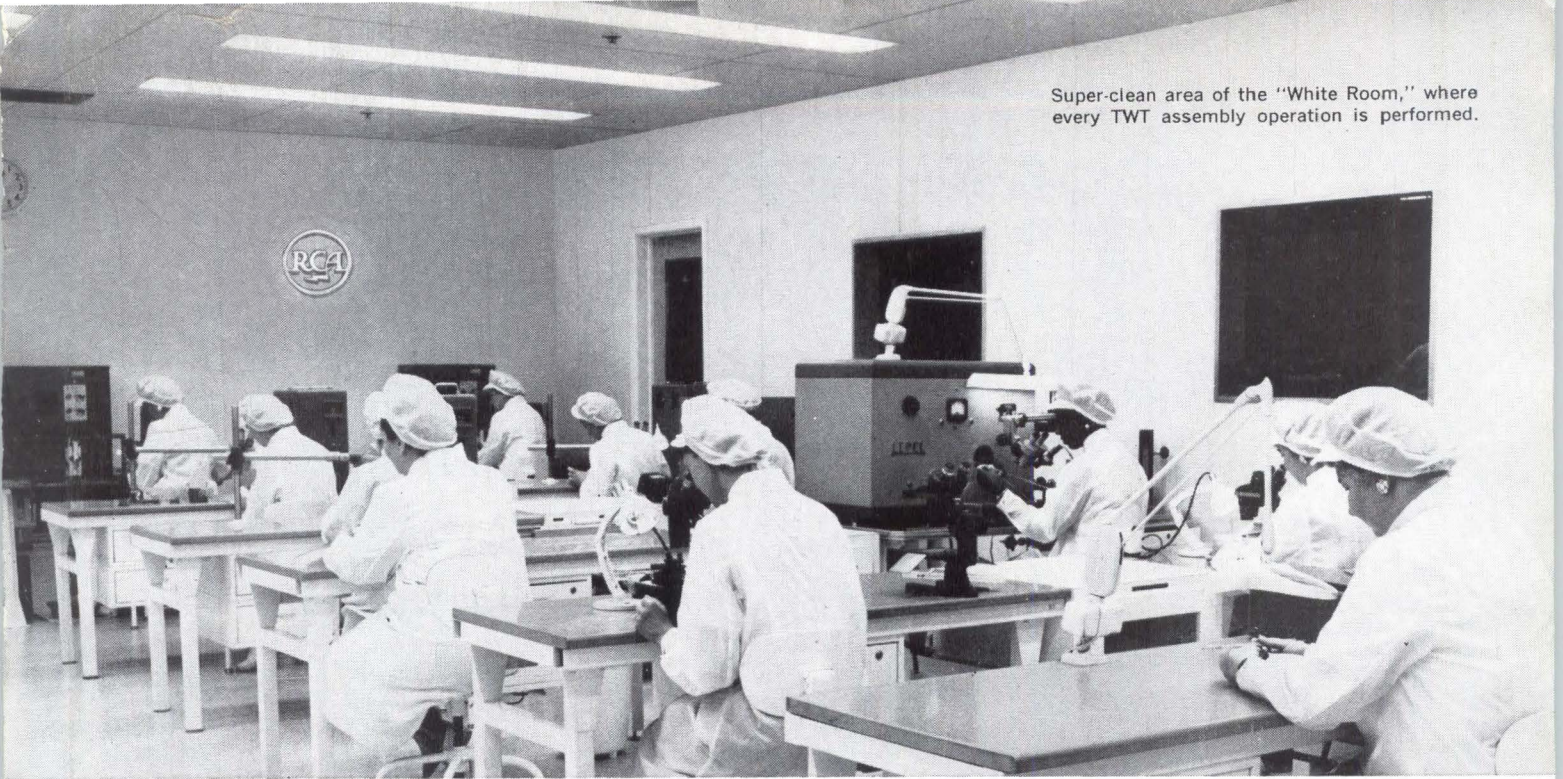

OPERATION TWT

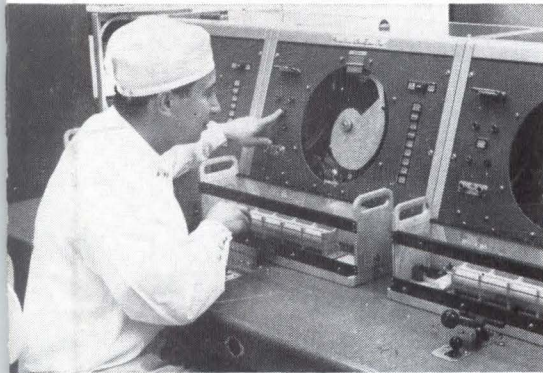

Automatic imbedding of helix assembly to insure reproducible rf loading from tube to tube, also providing maximum ruggedization of the tube structure.



All helices are inspected to a tolerance of ± 2 microns on a Helix Pitch Error Resolver.

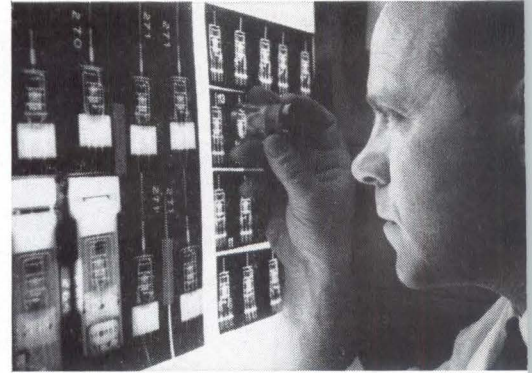

X-ray techniques are used for control of critical sub-assembly spacing and tolerance.

RCA'S MODERN PRODUCTION CAPABILITY SUPPORTS THE ADVANCE OF TRAVELING-WAVE TUBE TECHNOLOGY

Reliability and tube-to-tube uniformity in Traveling-Wave Tubes depend on skillful engineering design and modern production techniques. RCA has both. Backed by development at the David Sarnoff Research Center, RCA produces a variety of Traveling Wave Tube types for a wide range of frequencies. Assembly work is done in a "white room", under controlled conditions of temperature and humidity. Even air is filtered to limit dust particle size to .3 micron!

Many RCA Traveling-Wave Tubes produced in the "white room" were developed on contract for important industrial and defense projects. Tubes are subject to four levels of quality control. No wonder that there are reports of many tubes with 20,000 hours of service. It is no wonder, too, that RCA is the largest producer of TWTs for ECM applications.

If you have a problem in TWT research or development requiring the most recent concepts in TWT state-of-the-art; or require high production resources and capabilities, consult the leader in both areas—RCA.

For information, write: Manager, Microwave Marketing, RCA Electron Tube Division, Harrison, N.J.

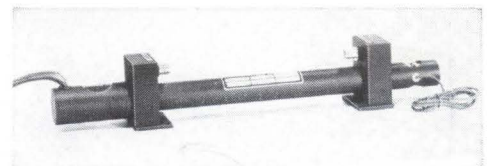

A typical example of an RCA ruggedized TWT for ECM applications.

INDUSTRIAL TUBE PRODUCTS FIELD OFFICES

OEM SALES: Newark 2, N. J., 744 Broad St., 485-3900 • Chicago 54, Ill., Suite 1154, Merchandise Mart Plaza, 527-2900 • Los Angeles 22, Calif., 6801 E. Washington Blvd., RA 3-8361 • GOVERNMENT LIAISON: Harrison, N. J., 415 South Fifth St., 485-3900 • Dayton 2, Ohio, 224 N. Wilkinson St., BA 6-2366 • Washington 7, D. C., 1725 "K" St., N. W., FE 7-8500 • INTERNATIONAL SALES: RCA International Div., Clark, N. J., 382-1000.



The Most Trusted Name in Electronics