

Electronics®

Electronics in the supersonic transport: page 60

Reducing noise in diode transistor logic: page 66

Special report on heat dissipators: page 83

September 7, 1964

75 cents

A McGraw-Hill Publication

Below: the large and small
in heat dissipators, page 83



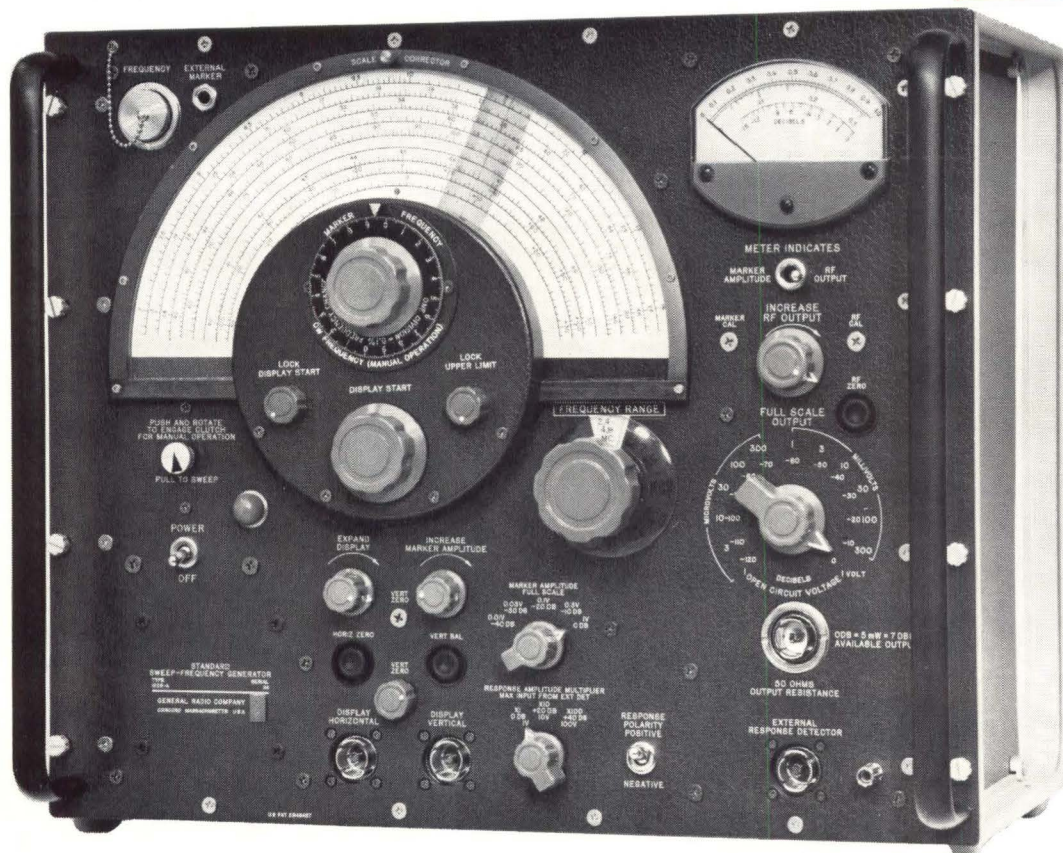

One-instrument sweep system

If you are interested in sweep-frequency measurements in the 0.7- to 230-Mc range, we have the instrument for you . . . so complete that all you need in addition is a scope. The 1025-A Standard Sweep-Frequency Generator is, as the name implies, a true standard-signal generator. It can be used as a sweep generator, a cw generator, or as a marker generator — it can be instantly switched from one mode of operation to another without readjusting, recalibrating, or reconnecting. In addition, the 1025-A features a precision output attenuator and meter for measuring *both* rf input and detected output of devices under test. This sweep generator has what has been called "the perfect marker" . . . continuously adjustable and accurately calibrated both in frequency and amplitude. With this marker you can take accurate quantitative data *directly* from a scope display. The marker is a single, narrow, unambiguous spike, not a confusing string of pips, and never interferes with the display.

Not only is the 1025-A complete, it is unique. A motor-driven variable capacitor produces a stable, swept signal, free from harmonic distortion, drift, and spurious responses. Residual fm is so low that steep response slopes can be investigated readily.

Like to know more? Call or write your nearest General Radio Sales Engineering Office for more information or a demonstration.

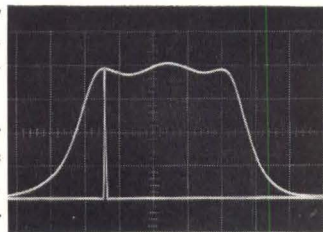

SPECIFICATIONS

Range: 0.7 to 230 Mc in ten overlapping octave ranges plus two bandspread ranges of 400-500 kc and 10.4-11 Mc. Other bandspread ranges available on special order.

Sweep Width: Entire selected range is swept. Portions of range as small as 10% can be expanded to full oscilloscope width for detailed visual display. Selected range is swept in 22.2 msec twenty times a second. Output is blanked off during return sweep.

Stability: Drift is less than $\pm 0.1\%$ over 5-hour period after warmup. Frequency dial accuracy is within $\pm 0.5\%$.

Marker: Adjustable from 3 mv to 1v; multiplier extends range to 100v. Resolution is better than $\pm 0.1\%$ of indicated frequency.

RF Output: 0.3 μ v to 1v behind 50 ohms. Output flat to within $\pm 1\%$ up to 100 Mc and within $\pm 3\%$ up to 230 Mc.

Price: \$3250 in U.S.A.

Write for Complete Information

GENERAL RADIO COMPANY

WEST CONCORD, MASSACHUSETTS

IN CANADA: Toronto 247-2171, Montreal (Mt. Royal) 737-3673
IN EUROPE: Zurich, Switzerland — London, England

NEW YORK, N. Y., 964-2722
(Ridgefield, N. J.) 943-3140

CHICAGO
(Oak Park) 848-9400

PHILADELPHIA, 424-7419
(Abington) 887-8486

WASHINGTON, D.C.
(Rockville, Md.) 946-1600

SYRACUSE
454-9323

DALLAS
FL 7-4031

SAN FRANCISCO
(Los Altos) 948-8233

LOS ANGELES
469-6201

ORLANDO, FLA.
425-4671

CLEVELAND
886-0150

SIX DIGITS!

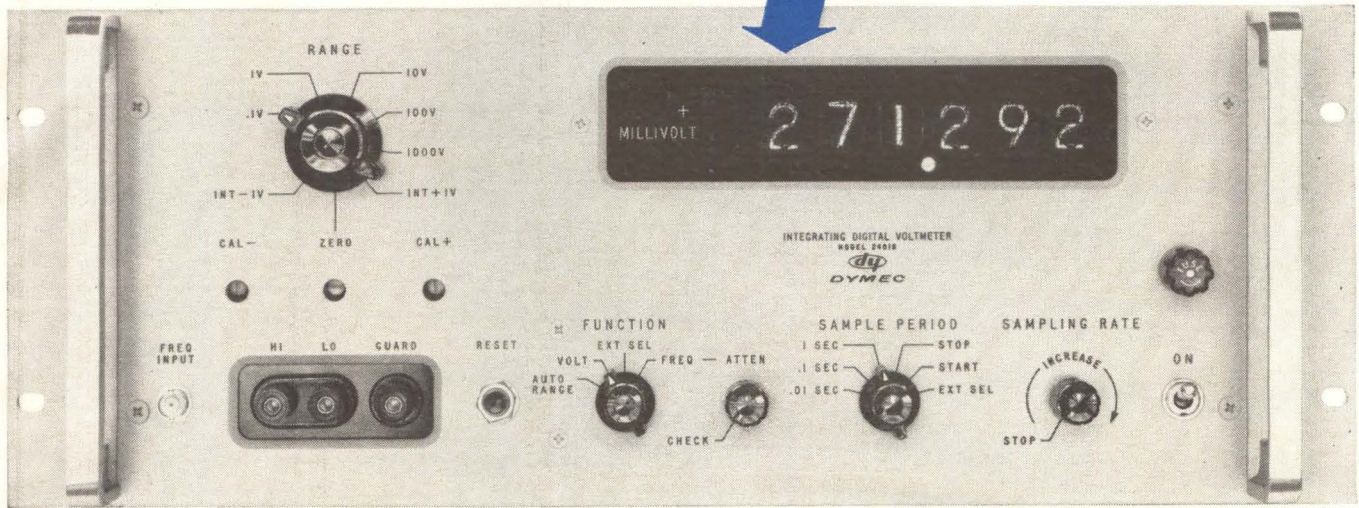

to display full 300% overranging of the Dymec Integrating Digital Voltmeter

A new sixth digit is available on the world's first and finest integrating digital voltmeter, the DY-2401B... and here's what it gives you:

New convenience in taking advantage of the voltmeter's 300% overranging capability on the 100 millivolt, 1, 10 and 100 volt ranges. For example, you don't have to measure 3 volts on the 10 volt range, thereby losing a full decade of resolution. Measure it on the 1 volt range, taking advantage of the overranging feature. The sixth digit tells you the most significant figure.

Additionally, an optional autoranging feature is available with the 2401B, for your maximum measuring convenience and speed (only 34 milliseconds maximum range-change time).

The DY-2401B offers a broader measuring capability than any other digital voltmeter available. Guarded input and integrating operation permit measuring low level signals... even in the presence of high common mode

and superimposed noise. Flip a switch and the voltmeter becomes a 300 kc frequency counter. All functions are programmable by contact closures to ground; BCD output is standard.

Accessory instruments include the DY-2411A Guarded Data Amplifier, which adds a 10 mv full scale range (again, with 300% overranging). The DY-2410B AC/Ohms Converter provides floated and guarded, broadband ac voltage and resistance measurements.

Ask your Dymec/Hewlett-Packard field engineer for a demonstration of the 2401B, now available with these new options: automatic ranging with or without the sixth digit, or the sixth digit with standard manual ranging.

DY-2401B	\$3950
DY-2410B	\$2250
DY-2411A	\$1150

Data subject to change without notice. Prices f.o.b. factory.

See us at I.S.A. Show, October 12-15, N.Y. Coliseum,
Booths 1314-1318

DYMEC

A DIVISION OF HEWLETT-PACKARD COMPANY

DEPT. E-8, 395 PAGE MILL ROAD, PALO ALTO, CALIFORNIA • PHONE (415) 326-1755 TWX 415-492-9363



New improved solid-state model of Hewlett-Packard's historic state-of-the-art **10 cps-10 mc test oscillator!** Offers unduplicated advances for unmatched utility: True 50-ohm and 600-ohm output system for simple matching. Plus these specified improvements in frequency resolution, noise characteristics, stability, accuracy, distortion specs, frequency response:

IMPROVED PERFORMANCE, 651A TEST OSCILLATOR

- Frequency range:** 10 cps to 10 mc, 6 bands, dial calibration 1 to 10
- Frequency response:** Flat within $\pm 2\%$ across range from 100 cps to 4 mc; $\pm 3\%$, 10 to 100 cps; $\pm 4\%$, 4 mc to 10 mc
- Dial accuracy:** $\pm 2\%$, 100 cps to 1 mc, including warm-up drift and $\pm 10\%$ line variation; $\pm 3\%$, 10 to 100 cps and 1 to 10 mc
- Frequency stability:** Typically 10 ppm (short term)
- Distortion:** Less than 1%, 10 cps to 5 mc; approx. 2% at 10 mc
- Output:** 3.16 v into 50 ohms or 600 ohms; 6.32 v open circuit
- Hum and noise:** Less than 0.05% of output
- Monitor accuracy:** $\pm 2\%$ of full scale
- Monitor flatness:** $\pm 1\%$ at full scale, 20 cps to 5 mc
- Attenuator:** 90 db in 10 db steps, $\pm 1\%$; with 20 db vernier between steps; $Z_0=50$ ohms and 600 ohms
- Dimensions:** 5-7/32" high x 16 3/4" wide x 13 1/4" deep; 17 lbs.
- Price:** \$590

This new test oscillator out-performs all its "copies," past and present . . . and even improves on the performance of the famous standard, the hp 650A! As a solid-state Wein bridge oscillator using capacitive tuning, it is ideal for wide band response testing, voltmeter calibration, testing of audio-video systems and low level measurements. Further versatility is offered with two outputs, 3.16 v into 50 ohms or 600 ohms. Matching to loads greater than 50 ohms can be accomplished by adding a series resistor. The unmatched per-

formance of the 651A is indicated by the specifications. Call your Hewlett-Packard field engineer for a demonstration or write Hewlett-Packard, Palo Alto, California 94304, Telephone (415) 326-7000; Europe: 54 Route des Acacias, Geneva; Canada: 8270 Mayrand Street, Montreal.

Data subject to change without notice. Price f.o.b. factory.

**HEWLETT
PACKARD**



An extra measure of quality

9618

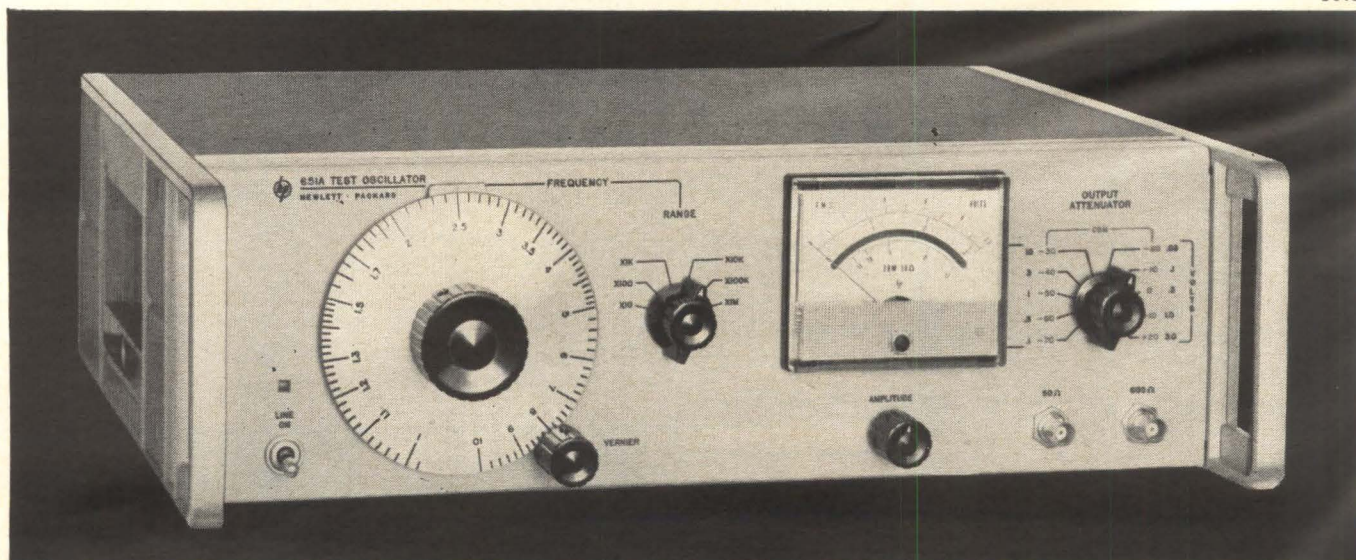

Electronics

Page 4	Readers Comment
8	People
10	Meetings
15	Editorial
17	Electronics Newsletter
47	Washington Newsletter
135	New Products
177	New Literature
181	New Books
182	Technical Abstracts

In this issue

Electronics review

Page 35	Tiny but potent	38	Electronic Shmoo
35	Like the plague	40	Cost-cutting circuit
36	Ship strike settled	40	Networks safe
36	Military satellites	40	Army talks digital
37	Nuclear Nimbus	42	The eyes have it
38	Comsat to economize	42	Japan looks eastward

Probing the news

111	Microwave at the kitchen door
114	Electronics in the Mekong Delta

Technical articles

Avionics	60	Electronics in the supersonic transport Because it flies faster than sound, the planned supersonic transport will need new electronic gear William J. Evanzia, avionics editor
Solid state	66	Less noise in high-speed circuits A systematic approach obtains optimum noise immunity to lessen the requirements for packaging logic circuits Donald R. Gipp, Radio Corp. of America
Manufacturing	73	A new way to package microelectronics New micromodule, assembled by electron-beam welding, holds 10 times as many components D.J. Garibotti and L.R. Ullery, United Aircraft Corp.
Circuit design	80	Designer's Casebook Staircase generator triggers unijunction transistor; constant current source controls sweep rate
Special report	83	Transistor heat dissipators
	84	Profile of the industry Lawsuits spring up as the use of semiconductor heat dissipators grows Jerome Eimbinder, solid state editor
	92	Beating the heat in semiconductor devices Existing circuitry can be improved by controlling operating temperatures J.C. McAdam, International Electronic Research Corp.
	99	Long-pin approach to dissipator design Quill-like fins impart thermal advantages to a different-looking heat sink John H. Jacoby, Pin Fin Inc.
	101	Liquid cooling Air cooling is more usual but there are some advantages to liquid cooling if it is done right John H. Sununu, Astro Dynamics Inc.
	104	Torque and thermal resistance A test setup determines the thermal impact of torque. Wayne E. Goldman, Wakefield Engineering Inc.

Electronics

Editor: Lewis H. Young

Senior editors

Technical: Samuel Weber
News: Kemp Anderson, Jr.

Senior associate editors: John F. Mason, George Sideris

Department editors

Advanced technology: George V. Novotny
Avionics: W.J. Evanzia
Circuit design: Michael Elia
Communications: Alexander A. McKenzie
Components: Michael F. Tomaino
Computers: Stephen B. Gray
Industrial electronics: Louis S. Gomolak
Instrumentation: George J. Flynn
Manufacturing: George Sideris
Military electronics: John F. Mason
New products: William P. O'Brien
Solid state: Jerome Eimbinder, G.G. Tirellis
Space electronics: Joel A. Strasser
Staff writers: Leon H. Dulberger, Peggy Jackson

Regional editors

Boston: Thomas Maguire, editor; Susan Turner
Chicago: Cletus M. Wiley, editor; Leslie Krimston
Los Angeles: Harold C. Hood, editor
San Francisco: Laurence D. Shergalis, editor; Mary Jo Jadin
London: Derek Barlow, editor

Copy editors

Howard Rausch, Sally Powell

Illustration

Assistant art director: John C. Wright, Jr.
Editorial production: Ann Mella, Sandra A. Le Mond

Editorial secretaries: Claire Benell, Mary D'Angelo, Lynn Emery, Kay Fontana, Carolyn Michnowicz, Lorraine Rossi, Lorraine Werner

McGraw-Hill news service

Director: John Wilhelm; **Atlanta:** Fran Ridgeway; **Chicago:** Bruce Cross;
Cleveland: Arthur Zimmerman; **Dallas:** Marvin Reid;
Detroit: Donald MacDonald; **Los Angeles:** Michael Murphy,
Ron Lovell; **San Francisco:** Margaret Ralston, Ed. Addeo;
Seattle: Ray Bloomberg; **Washington:** George Bryant Jr., Glen Bayless,
Charles Gardner

McGraw-Hill world news service

Bonn: Richard Mikton; **Brussels:** Arthur Erikson; **London:** John Shinn;
Mexico City: Wesley Perry; **Milan:** Bruce Bendow;
Moscow: Donald Winston; **Paris:** Dan Smith;
Rio de Janeiro: Leslie Warren; **Tokyo:** Marvin Petal, Charles Cohen

Circulation manager: Hugh Quinn

Reprints: T.M. Egan

Publisher: C.C. Randolph

Electronics: September 7, 1964, Vol. 37, No. 24

Printed at 99 North Broadway, Albany, N.Y.
Second class postage paid at Albany, N.Y.

Subscriptions are solicited only from those actively engaged in the field of the publication. Position and company connection must be indicated on orders. Subscription prices: United States and Possessions and Canada, \$5.00 one year, \$9.00 two years, \$12.00 three years. All other countries \$20.00 one year. Single copies, United States and Possessions and Canada 75¢. Single copies all other countries \$1.50.

Published every other Monday by McGraw-Hill Inc. 330 West 42nd Street, New York, N.Y. 10036. Founder: James H. McGraw, 1860-1948.

Subscribers: The Publisher, upon written request to our New York office from any subscriber, agrees to refund that part of the subscription price applying to copies not yet mailed. Please send change of address notices, subscription orders or complaints to Fulfillment Manager, Electronics, at the address below. Change of address notices should provide old as well as new address, including postal zone number if any. If possible, attach address label from recent issue. Allow one month for change to become effective.

Postmaster: Please send Form 3579 to Fulfillment Manager, Electronics, P.O. Box 430, Hightstown New Jersey 08520

Readers Comment

Weather or not

With regard to the weather map satellite [July 27, p. 81], I do not see how the average person could properly interpret the pictures of cloud cover to forecast his own weather.

If it is already cloudy he knows it without the satellite. The satellite doesn't tell him in what direction the clouds are moving or at what speed unless he is a skilled meteorologist.

It might make more sense for the average farmer to get his weather pictures from the telephone company along with the official U.S. Weather Bureau report. It would certainly seem to be more economical than maintaining his own equipment.

The telephone company could establish central receiving stations and transmit pictures over telephone lines using well-known slow-scan tv techniques. In fact, the picture could probably be displayed on the ordinary tv set by providing the proper receptacle on the telephone.

One alternative would be to establish an official uhf channel for each Weather Bureau regional office to transmit information. That might be a good step in establishing uhf tv sets.

Probably the best solution is one in which the local tv station sets up its own receiver and transmits the maps along with its commercials.

Bernard Fudim,
Calvert Electronics, Inc.
New York

▪ Mainly, those interested in obtaining their own weather pictures are institutions with meteorologists—airlines, utilities, etc.—who need accurate forecasting. Weather pictures are only part of the total information used in forecasting.

Weather map recorders

Congratulations on the excellent Hunter-Rich article "Birds-eye view of the weather" [July 27, p. 81]. Having worked closely with

Operating Temperature Range of Aluminum 'Lytic Capacitors Extended to -55 C, +125 C

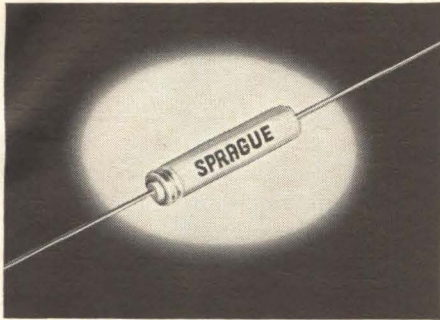

Type 600D Extralytic Capacitors are the first commercially-available aluminum electrolytics to extend their operating temperature range to -55 C, +125 C at voltage ratings up to 150 volts d-c.

Although Type 600D Capacitors, a recent development of the Sprague Electric Company, cost only half that of corresponding tantalum foil units, they have comparable performance characteristics and offer the advantage of generally being smaller and significantly lighter than military-grade tantalum foil capacitors of equivalent ratings.

Sprague Type 600D Extralytic Capacitors are only one-third the weight of their tantalum equivalents. In a case size of 3/8" x 2-3/16" it is possible to obtain a capacitance of 850 μ F at 5 WVDC or 26 μ F at 150 WVDC.

This significant advancement in the manufacture of aluminum electrolytics was made possible by increased foil purity, improved oxide systems, and newly developed methods of etching that yield higher etch ratios. An improved capacitor seal design and the development of a unique new electrolyte are two other factors contributing to their outstanding performance characteristics.

Extralytic Capacitors display excellent stability over their entire temperature range. Even at -55 C, their capacitance drop is very small. The operating and shelf life of 600D Capacitors is comparable to or better than that of foil tantalum capacitors.

For complete technical data, write for Engineering Bulletin 3455 to Technical Literature Service, Sprague Electric Company, 35 Marshall St., North Adams, Massachusetts 01248.

Circle 5 on reader service card

Electronics | September 7, 1964

6 Reasons Why SPRAGUE is a Major Resistor Supplier

FILMISTOR® PRECISION FILM RESISTORS



metal-film, molded case

Distinct limited temperature coefficients and low tolerances to meet exacting application requirements. Rugged end cap construction for long-term stability and reliability. Superior resistance to humidity and mechanical damage. Surpass MIL-R-10509E requirements. Send for Bulletin 7025B.



deposited-carbon, molded case

Approach precision wirewounds in reliability and stability, yet are smaller in size and have lower self-inductance. Low, controlled temperature coefficient. Dense molded case provides outstanding humidity protection. Send for Bulletin 7000A.



deposited-carbon, conformal coated

Full rated load operation at 70 C with no wattage derating. Assured uprated loads at lower operating temperatures. Ideal for circuitry where small size, humidity resistance, and close tolerance ($\pm 1\%$) are required. Send for Bulletin 7005A.

CIRCLE 270 ON READER SERVICE CARD

KOOLOHM® CERAMIC-SHELL POWER WIREWOUND RESISTORS

Exclusive ceramic-insulated resistance wire permits "short-proof" multilayer windings for higher resistance values. Standard and non-inductive designs. Non-porous ceramic shell for moisture protection and electrical insulation. Axial-lead, axial-tab, and radial-tab styles. Send for Bulletins 7300B, 7305, 7310.

CIRCLE 273 ON READER SERVICE CARD

GLASS-JACKETED POWER WIREWOUND RESISTORS

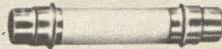

Ferrule terminals soldered to metallized ends of glass casing for true hermetic seal. Virtually failure-proof, even in extremely corrosive industrial and salt atmosphere. Standard and non-inductive windings. External meter-multiplier types also available. Send for Bulletins 7350, 7420, 7421.

CIRCLE 274 ON READER SERVICE CARD

For complete technical data, write for engineering bulletins on the resistors in which you are interested to: Technical Literature Service, Sprague Electric Company, 35 Marshall Street, North Adams, Massachusetts.

ACRASIL® PRECISION/POWER WIREWOUND RESISTORS



silicone-encapsulated

Combine the best features of both precision and power wirewound types. Resistance tolerances to $\pm 0.05\%$. Unusually tough encapsulation protects against shock, vibration, moisture, fungus. Meet MIL-R-26C requirements. Smaller than conventional wirewounds, yet greater in stability. Send for Bulletin 7450.

CIRCLE 271 ON READER SERVICE CARD

BLUE JACKET® VITREOUS ENAMEL POWER WIREWOUND RESISTORS



All-welded end cap construction with special vitreous coating for long-term dependability. Axial-lead style for conventional wiring or on printed boards. Tab terminals for higher wattage applications. Meet MIL-R-26C requirements. Send for Bulletins 7400B, 7410D, 7411A.

CIRCLE 272 ON READER SERVICE CARD

STACKOHM® POWER WIREWOUND RESISTORS



Flat silhouette permits stacking of resistor banks in close quarters. Aluminum thru-bar simplifies mounting and conducts heat from resistance element. Vitreous enamel protective coating. Meet MIL-R-26C performance requirements. Send for Bulletin 7430.

CIRCLE 275 ON READER SERVICE CARD

SPRAGUE®
THE MARK OF RELIABILITY

SPRAGUE®

MODEL 500 INTERFERENCE LOCATOR

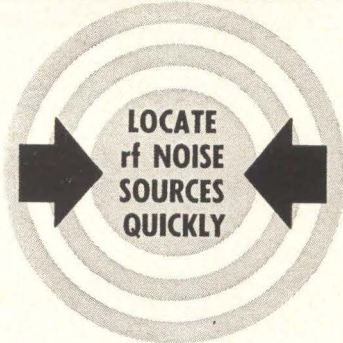

This versatile instrument is a highly sensitive interference locator—with the widest frequency range of any standard available unit! Model 500 tunes across the entire standard and FM broadcast, shortwave, and UHF-TV spectrums from 550 kc. to 220 mc. in 6 bands.

It's a compact, portable, rugged, versatile instrument—engineered and designed for most efficient operation in practical field use. It features a transistorized power supply, meter indications proportional to carrier strength as well as sensitivity of 5 microvolts minimum for 5% meter deflection over entire tuning range.

Send for brochure IL-106.

SPRAGUE ELECTRIC COMPANY
35 Marshall Street, North Adams, Mass.



584-R2

the budget-limited but extremely service-oriented U. S. Weather Bureau on the transmission of weather graphics (Alden Electronics is the supplier of the USWB's facsimile weather map recorders and scanners) we have been most active in the APT (automatic picture transmission) facsimile receiving systems and have sensed a real need for the definitive and down-to-earth articles simplifying the systems approach to APT weather satellite picture reception.

As a further service to your readers, however, we thought you might like to correct a small error in the first article. The Hunter-Rich article said the cost of Alden equipment for Commercial Facsimile Recorders for APT is \$5,000. The price of the Alden 9225 dual mode (APT and weather chart) recorder noted in the article is actually \$3,650.

John M. Alden,
President

Alden Electronics & Impulse
Recording Equipment Co.

Incremental recorders

I realize the editor's note on "Incremental digital recorder puts more data on less tape" [June 29, p. 51] was not intended to be a complete listing of all incremental recorders currently manufactured. There are, however, two additional incremental recorders worthy of mention.

The Digi-Data Corp. makes a series of incremental magnetic-tape recorders that write up to 400 characters per second at 200 or 556 bits per inch. Honeywell, Inc., Denver division, makes an incremental recorder that records up to 100 characters per second at 200 bits per inch.

Both manufacturers use magnetic detent motors to provide the incremental tape motion.

Raymund W. Nolan
Arlington, Va.

Flatpack standards

We have read with interest and not a little hope your July 27 Newsletter [p. 17] regarding the forthcoming flatpack standards. As a small business striving for a reasonable portion of the flatpack mar-

ket, we are continuously beset by contradictory requirements from our customers and vague, often ambiguous interpretations of such Mil-specs as are seemingly applicable to these relatively new devices.

While we recognize that no nascent industry can spring into being with its standards and minimum requirements fully delineated, it does seem out of keeping with both the significance of flatpacks to the microcircuit industry, and the sophistication of that industry itself, that no two users view these devices as equally applicable to nearly identical requirements.

In the hope that they may benefit users and manufacturers as well, we look forward to the findings of the Electronic Industries Association's microcircuits applications committee.

Norman M. Cox
Micro Science Associates
Mountain View, Calif.

Oscillator transistors

What type transistors are used in the circuit of the design item, "Oscillator generates sine, cosine waves simultaneously" [Aug. 10, p. 74]?

J. B. Morris
G. S. Nearman Co.
New York

- All three are 2N404.

Phase shifting

Please refer to the Designer's Casebook article, "Nomograph shows phase-shift angle" [July 27, p. 73].

How does one achieve a phase shift of 178°? Is this by heat or by some other manner unknown? The nomograph appears to be off by a factor of four.

John W. Anderberg
Holt Instrument Laboratories
Oconto, Wis.

- The nomograph was intended for use with transistor phase-shift circuits of the type described by James B. Collins [May 18, p. 92]. Collins says that a phase shift of 178° could be achieved with his circuit if the frequency were high enough, although the resistor would have to be very large.

HOW CAN THE OTHERS GIVE YOU GOOD SERVICE...

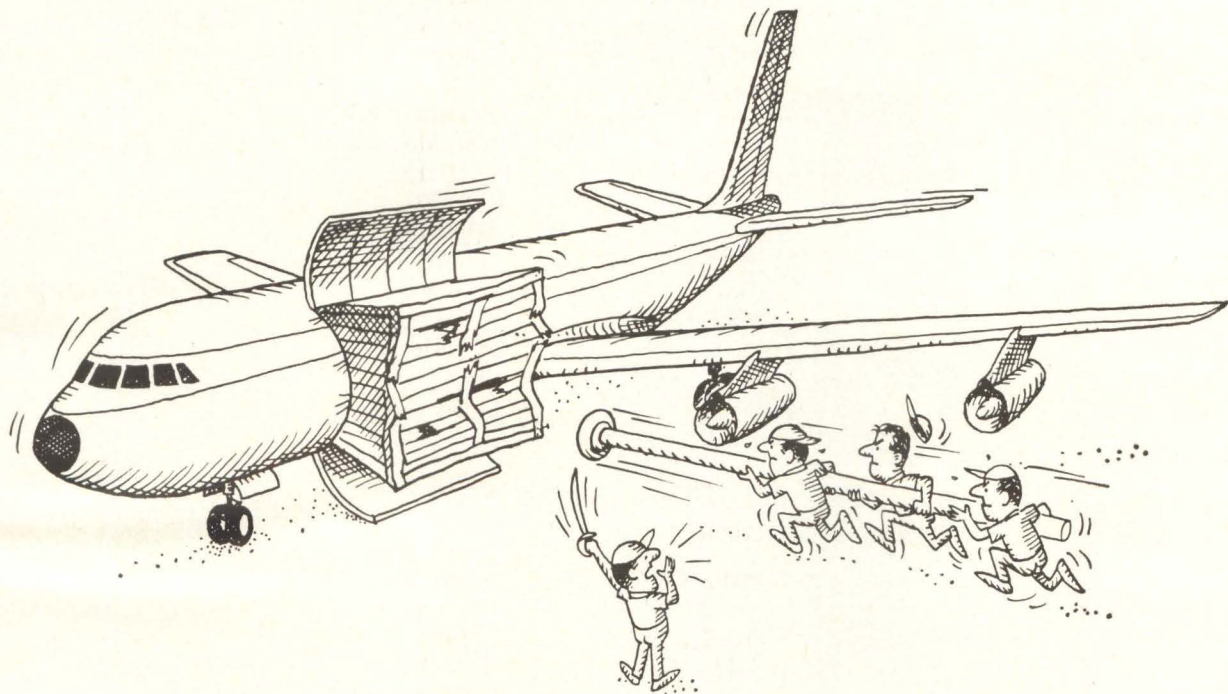

WHEN THEY CAN'T EVEN GET IT ON THEIR PLANE?

When you ship outside cargo by Flying Tigers, it gets on the plane... **easily**. There's no bending, slamming or jamming of cargo that won't quite fit into side-loading jet freighters. The reason—Tigers' huge break-away Swingtail-44. This Tiger swings its whole tail assembly aside to load two box car-lengths of cargo **straight in**.

That's a BIG part of the story, true. But perhaps the most crucial chapters are those devoted to Tiger service. And those chapters read like this:

- Skyroad Air/Rail/Truck System (Or: How to Ship Anything Anywhere In One Package, With Only One Bill)

- Expedited Door-to-Door Pickup & Delivery
- Scheduled Service
- Non-Stop Overnight Service
- Two-Way Radio Trucks
- Teletype Advance Manifest System
- Many Late Night Flights
- Specialized Experience

Each chapter has details that make your problems no problem at all. Main theme of our whole story—truly fanatic personalized service.

What's **your** story? We'd like to hear it, word for word. Why not call and tell it to us?

the airfreight specialist

FLYING TIGER LINE



[SUPER POWER TRIODE]

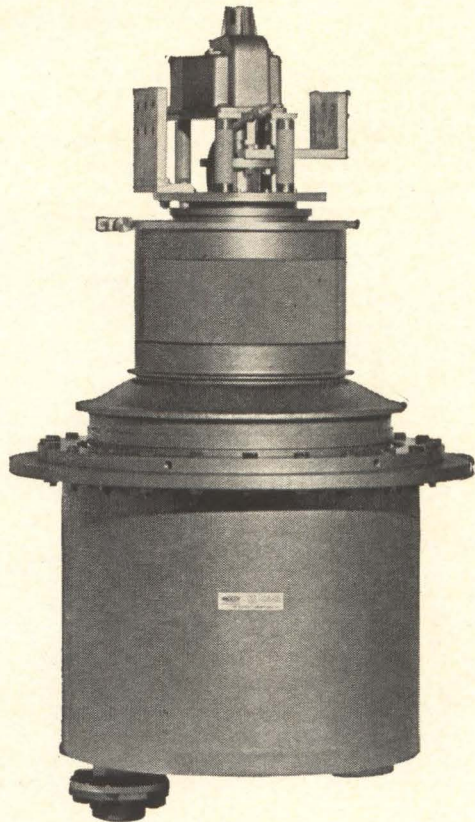

New ML-8549 Super Power Triode provides extremely favorable output/drive ratios. Typical power capabilities:

- 60 Mw pulse power . . . approximately 70 kw drive
- 10 Mw rf power, plate pulsed . . . approximately 33 kw drive
- 2.5 MW rf power, CW . . . approximately 10 kw drive
- 1.1 MW rf power, CW-plate modulated . . . approximately 4 kw drive

These extremely favorable output/drive ratios result from a novel beaming principle which permits a typical grid-to-plate current division of 100 to 1. Because of the very high power gain afforded, drive requirements are unusually low. Unique design of the ML-8549 utilizes two concentric anode cylinders permitting double-sided cathode operation resulting in low internal tube drop and highly efficient operation. Pulsed efficiencies higher than 90% are achieved. For data write: The Machlett Laboratories, Incorporated, Springdale, Connecticut. An affiliate of Raytheon Company.

MACHLETT
ELECTRON TUBE SPECIALIST.

People



W.E. Kock



A.J. Kelley

A distinguished inventor and a scientist manager will team up to direct the \$50-million Electronics Research Center that will be built in Cambridge, Mass., by the National Aeronautics and Space Administration.

Winston E. Kock, who will be the director, holds more than 50 patents—ranging from the electronic organ that he invented as a senior at the University of Cincinnati to a wave-guide microwave lens and the artificial dielectric lens.

The deputy director will be **Albert J. Kelley**, who has a reputation for being able to get things done. A Navy commander and former test pilot, he was loaned to NASA by the Navy four years ago to establish the Agena launch program. For three years, Kelley has managed the space agency's electronics research task group whose studies resulted in the creation of the Cambridge center.

Kock (pronounced "Coke"), an articulate scientist, is expected to attract the resourceful brains that NASA wants in its newest operation. Kelley, a 40-year-old doctor of science who in four years with NASA has demonstrated a flair for handling people, will be responsible for maintaining a balance among the scientists, teachers, bureaucrats and industrialists who will be involved with the center.

Kock's ambition is to make electronics one of NASA's strongest fields and to eliminate the electronic failures that have hurt the space program. He comes to NASA from the Bendix Corp. where he was vice president for research since 1962.

ON **JULY**
27th
1964

THE AIR FORCE
ACQUIRED AN ADVANCED
TELEMETRY CAPABILITY

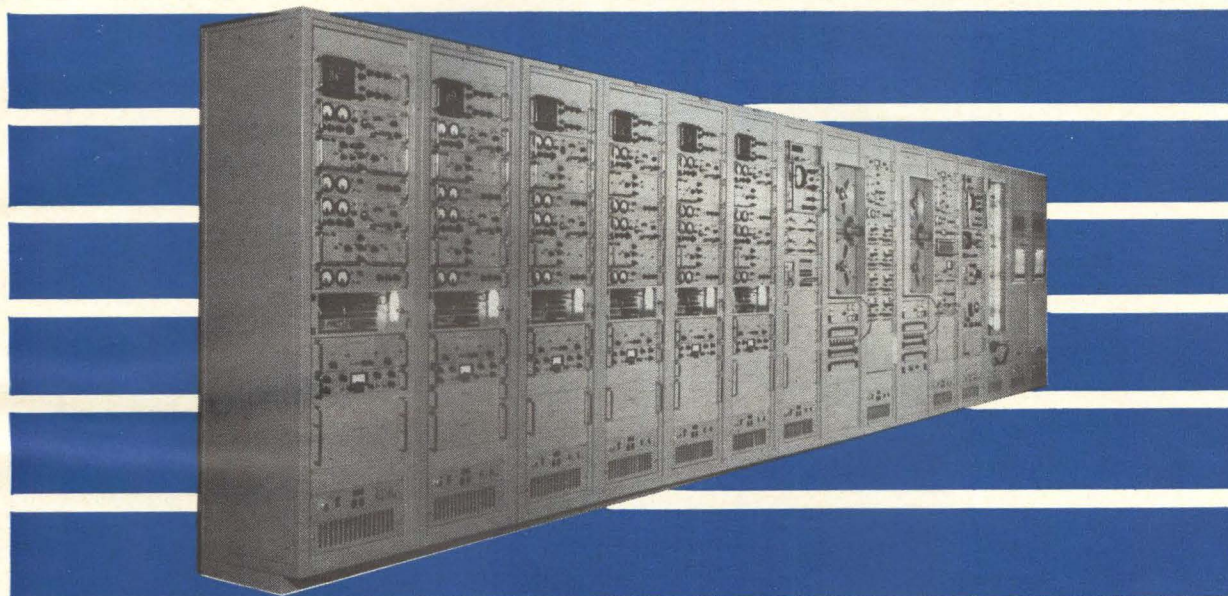

On that date, the Air Force received a completely integrated and self-sufficient predetection telemetry receiving and recording system capable of handling as many as twelve simultaneous telemetry signals of any known or projected telemetry format. The system will now undergo 60 days of exhaustive acceptance testing.

The new system, first of its kind ever designed and successfully factory tested, was developed and manufactured by Defense Electronics, Inc. It is expected to set the standard for years to come in space data acquisition facilities.

DEI developed and built more than 60 per cent of the equipment in the new system exclusively for the project. Successful completion of the unit was due largely to the perfection of new and improved techniques by DEI, including:

- Frequency-translation methods, enabling recording and reproduction of high bit-rate PCM and other wide bandwidth signals with minimum distortion.

- A diversity reception concept enabling optimum combination of telemetry data from diversity antenna systems without introduction of undesirable by-products and without need for special phase correction.

- A wide-band FM recording method, giving true DC to 500-kc bandwidth recordings.

Delivery of this initial "pre-d" telemetry system will be followed by shipment of three additional systems a month from DEI. Within less than a year, 19 fully-operational DEI systems are scheduled to go on the line at U.S. missile tracking sites on the Air Force Eastern Test Range.

Defense Electronics, Inc.
Rockville, Maryland



DEI
RESEARCH
DEVELOPMENT
MANUFACTURING

Rockville, Md. (301) 946-2600, TWX: 301-949-6788; Sherman Oaks, Calif. (213) 872-2870, TWX: 213-783-2742; Cocoa, Fla. (305) 632-5400, TWX: 305-632-5442; Willow Grove, Pa. (215) 659-5051; Export (212) Circle 6-2133, TELEX: TRIL 224326, 3 West 61st St., New York, N.Y.; Ottawa, Ont. EMISCO Ltd. (613) Central 6-0811; Cable: EMISCO.



PRECISION METALWORKING EQUIPMENT

di-acro

12 TON HYDRAULIC PRESS BRAKE

The Di-Acro 12 Ton Press Brake is designed for high speed, economical forming and fabricating of precision parts. Less than 15 seconds is required to pre-set the length of stroke for most efficient operation and maximum safety. The operator can easily "inch" the ram or reverse it at any point in the stroke. The 12 Ton series uses standard press brake dies and is available with 3 or 4 foot bed.

25 AND 35 TON SERIES

The rapid, dual speed work cycle provides fast approach, slow work and fast return—or a stroke as slow as 6 operations per minute. Dangerous sheet whipping with resultant costly kinking is virtually eliminated. This dependable hydraulic press brake is available in 6 and 8 foot bed sizes.

A complete selection of press brake dies for bending, blanking, box forming, corrugating, curling, hemming, punching and flattening. Fits all standard press brakes.

Di-Acro Rol-Form Dies eliminate work marking of highly polished or painted materials. Saves time and reduces die costs—one die does the job of many.

A new Di-Acro True Form Die contains an adiprene insert which "gives" under forming pressure. It forms the finest finishes without marking but requires more pressure than the Rol-Form Die.

See your Di-Acro distributor or write us.

Di-Acro manufactures a complete line of benders, rod parters, brakes, press brakes, press brake dies, shears, notchers, rollers, punch presses, layout machines, spring winders and punches and dies. Write for catalog.



439 Eighth Avenue • Lake City, Minnesota

Meetings

International Conference on Microwaves, Circuit Theory and Information Theory, Inst. Electrical Comm. Engrs. of Japan: Akasaka Prince Hotel, Tokyo, Sept. 7-11.

International Exhibition of Industrial Electronics, Swiss Industries Fair; Basel, Switzerland, Sept. 7-11.

International Convention on Military Electronics (MIL-E-CON-8), IEEE, Shoreham Hotel, Washington, Sept. 14-16.

Operations Research Society Annual International Meeting, Western Section of ORSA, ORSJ, University of Hawaii; Sheraton Meeting House and Princess Kaiulani Hotel, Waikiki, Honolulu, Sept. 14-18.

Ceramic-To-Metal Session, American Ceramic Society, Philadelphia, Sept. 17.

Annual Northwest Computing Conference, Northwest Computing Association, University of Washington Computing Center; University of Washington, Seattle, Wash. Sept. 17-18.

Engineering Management Annual Conference, IEEE-ASME; Pick-Carter Hotel, Cleveland, Sept. 17-18.

AIAA Military Aircraft Systems and Technology Meeting, (Secret), AIAA, USAF, BuWeps; NASA-Langley Research Center, Va., Sept. 21-23.

AE-4 Electromagnetic Compatibility Conference, SAE; McDonnell Aircraft Corp., St. Louis, Mo., Sept. 22-23.

Profession Technical Group on Antennas and Propagation International Symposium, PTGAP/IEEE; International Hotel, John F. Kennedy International Airport, N. Y., Sept. 22-24.

Annual Communications Conference, Cedar Rapids Section of IEEE; Hotel Roosevelt, Cedar Rapids, Iowa, Sept. 25-26.

Canadian IEEE Communications Symposium, Canadian Region IEEE; Queen Elizabeth Hotel, Montreal, Sept. 25-26.

Society of Motion Picture and Television Engineers Technical Conference, SMPTE, Inc.; Commodore Hotel, New York, Sept. 27-Oct. 2.

Allerton Conference on Circuit and System Theory, University of Illinois, CTG/IEEE; Allerton House, Conference Center of the University of Illinois, Monticello, Ill., Sept. 28-30.

Physics of Failure in Electronics Annual Symposium, Rome Air Development

Center, IIT Research Institute; IIT Research Institute, Chicago, Sept. 29-Oct. 1.

Tube Techniques National Conference, The Advisory Group on Electron Devices; Western Union Auditorium, New York. Sept. 29-Oct. 1.

Society for Information Display National Symposium, SID; Shoreham Hotel, Washington, Oct. 1-2.

Current Trends in Optical Physics Semiannual Symposium, American Physical Society; State University of New York College at Cortland, Cortland, N.Y., Oct. 2-3.

ISA Instrument-Automation Annual Conference and Exhibit, ISA; Biltmore Hotel and Los Angeles Sports Arena, Los Angeles, Oct. 4-7.

American Documentation Institute Annual Meeting, ADI; Sheraton Hotel, Philadelphia. Oct. 4-8.

The Road to Commercial Electronics: A Conference on Converting Military Capabilities to Civilian Markets, Electronics Magazine, IIT Research Institute; Grover M. Hermann Hall, Chicago, Dec. 1-2.

Call for papers

International Conference on Non-linear Magnetics (INTERMAG), IEEE; Sheraton-Park Hotel, Washington, Apr. 21-23. **Nov. 2** is deadline for submitting a 250-word abstract to E.W. Pugh, IBM Components Division, Dept. 231, Bldg. 703-2, Poughkeepsie, N.Y. 12602. Topics include computer magnetics, superconducting devices, magnetic recording, ferrite microwave devices, instrumentation and control, combined magnetic and semiconductor devices, magnetic material properties.

National Relay Annual Conference, Oklahoma State University, National Association of Relay Manufacturers, Oklahoma State University, Stillwater, Okla., Apr. 27-29. Deadline is **Nov. 2** for submitting 200-word abstract to D.D. Lingelbach, School of Electrical Engineering, Oklahoma State University, Stillwater, Okla. 74075.

Type TLS Wet Slug Tantalum Capacitor

MIL-C-3965 Styles CL64 and CL65

Mallory Type TLS wet slug tantalum capacitors meet requirements of MIL-C-3965C for Styles CL64 and CL65. They offer mfd-volt ratings per unit volume higher than most comparable tantalum units, wide operating temperature range, low DC leakage current, and high stability versus both temperature and life. Low DCL makes the TLS suitable for RC timing networks and instrument circuits. For example: 100 mfd, 25 volt TLS capacitor has maximum DCL of 2.5 microamperes at 125°C; other values have comparably low leakage.

The TLS withstands MIL requirements for vibration, shock, temperature cycling, immersion and moisture. Its small size makes it ideal for use in high-density circuit packaging subjected to severe physical environments. Cases are silver; three sizes are available.

The TLS capacitor is available in ratings from 1.7 mfd, 125 WVDC to 650 mfd, 6 WVDC. Operating

ambients range from -55°C to +125°C. For complete details, write or call Mallory Capacitor

Company, Indianapolis, Indiana 46206—a division of P. R. Mallory & Co. Inc.

TYPICAL PERFORMANCE CURVES TYPE TLS CAPACITORS

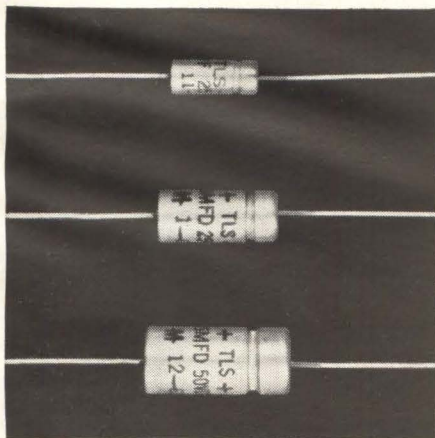
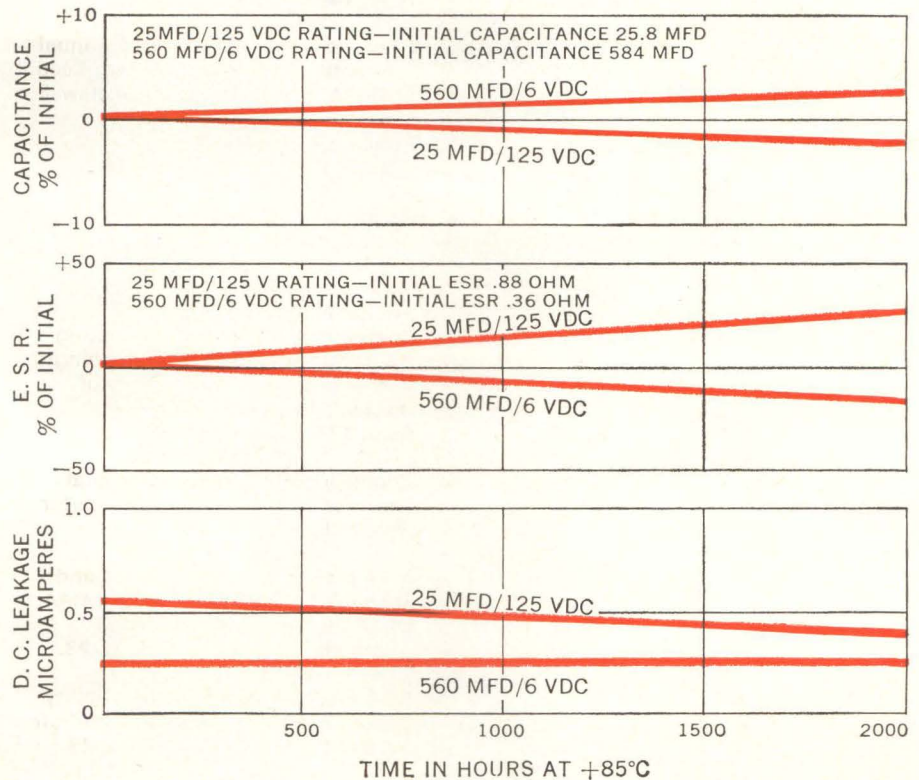

ACTUAL SIZE

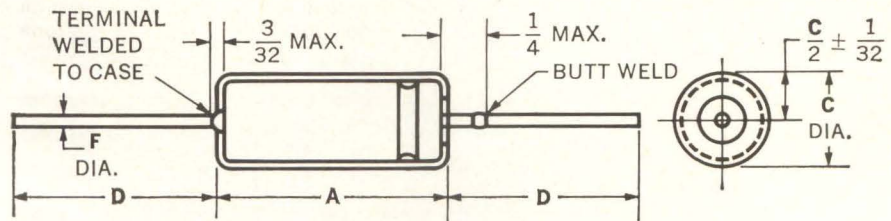

Case Size	UNINSULATED			INSULATED			F +.005 -.001
	A $\pm \frac{1}{32}$ $-\frac{1}{64}$	C $\pm \frac{1}{64}$	D $\pm \frac{1}{4}$	A $\pm \frac{1}{32}$	C Max.	D $\pm \frac{1}{4}$	
A	$\frac{29}{64}$	$\frac{3}{16}$	$1\frac{1}{2}$	$\frac{31}{64}$	$\frac{7}{32}$	$1\frac{1}{2}$.025
B	$\frac{41}{64}$	$\frac{9}{32}$	$2\frac{1}{4}$	$\frac{43}{64}$	$\frac{5}{16}$	$2\frac{1}{4}$.025
C	$\frac{49}{64}$	$\frac{3}{8}$	$2\frac{1}{4}$	$\frac{51}{64}$	$\frac{13}{32}$	$2\frac{1}{4}$.025

WET SLUG, FOIL AND SOLID TANTALUM CAPACITORS



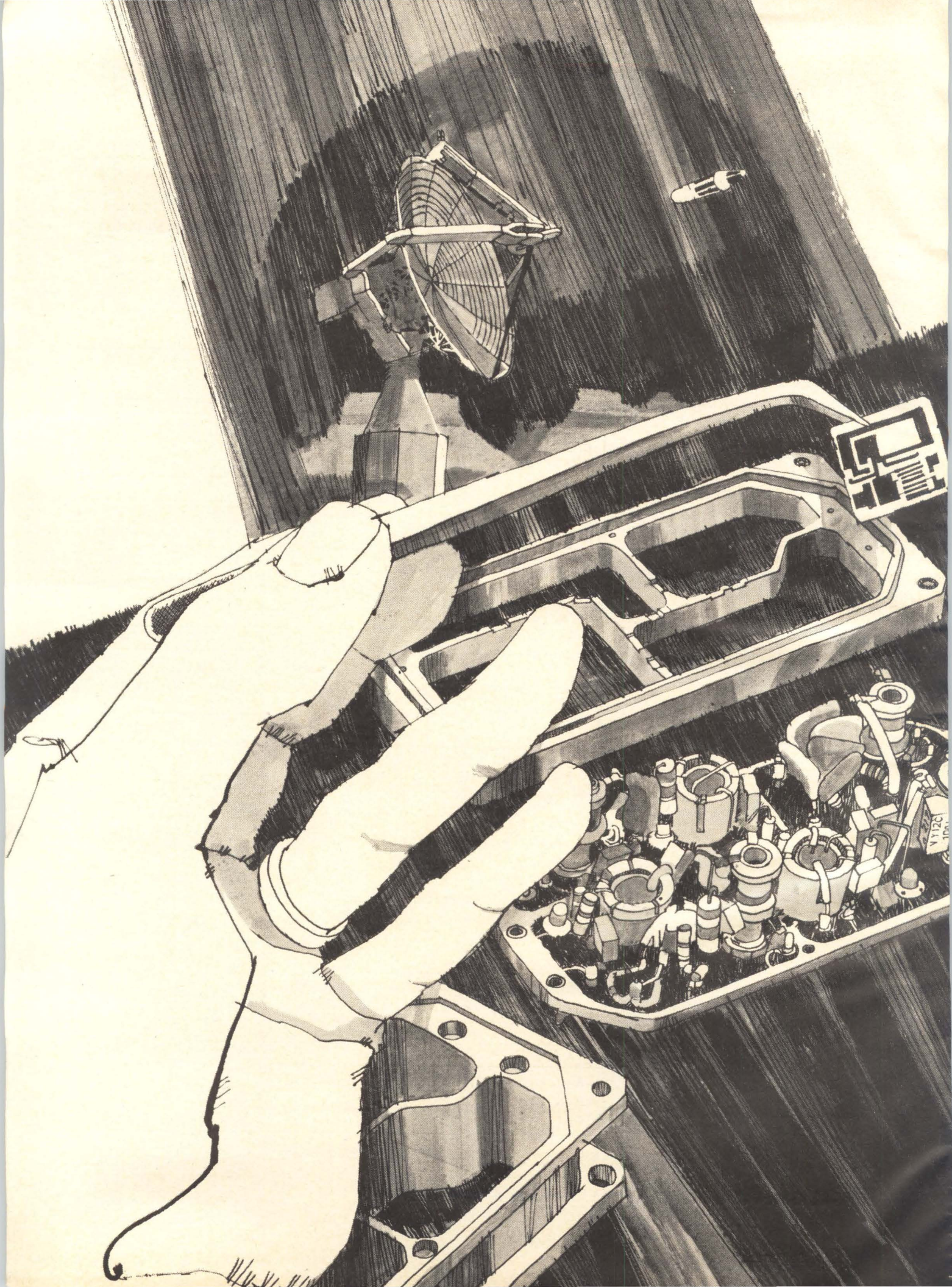

ELECTRONICS...THE MITE AND THE MIGHTY

No other technology in the history of man has moved with the staggering swiftness of electronics, and nowhere is electronics moving faster ahead than at LTV — ranging from sophisticated boxes of circuits that strain the naked eye, to super-power radars that reach out across vast distances in space to analyze moving bodies.

Electronics at LTV is moving from circuitry to "thin film" microcircuitry. Applied research by LTV Military Electronics Division in "thin film" microelectronics is setting new industry standards and bringing the company's product size down and reliability up in automatic controls, guidance systems, test equipment, display and other command and control systems . . . Electronics at LTV is moving from black boxes to gold-plated boxes for exotic space systems.

LTV Military Electronics is in the forefront of thrust vector control technology, designing and producing fluid injection valves, electro-hydraulic actuators and the electronic computing equipment to drive them on such programs as Minuteman and Titan III-C . . . LTV

Continental Electronics Division is unexcelled in building super-power radar and communications systems for space and defense projects, such as the Air Force pencil-beam radars at White Sands Missile Range, part of an advanced technology study that could influence radar design for years to come . . . Super-power electronics is also a specialty of LTV Ling Electronics Division, which produces vibrational test systems, including electro-dynamic shakers and the high-power amplifiers that drive them. LTV Ling also builds super-power pulse modulators used in klystron testing, radar and linear accelerators . . . LTV Temco Aerosystems Division has unique capabilities for transforming aircraft into flying electronic platforms that exercise command and control and other mission functions.

Sophisticated electronics systems are another example of the versatile store of science and technology at LTV, leader in electronics, aircraft, missiles, space, mobile ground vehicles, ground and airborne communications and range services. Ling-Temco-Vought, Inc., Dallas, Texas.

Divisions and subsidiaries: LTV Altec • LTV Astronautics • LTV Continental Electronics • LTV Ling Electronics • LTV Michigan • LTV Military Electronics
LTV Range Systems • LTV Research Center • LTV Temco Aerosystems • LTV University • LTV Vought Aeronautics • Kentron Hawaii, Ltd.

LTV

LING-TEMCO-VOUGHT, INC.

Circle 13 on reader service card

Fluid injection valve (foreground) and control box provide latest in thrust vector control.

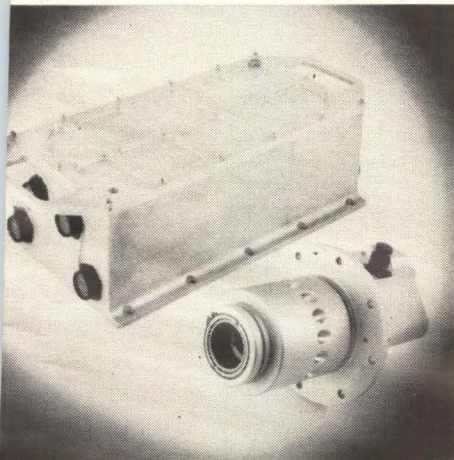

LTV Temco Aerosystems produced data handling console for pencil-beam radars at White Sands.

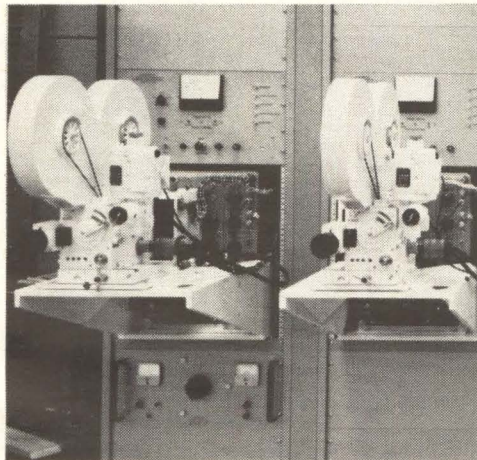

LTV Military Electronics display systems are used in Naval combat information centers.

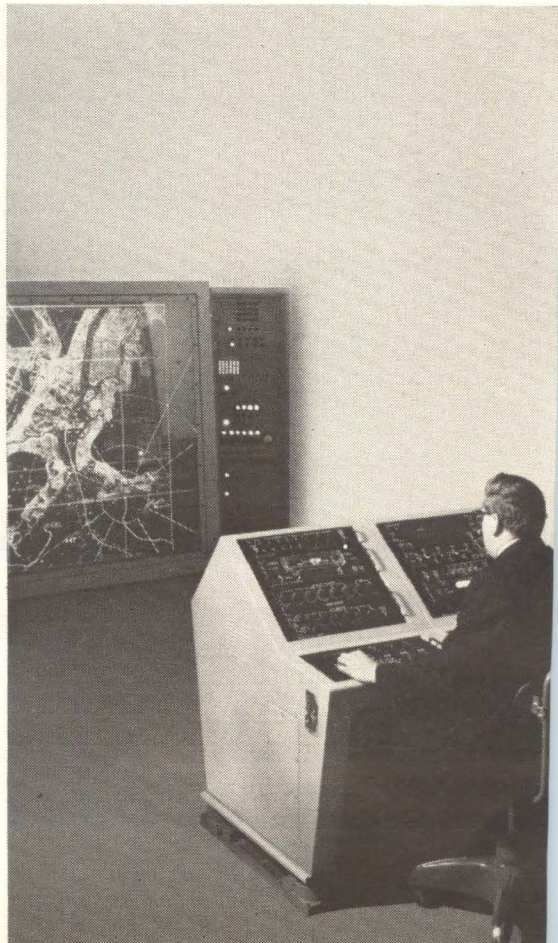

LTV Ling Electronics Division's powerful L-200 shaker vibrates Saturn S-IV rocket components.

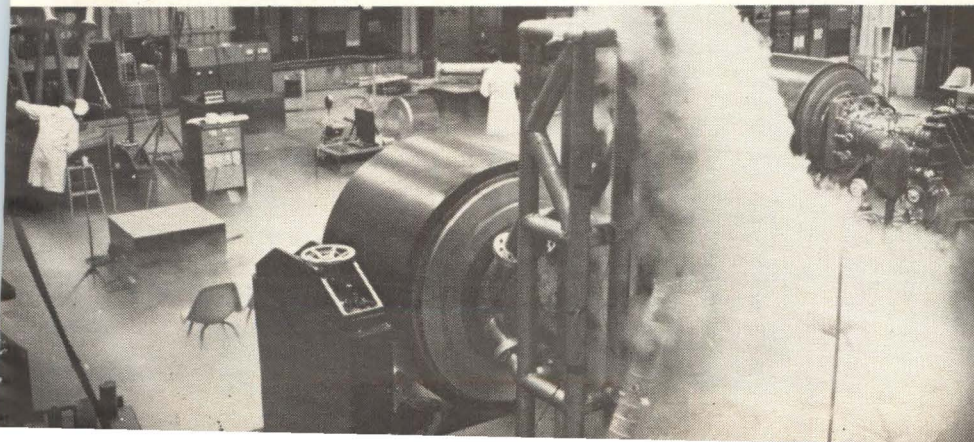

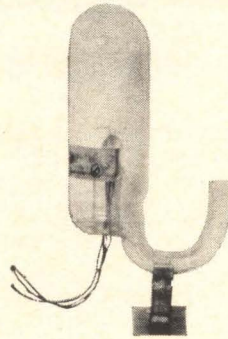

1912—General Electric's Dr. Irving Langmuir developed this early high-vacuum tube useful in establishing laws of electron flow.

GREAT!

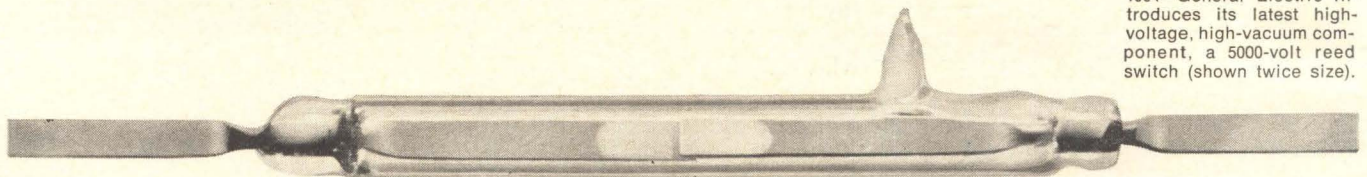

1964—General Electric introduces its latest high-voltage, high-vacuum component, a 5000-volt reed switch (shown twice size).

GREAT, GREAT "grandson"

Over 50 years' manufacturing experience in vacuum components backs up the reliability of this new General Electric high-voltage vacuum reed switch

Maximum ratings of 5000 volts (rms) and three amps are high for a reed switch. But this is the current-carrying capability of General Electric's new high-voltage, vacuum 2VR15. And, in spite of the high rating, this new switch offers the same long-life characteristics General Electric builds into its complete line of reed switches.

Here are some characteristics of the new 2VR15 to illustrate the point:

Voltage Breakdown.....	7000 V (RMS)
Switching Voltage	5000 V (RMS)
Current-Carrying Capacity	3 amps
Contact Resistance050 ohms
Operate	113 ± 20 AT
Release	55 ± 10 AT

Small, simple, rugged, fast-acting. There are now 17 General Electric reed switches, available in a variety

of terminal finishes, pull-ins (from 20 amp turns to 185) and drop-outs (from 18 amp turns to 60). You can get milliwatt sensitivity up to 100 million cycles or more, operating speeds less than a millisecond, and life-test results which we challenge any other reed switch manufacturer to match. This is the kind of quality which the industry's tightest assurance program produces. (Every switch you buy has run a gantlet of 14 electrical and mechanical tests including pull-in operate, drop-out release, high-voltage and leakage.)

May we send you a free folder that gives life data and specifications on our full line of reed switches? Write General Electric Tube Department, Owensboro, Kentucky.

Progress Is Our Most Important Product

GENERAL  ELECTRIC

Editorial

Boon or bomb?

The day of microelectronic circuitry is coming faster than a lot of people might wish. The big question is how many companies and engineers are ready for it.

If you need fresh evidence of the speed with which integrated circuits are reaching maturity, Wescon supplied it last month. At the show, Texas Instruments introduced 11 microelectronic products, Motorola announced an annular cross-section that makes integrated circuits twice as fast as those built with planar cross-sections and with better manufacturing yields, and other suppliers made microelectronic news too (see p. 35).

Some of the most significant developments have been deliberately hidden in the applications laboratories: breadboards of microelectronic consumer products, prototypes of high-speed computer memories made of integrated circuits, and some new packaging techniques that cut costs and make design simpler. These are still behind the scenes, but they're ticking away like time bombs. One day they'll explode in the face of the industry.

People who see the explosion coming liken it to the switch from tubes to transistors—but with an important economic difference. Transistorized equipment often costs more than its vacuum-tube predecessors. But in many applications, equipment built with integrated circuits can cost less than either transistor or tube versions.

This economic advantage is sure to step up the velocity of the change to integrated circuits, just as it's sure to put a crimp in the conventional component business.

Unfortunately, despite clear warning signs, a lot of component makers don't recognize the danger. They aren't lifting a finger to avoid it. Some are whistling in the dark; they tell you microelectronics will be an evolutionary change, with no real impact before 1970. However, there are indications already that the effects will be felt much sooner. Others sit back sadly, wringing their hands in despair at the prospect of their markets disappearing. Only a few are studying the situation seriously to find a niche for themselves in the coming tide.

The swing to integrated-circuit equipment will have an even greater impact on electronics engineers. It will obsolete a lot of circuit designers whose present job is solely to lay out or breadboard a circuit. In most microelectronic applications, circuit design is the easiest part of the job. The tough parts are devising interconnections, packaging (see p. 73), and manufacturing.

Thus the engineer will need a broader knowledge. He'll have to keep abreast of advanced technology more than ever. He'll have to design circuits, instrument and test them, package them, and make sure his design can be built at a reasonable yield. He'll have to understand the limitations of manufacturing processes to avoid designing circuits that cannot yet be manufactured.

One big user of microelectronics has reorganized his engineering department so the same technical man carries a project from conception through design, test and packaging, into manufacturing and finally to the shipping-room door. This kind of procedure is likely to become the rule rather than the exception.

Economics is going to be more important, and the engineer will have to understand this. Technically brilliant designs will not be acceptable unless they are also economic.

Some engineers will never be able to adapt to such radical changes. Their long-time narrow specialization has ruined them.

The age of microelectronics is for the engineer whose knowledge and capability are broad.

1000 Volts

High Potential Test

Clifton Precision Synchros

— Leakage less than 300 μ a

THE advent of the ultra high altitude airplane has made necessary synchros with better than ordinary insulation characteristics.

It has also made necessary repeated high potential testing of synchros at RMS voltages of 900 and 1000 across the windings and the case.

Stated simply, we believe that CPPC synchros have the best insulation available. Our Quality Control department has for years insisted that we be able to high potential test 100%, repeatedly. This we can do and maintain current leakage levels three times better than the industry standard.

We have made numerous test runs at

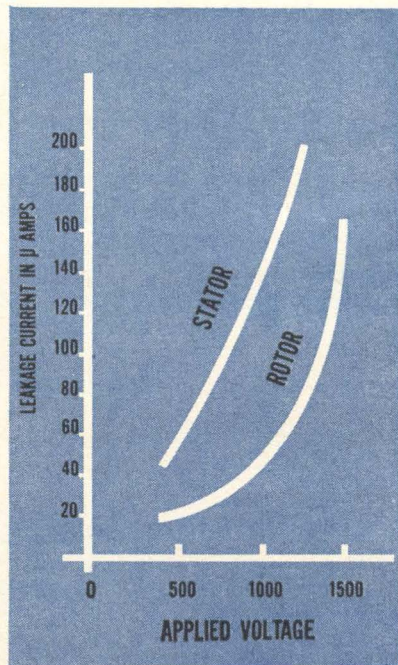

voltages much higher than specification just to make sure that we can, if necessary, accept specifications as high as 1000 volts on even the smallest synchros. If you have high voltage or leakage problems, see us.

CLIFTON PRECISION PRODUCTS

Division of Litton Industries

CLIFTON HEIGHTS, PA. COLORADO SPRINGS, COLO.

cppc

Electronics Newsletter

September 7, 1964

Show business in the sky

A United States video recorder manufacturer hopes to knock the Sony Corp. of Japan out of the airline-passenger entertainment business with its new color tv system. The Ampex Corp. will demonstrate Travelvision to TWA, Delta, United and Continental Airlines this month. Sony's Astrovision, which started on American Airlines on Aug. 31, shows passengers only black-and-white pictures from a Sony portable video recorder.

To squeeze a color recorder aboard an airliner, Ampex has modified its VR-1500 suitcase-type helical recorder so it weighs only about 60 pounds.

But the unique part of the system is the color. Ampex is using the Mexican bicolor scheme invented by Gonzales G. Camarena because it needs less tape channels than other color systems. Pictures are taken by a black-and-white camera behind a spinning red-and-green filter. The Ampex video recorder then plays the color back into Japanese Yaou monitors built with the new vertical-stripe color tube.

Though the bicolor system doesn't have a full color range—it doesn't reach blues or yellows—and is subject to flicker, Ampex believes it will be satisfactory because airliner reception requires a low light level.

Go-everywhere tv station

Lyndon Johnson was the star of the Democratic National Convention, but electronics played a major supporting role.

Mingled with pennants in the haze of Atlantic City's Convention Hall were scores of antennas of many sizes and colors. Delegates constantly stepped—or tripped—over miles of cable. And some 182 television cameras followed every phase of the proceedings.

Half of the National Broadcasting Co.'s coverage was provided by eight 53-pound Walking Broadcasting Stations that first proved themselves at the Cow Palace in San Francisco. Each unit emits a 13-megacycle signal and provides a bandwidth of 15 megacycles. The transmitter output is one-third of a watt.

Lou Hathaway, NBC senior staff engineer, says the high operating frequency overcame much of the standing wave-interference that often causes dead spots throughout the hall. The high frequency allows the use of a small antenna, which permits high signal directivity, reducing wave interference and signal cancellation at the receiver.

The NBC transmitter is transistor-operated with three exceptions: the vidicon camera tube, kinescope view-finder and klystron transmitting tube. The sound channel is transmitted by a separate radio-microphone unit over a special radio-frequency channel in the 450-Mc region.

The eight NBC units were developed for NBC by its parent company, the Radio Corp. of America.

Transistor ranks keep growing

Of the five companies entering the transistor-manufacturing field, four are heading straight for the thin ranks of field-effect transistor producers.

The reason for this flurry of activity is that engineers, after an initial resistance, are now convinced that field-effect transistors, particularly in low-noise amplifiers, are superior to both junction transistors and vacuum tubes.

The Union Carbide Corp., most recent entry in the field, is supplying

Electronics Newsletter

both p-channel and n-channel field-effect transistors. The other newcomers are the Dickson Electronics Corp., the KMC Corp., and General Microelectronics, Inc. All are supplying both junction and field-effect transistors. In addition, the Vector Solid State Laboratories of the United Aircraft Corp., is marketing silicon npn types for radio-frequency applications.

Another firm, the Stewart-Warner Corp., won't confirm rumors that it plans to supply field-effect transistors but acknowledges that it has been studying the possibility.

Now available: FETs at 300 Mc

The industry's first field-effect transistors to operate as amplifiers at 300 Mc will be announced in two weeks by the KMC Corp., Long Valley, N. J.

The new small-signal transistors reduce the amount of cross-modulation distortion associated with conventional uhf-vhf junction transistors. In addition, the new units are considerably less sensitive to radiation fields than high-frequency planar-epitaxial transistors.

The new diffused field-effect devices will be available in six families, with current ratings to 100 milliamps. They will be packaged in the TO-18 case.

This will be the second venture into high-frequency field-effect transistors by the five-month old company. In July, KMC began supplying customers with metal-oxide semiconductor devices capable of amplification to 200 Mc.

RCA shifts policy and 150 engineers

At the beginning of next year the Radio Corp. of America will start to transfer about 150 engineers from its tube manufacturing operation at Harrison, N. J. to its semiconductor plant in Somerville, N. J. These engineers will be gradually phased out of receiving-tube work and into transistors.

The shift of engineers indicates a shift in RCA's oft-stated position that transistors would not take over the tube market.

The move is a costly one for RCA since the Somerville facility is already completely staffed. To accommodate the transferred engineers, the company will relocate some of Somerville's manufacturing activities to its plants in Woodbridge, N. J., and Cincinnati, Ohio.

Three-dimensional underwater range

The Navy has called for industry method and management proposals to build an underwater test range in the Pacific, west of Hawaii. It will cover a 50-sq. mile area with water depths ranging from 2,000-ft. to over 5,000-ft. The range should be in use by 1966.

Described as a three-dimensional underwater tracking range, it will be used to evaluate the performance of various anti-submarine warfare weapons by tracking the target vessel, the launching vehicle and the trajectory of the weapon. Anti-submarine weapons will be fired by submarines and surface ships against both submarines and surface vessels.

The initial cost of the new range is estimated at about \$10-million with a good possibility of expansion. The method and management proposals are due by Sept. 25. Technical proposals are expected to be requested shortly thereafter.

EIME

news

NOW . . .

A NEW DIMENSION HAS BEEN ADDED TO
ELECTRONIC INSTRUMENT MANUFACTURERS
EXHIBIT 5TH ANNUAL ROAD SHOW



AMPEX CORP.

brush

BRUSH INSTRUMENTS
DIV. OF CLEVITE CORP.



GENERAL RADIO COMPANY



KEITHLEY INSTRUMENTS



LAMBDA ELECTRONICS CORP.



NON-LINEAR SYSTEMS, INC.

GAP/R

GEORGE A. PHILBRICK
RESEARCHES, INC.



THE SINGER COMPANY
METRICS DIVISION



THE SINGER COMPANY
METRICS DIVISION

Attend Informative Technical Sessions See New Electronic Instrument Displays

The fifth annual Electronic Instrument Manufacturers Exhibit (EIME) will feature informative technical sessions in addition to practical operating displays of electronic instruments by nine leading manufacturers. Engineering representatives from participating companies will be present at the displays to answer your technical and application questions.

The technical sessions, offered this year for the first time, will be conducted by engineering personnel from each member company and will feature a variety of electronic instrument design considerations, techniques and applications for industrial, military and research purposes.

We cordially invite you and your associates to attend.

FREE PARKING

• BUFFET

NO TICKETS REQUIRED

PROGRAM

OF

TECHNICAL SESSIONS

1964 EIME

ELECTRONIC INSTRUMENT MANUFACTURERS EXHIBIT

EXHIBIT HOURS: 12 NOON TO 7:30 P.M. • TECHNICAL SESSIONS: 2 P.M. TO 6 P.M.

AMPEX CORP. Advanced Telemetry Recording Techniques—A discussion of the requirements for recording telemetry signals utilizing new coding techniques.

BRUSH INSTRUMENTS, DIVISION OF CLEVITE CORPORATION—It's The Record That Counts.—covering all aspects and methods of producing the written record; advantages and disadvantages of each in terms of record clarity, reproducibility, accuracy and economy.

GENERAL RADIO COMPANY Precision Recorded Sweep Frequency Response Measurements—New techniques and systems for precision response measurements from .01 cps to 2Gc with as much as 80 db dynamic range.

KEITHLEY INSTRUMENTS, INC. Electrometer and Picoammeter Measurements—High input impedance is the key to a wide variety of applications not possible with the conventional VTVM.

LAMBDA ELECTRONICS CORP. Envelope Regulation — the concept and factors affecting the total regulation "R" of DC power supplies.

NON-LINEAR SYSTEMS, INC. Application Considerations in the Selection of Digital Measuring Instruments—digital measurement of varying signals, noisy signals, source impedance vs. input impedance, resistance measurements, significance of DVM logic in the application, high speed measurements, and automatic data systems.

GEORGE A. PHILBRICK RESEARCHES, INC. Electronic Analog Computing Devices As Tools of Measurement—the role of operational amplifier with non-linear device emphasizing thermocouple linearization, wide range logarithmic transformations, true RMS measurements and adding flexibility to digital-to-analog converters.

THE SINGER CO., METRICS DIVISION, PANORAMIC INSTRUMENTS Spectrum Analyzer Measurement Techniques—A discussion of swept-band measurement techniques using spectrum analyzers. Applications covering the frequency range from 0.5 cps to 73 GC/S.

THE SINGER CO., METRICS DIVISION, SENSITIVE RESEARCH INSTRUMENTS Self Checking DC Ratio Devices In The Laboratory—how such autocalibrations may be accomplished and why such procedures can establish a provable accuracy within the stated requirements of the military without being tested by NBS.



Ampex instrumentation recorders, M.D., E.E., M.E., B.S., PhD, DSc, Ch.E.

No matter what your field of testing or research, Ampex has a magnetic instrumentation recorder that can give you faster, more accurate, more useable data. Reason: any phenomena that can be converted into an electrical signal can be recorded, stored and processed on magnetic tape. And magnetic tape has no end of advantages. It permits time base expansion and contraction. Slow playback for data analysis on conventional readout devices. High-speed playback for computer processing. It can provide nearly any parameter needed to recreate experiments, or simulate environmental testing. You can store several million bits of data on a 10½ inch reel of magnetic tape. Record 14 or more different events at



the same time. Erase and reuse the tape, or store it permanently. Suggestion: why not write Ampex and find out how instrumentation recording can be applied to your particular operation. Why Ampex? Because we make more different kinds of recorders. Recorders with a wider range of recording techniques: Direct Performance, FM, PCM (2000+bpi), PDM, Frequency Shift Modulation. With frequency ranges from DC up to 1.5 Mc., sinusoidal or pulsed. Signal-to-noise ratios averaging as high as 46 db. Recorders that can record 23 hours, compress them to twelve minutes. Or expand 12 minutes to 23 hours. Write: Ampex Corporation, Redwood City, California. Sales and service throughout the world.

Brush Instruments at



it's the record
that counts!

... and these high-performance direct writers produce records of such accuracy and clarity ... with such ease of control and convenience ... that you'll have to see to believe it!

At the E I M E Road Show you'll see:

- The all-new solid state Brush Mark 200
- The 80-millimeter high resolution Mark 280
- The Series 2300—an *uncomplicated* lightbeam recorder
- The Mark 10, new concept in potentiometric recorders

See pressurized ink recording in action ... position feedback pen-control techniques that will not wear out ... a complete line of functional preamplifiers, and other innovations that place recording instrumentation on a wholly new level.

It's all for the record ... and it's the *record* that counts.

Compact Mark 280
—with 80 mm channels.
Doubled resolving power.

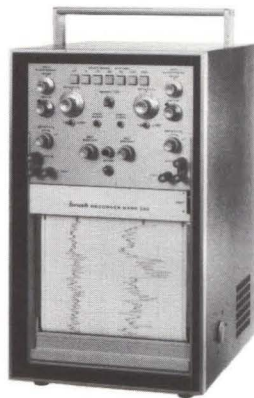

Series 2300 oscillograph—instant-start
incandescent light source.



Mark 10 wide-channel
potentiometric recorder—
all solid state ... even the ink!

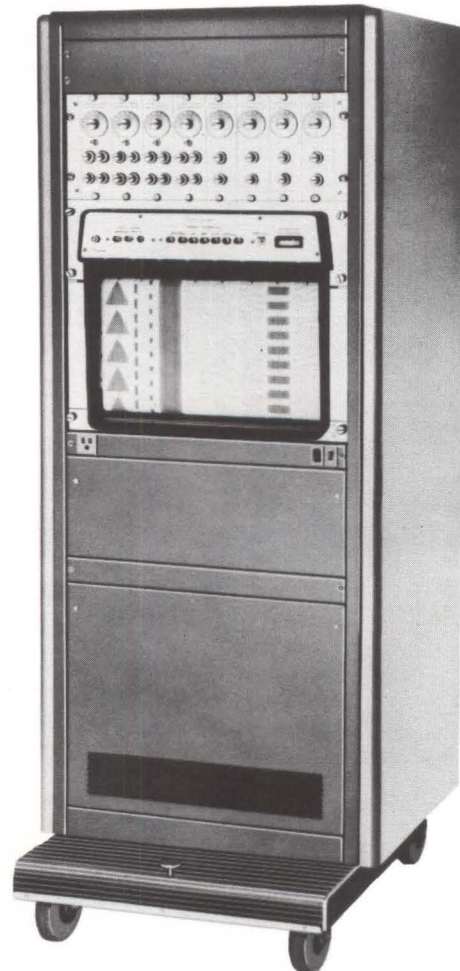

Recorder Mark 200, modular all solid state design.

a **NEW** approach
in signal sources

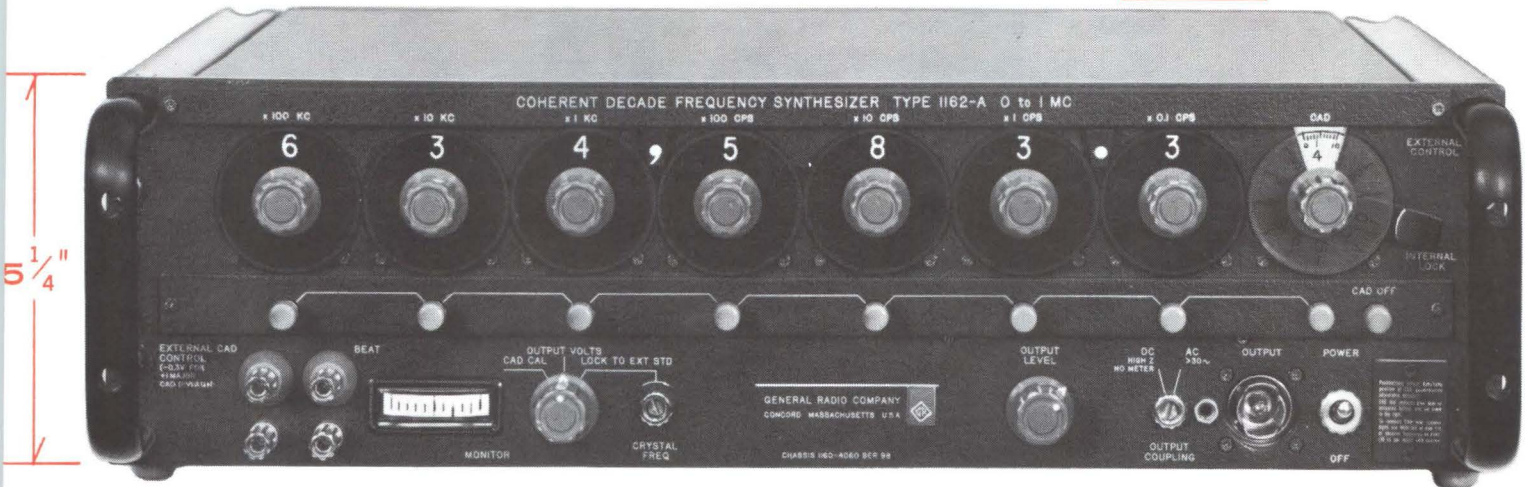

COHERENT DECADE FREQUENCY SYNTHESIZERS

Prices range from \$3255 to \$5600 (dc to 1-Mc model illustrated)

**... Provide Precisely Known, Stable Signals,
Continuously Variable or in Crystal-Locked Steps**

Modular Design: You buy only the resolution you need (add more later if you wish). Digit-decade modules are identical and interchangeable; they plug in to provide from 3 to 7 significant figures in decade steps. You can add the continuously-adjustable-decade module (CAD) for even greater resolution and versatility.



Continuously Adjustable Decade (CAD): Supplements digit-decades; provides the last significant figures of output frequency (2 figures directly, 3 or more with built-in calibration). By operation of the push-button below any digit dial, the CAD is connected to replace the digit directly above the actuated button and all digits to the right.

In-Line Readout of all digits — each is rear-lighted when in use, darkened, but still readable, when replaced by CAD. CAD dial is illuminated when in use, darkened when not used.

Frequency Sweeping: CAD frequency may be swept electronically by a signal applied to front panel binding posts. The resulting sweep range in the Synthesizer output

may be made very small, if a push-button to the right is actuated, or progressively larger as push-buttons toward the left are used.

Frequency Markers: In sweeping applications the circuitry provides for generation of precision frequency markers, with a minimum of external equipment. A marker will occur at center frequency, as displayed on all the digit dials. Side markers, at any chosen spacing about center, can also be easily formed.

Self-Contained Primary Source: All signals are frequency-coherent with a single, built-in, room-temperature primary crystal oscillator. For extremely exacting requirements, this primary oscillator may be phase-locked to any external frequency standard capable of supplying a signal at 5 Mc or any submultiple of 5 Mc, down to 100 kc; the standard frequency simply plugs into a rear receptacle.

Output: Level is adjustable up to 2 volts into 50 ohms with choice of ac or dc coupling. A panel meter reads the output voltage when ac coupled. Low harmonic and spurious levels.

*You Can See This New Synthesizer at the
Forthcoming Series of EIME Exhibits or by
Calling The Nearest GR Office.*

GENERAL RADIO COMPANY

WEST CONCORD, MASSACHUSETTS

IN CANADA: Toronto 247-2171, Montreal (Mt. Royal) 737-3673
IN EUROPE: Zurich, Switzerland — London, England

- | | | | | | | | | | |
|---|--------------------------------|---|--|----------------------|---------------------|---------------------------------------|-------------------------|---------------------------|-----------------------|
| NEW YORK, N. Y., 964-2722
(Ridgefield, N. J.) 943-3140 | CHICAGO
(Oak Park) 848-9400 | PHILADELPHIA, 424-7419
(Abington) 887-8486 | WASHINGTON, D. C.
(Rockville, Md.) 946-1600 | SYRACUSE
454-9323 | DALLAS
FL 7-4031 | SAN FRANCISCO
(Los Altos) 948-8233 | LOS ANGELES
469-6201 | ORLANDO, FLA.
425-4671 | CLEVELAND
886-0150 |
|---|--------------------------------|---|--|----------------------|---------------------|---------------------------------------|-------------------------|---------------------------|-----------------------|

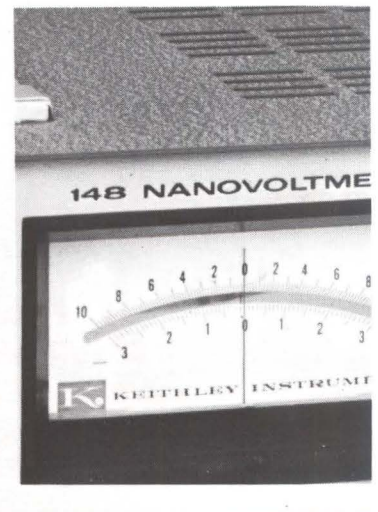
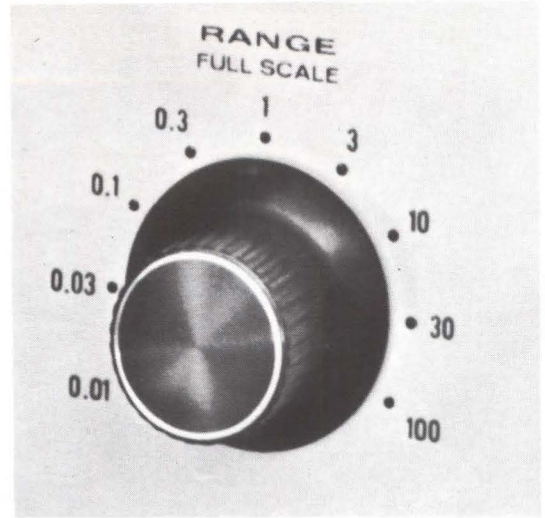
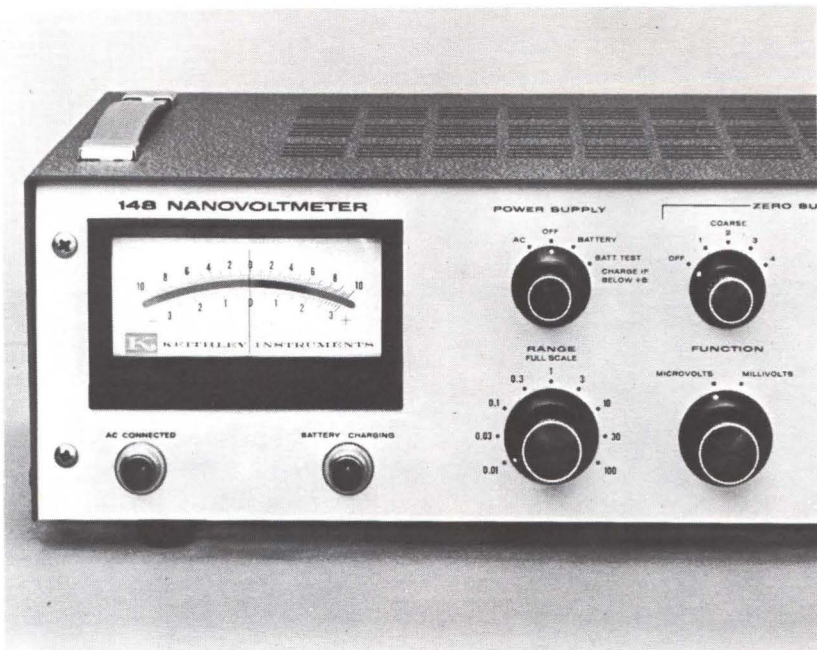

MEASURE A NANOVOLT!

The new Keithley 148 Nanovoltmeter provides the most dc voltage sensitivity, highest stability and lowest noise of any commercially available voltmeter. The 148 has 1% accuracy at the output terminals, input impedance of 1000 ohms on the 10^{-8} volt range rising to 1 megohm on the 10^{-3} volt range, front panel zero suppression and amplifier gains up to 10^8 .

Applications include measuring outputs of thermocouples; measuring super conductivity in the 10^{-6} ohm range; conducting Hall Effect studies and use as a null detector.

- 10 nanovolts (10^{-8} v) full scale sensitivity
- 10 nanovolts per 24 hours stability
- 1 nanovolt noise, peak-to-peak
- 3000:1 line frequency rejection
- line or rechargeable batteries
- \$1275

SEND FOR NEW
148 ENGINEERING NOTE

other Keithley microvoltmeters

Model 149	0.1 μ v sensitivity	\$895
Model 150A	1 μ v sensitivity	\$750
Model 151	100 μ v sensitivity	\$420



KEITHLEY INSTRUMENTS, INC.

12415 EUCLID AVENUE • CLEVELAND, OHIO 44106

electrometers • picoammeters • differential voltmeters • wideband voltmeters

LAMBDA MULTI-CURRENT-RATED[®]

power supplies offer maximum flexibility for any application at any ambient to 71°C

NOW 0-60, 0-40, 0-20 VDC IN ¼ and ½ RACK MODELS

ALL SILICON
Modular-Subrack
LH
SERIES



Lab Ambient
30°C

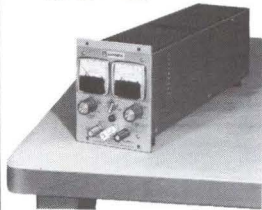

Industrial Ambient
50°C

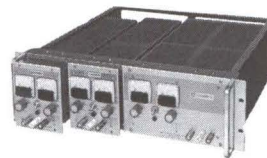

Elevated Ambients
60°C 71°C



CURRENT RANGE AT AMBIENT OF: ⁽¹⁾

Model	Voltage Range	30°C	50°C	60°C	71°C	Price ⁽²⁾
LH 121	0-20VDC	0-2.4A	0-2.2A	0-1.8A	0-1.5A	\$159.00
LH 122	0-20VDC	0-5.7A	0-4.7A	0-4.0A	0-3.3A	\$260.00
LH 124	0-40VDC	0-1.3A	0-1.1A	0-0.9A	0-0.7A	\$154.00
LH 125	0-40VDC	0-3.0A	0-2.7A	0-2.3A	0-1.9A	\$269.00
LH 127	0-60VDC	0-0.9A	0-0.7A	0-0.6A	0-0.5A	\$184.00
LH 128	0-60VDC	0-2.4A	0-2.1A	0-1.8A	0-1.5A	\$315.00

(1) Current rating applies over entire voltage range. DC OUTPUT Voltage regulated for line and load

(2) Prices are for non-metered models. For metered models and front panel controls, add suffix (FM) to model number and add \$25.00 to the price. For non-metered chassis mounting models, add suffix (S) to model number and subtract \$5.00 from the non-metered price.

- AC INPUT—105-135 VAC, 45-480 cps
- REGULATION—Line or Load—.015% or 1 MV
- RIPPLE—less than 250 microvolts rms and 1 millivolt P-P
- TEMPERATURE COEFFICIENT — .015%/°C
- MEETS RFI SPECIFICATIONS—MIL-I-26600, Class 3
- CONSTANT CURRENT/CONSTANT VOLTAGE
- REMOTELY PROGRAMMABLE AND CONTINUOUSLY VARIABLE
- SIZE: LH 121, 124, 127 5³/₁₆" x 4³/₁₆" x 15¹/₂"
LH 122, 125, 128 5³/₁₆" x 8³/₈" x 15⁵/₈"
- RACK ADAPTERS
Model RA-1 for ruggedized mounting—Price \$60.00
Model RA-2 for conventional mounting—Price \$25.00

SEND FOR COMPLETE LAMBDA CATALOG.



LAMBDA ELECTRONICS CORP.

515 BROAD HOLLOW ROAD • MELVILLE, L. I., NEW YORK • 516 MYRTLE 4-4200

SALES OFFICES AND REPRESENTATIVES CONVENIENTLY LOCATED IN MAJOR CITIES

There's big news in all-electronic digital voltmeters . . . and NLS is making it

Quality 3-digit dvms from \$545 to \$995

Here is a complete line of 3-digit voltmeters, ratiometers and ohmmeters built with the same care and precision construction as NLS dvms costing \$6000. All nine models in Series 4700 are burnout proof, even with 500 v on the 1-v range, 1000 v on others. Specs are what you'd expect from NLS: common mode rejection of 60 db at 60 cps with 1000 Ω line unbalance . . . accuracy of $\pm(0.1\%$ of full scale +1 digit), signal leads can float 1000 v above gnd. . . ranges of $\pm.999/9.99/99.9/999$ v and k Ω . . . input Z of 1-10 megs . . . 2 rdgs/sec.



Solid state 4-digit dvms starting at \$875

Need a low-cost, high quality 4-digit dvm? New Series 4300 with 18 models is the answer.

Only low-cost dvms with high common mode rejection (60 db @ 60 cps) and 1000 v gnd. isolation. Auto or remote control for systems use. Digital outputs in decimal contact closures operate digital recorders at lower cost. Ranges: $\pm.9999/9.999/99.99/999.9$ v dc; speed: 2 rdgs/sec + 0.5 sec/range change; accuracy: $\pm 0.05\%$ of rdg $\pm 0.01\%$ of full scale; input Z: 10 megs.



AVAILABLE SOON

HIGHER SPEED LOW-COST SERIES 4200

Similar in many respects to 4300 dvms (above) but speed exceeds 10 rdgs/sec. Under \$1,900.

Highly reliable 5-digit models

The 10 new 5-digit models in the medium-priced Series 9100 provide highly reliable operation, even with unfavorable component tolerance stack-up. Servicing, if needed, is simplified because non-selected, non-critical parts can be used in most circuits. No damage or accuracy degradation occurs with 1000 v continuously applied on any range, polarity or mode. Specs—ranges: $\pm 9.9999/99.999/999.99$ v dc auto . . . ± 9.9999 dc ratio; accuracy: $\pm(0.01\%$ of rdg +0.001% of full scale); speed: 12 ms/rdg in any 1 range, 1 sec/rdg in worst case; input Z: 10 megs for volts, 1000 megs for ratio; digital outputs available. Price: \$3,490-5,990 (some measure Ω and ac).



4 & 5-digit integrating digital volt/millivoltmeters without "negative error" . . . without problems from heat

New Series 2900 (22 models in all) utilizes the full capabilities of integrating dvms by giving the true mathematical integral of input voltages, and measuring the average value of noisy inputs without using input filters. A unique circuit innovation eliminates "negative error" (accumulated error occurring each time the input crosses the zero axis) . . . and also gives the true algebraic value of integrated inputs—and the true average value of noisy inputs (even if they change polarity during the sample period)—rather than treating all inputs as unipolar during integration. NLS 2900 dvms also eliminate drift and extra circuits for readjusting blocking oscillators, etc., through automatic calibration. Only 25 watts power dissipation eliminates fan noise and reduces rack heat. Light beam coupling totally isolates digital output from input circuits. Over-ranging provides limited 6-digit accuracy on 5-digit models—5-digit over-ranging on 4-digit models. And 2900 instruments are only 5¼" high. Other features: high common mode rejection and ground isolation . . . remote programming . . . up to 100 rdgs/sec . . . choice of BCD and/or decimal digital output . . . new all-modular, high-contrast readout. Price: \$2,990-4,990.



WHAT DOES ALL THIS MEAN TO YOU?

Now you can select exactly the right all-electronic dvm to solve your individual measuring problems—without paying for features you don't need.

In addition to the entirely new instruments shown here, NLS offers a wide range of other all-electronic dvms it has made for years. This means you can now select from more than 100 all-electronic models. Details are waiting for you in an 8-page guide.



originator of the digital voltmeter

non-linear systems, inc.

P.O. BOX 728, DEL MAR, CALIFORNIA

Modularized Calibration Standards

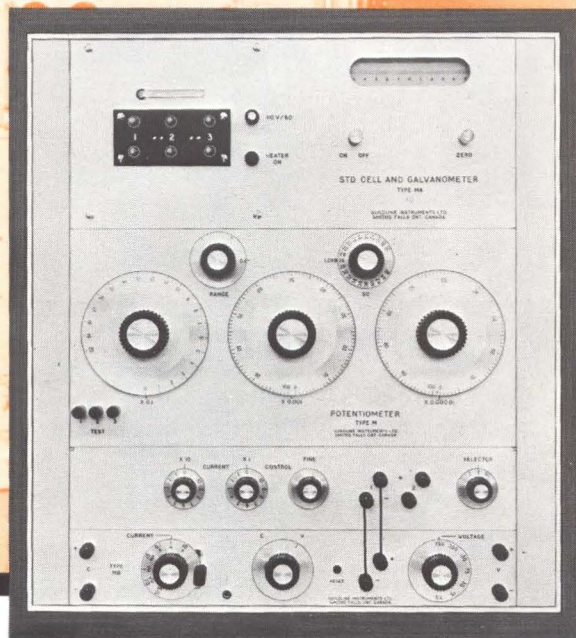

TYPE M

DC CURRENT/VOLTAGE STANDARD

"COMMANDER" TYPE MR, NEW HIGH ACCURACY DC POTENTIOMETER SYSTEM modularized for standard 19" rack mounting. Each module may be used independently. When employed together as a system, interconnection facilities are provided to speed up operation and reduce dependence on user technique. It consists of the following instrumentation:

- **5 FIGURE, 3 DIAL, SHIELDED POTENTIOMETER** having measuring ranges of $-10 \mu\text{v}$ to 2 v in steps of $10 \mu\text{v}$ and $-1 \mu\text{v}$ to 0.2 v in steps of $1 \mu\text{v}$. All positions on the switches are individually calibrated points and there is no slidewire in the circuit. Accuracy is $\pm (0.003\%$ of reading $+1 \mu\text{v}$) on X1 range and $\pm (0.003\%$ of reading $+5 \mu\text{v}$) on X.1 range. Thermals are less than $0.5 \mu\text{v}$.

- **CURRENT/VOLTAGE RANGE EXTENSION UNIT** made up of seven 0.01% accurate, 4 terminal, standard resistors (0.01Ω to $10,000\Omega$) enabling measurements from 0-10 amps and an overload protected 0.01% accurate volt ratio box enabling measurements from 0-1000 v.

- **± 5 PPM VOLTAGE REFERENCE;** 3 portable saturated cells installed in a $\pm 0.03^\circ\text{C}$ constant temperature enclosure with solid-state temperature controller.

- **HIGH SENSITIVITY OIL DAMPED GALVANOMETER** with a double light spot.



Type MB consisting of the potentiometer and range extension modules is available as a bench mounted system with 30° sloping top panel.

**DEMONSTRATIONS
AT EIME SHOWS**



LTC-2

AC/DC CALIBRATION CONSOLE

MODEL LTC-2, NEW AC/DC CURRENT/VOLTAGE CALIBRATION STANDARD featuring high speed operation up to 25 kc and digital readout. Designed for 19" rack or bench mounting, the console covers a range of .2 mv to 1110 v and $.2 \mu\text{a}$ to 11.1 amps. Readout is in "% error" or actual values, 6 digits in steps of 1 mv on voltage and 5 digits in steps of $100 \mu\text{a}$ on current, (except below 100mv , 5 digits in steps of $10 \mu\text{v}$, and below 1 ma, 6 digits in steps of $0.001 \mu\text{a}$). Accuracy is better than $\pm 0.035\%$.

To reduce calibration time a thermocouple reference circuit with better than 0.01% stability per hour has been designed. This permits direct AC readings without frequent AC-DC transfers.

The galvanometer is oil damped and relatively free from the effects of vibration. It has a clearly defined light spot and front panel zero control over the entire scale.

The console is completely shielded and when ordered case mounted is installed in a durable formica case. Compact — versatile — rugged, a Calibration Standard in both appearance and function.

MODEL RFS IS A NEW RF TRANSFER STANDARD enabling measurements from .5 ma to 100 amps and $1 \mu\text{v}$ to 1125 v at frequencies up to 1000 mc and "state of the art" accuracies. Its availability in modular form makes it compatible for rack mounting in a single console with the AC/DC standards described above.

MODEL LTPS-11 is a variable frequency (20 c/s to 100 Kc/s), ultra stable (0.005% short term), low distortion (0.05%), compatible AC power source with 200 va output.

WRITE FOR COMPLETE INFORMATION OR CONTACT YOUR LOCAL SALES REPRESENTATIVE

**THE SINGER COMPANY
METRICS DIVISION**

915 PEMBROKE ST., BRIDGEPORT, CONNECTICUT
PHONE (203) 366-3201 • TWX 710-453-3483

Design and production of PANORAMIC • SENSITIVE RESEARCH • EMPIRE • GERTSCH instruments for measurement



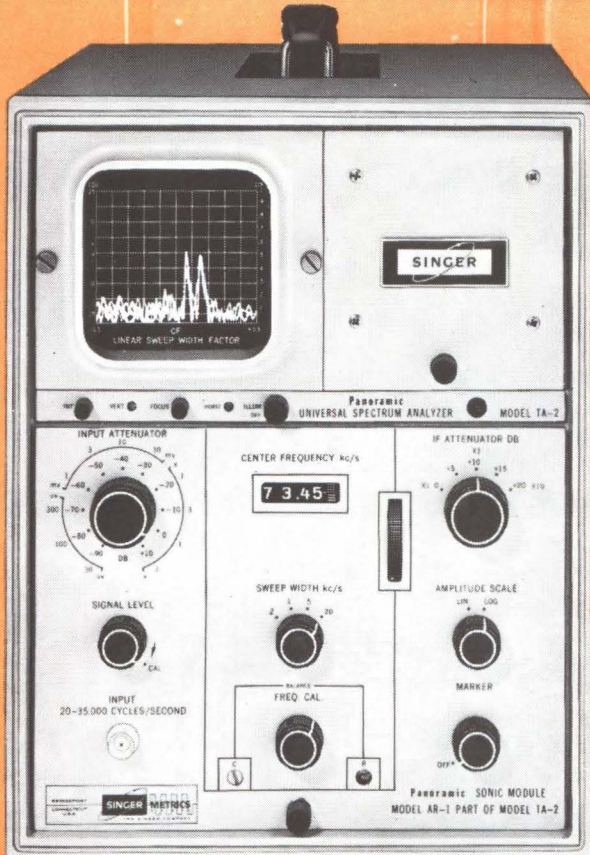

First universal portable spectrum analyzer

ON DISPLAY AT EIME



Panoramic Spectrum Analyzer Model TA-2 combines solid-state dependability, compactness, light weight, battery operation, and modular, plug-in construction to provide the first fully portable, truly universal instrument of its kind.

The TA-2 Spectrum Analyzer provides level-vs-frequency analyses on a calibrated 3" CRT. Both "quick-look" and narrow band scans are shown over the range 20 cps to 27.5 mc using the same main frame and four interchangeable modules. Thus, complete on-location analyses can be made of vibration, noise, and RFI.

Rugged, transistorized, and completely portable, the TA-2 operates from internal rechargeable battery or AC line. All modules feature high sensitivity, excellent resolution, and remarkable stability. Dynamic range is at least 60 db. Modular, highly reliable etched circuit-card construc-

tion provides minimum downtime. Always on battery, even when recharging, the TA-2 is free of power hum.

A Model RTA-5 rack mount version with 5" CRT accommodates the same plug-in modules for laboratory, plant, and systems installations.

TA-2 features: Light and compact—8³/₄" w x 11" h x 18" d; approx. 40 lbs. with module ■ Calibrated, adjustable center frequency with digital readout ■ Interchangeable plug-in modules for present and future needs ■ Built-in markers for self-checking calibration ■ Simplified operation—few controls, many pre-set for optimum analysis ■ Future modules will further extend TA-2 and RTA-5 versatility.

For complete details and applications assistance, contact your nearest *Panoramic* representative or the address below.

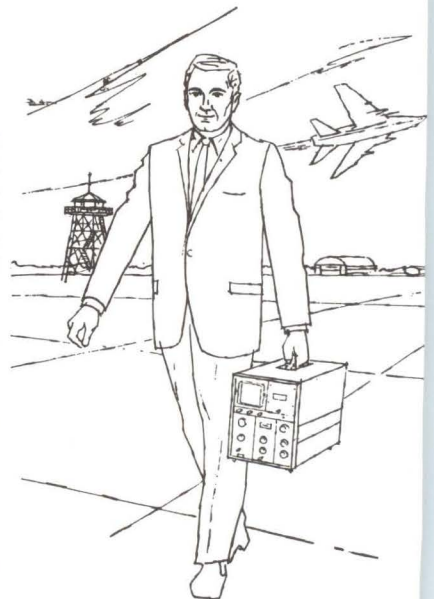

Available Modules	AR-1 (Sonic)	AL-2 (log-scan sonic)	UR-3 (Ultrasonic)	VR-4 (RF)
Frequency	20-35,000 cps	20-35,000 cps	100 cps-700 kc	1 kc-27.5 mc
Sweep Widths	0.2, 1, 5, 20 kc	0.2, 1, 5, 20 kc; 25-25,000 cps log	adjustable to 0-400 kc	adjustable to 0-5 mc
Resolution	Automatic optimum	Automatic optimum	adjustable to 100 cps	adjustable to 200 cps
Residual distortion	All unwanted products at least 60 db down			50 db down
Sensitivity	30 μ v full scale deflection			



THE SINGER COMPANY METRICS DIVISION

915 PEMBROKE ST., BRIDGEPORT, CONNECTICUT
PHONE (203) 366-3201 • TWX 710-453-3483

Design and production of PANORAMIC • SENSITIVE RESEARCH • EMPIRE • GERTSCH instruments for measurement

SCHEDULE OF TECHNICAL SESSIONS AND DISPLAYS

5TH ANNUAL EIME ROAD SHOW

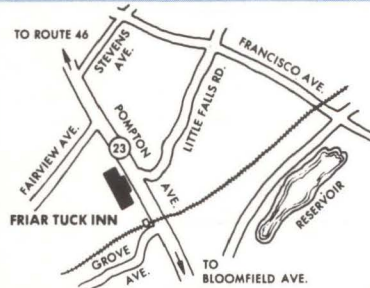

CEDAR GROVE, N. J.

September 30th
Friar Tuck Inn
691 Pompton Ave. (Rt. 23)
Hours: 12 Noon — 7:30 P.M.

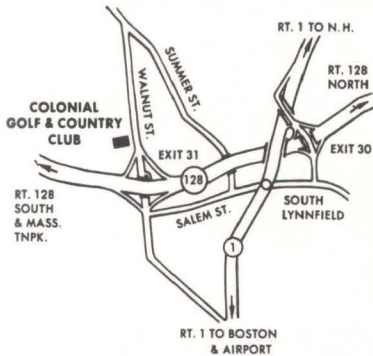

BOSTON, MASS.

September 21st
Colonial Country Club
Route 128,
Hours: 12 Noon — 7:30 P.M.



NORTH PLAINFIELD, N. J.

October 1st
Washington House
559 U.S. Highway 22
Hours: 12 Noon — 7:30 P.M.

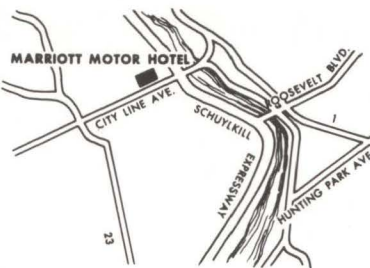

PHILADELPHIA, PA.

October 5th
Marriott Motor Hotel
City Line Ave. & Monument Rd.
Hours: 12 Noon — 7:30 P.M.

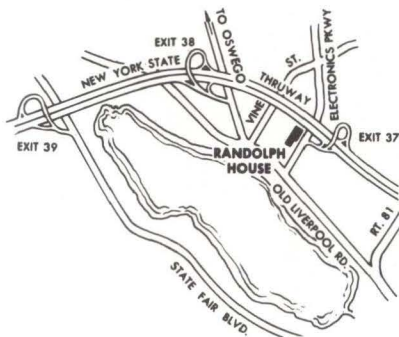

SYRACUSE, N. Y.

September 23rd
Randolph House
Exit 37, N. Y. State
Thruway
Hours: 12 Noon — 7:30 P.M.

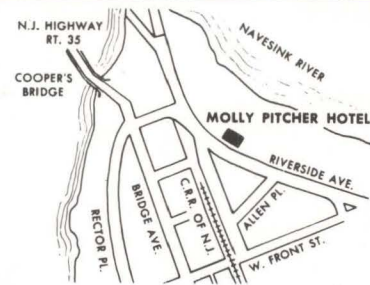

RED BANK, NEW JERSEY

October 6th
Molly Pitcher Inn
Route 35
Hours: 12 Noon — 7:30 P.M.

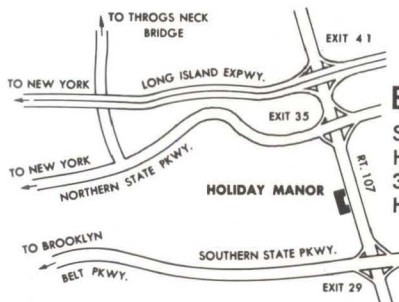

BETHPAGE, L. I., N. Y.

September 28th
Holiday Manor
345 Hicksville Road
Hours: 12 Noon — 7:30 P.M.

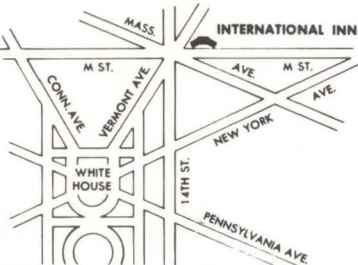

WASHINGTON, D. C.

October 8th
International Inn
Thomas Circle
14th & M Sts., N. W.
Hours: 12 Noon — 7:30 P.M.

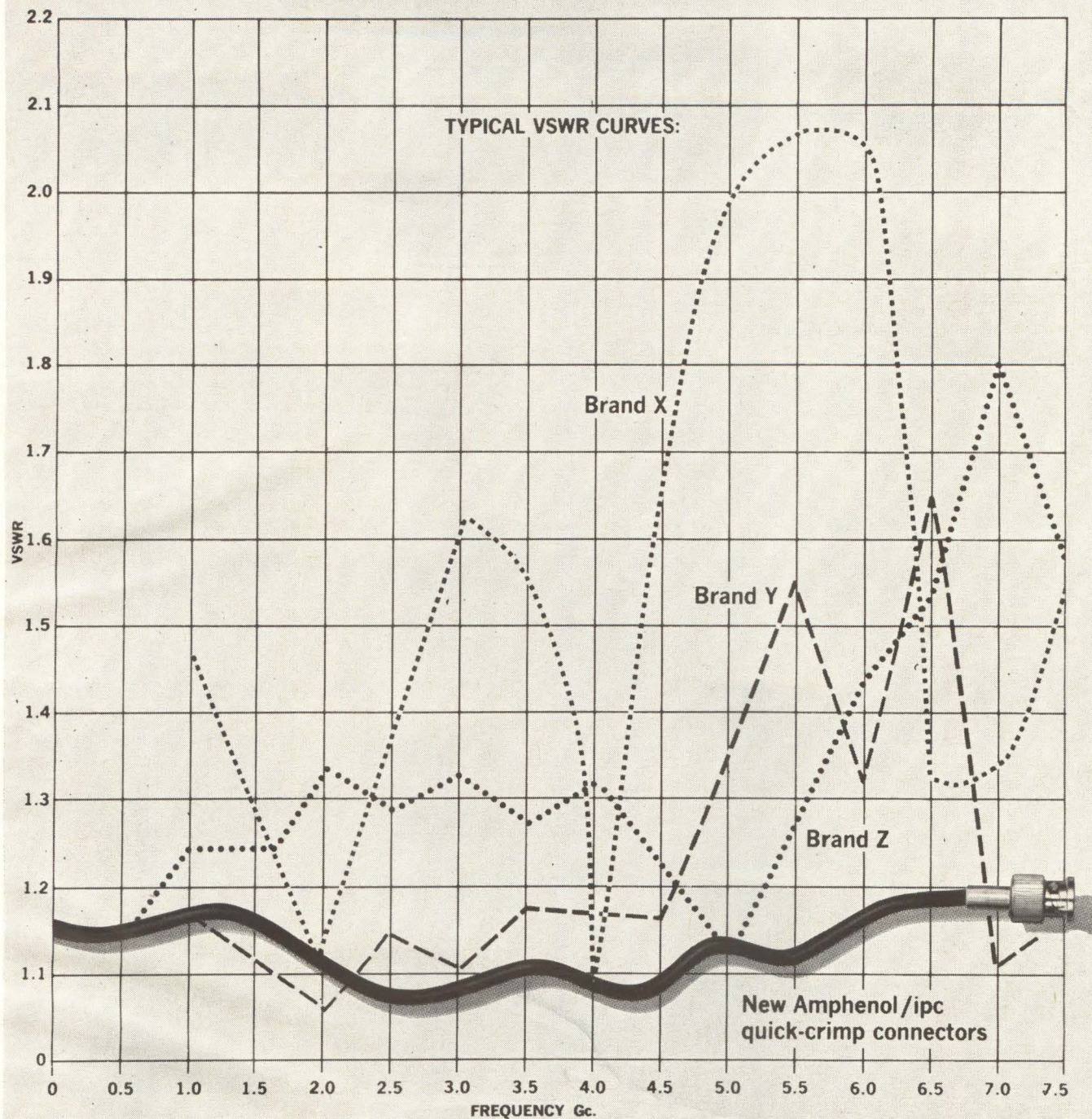

You get the straightest story from FXR

Coaxial connector performance you can rely on—from 1.0 to 7.5 Gc, with every Amphenol/IPC quick-crimp BNC or TNC coaxial connector. The graph tells the story better than we can.

Simple to assemble—just three pieces. Excellent cable retention, too. And it costs less—much less—

than comparable UG standard braid-clamp connectors.

See for yourself. Order from your local Amphenol sales engineers or write directly to FXR, 33 East Franklin Street, Danbury, Connecticut.



SEPTEMBER

S M T W T F S

6

13

20

27

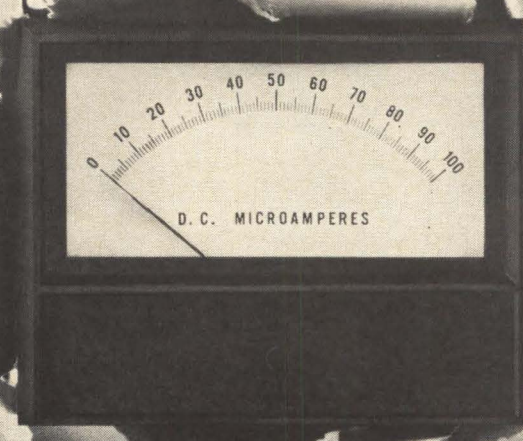

Meter of the Month—the new Honeywell picture-frame "45"

The picture-frame Model 45 by Honeywell brings fresh, modern styling to the traditional rectangular meter. This new 5-inch meter is available with pivot and jewel or taut-band mechanism. Thermosetting plastic cover is dull black with 2-color styling optional. Standard ASA four-hole, front-of-panel mounting; all standard AC and DC current and voltage ranges. ■ Honeywell makes quality meters in every shape and size imaginable. Order direct from the Honeywell stocking distributor nearest you. For his name (and more information on the new "45"), write: Honeywell Precision Meter Division, Manchester, N.H. 03105. In Canada, Toronto 17, Ontario.

Honeywell

For lab or field, there is an NF-105 for every RFI measurement

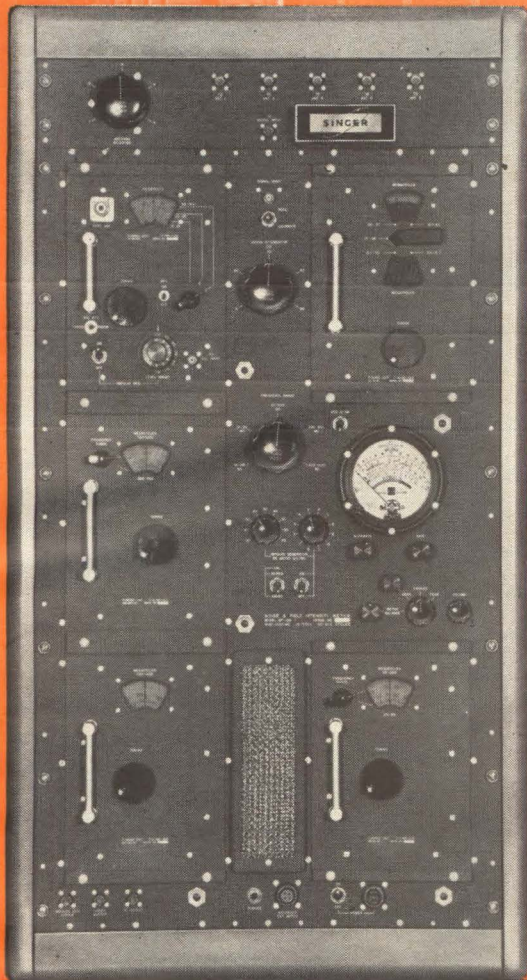

- Electromagnetic compatibility
- Field intensity
- Antenna analysis
- Noise studies
- Shielding effectiveness
- Spurious radiation
- Harmonic measurements

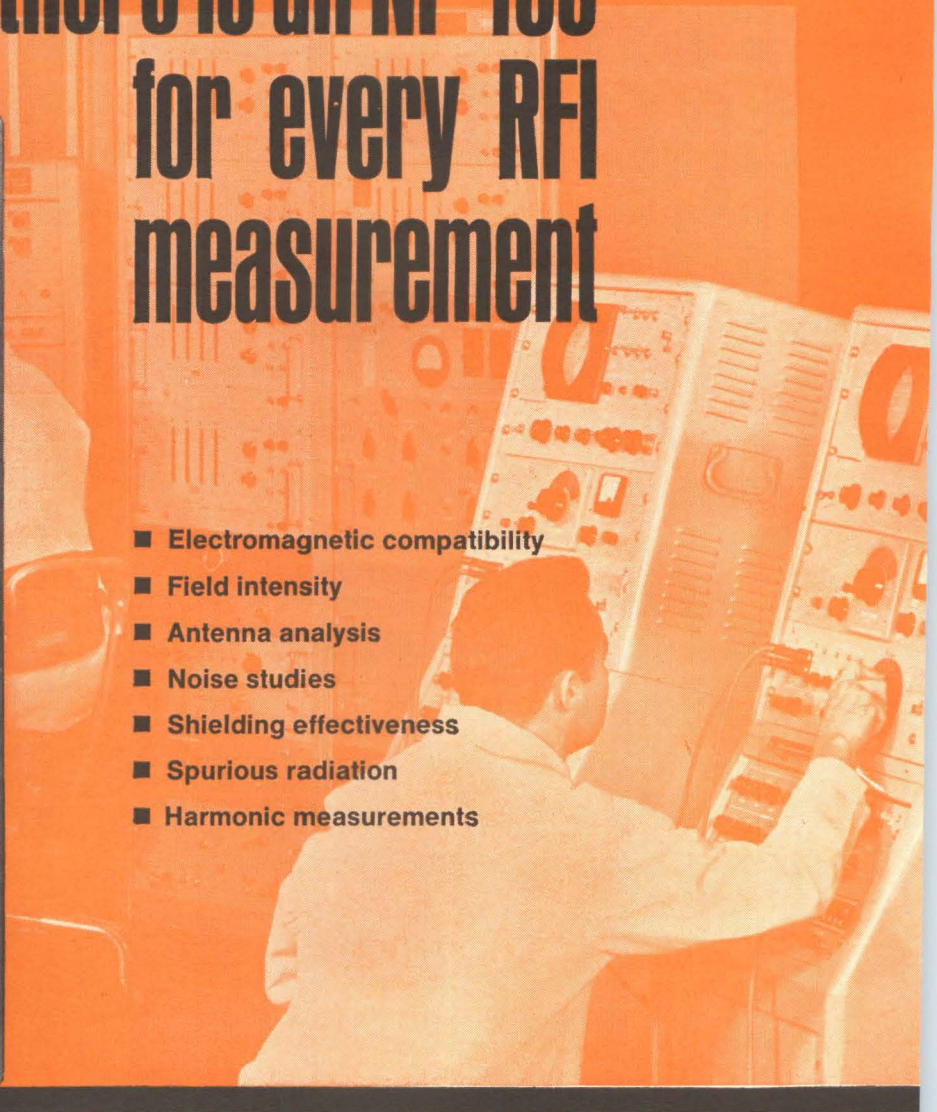

PERMANENT INSTALLATIONS—Newest in the NF-105 family of Noise and Field Intensity Meters, the Model NF-105F, serves permanent installations or those that cannot tolerate even the short delay of unit replacement in the regular NF-105. Rack mounted in fixed locations, in vans or in airplanes, it supplements rather than supersedes the regular NF-105 for quick scanning of the entire frequency range from 14 kc to 1 gc.

ULTRA-SENSITIVITY—Model NF-105/M-126 is the ultra-sensitive instrument. Available in both portable and fixed-location designs, it has sensitivities of minus 126 to minus 130 dbm for narrow band measurements.

PORTABLE VERSATILITY—Most popular instrument of them all, the NF-105 covers the range from 14 kc to 1 gc by means of five quick-change tuning units and one basic measuring unit (no expensive redundancies). It has X-Y output for recording and IF output for panoramic viewing.

SPECIAL APPLICATIONS—In some instances, Model NF-205 may be preferred. Similar to Model NF-105, it utilizes a single repetition rate mercury type impulse generator.

The entire range 20 cps to 21 gc is now covered with just three instruments—the NF-315 (20 cps-15 kc), NF-105 (14 kc-1 gc), and NF-112 (1-21 gc)—instead of the six or more required with other, less versatile makes.

For complete information, contact the address below or your nearest Empire representative, requesting Catalog No. 634 and a demonstration.

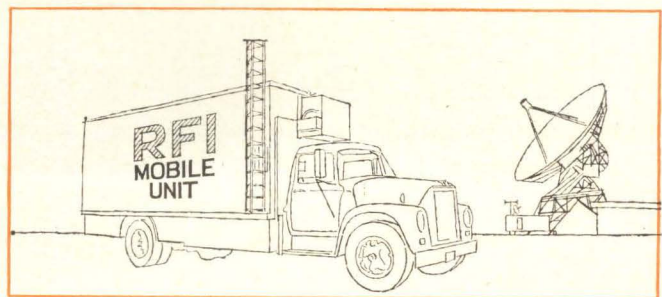

* A Trademark of THE SINGER COMPANY

THE SINGER COMPANY
METRICS DIVISION

915 PEMBROKE STREET
BRIDGEPORT, CONNECTICUT

ELECTRICAL AND ELECTRONIC INSTRUMENTS FOR TEST, CALIBRATION, AND MEASUREMENT

Circle 33 on reader service card

E-64-2



Actual
Size of
Sample

THIS IS NO ORDINARY SOLDER

*...and if you're not using it
your rejects are probably
too high!*

FOR TESTING PURPOSES—

let us send you a full pound of ERSIN Multicore 5-Core Solder FREE OF CHARGE. Simply fill in the coupon and mail on your company letterhead to: Multicore Sales Corp., Dept. MK164, Port Washington, New York.

Name _____ Title _____

Company _____

Address _____

City _____ State _____ Zip Code _____

ERSIN MULTICORE CONFORMS TO FEDERAL SPECIFICATIONS

ONLY ERSIN MULTICORE 5-CORE SOLDER IS MADE THIS WAY

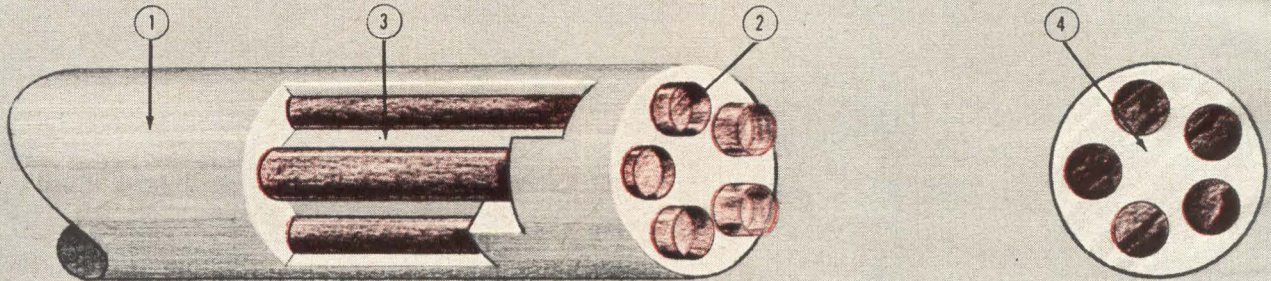

These illustrations show the construction of ERSIN Multicore 5-Core Solder. Multicore solder is made only from pure virgin metals (1) with 5 cores of exclusive extra-active, non-corrosive ERSIN Flux (2). Multicore's special manufacturing process locates the 5 cores of ERSIN Flux close to each other and at the perimeter, so

that there is only an ultra-thin wall of solder between the cores of flux and the work (3). This unique core configuration (4) also keeps the flux near the heat source, to melt faster — wet the metal more effectively. This enables ERSIN Multicore solder to produce the consistently reliable joints for which it is known.

ONLY ERSIN MULTICORE 5-CORE SOLDER WORKS THIS WAY

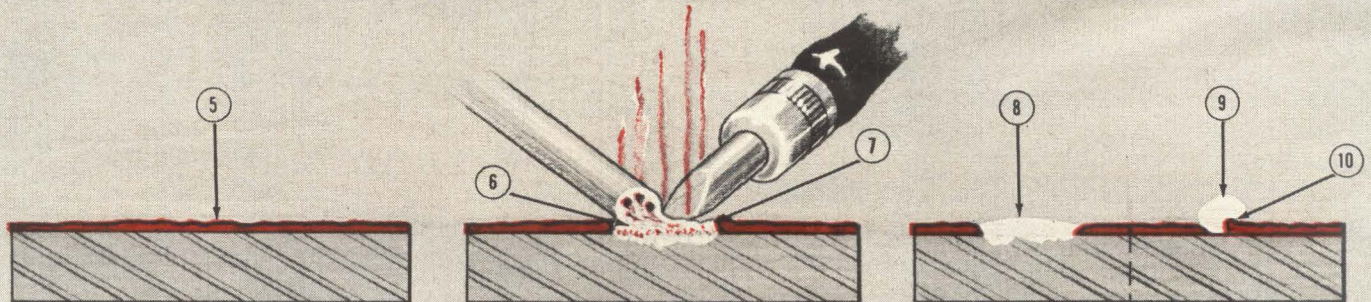

All metals are covered with a non-metallic film or oxide (5) which prevents the fusing of solder to the metal. In fact, the oxide has a surface tension which isolates the metal from the solder. For a reliable solder joint this oxide must be released and removed instantaneously during the application of the solder. ERSIN Multicore's exclusive construction guarantees an uninterrupted and vigorous fluxing action from 5 cores instead of the single core of flux found in ordinary solders. Yet, there is no greater percentage of flux to solder than in the usual single cored solders. In operation, the ERSIN Flux prewets the work, and Multicore's ultra-thin wall of solder becomes instantly fluid (6) ... flows rapidly and con-

sistently on to the wire or metal. The ERSIN Flux has loosened and removed the oxides from the surface (7). Unimpeded by these oxides, the ERSIN Multicore solder is molecularly fused with the metal. ERSIN Multicore guarantees instant spreading and actually alloys with most "difficult" metals used in electronic applications. The result is an evenly spread, reliable joint (8). Lack of sufficiently vigorous fluxing action, characteristic in ordinary solders, results in a cold joint or ball (9). A portion of the oxide, unseen but still in the joint (10) acts as an insulation resulting in high resistance and costly rejects. ERSIN Multicore prevents this, and insures excellent electrical conductivity.

MULTICORE SALES CORPORATION • PORT WASHINGTON, NEW YORK

DIVISION OF BRITISH INDUSTRIES CORPORATION



Electronics Review

Wescon

Tiny but potent

Two technical developments shown at Wescon promise to accelerate the adoption of integrated circuits into new applications. The Semiconductor Products division of Motorola, Inc., proved that it has its radical process under sufficient control to turn out high-voltage, very fast microelectronic circuits. The process involves diffusing a ring of p-type material around the base collector junction instead of building a planar structure.

At the same show, Texas Instruments, Inc., exhibited 125 new semiconductor products, 11 of which were multifunction microelectronic circuits that incorporate four or more separate functions on a single chip.

In a circle. About a year ago, Motorola began building silicon pnp transistors by diffusing a ring of p-type impurities into a silicon base to circumvent channeling—a condition in which majority carrier leakage occurs on the surface. In experiments, Motorola was able to boost breakdown voltage to 80 volts, compared with about 40 volts in pnp transistors with conventional planar structure. At Wescon, Motorola was showing a pnp type—1739—with a breakdown of 175 volts at 150 megacycles.

What makes the development additionally attractive is the fact that the annular structure is easier to build than the planar. That's important in microelectronics manufacture. Said a Motorola spokesman: "This is just the beginning. By the first of the year, we'll have some really high-voltage devices."

NPN too. Motorola is using the same annular ring technique in the manufacture of silicon npn transistors with an additional production step added. A channel is delib-

erately formed in the surface by epitaxial growth rather than by induction as in the case of the pnp devices. Terminating the channel with the diffused annular ring is the key to the device's high-voltage capabilities. Motorola has applied these techniques in its new 2N3501, a silicon npn transistor with a breakdown voltage of 150 volts, a collector current rating of one ampere and a speed of 150 megacycles.

In another Wescon announcement, Motorola disclosed a new method of making monolithic integrated circuits. The system eliminates the effects of closely associated components on each other in an integrated circuit.

A layer of a nonconductive material is used to surround each element and separate one element from another on a common substrate. The method is called the Epic process.

TI's flood. Of TI's 125 new products, microelectronic devices seem destined to have the greatest impact on the market. The new multifunction devices offer a significant reduction in cost. Engineers in the commercial field, for example, have been saying that the key to integrated consumer products lies in increasing the number of functions per chip because it drastically reduces the cost per function.

Like the plague

To the rest of the microelectronics industry, Motorola's and Texas Instruments' announcements were as welcome as the plague. The new industry is already suffering from a serious imbalance—supply of its products far outstrips demand, so much so that price-cutting has flared up almost everywhere.

At Wescon, financial men were looking for a purchaser for one microelectronics company. The

asking price: "Just pick up the company's debts."

Other suppliers were quick to pooh-pooh the announcements. The last thing they needed was more and tougher competition.

One problem is that improvements in production techniques have resulted in higher yields. Production lines have been rolling, but buying hasn't kept pace. One manufacturer in the San Francisco area claims a capability of 50,000 units a week. But he's unable to sell many of them. Warren Erickson, vice president of Hoffman Electronics Corp.'s Semiconductor Division, says, "We have a whole barrel of circuits not quite up to military requirements which we would sell for \$5 each."

Auto market. The government is now the big user with such programs as the Minuteman, TFX plane and Apollo. But the non-government market could be tremendous. Computers, instruments, and commercial and industrial equipment are big targets.

For instance, Varo, Inc., of Garland, Tex., estimates that before long the average automobile will use 32 semiconductor devices. Some of these could be in integrated-circuit form. Domestic auto production has been about 7.5 million cars a year—that would mean about 240 million semiconductor devices a year.

None of the integrated-circuit makers will predict when this market breakthrough may come. Most think it's at least a couple of years away. Many see the problem as purely a matter of price. When integrated-circuit components are priced so that they are cheaper than those they replace, they'll be used, these producers say.

In computers? There are other encouraging signs. Computer makers are evaluating integrated circuits; instrument firms are begin-

ning to try to determine where integrated circuits can be used in existing projects.

The problems remain tough. Producers must further improve the efficiency of their manufacturing processes and reduce overhead. Risks and costs are high.

Robert Sprague, chairman of the Sprague Electric Co., says it costs \$1 million to set up one prototype line to produce monolithic integrated circuits. And there's always the question of whether a production process is taking the correct circuit approach.

Question of survival. There's also the question of whether small firms can survive in competition with such giants as Texas Instruments and Motorola.

Erickson says Hoffman will be able to compete successfully with larger companies. "We spend more time giving the customer what he wants," he explains.

The Raytheon Co. says its business is custom-oriented. Its approach is customer-by-customer, program-by-program.

The Bendix Corp. also sticks to custom circuits. A Bendix executive says price-cutting encourages commercial use of microelectronics that would otherwise be limited to military use. Although he isn't in favor of this, he concedes it's one way to get things started. Smaller companies can survive if they specialize, he asserts.

"This is a game of the fewest mistakes," says Richard Hanschen, marketing director for the Semiconductor division of Texas Instruments. Those companies that fail in microelectronics will have to invest in something else, he says. There have always been special producers in this field, so all won't be frozen out.

Industrial electronics

Ship strike settled

The settlement of a seven-day strike by the members of the Marine Engineers Beneficial Associa-

tion against the Moore McCormack Lines, owners of the first automated ship in the United States merchant marine, raised hopes of smooth sailing for automated vessels.

At issue was the reduction of the number of engineers required, from seven to five, by the installation of an electronic centralized engine-room control system on the S. S. Mormacargo.

After a week of round-the-clock negotiations, the union agreed to the reduction in crew and the company agreed that the Marine Engineers Beneficial Association would have jurisdiction over all of the licensed engineers on board. Jesse M. Calhoun, president of the union, said that he had wanted assurance that there would be no increase in hours for the five engineers and that all the licensed engineers on board—regardless of the work they did—would be members of his union. "We're not against automation," he said. "All we want is jurisdiction."

The Mormacargo had been scheduled to sail on August 20 from Pascagoula, Miss., to New York, but the engineers refused to man the vessel.

Settlement hailed. William T. Moore, president and chairman of Moore McCormack, said that the settlement "would ensure the successful achievement of the automated-ship program which, in the case of Moore McCormack, could affect the course of its entire replacement program." He added that "labor, management and government have long recognized that the automated-ship program is the real hope for the future of the American merchant marine."

While the agreement covers only the Mormacargo, both sides believe it will establish a pattern for future negotiations. About 30 more automated ships are being built by various U.S. companies; this includes five more by Moore McCormack. The next ship scheduled to sail late this month is owned by the Central Gulf Lines, a company owned equally by the Grace Lines and the Lykes Brothers Steamship Co.

Transatlantic. The Mormacargo will carry cargo and 12 passengers between New York and northern Europe. More than 150 of her operations have been changed from manual to push-button control. The General Electric Co. built the control system that checks 108 separate points in the engine room every five minutes for temperature, pressure, liquid levels and motor condition and automatically records the results. If trouble is spotted, a danger alarm is sounded and the source is shown on a console.

Space electronics

Military satellites

The design for the defense communications satellite system slated for launch early in 1966, is expected to follow that developed by the Philco Corp. and its major subcontractor, TRW Space Technology Laboratories, a division of Thompson Ramo Wooldridge, Inc.

Philco's work was on a medium-altitude satellite (6,000 miles), which originally figured in the military's plans. But now the Department of Defense has decided that the system will be placed into a near-synchronous orbit at 19,000 miles. The main change caused by the higher orbit will be more directivity in the antenna.

Each of the 24 satellites in the military system will be an eight-

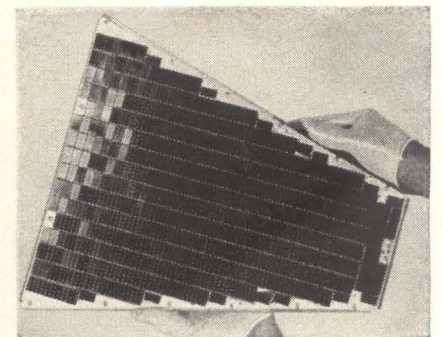

Solar-cell panels will supply 38 watts to the spacecraft. Each vehicle will have 16 panels like this one on each of two flattened conical sections, and eight smaller panels in the central band.

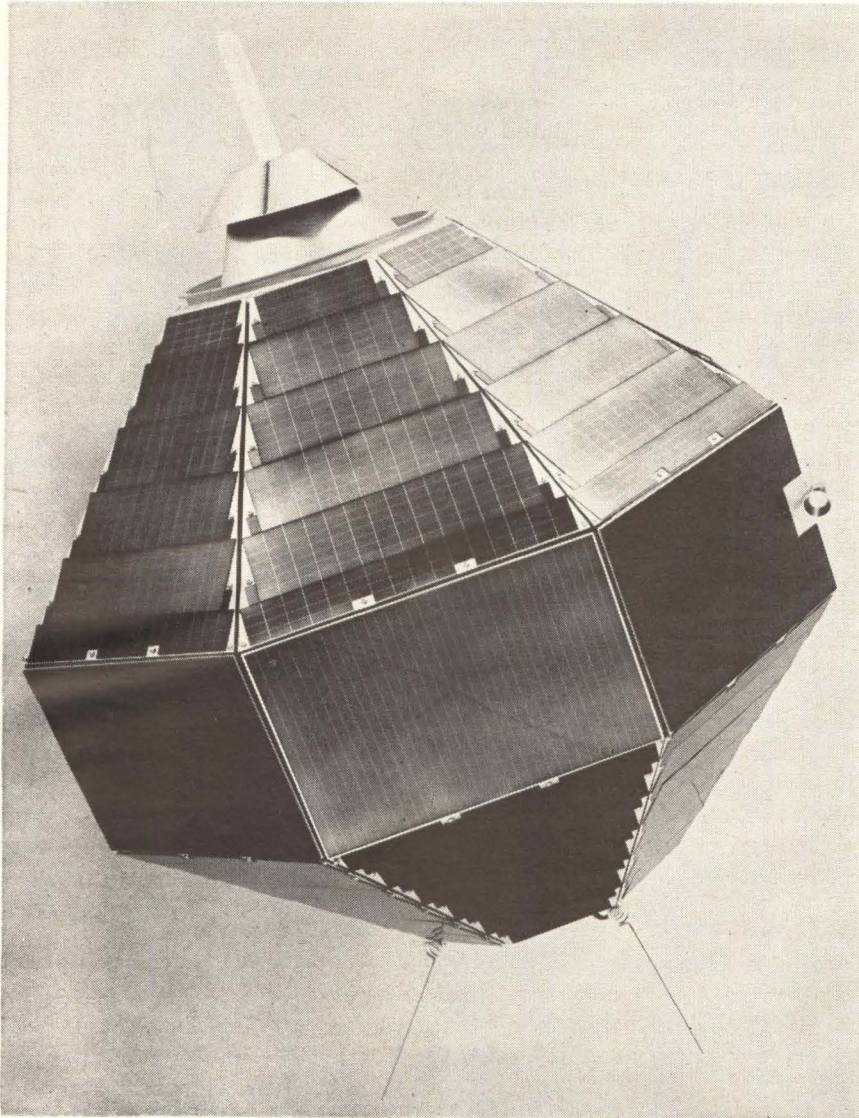

First photo of defense communications satellite being built by the Philco Corp. and Space Technology Laboratories. Twenty-four satellites similar to this mockup will be launched early in 1966, eight at a time, aboard three Titan III-C boosters.

sided vehicle with a flattened conical section on either side. Each satellite will have 24 solar-cell panels, providing a total of 38 watts of solar power. There will be eight solar panels on the upper flattened conical section, eight on the lower and eight in the central band. Each satellite's output will be two watts. The satellite will receive at about eight gigacycles and transmit at 7 Gc.

Small and simple. Two communication antennas will project outward from one of the flattened conical sections. Four whip antennas, radiating outward from the other end of the other flattened

conical section, will handle beacon and telemetry transmissions.

Each satellite will weigh 90 pounds and carry 1,000 electronic parts, compared with 550 pounds and more than 10,000 electronic parts in Syncom, the synchronous communications satellite of the National Aeronautics and Space Administration. The military satellites will have lifetimes of three to five years, compared with one to two years for Syncom. The initial set of 24 satellites will be spin-stabilized, but the basic configuration could be altered to accommodate gravity-gradient stabilization or a radioisotope power supply.

The communications capability of the satellite, using a transportable station with a 40-foot dish and 10 kilowatts of power, will be two CCIR voice channels and five voice channels of tactical quality, also 690 teletype channels and 49 vocoder channels. With a 15-foot dish, the capability will be reduced from five to one voice channel; in vocoder, from 49 to 7 channels; in teletype, from 690 to 100 channels.

Ground stations. The major addition to the satellite system's ground network, which will be operated by the Army's Satellite Communications Agency (Satcom), will be six AN/MSC-46 transportable link terminals with 40-foot dishes, to be built by the Hughes Aircraft Co. for \$9.7 million. Each terminal will consist of seven vehicles and will be capable initially of transmitting and receiving four voice and five teletype messages simultaneously.

The assembly will consist of three 30-foot-long equipment vans, set up in T-formation, also three power units and a 40-foot parabolic antenna. All components are air-transportable for rapid deployment to remote areas of the world to provide semipermanent communications or emergency communications support.

The link terminals are scheduled to be completed in mid-1965 and, together with the eight existing Satcom link terminals (Electronics, Aug. 24, p. 37), will form the ground network.

Nuclear Nimbus

Nimbus B, the second of the series of Nimbus weather satellites, is slated to become the National Aeronautics and Space Administration's first satellite to use a nuclear power source when it is launched in 1965. The spacecraft will carry two SNAP-19 nuclear generators that will supply 30 watts of power each, in addition to the 250 watts that will be provided by Nimbus' two solar cell paddles.

Nimbus A, which was launched

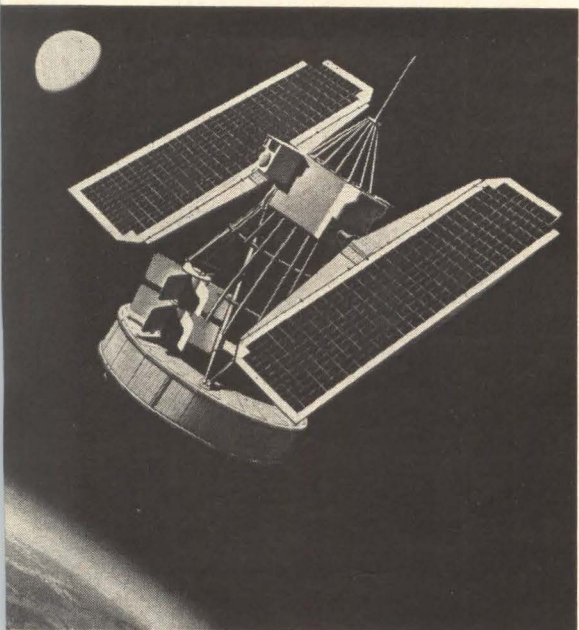

Solar cells will share load with nuclear power.

last week, and Nimbus B are research and development vehicles funded by NASA. When the Weather Bureau suddenly cancelled plans for launching a group of operational Nimbus spacecraft several months ago, there was speculation that a nuclear-powered weather satellite with a long lifetime was being sought. The two piggy-back nuclear power sources on Nimbus B have a design lifetime of five years.

On the dark side. The generators, being developed by the Martin Co., a division of the Martin-Marietta Corp., as part of a \$1.5-million contract with the Atomic Energy Commission, are fueled with plutonium-238. They will be delivered to NASA early next year. The 60 watts of added power from the two generators will be used with the 250 watts of solar power. When Nimbus is on the dark side of the earth, it can use the additional power for the infrared instrumentation and control system electronics.

The generators have no moving parts. Each is 11 inches high and 22 inches in diameter, including fins. Spontaneous decay of the plutonium isotope generates heat inside a tightly-sealed container. This

heat is converted directly into electrical energy by an assembly of thermocouples.

Comsat to economize

For its second-generation satellite system, to be launched in 1966, the Communications Satellite Corp. expects to slash ground-station costs without impairing performance.

In its first four ground stations in the United States, the company expects to use a simpler, 85-foot parabolic dish instead of the 370-ton, 68-foot horn antenna that is part of the American Telephone & Telegraph Corp. station at Andover, Me.

Comsat expects its antenna to equal or exceed AT&T's specifications that include a gain of 61 decibels at 6 gigacycles with a noise temperature of 50° K at 5° elevation. The new corporation plans to build stations in the Northeast, Northwest and Southeast as well as in Hawaii. Each station would be protected by a radome-like structure.

Will use klystrons. Because its stations will require power outputs of 5 to 15 kilowatts, Comsat plans to use a klystron for its amplifier, instead of a traveling-wave tube. Each station will transmit at six gigacycles and receive at four gigacycles. The exact power output will be determined after Comsat decides whether its satellite system will be at medium or synchronous altitude.

Florida and Washington are considered strong contenders for two of the Comsat station sites. In the Northeast, the company would consider buying the AT&T station in Maine if the price is right.

Advanced technology

Electronic Shmoo

The electronic counterpart of Al Capp's all-purpose Shmoo seems to have been discovered by a French inventor, Antoine Berard.

According to Atlantic Instruments & Electronics, Inc., a Boston company with exclusive United States rights to the device, the Silistor can do practically everything except print the money the company is seeking for further development of the electronic wonder.

Good for everything. Potentially, says the company, the Silistor might act as a battery, a light-sensitive cell, a d-c transformer or energy accumulator. That's not all. With an indefinitely long life, the Silistor is burnout-proof, chemically inert and will hold an electric charge given it at any voltage and return it later, as needed, at almost any rate of current. It can be flash-charged by a very brief high-voltage spike or trickle-charged over a long period. It can hold a charge given it by sunlight, qualifying it for use as a retentive solar cell. With a special formulation, a simple shake will induce it to generate current.

Land, sea, air. Military and space authorities in this country are interested in developing the Silistor, says Atlantic Instruments. The company claims the device could save the Navy a million dollars a year in mine-battery storage and replacement; that it could provide internal detonating power to missile heads and proximity fuses, and could be used as a capacitor with greater capacitance per unit volume than conventional components. Values of 10,000 to 100,000 microfarads have been achieved.

Under-water submarine detection, space-vehicle power and accelerometers are other potential applications.

Mighty midget. Possibly the most startling characteristic of the Silistor is its size. Laboratory prototypes as small as 0.002 cubic centimeters have been developed and it's hoped to make these even smaller—up to 100 times smaller than batteries now used.

At your local drugstore. The inventor won't say how it works. He declares his theories are not completed. A. H. Lamb, director of engineering at Atlantic Instruments & Electronics, speculates that the action involves long polar organic

If you need stability...

in a capacitor this small...

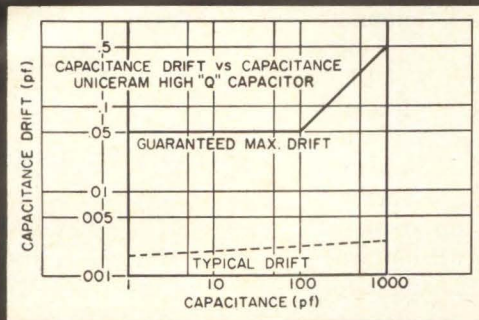
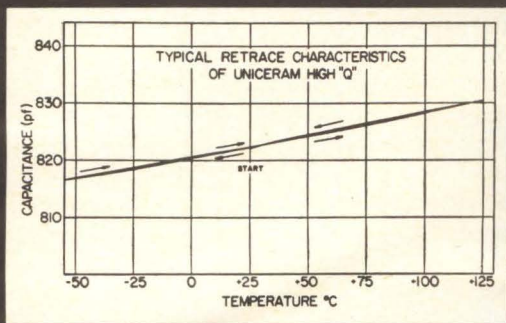

Model UYO1
Actual Size

specify JFD High Q Uniceram ceramic fixed capacitors

Uniceram High Q ceramic fixed capacitors offer a previously unobtainable combination of small size and exceptional stability. High Q model UYO1, shown actual size, provides 62.0 pf . . . up to ten times more capacitance per unit volume than competitive units . . . and at competitive prices.

NOTE THESE ADVANTAGES OF HIGH Q UNICERAM CAPACITORS:

- 160 models . . . capacitance values from 0.5 to 10,000 pf.
- Extremely high ratio of capacitance to unit volume.
- Built-in stability . . . remains constant through voltage, frequency and temperature variations.
- Ceramic dielectric layers, fused into a solid monolithic structure, encapsulated in glass, insure complete protec-

tion from moisture and the severest environmental stresses.

- Very high Q and excellent high temperature insulation resistance.
- Lower series resistance and lower inductance than semiconductor type capacitors—suited for HV, VHF, and UHF, and low frequency RF requirements.
- Pure silver leads bonded to capacitor by unique solderless process.
- Meet or exceed MIL-C-11272B specifications.

UNICERAM HIGH K SERIES

Uniceram High K ceramic capacitors with greatly increased capacitance per unit volume . . . up to 1 mfd . . . meet or exceed MIL-C-11015C specifications.

WRITE FOR BULLETIN UNM 64-1

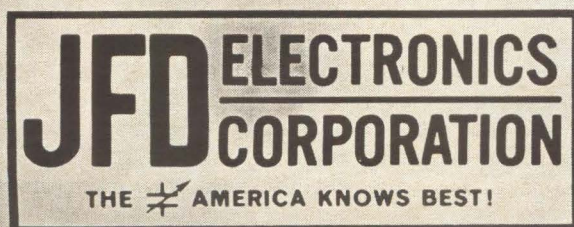

Components Division

JFD ELECTRONICS CORPORATION, 15th Ave. at 62nd St., Brooklyn, N. Y. 11219
 JFD NORTHEASTERN, Ruth Drive, P. O. Box 228, Marlboro, Mass. 07152
 JFD NEW YORK-NORTHERN, Damiano Pl., P. O. Box 96, New Hartford, N. Y. 13503
 JFD MID-ATLANTIC, 313 E. Broad St., Palmyra, N. J. 08065
 JFD MID-ATLANTIC-MARYLAND, P. O. Box 7676, Baltimore, Maryland 21207
 JFD MIDWESTERN, 6330 W. Hermione St., Chicago, Illinois 60646
 JFD MIDWESTERN-OHIO, P. O. Box 8086, Cincinnati, Ohio 45208
 JFD WESTERN, 9 Morlan Place, Arcadia, California 91006
 JFD CANADA LTD., 51 McCormack Street, Toronto, Ontario, Canada
 JFD ISRAEL LTD., Industrial Area B, Bldg. 23, Azur, Israel
 DUCON CONDENSER PTY., LTD., Christina Road, Villawood, N.S.W., Australia
 LCC STEAFIX, 128 Rue de Paris, Boite Postale 51, Montreuil-sous-Bois, Seine, France
 MURATA MANUFACTURING CO., LTD., Nagaoka Otokuni, Kyoto, Japan
 STANDARD TELEPHONE & CABLES LTD., Footscray, Sidcup, Kent, England

molecules that move at different speeds in different substances. The Silistor elements are made up of a solid or liquid mixture of two common chemicals, with impurities added. Heightening the mystery, the inventor will identify neither the chemicals nor the impurities. He does say that the chemicals can be bought in any drugstore. Without a prescription, presumably.

It is known that copper or zinc electrodes reach into the mixture and, by providing more than two electrodes per element, Atlantic says the device can also act as a delay line.

Microelectronics

Cost-cutting circuit

A new microcircuit pulsed voltage source that promises to reduce computer costs by replacing the power amplifier and the squaring device usually required in computer interface circuitry will be marketed this month.

The Norden division of the United Aircraft Corp. developed the circuit for use in the Apollo guidance computer under a contract with the Massachusetts Institute of Technology.

The circuit is essentially a power switch that accepts low-level logic input pulses and produces 2-volt, 40 milliamp output pulses into a coax line. It has rise, fall, storage and propagation delay times of less than 15 nanoseconds. The output pulse is in phase with the input pulse and is unaffected by fluctuations of the line voltage driving the unit. With the circuit, pulses can be transmitted through complex wiring without degradation of rise and fall time.

The company expects the unit to be used as a complement to existing circuitry or as new circuitry in computer designs requiring fast switching time, small size, reliability and low cost. Although prices are not yet firm, Norden expects the units to cost \$54 each when ordered in 1,000 lot quantities. This is about 25% below the cost of the parts

the unit will replace. The device will be packaged in a TO-47 can, a ¼ by ⅛ in. flat pack, or, on special order, in a TO-5 can.

Communications

Networks deemed safe

The Air Force's termination of a contract with the Adler-Westrex Communications division of Litton Industries, Inc., for Project 484M, called "Build Back," reflects a good deal of optimism about the United States' invulnerability to a nuclear attack.

The Air Force Electronic Systems division, which is responsible for the program, says it ended the contract on orders from the Air Force. The division adds: "A critical examination of the vulnerability of our communications systems revealed that automated switched networks now in procurement would establish a net with the highest survivability. Therefore, a requirement for the Adler contract no longer existed."

Build Back was to include 400 sets of high-frequency, line-of-sight and tropospheric equipment that could be stored in National Guard armories. If an attack knocked out normal wire and cable routes, the units could be hauled into place to reestablish the destroyed circuits. Forty units were planned in the first phase; the high-frequency equipment was to be furnished by the government.

The Philco Corp. held the sub-contract for the tropospheric scattering equipment, but hadn't done much work on it when the project was terminated.

Alternate routes. The Western Union Telegraph Co. and the Bell System have been establishing alternate microwave routes for several years. Bell has also been putting its cables underground to make wire routes more secure. It recently awarded a multi-million-dollar contract to the Kellogg Communications System, a division of the International Telephone and Telegraph Corp., to place about 220

miles of cable in trenches in New York, Connecticut and Massachusetts.

Another big factor suggested by the Electronic Systems statement is the growth of the Defense Communications System. A world-wide telegraph network is scheduled to be completed in 1966, and one for record communications by 1967. The automatic digital network (Autodin), for telegraph, uses a centralized computer to control teletypewriter and data messages. The automatic voice network (Autovon), for telephone, uses the same type of central control that Bell will use in its new electronic switching systems for central offices. With this system, the computer logic immediately finds an alternate communications route if there is a failure in the main route.

Army talk goes digital

The Army is switching to pulse code modulation (pcm), a digital system, for all multichannel communications, a move which increases the capability of present radio and switchboard gear. The Army Electronics Command is backing the decision with a \$22.7-million contract to the Raytheon Co. for initial production of required transmission equipment. The new system will carry up to 96 voice messages simultaneously on either cable or radio channels. Telephone channels will handle voice, teleprinter, facsimile or digital data.

The Signal Corps, predecessor of the Electronics Command, began working with pcm 20 years ago but adopted, instead, for its multichannel circuits another system called frequency division multiplex, a technique well-understood and in use for years by telephone companies. Pulse code modulation was rejected at the time because electron-tube equipment proved bulky, heavy and consumed a tremendous amount of power. Transistors and improved equipment packaging have made pcm practical for tactical military use.

Two-level waveform. Each in-

FURTHER ADVENTURES WITH ONE MICROVOLT

PART 7 OF A SERIES ON THE STATE OF THE CHOPPER ART

Probably one of the homely facts we discover as we peel back layer after layer of noise is that cleanliness is next to zero offset. This is particularly true of things that get blamed on poor Mr. Seebeck. Thermal differentials existing apparently across a metallic joint will frequently appear as DC signal levels upward of 40 microvolts, and just when we thought we had eliminated dissimilar materials. To our considerable surprise, complete and painstaking cleaning of everything physically close to our low level signal, from insulator to technician, caused most of the offset to vanish.

We theorize that we have eliminated electrochemical potentials existing on insulation surfaces. Apparently, such potentials also have a Seebeck effect all their own, since they will come and go with a hot air blast from the wife's hair dryer. One of these days we must buy one for the lab. The cessation of research every time she sets her hair tends to get the chief engineer all upset. If you also raid the boudoir, mount the thing 3 to 6 feet away and conduct your air via a pipe of plastic tubing, otherwise the great hum field from it will blanket everything.

The cleaning process involves the use of chemically stable solvents, such as Cobehn, sprayed on. Apparently solder fluxes will vaporize and redeposit as an invisible film, at least invisible under moderately powered microscope up to 300. We say apparently, since we have been able to recreate the thermal offset by heating rosin flux near cleaned surfaces.

We have spoken earlier about the Fixed Offset Contribution and the Variable Offset Contribution. The Variable is usually thermal in nature. Our chart, at the right, has full scale values of $-20\mu\text{v}$ to zero to $+20\mu\text{v}$, and is representative of what we consider fairly good performance. The circuit impedance in this case was about 1000 ohms. The low level circuits are housed inside shielding and that inside an oven. The ambient of $+30^\circ\text{C}$ is re-attained by opening the door, hence the step response. The Fixed Offset Contribution at 30°C stayed at $-1\mu\text{v}$ for days, and could of course be summed to exactly zero. Usable resolution was evidently much better than $1\mu\text{v}$.

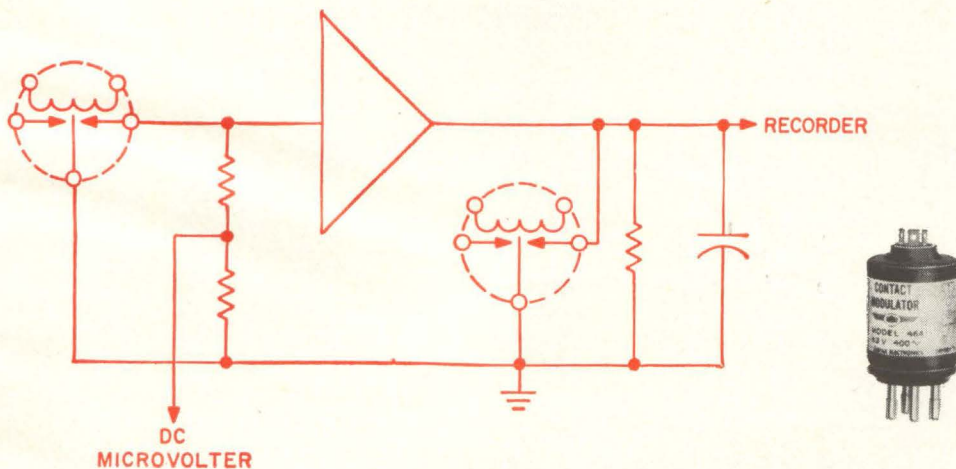

We have much more information — it's yours for the asking.



Phone (301) 228-4600

AIRPAX ELECTRONICS
incorporated

TWX 301 228-3558

CAMBRIDGE DIVISION • CAMBRIDGE, MARYLAND

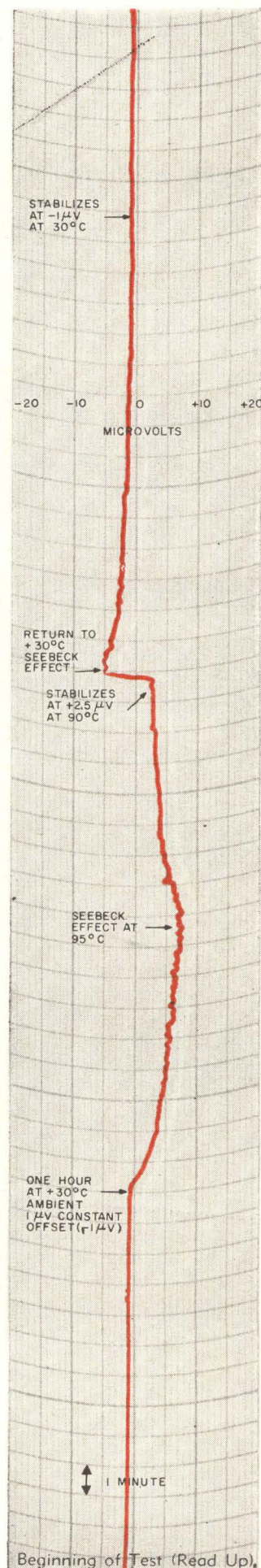

put voice channel is sampled sequentially 8,000 times each second to provide a pulse amplitude modulated (pam) signal. All channels are then combined on a single line to produce a time-multiplexed pam signal. Each sample is then coded, or converted into a six-digit binary number. The six digits of the coded signal determine that the number of quantized levels must be 64. (A binary number has two states, "0" and "1", and two raised to the sixth power is 64.)

The output of the coder is a series of six-digit numbers represented by a waveform having only two distinct levels. The advantage of such a waveform over an analog form that is produced directly by the human voice, for example, is that its characteristics are recognizable even when somewhat distorted or mixed with other signals and noise. The signal can be regenerated countless times by simple equipment that looks at the degraded signal, makes a decision as to which discrete level is represented and then reconstructs the signal in amplitude and time to produce a clean waveform identical to the signal before transmission.

Regenerating the signal. Unattended repeaters, small rugged units placed at one mile intervals in a cable system, perform this function of regeneration. A limitation of 240 miles for either radio or cable is based mainly on the limit of the analog order wire, a plain telephone connection used in emergency or when lining up a new circuit.

At each receiving location, three steps are necessary. A demodulator separates two 12- or two 48-channel trains, if the maximum capability of the equipment is being employed. Next, the six-digit numbers of the pam waveform are decoded by conversion into analog form and finally, the output of the decoder is demodulated or separated into individual voice channels. When high-density channeling is used over radio circuits, a three-level waveform is employed to conserve radio-channel bandwidth.

Special construction protects and

accommodates a thousand transistors in an average of 1.73 cubic inches per transistor. After mechanical assembly of components, flow soldering and cleaning, a thin conformal coating of epoxy 0.012 inch thick is applied to both sides of the circuit panels. The coating enhances resistance to humidity, yet permits circuit-generated heat to be readily dissipated. Since there is no noticeable difference in the surface temperature of the components and the coating, there is no need to derate components.

Medical electronics

The eyes have it

Glaucoma is being attacked with a computer at the Presbyterian Medical Center in San Francisco.

Carter Collins, a biophysicist at the center, is using a TR-20 transistorized analog computer built by Electronic Associates, Inc., to simulate the workings of the human eye, with the neurophysiological functions of the optic system translated into computer language. The studies are expected to unravel the causes of several eye diseases.

Muscles first. The initial studies concern eye muscles. The computer is programmed to produce a two-channel output, in the form of two dots, on an oscilloscope that is placed on its side. A radio-frequency generator causes each dot on the oscilloscope to go in and out of focus in the same way the human eye does. The computer can be controlled manually to make the

Oscilloscope "eyes" follow pencil.

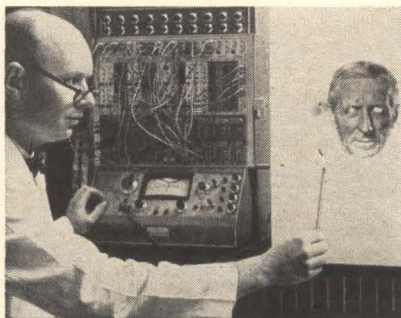

mechanical eyes follow a pencil (see photo).

Dr. Arthur Jampolsky, director of the center's Eye Research Institute, says analog computers can eventually help to determine how information is transmitted from the eyes to the brain. A matrix of photo cells, or a scanning device similar to a television camera, will act as a retina and receive images. Later, color filters will be added to simulate color vision.

The research center has bought a second computer from Electronic Associates to carry its studies still further.

Electronics abroad

Japan looks eastward

Japanese electronics manufacturers, faced with a shrinking market at home, are looking elsewhere for customers, and the United States is the number one target.

In 1963, Japan exported 22% of its electronics output, or \$364 million, compared with 18% the year before. Half of these exports went to the United States.

Last year, Japan's electronics production totaled \$1.67 billion, up only 3% from 1962. The gain was far smaller than the 13% increase in 1962 and the 20% rise in 1961.

The U. S. Department of Commerce says the major reason for the slowdown in growth is a near-saturation of the Japanese domestic market for consumer electronics products—the staple of the country's manufactures. It is estimated that 83.2% of Japanese households had television receivers on Jan. 1—an increase of 85% since 1961. U. S. television ownership is estimated at 90% of all households.

Besides the increased emphasis on exports, the Japanese are stepping up production of commercial, industrial and military electronic equipment. Output in these areas was up 16% last year from 1962. Leading the list were electronic computers, whose value doubled from \$26 million in 1962 to \$52 million last year.

If you use Piezoelectric Accelerometers CEC can make your job much easier

By banishing cable calculations... CEC's new 4-280 accelerometers combine electronics and crystal in one package. As a result, a low-impedance output can be recorded or read directly on conventional a-c meters, scopes, etc.—without signal conditioning or sensitivity and frequency variation.



Sens: 24 mv/g
Freq: 2-6000 cps $\pm 5\%$
Wt: 1.5 oz
 Z_o : 150 ohms

Type 4-280-0001 contains source follower—constant voltage sensitivity for any cable capacitance up to 1600 pf.



Sens: 24 mv/g
Freq: 2-6000 cps $\pm 5\%$
Wt: 1.5 oz
 Z_o : 15 ohms

Type 4-280-0002 contains source follower with augments (power amplifier)—drives extra-long cables without loss in high frequency response.



E_o : To VCO
Sens: 24 mv/g
Freq: 2-6000 cps $\pm 5\%$
Wt: 2 oz

Type 4-280-0003 contains source follower, a +2.5 v dc reference and 5 v p-p limiter—a unique telemetry package.

With miniature electronics that can take a beating... CEC's all-solid-state source followers, voltage amplifiers, and charge amplifiers assure performance second-to-none, regardless of size, even in accelerometer environments.



Z_{in} : 500 megohms
Gain: Adj 5-90
Freq: 5-10,000 cps $\pm 5\%$
Wt: 45 gm

Type 1-302-0001 Voltage Amplifier, with adjustable 5-90 gain, drives hundreds of feet of cable without loss of sensitivity or signal distortion.

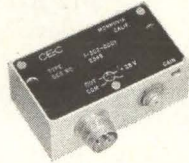

E_o : To VCO
Gain: Adj 5-90
Freq: 5-10,000 cps $\pm 5\%$
Wt: 45 gm

Type 1-302-0002 Voltage Amplifier includes adjustable 5-90 gain, an adjustable VCO reference supply, and limiter—for "fool-proof" telemetry use.



Gain: 2 mv/pcmb
Freq: 5-10,000 cps $\pm 5\%$
Wt: 25 gm
 Z_o : 150 ohms

Type 1-303-0001 Charge Amplifier is an extra-rugged, fixed gain, miniature unit. Voltage sensitivity is independent of system capacitance.



Z_{in} : 500 megohms
Gain: 0.98
Freq: 2-10,000 cps $\pm 5\%$
Wt: 10.5 gm

Type 1-304-0001 Source Follower, smallest impedance-matching unit on the market, actually enhances accelerometer performance.



Z_{in} : 500 megohms
Gain: 0.98
Freq: 2-10,000 cps $\pm 5\%$
Wt: 15 gm

Type 1-304-0002 Source Follower with Augments (power amplifier) drives extra-long cables without loss in high frequency response. Input impedance is 500-megohms.



E_o : To VCO
Gain: 0.98
Freq: 5-10,000 cps $\pm 5\%$
Wt: 15 gm

Type 1-304-0003 Source Follower with +2.5 v dc reference and 5 v p-p limiter is a break-through for telemetry applications.

With accelerometers you can depend on... Painstakingly calibrated and rigorously tested before shipment, CEC accelerometers are conservatively rated. Will consistently outperform their specifications. Are engineered for extra dependability.



Sens: 72 mv/g (OC)
Freq: 2-8000 cps $\pm 5\%$
Cross-Axis: 3.5% max
C: 450 pf

Type 4-270-0001 is a high-voltage-sensitivity unit with exceptional dynamic range and temperature capability, yet weighs only 1 oz.



Sens: 52.5 pcmb/g
C: 1400 pf
Freq: 1-7000 cps $\pm 5\%$
Cross-Axis: 3.5% max

Type 4-271-0001, also weighing 1 oz., features high capacitance (high charge sensitivity) for minimal cable effects over a wide dynamic range.



Sens: 12 mv/g (OC)
Freq: 2-10,000 cps $\pm 5\%$
C: 450 pf
Wt: 14 gm

Type 4-273-0001 is a "shielded compression" design with all-welded construction which virtually eliminates environmental effects on output.

By giving you unexcelled support... As the world's largest manufacturer of transducers, CEC assures every customer products which are competitively priced, honestly represented, promptly delivered, fairly warranted, and faithfully serviced by factory specialists and engineers in offices throughout the U.S. Though all of the devices described here are standard instruments produced for stock, modifications and innovations can be made to meet special requirements.

For complete information on this advanced piezoelectric line, just call CEC or write for bulletins in CEC Kit #5044-X5.

Transducer Division

CEC

CONSOLIDATED ELECTRODYNAMICS

A SUBSIDIARY OF BELL & HOWELL/PASADENA, CALIF. 91109
INTERNATIONAL SUBSIDIARIES: WOKING, SURREY, ENGLAND
AND FRANKFURT/MAIN, GERMANY

Circle 43 on reader service card

THE COMPONENTS THAT HAVE MADE THE ALLEN ORGAN FAMOUS
ARE USED BY AMERICA'S LEADING ELECTRONICS MANUFACTURERS

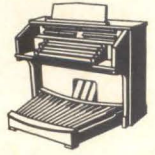

A NEW CONCEPT IN VARIABLE COIL DESIGN

ALLEN ADJUSTABLE TOROIDAL INDUCTORS

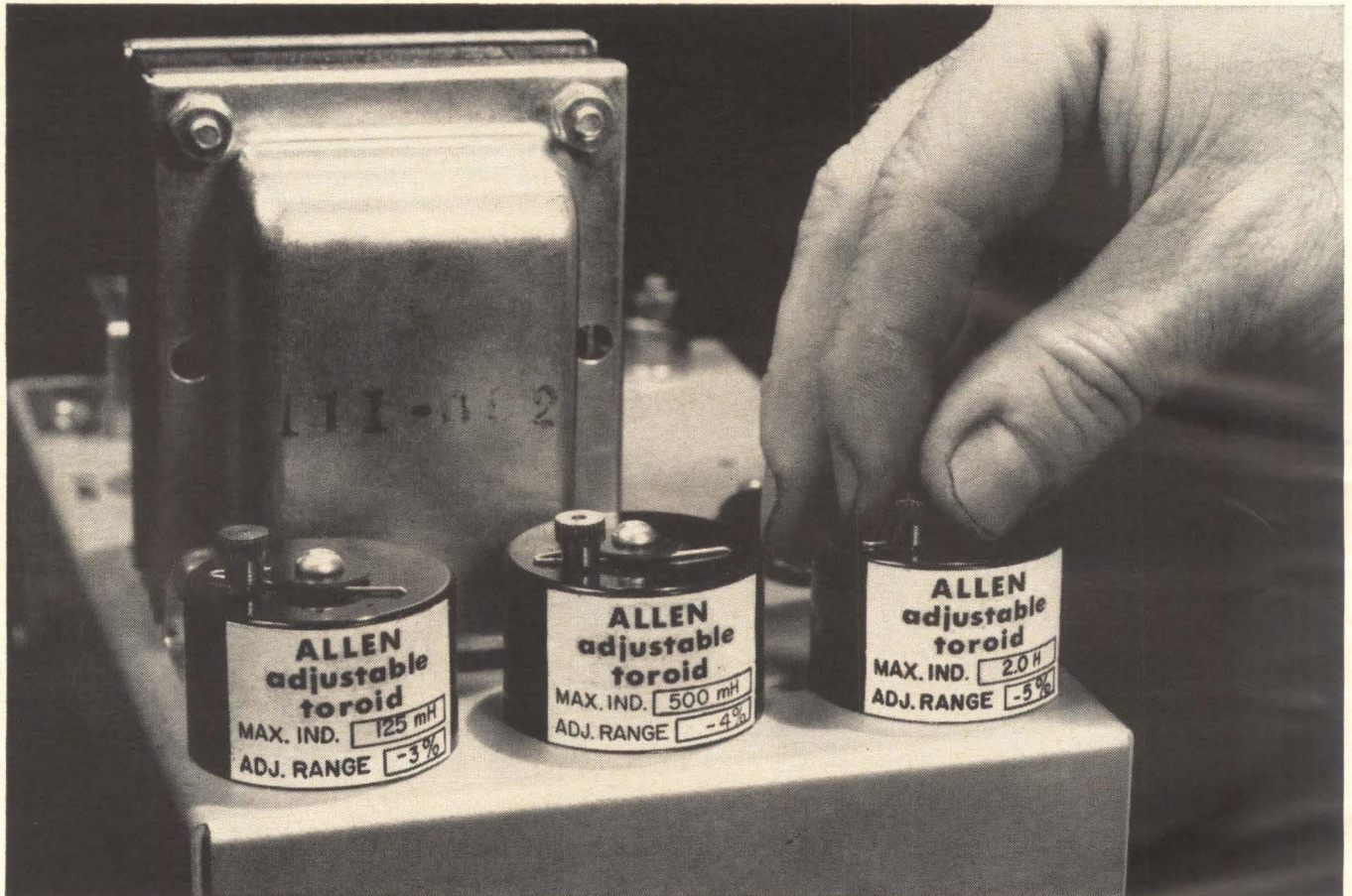

They allow 8 to 14 turns of the screw for precise and smooth adjustment of inductance

The Allen Adjustable Toroid is a recently introduced inductor* that provides an adjustment range of from 4 to 8 percent of the maximum value.

A molybdenum Permalloy toroidal core is modified to produce a variable-gap inductor. An adjusting screw provides a stepless adjustment range through 8 full turns of the screw for inductors up to approximately 500 mH and 14 turns for values above 500 mH.

96 different sizes produce a range from 20 H to 6.2 mH. Maximum operating temperature is 85° C.

This new inductor represents another Allen Organ development now available to industry. Write and we'll be glad to furnish full price and delivery information.

*Patent applied for

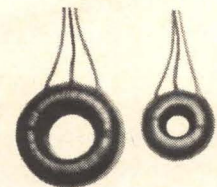

Allen Toroids in Stock

Over 150 sizes available from stock include Permalloy, Ferrite and Powdered Iron types. Inductance and Q measured at 1 volt 1000 c.p.s. Inductance tolerance $\pm 2\%$.

© A.O. Co.

Allen

COMPONENTS DIVISION

Allen Organ Company, Macungie, Pa. Phone 215-965-9801

BOURNS TRIMPOT® POTENTIOMETERS

World's largest selection — longest record of reliability

Units shown approximately 3/5 actual size.

TRIMPOT® POTENTIOMETERS—UNSEALED



General-Purpose Wirewound Model 200. Max. temp. 105° C / L, S, P terminals / 0.50 watt at 70° C / 10 ohms to 100K.

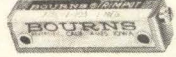

General-Purpose RESISTON® Carbon Element Model 215. Max. temp. 125° C / L, S, P terminals / 0.25 watt at 50° C / 20K to 1 Meg.



High-Temperature Wirewound Model 260. Max. temp. 175° C / L, S, P terminals / 1.0 watt at 70° C / 10 ohms to 100K.

TRIMPOT POTENTIOMETERS— HUMIDITY PROOF



General-Purpose RESISTON Carbon Element Model 235. Max. temp. 135° C / L, S, P terminals / 0.25 watt at 50° C / 20K to 1 Meg.



General-Purpose Wirewound Model 236. Max. temp. 135° C / L, S, P terminals / 0.8 watt at 70° C / 10 ohms to 100K.

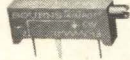

Micro-Miniature High-Temperature Wirewound Model 3000. Max. temp. 175° C / P terminals / 0.5 watt at 70° C / 50 ohms to 20K.



Micro-Miniature High-Temperature RESISTON Carbon Element Model 3001. Max. temp. 150° C / P terminals / 0.20 watt at 70° C / 20K to 1 Meg.



Sub-Miniature High-Temperature Wirewound Model 220. Max. temp. 175° C / L, W terminals / 1.0 watt at 70° C / 10 ohms to 30K / Mil-Spec style RT10 and meets MIL-R-27208A.

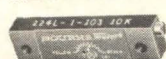

High-Temperature Wirewound Model 224. Max. temp. 175° C / L, S, P terminals / 1.0 watt at 70° C / 10 ohms to 100K / Mil-Spec style RT12 and meets MIL-R-27208A.



Ultra-Reliable High-Temperature Wirewound Model 224-500. Max. temp. 150° C / L, P terminals / 0.5 watt at 70° C / 100 ohms to 20K. Performance and reliability statistically verified to customer.



High-Temperature, High-Resistance RESISTON Carbon Element Model 3051. Max. temp. 150° C / L, S, P terminals / 0.25 watt at 50° C / 20K to 1 Meg / Mil-Spec style RJ11 and meets MIL-22097B.



High-Temperature High-Resistance PALIRIUM® Film Element Model 3052. Max. temp. 175° C / L, P terminals / 1.0 watt at 70° C / 20K to 1 Meg.



High-Temperature, Low-Resistance PALIRIUM Element Model 3053. Max. temp. 175° C / L, P terminals / 0.5 watt at 70° C / 2 ohms to 100 ohms.



High-Temperature Wirewound Model 3010. Max. temp. 175° C / L, P terminals / 1.0 watt at 70° C / 10 ohms to 100K / Mil-Spec style RT11 and meets MIL-R-27208A.



High-Temperature RESISTON Carbon Element Model 3011. Max. temp. 150° C / L, P terminals / 0.25 watt at 50° C / 20K to 1 Meg / Mil-Spec style RJ11 and meets MIL-R-22097B.



High-Temperature High-Resistance PALIRIUM Element Model 3012. Max. temp. 175° C / L, P terminals / 1.0 watt at 70° C / 20K to 1 Meg.



3/8"-Square Wirewound Model 3280. Max. temp. 175° C / L, P, W terminals / 1.0 watt at 70° C / 10 ohms to 50K.



3/8"-Square RESISTON Carbon Element Model 3281. Max. temp. 150° C / L, P, W terminals / 0.5 watt at 50° C / 20K to 1 Meg.



1/2"-Square, High-Temperature Wirewound Model 3250. Max. temp. 175° C / L, P, W terminals / 1.0 watt at 70° C / 10 ohms to 50K / Mil-Spec style RT22 and meets MIL-27208A.



1/2"-Square High-Temperature RESISTON Carbon Element Model 3251. Max. temp. 150° C / L, P, W terminals / 0.50 watt at 50° C / 20K to 1 Meg / Mil-Spec style RJ22 and meets MIL-R-22097B.

BOURNS® SINGLE-TURN POTENTIOMETERS



5/16"-Diameter Micro-Miniature High-Temperature Humidity-Proof Wirewound Model 3300. Max. temp. 175° C / W, P, S terminals / 0.5 watt at 70° C / 10 ohms to 20K.



5/16"-Diameter Micro-Miniature High-Temperature Humidity-Proof RESISTON Carbon Element Model 3301. Max. temp. 150° C / W, P, S terminals / 0.25 watt at 70° C / 10K to 1 Meg.



Sub-Miniature Wirewound Model 3367. Max. temp. 105° C / P, S terminals / 0.5 watt at 70° C / 10 ohms to 20K / meets steady-state humidity.



Sub-Miniature RESISTON Carbon Element Model 3368. Max. temp. 105° C / P, S terminals / 0.25 watt at 50° C / 20K to 1 Meg / meets steady-state humidity.

LOW-COST COMMERCIAL POTENTIOMETERS

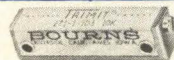

Wirewound TRIMIT® Potentiometers Models 271, 273, 275. Max. temp. 105° C / L, S, P terminals / 0.5 watt at 25° C / 50 ohms to 20K.



RESISTALOY® Carbon Element TRIMIT Models 272, 274, 276. Max. temp. 105° C / L, S, P terminals / 0.2 watt at 25° C / 20K to 1 Meg.

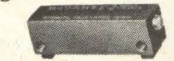

Wirewound E-Z-TRIM® Potentiometer Model 3067. Max. temp. 85° C / S, P terminals / 0.5 watt at 25° C / 50 ohms to 20K / Priced under \$1 in production quantities.



Carbon Element E-Z-TRIM Potentiometer Model 3068. Max. temp. 85° C / S, P terminals / 0.2 watt at 25° C / 20K to 1 Meg.

SPECIAL-PURPOSE POTENTIOMETERS



High-Power (2 watts) High-Temperature Wirewound Model 207. Max. temp. 175° C / L terminals / 2 watts at 50° C / 100 ohms to 100K. As Rheostat Model 208, available 100K to 200K.



High-Power (5 watts) Humidity-Proof Wirewound Model 3020. Max. temp. 200° C / L terminals / 5.0 watts at 25° C / 100 ohms to 50K.



Dual-Element Wirewound TWIN-POT® Potentiometer Model 209. Max. temp. 135° C / L terminals / 0.50 watt (each element) at 70° C / 10 ohms to 50K.



15 watts, High-Temperature Wirewound Model 3030. Max. temp. 265° C / L terminals / 15 watts at 25° C / 10 ohms to 10K.



Radiation-Resistant, High-Temperature Wirewound Model 3040. Max. temp. 350° C / W terminals / 150 megarad / 5X10¹⁵ neutrons per sec. / 5.0 watts at 70° C / 500 ohms to 20K.

PANEL-MOUNTED POTENTIOMETERS

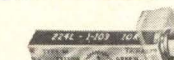

Most models are available with panel mounting. Unique design permits quick factory assembly to "on-the-shelf" units. In addition, mounting screws, brackets and clip brackets are available to meet almost any mounting requirement.

KEY TO TERMINAL TYPES

- L=Insulated stranded leads
- S=Solder lugs (includes panel-mounting bushing on Models 3367S, 3368S, 3300S and 3301S only)
- P=Printed-circuit pins
- W=Uninsulated wires (edge-mounting 3250, 3251, 3280 and 3281).

Write **TODAY** for detailed specifications on any model in the large BOURNS® Potentiometer and TRIMPOT® Potentiometer line **AND** a list of factory representatives.

TRIMPOT® means BOURNS, BOURNS means QUALITY, so remember...

Don't MIL-SPECulate... SPECify BOURNS.

TRIMPOT is a registered trademark of Bourns, Inc.





REGULATED POWER SUPPLY
 20 VDC - 45 AMP
 2000 VA - 10000 CAP
 MIL SPEC - 8830A
 CONTRACT NO. 44-119-1000
 CHATHAM ELECTRONICS
 DIVISION OF TUNG-SOL ELECTRIC INC.
 LIVINGSTON, NEW JERSEY

Weatherproof unit for battlefield communications trailer

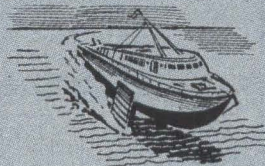
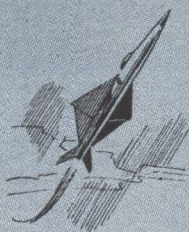

**If it flies, floats, runs, or hides in the ground
 CHATHAM BUILDS POWER SUPPLIES FOR IT**

Chatham power supply capability spans the full range of circuit concepts. Unregulated rectifier, magnetic, precision transistor, silicon controlled rectifier, high-power gas types—Chatham makes them all. Parameters, packaging and performance meet every requirement, industrial, commercial or military, even as high as MIL-E-4158, 8189 or 16400. Chatham makes its own key elements such as transformers and diodes to safeguard reliability standards against the fluctuation of commercially available components. All standard and custom-built equipment undergo exhaustive evaluation in our own functional and environmental test laboratories which are unequalled in the industry. Write for more information about why it would be to your advantage to talk to Chatham about your power supply requirements.

CHATHAM ELECTRONICS
 LIVINGSTON, N. J. TWX: 201-992-7350
 DIVISION OF TUNG-SOL ELECTRIC INC.

Washington Newsletter

September 7, 1964

Johnson warned on arms cutbacks

President Johnson's post-convention legislative program may run into serious difficulty because of the effect of military cutbacks on defense contractors.

Just before the Democratic National Convention, governors of nine states that have been particularly hard hit asked the President for help. They told him that layoffs would hurt at the polls even though they agreed that defense spending must be held in rein and that Defense Secretary Robert S. McNamara has a good national reputation.

Later, nearly 100 congressmen from those nine states promised to back up their governors. The lawmakers threatened to vote against all Johnson legislation unless he offered some help soon in the form of defense spending in their states.

Johnson will attempt to soften the impact of the Pentagon's cost-cutting program, even though he will continue to back the program. The administration will delay announcement of further cutbacks until after the election. On the constructive side, the Labor Department is expanding its profiles of areas where jobs are available, to steer workers to those places.

Medium-range missile is killed

Despite the Pentagon's abandonment of plans for a medium-range ballistic missile, development will continue on a stellar inertial-guidance system and on advanced command-and-control elements that are applicable to succeeding generations of missiles.

Details of the command-and-control requirements are classified, but the goal is to achieve a high degree of accuracy—a strike within a radius of about one-fifth to two-fifths of a mile from more than 1,000 miles away. Another important objective is the ability to launch from a mobile vehicle within about 15 minutes of command to stop and fire.

General Precision, Inc., is developing the guidance system; the Martin-Marietta Corp. and Sylvania Electric Products, Inc., are making the studies of advanced command-and-control elements. Sylvania is a subsidiary of the General Telephone & Electronics Corp.

The missile was abandoned after an investment of more than \$100 million because Congress doubts the weapon is essential. Defense Secretary McNamara and the Joint Chiefs of Staff wanted the missile to fill a gap between the 400-mile-range Pershing and the 3,000-mile intercontinental missiles. Funds for this year were cut from \$110 million to \$40 million—an amount considered insufficient by the Defense Department to advance the development of the missile system. The Air Force Ballistic Systems division was program manager for the missile; the Hughes Aircraft Co. was the system's integration contractor.

Mobile station flown to Saigon

A small mobile ground station, that can be flown quickly to trouble spots around the world to provide instant communications via satellite to Washington and elsewhere, will soon be tried out in South Vietnam.

The Army recently flew a transportable ground station to Saigon. The station, only 15 feet in diameter, will transmit and receive military traffic via National Aeronautics and Space Administration's satellites, Syncom

Washington Newsletter

II and III, now in orbit over the Pacific Ocean.

The Pentagon won't comment on the experiment. However, the small ground station has been tested by the Army for several months under lease arrangement from its developer, the Hughes Aircraft Co. Backers of the plan include Gen. Paul D. Adams, commander of strike forces at MacDill Air Force Base, Fla.

Humphrey may be space unit head

If they're elected in November, President Johnson will name his running mate, Sen. Hubert H. Humphrey (D., Minn.), head of the National Aeronautics and Space Council. Johnson held the chairmanship when he was Vice President.

Humphrey has definite ideas about greater international participation in the cost of space research. He will push this strongly, as well as his idea of sharing nonmilitary and nonstrategic research with the Soviet Union.

A favorite Johnson theme, improved efficiency and coordination among agencies, also is expected to be advanced. Humphrey has a long record of vigorous support for improving coordination through such means as more extensive use of information retrieval systems.

The Democratic platform pledges continuation of the "world's largest research and development effort in weapons systems and equipment." Pentagon planners are taking this to mean there will be no further cuts in military R&D in the next budget.

SAC overruled by the Pentagon

Attempts by the Strategic Air Command to include satellites in the Defense Department's new command-and-control communications system (Project 487-L) have failed. Top Pentagon officials are said to have overruled SAC's request on the ground that it is technically premature. Selection of contractors for the multimillion-dollar electronic system is expected within a month. On June 25 nine companies bid on the project. Linking aircraft into a satellite communication system is under study, but is expected to take several years to perfect.

EIA protests FCC rule

A new controversy is going on between the Electronic Industries Association's consumer products division and the Federal Communications Commission. In April, the FCC adapted a rule allowing very-high-frequency telecasters to maintain the radiated sound and channel power at 10% to 70% of the peak radiated power of the picture transmitter. The level was formerly 50% to 70%.

Receiver manufacturers complained that the wide range of possible sound-signal power made the design of receivers difficult, so the FCC has now proposed a sound-to-picture ratio of 10% to 20%.

Most manufacturers are unhappy with the new proposal, but would go along with the EIA's proposed ratio of 20% to 30%. They point out that the European CCIR (Radio Advisory Committee) standard is 20% and that sound bars on color-tv programs are not annoying at this sound level. But in areas of weak reception, they add, sound ratios of much less than 20% result in poor signals for good receivers and pure static for cheap receivers.

The Committee for the Full Development of All-Channel Broadcasting essentially backs the EIA proposal for the 20% to 30% limits.

**YOU ARE LOOKING
AT A DISPLAY THAT
HAS NEVER BEEN
SEEN BEFORE!**



Upper insert photo shows 1 microsecond L-Band pulse on full 60 db vertical display, 300 mc wide

Now possible exclusively with

HEWLETT-PACKARD'S



new state-of-the-art

SPECTRUM ANALYZER!

Add the Hewlett-Packard reputation for innovation, quality and reliability to these unique features... and introduce yourself to the world's most remarkable instrument for spectrum monitoring, spectrum signature identification and RFI analysis:

never before an instrument with the capabilities of the

New Hewlett-Packard 8551A/851A SPECTRUM ANALYZER!

Complete calibration

All basic functions of this new spectrum analyzer are completely calibrated...the first time such a feature has ever been offered. Spectrum width accuracy is $\pm 5\%$, and calibration makes conventional marker pulses unnecessary. Sweep rate offers 2% accuracy. Resolution is adjustable, manually or automatically, at 1, 3, 10, 100 or 1000 kc. Frequency response is ± 1 db over 200 mc, ± 3 db over 2000 mc. Frequency dial accuracy is 1% of the local oscillator frequency.

The vertical display is calibrated, too: log, 60 db ± 2 db; linear, 70:1 $\pm 3\%$; square (power) 70:1 $\pm 5\%$. An exclusive new turret-type input attenuator has zero insertion loss at dc and less than 2 db at 10 gc.

Broad spectrum

By sweeping the first local oscillator, a BWO, the 8551A/851A offers a sweep bandwidth of up to 2 gc, throughout the instrument range, 10 mc to 40 gc. This technique provides flat response over a broad range, independent of the first IF amplifier, which therefore can be narrow-band.

First IF frequency is 2000 mc, which puts images 4000 mc apart, eliminating many of the frustrating responses of present multi-band analyzers. Excellent sensitivity

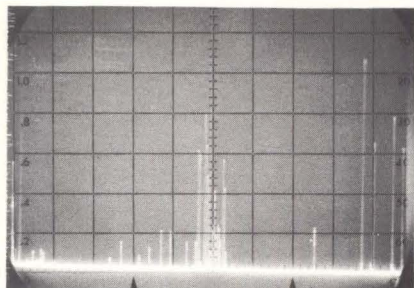

200 mc sweep, 10 mc to 200 mc, showing TV channels and FM station cluster, plus several aircraft transmissions.

—95 dbm, 10 mc to 2 gc at 10 kc bandwidth. No other analyzer provides this margin of safety. For further flexibility, a 200 mc first IF amplifier can be selected.

Narrow spectrums are available, too. A phase-lock system operates at spectrum widths of 10 mc and below, reducing residual FM of the BWO below the level of perceptibility, even on the 100 kc width. Stabilities of better than 1 kc are held.

Signal identifier, amplitude controls

Simple display adjustments with front panel controls make exact frequency identification of signals simple...and direct-reading, as well. After simple adjustments, the precise frequency of an unknown signal may be read directly on the main tuning dial—no markers needed.

Signal amplitude is controlled by an RF step attenuator, 0 to 60 db, and a calibrated 0 to 80 db IF step attenuator. The RF attenuator is calibrated in 10 db increments, the IF in 1 and 10 db steps.

Other advantages

Pulse work is simplified with the 8551A/851A Spectrum Analyzer's wide range of resolution. Calibrated sweep speeds also simplify measurement of pulse repetition rate, which can be determined directly from the display.

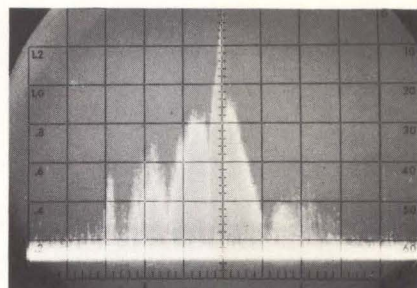

Display of radar transmission in low L-Band, showing spurious radiation over 300 mc below main carrier and interfering in TACAN channels (100 mc/cm).

Automatic Resolution Control, selectable on the front panel, automatically provides and retains optimum combinations of sweep width, sweep rate and IF bandwidth to retain full signal response, thus simplifying operation of the spectrum analyzer, even by non-technical personnel.

A baseline dimmer eliminates "blooming" from photographs and simplifies observation of low repeat rate signal situations. Permanent cw plots may be obtained with the calibrated x-y recorder output.

Coverage to 40 gc

The basic analyzer, consisting of the 8551A RF unit and the 851A Display unit, offers accurate analysis to 10 gc and is useful to 12.4 gc. A special X-band waveguide mixer is available for higher sensitivity from 8.2 to 12.4 gc.

Another external mixer extends the range to 40 gc, with three transition sections available for standard waveguide sizes. Flexible waveguide connections are unnecessary.

An internal-graticule crt provides parallax-free traces on a 7 x 10 cm display area. Except for the crt, the display unit is completely solid state. Both units together weigh less than 140 pounds and occupy a mere 19 inches of rack space. Weight and form factors make the units easy to transport.

hp 8551A RF Section, \$7100

hp 851A Display Section, \$2400

Demonstrations are available. Use the postcard for complete information and specifications. Or write Hewlett-Packard Company, Palo Alto, California 94304, Tel. (415) 326-7000; Europe: 54 Route des Acacias, Geneva; Canada: 8270 Mayrand St., Montreal.

*Data subject to change without notice.
Prices f.o.b. factory.*

General Spectrum Work • Broadband Frequency Surveillance • Spectrum Monitoring

Varactor Multiplier Tuning • Paramps • RFI • Spectrum Signature

HEWLETT
PACKARD



An extra measure of quality

a miniature eye for the '64 Tokyo Olympics



the

HITACHI
7038, 7735-A
7262-A, 8051
VIDICON

The miniature portable TV camera above will be used to cover the track and field events at the coming '64 Olympic Games in Tokyo. The eye of this micro-modular handy camera is a new half inch Vidicon. This particular model is in the experimental stage. Other types, however, are now available: 7038, 7735-A, 7262-A, 8051 plus some small Vidicons to choose from. For reliability and availability, specify a HITACHI Vidicon for your product. Write us for complete technical information and quotations.



Hitachi, Ltd.

Tokyo Japan

TOKYO, JAPAN

CABLE ADDRESS: "HITACHY" TOKYO

HITACHI SALES CORPORATION: 12715, S. Daphne Avenue, Hawthorne, Calif., U.S.A. Tel: 757-8143
333, N. Michigan Avenue, Chicago 1, Ill., U.S.A. Tel: 726-4572/4
666, 5th Avenue, New York, N.Y. 10019, U.S.A. Tel: 581-8844

HITACHI, LTD., DUESSELDORF OFFICE: Graf Adolf Strasse 37, Duesseldorf, West Germany Tel: 10846



MICRO SWITCH Precision Switches

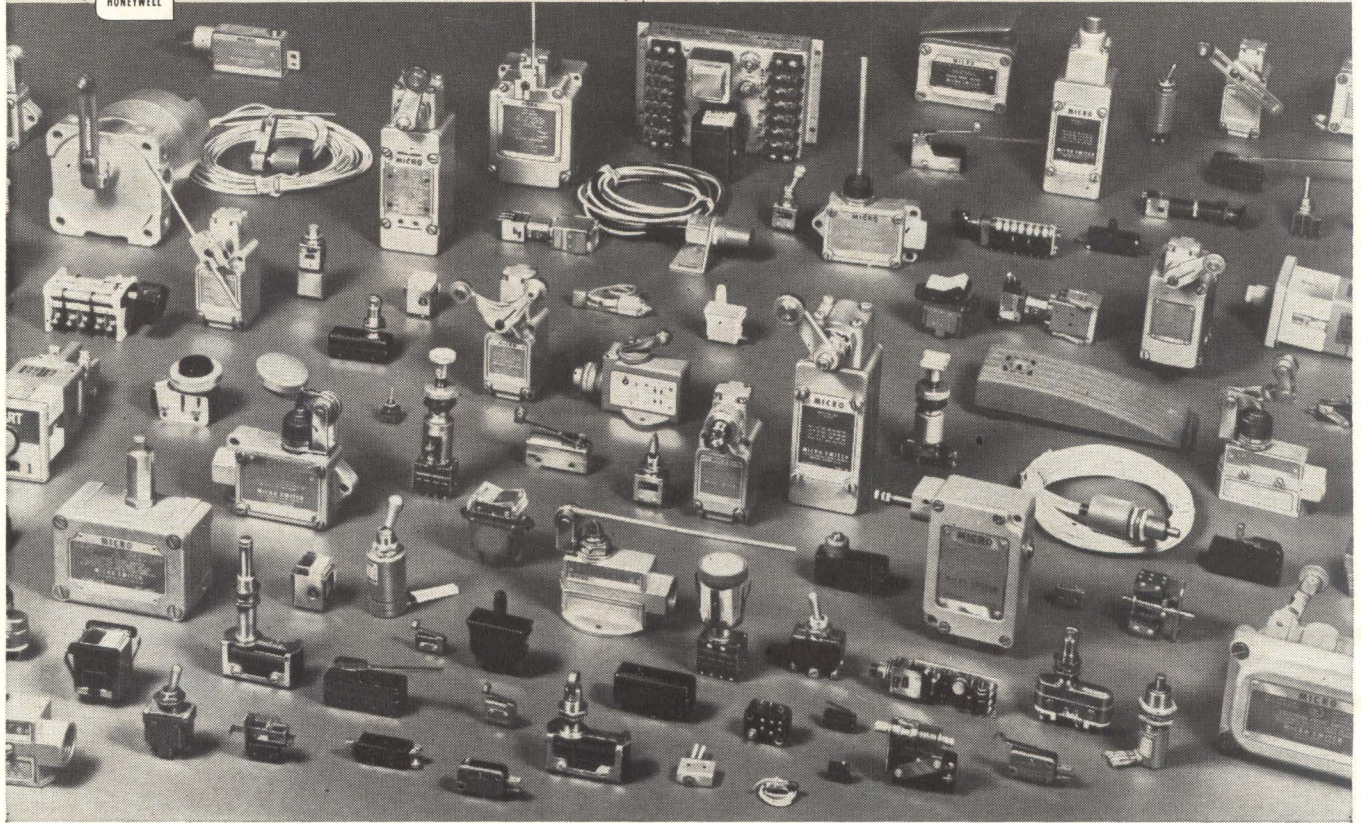

When you have a selection like this... 

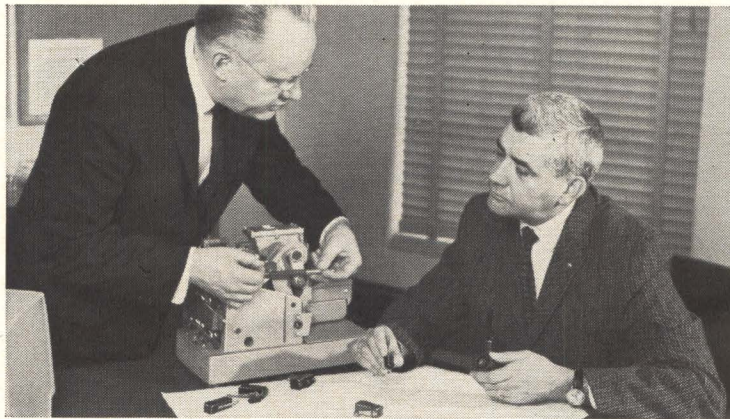

and application service like this...

WHY COMPROMISE?

With the largest selection of switches, MICRO SWITCH gives you the best possible opportunity to find the right combination of switch design, quality and cost. You don't risk taking less than your application requires—you don't pay for unnecessary extras.

MICRO SWITCH field engineers are all trained switch specialists. They are experienced in solving all types of tough application problems. Their sole job is to help

you find the right switch for your application.

See your Distributor, or call a MICRO SWITCH Branch Office (see Yellow Pages).



MICRO SWITCH

FREEPORT, ILLINOIS 61033

A DIVISION OF HONEYWELL

IN CANADA HONEYWELL CONTROLS LIMITED, TORONTO 17, ONTARIO

HONEYWELL INTERNATIONAL—SALES AND SERVICE OFFICES IN ALL PRINCIPAL CITIES OF THE WORLD. MANUFACTURING IN UNITED STATES, UNITED KINGDOM, CANADA, NETHERLANDS, GERMANY, FRANCE, JAPAN.

LOT CONTROL ASSURES

...series 88 resistor quality

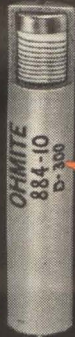

LOOK FOR THE LOT CONTROL NUMBER ON EVERY SERIES 88 RESISTOR

AXIAL LEAD WELD TEST LOG SERIES 88 - LOT CONTROL DATA

SUR LOT NO.	DATE	OP'R.	LEAD DATA	CAP DATA	REMARKS
1454	3/24/63	K.L.	M.S.O. 125V-1	M.S.O. 339	

CAP LEAD AND CORE ASSEMBLY TEST LOG SERIES 88 - LOT CONTROL DATA

SUR LOT NO.	DATE	OP'R.	CORE P.O.	LEAD DATA	USED FOR	COIL SIZE	REMARKS
2491	8/16/63	B.G.	B-3764	P.O.# B-2887	Weld	1 3 5 10	QUANTITY 500

WINDING SUB LOG SERIES 88 - LOT CONTROL DATA

WINDING SUB-LOT NO.	DATE	CUSTOMER NAME	CUSTOMER ORDER NO.	SHOP ORDER NO.	SPEC. NO. & REVISION	WIRE CODE	ASSEMBLED SUB-LOT NO.	NO. WIND	MACHINE NO.	SET-UP APPROVED BY
6203	10/16/63	H.B.P.	212-41127	37497	44392	222	2491	40	B1	J.C.

AGING SUB LOT LOG SERIES 88 - LOT CONTROL DATA

SUB LOT NO.	DATE	EQUIP. NO.	TIME IN	TIME OUT	SET	OPERATOR	REMARKS
1359	10/14/63	113-73	2-15		M:15		

MOLDED RESISTORS - MOLDING LOG SERIES 88 - LOT CONTROL DATA

SUB LOT NUMBER	MOLDING DATE	EXTRUSION	CYCLE TIME & OVEN			DIP	RESULTS OF MOLDING				OPERATOR'S SIGNATURE & REMARKS	
			CYCLE TIME IN SEC.	TEMPERATURE SETTING	TEMPERATURE SETTING		NO. MOULD	MOLD SAMPLE SIZE	SEAM	BODY		DELIMITERS
1235	10/16/63	100	100	100	0	65	65	3	1	80		
1236	10/16/63	100	100	100	0	65	65	3	1	80		

CURING LOG MOLDED RESISTORS SERIES 88 - LOT CONTROL DATA

CURING SUB LOT NO.	CURING DATE	CURING OVEN NO.	CURING CAN NO.	CURING OVEN START OF CYCLE TIME	BY	REMOVED FROM OVEN BY	REMARKS
400	10-11-63	148/131	3	0400	AUTO	J.W.	
401	10-14-63	148/131	3				

SILICONE CERAMIC, BATCH MFG. RECORD SERIES 88 - LOT CONTROL DATA

BATCH NO.	DATE MADE	PHENOLIC PENE-TRANTER READING	BATCH NO.	SIGNATURE	REMARKS
702L	9/16/63	138	170	C.C.	
703L	9/23/63	137			

SERIAL LOT NUMBER LOG SERIES 88 - LOT CONTROL DATA

LOT NO.	SUB LOT NUMBERS				TEST V. OTHER THAN 1500V	DIELECTRIC TESTING			RESISTANCE	ACCP. NO. & NO. FAIL	DATE STAMP	OPERATOR	CUSTOMER NAME		
	WINDING	AGING	HOLDING	CURING		WATT SIZE	NO. PASS	NO. FAIL						NO. STAMPED	
D-300	6203	1359	1236	401	Y	1	3	5	7	10	0	0	40	10/16/63	G.L.P. 27497 GARDNER Corp 05381 G.E.P. 27498
D-301	1359	1236	401		Y									10/16/63	

Lot control provides a permanent record of all the materials, manufacturing procedures, and testing that go into each Series 88 resistor. These records can be analyzed for any resistor, by means of the lot number marked on each unit, permitting a continuous program of reliability improvement.

LOAD LIFE TESTING—Production is constantly sampled, and units are put on load life tests for 10,000 hours.

LOW TEMPERATURE COEFFICIENT—Standard T.C. is only ± 20 ppm/ $^{\circ}$ C. Still lower T.C.'s are readily available.

CONSTRUCTION—Single layer winding of resistance alloy wire on a ceramic core with metal end caps and axial leads. All internal connections are welded. The silicone-ceramic coating is molded on (not dipped). This gives a hard, dense jacket, uniform in size and shape, which permits 100% safe, snug fits in clips, and qualifies resistors as insulated units (1000 VAC

V-block test). Standard leads are solderable. Weldable leads are also supplied.

THREE CATEGORIES FOR DIFFERENT APPLICATIONS

MIL-R-26C (Series 881)—Available in 107 MIL values from 0.1 to 8200 ohms; G and V characteristics from 2.5 to 11 watts.

COMMERCIAL POWER (Series 882)—1.25, 3.75, 6.5, 8, and 11-watt sizes with 3% tolerance for one ohm and higher values. Units derate to zero watts at 350 $^{\circ}$ C ambient. Made to order in values from 0.1 to 200,000 ohms.

HIGH STABILITY, PRECISION POWER (Series 884)—Tolerances down to 0.05. Derate to zero watts at 275 $^{\circ}$ C ambient. Supplied off-the-shelf in 3, 5, 10-watt sizes, and all 1% standard values of MIL-Bell System up to 200,000 ohms. Also made to order in 1 and 7-watt sizes.

Be Sure You Have the Latest Data. Write for Bulletin 101.

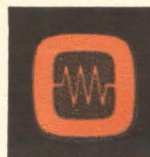

OHMITE
MANUFACTURING COMPANY
3610 Howard Street, Skokie, Illinois 60076
Phone: (312) ORchard 5-2600



RHEOSTATS • POWER RESISTORS • PRECISION RESISTORS • VARIABLE TRANSFORMERS
TANTALUM CAPACITORS • TAP SWITCHES • RELAYS • R.F. CHOKES • SEMICONDUCTOR DIODES

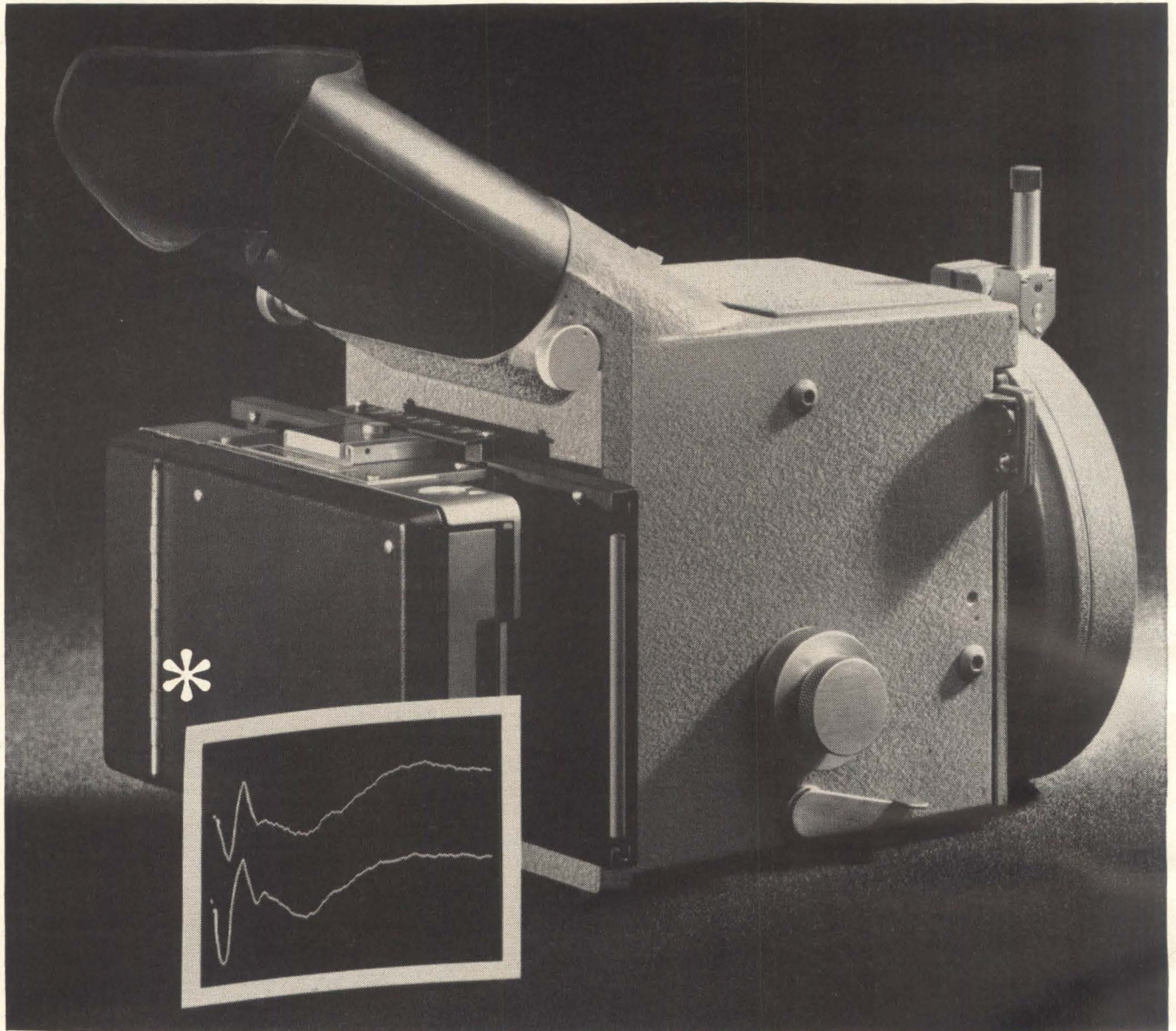

FAIRCHILD SCOPE CAMERA AIDS EYE RESEARCH

Use as clinical tool illustrates versatility of Type 450-A camera; Polaroid Land Back and Film provide immediate record

Electroretinography is but one of the scientific frontiers where Fairchild Oscilloscope Cameras are providing high precision recording of displayed phenomena. Among the features which contribute to this high performance are: • helical rack and pinion mechanism for pinpoint focusing and image reduction • heavy duty synchro-shutters • jam-proof lever for positive tripping of shutter. • Object-to-image ratio is continuously adjustable from 1:1 to 1:0.85, permitting recording of full 6 x 10 cm field on Polaroid Land film in 0.9 actual size. With the new Polaroid Land Film Pack Adapter prints — developed outside the camera — are available in 10 seconds. • Accessories include data chamber for writing in test identification for recording simultaneously with CRT display. If your work requires precision recording of oscilloscope displays, call your local Fairchild Field Engineer or write for complete data on the Type 450-A and other Fairchild Oscilloscope Cameras. Fairchild Scientific Instrument Dept., 750 Bloomfield Ave., Clifton, N.J. ("Polaroid"® by Polaroid Corp.)

* Traces show reaction of human eyes to a short light stimulus. The retinae electric potential is picked up with contact lens electrodes, fed to scope and recorded by Fairchild Oscilloscope camera fitted with Polaroid Back. Sequence is initiated by synchro-shutter of camera. Polaroid print is reproduction of one of thousands made at New York Medical College by G. Peter Halberg, M.D., Associate Clinical Professor of Ophthalmology.

FAIRCHILD

DU MONT LABORATORIES
SCIENTIFIC INSTRUMENT DEPARTMENT

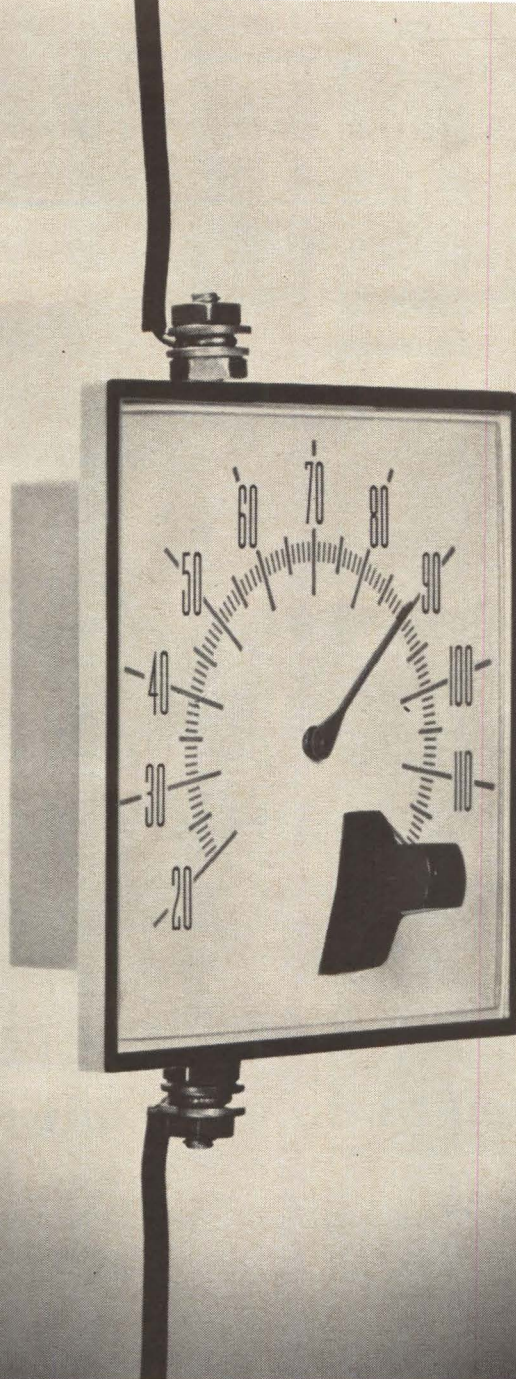

Should a circuit breaker be a thermometer?

Most are. Most circuit breakers are designed to be heat sensing. They respond to the heat byproduct of current. And, like a thermometer, they respond just as readily to ambient temperature changes. This is an inherent characteristic of thermal-type protection devices.

Heinemann circuit breakers are *magnetically* actuated. That makes a big difference. They are neither heat sensitive nor heat sensors. Their overcurrent trip values and current-carrying capacity are temperature stable, free from ambient effect.

You can always count on a Heinemann breaker to trip predictably at specified overload values. And to carry full rated current at any temperature within its overall operating range. In fact, a hydraulic-magnetic breaker is about the only way you can get this kind

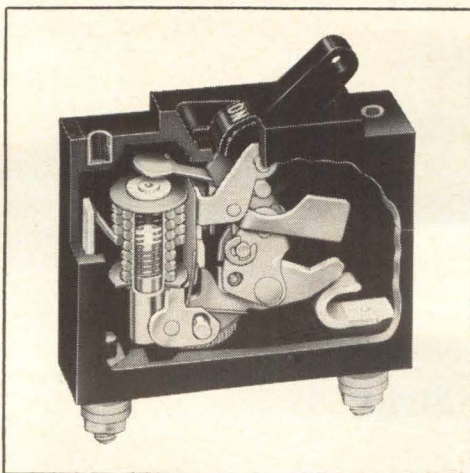

of close-tolerance overcurrent protection.

Magnetic actuation also permits us to give you uncommonly precise current ratings when you need them. Like 19 amp. Or 3.7 amp. Or any other integral or fractional rating from 0.010 amp up. You don't have to design a circuit around a stock rating. Or compromise protection in any way.

We also give you a choice of time-delay tripping characteristics, or no time delay, for instantaneous response.

You get this unique combination of advantages in any Heinemann circuit breaker. In a range of models that includes subminiatures, not much bigger than a common toggle switch, and big jobs for 480-volt service. Our Engineering Guide, Bulletin 202, will give you complete technical data. Yours for the asking.

HEINEMANN ELECTRIC COMPANY  **2600 Brunswick Pike, Trenton, N. J. 08602**

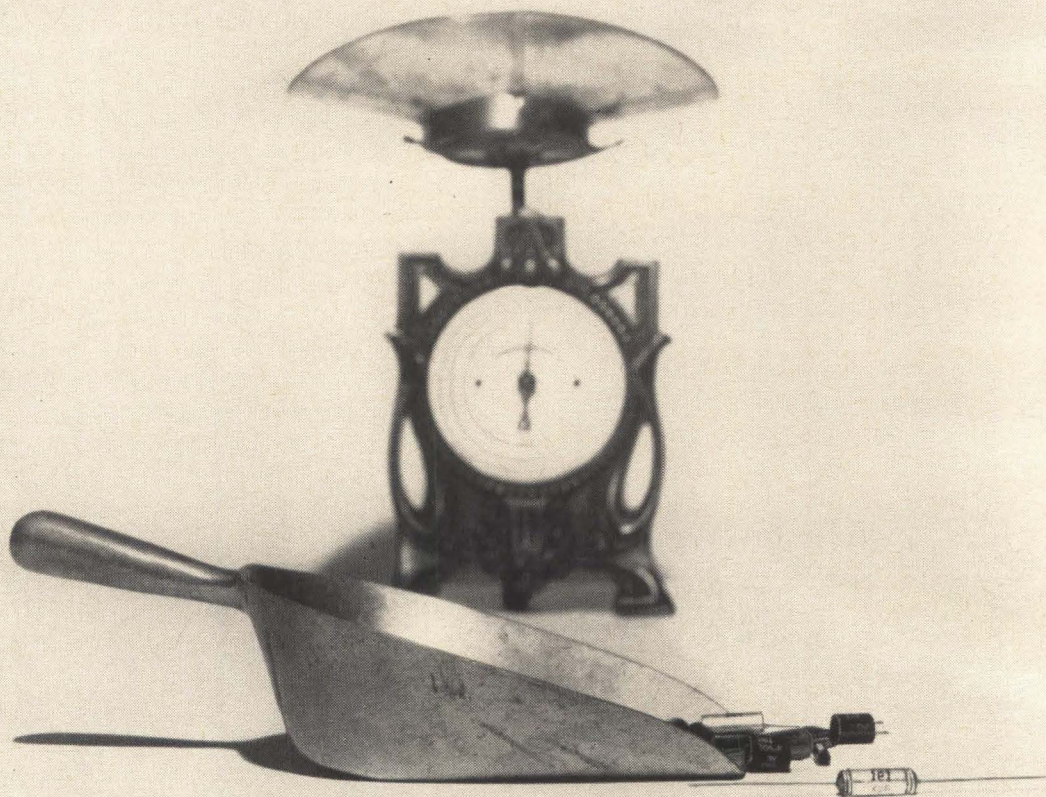

The last full measure of performance is built into every IEI design.

Today, progressive engineers in every field of electronics count on IEI to provide capacitors which will invariably deliver the superior performance required as modern circuits grow more and more sophisticated.

IEI has consistently and successfully pioneered the newest developments in aluminum and tantalum foil capacitors. In both wet and dry slug tantalums, IEI performance curves dramatically demonstrate a decided superiority over the usual MIL spec requirements.

IEI engineering starts where typical specifications leave off. Poured into every design are extra measures of research . . . materials . . . workmanship . . . test proce-

dures to provide quality far beyond the most stringent MIL specs.

Automated and other advanced manufacturing techniques assure better and faster production . . . high quality repeatability. A separate quality control department provides a 100% checkout for all capacitors of the five critical parameters with automatic QC instrumentation.

At IEI, **Quick Reaction Capability** is not just an empty phrase. Engineering and production facilities are geared to **deliver**—unbelievably fast! Let us demonstrate on your next requirement—whether routine assignment or special design problem.

Write for complete information.



INTERNATIONAL ELECTRONIC INDUSTRIES
Box 9036-12, Nashville, Tennessee

A DIVISION OF **sps** STANDARD PRESSED STEEL COMPANY "Where reliability replaces probability"

Why Motorola uses capacitors of Mylar® in its TV line

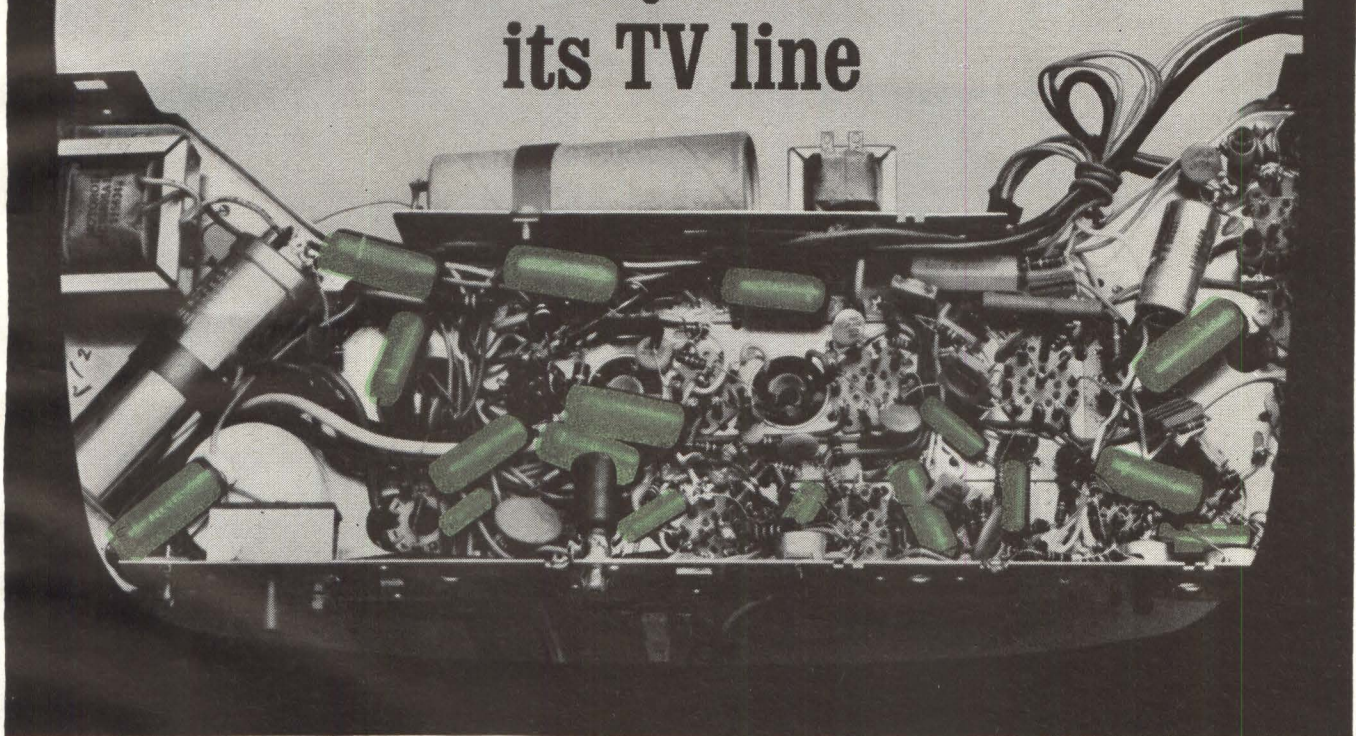

Chassis KTS-586-A00

“RELIABILITY!”

says Dick Kraft, Assistant Chief Engineer—TV Design

Under its exacting Golden M program, Motorola is placing emphasis squarely on reliability. Every tube and part in every color and black-and-white set in its complete line is guaranteed for a full year. It's no wonder that in the chassis shown (used for a group of portables) Motorola specified 17 tubular capacitors of “Mylar”.*

“With the reliability of ‘Mylar’ available to us, we simply couldn't afford to use paper,” says design engineer Kraft. Capacitors of “Mylar” also offer these advantages for

home entertainment and similar circuits: reduced size, high IR, thermal stability, moisture resistance and AC/DC compatibility... all at a price about the same as paper!

For complete data on the performance of capacitors of “Mylar” and how they can help you in your design problems, write: Du Pont Co., Film Department B-22, Wilmington, Delaware 19898.



*Du Pont registered trademark for its polyester film

Why buy
4 materials
when one
will
do... at
no
premium!



Industrial plastics

FORMICA CORPORATION

Department I-425, Cincinnati, Ohio 45232

subsidiary of

CYANAMID

At last! A single grade which meets the property requirements of NEMA G-10, G-11, FR-4, and FR-5! It's Formica's new FR-45...

New Formica FR-45 also meets requirements of MIL-P-18177 Types GEE & GEB and MIL-P-13949C Types GE, GB, GF, & GH.

New Formica FR-45 gives you the NEMA G-11 feature of high strength retention at elevated temperatures plus the excellent machining characteristics of G-10.

New Formica FR-45 easily passes through processing environments encountered in printed circuit operations with no harmful effects.

New Formica FR-45 meets the flammability requirements of NEMA LP 1-7.07E, both horizontal and vertical.

With new Formica FR-45 you have a single grade, a single inventory... yet, you pay no more for versatile Formica FR-45 than you would for any top-quality single-purpose grade!

Evaluation samples and detailed data available upon request.



Also write for catalogs on:

- Electrical/electronic grades
- Copper clad laminates
- Mechanical grades
- Engraving stock

See The Formica World's Fair House at New York for the newest and best in carefree contemporary living.

Technical articles

Highlights

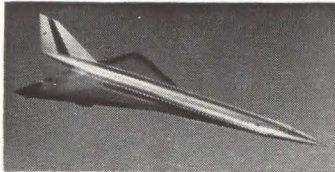

Electronics in the supersonic transport: page 60

Faster than sound, the planned commercial transport will require electronic systems not normally carried by airlines. Some problems make system design difficult but fascinating.

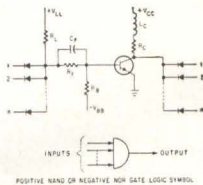

Less noise in high-speed circuits: page 66

Improving noise immunity makes the requirements for packaging and backboard wiring less stringent. A systematic approach has been developed to obtain optimum noise immunity.

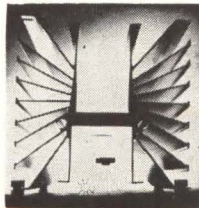

Special report on transistor heat dissipators: page 83

I. Profile of the industry: page 84

Use of heat sinks is rising rapidly as semiconductor circuitry is being pushed to higher power-levels. Companies in the industry used to be friendly, but now they are suing each other.

II. How to order a heat sink: page 89

A simple checklist for the engineer includes specifying material, finish, dimensions and hole pattern. Also, you'll want this directory of manufacturers.

III. Beating the heat in semiconductor devices; page 92

Operating temperatures are a problem and a challenge to designers of semiconductor circuitry. Even though temperatures limit the operation of transistors, they can be controlled to improve existing circuitry.

IV. Long-pin approach to dissipator design: page 99

This heat sink looks like a porcupine. Despite the thermal advantages obtained through its quill-like fins, high cost of fabrication has limited its use. Now the cost is going down.

V. Liquid cooling: page 101

Almost all solid-state equipment is air-cooled. But there are some advantages to liquid cooling if it is done right.

VI. Torque and thermal resistance: page 104

Here's a test setup to help determine the thermal impact of torque.

**Coming
September 21**

- Industrial applications of the scr
- Tunnel diode inverters
- Transmitting power by microwave

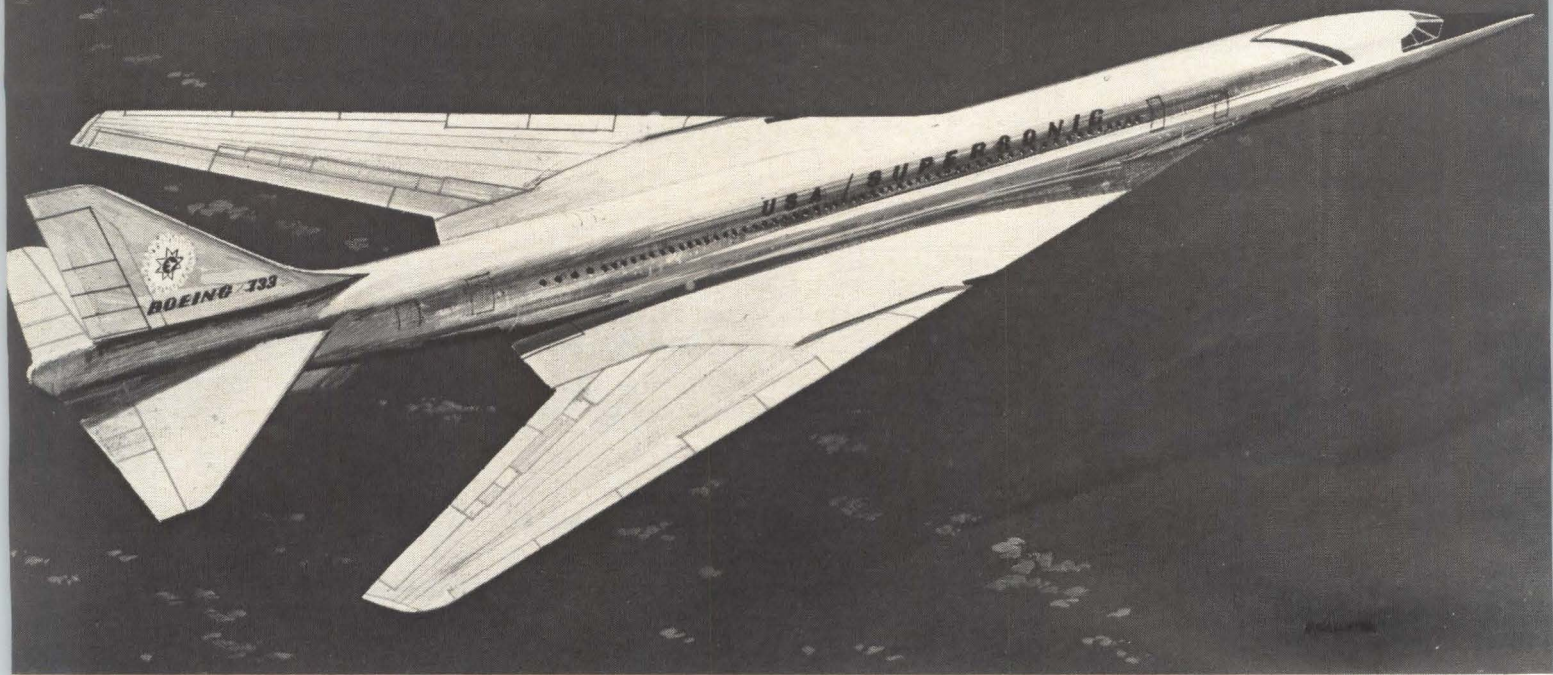

Lockheed and Boeing entries in the supersonic race. The Boeing "variable-sweep" supersonic transport is shown above.

Avionics

SST: challenge to avionics designers

Some of the problems it poses are big and complex and may require new equipment; others may be solved with existing electronic gear

By W.J. Evezia

Avionics Editor

The supersonic transport plane will ease many of man's logistic problems one day. Meanwhile, its development is creating some new problems in avionics and pointing up some old ones.

Its speed—1,300 to 2,000 miles an hour—makes sophisticated automatic computers necessary. During the 7 to 17 minutes in which a navigator takes celestial fixes to obtain a position, the aircraft might travel 530 miles, making the fixes obsolete.

It requires better long-distance communications equipment than any now available, for use over such out-of-the-way places as the North and South Poles, the South Atlantic and mid-Pacific oceans.

It needs a new breed of antenna, one that can endure temperatures of -65° to almost 600°F and altitudes up to 70,000 feet.

It makes all-weather landing capability a must. Supersonic transports will burn fuel at an enormous rate—over 164,500 pounds for a 140-minute flight—and won't be able to carry enough to linger for long while waiting for the weather to clear over an airport.

Much of today's standard electronic equipment is expected to satisfy requirements of the supersonic plane. This includes aircraft intercommunications, cockpit voice and flight data recorders, vhf short

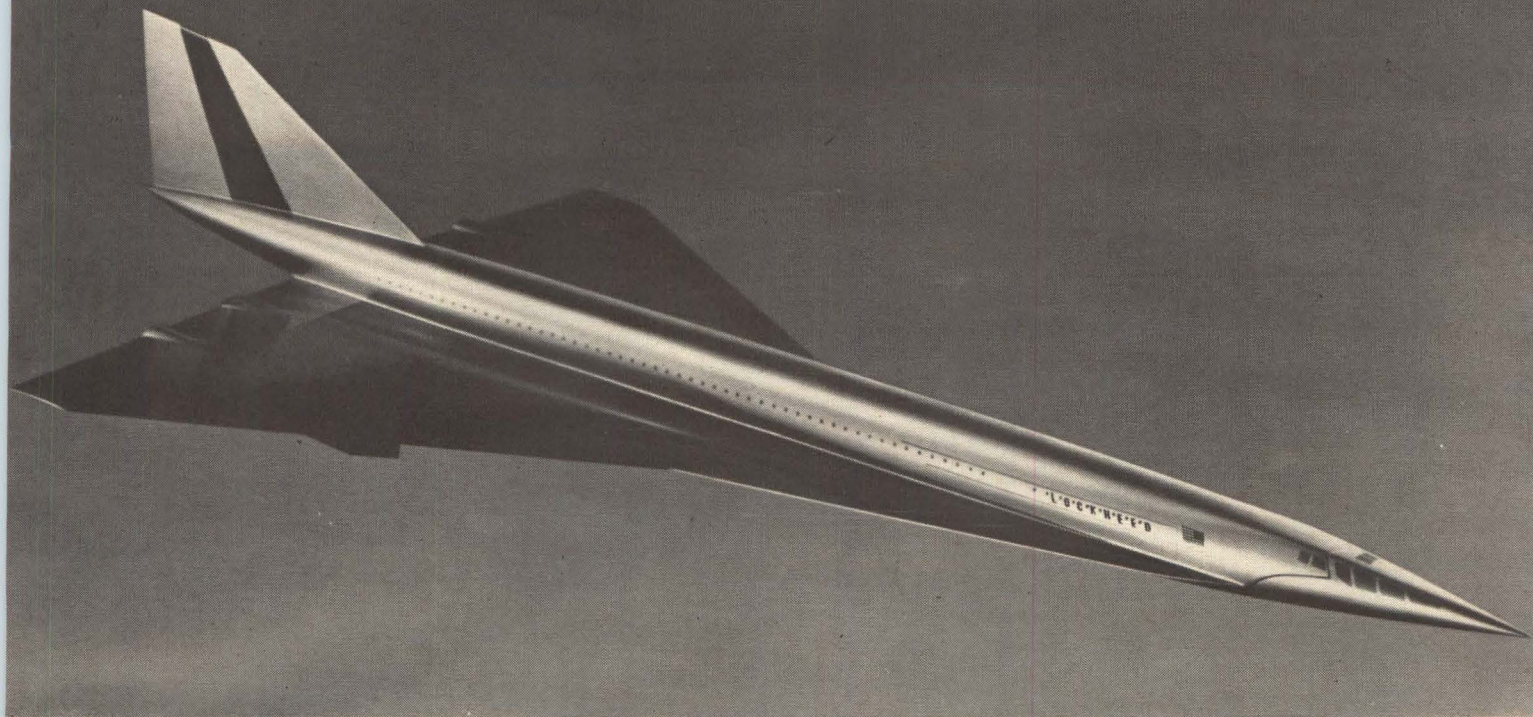

The Lockheed "double-delta" version.

distance transceivers and high-frequency long-distance radios. Vertical omnirange and Loran-C navigational aids, as well as the present airborne directional finders and weather radar, should suffice for some purposes.

But in some critical areas, such as those mentioned, new concepts in avionics will be needed to control and protect this plane, which represents so many new concepts in aviation.

Inertial platforms a must

Americans and the British-French developers agree that the inertial guidance platform is the best type of navigation equipment for the supersonic transport. However, full utilization of this high-accuracy data can be achieved only through the use of sophisticated automatic computers.

The big drawback to full use of such platforms has been their high cost, low reliability and difficulty of maintenance. The recent purchase of a Sperry Rand Corp. inertial system, SGN-10, by Pan American World Airways, Inc. (Electronics, Aug. 10, p. 18), shows that breakthroughs have been made in these areas. Other companies, notably Litton Industries, Inc., and Honeywell, Inc., are also active in developing low-cost inertial-guidance equipment.

The vertical omnirange and distance-measuring equipment provide reliable determination of position over habitable areas. For flight over water and barren land masses, doppler navigation equipment is available. However, the accuracy of doppler equipment depends on the accuracy of the magnetic compasses aboard the aircraft.

In overwater flight, errors also result from specular reflection of the incident radar beam, which reduces the back-scatter energy and lowers the signal-to-noise ratio. This causes an increase in the angle of depression by favoring returns from the lower half of the incident beam, and results in a corresponding error in ground-speed reading.

Another possible error in doppler systems operated over water can be caused by the mass movement of the water by tides, currents and winds. This results in a doppler frequency shift in addition to that caused by the aircraft's motion. Inertial systems, being completely independent of magnetic compasses and frequency shifts, can provide positional information with 10 times the accuracy obtained by doppler methods.

The "shortest distance" or dead reckoning type of navigation, common in military aircraft, does not readily lend itself to use in a commercial supersonic vehicle. For a military mission, a computer aims the aircraft directly at the destination point from wherever it happens to be. But adherence to prescribed ground tracks is essential for safe civilian navigation. The inertial platform has the capability of accurately determining position on the track at any instant.

Rapid data-handling

The supersonic transport's speed demands that accurate positional information be received constantly and that it be used immediately.

An automatic computer can perform its operations almost instantaneously. It can continuously monitor all inputs, ensuring that all changes are

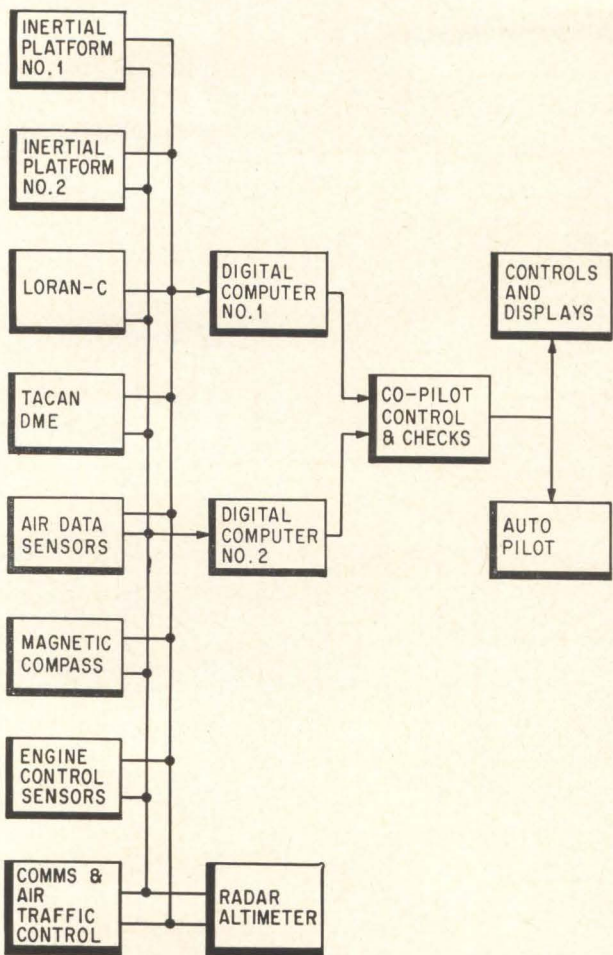

Computer complex of the type proposed for the supersonic transport. Inputs from various sensors are sent to the computer, which processes the signals and sends them on to the copilot's check panel for monitoring. The information is then available for displays and use in automatic flight control.

recognized and acted upon immediately.

An avionics system tie-in, shown above, achieves reliability by utilizing two redundant central digital computers. This is one kind of a system proposed by Litton Industries.

The computer complex receives inputs from the inertial platforms, tactical air navigation (Tacan) and distance-measuring equipment (DME), as well as basic information from air-data and engine-control sensors. Inputs also include magnetic compass headings and communications-link signals.

The computer's role may be understood better from a typical flight of a supersonic transport.

The crew starts its departure checkout procedures by placing the inertial systems in the align mode. Using a control panel similar to that in the figure on page 63, the copilot inserts the present position—latitude and longitude—and position of the primary and alternate destinations. These destinations may be changed or added in flight. The heading readouts are also selected for display at the captain's and copilot's stations.

After the alignment and self-test cycles are completed and the platform's guidance-controls switch

is placed in the "navigate" position, the plane can take off.

In flight, the computer calculates and updates the plane's position, magnetic variations, time to destination, and along-track and cross-track errors. All inputs are constantly monitored and used in the updating process. The system is now guiding the aircraft to its destination along a great-circle course.

A computer to do this job will probably need integrated circuitry and magnetic memory drums with storage capacity of about 10,000 words. System reliability of 3,500 hours can be achieved.

An alternate system, based on the modular concept, has also been proposed by Litton Industries. In this system, the avionics are broken down into functional units, each with its own redundant features. One advantage of the modular construction is its ability to expand as needed, as well as the inherent capability of providing a certain level of performance in spite of failures. A typical modular system is shown at the top of page 63.

Communications around the world

The long-distance radios in general use today are adequate for intracontinental work but, as a means of reliable communication on the intercontinental routes, they fall short.

High-frequency radios do a good job of communicating in areas of heavy airplane traffic, but there are many sections of the world that lack the relay capability of high-density traffic. Development of new ground-station equipment as well as the aircraft's radio is part of the over-all improvement plan of both American and European designers. Also under consideration is the adoption of single-sideband transmitters for aircraft.

Revolutionary antennas needed

Changes in navigation and communication systems will be natural outgrowths of present systems. However, antennas will have to undergo revolutionary changes.

Antennas aboard a supersonic transport will be subjected to variations in temperature and altitude that will make current designs inadequate. These variations have stimulated research and development into methods of making the antennas more reliable without environmental conditioning and without improving techniques of bonding and sealing. Each type of antenna has different problems to overcome.

VHF antennas are used for omnidirectional line-of-sight communications. At present, two annular slot antennas are usually installed: one on the bottom centerline of the airplane and connected to the pilot's radio, the other on the tip of the vertical stabilizer and connected to the copilot's transceiver. For the supersonic transport a third antenna is needed on the top centerline. This will have a better radiation pattern. The annular slot for this antenna is large and would require new sealing and bonding techniques to prevent moisture absorption.

The high-frequency communication antennas

now used on subsonic aircraft are not suitable for the SST because they are located in the highest surface-temperature regions of the airplane. An alternate position, such as end-loading of the airframe by a nose boom, would require the antenna tuner to be placed in the nose radome and the connections to be made along the inner surface. As well as impairing the efficiency of the radar by partially blocking the aperture, this type of antenna is susceptible to lightning and to corona breakdown.

Notch-type antennas, located in the vertical stabilizer's leading edge, have the advantage of zero drag and radiation patterns that are equal or superior to other high-frequency antennas. Corona breakdown is lower because of the relatively lower voltages present. Because of the construction of this type of antenna, lightning is less likely to damage it.

Similarly, new designs are in progress for all the antenna systems, from navigation to direction finders. Sector-scanning, line-of-sight stabilized radar antennas are also being considered. The pitch-axis gimbals must be designed with limits broad enough to permit full stabilization regardless of the nose position. These antennas must function reliably through the full range of temperature variations; this requires thermal insulation and cooling of certain elements in the sensor, such as ferrites, as well as use of unusual dielectric materials.

All-weather landing

All-weather landing capability is almost a must before a supersonic transport can be used fully. Many travelers have spent a couple of hours circling Kennedy, LaGuardia or Los Angeles Airport unable to land because of fog or smog. If this is a problem with today's piston and subsonic jet aircraft, it will be more so with the supersonic transport, not only because of personal inconvenience, but because the high rate of fuel consumption prohibits the aircraft's lingering as long over a landing site.

Moving the pilot

The normal position for the pilot is in the front where he can see what is going on. Therefore, when the aircraft is landing, because the pilot is far from the center of gravity he receives unreal motion cues—that is, physical sensations unrelated to actual aircraft performance. This has been no problem in modern aircraft transportation, but simulator results by the National Aeronautics and Space Administration indicate that this will be a problem in the supersonic transport.

Another problem area for the pilot during the landing phase is the supersonic plane's body it-

Inertial navigation control panel proposed by North American Aviation, Inc., in its SST studies. This kind of panel, in conjunction with a digital computer, would perform guidance computations for a supersonic transport.

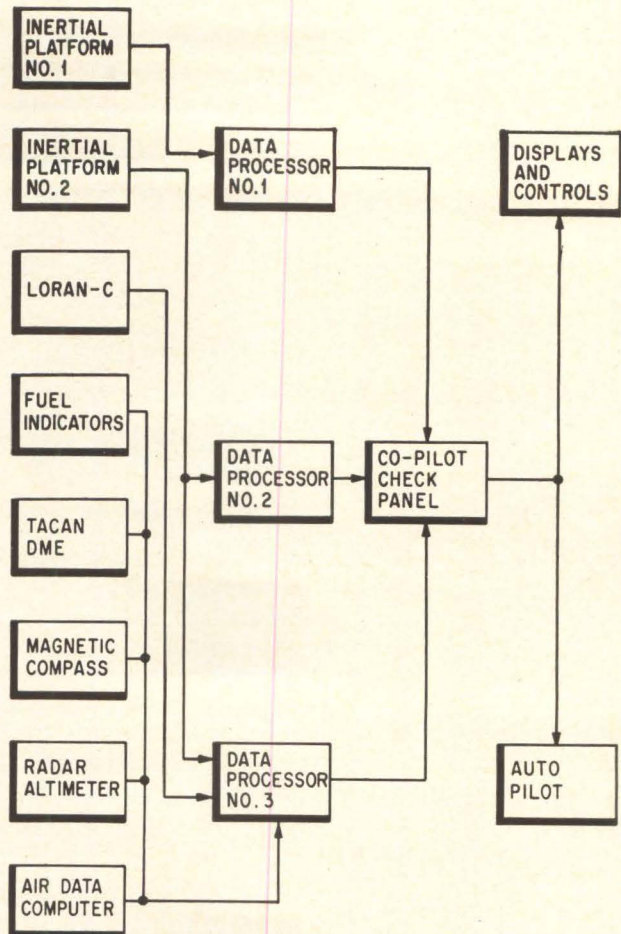

Airborne computer of modular design; any two computers could fail, and the crew could still guide the aircraft to its destination.

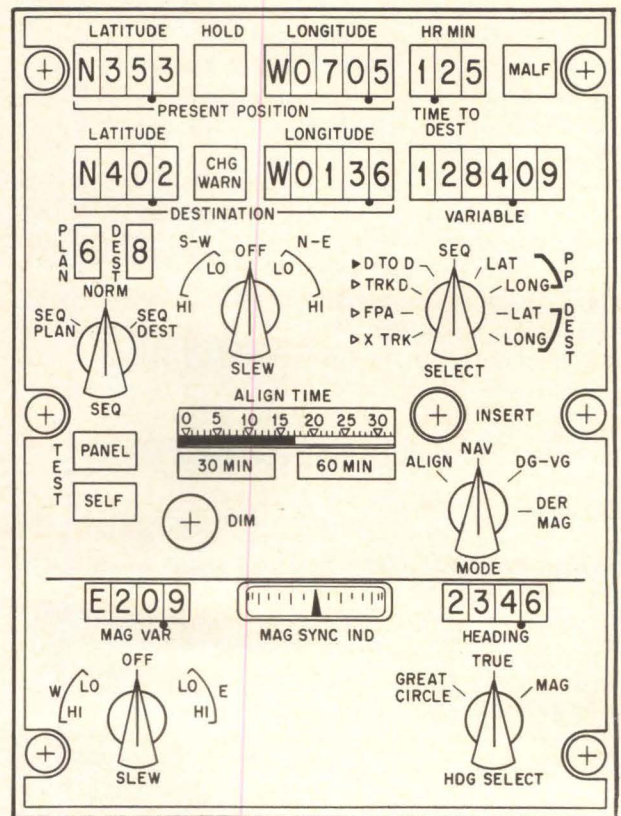

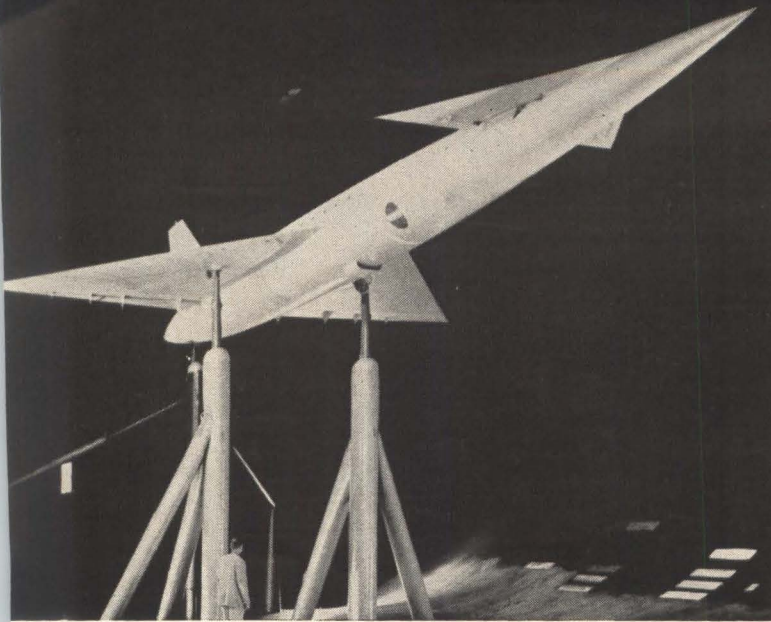

One-third scale model of the SCAT-17 (supersonic commercial air transport) in the NASA wind tunnel at the Ames Research Center, Calif.

self. Since the pilot is not at the very front of the plane, the heat-resisting portion of the aircraft may be in the way of what the pilot wants to view during landing. This could make it impossible to land a plane even in good weather.

Three approaches to solving this type of problem are under investigation.

1. Bringing the pilot back to the plane's center of gravity to reduce his false motion cues.
2. Using television and optics (binoculars) to let the pilot "see" from outside the craft. This is necessary because the plane may come down at such a steep angle that most of the pilot's vision is obscured.
3. Using all-instrument approach (contact analog display). A display of this type would simulate the runway for the pilot.

As part of the program for developing the concept of a zero-zero landing system, NASA is outfitting an experimental aircraft with inertial platforms, doppler and forward-looking radars, a central digital computer and other display media. This flying laboratory will attempt to develop the sensory equipment required to implement such a

Nations and companies compete

When Gordon Bain, deputy administrator for supersonic transport development for the Federal Aviation Agency, outlined the requirements for the American SST, he set forth five major goals.

1. The aircraft's nominal range should be 4,000 miles with a payload of 30,000 to 40,000 pounds.
2. The plane should be able to carry 125 to 160 passengers.
3. It should be able to operate from existing major jetports.
4. The cruising speed should be Mach 2.2 or better.
5. Noise in the vicinity of the airports should not exceed the present levels created by long-range jet transports.

system. It should be aloft by about January.

The French speak of the feasibility of a completely automatic flight system. They point out that they already have the equipment that gives their Caravelle aircraft this capability, although permission for its use has never been granted.

The solution to all-weather landing problems may be a completely automated system, but the pilot must still be able to land the plane if the automatic system goes out. This means that the aircraft designer must provide certain displays, sensors and other equipment to do the job. Achievement of zero-zero visibility means added complexity as well as added weight.

The landing pattern

One of the original objectives of the United States supersonic transport is that it should be able to operate from existing airports. This means that air-traffic controllers must be able to bring the SST, from cruising altitude down to final approach, or have them take off and accelerate to cruising altitude in the same way that subsonic jet craft do.

To prove or disprove this compatibility the Air Force, in cooperation with engineers from the Federal Aviation Agency and NASA, flew A-5J Vigilante supersonic fighters in a simulated SST landing profile at Los Angeles International Airport. The A-5J attack bombers are especially suited for these tests. They have a maximum speed of Mach 2.1 at 40,000 feet and a normal ceiling of 60,000 feet; such craft have flown over 91,000 feet high.

The initial results of this test were favorable, and further tests may be now in progress at such airports as Kennedy International in New York and Dulles in Washington. Simulator approaches are being conducted at Langley Field, Va., to test compatibility further.

Clear-air turbulence

One of the most difficult meteorological phenomena to detect is clear-air turbulence (CAT). It is the subject of an intensive research effort by the FAA. The British and French have been relatively unconcerned about this problem, especially with respect to their supersonic plane, the Concorde.

However, both the FAA and NASA believe that

As with the Concorde, optimum operating safety and potential commercial profitability are prime considerations.

American and Anglo-French designers differ over whether Mach 2 or Mach 3 is the better design objective. SUD Aviation and the British Aircraft Corp. are going for Mach 2 on the basis that more experience is available and this speed promises to give peak efficiency.

American designers, on the other hand, point out that flight efficiency is a direct function of the Mach number, and that the combination of these contributes to range and payload. Furthermore, faster equipment means faster turn arounds and greater utilization of equipment per day. In aviation, it has always been the fellow with the fastest equipment who got all the business.

One must also consider that an aluminum airframe at Mach 2.2 is already at the limit of its safe strength and, because of this, the Concorde may be outmoded before it

clear-air turbulence becomes more important as speed increases. They suspect clear-air turbulence of having contributed to at least two recent crashes of jet aircraft. Consequently, the FAA has ordered research into the area of detection of turbulence study of human factors, aerodynamics, cockpit instrumentation and weather.

Project Taper (for turbulent-air pilot environmental research) began in May, 1963, under the sponsorship of NASA and the FAA. A Convair 880 jet flew penetration flights into turbulent air masses. The flights originated at the FAA Aeronautic Center in Oklahoma City, Okla., and data from the flights is being used in simulator studies at NASA's Ames Research Center in California to study pilot reactions and to explore aspects of flight that cannot be studied while the plane is in the air.

Correlation between position of mountain ranges, valleys and coastlines with the occurrence of clear-air turbulence in the upper troposphere and lower stratosphere indicate that gravity-type wave disturbances are factors leading to such turbulence in a stable environment.

From the theoretical studies of Herman L. Von Helmholtz, Bernhard Haurwitz, Zdenek Sekera and others, efforts are being made to provide a physical model of clear-air turbulence. Present studies are directed toward deriving the critical wave numbers and instability criteria that could apply to subsonic aircraft operations in turbulence.

By considering the greater wavelength of the disturbances to which the SST will respond, this model can be extended into the region where this aircraft will operate. The up- and down-drafts also must be considered, as well as the effects of temperature discontinuities that can form wave-like patterns. According to a report by E. R. Reiter of Colorado State University, "If an SST skimmed along such a discontinuity surface, a periodic change in mach number may result in equivalent changes in drag coefficient and consequently lead to CAT without a 'wind-generated cause'."

At present there is no simple and effective warning system for in-flight clear-air turbulence. Techniques using ground-based radar detection of layers of air that may be turbulent may be technically

is built. On the other hand, a titanium aircraft offers capability for increased speed.

On May 20, President Johnson directed that contracts be negotiated with two airframe and engine manufacturers to continue their efforts to achieve optimum designs for a U.S. supersonic transport.

The contract for each airframe manufacturer was \$6 million. The government's share is \$4.5 million and the company's \$1.5 million in each case.

The two American airframe manufacturers, the Lockheed Aircraft Corp. and the Boeing Co., have presented widely differing designs. These designs are extensions of NASA's supersonic commercial air transport (drawing on page 64) program, under which possible supersonic airframe designs were studied.

The Lockheed entry has a double-delta wing configuration. It is designed to provide maximum lift and to enable

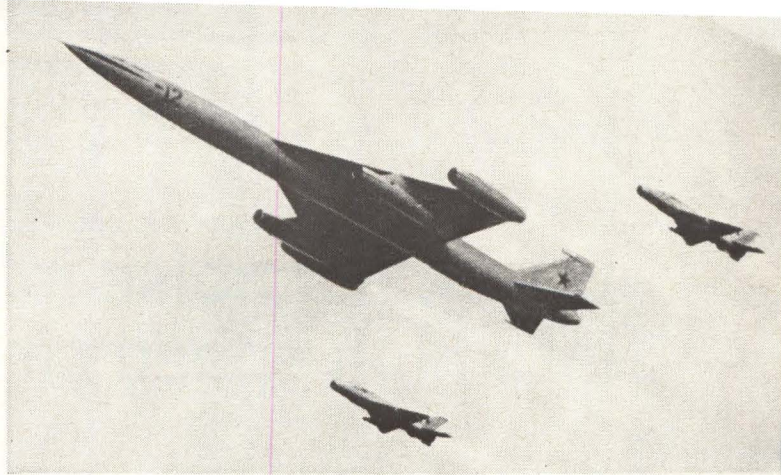

Soviet supersonic research bomber designated "Bounder" by NATO. Built by Vladimir M. Myasishchev, it is shown at the Tushino Air Show in 1961.

feasible, but they would be very expensive. However, research efforts to determine the causes of clear-air turbulence, as well as to detect and forecast it, are continuing.

The Soviet effort

At a recent press conference, Gen. Yevgeny F. Loginov, chief of the Soviet state-owned airline, confirmed that the Russians are aiming to achieve supersonic commercial flights before the United States does. The Soviets expect their plane to be similar in design and almost as fast as the American SST.

Vladimir M. Myasishchev, who developed the four-engine jet bomber known as the Bison, has been working on a super bomber, as well as an SST. A deputy of the Supreme Soviet, he is one of a very few individual scientists who head design bureaus in the Soviet Union; most bureaus are run by committees.

He predicted earlier that the Soviets would have jet airliners with cruising speeds approaching 1,250 miles an hour in service by 1970.

The Soviet SST might be an improvement of the supersonic research plane designated "Bounder" by the North Atlantic Treaty Organization (photo above). Bounder, a delta-wing craft, was disclosed in 1961. Very little is known about it, except that the plane might also be used as a flying test-bed for a nuclear-propulsion engine.

the plane to fly higher than other SST shapes. It is also the simplest wing configuration to construct; is aerodynamically "clean" and has no slats, flats or slots, either on the leading or trailing edges. The Anglo-French Concorde comes closest to this design.

The Lockheed plane could seat 218 passengers five abreast.

Boeing's variable-sweep plane would provide a high lift-off characteristic. The higher the lift coefficient, the slower the take-off speed.

It should also provide a high lift-to-drag ratio. This would give the plane a fast climbing capability. The main disadvantage with the variable-sweep concept is its weight and the cost of such a design.

The basic Boeing 733 design calls for a payload of 150 passengers. However, Boeing says the body can be extended 45 feet to carry 227 passengers.

Designing noise immunity into high-speed circuits

Noise is a serious problem in diode transistor logic. Here's a way to plan for a desired 'percent noise immunity'

By Donald R. Gipp

Radio Corp. of America, Somerville, N.J.

As ultrahigh-speed switching transistors become more common in circuits using diode-transistor logic, noise control becomes an increasingly serious problem.

Now a systematic approach has been devised to determine the noise immunity of diode-transistor logic circuits in terms of circuit design parameters. A procedure to optimize noise immunity for a given circuit fanout (driving capability) is then presented.

In low-speed logic circuits, noise is not a major factor. The circuits can be designed with little or no consideration to noise immunity.

High-speed circuits, however, yield output noise voltages that cannot be distinguished from the de-

sired signal voltages. Therefore it is necessary to consider noise immunity in the initial design stages.

Controlling noise

There are three main sources of noise in computer circuits: capacitive cross-coupling, inductive cross-coupling, and coupling through common impedances. Capacitive noise is predominant in vacuum-tube circuits because of large voltage swings and low currents. Transistor applications involve relatively low voltages and high currents; accordingly, the inductive noise component and coupling through common impedances are generally the most significant.

Noise control can be achieved by designing a noise-immunity factor into the circuit or by designing package and backboard wiring for shortest length and least cross-coupling. Generally, an efficient compromise must be made between these two methods. The better the noise immunity, the less stringent are the requirements in package and backboard wiring.

Usual design procedure

The diode-transistor logic circuit at the left is basically a positive NAND or negative NOR logic element. A disadvantage of this type of circuit is the relatively slow fall time of the collector output. Inductance L_C is used to reduce the collector output's fall time without affecting the rise time. Capacitor C_F compensates for stored charge and reduces the other switching times. In the following design procedures, maximum values are denoted by bold-faced symbols and minimum values by light-faced symbols.

The normal worst-case design procedure for satisfying the conditions of such a circuit is as follows:

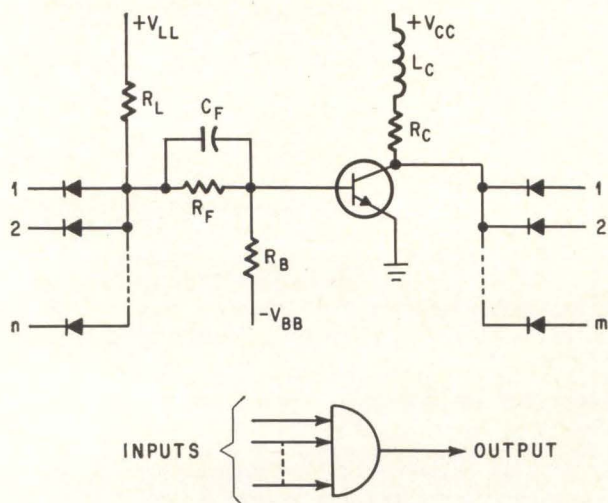

POSITIVE NAND OR NEGATIVE NOR GATE LOGIC SYMBOL
 Typical diode-transistor logic circuit is basically a positive NAND or NOR logic element.