

Electronics®

New optoelectronic switch for multiplexing: page 54

Inexpensive laser tv: page 75

Electronics in navigation satellites: page 79

February 8, 1965

75 cents

A McGraw-Hill Publication

Below: A universal package
for microelectronics, page 67

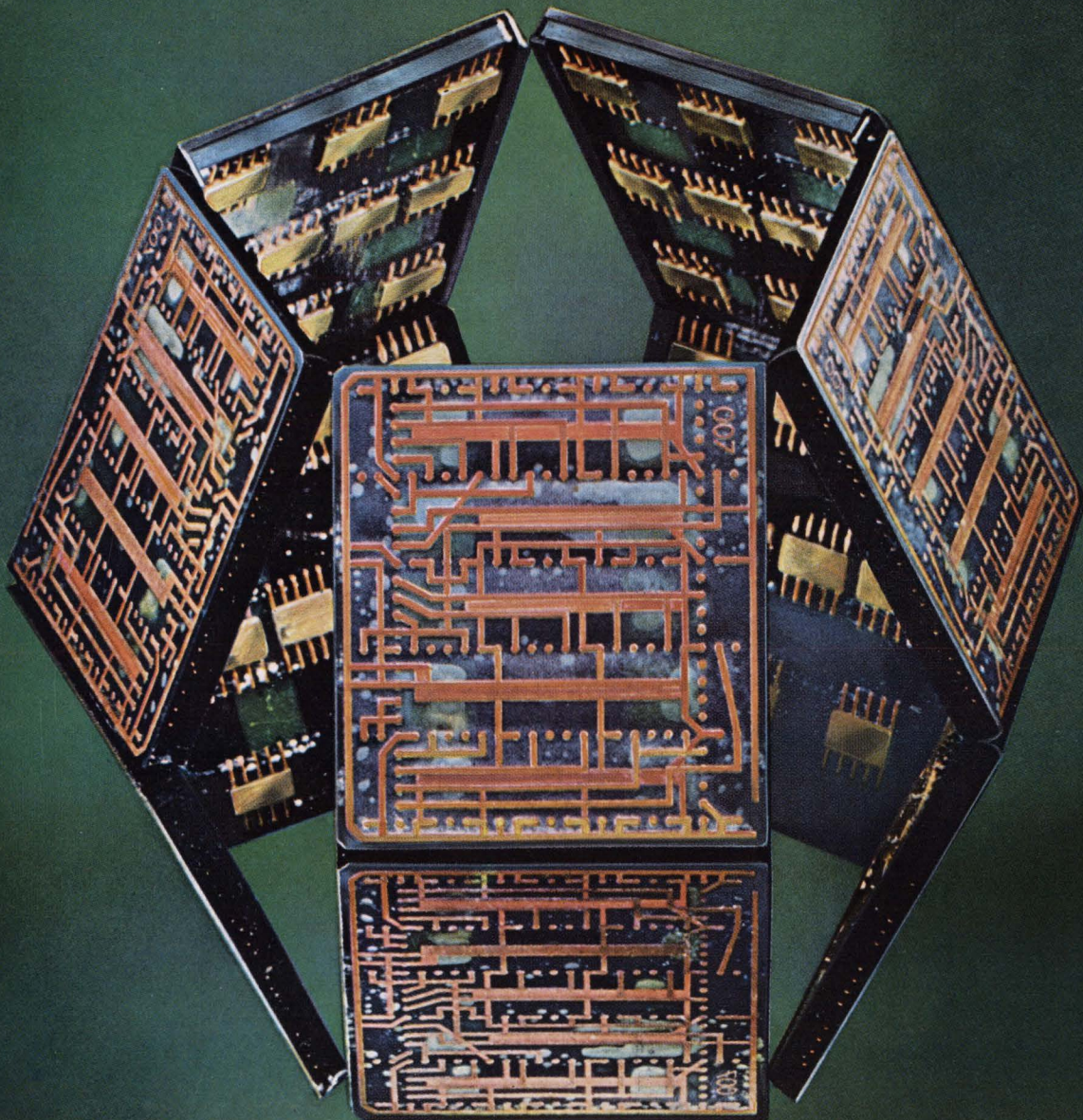

F PREZIOSI
2921 SOUTHER AV SE
CEDAR RAPIDS IA
L



HERMETICALLY SEALED
NOW to MIL-T-27B

VARIABLE INDUCTORS

HIGH-Q plus HIGHEST STABILITY

IMMEDIATE DELIVERY FROM STOCK

For almost a third of a century UTC has pioneered in the development of transformers, electric wave filters, high Q coils, magamps and similar iron core components. Highest engineering talent plus the most complete facilities for research and testing has made UTC the leading

supplier in the industry for both stock and custom built components. UTC Variductors (stock variable inductors) have served as a simple solution to tuned circuit for almost 20 years . . . for oscillators, equalizers, filters, tuned radio circuits, etc.

NEW! - VERNIER

HVV VARIDUCTOR™ HERMETICALLY SEALED

NARROW RANGE

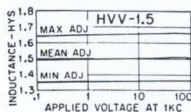
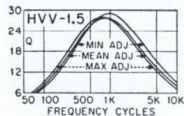

The HVV Variductors have been designed to emphasize extremely high stability with temperature, level, shock and vibration commensurate with the highest obtainable Q. They are ideal for precise matching to other components such as capacitors with standard 10% tolerance. Units are provided with a vernier adjustment variation of $\pm 10\%$ through 900° rotation of adjustment screw on top of case. Setting is positive. There are 12 units in the stock line with mean inductances ranging from .006 Hy to 150 Hys. Specific mean inductances other than stock items are available on special order. Manufactured and guaranteed to MIL-T-27B, MIL type TF4RX20YY. Drawn metal case: 1 1/8" long, 25/32" wide, 1-7/32" high (including adjustment screw); weight: 2 ounces. Effective Q over a wide frequency range and variation of inductance with applied AC voltage are illustrated for a typical unit. Patent pending.

HVC VARIDUCTOR™ HERMETICALLY SEALED

WIDE RANGE



HVC units are usable over a wide frequency range and have high stability with temperature and voltage change. Nominal inductance values of 12 stock units in series range from .006 Hy to 150 Hys. The variable inductance range of each unit is +200%, -70% of nominal value through 900° rotation of adjusting screw on top of case. Setting is positive. Case size and weight is the same as HVV. U.S. Patent No. 2,879,489.

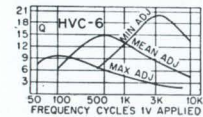

TVC VARIDUCTOR™

TVC Variductors are identical to the HVC units, but provide taps at 30% and 50% of total turns. Different taps are available on special order. U.S. Patent No. 2,879,489.

WIDE RANGE

VIC VARIDUCTOR™ COMMERCIAL GRADE



Nominal inductance values of 22 stock items in this series range from .0085 Hy to 130 Hys. Mean inductance may be varied +85%, -45% through 600° rotation of adjustment screw in side of case. Rugged die cast case: 1-11/13" long, 1 1/4" wide, 1-7/16" high; weight 5 1/2 ounces.

AND "SPECIAL" CUSTOM BUILT UNITS TO YOUR SPECIFICATIONS

Write for catalog of over 1,200 UTC HIGH RELIABILITY STOCK ITEMS IMMEDIATELY AVAILABLE from your local distributor.



UNITED TRANSFORMER CORP.

150 VARICK STREET, NEW YORK 13, N.Y.

PACIFIC MFG. DIVISION: 3630 EASTHAM DRIVE, CULVER CITY, CALIF.
EXPORT DIVISION: 13 EAST 40th STREET, NEW YORK 16, N.Y. CABLE: "ARLAB"

NEW, IMPROVED Frequency Range

(5 cps to 600 kc fundamental)

Sensitivity

(0.3 v rms for 100% set level)

Selectivity

in the hp 331A Harmonic Distortion Analyzer—solid-state version of the historic standards of the industry, the Hewlett-Packard 330 Series!

The industry-leading 330's have gone solid-state in the new Hewlett-Packard 331A, which offers extended tuning range, greater set level sensitivity, improved selectivity, greater overall accuracy and easier use—AND PRICED AT ONLY \$590!

Solid-state design allows battery operation for floating measurements, and total improvements add up to previously unavailable measuring capabilities in determining total audio distortion; voltage level, power output and gain; total distortion of AM rf carrier; noise and hum level and audio signal frequency.

The specifications tell the total story. Check them over carefully. Compare them with performance of any other distortion analyzer. Then call your Hewlett-Packard field engineer or write for complete data to Hewlett-Packard, Palo Alto, California 94304, Tel. (415) 326-7000; Europe: 54 Route des Acacias, Geneva; Canada: 8270 Mayrand Street, Montreal.

Distortion measurement range: Any fundamental frequency, 5 cps to 600 kc; distortion levels of 0.1% to 100% measured full scale in 7 ranges

Distortion measurement accuracy:

Harmonic Frequency		Input	
0.3% to 100% F.S.	0.1% F.S.	Below 30 v	Above 30 v
10 cps—1 mc	20 cps—500 kc	±3%	±3%
1 mc—3 mc	500 kc—1 mc	±6%	±12% (1 db)
	10 cps—20 cps	±12% (1 db)	±12% (1 db)

Elimination characteristics: Fundamental rejection >80 db
 Second harmonic accuracy: Better than +1 db from 5 to 20 cps; ±0.6 db from 20 cps to 20 kc; —1 db from 20 to 100 kc; —2 db from 100 to 300 kc; —3 db from 300 to 600 kc

Frequency calibration accuracy: Better than ±2% from 10 cps to 200 kc; —3% from 5 to 10 cps; +8% from 200 to 600 kc

Input impedance: Distortion mode: 1 megohm shunted by <60 pf or use hp 10001A divider probe
 Voltmeter mode: 1 megohm shunted by 30 pf, 1 to 300 v rms; 1 megohm shunted by 60 pf, 300 μv to 0.3 v rms

Input level for distortion measurements: 0.3 v rms for 100% set level (up to 300 v for set level indication may be obtained with front panel attenuator)

DC isolation: Signal ground may be ±400 v dc from external chassis

Voltmeter range: 300 μv to 300 v rms full scale (13 ranges)
 10 db per range; 5 cps to 3 mc
 (300 μv range: 10 cps—1 mc)

Voltmeter accuracy:

Range	±2%	±5%	±12%
300 μv	30 cps—300 kc	20 cps—500 kc	10 cps—1 mc
1 mv—30 v	10 cps—1 mc	5 cps—3 mc	
100 v—300 v	10 cps—300 kc	5 cps—500 kc	5 cps—2 mc

Noise measurements: Voltmeter residual noise on the 300 μv range: <25 μv rms terminated in 600 ohms; <30 μv rms terminated with a shielded 100 k resistor

Price: \$590

*Data subject to change without notice.
 Price f.o.b. factory.*

HEWLETT PACKARD

An extra measure of quality

9798

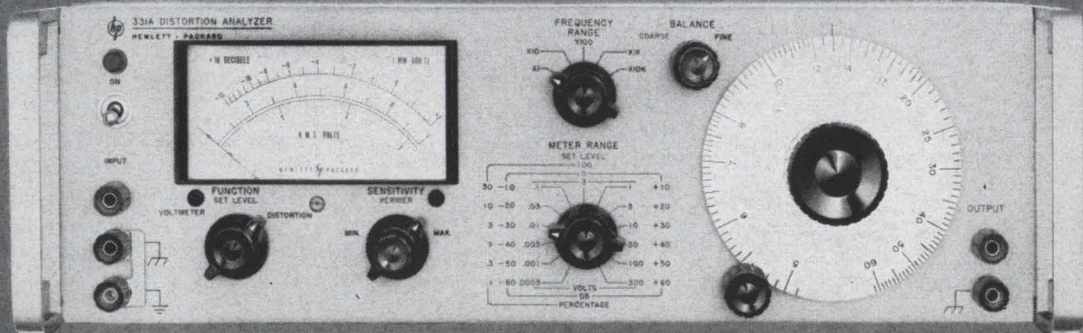

New!

VHF

OSCILLATOR

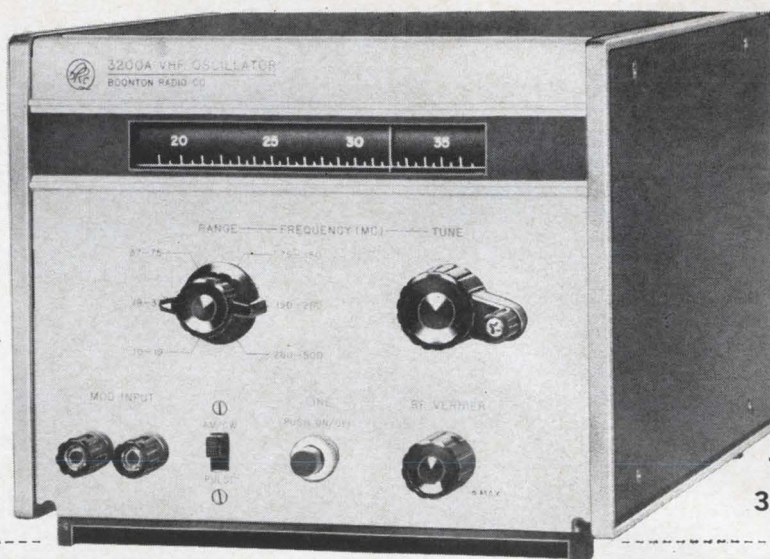

10 Mc - 500 Mc

Features:

$\pm 0.002\%$ Frequency Stability

External AM and Pulse Modulation

Waveguide-Below-Cutoff Output Attenuator

Solid-State Power Supply

The VHF Oscillator Type 3200A is designed for general purpose laboratory use including receiver and amplifier testing, driving bridges, slotted lines, antenna and filter networks, and as a local oscillator for heterodyne detector systems in the frequency range from 10 to 500 mc.

The push-pull oscillator is housed in a rugged aluminum casting for maximum stability and extremely low leakage; six frequency ranges are provided for adequate bandsread on the slide-rule dial. Internal CW operation is provided; AM and pulse modulation may be obtained through the use of a suitable external source. The RF output is coupled through a waveguide-below-cutoff variable attenuator; in addition, an electrical RF level vernier is included as a front panel control.

A solid-state power supply furnishes all necessary operating voltages including regulated dc to the oscillator heaters for minimum hum modulation and maximum tube life.

Specifications:

Radio Frequency Characteristics

RF RANGE: 10 to 500 mc

RF ACCURACY:
 $\pm 2\%$ (after $\frac{1}{2}$ hour warmup)

RF STABILITY:
Short Term: $\pm 0.002\%$ (5 minutes)
Long Term: $\pm 0.02\%$ (1 hour)
Line Voltage: $\pm 0.001\%$ (5 volts)

*After 4 hour warmup, under 0.2 mw load

RF OUTPUT:

Maximum Power:
 $> 200 \text{ mw}^*$ (10-130 mc)
 $> 150 \text{ mw}^*$ (130-260 mc)
 $> 25 \text{ mw}^*$ (260-500 mc)

*Across external 50 ohm load

Range: 0 to $> 120 \text{ db}$ attenuation from maximum output

Load Impedance: 50 ohms nominal

RF LEAKAGE: Sufficiently low to permit measurements at $1 \mu\text{v}$

Amplitude Modulation Characteristics

AM RANGE: 0 to 30%

AM DISTORTION: $< 1\%$ at 30% AM

EXTERNAL AM REQUIREMENTS: Approx. 30 volts RMS into 600 ohms for 30% AM

Pulse Modulation Characteristics

EXTERNAL PM REQUIREMENTS: 140 volts peak negative pulse into 2000 ohms for maximum power output; typically 10 volts peak (except 50 volts on 260-500 mc range) for 1 mw peak power output

Physical Characteristics

DIMENSIONS: Height: $6\frac{1}{2}''$ (16.5 cm)
Width: $7\frac{25}{32}''$ (19.8 cm)
Depth: $12\frac{17}{32}''$ (31.8 cm)

Power Requirements

105-125/210-250 volts, 50-60 cps, 30 watts

Price: 3200A: \$475.00

F.O.B. Rockaway, New Jersey



BOONTON DIVISION

PRECISION ELECTRONIC INSTRUMENTS SINCE 1934
GREEN POND ROAD, ROCKAWAY, NEW JERSEY 07866



Hewlett-Packard Company

TELEPHONE: (201) 627-6400 • TWX: (201) 627-3912 • CABLE ADDRESS: BOONRACO

Electronics

February 8, 1965
Volume 38, Number 3

Page 4	Readers Comment
8	People
10	Meetings
15	Editorial
17	Electronics Newsletter
37	Washington Newsletter
103	New Products
140	New Books
142	Technical Abstracts
147	New Literature

Electronics Review

Page 25	Telephones aloft	28	Heart readings
25	Radios in subways	28	Accordion circuits
26	Pi-winder	30	Balloons and buoys
27	High hope for low-light	30	Comsat's customers
27	Price slash	32	Stemming the tide

Electronics Abroad

149	Computer outlook	151	New tv networks
150	Electronics in court	152	The computer age
150	One up, one down	152	Cairo calling
151	More expansion seen	153	Europa's plight

Probing the News

93	The giant of Eindhoven
96	LBJ's budget: less money for arms

Technical Articles

I. Design

Solid state	54	Light-coupled switch for multiplexing Newest optoelectronic device is a four-terminal semiconductor switch Edward L. Bonin, Texas Instruments, Inc.
Circuit design	60	Designer's casebook Magnetoresistors isolate load from control circuit; scr's regulate a-c line voltage; diode eliminates multivibrator bias; two transistors simulate high-current tunnel diode
Solid state	64	FET detects alpha particles better A low-noise detector, the FET improves signal-to-noise ratios at least tenfold C.R. Seashore and C.D. O'Brien, Honeywell, Inc.
Packaging	67	II. Manufacturing Connecting integrated circuits (Cover) A universal packaging technique cuts the cost of integrated circuits for systems John Marley, ITT Federal Laboratories
Communications	75	III. Application Laser-television system developed An inexpensive system is proposed to link plants and provide security checks C.J. Peters, R. Lucy, K.T. Lang, E.L. McGann and G. Ratcliffe, General Telephone & Electronics Corp.
Space electronics	79	Navigation satellites: space beacons Space electronics may pinpoint positions of ships and planes E.S. Keats, Westinghouse Electric Corp.

Electronics

Editor: Lewis H. Young

Senior editors

Technical: Samuel Weber
News: Kemp Anderson, Jr.

Senior associate editors: John F. Mason, George Sideris

Department editors

Avionics: W.J. Evanzia
Circuit design: Michael Elia
Communications: Alexander A. McKenzie
Components: Michael F. Tomaino
Industrial electronics: Louis S. Gomolak
Instrumentation: Carl Moskowitz
Manufacturing: George Sideris
Military electronics: John F. Mason
New products: William P. O'Brien
Solid state: Jerome Eimbinder, G.G. Tirellis
Space electronics: Joel A. Strasser
Staff writer: Leon H. Dulberger

Regional editors

Boston: Thomas Maguire, editor; Robin Carlson
Chicago: Cletus M. Wiley, editor; Leslie Krimston
Los Angeles: William B. Wallace, editor; June Long
San Francisco: Laurence D. Shergalis, editor; Mary Jo Jadin
London: Derek Barlow, editor

Copy editors

Howard Rausch, Sally Powell, Stanley Zarowin

Graphic design

Art director: Saul Sussman
Assistant art director: John C. Wright, Jr.
Editorial production: Ann Mella
Production editor: Arthur C. Miller

Editorial secretaries: Claire Benell, Mary D'Angelo, Lynn Emery, Kay Fontana, Carolyn Michnowicz, Lorraine Rossi, Lorraine Werner

McGraw-Hill news service

Director: John Wilhelm; **Atlanta:** Fran Ridgeway; **Chicago:** Bruce Cross; **Cleveland:** Arthur Zimmerman; **Dallas:** Marvin Reid; **Detroit:** Donald MacDonald; **Los Angeles:** Michael Murphy, Ron Lovell; **San Francisco:** Margaret Ralston, Ed. Addeo; **Seattle:** Ray Bloomberg; **Washington:** Arthur L. Moore, Glen Bayless, Charles Gardner, Herbert W. Cheshire, Seth Payne

McGraw-Hill world news service

Bonn: Richard Mikton; **Brussels:** Arthur Erikson; **London:** John Shinn; **Mexico City:** Wesley Perry; **Milan:** Bruce Bendow; **Moscow:** Donald Winston; **Paris:** Dan Smith; **Rio de Janeiro:** Leslie Warren; **Tokyo:** Marvin Petal, Charles Cohen

Circulation manager: Hugh J. Quinn

Reprints: T.M. Egan

Publisher: C.C. Randolph

Electronics: February 8, 1965, Vol. 38, No. 3

Printed at 99 North Broadway, Albany, N.Y.
Second class postage paid at Albany, N.Y.

Subscriptions are solicited only from those actively engaged in the field of the publication. Position and company connection must be indicated on orders. Subscription prices: United States and Possessions and Canada, \$6.00 one year, \$9.00 two years, \$12.00 three years. All other countries \$20.00 one year. Single copies, United States and Possessions and Canada 75¢. Single copies all other countries \$1.50.

Published every other Monday by McGraw-Hill Inc. 330 West 42nd Street, New York, N.Y. 10036. Founder: James H. McGraw, 1860-1948.

Subscribers: The Publisher, upon written request to our New York office from any subscriber, agrees to refund that part of the subscription price applying to copies not yet mailed. Please send change of address notices, subscription orders or complaints to Fulfillment Manager, Electronics, at the address below. Change of address notices should provide old as well as new address, including postal zone number if any. If possible, attach address label from recent issue. Allow one month for change to become effective.

Postmaster: Please send Form 3579 to Fulfillment Manager, Electronics, P.O. Box 430, Hightstown New Jersey 08520

Readers Comment

Overheated parking meter

To the Editor:

Author W. E. Osborne seems to have missed what I believe to be Robert Salzman's point [Jan. 25, p. 4]: Okay, so you invented something complicated to do a simple job. Now get busy and combine the simplicity of the mechanical trip with the reliability of the astronomical clock in a package too cheap to be worth stealing. And if you can't do it, step aside in favor of someone who can.

Charles D. Mace
Consulting engineer
Maple Glen, Pa.

Gremlins at work

To the Editor:

In "The dangerous depths" [Dec. 28, p. 77] you stated that "Both men report to the top—Kara-beris to the Secretary of the Navy, Admiral Paul H. Nitze, and Martell to the Chief of Naval Operations, Admiral David L. McDonald."

The Secretary of the Navy, Paul H. Nitze, is a civilian and has no military rank.

D. A. Olson
Director Special Training
U. S. Fleet Sonar School
Key West, Florida

▪ Printers' gremlins commissioned civilian Nitze.

In California

To the Editor:

In your Market Report 1965, you picture an unusual miniature tape recorder [Jan. 11, p. 98]. Where is the manufacturer, Craig-Panorama, located?

Albert L. DeGraffenried
Sanders Associates, Inc.
Plainview, L. I.

▪ A number of readers were fascinated by this device and asked the same question. Craig-Panorama, Inc., is at 3412 South LaCienega Blvd., Los Angeles 16, Calif.

FET reliability

To the Editor:

I have read the articles on FET

Now from Sprague!

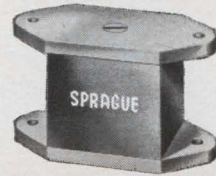

First Major Change in HIGH-POWER MICA CAPACITORS In Over 25 Years!

New
**CAST MICA
CAPACITORS
FEATURE:**

- ✓ **Operation to 125C**
- ✓ **Reduced Sizes**
- ✓ **Lighter Weight**
- ✓ **Greater Ruggedness**
- ✓ **Cooler Operation**

For application engineering assistance without obligation, write to Mica Capacitor Section, Field Engineering Dept. For complete technical data write for Engineering Bulletins 1230 and 1240 to Technical Literature Service, Sprague Electric Company, 35 Marshall Street, North Adams, Massachusetts. 01248

- SOMETHING NEW and important has happened to transmitter-type mica capacitors! In place of the old-fashioned, bulky assemblies you've had to use in the past, Sprague now offers modern, miniaturized Cast Mica Capacitors—30% smaller in size, 30 to 40% lighter in weight, available in new shapes and mountings for liberal new design possibilities.

- Encapsulated in high-temperature epoxy resin by a patented process, Sprague Cast Mica Capacitors will operate at temperatures to 125 C *without derating*—greatly in excess of the 70 C or 85 C limits of conventional capacitors. This exclusive construction also provides superior thermal conductivity—far better than with porcelain—enabling these capacitors to carry higher r-f currents.

- Unlike older units with fragile insulating housings, Sprague Cast Mica Capacitors are rugged. Their tough epoxy resin encapsulation, with improved hermetic seals, eliminates use of potting waxes which tend to melt and cause damage to electron tubes and other components.

- Sprague Cast Mica Capacitors, designed not only to meet but *exceed* MIL Specifications, are made in both the familiar cylindrical as well as a new rectangular shape, with female threaded terminals on opposite ends. Although smaller in size than conventional capacitors, Cast Micas can be procured—for interchangeability—with one or two aluminum plates having the same center-to-center mounting holes as standard types. Where space is critical, they may also be mounted or stacked without plates by means of dual-ended headless screws.

SPRAGUE COMPONENTS

CAPACITORS	PULSE TRANSFORMERS	CERAMIC-BASE PRINTED NETWORKS
TRANSISTORS	INTERFERENCE FILTERS	PACKAGED COMPONENT ASSEMBLIES
RESISTORS	PULSE-FORMING NETWORKS	BOBBIN and TAPE WOUND MAGNETIC CORES
INTEGRATED CIRCUITS	TOROIDAL INDUCTORS	SILICON RECTIFIER GATE CONTROLS
THIN-FILM MICROCIRCUITS	ELECTRIC WAVE FILTERS	FUNCTIONAL DIGITAL CIRCUITS

45-300 R3



'Sprague' and '®' are registered trademarks of the Sprague Electric Co.

Obviously from Sprague!

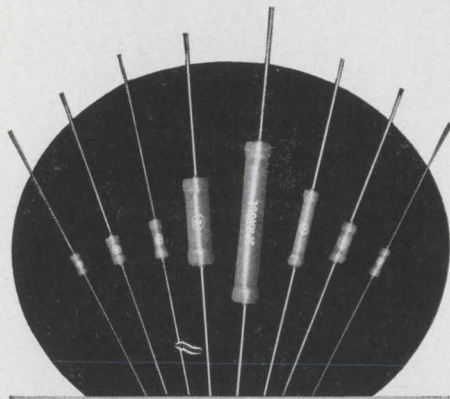

ACRASIL®

... the precision/power wirewound resistor with more PLUS features!

Silicone Encapsulated—Seals resistance element. Provides exceptional protection against severe environmental conditions as well as physical damage.

Wide Application—Standard and non-inductive windings. Equally suited for printed wiring boards, custom packaging, and point-to-point wiring.

Close Resistance Tolerances—Standard tolerances to $\pm 0.05\%$.

Wide Range of Ratings— $\frac{1}{4}$ watt to 10 watts. Resistance values from $.05\Omega$ to $66K\Omega$.

Minified Sizes—Smaller than other conventional wirewound resistors.

Excellent Stability—Under extended load life and environmental operating parameters, Acrasil Resistors show exceptionally small change in resistance values.

Outstanding Reliability—Fully meet electrical performance requirements of MIL-R-26C, as well as individual customer high reliability specifications.

For complete technical data, write for Engineering Bulletin 7450 to Technical Literature Service, Sprague Electric Company, 35 Marshall St., North Adams, Mass.

SPRAGUE®

THE MARK OF RELIABILITY

® Sprague and ® are registered trademarks of the Sprague Electric Co. 45 R-186-63

transistors [Nov. 30, p. 45; Dec. 14, p. 53 and Dec. 28, p. 45] with great interest. Unfortunately, there was little or no information relating to the reliability of such devices. It is all very nice to be able to build new circuits, but with the present emphasis on reliability, an engineer takes a risk using them unless he knows the appropriate failure rates.

To date I have been unable to obtain much reliability information on FET's. However from the few reliability reports I have, it appears as though FET's may be between one and two orders of magnitude worse than "conventional" transistors. One manufacturer of FET's reports a failure rate of approximately 0.7%/1,000 hours at 60% confidence, after 2×10^6 hours operation. In catastrophic failures only, the failure rate drops to 0.2%/1000 hours at 60% confidence. Test conditions were an ambient of 150°C , with 24 volts reverse bias (80% of rating) applied to both junctions. These failure rates appear comparable with those of "ordinary" transistors, until it is realized that these particular FET's have been subjected to comprehensive screening and that suspect devices were eliminated prior to test.

The purpose of my letter is not to discuss a particular manufacturer's reliability report but to emphasize that there is comparatively little known about FET failure rates and modes. In addition to articles on how FET's work, it would be advantageous to read an article describing how they do not work. To be most useful such an article would discuss the failure

modes of FET's and indicate in what environments they should not be used.

N. Lewis

Reliability engineer
Canadian Westinghouse Co.
Hamilton, Ont.

▪ Almost all the manufacturers and users tell us it is still too early to get the kind of information reader Lewis seeks. But Electronics did publish an article [Dec. 28, p. 58] cautioning about using FET's in a radiation environment.

Which came first?

To the Editor:

Some time ago [Dec. 6, 1963, p. 69] I saw the article "Circuit with a twist: the cascode follower" by R. W. Johnson (the circuit is shown below, left).

The application note suggests that "a transistor version of the circuit should be possible". The future conditional tense surprises me. I have a circuit (below, right) which is a transistor equivalent to the cascode follower, except that it is useful down to d-c. If so desired it may deliver ± 100 volt and several watts, and a preceding pnp emitter-follower, or a diode, would reduce the temperature drift to approximately $0.2\text{mV}/^\circ\text{C}$.

The transistor version has been used for a couple of years at the Norwegian Defense Research Establishment, and I think it unlikely that it had not been used extensively by others before that time.

It seems to me that in this case the transistor version came first.

Per Bugge-Asperheim
Norwegian Defense Research
Establishment

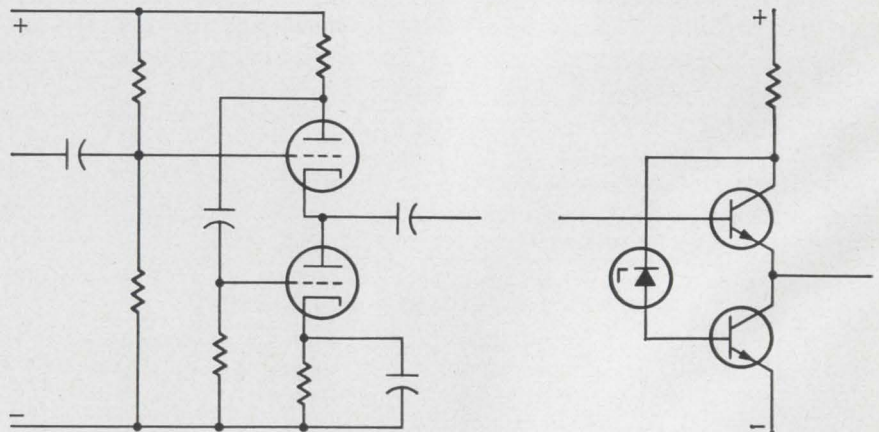

Did the Bugge-Asperheim transistorized circuit, right, precede the tube version, left?

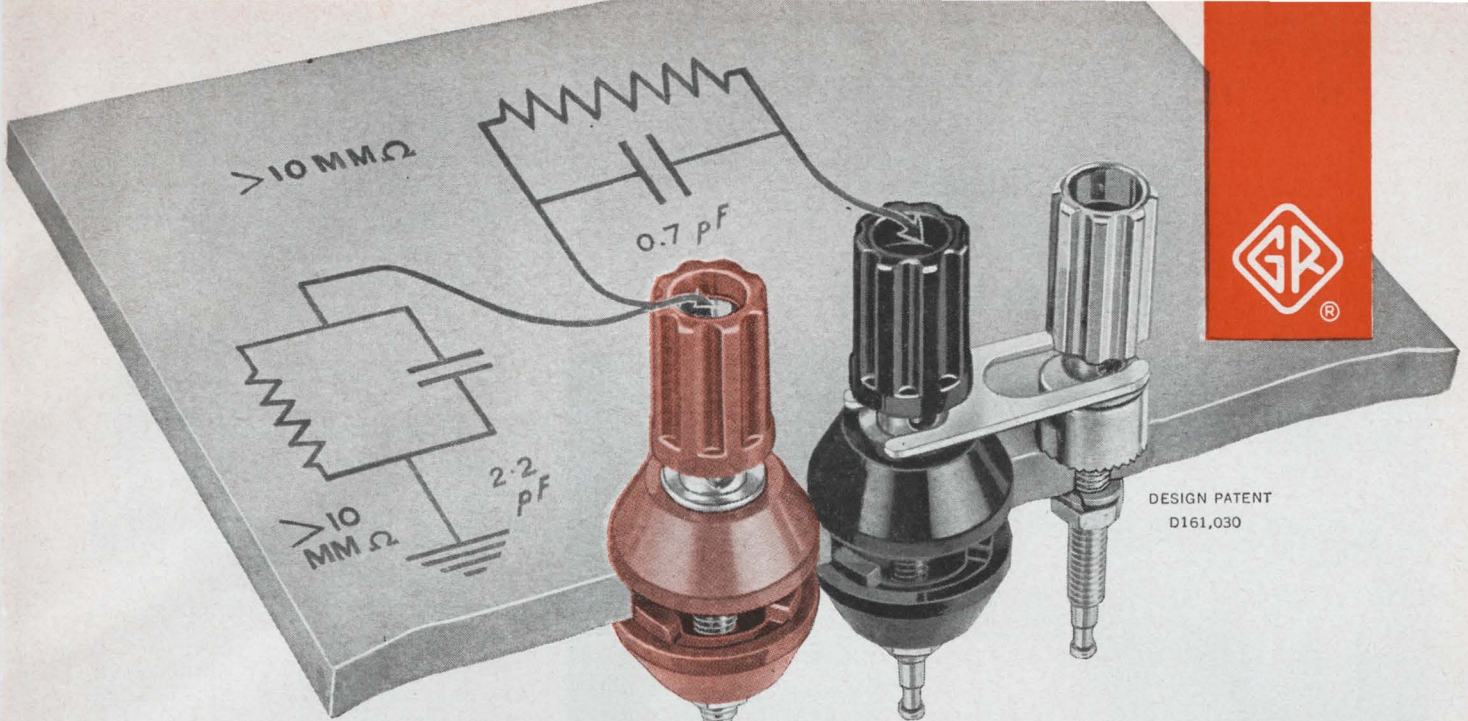

The Engineer's Best Connection

Now Available in Two Versions

Low-Thermal-EMF Binding Post . . .

Gold-Plated Copper in Critical Parts . . .
for Low-Level DC Applications Needing
Minimal Thermal Noise

Type	Description	Quantity Prices		
		10-99	100-999	1000-up
938-GM	Metal top binding post with metal spacer	\$1.10	\$.98	\$.92
938-HB	Black top, black insulator	1.00	.83	.78
938-KR	Red top, red insulator	1.00	.83	.78
938-LG	Gold plated shorting link	.25	.22	.20

Standard Binding Post . . .

of Nickel-Plated Brass . . .
for General Purpose Use

Type	Description	Quantity Prices		
		10-99	100-999	1000-up
938-P	Metal top binding post with metal spacer	\$.52	\$.38	\$.36
938-WB	Black top, black insulator	.75	.52	.49
938-WR	Red top, red insulator	.75	.52	.49
938-L	Shorting link	.10	.09	.09

- Banana plug fits snugly into body of post, NOT just the top
- Countersunk top insures proper seating of banana plug
- Top is captive to prevent loss
- No awkward lugs — you solder directly to turret on mounting stud
- Grounding post has spacer for proper height — knurl on bottom of spacer bites into panel for good contact and prevents rotation
- Will accommodate banana plugs, telephone cord tips, spade lugs, slender alligator clips, wire, etc. — contoured cross-hole grips without shearing any wire from A. W. G. No. 40 to No. 10
- Interlocking, anti-rotation keyed base for any panel thickness to $\frac{5}{16}$ ". If keying is not desired, $\frac{3}{8}$ " hole in panel frees key
- Polystyrene insulating bushings, hollowed to minimize capacitance and losses caused by solid dielectric
- Low dielectric constant and dissipation factor
- High leakage resistance
- Minimum moisture effects
- Self-storing, compatible grounding link available

Write for complete information

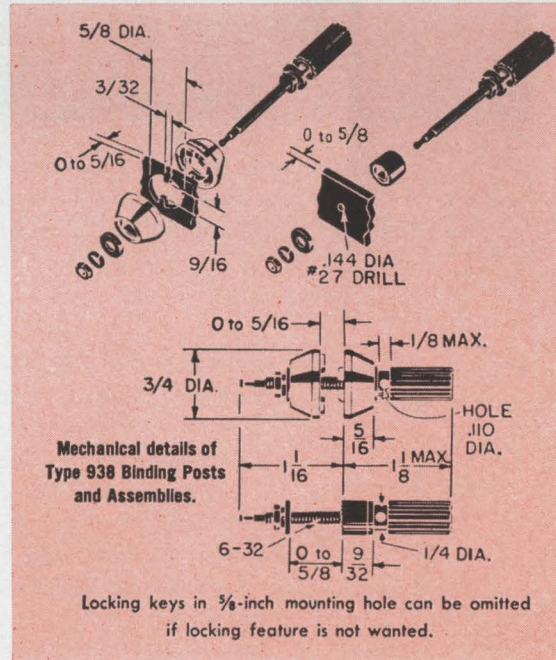

IN CANADA: Toronto 247-2171, Montreal (Mt. Royal) 737-3673
IN EUROPE: Zurich, Switzerland — London, England



GENERAL RADIO COMPANY

WEST CONCORD, MASSACHUSETTS

NEW YORK, N. Y., 964-2722
(Ridgefield, N. J.) 943-3140

CHICAGO
(Oak Park) 848-9400

PHILADELPHIA
(Ft. Washington) 646-8030

WASHINGTON, D.C.
(Rockville, Md.) 946-1600

SYRACUSE
454-9323

DALLAS
FL 7-4031

SAN FRANCISCO
(Los Altos) 948-8233

LOS ANGELES
469-6201

ORLANDO, FLA.
425-4671

CLEVELAND
886-0150

Circle 7 on reader service card

World's Highest Power Tetrode— Machlett's ML-8545



The Machlett ML-8545 general-purpose, vapor-cooled tetrode delivers 16% more power with 25% less plate voltage (plate modulation service) than the closest competitive tube. It is capable of 300 kW continuous output as a Class C amplifier or oscillator at frequencies to 50 Mc. Maximum plate input is 420 kW. Applications include: High-power broadcast and communications; all-purpose rf generation; particle acceleration. For details on the ML-8545 and the ML-8546 water-cooled version, write: The Machlett Laboratories, Inc., Springdale, Conn. 06879. An affiliate of Raytheon Company.

MACHLETT
ELECTRON TUBE SPECIALIST

People

"It's a challenge I just couldn't resist," says **B. David James**, who recently resigned as the Signetics Corp.'s vice president, research, and now serves as director of research and engineering for the Ultek Corp.



In 1960, James helped to set up the Signetics Corp. and contributed to the company's advances in epitaxial and thin-film processing techniques. Recently he decided he was becoming too specialized, and turned his attention to ultra-high-vacuum equipment because "right now there is no sophistication" in the field.

James, who is 36 years old and has a doctorate in physics, will retain an affiliation with Signetics as a consultant, and he expects "quite a bit" of his evening and weekend time to be devoted to microcircuitry.

Simon Reich may play an important, if little-known, role in the lives of the 3.7 million residents of the San Francisco Bay area.



The 26-year-old physicist designed the electronic safety feature that's the heart of the General Railway Signal Co.'s automated rapid-transit system which will be tested soon in San Francisco. General Railway is competing against several other companies for a contract to install a transit network.

Reich, who has no formal training in electronics, considers electronics engineering "the only creative process left in the world." He uses component catalogs as textbooks, explaining, "Reading only spoils the creative spark. You only learn what others have done. To create unheard-of things your mind has to be free to go in any direction."



Ed Maloney knows rectifiers.

And he's got it made.

Ed's satisfaction with his silicon power rectifiers borders on smugness. But that's understandable. Look what he's got going for him and you: Competitive prices always. Broad market acceptance. Rapid delivery on all types. Over 300 1N types in the JEDEC DO-4 package, any one of which can take a lot more punishment than the "lightweights." Devices that withstand the environmental and mechanical

requirements of MIL-S-19500 and MIL-STD-750.

Not only that, but you and Ed have: Single-junction construction for lower forward drop.

PRV=50 V to 1000 V. $I_0=1$ A to 12 A. Each device dynamically tested for performance before leaving the plant. 100% testing at 150°C operating. And 23 different types meeting military specs.

Join Ed in feeling really confident, use Bendix rectifiers!

TYPE NUMBER	MEETING MIL SPEC
USN1N1124A,26A,28A	MIL-S-19500/104B
USAF1N1199-1206	MIL-E-1/1108
JAN1N1202,R,04,R,06,R	MIL-S-19500/260
USA1N1614,R-16,R	MIL-S-19500/162A



Bendix Semiconductor Division

HOLMDEL, NEW JERSEY



Baltimore (Towson), Md.—(301) 828-6877; Chicago—(312) 637-6929; Dallas—(214) 357-1972; Detroit—(313) Jordan 6-1420; Holmdel, N. J.—(201) 747-5400; Los Angeles—(213) 776-4100; Miami Springs, Fla.—(305) 887-5521; Minneapolis—(612) 926-4633; Seattle—Ray Johnston Co., Inc., (206) La-4-5170; Syracuse, N. Y.—(315) 474-7531; Waltham, Mass.—(617) 899-0770; Export—(212) 973-2121, Cable: "Bendixint," 605 Third Avenue, New York; Ottawa, Ont.—Computing Devices of Canada, P.O. Box 508—(613) TALbot 8-2711.

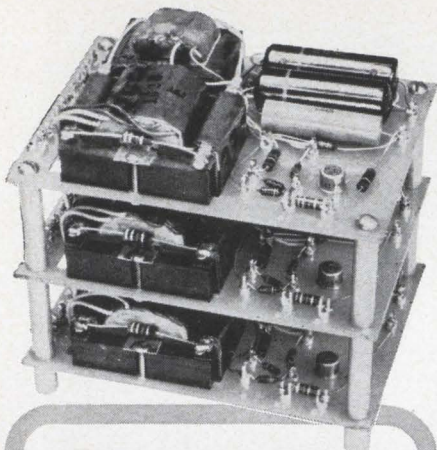

**SCR Gate Pulse
Rise Time of
1 to 3
Microseconds
with
SILICONTROL®**

- Meet triggering requirements for completely balanced SCR firing in 3-phase a-c or d-c power control.
- Gate firing characteristics are balanced to within 5° over full 180° excursion in all pulse patterns with milliwatt signal power. Wide angle phase shift technique of SCR conduction angle control with saturable reactor.
- No bias for pulse reset required—fail-safe—load and control circuits fully isolated.
- Each gate signal output is a constant amplitude pulse 180° wide, which provides a full range of control at all phase angles without SCR damage.
- Pulse rise time less than 3 microseconds to meet gate firing requirement of high-current-rated SCRs.
- Pulse amplitude is 5 volts minimum into a 10 ohm load.
- Components terminal-mounted on epoxy-laminate cards for printed circuit wiring.
- Units available for firing of several SCRs in parallel.

For complete technical data, write for Engineering Bulletin 85520A to the Technical Literature Service, Sprague Electric Co., 35 Marshall St., North Adams, Mass. 01248

45V-4139R4



'Sprague' and '®' are registered trademarks of the Sprague Electric Co.

Meetings

Electronics Design Conference, IEE, Savory Place, London, W.C.2, England, Feb. 8-9.

American Astronautical Society Meeting, ACRS, IEEE; Denver, Feb. 8-10.

Electrical/Electronic Trade Show, Electrical Representatives Club, Electronic Representatives Assn.; Denver Auditorium Arena, Denver, Feb. 15-17.

Solid-State Circuits International Conference, University of Pennsylvania, IEEE; University of Pennsylvania and Sheraton Hotel, Philadelphia, Feb. 17-19.

Annual West Coast Reliability Symposium, ASQC, UCLA; Moore Hall, University of California Los Angeles, Feb. 20.

Electromagnetic Compatibility Spring Conference, SAE; Orlando, Fla., Feb. 23-24.

Particle Accelerator Conference, AIP, NSG/IEEE, NBS, USAEC; Shoreham Hotel, Washington, Mar. 10-12.

ISA National Conference on Instrumentation for the Iron and Steel Industry, ISA; Pick-Roosevelt Hotel, Pittsburgh, Mar. 17-19.

Management Conference on Operations Research, Systems Engineering and Electronic Data Processing, University of Pennsylvania, Philadelphia, Mar. 17-19.

IEEE International Convention, IEEE; N.Y. Coliseum and New York Hilton Hotel, New York, Mar. 22-25.

Society of Motion Picture and Television Engineers Semiannual Conference and Exhibit, SMPTE; Ambassador Hotel, Los Angeles, Mar. 28-Apr. 2.

Association of Electronic Manufacturers National Convention, AEM, Inc.; New York Hilton Hotel, New York, Mar. 29-Apr. 1.

Electron Beam Annual Symposium, Pennsylvania State University, Alloyd Corp.; Pennsylvania State University, University Park, Pa., Mar. 31-Apr. 2.

Electronic Parts Distributors Show, Electronic Industry Show Corp., New York Hilton and Americana Hotels, New York, Mar. 31-Apr. 4.

IEEE Seminar on Space Vehicle Reliability, IEEE; Airport Marina Hotel, Los Angeles, Apr. 2.

National Packaging Exposition, AMA; McCormick Place, Chicago, Apr. 5-8.

Cleveland Electronics Conference, Cleveland Electronics Conference, Inc., IEEE, ISA, CPS, Western Reserve University, Case Institute of Technology; Cleveland Public Auditorium, Cleveland, Apr. 6-8.

Conference on Impact of Batch-Fabrication on Future Computers, PGEC/IEEE; Thunderbird Hotel, Los Angeles, Apr. 6-8.

Airlines Electronic Engineering Committee General Session, AEEC of ALCAC; Eden Roc Hotel, Miami Beach, Apr. 7-9.

IEEE Region 3 Meeting, Robert E. Lee Hotel, Winston-Salem, N.C., Apr. 7-9.

Electronic Components International Exhibition, FNIE, SDSA, Parc des Expositions (Fair Grounds), Paris, Apr. 8-13.

IEEE Region 6 Annual Conference, Nuclear Rocket Development Station, Las Vegas, Apr. 13-15.

Telemetry National Conference, AIAA, IEEE, ISA; Shamrock-Hilton Hotel, Houston, Tex., Apr. 13-15.

Call for papers

Electromagnetic Compatibility National Symposium, G-EMC/IEEE; Waldorf-Astoria Hotel, New York, June 28-30. Feb. 26 is deadline for submitting 500-word abstract to D. Fidelman, Chairman, Technical Program Committee, Electro-Magnetic Measurement Co., 50 Baiting Place Rd., Farmingdale, N. Y. Topics include measurement techniques, suppression materials, electro-magnetic pulse problems, advanced EMC theory, radiation hazards, interference prediction, susceptibility—from DC to light, specification considerations, etc.

Symposium on Plasma Sheath—Plasma Electromagnetics of Hypersonic Flight, OAR; New England Life Hall, Boston, and classified session at Base Theater, L.G. Hanscom Field, Bedford, Mass., Sept. 21-23. Mar. 20 is deadline for submitting both classified and unclassified 200-word abstracts to Alice Cahill, CRD, Symposium Secretary, Air Force Cambridge Research Labs., L.G. Hanscom Field, Bedford, Mass. 01731.

A LOT OF MANUFACTURERS NO LONGER MAKE THESE POPULAR GERMANIUM AMPLIFIER AND SWITCHING TRANSISTORS

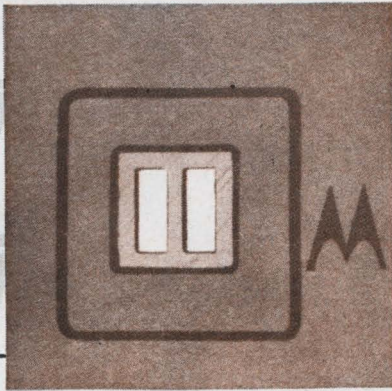

HIGH-SPEED 10 mA LOGIC SWITCHES				
Conditions: All characteristics at 10 mA except C_{ob} @ 10 V.				
DC	BV_{cbo} 6(typ)	$V_{CE(sat)}$ 0.2(typ)	V_{BE} 0.55	
AC	f_T 350 mc(typ)	C_{ob} 6 pf(typ)	τ_s 70 ns	
2N705 JAN 2N705 2N710 2N711 2N827	2N837 2N968 2N969 2N970 2N971	2N972 2N973 2N974 2N975 2N258	2N2259 101 201	
ULTRA-HIGH SPEED 10 mA LOGIC SWITCHES				
Conditions: Same as above. See 2N964A data sheet for curves.				
DC	BV_{cbo} 10(typ)	$V_{CE(sat)}$ 0.12(typ)	V_{BE} 0.45	
AC	f_T 450 mc(typ)	C_{ob} 4 pf	τ_s 30 ns	
2N711A 2N711B 2N759A 2N828 2N828A	2N829 2N838 2N960 2N961 USN 2N962	2N962 2N963 USN 2N964 2N964 2N964A	2N965 2N966 2N967 2N985	
HIGH-VOLTAGE HIGH-SPEED 50 mA SWITCHES				
Conditions: $V_{CE(sat)}$ & V_{BE} at 50 mA. All other characteristics at 10 mA except C_{ob} at 10 V. See 2N2955-7 data sheet for curves.				
DC	BV_{cbo} 25(typ)	$V_{CE(sat)}$ 0.2(typ)	V_{BE} 0.60	
AC	f_T 375 mc(typ)	C_{ob} 4pf	τ_s 50 ns	
2N2630 2N2635	2N2955 2N2956	2N2957 107	207	
HIGH-CURRENT HIGH-SPEED 200 mA SWITCHES				
Conditions: $V_{CE(sat)}$ & V_{BE} at 200 mA. All other characteristics at 10 mA except C_{ob} at 10 V. See 2N2381-2 data sheet for curves.				
DC	BV_{cbo} 30(typ)	$V_{CE(sat)}$ 0.25(typ)	V_{BE} 0.70	
AC	f_T — 300 mc(typ)	C_{ob} — 6 pf	τ_s — 30 ns	
2N1204 2N1204A 2N1494	2N1494A 2N1495 2N1496	2N2096 2N2097 2N2099	2N2100 2N2381 2N2382	
SMALL-SIGNAL AM — FM — IF AMPLIFIERS				
Type No.	Typ NF/db	Typ G_a /db	Typ f_{max} /mc	
2N700	6 @ 70 mc	23 @ 70 mc	1000	
2N700A	6 @ 70 mc	23 @ 70 mc	1000	
USA 2N700A	7 @ 70 mc	23 @ 70 mc	1000	
2N741	7 @ 70 mc	22 @ 70 mc	400	
2N741A	7 @ 70 mc	22 @ 70 mc	400	
2N3323	6 @ 60 mc	13 @ 100 mc	500	
2N3324	5.5 @ 60 mc	29 @ 10 mc	500	
2N3325	5 @ 60 mc	30 @ 10 mc	500	
SMALL-SIGNAL VHF — UHF AMPLIFIERS				
Type No.	Typ NF db @ 200 mc	Typ G_a db @ 200 mc	Typ f_{max} mc	
2N3279	2.9	20	2000	
2N3280	2.9	20	2000	
2N3281	4.0	20	2000	
2N3282	4.0	20	2000	
2N3283	5.0	20	2000	
2N3284	5.0	20	2000	
2N3285	5.0	19	2000	
2N3286	5.5	18	2000	
SMALL-SIGNAL EXTREMELY VHF — UHF AMPLIFIERS				
Type No.	Typ NF db @ 200 mc	Typ G_a db	Typ f_{max} mc	
2N2415	2.6	14 @ 500 mc	2500	
2N2416	3.4	12.5 @ 500 mc	2500	
MM1717	2.4	25 @ 200 mc	3000	
SMALL — AND LARGE-SIGNAL VHF — UHF AMPLIFIERS				
Type No.	Typ NF db @ 100 mc	Typ G_a db @ 70 mc	Typ f_{max} mc	Typ P_o (mW) @ 175 mc
2N1141	3.0	25	1600	120
2N1142	3.5	24	1600	110
2N1143	4.0	24	1600	100
2N1195	3.0	25	1400	120
USN 2N1142	3.5	24	1400	110
JAN 2N1195	3.0	25	1400	120
LARGE-SIGNAL VHF POWER AMPLIFIERS				
Type No.	Min G_a (db) 0.5 W P_o @ 160 mc	Typ f_T mc	Typ P_o (mW) @ 160 mc	
2N1561	6	500	700	
2N1692	6	500	700	
2N1562	(0.4 W P_o) 5	500	600	
2N1693	(0.4 W P_o) 5	500	600	

...but Motorola is Still Your
Off-The-Shelf Source!

You can count on Motorola as your continuing source for a complete line of germanium mesa transistors. Over 90 PNP device types are in stock for widely used switching and amplifier applications!

Some of the more popular types included are:

- the 2N1141-43 with typical f_T as high as 1200 mc. Units meeting Mil-S-19500/87 are available.
- the 2N700 series . . . excellent for video amplifiers since h_{fe} is flat out to high frequencies.
- the 101 and 201 series used in the critical Minuteman missile program. These transistors achieved a system application failure rate of less than 0.0007%/1000 hours! They're now available to all military contractors!

Looking for excellent forward AGC? Try Motorola types 2N3279 through 2N3286 in your high-gain, low-noise amplifiers, oscillators and mixers, and frequency multipliers.

These and many more low cost, high-performance transistors are available today. And, what's more, Motorola's volume production capability assures you of a continuing source of supply.

For complete details, contact your nearest Motorola semiconductor representative or distributor or write: Motorola Semiconductor Products Inc., Dept. TIC, Box 955, Phoenix, Arizona 85001. Meantime, clip this handy listing for future reference.



MOTOROLA
Semiconductors

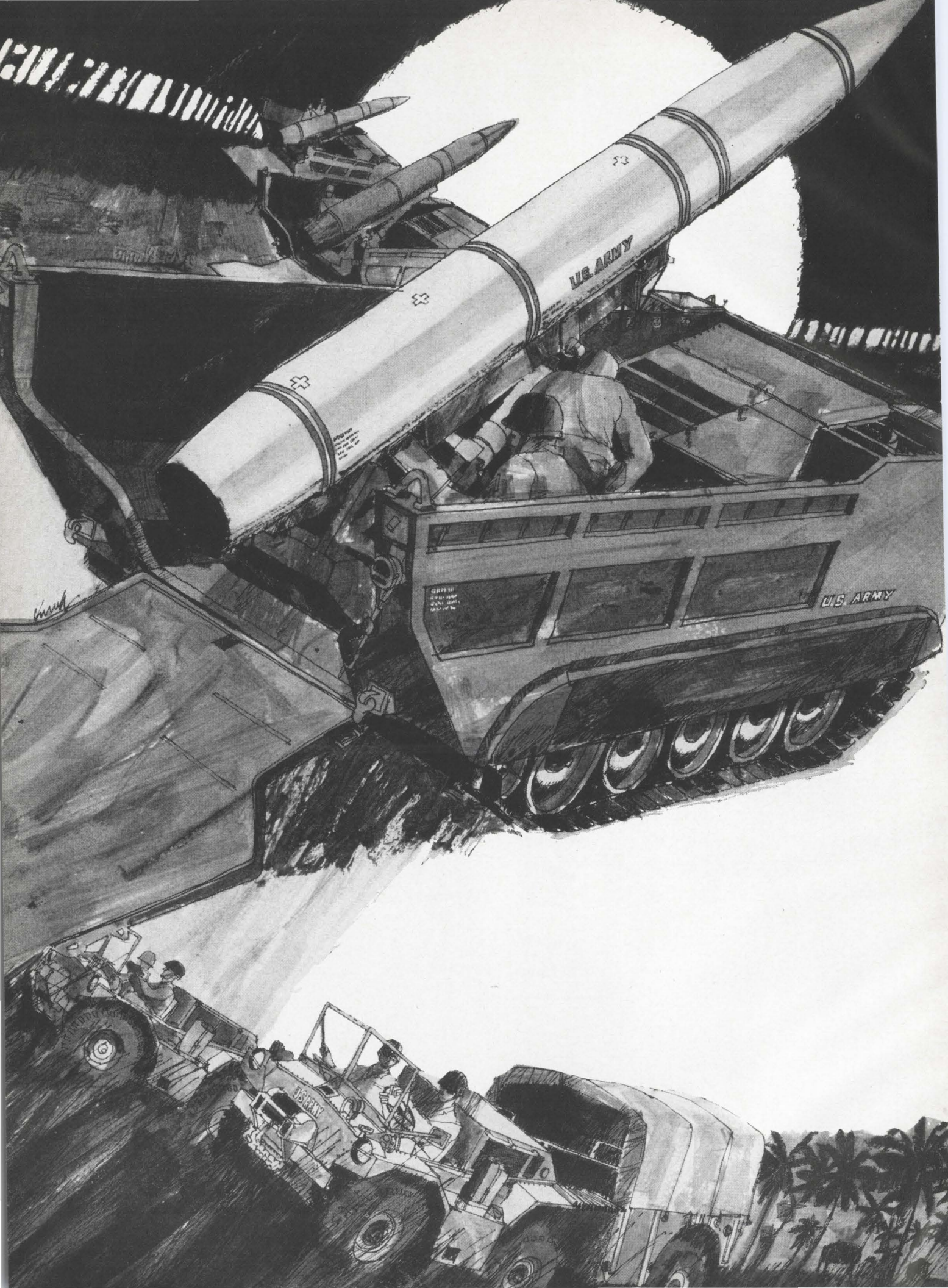

MISSILES, MOBILITY...POWER ON THE GROUND

Air and space are not the only exciting challenges in the science of defense. The Army is finding new ways of covering old terra firma in meeting its objective: The best equipped tactical force for limited or full-scale action anywhere on the globe.

A good part of the answer lies in battlefield missiles and mobility. LTV Michigan Division is supplying the Army on both counts. The Army/LTV LANCE, the newest battlefield missile, is undergoing development tests and the first firing is scheduled for early 1965. Being developed to replace the Honest John and LaCrosse missile systems, LANCE utilizes a new simplified guidance and control concept, is the first Army missile to use pre-packaged storable liquid propellants. The highly mobile LANCE system will extend the division commander's nuclear and non-nuclear firepower.

LTV Michigan is also prime contractor for the XM-561, a unique double-bodied, articulated six-wheeled vehicle which can go almost anywhere the Army fights. It will be used for test and evaluation by the military in widely varied terrain from arctic wastelands to tropic jungles. The design is based on the Gama Goat truck, which LTV privately developed. Another highly mobile vehicle being developed by LTV Michigan is the PATA (plenum air tread amphibian). A series of air cells mounted on a belt provides a continuous track on which the vehicle rides.

Highly mobile missile systems and ground vehicles are another example of the versatile store of science and technology at LTV, leader in electronics, aircraft, missiles, space, mobile ground vehicles, ground and airborne communications, and range services. Ling-Temco-Vought, Inc., Dallas, Texas.

DIVISIONS AND SUBSIDIARIES • LTV ALTEC • LTV ASTRONAUTICS • LTV CONTINENTAL ELECTRONICS • LTV LING ELECTRONICS • LTV MICHIGAN • LTV MILITARY ELECTRONICS • LTV RANGE SYSTEMS • LTV RESEARCH CENTER • LTV TEMCO AEROSYSTEMS • LTV UNIVERSITY • LTV VOUGHT AERONAUTICS • KENTRON HAWAII, LTD.

Circle 13 on reader service card

LTV
LING-TEMCO-VOUGHT, INC.

Unique articulation system gives six-wheeled XM-561 its maneuverability.



PATA crosses hard and soft terrain on continuous track of air-filled cells.

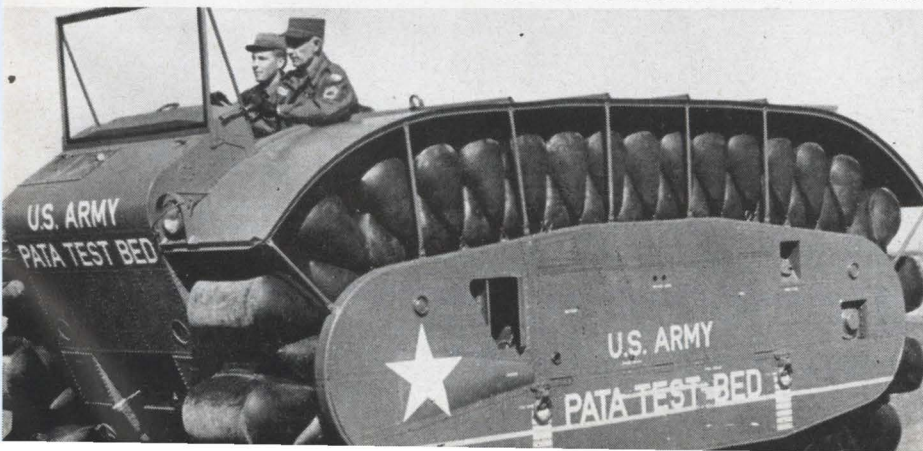

Army crews at Fort Sill, Okla., train to operate LANCE. First firing is scheduled for early 1965.



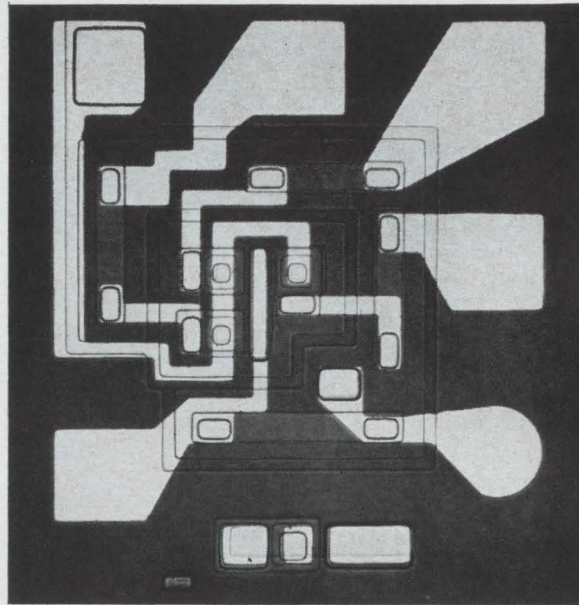

PHOTOMICROGRAPH OF FAIRCHILD SILICON PLANAR EPITAXIAL MICROCIRCUIT

\$2.55!

Low-priced microcircuits for commercial/industrial applications



The three-input gate shown above (actual size: \square) is one of Fairchild's new integrated circuits selling for \$2.55 each. These devices are functional equivalents of Fairchild Micrologic and Milliwatt Micrologic, guaranteed from 15°C to 55°C. Using the same Planar Epitaxial techniques and rigid production control, they are specially manufactured for a wide range of non-military applications—including commercial computers, industrial controls, instrumentation and test equipment.

Fairchild low-priced microcircuits are immediately available in volume quantities. Package: low-silhouette TO-5 type with 8 or 10 leads. For complete details, write for the comprehensive data sheet.

PRICE LIST

	1-24	25-99	MIX 100	NON MIX 100
F μ L 92329 J-K FLIP-FLOP	9.50	7.60	6.65	6.35
F μ L 90529 HALF SHIFT REGISTER	6.50	5.30	4.55	4.35
F μ L 90029 BUFFER	3.75	3.00	2.65	2.55
F μ L 90329 3-INPUT GATE	3.75	3.00	2.65	2.55
F μ L 91529 DUAL 3-INPUT GATE	4.75	3.80	3.35	3.20
F μ L 91129 4-INPUT GATE	4.00	3.20	2.80	2.65
F μ L 91029 DUAL 2-INPUT GATE	4.00	3.20	2.80	2.65
F μ L 92129 EXPANDER	4.00	3.20	2.80	2.65
F μ L 91429 DUAL 2-INPUT GATE	4.00	3.20	2.80	2.65

IMMEDIATELY AVAILABLE FROM DISTRIBUTOR STOCKS

FAIRCHILD

SEMICONDUCTOR

EASTERN CONNECTICUT Hamden: Cramer Electronics, 288-7771. **FLORIDA** Orlando: Crescent Electronics Sales, 423-8586; G. F. Bohman Associates, 425-8611/Winter Park: Valley Electronics, 647-1216. **MARYLAND** Baltimore: Valley Electronics, NO8-4900/Beltsville: Powell Electronics, 474-1030. **MASSACHUSETTS** Newton: Cramer Electronics, WO9-7700/Watertown: L. L. Schley Co., WA6-0235. **NEW JERSEY** Cherry Hill: Valley Electronics, NO2-9337. **NEW YORK** Baldwin, L. I.: Taylor Electronics Corp., 223-8000/Buffalo: Dart Sales, 684-6250; Summit Distributors, 884-3450/Syracuse: Dart Sales, GL 4-9257; Eastern Semiconductor, 454-9247/Westbury, L. I.: Schweber Electronics, ED4-7474. **PENNSYLVANIA** Philadelphia: Powell Electronics, 724-1900. **CENTRAL** ALABAMA Huntsville: Schweber Electronics, 539-2756. **ILLINOIS** Chicago: Avnet Electronics, 678-8160; Semiconductor Specialists, 622-8860; Solid State Electronics, 889-8033. **MICHIGAN** Detroit: Semiconductor Specialists, LU 4-5901; Sheridan Associates, 353-3822. **MINNESOTA** Minneapolis: E. C. Electronics Sales, 888-0102; Semiconductor Specialists, UN6-3435. **MISSOURI** St. Louis: Durbin-Hamilton Electro Corp., 966-3003. **OHIO** Cincinnati: Sheridan Associates, 761-5432; Cleveland: 884-2001; Dayton: 277-8911. **TEXAS** Dallas: Norvell Associates, FL 7-6451/Houston: Norvell Associates, MO 5-0558. **WESTERN** ARIZONA Phoenix: Hamilton Electro, 272-2601; G. S. Marshall Co., 946-4276. **CALIFORNIA** Los Angeles: Hamilton Electro, 870-3300/Palo Alto: Hamilton Electro, 321-7541/Redwood City: G. S. Marshall Co., EM 6-8214/San Diego: Denny-Hamilton Electronics, 279-2421; G. S. Marshall Co., 278-6350/San Marino: G. S. Marshall Co., MU 1-3292. **COLORADO** Denver: Hyer Electronics, 771-5285. **NEW MEXICO** Albuquerque: Hyer Electronics, 268-6744. **WASHINGTON** Seattle: Hamilton Electro, 282-3886. **UTAH** Salt Lake City: Hyer Electronics, 322-5849. **CANADA** Toronto, Ontario: Avnet, 789-2621.

FAIRCHILD SEMICONDUCTOR SALES OFFICES

EASTERN ALABAMA Huntsville 536-4428. **FLORIDA** Orlando CH 1-2596. **MARYLAND** College Park 779-6868. **MASSACHUSETTS** Bedford 275-8450. **NEW YORK** Endwell 754-2600; Long Island ED 4-8500; Poughkeepsie 454-7320; Syracuse GR 2-3391. **PENNSYLVANIA** Jenkintown TU 6-6623. **CENTRAL** ILLINOIS Chicago V18-5985. **OHIO** Dayton 228-1111. **MINNESOTA** Minneapolis UN6-3301. **TEXAS** Dallas FI2-9523. **WESTERN** ARIZONA Phoenix 946-6583. **CALIFORNIA** Los Angeles HO6-8393; Palo Alto 321-8780. **COLORADO** Denver 761-1735. **WASHINGTON** Seattle AT 2-5344. **CANADA OFFICE:** Ontario, Toronto 782-9230.

PLANAR: A PATENTED FAIRCHILD PROCESS

FAIRCHILD SEMICONDUCTOR/A DIVISION OF FAIRCHILD CAMERA AND INSTRUMENT CORPORATION/313 FAIRCHILD DR., MOUNTAIN VIEW, CALIF./962-5011/TWX: 910-379-6435

Editorial

Inspiration for product planning

Steadily and inevitably, microelectronics activity is accelerating. The latest giant step is described on page 67: a universal packaging technique that will mean low-cost complex systems.

Advances of this kind should supply a much-needed stimulus to product planning. Now an imaginative engineer has an unprecedented opportunity: to apply a new technology to generate a torrent of new products.

A development like the new packaging technique couldn't come at a better time. Many companies, in and out of the electronics industry, have suddenly realized that their product planning is moribund or nonexistent. At a recent meeting of the National Industrial Conference Board, one management consultant charged that new product planning was U.S. industry's worst weakness. In the electronics industry, product development is especially weak.

Certainly a few companies—such as Hewlett-Packard and Texas Instruments—have enjoyed spectacular growth as a result of their ability to market new products. But a success story is the exception. Most companies stumble onto new products or rehash their old ones.

Large companies and small have suffered the same disappointments in product planning. The reasons are as numerous as the companies, but a few explanations recur again and again. Small companies believe they are too small to engage in product planning. Big companies strangle new ideas with rigorous procedures that involve too many people. And product planning is based too often on fuzzy desires.

Although engineers have traditionally played a leading role in product planning, their position has been usurped in the past

10 years by professional product planners. These are usually marketing men who are supposed to understand what the customer wants. After interviewing consumers, the product planners tell the engineers what to design.

The great weakness in this procedure is that the customer—even a sophisticated one in industry—may not know what he wants. The road to bankruptcy court is paved with products that were developed to satisfy nonexistent desires.

Generating new product ideas—and then identifying the good ones—is one of the toughest jobs in industry. Nobody can tell you how a good idea is created or where it may come from, yet many companies ignore free sources of good ideas.

At Hewlett-Packard—a company almost everybody respects for its product planning—an executive says: “Whenever we run into a measurement problem in the laboratory or on the production line, we figure other people have the same problem too, so it becomes an idea for a new product.” Then Hewlett-Packard screens its product ideas, on the premise that it doesn't pay to introduce a product unless the device represents a real engineering advance.

Another often-slighted source is the coterie of purchasing agents in a customer's plant. Every day these men are searching for equipment to satisfy current demands. They can tell you what features are needed and what features their companies won't buy.

But nothing is richer as a source of ideas than a big advance in technology; that's what makes microelectronics such a potential stimulus. Many economic limitations on the kinds of products you can build with microelectronics—consumer, industrial or medical—have suddenly been swept away. Many products that were deemed too expensive to be built in an electronic form can now compete favorably with nonelectronic devices.

With low-cost microcircuits and packaging techniques, designers tell us they can slash the costs of systems at least 50%—as much as 90% in a few cases. And if that thought is intriguing, consider this: one approach may make microcircuit chips with nearly 100 separate components for only a few cents!

What more encouragement does an engineer need?

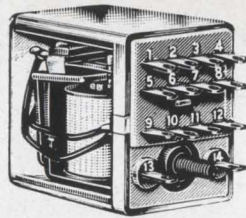

Should YOU specify this small four-pole relay by P&B?

Here is why so many engineers have

An extraordinary combination of features distinguish the KH relay. Small size (only slightly larger than one cubic inch), 4-poles, exceptional electrical stability over a long life, a wide choice of mountings... all of these and more are found in the KH.

SWITCH FOUR CIRCUITS FROM LOW LEVEL TO 3 AMPS

This is a four-pole relay normally used in a 4 Form C arrangement. It can be supplied with a 2 Form Z (DPDT-DB) configuration or, by not wiring certain contact terminations, any four-pole combination of Forms A or B may be achieved. Beryllium copper is used for the contact arms for excellent conductivity and long mechanical life.

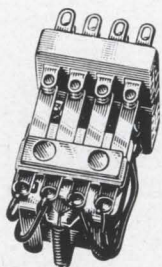

Both AC and DC relays are available. Minimum power requirement for AC relays is 0.55 volt amperes at 25° C. DC relays will operate on only 0.5 watts at 25° C. KH relays are rated at 3 amperes, as shown below. Under certain favorable conditions, KH relays will switch up to 5 amperes providing extended life is not required.

TERMINAL BLOCK CONSTRUCTION CONTRIBUTES TO RELIABILITY

Glass reinforced alkyd, a material of exceptional dimensional stability and dielectric properties, is used for the terminal block. The terminals are molded into the block. This construction serves to keep the relay in precise adjustment throughout its life. The pierced solder terminals are easily accessible, speeding hook up.

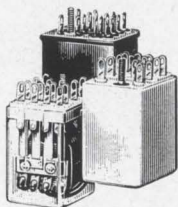

CHOOSE FROM WIDE VARIETY OF MOUNTINGS

The terminal block is uniquely embossed to allow for mounting KH relays on metal strips or angles. This embossing, around the two bottom terminals, keeps the relay from turning when the nut is tightened on the stud. The KH may be mounted in a variety of ways. A tab-and-stud mounting plate on any side or the top of the dust cover is available. Also, a choice of three sockets may be used to make the KH a plug-in-relay. One socket has printed circuit tabs, the other two have pierced solder terminals.

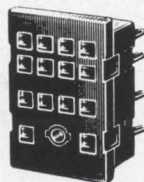
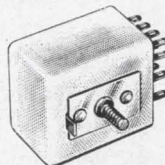

CHOICE OF ENCLOSURES TO MEET ALL REQUIREMENTS

Dust covered KH relays (KHP) can be ordered with translucent nylon or clear Lexan cases. Hermetically sealed relays are designated KHS, and are enclosed in a steel cover. The nylon cases are available on special order in red, blue, green, yellow or black so that relays in various circuits may be color coded.

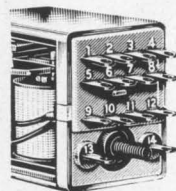

RELIABILITY OF KH SERIES FIELD-PROVED IN MANY APPLICATIONS

The KH has found its way into such diverse gear as citizens band transceivers, dictating machines, walkie-talkies, computers, aircraft communications equipment, scoreboards, alarm systems, and many others.

For full information call your local P&B distributor or Sales Representative, or write: Potter & Brumfield, Princeton, Indiana.

KH SERIES SPECIFICATIONS

CONTACTS:

Arrangements: 4 Form C (4PDT), 2 Form Z (DPDT-DB).

Rating: 3 amps @ 30 volts DC or 115 volts AC resistive for 100,000 operations.

COILS:

Resistance: DC: 11,000 ohms max.
AC: 3,900 ohms max.

Power: AC: 1.20 volt amperes nominal @ +25°C., .550 volt amperes minimum @ +25°C.

DC: 0.9 watt nominal @ +25°C., 0.5 watt minimum operate @ +25°C., 2.0 watts maximum @ +25°C.

TIMING VALUES:

Nominal Voltage @ 25°C.	Max. Values
Pull-in time	13 ms
Drop-out time	10 ms

INSULATION RESISTANCE:

1500 megohms min.

MECH. LIFE:

DC: In excess of 100 million cycles.
AC: In excess of 50 million cycles.

ENCLOSURES:

Dust cover or hermetically sealed.

TERMINALS:

Solder lug and taper tab.

SOCKET:

Solder lug or printed circuit terminals.
Available as accessory.

DIMENSIONS:

1-21/64" x 1-7/64" x 55/64"

*Now available at leading
electronic parts distributors*



POTTER & BRUMFIELD

Division of American Machine & Foundry Company, Princeton, Indiana
In Canada: Potter & Brumfield, Division of AMF Canada Ltd., Guelph, Ont.

Electronics Newsletter

February 8, 1965

Simpler memory with plasmas

Scientists at the Boeing Co. are experimenting with solid-state plasmas as a way to achieve simplified associative memories. The plasmas, dense collections of charge carriers free to move within the material, are generated by applying an electric field to a bar of germanium or indium antimonide.

When a magnetic field is applied parallel to the electrical field, the plasma becomes unstable and causes oscillations characterized by waves traveling in a helical pattern along the bar. Detection of the presence or absence of the oscillations or their frequency provides a mechanism for reading out binary data.

Because the frequency of oscillation depends on the applied voltage and magnetic field, such memory elements can be addressed in several ways, Boeing says. This would allow cross-indexing of data stored in the memory, with circuitry much simpler than that of conventional wired-core memories. Although operation at low temperature is now mandatory, Boeing thinks it will be possible to devise systems operating over a wide temperature range.

Japan expected to bar TI plant

The Japanese government is expected to reject a proposal by Texas Instruments, Inc., to establish a semiconductor plant in Japan.

Japanese electronics concerns have been fighting to bar TI, which they fear might capture the integrated-circuit market before they get commercial production going. TI also wanted to make control devices.

A government spokesman said TI will be advised to make another application later, on what Japan considers a more reasonable basis. The Japanese may relent if TI agrees to make technical agreements with local companies or to share its technology in some other way, the spokesman indicated.

Two lasers work at room heat

Lasers are warming up. A West German laboratory announced the first continuous operation of a ruby laser at room temperature, and a United States company said it had operated a pulse-type liquid laser at room temperature. Until now, both laser actions have required cooling to cryogenic temperatures.

The continuous-wave laser was reported by the quantum electronics group at the central laboratory of Siemens & Halske AG in Munich.

The ability to produce continuous output from ruby at relatively low pumping power is attributed to a pumping arrangement developed by D. Roess, who heads the laser and maser laboratory at Siemens. An elliptical mirror and water cooling are used for the light source and crystal.

Researchers used a rod ruby with a chromium content of about 0.035%. The threshold for c-w laser action was achieved with a two-inch mercury arc lamp at a pump input power of 3.2 kilowatts. Measured output of the laser was 10 milliwatts. Roess says that eventually the threshold level could be reduced to less than 1 kilowatt for a rod of the same size.

He expects his technique to make c-w output of 10 to 100 watts available soon.

The liquid laser development was announced by General Telephone &

Electronics Newsletter

Electronics Laboratories Inc., the research subsidiary of the General Telephone & Electronics Corp.

The laser uses a europium-chelate solution, in which the pump energy is absorbed in the large organic part of the molecule and is transferred to the rare-earth ion.

CT&E scientists Harold Samelson, Charles Breacher and Vincent Brophy used a cavity consisting of a cell one millimeter in diameter closed by mirror pistons. The cell was surrounded by a water-cooled spiral flash tube. Above threshold, output showed the spiking characteristic of laser action, and the spectral distribution narrowed to a single sharp line at 6,119 angstroms.

Early in the work, 1,700 joules input was needed to produce laser action; but recently the energy threshold was reduced to about 100 joules, with output measured at 30 millijoules per cubic centimeter of the solution.

New circuits for computers?

A new family of commercial complementary microcircuits is being examined by Burroughs Corp. and Honeywell, Inc., with an eye toward including them in new computer systems. The microcircuits are produced by the Fairchild Semiconductor division of the Fairchild Camera & Instrument Corp.

The new circuits, called CTL's for complementary transistor logic, are npn-pnp circuits arranged on a single chip.

Texas Instruments, Inc., has produced such microcircuits for the Minuteman missile. And Motorola, Inc., says it has the technology to produce them, but has found no demand.

Plane contacts base via Syncom

A teletype message from a Pan American 707 cargo plane took the long way home from the Formosa Strait to Camp Roberts, Calif., 7,000 miles away. The message and the reply traveled 40,000 miles via Syncom 3, the communication satellite. **It was the first such air-to-ground transmission, and it indicates that interference-free communications between aircraft and out-of-sight land stations are practicable.**

The message was transmitted at 148 megacycles and received at 136.5 megacycles. The over-all noise level was only three decibels, and engineers said there was no noticeable Doppler effect.

"The tests conclusively prove that worldwide satellite communications for commercial aircraft is a possibility within two years," said Waldo W. Lynch, vice president, communications, at Pan American World Airways, Inc.

Focused light makes masks

Photographic masks, tiny enough to be used directly to etch integrated circuits, are being made automatically by an experimental machine developed by the National Cash Register Co. for the Air Force Avionics Laboratory.

Masks are conventionally made by photographically reducing the size of large patterns. The new machine draws the pattern on a photoplate with a focused spot of light. The plate is on a stage that is moved under the light by a punched-tape control.

The company says errors in lines are less than 0.00002 inch and errors over a 1-inch plate are less than 0.0001 inch.

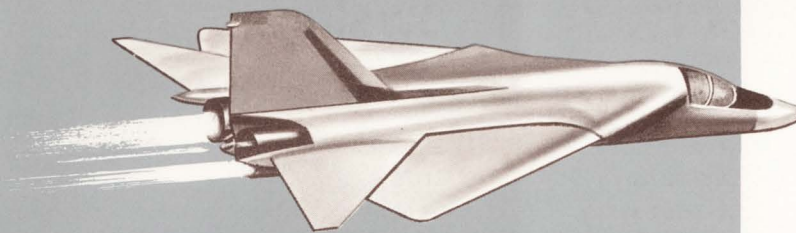

WORLD'S
SMALLEST
and
MOST
RELIABLE!

**Monolithic Analog
Computing Modules...**



**G/M Analog
Voltage
Multiplier**

New Micro-miniature G/M
Analog Voltage Multiplier
measures only 0.1 cubic
inch, weighs but 0.1 ounce.



"MAG MOD"®

Micro Magnetic Multiplying and Dividing Modulators*



THERE IS NO SUBSTITUTE
FOR RELIABILITY!
*CIRCUIT COVERED BY U.S.
PATENT NO. 2758162

MONOLITHIC MICRO CIRCUIT BLOCK for analog voltage multiplying
of D.C. and A.C. voltages.

ADDITION, SUBTRACTION, MULTIPLICATION AND DIVISION of many
voltage variables may be handled by one G/M Magnetic Microblock.

PRODUCT ACCURACY of up to 0.2% of full scale, with very slight
derating over a wide temperature range.

FOR ADDITIONAL DATA AND SPECIFICATIONS REFER TO REVERSE SIDE

...THE LATEST ADVANCE IN

Micro Miniaturization

**G/M
SOLID
STATE
MAGNETIC DIVISION
MODULES**



Completely solid state modules that perform analog division, provide accuracy of 1% or better over numerator and denominator ranges of 20 to 1. Numerator consists of an A.C. input signal; denominator is a D.C. control signal. These modules make it possible to avoid complex, cumbersome circuitry formerly used in solving analog equations, and in trig function conversion. Features include the high reliability of magnetic devices, adaptability to any signal frequency from 60 cps to over 100 kc, operation over wide ambient ranges and in severe environments. Small size is ideal for printed circuits.

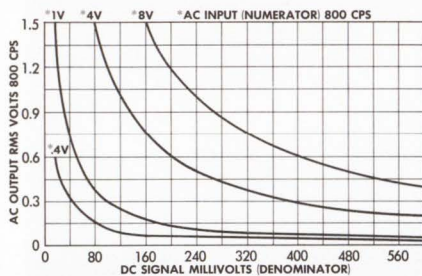

GENERAL MAGNETICS
MICRO MAGNETIC
MULTIPLYING MODULATORS

- Absolute reliability—unlimited life
- Extreme stability with negligible change of product accuracy over a wide temperature range
- High shock and vibration proof
- Bandwidth may be extended for the kilocycle range
- Low milliwatt power consumption
- Four quadrant operation
- Repeatable data over years of continuous, unattended operation
- Simple, lightweight, rugged
- May be mounted directly on printed circuit cards

SPECIFY "MAG MOD" for proven reliability in solid state amplitude module applications. These dependable instruments are widely employed in flight systems, fire control, analog computers, guided missiles, nuclear equipment, antennas and thousands of control systems. Micro-circuit, miniature, subminiature, standard and specials available.

CUSTOM REQUIREMENTS — Customized application engineering, when required, will be performed on a no-charge basis.

CIRCUIT AND PRINCIPLES OF G/M MAGNETIC MULTIPLIERS COVERED BY U.S. PATENT NO. 2758162

TYPE NUMBER	MCM-827-2	MCM-836-1	MCM-845-1	MCM-847-1	MCM-848-1
Accuracy (% Error of Theoretical Prod.)	1% Maximum	Approx. 0.5%	Less than 1%	2% Maximum	5%
Input Control Signal Range	0 to $\pm 800 \mu a$ (DC to 5,000 cps)	0 to $\pm 200 \mu a$ (DC to 200 cps)	0 to $\pm 200 \mu a$ (DC to 100 cps)	0 to $\pm 200 \mu a$ (0 to 50 cps)	0 to $\pm 500 \mu a$ (DC to 40 cps)
DC Resistance of Input Signal Range	500 ohms	12.5 K ohms	12.5 K ohms	12.5 K ohms	70 K ohms
Input AC Sig. Range Amplitude, Freq.	0.6 V to 3 V RMS Phase Rev. 100 KC	0 to 3 V RMS Phase Rev. 3200 cps	0 to 3 V RMS Phase Rev. 2400 cps	0 to 3 V RMS Phase Rev. 800 cps	0 to 3 V RMS Phase Rev. 400 cps
AC Output Product Range	0 to 1 V RMS @ 100KC	0 to 1 V RMS @ 3.2 KC	0 to 1 V RMS @ 2.4 KC	0 to 1 V RMS @ 800 CPS	0 to 1 V RMS @ 400 CPS
Null at Max. AC Signal, Zero DC Sig.	15 mv RMS	10 mv RMS Max.	10 mv RMS Max.	10 mv RMS Max.	5 mv RMS Max.
Output Impedance	650 ohms	13 K ohms	12 K ohms	8 to 10 K ohms	15 K ohms
External Load	10 K to 100 K ohms	50 K ohms	50 K ohms	50 K ohms	50 K ohms
Temperature Range	-55°C to +85°C	-55°C to +100°C	-55°C to +100°C	-55°C to +100°C	-55°C to +100°C
Null Drift over Temp. Range	0.1% of f.s.	0.1%	0.1%	0.1%	$\pm 0.2\%$
Accuracy Variation over Temp. Range	$\pm 0.5\%$	$\pm 0.2\%$	$\pm 0.2\%$	$\pm 0.2\%$	1%
Hysteresis in % of Max. Input DC Sig.	0.1%	0.1%	0.1%	0.1%	0.25%
% Harmonic Dist. in Output Prod. Wave	Less than 5%	3%	3% to 5%	5% Maximum	5%
Overall Dimensions (in Inches)	$\frac{5}{8} \times \frac{25}{32} \times \frac{1}{2}$	$\frac{37}{64} \times \frac{25}{32} \times \frac{1}{2}$	$\frac{37}{64} \times \frac{25}{32} \times \frac{1}{2}$	$\frac{37}{64} \times \frac{25}{32} \times \frac{1}{2}$	$\frac{37}{64} \times \frac{25}{32} \times \frac{1}{2}$
Approximate Weight (in Ounces)	0.26 oz.	0.26 oz.	0.26 oz.	0.26 oz.	0.26 oz.

OTHER G/M COMPONENTS
Also available is a complete line of magnetic modulators, magnetic multiplying modulators, high stability oscillators and relays. Write today for bulletins MM 101 Series Micro Magnetic Modulators, MM 102 Miniaturized Magnetic Modulators, MM 103 Standard Magnetic Modulators, MM 104 Miniaturized Multiplying Modulators, MM 105 Miniaturized High-stability Oscillators, MM 106 Micro Magnetic Multiplying Modulators, MM 107 Magnetic Relays and MM 108 Solid State Magnetic Demodulators.

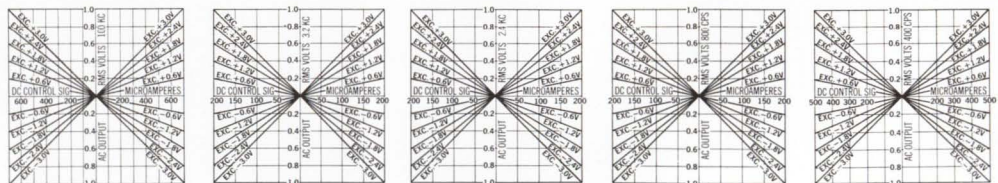

GENERAL MAGNETICS • INC
135 BLOOMFIELD AVENUE, BLOOMFIELD, NEW JERSEY 07003

THERE IS NO SUBSTITUTE FOR RELIABILITY

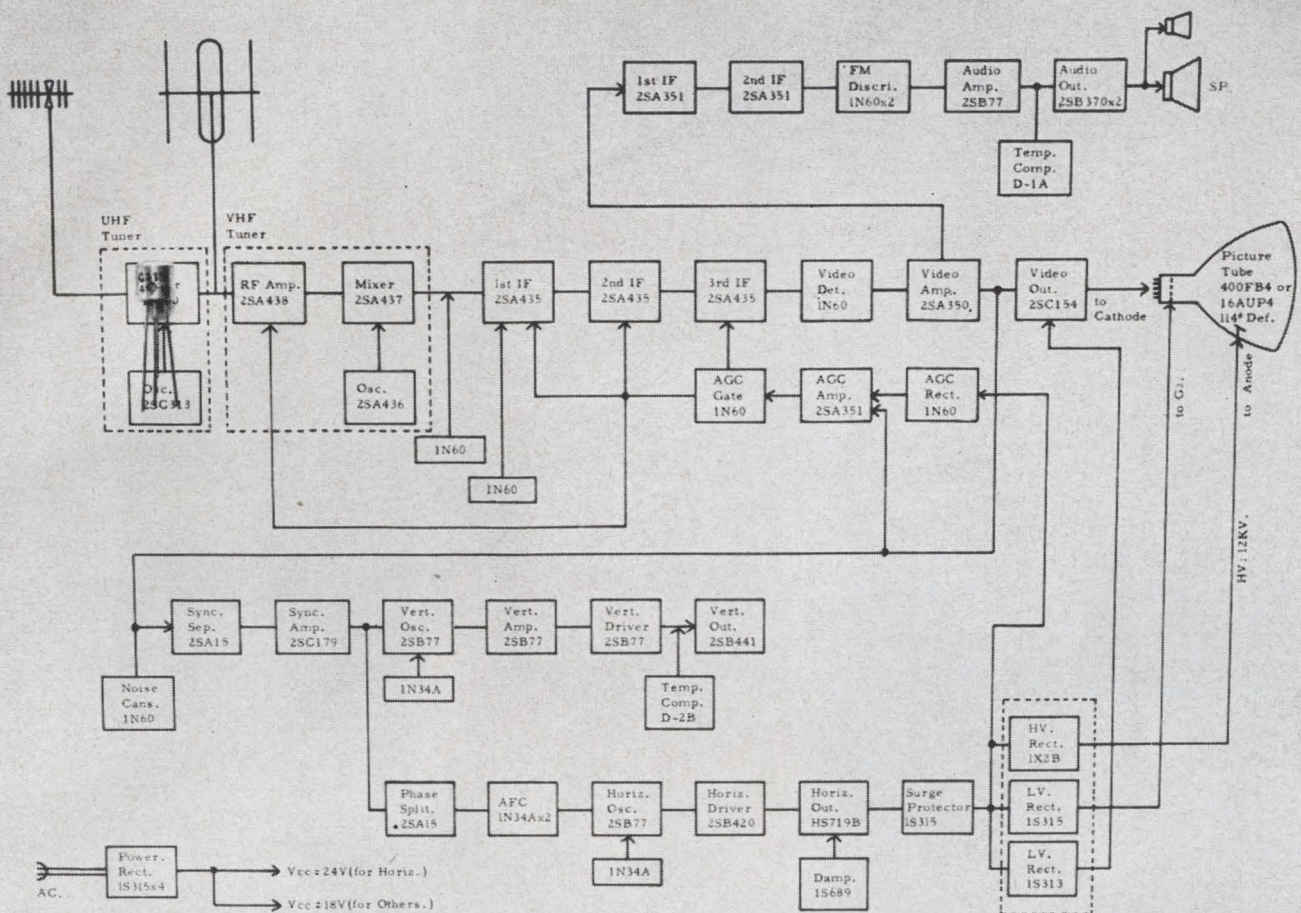

WE'VE DESIGNED AND PRODUCED THIS TRICKIER TRANSISTOR. AND NEARLY ALL THE REST BESIDES. NOW THERE'S HARDLY ANYTHING IN AN HITACHI TV THAT HITACHI DOESN'T MANUFACTURE.

For many years now Hitachi has been producing practically every transistor they need for their large TV range. All, that is, except one. The trickier one. But, now Hitachi is even producing this. It's called the Ultra High Frequency transistor. So, now the circuits are almost complete. Nearly all 100% Hitachi. Nearly every transistor... diode... and picture tube is designed... developed... and produced within the confines of Hitachi. The advantages in quality control, reliability and price must be distinctly apparent. For full details of all Hitachi transistors, please write to the addresses below:

HITACHI SALES CORPORATION: 333, N. Michigan Avenue, Chicago 1, Ill., U.S.A. Tel: 726-4572/4 / 666, 5th Avenue, New York, N.Y. 10019, U.S.A. Tel: 581-8844 / 12715, S. Daphne Avenue, Hawthorne, Calif., U.S.A. Tel: 757-8143 / HITACHI, LTD., DUESSELDORF OFFICE: Graf Adolf Strasse 37, Duesseldorf, West Germany Tel: 10846

 **Hitachi, Ltd.**
Tokyo Japan

CONSIDER YOUR HARNESSING OPERATION ...

SURVEY of HARNESS
TYING OPERATION
for
YOUR COMPANY



GUDEBROD BROS. SILK CO., INC.
FOUNDED IN 1870
Electronics Division

Area Code 215, WA 2-1122 • TWX 215-889-8851

12 SOUTH 12th STREET, PHILADELPHIA, PENNSYLVANIA 19107

• BRANCH OFFICES •

BOSTON, MASSACHUSETTS 02111
115 Chauncy Street, Area Code 617, MA 6-5347

CHICAGO, ILLINOIS 60654
1362 Merchandise Mart, Area Code 312, DE 7-3025

NEW YORK, NEW YORK 10001
225 West 34th Street, Area Code 212, LA 4-8888

BURBANK, CALIFORNIA 91804
2636 Ontario Street, Area Code 213, 848-3988
TWX 213-848-7891

PLANT: Pottstown, Pennsylvania 19464

Would you like to save money while improving the product?

TO FIND OUT HOW
—here is what you
need—and it's FREE

Have you considered that your company may be overlooking the possibility of achieving savings on harness operations while, at the same time, the product is improved? Gudebrod engineers have been making recommendations to companies like yours *with just such results!* Here's how it is done:

FOR THE STANDARDS ENGINEER

As electronic engineering becomes more and more sophisticated, as the use of electronic equipment becomes more widespread, the specifications, even for lacing materials, become more exacting. Gudebrod engineers can suggest the right tying tape for your particular requirements. The two hundred plus types of tape in the Gudebrod line are specially designed for specific purposes and each one of these tapes is engineered for efficiency in the tying operation as well. Our engineers will be happy to work with *your* Standards Engineer to save money while improving the product.

FOR THE METHODS ENGINEER

Gudebrod has engineered its entire tape line with the basic idea of producing tapes that "tie themselves." Easy, safe handling,

non-slip knots, trim harnesses have been kept in mind—features that speed the harnessing operation. In addition, there are dispensing packages, cut lengths, bobbins, color identification—custom designed for the lacing job. Gudebrod engineers will be pleased to work with *your* Methods Engineer to save money while improving the product.

FOR THE PRODUCTION ENGINEER

Gudebrod has a lacing tool, the Cable-Lacer, the first hand tool specifically designed to ease and speed harness tying. No longer need cable lacing be a hand wearing, hand tearing chore. The Cable-Lacer has paid for itself in as little as one day—you can benefit from the savings every day thereafter. A Gudebrod engineer would welcome an opportunity to demonstrate the Cable-Lacer—and to work with *your* Production Engineer to save money while improving the product.

HARNES OPERATION SURVEY—FREE

Consider then, this offer by Gudebrod to work with your Standards, Methods and Operating Engineers in suggesting how to save money on harness operations while you improve your product. A Gudebrod engineer will make, at your convenience, a complete survey of your harness materials, methods and production. It will be a thorough-going review well worth while—and there will be absolutely no cost or obligation. Why not write or phone today requesting *your* survey?



GUDEBROD BROS. SILK CO., INC.

FOUNDED IN 1870



Electronics Division

12 SOUTH 12th STREET, PHILADELPHIA, PENNSYLVANIA 19107

Area Code 215, WA 2-1122 • TWX 215-569-8551

PAR excellence in a digital voltmeter

It's small

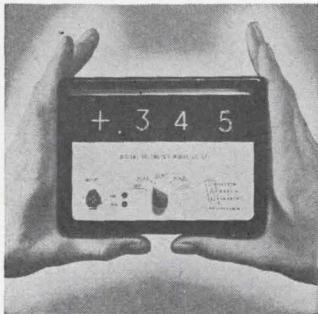

The new PAR Model CS-3.1 represents a breakthrough in reducing the size of digital voltmeters. The size reduction has been achieved without compromising the outstanding operating characteristics of this unit.

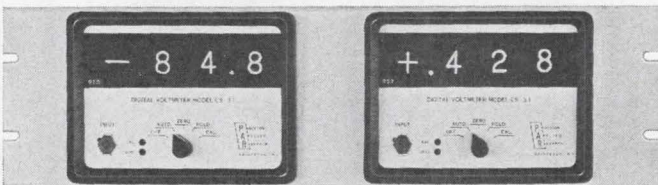

It is only 6½" wide, 5" high and 8¾" deep. Weighs but 9 lbs. Two units can be mounted in a 5¼" rack panel without any modification or special mounting hardware. Individual units can be used as digital panel meters.

It's reliable

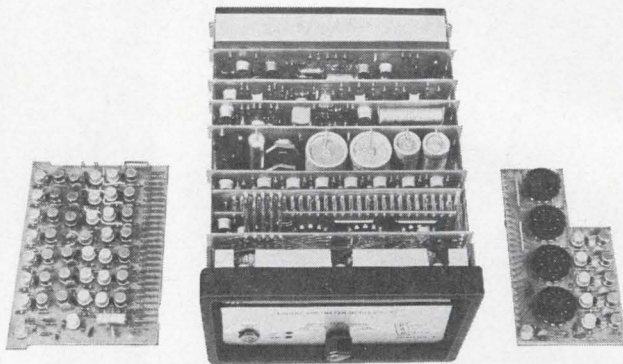

Completely solid state electronic circuitry except for two miniature nuvistor tubes at the input stage of the comparator to obtain high impedance input. High reliability dry-reed relays are used to switch the attenuators, for automatic ranging, automatic polarity, and amplifier stabilization. Long service free life is assured by use of glass epoxy boards, aged zener references, rugged plug-in printed circuit construction, and long life nixie tubes.

It's versatile

The CS-3.1 digital voltmeter can be used in many applications. Ranging is automatic. Polarity indication is automatic. It is available with ten line decimal coded output for digital print-out. It may be used with an associated remote readout. Balancing time is from 0.15 to 3.15 seconds, depending on the change of range. Sensitivity is 1 millivolt. Accuracy is $\pm 0.1\%$ ± 1 count.

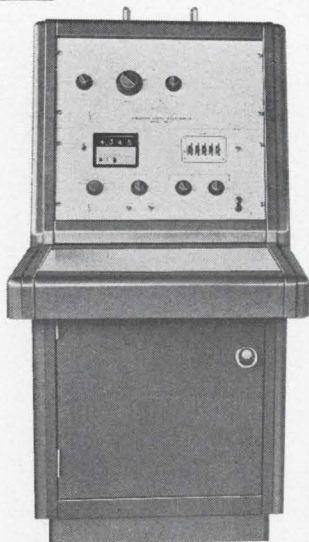

It's loaded

Truly floating and guarded differential input circuit permit differential voltage measurements with guard floating up to ± 500 volts DC with respect to chassis, which is at power line ground. Common mode rejection is greater than 100 d.b. Input impedance is a minimum of 10 megohms at all times.

Write for bulletin no. 107 to:



Princeton Applied Research Corp., Dept. D., Box 565, Princeton, New Jersey

Electronics Review

Volume 38

Number 3

Communications

Telephones aloft

Man's ability to escape the nagging ring of the telephone is about to be cut down again. Air-to-ground radiotelephone service may soon be available to the 35,000 business aircraft in the United States.

With approval of the commercial service by the Federal Communications Commission impending, makers of mobile radio equipment figure on \$100 million in sales of original equipment. Each two-way communication unit would cost about \$3,000.

The service has been in effect experimentally for about seven years, with 10 ground terminals serving more than 90 planes. It will take the American Telephone and Telegraph Co. two to three years to complete the 60 to 90 stations needed for nationwide service. But existing facilities will serve travelers over the Northeast as soon as equipment is installed in the aircraft.

Airlines are cool. Airlines are not enthusiastic about the service. They fear a tieup during bad weather. If a system under control of the crew could be worked out, however, they say they may be willing to provide an air-ground phone.

The airborne caller selects an open channel, and presses his talk button to signal the ground-station operator. He gives her the number and the call goes through in the usual manner except that the airborne party must push the button to talk and release it to listen.

From the ground, a caller dials long distance and gives the operator the approximate location of the aircraft. The operator dials a five-digit number and the control equipment automatically adds another digit that identifies the channel to be used. In the plane, the receiver automatically tunes in to that channel.

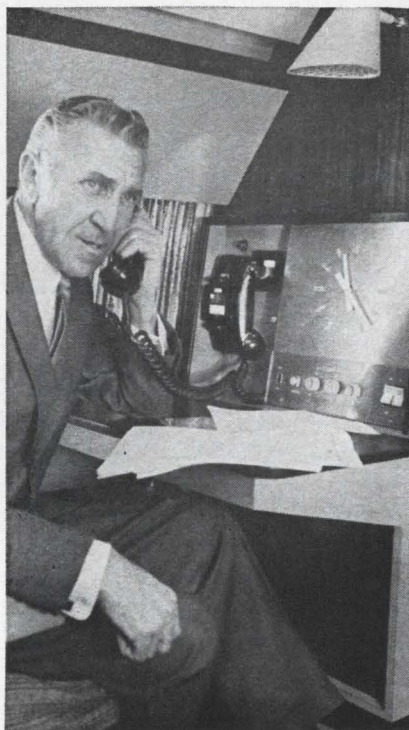

In a company plane, executive tries out airborne radiotelephone. He'll charge calls to his air telephone number.

Three-minute rates are expected to vary from about \$1.50 to \$4, with each additional minute adding from 50 cents to \$1.35.

Suppliers. Although AT&T is carrying the ball in this development, other companies will be involved immediately, notably the independent telephone companies and radio-equipment manufacturers. Airborne equipment is available now from the Delco Radio division of the General Motors Co. and other manufacturers of mobile radio equipment expecting to get into the market. The user, not the telephone company, furnishes the equipment.

Ground stations will be about 200 miles apart, and the same channel frequencies will be repeated at about 500-mile intervals to reduce co-channel interference.

Reception range. An aircraft will have to be flying between 5,000 and 30,000 feet for good coverage.

Communication with any one ground station will generally be good for about an hour. Low-flying planes generally travel slower than those at higher altitudes; therefore, one at 5,000 feet will cross a 200-mile-wide circle in about the same length of time that it takes for a jet airliner flying at 30,000 feet to cover a 500-mile-wide circle. Both craft will receive good signals in these instances.

The 450-megacycle band has been selected for the system. There are six frequency-modulation (± 15 kilocycles) duplex channels plus the ground-air (± 5) signal channel. Both airborne and ground transmitters are rated at 15 watts output.

When a channel is idle, a dial tone is transmitted from the ground station at about 0.5 watt; this permits the customer in the plane to select a channel. The ground-air signaling channel uses combinations of 600- and 1,500-cycle tones to operate the selective calling equipment in the channel chosen by the ground operator.

Radios in subways

The first link of a radiotelephone system for the New York City subways is expected to be operating by June. In part it's an answer to the crime wave that has terrorized subway riders. The system provides the first two-way communications for trainmen with police or track dispatchers.

A motorman will be able to communicate with a train dispatcher on one channel of the network. A second channel will link a central dispatcher's desk with subway police and track workers, who will carry mobile radios. Each channel will have its own frequency.

The first phase of the project, costing about \$750,000, covers a section on the Lexington Avenue line, from the Bowling Green Station to 125th Street.

Special cable. The system, which is being built by Motorola Communications & Electronics, Inc., a division of Motorola, Inc., uses a special cable produced by the Amphenol-Borg Electronics Corp. The cable acts as an antenna, "leaking" radio-frequency signals, which are picked up by the receivers.

Six separate 25-watt base-station transmitter-receivers must be installed over the 15-mile link because power falls off sharply in a tunnel. The cable, which is designed so that power losses don't exceed one decibel per 100 feet, is fireproof and can be used in radio systems in any tunnel or mine.

Signals from mobile radios are transmitted to and from the various fixed transmitters-receivers in the tunnel. The signals are then sent over wire lines to central control consoles. When a signal comes into the console, a light is activated on the panel telling the operator where the call originates.

Subway police, track walkers and flag men will carry 1.4-watt transmitter-receivers and motormen will have 8-watt radios that are plugged into the 32-volt outlet on the train.

Manufacturing

Pi-winder

Howard A. George, owner of the Coil Winding Equipment Co., has given coil designers some strangely shaped coil windings produced by an experimental machine he invented. He believes these coils are superior to those wound on conventional machines and will cost less. The new winder will be shown for the first time at the IEEE Show in New York on March 22.

The machine can wind universal coils at angles up to almost 90°, compared to the conventional 25°, and it's unusually fast—it is rated at 6,000 rpm and has made coils at 9,000 rpm. Use of the winder for other types of components is under investigation.

To minimize dielectric losses in

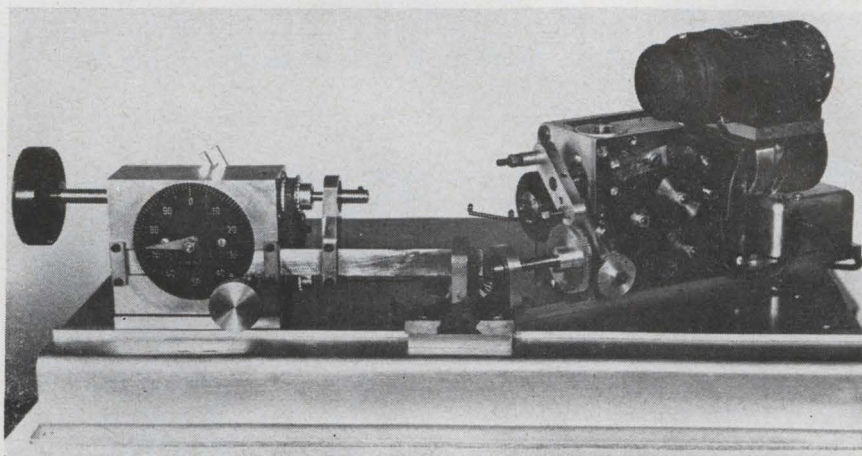

Winding angle of new machine is set by changing rotational plane of flyer at right.

radio-frequency coils, the aim is to keep the distributed capacitance as low as possible. In the familiar pi-wound or universal coil the wire crosses the coil face at an angle. The higher the angle, the fewer the turns in each layer, and the less the capacitance.

Bow ties and balls. Coils wound by the new machine look like bow ties in cross-section—their sides slope inward, instead of remaining straight as in the customary pi-wound coils. When wound at angles near 90° the coils resemble balls of twine.

The machine can wind toroids from the outside, instead of the slower inside-outside technique, by enclosing the toroid in wire. It might also be used to wind lumped-constant delay lines, with delays

adjusted by varying the capacity in the wound "lumps."

The most interesting new possibility, George says, is the winding of noninductive resistors from a single strand of wire. Normally, pairs of wires or pairs of windings are needed so that current can flow in opposite directions and cancel inductances.

However, if a ball is wound by using a 90° winding angle, the windings look like lines of latitude on the earth. When the windings have progressed 180° around the ball, the direction of current flow in the wire becomes reversed. The lines of latitude become pairs of wires facing in opposite directions.

These new forms are still experimental because the relationship between capacitance and inductance in coils wound at such high angles has not been studied.

Orbiting flyer. The machine winds at high speed because it does not use the cams and reciprocating motions generally used in universal winders to move the wire rapidly back and forth across the coil form.

The winding principle is akin to drawing scrolls on moving paper with a pendulum. The coil form revolves on a spindle at the left (see photo) while the wire guide rotates in a different plane on the flyer at the right. The winding angle is set by swiveling the right-hand mechanism on the bed plate.

The effect is as though the flyer were orbiting with a wobbling mo-

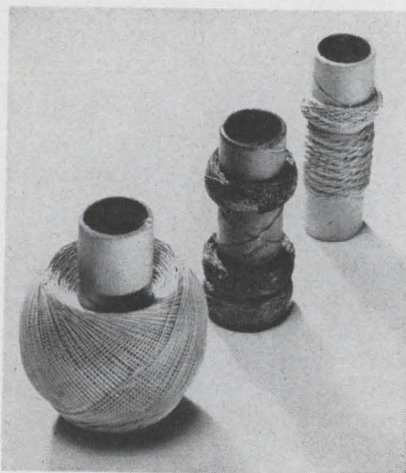

Machine can be used to wind coils into unusual shapes.

tion over the coil form, thus forming the lattice pattern. One-half or less cross per turn is made if the spindle revolves in the same direction as the flyer, and one-half to five crosses result if they go in opposite directions.

Higher angles. Conventional universal winders are limited to a 25° angle, George says, because of the need to balance winding slippage and wire tension. Also, as coil diameter builds up, the winding angle drops until at about 5° lattice tying becomes insufficient for further winding.

Because his machine winds at a constant angle, the tying or interlocking action is maintained as the coil builds up.



Electrostatic image orthicon was developed by General Electric Co. engineers Kurt Schlesinger, left, and Bernard Day. Reduced power, weight and size may now give it a place in military and space applications.

Components

High hope for low-light

Space and military applications may open up soon for the image orthicon, a low-light-level camera tube now restricted to entertainment and industrial uses.

These new applications are possible because of the reduction in weight, size and power needs of the electrostatic image orthicon developed at the General Electric Co.'s tube works in Syracuse, N. Y.

Now the "see-in-the-dark" tube can be tested for use in round-the-clock weather surveillance by satellite. Applications are seen for an electrostatic image orthicon with a fiber optics faceplate. In combination with image intensifiers, the new tube could provide passive target surveillance and detect enemy movements in the dark.

Portable tv studio. The 11-ounce tube can be housed in a lightweight, compact camera head. In combination with a small video tape recorder, it would make a suitcase-sized remote television studio.

According to GE, electrostatic focusing and deflection give 30-fold reduction in power drain, 20-fold reduction in weight, and a five-fold cut in size. The conventional

image orthicon weighs 14 pounds and employs magnetic focusing and deflection, requiring yokes and coils in its circuitry. Both the weight and bulk are prohibitive for satellite applications.

Camera system circuitry for the orthicon has been simplified and allows the designer greater flexibility to produce variable scan and frame rate capability.

On one watt. Operation of the electrostatic tube is similar to that of the magnetically focused version. But tiny, lightweight components—a Deflectron, an Einzel lens, and a spiral lens—which require much lower power levels, do the deflecting and focusing. Only one watt handles deflection, focusing and collimation.

The Deflectron was invented by Kurt Schlesinger of GE who, with Bernard Day, developed the electrostatic image orthicon. The Deflectron is a ceramic device with an internal circuit pattern for bending the electron beam. It has a common center of deflection for both horizontal and vertical beams, and replaces the deflection plates of the magnetically operated tubes.

The Einzel lens focuses the beam with an electrostatic field which is changed by varying the voltage.

A nonlinear, spiral lens plays a major role in tube readout by collimating the beam so that it strikes the target at precisely a 90° angle and prevents shading in image quality.

Sensitivity. Also, a high-gain, thin-film magnesium oxide target can store signals for a longer time prior to readout, providing greater sensitivity with low frame rates or beam pulsing.

The new electrostatic image orthicon has a resolution of 600 lines per frame. It is predicted that it will achieve higher sensitivity levels, but it also is expected that the magnetically focused and deflected tubes will outperform the electrostatic tube in very high resolution applications.

Price slash

When motors with printed circuits instead of conventional windings were first introduced in 1959, they cost \$350. Prices have been tumbling since then, and now Printed Motors, Inc., whose PM-368 motor had been selling for \$150, has slashed that price to \$65.

The motor, redesignated the U9, will be even cheaper in quantity; in lots of 2,000 the price is \$40, down from \$92. This, says the company, will make the U9 competitive with conventional a-c and d-c servo motors. All parts of the U9 are off-the-shelf equipment.

Big market. Producers of medium-speed data processing equipment, will be the big-volume buyers, according to the company, a division of Photocircuits, Inc.

Orders for the new U9 have come in for these applications:

- Driving tape reels in an analog magnetic tape recorder that operates at 100 inches per second;
- Operating in a point to point numerical control system that indexes a table at 90 positions per minute;
- Recording data in a 25-line printer that gets output from a computer;
- And driving a paper tape reader at 500 characters per second.

The company claims that the printed-circuit motor is used in these applications because it provides smoother torque and higher speed of response than conventional geared motors.

Printed Motors hints that in the near future it may introduce a less precise printed motor for under \$10.

Medical electronics

Heart readings anywhere

That little black bag the doctor carries on house calls may soon hold a device that, in emergency heart cases, could mean the difference between life and death.

The three-pound transistorized device, made by the Westinghouse Electric Corp., lets the doctor view magnified electrocardiograph signals on an oscilloscope screen right at the patient's bedside. Called the Miniscope, it works on four rechargeable flashlight batteries and will retail for about \$380.

Other portable instruments on the market now weigh about 20 pounds, provide a printed record of the electrical activity of the heart, and cost nearly \$600.

In Baltimore city hospitals the Miniscope is being used under the direction of Dr. Joseph Reddings,

chief of anesthesiology. Dr. Reddings says the instrument is useful for clinical observations of a patient's heart, although it wouldn't be used for detailed studies requiring a printed readout on calibrated tape.

The Miniscope contains a miniature oscilloscope mounted in a case that measures seven by five by two inches. The electrical pulses are picked up by two small suction plugs that are fastened to the palms of the patient's hands. The pulses are reproduced as waves on the face of the oscilloscope. Two control knobs are provided: one for amplifying or reducing the height of a wave and the other for centering the wave on the oscilloscope screen.

Computers

Accordion circuits

Another computer manufacturer has put microcircuits to work. The Burroughs Corp.'s newest modular multiprocessor, the D-84, developed for general-purpose military use, is the company's first with integrated circuits.

The 100-pound computer, like its big brother the D-825—of which more than 40 have been sold—is a collection of independently op-

erating memory, data-processor and input/output modules, each the size of an attaché case.

Each D 84 will be custom designed (the number of modules and the configuration depends on the application) so Burroughs hasn't fixed a price. The smaller D 84's will probably cost under \$100,000.

Folded circuits. The logic circuits are organized much like the computer itself. Each subassembly is a functional whole of up to 12 different integrated circuits. For example, the circuits needed in a six-bit register make one subassembly and four of these make a 24-bit register.

Although the subassembly design is unusual, it is relatively easy to make. The circuit flatpacks are welded or soldered to five-inch-long, double-sided printed circuits made on H-film. H-film is a new thermally stable plastic made by the Du Pont Co. Its char point is 800° C. Copper-foil tabs put on top of the flatpacks provide a ground path and heat sinking.

The strip assembly is accordion-folded into a comb-shaped plastic header with 28 pins. The header assembly is potted and plugged or soldered into a double-sided printed-circuit laminated to an aluminum plate by a silicone-rubber pad. The plate acts as stiffener, heat sink and ground plane. Two boards make a plug-in card of 48 subassemblies. Four cards make up the central-data-processor module.

Two circuit speeds. Resistor-transistor circuits for the nand-nor logic are supplied by Fairchild Semiconductor and General Micro-Electronics, Inc.

Power is saved and cooling problems avoided by using slower circuits where high speed isn't needed. Some circuits dissipate 4 milliwatts and have an average delay of 40 nanoseconds. Others dissipate 20 milliwatts and have 20-nanosecond delay. With a 2-microsecond memory, the computer can add in 4 microseconds.

Other types of circuits are used where higher power is needed. Thin-film circuits with attached transistors and diodes drive the 4,096-word memory. Some input/

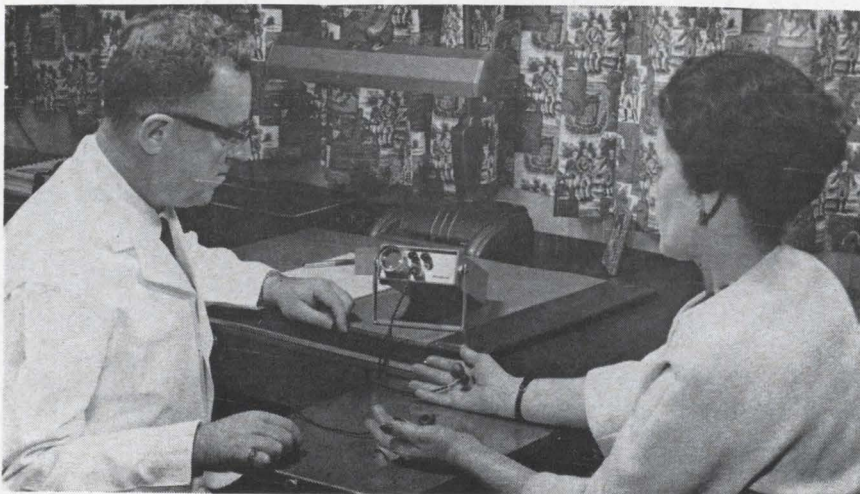

Electrocardiogram is taken with the new Miniscope. Portable instrument from Westinghouse Electric Corp. provides clinical data on patient's heart.

Now - TRIMPOT® Miniature Adjustable Time Delays for Critical Applications

Need to stall for time? These two miniature modules offer delays with a repeatable accuracy of $\pm 5\%$ from -55°C to $+120^{\circ}\text{C}$. They are the Bourns Model 3900 Time Delay Relay and Model 3907 Time Delay Module. Both units give you the versatility of either the DPDT high-current-carrying capabilities of an integral relay or the long operating life of a solid state timing switch.

Both modules are capable of providing a time delay range of 0.1 to 200 seconds by the external addition of a readily available resistor or a capacitor-resistor combination. More important, these miniature time delays have a self-contained adjustment feature by means of a Bourns TRIMPOT® potentiometer allowing precise selection of the desired delay time through a 1.5 sec. range.

Model 3900 employs a DPDT relay capable of one ampere at 26.5 VDC, while Model 3907 features an internal SPST NO solid state device rated at 250 milliamperes at 26.5 VDC.

An internal diode protects the units against accidental polarity reversal, and protection is provided against transients up to 200% of the operating voltage with pulse widths of 0.5 microseconds. Both models have all welded circuitry, are vacuum-

potted and meet the environmental requirements of MIL-R-5757D. They readily withstand 20G, 2000 CPS vibration and 75G shock.

Models 3900 and 3907 are available from stock. Write today for complete technical data.

	MODEL 3900	MODEL 3907
Time delay range:	0.1 to 200 Seconds	0.1 to 200 Seconds
Nominal voltage:	20 to 30 VDC	20 to 30 VDC
Life (min):	10^6 cycles	10^6 cycles
Output:	DPDT Relay	SPST NO — Solid State
Contact rating:	1 ampere resistive at 26.5 VDC, 120°C	0.05 amperes resistive at 26.5 VDC, 120°C ; 0.250 amps at 25°C
Ambient temp. range:	-55 to $+120^{\circ}\text{C}$	-55 to $+120^{\circ}\text{C}$
Size:	.4" x .8" x 1.31"	.4" x .8" x 1.0"

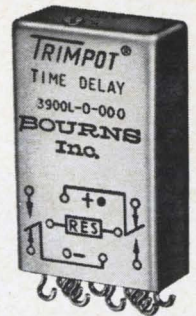

ACTUAL SIZE



BOURNS

BOURNS, INC., TRIMPOT DIVISION
1200 COLUMBIA AVE., RIVERSIDE, CALIF.
PHONE 684-1700 · TWX: 714-682 9562
CABLE: BOURNSINC.

MANUFACTURER: TRIMPOT® & PRECISION POTENTIOMETERS, RELAYS; TRANSDUCERS FOR PRESSURE, POSITION, ACCELERATION. PLANTS: RIVERSIDE, CALIFORNIA; AMES, IOWA; TORONTO, CANADA

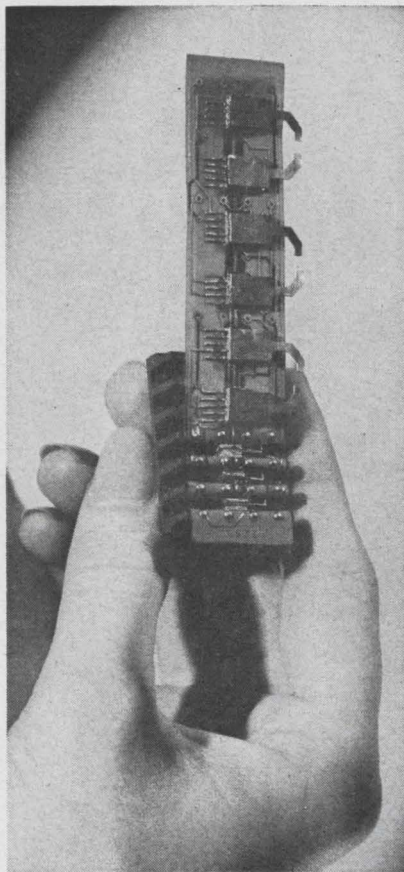

Accordion-folded subassemblies are made by attaching flatpacks to flexible strip of printed circuitry.

output-module circuits are made with discrete components, since the module usually must actuate electromechanical devices.

Expandable system. The memory and data-processor modules are standard assemblies, but the I/O module is custom-built to suit peripheral gear such as displays, printers or communications sets.

The basic D-84—one of each module plus a power supply in the housing—occupies 1.4 cubic feet and dissipates 110 watts of power. A half-size version can be made, too. If extra data-processor modules are used, a memory-switch module, also made with integrated circuits, lets them share the memories. Up to 16 memories, made with thin films or cores, can be included in a system.

The modules don't have to go into one housing. Walter Walsh, program manager, says they can be linked by cables and put, for example, in armor-plated bulges at different points on a tank. If the sys-

tem has more than one of each kind of module, and some get knocked out of action, the computer will continue operating as long as one of each module still works.

Space electronics

Balloons and buoys

Next year Nimbus B will be picking up weather data from free-floating buoys in the sea for the National Aeronautics and Space Administration. The Weather Bureau has other plans for collecting weather data and if an experimental program known as Scom (Satellite Collection of Meteorological Operations) works out, five years from now new satellites may be orbiting over a worldwide chain of 7,000 constant-latitude weather balloons to pick up information.

Scom has been in the works for some time [Electronics, Feb. 21, 1964, p. 14] but now seems ready to move ahead. The Weather Bureau has awarded a \$100,000 contract to the G. T. Schjeldahl Co. for five experimental weather balloons that will have two-dimensional circuitry deposited on an extremely thin, 0.001 inch Teflon substrate.

The experimental balloons will be demonstrated in May at a meeting of the World Meteorological Organization. If their performance is satisfactory, it may mean the go-ahead for a data-gathering system that would space 7,000 similar balloons around the world. Each balloon would be fixed at a constant altitude, ranging from 10,000 to 107,000 miles above the earth.

In the system, the ground station would send commands to the satellite and the satellite would interrogate the balloons. Responses would be stored in the satellite until its next pass, 90 minutes later, over the ground station where the data would be retrieved.

Thin package. The maximum thickness of an oscillator in the circuit will be 0.050 inch, while the transmitter, receiver, logic circuits and solar cells would be 0.010 inch

thick each. Platinum resistors less than 1 mil thick will be attached to the circuits, while the other circuit elements including plate capacitors, finger capacitors and inductors will be of deposited copper.

Buoys. For the NASA system, Nimbus B, in addition to taking cloud-cover pictures, will collect data from free-floating buoys in the sea and relay it to central ground stations every 90 minutes. Radiation, Inc. will receive \$1.7 million to produce four satellite electronics packages and six buoy electronics packages.

Up to 14 free-floating buoys will be equipped with sensors for readings of pressure, temperature, humidity wind speed and wind direction. These readings, along with two range measurements to enable location of the buoy, will be transmitted to Nimbus. Each buoy will have a transponder that transmits at 465 megacycles with 25 watts of power. Transducers and digital logic receive the satellite's coded address and digitize the weather information.

When the satellite passes over the buoy, it will transmit its address code at 400 Mc with 25 watts of power. This commands the buoy to send the weather information. The information will be stored in a 20,000-bit ferrite core memory and transmitted later on command to the ground stations at Fairbanks, Alaska and Rosman, N. C., by pulse-code modulation.

At the ground stations, a signal at 465 Mc commands Nimbus to transmit the contents of its memory to the ground.

Comsat's customers

The Communications Satellite Corp., preparing to begin commercial service to Europe in May, must first make some business decisions with far-reaching effects in the electronics industry.

Comsat is expected to file its proposed rates with the Federal Communications Commission. The FCC must also decide on who will own the ground stations, and who may lease channels.

There's no problem getting cus-

CONSTANT TEMPERATURE BATHS

—for voltage and
resistance standards

You can't measure
with more accuracy
than you know
your standards!

You can't know
your standards
with more accuracy
than you know
your temperature
stability!

AIR BATH (STABILITY $\pm 0.01^{\circ}\text{C}$)

Type 9152 series of saturated standard cell Constant Temperature Enclosures have $\pm 0.01^{\circ}\text{C}$ long term stability. Enclosures feature a new patented solid state temperature controller. Standard models house from 4 to 12 cells. Type 9152/P4 is a portable enclosure designed as a transfer standard for intercomparison with NBS and users lab. Operates in extreme ambients; testing down to -20°C shows no deterioration in internal temperature control. Saturated cells contain porous partitions and can be shipped by commercial carrier. Accuracy guaranteed to 0.0001% with NBS figures. Power required: 110 v/60 cps or 12 VDC with automatic switchover for AC power failure. A bridge detection system, that eliminates a thermometer and absolute temperature as an accuracy factor, indicates internal temperature variances to $\pm 0.001^{\circ}\text{C}$.

OIL BATH (STABILITY $\pm 0.05^{\circ}\text{C}$)

Type 9730 series of oil baths are thermostated at one fixed temperature setting or adjustable for a number of fixed points between 20°C and 40°C . New, patented solid state temperature controller regulates bath to $\pm 0.05^{\circ}\text{C}$. Thermistor bridge detects $\pm 0.01^{\circ}\text{C}$ variations in temperature control. Gradients in bath less than $\pm 0.01^{\circ}\text{C}$. Construction features are all copper terminals, 34" x 17" x 13" deep (ID) stainless steel insulated tank, 14" of formica bench space slanted toward bath, motor driven impeller for optimum oil circulation (mounted underneath tank) and cooling tubes to lower temperature of bath below ambient.



Type 9152 series



Type 9730 series

Manufactured by Guildline Instruments, Ltd.
Smith Falls, Ontario



THE SINGER COMPANY
METRICS DIVISION

915 PEMBROKE ST., BRIDGEPORT, CONNECTICUT
TELEPHONE (203) 366-3201 • TWX 710-453-3483

Design and production of PANORAMIC • SENSITIVE RESEARCH • EMPIRE • GERTSCH instruments for measurement

Circle 31 on reader service card

tomers. The American Telephone & Telegraph Corp. has offered to lease about half of the 240 channels that are expected to be made available. Canada also wants some channels. So do other prospective users.

Whatever the rates, the FCC has said it will insist that the public be able to make a telephone call to Europe via satellite at no more than the present \$12 cost for a three-minute call. By 1970, satellite service and worldwide direct-distance dialing are expected to cut fees 50%.

Who can use it? The selection of customers isn't as simple as it may sound. Congress has stipulated that Comsat make its services available to common-carrier communication companies, such as AT&T and the nationalized systems of Europe, and to "other authorized entities" as determined by the FCC. The obvious question is: what constitutes an authorized entity?

Comsat has received informal queries from news media, such as the Associated Press and radio networks; also from the International Business Machines Corp. and other companies interested in leasing circuits for private use, particularly for transmitting data for computers. If the FCC approves, these organizations could lease circuits directly from Comsat, probably at a lower rate than if they had to work through a common carrier such as AT&T.

Within the next few weeks, the FCC is expected to issue a proposed ruling and to call for comment from prospective users of the satellite. Some months after that, a decision will probably be reached.

Ownership. The communications industry is divided over who should own ground stations in the United States. The initial Early Bird service will use AT&T's station in Andover, Maine. But Comsat wants sole ownership of all ground stations; AT&T has said it would accept a 50% shared ownership arrangement between Comsat and the carriers. Some other users want to own the stations themselves and have the FCC li-

cense them like radio stations.

Final arguments were heard Jan. 25, and the FCC says it will make a decision by early spring.

There is more at stake than the first four stations, scheduled to be built in the Northeast, Southwest, Northwest and Hawaii. Eventually there is a good chance that ground stations may be placed near every major U.S. metropolitan area. It is this long-range potential that makes the scrambling so vigorous.

Instrumentation

Stemming the tide

The flood of test-data documents threatening to engulf the National Aeronautics and Space Administration may be stemmed by the use of video tape.

An automated document-filing and retrieval system developed by the Ampex Corp. will be installed at the Marshall Space Flight Center in Huntsville, Ala., by the middle of the year. The microfilming system, called Videofile, will cost \$875,000. Subsequent systems will cost from \$200,000 to \$1 million, depending on their complexity.

St. John Courtenay, of the technical and scientific staff of Marshall's Astrionics Laboratory, says that ultimately the system will be expanded to include all NASA installations, and their major contractors. The Videofile system at Marshall will be used primarily in connection with the Saturn program.

In videofiling, documents are recorded on the same kind of magnetic video tape used in television broadcasting. The system includes a video-tape recorder with electronic location-coding and a buffer stage. The output is displayed on a tv screen. Documents may also be retrieved in the form of printed copies.

Winning features. Ampex received the contract after competitive bidding. Factors in making the award, NASA technical staff members indicate, included the modular

nature of the system, permitting economical and virtually unlimited expansion; use of solid-state electronic techniques to record, erase, update and display; and ease of data transmission to and from remote locations by microwave video or standard facsimile.

In the Videofile system, which can be used as well in commercial and industrial applications, a tv camera photographs the document, and the image is stored on one space on the tape, which is held stationary. A recording head moves across it as the picture is scanned. A seven-digit code is put on the edge of the tape at each document location. The code, punched in by a keyboard operator, permits automatic location of a document.

Queries come through a keyboard, punched cards from a computer, or other input methods. The Videofile locates the material by scanning the codes on the tape track. A searcher can scan a complete category until the required document is located.

No tie-ups. A buffer stage is provided so that the system will not be tied up while a document is being read out. A memory tube stores the image of the document when it is located, and this is read out on the tv screen.

The Videofile at Huntsville will be available to all NASA organizations and their contractors. It will store source documents and other technical data for the Parts Reliability Information Center, or Prince, a clearing house of information on reliability of parts and equipment used in space programs.

Graphics. At present, the index to Prince is automated to provide access to abstract and bibliographic data on parts reliability and performance. The next step, Videofile, will automate graphic technical-data storage, retrieval and dissemination.

The prodigious storage capability of the modular Videofile on-line hardware configuration can economically handle systems exceeding 25 million graphic images, according to NASA estimates. Each reel of videotape can store more than a quarter of a million 8½ by 11-inch images.



ITT Heat-Shrink
Tubing forms
a tight mechanical
bond seconds after
applying heat.

ITT Heat-Shrink Tubing bonds / jackets / insulates / splices / encapsulates / weatherproofs

ITT Heat-Shrink Tubing is used to insulate terminals and tools, to assemble and weather-proof wire bundles and to protect them against abrasion, to vibration-proof and weatherproof electrical connectors. Possibly you can add to the growing list of other mechanical and electrical insulation applications.

This highly versatile tubing is made of irradiated polyolefin which, upon exposure to heat at 250° F., shrinks in seconds to form a tight mechanical bond over even irregularly shaped items. Heat can be applied by a hand held industrial hot air gun (for applications such as terminal insulation in junction boxes) or by

conveyor belt through-oven installations for mass production. In fact, almost any heating method except direct flame can be used.

ITT Heat-Shrink Tubing is available now from stock in a variety of colors (for color coding), sizes (up to 1" diameter) and wall thicknesses (for increased strength and high dielectric).

Undoubtedly there are money-saving, time-saving applications of ITT Heat-Shrink Tubing in your operation. Discover its almost limitless possibilities. For a free sample write Wire and Cable Division, International Telephone and Telegraph Corporation, Clinton, Mass.

wire and cable division **ITT**

A. King McCord,
President, Westinghouse Air Brake Company, says,

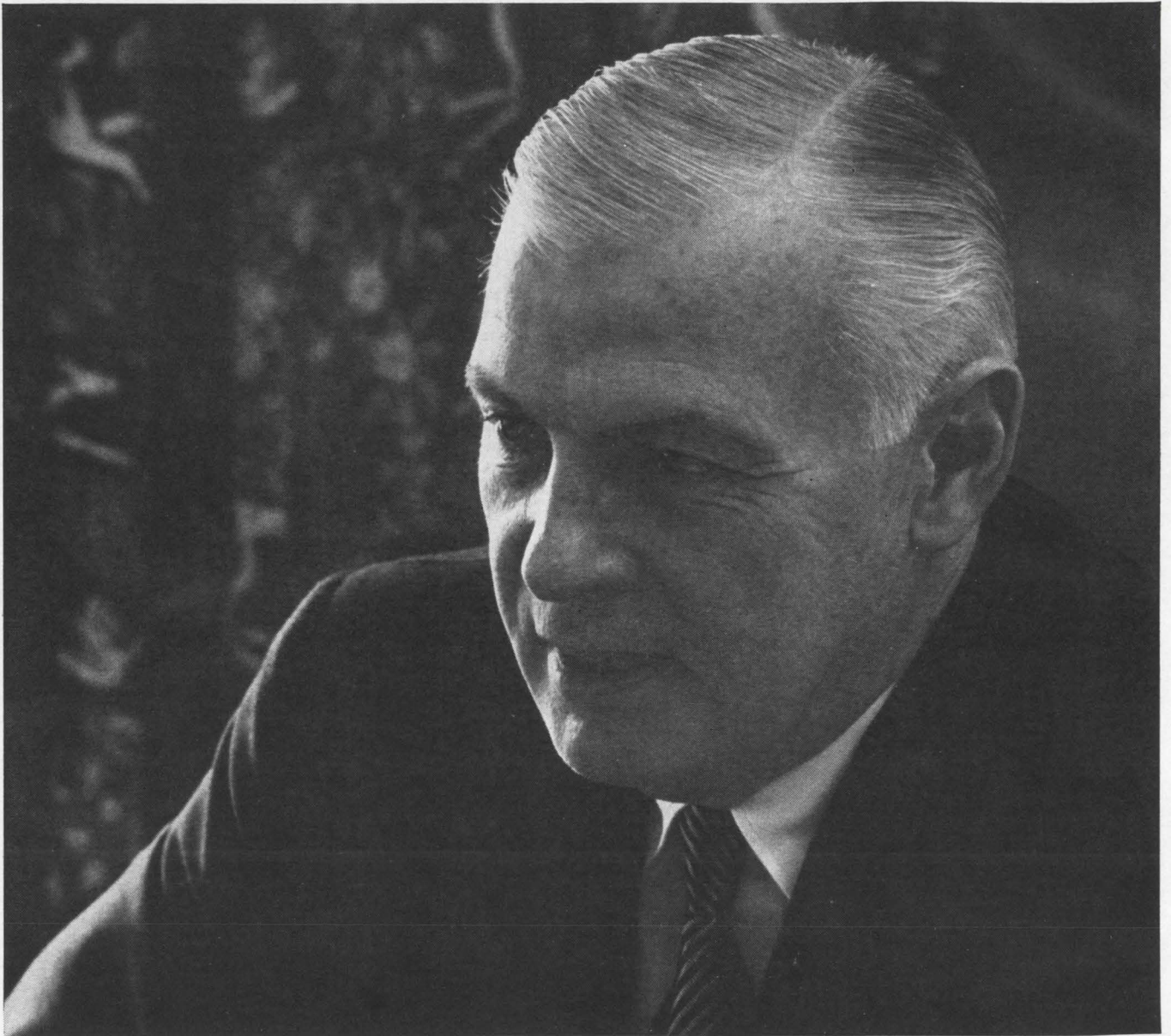

“We’ve introduced the world to WABCO with Industrial Advertising.”

“We gave *seven* individual companies a single corporate identity—virtually overnight. We let customers in thirty major markets know that Westinghouse Air Brake now ranks among the world’s most skilled and diversified suppliers—of earthmovers, drilling equipment, compressors,

automatic signal and control systems, electronic guidance detection and communications equipment, control valves, hydraulic and pneumatic cylinders, and—that’s right—air brakes. We told the story fast and inexpensively to hundreds of thousands of purchasing influences, with Industrial Advertising.”

Advertising cuts the cost of selling . . .

ASSOCIATION OF INDUSTRIAL ADVERTISERS



271 Madison Ave., New York, N. Y. 10016

You need a pushbutton switch.



Bill, at the next board, needs a toggle switch.



Sam's looking for placard indicators.

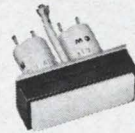

Joe wants a switchlite.



Harry wants a hermetically-sealed switch.

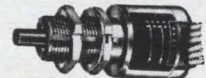

Here's the easy way to get all the answers at once!

Just check the bingo card in this book for any or all of the Control Switch catalogs listed below. Or send us a card of your own.

If you get all of our catalogs you'll have it made.

First, because these catalogs cover a combination of switch types and switchlites that no other manufacturer can offer. So you get a concentrated reference.

Second, because some switch manufacturers don't make *any* of the switches we make. So Control Switch catalogs save wild goose chases.

Third, because we make only quality switches. For computers, aircraft, missiles, control panels, and such. So our catalogs save time screening out switches that haven't got it.

Here's the list. Check the Reader Service Card number at the left for the catalogs you want.

- #233 *Condensed Switch Catalog 100*
- #234 *Basic Snap-Action Switch Catalog 110*
- #235 *Toggle Catalog 180*
- #236 *Indicator Light Catalog 120*
- #237 *Hermetic Switch Catalog 130*
- #238 *Switchlite Catalog 220*
- #239 *Pushbutton Catalog 190*



CONTROL SWITCH DIVISION
1420 Delmar Drive, Folcroft, Pennsylvania 19032

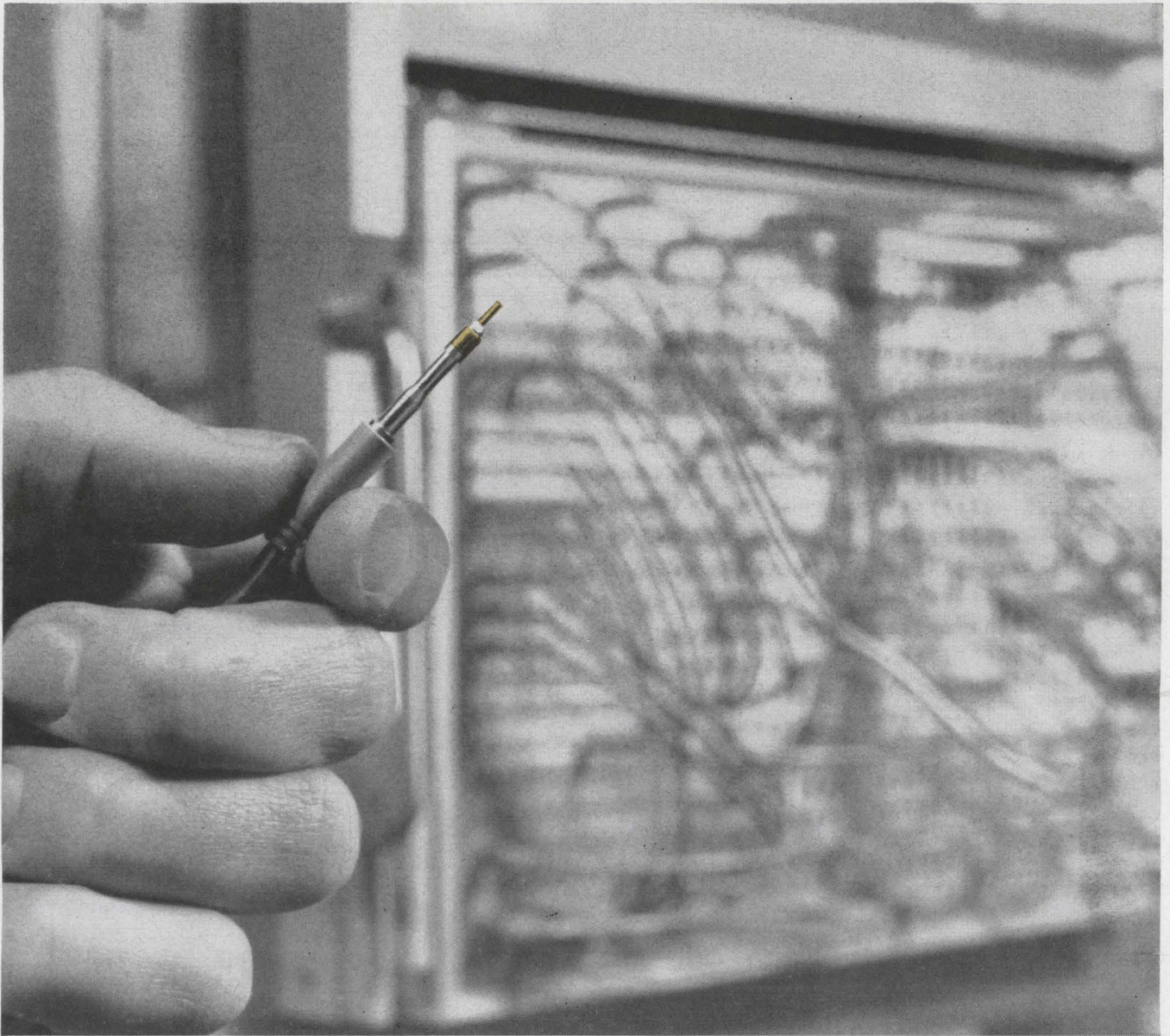

Now...coaxial patchcord programming!

If you've been inserting, removing, changing and re-inserting individual or multiple coaxial connectors... hold everything! Simple or complex switching of coaxial circuits needn't be that tedious. Not any more. We've designed a Coaxial Patchcord Programming System to do the job for you.

This system is a natural for analog work as well as other critical low-level applications including telemetry instrumentation, data processing, communications and test equipment. You can change programs as rapidly as you can change a patchboard, and pre-program at your convenience.

In fact, our Coaxial Patchcord Programming System gives you all the flexibility of Universal Patchcord Systems, including post patching. Permanent boards feature up to 3036 individually shielded contacts... one-crimp coaxial contacts that connect the rear board with the equipment you are programming. A special crimping mechanism provides AMP's exclusive double wiping action. This action removes lint, dust and other foreign contaminants from the surfaces of the rear board spring contacts and patchcord tips and assures reliable electrical contact.

Not only is this the first patchboard programming system for coaxial cable, it's universal in concept. Hybrid systems are available to let you mix coaxial and universal patchcords in one system!

Here's a rundown on performance specs:

- Minimum resistance between adjacent contacts: 10^{13} ohms
- Maximum VSWR: 1.2 from 0 to 100 megacycles
- Adjacent cross talk: -60db from 0 to 100 megacycles
- Contact spacing: .375" x .270"
- Double wiping action and redundant contacts assure positive contact
- Contact areas: gold over nickel plated
- Four standard sizes: 506, 1012, 2024 and 3036 contact positions

Find out how easy coaxial patchcord programming can be in your operations. Write today for complete specifications.

*Trademark of AMP INCORPORATED



A-MP* products and engineering assistance are available through subsidiary companies in: Australia • Canada • England • France • Holland • Italy • Japan • Mexico • West Germany

Washington Newsletter

February 8, 1965

Budget plays down civilian electronics

President Johnson's spending plans for fiscal 1966, starting July 1, are skimpy for civilian programs requiring electronics. Great Society programs in health, welfare, job training and education get the big increases this year. Many programs involving electronics are postponed in Johnson's drive to hold spending under \$100 billion.

The Administration is deferring major research and development sought by federal agencies in astronomy, seismology, high-energy physics and oceanography. While the Post Office checks out automatic zip-code and address readers, its research and development budget drops by \$3 million, to \$16 million.

The Weather Bureau, one of the few gainers, gets an increase of \$28 million, to \$145 million. Of the increase, \$20 million is for weather satellites. The Bureau of Standards' research to develop a common language for computers goes up \$1 million, to \$5.5 million.

The economy drive slows efforts throughout the government to automate the handling of scientific and technical information. Spending for these programs will be held close to the present \$200-million-a-year level, although they have been growing 10% annually.

Johnson's science adviser, Donald Hornig, says that some R&D efforts that were deferred this year will stand a better chance next year.

'Rewson' means quicker data

The Navy is making life easier for electronics companies working on certain highly classified projects, and for its own bureaus, by establishing a central projects office to which both industry and Navy bureaus can go for information.

The new office also is expected to eliminate duplication in Navy research activities.

The new office is called Rewson, an acronym that is freely derived from its list of interests: reconnaissance, electronic warfare, special operations and Naval intelligence processing systems. Rewson is part of the Office of Naval Materiel. Before Rewson was established, these projects were managed independently by different Navy bureaus.

Eglin's radar to be rebuilt

The Pentagon definitely will rebuild the AN/FPS-85 early-warning and satellite-tracking radar at Eglin Air Force Base, Fla., high military sources say. The \$30-million system was destroyed by fire Jan. 5 [Electronics, Jan. 25 p. 101.]

The new phased-array unit will have the same basic design as the original, but some improvements will be incorporated, taking advantage of technical advances made since the original system was designed.

The radar is expected to cost far less than the original, since research won't have to be duplicated.

Changes planned in patent system

Each branch of the federal government has plans that could profoundly change the patent system.

The Johnson Administration plans to increase fees so that patent holders will pay the full cost of operating the Patent Office; the Supreme Court has agreed to consider whether an inventor can sue for triple

Washington Newsletter

damages if it is proved that a rival fraudulently patented his idea; and Senate Whip Russell B. Long is stepping up his drive to tighten the Federal grip on patents generated by government research.

Under the Administration's fee plan, the Patent Office's \$8-million annual income from fees would eventually be tripled. Operations, which now cost \$30 million a year, would be streamlined and automated. The biggest boost would be in periodic renewal fees, so that inventors would be less inclined to leave the Patent Office clogged with uncommercial ideas. A patent that now costs \$60 to obtain and maintain for its 17-year life would cost \$400 under the new plan.

The Justice Department urged the Supreme Court to take the patent case because patent fraud is a recurring problem and present law gives an inventor no ground to recover damages. The court is being asked to allow the inventor to sue under the antitrust laws.

Sen. Long, in his drive to stop the government from "giving away" patents that "belong to all the people," is tacking amendments to every piece of research and development legislation in the Senate.

Two V/STOL's gaining favor

The Pentagon is expected to narrow the field soon to two prototypes of a V/STOL, a vertical or short-takeoff and landing craft. It has been studying six different versions.

The two survivors probably will be the XC-142, a tilt-wing transport plane made by Ling-Temco-Vought, Inc., the Ryan Aeronautical Co. and the Fairchild Hiller Corp.; and the P-1127, a swiveling-jet strike-reconnaissance plane built by the Hawker Siddeley Group, Ltd., and jointly funded by the British, United States and West German governments.

Operational tests will determine, as one Pentagon civilian official put it, whether V/STOL craft "are worth the extra cost."

After 14 years and a \$300 million investment in V/STOL programs, the House Armed Services Committee is pressuring the Pentagon to decide whether a V/STOL tactical fighter can be developed. Meanwhile it is urging the services not to overcommit themselves to helicopters.

Steeper cut seen in excise taxes

Top administration officials hint that the \$1.75 billion excise tax reduction proposed by President Johnson may be even steeper—possibly double that size.

This encourages makers of business machines, radios and television sets to fight for repeal of excise taxes that now add about \$300 million a year to the prices of these products.

There will be intense lobbying until late March or April, when the President will specify which excises should be cut to make up his tax-cut package. Then the focus will shift to the House Ways and Means Committee and the Senate Finance Committee, where specifics will be thrashed out.

Prospects are good that at least half of the present excise burden will be lifted from consumer electronics and business machines.

Addenda

The Commerce Department is expanding an experiment with the Electronic Industries Association and five regional organizations to get government research results into the hands of local industries. A 23-state network should be operating by July 1.



Him say, "When reliability counts, count on Mylar®."

There'll be no signaling from your computer (or its operators) if you make certain that all your tapes are on a base of "Mylar"*. That's because "Mylar" is strong (a tensile strength of 20,000 psi), stable (unaffected by

temperature or humidity changes) and durable (no plasticizer to dry out or become brittle with age). No wonder it has been the most used tape base for the past ten years. Remember: When reliability counts, count on "Mylar".

DU PONT
REG. U. S. PAT. OFF.
 Better Things for Better Living
 ... through Chemistry

only **DU PONT** makes
MYLAR®
 POLYESTER FILM

*Du Pont's registered trademark for its polyester film.

FOR PRECISION INSTRUMENTATION
 CONSIDER ROHDE & SCHWARZ

UNIQUE

PHASE AND LOSS MEASURING SYSTEM TYPE PDF

10 CPS TO 50 MC FREQUENCY RANGE

The PDF measures phase and attenuation of 4-terminal networks or transmission lines. Major applications include measurement of filters, crystals, cables, communication and television systems, antenna arrays, semi-conductors, ferrites, microcircuits, amplifiers, receivers, attenuators, etc.

- Simultaneous reading of attenuation and phase.
- Extremely wide range of frequency 10 cps to 50 Mc.
- Frequency converter increases sensitivity to 50 microvolts.
- Inputs adaptable to conventional characteristic impedances or usable with high impedance.
- High impedance attenuator probes are also included.



Circle No. 222

FIELD STRENGTH METER TYPE HFH

0.1 to 30 Mc
 Frequency Range

Measures electric and electromagnetic components of a field **directly** by means of one calibrated rod and three rotatable loop antennas. Does not require use of calibration charts because it has a built-in tracking calibrating oscillator.

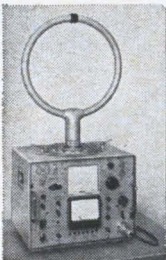

- Linear range of 20 db and logarithmic ranges of 40 and 60 db.
- As field strength meter, its range is 0 to 120 db ($1\mu\text{V/m}$ to 1V/m).
- Calibration is independent of aging of tubes and components.
- Can be operated from 12 volt battery for field operation.
- Measures average and peak value.



Circle No. 223

FREQUENCY SYNTHESIZER TYPE XUA

30 Cycles to 30 Mc
 Continuously Adjustable

This extremely popular instrument combines excellent resolution (0.5 cps) with wide range. Frequency is read on only three scales in Mc, kc, and cycles. It is widely used for determining frequency characteristics of filters, frequency selective networks, amplifiers and communications systems **without** need for accessory counters or frequency meters.

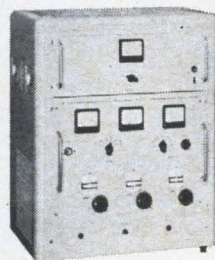

- Adjustable in crystal-controlled steps of 100 kc and 1 kc.
- 0 to 1000 cycle scale has 0.5 cps reading accuracy.
- Output voltage continuously variable from $100\mu\text{V}$ to 1 V by means of precision attenuator and output voltmeter.
- Stability of built-in crystal is 2×10^{-8} per day.



Circle No. 224

DIAGRAPHS PLOT IMPEDANCE DATA

30 to 2400 Mc
 Frequency Range

The Diagraphs employ the directional coupler principle. Measurements are made directly on a Smith or transmission-line chart without computation — saving time, expense, and eliminating error.



Baluns, variable shorts and accessories for measurements of semi-conductors available.

- Measures impedance and admittance.
- Plots transmission characteristics.
- Acts as a phasemeter from -180° to $+180^\circ$.
- Acts as a linear measuring receiver.
- Two frequency ranges available: 30 to 420 Mc or 300 to 2400 Mc.



Circle No. 225

Please have salesman call on me. Circle No. 226



ROHDE & SCHWARZ

ELECTRONIC MEASURING EQUIPMENT FOR THE UNCOMPROMISING

111 LEXINGTON AVE.
 PASSAIC, N. J.
 201-773-8010



HOW DO YOU DESIGN PEACE OF MIND?

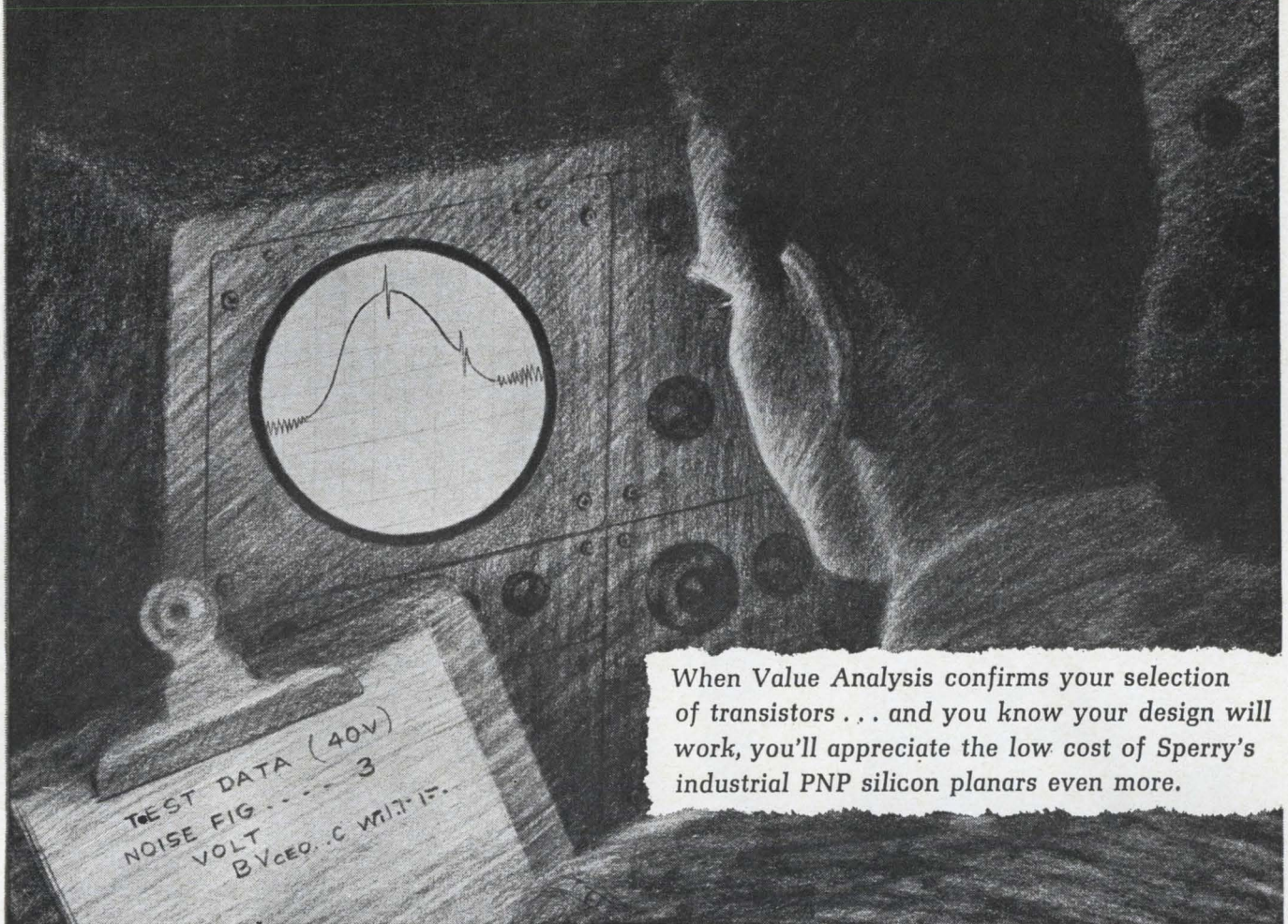

When Value Analysis confirms your selection of transistors . . . and you know your design will work, you'll appreciate the low cost of Sperry's industrial PNP silicon planars even more.

**EVALUATE
SPERRY**



Send for Sales Representative

Circle 220 on reader service card

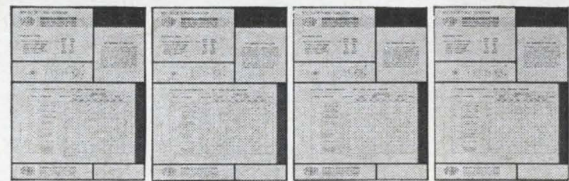

Specification Sheets

Circle 41 on reader service card

Low cost PNP Planar Transistors, Sperry's industrial types, provide quality . . . and a heads-up method of reducing cost. You get the proven reliability of the planar process in a hermetically sealed TO-46 package. Which of these features will provide your peace of mind . . . low noise figure for minimum error signal detection; a typical gain bandwidth in the 50 mc range to provide design ease in broad band amplifiers; BV_{CEO} of 40 V and 60 V compatible with commonly used industrial power sources. Circuit designers and systems designers in many industries are turning to Sperry's industrial transistors to preserve their own economy. Makes sense. Here are our new types: 2N3579 . . . 2N3580 . . . 2N3581 . . . 2N3582.

Try a little peace of mind for yourself . . . write for the technical data on Sperry's industrial types . . . now. **SPERRY SEMICONDUCTOR, Norwalk, Connecticut 06852.**

SPERRY

**SEMICONDUCTOR
DIVISION OF
SPERRY RAND
CORPORATION**

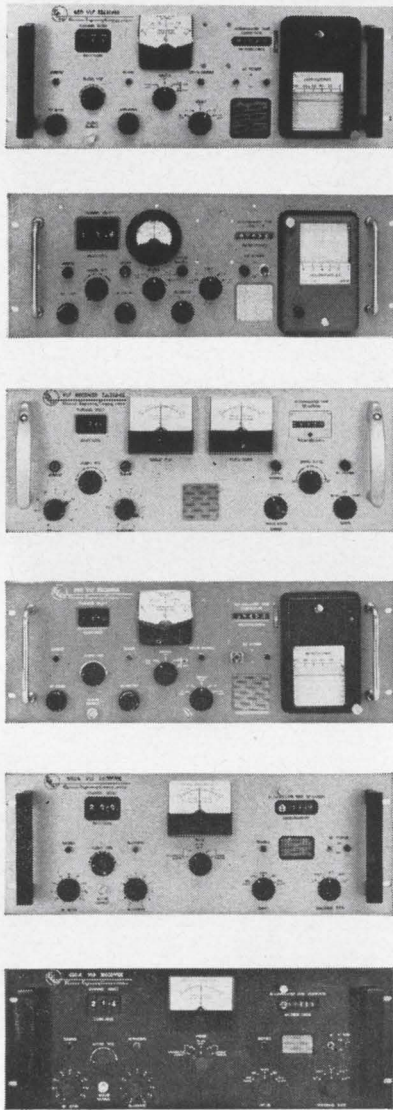

WHICH ONE IS THE BEST VLF RECEIVER?

They all are! Whichever you select, you can't go wrong because all six are EECO 880 Series VLF Receivers/Phase Comparators. And now—with major new features including an all electronic servo—EECO VLF Receivers are better than ever!

- Tunes entire IRIG designated VLF band using only three digital thumbwheel switches; no other tuning, filter selection, or local oscillator switching is required
- Utilizes an electronic servo with adjustable tracking rate for phase correction
- Provides a built-in counter and recorder to display phase correction
- Disables servo automatically during loss of VLF signal
- Makes a nearly instantaneous frequency comparison to an accuracy of 1 part in 10^8 ; comparison to 1 part in 10^{10} can be made in a few hours
- Will not lose phase continuity (or phase reference) when tuning from station to station
- Has optional features such as 60 KC channel reception.

Prices for the improved EECO 880 Series VLF Receivers start below \$4000, depending upon the options—another reason why you should look to EECO for precision timing products... automatic programming equipment... test instrumentation... data handling equipment... and complete timing and data systems.



Electronic Engineering Company *of California*

1601 EAST CHESTNUT AVE. • BOX 58 • SANTA ANA, CALIF. • KIMBERLY 7-5501

TRW CARE PACKAGE



14-56

METALLIZED MYLAR... packaged with CARE!

We care... when we select basic materials, when we precision-process, when we test, when we deliver.
Our reward: unqualified industry acceptance!

- **DRAMATIC SIZE REDUCTION IN 50V SERIES**

A full range of capacitance from .01 through 10.0 mfd. Sized from 7/16" long x .187" wide x .094" thick.

- **RECTANGULAR SHAPE FOR GREATER FLEXIBILITY**

Axial leads (X663F) or radial leads (X663FR) for flat or edge mounting.

- **JOIN THE TREND**

Metallized Mylar's* proven superiority in D.F., I.R. and stability with life is speeding the industry trend away from metallized paper types.

- **ULTRAMINIATURE, LIGHTWEIGHT**

- **ALSO 100, 200, 400, and 600-VOLT RATINGS**

- **MIL-C-27287 PERFORMANCE and RUGGEDNESS**

- **AVAILABLE FROM STOCK**

Write for details on the complete TRW Capacitor line:
112 W. First St., Ogallala, Nebraska

Phone: 308-284-3611

TWX: 308-526-7816

FORMERLY
GOOD-ALL

TRW CAPACITOR DIVISION
THOMPSON RAMO WOOLDRIDGE INC.

*Du Pont registered trademark



PRECISION SWITCHES

for accurately controlled switching in electrical circuits...

Unlimited applications—C.D.I. thumbwheel and rotary switches offer fast, sure settings and quick read-out for computer, automated machine control consoles, check-out equipment, test equipment, programming applications, etc.

Quick Serviceability—In five seconds, any wafer of a C.D.I. rotary switch can be removed. No soldering, disassembling or wiring required. The entire module on thumbwheel switches is removable for equally fast maintenance or replacement.

Extreme versatility—Regardless of size or shape, C.D.I. is well prepared to meet your every switch requirement. Our comprehensive line of thumbwheel and rotary switches is supplemented by an engineering capacity that will custom design any switch to your precise specifications.

Patent No. 3104299
Other Pat. Pend.

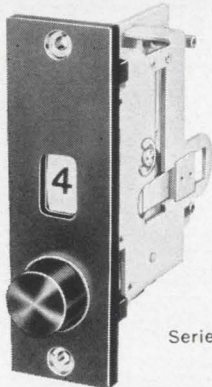

Series PSB

NEW PUSHBUTTON SWITCH

IMPERVIOUS TO DUST AND LIQUIDS

The completely sealed front panel portions of Series PSB binary and decimal rotary pushbutton switches are completely impervious to dust and liquids. Ten positions. Ideal for limited space—requires only 1" panel space per module. Simply press button to operate. Available with or without internal lighting. Data Sheets available.

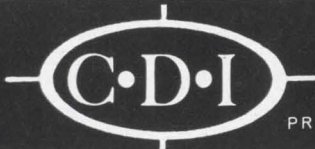

CHICAGO DYNAMIC INDUSTRIES, INC.

PRECISION PRODUCTS DIVISION 1725 Diversey Blvd., Chicago, Illinois 60614 Phone: WEllington 5-4600

Now you see 'em.

Now you don't.

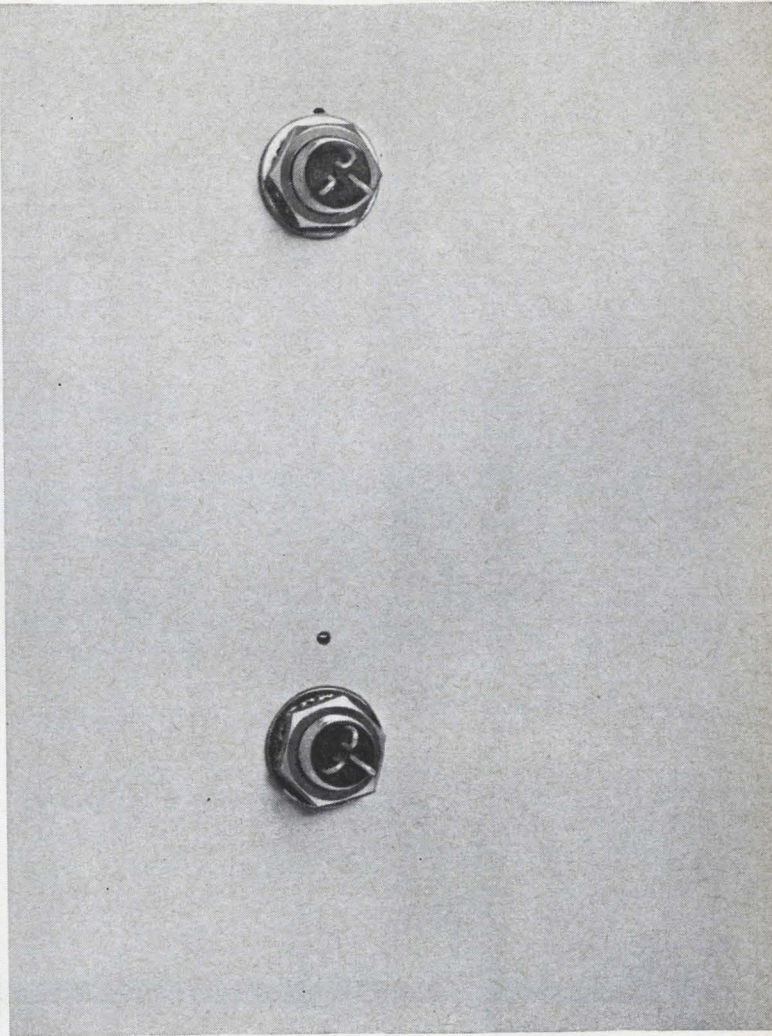
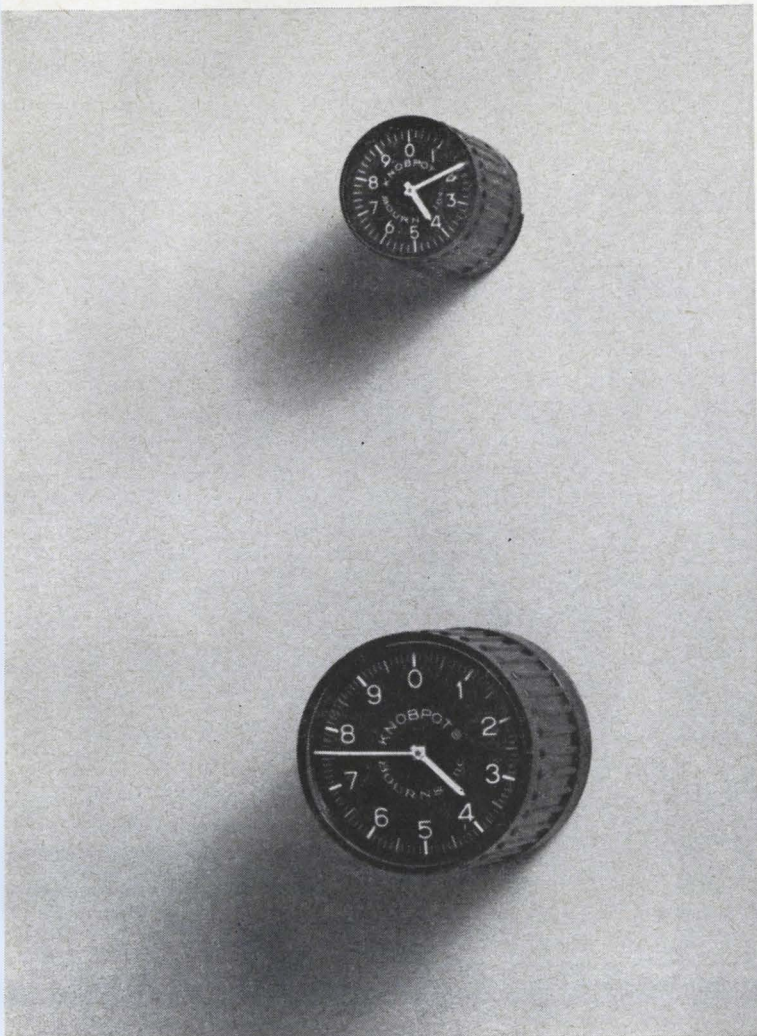

**Bourns KNOBPOT® potentiometers—
dial, knob and
precision potentiometer,
all in front of the panel!**

Nothing behind the panel but the solder hooks and the bushing—everything else is out in front in a single unit! Take your choice of two models: 3/4"-diameter Model 3600 or the 1 1/4" "Senior" Model 3640. Both are highly accurate. Model 3640, for example, has a combined dial/potentiometer accuracy of $\pm 0.1\%$ —better than most potentiometers before a dial is added! Both are also outstandingly compact. Model 3600 is shorter by 1/2" than comparable potentiometers—to say nothing of the space it saves by incorporating its own turns-counting dial.

Installation is simple: no separate dial to attach, no complicated mounting procedure, no phasing. Just drill two holes, put the unit on the panel and tighten a nut. That's it! Be out in front with Bourns KNOBPOT potentiometers—write for complete technical information.

	Model 3600 3/4" dia., 10-turn	Model 3640 1 1/4" dia., 10-turn
Std. resistances	100 Ω -250K	100 Ω -500K
Std. dial accuracy (correlation of dial reading to output, including linearity)	$\pm 0.5\%$	$\pm 0.1\%$
Std. repeatability of dial reading	0.1%	0.05%
Power rating	1.5W at 25°C	2.5W at 25°C
Max. operating temp.	125°C	125°C
Humidity	MIL-R-12934C cycling	MIL-R-12934C cycling

**MODEL 3660 LABPOT®
PRECISION POTENTIOMETER**

Compact dial-readout potentiometer for many laboratory uses. Contains a specially selected KNOBPOT unit with 1% resistance tolerance to provide highly precise measurement. Large 5-way binding posts permit easy hookup of any kind of leads. Fused for protection against burnout. Standard resistances: 1K, 10K, 100K ohms.



BOURNS, INC., TRIMPOT DIVISION
1200 COLUMBIA AVE., RIVERSIDE, CALIF.
PHONE 684-1700 • TWX: 714-682 9582
CABLE: BOURNSINC.

**CLARE automated
production makes possible
this high quality Type LB
Relay at lowest
possible cost**

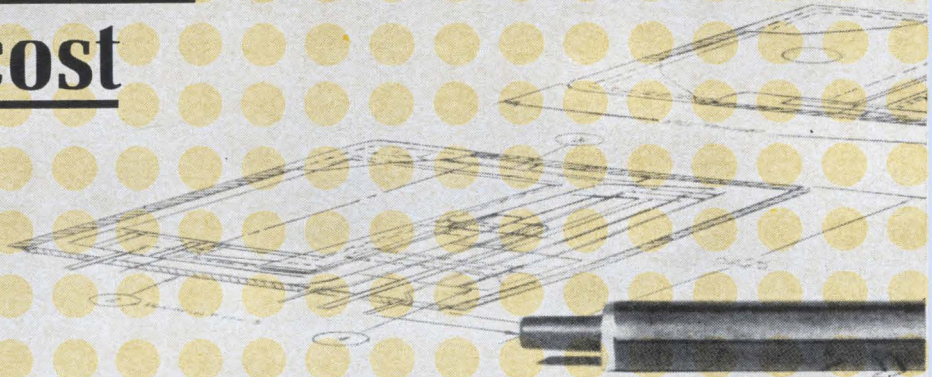

■ This new CLARE Type LB Relay is designed for the customer who must have a high quality relay at a reasonable price. A miniature telephone type relay of extraordinary switching capacity and versatility for its size, it is an ideal component for such industrial and commercial applications as:

BUSINESS MACHINES

PROCESS DATA LOGGERS

DIGITAL INSTRUMENTS

**AIRCRAFT & MISSILE
SIMULATORS**

VENDING MACHINES

COMMUNICATIONS EQUIPMENT

PROCESS CONTROLS

**COMPUTER PERIPHERAL
EQUIPMENT**

GROUND SUPPORT EQUIPMENT

ENTERTAINMENT DEVICES

Manufacture and adjustment of the CLARE LB relay are completely automatic — producing consistently high quality, at an outstanding low price.

Characteristics • Maximum Switching Capacity

Type LB Relay with mating socket—
for wired assembly mounting.

Type LB Relay with cover plate—
for mounting on printed circuit boards.



The Type LB provides contact versatility, good power gain characteristics and maximum switching capacity in relation to its small compact size. The overall height of the LB assembly (for printed circuit board application) is but 1.24 inches. Mounting styles include 1) a direct plug-in socket for wired assemblies and 2) printed circuit terminals for direct mounting to printed circuit boards.

All Type LB relays are available with contact forms A, B, C, and D—with up to six forms on a relay. For high level applications, the Type LB is rated at 2 amps, 28vdc resistive, 100,000 operations. For low level ap-

plications, 10 micro amperes, 10mv, with a maximum dynamic contact resistance of 50 ohms. Must operate sensitivity for a 6 form C arrangement is 350mw. Coil resistances up to 6550 ohms are available.

Send for data sheet No. 552. For more detailed information on the application of the Type LB Relay to a specific requirement, write CLARE Application Engineering. Address: C. P. Clare & Co., Group 02N5, 3101 Pratt Boulevard, Chicago, Illinois 60645.



*relays and
related control
components*

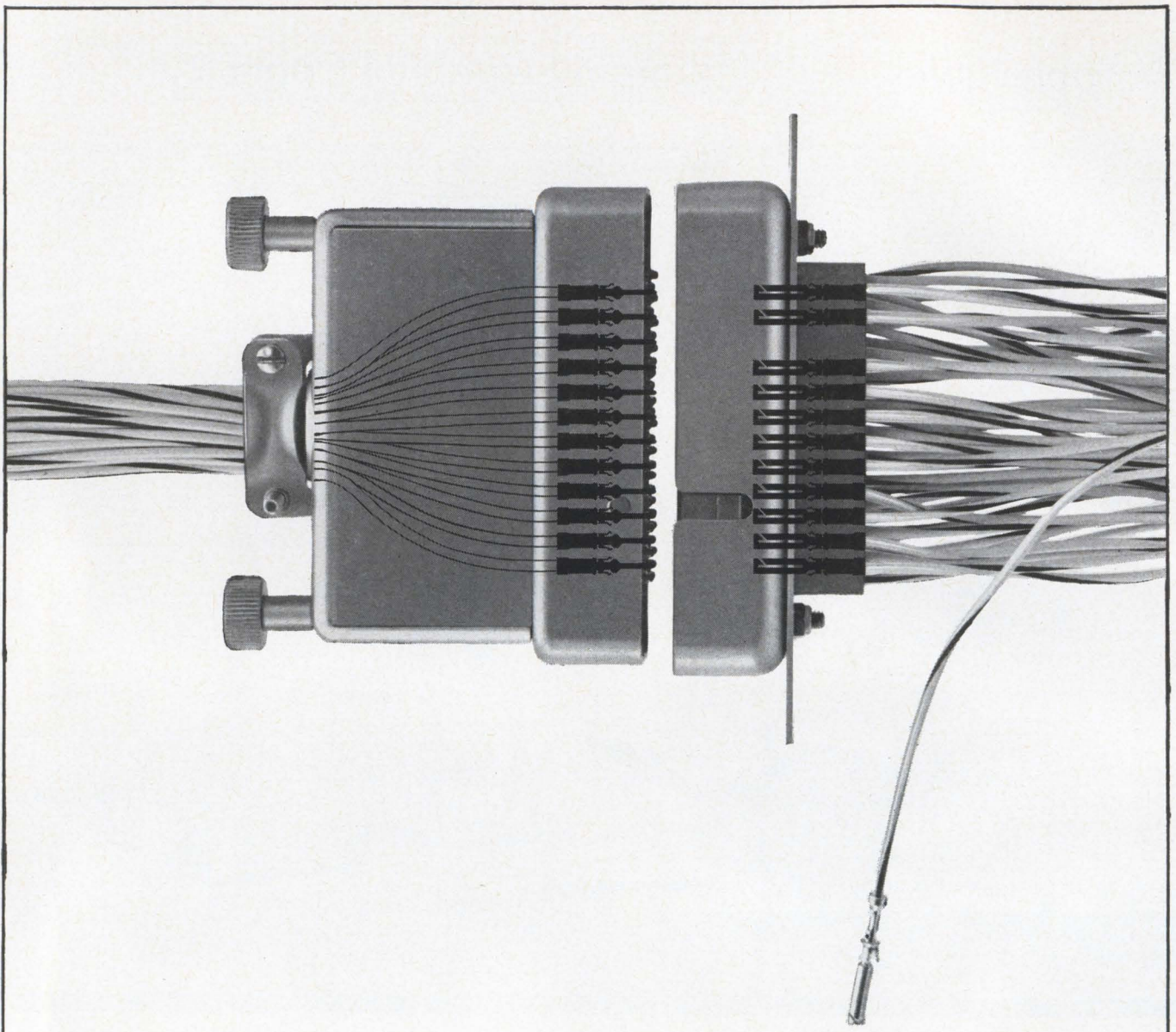

LET WINCHESTER ELECTRONICS HELP YOU CRIMP HIGH CONNECTOR COSTS

Lowest production and replacement costs, greatest design flexibility, increased reliability... these are the all-important benefits of incorporating removable, crimp contact connectors into your system. And industry-pacing Winchester Electronics supplies the whole package—inserts, shells, contacts, hoods, mounting plates, jackscrews and jacksockets, insertion and removal tools, and automated, portable pneumatic and manual crimping tools.

Our removable, crimp contact connector package means faster assembly of wires during any phase of the production cycle; circuit changes or replacement of individual contacts without destroying the connector; and positive crimped connections with contacts that can accommodate a wide range of wire sizes. Stock is readily available in numerous

miniature and subminiature rack and panel, and printed circuit types.

We also offer complete lines of miniature and subminiature rectangular, round, printed circuit, quick-disconnect/heavy-duty, environmental and special-application connectors. Prompt delivery and engineering assistance are assured by a nationwide network of distributors, regional offices and representatives. For a complete description of our connectors, accessories and tools, write for a copy of Catalog No. 364: Winchester Electronics, Main Street and Hillside Avenue, Oakville, Conn.

WINCHESTER ELECTRONICS 
A DIVISION OF LITTON INDUSTRIES

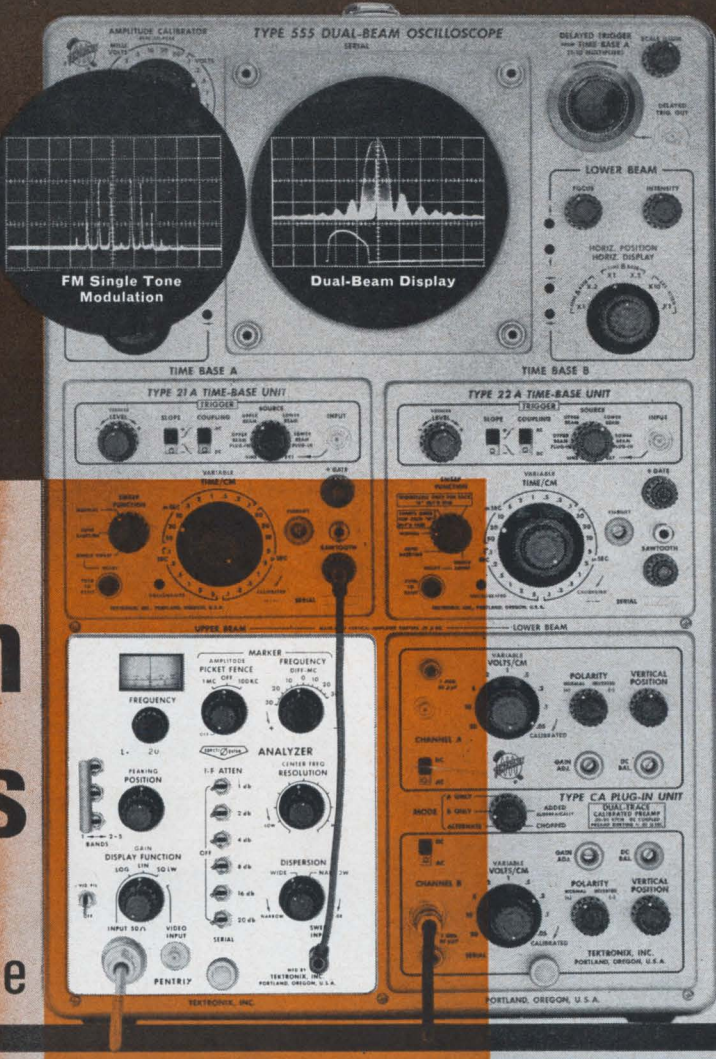
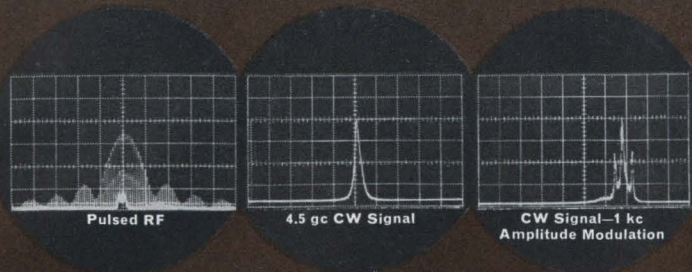

spectrum analysis

with your Tektronix oscilloscope



... with these new Tektronix Spectrum Analyzer Units—which fit all Tektronix Oscilloscopes that accept letter-series or 1-series plug-ins.

You buy only the plug-in unit.

You have a complete spectrum analyzer at a fraction of the cost of other analyzers. You don't have to purchase, store, and maintain both an oscilloscope and a separate analyzer.

It's the simplest way of spectrum analysis—for you're already familiar with the oscilloscope controls. Add the analyzer functions and you convert quickly and conveniently from time-based displays to frequency-based displays.

Original units previously manufactured by Pentrix, now manufactured and marketed by Tektronix, Inc.

CHARACTERISTICS	L-20	L-30
Frequency Range	10 Mc—4 Gc	1 Gc—10.4 Gc
Minimum Sensitivity	110—90 (-dbm)	105—75 (-dbm)
Dial Accuracy	±(2 Mc + 1% of R.F. frequency)	
Dispersion	15 kc to 60 Mc. Oscilloscope magnifier usable to 3 kc.	
Resolution BW	1 kc to 100 kc, variable	
Display	Log, linear, square law, video	
Price	\$1,995 each	

U. S. Sales Prices, f.o.b. Beaverton, Oregon

Several Spectrum Analyzer Plug-In Units — covering other frequency ranges—are available from Tektronix, and comprehensive field services back up every instrument.



For more information or a demonstration, call your Tektronix field engineer now.

Tektronix, Inc.

P.O. BOX 500 • BEAVERTON, OREGON 97005 • Phone: (Area Code 503) 644-0161 • Telex 036-691
TWX: 503-291-6805 • Cable: TEKTRONIX • OVERSEAS DISTRIBUTORS IN OVER 30 COUNTRIES
TEKTRONIX FIELD OFFICES in principal cities in United States. Consult Telephone Directory.

Circle 49 on reader service card

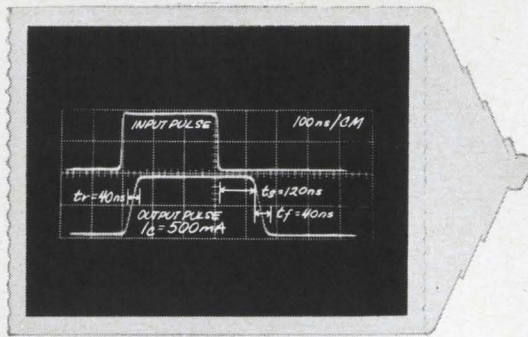

Fleet-footed at 0.5 amp

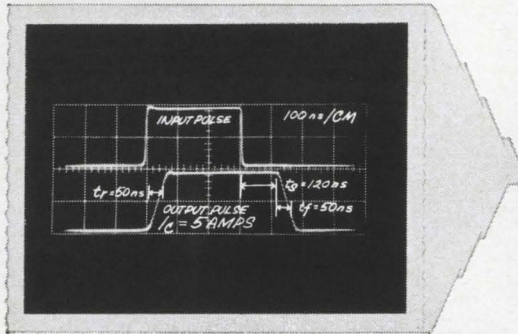

and still a speed merchant
at 5.0 amps.

2N2657
2N2658

2N2697
2N2698

2N2877
2N2878
2N2879
2N2880

2N2632
2N2633
2N2634

Packages available: TO-5, 4 watts @ 100°C; small stud, 20 watts @ 100°C. 7/16" hex, 30 watts @ 100°C; 9/16" hex, 40 watts @ 100°C.

Your fast solution for high-current switching: the 5-amp silicon planar family from Honeywell

Silicon-NPN All Types	Test Conditions	Performance Specifications
I_{CBO}	$V_{CB} = 60V$	0.1 μA max.
f_T	$V_{CE} = 10V, I_C = 200mA$	30 mc min.
BV_{CBO}	$I_{CBO} = 10 \mu A$	80-150V min.
BV_{CEO}	$I_{EBO} = 10 \mu A$	60-100V min.
BV_{EBO}	$I_{CEO} \leq 10 mA$	8V min.
$V_{BE(sat)}$	$I_C = 1A$	1.2-1.5V max.
$V_{CE(sat)}$	$I_C = 1A$	0.25-0.5V max.

Honeywell

FOR PRICE AND DELIVERY contact your nearest sales office or distributor. For more complete specifications or circuit design assistance, write: Mr. Charles Olson, Honeywell Semiconductor Products Division, 2747 Fourth Avenue So., Minneapolis, Minn. 55408.



SILICON AND GERMANIUM POWER TRANSISTORS • INTEGRATED CIRCUITS

HONEYWELL INTERNATIONAL: Sales and service offices in principal cities of the world.

R-Series
2-sizes: 3-1/2", 4-1/2"

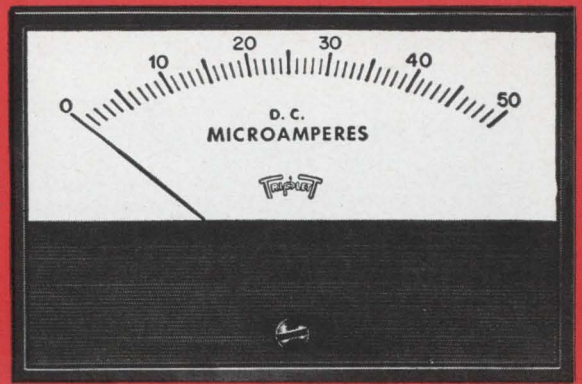

TRIPLET

"CLEAN SWEEP" PANEL INSTRUMENTS

A fresh approach to ultra-modern instrument design provides a "clean sweep" of the pointer over the full scale.

- 1** You get instant readability easier and at greater distances—plus more attractive designs to integrate into your equipment.
- 2** Self-shielded, accurate, reliable D.C. instruments have the exclusive Triplet BAR-RING movements.
- 3** Whatever your panel instrument requirement, look to Triplet for the right size and style, the right capability at the right price.



M-Series
5 sizes: 1-1/2", 2-1/2", 3-1/2", 4-1/2", 8"

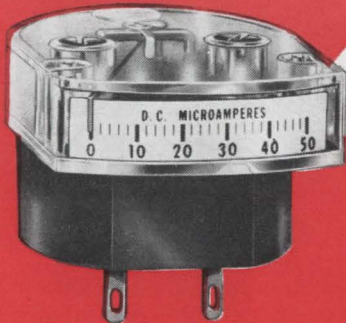

MODEL 120 Edgewise Panel Meters

SHIELDED BAR-RING MOVEMENTS

ALNICO MAGNET IS MOUNTED INSIDE SOFT IRON RING; FULLY SELF-SHIELDED

Not affected by magnetic panels or substantially by stray magnetic fields for D.C.

More Torque
Lower Terminal Resistance
Faster Response
Exceedingly Rugged and Accurate

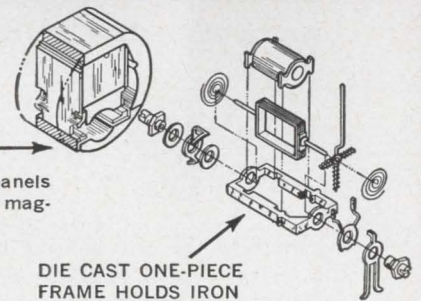

DIE CAST ONE-PIECE FRAME HOLDS IRON CORE IN EXACT ALIGNMENT



TRIPLET ELECTRICAL INSTRUMENT COMPANY, BLUFFTON, OHIO

Circle 51 on reader service card

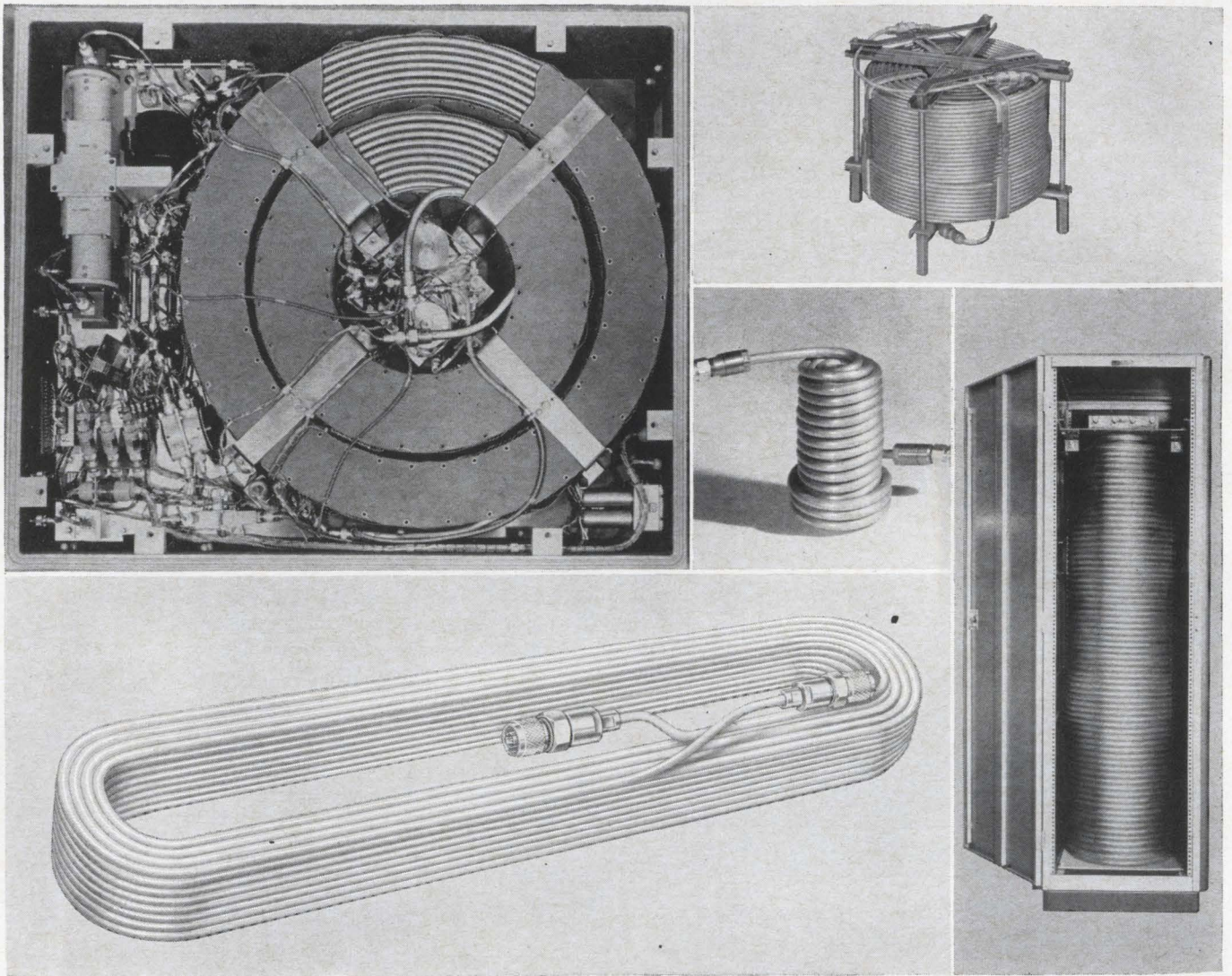

Coaxial cable delay lines. Big. Miniature. Plain, packaged or potted. Capable of accuracies up to $\pm .02$ nanoseconds.

Combine the outstanding performance characteristics of Phelps Dodge Electronic's coaxial cables with a proprietary ability to bend to a radius of three times the sheath diameter to the center line of the bend. Add newly developed measuring and testing techniques to meet unheard-of accuracies. Result? The unique in coaxial delay lines.

Here is broader band operation, less attenuation per nanosecond of delay and greater stability over wide temperature ranges. Here too, is great lati-

tude in the specification of operating parameters, physical dimensions or, moisture, vibration, shock and temperature resistance. Packaging? Containers, shock mounting, standard rack panel mounting, strapping, potting and encapsulating. And, availability for operation at frequencies from 60 cps to 12 Gc, power from one milliwatt to many kilowatts, impedances of 50, 70, 75, 100 and 125 ohms.

Can we tell you more? Let us know your requirements, or write for Bulletin DL-2.

PHELPS DODGE ELECTRONIC PRODUCTS
NORTH HAVEN, CONNECTICUT



Technical Articles

**Solid-state light-coupled
switch for low-level
multiplexing:
page 54**

As activity in optoelectronics picks up momentum, new devices are appearing with increasing frequency. One problem that optoelectronic devices solve neatly is circuit isolation, which is never complete when a three-terminal switching transistor is used. This four-terminal solid-state switch isolates the signal circuit by coupling with a beam of light.

**Microcomponent boards
link integrated circuits:
page 67**

These days, the big problem in microelectronics is often packaging or interconnecting the elements rather than designing the circuit. A universal packaging technique not only solves the interconnection problem but opens the door to other benefits: automation of engineering and production, and cost-cutting.

**Laser-television system
with off-the-shelf gear:
page 75**

One of the applications considered when the laser was first demonstrated was for carrying television programs. Now a step has been made toward realizing that application inexpensively. In this system, proposed for plant security and interoffice communications, the laser beam travels a mile.

**Navigation satellites
for ships and planes
page 79**

Ever since he learned to walk, man has been asking, "Where am I?" Satellites with electronic instrumentation and communications promise an automatic answer to that question for ships and aircraft. Several systems have already been proposed to do the job.

**Coming
February 22**

- **Missile range updates its instrumentation**
- **A look at micropower transistors**
- **Microelectronic receiver controls monkey's actions**
- **Production tips**

Light-coupled semiconductor switch for low-level multiplexing

Four-terminal device isolates the drive signal from switching terminals and has flow offset voltage

By Edward L. Bonin

Texas Instruments, Inc., Dallas, Texas

A four-terminal semiconductor switching device has been developed that completely isolates the drive circuit from the switching circuit. Using light-beam coupling,¹ it permits the engineer to design without worrying about electrical interaction between circuits. Its useful frequency range is from d-c to several kilocycles per second.

This switch permits only a feeble offset voltage—30 microvolts in the case of one device—to be developed across the signal terminals. This characteristic makes the new switch particularly useful for low-level chopper or multiplex applications.

Texas Instruments, Inc., calls the switch OMS, for optoelectronic multiplex switch, to emphasize the major application for which it is intended.

Light source and detector

The device [shown on page 55] combines a gallium arsenide-pn-junction light source and a silicon photodetector in one package. The photodetector is a diffused, planar photo-transistor with symmetrical conduction characteristics. The pn-junction light source is gallium arsenide.

Drive current forward-biases the light-emitting diode, causing it to give off photons that are collected efficiently by the detector. This light is in the near-infrared range at a wavelength of about 0.9 micron.

The emitting diode operates at high efficiency at -25° to $+75^{\circ}\text{C}$, the operating range of conventional devices. At 25°C the efficiency is about 2%; that is, for every 100 electrons that flow through the diode, two photons are transmitted out of the gallium arsenide. Earlier devices that operated on a similar principle provided emission efficiencies of 0.1% to 0.3%.

The construction of the four-terminal switch is

shown on page 55. The light-source diode and photo-detector are mounted in separate headers to permit adjustment prior to hermetic sealing. The stud is also the positive drive terminal. Two of the three leads at the other end of the package are terminals for the signal section; the third lead, the negative drive terminal, is connected to the case.

The n-region of the light-source diode lies between the positive drive connection (p-region) and the photo-detector. The n-region, which is also connected to the metal case, forms an electrostatic shield between the drive and signal sections.

Electrical characteristics

Two devices that use this construction are being marketed commercially. These are the PEX3002 and the PEX3003. In both, the light source and the detector are separated by only a few thousandths of an inch, which is sufficient to support a 400-volt potential without breakdown. The leakage resistance between the drive and signal terminals is due primarily to the package itself, and is typically 4×10^{12} ohms. Even if the device is removed from the package, this resistance does not change appreciably.

For fixed values of drive current, the detector exhibits a symmetrical, bilateral current-voltage characteristic as shown in the graph on page 56. This characteristic is similar to that of a conventional double-emitter chopper transistor. The detector biasing that results from light absorption in the region near its pn junction corresponds closely to base-collector forward biasing for a conventional double-emitter transistor. However, the four-terminal optically coupled switch does not duplicate the accelerated turn-off that is obtained with the double-emitter device by reverse-biasing its base-collector junction.

The voltage-current curve for a constant drive

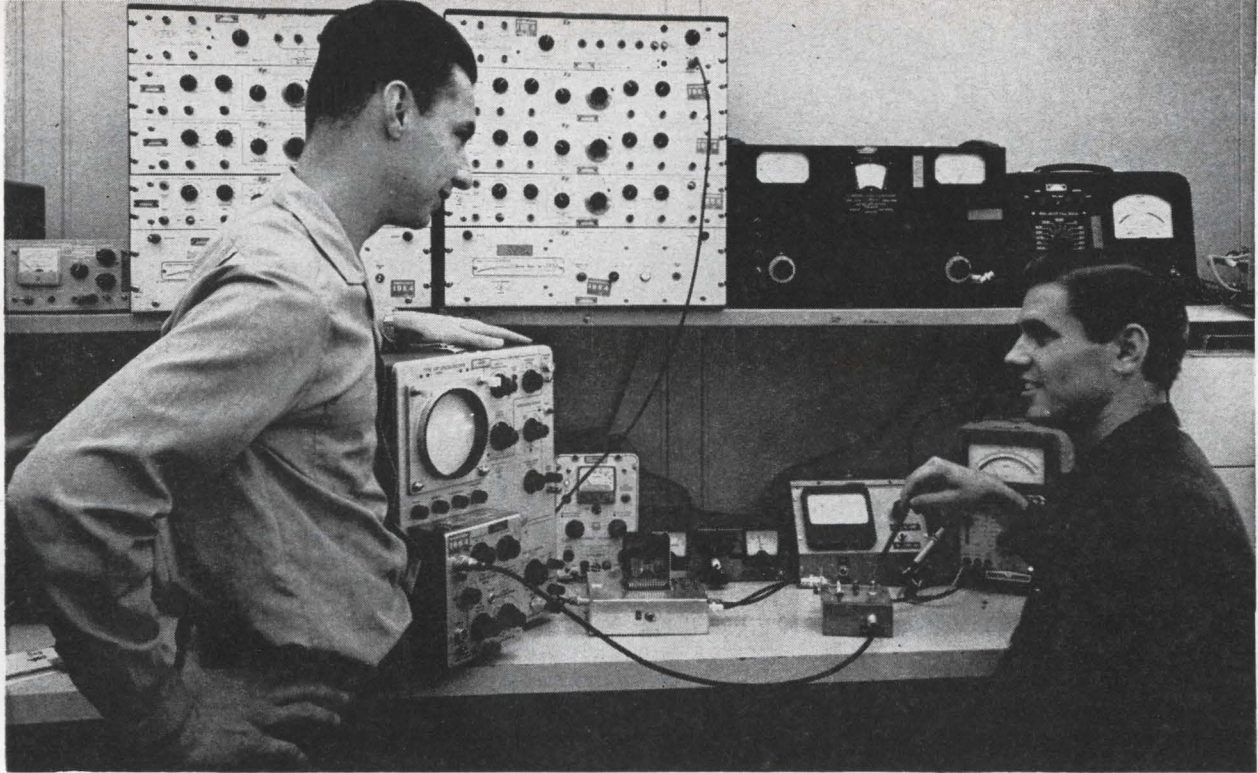

Checking the performance of the four-terminal switch in a series-shunt chopper circuit are Edward Bonin, engineer at TI, and Gerald Meeks, a technician. Oscilloscope shows the square-wave output obtained at an operating frequency of one kilocycle.

current I_D crosses the V_s and I_s axes near the origin ($V_s=0$, $I_s=0$). The curve does not necessarily cross exactly at the origin; even for zero signal current, a small voltage may be developed across the signal terminals. This terminal voltage, called the offset voltage V_0 is added algebraically to the incoming signal and determines the minimum practical level for the signal voltage.

An unusual feature of the device is that the offset voltage of individual units may be adjusted to a minimum prior to hermetic sealing. This is accomplished by moving the light source closer to the detector or farther from it. This adjustment accounts for the low offset voltage for the switch.

As shown on page 56, the magnitude of V_0 for

the PEX3002 does not exceed 30 microvolts at case temperatures of -25° , $+25^\circ$ and $+75^\circ\text{C}$ for a drive current of 100 milliamperes. For the PEX3003, the magnitude of V_0 does not exceed 100 microvolts under the same conditions.

In general, the V_0 of a device may be positive or negative with respect to the V_0 of another device. For the PEX3002, the algebraic difference of V_0 values at -25°C and $+75^\circ\text{C}$ does not exceed 40 microvolts; for the PEX3003 this difference is 125 microvolts or less. Changes in V_0 with temperature are a result of changes in the diode source's light output and in detector parameters. As experience is gained in fabricating the switch, it should be possible to produce one with a V_0 of less than 10 mi-

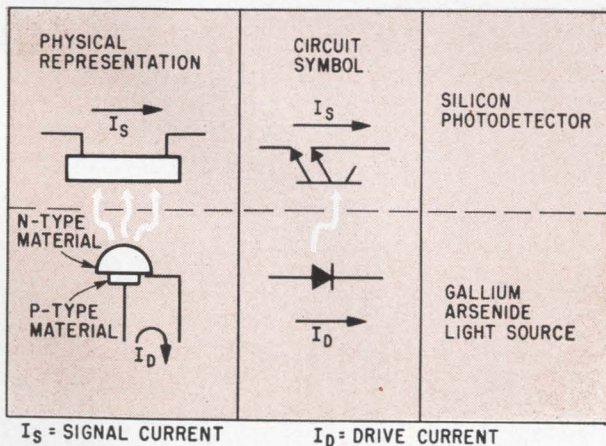

Four-terminal switch consists of a gallium-arsenide light-injection diode (source) and a silicon phototransistor (detector). The source and detector are only a few thousandths of an inch apart.

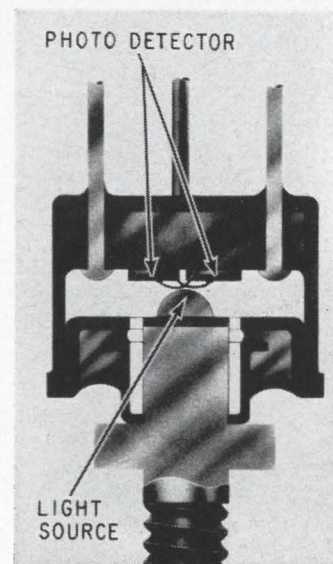

Cross section of the four-terminal switch. The detector consists of two sections to the left of the semicircular source. Top and bottom leads at left are switch terminals. The center lead and the stud are drive terminals.

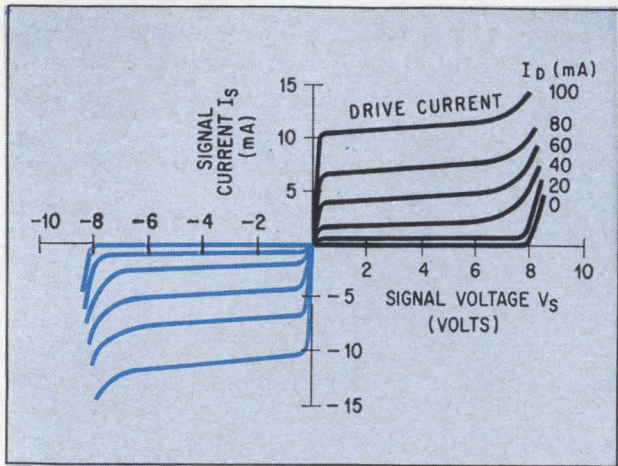

Current-voltage characteristic for the four-terminal switch is similar to that for a conventional double-emitter chopper transistor.

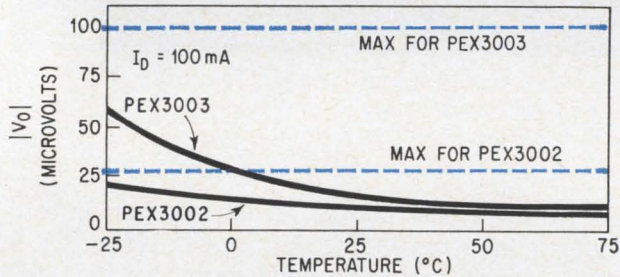

Offset voltage varies with temperature. Curves indicate characteristics for four-terminal switches. Straight lines are guaranteed maximums.

crovolts over the operating temperature range.

The switch's "on" resistance R_{ON} , although small, accounts for an algebraic increase in the voltage across the signal terminals as the signal current is increased. Because V_O is small, the on resistance is largely a measure of the static slope (V/I) of the current-voltage characteristic. When the switch is on, the signal terminals are usually biased in the region near the origin, where the curves are nearly vertical. For an ordinary transistor switch, this would be called the saturation region.

In chopper applications, for high accuracy, R_{ON} should be small compared with the input impedance of the following electrical stage. For the four-terminal switch, R_{ON} is typically 30 ohms for a signal current I_S of ± 1 ma, drive current I_D of 100 milliamperes, temperature T_C of 25°C . The effects of changes in I_S , I_D , and T_C on R_{ON} are indicated in the graphs below. For very large values of I_S , the detector will be biased out of saturation and R_{ON} will increase abruptly. The reduction in R_{ON} with I_D shown below reflects the increase in the light output of the source with bias. As the temperature increases, the reduction in the source's output efficiency is balanced by the increasing current gain of the detector.

Current in the off state

For zero bias on the light source, the switch is off and generally only a small current flows. This off current $I_{S(OFF)}$ is a function of the signal voltage V_S and temperature, as shown at the top of p. p.

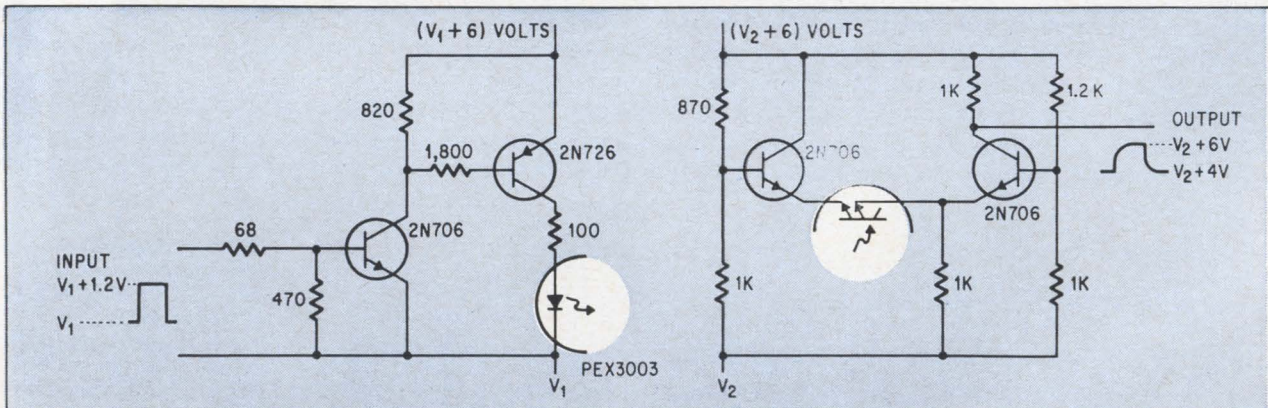

Binary switching circuit. The four-terminal switch makes possible the transfer of binary (on-off) signal between two electrically isolated circuits. Besides the switch, four conventional transistors are employed.

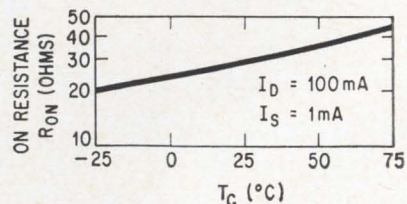
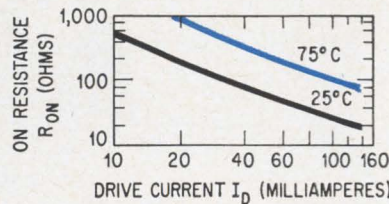
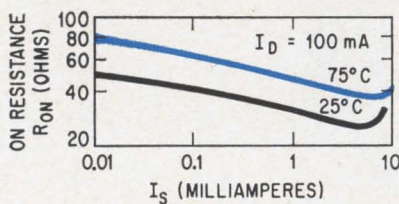

Relationship between signal current and on resistance, at room temperature and at an elevated temperature, are shown in top set of curves. Middle set depicts decrease of R_{ON} as I_D is increased. I_D is equal to 0.01 I_S . Bottom curve shows how R_{ON} increased with temperature.

56. The leakage current increases considerably as the signal voltage approaches the breakdown voltage BV_s , which is typically eight volts.

Drive requirements

The gallium-arsenide-source diode has a highly nonlinear current-voltage characteristic and should be used in a high-resistance [stable current] circuit.² The diode's voltage drop for the typical operating forward current of 100 milliamperes is about 1.3 volts. Operation at 100 milliamperes is a compromise between low R_{ON} and V_O over the temperature range, and good operating speed. Of course, other values of drive current can also be used.

The best switching speeds are obtained with the

signal terminals operating in a low-impedance circuit. An example of general-purpose switching between two isolated circuits is shown in the diagram on page 56. Voltage V_1 and V_2 are the bias voltages and may differ by as much as 400 volts. In this circuit, the drive current I_d is 40 milliamperes, the signal current I_s is 2 milliamperes, the output voltage is 2 volts peak-to-peak, and the switching (rise and fall) times are 10 microseconds. The low impedance for the signal terminals is provided by connecting the four-terminal switch in series with an emitter in the current-mode switching circuit.

Binary switching

This circuit is useful for binary (on-off) switching. For analog switching, in which the amplitude

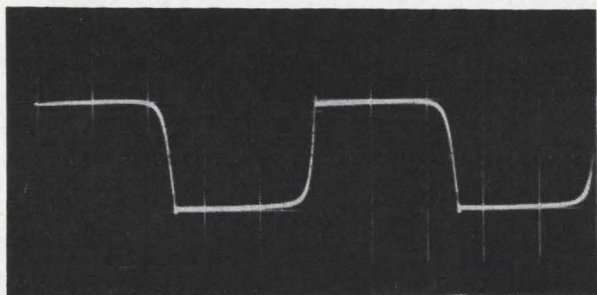
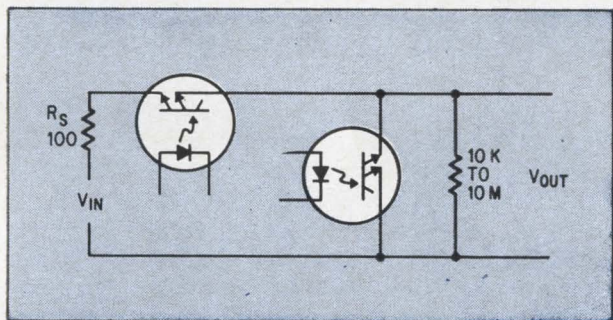
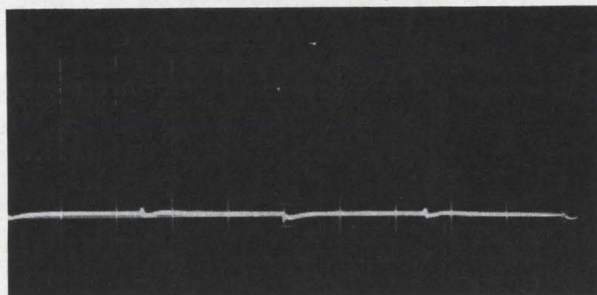
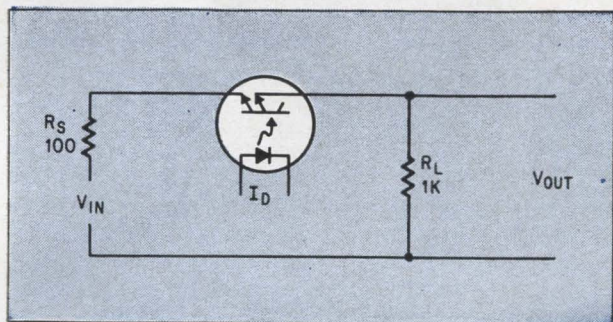

Analog switching circuits. Top series chopper circuit requires low R_s and R_L values. The series-shunt-connected circuit at bottom is better for a large load resistance.

Output waveforms for series-shunt chopper circuit. Top waveform is for zero input signal. Bottom waveform was obtained for a one-millivolt signal with R_L of 10 megohms and a frequency of two kilocycles per second. Each major vertical box represents 500 microvolts; each major horizontal box represents 100 microseconds.

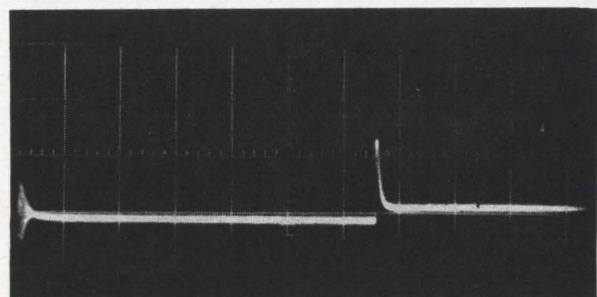
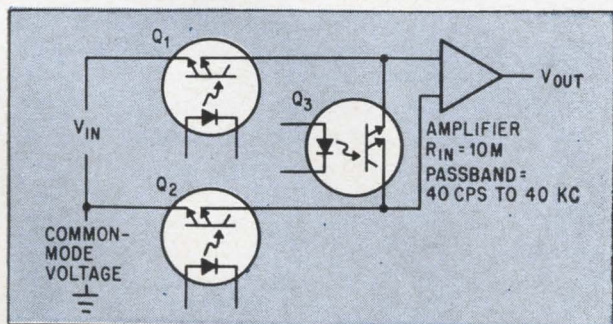

Application of four-terminal switches in a high-noise environment. Three switches are used with a differential amplifier.

Output waveform for the circuit at left, with zero signal and common-mode voltage of five volts rms at 400 cycles per second. Each major vertical box represents 200 microvolts (referred to the input); each horizontal vertical box represents 50 microseconds.

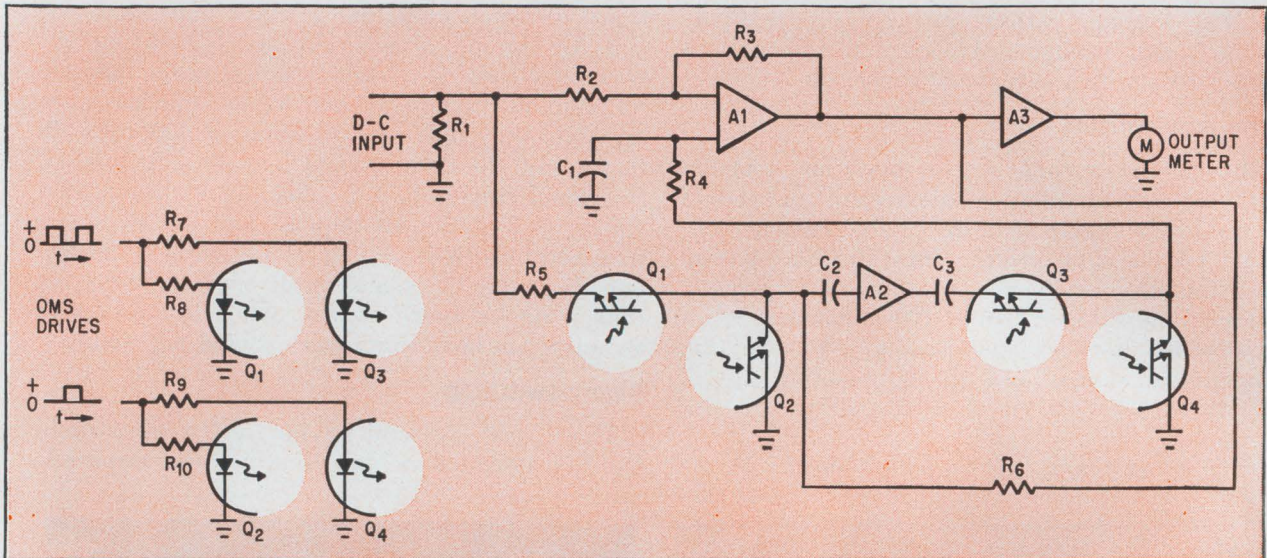

Chopper-stabilized microammeter uses four-terminal switches. A_1 is a differential amplifier; A_2 and A_3 are linear amplifiers. The D-c input handled varies from a few hundred microvolts to several volts.

of a signal must be preserved, circuits such as those shown on page 57 may be used. These chopper circuits convert low-level d-c or low-frequency signals to a-c signals by applying square-wave drive currents to the four-terminal switch devices. The a-c signals can then be amplified with low-level a-c circuits that are easier to design for stable performance than are direct-coupled stages.

Because the signal terminals of the four-terminal switch have symmetrical characteristics, the input signal may have either positive or negative polarity. Obtaining low impedance for the signal terminals with a series-type chopper circuit generally requires a small source resistance R_s and small load resistance R_L .

For a large load resistance, the series-shunt-connected circuit is faster. In this circuit two four-terminal switches operate alternately. For this circuit, the first switching device is provided with a small load resistance for faster turn-off by the shunting action of the second device when it is turned on. Output waveforms for the series-shunt circuit, operating at 2 kilocycles per second with I_D equal to 100 milliamperes square-wave and R_L equal to 10 megohms, are shown on page 57 for

zero input signal and with a d-c signal of one millivolt. The scales for the major divisions are 500 microvolts for the vertical boxes and 100 microvolts for the horizontal boxes. Switching times for this circuit typically range from 5 to 20 microseconds. For the series type of circuit with I_D of 100 milliamperes and R_L of 1,000 ohms, the rise time is typically 3 microseconds and the fall time is 20 to 40 microseconds.

The advantages of complete isolation of the drive and signal circuits are particularly evident when considering common-mode noise.³ Often, with signals of small amplitude, neither lead from the signal transducer can be grounded at the amplifier. This may be the case, for instance, if the transducer is remotely connected in airborne equipment. If one lead of the transducer is grounded on the airplane frame and if one side of the amplifier input is also grounded, noise voltages between these two ground points on the airframe appear as additional signal input to the amplifier. A circuit in which this noisy environment occurs is shown at bottom of page 57.

To overcome the presence of the noise voltage or common-mode voltage, three 4-terminal switching devices are used. Switches 1 and 2 operate simultaneously and alternately with switch 3. Rejection of much of the common-mode voltage is provided by a differential amplifier because neither input terminal of the amplifier needs to be grounded.

When switches 1 and 2 are on, the two input leads of the amplifier are connected across the signal source. The amplifier is designed so that its input is determined by the difference between the voltages applied to the two input terminals, in this case, this difference is the signal.

The amplifier is nearly immune to the common-mode noise that is applied from one input lead to ground. When drive to switch 3 is applied, it is removed from switches 1 and 2. This low-imped-

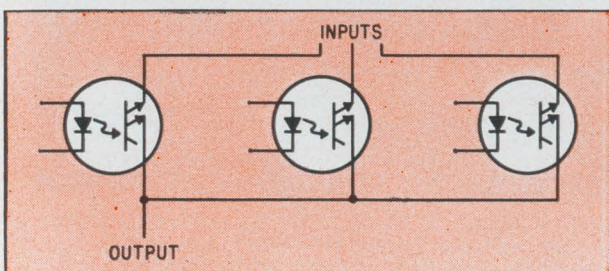

Multiplex switching circuit is used for sequential sampling of a large number of signals.

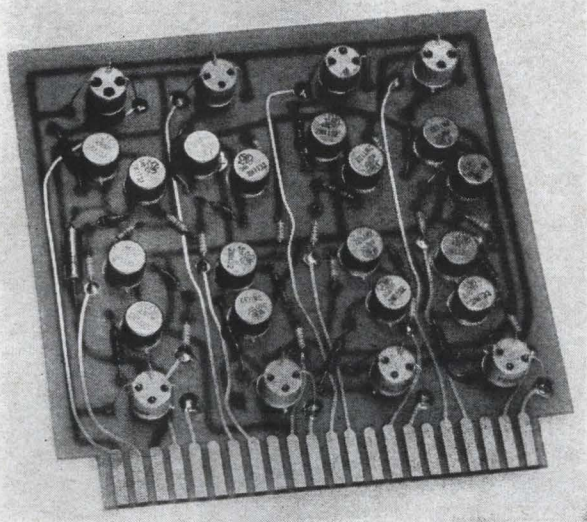

Eight-channel multiplex switch uses eight 4-terminal switches. Each switch circuit includes a pair of drive transistors.

ance shunting accelerates the turn-off. Similarly, when switches 1 and 2 are turned on, a low impedance through the signal source is provided to turn off switch 3. The waveform on page 57 shows the amplifier output for zero signal and a common-mode sine-wave voltage of 5 volts rms at 400 cycles per second. The repetition rate for the switches is about 1.4 kilocycles per second. Even with such high common-mode noise, the circuit can amplify small signals.

Multiplex circuit

The multiplex circuit shown on page 58 is used when a large number of signals must each be monitored frequently. In the Titan II missile, for example, 250 variables are monitored and transmitted in flight.⁴

Each signal input is connected to one terminal of the switch. In general, this input signal may come directly from a signal transducer or may be the output of an intermediate amplifier, depending on the circuit impedances and voltage levels. The complementary switch terminals are all connected to form a single signal-output terminal. When the switches are turned on one at a time, the output waveform becomes a repetitive sampling of all input voltages.

The operation of the multiplex circuit is similar to that of the series-shunt chopper that was discussed previously. Assume at a given time that one switch is on. Drive is removed from this switch and offered to the next simultaneously. The low-impedance paths that run through the switch that is turning on and through the inputs help to reduce the turn-off time. This action is identical in the series-shunt chopper.

In each switch, both terminals remain at signal potential as shown in the diagram on page 58. This makes it necessary for the signal section of the switch to have good isolation from the drive sec-

tion. With optical coupling across the air gap, the coupling between the drive and signal sections of the OMS device is represented by a leakage resistance of about 4×10^{12} ohms and capacitance of about 3 picofarads. Also, because the offset voltage of the four-terminal switch is small, signal transducers may be connected directly without the need for amplification before the multiplexing operation.

A complete eight-channel multiplex-switch board, using eight OMS devices for sampling bit rates of up to 30 kilocycles per second, is shown at the left. Development of the basic switching device and printed circuit board were sponsored by the Electronics Technology division, Air Force Avionics Laboratory, under contract AF33(616)-8339.

Test-equipment circuit

Several four-terminal switching devices are used in the chopper-stabilized d-c microammeter shown on page 58. In the circuit⁵, a small voltage is developed when input current flows through the small resistor R^1 , which shunts the input. In one signal path, this voltage is chopped with the series-shunt connection of switches 1 and 2. This a-c signal is amplified by the a-c circuit A^2 , then the zero-reference level of this signal is established by the synchronously driven series-shunt chopper, switches 3 and 4. After passing through a low-pass filter (R_4 and C_1), the signal—now d-c—is applied to one input of differential amplifier A_1 . A_1 's other input is connected to the signal-input terminal. With this circuit, the amplifiers have stable gain.

The high-level output of A_1 is then connected to a low-gain d-c amplifier A_3 , which drives the output meter. The low offset voltage rating of the four-terminal switch requires only a millivolt or less to be developed across the input resistor R_1 . This resistor can be changed to establish the measuring range of the meter. For measuring very small currents, the size of the input resistor determines the maximum speed of the switches.

References

1. M.F. Wolff, "Look at what optical semiconductors do now," *Electronics*, June 28, 1963, p. 32.
2. E.L. Bonin, "Drivers for optical diodes," *Electronics*, Aug. 10, 1964, pp. 77-82.
3. E. Cunningham, "Isolated-input analog/digital data-acquisition instrumentation," *Data Systems Engineering*, December, 1963, pp. 8-11.
4. J.V. Dirocco and J.W. Peghing, "Low-level encoding approach: latest details of Tital II telemetry," *Electronics*, Nov. 23, 1962, pp. 36-39.
5. P. Beneteau, L. Blaser and R. Lane, *Transistor Operational Amplifiers*, Report TP-20, Fairchild Semiconductor, Mountain View, Calif.

The author



E.L. Bonin is project engineer for pilot production of commercial optoelectronic devices in the Semiconductor Components division of Texas Instruments, Inc. His article on drivers for optical diodes appeared in the Aug. 10 issue of *Electronics*.

Designer's casebook

Designer's casebook is a regular feature in Electronics. Readers are invited to submit novel circuit ideas, packaging schemes, or other unusual solutions to design problems. Descriptions should be short. We'll pay \$50 for each item published.

Magnetoresistors isolate load from control circuit

By Robert M. Gitlin

American Aerospace Controls, Inc., Farmingdale, N.Y.

Magnetoresistance triggering is one of the few methods of applying d-c bias levels and a-c trigger pulses while maintaining complete isolation between the control and load circuits. The magnetoresistance trigger module is a solid-state device requiring neither heaters nor filaments.

The operation of the basic trigger module depends upon the flux-variable characteristics of two magnetoresistance elements, M_1 and M_2 , connected in a simple wheatstone bridge, as shown at the left on page 61. Flux excited by the current in the coil, alters the resistances of M_1 and M_2 , causing the bridge to become unbalanced. The magnetic circuit is physically arranged with an internal magnetic bias so that the flux field causes opposing resistance variations in M_1 and M_2 , increasing the

sensitivity of the bridge output. When the bridge is unbalanced, some part of the bridge excitation voltage appears across the output terminals.

The output for the module shown in the diagram is about 1 volt d-c (or a-c rms) with coil current of 25 ma and bridge excitation of 24 volts. Larger modules develop proportionately greater outputs. Note that the input current or the bridge excitation voltage can be either polarity.

Since the magnetoresistance trigger module does not rely on conventional transformer principles for coupling between input and output, both a-c and d-c inputs can be applied separately or in combination to the bridge circuit and the input coil. The graph shows that with constant d-c coil current as a parameter the input-output voltage characteristics are linear. The table of waveshapes illustrates the various possible operating modes.

A-c signals of the same frequency applied simultaneously to the coil and bridge produce an output at twice the input frequency. This a-c output is offset from zero by the d-c bias level. The a-c signal can be filtered out or a capacitor can be used to block the d-c bias level, in either case, providing useful control features.

A basic control circuit for adjusting the firing

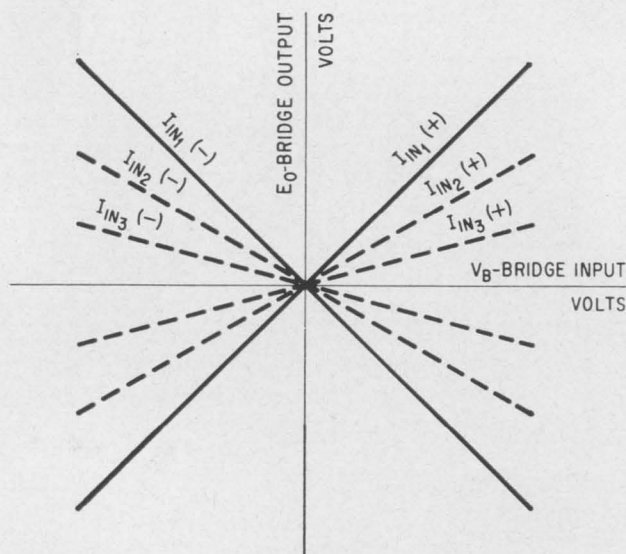

COIL INPUT	BRIDGE INPUT	BRIDGE OUTPUT
D-C + 0 -	D-C + 0 -	ANALOG MULTI. + 0 -
D-C + 0 -	A-C + 0 -	+ 0 -
A-C + 0 -	D-C + 0 -	D-C TO A-C CONVERSION MULTI. PHASE SENSITIVE NULL DETECTION
A-C + 0 -	A-C + 0 -	MODULATION + 0 -
A-C + 0 -	A-C + 0 -	+ 0 - D-C OFFSET DOUBLE FREQ.

Input-output voltage characteristics of the magnetoresistance module with coil current as a parameter. The table of waveshapes shows that the roles of the current coil and bridge excitation in control circuits can be interchanged. The flux-resistance variations of the magnetoresistance elements are physically arranged to provide maximum output sensitivity.

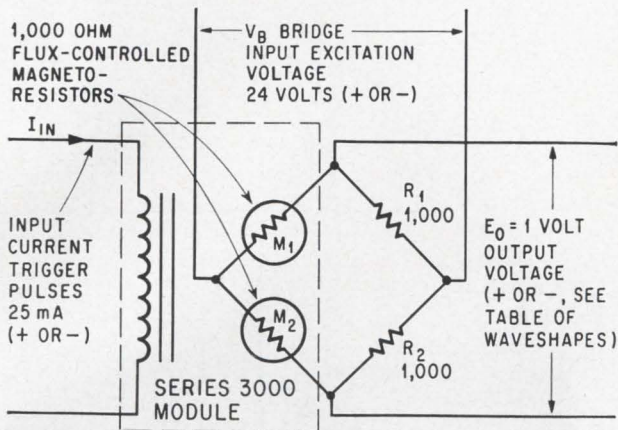

Magneto-resistance trigger module provides electrical isolation between load and control circuits. Flux induced by the trigger current in the coil changes the resistance of the magneto-resistance elements M_1 and M_2 , unbalancing the bridge and producing an output voltage E_0 .

angle and trigger level of an scr, is shown above right. The capability of this circuit can be increased by introducing an AND logic function. Two windings can be provided on the magnetic core of the magneto-resistance module. One winding provides the bias for the bridge and the other transmits the trigger pulses. The scr fires only when both bias and trigger pulses are present simultaneously. It is also possible to implement the AND function by varying the level of bridge excitation. Since no output is developed unless the bridge is excited, adjustment of excitation voltage provides a flexible means of control.

In some applications it may be necessary to ap-

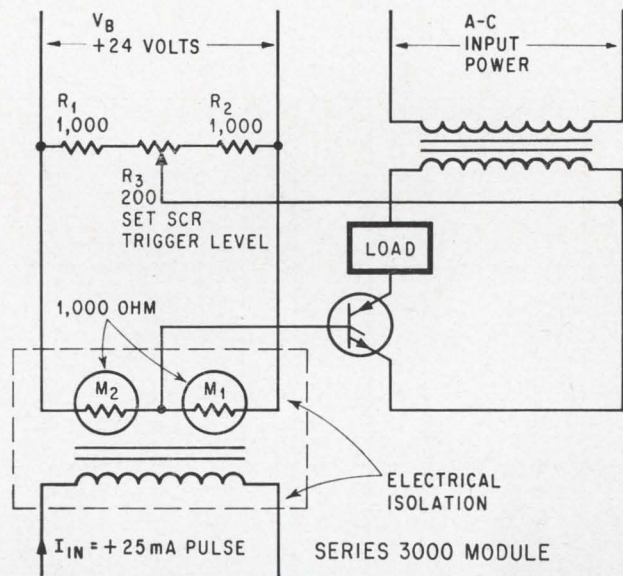

Scr trigger module. The output voltage has the same waveshape as the input coil current. A thermistor can be inserted between the bridge output (junction of M_1 and M_2) and the scr gate for temperature compensation.

ply input signals to the bridge and use the coil as the bias control. The magneto-resistance module then becomes a continuously variable bridge whose input-output ratio depends upon coil current (bridge imbalance). This circuit can be useful as a variable attenuator for automatic gain control and related applications.

The rate of resistance variation of the magneto-resistance elements in response to changes in magnetic flux is of the order of megacycles per second.

Scr's regulate a-c line voltage

By Reuben Wechsler

Semiconductor Division, Motorola, Inc.
Phoenix, Ariz.

The a-c line-voltage regulator shown in the diagram on the following page, maintains the nominal output load voltage within 1 volt as the line voltage varies between 105 and 125 volts. The circuit package is compact and lightweight because the regulating is actually done by silicon controlled rectifiers.

The full-wave bridge (MDA 920-4, Motorola) rectifies the line voltage and furnishes low d-c

power for the unijunction transistor trigger circuit. The trigger circuit supplies the scr gate trigger pulses via transformer T_1 and regulates the scr firing time as the line voltage varies.

When the line voltage increases, the voltage applied to base 2 of the unijunction transistor also increases, but the emitter supply voltage is held constant by zener diode D_2 . The trigger frequency decreases, delaying the scr firing time. The average current through the scr's and T_2 decreases until the load voltage returns to its nominal value. Similarly, when the line voltage decreases, the unijunction transistor trigger frequency increases, scr conduction increases, the average current through the scr's and T_2 increases until the load voltage again returns to its nominal value.

Zener diode D_3 only serves to drop the rectified line voltage to a safe operating level for the UJT. Using a zener diode instead of voltage-dropping

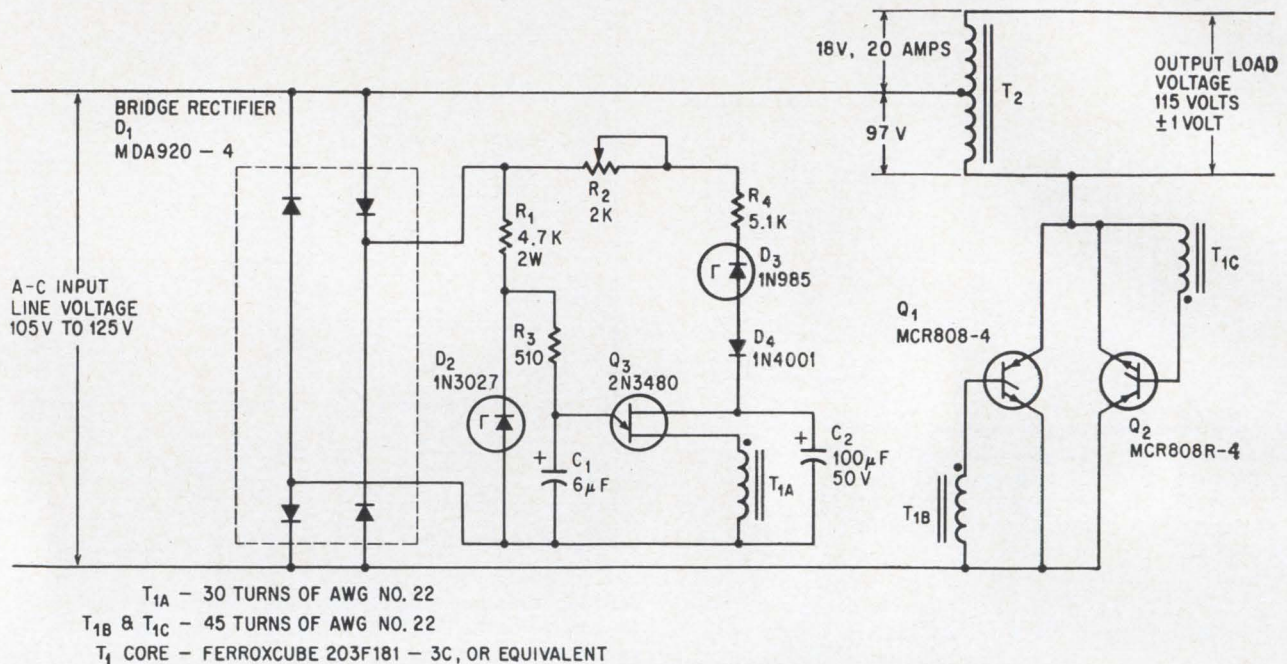

A-c input line voltage controls the trigger rate of the unijunction relaxation oscillator. Average current through scr's is controlled by the unijunction transistor triggers. Reference source for the regulator is zener diode D_2 . The regulated output voltage level is adjusted by R_2 .

resistors provides some regulation for the trigger circuit supply. Diode D_4 prevents filter capacitor C_2 from discharging back through the circuit.

Optimum regulation is achieved by applying 125 volts across the input terminals and adjusting potentiometer R_2 to provide 97 volts across the lower section of autotransformer T_2 as indicated in the circuit diagram. Autotransformer T_2 steps up the output voltage from 97 volts to the nominal 115-volt line voltage.

The specified scr's can handle load currents of 25 amperes. It is important to note that one of the scr's is of reverse polarity (i.e., the anode and cathode are interchanged with respect to the case). Both scr's can be mounted on the same heat sink, without insulating washers.

For lower current applications, the scr's in the circuit diagram can be replaced by the MCR1304-4 and MCR1304R-4; these are capable of an average load current of 11 amperes.

Diode eliminates multivibrator bias

By C. S. Osborne

Racal Instruments, Ltd., Berkshire, England

A conventional one-shot multivibrator circuit usually needs a bias voltage to keep one of the transistors nonconducting while the circuit is quiescent. But this bias voltage can be eliminated by connecting diode D_1 to keep Q_1 nonconducting in the circuit at right, on page 63, top.

When the transistor is quiescent, the only voltage available to cause base current to flow in Q_1 is the saturated emitter-collector voltage of the conducting transistor Q_2 . This voltage is too small to cause any base current to flow in Q_1 because the base-emitter voltage of Q_1 is larger than the saturated emitter-collector voltage of Q_2 . Also, diode D_1 presents a high forward impedance when a small potential is impressed across it (especially if D_1 is a silicon diode). A low-voltage zener diode could be used instead of the forward-conducting diode shown in the lower circuit diagram.

With the base effectively open-circuited, the collector current is I_{CEO} , which is negligible compared with the collector current I_C when Q_1 is conducting. This causes a slight decrease in the volt-

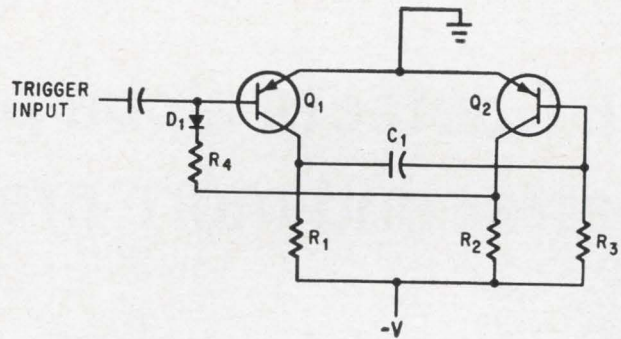
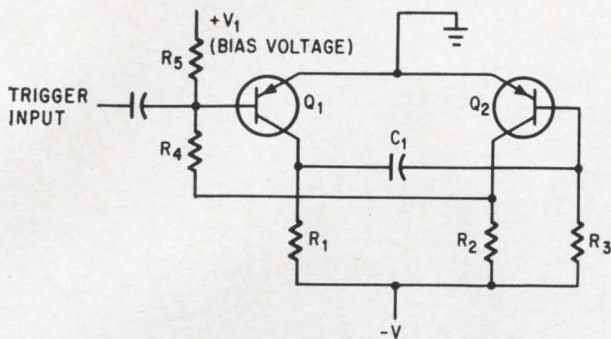

Standard one-shot multivibrator circuit, shown at the left, must have a bias voltage that keeps transistor Q_1 from conducting during quiescence. But if diode D_1 is added, right, it keeps Q_1 nonconducting during quiescence and the bias voltage is unnecessary.

age swing applied to C_1 , which causes an insignificant decrease in the circuit's on time.

When Q_1 conducts, its base current is slightly

modified by the forward voltage drop across D_1 , which must be considered in calculating the value of R_4 .

Two transistors simulate high-current tunnel diode

By Sidney V. Soanes

Ferranti Electronics, Toronto

The volt-ampere characteristic of the circuit shown at right is similar to that of a tunnel diode but the V-I characteristic can be controlled conveniently. The peak current of this simulated "tunnel diode" circuit can be varied over a wide range by the current I_K .

The negative resistance region of the volt-ampere characteristic is explained as follows. Current I_K is derived from a constant-current source. Assume Q_1 and Q_2 are identical transistors, and consider the circuit to be in the condition where $I_X = I_K$ and $V_{XY} = V_{KY}$ (point *a* on the V-I curve). From these assumptions, the condition must also exist that $I_{B1} = I_{B2}$.

Let V_{XY} increase positively by a very small amount. Then I_{B1} increases, causing I_{C1} to increase. Because I_K is fixed, I_{B2} decreases. But I_{B2} decreases more than I_{B1} increases because of the gain of Q_1 . Now $I_{B1} > I_{B2}$.

Since the change in V_{XY} has been small, the collector current of Q_2 will depend principally on its base current rather than on its collector voltage. Then I_{C2} decreases directly with the decrease in I_{B2} , and I_{C2} decreases more than the increase in I_{B1} , roughly by a factor of β^2 . It follows then, that I_X has decreased (point *a'* on V-I curve).

If leakage currents are neglected, the peak current is equal to βI_K and the valley current is equal to I_K/β . Measured values of peak current varied

from 1.2 microamperes (where $Q_1 = Q_2 = 2N2218$) to 7.0 amperes ($Q_1 = Q_2 = 2N1314$). The valley voltage is about 0.15V for germanium transistors and 0.55V for silicon transistors.

This circuit is adaptable to integrated circuit techniques and in this form, could make simulated tunnel-diode logic economically practical. Implementing tunnel diodes in microcircuits is an expensive process.

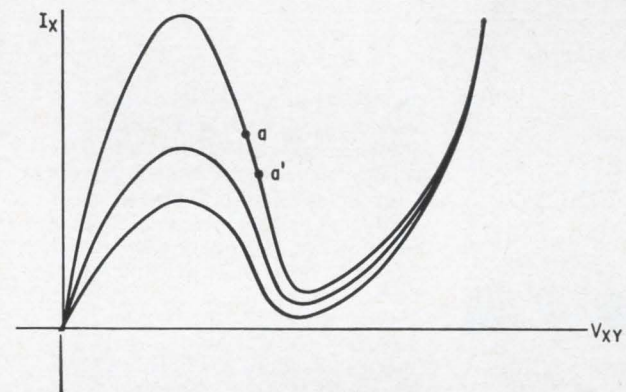
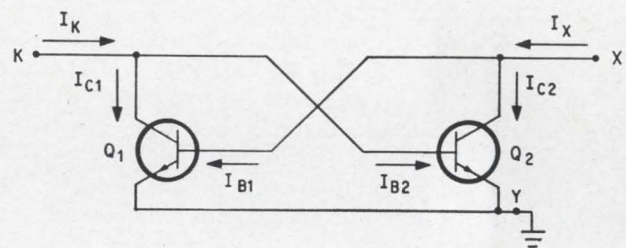

Volt-ampere characteristics at terminals X-Y are similar to the V-I characteristics of a tunnel diode. Peak point current of this simulated tunnel diode can be adjusted from 1.2 microamps to 7.0 amps by varying the current I_K .

FET detects alpha particles better and more precisely

Applied as a detector and amplifier, the FET improves signal-to-noise ratios at least tenfold, allowing more precise measurements

By Charles R. Seashore and Clement D. O'Brien

Honeywell, Inc., St. Paul, Minn.

Since the field-effect transistor is built with a thin silicon-monoxide layer over its active areas, it can serve as a delicate radiation detector, more efficient than the pn-junction diode sometimes used for counting alpha particles. When the top of its TO-5 can is removed, the FET will detect alpha particles as they impinge on the near gate of the FET (2N2386) structure generating a current across the gate-channel junction. Oscilloscope observations show that the signal-to-noise ratio of a p-channel FET is more than 10 times higher than a conventional diode detector in this application.

In the FET, the alpha particles penetrate the thin protective layer of silicon monoxide without loss of energy to produce a uniform output that is not dependent on the energy of the nuclear particles. In the junction diode, on the other hand,

the barrier region is so wide that alpha particles lose some of their initial energy. The output of the device then depends on the energy of the particles.

This difference in operation between the FET and the junction diode can be seen on a pulse height analyzer. The wave shape for the FET is uniform; for the diode it is dependent on the energy distribution of the alphas (see figure, page 65).

In a Honeywell dew-point hygrometer (which measures atmospheric dew point in a balloon at high altitudes) the FET has already demonstrated its superiority over the junction diode as a detector. This instrument is a closed-loop system which can determine precisely the dew point by measuring the number of alpha particles impinging on the detector.

Signal processing

In the hygrometer circuitry the FET has some other advantages. For example the FET detector supplies a uniform pulse count even if gain changes occur in the pulse amplifier. The junction diode detector does not; in fact, it yields a random output pulse with a change in amplifier gain (see p. 66).

In a hygrometer application if the pulse discriminator level shifts even a small amount, the discriminator total output count shrinks because the diode detector produces a random amplitude energy distribution. The FET detector, however, will produce the desired uniform output count despite any shift in discriminator pulse level.

Detector-amplifiers compared

Comparing the detector-amplifier that uses an FET with one that has a pn-junction diode (see opposite page), you learn the biggest advantage accrues only if the FET appears in both the detector and amplifier stages. In fact, a tabulation

The authors



Clement O'Brien worked on the development of a transistorized guidance package for the Thor and Titan missiles at the General Motors Corp. Since joining Honeywell in 1961, he has designed solid-state analog-to-digital converters as well as dew-point hygrometers.



Charles Seashore has been with the Honeywell Military Products Research Laboratory as a senior research engineer since 1961. He has designed cryogenic circuits, a sun sensor circuit and circuits for flicker noise measurement.

FET detector

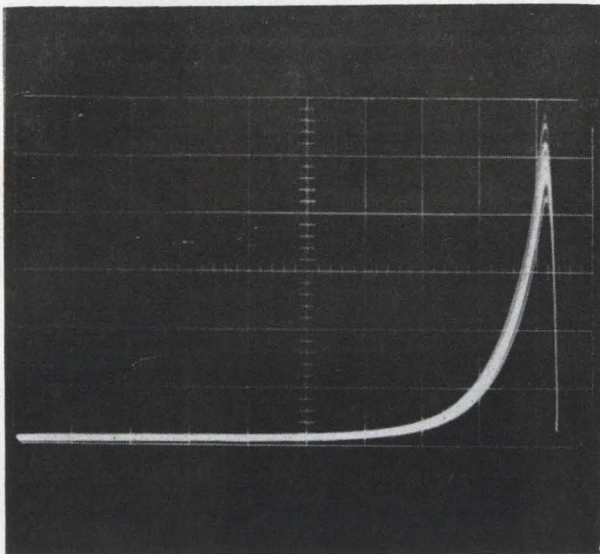

Diode detector

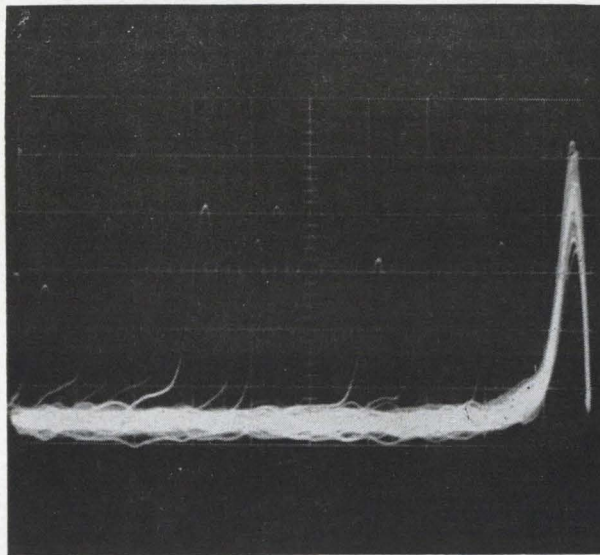

Comparison of single-pulse output waveforms generated by the junction diode and FET detectors. FET device is superior because it reduces signal-to-noise ratio more than 10 times.

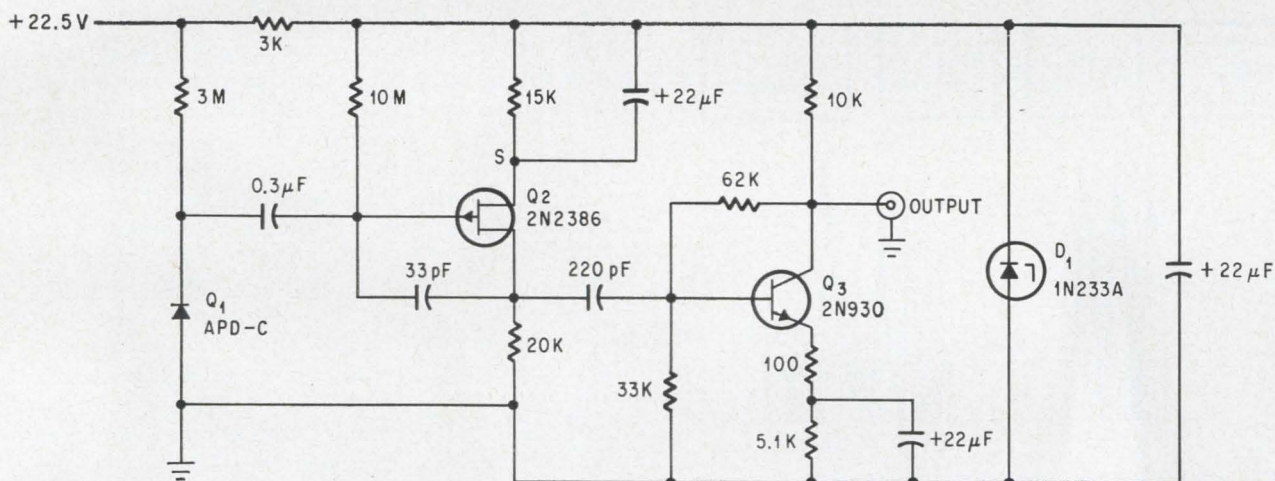

A basic circuit for alpha-particle detection has a pn-junction diode followed by amplifier stages.

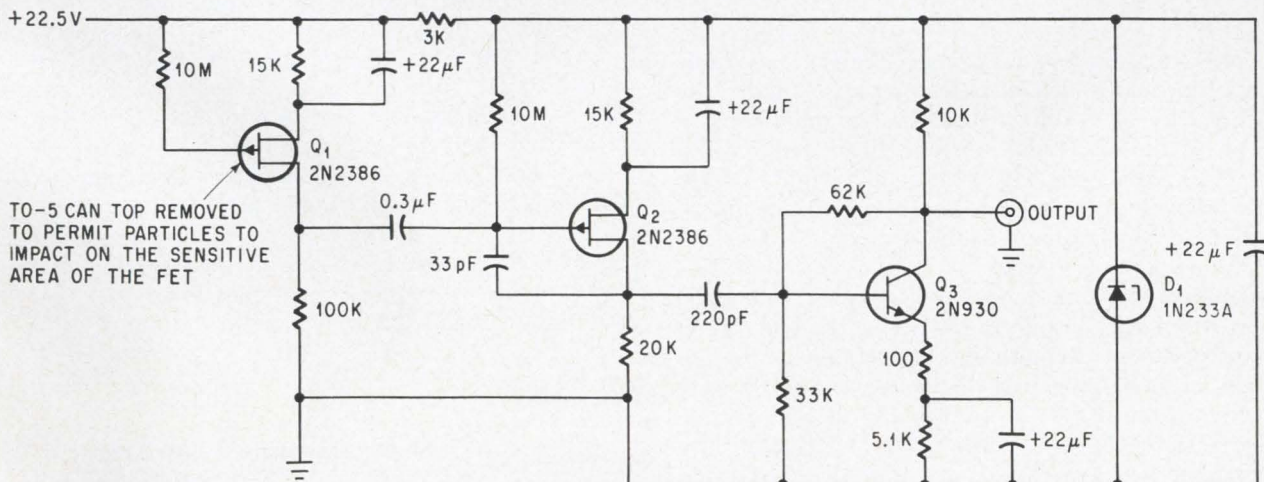

Alpha-particle detector circuit with a 2N2386 p-channel field-effect transistor; the top of the transistor housing is removed and the exposed FET is used as the detector element.

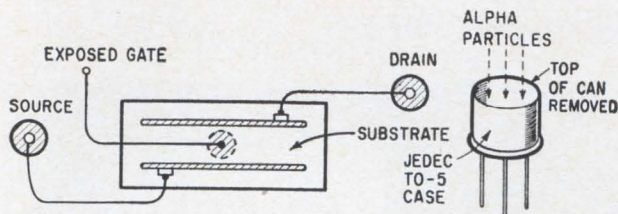

Removing the top of the 2N2386 case (a TO-5 package) exposes the gate of the FET to bombardment by alpha particles and makes it a sensitive radiation detector.

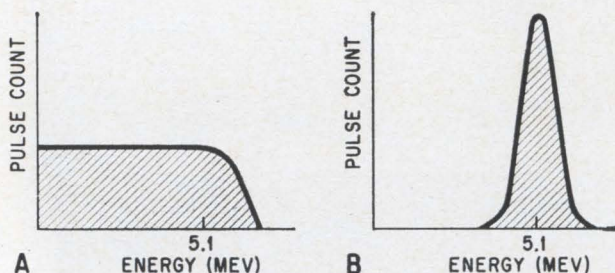

Plots of energy distribution of alpha particles transduced by detectors shows that the diode detector's output (A) depends on the energy, but the output of the FET detector (B) is uniform.

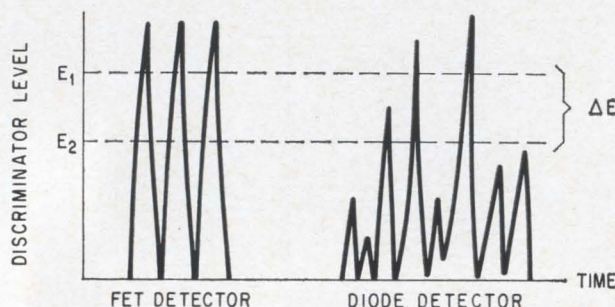
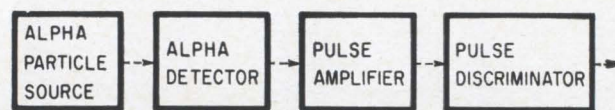

FET detector supplies a uniform output pulse count despite changes in pulse amplifier gain. A change in gain of the amplifier affects the magnitude of the diode detector signal.

of the measured-signal-to-noise ratio (see table above) proves there is nothing to be gained by putting the FET only in the first amplifier stage.

When the FET's are used in both circuits, the great improvement—15 times—in signal-to-noise ratio shows up from the single-pulse outputs of both detector-amplifier configurations.

One explanatory word is necessary about this circuit. The detector and its bias circuits are located away from the amplifying devices Q_2 and Q_3 in this experiment. Remote operation requires the addition of a 33-picofarad capacitor from the gate to the drain of Q_2 to offset the detector-cable voltage drop. In this circuit, the FET units are p-channel and are operated in an inverted drain configuration to be compatible with a positive power supply and high gain npn device Q_3 .

Signal-to-noise ratios of alpha-particle detector circuits

Detector	Amplifier (First stage)	Signal-to-noise ratio
pn-junction diode type APD-C	nnp transistor type 2N930	4:1
pn-junction diode type APD-C	FET type 2N2386	6:1
FET type 2N2386	FET type 2N2386	67:1

More advantages of FET

Operation of the FET with its top surface exposed as a radiation detector combines the circuit and device characteristics of a radiation-sensitive diode and a high-impedance low-noise amplifier in one device. This consolidation eliminates signal transmission loss from detector to preamplifier. Then the FET transconductance provides an output-pulse spectrum increased in amplitude.

The fundamental advantages of the FET alpha-particle detector are: improved signal-to-noise ratio due to the intrinsic FET gain mechanism, and an absence of an energy-sensitive characteristic in its output spectrum. These results are based on observations made during the hygrometer development. An analytical treatment of the FET as an alpha-particle detector has not been made.

Other advantages of using the FET radiation detector are its small size and low voltage requirement. This last is very attractive compared to the 700-volt anode potential developed from an inverter circuit in a miniature radiation-counter tube.

The table above shows the significant increase of a factor of 11 in signal-to-noise ratio when the FET 2N2386 device is used both as the detector and as the first-stage amplifier. However the conventional circuit (the one in which the pn-junction diode was used as a detector) was examined with an FET as a first-stage amplifier and only a slight improvement in signal-to-noise ratio was observed. From the table it can be seen that the measured signal-to-noise ratio of the diode detector and the FET amplifier configuration was 6 to 1 while that of the diode detector and npn amplifier was 4 to 1.

The FET is not without limitations. A major disadvantage may be short operating life as a result of gate-degradation caused by the bombardment of high-energy alpha-particles. However the gate lead provides a means for compensating gate degradation with an external control voltage.

References

1. F.M. Wanlass and C.T. Sah, "Nanowatt Logic Using Field Effect Metal Oxide Semiconductor Triodes," International Solid Circuits Conference, Philadelphia, 1963.
2. S.R. Hofstein and F.P. Heiman, "The Silicon Insulated-Gate Field Effect Transistor," Proceedings of the IEEE, Volume 51, 1963, p. 1190.

Laminates and cribbage boards connect integrated circuits

Multifunction mounting board and 5-mil-thick laminate connect a dozen flatpacks. Photochemical processing enables design to move toward flexible wiring and arrays of unpackaged integrated-circuit chips

By John Marley

ITT Federal Laboratories, a division of the International Telephone and Telegraph Corp., Nutley, N. J.

The ideal subassembly for complex microelectronic systems, from the manufacturers' point of view, would be one that could use simple, standardized techniques to make and interconnect a wide variety of modules.

Developing such a subassembly has been a problem. Now it has been solved by engineers at the ITT Federal Laboratories, who have come up with a manufacturing and packaging system that can be used in many types of equipment that ITTFL is now making or likely to make.

The system developed for this subsidiary of the International Telephone and Telegraph Corp. is based on prefabrication and photoetching. Mechanical, electrical and fabrication functions common to most assemblies are prefabricated. Interconnection wirings, which differ, are isolated and produced by photoetching.

The basic building blocks of the plug-in integrated-circuit assemblies illustrated here are called microcomponent boards. They are made from two parts: a tiny, prefabricated board— $1\frac{1}{4}$ inches square—that carries up to 12 flatpacks of integrated circuits, and a partially prefabricated etched circuit that interconnects the flatpacks.

Each board is made of plastic, glass-filled diallyl phthalate. The connectors and welding pins are molded in place. The etched circuit is welded to one side of the board; flatpacks or other ribbon-lead components are welded to the other side, as shown on page 68. Such an assembly weighs only about $\frac{1}{4}$ ounce.

With these microcomponent boards, it is possible to automate the production of integrated-circuit or

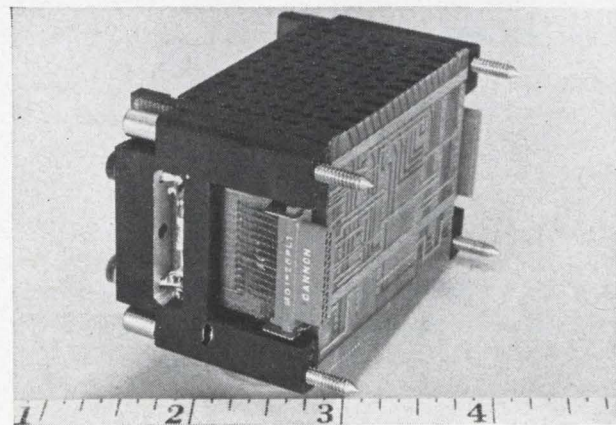
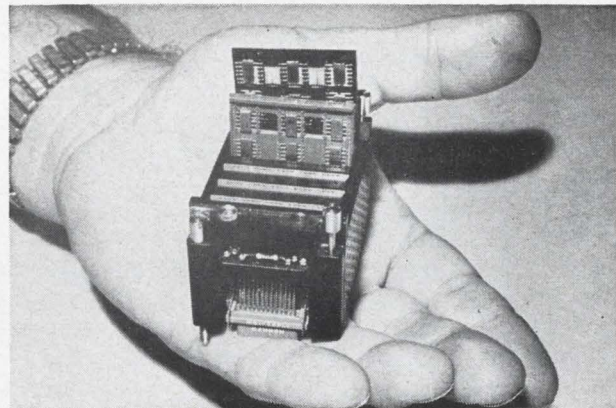

Prototype module, only a few inches long, contains 10 plug-in microcomponent boards. Each board has up to 12 integrated-circuit flatpacks. Below, module is turned on side to show the double-sided printed circuit board into which the microcomponent boards are plugged.

hybrid subassemblies, and simplify the interconnection and packaging of the subassemblies into systems.

Complex and expensive interconnections, such as a multilayer printed-circuit motherboard, normally required for high-density packaging of subsystems are no longer needed. (See "The packaging squeeze", p. 69). Each microcomponent board can interconnect a dozen flatpacks with the required crossover wiring. And each flatpack can contain several independent circuit functions—four to six logic gates, for example. In effect, each microcomponent board assembly can be the equivalent of a subsystem made with discrete components.

Large numbers of microcomponent boards—36 in one system—can be interconnected through a conventional two-sided printed circuit board.

The etched interconnections for a board assembly can go from layout, through photoetching, to production in as little as two hours. Speed is important in producing microelectronics systems that require many different subassemblies.

On the average, the same design of microcomponent board assembly will be used no more than 10 times in each system, since each is a combination of several circuit functions. In addition, each interconnection may be subject to modification during prototype and initial production.

ITT's microcomponent boards meet military requirements for cost, life, and reliability after being repaired. It is estimated that the microcomponent board assembly, complete with integrated circuits, will cost about \$1 for each 10,000 hours of mean time between failures (MTBF) in operational use—the military's rule of thumb for replaceable electronic modules.

The assemblies are made by photoetching and microwelding; these techniques lend themselves to machine control and are compatible with computer-assisted design and drafting methods, mechanized assembly and automated production testing.

Equally important, ITT's modular design can handle more advanced packaging, such as the assembly of arrays of unpackaged integrated circuits, with no change in the basic processes.

Circuits and cribbage boards

The prefabricated board takes care of such functions as mechanical support, plug-in connection, component mounting, heat dissipation and insertion guidance. In addition, it is an assembly and test fixture.

In contrast to the custom handling required to connect both sides of a conventional two-sided printed circuit board, the new design uses prefabricated feedthroughs and a new laminate. More than 50% of the circuit is prefabricated with the laminate material.

Although etching defines the interconnections on a conventional printed circuit board, the board is not a universal structure; other functions must be designed and fabricated board by board. For example, plug-in connectors must be added and lead-

Laminate, etched circuits and microcomponent boards

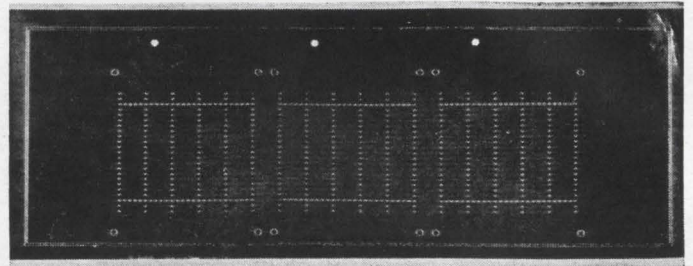

Plated riser laminate with three riser patterns. The risers are prefabricated feedthroughs and weld pins.

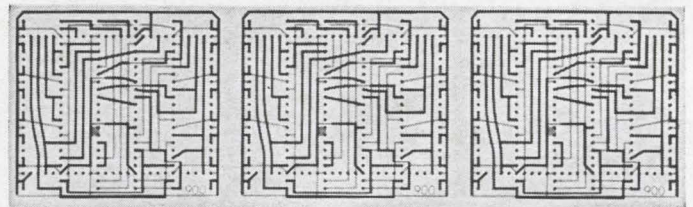
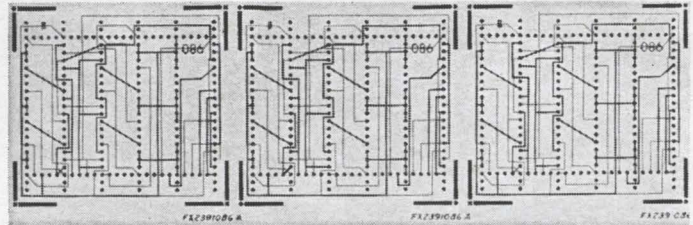

Two sets of circuits etched from the laminate. In each case, the lighter lines are wiring on the reverse side.

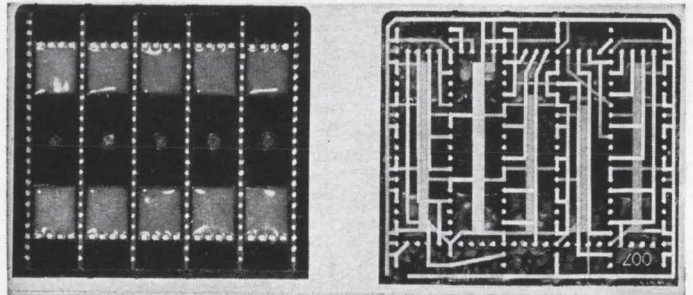

Back of microcomponent board, unassembled and assembled. Circuit is welded to the board by means of the risers.

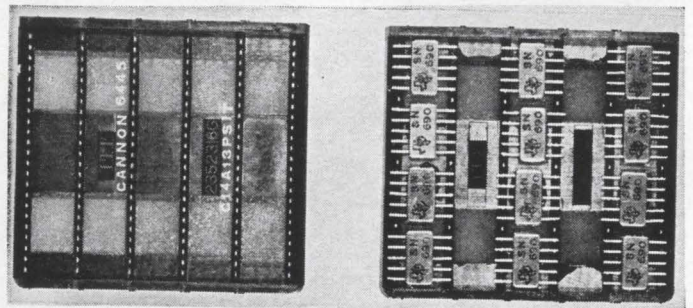

Front of board, unassembled and assembled. The maximum number of flatpacks, 12, have been welded in place.

insertion holes punched. The holes in two-sided boards must also be plated or eyeletted.

For the interconnection wiring the printed circuit is stripped down to the bare essentials: one-ounce copper foils are laminated to each side of a 2-mil (0.002 inch) film of Mylar, making a laminate approximately 5 mils thick, and joined by feed-through connectors.

The feedthroughs, which also weld the wiring to the board, are 178 nickel-alloy plugs or lands, called risers. They are preplated into the laminate in a regular pattern, usually 6 vertical rows with 23 risers each and 2 horizontal rows with 20 risers each. This plated riser laminate meets the requirements for a wiring matrix that is nearly universal since a wide variety of interconnection patterns can be formed by photoetching.

The molded board is nicknamed the "cribbage board" because of the pin pattern on its back surface, which corresponds to the riser pattern. Of

the 178 weldable nickel-alloy pins, 138 pass through the plastic to the front surface of the board so flatpacks and other components with ribbon leads can be welded to them. Twenty pins terminate in Micropin contacts at the bottom edge of the board (Micropins are flexible male contact pins made by ITT Cannon Electric Inc.). The other 20 pins terminate in test-probe receptacles at the top edge of the board (page 70).

Prefabricating the laminate

After they are laminated, the copper foils are coated with photoresist. A pattern of 178 holes each 10 mils in diameter, is etched in the top foil. Using the top foil and its undeveloped photoresist as a mask, holes are etched through the Mylar and laminating adhesive. Etchant undercutting makes these holes about 15 mils in diameter, so they extend under the top foil, as illustrated on p. 70.

The Mylar etchant mildly attacks copper, so it

The packaging squeeze

Merely packing more and more circuits onto conventional printed circuit boards—or into cordwood modules that plug into motherboards—does not take full advantage of the savings in design and manufacturing costs that are offered by integrated circuits.

The only virtue of these traditional approaches has been expediency—they have permitted the production of integrated-circuit systems to begin before the search for better methods paid off.

Craftsmanship

Surface wiring on a printed circuit card cannot cope with all the cross-overs required in a high-density interconnection pattern. In many instances the wiring does no more than extend the leads of the integrated-circuit package.

The designer has a solution that's easy to specify: mount the packages on a motherboard made of many layers of printed circuits laminated together.

But the solution creates a costly production bottleneck. A high degree of craftsmanship is required to make reliable multilayer boards and few draftsmen can visualize wiring patterns in multiple planes; also, few production personnel can make them.

To keep engineering costs within bounds requires computer assistance in design layout and rigid restrictions on geometry. Engineering must be completed before fabrication can begin.

Greater diversification

The most significant trend in microsystem manufacturing is less and less use of identical subassemblies. Even a fairly large discrete-component assembly can be boiled down at present into an integrated-circuit flatpack containing up to six independent circuit functions.

This shifts the assembly operation from the circuit to the subsystem level. Therefore, equipment production requires smaller quantities of larger varieties of assemblies, rather than large quantities of relatively few types of identical assemblies.

Too tiny to handle

Microelectronics already defies conventional bench assembly. Assembly under a microscope is rapidly becoming unsatisfactory as a substitute. Flatpack leads are now spaced 20 to the inch (50-mil centers). The density of signal wire terminations is high. It will go higher.

All of these factors add up to the core of the problem: how can the equipment manufacturer perform his main job, interconnection and packaging of components into a system, when the interconnection is becoming too complex and too minute for manual assembly methods?

He must substitute standardized processes for inadequate manual skills. The processes selected for use today must also be applicable to future modules, so there won't have to be an upheaval in production

methods with each advance in microelectronics.

Chemofacture, not manufacture

This analysis of the problem underlies the microcomponent-board assembly described in this article.

"Chemofacture" has replaced manufacture. Photochemical processes—the use of pictures and juices—are employed whenever a variable appears. Photography is the simplest way to describe complex information and to effect design changes, and chemistry is the simplest way to produce designs.

This has already been demonstrated in the conventional printed circuit and in the "master slice" approach to custom integrated circuits. A collection of standard parts is provided with a unique interconnection pattern by photochemical processes.

The microcomponent board design is one of several microelectronic techniques developed under a special program established more than two years ago at ITTFL. This program, called Chico (Coordination of Hybrid and Integrated Circuit Operations), is responsible for the continued improvement of microelectronics design, interconnection, assembly and packaging methods.

To assure use of improved methods, ITTFL has also formed a Microelectronic Technology Department which provides services, advises on and monitors microelectronic applications in the various ITTFL equipment-design and production groups.

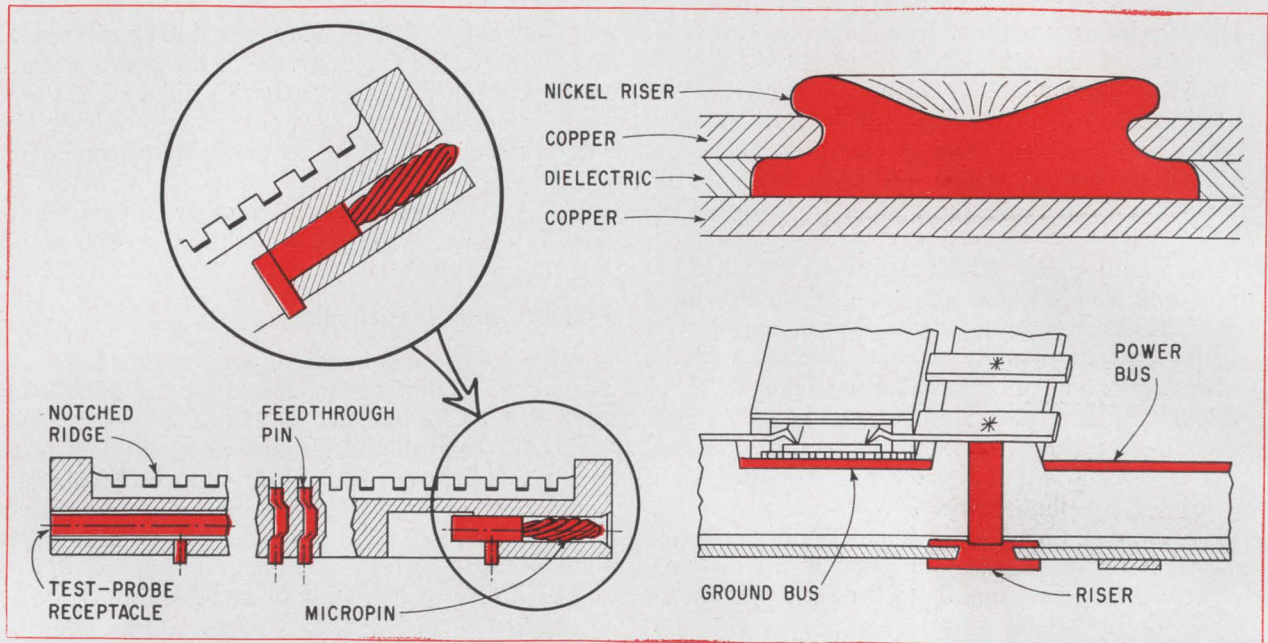

Molded board details are diagramed at left, with pins in color. A laminate riser pin is shown in color at the top right. Lower right sketch shows how flatpack leads, pins and risers are welded (color). Also shown in color is developmental plan for plating board alleys with bus bars.

chemically cleans the exposed surface of the lower foil and rounds the edges of the top foil. Erosion of the photoresist on the top foil around the hole leaves a chemically clean surface there, too.

With the bottom foil as an electrode, a nickel alloy is electroplated into the hole. When the plating grows up to the top foil, the top foil becomes an electrode and the riser grows over it. The nickel spreads in a ring around the top of the hole, solidly joining the riser to both foils.

As the ring grows it robs nickel from the center of the hole, leaving a slight depression in the riser. Tests indicate the depression may help concentrate the pressure of the welding electrodes when the risers are later welded to the pins in the board.

The risers have several advantages over the plated-through holes or eyelets used as feedthroughs in printed circuit boards:

- Chemical batch processing avoids the manual punching or drilling of holes and the quality control problems of particles and burrs. The chemical process is also cheaper than eyelet insertion and the electrical bond is better.
- The nickel under and over the top foil locks the riser securely in the laminate.
- A reliable bond between the nickel and copper is assured because the copper is chemically cleaned. In contrast, when electroless plating is used on thick boards, chemicals are used to sensitize the plating surfaces, resulting in an additional chemical and metallurgical interface between the metals.

▪ The process is cheaper than electroplating holes in thick boards, primarily because the geometry is more favorable and yield is higher. Current-focusing pins are not needed to get even plating

inside the riser holes because they are about six times as wide as they are deep.

Registration holes, needed to align the circuit and connector during subsequent assembly, are etched in the top foil and the Mylar at the same time the riser holes are etched. Nickel plugs fill the holes during plating, but fall out when the supporting foils are dissolved during circuit etching.

At present, the plated riser laminates are prefabricated in strips five inches long with three matrix arrays. Continuous strip forms are being developed so large numbers of circuits can be etched in a continuous operation.

Spray etching, rather than tank etching, is used throughout the processing to obtain better process control. Only fresh etchant contacts the foil. Specialized apparatus is required for precise registration of etched patterns and control of dirt particles.

Microcomponent-board design

The cribbage board is a printed-circuit-card connector that is altered in form so it functions as a card as well. It is thicker than a conventional card in proportion to its surface area and more rigid. Ridges on the front surface (diagram above) make it still more rigid.

The ridges look like a square wave with rounded corners. Ribbon leads fit snugly into the depressions in the ridges and contact the welding-pins.

The present design has six rows of 23 pins spaced 50 mils apart. Components nest in five depressed-surface channels, called alleys, between the rows. There is room in the alleys for strain-relieving crimps in the leads.

Flatpacks usually go into the first, third and fifth alleys to keep interconnection layout simple. Four

10-lead flatpacks, spaced one pin apart, or three 14-lead flatpacks fit in each alley. Components too large to fit in the alleys can be mounted on a miniature printed-circuit card that fits into a molded frame the size of a board.

When the board is molded, nickel pins are prepositioned in the molding form in attached rows, like combs. After the plastic sets, the combs' backbones are removed.

The board has access openings at the end of each alley. The test-probe and Micropin contact assemblies are inserted through these openings into 20 open tubes or wells that go to the outside edges of the molded form and protect the contacts. These parts are prewelded at right angles to their pins. Epoxy is used to fill the access holes, locking the pins in place.

This construction meets military reliability requirements, yet is inexpensive enough for use with integrated circuits, which are expected to become very low in cost. The Micropins plug into a mating connector, so the board assembly can be removed from the module without desoldering.

For commercial use, an easy-to-mold plastic such as phenolic could be used. Longer weldable pins, bent at right angles and molded in place as leads extending beyond the board edge, could be soldered into a printed-circuit board.

Engineering cycle

To lay out the etched-wiring pattern, the draftsmen work from a layout, prepared by engineers, of the circuit functions. The engineers use adhesive symbols to mark the flatpacks by catalogue number, circuit type and signal lead positions. Then they sketch the wiring paths between leads (this meets MIL-STD-806B on functional diagrams).



Worst-case test pattern for etched circuit is scribed on a coordinate drafting machine. Note registration-hole pattern around edge of circuit pattern.

The draftsmen draw the interconnection layout on a geometrical form at four times scale. Numbers are used to identify the riser/pin locations, contact pins and test probes. Solid lines represent the etching pattern for one side of the laminate and dotted lines the other side.

The layout is traced on master artwork sheets that already have land patterns corresponding to the riser array. The artwork is scribed or taped on the type of stable plastic film used to make artwork

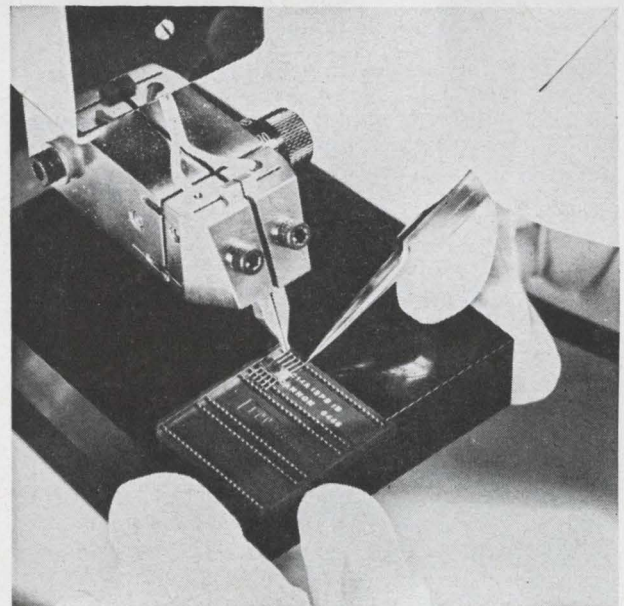
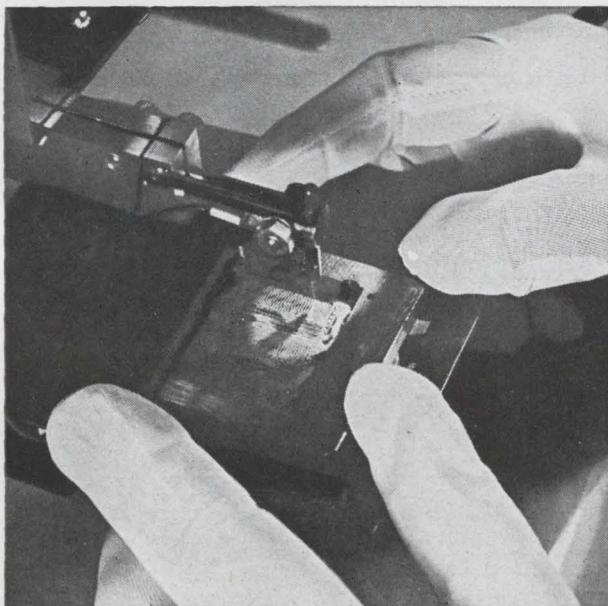

Welding the assembly. At left, an opposed-electrode resistance welder welds the risers to the board pins. At right, parallel-gap electrodes weld component leads to the board. This board design, different from the one on page 68, is used when large, ribbon-lead components must be mounted. The alleys are wider.

masters for conventional printed circuits.

Interconnection matrix topology

The dimensional standards for the wiring matrix are: area, 1.40 inch wide by 1.28 inch tall; land spacing, 50 mil centers; land diameter, 23 to 25 mils; minimum line width and spacing, 7 mils.

An average assembly of 10 flatpacks requires only 100 to 110 wires for full interconnection and input/output and test leads. Crossovers average about 30%.

Two rules of topology are followed:

1. An independent conductor can be between adjacent nodes on either or both surfaces. If two wires go to neighboring risers, a third wire can be threaded between them and around either riser.

2. Each riser is a feedthrough. The draftsman has 178 opportunities to get out of a dead end or avoid crossover on one surface by going to the opposite surface.

At present, these rules are flexible enough for a large range of useful networks, with little trial and error in layout. Extra rows of nodes can be added for higher connection density.

The photograph on page 71 shows the top surface of a worst-case test pattern—one with the longest practical wiring run and most risers—being scribed with a coordinate drafting machine. The bottom surface is a mirror image. This pattern demonstrates the technique's ability to solve crosstown traffic problems. It is also used as the master for process quality control and to test series resistance.

The array has six test loops, interwoven into isolated pairs where the conductors of one loop independently thread around the feedthrough lands of the other loop.

Series resistance of each loop, including 12 inches of wiring, 17 risers and two contact pins and sockets, is 960 milliohms. The low impedance in ground and power paths avoids mutual coupling or "ground noise" buildup.

Welding the wiring matrix

Connectors are plugged into the Micropin and test-probe receptacles and the board is oriented in a cavity fixture. A thin film of B-stage epoxy (cured

to the dry, solid state, but not thermoset) pre-punched at land locations is placed between the back of the board and the circuit. This film, when thermoset after the welded circuit is tested, will provide a bond and act as a moisture and contaminant barrier. It is set by a rubber-blanket heater.

The registration holes in the circuit and pins in the fixture orient the board and circuit. A frame that fits over the unused Mylar locks the circuit in place. Registration tolerance is about 1 mil, more than ample since the nickel riser lands which contact the welding pins are 15 mils in diameter.

A resistance welder, like those used to make cordwood modules, but with opposing electrodes, welds the risers to feedthrough weld pins. A dynamically controlled weld cycle maintains weld quality.

The operator positions the top electrode over the copper lands above the risers (see photo on p. 71), by moving the fixture. The bottom electrode centers itself in the serrations on the board face and the weld is made.

Test point and plug contact connections are welded through the fixture pins, or through access holes that are left in the board until after the welds are tested.

Electrical network test

The board-circuit assembly is "buzzed out" with needle probes. This is done from the component side of the board, so weld-pin continuity is checked along with weld joint and etched wiring continuity. Anticontinuity tests are also made, to detect unetched bridges, and to make sure the tiny gaps between wiring are not shorted by foreign particles.

The test is similar to conventional high-potential testing, except that only 50 volts rms is used.

If faults are found, the assembly is discarded, since investment in it is low until the flatpacks are welded in place. Good circuits are sealed with a conformal film of epoxy or adhesive Mylar.

Final microcomponent assembly

The opposing-electrode welder could be used to weld flatpack leads and the etched circuit to the weld pins simultaneously. But a high-resistance weld could cause current surges to enter the integrated circuit and damage it. Moreover, that would be contrary to the design concept since it would complicate assembly and prevent testing of the board and matrix as a subassembly.

Therefore, the component leads are welded with a dynamically controlled parallel-gap welder. This type of resistance welder is commonly used to weld flatpack leads to printed circuit board surfaces, since the weld pulse and weld heat are confined to a small area on the lead (see photo on page 71).

The completed assembly is generally tested for electronic performance in the actual equipment environment.

Repairability and reliability

During prototype development, engineering or

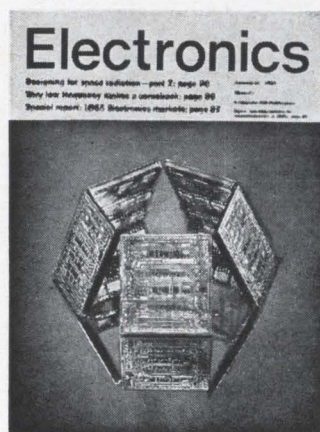

The cover

One microcomponent-board assembly looks like a satellite floating in space. This effect was obtained by positioning the assembly in a corner of front-surface mirrors.

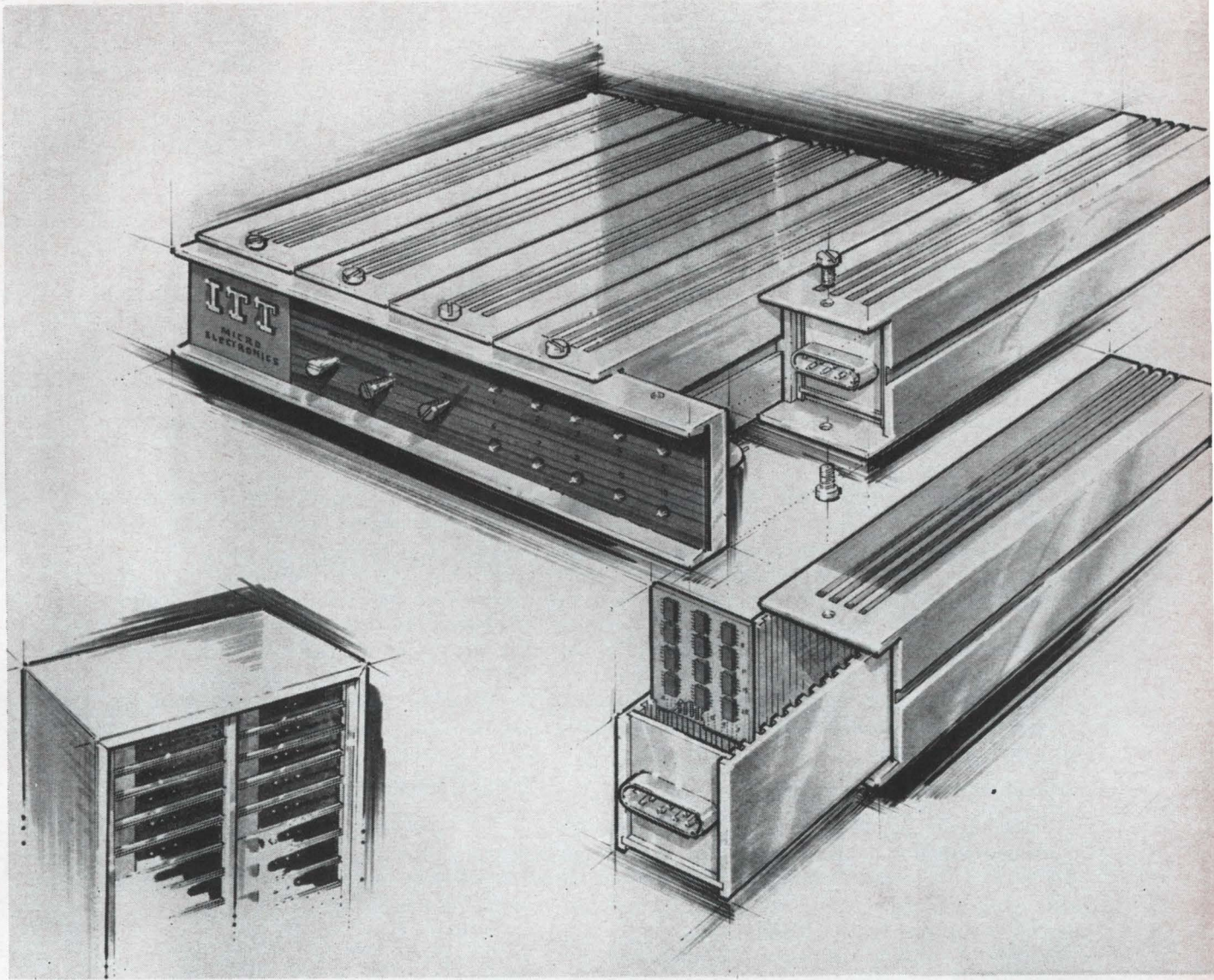

Packaging design for a microelectronic system composed of modules containing large numbers of boards.

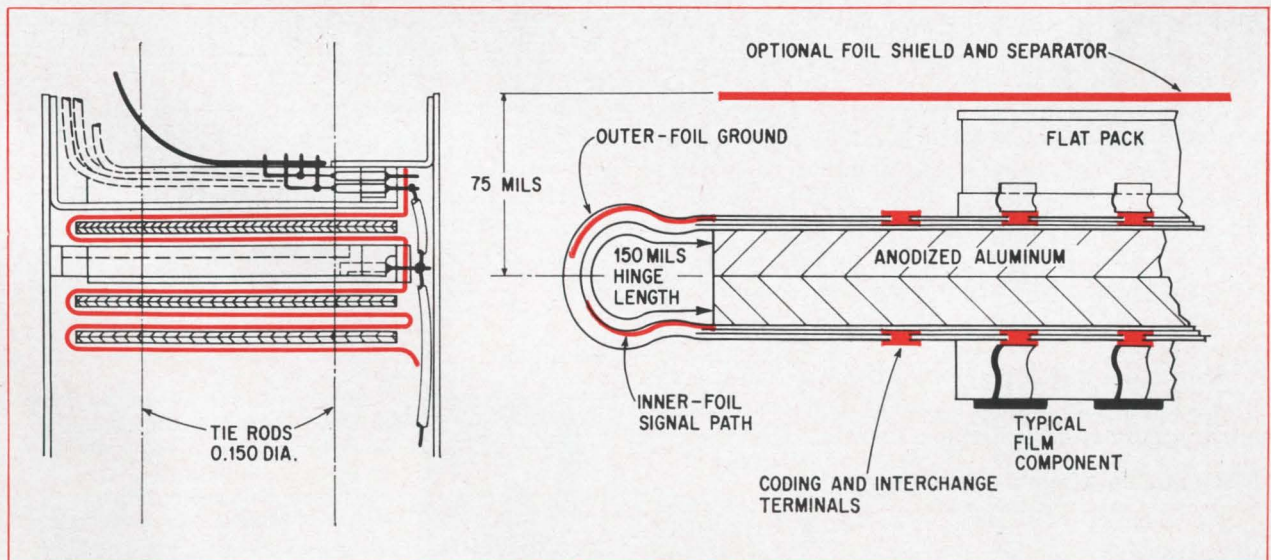

Second-generation design. Flatpacks are still welded to the laminate, but the laminate is folded accordion-style into a housing. Risers and metallic circuit elements are shown in color.

assembly errors may make it necessary to replace welded components. For removal, leads are cut near the weld with a small, razor-blade knife. The end of the lead is pulled off with a pair of tweezers. The pin surface is scraped clear with the knife.

Because indents lock the pins in the plastic, they do not readily loosen. Leads have been removed and replaced as many as four times. This repairability is a decided advantage in production, and also allows the customer to make emergency repairs. Replacing components welded to conventional printed wiring is difficult because the etched wiring may be pulled loose or stressed.

Among the reliability considerations built into the design (besides the choice of materials) are the avoidance of mechanical stresses on the components during production and use. For example, there are no significant production stresses because components are added last.

Ounce for ounce, the board-and-circuit assembly is stronger than conventional laminates. No thermal shock problems have been found, for two reasons: the laminate dielectric is thin compared to riser height and the pins are locked in the plastic. The maximum thermal expansion differential between the metal and plastic members is around $\frac{1}{4}$ mil, more than absorbed by the materials' resiliency.

Heat dissipation is no problem, either, since an average microcomponent-board assembly dissipates only around $\frac{1}{3}$ watt.

Second-generation assemblies

Under development is a technique for welding packaged integrated circuits directly to weldable risers, as indicated on page 73, after the custom interconnection matrix is tested and bonded to a mechanical-support sheet. High yield and other advantages of the basic processes are retained, but packaging density rises.

The technique will not be used until there is sufficient confidence in the reliability of the construction. It is not probable that devices can be replaced and the desired reliability retained. The technique appears most suitable for equipment with very long MTBF's and with designs that are "frozen."

The laminate-etching process is being modified so that conductors can be etched between riser patterns. This will allow subassemblies to be assembled continuously on strips. For heat-sinking, anodized aluminum squares can be attached to the back of each assembly, the strip folded like an accordion and tucked into a housing. Another approach is to spiral-wrap the film around a fluid-cooled pipe.

Also under development are techniques of using a flexible printed circuit to interconnect unpackaged integrated-circuit chips.

Mechanizing assembly operations

The assembly procedures are being mechanized to overcome a problem that became apparent during development. No matter how competent an operator is, he cannot maintain the concentration

required to make perfect welds, centered at each of the 178 risers on a matrix. Yet welds centered within 1 mil are needed for highest probability of reliability.

A new automated welder steps the welding fixture so each pin in a row is positioned under the electrode, at a rate of about two welds per second. The bed plate moves in 50-mil increments along the X axis. Movement in the Y axis is still manual: the operator positions the electrode at the first pin in each row.

For high-volume production, a machine with a 10-inch bed and automatic stepping in both the X and Y direction is being designed. This will enable five board assemblies to be welded in one setup.

Laminates can be mechanized in long strips, similar to 70-millimeter movie film. The sprocket holes in the film will keep the strip in registration throughout processing. The Western Electric Co. is now using such a process to make identical etched circuits on single-sided laminate strip (see *Western Electric Engineer*, July, 1964, p. 2).

ITTFL is working on a method of etching a sequence of different double-sided interconnection patterns. The pattern sequence could be scheduled by using a setup similar to an automatic slide projector to expose the photoresist.

After the patterns are etched in a continuous process, the series of etched circuits could be fed into programed positioning fixtures for assembly.

Future automation

The development program for the microcomponent boards included an intensive study of automation possibilities. The present design incorporates the most likely of these.

Because the assembly and wiring matrices are standardized, circuit and system engineers can readily use computers to assist design of optimum layouts. The computer output, fed into coordinate drafting machines, will draw the artwork masters.

Available drafting machines are being evaluated for production of the wiring pattern representation on tape or punched-cards to automate the interconnection-continuity test set.

The manual needle-probe test, done now by a technician, is slow and prone to human error. An automated test set is being specified. It will use clusters of probes similar to those now used by integrated-circuit manufacturers to test integrated circuits before they are diced from the silicon slice.

The author



John Marley's interest in sculpture, biology and architecture, has helped him solve three-dimensional problems in microelectronics construction. A senior project engineer, Marley also conducts a company course on the impact of microelectronics on the future design of electronic systems.

Laser-television system developed with off-the-shelf equipment

Signals are transmitted in atmosphere for more than a mile. Inexpensive system may be used for tv link among 11 buildings during the day and night

By C. J. Peters, R. F. Lucy, K. T. Lang, E. L. McGann and G. Ratcliffe

Applied Research Laboratory, Sylvania Electronics Systems Division of Sylvania Electric Products, Inc., Waltham, Mass., a subsidiary of General Telephone & Electronics Corp.

A relatively inexpensive gas laser television system using off-the-shelf equipment has been developed to transmit through the atmosphere during the day or the night.

Excellent picture definition has been achieved in an experiment with the system over a 6,000-foot transmission link. The developer, Sylvania Electric Products, Inc., is considering using the television system to interconnect an 11-building complex in a 12-mile diameter circle in Waltham, Mass.

The key to the laser-tv system is a video modulator developed by Sylvania's Applied Research Laboratory. The type S2A device is electrically and optically similar to a device described at the 1964 Northeast Research and Engineering Meeting¹ in Boston, except that the S2A is not a traveling-wave type of structure. Such a structure isn't required in this system because the bandwidth for the simple video link is relatively narrow. The electro-optic effect on which the S2A depends for its operation is a variation in the index of refraction along a particular axis of the crystal material used, in response to an electric field, in this case the applied video signal.

Previous attempts

The laser-tv experiment over the 6,000-foot link is not the first time that a tv signal was imposed on a laser beam. S.M. Stone and L.R. Bloom² at the laboratories of Sylvania's parent company, the General Telephone & Electronics Corp., demonstrated transmission and detection of a three-giga-cycle microwave subcarrier superimposed on a laser beam to carry tv and audio modulation.

Nor is it the first time such a signal has been received³ over an atmospheric path. However, it is the first time that television has been trans-

mitted over a long path using a small laser system constructed of readily available components.

In the first step of the tv-laser experiment, the laser link was operated over a path that included a mirror and a remote receiver. The mirror was used to achieve a long path and to show that the laser beam could be successfully reflected at an angle.

A retroreflector—similar to a radar corner-reflector—comprising three mirrors mutually intersecting at right angles, was used in the final experiment so that the sending and receiving terminals were at the same place to simplify evaluation of the received picture.

The television signal is imposed on the beam from the laser in the form of video amplitude modulation as shown in the diagram on page 77. The signal is obtained from one of the video stages of a television receiver, amplified by a commercial

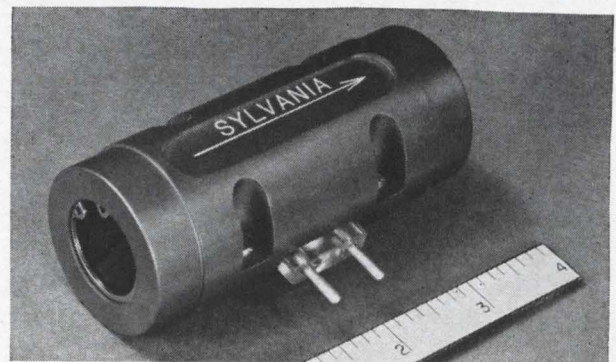

Coherent-light optical modulator is inserted between laser beam source and output of the laser transmitter. Modulation is usually limited to 30%, requiring an applied voltage of 110 volts.

Table of experimental details

Laser wavelength	6,328 angstroms
Laser output power	500 microwatts
Transmitted beam width	1/2 milliradian
Retroreflector diameter	2 1/2 inches
Effective receiver aperture	5 inches
Receiver optical filter	50 angstroms
Photomultiplier type	7265
Modulation	a-m
Transmitter optics	none

video amplifier and placed on the laser beam using the S2A video modulator shown on page 75.

At the receiver, the signal is collected with inexpensive optical equipment, passed through a narrow-band optical filter and field stop and detected by a photomultiplier. Two simple devices, the narrow-band filter and the field stop, are essential for daytime operation. The output from the photomultiplier after video amplification is injected into the picture tube of a second television receiver. Comparison of the pictures is on page 77. The excellent definition of the laser-transmitted picture indicates good transient response of the modulator and associated electronic circuits. The lack of "snow" indicates a qualitative idea of the good signal-to-noise performance of the system. Part of the noise results from the laser and part from the intense daylight background. The relative noise contributions from these two sources is not known precisely, but it is expected that the laser noise will be negligible in a final system design. A comparatively wideband optical filter (50 angstroms) is used in this receiver. If

necessary, daylight discrimination can be improved substantially with a narrower band optical filter.

Effects of weather

Fog and rain, of course, attenuate transmission over the system. But records of visibility in the area where the system may be constructed indicate that it can operate more than 98% of the time. Such performance is acceptable for the purposes envisioned—interplant conferences during the day and surveillance at gates after dark.

Optical systems also appear attractive for re-entry communications applications and for transmitting vast amounts of data within a short period between an orbiting satellite and the earth. Although the transmitter portion is now available, it seems likely that an optical superheterodyne receiver will be needed to cope with intense background light encountered in both these applications.

A satellite's battery power can be conserved by using pulse-code modulation for the tv transmission. This digital approach requires a more elaborate system than the analog system described here. However, it is justified when prime power is at a premium. Polarization modulation of the laser beam should be used in the pcm system to get increased range and to reduce atmospheric effects. A model S2P modulator would be used for the polarization modulation. The S2P is electrically identical to the S2A.

Amplitude modulator

The new amplitude modulator requires comparatively small drive voltages. Previously a Pockels cell, in which the modulation voltage is applied to an electro-optic crystal along the direction of the light travel, was used for amplitude modulation.

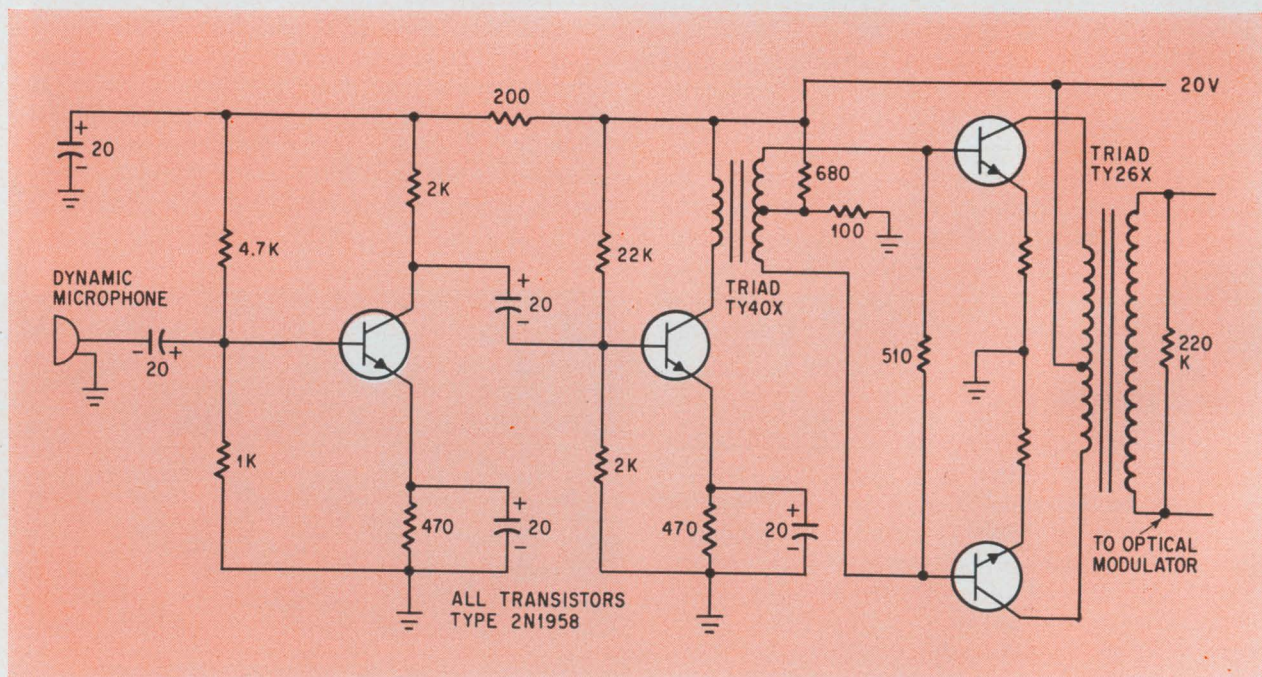

Audio driver circuit illustrates simplicity of equipment needed to actuate the optical modulator for a laser-television system.



Television broadcast picture used for test is shown on the screen at the left. The picture received through the laser system is displayed at the right, showing that, despite deterioration, resolution is adequate and noise low.

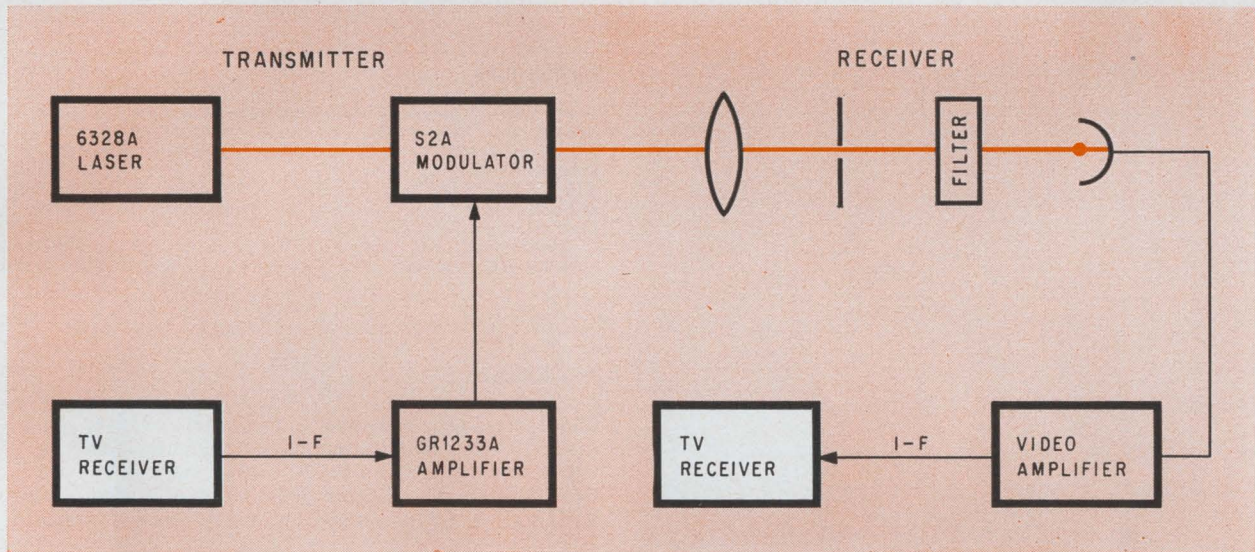

Experimental laser-television link uses home tv receivers as inexpensive input and output devices. The entire system contains off-the-shelf equipment.

It is difficult to generate the kilovolt signals at video bandwidths to drive the Pockels cell and to dissipate the heat generated within the cell as a result of the high voltage. The S2A modulator requires approximately a 10th the voltage of the Pockels cell, so the power levels are reduced by 100.

The active element in this modulator is KDP (potassium dihydrogen phosphate), which has good optical transmission from about 0.2 to 1.5 microns. However, as is usual in optical modulators, this one contains a quarter-wave plate and other wavelength-sensitive optical elements so that any one modulator is at its peak performance over a comparatively narrow wavelength interval of perhaps 1,000 angstroms.

Since the drive voltage needed to produce a given level of modulation increases proportionately with the optical aperture, a small aperture is desirable. The output beam from a gas laser can

easily be collimated to a diameter of about 1 mm (0.04 inch). The modulator aperture of 0.1 inch was chosen to provide a generous tolerance on alignment and centering of the modulator and to accommodate the spreading of the beam caused by diffraction. For ruggedness, the modulator is contained in an aluminum body 1.5 inches in diameter and 3.5 inches long.

The operating characteristics of the modulator can be described in terms of the circuits required to drive it for various applications. The factor of 100 reduction in drive power mentioned earlier is best illustrated by the simplicity of the audio driver circuit on page 76. The input power to this circuit is approximately 50 milliamperes at 18 volts. The only novel feature of the circuit design is its step-up output transformer that produces approximately 300 volts peak to peak.

Optical radars sometimes use a sinusoidal am-

plitude modulation of the light beam to measure range. For accuracy, this modulation frequency is chosen to be as high as possible. Because the KDP crystal has low loss, the 20-picofarad input capacitance of the modulator can be resonated with an inductance at frequencies up to at least 30 megacycles to obtain high-frequency operation at low power.

Such a modulator is ideally suited to pulse-modulation applications, because its frequency response extends down to zero. There is no definite limitation on the upper frequency response. For high duty cycle applications, the bandwidth of this modulator is determined by the internal heating of the crystal. Except for this factor, pulse response equivalent to a bandwidth of 200 megacycles should be realized at a low duty cycle. The time constant of the modulator in parallel with a 200-ohm impedance, which is equal to the output impedance of a Hewlett-Packard 460BR wide-bandwidth am-

plifier, works out to a value of approximately 4 nanoseconds.

Although this modulator uses KDP crystals in an unusual orientation to reduce modulation voltage, the modulator and the Pockels cell have a similar nonlinear relationship between modulation voltage and light intensity. A photomultiplier, when used as a power detector, is also a nonlinear device and to a certain extent these two nonlinearities compensate each other.

The relationship between the instantaneous voltage applied to the modulator and the instantaneous current out of the photomultiplier is shown in the diagram below. The slight curvature of this transfer function produces harmonic distortion in the photomultiplier current. The magnitude of the third-harmonic distortion as a function of the depth of modulation⁴ is shown in the lower curve. The third-harmonic distortion, as shown, is negligible below 75% amplitude modulation.

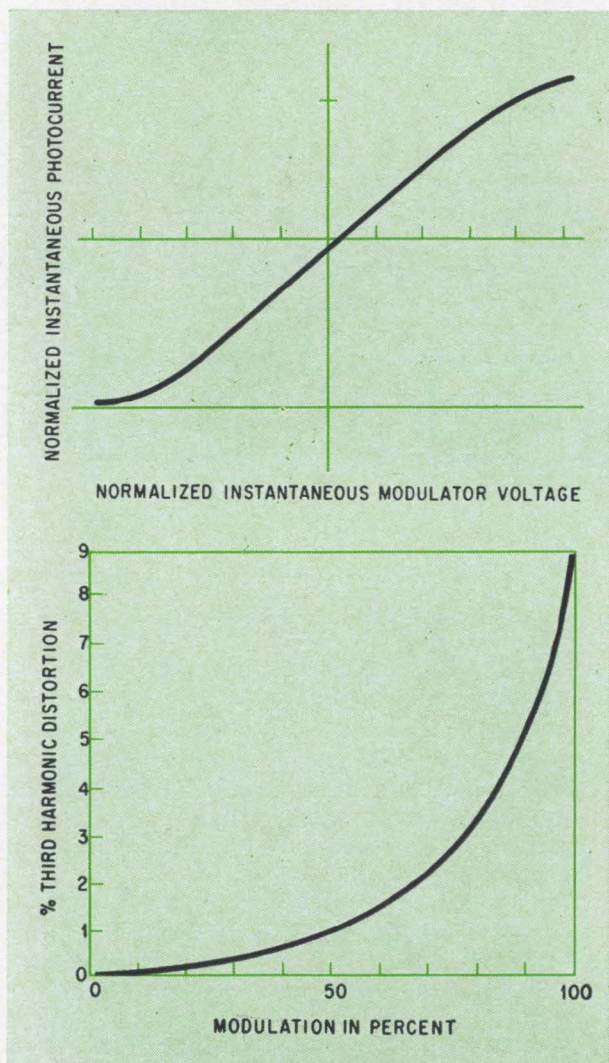

Amplitude-modulator and phototube system produces a transfer function (above) that relates photomultiplier output current to modulator input voltage. Third-harmonic distortion (lower curve) is not appreciable until depth of modulation exceeds 75%.

References

1. C.J. Peters, "Traveling Wave Amplitude Modulator," NEREM Record, Nov., 1964, p. 70.
2. Samuel Weber, "Laser beam carries tv video and audio," Electronics, Feb. 22, 1963, p. 28.
3. R.J. Keyes, T.M. Quist, R.H. Rediker, M.J. Hudson, C.R. Grant and J.W. Meyer, "Now out of the lab: modulated infrared diode," Electronics, Apr. 5, 1963, p. 38.
4. B.H. Billings, "The Electro-Optic Effect in Uniaxial Crystals of the Type XH_2PO_4 , II. Experimental," Journ. Opt. Soc., Oct. 1949, p. 802.

The authors

Charles J. Peters, developer of the wideband laser modulator and senior scientist at Applied Research Laboratory, received his Ph.D. in electrical engineering from the Carnegie Institute of Technology. Before joining Sylvania in 1957, he worked on missile countermeasures.

Gerard Ratcliffe has recently been in charge of the physical design of many components used in the laser research program, including special optical benches, electro-optical modulators and high-precision nonmicrophonic mirror mounts.

Kenneth T. Lang has worked on electromechanical devices for automatic frequency control of lasers in an optical superheterodyne and on a laser doppler shift experiment using a rotating target mirror. He has also worked on a precision optical tracker.

Edward L. McGann is participating in the design and development of an optical superheterodyne receiver, a laser tracking system and optical modulators. He was previously engaged in radiolocation work, countermeasures techniques and the development of specialized uhf filters.

Robert F. Lucy has designed and constructed a special microwave phototube for laser systems and has designed numerous laser experiments, including the optical beating of two gas lasers, doppler shift and atmospheric propagation. He is author of a previous article for Electronics on crystal switches for radar use.

Navigational satellites: beacons for ships and planes

Recent advances in space electronics make possible techniques for determining a craft's position, for controlling crowded traffic lanes and for communications

By E. S. Keats

Manager of display and navigation systems of Westinghouse Electric Corp.'s Electronics Division, Baltimore

"Where are we?" has been the question posed by captains since the early days of sailing and more recently by the commanders of high-speed jets. Traditional navigational techniques, using the sun or the stars or the more modern radio aids, have serious limitations, so that navigators usually can only report to the captain: "Here is about where we were a while ago."

Today researchers are looking to satellites to provide both reliable communications and beacons across thousands of miles of ocean.

A satellite navigational system could automatically calculate the position of an aircraft or ship. The position, accurate to within one mile, could be displayed at frequent intervals in the craft within a second after it is measured. And the position could also be displayed simultaneously at a traffic-control center and furnished to rescue services if needed.

Air-traffic control centers would have a continuously updated plot of all craft. Control over the oceans would be as precise as though the entire area were under radar surveillance.

Communication link

Traffic-control instructions, weather information and warnings of hazards could be sent to aircraft and ships by the communication link that the system could provide. Routine and emergency messages could also be handled on the very-high-frequency band with line-of-sight reliability.

Before examining the systems that could be developed for navigation, it would be valuable to look at the limitations of the current systems.

The obvious obstacle to navigation is weather: clouds block out celestial sightings and bad

weather and atmospheric disturbances hinder communications.

Time is a serious problem for fast-moving craft, such as a jetliner: by the time a fix is obtained, the plane is miles from that location; and the ground base knows of the jet's location only when the navigator reports the data.

Because of these shortcomings, the heavily traveled air corridors must be widely spaced for safety. As air traffic grows, the requirement for more efficient use of air space becomes more immediate.

Choice of systems

Before designing navigational equipment for the satellite, broad decisions must be made:

- Should the navigator transmit to the satellite?
- If the navigator transmits, should the measurements be made on the craft or in the satellite?
- Should the measurements be made on command or periodically?
- What should be measured—distance, direction, or both?
- Should the navigational system use one satel-

The author



E.S. Keats, a former jet fighter pilot and a retired rear admiral, is manager of Westinghouse's display and navigation systems. He recently managed the company's portion of the Navy's Transit program as well as a NASA study of ship and aircraft navigation. He is a graduate of the U.S. Naval Academy and the Massachusetts Institute of Technology.

lite or several simultaneously?

Following are some trade-offs that have led various groups to recommend different systems.

To transmit or not?

Military aircraft and ships would not have to give away their location with a nontransmitting system, but they pay the penalty of having to carry costly and complex equipment. In such a system all necessary signals for navigation must be radiated from the satellite and each aircraft and ship must carry sensitive measuring equipment. The craft must also carry computing equipment to process the data. The satellite must continuously transmit the signals that enable the user to make measurements. These signals include:

- Data on the location of the satellite in any convenient coordinate system.
- And a carrier at a level sufficient to provide the signal-to-noise ratio required for accurate measurements.

One type of system in which the craft does not transmit is based on using the satellite as if it were a reference star and making measurements of altitude and azimuth with respect to it. Such a system is conceptually attractive because the position can be computed by the same techniques used in conventional celestial navigation. On the other hand, this system requires many satellites, because at any one time and at any place on earth at least two must be visible to the navigator at elevations about 10° but below 80° and separated by more than 30° in azimuth. In addition,

the need for accurate, narrow-beam antennas makes the system expensive for ships and impractical for aircraft.

Another technique in which the user need not transmit is the measurement of the doppler shift of a stable frequency signal broadcast by the satellite. The United States Navy's navigational satellite, Transit, is used in such a system. Transit uses currently available high-stability frequency generators and counters but requires every user to have complex and relatively expensive equipment. The high cost of the Navy system can be justified because warships' position must be concealed, but a system for commercial and private operators should be more economical. Money can be saved by not using measuring and computing equipment on the user's craft, but instead, having the user transmit.

Who measures: satellite or user?

In an active navigational satellite system, where the craft transmits, the computation of position may be made either on the craft or in the satellite. Making measurements in the satellite requires special equipment only in the satellite, while making measurements on the craft requires each user to carry special equipment.

If the user transmits and receives a response from the satellite, then the measurements could be made and calculations performed on the craft. But this would be as complex and as costly as a system in which the user remains concealed.

The user could also send the measurements to

Where we stand

The use of satellites as a navigational tool for ships and for airplanes that span oceans has been widely discussed and studied over the past few years.

The following studies have been paid for either by the government or private industry:

- Pairs of satellites orbiting at synchronous altitude to determine positions of aircraft were recommended in a study by the University of Michigan in December, 1963. The study of trans-ocean air-traffic control was prepared for the Federal Aviation Agency.
- Medium-altitude satellites to determine a craft's location by measuring distance simultaneously from two satellites were recommended by the General Electric Co. This study in February, 1964, was made under contract to the National Aeronautics and Space Administration.
- The Univac division of the Sperry Rand Corp. studied the computing requirements of navigational satellite systems under contract to NASA. The division submitted a feasibility report in February, 1964.
- The Westinghouse Electric Corp. recommended that medium-altitude satellites determine position by measurement of distance and direction. This NASA study in January, 1964, investigated the feasibility of a navigational-satellite system for worldwide navigation and traffic control for commercial and private aircraft and ships. A follow-on contract for additional study, in October, 1964, recommended the use of synchronous-altitude satellites for these measurements.
- The Navy has been developing a navigational-satellite system called Transit for warships. Information published

up to about a year and a half ago disclosed that it was based on low-altitude satellites broadcasting a radio signal with a stable frequency and that position was determined by measurement of the doppler shift of the radio signal as the satellite passed over the ship.

- Several groups have said that they have studied adaptations of the doppler-shift principle for commercial and private vessels. In April, 1962, the Applied Physics Laboratory of Johns Hopkins University said that it was working in this area. In June, 1964, the Radio Corp. of America proposed the use of medium-altitude satellites with a worldwide tracking network. Westinghouse has also worked in this area.

- The Collins Radio Co., in a series of presentations to the Institute of Navigation from 1961 to 1964, has described studies involving measurements of the altitude and azimuth of satellites by radio sextants in a technique similar to celestial navigation.

- The Cubic Corp. suggested an adaptation of the Secor geodetic satellite, which measures distance from the satellite to three known points and one unknown point, for navigational purposes.

A Joint Navigation Satellite Committee, with representatives from NASA, the Federal Aviation Agency and the Departments of Defense, Commerce, Interior and Treasury, was organized in October, 1964, to evaluate requirements and costs for improved navigation, traffic control and search-and-rescue services. If the committee decides in favor of the system, it will recommend that NASA undertake a research and development program.

In view of this activity, there is a strong likelihood that a navigational satellite system may be in operation within the next few years.

the satellite for relay to a ground station for computation, but this is an awkward arrangement.

Therefore, making the measurements in the satellite is the most economical method.

Instantaneous or sequential measurements

Aircraft that carry altimeters, and ships, can be located in geodetic coordinates with two measurements. Distances from the moving satellite are determined at two different times, with allowances made for the user's motion during the interval between measurements. This would provide the user's position, but with inaccuracies, because his exact absolute speed is unknown.

A measure of the rate of change of distance, which can be accomplished by recording the doppler shift of a radio signal from a satellite transmitter, also provides the position of a craft. Movement of the satellite permits the user to obtain subsequent measurements. Again, errors are introduced by the user's unknown absolute speed.

All navigation schemes that provide position data from multiple-distance measurements over discrete time periods require accurate information on the velocity of the aircraft or ship with respect to the earth, not the sea or air. Undetermined motion of the vehicle results in large errors in its position. It is possible to adequately measure the motion of ships without a satellite for an acceptable position fix, but for aircraft, the magnitude of displacement caused by air current, for example, is great enough to produce unacceptable errors.

It might appear that the unknown motion parameters might be computed from the satellite measurements and the data used to eliminate the position errors. But this is not true in practice. For example, if an aircraft is assumed to have a steady but unknown velocity, there is theoretically enough information available from multiple measurements to calculate it. Unfortunately, small variations in the assumed steady velocity will produce large errors in the calculated velocity. And there will be correspondingly large errors in the position with computation based on the incorrect calculated velocity. These problems cannot be solved by advancing technology. These are additional reasons why the Transit system has not been used for aircraft. Such difficulties rule out the technique of making distance measurements from one satellite over a period of time. A system that serves both aircraft and ships must make all measurements instantaneously.

The choice narrows

Various combinations of instantaneous measurements are possible for a system in which the user transmits to the satellite. Two systems recommended to the National Aeronautics and Space Administration under study contracts are the Westinghouse Electric Corp.'s concept for the measurement of distance and direction from one satellite and the General Electric Co.'s concept for the measurement of distance from two satellites in addition to using altitude data obtained, in the

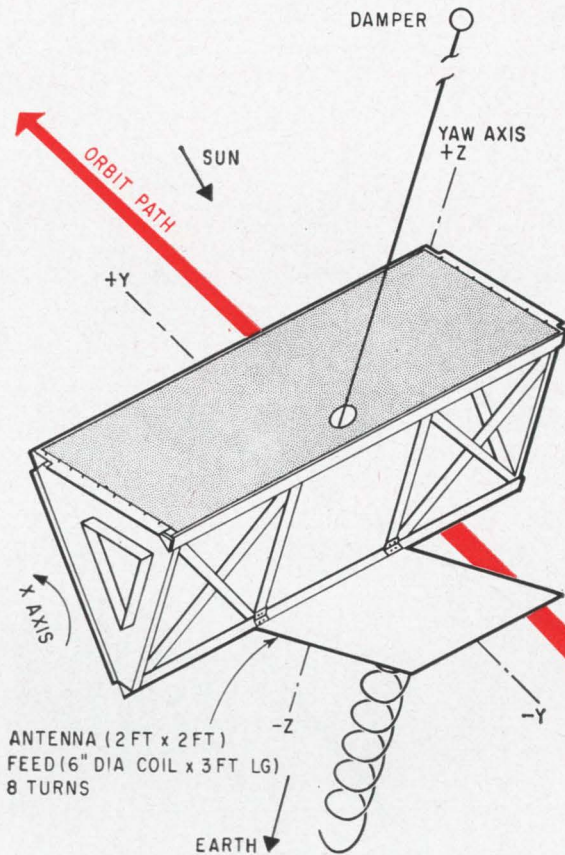

Navigational satellite system proposed by GE would use two medium-altitude satellites to determine position by simultaneously measuring their distances from a craft.

case of aircraft, from the plane's own instruments.

The advantage of GE's system is that the satellites are simpler. Disadvantages: twice as many satellites are required and position accuracy is degraded near the line joining the subtrack points—points on the earth's surface directly under the satellite. Near this line, the acute angle of intersection of the measurement vectors results in magnification of altitude errors, which may be several hundred feet when measurements are made with barometric altimeters. But more accurate radar altimeters are expensive. Position fixes from synchronous satellites in relative position over the equator, for example, may be in serious error within an area between 15° north latitude and 15° south latitude because of these altitude errors.

The advantages of Westinghouse's distance and direction system are that one satellite is required instead of two and its accuracy is not degraded anywhere on the globe. But the satellite is more complex than the satellites that only measure distance.

A typical system

Each system would require different equipment. A possible system proposed by Westinghouse would consist of satellites orbiting at synchronous altitude—22,300 miles. Position could be determined by instantaneous measurements of distance and direction, with transmitting equipment on aircraft and ships, and control stations on the ground.

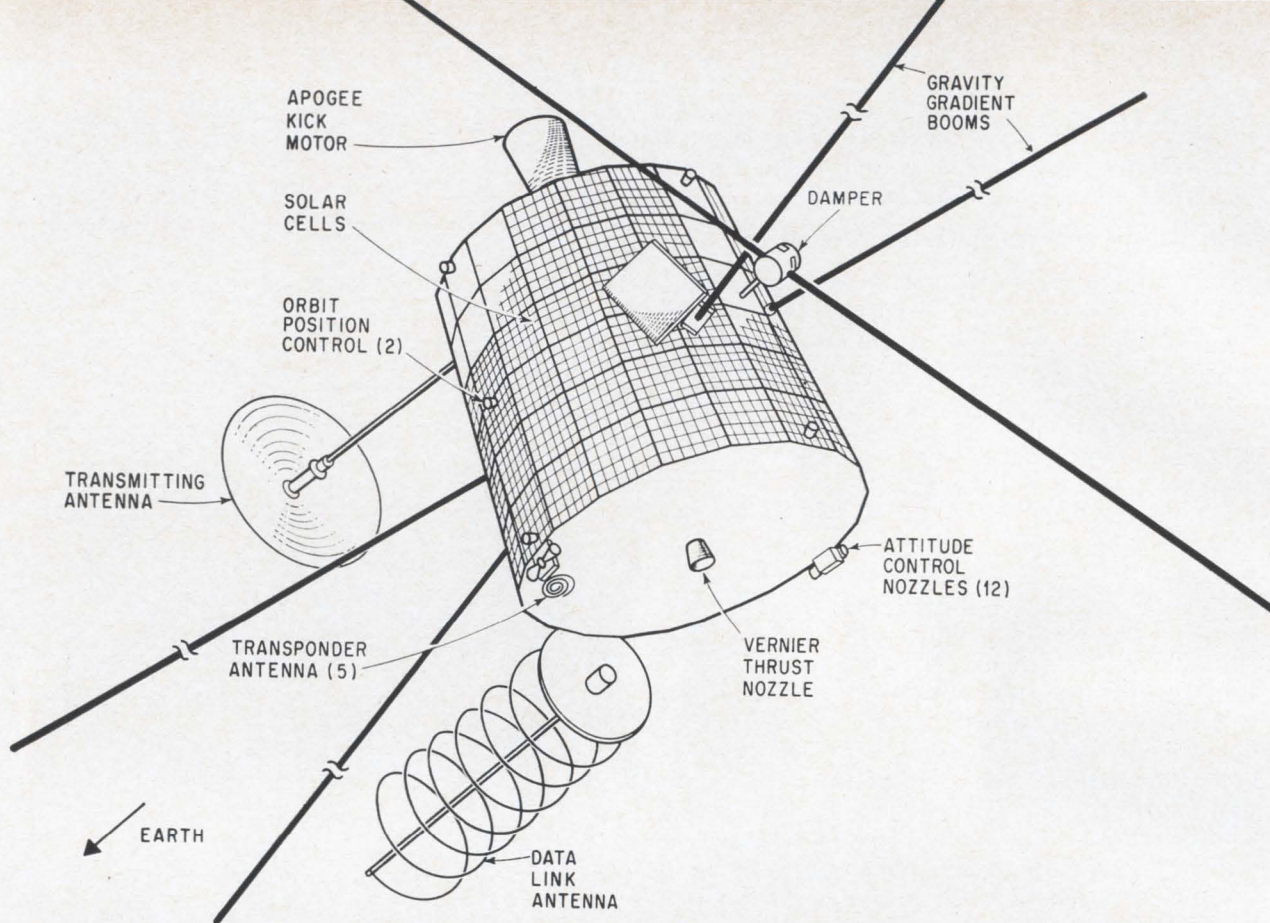

Gravity-gradient attitude control system points this Westinghouse Electric navigational satellite at the earth from its orbit at synchronous altitude.

Each satellite would be gravity-gradient stabilized. The satellite's surface would be covered with solar cells to supply power. The booms of the gravity-gradient system would provide attitude control. Interferometer antennas for the direction-measurement radar would be placed at the ends of the booms, facing the earth. The radar antenna and the communications helical antenna would be below the satellite body and directed toward the earth. The nozzle of the engine that positions the satellite into its synchronous orbit—after it has been lifted into space—would project from one base of the body. A small helical antenna around the nozzle would form part of the command and telemetry system.

The satellite would also have sensors and a thrust system to control attitude during initial orbit injection and to stop the satellite from spinning before the gravity-gradient boom is deployed. Position would be maintained by a command from the earth.

All the electronic equipment in the satellite, with the exception of the final output tube, would be solid-state integrated circuits for reliability and weight savings.

One satellite in an orbit synchronous with the earth at the equator and 33° west longitude would provide coverage for the Atlantic. Three satellites spaced at equal distances around the equator would cover all of the earth except near the poles.

If coverage of the entire earth were required, the system would need two synchronous satellites

in equatorial orbits plus three additional satellites in polar orbits at altitudes of 22,300 miles.

The location of the satellites with respect to the earth is, of course, the reference point for all calculations of position for the user. Determination of satellite position at the instant the navigation measurements are made would involve only the substitution of ground reference stations at known locations for craft in the measurement cycle. Eight reference stations would be required for worldwide coverage. These reference stations would also determine the satellite's attitude.

A ship or aircraft would tune into the system by notifying a control station that it is ready to depart from a port or airfield. An automatically generated identifying code would be sent via the satellite to the control station. Then the computer would signal the craft to start receiving the satellite's data. The craft could verify the accuracy of the position report before it starts its trip by comparing the position it receives with its known location.

Two ground stations would provide control of all five satellites required for world coverage. The satellite would act as a relay between the control stations and all craft. A control station would initiate the position determination by sending a message to a craft via the satellite. The craft would recognize its own signal and prepare to respond to the distance-measuring pulse that would follow. The user would receive this distance pulse, im-

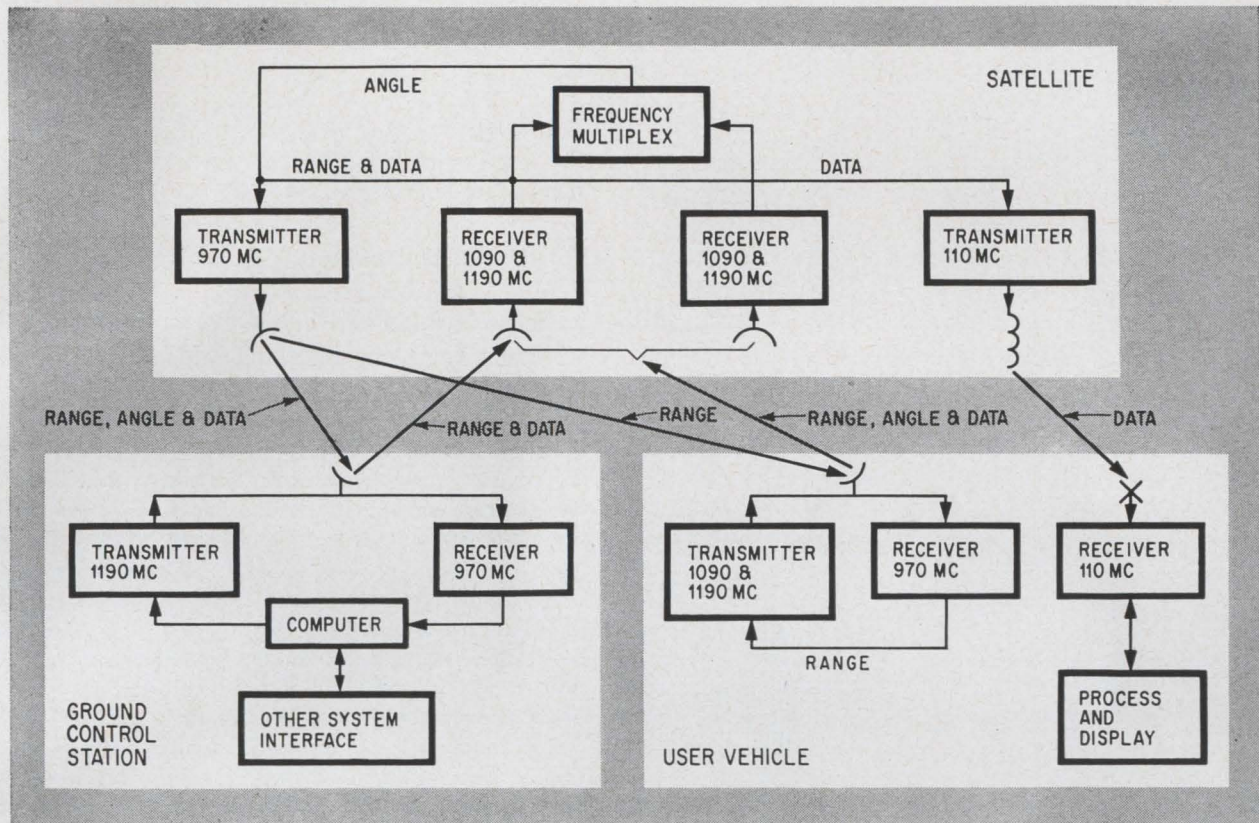

Electronic equipment in the navigational system is shown for the satellite, the ground control station and the user vehicle in this operational block diagram.

mediately retransmit it, and then send a longer pulse to the satellite for direction measurement. The craft would continue to receive position fixes on a regular basis until it arrives at its destination.

Distance measurement

The satellites would relay the distance pulse to the control station, where distance from the satellites to the craft is determined by conventional radar-ranging techniques. The time for the pulse to make the round trip from the control station to the satellite and back is subtracted from the time the pulse takes to travel to the craft via the satellite and back to the control station via the satellite.

There would be no difficulty in achieving high accuracy with this method. Emphasis, therefore, is placed on reducing transmitted power and, thus, satellite weight.

The system would use a linear f-m pulse-expansion technique to obtain accurate measurements of distance while reducing the peak power transmitted and increasing the pulse time from 6.3 μ sec to 318 μ sec. The signal bandwidth transmitted would be 159 kilocycles. The signals would be transmitted sequentially over a longer period of time, producing a linearly swept carrier frequency within a pulse of lower peak power. The expanded pulse would be transmitted from the control station to the satellite, to the craft and back along the reverse route. When the signal is received by

the control station, it would be compressed to its original 6.3- μ sec width. The peak signal power would be effectively increased because the energy in the pulse remains constant.

The pulse-compression and expansion circuitry can be at the ground station, thus less equipment would be required in the satellite or on the craft.

Many position fixes can be obtained although the satellite transmitter is used only part-time.

Distance could also be determined by using a continuous-wave signal that has a number of tones modulated upon it, together or in sequence. Measurement of relative phase shift at five different frequencies can be used to compute distance.

Direction measurement

The direction pulse would be received at the satellite by two sets of interferometers. The interferometers would be at right angles to each other. Each interferometer consists of antennas on booms extending from the satellite, plus electronic equipment for amplifying, frequency shifting and combining the received signals for retransmission to the control station. The frequency multiplexer and repeater would be in the satellite, and the phases of the signal would be transmitted to the phase detector, situated at the control stations. The phase detector measures phase by counting the interval between zero crossings of the signal.

The interferometer technique provides accuracy, simplicity and broad angular coverage without

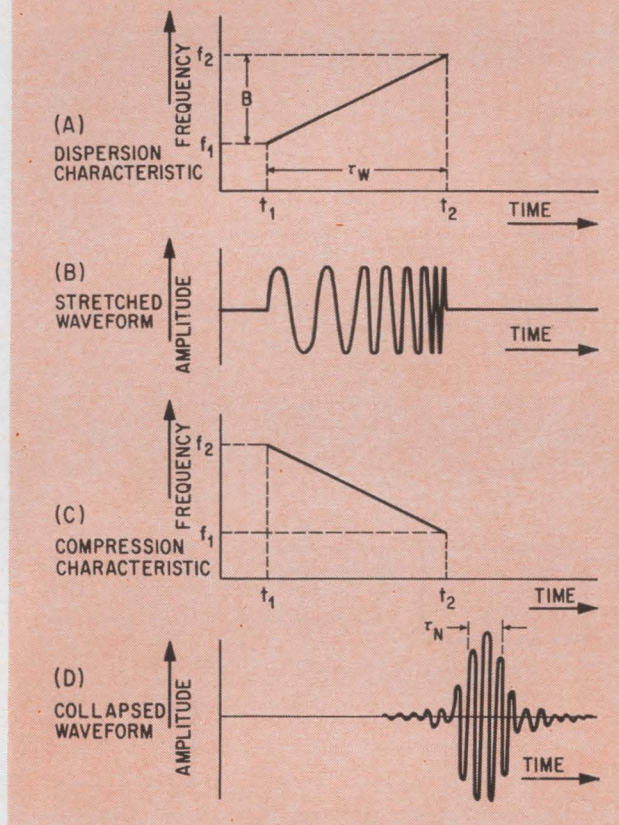

Dispersion characteristic (a) illustrates how frequency is swept linearly across bandwidth B so that each component frequency is delayed in time by an amount proportional to its frequency. This results in an expanded pulse of width τ_w with the shape of B . When the returning signal is received, the expanded waveform (b) is processed through a delay line with slope (c), which is opposite to the dispersion characteristic. The expanded waveform is collapsed (d) to a narrow pulse whose effective width τ_n equals $1/B$.

moving parts. High accuracy is obtained by measuring the difference in phase between the signals arriving at the two antennas, which are spaced many wavelengths apart.

The interferometer would have two antennas connected by transmission lines of equal length to a phase meter. The wavefront of a signal, originating at a remote point making an angle with the antenna baseline, arrives at the two antennas at different times. The two received signal components are therefore out of phase. The electrical phase-difference angle between signal components arriving at the two antennas, as measured by the phasemeter, is

$$\phi = \frac{2\pi D}{\lambda} \sin \theta$$

where D = antenna separation, λ = wavelength and θ = angle of incidence of the signal.

This discussion assumes the wavefront to be planar, and the direction of signal propagation to the two antennas as essentially parallel lines because of the great distance from the earth to the satellite.

The sensitivity of the interferometer may be

determined by differentiating the phase equation:

$$\frac{d\phi}{d\theta} = \frac{2\pi D}{\lambda} \cos \theta$$

The angle θ varies from 0° to about 15° . This is the angle subtended by the earth at the synchronous altitude. Since $\cos \theta \approx 1.0$,

$\frac{d\phi}{d\theta}$ will not change appreciably over the range of

angles to be measured, and any error in phase measurement results in a space angle error that is smaller

by a factor of $\frac{\lambda}{2\pi D}$.

This navigational satellite system would achieve an accuracy of one nautical mile 95% of the time. At synchronous altitude, this corresponds to an angular accuracy of 6 seconds of arc when combined with satellite-to-user measurement accuracy of 0.1 nautical mile. The three quantities that may be traded off to achieve this are the accuracy of phase measurement, the separation of the antennas and the wavelength of the signal.

The accuracy of phase measurement depends upon the signal-to-noise ratio of the received signal. This can be improved by increasing the energy transmitted by the user. The accuracy of phase measurement is dependent upon total energy received rather than the peak power received. The energy may be transmitted over a short interval with high peak power or over a longer interval with reduced peak power. Twenty-five joules of energy in a 7-millisecond pulse would be transmitted using low-cost tetrodes in the power output stage of the user's equipment.

The interferometer antennas on the satellite must have fixed gain because of size limitations. The effective aperture of such an antenna is proportional to the square of the signal wavelength. A reduction in wavelength, therefore, requires an increase in power transmitted by the user.

Increasing the antenna separation means longer antenna booms; this complicates the satellite structure and increases satellite weight.

Angular accuracy thus is a trade-off between the power output of the user's equipment and the antenna separation on the satellite. A reasonable operating point appears to be at a signal-to-noise ratio of 42 decibels, which permits a phase-measurement accuracy of one degree, a wavelength of about one foot (at a frequency of about one gigacycle) and an antenna separation of 100 feet.

Antenna gain of six decibels appears to be the highest that can currently be obtained on most user equipment. Phased antenna arrays may, however, provide more gain. A breakthrough in antenna design or in power-tube design is needed to permit more effective energy to reach the satellite without increasing the cost of the user's equipment.

Phase measurement can be done at radio frequencies, at intermediate frequencies or in the au-

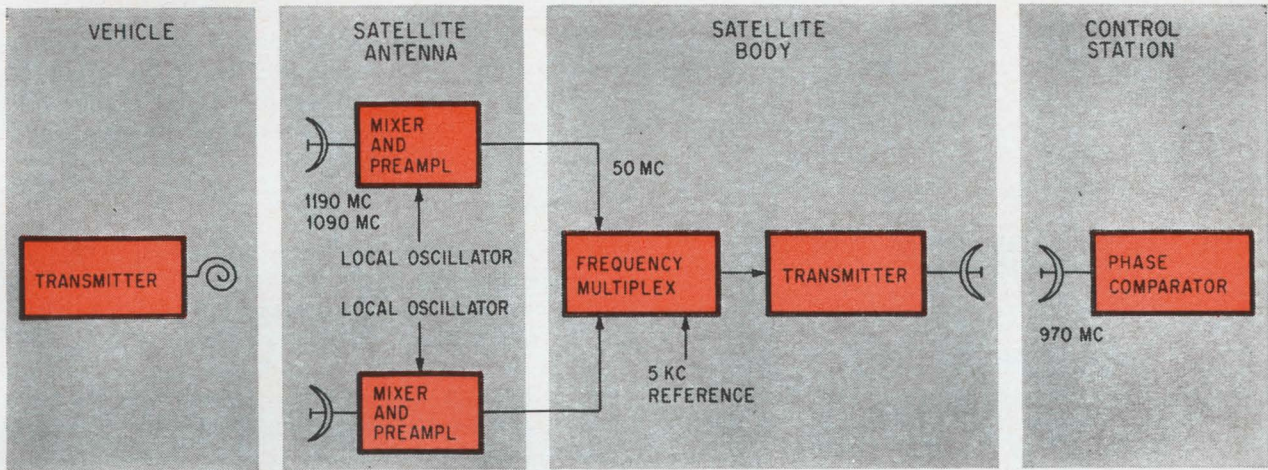

Signal flow for angle measurement in the Westinghouse system. Diagram shows equipment involved in the satellite, the user vehicle and the ground-control station.

Interferometer technique for measuring angles

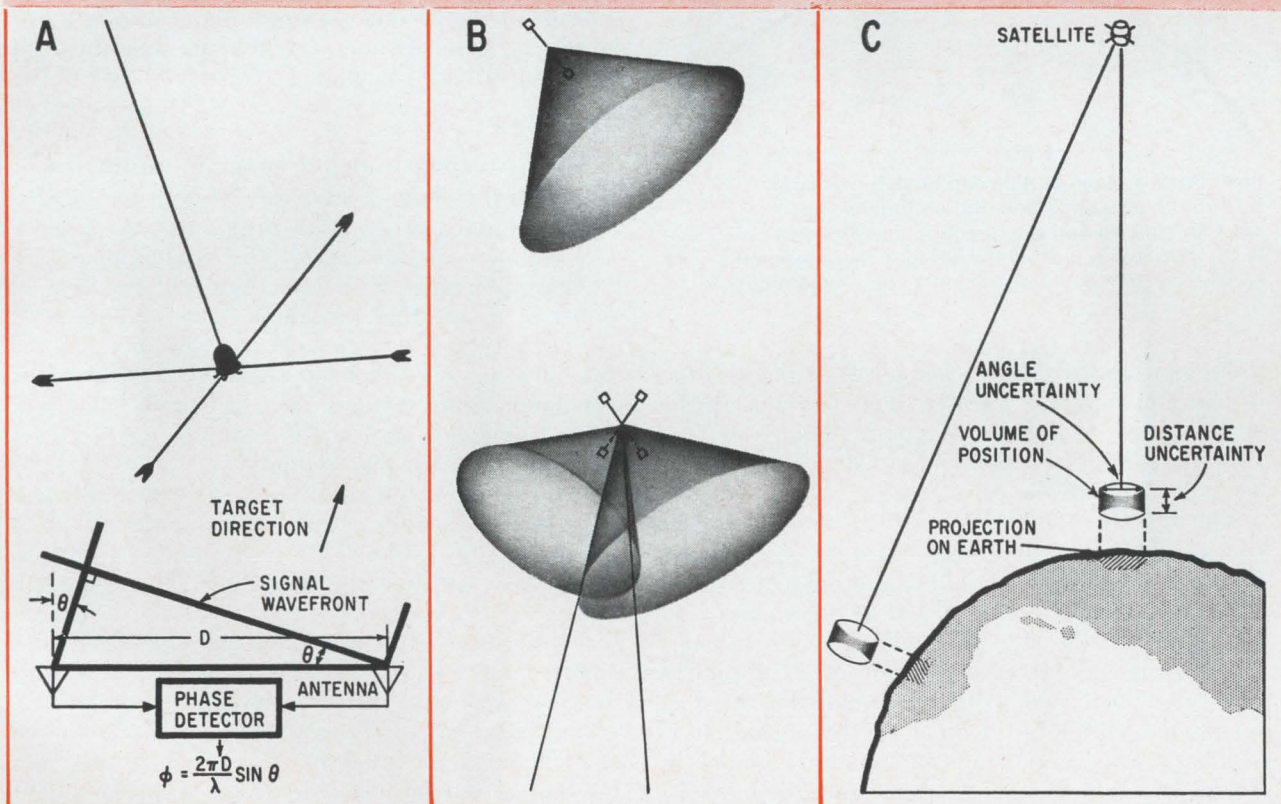

a) The navigational satellite contains two interferometers, which consist of phase-angle measuring antennas plus amplifiers and data-transmission circuits. The antenna sets are at right angles to each other and are positioned parallel to the earth's surface.

b) The angle measured by the set of interferometer antennas describes the surface of a cone, with its apex at the interferometer and its axis coincident with that of the interferometer. Thus, the volume covered by two sets of interferometers at right angles to each other and parallel to the earth's surface is described by two cones. The cones intersect along two straight lines, one pointing

toward the aircraft, ship or reference station and the other away from the earth.

c) The lines representing distance and direction from the satellite to the aircraft or ship describe a cylinder whose diameter is the angular-error and whose depth is the distance error. The projection of this volume on the surface of the earth encompasses the position of the user. Since the volume projected on the earth is approximately spherical, its projection has the same size in all positions and the accuracy of the system is independent of the relative position of the aircraft or ship with respect to the satellite.

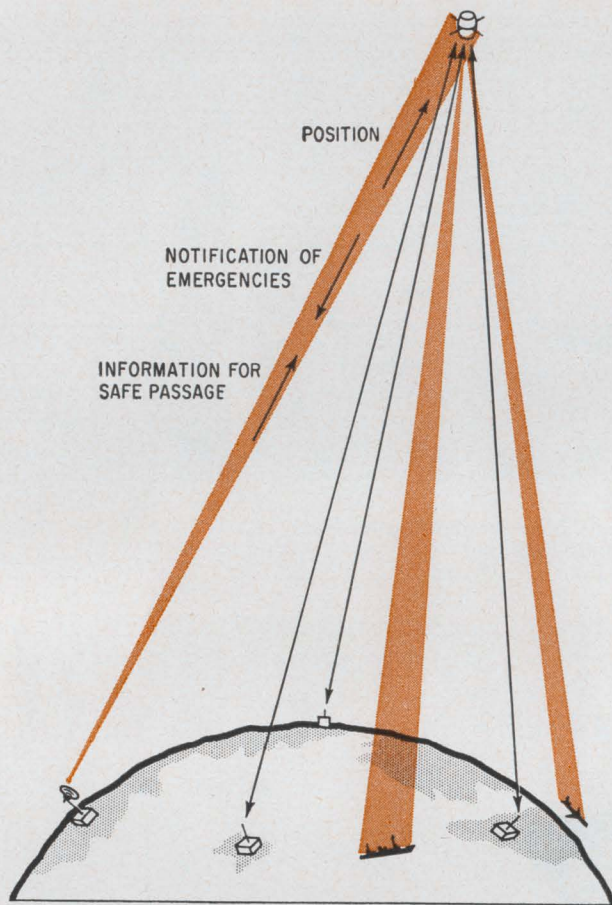

Position of a plane or ship can be determined by finding the exact position and altitude of the satellite, and finding the direction and distance of the target vessel from the satellite. Navigational-satellite system could also handle communications.

dio region, and with open-versus closed-loop (direct measurement versus error nulling) systems. In this system, there would be an intermediate frequency (i-f) open-loop measurement at 30 megacycles to directly compare the phase of the two signals.

The signal components would be received at the two interferometer antennas with a phase difference between them. They would be heterodyned down to the first intermediate frequency by a common local oscillator, but the signals would retain their phase relationship through the wideband i-f preamplifiers. The two signals would be heterodyned down to a second i-f with one channel of the second local oscillator separated from the second channel by 5 Kc; the two signals would retain their phase relation because of the small frequency separation. After mixing, two signals would be compared with the reference-oscillator frequency in a phase comparator, which consists of a zero-crossing detector and a counter.

With an antenna spacing of many wavelengths, there are multiple angles in space that correspond to each angle of phase that is measured.

These ambiguities can be resolved by making the angle measurements sequentially on two frequencies spaced about 100 Mc apart on the 1,090-

Mc center frequency. The vehicle transmits half of the time for each measurement. There are some angle ambiguities remaining. These correspond to 700-mile areas on earth and it is far easier to remove them by computations than by using additional frequencies.

Communications

A navigational satellite with two sets of interferometers, such as the Westinghouse distance and direction system, may be oriented continuously by the reference stations. If a phased array—which could be steered electronically—were mounted on the satellite, it would be possible to direct the transmission from the satellite to a particular craft. With such a high-gain antenna on the satellite, the craft could get along with a simple six-decibel gain antenna. This is the opposite of the Syncom approach, in which the high-gain antennas are on the ground. Use of a high-gain antenna permits the satellite to relay voice communications to ships or planes, or alternatively, to relay many teletype channels.

When both the ground station and the satellite have high-gain antennas, switching can be accomplished at the ground station without adding noise to the system. Ground switching simplifies the satellite further.

The future

The navigational-satellite program can use many of the technological advances of communication and meteorological-satellite programs. A conservative estimate of the cost of the navigational program would place it at less than half the cost of either of these other programs.

The question of who will pay for navigational satellites has not yet been resolved. Traditionally, communication systems are privately financed, while navigation and traffic controls have always been provided by governments.

Even if a governmental body were to build and operate the satellites and control stations, it is expected that airline and shipping companies would buy or lease the electronic equipment for craft.

It has been estimated that the operating and amortization costs for a navigational-satellite system would amount to a few cents per position fix.

The program awaits recommendations from the Joint Navigation Satellite Committee, NASA and the Budget Bureau. It would be up to the President and Congress to earmark funds for the system. The views of the potential users would also affect the choice of a system.

A logical initial step would be to conduct one or more navigational experiments in the current NASA program of Applications Technology Satellites. These experiments would test the accuracy of distance and direction measurements from a satellite. An experimental satellite might be launched soon after. Then all will be ready if it is decided to go ahead with the system.

this authentic
hand-cut
quill pen is
yours FREE!

for helping in this **NATIONAL**
COPYMAKER SURVEY

JUST ANSWER THE FIVE QUESTIONS ON THE POSTAGE-PAID REPLY CARD AND WE'LL SEND YOU AN AUTHENTIC HAND-CUT QUILL PEN...EXACTLY LIKE THE TYPE USED BY THE SIGNERS OF THE DECLARATION OF INDEPENDENCE.

APECO is now making a survey of the uses and needs for copymakers in specific industries that are volume users of this equipment. These questions will provide information needed to help us improve upon future copymakers in order to better service your requirements. For your cooperation in helping us to secure this information, we will be happy to send you an authentic hand-cut quill pen that will serve as an interesting reminder of the technological advances man has made since the days when all documents were copied by hand. Thank you for your cooperation.

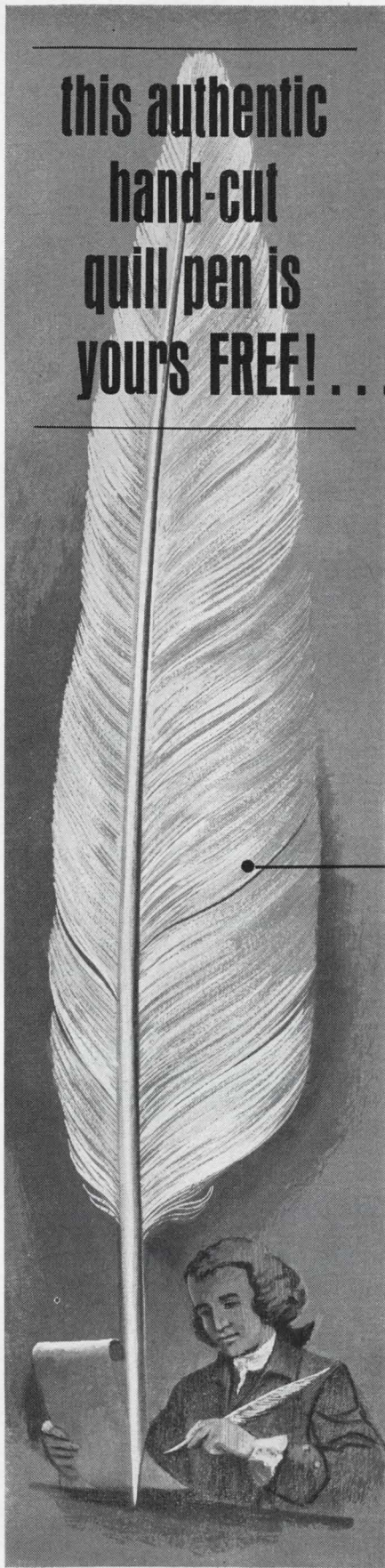

APĒCO  *copies for communication throughout the world...*
AMERICAN PHOTOCOPY EQUIPMENT COMPANY
2100 West Dempster Street • Evanston, Ill.

EAGLE *Cycl-Flex*® TIMERS/COUNTERS

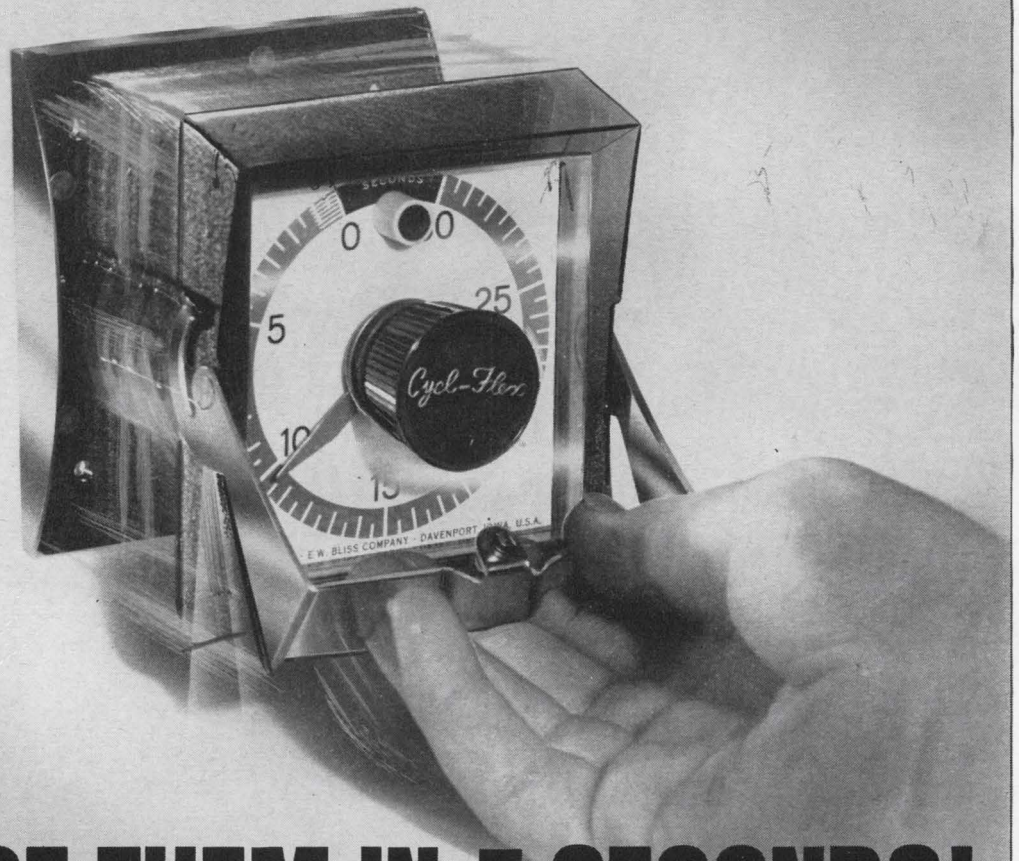

REPLACE THEM IN 5 SECONDS!

Cut down-time and increase production with Eagle Cycl-Flex time and count controls. You can remove them, check them and replace them in 5 seconds or less...no tools needed!

- Cycl-Flex plug-in timers can be controlled to within 0.5% of the dial range.
- Front-panel mounting makes them easy to install and set.
- Long cycling life—through extensive quality control and life testing programs.
- A synchronous motor and toothed clutch, produced by a special Eagle process, assure totally accurate settings and performance.

Add all these features together. Then add Eagle's special consultation, development and design services...and custom production of all types of units.

165-1

Compare. You'll choose Eagle.

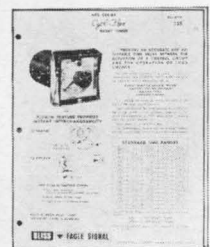
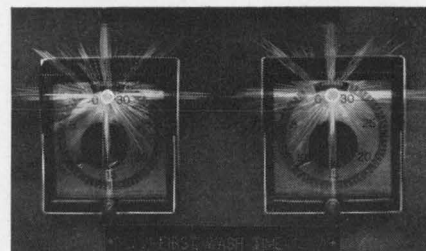

NEW—Now standard on all Cycl-Flex timers, a built-in pilot light, to indicate, even from a distance, that the timer is operating.

For full details on Cycl-Flex timers, write for Bulletin 125, Eagle Signal Division, E. W. Bliss Company, Federal Street, Davenport, Iowa.

BLISS



EAGLE SIGNAL

A DIVISION OF THE E. W. BLISS COMPANY

Electro-Mechanical, Electronic, Solid State Timing/Counting/Programming Controls General Purpose, Medium Power Relays

NEW EAGLE RELAYS

COMPARE
Better Life Characteristics

COMPARE
Higher Reliability

COMPARE
Fewer Parts

COMPARE
More Design Flexibility

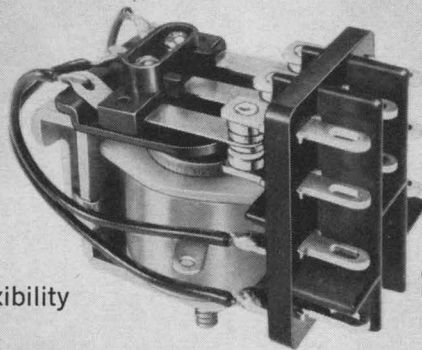

Eagle 25AA
General Purpose
Relay (Actual Size)

COMPARE
Lower Pull-in Voltages

COMPARE THEM!

New Eagle relays... more than 3,000 types... are the best you can get anywhere. Be crafty. Check the specs and the product. Convince yourself.

One example: Gold-plated contacts are *standard* on every general purpose Eagle relay. And on medium power relays, silver cadmium oxide contacts are standard, since they deliver the best possible current-bearing characteristics in this power range.

Check some more. Note the sturdy designs... the ratings that exceed all other competitively-priced units... the precise engineering and inventive use of materials. They're all what you'd expect from Eagle—leaders in time/count control devices.

If you've ever dealt with Eagle you'll expect more, and you'll get it. We're talking about unequalled service... service that frankly has never before been available from any relay manufacturer.

Compare. You'll choose Eagle.

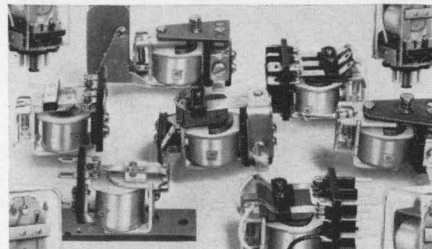

Part of the "big" picture... more than 3,000 types: plug-in with dust covers; dual latching; hermetically sealed; custom-engineered styles.

Get full details in our new, 16-page color catalog. Send for your free copy to Eagle Signal Division, E. W. Bliss Company, Federal Street, Davenport, Iowa.

BLISS



EAGLE SIGNAL

A DIVISION OF THE E W BLISS COMPANY

Electro-Mechanical, Electronic, Solid State Timing/Counting/Programming Controls General Purpose, Medium Power Relays

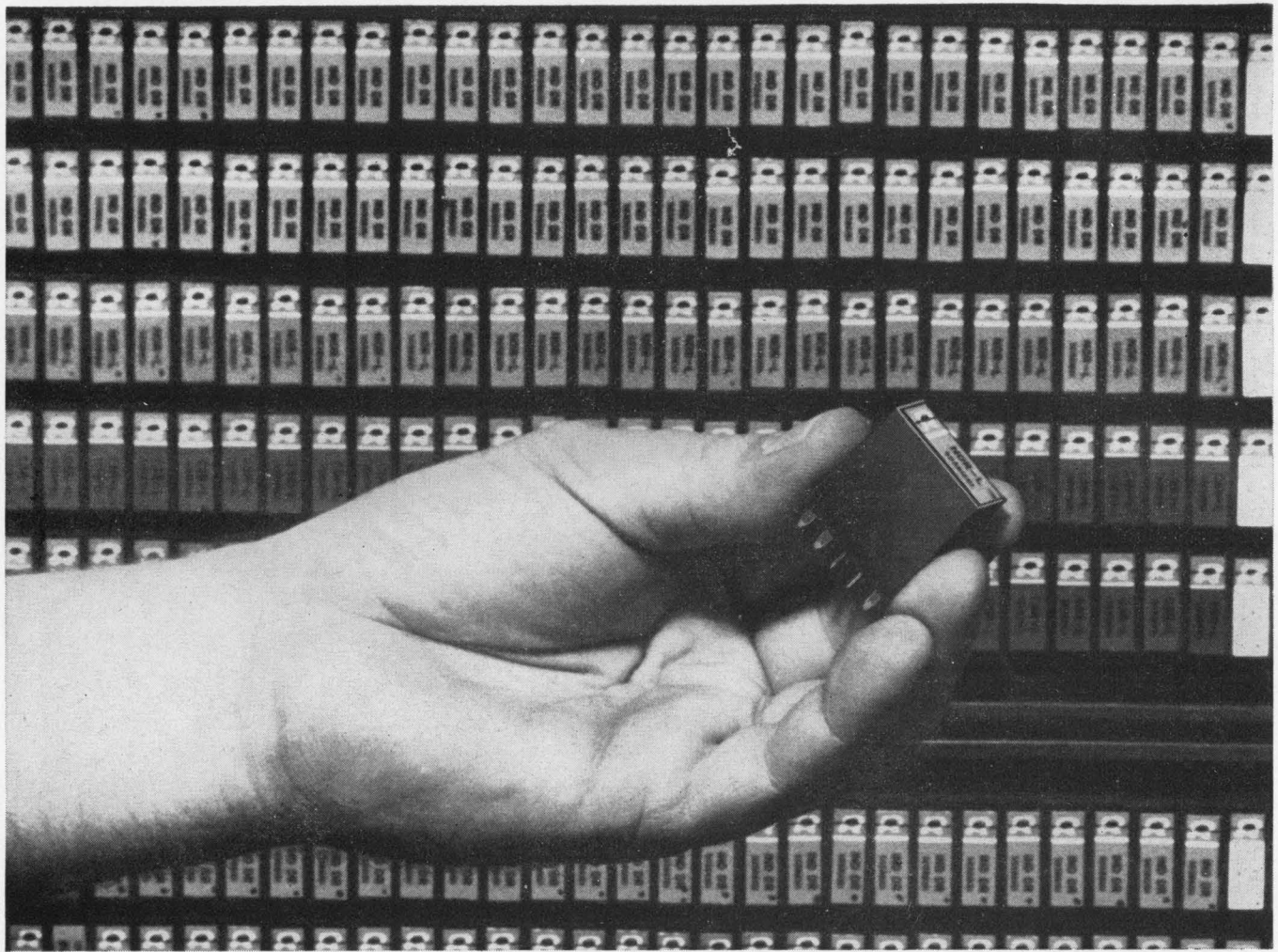

Simplify Digital Design

Radiation Logic Modules are packaged for flexibility, reliability, high-density mounting

There's no need for design compromise when you specify Radiation Logic Modules. They can be used in any configuration, type or number compatible with your digital system requirements. They can be mounted in vertical or horizontal drawers, in standard 19" racks, or on breadboards...fixed or removable.

Radiation Logic Modules are supplied from stock in standard as well as special-purpose types. Two sets of fully compatible resistor-transistor logic circuitry are available. They cover bit rates up to 200 kc, and rates to 1 Mc. More than a dozen types include: 4-input NOR-Counter Shift Register-Power Inverter-Emitter Follower-Complementary Driver-Differential-Filter (Decoupler).

RELIABILITY Superior engineering and rigid component selection assure highest reliability: based on extensive tests, MTBF for low-speed NOR Modules exceeds 2,940,000 hours! The units are also packaged for rugged use. Construction consists of welded circuitry

molded in epoxy and mounted with high-density module connectors on cast aluminum frames. The resulting positive-contact units measure only 0.4" x 1" x 1.1" with a 0.25" pin protrusion.

ECONOMY Each module represents a fraction of the entire digital system. Each is designed for easy interrogation. Change or replacement is as simple as plugging in another unit. Thus, expensive downtime is reduced, costly benchwork completely eliminated.

APPLICATIONS ASSISTANCE Radiation offers the services of its engineering staff in the application of digital logic modules, or in helping solve your unique data problems. Write or phone for technical data sheets. Radiation Incorporated, Products Division, Department EL-02, Melbourne, Florida. Telephone: (305) 723-1511.



RADIATION
INCORPORATED

PRICE LIST-DIGITAL MODULES

Model	Description*	Unit Price
92600	NOR-L	\$4.50
92601	NOR-M	5.00
92602	Dual NOR-M	9.50
92603	CSR-L**	5.00
92604	CSR-M**	5.25
92605	CSR-M1	10.00
92606	Comp. Driver-L	6.00
92607	Power Inv.-L	5.00
92608	Power Inv.-M	5.50
92609	Diff.-L (MSMV (1/2) "A")	5.00
92610	Ind. Driver-8	9.00
92611	Filter Dec.	4.25

*Two sets of fully compatible resistor-transistor logic circuitry are available: L—low speed, for operation at bit rates up to 200 kc; M—medium speed, for operation at bit rates to 1 Mc.

**Two modules are required per counter/shift register stage.

Probing the News

Companies

The giant of Eindhoven

Philips moves quietly but successfully to expand its electronics empire into 56 countries

In 1895, Gerard Philips put his light-bulb factory up for sale. He asked 25,000 Dutch guilders for the former buckskin plant in Eindhoven, the Netherlands, but the best offer was 24,000—about \$9,600. Gerard turned it down. Instead, the engineer brought in his younger brother, Anton, a banker, to help reorganize the four-year-old business.

Today, Gerard's and Anton's descendants operate a corporate complex that controls about 200 plants in 30 countries. Its sales, in some 56 nations, total nearly \$2 billion a year. Philips Gloeilampenfabrieken, N.V., is the fourth-largest electronics company in the world, trailing only the General Electric Co., Westinghouse Electric Corp. and Radio Corp. of America, in that order.

The concern is still tightly controlled by the Philips family. Its president, Frits J. Philips, a 59-year-old nephew of Gerard, is proud of the company's farflung organization and financial connections.

"Plants and machinery any man can buy," he declares, "but an organization must be grown, like a tree."

I. Complex and secret

Philips' growth does resemble a tree's, with branches above ground and roots deep below the surface. The company declines to disclose details about its plants or its network of licensing agreements with electronics concerns around the world.

Although secretive about some corporate affairs, Philips is willing



Frits J. Philips, president of Philips Gloeilampenfabrieken: "Plants and machinery any man can buy, but an organization must be grown like a tree."

to expound at length about its immediate objectives. These goals include:

- Development of a commercial line of computers;

- A shift in emphasis from consumer products to the industrial and military markets while expanding in household appliances and electronic gadgets;

- Color television for Europe; and

- Broadened markets in Africa, Asia and Latin America.

II. Entering the computer market

Philips entered the computer race only two years ago. Could Philips afford to spot its competitors a head start of 16 years or so?

Frits replies wryly: "The only thing we cannot afford is *not* to do it."

He knew he had at least 200 acres in the hole—Philips' plants, whose automation needs alone could keep the computer operation busy for three or four years.

While it's new in the computer business, Philips is a veteran designer of ferrite magnetic cores, the basic material for computers' internal memories. The company decided in the late 1940's that quality mass-production was still out of reach, so Philips licensed other companies to produce the cores. Sometimes a licensee beat Philips to the market with ferrites.

Widening the field. True, Philips' licensing policy invited competition. But A. E. Pannenberg, chief of the company's main laboratory at Eindhoven, explains: "We license to expand the field. We have such faith in our research, development and production teams that we feel we do better with this approach than we would be playing it close to the chest."

Philips is considered the world's largest supplier of cores. Half of the core-producing companies operate under Philips' license.

III. Tailored to industry

Philips has always stressed consumer products. But as other industries turned to electronics to automate their plants, and as mili-

tary equipment began to incorporate more electronic equipment, Philips decided to direct its growth accordingly.

Although sales have tripled since 1955, Philips concedes that much of that sales leap was attributed to new markets for consumer goods in Europe. But now the markets for many consumer items have leveled off and can't sustain the sales gains of up to 12% that the company has been posting annually.

Today, about 66% of Philips' sales come from consumer products, with military markets comprising about 5%. By 1980, the company hopes that two-thirds of its volume will be from the industrial and military markets.

Eye on video. But Philips has no intention of letting its consumer sales recede very far. It plans to continue to push new electronic gadgets, keeping pace with the increasingly richer tastes of Europeans. Recently, for example, Philips introduced a video-tape recorder and an electronic organ called the Philicordia.

Tied in with this effort is Philips' campaign in color television. The Dutch company expects color tv sets to account for 25% of Europe's tv sales by 1970. To take advantage of this potential, Philips has launched experimental color tv broadcasting in an effort to sway

the government-run European networks to decide on a single transmission system—the United States' NTSC. Meanwhile, France is pushing her Secam system and West Germany the PAL system.

Nationalism. Military equipment brings Philips' sales force up against nationalism among its customers. But Philips' unique worldwide organization is apparently overcoming this obstacle.

When the U.S. Defense Department showed interest in Philips' fire-control equipment, the Dutch company licensed the Ford Instrument Co., a division of the Sperry Rand Corp., to build the items. In Great Britain a Philips subsidiary, Mullard, Ltd., is supplying radar-display units for the Royal Navy. Through its West German unit, Philips has found a modest market for shipborne fire-control gear.

Philips expects its nationally oriented subsidiaries to open more doors for military contracts.

IV. In search of new markets

Philips' market is international: 75% of its sales are in Western Europe; 15% more comes from the Western Hemisphere. In its drive for new markets, Philips is turning more attention to Africa, the Orient and Latin America. It has plans to spend \$2.8 million on plants in South Africa. In the past



Hendrick B.G. Casimir, director of research, coordinates Philips' worldwide research activities. Six percent of Philips sales is devoted to research.



Willem A. De Jonge, Philips' top financial officer "We don't leave (a market) until they kick us out."

18 months Philips' 50-kilowatt transmitters have started broadcasting in Cambodia, Indonesia and Mozambique, and the last sections of a 7,000-megacycle microwave network are being installed in Sierra Leone and Ghana.

These markets involve higher risks than in Europe, but Philips sees a large potential in these emerging countries.

Philips is cautious with new products, but it's not easily dislodged from a precarious market. "We don't leave until they kick us out," says Willem A. De Jonge, a top financial officer. In Brazil, a Philips subsidiary weathered the country's economic chaos by "inflation-proofing"—cutting down on credit and keeping inventories high. Now Philips plans to build a \$10-million glass plant in Brazil to supply television tubes for its plants throughout South America.

V. How did it happen?

How did Philips become such a giant? Why do electronics executives lose sleep when they hear that Philips is planning to move in with a new product?

Basically, the answers are rooted in the company's unique organizational structure and its enormous, free-wheeling research program.

"I like to think of Philips as a world federation of companies coordinated by Eindhoven but not

dictated to," says Frits Philips who, with three vice presidents, comprise the company's inner circle. Because of the complex financial relations between Eindhoven and the plants around the world, some members of the Philips industrial family have the power to thumb their noses at their Dutch bosses, although it's doubtful that they exercise this right very often.

Twin leaders. Like Janus, each major part of the Philips network has two heads: a businessman and a scientist. The company's top executives cite this arrangement as the key to Philips' success. Their reasoning: each manager acts a check on the other.

Because of the near-autonomous organization, subsidiaries in different lands have the authority to adapt to their customers' needs. The strongest link between Eindhoven and the subsidiaries is research. Of Philips' 246,000 employees, 20,000 are working on research and development. About 6% of Philips' annual sales income is plowed back into research. At the main laboratory at Eindhoven, 2,200 scientists are engaged in pure research, unfettered by rigid budgets; 300 members of this group have doctorates. Another 1,600 scientists work in laboratories in West Germany, Britain and France.

The director of Philips' research programs is Hendrik B.G. Casimir, a nuclear physicist who once worked with Niels Bohr. One of his responsibilities is to coordinate the research of the various subsidiaries. To keep all the researchers abreast of Philips' developments, confidential bulletins are issued to scientific personnel, outlining progress on various projects and sharing new production tricks.

Look to U.S.? Its continued expansion leads some observers to ask: "Will Philips try to broaden its activities into the United States?" The U.S. now provides about 4% of Philips' volume. But indications are that Philips will focus its attention on new, underdeveloped countries.

Frits Philips sums up the pragmatic approach this way: "We don't fight our way into established markets." There are enough opportunities elsewhere.

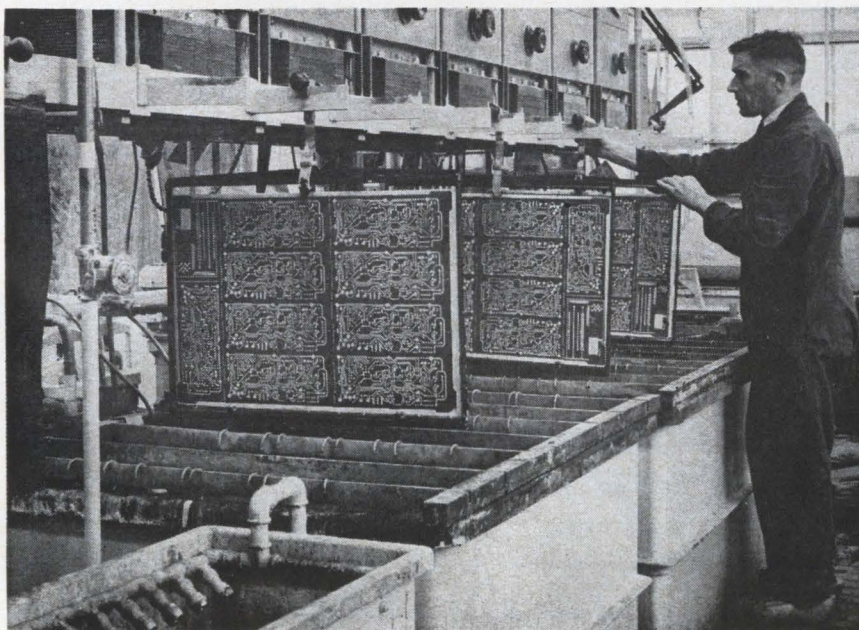

Printed-circuit production line at a Philips plant in the Netherlands. The company is the fourth largest electronics concern in the world.

LBJ's budget: less money for arms

Defense Department would continue its shift in stress to mobile conventional forces and penetration aids

More money for space electronics, penetration aids and mobile conventional forces; less for strategic weapon systems. These are the significant changes for the electronics industry in President Johnson's proposed budget for fiscal 1966.

The total military budget would authorize \$49 billion in spending. That's down about \$300 million from the amount that's expected to be spent in the current fiscal year, which ends June 30, and down \$2.2 billion from outlays in fiscal 1964.

Total spending authority—past, present and future—would climb to \$51.7 billion from \$50.9 billion this year.

The total spending for space, both military and civilian, would be about the same as this year. The National Aeronautics and Space Administration, which runs the civilian space effort, would receive a record \$5.1 billion. Of this, \$4.6 billion would be for research and development, up \$200 million from this year but the narrowest increase since the space program started. NASA estimates that half of its R&D spending is for electronics.

1. Improved missiles and bombers

Missile and bomber forces will be trimmed as older models are retired, but their weapons systems will be improved. Outdated Atlas and Titan I missiles will be phased out, as will the 225 B-47 bombers. Two squadrons of early-model B-52s also will be scrapped. The Minuteman missile force will be limited to 1,000 instead of the 1,200 that were planned earlier.

Spending authority for strategic weapons would continue to drop under the new budget, to \$4.5 billion next year from \$5.3 billion in fiscal 1965.

Johnson has rejected insistent Air Force pleas for a new bomber to replace the aging B-52. But his

budget does ask for \$300 million to continue strengthening the remaining bombers structurally so they can be used well into the 1970's. Top civilian officials in the Pentagon indicate doubt that a new bomber will be needed in view of continuing improvements in missiles.

Studies to continue. As insurance, the budget does call for \$70 million for continuing definition studies for a new plane, for advanced avionics and for starting the development of Sram—for short-range attack missile—an air-to-ground missile with a range of 75 miles. If the Pentagon continues to veto a new strategic bomber, these avionics and missile systems could be used on tactical bombers.

Sram could become operational early in 1969 if development went full-speed ahead. However, defense officials haven't committed themselves to it. The missile would be launched from planes flying at tree-top levels; it would go into a programmed climb, then dive onto pre-selected targets. Its main mission would be to knock out anti-aircraft defenses from beyond the range of their fire.

The budget also provides for pro-

duction and deployment of the SR-71 strike-reconnaissance plane, a modification of the supersonic A-11. Deliveries to the Strategic Air Command will begin in fiscal 1966. The Pentagon hasn't disclosed how many of these planes will be built.

Report back. In the missile field, improvements in penetration and guidance will continue. A new program will also develop methods by which missiles can report their arrival on target, up to and including the time of explosion.

Spending also will begin for developing the recently announced Poseidon missile, formerly the Polaris B-3. The Poseidon will have double the accuracy and payload of the Polaris A-3, which carries a one-megaton nuclear bomb, and approximately the same 2,800-mile range. The Poseidon will use micro-circuitry throughout. Development will cost \$800 million and production an additional \$1 billion.

II. Air and missile defense

Total obligation authority for continental air and missile forces will remain at this year's level, \$1.8 billion. Because the Pentagon considers the Soviet bomber threat to be diminishing, it will continue to



Supersonic F-111, formerly the TFX, is being developed by the General Dynamics Corp. Funds for the first large-scale procurement of the variable-sweep-wing craft are included in proposed defense budget.

reduce air-defense interceptor forces, missiles, radars and control centers. The Air Force's proposal for production and deployment of the YF-12A as an interceptor plane is being rejected, although funds are budgeted for continued study and tests. This plane, another member of the A-11 family, is already flying.

Defense Secretary Robert S. McNamara, with the President's backing, also rejected a recommendation from the Joint Chiefs of Staff for funds in fiscal 1966 for production of the Nike-X antimissile system. The cost of this system, plus a program of fallout shelters, has been estimated at a minimum of \$20 billion. McNamara is putting off the decision for another year, but is budgeting \$400 million for continued development of the Nike-X and \$100 million for what is described only as "other developments associated with the program."

With China in mind. The Pentagon is also considering a less-complicated system that could defend against any crude missile offensive the Chinese Communists might mount. It would complement the present system, which is designed for use against the more sophisticated Soviet missile force.

The budget also asks funds for over-the-horizon radar to detect enemy ballistic missiles when they are launched; for continued operation and improvement of the anti-satellite system, and for an improved system for early warnings against missiles, including what is described only as "an austere sea-launched missile-detection system."

III. General-purpose forces

Obligational authority for general-purpose forces would rise to \$19.1 billion from \$18.1 billion this year, with emphasis on improving quality and mobility.

The Army would begin buying the Chapparral—a ground-to-air version of the Sidewinder air-to-air missile—for forward-area air defense. Procurement of the Redeye man-held air-defense missile would rise from the current token level.

In communications, the Army will continue to buy modern f-m communications sets, to be carried in vehicles and on soldiers' backs, and will begin to buy single-side-



how to measure resolver or synchro position with 30 second repeatability

In both production test and ground checkout systems, North Atlantic's high performance Angle Position Indicators provide exceptional operator ease and precision in the measurement of synchro and resolver position. Features include digital readout in degrees and minutes, 30 second resolution, continuous rotation, plug-in solid-state amplifier and power supply modules. Due to the design flexibility of these units, they can be readily provided with a variety of features for specific requirements. Typical units in this line incorporate combinations of the following features:

- Single Synchro or Resolver Input
- Dual Synchro or Resolver Inputs
- Retransmit Synchro, Resolver, Potentiometer, or Encoder
- 2-Speed Synchro Input
- Multi-frequency Inputs
- DC Input
- 0-999 Counter

BASIC SPECIFICATIONS

Range	0°-360° continuous rotation
Accuracy	6 minutes (standard)
Repeatability	30 seconds
Slew Speed	25°/second
Power	115 volts, 400 cps
Size	API-8025 1¾" h x 9½" w x 9" d
	API-8027 3½" h x 4⅞" w x 9¾" d



Your local North Atlantic representative has complete data on the API line. Call him today or write direct for technical literature.

NORTH ATLANTIC industries, inc.
TERMINAL DRIVE, PLAINVIEW, L. I., NEW YORK • Overbrook 1-8600

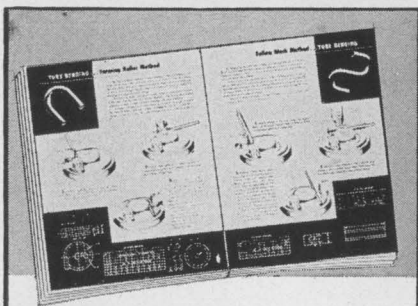

How to form it by **BENDING...**

Free Manual shows techniques of forming round, square, or hex bar stock... tubing... channel... angle... flat and other materials.

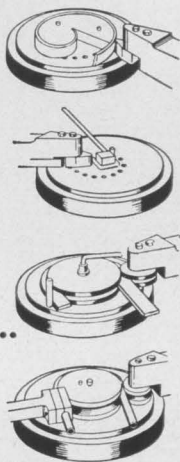

Di-Acro
Hydra
Power
Bender

It's easy to bend a wide variety of material when you know how—profitable too because bending can simplify product design—make one curved piece do the job of two or more. Bending can improve product appearance and lower your production costs!

This 32-page illustrated manual shows how to make center eye and off center bends, circles, zero radius bends, scrolls, squares, springs and coils, loops and spirals—all with *one versatile machine*. Booklet also tells how to tool for tubular, channel, angles and other special bending needs.

ORDER YOUR FREE COPY TODAY.
SEE YOUR NEAREST DIACRO DISTRIBUTOR
OR WRITE US.



DI-ACRO CORPORATION

432 Eighth Avenue, Lake City, Minnesota

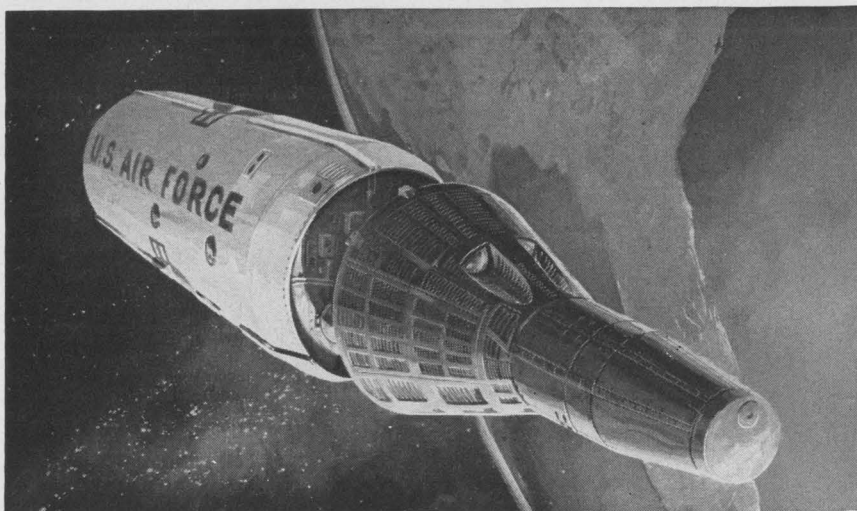

Manned orbiting laboratory for the military is included in the defense budget, but Defense Secretary McNamara is insisting on further studies.

band radio equipment that offers greater frequency and range.

The Army's 15,000-man experimental air-assault division—one that relies almost totally on helicopters for logistics and mobility—will be disbanded. The Defense Department is likely to let the Army incorporate some air-assault units—possibly of brigade size—into existing airborne divisions rather than establishing a permanent specialized division.

Fighter planes. Spending on tactical aircraft for the Air Force and Navy would rise. Funds would be provided for the first large-scale procurement of the Air Force's F-111A fighter-bomber and the Navy's A-7 attack aircraft, plus improvements in the F-4 fighter used by the Navy and Air Force. The advanced Navy F-4 will incorporate a new radar system, the AWG-10, being built by the Westinghouse Electric Corp. The Air Force hasn't yet decided whether to use this system or develop a new one of its own. The Navy F-4 is a fighter-bomber; the Air Force version is an interceptor.

Work will continue on the Mark II, an advanced integrated electronics package that eventually will be incorporated into the F-111. The Air Force is now selecting contractors—probably three—from 10 competitors for studies prior to project definition.

Navy's plans. The Navy plans to start procurement of 641 aircraft and 64 ships for its general-purpose force. Some of the ships may be conversions of vessels currently in

the fleet. Included will be P-3A long-range patrol aircraft, 20 anti-submarine ships, four nuclear-attack submarines, 15 fast new assault ships, three guided-missile frigates and four new minesweepers.

One aircraft carrier of the Midway class will be altered to accommodate new, heavier planes. The budget makes no provision for a new nuclear aircraft carrier, but McNamara has indicated he will approve one in fiscal 1967.

Better missiles. The Navy's family of ship-launched ground-to-air missiles would be improved with pilot production of a missile that eventually would replace the Talos, Tartar and Terrier. Work will continue on a system to replace the Typhon, a longer-range air-defense missile plagued by weight problems. And development of the television-guided Walleye bomb would begin.

General support. Total obligational authority for general support would drop slightly to \$14.3 billion from \$14.6 billion this year under the Johnson proposals. This includes funds for intelligence, department-wide communications and command and control. The new budget emphasizes two automated worldwide communication networks—Autovon and Autodin—which will become the backbone of the national military communications system.

Total obligational authority for airlift-sealift forces would rise to \$1.6 billion from \$1.5 billion. The budget provides for continued pro-

CONSIDER COLORADO

...where greater productivity characterizes labor... And higher education and self-improvement contribute to your business profit.

Consider Colorado's labor force. Other companies have. Many with multi-state facilities have found Colorado labor to be the most productive. It is 750,000 strong by Census definition. Stable and conscientious—documented by the fact that Colorado unemployment and compensation rates are among the nation's lowest. When it comes to education and self-improvement, in the 25 and older age group, the average employee has better than a high school education. And each year 80,000 workers study under adult education programs offered by 70 public and private schools throughout the State.

If a self-improved, well-educated, highly productive labor force is a consideration in your business, consider Industrial Colorado for your expansion or plant relocation. Complete information is available from Dwight E. Neill, Director, Division of Commerce and Development, 16 State Services Building, Denver, Colorado, 80203.

INDUSTRIAL COLORADO

D-3378





financeability

(to meet your needs)

In WESTern PENNSylvania you can obtain 100% financing of industrial plant space at average interest rates as low as 3¾%. This can result in savings of as much as \$84,632 on a 62,000-square-foot industrial plant. In addition, financing of machinery and equipment and loans for working capital are readily available. This complete financing ability . . . plus a favorable tax climate . . . plus pre-

production training of a work force, usually at no cost to you . . . give WESTern PENNSylvania a top combination of plant-location values.



WEST PENN POWER

an operating unit of ALLEGHENY POWER SYSTEM

Area Development Department, Room 568
WEST PENN POWER—Greensburg, Pa. 15602
Phone: 412—837-3000

In strict confidence, I'd like details about WESTern PENNSylvania's: Financing Plans Pre-Production Training
 Favorable Tax Climate Industrial Properties

Name _____

Title _____

Company _____

Address _____

City _____ State _____

Code _____ Phone _____

curement of the C-141 transport plane and the beginning of development of the C-5A, which is to have the largest cargo capacity of any plane ever built.

The Navy would have a go-ahead to build four fast-deployment cargo ships with gas-turbine engines. In addition, 14 more Victory ships would be modified to serve as floating depots for storing military equipment near potential trouble spots.

IV. Space: Starting to peak out

Spending on military and civilian space programs would be \$6.9 billion, up some \$233 million from estimated expenditures for the current year.

Officials predict fiscal 1967 spending may rise a bit further. The big upward surges in space money seem to be finished, however. Next year's spending increase will be the narrowest since the big space programs started. In the current fiscal year, total spending on space is expected to rise about \$700 million from fiscal 1964.

Most space officials and key legislators believe total space expenditures will remain at \$6.5 billion to \$7 billion for several years. The huge sums for the basic family of space boosters in the Saturn series, the Titan III-C and the Gemini and Apollo spacecraft programs will be channeled into new projects when these programs are completed between now and 1969.

Moon mission. For the next couple of years, the manned lunar-landing program will dominate NASA's spending. It takes nearly two-thirds of the 1966 budget.

NASA's new budget generally provides only enough money to keep already-started programs afloat. The major exceptions are the beginning of the Voyager program, which is designed to land an unmanned capsule on Mars in 1971. The project is estimated to cost \$1.2 billion; toward this, \$43 million is included in the new budget. In addition, \$25.6 million is included to develop an advanced orbiting solar observatory that will be designed to make detailed studies of the sun.

Development curtailed. Lack of funds, however, forced the space agency to drop development of the huge 1.5-million-pound-thrust M-1

engine after spending close to \$100 million on the liquid-fuel project. The contractor for the project was the Aerojet-General Corp., a subsidiary of the General Tire & Rubber Co. Also canceled was the large solid-fuel, 260-inch-diameter booster. About \$15 million was divided this year between Aerojet-General and the Thiokol Chemical Corp. for this program.

NASA also has stopped spending on the Snap-8 program to develop nuclear power for satellites. Aerojet-General had the contract for this program also, with \$17 million provided in the current budget. The Atomic Energy Commission, which had funded the Snap-8 jointly with NASA, will continue to finance some work on the program.

The new Electronics Research Center in Boston would get \$10 million in facilities in fiscal 1966 when NASA acquires a site. Included is a space-guidance laboratory, an optical communications laboratory and a microwave radiation laboratory. Funds for advanced research and technology support would more than double this year's total to \$7.6 million.

NASA will round out its deep-space tracking network and Apollo ground-support stations in the new year. Funds to complete deep-space tracking stations in Canberra, Australia and Madrid, Spain, are included in the President's budget. Some \$5.7 million would go to build support facilities for an S-band system and facilities for the Apollo ground-station network on Antigua Island. A \$7.6-million Apollo ground station would also be built in the Canary Islands.

Secret work. Military space spending, forecast at \$1.6 billion, is cloaked in secrecy. Most of the money would go for continued development of the Titan III-C booster, designated as the launch vehicle for a manned orbiting laboratory for the military. The status of the MOL program, however, is still indefinite. About \$150 million has been included in the military budget for the program. But McNamara is insisting on further studies to convince him of the military need for the program. These studies are expected to start soon. NASA, which also wants a manned orbiting station, is spending close to \$50 million to find out how the

capabilities of its Apollo spacecraft can be extended. Both agencies promise to coordinate on the programs.

The fleet of intelligence-gathering satellites and the Navy's navigational-satellite network would continue to get substantial funds. Details of the programs are withheld, however. During fiscal 1966, the military hopes to be well along on development of its own satellite-communication system, but it won't tell how much money is earmarked for the project.

Gain for Tiros. The Weather Bureau, whose budget would jump to \$30 million from \$10 million this year, will start its Tiros operational satellite system.

The Atomic Energy Commission has requested \$154.6 million to perfect nuclear propulsion and power systems in space under Projects Rover and Snap, down from \$162.9 million in the current budget.

Space research funded by the National Science Foundation would continue at slightly over \$3 million.

V. Supersonic transport

No money is specifically requested in the new budget for the supersonic transport. However, the President notes that intensive studies are being conducted on economic feasibility, cost design and noise abatement, and he promises to decide as soon as possible "what our next steps should be." Meanwhile, part of the \$400 million he seeks for his contingency fund could go for further development of the supersonic plane.

The Federal Aviation Agency is seeking \$51 million for facilities and equipment, \$1 million more than this year. More than two-thirds of this would be used to continue the program to increase automation of the en-route air-traffic control system.

The budget includes \$40 million for research and development, the same as this year. One-half would be devoted to development of automatic data-acquisition and processing equipment for modernization of the air-traffic control system. In addition, \$9 million would be included for projects related to air-navigation facilities, with major emphasis on the development of improved instrument-landing systems.

If you missed this feature story in Electronic News...

New RFI/EMC Unit Designed to Meet 20cps to 50kc Range Scanning Needs

By GEORGE DEUBER

AMSTERDAM, N. Y. — Electro-Metrics Corp. has developed an RFI/EMC instrument to meet the demand for accelerated data acquisition.

Designated Interference Analyzer Model EMC-10 by the new Fairchild Camera & Instrument Corp. subsidiary, the model provides facilities for complete electronic scanning over its range of 20 cps to 50 kc.

Electro-Metrics' vice-president and general manager, William S. Lambdin, described the device as being designed to comply with the

The VCO circuit employed is basically an astable multivibrator whose frequency is controlled by variation of a current source inserted in the RC discharge path, Mr. Kelmer said. The rate of discharge and the frequency are linear functions of the current. By making the current vary linearly with an applied voltage, an oscillator whose frequency varies linearly in response to an applied voltage is achieved.

Superhet Design

As indicated by the presence of a local oscillator, the selector circuitry is basic

A wide range of input impedance is provided to permit full versatility of the instrument in its primary function of an RFI/EMC meter in its subsidiary function as a flexible wave analyzer. Input impedance can be chosen using the front panel selector switch to be 50, 600, 10k, 100k or 1m ohms.

In order to obtain maximum usable sensitivity, a low-noise amplifier employing Fairchild Semiconductor Type 2N2484 is used. Since the noise

WE'LL SEND YOU A FREE CATALOG THAT TELLS ALL

Fairchild's Interference Analyzer Model EMC-10 is the only RFI/EMC measuring instrument that can be electronically scanned over its frequency range.

As a result, it can be remotely tuned, either manually, or by electronic sweep, over the complete 20 cps to 50 KC spectrum.

With its X-Y outputs, plus numerous other new features, it meets all new demands for automated testing.

Because it is a modern solid-state unit, operated from either its self-contained, rechargeable battery supply, or external AC or DC, it provides minimum internal noise and maximum sensitivity—approximately 3 nanovolts in its 5-cycle bandwidth position. Thus it

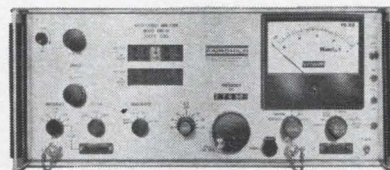

meets the requirements, also, of the most stringent RFI/EMC sensitivity specifications.

With 170 DB dynamic range, including 40 DB on the meter, and excellent amplitude and frequency accuracies, many of the old low-frequency testing problems are gone. Especially important to the operator is the complete elimination of tedious calibration procedures.

Electronic News gave you the highlights; now get the details, or a demonstration of Model EMC-10 and its complete set of accessories. Contact your local Fairchild/Electro-Metrics representative or...

FAIRCHILD
ELECTRO-METRICS CORPORATION
A SUBSIDIARY OF FAIRCHILD CAMERA AND INSTRUMENT CORPORATION
88 CHURCH ST., AMSTERDAM, NEW YORK 12011

MCB
VERITABLE ALTER

actualités

NEW!

**BOBI 12-Hermetically sealed 12 mm.
wire wound variable resistor.**

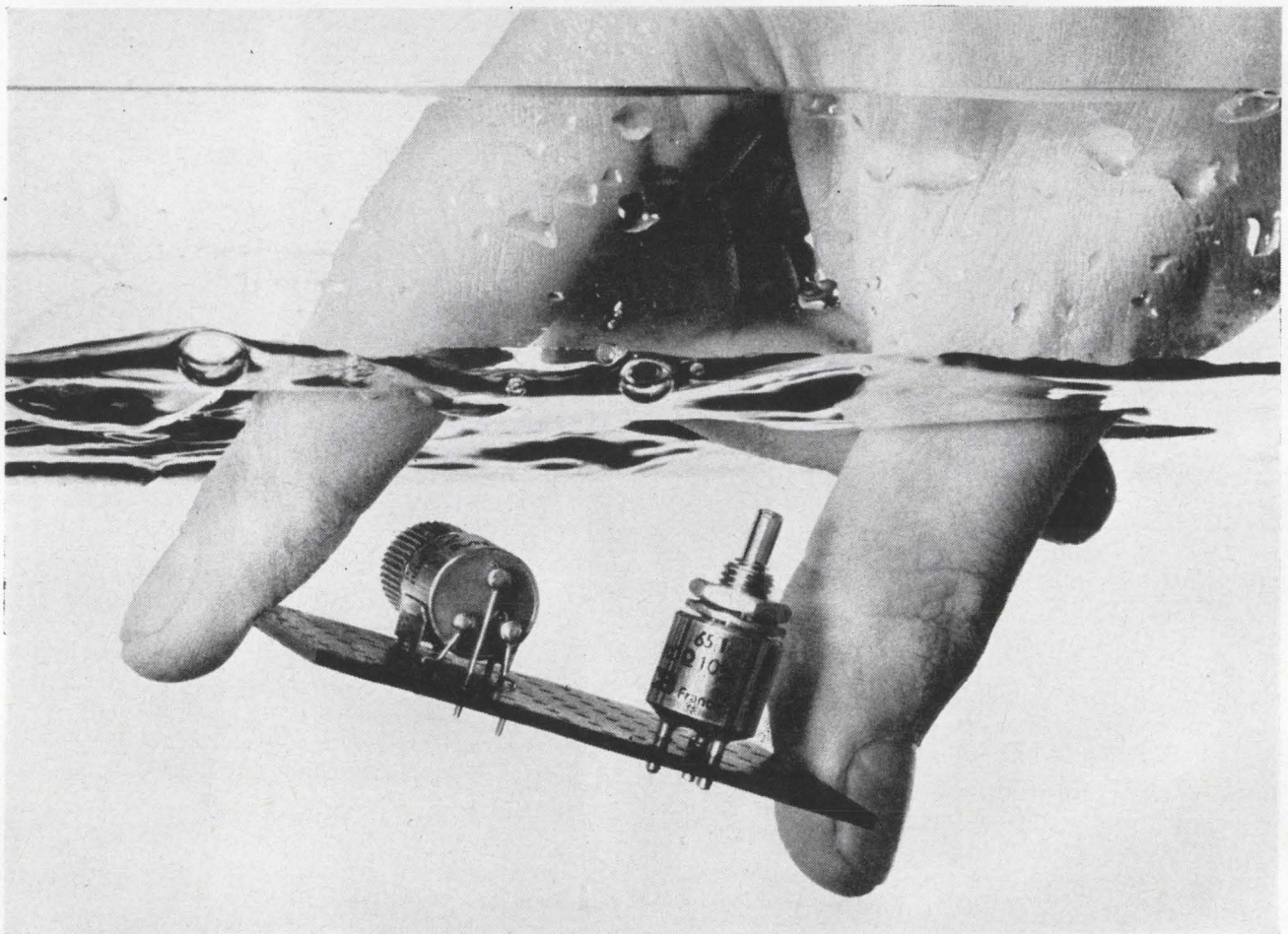

■ This small size potentiometer has been especially developed for printed circuit applications ■ Total protection against moisture or solvents - Use of Bobi 12 makes wave soldering easier - saves time and money ■ High reliability - Bobi 12 meets french (Nato) military specifications C.C.T.U. 05 02 ■ The highest standard of quality, the lowest possible price for quality, mass production, MCB quality.

■ **Circuits imprimés : de fortes économies.** Rigoureusement étanche à l'humidité, inoxydable, le Bobi 12 se fixe sur les cartes des circuits imprimés par simple soudage à la vague. Aucune reprise manuelle. Economie en temps et en main-d'œuvre.

■ **Performances : une très grande fiabilité.** Le Bobi 12 satisfait aux prescriptions de la spécification CCTU 0502.

Les qualités du Bobi 12 le placent en tête de la production mondiale de ce type de potentiomètre.

■ **Grande série : des prix très bas.** Une grande unité de fabrication récemment lancée, un automatisme poussé, la qualité M.C.B. : trois éléments qui permettent de proposer un prix très bas pour un matériel de haute performance.

MCB
VERITABLE ALTER

11, RUE P.-L'HOMME
COURBEVOIE
SEINE - FRANCE

Tiny reed switch is mercury-wetted

Characteristics of device remain constant throughout a life expectancy of 100 million operations

A breakthrough in reed switch design is claimed for the MRC-1, a magnetically actuated miniature reed switch with mercury-wetted contacts. The device combines the high speed advantages of a reed switch with the low contact resistance and high power capabilities of a mercury switch. It is ideal for dry circuit or no-contact-bounce applications, as well as for switching power circuits. Unlike many conventional dry reed switches, the manufacturer says, the MRC-1 offers the circuit designer the ulti-

mate in reliability because the switch characteristics remain constant throughout its long life.

Contact arrangement is single pole, normally open-form A. Said to be many times smaller than any other mercury-wetted reed switch available, the over-all length, including the leads, is $1\frac{5}{8}$ in., with glass length of only $\frac{1}{16}$ in. and a maximum glass diameter of 0.130 in.

Since the contact material is mercury to mercury, as shown in the accompanying sketch, there is no contact bounce, making it ideal for

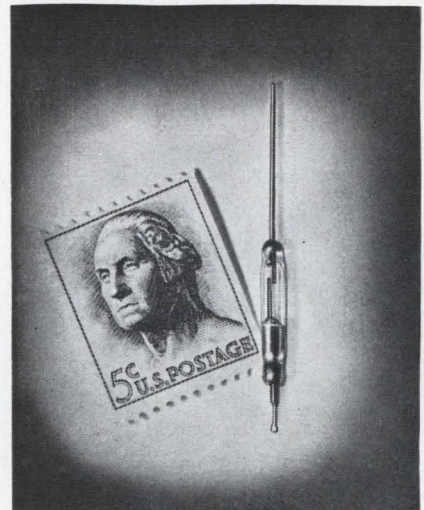

This reed switch is claimed to be the smallest mercury-wetted type available.

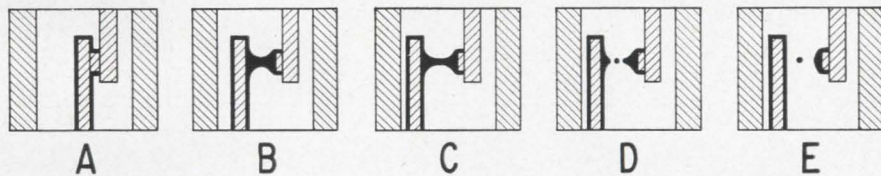

Mercury, shown in heavy black, covers armature and contact surfaces (A). As armature moves to open position, mercury retains circuit momentarily (B & C). Ruptured mercury surfaces accelerate away from each other, providing rapid breaking action (D). As armature moves to remake circuit, mercury dampens rebound, eliminates electrical chatter and provides circuit reliability with uniform contact resistance (E).

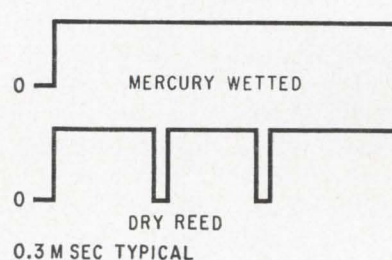
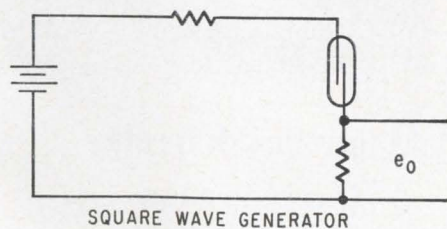
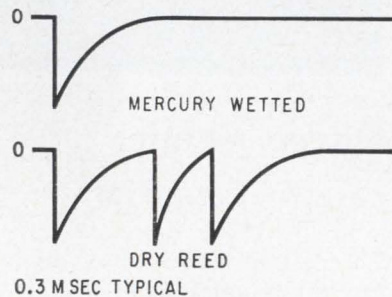
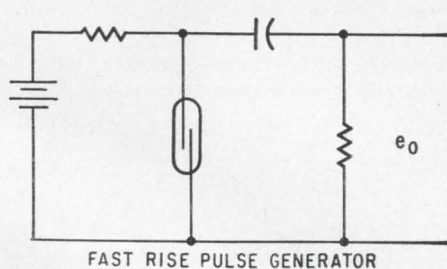

applications such as high-speed counting systems where contact bounce could give erroneous impulses. Actuation time averages merely one millisecond, depending on drive, which allows it to follow impulses up to 180 cps.

The minimum breakdown voltage is 500 v d-c, contact rating at 28 v is 75 w d-c resistive, and available actuation ranges from 30 to 90 amp-turns for pull-in. Life expectancy for the MRC-1 is 100 million operations at full rating and almost infinite at dry circuit loads. The contact resistance remains constant at 50 milliohms throughout the 100 million operations at full load.

A minimum of 10 seconds should be allowed to drain excess mercury from the contact area after correctly positioning the switch, which can be operated as much as 30° from vertical due to surface tension in the narrow capsule.

Switches are priced as low as \$1 each in large quantities (50,000). Hamlin, Inc., Lake & Grove Streets, Lake Mills, Wisc. 53551.

Circle 350 on reader service card

How to Calibrate Gaussmeters

... or the next best thing to having NBS as a neighbor.

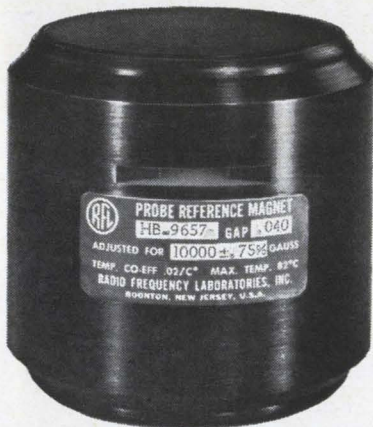

It's simple. Own one or more RFL permanent reference magnets. These magnets, available in field strengths from 5 to 20,000 gauss and having gaps from .040" to .343", are unchanging standards for calibrating whatever type of gaussmeter you may now be using whose probe will enter the gap. Especially important for Hall effect probes whose response is subject to change with age.

Pole faces are accurately machined of special alloys for uniform flux distribution. Coaxial design eliminates stray fields and protects against strong external fields. Each magnet is stabilized thermally and magnetically; mutual inductors and search coils having NBS certificates are used in final calibration.

We also have an accurate AC reference magnet (1000 gauss peak-to-peak) for calibrating Hall effect gaussmeters used for measuring pulsed magnetic fields.

Some customers buy every size we make... but we're glad to sell them one at a time too. Prices start at \$40.; may we send you descriptive information and a price folder? Write or call Radio Frequency Laboratories, Inc.



New Components and Hardware

Thermal converter works outside of lab

The TC-101 series thermal converter is available in a 4-lead JEDEC TO-5 transistor can to replace vacuum thermoelements used in transfer standards and audio substitution measuring instruments. The thermal converter is completely solid state and operates over a temperature range from -65°C to $+85^{\circ}\text{C}$ providing for the first time, according to the manufacturer, a thermal converter for use outside of laboratory environments. The specially designed heater has a temperature coefficient of resistance less than 300 ppm thereby providing an extended square law response. The TC-101 series is available with the heater isolated from semiconductor thermocouple. This configuration permits the use of the thermal converter at d-c as well as at a-c for transfer standards and rms meas-

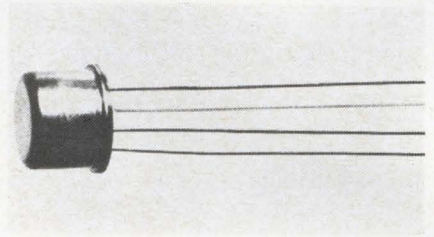

urements. The heater currents of these devices are rated from 1 ma to 20 ma to provide an open circuit output of 15 mv. Response time is less than 5 sec and output impedance is approximately 1 ohm. Sensitivity of the device is typically 1.0 mv/mw. This new concept in thermal converters is said to extend to portable instrumentation the convenience and accuracy of transfer standards that previously were not available. Price is \$65 each.

MSI Electronics Inc., 116-06 Myrtle Ave., Richmond Hill, N.Y., 11418. [351]



Microminiature ceramic capacitors

The ATC100 series of microminiature, precision, high-Q ceramic capacitors is announced. They are available in standard values up to 500 pf in a case size of 0.1 in. by 0.1 in. by 0.075 in., and values from 500 to 1,000 pf are available in the same 0.1 in. square case size on special order. They feature a minimum Q of 5,000 and a working voltage to 500 v d-c (no derating -55°C to $+125^{\circ}\text{C}$). Leads are available in all configurations, both in solderable and solderable-weldable ribbon and wire alloys, or

without leads for direct soldering. The ATC 100's minimal size, versatility, and high Q lends itself to vhf-uhf applications, cordwood packaging pellet circuitry, and integrated circuits. Price is dependent upon capacitance, tolerance, and quantity.

American Technical Ceramics, 241 E. 127th St., New York, N.Y., 10035. [352]

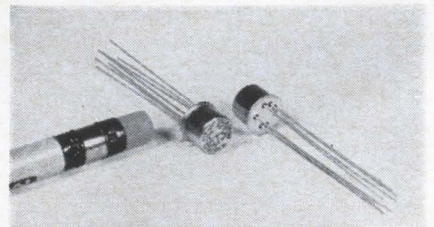

Magnetic latch relay in TO-5 type case

Series 421 relay is a spdt, bistable design with a contact rating of 1,000,000 operations at 0.5 amp and 10,000,000 at low level. The

NEW! TRYGON Modular DC Supplies



SERIES 1, 2 & 4
(71°C ambient)



SERIES 8
(50°C ambient)

Plug them in anywhere... then forget them!

Whether you need Trygon modules for your own use or to incorporate into systems you are producing, you can rely on Trygon dependability. You merely select the proper Trygon module, mount it—horizontally or vertically—and forget it!

Here's why: High-efficiency circuits result in less internal heat build-up and longer life. Series 1, 2 and 4 feature all silicon semiconductors, designed to operate in ambients up to 71°C **WITHOUT ANY DERATING!** All series have generous built-in heat sinks—no additional heat sinking or forced air cooling is required. Current-limited short circuit protection automatically resets when the fault is removed—so again, you don't have to worry about where you place a Trygon module in a system.

Remote sensing and programming provisions are also built-in. And premium components plus derated circuits yield MTBF figures in excess of 30,000 hours. All components are readily accessible. For additional flexibility, input/output connections are available with either terminal strips, solder lugs or octal sockets.

Overvoltage protection is available on all units as an optional extra. Series 1 is provided with Fixed Overvoltage Protection (FOV) while all other modules (Series 2, 4 and 8) are available with Trygon's standard Automatic Overvoltage Protection (OV).

See the chart for standard models, then contact your Trygon rep. Or, write for complete catalog to Dept. E-24.

ELECTRICAL SPECIFICATIONS

Model	Reg: Load	Reg: Line	Ripple mv RMS	Recovery Time	Ambient Oper. Temp.
Series 1, 2 & 4	0.02%	0.01%	Less than 0.5	Less than 50 μ sec	-20°C to +71°C
Series 8	0.01%	0.01%			-20°C to +50°C

Complete line of module rack adapters available for assembly of complex power supply systems to meet your specific needs.

MODELS

Series	Model	OUTPUT		PRICE† 1-14	Overvoltage Protection
		Volts	Amps		
1*	PS20-400	0-20	0-0.4	\$140	For Fixed Overvoltage Protection (FOV) add \$75 per unit.
	PS32-250	0-32	0-0.25	140	
	PS50-150	0-50	0-0.15	155	
	PS3-1.5F	2.5-3.5	0-1.5	130	
	PS6-1F	4-8	0-1	120	
	PS12-900F	10-14	0-0.9	115	
	PS15-800F	13-17	0-0.8	120	
	PS18-800F	16-20	0-0.8	120	
	PS24-700F	22-26	0-0.7	120	
	PS28-600F	26-30	0-0.6	120	
PS48-400F	46-50	0-0.4	130		
2	PS10-2	0-10	0-2	160	Note A
	PS20-1.5	0-20	0-1.5	160	
	PS32-1.25	0-32	0-1.25	165	
	PS50-750	0-50	0-0.75	180	
4	PS10-4	0-10	0-4	195	Note B
	PS20-3	0-20	0-3	195	
	PS32-2.5	0-32	0-2.5	200	
	PS50-1.5	0-50	0-1.5	215	
8	PHR20-5	0-20	0-5	250	Note C
	PHR20-10	0-20	0-10	325	
	PHR40-2.5	0-40	0-2.5	250	
	PHR40-5	0-40	0-5	295	
	PHR60-2.5	0-60	0-2.5	325	
	PHR60-5	0-60	0-5	395	

* Lower current models also available, at lower prices

† Write for discount prices on larger quantities

- A. For Automatic Overvoltage Protection (OV) add \$90 per unit.
- B. For Automatic Overvoltage Protection (OV) add \$95 per unit.
- C. For Automatic Overvoltage Protection (OV) add \$95 per unit, except for Model PHR60-5, \$125.

TRYGON

ELECTRONICS INC.

111 Pleasant Avenue
(516) FReeport 8-2800

Roosevelt, L.I., N.Y.
TWX (516) 868-7508



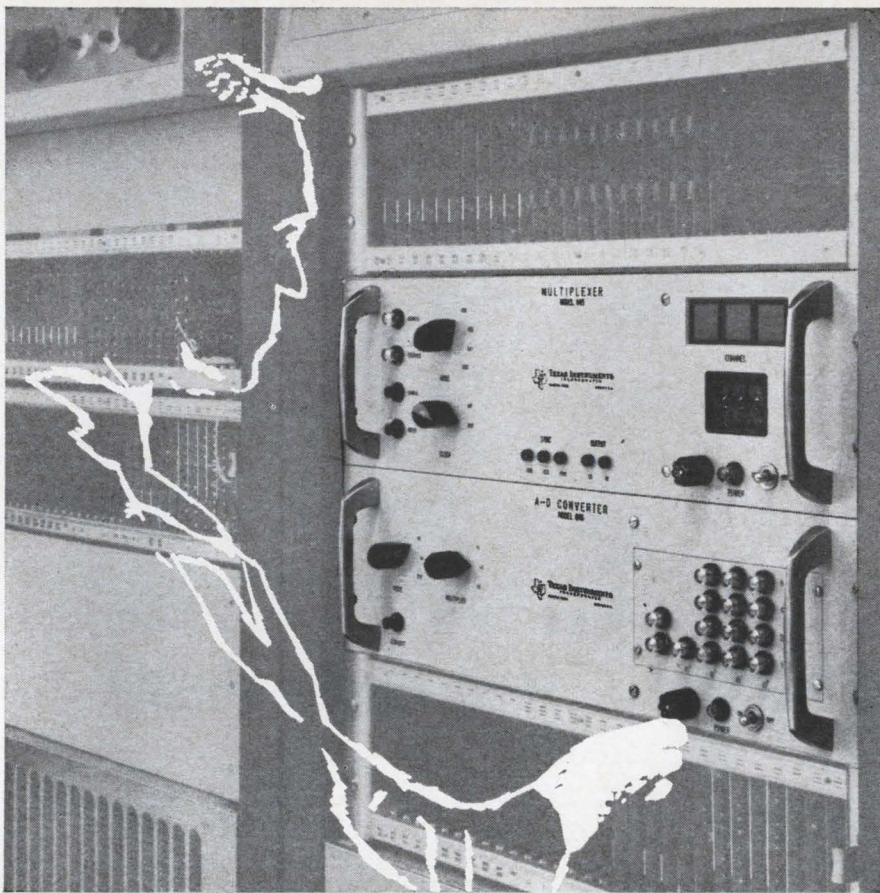

Accurate Data Sampling and Conversion at 50 KC plus

Model 846 A-D Converters, in straight binary or BCD code, include an integral sample and hold circuit with 100 nanosecond aperture and automatic zero stabilization. Accuracy at 50 kc is 0.025% full scale . . . *sample and hold included!* Offered in a wide choice of input specifications, logic levels and output codes, plus D-A conversion option.

Model 844/845 Multiplexers feature 0.01% linearity with low dynamic crossfeed, fast settling time and variable sample duration. Choose from addressable, sequential, direct channel select, or combined addressable/sequential—all accommodate input levels to ± 10 volts. Basic capacities of 10 and 16 channels can be expanded tenfold with plug-in PC cards.

Ask a TI Application Engineer for further information on digital data handling equipment for your specific needs; one model must meet your requirements!

INDUSTRIAL
PRODUCTS
GROUP



TEXAS INSTRUMENTS
INCORPORATED
P. O. BOX 66027 HOUSTON, TEXAS 77006
7 RUE VERNONNEX GENEVA, SWITZERLAND

692

New Components

compact and rugged device can withstand 150 g shock and operates in an ambient temperature range from -65°C to $+125^{\circ}\text{C}$. Power required to trip is 100 mw maximum and the trip time is 1.5 millisecc. The 421 is hermetically sealed and all welded in a TO-5 case and meets applicable requirements of MIL-R-5757D.

Teledyne Precision, Inc., 3155 W. El Segundo Blvd., Hawthorne, Calif. [353]

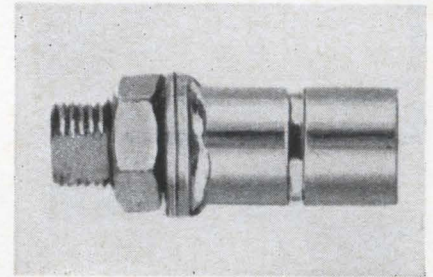

Glass dielectric piston capacitor

A glass dielectric, piston trimmer capacitor has been developed that measures $\frac{1}{4}$ in. diameter by $\frac{1}{8}$ in. behind panel length. Capacitance ranges from 1.0 pf to 15.0 pf. Temperature coefficient is 0 ± 50 ppm/ $^{\circ}\text{C}$. Dielectric strength is 1,000 v d-c at 50% relative humidity and maximum rated capacitance. Working voltage is 500 v d-c and operating temperature is -55°C to $+125^{\circ}\text{C}$. Insulation resistance of the capacitor is 10^6 megohms at 50% relative humidity. Q at 1 Mc is 750 minimum. Solid metal electro bands permit soldering and unsoldering without capacitor damage. Design simplicity insures reliable Q.

Elcom Department, Roanwell Corp., 180 Varick St., New York, N.Y., 10014 [354]

High frequency low-pass filters

Subminiature, high frequency low-pass filters that feature ultra high attenuation effectively reduce and/or eliminate r-f radiation and feedback in low power circuits. Series MF-220 space-saving filters are

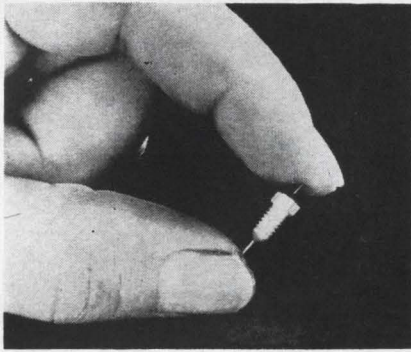

typically used with cable connectors for conducting heater currents and d-c operating voltages to vacuum tubes. Minimum attenuation, measured according to MIL-STD-220A is 75 db from 100 to 2,000 Mc, over the temperature range of -55°C to $+125^{\circ}\text{C}$, with voltage and current biases up to 50 v and 25 amps, respectively. The filters greatly attenuate the reverse passage of high frequency energy to the outside, while allowing the passage of direct and low frequency alternating currents into circuit compartments. Series MF-220 filters measure 0.25 in. diameter by 0.41 in. long, for bolt mounting. Length of terminal is 0.81 in.

Gulton Industries, Inc., 212 Durham Ave., Metuchen, N.J. [355]

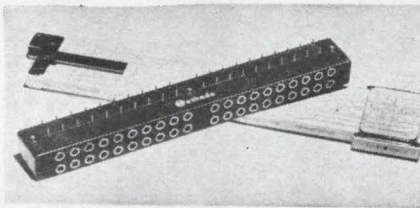

Terminal block for p-c mounting

A new 40-contact terminal block, model TB-840DS, has been designed for wave soldering to large p-c boards. Designed for the Minuteman missile program, it is expected to find use in power supply hook-up in computers, and other data acquisition and transmission equipment. The TB-840DS has 40 tapped hole contacts which accept No. 4-40 screws. The contact is terminated in a 0.031 in. diameter by 0.150 in. long pin, suitable for insertion into a p-c board. Mounting is accomplished through three

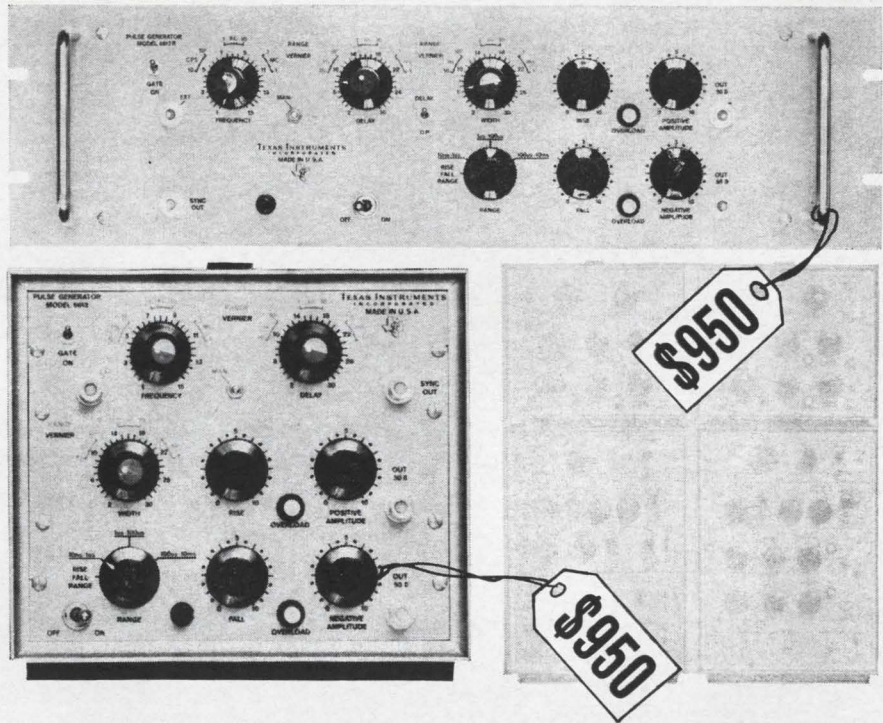

more general-purpose features, higher performance and quality with TI's 6613 pulse generator

The Model 6613 General Purpose Pulse Generator fills the need for a low-cost, high-quality test instrument with exceptional performance specifications. It is a general purpose instrument ideal for most pulse applications such as testing integrated circuits, digital circuit design, system design and checkout, testing of diodes and transistors.

The 6613 provides coincident positive and negative pulses determined by an internal clock generator or external source, with rep rate variable in 6 steps. Pulse width and delay are also variable in 6 steps. Amplitude is variable from near zero to 10 volts, with overload protection provided. Solid-state circuitry is utilized throughout. The compact unit measures $8\frac{1}{2}$ in. high, $8\frac{1}{2}$ in. wide, 12 in. deep and weighs only 10 lb.

SPECIFICATIONS

Clock Pulse Repetition Frequency

15 cps to 150 cps	15 to 150 kc
150 to 1500 cps	150 kc to 1.5 mc
1500 cps to 15 kc	1.5 mc to 15 mc

Delay

30 to 300 nano-sec	30 to 300 microsecs
300 nanosecs to 3 microsecs	300 microsecs to 3 milliseccs
3 to 30 microsecs	3 to 30 milliseccs

Width

30 to 300 nano-sec	30 to 300 micro-sec
300 nanosecs to 3 microsecs	300 microsecs to 3 milliseccs
3 to 30 microsecs	3 to 30 milliseccs

Pulse Amplitude—10 v into 50 ohms

Rise and Fall Times—variable; less than 10 nanosecs to 1 microsec, 1 microsec to 100 microsecs, 100 microsecs to 10 milliseccs, minimum rise time typically 8 nanosecs

INDUSTRIAL PRODUCTS GROUP



TEXAS INSTRUMENTS

INCORPORATED

P. O. BOX 66027 HOUSTON, TEXAS 77006
7 RUE VERNONNEX GENEVA, SWITZERLAND

712



It's New...

**SINGLE AND THREE PHASE
Hermetically Sealed • Epoxy Molded
POWER TRANSFORMER**

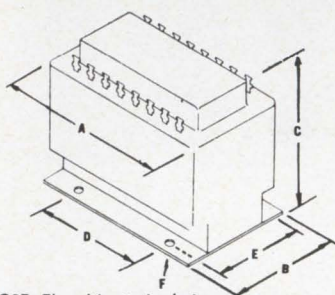

*OPT. The ultimate in design to achieve smaller construction at additional cost.

Thermex transformers have been engineered to meet all the rigid environmental requirements of MIL-T-27B Grade 5. These transformers have identifications and circuit diagrams printed on the face of the unit in accordance with MIL Specifications. The following sizes as shown in the tables can be fabricated from available stock molds.

THERMEX MOLDED — SINGLE PHASE — TYPE M1

DIMENSIONS (Approx. In.)						VA RATING (CPS)			SERIES	Approx. Wgt. Lb.
A	B	C	D	E	F	50/60 NOM. DESIGN	380/420	380/420 *OPT.		
1.50	1.62	2.12	1.00	1.06	6/32 x 3/8	8	40	56	100	.6
2.00	2.25	2.87	1.50	1.75	8/32 x 3/8	26	120	165	200	1.5
2.87	3.00	3.37	2.00	2.37	10/32 x 1/2	55	200	275	300	3.3
3.19	3.50	4.12	2.19	2.50	10/32 x 1/2	110	400	500	400	5.7

THERMEX POWER — THREE PHASE — TYPE M2

3.63	2.50	2.63	2.00	2.00	.171 Hole	75	375	560	100	2.8
3.63	3.00	2.63	2.00	2.50	.171 Hole	110	550	800	150	3.2
4.50	2.75	4.16	3.50	2.25	.171 Hole	200	820	1130	200	5.9
4.50	3.38	4.16	3.50	2.88	.171 Hole	300	1200	1800	250	7.3
6.19	3.38	4.88	5.00	2.38	.187 Hole	450	1900	2700	300	11.5
6.19	4.38	4.88	5.00	3.63	.187 Hole	650	2800	4200	350	15.0

VA Ratings are based upon nominal voltages and two winding design. VA Ratings will decrease with additional windings, high secondary voltages, and high insulation voltages.

INDUSTRIAL TRANSFORMER CORP.

GOULDSBORO, PENNSYLVANIA • Tel.: (717) VICTOR 2-2111 • New York (212) WALKER 5-9860

Circle 204 on reader service card

Amerline Corporation reports:

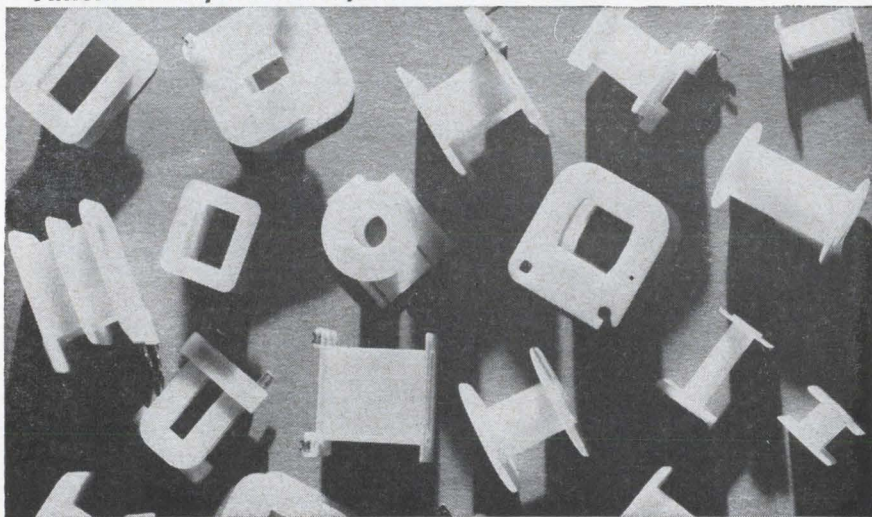

NYLAFIL® molded coil bobbins stay in shape!

Amerline Corporation, Chicago, produces a complete range of stock and custom injection molded coil bobbins for motors, relays, solenoids, transformers, etc. They say, "Our reasons for selecting Fiberfil's NYLAFIL (fiberglass reinforced nylon) in these applications are:

1. Better dimensional stability and better moisture characteristics than the unreinforced material.

- 2. Better rigidity which prevents the bobbin from distorting during and after the coil winding operation.
- 3. Increased resistance to heat, especially for soldering."

When you want high physicals not available in an unreinforced thermoplastic, specify Fiberfil FRTP... "reinforced insurance for all injection molding!" Write for technical data.



FIBERFIL, INC.
EVANSVILLE 17, INDIANA

New Components

No. 4-40 tapped stainless steel inserts molded into the terminal block body. The body of the terminal block is molded of glass-filled green diallyl phthalate. The molded-in contacts are gold-plated brass. Pin terminals are at right-angle to the tapped contacts for space-saving laydown wiring. The body of the terminal block measures 6.975 in. long by 0.625 in. high by 0.875 in. deep, with pin terminals extending 0.150 in. from the height dimension. Model TB-840DS is priced at \$8.50 each in production quantities.

Methode Electronics, Inc., 7447 West Wilson Ave., Chicago, Ill., 60631. [356]

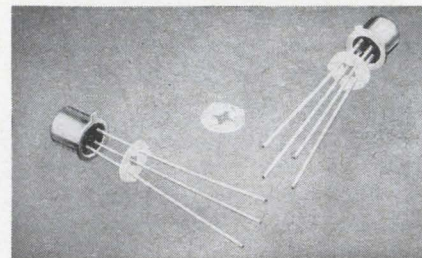

**Mounting pad
for transistors**

Model 10168-N Transipad has been designed for inexpensive installation of a variety of components in p-c boards. Requiring 0.200 in. diameter of board space, it accepts transistors having four leads on a 0.100 in. diameter circle, such as the TO-52. It can also be used effectively with three-lead transistors such as the TO-18. Only 0.030 in. max in thickness, the new Transipad nevertheless elevates components sufficiently so flux can be thoroughly washed off circuit boards after soldering. Molded from nylon, the 10168-N meets MIL-P-20693 specifications. Standard stock color is natural. Milton Ross Co., Southampton, Pa. [357]

**Metal film resistor
saves mounting space**

A molded, precision metal film resistor, type PE-1/8, is now avail-

able for use in microminiature assemblies. Its performance levels surpass the requirements of MIL-R-10509E, all applicable characteristics. Power rating is $\frac{1}{8}$ w at 100°C and $\frac{1}{16}$ w at 125°C. Voltage rating is 100 v while resistance range coverage is 25 ohms to 110,000 ohms. Dimensions are 0.140 by 0.070 by 0.218 in. high, and the two leads projecting from one end are 0.016 in. diameter tinned copper, or gold plated Dumet, in either case $\frac{1}{2}$ in. long, and can be trimmed to suit the application. Standard tolerance is $\pm 1\%$, but tolerances lower and higher are available upon request. The PE- $\frac{1}{8}$ features low noise construction, low voltage coefficients, and a choice of temperature coefficients of ± 25 ppm/°C, ± 50 ppm/°C, ± 100 ppm/°C, and ± 150 ppm/°C. They are also available as matched pairs with tracking features. Prices range from \$2.12 to 75 cents depending on tolerance, temperature coefficient, and quantity.

American Components, Inc., 8th Ave. & Harry St., Conshohocken, Pa. [358]

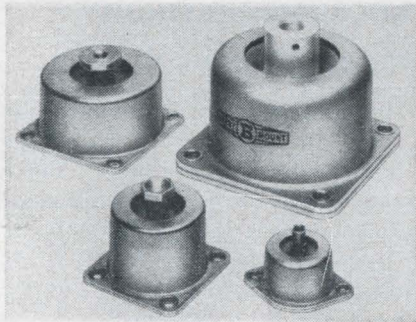

Damped isolators handle varied loads

Compact shock and vibration isolators, series T22 through T94, are designed for protecting equipment in aircraft, ground vehicles, or on shipboard. Equal protection is assured in every attitude since vertical to horizontal stiffness and damping ratios are equal. Excellent isolation is obtained even under sustained g-loads or regardless of load direction. Resonant transmissibility is limited to less than 3.0. The Hi-Damp elastomer used in the series provides equal performance in ambient temperature ranges from -67°F to +300°F and is not affected by fuels, fungus,

new, economical WIREWOUND VERNIER CONTROL



Series
VA-AW

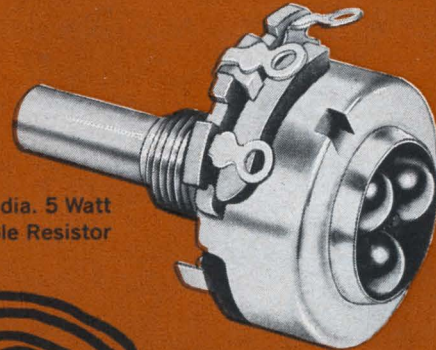

15/16" dia. 5 Watt
Wirewound Variable Resistor



8 $\frac{3}{4}$ turns: 1 turn

priced under \$1.50 ea. in lots of 300

SUBSTANTIAL SAVINGS

Replaces more expensive multi-turn semi-precision wirewound potentiometers.

For fine tuning commercial and industrial uses which are difficult or impossible to adjust with a conventional single turn control.

ELECTRICAL SPECIFICATIONS

Resistance Range: 1 through 25,000 ohms.

Voltage Rating Bushing to Terminals: High pot test, 1,000 VAC. Operating Max. 500VDC.

Power Rating: 5 watts @ 25°C, 4 watts @ 55°C, derated to no load @ 105°C.

Tapers Available: Standard—linear. Special—non-linear, such as 15% modified log.

Request Catalog 2150 for complete technical data.



Founded 1896

CTS OF ASHEVILLE, INC.
SKYLAND, N.C.

Subsidiary of CTS CORPORATION, Elkhart, Indiana



Need a slippery electrical grade polyester film? ask about "SCOTCHPAR"

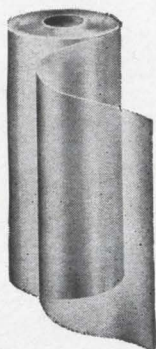

When you want an electrical grade film with a smooth, slippery surface — call for "SCOTCHPAR" polyester film. But, you may not be a "slippery" customer. In that case let us know your special requirements. We can customize this film in other ways — thick or thin . . . clear or opaque . . . releasable or bondable. Our laboratories are famous for their capacity to modify a product for a specific function. Contact: 3M Co., Film & Allied Products Division, 2501 Hudson Rd., St. Paul, Minnesota, Dept. ICL-25.

Scotchpar® electrical grade
BRAND polyester film

®SCOTCHPAR™ IS A REG. T.M. OF 3M CO.

3M
COMPANY

New Components

sand, dust petroleum products, high humidity, and ozone. Interlocking metal parts provide fail-safe construction. Four standard sizes, each with several load ranges, are available to accommodate loads from 1.0 to 150.0 lb per isolator. Units meet MIL-S-901C, Navy high-impact shock testing, and Signal Corps bounce test requirements.

Barry Controls, 700 Pleasant St., Watertown, Mass. 02172 [359]

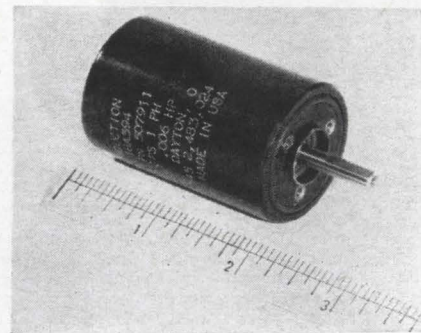

Encapsulated motor for continuous duty

This miniature encapsulated motor is designed to meet stringent environmental conditions. Power source is 115 v a-c, 420 cps, single phase with a 0.12 μ f (600 vdc) capacitor. Output is 0.625 oz. in. minimum at 9,400 rpm at a power input of 17 w. Designed for continuous duty, the unit is ideal for high humidity, salt-air atmospheres, liquid splashing and applications requiring high reliability under adverse conditions. Variations in output speed, torque, input voltage, and frequency are possible. Hysteresis synchronous and induction versions are available.

Globe Industries, Inc., 1784 Stanley Ave., Dayton, Ohio, 45404. [360]

Multifilament lamp can spell out words

The tiny "O"-Lite is a circular, multifilament, incandescent lamp made in sizes as small as $\frac{3}{16}$ in. o-d with a $\frac{1}{16}$ in. minimum diameter center opening. Meeting requirements for vibration and shock re-

sistance in space and missile applications and operating on current from 1 to 6 v, it provides a high intensity ring of light. Life expectancy of the lamp ranges from 10 to 10,000 hours depending upon voltages used. Application suggestions include probes and readout devices. Since other applications necessarily require other shapes, an array of filaments can be consolidated into a single incandescent lamp of any shape whether it is square, elliptical or polygonal. The lamp can be built into a cable, be fastened directly to a module with a plug-in socket or become an integral part of any piece of equipment. Filaments can be spaced, as well, on centers as close as 0.015 in. by 0.030 in. forming a dense matrix within a single lamp. An array of filaments can be arranged within a single lamp to spell out words with letters only $\frac{1}{8}$ in. high, or the lamp may be shaped to trace out directions.

Pinlite Division, Kay Electric Co., Fairfield, N.J., 07007. [361]



High-Q inductors cover low frequencies

High-Q, temperature-stable inductors have been announced for use at frequencies below 1 kc. These units cover the range from 2 to 300 henries and are designed for geophysical, sonar and other low-frequency circuits. They feature a high degree of inductive stability and a minimum Q of 8.0 at 60 cps. They may also be used as the inductive component in filter circuits at frequencies as low as 20 cps when coupled with capacitors in the order of 0.2 μ f. Identified as series ILM, their size is $1\frac{1}{8}$ in. by $1\frac{1}{2}$ in. by $\frac{7}{8}$ in. high.

Arnold Magnetics Corp., 6050 West Jefferson Blvd., Los Angeles, Calif. [362]

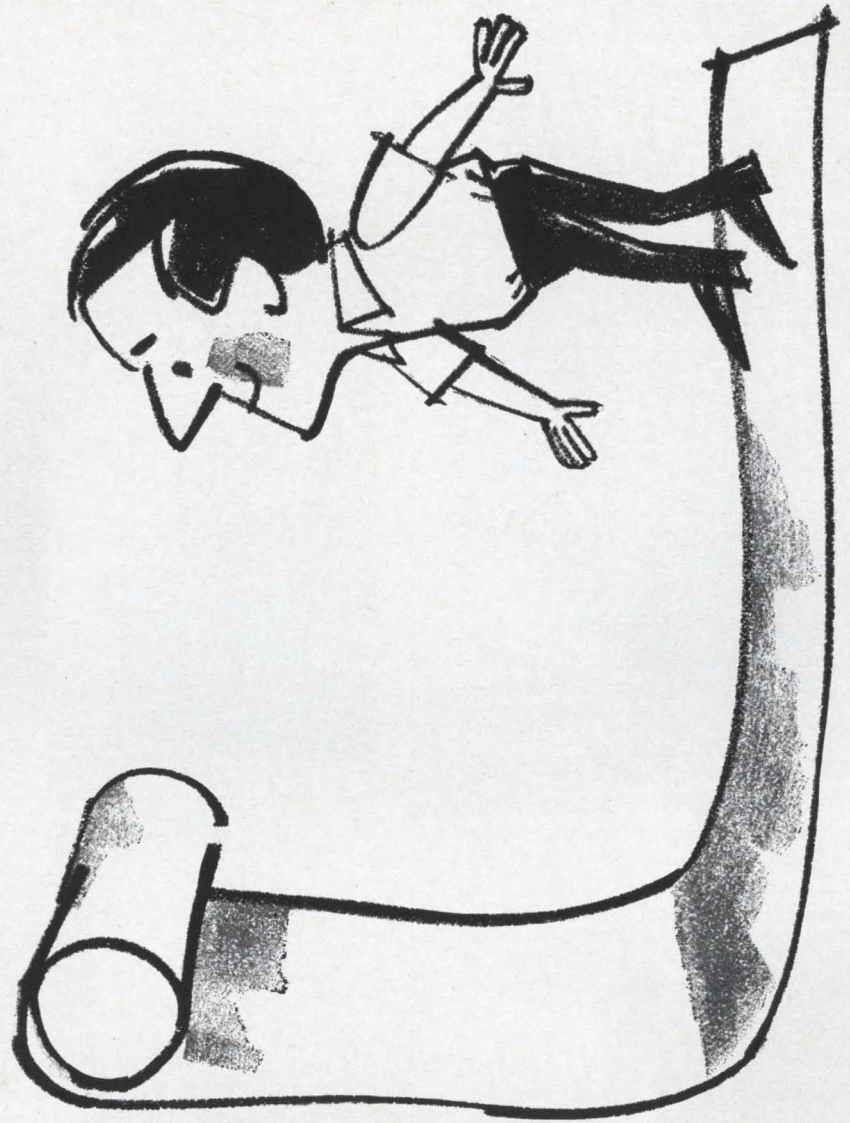

Need a non-slip electrical grade polyester film? ask about "SCOTCHPAR"



When you want an electrical grade film with a non-slip, friction surface — let us know. Perhaps a modified version of "SCOTCHPAR" can solve your problem. Or, do you have some other special requirement? Want a film that's thick? Thin? Clear? Opaque? Whatever your need present it to our laboratories for consideration. They've already made hundreds of variations to basic polyester. Whether you demand basic or customized "SCOTCHPAR", we'll be happy to serve you. Contact 3M Co., Film & Allied Products Division, 2501 Hudson Rd., St. Paul, Minnesota, Dept. ICL-25.

Scotchpar[®] electrical grade polyester film
BRAND

"SCOTCHPAR" IS A REG. T.M. OF 3M CO.

3M
COMPANY

Quick Reaction Capability that Counts



JANUS
Model B100-82
Forward-Backward
Counter Module with Display

HERE'S WHY:

These 1-mc Forward-Backward Decade Counters may be applied quickly and easily to systems and products requiring reliable high-speed bi-directional counting.

JANUS Model B100-80 Series Forward-Backward Counters Provide:

SPEED: Accept pulses to 1-mc in either direction.

QUICK REVERSING TIME: Less than two microseconds.

RELIABILITY: All transistorized, silicon circuitry throughout.

LOW COST:* \$115.00 (or less) for units with display. \$46.50 (or less) for units without display. Less costly than making them yourself.

FAST DELIVERY: From stock.

Available (with or without display) individually or in quantity for use in high speed counter applications where quality, low-cost and reliability are important.

Write for Technical Literature.

The Next Time You Need Counters Count on JANUS

*Price (FOB Newton, Mass.)
even lower in large quantity.



JANUS CONTROL CORPORATION
HUNT ST., NEWTON, MASS. TEL. 926-1037

New Instruments

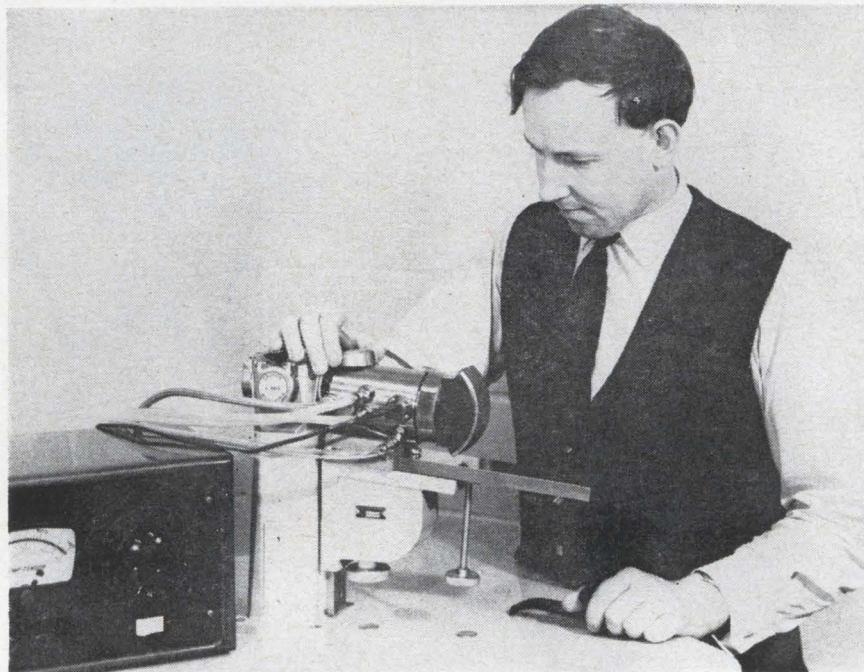

X-ray camera uses ultrahigh-pressure

An ultrahigh-pressure, x-ray diffraction camera has been developed for studying crystal structures of materials. The unit will expose a sample to pressure up to 1,500,000 psi while it is being "photographed". The XKB-100 camera contains a pair of gem-quality diamonds that have been ground optically flat along a particular crystallographic plane for maximum strength. A small powdered sample of the material under study is placed between the diamonds, which are then squeezed together

by relatively low pressure gas, providing a concentrated pressure of up to 100 kilobars (100,000 atmospheres) on the sample. X-rays are directed through the diamonds to produce a diffraction pattern photograph on the integral 35 mm x-ray camera. Spacing between the sample and the curved cassette is 57.3 mm to insure easy measurement of diffraction angles. Temperatures of up to 200°C may also be generated in the camera.

MRC Mfg. Corp., Orangeburg, N.Y., 10962. [381]

Range switches adjust multiple programmer

A new multiple programmer, model 10001, has been developed. Each of its eight channels adjusts from 1 millisecc to 100 sec by use of range switches. The unit offers a serial type programming with each channel starting its timing after the preceding channel is gated on. Timing control is achieved with 10-turn precision potentiometers which

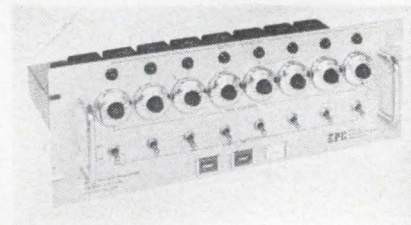

give a resolution to 0.001% of maximum time range. The programmer features $\pm 2\%$ maximum repeatability, and each channel has a pair of 5-amp scr's capable of switching

either the positive or ground side of the 28 v d-c. Operating voltage is 28 v d-c.

EPC Division of Artisan Electronics Corp., 171 Ridgedale Ave., Morristown, N.J. [382]

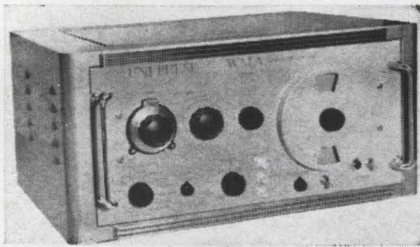

Instrument tests delay lines

The Uni-Pulse is designed to test any delay line having a length of 1 μ sec to 18,000 μ sec. It features an internal trigger generator with a short-term stability of better than 1 part per million. A pulsed r-f output is provided covering the frequency range of 8.5 to 130 Mc. In addition, video pulses and square waves are available. All of these outputs are normally triggered by the above-mentioned trigger generator. Either the r-f or video pulse widths cover the range of 0.2 μ sec to 50% of the duty cycle. The pulsed r-f output has a rise-time of 40 nsec and means are provided to degrade this rise-time for special applications. An external trigger may also be employed when needed.

WMA andersen Co., Inc., Pleasant Valley, Conn. [383]

X-Y recorders feature direct-drive tape

Two new low-cost X-Y recorders have been introduced. The Variplotter 1120 is an 8½ in. by 11 in. recorder, and the Variplotter 1130 is an 11 in. by 17 in. unit. The recorders feature a direct-drive tape that is used in the instruments' linear ball-bearing drive systems. This ⅛-in. stainless steel tape prevents backlash and replaces the complex pulley and string system found in other recorders. Both recorders are designed for use in a wide variety of electronic and an-



This is PEMCO'S 17-pound Portable

It stands apart from the crowd of "portable" instrumentation recorders that weigh anywhere from 65 to 200 distressingly unportable pounds. It logs data from DC to 100 KC with laboratory precision* on only 20 to 45 watts (d-c or a-c). And it offers such large-instrumentation-recorder features as:

- Tape widths of ¼", ½", or 1"
- Standard speeds from 15/16 to 60 ips
- Record times from 3½ minutes to 3½ hours
- All-solid-state, plug-in Direct or FM electronics
- Up to 14 channels (I.R.I.G. compatible)
- Performs in any position to altitudes of 70,000 feet

It could be just what the doctor ordered. If the prescription fills your need, ask about the PEMCO Model 110 General-Purpose Data Recorder. You'll receive our 12-page product brochure forthwith.

*FOR EXAMPLE

- FM center carrier drift within 0.1% over a full reel of tape
- Signal-to-noise ratio of 40 db FM, 35 db Direct at 30 ips



**PACIFIC
ELECTRO
MAGNETICS**

942 Commercial Street, Palo Alto, Calif. 94303 / (415) 321-1177 / Cable: PEMCO

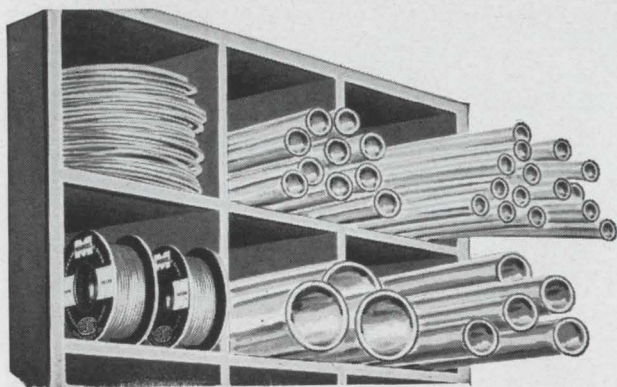

JUST SAY WHEN

You want insulating tubings for regular production *when you want them*—not weeks later! That's why we stock miles and miles of the dependable FLEXITE Extruded Tubings at our factory and at other points across the country—for immediate delivery!

FLEXITE HT-105C EXTRUDED VINYL TUBING

This strong, flexible vinyl tubing has excellent dielectric strength, heat stability, and oil and fungus resistance. It is U/L-approved up to 105°C and qualified to MIL-I-631C, Grade C. specifications.

FLEXITE E EXTRUDED VINYL TUBING

Highly flexible tubing for use at temperatures down to -55°C, as in aeronautical applications. Performs to MIL-I-22076 and MIL-I-7444B specs. Both of the above tubings are available in sizes from #24 to 1½", in clear and in standard colors—on spools or in coils.

Quality
Approved

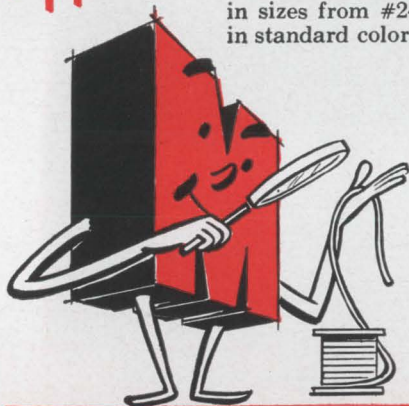

Send for samples, data and prices of these FLEXITE Vinyl Tubings

A letterhead request will bring the complete Markel Sample File of insulating tubings & sleeveings.

FLEXITE®

EXTRUDED PLASTIC TUBINGS

L. FRANK **MARKEL** & SONS
SINCE 1922

Norristown, Pennsylvania



SOURCE for
EXCELLENCE

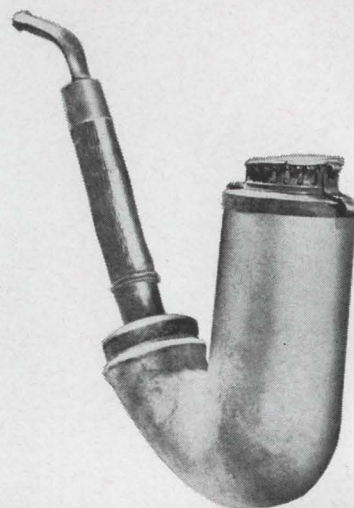

NO 'PIPE DREAM' ACTON DELIVERS ON PERFORMANCE PROMISES



PRECISION PHASE/VOLTMETER 360-A

Accurate to $\pm 1^\circ$ absolute, 0° — 360° • Full-scale 90° meter readings for each quadrant • Voltage accuracy $\pm 2\%$ for signals containing up to 30% harmonic distortion; full scales from 0.001v to 300v • Measures total, in-phase, fundamental, quadrature voltage components • 10x over-ranging capability • Operates at up to four frequencies, 200cps to 20kc • SOLID STATE THROUGHOUT.

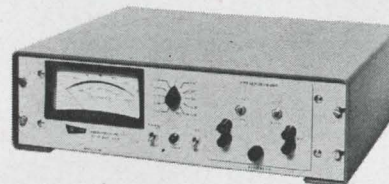

PRECISION PHASE METER 329-B

Accurate to $\pm 1^\circ$ min., $\pm 0.5^\circ$ with low signal-to-reference ratios • Useful range from 10cps to 500kc • Meter sensitivity and resolution, 0.2°, 0° — 360° • Expanded scales for accurate reading and visual ease • 1mv to 150v input sensitivity • Plug-in construction for extended operation, including phase shifter, high-gain preamp, buffer amp • SOLID STATE THROUGHOUT.

COMPLETE SPECIFICATIONS ON REQUEST

ACTON®

Laboratories, Inc.

533 Main Street • Acton, Massachusetts
A Subsidiary of Bowmar Instrument Corporation

Digital Phase Meters, Precision Oscillators, Scientific Instrumentation, Phase/Voltmeters, Primary and Secondary Phase Standards, Transmission Delay Measurement Sets, Impedance Meters, Special Test Equipment, Amplifiers, Spectrum Analyzers, Resolver Phase Shifters.

New Instruments

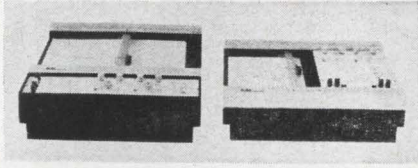

alytical applications, and both can be used without extensive intermediate equipment. The two recorders combine static accuracy of $\pm 0.1\%$ with a dynamic accuracy of $\pm 0.2\%$ and repeatability of $\pm 0.05\%$. They incorporate 18 calibrated d-c ranges from 1 mv per inch to 20 v per inch; and feature continuously variable scale factor and a built-in time base with six calibrated ranges. Other features include: porous vacuum system to hold any size or shape of paper; plug-in, collapsible ink cartridge; all solid-state circuitry; zener diode reference supplies; one full board-length of zero suppression; and high input impedance. The model 1120 is priced at \$1,450, and the 1130 costs \$1,790.

Electronic Associates, Inc., West Long Branch, N.J. [384]

Analog memory serves as envelope detector

This dual purpose instrument provides either a long-term memory of transient signal voltages or an envelope-detected output of signals in the audio and sub-audio range. Transient signal peaks of either polarity are sensed, stored, and presented as a panel meter reading. A 0 to 10 v $\pm 2\%$ output signal for external recorders, etc., is provided. Output is directly proportional to the largest prior a-c signal at input, subject to 2% maximum drift in 10 minutes. When operating as an envelope detector, various decay rates are selected with a panel control. Model 511 has low-frequency cutoff at 4 cps, with high-frequency cutoff limited by the 100- μ sec maximum full scale charging time. A panel alarm light provides indication when the signal exceeds preset level. D-c response and more rapid charging time are available in other models. Analog memories

(THREE OF A KIND?)

V.O.M.-5

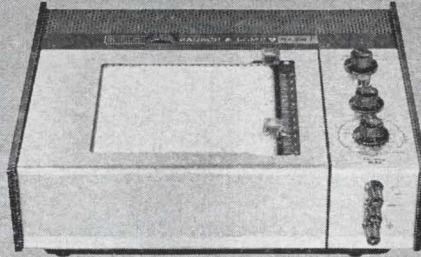

V.O.M.-6

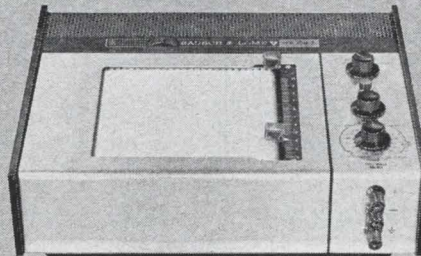

V.O.M.-7

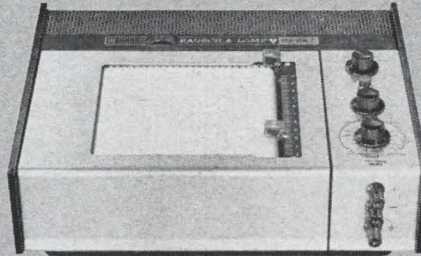

YES — and NO!

All three of these 5-inch, strip-chart recorders are built to the same outstanding design—each one records volts, ohms, milliamps directly. But each of these Bausch & Lomb V.O.M. Recorders works in a different range.

	V.O.M.-5	V.O.M.-6	V.O.M.-7
Voltage range:	10 mv—500 v	2.5 mv—125 v	0.5 mv—10 v
Current range:	10 m μ a—100 ma	2.5 m μ a—25 ma	1 m μ a—10 ma
Resistance range:	1-100,000 ohms	0.25 ohms—25,000 ohms	1 ohm—100 K ohms
Prices: (suggested retail)	\$595 COMPLETE	\$700 COMPLETE	\$885 COMPLETE

And, at no added cost, B&L V.O.M. Recorders give you 5 built-in chart speeds, built-in event marker, built-in take-up reel, and a number of other features.

For further information just circle our ad number below on the magazine's reply card and mail it, or write Bausch & Lomb Incorporated, 61414 Bausch Street, Rochester, New York 14602.

BAUSCH & LOMB 

1964 MASTER DESIGN AWARD WINNER—Microscopes for Science Teaching and Flexiscope

To order reprints
 from Electronics
 fill in, cut out
 coupon below,
 insert in envelope
 and mail to:

Electronics Reprint
 Dept.

330 West 42nd Street
 New York, N. Y. 10036

Reprint order form

For listing of reprints available see
 the reader service card

To help expedite mailing of your
 reprints please send cash, check
 or money order with your order.

For reprints of the latest
 Special report:

Electronics Markets 1965

Send me reprints of key
 no. R-67 at 50¢ each.

For reprints of previous special
 reports fill in below:

Send me reprints of key no.(s)

..... at¢ each.

For prices see the reader service
 card.

Name

Number & Street

City, State

Zip Code

New Instruments

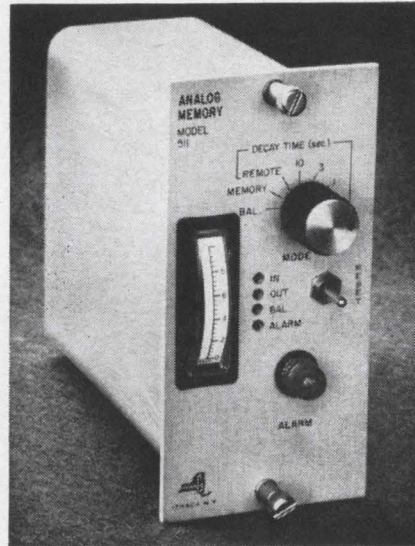

are used in instrumentation of
 shock and vibration tests, and in
 process instrumentation.
 Ithaco Inc., 413 Taughanock Blvd.,
 Ithaca, N.Y. [385]

less in the full 300 kc bandwidth
 measured at gain 1000. Input im-
 pedance is 150 megohms or greater
 on gains above 3, and 100 kc on
 lower gain steps. Overload recov-
 ery to 0.01% of final value achieved
 in 200 μ sec is an outstanding per-
 formance feature, according to the
 manufacturer. High current output
 (± 10 v at 100 ma) is coupled with
 low output impedance (1 ohm or
 less d-c to 1 kc, 20 ohms or less d-c
 to 150 kc). Each amplifier module
 has an integral power supply, re-
 quires 105-130 v a-c, 60 cps 8 v
 amps, and is fully isolated. Size is
 2 $\frac{7}{8}$ in. wide, 5 $\frac{1}{4}$ in. high, 13 $\frac{1}{2}$ in.
 deep. Price is \$685 each.

Dynamics Instrumentation Co., 583
 Monterey Pass Road, Monterey Park,
 Calif. [386]

**D-c voltmeter
 covers wide range**

A new, low-priced d-c voltmeter
 features wide range, overlapping
 scales and internal calibration
 source. Model 1115 Polyvolter has
 been designed for laboratory work
 and industrial plant trouble-shoot-
 ing. Because the instrument meas-
 ures d-c voltage over broad ranges
 and has a fast meter response and
 good stability, it also has applica-
 tion for almost all d-c measure-
 ments in circuit development. The
 Polyvolter is said to be very suit-
 able for transducer voltage read-
 out, such as thermocouples or
 strain gages. It measures very low
 and very high voltage, covering a
 range from 250 μ v to 1,000 v full
 scale in a total of 21 scales. The
 overlapping scales feature makes it
 unnecessary to take a measurement
 on the lower third of the scale, thus
 permitting a more exact reading. A
 full scale accuracy of $\pm 1\%$ is
 maintained on all scales above 2.5
 mv and $\pm 2\%$ below that level.
 This accuracy and freedom from
 zero or calibration drift is attained
 by the use of a precision d-c ampli-
 fier of the chopper type and a
 regulated voltage source. Further
 accuracy of readings is assured by
 the use of a taut-band meter move-
 ment which eliminates such serious

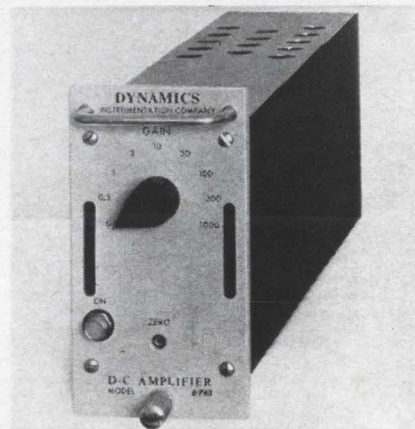

**Chopperless, 300-kc
 d-c amplifier**

New in concept, the model 6761 is
 a gain 1000, 300-kc, chopperless
 d-c amplifier offering an order of
 magnitude increase in bandwidth
 while retaining all the quality and
 precision of instrumentation ampli-
 fiers. Variable gain is provided
 in nine steps (0.1, 0.3, 1, 3, 10, 30,
 300, and 1000), and drift of ± 2 μ v
 referred to the input or ± 1 mv re-
 ferred to the output, whichever is
 greater, at a constant temperature
 is achieved. Noise is 15 μ v rms or

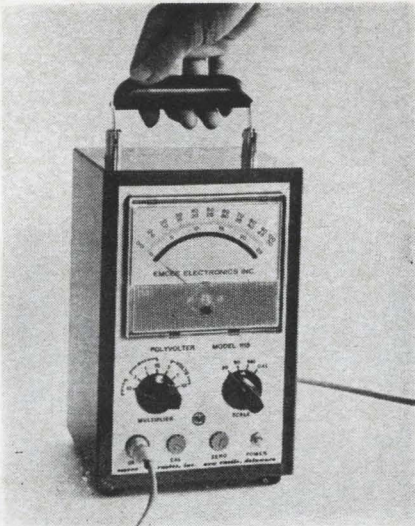

problems as hanging and hysteresis. Another feature is the internal calibration source. By applying the internal voltage of 2.0 mv $\pm 0.5\%$, a single recalibration of one scale of the instrument by the external knob corrects all remaining scales. The 1115 sells for \$250. Emcee Electronics, 1202 Arnold Ave., Greater Wilmington Airport, New Castle, Del. [387]

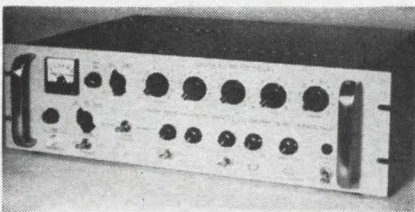

All-transistor radar range calibrator

This radar range calibrator provides a single pulse of variable width and amplitude from 0.1 mile to 1,000 nautical miles range. Model 1000N may be internally or externally triggered and is completely transistorized for reliable, long life operation. Decade pulse-frequency dividers in conjunction with diode coincidence circuits provide pulse selection with a high degree of accuracy and stability. Ideally suited for use as a calibration standard for radar systems, the compact unit is capable of accuracies of ± 0.005 mile, or 0.01% of the measured range. This instrument is also available calibrated in statute miles or yards range. Orbitran Co., Inc., 11487 Woodside Ave., Lakeside, Calif., 92040. [388]

Mallory Film Resistors

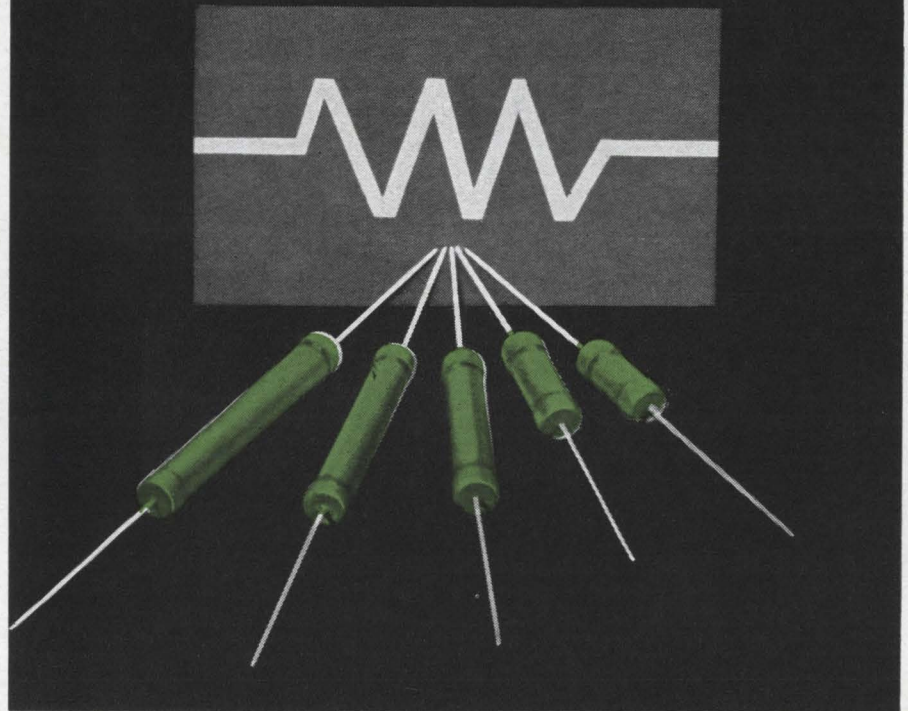

now in wider resistance range

Type MOL metal oxide film resistors now cover more resistance values than ever before, at both the high and low ends of the list.

In the 2-watt size, for instance, you can get resistances from 30 to 500,000 ohms. More values are now available also in the 3, 4, 5 and 7 watt ratings.

This broadened range has been made possible by continuing Mallory developments in applying and controlling the metal oxide film. At the same time, the MOL line's exceptional properties of stability, humidity resistance, low noise and flame resistance have not only been retained but improved.

For complete data and a quotation, write to Mallory Controls Company, Frankfort, Ind.—a division of P. R. Mallory & Co. Inc.

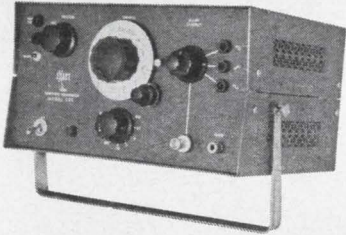

NEW**TYPE 301
FUNCTION
GENERATOR**

- 0.001 cps to 1 mc
- SOLID-STATE
- SQUARE-TRIANGLE-SINE
- 10 nsec RISETIME
- 10v P-P into 52 ohms
- SIMULTANEOUS OUTPUTS
- TRIGGERED and GATED MODES
- \$550.00 F.O.B. FACTORY

SIMULTANEOUS OUTPUTS

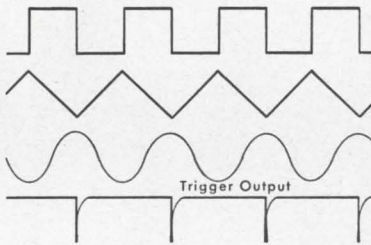

EXTERNALLY TRIGGERED

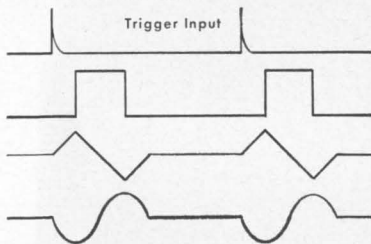

EXTERNALLY GATED

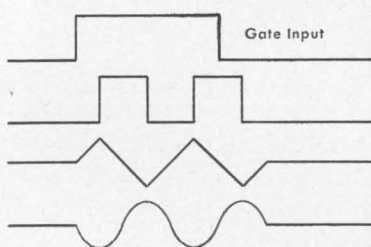

For comprehensive data sheets on the 301 and other EXACT FUNCTION GENERATORS, write, phone or TWX:

EXACT ELECTRONICS INC.

Dept. E-2
455 S.E. 2nd AVENUE
HILLSBORO, OREGON 97123
Phone (503) 648-6661
TWX: 503-821-6927

**New Semiconductors****Voltage-variable capacitance diodes**

A series of voltage-variable capacitance diodes, called Epicaps, is now in production. The initial series consists of three devices with nominal capacitance values of 6.8, 22 and 33 pf at a reverse voltage of 4 v and a frequency of 1 Mc. Designed for electronic tuning and harmonic generation applications, the units are manufactured by the epitaxial process to provide high reverse breakdown voltage, high Q, and low leakage current. The 6.8 pf unit (type MV1864A) is housed in a pill-type package while the other devices (MV1872 and MV1876) are in glass packages (DO-7). Additional capacitance values, including 15, 27 and 47 pf de-

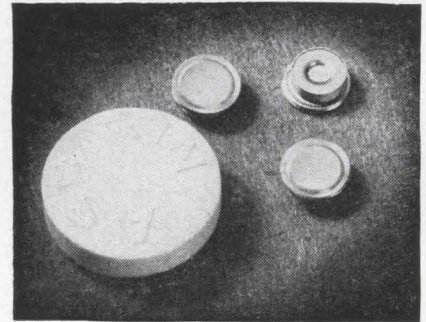

vices, are now being stocked and any other design-center capacitance value between 6.8 and 47 pf can be made on special order.

Motorola Semiconductor Products Inc., P.O. Box 955, Phoenix, Ariz., 85001. [371]

**Microelectronic
analog switches**

Two microcircuit analog switches (PC-401 and PC-402), characterized by exceptionally low saturation voltages, have been developed for use in the new microelectronic generation of digital-to-analog converters. They are believed to be the first such devices of their kind to be produced in microelectronic form. The PC-401 is a single input switch; the PC-402 a double, or complementary, input switch. Both units are identical in size (only 0.375 in. square and 0.085 in. thick) and come in wafer-style flat package. This packaging makes for added space-saving since the switches can be stacked in series, for use in conjunction with either serial or parallel resistor networks to simulate a digitally actuated potentiometer. The microcircuits, produced by the customized multi-chip process, provide offset voltages consistent with the performance of epitaxial planar transistors; they may be used with a variety of loads over an ambient temperature range of -55°C to $+125^{\circ}\text{C}$. Turn-on delay time is typically 0 nsec,

and maximum 50 nsec; rise time, typically 50 nsec; turn-off delay time, typically 100 nsec; offset voltage, worst case output and load resistance voltage, typically 20 mv; overshoot voltage, typically 2.5 volts peak; input turn-on voltage, typically 3 v peak; repetition rate minimum 200 kc.

General Instrument Corp., 600 West John St., Hicksville, L.I., N.Y. [372]

**Thin-film substrate
integrated circuits**

A new integrated circuit product line has been developed. Featuring custom circuit configurations comprising active and passive elements, all semiconductor segments are manufactured by a high reliability Minuteman process. The new series—called Mesa-Logic—is available in a variety of form factors including TO-5, TO-18 and standard flat package. Thin-film substrate techniques utilized in the Mesa-Logic construction are characterized by ultrastable, high quality, vacuum-deposited nichrome resistive elements and gold interconnect elements; on high-grade alumina substrates. The man-

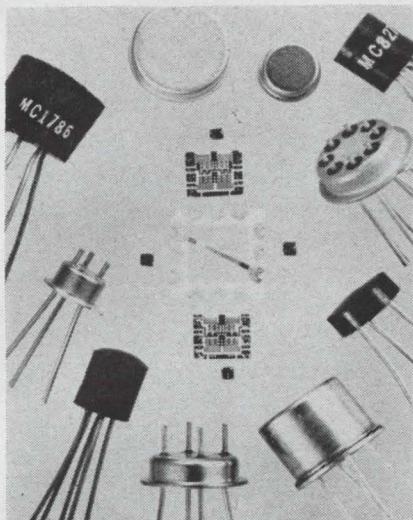

ufacturer claims that parametric stability over an operating range of 1 w per square inch—up to 500 Mc switching rate—is made possible by a stable-surface passivation technique. Units currently available provide interface logic functions to both RTL and DTL computing operations. Straight diode arrays and other custom configurations are available, as well as standard circuits. Prices in quantity start at \$6.50 each.

MicroSemiconductor Corp., 11250 Playa Court, Culver City, Calif. [373]

High-frequency silicon transistors

Planar npn transistors, designated 2N2217-2N2222, are available in the Leaf-Let (little epitaxial transistor) configuration. These high-frequency, low-power units are excellent for high-speed switching and amplifier applications. Use of the Leaf-Let configuration is said to result in lower saturation voltage, higher gain because of larger emitter area, improved beta linearity because of larger emitter periphery and greater reliability because of larger bonding area when compared to other related planar configurations. Features include: low collector saturation voltage, $V_{CE(s)} = 0.25$ v typical at $I_C = 150$ ma; high current gain, $h_{FE} = 100$ to 300 at $I_C = 150$ ma, $V_{CE} = 10$ v (2N2219, 2N2222); gain bandwidth product, $f_t = 400$ Mc typical at $I_C = 20$ ma, $V_{CE} = 20$ v, $f = 100$ Mc; collector-to-base voltage, $V_{CBO} = 60$ v minimum at $I_{CBO} = 10$ μ a; low

new!

A free guide book to the profit potential available in Florida's electronics industry.

Write for your free copy today! Full, factual and detailed information about your future as a Florida industrialist. A partial list of subjects covered: the fantastic "Space-Age Market"; the solid growth of the industry in Florida; the markets for electronic components... instrumentation... and general manufacturing; the welcome climate that offers a tax structure so favorable, you'll want to investigate; the unlimited R&D facilities available to you; the ease of recruitment of engineers and technicians, and the solid growth environment Florida offers you.

But write today! Investigate Florida—the growth state! Discover what a Florida plant can mean to you and your company's profit picture! Write today for your free copy of "OPPORTUNITIES IN ELECTRONICS."

INDUSTRIAL Florida

opportunities
in
electronics

Mr. Charles W. Campbell
Chairman
Florida Development
Commission, Dept. 4447-B
Tallahassee, Florida 32304

Please send me free copy of
"OPPORTUNITIES
IN ELECTRONICS"

NAME.....
FIRM NAME.....
ADDRESS.....
CITY.....STATE.....ZIP.....

Designed for

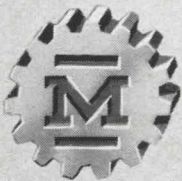

Application



MAGNETIC SHIELDS

Illustrated are a few of the stock mumetal or nicaloy magnetic shields for multiplier photo tubes and cathode ray tubes. Stock shields are available for all popular tubes. Custom designed shields are made for special applications.

JAMES MILLEN MFG. CO., INC.

**MALDEN
MASSACHUSETTS**

Circle 120 on reader service card

Find the manufacturer... Fast!

It's just a matter of seconds to get the valuable information you need about electronic manufacturers and suppliers in the Electronics Buyers' Guide. The EBG has over 200 pages listing the names, addresses, phone numbers and key individuals of manufacturers of electronics equipment, related components and materials. All this plus vital company statistics. At a glance you know important facts about the company, exactly what each company makes, and where to find the manufacturers' representatives in your area. No wonder the EBG is the industry's standard catalog-directory!

Electronics Buyers' Guide

A McGraw-Hill Publication
330 West 42nd Street, New York, N. Y. 10036

New Semiconductors

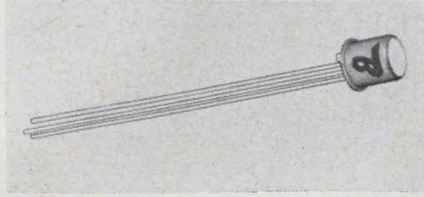

thermal resistance, $\theta_{J-C} = 25^{\circ}\text{C}/\text{w}$ typical (2N2217-2N2219, TO-5), $30^{\circ}\text{C}/\text{w}$ typical (2N2220-2N2222, TO-18).

Bendix Semiconductor Division, The Bendix Corp., Holmdel, N.J. [374]

N-channel-type MOS FET

The developmental type X-5 field-effect transistor is now being marketed under the JEDEC type number 2N3631. This is a metal-oxide-semiconductor device. For linear applications, the n-channel unit features a minimum input resistance of 10^{15} ohms with typical values of 10^{16} ohms. Transconductance at a drain current of 3 ma is typically 2,000 μmho . For chopper applications, the device has a typical drain current (off) of 5 picoamps and on-resistance of 100 ohms at gate-to-source voltage = +10 v. The unit is priced at \$16.20 in 100 to 299 quantities.

Siliconix Inc., 1140 West Evelyn Ave., Sunnyvale, Calif. [375]

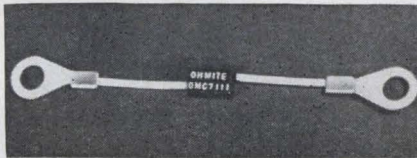

Semiconductor device protects meters

This inexpensive semiconductor device protects sensitive meters against burnout due to overload. Consisting of two silicon diodes in a compact case, the Metersaver is connected across the meter terminals. Under normal conditions, a minute portion of the meter current is shunted by the Metersaver

JUST CUT TO PATTERN

Netic & Co-Netic Magnetic Shields



HAND FORM IN SECONDS

A great convenience to design engineers, packaging engineers, R/D, etc. A fast inexpensive empirical tool to determine and shield the necessary components of systems. Use multiple layers if needed. Thicknesses from .002". Also widely used in automated or manual production line techniques.

Netic attenuates high intensity fields, Co-Netic low intensity fields. Permanently Pre-Annealed. Not affected by bending, vibration or shock. Minimum retentivity. Increases systems reliability.

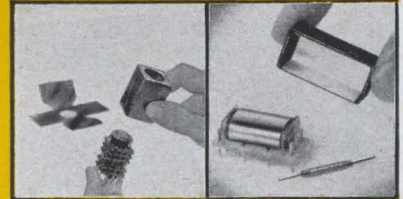

Module Shielding

Reed Relay



Wein Bridge Oscillator

Peelback Adhesive Foil

MAGNETIC SHIELD DIVISION

Perfection Mica Company

1322 N. ELSTON AVENUE, CHICAGO, ILLINOIS 60622

ORIGINATORS OF PERMANENTLY EFFECTIVE NETIC CO-NETIC MAGNETIC SHIELDING

Circle 207 on reader service card 207

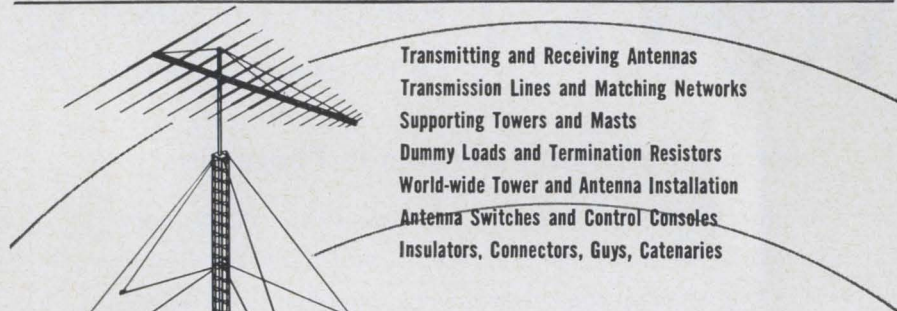

Transmitting and Receiving Antennas
Transmission Lines and Matching Networks
Supporting Towers and Masts
Dummy Loads and Termination Resistors
World-wide Tower and Antenna Installation
Antenna Switches and Control Consoles
Insulators, Connectors, Guys, Catenaries

This 33-year concentration under one roof of sophisticated equipment and staff for the design, fabrication and installation of complete antenna and tower systems anywhere in the world may be your good fortune.



Elverson, Pa. 19520 (215) 942-2981 — International Division, 750 Third Avenue, New York, N.Y. 10017, U.S.A.

D
DAMON

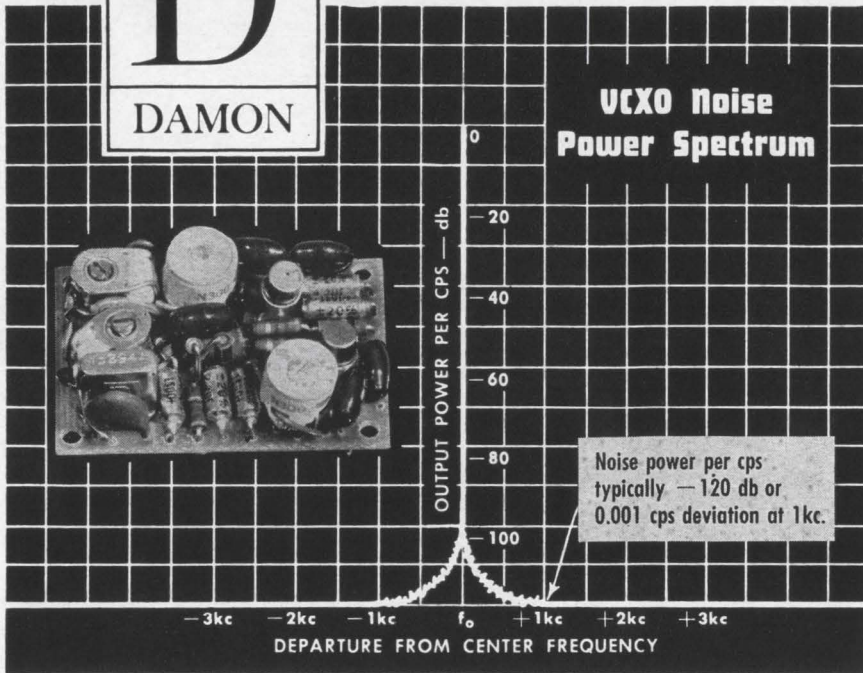

Low Noise VCXOs (Voltage Controlled Crystal Oscillators)

for an Important Reduction in Phase Jitter

Another FIRST from DAMON . . . Low Noise VCXOs with extremely low phase-jitter (—120 db or 0.001 cps deviation at 1kc.) This excellent short term stability is typified in the VCXO output spectrum illustrated, above.

Damon Low Noise VCXOs may now be inserted into systems as simple components with no auxiliary compensating circuitry. Only a source of power and a control signal are required.

Applications include: Doppler Radar (CW, CW-FM, FM and Pulse Doppler); Phase Locked Receivers and Transmitters; Doppler Simulation and Compensation; Frequency Synthesizers and other applications requiring electronic frequency control with crystal stability and extremely low phase jitter.

Write for Data on Low Noise VCXOs

DAMON ENGINEERING, INC.
240 HIGHLAND AVENUE, NEEDHAM HEIGHTS 94, MASS.
(617) 449-0800

New Semiconductors

but the error introduced on sensitive (high internal resistance) meters is negligible. If over 500 mv ($\frac{1}{2}$ v) is impressed across the meter, then the resistance of the Metersaver drops rapidly and it shunts out a considerably greater amount of current. Thus, it can, for example, convert what might be a 200 times overload to about a 3 times overload—one which most standard meters can tolerate very well. Also, the Metersaver allows the use of less expensive meter fuses. The use of two diodes eliminates concern about the polarity of connection and assures the user of protection in case of accidental reversal of potential.

Ohmite Mfg. Co., 3638 Howard St., Skokie, Ill., 60076. [376]

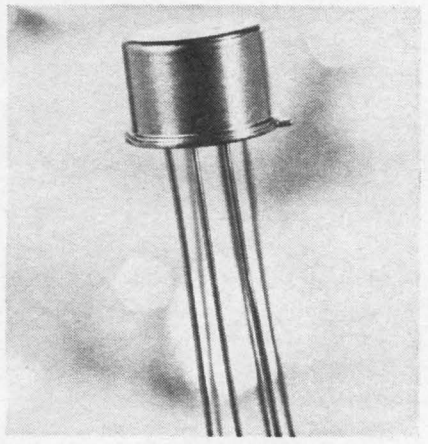

Silicon planar dual transistors

A line of dual, silicon planar transistors, both npn and pnp, is now available. Two isolated transistors are in a single 6-lead TO-5 header featuring high reliability silicon planar construction. These low-level differential amplifier packages have a matching characteristic of better than 10% and drift figures of less than $5 \mu\text{V}/^\circ\text{C}$. All units feature high gain at low current levels, extremely tight matching and low drift characteristics. A typical unit is the 2N2453A differential amplifier with npn silicon planar transistors. It has the following characteristics: d-c current gain

matching ratio, 10% max; beta, 600 max; breakdown voltages, 80 v minimum; base-to-emitter voltage, $5.0 \mu\text{V}/^\circ\text{C}$ max. Over 40 types are currently available and a special test program provides for reliability testing to customer's specifications by order or by specific families of devices.

Union Carbide Electronics, 365 Middlefield Road, Mountain View, Calif., 94041. [377]

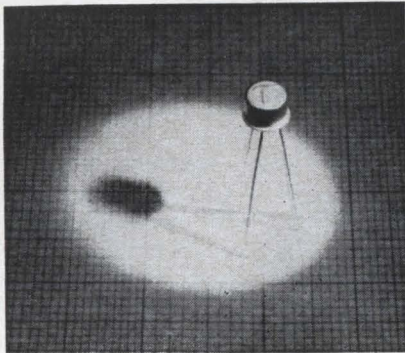

High-frequency npn transistor

The 2N3633 is a high-frequency npn transistor of the silicon planar epitaxial type. It features a 1,300 Mc minimum gain-bandwidth product (f_T), and is ultrasonically bonded with aluminum wire to eliminate purple plague at the chip. The advanced design of the 2N3633 is said to make it highly resistant to nuclear particle irradiation. Typically, d-c current gain (h_{FE}) is still greater than 10 after an equivalent neutron dose of 10^{15} neutrons/cm². The 2N3633 is available in a TO-18 package. Similar electrical equivalents are available in TO-52, TO-46, TO-51, pico, nano, dual TO-5, and dual flatpack packages.

Transitron Electronic Corp., 168 Albion St., Wakefield, Mass. [378]

Epitaxial junction n-channel FET's

Six new n-channel field effect transistors are now available—types C680, C682 and C684 in TO-5 cases; and types C681, C683, and C685 in TO-18 cases. All of these devices combine a high g_m/I_{DSS} (transconductance/drain-to-source

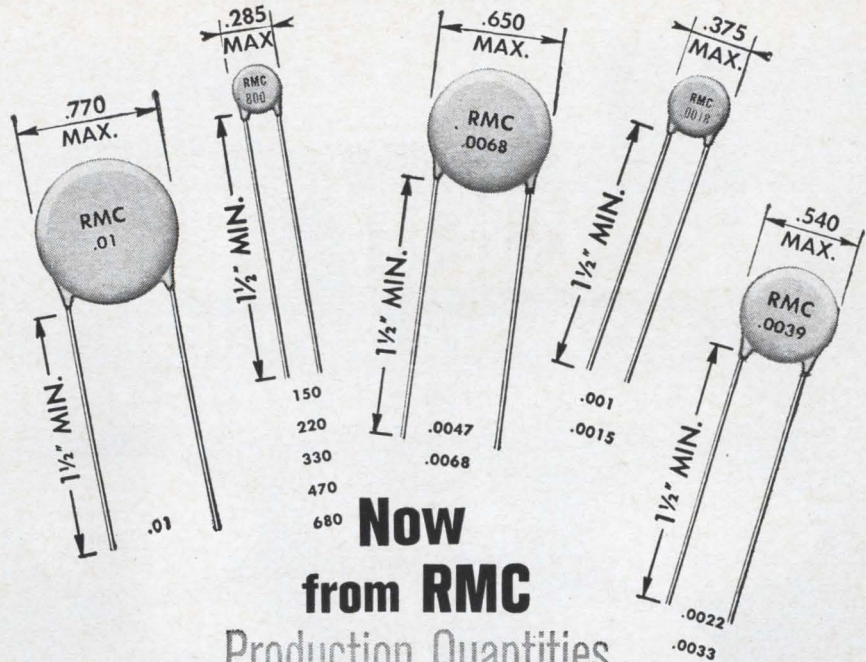

Now from RMC

Production Quantities

BY-PASS DISCAPS

(TYPE BA)

engineered to X5U specifications

RMC type "BA" Discaps offer high capacitance over an extended temperature range while maintaining acceptable stability characteristics. These DISCAPS can be specified, with complete confidence, for coupling and by-pass applications operating in environmental extremes. Write on your letterhead for additional information on type BA and other high quality DISCAPS.

SPECIFICATIONS

CAPACITANCE: Within tolerance @ 1KC and 25°C

CAPACITANCE TOLERANCES: + - 20% or + 80 - 20%

WORKING VOLTAGE: 500 V.D.C.

POWER FACTOR: 1.5% maximum @ 1KC

INSULATION RESISTANCE: Greater than 7500 Megohms @ 500 V.D.C.

TEMPERATURE COEFFICIENT: Y5U, X5U

FLASH TEST: 1250 V.D.C. for 1 second

LIFE TEST: Per EIA RS-198 Class II

POWER FACTOR AFTER HUMIDITY: 2.5% maximum @ 1KC

INSULATION RESISTANCE AFTER HUMIDITY: Greater than 1000 Megohms @ 500 V.D.C.

BODY INSULATION: Durez phenolic - vacuum wax impregnated

LEAD STYLES AVAILABLE: Long lead - #22 AWG tinned copper - fin-lock, kinked lead plug-in and pin type plug-in

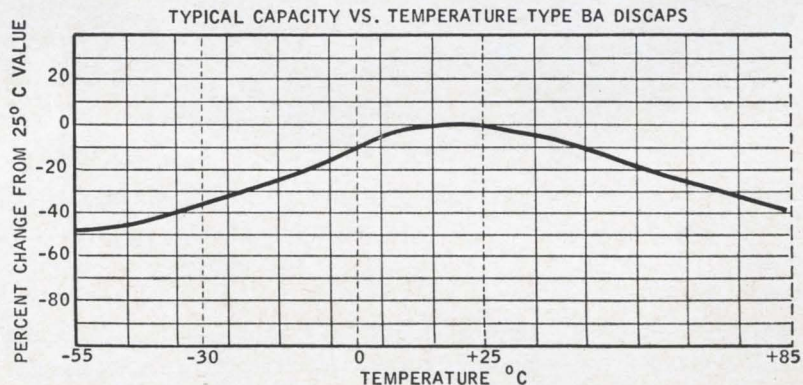

RADIO MATERIALS COMPANY
 A DIVISION OF P. R. MALLORY & CO., INC.
 GENERAL OFFICE: 4242 W. Bryn Mawr Ave., Chicago 46, Ill.
 Two RMC Plants Devoted Exclusively to Ceramic Capacitors
 FACTORIES AT CHICAGO, ILL. AND ATTICA, IND.

CHRISTIE

SINCE 1929 [®]

"TRANSIENT FREE"

D-C POWER SUPPLIES

100-200-250-400-600 AMP.

15 to 36 volt d-c
50 microsec
Response

F. L. Regulation:
Static: .05%
Dynamic: .5v

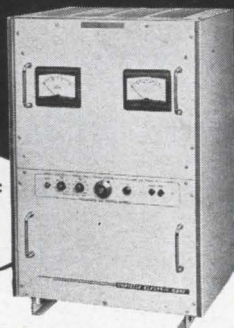

Impedance: 1 milliohm
Ripple: 1 millivolt

Military & RFI Specs
Also Mobile & Rack

Also 200 other Models of Power Supplies & Battery Chargers • Write for Catalog
CHRISTIE ELECTRIC CORP. 3402 West 67th Street, Los Angeles 43, Calif.

Circle 208 on reader service card

rugged and reliable

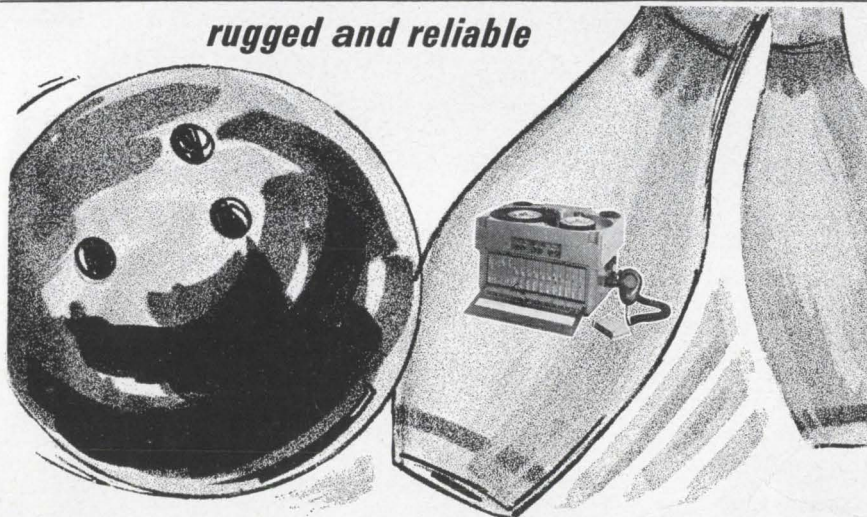

Capability to spare when the going gets toughest! Genisco's 10-126 Portable Tape Transport delivers 14 channels of record and reproduce ability in less than one cubic foot...tape drive complete with two switchable speeds within a full speed range, local and remote controls and 2400 feet of 1/2" or 1" magnetic tape. Model 10-126 belongs to a ruggedized family of transports designed for reliability in such demanding applications as onboard sled recording...F-111 escape pod tests...Apollo re-entry and Gemini drop tests...helicopter in-flight recording and VTOL flight testing.

Write or call for full information on the right model to meet your most exacting requirements.

Genisco TECHNOLOGY CORPORATION
DATA DIVISION

18435 Susana Road, Compton, California (213) 774-1850

124 Circle 124 on reader service card

New Semiconductors

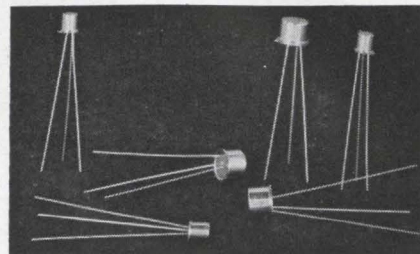

current with zero gate voltage) ratio with low gate capacitance (1.5 pf typical) and low leakage currents (0.2 na typical). They are ideal for high-impedance amplifier applications from sub-audio to low r-f, and can also be used as bilateral resistive elements for switching and voltage-controlled resistance applications. The devices are manufactured by the epitaxial junction process, which combines the advantages of alloyed, epitaxial, and planar techniques, and provides extreme ruggedness and parameter stability. Unit price is \$6 in single quantity.

Crystalonics, Inc., 147 Sherman St., Cambridge 40, Mass. [379]

Silicon transistors feature low noise

A new silicon, npn, epitaxial planar transistor has been developed for use as a general purpose r-f amplifier at frequencies up to 450 Mc in industrial and commercial communications equipment. The 2N3478 has a noise figure not exceeding a maximum value of 4.5 db and a minimum power gain of 11.5 db when used as an unneutralized amplifier. It utilizes a hermetically sealed four-lead package in which the active elements of the transistor are insulated from the case. The case may be grounded by means of the fourth lead in applications requiring minimum feedback capacitance, shielding of the device, or both. This technique contributes to highly reliable performance at vhf and uhf. When used as a vhf oscillator, the 2N3478 will deliver a power output of 30 mw (typical) at 200 Mc.

RCA Electronic Components and Devices, Harrison, N. J. [380]

Electronics | February 8, 1965



actual size

ULTRA MINIATURE MOTOR

Globe's Type VT permanent magnet d.c. motor is the smallest **standardized** power motor we know about. Fourteen standard armature windings are available for 3 to 50 v.d.c., with no-load speeds from 5,000 to 22,000 rpm. You can apply this miniaturized unit for continuous duty ratings up to 1-1/2 watts, and for starting torques up to 1.0 oz. in. Unit is 5/8" in diameter by 1-5/8" long; weight is 1.5 ounces. Brakes, governors, gear heads, and radio noise filters can be supplied.

Type VT is only one of many d.c. and a.c. motors built to high standards of quality by the largest manufacturer of precision miniature motors. Request Bulletin VT-2.

Globe Industries, Inc., 1784 Stanley Avenue, Dayton 4, Ohio.

GLOBE



Circle 209 on reader service card

~~36~~
~~48~~
~~72~~
84
DB/OCTAVE*
IN A
TUNABLE
ELECTRONIC
FILTER!

*SECTIONS
CASCADED

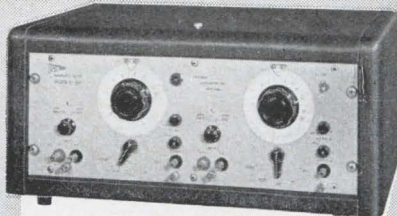

- Max. Stop Band Attenuation of 84 db/octave.
- Direct Coupling—no phase distorting blocking capacitors.
- Unity Gain— $\pm 1/4$ db.
- Low Impedance Isolated Output—under 150 ohms DC to 2.5 mc.
- Widest Cutoff Coverage—independent sections as high pass or low pass; combined sections as high pass, low pass, band pass or band reject.
- Highest Cutoff Accuracy—2%.
- Greatest Dynamic Range—over 100 db.
- The ONLY Filter available in 8 styles to meet your specific needs AND SAVE YOU MONEY:

Style A	20	- 200,000 cps
Style B	2	- 20,000 cps
Style C	0.2	- 2,000 cps
Style D	2	- 200,000 cps
Style E	0.2	- 20,000 cps
Style F	0.2	- 200,000 cps
Style G	0.02	- 2,000 cps
Style H	0.02	- 20,000 cps

All styles standard 19" rack mounting, 7" high, 15" deep. Weight, 44 lbs. Accessory cabinet illustrated available at additional cost.

Send for Brochure E
INSTRUMENTS, INC. Box 474
Tuckahoe, N. Y., (914) SP 9-8111

SPECTRUM

Circle 210 on reader service card

How to measure
VSWR
in SECONDS!

Just about as quickly as you can make cable connections to the Telonic Rho-tector, you'll have your VSWR readings — displayed as a continuous function of swept frequency on an oscilloscope, or an X-Y recorder, or as a point value with a galvanometer or voltmeter. The Rho-tector provides unsurpassed sensitivity and speed for measuring VSWR of filters, couplers, amplifiers, cable connectors, and many other components and instruments.

TRB Rho-tector Specifications

Model No.	Frequency Range	Unbalance
TRB-1	1 Mc to 1 Gc	30 db
TRB-2	1 Mc to 2.5 Gc	30 db
TRB-3	1 Mc to 1 Gc	50 db (1 Mc to 800 Mc) 45 db (800 Mc to 1 Gc)

VSWR calibrating kits complete with standard impedance match and mismatch terminations are also available. Specifications and complete data on the Rho-tector, terminations, and kits, on request.

Telonic®

ENGINEERING CO.

480 Mermaid St., Laguna Beach, Calif.
Tel: (714) Hyatt 4-7581 TWX: 714 673-1120

*Specialists in microwave band pass and low pass filters, miniature, cavity, interdigital, tunable types, and associated equipment.

Representatives in principal cities throughout the world.

Circle 125 on reader service card

125



**Did you say
160 mc
AMPLIFIERS or
CONVERTERS?**

Either way LEL has the answer in off-the-shelf, solid state equipment that is just right for your job.

**Need a HIGH FREQUENCY
IF AMPLIFIER?**

160 mc IF, all-silicon units are immediately available with 30 mc bandwidths and offering both IF and Video outputs.

**Need a HIGH LEVEL
CONVERTER?**

LEL's 160 mc transistorized models have 21.4, 30 or 60 mc outputs, self-contained local oscillators and offer linear operation to plus 10 dbm of input.

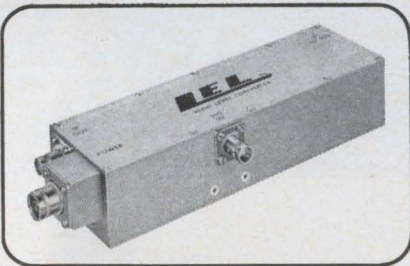

At any frequency you can count on LEL IF, RF or log amplifiers. Either solid state or tube types are available for every receiving system application.

**For all your receiver
requirements...
call on LEL capability!**

**Send for your FREE copy
of LEL's Catalog**



LEL INC.
AKRON ST., COPIAGUE, L. I., NEW YORK 11726
(516) AMityville 4-2200/(516) PYramid 9-8200
TWX Code 516-691-5085

New Subassemblies and Systems

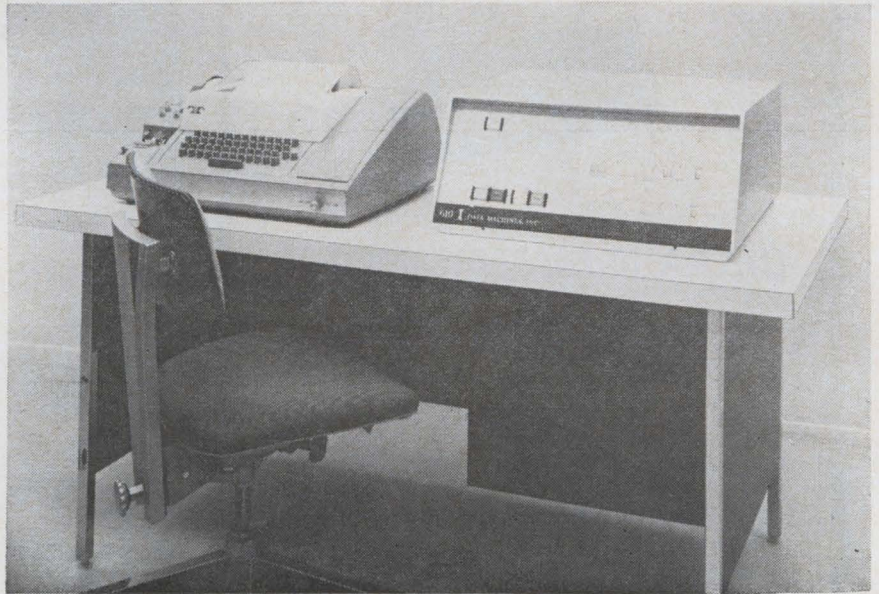

Desk-type digital computers

A low-cost line of digital computers has been developed. Three machines in the series are now available, designated DMI610, 611 and 612. These computers feature a wide operating temperature range of 0°C to +55°C, and exceptional reliability, according to the manufacturer. Word size is 12 bits including sign. Memory is magnetostrictive delay line, packaged in modules of 256 words per module. Up to 16 memory modules (4,096 words) may be used. The 610, 611 and 612 computers have 28, 38 and 50 commands, respectively, plus

special microinstruction features. Input/output includes Teletypewriter, paper tape reader and punch. Power dissipation is only 100 w including display lights. The computer is priced at \$11,250 including desk console, chair and all input/output equipment. A rack-mounted version is available for systems applications. The company says the computers are ideally suited for educational and training programs, problem solving, system control functions and a wide range of scientific applications. Data Machines, Inc., 1590 Monrovia Ave., Newport Beach, Calif. [401]

**IFF transponder
delay lines**

New IFF transponder delay lines are distinguished by their relatively miniature size and construction. Models 53-89 and 53-92, exhibiting delays of 20.3 μ sec and 24.65 μ sec respectively, each occupy only 4 in. by 4 in. by $\frac{3}{8}$ in. of p-c board space and can be supplied as separate p-c mounting components or together with associated circuitry. Impedance is 400 ohms for the

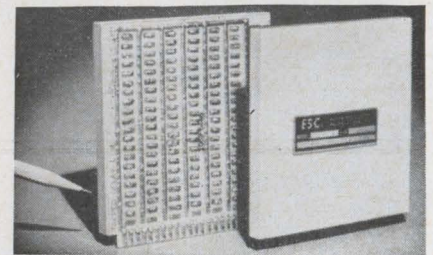

model 53-89 and 470 ohms for the model 53-92. The delay to rise time ratio is better than 50:1, attenuation is less than 0.12 db/ μ sec and

temperature coefficient less than 50 ppm/°C over a temperature range of -55°C to +85°C. Taps are provided at 1.45 μsec intervals to a ±0.05 μsec tolerance, but can be relocated as required. Units are available for short-term test purposes on a consignment and first come, first served, basis.

ESC Corp., 534 Bergen Blvd., Palisades Park, N.J. [402]

Memory system uses 3 channels

Three separate and independent, dynamic digital storage elements, each with a maximum capacity of 8,000 bits, are packaged into a single compact memory system. The MA917 memory consists of magnetostrictive delay lines as the storage element, plus associated input/output circuitry including drivers, output amplifiers, and gates, and the necessary circuitry for recirculating and reclocking. It operates at 2 Mc non-return-to-zero, and any desired storage capacity up to 8,000 bits can be provided in each of the three channels, or a total maximum storage capacity of 24,000 bits. Input requirement for the unit is 3 v at 3 ma.

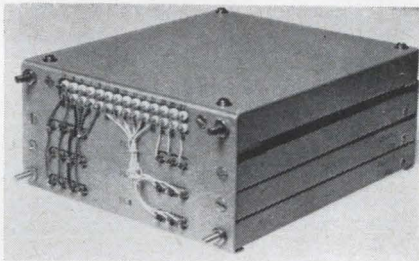

Power required is +12 v and -12 v. Output is reshaped and reclocked in order to reproduce the input. Overall size is 7 by 5 7/8 by 3 in. The unit is designed to meet commercial and military specifications. Magnetostrictive delay line memories, due to their versatility, small size and low cost per bit stored, are ideal for computer uses where a volatile memory is acceptable. Their cost per bit is about 1/4 that of drums or disk memories and less than 1/50 that of magnetic core memories, according to the manufacturer.

Computer Devices Corp., 6 W. 18th St., Huntington Station, N.Y. [403]

Still home-brewing SERVO AMPLIFIERS?

BULOVA — *the leader* — can make 'em faster, better, and at less cost!

Developing your own electronic components to meet servo system requirements is a waste of time, money, and engineers! Bulova's group of engineering specialists probably have already tackled a problem similar to yours, and can quickly provide you with unexcelled servo products at surprisingly low cost.

Bulova provides you:

- Many engineering man-years of experience developing electronic servo products to solve problems like yours.
- Full line of products—off-the-shelf, or custom designed to your requirements.
- Quick action—prototypes when you need them.
- Production units to your schedule.

No matter what your problem in servo amplifiers or frequency control, you'll get quick, usable answers from Bulova Electronics, the company with the widest line. Call or write to us at Dept. E-12.

SPECIFY BULOVA SERVO PRODUCTS

Bulova offers a **full line** of electronic products for the servo system, featuring:

- Solid-state servo amplifiers, resolver amplifiers, modulators and demodulators, quadrature rejection filters, buffer and pre-amplifiers, and solid-state relays.
- DC torquer amplifiers and general-purpose power amplifiers also available.
- Standard and miniature units (down to 3.5 watts in 1/4 cubic inch)!
- Voltage gains up to 5000; higher, on request!
- Power up to 16 watts standard; higher, on request!
- MIL-E-5272 environmental specs met; NASA-200 as required.
- Maximum output per unit volume and weight.

BULOVA / **ELECTRONICS DIVISION**
WATCH COMPANY, INC. 61-20 WOODSIDE AVE., WOODSIDE 77, N.Y., 212 NE 9-5700

AT LAST!



A Temperature Chamber You Can Set... and Forget!

Here is the first temperature chamber that's really automatic. You set it to the desired temperature and the Mark III does the rest. Without human decisions, it heats or cools automatically to maintain the set temperature—even in the presence of heat generated by parts under test.

Another exclusive—an ease and flexibility of programming never before possible. Complex heat/cool cycles like the one below are routine . . . ranging from -300°F to $+1000^{\circ}\text{F}$.

This plus provable $1/10^{\circ}\text{F}$ control . . . positive protection against "runaways" . . . all solid state design . . . low gradients throughout the entire test volume . . . and more—at competitive prices. Three sizes starting at \$785.

Contact Delta or your nearby Delta/Non-Linear Systems office on the Mark III or any problem involving accurate control of environments. It's our specialty.

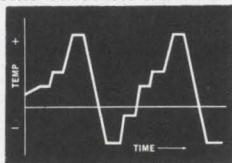

The Environmental Control People



DELTA DESIGN 8000 Fletcher Parkway
INC. La Mesa, Calif.
Phone: (714) 465-4141

New Microwave

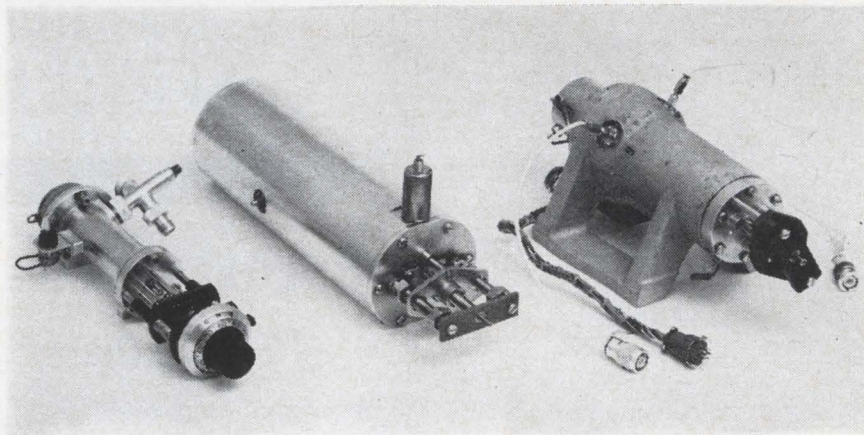

Ultrastable tunable local oscillators

A new line of tunable local oscillators feature high accuracy. These stalos are available from a series that cover the frequency ranges between 245 Mc and 7 Gc. The model 101C1, for example, is tunable over the 2.0 to 7.0 Gc range with a minimum power output of 100 mw. The short term stability characteristic for the complete series is 1 part 10^9 , and 1 part in 10^6 for the long term stability factor. Seventeen standard units are available and can be provided with up

to three outputs, fine tuning, or automatic frequency control. The ball bearing construction of some units, such as the model 5C4, which is tunable over the 525 to 570 Mc range, facilitates their use in motor driven applications. The stalos range from a minimum of $8\frac{3}{4}$ in. to a maximum of 12 in. in length and can be installed as components in radar and other microwave systems.

The G. C. Dewey Corp., 202 E. 44th St., New York, N.Y., 10017. [421]

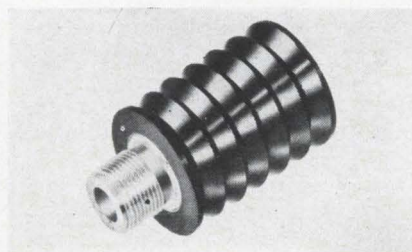

Medium-power coaxial terminations

Small 20-w coaxial terminations are announced for the 0 to 10 Gc frequency range. Two models—with male and female connectors—are available: 374 NM, weighing less than $5\frac{1}{2}$ oz, and 374 NF, weighing less than $4\frac{1}{2}$ oz. Both types are only $2\frac{1}{2}$ in. long by $1\frac{1}{2}$ in. diameter (max). The vswr in the 0 to 4 Gc range is but 1.05; in the 4 to 10

Gc range, 1.25. The terminations were developed for limited space applications, where weight also is an acute factor, and where good matched loads are required to terminate coaxial lines. Price of either model is \$65.

Narda Microwave Corp., Plainview, L.I., N.Y. [422]

Single-pole, 4-throw X-band switch

A new sp4t switch operates from 8 to 12 Gc. Designed originally for a special instrumentation program, the X-band switch can select a number of input signals to be joined into a common output. It features a very rapid switching time, in the order of 1 nsec, over its wide band of operation. The

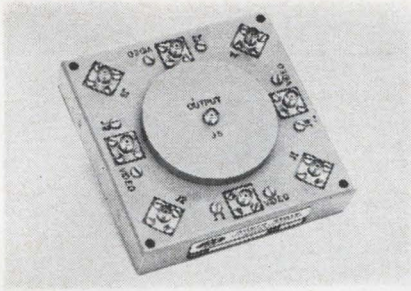

rapid switching performance is accomplished with a video driving voltage of -2 v at 75 ma and $+5$ v at $0.1 \mu\text{a}$. Insertion loss is less than 10 db and typical isolation between input ports is 30 db. The Micro State Electronics Corp., a subsidiary of Raytheon Co., 152 Floral Ave., Murray Hill, N.J. [423]



Traveling-wave tube spans 5.4 to 10.7 Gc

A new $1\frac{1}{2}$ -lb traveling-wave tube provides a minimum of 2 w c-w and 60 db small signal gain in the frequency range 5.4 to 10.7 Gc. The L-3957 twt is approximately 11 in. long. Its weight includes a heat-sink mounting plate for conduction cooling. Outstanding features include simplicity of operation, an insulated helix for modulation purposes and only one high voltage, thus reducing power supply costs. The L-3957 was designed for target augmentation. However, it is readily adaptable for countermeasure systems, communication systems or any amplifier application where high gain is required. The all metal-ceramic twt has been shock tested at 125 g and operated in ambient temperatures of 150°C without degradation in performance. Litton Industries, Electron Tube Division, 960 Industrial Road, San Carlos, Calif. [424]

Transistor oscillator for 650 to 840 Mc

A new transistor c-w oscillator is announced for l-o applications at a frequency of 650 to 840 Mc. Manual

LAPP GAS FILLED CAPACITORS ARE DESIGNED FOR

HIGH
VOLTAGE

HIGH
CURRENT

HIGH
CAPACITANCE

APPLICATIONS

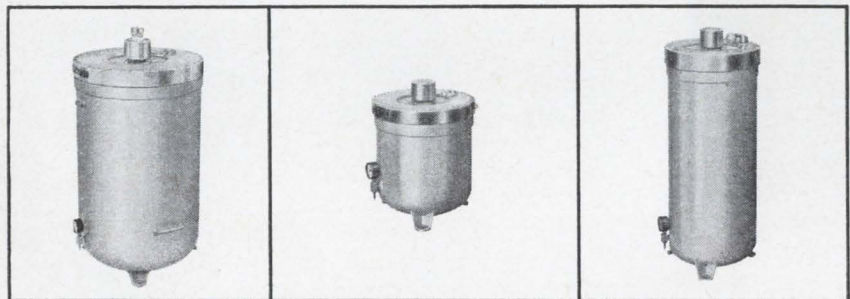

These uniquely designed Lapp Gas-Filled Capacitors are completely unaffected by atmospheric or dust conditions. They are precision built and of extra strong construction to assure years of accurate, trouble-free operation. ■ Lapp Gas-Filled Capacitors are available in either fixed or variable models. All are equipped with an external safety gap to protect against internal flashover on excess voltage peaks. Capacitance available up to 30,000 mmf, safety gap settings up to 85 kv peak and current ratings up to 400 amps at 1 mc. ■ Write for Bulletin 302... get our complete Gas-Filled Capacitor story. Lapp Insulator Co., Inc., Radio Specialties Division, 227 Sumner St., LeRoy, N.Y. 14482.



YOKE SPECIFYING PROBLEM?

**ASK AN
EXPERT...**

A SYNTRONIC DEFLECTION YOKE SPECIALIST



Since we make more types of yokes than anyone else, it's natural enough for our team of experts to know more about yoke design, application engineering, and quality control.

Specifying can be a challenging problem, and with this in mind, we put our experience at your disposal. Don't hesitate to call or write us when you're puzzled as to the right deflection yoke for **your** display.

syntronic

INSTRUMENTS, INC.

100 Industrial Road, Addison, Illinois
Phone: Area 312, 543-6444

Circle 211 on reader service card

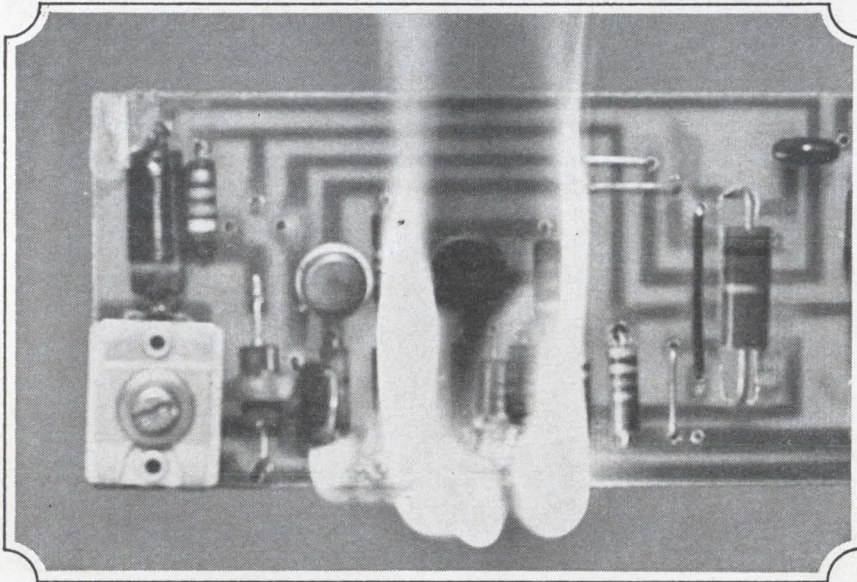

PREVENTION IS A HYPERSENSOR

HYPERSENSORS, "NANOSECOND FUSES," PREVENT COSTLY TRANSISTOR BURN-OUTS.

Save a transistor; save a circuit; save a computer; save a mission. Solid state Hypersensors react in time to prevent transistor burnout... in nano-seconds... and they can be reset over and over again with application of only 12 V. Standard units, TO-18 transistor size, rated 10 to 300 ma, available from stock. Subminiature, axial lead Hypersensors made to order. For information, write or phone, 1100-1 E. Ash Ave., Fullerton, California, 92631. Phone: 871-1930 (714)

QUALTRONICS CORPORATION

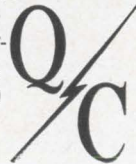

New Microwave



tuning range is 190 Mc; power output, 40 mw minimum; power input requirements, 18 v d-c at 17 ma max; frequency stability vs temperature, 5 ppm/°C. The oscillator, Part No. 9511-1005, is 1 in. square by 2 in. long, excluding projections and weighs 2 oz.

Trak Microwave Corp., Tampa, Fla. [425]

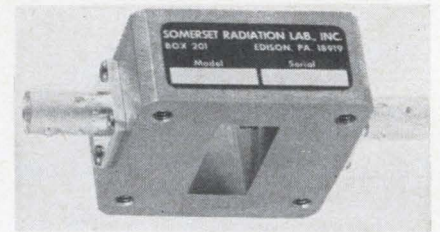

Step-recovery diode multiplier

Model H802 is an H-band, step-recovery diode multiplier. The step-recovery diode offers considerable advantage over conventional harmonic generating elements in the efficient production of very high order harmonics permitting single-stage jumps from a convenient vhf or uhf excitation frequency to shf H-band frequencies. Input power at 2.0 Gc or lower frequencies produces output power in the 7.05 to 10.0 Gc band with a conversion efficiency of 1.0 db per harmonic number. The H802 multiplier is ideal for high-stability, all-solid-state, local-oscillator and low-power transmitter service, precision frequency measurements, and general laboratory and classroom use. It consists of a step-recovery diode mounted in a short section of H-band aluminum waveguide. Low-frequency input power at one BNC receptacle is fed through a low-

pass filter to the diode where power at a high harmonic frequency of four times to 100 times the excitation frequency is launched in the waveguide at H-band. A second BNC receptacle is provided for conveniently attaching an external bias resistor for self-biasing. Price of the H802 is \$120.

Somerset Radiation Laboratory, Inc., P.O. Box 201, Edison, Pa., 18919. [426]

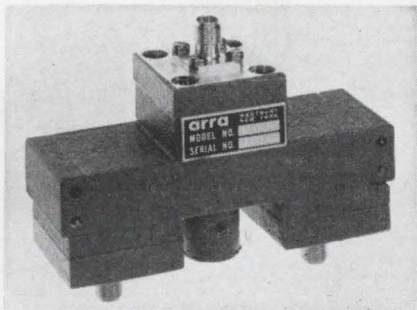

Co-ax diode switch designed for X-band

This solid-state diode switch has OSM type bias and r-f connectors. The spst switch was designed to meet military specifications and will meet or exceed the following electrical characteristics: frequency range, 8.4 to 9.4 Gc; typical minimum isolation, 20 db; typical maximum insertion loss, 2.0 db; r-f power, 4 w average, 150 w peak, 0.001 duty cycle; switching time, 10 nsec; operating temperature range, -55°C to $+85^{\circ}\text{C}$; size, 3 in. by $2\frac{1}{2}$ in. by 1 in. including all connectors. The unit is especially useful for r-f switching, r-f modulation, and voltage controlled variable attenuation.

Antenna and Radome Research Associates, 27 Bond St., Westbury, N.Y. [427]

High gain twt suitable for radar

A traveling wave tube is announced for pulse position modulation. Type WX-30046 is designed for radar systems in the frequency range of 8.5 to 9.6 Gc. Peak power output is over 1 kw; the power output curve is flat within ± 0.5 db. Saturation gain

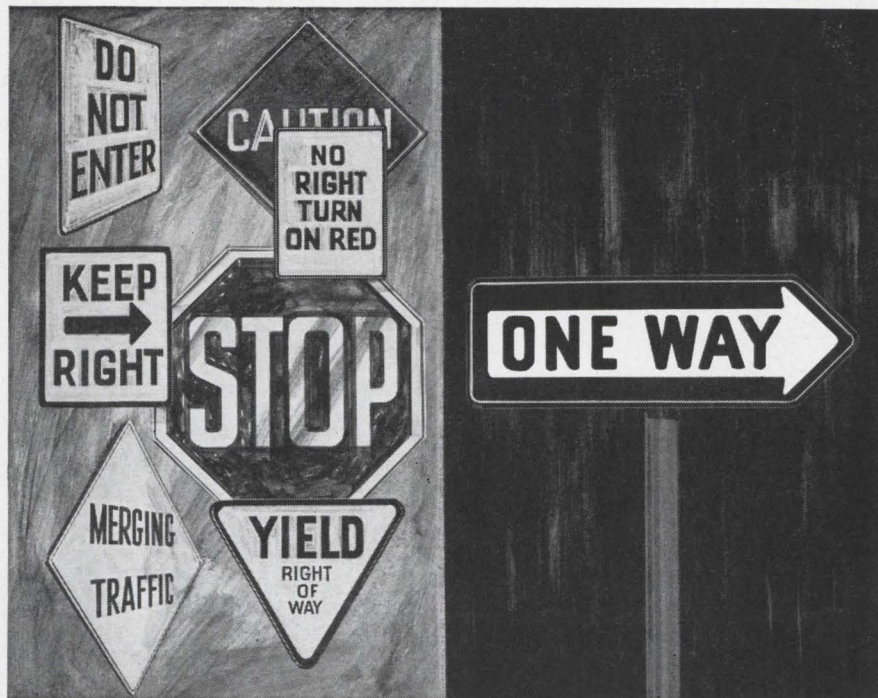

There's only one way to go...computerized filter and transformer design

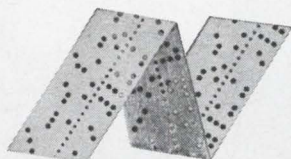

Here's the newest, shortest way to accuracy and top performance in filters and transformers: design by computers.

It's your fastest route. Computer designs take minutes instead of hours. No crossroads or by-passes, either. Computer design explores possible approaches, guides you straight to the best solution when you're in a hurry.

And no detouring for trial-and-error prototype costs. Designs are "performance tested" before production starts. Genisco's computer method searches through existing designs and singles out any that can be used.

Your filters and transformers arrive on time and at lower shipping cost because Genisco plants are on the map in key market areas. Price quotations are fast and accurate. There's never any guessing about costs with Genisco computer design of filters and transformers.

Find out how this new design capability can put you on the right track. Write today for complete information.

Genisco

TECHNOLOGY CORPORATION



INSTRUMENTS DIVISION
(Wave Filters)
9036 Winnetka Ave.
Northridge, California
(213) 341-4320

CEECO DIVISION
(Wave Filters & Transformers)
3223 W. Armitage Ave.
Chicago 47, Illinois
(312) 327-3130

TRANSONIC DIVISION
(Transformers)
808 16th Street
Bakersfield, California
(805) 327-5701



POTENTIOMETERS · POTENZIOMETRI · POTENTIOMETER
 POTENTIOMETRES · POTENCIOMETROS

- CHOOSE FROM HUNDREDS OF FACTORY MODELS
- CUSTOM MADE TO YOUR SPECIFICATIONS
- WORLD RENOWNED RELIABILITY

OTHER LESA PRODUCTS:

- automatic record changers
- manual record players a.c. & d.c.
- portable phonographs
- tape recorders
- fractional power motors

LESA COSTRUZIONI ELETTROMECCANICHE S. p. A. — VIA BERGAMO, 21 — MILANO — ITALY
 LESA OF AMERICA CORPORATION — 32-17 61st St., Woodside 77, New York (212) YE 2-9330 — U.S.A.
 LESA DEUTSCHLAND GMBH — Wiesentalstrasse 1 — Freiburg i. Br. — DEUTSCHLAND
 LESA FRANCE SRL — 19 Rue Duhamel — Lyon — FRANCE
 LESA ELECTRA S.A. — Via Portone 27 — Bellinzona — SWITZERLAND

Circle 212 on reader service card

NEW! from VULCAN

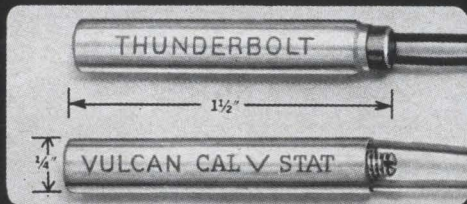

MINIATURE HEATER/THERMOSTATS

Now! The Vulcan Thunderbolt **Cartridge Heater** and the Vulcan Cal-Stat **Thermostat** in 1/4" diameter x 1 1/2" long . . . ideal for difficult and critical thermal systems. **Thunderbolt** delivers up to 100 watts/sq-inch under ideal conditions, has stainless steel case, is available for either 110v or 220v. **Vulcan Cal-Stat** is shell sensitive type with -100°F to +500°F range, inherent sensitivity of 1°F, slotted screw for full range adjustment. Both heater and thermostat available with any hardware or environmental "package" required by application.

Simplify your design problems . . . by using these Vulcan miniatures — send for complete details, today. Application assistance also available, with results assured because of single-source thermal systems. Vulcan Electric, 88L Holden St., Danvers, Mass.



132 Circle 132 on reader service card

MRC-1
 (ACTUAL SIZE)



HAMLIN
 MINIATURE
 Hg WETTED
 magnetic reed
 SWITCHES

the largest selection ever offered

The use of magnetic reed switches has been increasing by leaps and bounds, and Hamlin engineers have set the pace with the greatest selection. All standard varieties, of course, and many more designed for special requirements . . . YOUR specifications.

SEE IT! HEAR IT!



FREE CARD
 with magnet
 and switch

- DRVT-1 High Voltages (up to 5000 v)
- DRT-5 Heavy Duty (up to 50 v amp.)
- DRS-5 Heavy Duty (in-rush to 15 amp.)
- DRG-DTH Double Throw (Form "C")
- HRC-1 No Bounce (Mercury wetted)
- HWDT-1 Mercury Wetted Double Throw
- MRG-DT Miniature Form "C"
- MRC-1 Mercury Wetted Miniature

Send for literature.

HAMLIN INC.
 DEPT. EL • LAKE AND GROVE STREETS • LAKE MILLS, WIS. 53551

Circle 213 on reader service card

New Microwave



is 44 db with a duty cycle of 0.01. The tube is normally operated by cathode pulses of 14 kv at a peak current of 1 amp. The input and output r-f connectors are miniature coaxial lines. The WX-30046 weighs only 4 lb including the magnet, and is 15 in. long by $1\frac{3}{4}$ in. in diameter. Westinghouse Electronic Tube Division, Elmira, N.Y. [428]

Variable attenuators cover 2 to 11 Gc

Series 254 coaxial variable attenuators cover the frequency range from 2 to 11 Gc in three broadband devices. Each attenuator is in a 3-in. square housing and is available in the micrometer drive or with a translating shaft for remote control. The range of attenuation is 20 db with an insertion loss of 0.5 db maximum. The vswr over the entire range is less than 1.5:1. These attenuators are rugged and suitable for use in military environments. They are supplied as standard with type N female connectors. Price is \$195 each.

MSI Electronics Inc., 116-06 Myrtle Ave., Richmond Hill, N.Y., 11418. [429]

Circulator subassembly covers 4.9 to 5.1 Gc

A new circulator subassembly has been announced. The CWF-492-NT consists of a 5 port switchable circulator mounted on RG 95/U waveguide. An image rejection filter is included in the output leg. Frequency is 4.9 to 5.1 Gc. Isolation is 40 db, minimum. Insertion loss is as follows: ports 1-2, 0.4 db; ports 1-3, 1.2 db (switched, including filter); ports 2-3, 1.0 db (normal condition, including filter). Vswr is 1.15:1; switching power, 7 w. The

90% of all Japanese ITV cameras use COSMICAR lenses.

COSMICAR
INDUSTRIAL TV LENSES



For your vidicon, image orthicon and professional movie cameras, Cosmucar lenses are available in focal lengths from 12.5mm up to 1000mm.

New zoom lenses are now available.



ICHIZUKA OPTICAL CO., LTD.

2-568, SHIMOOCHIAI, SHINJUKU-KU, TOKYO

CABLE ADDRESS: "MOVIEKINO TOKYO"

Circle 214 on reader service card

Specialist in

CUSTOM-BUILT TRANSFORMERS

TO YOUR SPECIFICATIONS

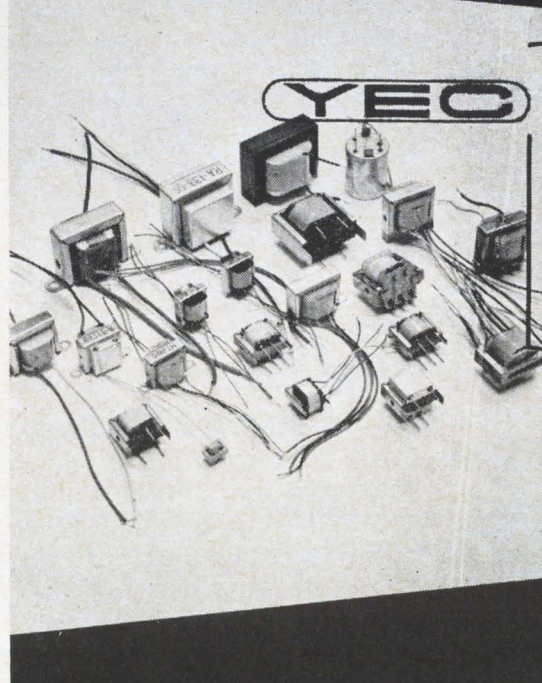

YUTAKA ELECTRIC invites you to submit your detailed specifications and quantity information to our engineering and production staff.

**YUTAKA
ELECTRIC
MFG.
CO., LTD.**

1253, 1-chome, Yutaka-cho,
Shinagawa-ku, Tokyo, Japan
Tel: (04472) 2171-3 Cable
Add: "EDOYUTACO" Tokyo

4ways NEW

SPACE-SAVERTM

PANEL METERS

WITH VALUABLE FEATURES
ENGINEERS HAVE
ALWAYS WANTED

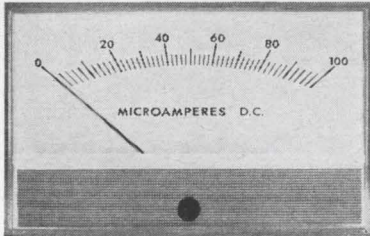

**Minimum height design
to save panel space!**

NEW! 15% longer scale —
40% less space.

NEW! Crisp, low profile for
modular styling. Per-
mits the equipment designer to
achieve the ultimate in design.

NEW!

Quick clip
mounting saves
90% of normal
installation time.
No washers, nuts
or screws.

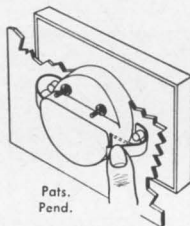

NEW! Recessed terminals
require less chassis
depth, leave more space for
components.

FOR YOUR APPLICATION,
MAY WE QUOTE ON YOUR
SPECIFICATIONS, OR HAVE
OUR REPRESENTATIVE CALL?

Experienced manufacturers of meters in
volume, for both commercial and military
applications, including ruggedized
and sealed meters to military standards

Designed and Manufactured by

DIXSON, INC.

METER DIVISION  DEPT. B

GRAND JUNCTION, COLORADO

New Microwave

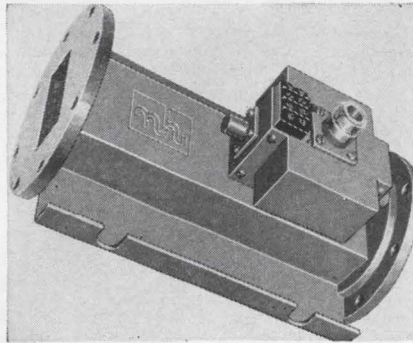

single section output filter provides
approximately 15 db rejection, 75
Mc from center frequency, and is
tunable over the 4.9-5.1 Gc range.
An integral mounting bracket can
be supplied with the unit as shown
in the picture.

N-H Microwave, Inc., P.O. Box 1009,
Red Bank, N.J., 07701. [430]

Ferrite circulator in miniature size

A 5-port ferrite circulator weighing
less than 3 oz has been developed
for use with parametric-amplifier
or tunnel diode amplifier designs
operating in the 8.5 to 9.6-Gc range.
Model H-522-211 circulator has a
minimum isolation of 35 db, maxi-
mum insertion loss of 0.5 db, and
maximum vswr of 1.2. Equipped
with OSM connectors, the circula-
tor is only 1 $\frac{3}{8}$ in. long, 1 $\frac{1}{2}$ in.
wide, and $\frac{5}{8}$ in. high, excluding
the connector length. The unit is
available with terminations for
service as an isolator that pro-
vides more than 60-db isolation,
and no more than 0.7-db insertion
loss.

Melabs, 3300 Hillview Ave., Stanford
Industrial Park, Palo Alto, Calif. [431]

Reflex klystrons for paramp pumping

Reflex klystron oscillators, which
are warranted for 5,000 hours of
operation, have been specially de-
signed as parametric amplifier
pump tubes. The tubes are also
ideal for other applications that
require frequency and power sta-

bility, ruggedness, and light weight.
Each complete klystron weighs
only 5 $\frac{1}{2}$ oz and mounts in any
position. The tubes operate at any
specified fixed frequency between
18.0 and 36.5 Gc. The VA-282 se-
ries are tuned by the factory to a
frequency between 18.0 and 26.5
Gc, and the VA-283 series are
tuned to a frequency between 26.5
and 36.5 Gc. Depending upon the
beam voltage and the operating
frequency selected, each tube will
deliver between 20 and 200 mw.
R-f output is through a special
flange for heat-sink mounting on
RG-53/U (WR42) waveguide. Ade-
quate cooling can be obtained by
heat conduction through the output
flange to a heat sink. Maximum
beam voltage for the tube is 800 v
d-c; reflector voltage, -50 to -400
v d-c; heater voltage, 6.3 \pm 0.6 v;
typical heater current, 1.25 amps;
dimensions, 3 in. by 1 $\frac{3}{8}$ in. by 1 $\frac{1}{4}$
in.

Varian Associates, 611 Hansen Way,
Palo Alto, Calif. [432]

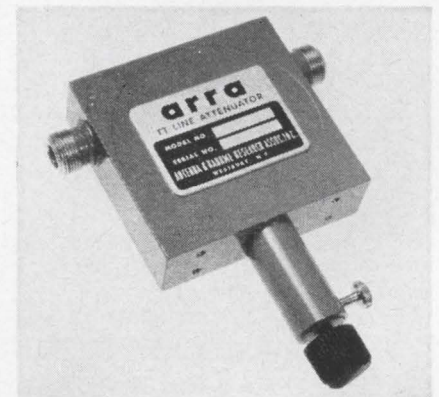

Variable attenuators for L- through X-band

Continuously variable attenuators
with a 3-in.-square form factor are
announced. The units have a non-
translating shaft or micrometer
drive. They may easily be panel
mounted, and the nontranslating
shaft model can be supplied with
a digital readout, or turns-counting
dial. Models are available in L, S,
C and X-band in 10, 20, and 30 db
attenuation values. Other charac-
teristics are: max vswr, 1.50; max

insertion loss, 0.5 db; power capacity, 10 w average, 5 kw peak. The units are normally supplied with type N female connectors; however, type N male, type TNC, BNC, OSM or other miniature connectors are available upon request. The 20 db attenuation model in S, C and X-band costs \$175.

Antenna & Radome Research Associates, 27 Bond St., Westbury, N.Y. [433]

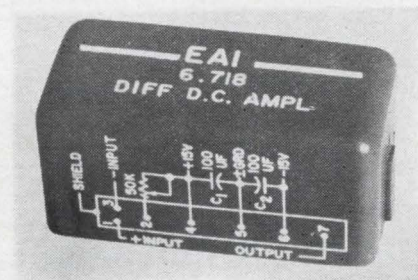

Chopperless d-c differential amplifier

A highly versatile, chopperless d-c differential amplifier is now available. Type 6.718 is a single-channel, high-gain unit. Designed as a general-purpose amplifier, it is especially suited for use in analog circuits employed in special-purpose computers, analog simulators, data acquisition and/or continuous analysis systems, or advanced instrumentation and control systems utilizing transducer measuring equipment or requiring continuous calculations. Specifications of the unit include a gain of 86 db and a minimum output current of 25 ma (at ± 10 v) without a booster. Rugged in construction, the silicon solid-state amplifier features low-drift input/output protection and welded encapsulated construction. It is capable of driving a $0.1 \mu\text{f}$ capacitor with high stability, and can drive multipliers and other function generators with ease. One to four of these units can be card-mounted in a standard computer amplifier chassis that includes balance networks with summing junctions connected to rear plug-in pins and outputs to a patching block. The unit weighs $2\frac{1}{2}$ oz and measures $1\frac{1}{8}$ in. by 1 in. by 1 in. It is priced at \$120 in small lots; less in quantities.

Electronic Associates, Inc., West Long Branch, N.J. [434]

The top left shows a cross-section of a cooling structure with a central oil channel and two surrounding air channels. Labels indicate 'OIL' and 'AIR' with a $\frac{5}{8}$ " dimension. The top right is a perspective view of the rectangular unit. The bottom part is a schematic diagram of the internal air circulation, showing air being forced through two air circuits surrounding a sealed oil circuit by vaneaxial fans.

Unit illustrated can dissipate up to 3 kw pressurized to 20 psig. Internal circulation is provided by vaneaxial fans that force air through two air circuits surrounding a sealed oil circuit. Material is aluminum alloy.



STRUCTURAL heat exchangers cool electronics

This new kind of electronics enclosure can help solve cooling problems in higher power level circuits—especially where you must pack the maximum electronics into minimum space. A typical exchanger measures 24" x 18" x 12" and forms a **pressurized** housing for a high-powered radar modulator, a low frequency transmitter, or a power supply.

Walls are only $\frac{5}{8}$ " thick but contain two air circuits straddling a sealed oil cooling circuit. Janitrol precision engineering, coupled with new methods of forming and brazing foil-thin sheets, makes it possible to fabricate leak-proof housings.

Janitrol can fabricate thin-wall cooled housings to your specifications using thoroughly proven techniques. For details about our capability write to Janitrol Aero Division, Midland-Ross Corporation, 4200 Surface Rd., Columbus, Ohio.



JANITROL AERO DIVISION
Midland-Ross Corporation



**No Book
More
Timely!**

None More Indispensable!

THE ELECTRONIC ENGINEERING

MASTER INDEX

(January 1949 - June 1964)

A definitive compilation indexing over 20,000 articles from more than 100 scientific and engineering periodicals.

YOUR MASTER KEY TO INFORMATION RETRIEVAL

The Master Index gives you, in minutes, exhaustive bibliographies on over 400 subjects in research, development and production problems in electronic engineering. Alphabetically arranged, these subjects cover the spectrum from Acoustics to Zener diodes, including such major topic areas as Antennas, Computers, Data Processing, Electronic Controls, Information Theory, Instrumentation, Integrated Circuits, Lasers, Magnetics, Masers, Plasma Physics, Semiconductors, Superconductors, Systems Engineering, Telemetry, Transducers, Transistors—in fact, all subjects as reflected in the immensely rich engineering literature of the past 15 years.

This Statement of the Engineer's Joint Council Highlights The Unique Usefulness of The Master Index:

"The ever expanding volume of technical information makes it impossible for those engaged in research and development to scan all the literature in their field. More than ever before, vital information needed for a successful project may be overlooked. The result of information unavailability is expensive duplication of work, wasted time, and wasted scientific and engineering talent."

SUMMARY REPORT, 1963

Avoid such waste in your organization by ordering The Electronic Engineering Master Index now.



Clothbound—\$29.75
491 pages, 7x10

MASTER INDEX SERVICES, INC.
151 West 18th Street
New York, N. Y. 10011

Send me _____ copies of the Electronic Engineering Master Index.

NAME _____

TITLE _____

COMPANY _____

ADDRESS _____

BILL ME BILL COMPANY

New Production Equipment

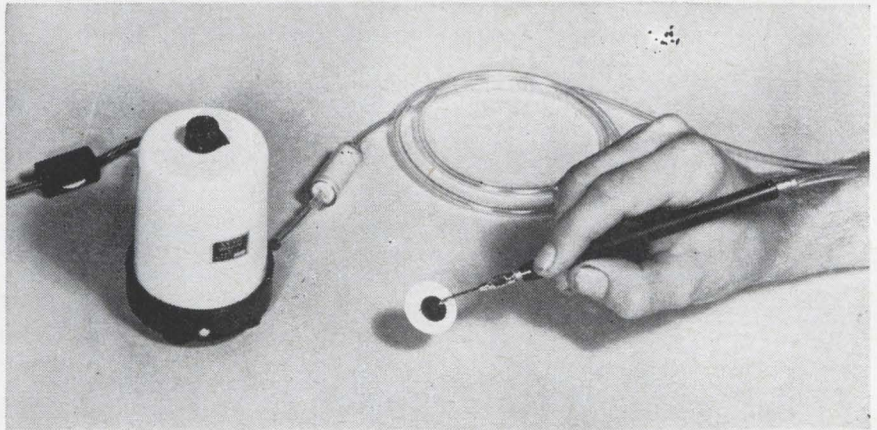

Vacuum probe system handles small parts

A new CS-100 vacuum probe system is available to handle small parts with speed and without damage. By plugging in the electromagnetic vacuum generator and selecting the correct tip for the cylindrical type vacuum probe, the system is ready for operation. Also included in the CS-100 system are a filter, on-and-off switch, five probe tips and four feet of flexible tubing. The system is completely portable. The aluminum cylindrical vacuum probe is light and easy to handle for numerous applications.

A selection of additional tips can be made from over 20 standards for use in assembling small silicon and germanium wafers in semiconductor, microminiature electronics manufacturing, laboratory work where vacuum pickup is functional, and other uses where light vacuum power is fast and safe. Price of the complete system is \$26.75. Additional cylindrical vacuum probes with different types of valve controls are \$4.50 each.

Air-Vac Engineering Co., 100 Gulf St., Milford, Conn. [451]

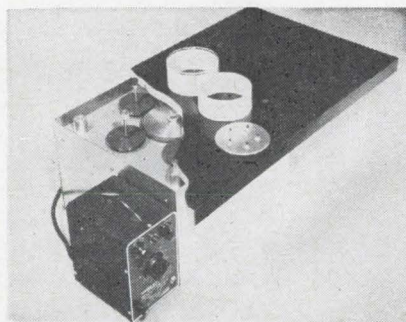

Multiple-spindle photoresist spinners

A new line of spinners is designed for long lasting, heavy duty use in the application of photosensitive films to microcircuits. They have the advantage of up to five individual spinners with the cost of

only one high quality, electronically regulated motor drive. The drive motor runs continuously. Each vacuum chuck is individually engaged and disengaged with the drive. Starting torque is high—mechanical braking provides quick stopping. Operation is simple. Each spin cycle is automatic with the push of one button—including the application and removal of vacuum to the chuck. A vacuum interlock on each chuck—no vacuum, no spin—provides protection from substrate breakage due to improper seating, or loss of vacuum to the machine. Also featured is variable speed from 150 to 5,000 rpm, electronically regulated. Substrate sizes from 0.25 in. to 2.5 in. square can be handled. These machines are designed for mounting beneath a

table top. Only the spinner shafts and pushbutton switches are exposed on top. The main box size is approximately 13 in. by 13 in. by 8.5 in. Options include higher speeds, larger substrate capability, manual instead of automatic operation, indicating tachometer, and vacuum pump. Price ranges from \$400 to \$1,280.

Headway Research, Inc., P.O. Box 848, Richardson, Texas 75081. [452]

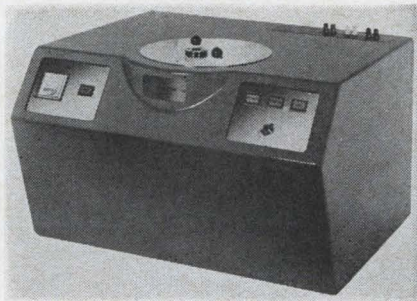

High-vacuum furnace fits on lab bench

A high-vacuum furnace compact enough to fit on a laboratory bench has been developed. The complete furnace mounted in a console is 18 in. high by 30 in. wide by 26 in. deep, and requires no more space than an ordinary 260°C atmosphere oven. Offering high vacuum, high temperature capability previously available only in substantially larger laboratory and production units, the model 224 furnace performs all types of high temperature, high vacuum lab experiments such as sintering, thin film deposition, bright annealing, melting, etc. It has a 2 in. diameter by 4 in. high work zone with an operating vacuum range of 10^{-3} to 10^{-6} Torr and temperature capability up to 2200°C. The hot zone is heated by unique radiant electric resistance type refractory metal element. Full access to the heat zone is provided from the top through a quick release combination loading port and sight glass. Utility requirements are 230 v, 1 phase, 60 cps electrical connection capable of 6 kw at full temperature and cooling water at 0.7 gpm at 70°F inlet temperature. A manually set voltage adjustment provides infinitely variable temperature control.

Richard D. Brew and Co., Inc., Airport Road, Concord, N.H. [453]

GET ALL 5

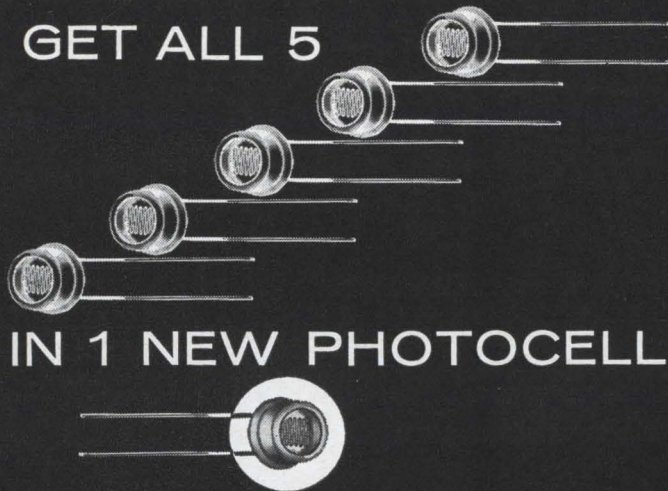

IN 1 NEW PHOTOCELL...

Now, the 5 best characteristics of CdSe and CdS are combined in 1 new Clairex CdS photosensitive material, the type "5H".

1. High speed (1-2 millisecond response)
2. Low temperature coefficient (0.5%/°C)
3. Low memory (15 X lower than CdSe)
4. High linearity (slope of 0.9 from 0.1 to 100 FC)
5. Uniform color temperature response (100% - 106%, 2854°K-6700°K)

Detailed information on type "5H" photocells plus the new Clairex 16 page Designers' Manual free on request.

CLAIREX

"The LIGHT Touch in Automation and Control"

8 West 30 Street, New York, N. Y. 10001, 212 MU 4-0940

Circle 215 on reader service card

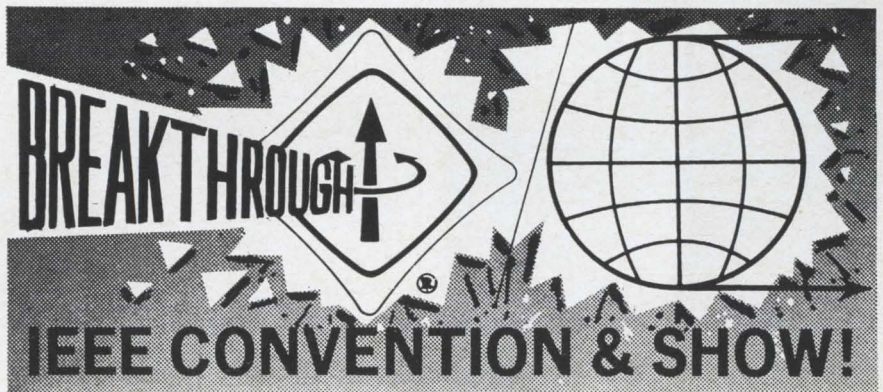

March 22-26, 1965

ELECTRICAL-ELECTRONICS

◆ Exhibit hours (4 days): Monday & Thursday, 9:45 a.m.-9 p.m.; Tuesday & Wednesday, 9:45 a.m.-6 p.m.

◆ Technical sessions (5 days) 10 a.m.-5 p.m. (Hilton, Tuesday to 10 p.m.)

◆ 80 subject-organized technical sessions presenting 400 vital "breakthrough" papers.

◆ Over 1000 Exhibits using 140,000 running feet of display units in N. Y. Coliseum & N. Y. Hilton.

◆ Gala IEEE Banquet on Wednesday, March 24, 1965 at 6:45 p.m. in Grand Ballroom, N. Y. Hilton.

◆ Registration: \$2.00 IEEE Members, \$5.00 Non-members. High School students admitted Thursday afternoon only, \$2.00 if accompanied by an adult (not over 3 per adult).



NEW YORK COLISEUM and the NEW YORK HILTON

Buses every few minutes

AD-YU

ELECTRONICS INC.

249 TERHUNE AVE., PASSAIC N. J. PHONE 472-5622

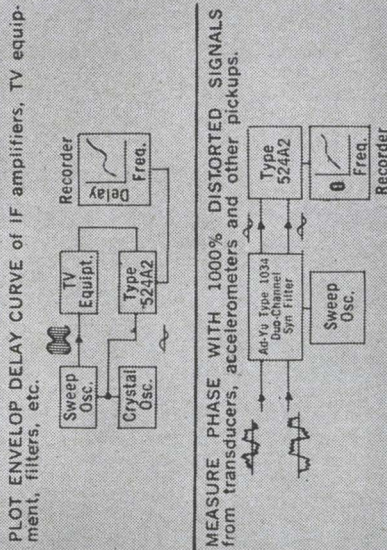

FEATURES:
 No frequency adjustment, no amplitude adjustment.
 Analog or digital output for external recorder or programmable system.
 Relative accuracy = 0.03% with 5-digit voltmeter.

USES:
 Plot phase vs. frequency curve from 20 cps to 500 Kc.
 Plot analog curve with RF sweep oscillator.
 Use as standard phase meter with 5-digit d.c. voltmeter as readout.
 Use as phase computer for system control.

THE ULTIMATE PHASE METER

±0.03 ACCURACY 20 CPS TO 500 KC

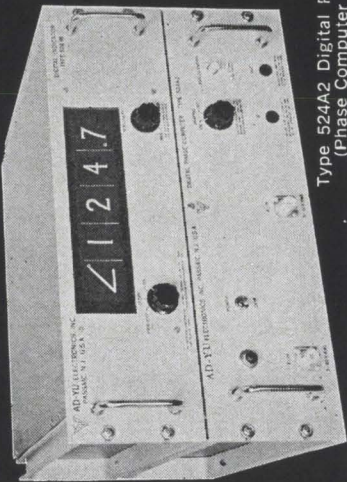

Type 524A2 Digital Phase Meter
 (Phase Computer — \$965)

New Materials

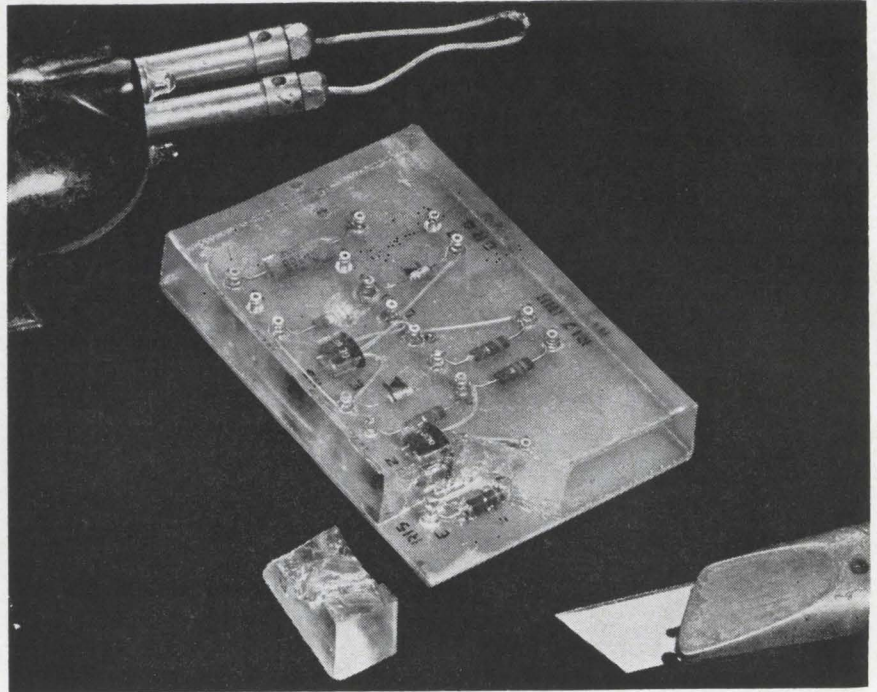

Repairable urethane used for potting

Conathane 2000 with hardener AH-16 is a moderately priced, flexible urethane system for potting and encapsulation—wherever reparability is important. Cured sections can be easily cut for placement or replacement of components. The color is a light, transparent amber and markings on components are easily read through sections one

inch thick. The shore A hardness at 25°C is 40-50. The system will cure in six hours at 50°C or in two hours at 85°C. The viscosity at 60°C is 500 cps and the pot life is 40-50 minutes. The dielectric strength is 250 v/mil and the water absorption after 24 hours immersion is 0.13%.

Conap, Inc., 184 East Union St., Allegheny, N.Y. [441]

Single crystals in noble metal

High-purity noble metal single crystals including gold, palladium, platinum, and silver with purities of 99.9999% are now available. Standard single crystal noble metals are available in standard diameter rods from 1/4 in. up to 1 in. diameter, and in lengths to 6 in. The single crystals are grown from crucible, and are normally supplied with random orientation. Specific orientations within 3° of the major axis 100, 110, 111 are available as well

as other specific orientations. Minimum orders are 1 in. lengths of any standard size diameter. In addition to gold, palladium, platinum, and silver, the manufacturer also offers materials researchers other unique noble metal single crystals including iridium, osmium, rhodium, and ruthenium. These latter elements are not available as standards, but are available upon specific customer request. All of these single crystals are prepared using the spark erosion process which produces accurate, strain free metallurgical specimens.

Advanced Research Materials Co., 77 Hickory Road, Briarcliff, N.Y. [442]

The Hughes/NASA Syncom stands still at 6875 mph to talk to a billion people.

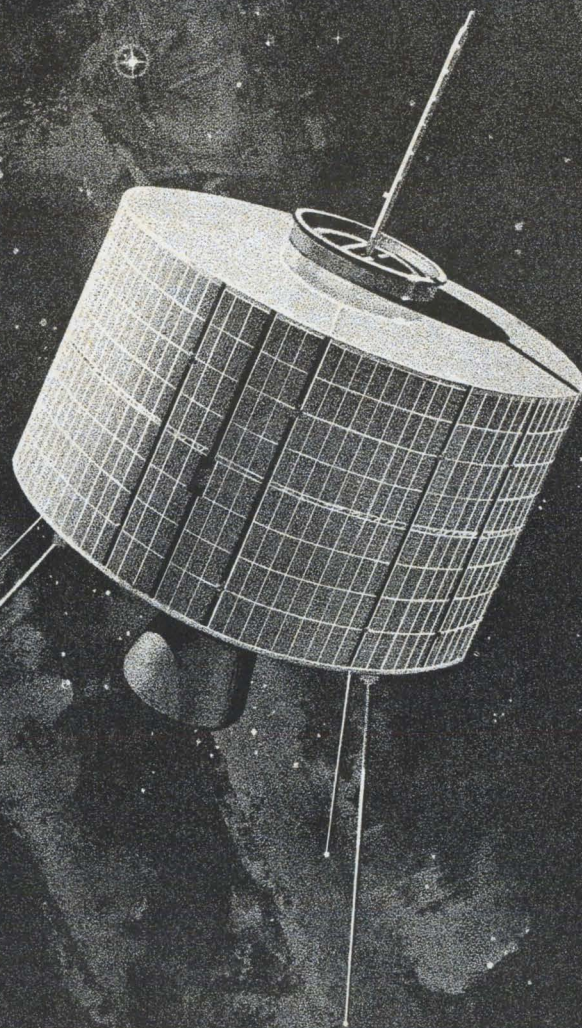

CIRCUIT DESIGNERS... is your appointment in space with Hughes?

Today, Hughes is one of the nation's most active aerospace/electronics firms. Projects include: F-111B PHOENIX Guided Missile System, TOW Anti-Tank Missile, SURVEYOR Lunar Spacecraft, SYNCOM, VATE, ARPAT, POLARIS, Hard Point Defense and others. This vigor will assist the qualified engineers and scientists towards more and better opportunities for both professional and personal growth.

Many immediate openings exist. The engineers selected for these positions will be assigned to the following design tasks: the development of high power airborne radar transmitters, the design of which involves use

of the most advanced components; the design of low noise radar receivers using parametric amplifiers; solid state masers and other advanced microwave components; radar data processing circuit design, including range and speed trackers, crystal filter circuitry and a variety of display circuits; high efficiency power supplies for airborne and space electronic systems; telemetering and command circuits for space vehicles, timing, control and display circuits for the Hughes COLIDAR (Coherent Light Detection and Ranging).

If you are interested and believe that you can contribute, make your appointment today.

For immediate consideration, please airmail your resume to:

Mr. Robert A. Martin
Head of Employment
Hughes Aerospace Divisions
11940 W. Jefferson Blvd.
Culver City 14, California

Creating a new world with electronics

HUGHES

HUGHES AIRCRAFT COMPANY
AEROSPACE DIVISIONS
An equal opportunity employer.
U. S. CITIZENSHIP REQUIRED

Major Supplier of **INDIUM**

Dimensions and weights of Standard (99.99%) and 59 (99.999%) Grade Indium shapes available as follows:

Ingots - 321.5 tr. oz. (this size in Standard Grade only), 100 tr. oz., 10 tr. oz. **Sheets** - maximum width of 5 in., minimum thickness of 0.002 in. **Wire** - minimum diameter 0.01 in. **Ribbon** - minimum thickness 0.005 in., maximum width 0.75 in. **Powder** - several sizes from -100 to -325 mesh. **Shot** - approximate diameter $\frac{1}{8}$ in. **Indium Compounds** - sulphate, chloride, oxide and hydroxide in crystal or solution form. Wide range of sizes of **Preforms** available in Standard and 59 Grades INDIUM and custom alloys based on these grades. Fabricated shapes include discs, spheres, squares, rectangles and washers. Very close tolerances maintained. Enquiries invited for special shapes, sizes and analyses.

COMINCO PRODUCTS, INC.

ELECTRONIC MATERIALS DIVISION,

818 West Riverside Ave., Spokane, Wash. 99201
Phone 509 747-6111 Telex 032 610

5606

TWX 509-328-1464

Circle 216 on reader service card

Telrex



The Choice of the Discriminating Communication Engineer . . . the Man who Never Settles for Anything Less than THE-VERY-BEST!

telrex "BEAMED-POWER" ANTENNAS and ANTENNA SYSTEMS

Provide optimum performance and reliability per element, per dollar. Antennas from 500 Kc to 1500 Mc. Free PL88 condensed data and pricing catalog, describes military and commercial antennas, systems, accessories, Towers, Masts, Rotators, "Baluns" and transmission line data.

ANTENNAS

SINCE
1921

Communication
and TV Antennas

telrex

LABORATORIES

Asbury Park 41, New Jersey, U.S.A

New Books

Energy bands

Energy Band Theory

Joseph Callaway

Academic Press, Inc., New York 1964

357 pp., \$10

This book offers a good foundation in the general methods of the theory of energy bands in solids.

It is written for advanced graduate students or anyone at a comparable technical level. The most pertinent mathematical methods are discussed at some length in the second chapter. The development is not, completely self-contained, but is more in the nature of a selection from the large quantity of mathematical methods at the disposal of the physicist.

A background in quantum mechanics is necessary for an understanding of the book, but it is even more necessary to be familiar with the mathematics pertaining to quantum mechanics.

Except for chapter 3, the book stresses the formalism used in working with band theory. Chapter 3 is too sketchy to be a good source of data for results obtained for particular materials.

The numerous references in the text seem to indicate that even the author felt that his treatment was a guide to additional literature. There is also an extensive bibliography.

The ideas behind Bloch's theorem and Brillouin zones are reviewed. The fundamentals of group theory are introduced with emphasis on cubic structures. Effective mass, density of states, and the Fermi surface are discussed, as well as factors affecting the group characteristics of the crystal, such as spin-orbit coupling. It is pointed out how symmetry requirements give rise to a degeneration of the band structure.

The solution of the one-particle Schroedinger equation with a periodic crystal potential is treated in detail. The methods based on expansion techniques are presented first. Variational methods are discussed in connection with the cellular method of solving the equation. The tight-binding approximation is explained, and its limitations and advantages pointed out. Wan-

nier functions are constructed. The determination of the crystal potential by means of the Hartree-Fock equations, is also given for the many-electron system. To this strictly theoretical approach is added a discussion of the semi-empirical quantum-defect method.

The author also discusses the results of experimental and theoretical determinations of band structures in the alkali metals, germanium, silicon, indium antimonide, gallium arsenide, aluminum, the noble metals, the transition metals and others. This is not a systematic enumeration or tabulation of results, instead, a specific topic is chosen for each case and discussed in some detail: cohesive energy and shape of Fermi surface for the alkali metals, wave functions and bands for valence crystals, the Fermi surface for aluminum.

Point impurities and the influence of external fields are also discussed. An addition of a nonperiodic part to the periodic crystal potential is analyzed. The wave function for the perturbed Hamiltonian is expanded in various possible sets of functions: the crystal momentum representation using Bloch functions, the modified crystal-momentum representation and the expansion in Wannier functions. An example is worked out for the point impurity using the crystal-momentum representation. The effective-mass equation is derived (one-particle theory) and the application of this formalism to real crystals is discussed. The effective-mass equation is generalized to include a magnetic field, and the book shows how the energy band splits into Landau levels.

In general the book seems to be an excellent source of information about the methods, results and general developments in energy band theory. The text is sufficient to give a clear picture of the subject, further detail is available in the numerous references.

Irene Petroff

University of California, Los Angeles

Recently published

Field Effect Transistor Applications,
William Gosling, John Wiley & Sons, Inc.,
144 pp., \$6.50

Physics of Semiconductors, proceedings of
Seventh International Conference, Paris,
1964, Dunod, Paris, 1368 pp., approx. \$30.00

SPECIAL INTRODUCTORY OFFER

FREE

Because electronic and control engineers have a lot of questions that need current, quick, clear answers and because books written by specialists in various branches of electronic and control engineering have those answers, the Electronic and Control Engineers' Book Club has been organized. It brings to your attention outstanding books in your field that you might otherwise miss.

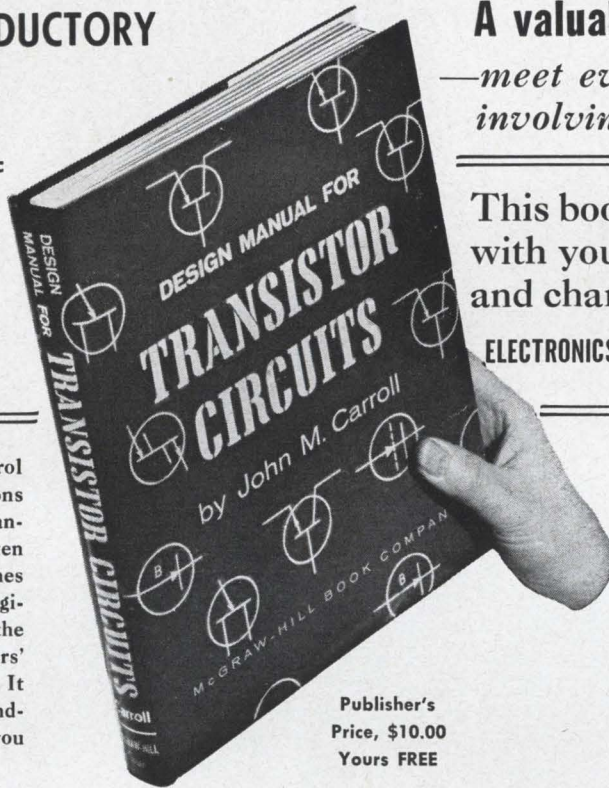

Publisher's Price, \$10.00
Yours FREE

A valuable guide to help you meet everyday design problems involving transistors

This book will be given to you with your first selection and charter membership in the **ELECTRONICS AND CONTROL ENGINEERS' BOOK CLUB**

Design Manual for Transistor Circuits
By John M. Carroll

Author, Modern Transistor Circuits, and Transistor Circuits and Applications; Managing Editor, Electronics

OUTSTANDING SELECTIONS AT SUBSTANTIAL SAVINGS.

Possibly just one idea from one of these books could mean more to you in actual dollars and cents than many times the cost of the book. By taking advantage of this special introductory offer you will receive absolutely FREE a copy of *Design Manual for Transistor Circuits*, together with your choice of any one of these twelve books as your first selection—at the special club price. (If you already have Carroll's work, you may take another of the books listed in the coupon as your gift copy.)

Selections cover the sound, hard core of electronic and control engineering practice. These books suggest the quality of the volumes that are available to you as a Club member. All books are chosen by editors and specialists whose thoroughgoing understanding of the standards and values of technical literature is your guarantee of authoritativeness.

FOR EXAMPLE — SEE COUPON.

The Club will describe all forthcoming selections to you. Periodically you will receive free of charge *The Electronic and Control Engineers' Book Club Bulletin*, as issued. This gives complete advance notice of the next main selection as well as a number of alternate selections.

From this point on, the choice is yours. If you want the main selection you do nothing; the book will be mailed to you. If you want an alternate selection or if you want no book at all for that particular period, you notify the Club by returning the convenient card enclosed with your *Bulletin*. We ask you to agree only to the purchase of four books in two years. Certainly out of the large number of books in your field offered during this time there will be at least four you would buy in any case. By joining the Club you will save, in cost, about 15 per cent from publishers' prices.

YOUR NO-RISK GUARANTEE

Remember, the goal of this economical technical reading program is your satisfaction. We ask you to take no risk whatever. If you are not delighted with the volumes you receive for this introductory offer, return the books within ten days and your membership will be cancelled without further obligation. So while this offer is in effect, put your coupon in the mail today!

Here's a wealth of practical information to help you meet everyday design problems involving the use of transistors and other semiconductor devices. Conveniently arranged for easy use, this information—in the form of articles, design charts, nomographs, and actual ready-to-use circuits—covers a wide range of applications—from simple one-transistor "push-pull" amplifiers . . . to complex computer switching circuits.

MAIL ENTIRE COUPON FOR FREE BOOK AND SELECTION

The Electronic and Control Engineers' Book Club
330 West 42nd Street, New York, N. Y. 10036

Please enroll me as a member of the Electronic and Control Engineers' Book Club. I wish to take as my first selection the book checked below:

- Electronic and Radio Engineering**, 4th Ed.,* by P. E. Terman. Publisher's Price, \$16.00. Club Price, \$13.60.
- Information Transmission, Modulation, and Noise** by Mischa Schwartz. Publisher's Price, \$12.50. Club Price, \$10.65.
- Mathematics for Electronics with Applications** by H. M. Nodelman and F. W. Smith, Jr. Publisher's Price, \$7.00. Club Price, \$5.95.
- Digital Computer and Control Engineering*** by R. S. Ledley. Publisher's Price, \$14.50. Club Price, \$12.35.
- Electronic Designers' Handbook*** by R. W. Landee, D. C. Davis, and A. P. Albrecht. Publisher's Price, \$18.50. Club Price, \$15.75.
- Electronic Measuring Instruments** by Harold E. Soisson. Publisher's Price, \$7.50. Club Price, \$6.40.
- Magnetic Tape Instrumentation** by G. L. Davies. Publisher's Price, \$9.50. Club Price, \$8.10.
- Electrical Engineering for Professional Engineers' Examinations** by John D. Constance, P.E. Publisher's Price, \$10.00. Club Price, \$8.50.
- Electronic Switching, Timing, and Pulse Circuits** by J. M. Pettit. Publisher's Price, \$8.95. Club Price, \$7.60.
- Adaptive Control Systems***, Edited by Eli Mishkin and L. Braun, Jr. Publisher's Price, \$17.50. Club Price, \$14.95.
- Transistor Circuit Design*** by the staff of Texas Instruments Incorporated. Publisher's Price, \$15.00. Club Price, \$12.75.
- Control Engineer's Handbook***, Edited by J. C. Truxal. Publisher's Price, \$23.50. Club Price, \$19.95.

I am to receive FREE with the book checked above a gift copy* of *Design Manual for Transistor Circuits* or an alternate gift copy of

Bill me for my first selection at the special Club price, plus local tax, and a few additional cents for delivery costs. Forthcoming selections will be described to me in advance and I may decline any book. I need only take 4 books in two years of membership. All further selections I choose will be at the member's special price.
* Titles marked with an asterisk carry an extra \$1.00 charge.

(Print)
Name

Address

City State Zip Code

L-2-8

Free Chart dielectric materials

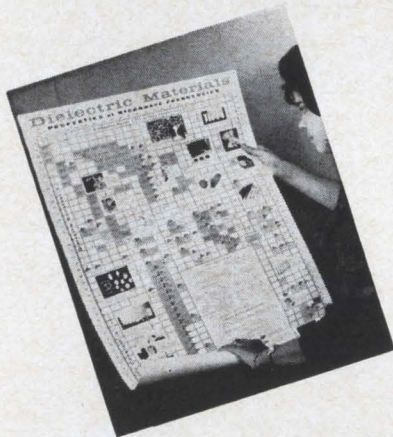

Over 200 materials are displayed on this full color chart. Each material is located with respect to dielectric constant and dissipation factor. Many physical properties are given. Foams, solids — plastics, ceramics — low loss, high loss dielectrics — all are included.

*This valuable reference chart is yours.
Write or use the Reader Service Card.*



EMERSON & CUMING, INC.
CANTON, MASS.
604 W. 182nd ST.,
GARDENA, CALIF.
9667 ALLEN AVE.,
ROSEMONT, ILL.

Circle 217 on reader service card

DC POWER SUPPLIES



CONTINUOUS VOLTAGE COVERAGE—4.7 to 60 vdc.

Input: 105-125 vdc, 50-400 cps
Regulations: From $\pm 0.05\%$
Ripple: From .002% or 1 mv, rms
Temp. Coeff.: From $\pm 0.01\%/^{\circ}\text{C}$
Voltage Adjustments: $\pm 5\%$
Max. Temp. of Base: 65°C

- WIDE VARIETY OF CURRENT RATINGS
- ELECTRONIC SHORT CIRCUIT PROTECTION
- FULLY REPAIRABLE
- 7 STANDARD SIZES (OVER 450 MODELS)

• PRICE RANGE

\$45-\$225



INSTRUMENTS: EEM ('63-64 Pg. 902)
EBG (1964 Pg. 462)
POWER SUPPLIES: EEM ('64-65 Pg. 1341)
EBG (1963 Pg. 307)
VOLTAGE STANDARDS: EEM ('64-65 Pg. 929)



DYNAGE, inc.

390 CAPITOL AVE., HARTFORD, CONN.

142

Circle 142 on reader service card

Technical Abstracts

Skin-deep junction

The planar-annular varactor and its application to millimeter-wave parametric transducers. D.R. Anderson, R.R. August, J.C. Ankland, R.L. Palmquist, and S.G. Plonski, Autonetics Research Center, North American Aviation Inc., Anaheim, Calif.

Varactor technology now permits the design of practical parametric amplifiers operating in the millimeter wavelength region. A new varactor of the planar-annular type allows the waveguide conductive walls to be brought closer to the diode junction. Thus, radio-frequency skin and parasitic losses are considerably reduced.

Recent advances in photolithography and diffusion permit semiconductor junctions comparable to the skin depth in the millimeter-wavelength region of operation. The varactor-diode depletion layer is imbedded in a gallium arsenide or silicon chip underneath a planar-annular passivation layer of silicon oxide. The outside diameter of the annulus is 11 microns and the inside diameter is 5 microns. Thus, the total path length of conduction through the semiconductor to charge the depletion layer is 3 microns. Normally path lengths of 300 microns are common for semiconductors operating at high frequencies.

The short conduction path reduces the spreading resistance and thus increase the cutoff frequency at reverse breakdown. Measurements at 15-millimeter wavelengths show that the zero-bias cutoff frequency for the silicon varactor is 500 gigacycles per second. Calculated cutoff frequency for the gallium-arsenide diode is 1,500 gigacycles per second.

The planar-annular varactor is fabricated from single crystals of tellurium-doped gallium arsenide and phosphorus-doped silicon. These semiconductor materials with carrier concentrations of 10^{19} atoms/cm³ and a mobility as high as 3,000 cm²/volt-second are sliced in the 111 plane and are optically polished on one side only. A 4,000 to 6,000-angstrom-thick layer of SiO₂ is deposited on the polished slices by various techniques.

The definition of the annular patterns in the SiO₂ layer is accomplished by photolithography using a special formulation of either Kodak photoresists for negative images or Shipley's photoresists for positive images. To avoid diffraction problems, ultraviolet light is used to form the latent image. Following the normal photoresist development, a combination of hydrofluoric, nitric, and acetic acids is used to etch the annulus center hole through the SiO₂ layer.

To form the diode junction, a zinc diffusion in an arsenic-argon rich atmosphere is performed in the gallium slice through the etched hole. For a silicon slice, conventional boron diffusion is used.

Presented at the Electron Devices Conference, Washington, Oct. 29-31

Data recording

Silicon avalanche light sources for photographic data recording. L.J. Kabell, Fairchild Semiconductor, Palo Alto, Calif., and C.J. Pecoraro, Fairchild Space and Defense Systems, Syosset, N.Y., division of Fairchild Camera & Instrument Corp.

An all-solid-state photographic auxiliary data-annotation system has been designed incorporating a silicon light-pulsar matrix. The data-handling and annotation system equipment is designed to service a complete reconnaissance system consisting of photographic, radar and infrared systems.

Emission of visible light from avalanching silicon p-n junctions has been studied by many workers over the past decade. Because of the relative inefficiency of this means of generating light, no practical applications of the phenomenon were made until 1960, when Fairchild Semiconductor began to market a silicon light-pulsar device for use in calibrating nuclear-event detection systems.

Additional investigation of the silicon avalanche light source began in 1963 in connection with computer memory research involving the recording of digital data on photographic film. The resulting device structure is an integrated matrix array of light pulsers for data recording. In the device, the

Instant Graphic Recording



For the first time . . . ultra high speed and precision accuracy in binary graphic display! 660 inches/second recorded at 40 lines/inch. Sweep information is amplitude measured to 15 microseconds or .010" against a grid generated at recorder.

Simple, reliable Alden "flying spot" helix recording techniques—combine with ALFAX electro-sensitive paper to produce visible, informative "pictures" of sonar, radar, infrared and other instrumentation outputs. Pulse length, relative signal strength and timing are continuously integrated on a single real-time recording. Data from sampling arrays, time-base signals, scan or sweep sources are synchronized with the Alden "flying spot" helix to present—as scale model "visual images"—observed phenomena, with new and essential meaning instantly revealed.

Why? Because of EXCLUSIVE ALDEN FLYING SPOT RECORDING TECHNIQUES

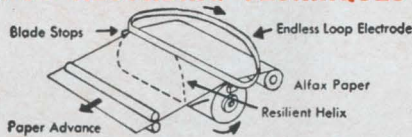

Resilient helix provides low inertia, constant electrode pressure over a wide range of recording speeds. Endless loop electrode deposits ions on the Alfax Paper when a signal appears on the helix. The electrode "blade" moves continuously to provide a freshening of its surface, for thousands of feet of continuous recording. Precision blade stops maintain precise, straight-line electrode relationship to the resilient helix, while protecting paper sensitivity by acting as paper chamber seal-off.

Alden "flying spot" recorders are available . . .

- for any recording speed from 8 rpm to 3,600 rpm
- with any helix configuration — linear 360° sweep — nonlinear — reciprocating — multi-helix
- in any record size — 2", 5", 8", 11", 19" . . . to five foot widths
- plus plug-in modular construction — interchangeability with a high degree of flexibility and adaptability

It's simple to get started.



Alden "flying spot" Component Recorders, detachable drives, plug-in electronics, accessories are available to incorporate the Alden instant graphic recording techniques into your instrumentation.

ALDEN

ELECTRONIC & IMPULSE
RECORDING EQUIPMENT CO., INC.
Westboro, Mass.

Technical Abstracts

spectral distribution of the emitted light over the visible region, which approximates the radiation from a black body having a color temperature of 2,500°, is achieved by fabricating a diffused structure that forces the avalanche breakdown to occur within a few tenths of a micron from the silicon surface.

The light is emitted from a line source, which, in the matrix array, is 6 mils long and 0.3 microns wide. Despite low efficiency and low total output, enough light is emitted to expose moderate-speed film to saturation density in about one millisecond.

The data-recording format consists of a block of dots in a rectangular 32-by-6 matrix with dots spaced on 18-mil centers. As such a format precludes the use of individual devices without optical systems, it was necessary to integrate an array of 192 devices into a monolithic silicon chip.

The solid-state record head is extremely rugged because the construction yields a compact cube. The solid-state technique also provides greater immunity from radio-frequency interference and vibration effects encountered in military and other environments.

Broadband design

Integrated high-frequency d-c amplifiers. David Roy Breuer, TRW Space Technology Laboratories a division of Thompson Ramo Wooldridge, Inc., Redondo Beach, Calif.

An integrated high-frequency linear amplifier has several advantages over an amplifier consisting of discrete components. These include high d-c accuracy over a wide environmental range, because of close matching of component characteristics and thermal intimacy of all portions of the integrated circuit; higher bandwidths, because packaging capacitances are eliminated; exceptionally flat frequency response and almost ideal roll-off characteristics because wiring reactances are minimal.

These advantages are derived only after the inherent problems of integrated circuit design are re-

There's nothing so simple or satisfactory as recording with

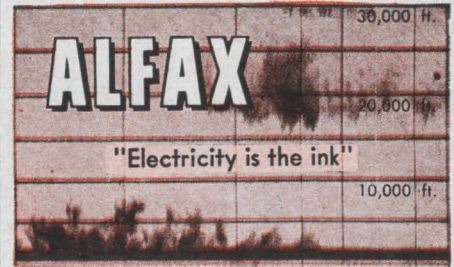

High-altitude weather data from radar ceilometer is recorded instantly and vividly on ALFAX electro-sensitive paper. 20-minute chart segment shows returns to 30,000 feet.

Progressive innovators are obtaining **vital information never before possible** and often unsuspected in such fields as . . .

- **LONG RANGE RADAR DETECTION**
As opposed to scope cameras, operator sees returns instantly, evaluates more rapidly, gets permanent record with increased sensitivity.
- **RADAR SAMPLING**
Tone shades keyed to signal intensity provide vivid "picture" of radar return even when bulk of data is gated out.
- **SONAR ACTIVE AND PASSIVE**
Unparalleled identification and location of returns even in poor signal to noise ratio through integrating capability of Alfax paper.
- **OCEANOGRAPHY**
High resolution capability, dynamic tone shade response with Alden recording techniques adding synchronizing ease provide "optimization" of underwater sound systems.
- **FREQUENCY ANALYSIS, SAMPLING AND REAL TIME**
Intensity modulation and frequency vs. real time provide continuous vital information with permanence and past history to achieve previously unattainable evaluation.
- **SEISMIC STUDIES**
Dynamic response at high writing speeds yields discrete geological data at resolution never before possible.
- **HIGH SPEED FACSIMILE**

Why? Because of ALFAX EXCLUSIVES

- broad, dynamic response of 22 distinct tone shades
- remarkable expansion at low level signal, where slight variation may provide critical information
- records in the sepia area of the color spectrum where the eye best interprets shade differentials in diminishing or poor light
- writing speed capabilities from inches per hour up to 1400 inches/second
- captures 1 microsecond pulse or less
- dynamic range as great as 30 db
- integration capability for signal capture in signal to noise ratio conditions worse than 1 to 4
- resolution capabilities of 1 millisecond = 1 inch of sweep
- accuracy capabilities of few thousandths of an inch
- sensitivity to match most advanced sensing devices

By merely passing a low current through Alfax everything from the faintest trace signal of microsecond duration to slow but saturated signal can be seen instantly, simultaneously.



write for
**ALFAX HANDBOOK
OF INSTANT
GRAPHIC
RECORDING
PAPERS**

ALFAX

PAPER AND
ENGINEERING
COMPANY, INC.
Alden Research Center, Westboro, Mass.
Dept. A-1

Instrument Line Magnetic Tape Heads by NORTON

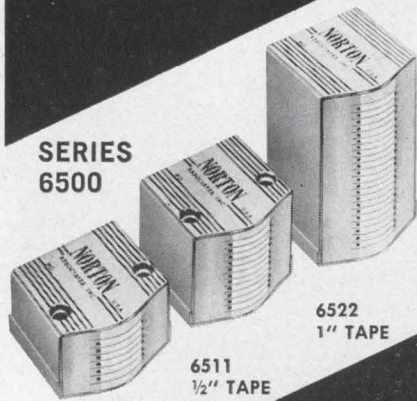

**SERIES
6500**

6511
1/2" TAPE

6522
1" TAPE

6506
1/4" TAPE

Send now for technical literature with specifications on the complete Norton line of magnetic heads.

NORTON
ASSOCIATES, INC.

240 Old Country Road, Hicksville, N. Y.

Circle 144 on reader service card

SHIZUKI CAPACITORS

Injection Polypropylene Resin
Molded Metallized Lacquer Film
Capacitors (-30°C +85°C)

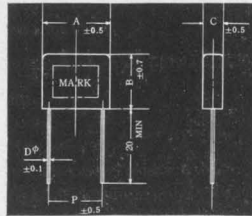

50 volts D.C. Working unit: mm

TYPE	CAP	A	B	C	D	P
PML-0.47/50	*0.47 μ F	14.0	14.0	5.0	0.6	10.0
PML-0.5 /50	0.5 μ F	14.0	14.0	5.0	0.6	10.0
PML-0.68/50	*0.68 μ F	19.5	16.0	5.5	0.6	15.0
PML-1.0 /50	*1.0 μ F	19.5	16.0	5.5	0.6	15.0
PML-1.5 /50	*1.5 μ F	24.0	19.0	6.5	0.7	19.0
PML-2.0 /50	2.0 μ F	24.0	19.0	6.5	0.7	19.0
PML-2.2 /50	*2.2 μ F	24.0	19.0	6.5	0.7	19.0
PML-3.3 /50	*3.3 μ F	30.0	20.0	7.0	0.7	25.0
PML-6.8 /50	*6.8 μ F	31.0	23.0	10.0	0.8	25.0

*STANDARD

- ◇ Lacquer Film Capacitors ◇ Mylar Capacitors
- ◇ Metallized Paper Capacitors for Motor running, fluorescent ballasts ◇ Noise Suppression Capacitors ◇ Ignition Capacitors ◇ Miniature Electrolytic Capacitors



SHIZUKI ELECTRICAL MFG. CO., LTD.

HEAD OFFICE: TAISHA-CHO, NISHINOMIYA, JAPAN
CABLE ADDRESS: "CAPACITOR" NISHINOMIYA
TOKYO FACTORY: 10-7, ARAJYUKU, OTA-KU, TOKYO

Circle 219 on reader service card

Technical Abstracts

solved. These problems are large absolute tolerances of passive diffused components, restricted range of component values, parasitic isolation junction capacitances, and lack of inductive reactances. Thin-film cermet structures have solved the resistor tolerance problem. The parasitic capacitance problem has been significantly diminished by using small-geometry components, thin-film resistors and optimized circuit organization. The lack of inductors and large capacitors has been compensated for by using proper circuit techniques.

A survey and evaluation of integrable low-pass broadbanding techniques yield an optimum circuit configuration that consists of alternately cascading series-feedback and parallel-feedback stages.

The SPAF (series-parallel alternate feedback) technique is considered optimum. The effects of parasitic capacitances are negligible because the collector impedance of each transistor in the cascade is low. The technique provides maximum flexibility in meeting impedance requirements.

The technique is implemented by simple straightforward design equations, it yields high gain for a given stability figure, and controlled bandwidth with roll-off characteristics independent of high-frequency instabilities. Only simple bias networks are needed.

Two design examples demonstrate the capability of the integrated amplifier technique. The first design uses triple-diffused components; the second uses buried-layer epitaxial active components and thin-film resistors.

The results of laboratory tests on the integrated high-frequency linear amplifier were: differential voltage gain > 70.7 ; output rise time < 5 nanoseconds; delay time < 10 nanoseconds; common-mode rejection > 200 for 1-nanosecond pulses, and $> 10,000$ for d-c; 45-milliwatt power dissipation.

Design equations and two design examples are presented in the paper, with circuit diagrams, structural and assembly drawings.

Presented at the 1964 Western Electronics Show and Convention (Westcon) Los Angeles, Aug. 25-28.

SPECIAL OFFER: Reprints of Special Reports from Electronics

Now, for your reference file—a complete set of Special Reports reprinted from the pages of Electronics in 1964. A total of 172 pages of valuable and informative articles combined in an attractive folder. The reports are individually bound. The special discount price for the reports is \$2.50 which includes both handling and shipping costs. Order now, using the coupon below. The following reprints are included in this offer:

- Electronic Telephone Switching 16 pages.
- Direct Digital Control in Industry 24 pages.
- Transistor Heat Dissipators 32 pages.
- Oceanography 15 pages.
- Magnetics 24 pages.
- Electronic Markets New Directions 1963-64-67 24 pages.
- Digital Instrumentation 16 pages.
- Modern Electronic Packaging 16 pages.

Send your order to: Electronics Reprint Dept. McGraw-Hill Inc.
330 W. 42nd Street, New York, N.Y. 10036

Reprint order form

A-1

For reprints of feature articles or special reports fill in below:

Send me reprints of Key No.(s) at ¢ each.

For prices and listing please see the reader service card.

Send me complete set(s) of special reports listed above at \$2.50 per set.

Name

Number of street

City, State, Zip code



EMPLOYMENT OPPORTUNITIES

PROFESSIONAL SERVICES

GIBBS & HILL, Inc. Consulting Engineers

Systems Engineering
Operations Research • Development
Field Studies • Design • Procurement
Power • Transportation • Communications
Water Supply • Waste Treatment

393 Seventh Avenue New York 1, N. Y.

PINPOINT *your* RECRUITMENT ADVERTISING

to the Engineers
and Technical
Management men

in the Electronics Industry

When you need Engineers—remember this fact: Electronics serves thousands of engineers with the latest engineering developments and news of the electronics industry. Engineers read Electronics because its high calibre editorial content is specially designed for them . . . that's why your Employment advertising in Electronics can pinpoint a most concentrated source of experienced engineers. Your MOST DIRECT LINK to these qualified men is in the EMPLOYMENT OPPORTUNITIES section. For more facts, of placement of your ad,

For Rates and Information Write:

Electronics

A McGraw-Hill Publication
Classified Advertising
Division
P.O. Box 12, New York
10036

hp associates Electrical Engineers

Electrical Engineers, Physicists, Physical Chemists: PhD or equivalent, to carry out applied solid-state research and exploratory development in various highly advanced areas in semiconductor physics and technology, as well as related device physics, technology, engineering and applications. Positions are available in the following specific areas of activity, some include technical supervision:

- * Physics and chemistry of semiconductor surfaces
- * Injection luminescence and optical properties of materials
- * Transport and hot electron phenomena
- * MOS devices
- * Photo-sensors
- * Nuclear detectors

An affiliate of:

HEWLETT-PACKARD

1501 Page Mill Road, Palo Alto, Calif.

326-7000 extension 2361

Call or send resume in confidence to:

Professional Employment Manager

An equal opportunity employer

ADDRESS BOX NO. REPLIES TO: Box No.
Classified Adv. Div. of this publication.
Send to office nearest you.
NEW YORK, N. Y. 10036: P. O. Box 12
CHICAGO, Ill. 60611: 645 N. Michigan Ave.
SAN FRANCISCO, Cal. 94111: 255 California St.

SELLING OPPORTUNITY AVAILABLE

Salesmen . . . Excellent add'l income! Mfr. of precision engraved Dials, Scales, Panels, Nameplates. If you call on OEM in Electronics and Industry, sell this lucrative sideline. Nationally advt. We quote on blueprints. Liberal comm. RW-5967, Electronics.

SELLING OPPORTUNITIES WANTED

Manufacturers Rep Available in Los Angeles. Can provide complete coverage to increase your sales volume and improve your profit. Balboa Industries, 15336 Roscoe, Van Nuys, Calif.

RF CONNECTOR Sales Manager

Unusual opportunity
to get in on ground floor
of a growing business

Must have specific
applicable experience

SALARY OPEN

Located New York City

Submit resume to

P-5980, Electronics
Class. Adv. Div., P.O. Box 12, N.Y., N.Y. 10036
An Equal Opportunity Employer



E. E.'s

for FEE-PAID Positions
WRITE US FIRST!

Use our confidential application
for professional, individualized
service . . . a complete national
technical employment agency.

ATOMIC PERSONNEL, INC.
Suite 1207L, 1518 Walnut St., Phila. 2, Pa.

EMPLOYMENT PROBLEM?

When you are in need of specialized men for specialized jobs,
contact them through an employment ad in this publication.

New VACUUM PENCIL

for picking up miniature parts

PHILIP FISHMAN CO.
7 CAMERON ST., WELLESLEY, MASSACHUSETTS

\$7.50 ea.

CIRCLE 961 ON READER SERVICE CARD

V-I-S* SERVICE

FASTEST TO BOTH COASTS

FOR YOUR VERY IMPORTANT SHIPMENTS

2nd DAY between Chicago—Milwaukee and Eastern Terminals

4th DAY between Chicago—Milwaukee and West Coast

LIFSCHULTZ FAST FREIGHT

NEW YORK — CHICAGO — PHILADELPHIA — BOSTON
HOLYOKE — BALTIMORE — BLOOMFIELD, N. J.
NEW HAVEN — PROVIDENCE — MILWAUKEE
LOS ANGELES — SAN FRANCISCO

CIRCLE 951 ON READER SERVICE CARD

SMALL AD but BIG STOCK

of choice test equipment and surplus electronics

Higher Quality—Lower Costs
Get our advice on your problem

ENGINEERING ASSOCIATES
434 Patterson Road — Dayton 19, Ohio

CIRCLE 952 ON READER SERVICE CARD

FREQUENCY STANDARDS AND MEASURING EQUIPMENT

GENERAL RADIO

Group 1: #1103B; 1112A; 1113AR; 1114AR
Group 2: #1106A; 1106B; 1107A; 1108B; 1109B

All equipment is brand new, never used, in original carton. Will sacrifice.

KAHN AND COMPANY, INC.
P. O. Box 516, Hartford, Connecticut 06101
203-529-8643

CIRCLE 953 ON READER SERVICE CARD

EDMUND CATALOG

EDMUND SCIENTIFIC CO.
Barrington, N. J.

OVER 2,000,000

RELAYS IN STOCK!

Send for Catalog \$5

Universal RELAY CORP.
42 WHITE ST., N.Y. 13, N.Y. • Walker 5-6900

CIRCLE 955 ON READER SERVICE CARD

ELECTRON TUBES

KLYSTRONS • ATR & TR • MAGNETRONS
SUBMINIATURES • C.R.T. • T.W.T. • 5000-6000 SERIES

• SEND FOR NEW CATALOG A2 •

A & A ELECTRONICS CORP.
1063 PERRY ANNEX
WHITTIER, CALIF.
696-7544

CIRCLE 956 ON READER SERVICE CARD

SAVE ON DIODES

If you use Germanium or Silicon Diodes in quantities of 5000 to a million, get our low, low prices. Send specs or request samples.

RULAND MANUFACTURING CO.
WATERTOWN, MASS. 617-924-8000

CIRCLE 957 ON READER SERVICE CARD

SEMICONDUCTORS MAJOR BRANDS

INTERGRATED CIRCUITS • DIF. AMPS DARLINGTONS • POWER DIODES & TRANSISTORS • SPECIAL DEVICES

Write for Catalog S-1

SEMICONDUCTOR SALES OF CALIF.
1063 Perry Annex Whittier, Calif.
(213) 696-7544

CIRCLE 958 ON READER SERVICE CARD

ATMOSPHERE FURNACE

Lindberg type RO-3048-A electric atmosphere furnace. Purchased new 1962. All accessories incl. steel cooling hood, complete structural steel frame-work assembly and 5 T. motorized trolley hoist. Work space 30" in diameter; 48" high. Maximum temp. of 2200 F. Located on Long Island.

FS-5930, Electronics
255 California St., San Francisco, Calif. 94111

CIRCLE 959 ON READER SERVICE CARD

Watch—
the Searchlight Section
for
Equipment Opportunities

AUTOTRACK ANTENNA MOUNT

360 degree azimuth, 210 degree elevation sweep with better than 1 mil. accuracy. Missile velocity acceleration and slewing rates. Amplidyne and servo control. Will handle up to 20 ft. dish. Supplied complete with control chassis. In stock—immediate delivery. Used world over by NASA, USAF. TYPE MP-61 B. SCR-584. NIKE AJAX mounts also in stock plus several airborne trackers.

SCR 584 AUTOMATIC TRACKING RADARS

Our 584s in like new condition, ready to go, and in stock for immediate delivery. Ideal for telemetry research and development, missile tracking, satellite tracking, balloon tracking. Used on Atlantic Missile Range, Pacific Missile Range, N.A.S.A. Wallops Island, A.P.M.A. Write us. Fully Desc. MIT Rad. Lab. Series, Vol. 1, pps. 207-210, 228, 284-286. Compl. inst. Bk. avail. \$25.00 each.

PULSE MODULATORS

MIT MODEL 9 PULSER

1 MEGAWATT—HARD TUBE
Output 25 kv 40 amp. Duty cycle .002. Pulse lengths .25 to 2 microsec. Also .5 to 5 microsec. and .1 to .5 microsec. Uses 6C21. Input 115v 60 cycle AC. Mfr. GE. Complete with driver and high voltage power supply. Ref: MIT Rad. Lab. Series, Vol. 5, pps. 152-160.

500KW THYRATRON PULSER
Output 22kv at 28 amp. Rep. rates: 2.25 microsec. 300 pps. 1.75 msec 550 pps. 4 msec 2500 pps. Uses 5C22 hydrogen thyatron. Complete with driver and high voltage power supply. Input 115v 60 cy AC.

2 MEGAWATT PULSER
Output 30 kv at 70 amp. Duty cycle .001. Rep rates: 1 microsec 600 pps, 1 or 2 msec 300 pps. Uses 5948 hydrogen thyatron. Input 120/208 VAC 60 cycle. Mfr. GE. Complete with high voltage power supply.

15KW PULSER—DRIVER
Biased multivibrator type pulse gen. using 3E29. Output 3kv at 5 amp. Pulse lgths .5 to 5 microsec, easily ad. to .1 to .5 msec. Input 115v 60 cy AC. \$575. Ref: MIT Rad. Lab. Series, Vol. 5, pps. 157-160.

MIT MODEL 3 PULSER
Output: 144 kv (12 kv at 12 amp.) Duty ratio: .001 max. Pulse duration: .5, 1 and 2 microsec. Input: 115 v 400 to 2000 cps and 24 vdc. \$325 ea. Full desc. Vol. 5, MIT Rad. Lab. series, pg. 140.

250KW HARD TUBE PULSER
Output 16 kv 16 amp. duty cycle .002. Pulses can be coded. Uses 5D21, 715C or 4PR60A. Input 115 v 60 cycle ac. incl. H.V. pwr supply \$1200 ea.

5949 THYRATRON AGING RACK
Compl. Chatham Electronics Console incl. 15 kv power supply & PFN's. \$1800.

H.V. POWER SUPPLIES

1) 12 kv 75 amps nominal \$1400 ea. 2) 22 kv 100 ma nominal \$2200 ea. Std. 60 cycle inputs.

MICROWAVE SYSTEMS

E-4 FIRE CONTROL SYSTEM
Hughes Aircraft X Band. Complete. In stock.

C-BAND RADAR
250 KW output, C-band, PPI indicator, 5C22 thyatron modulator. Antenna hi gain parabolic section. Input 115 volts 60 cycle AC, complete \$2750.00.

300 TO 2400MC RF PKG.
300 to 2400 MC CW. Tuneable. Transmitter 10 to 30 Watts. Output. As new \$475.

500KW "L" BAND RADAR
500 kw 1220-1350 mcs. 160 nautical mile search range P.P.I. and A Scopes. MTI, thyatron mod. 5426 magnetron. Complete system.

PHILCO MICROWAVE LINKS
C Band Microwave Link terminal bays and repeater bays in stock. New \$1500 each or \$2500 per pr.

10KW 3 CM. X BAND RADAR
Complete RF head including transmitter, receiver, modulator. Uses 2J42 magnetron. Fully described in MIT Rad. Lab. Series Vol. 1, pps. 616-625 and Vol. 11, pps. 171-185. \$375. Complete System \$750.

100—800CM. CW SOURCE
150 watts CW nominal output 115 V 60 Cy AC input. \$1600.

100KW 3CM. RADAR
Complete 100 kw output airborne system with AMTI. 5C22 thyr. mod. 4J52 magnetron, PPI. 360 deg az sweep, 60 deg. elev. sweep, gyro stabilizer, hi-gain rcvr. Complete with all plugs and cables.

M-33 AUTO-TRACK RADAR SYSTEM
X band with plotting board, automatic range tracking, etc. Complete with 1 megawatt acq. radar.

400 CYCLE SOURCE
Output: 115v 400 cycle 1 ph 21.7 amps cont. duty input: 208v 60 cycle 3 ph. req. 30v dc static exc. New. \$325 ea.

3KW RCA PHONE & TELEG XMR
2—30 MC. 10 Autotone channels plus MO. Input 220 vac. 50/60 cycles.

Radio-Research Instrument Co.
550 5th Ave. New York 36, N.Y.
Tel. JUdson 6-4691

CIRCLE 960 ON READER SERVICE CARD

FREE CATALOG!
NEARLY 4,000 BUYS FOR INDUSTRY

OPTICS! SCIENCE! MATH!
GIANT 148 PAGES

Many on-the-job helps . . . Quality Control Aids! Write for this completely new, 1965 Catalog. New items, new categories, new illustrations. 148 easy-to-read pages packed with hundreds of charts, diagrams, illustrations. A treasure-house of optical and scientific information . . . unusual bargains galore. Optics for industry, research labs, design engineers, experimenters, hobbyists! Instruments for checking, measuring—to speed work, improve quality, cut production costs. We give you facts: what it is—how it works—where it's used!

COMPARATORS, MAGNIFIERS, MICROSCOPES

Hard-to-get war surplus bargains—ingenious scientific tools—imported—domestic. Thousands of components: lenses, prisms, wedges, mirrors, mounts—accessories of all descriptions. Dozens of instruments: magnifiers, stereo microscopes, telescopes, binoculars, infra-red equipment, photo attachments. Shop by mail. No salesman will call. Use the Catalog of America's greatest Optics—Science—Math Mart. Known for reliability. Mail coupon below for catalog "EX". No obligation.

EDMUND SCIENTIFIC CO.
Barrington, N. J.

MAIL COUPON FOR FREE CATALOG "EX"!

EDMUND SCIENTIFIC CO., Barrington, N. J.
Please send FREE Giant 148-page Catalog 'EX'

NAME

ADDRESS

CITYZONE.....STATE.....

CIRCLE 954 ON READER SERVICE CARD

New Literature

Multilayer p-c boards. Melpar, Inc., 3000 Arlington Blvd., Falls Church, Va., 22046, has available a test-program report entitled "Multilayer Printed Circuit Boards Performance and Reliability." Circle 461 on reader service card

Charge amplifier. Gulton Industries, Inc., 212 Durham Ave., Metuchen, N.J. A miniature charge amplifier measuring only 0.55 cu in. is described in bulletin ASI-112. [462]

Digital voltmeter. Non-Linear Systems, Inc., P.O. Box 728, Del Mar, Calif. A five-page bulletin describes a 5-digit digital voltmeter that will measure, average, or mathematically integrate voltages from $\pm 1 \mu\text{v}$ to $\pm 1,000 \text{ v}$. [463]

Relays. Magnecraft Electric Co., 5565 N. Lynch Ave., Chicago, Ill., 60630. An eight-page catalog covers 310 high-reliability relays stocked in quantity for immediate shipment. [464]

Sweep generators. Telonic Industries, Inc., 60 N. First Ave., Beech Grove, Ind. A two-page, illustrated catalog sheet describes the model SV-14 sweep generator for aligning f-m tuners and the SV-70 sweeper for testing and aligning uhf-tv tuners. [465]

Switches. Licon Division, Illinois Tool Works Inc., 6615 W. Irving Park Road, Chicago, Ill., 60634. Catalog G-102 describes basic, illuminated and environment-free switches with illustrations, engineering drawings and ordering information. [466]

Coaxial r-f loads. Sierra Electronic Division of Philco, 3885 Bohannon Drive, Menlo Park, Calif., 94025. A four-page brochure describes eight basic types in the model 160 50-ohm r-f coaxial load product family. [467]

Four-layer diodes. National Transistor, 500 Broadway, Lawrence, Mass., has available engineering application sheet E-506 on four-layer diodes. [468]

Modular pushbutton switches. Micro Switch, Freeport, Ill. Data sheet 233 explains how compact design, custom push-button switches can be built up from interchangeable modular units in the versatile new series 6 line. [469]

Induction and synchronous motors. Globe Industries, Inc., 1784 Stanley Ave., Dayton, Ohio, 45404. Two-page bulletin E-3608 gives dimensional and performance details on 115 v a-c, 50/60 cps a-c induction and synchronous motors. [470]

Nickel aluminide coatings. Metco Inc., Westbury, N.Y. A four-page technical report tells how and where to use flame-sprayed nickel aluminide coatings. [471]

High-voltage capacitors. Aerovox Corp., New Bedford, Mass. A four-page brochure catalogs types 20, 25, 26 and 27 high-voltage capacitors. [472]

Pressure transducers. Aerospace Electronics Division, Taber Instrument Corp., 107 Goundry St., North Tonawanda, N.Y. An illustrated bulletin presents the series 177 Teledyne bonded strain-gage pressure transducers. [473]

Amplifiers. Melcor Electronics Corp., 1750 New Highway, Farmingdale, L.I., N.Y., has available a pamphlet entitled "Amplifiers for Industry." [474]

Pressure switches. Computer Instruments Corp., 92 Madison Ave., Hempstead, L.I., N.Y., has published a 16-page catalog featuring a new line of precision pressure switches. [475]

Dispersive delay lines. Anderson Laboratories, Inc., 501 New Park Ave., West Hartford, Conn., 06110. Form MSD 300 fully describes metallic strip dispersive delay lines that provide a linear function of delay versus frequency. [476]

Film engineering. E. I. duPont de Nemours & Co., Inc., Wilmington 98, Del., has introduced a quarterly publication called "Film Engineering News" that will be distributed on request to product design personnel who use plastic films as engineering materials. [477]

Electronic counter. Non-linear Systems, Inc., P.O. Box 728, Del Mar, Calif. A four-page brochure contains details on a 2-Mc electronic counter that will measure frequency and frequency ratio, totalize pulses, and measure waveform periods and averaged periods. [478]

Ultrasonic testing instruments. Magnaflux Corp., 7300 W. Lawrence Ave., Chicago, Ill., 60656. A new series of pulse ultrasonic testing instruments for detecting internal and surface flaws is illustrated and described in a two-page bulletin. [479]

Coaxial cable assemblies. Technical Accessories Co., Box 343, Metuchen, N.J. Coaxial cable assemblies available for use with microwave, pulse and video frequency equipment are listed in catalog CCA-1. [480]

Automatic switching time test system. General Applied Science Laboratories, Inc., Merrick and Stewart Avenues, Westbury, L.I., N.Y., has published a four-page brochure on the model AST-2-A automatic switching-time test system for high-speed sorting of transistors. [481]

Pulse transformers. The Gudeman Co., 340 W. Huron St., Chicago, Ill., 60610, has available an engineering bulletin describing pulse transformers for scr applications. [482]

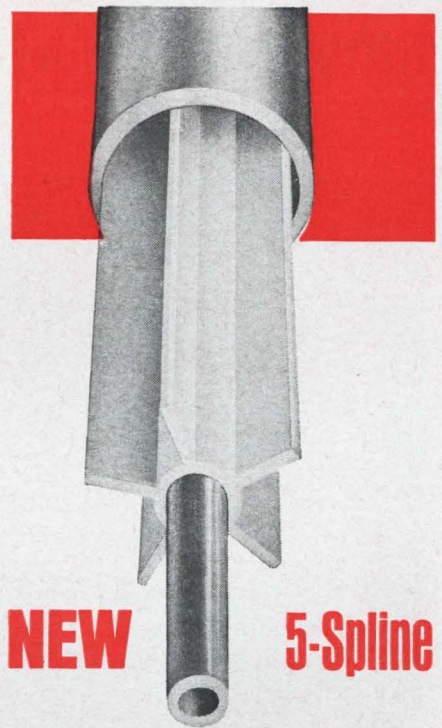

NEW

5-Spline

Coaxitube

50-ohm Semi-flexible Air-Dielectric Coaxial Cable

This new Precision product is a unique semi-flexible coaxial cable for low-loss RF transmission. Five linear splines of Teflon® support the center conductor within a seamless aluminum or copper tube—achieving essentially an air-dielectric coaxial cable, light in weight and mechanically strong. Can be supplied with a jacket of vinyl or Teflon. **Let's discuss how you might use it.**

*Du Pont Trademark

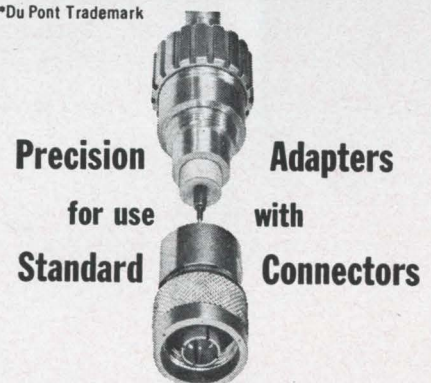

Precision

Adapters

for use

with

Standard

Connectors

With this special adapter designed by Precision's engineers, Coaxitube can be terminated in standard UG connectors—with no deviation of electrical characteristics.

YOUR BEST DECISION:
PRECISION
TUBE COMPANY, INC.
North Wales, Pa.
Phone: (215) 699-4806—Telex: 083-381

FROM RFD: THE NEW LOOK IN MICROWAVE ENERGY DEVICES

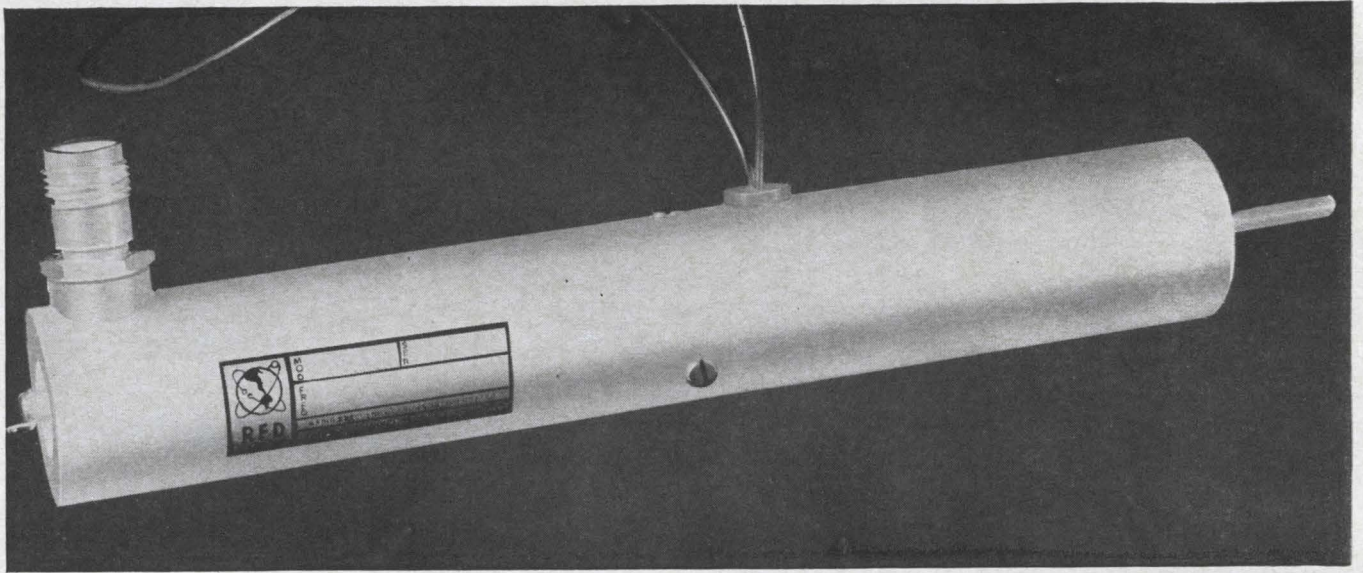

We can't help bragging about the LS 5101. Shown above in its actual dimensions, this oscillator spans the 1.0 to 2.5 gc frequency range, yet it can be precisely tuned with a single, 18-turn adjustment.

Designed for use in signal sources, frequency standards, spectrum analyzers and signal references, the LS 5101 matches wide range performance with long life (1000 hours, minimum) and maximum immunity to shock and vibration. Power output is 50 mw where $E_p = 50$ v, or 10 mw where $E_p = 10$ v . . . across the entire band. Frequency resolution is better than 20 kc, shaft concentricity is less than .005", and RFD's exclusive TEMLOC® temperature compensation assures highest order temperature stability *without* thermostat metal.

The LS 5101 reflects the advanced features and specs characteristic of the entire line of RFD oscillators, already performance-proven in L-, S-, C-, and X-Band military and space applications. Check the listing of representative RFD oscillators below. And remember, if there is no stock item matching your exact needs, we will design one—swiftly and economically.

**SINGLE CONTROL
TUNING...
OVER MORE THAN
AN OCTAVE**

**EXCEPTIONAL FEATURES AND
VERSATILITY IN AN
L-BAND CW OSCILLATOR**

RFD Model #	Frequency (GC)	Type*	Output (Minimum)		Dimensions (Less Projections)	
					Length	Diameter
LC 1301	1.710-1.770	CW	1.6	w	2 3/8"	7/8"
LC 1402	1.700-1.740	CW	10	w	3 7/8"	1 1/2"
LS 5101	1.0-2.5	CW	50	mw	6 3/8"	1"
SC 1102	2.6-3.2	CW	50	mw	3 1/8"	1"
CG 2103	3.9-4.4	CW	20	mw	3 1/8"	7/8"
CC 2101	4.0-5.0	CW	20	mw	2 1/2"	7/8"
CC 1101	5.0-6.0	CW	5	mw	2 1/2"	7/8"
CC 1102	5.0-6.0	CW	10	mw	2 1/2"	7/8"
CG 5401	5.4-5.9	GP	50	w	2"	3/4"
XC 1101	8.5-9.6	CW	3	mw	2 1/2"	7/8"

* CW = Continuous Wave GP = Grid Pulsed

(Oscillator)
Doubler: Standard
UG-30/U flange by
1" high

For additional information, please write:

RFD, INC.

(Subsidiary of Aero Geo Astro Corporation)

1501 West Cass Street • Tampa, Florida • Telephone: 253-0637

Electronics Abroad

Volume 38

Number 3

Great Britain

Computer outlook

To computer makers, Britain has long been a market that never attained its rich potential. Now there are strong signs that that potential is becoming a fact.

In mid-November there were 852 electronic computers installed in the British Isles; near the end of January the total exceeded 1,000. In November, computers on order totaled 267; this figure rose to 400 last month. In all, that's a 25% increase in just 10 weeks.

The new Labor government of Prime Minister Harold Wilson, setting the tone, has announced it will double the number of computers in government use by 1970—to 104. But that's still small beer, as the British put it, compared with the 1,700 computers available to agencies of the United States government.

Slow start. Britain moved into the computer age slowly. In computer installations she still trails West Germany and France; in dollar volume of computers she also lags behind Italy, according to Computer Consultants, Ltd., a publisher of several periodicals devoted to the computer industry.

Now she is painfully aware that she needs to increase production and exports, and that this cannot be done without making her industry more efficient [Electronics, Nov. 2, p. 119].

All of this bodes well for British computer companies.

New World ties. For U. S. companies, there are still two difficult problems to overcome: Britain's reluctance to enlarge her \$2.1 billion balance-of-payments deficit—the excess of debts abroad over credits abroad—and a growing resentment against domination of Britain's computer market by U. S. firms.

The payment gap is considered

a result of the slow pace at which British industry has modernized. Yet the obvious remedy—automation with computers—would send still more money abroad. Even British-based computer companies import many components and materials. In the first seven months of 1964, for example, Britain imported \$32 million worth of punched-card inputs for computers while export-



Sir Gordon Radley, chairman of English Electric Co. Is there a Spectra 70 in his future?

ing only \$15 million worth of input machines.

Competition. A survey last year showed that 40% of the computers in Britain were either imported from the U. S. or manufactured under license with an American company. This figure is expected to grow; of the 267 machines on order near the end of 1964, 49% were U. S. models.

One computer out of every four in Britain was supplied by the International Business Machines Corp. IBM already has received orders for nearly 200 of its System 360 machine in Britain.

But IBM ranks second in Britain, closely trailing International Com-

puters & Tabulators, Ltd., an English company with close ties to the Radio Corp. of America. ICT made about 30% of the computers in operation in Britain today, and has orders for 120 more machines valued at \$45 million.

Strong base. ICT has built a strong base in Britain. In the past few years it has acquired the computer activities of EMI Electronics, Ltd., and the data-processing business of Ferranti, Ltd. ICT has 20,000 employees.

The British company sells the RCA 301 computer, named the ICT 1500. ICT isn't likely to add RCA's Spectra 70 line, however; as its reply to the System 360, the British concern has introduced its 1900 series of modular machines. The 1900 is a modification of the FP 6000, developed by Ferranti-Packard Electric, Ltd.

ICT also sells the Univac 1004 in Britain. Univac is made by the Sperry Rand Corp.

Outlet for RCA. If RCA invades Britain with its Spectra 70, it will probably be through English Electric Leo Marconi Computers, Ltd., a subsidiary of the English Electric Co. English Electric manufactures the RCA 501 and sells it under the designation KDP 10. English Electric's own principal computers are the small KDN 2, for industrial control, and the Myriad, a unit smaller than a desk.

Through the Marconi Co., another subsidiary, English Electric has also been developing integrated-circuit computers.

Elliott-Automation, Ltd., has a working arrangement with the National Cash Register Co. in the U. S. NCR exploits the data-processing applications for which Elliott makes the machines. Elliott has been successful with a small machine, the 803, and is now offering a larger, faster version.

The only other major British producer is Ferranti, which now concentrates on process control.

Other British companies supply

U.S. machines. Associated Electrical Industries, Ltd., sells the General Electric Co.'s process-control computers and Machines Bull, Ltd., offers GE data systems.

Surcharge may cease. For the other U.S. companies active in Britain, there's also the tariff problem. Britain has long maintained a 16% tariff on computers; recently the Labor government added a 15% surcharge that is expected to be lifted early in the summer.

Besides those mentioned, major U.S. computer companies active in Britain include Honeywell, Inc., the Burroughs Corp., Packard-Bell Electronics Corp. and Litton Industries, Inc.

Electronics in court

Since 1949, the Western Electric Co. has collected \$4.2 million in royalties from British users of its basic transistor patent. That income is now ended.

The High Court of Justice has refused to renew Western Electric's patent. The verdict, handed down Jan. 11, is beyond the reach of any appeal. However, Western Electric still holds patent rights to significant improvements to the transistor. The company will continue to receive royalties on these later patents, which include devices such as alloy-junction transistors, silicon planar epitaxial transistors and widely used transistor circuits.

Western Electric is the manufacturing arm of the American Telephone and Telegraph Co. The transistor was invented in 1948 by three physicists—John Bardeen, Walter Brattain and William Shockley—at AT&T's research facility, the Bell Telephone Laboratories.

Industry cheers. Britain's electronics industry is jubilant. The savings won't be great—about 0.2% on a transistor for a radio—but the English cheer any loosening of United States control of British industry.

G. O. Stanley, chairman of Pye of Cambridge, Ltd., adds: "It appears unlikely that remaining patents on transistor applications will

be extended at the end of their normal term" of 16 years.

Pye led a 12-company group in the court fight against Western Electric. The British concerns were joined by the Scientific Instrument Makers Association and by International Computers & Tabulators, Ltd., Britain's largest manufacturer of computers.

Rights in U. S. AT&T's revenues from its basic transistor patent in the U. S. ended nine years ago. In a consent decree in a government antitrust suit, on Jan. 24, 1956, the company made all existing patents up to that date available to applicants without any royalty. Later patents must be made available for a "reasonable" fee.

The U. S. court made this concession to the world's biggest corporation: any company that demands a license from AT&T must in turn offer use of its own patents in the communication field.

High price of research. Western Electric told the British court that research and development on the basic transistor cost \$420,000 up to the time of application for the patent. But as transistors became successful, and as new applications were found, the company said it spent about \$168 million in subsequent R&D, half of it since 1961.

The court had to decide, basically, whether the royalties were fair in terms of the company's investment. The answer was "Yes."

Hong Kong

One up, one down

Transistor-plant tally: add one factory, scratch one prospect.

Microelectronics, Ltd., was founded by Frank Yih, who developed a low-cost method of packaging in epoxy when he worked for the Fairchild Camera & Instrument Corp. When he formed his own plant, Yih took along five technicians from Semiconductor, Ltd., Fairchild's subsidiary in Hong Kong.

Yih, a graduate of the Massachu-

setts Institute of Technology, has his hands full competing with Fairchild. He's probably happy that another big potential rival, the Hughes Aircraft Corp., has canceled plans to manufacture semiconductors in Hong Kong.

Show biz. Like Semiconductor, Ltd., Yih's company will concentrate on components for the entertainment field. The new company's line consists almost entirely of silicon devices; Fairchild is gradually replacing its germanium semiconductors with silicon units. Yih says Japanese companies are still new in the silicon field and have not yet mastered modern production techniques.

Yih's plant occupies 23,000 square feet on the two top floors of a six-story building. There 60 employees are producing 10,000 components a month. By midsummer, when 150 workers are expected to turn out half a million units a month, Yih plans to occupy the entire building.

So far the new company has spent \$500,000, obtained entirely from local businessmen of Chinese descent. It will take that much again to bring the plant to full capacity, Yih figures.

Higher pay. By Hong Kong standards, Yih pays well—\$7 to \$8 a week compared with an average of \$6.50 for factory workers.

Microelectronics, Ltd., has imported 10 lead-bonding machines and eight diffusion furnaces from the United States. Eight more furnaces are on order. Yih says he has four major U.S. suppliers of diffused chips. All wire, screws, nuts and other parts are imported from the U.S.

Fairchild employs 1,500 girls. The company imports wafers from the U.S. and fabricates them into resin-seal transistors. The Hong Kong subsidiary is building a modern 11-story factory and plans to increase its output.

U. S. firms' activity. Hong Kong is attracting an increasing number of U.S. concerns.

Ferrotec, Ltd., a subsidiary of the Ampex Corp., manufactures core arrays for computers. The Oak Electro-Netics Corp. has moved its

television tuner operation from Japan to a 45,000-square-foot factory in Hong Kong that is expected to cost \$1 million by the time it's finished at the end of 1965.

Japan

More expansion seen

Among the world's advanced countries, Japan's economic growth last year was the highest, 12.5%. The electronics industry's climb was 16.5%, compared with 10.3% for electronics in the United States.

This year Eisaku Sato, the new premier, is worried about inflation, mounting inventories and a rise in bankruptcies. He wants to hold total growth to 8% over 1964. Still, electronics output will rise 14.5%, according to the Electronic Industries Association of Japan. The U.S. electronics industry, in contrast, is expected to expand only 2.13% [Electronics, Jan. 11, p. 88].

If the forecasts hold true, Japan's electronics production would climb to \$2.55 billion, or 14.48% of the U.S. total of \$17.6 billion. Last year, Japanese electronics output was \$2.22 billion, or 12.9% of the \$17.2 billion in the U.S.

Concern about consumers. Sato seems particularly concerned about consumer electronics, which comprises 42.5% of the Japanese industry. That's why the association bases its 1965 estimate for that category on demand instead of production. It hopes this will discourage overproduction and subsequent price-cutting.

The biggest consumer item is expected to be television, with production valued at \$500 million, up 7% from last year. Fewer sets will be sold, but they'll be bigger and more expensive; 100,000 of them will be color, accounting for sales of \$39 million. Exports will continue to rise, to \$1.2 million from \$900,000 last year.

The number of radios produced will increase 11%, but sales will be up 15%; the difference is due to an increase in f-m receivers and in the

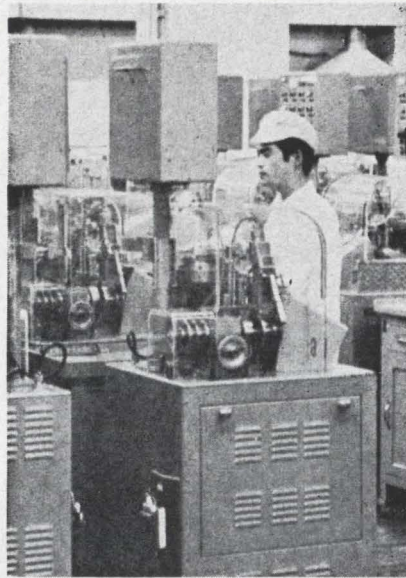

Dice-handling machines are used in producing germanium transistors at Tokyo Shibaura Electric Co.

quality of radios exported.

Other big boosts in consumer electronics this year: tape recorders, up 31% to \$158 million; radio-phonographs, up 22% to \$110 million.

Computer gain. In industrial electronics, the largest gains will be in digital computers. Domestic output is expected to climb 25% to \$83.3 million, exceeding imports (\$56 million) for the first time.

Process-control equipment is expected to register only a 6% gain, to \$103 million, after last year's phenomenal 83% climb. One reason for the slowdown in expansion is overcapacity in production facilities for many synthetic fibers.

Testing and measuring equipment will rise 10% to \$54 million in sales.

Communications. Traditional communications will rise 12% to \$67 million. But other wireless equipment—radar, sonar, loran—will score a 17% gain to \$37 million. Both kinds of communications gear are finding increasing use in shipbuilding, broadcasting, and in commercial vehicles such as taxis.

Production of telephone and telegraph equipment is expected to rise 18% to \$360 million. For the first time, this category includes data-transmission gear, still only a \$14 million industry but expected to grow rapidly.

Africa

New tv networks

While politics is delaying the arrival of television in South Africa [Electronics, Jan. 11, p. 209], two North African countries, Algeria and Morocco, have ambitious plans that could result in new markets for electronics companies.

Algeria is seeking bids for an entire system to replace her 10-year-old tv network. The system would cost about \$7 million, and include a 625-line scanning setup with f-m sound, also seven or eight microwave relay stations between Algiers, Oran and Constantine along the Mediterranean coast.

U.S.-French rivalry. The Socialist government of President Ahmed Ben Bella has opened the bidding to all comers. Besides French companies, at least one United States concern—the Radio Corp. of America—is anxious to do more business with Algeria.

The new country's 25,000 tv receivers are now served by the 625-line system that's standard for all of North Africa including the United Arab Republic. Thirteen African countries have tv so far. In all of Africa, tv is government-owned.

Bound for Morocco. Morocco began using a new 10-kilowatt transmitter Oct. 28 to serve the Casablanca area. The equipment, made by the Compagnie Générale de Télégraphie Sans Fil (CSF) in France, replaces a one-kilowatt transmitter that has been put on standby service.

A microwave network is being completed by CSF between Tangier, at the Straits of Gibraltar, and Rabat, 200 miles down the Atlantic coast. Casablanca is already linked with Marrakech, 150 miles to the south, by an Italian-built microwave system. In the rest of the country north of the Atlas Mountains, rebroadcast transmitters are used. When these improvements are made, Morocco hopes to expand ownership of tv sets far beyond the present 16,000.

Enter Eurovision. Eurovision is al-



Model CS-151

GYRO TORQUER SUPPLY

- Ultra Precision Current Source
- DC and/or AC
- Programmable
- All Silicon/Solid State

For testing and measurement of gyro torquers, zener, reference diodes, magnetic components, other current sensitive devices.

- Superior performance at low currents
- Current Range is 0.1 μ a to 10 ma
- Regulation 0.0005%
- Resolution 1 part per million
- Stability 10 parts per million

In use by leading companies for gyro torquer supply, component reliability testing, calibration, reference zener testing.

Also available Model CS-152 with a current range of 0.1 μ a to 150 ma.



NORTH HILLS
ELECTRONICS, INCORPORATED
GLEN COVE, L. I., N. Y. ORiole 1-5700

Circle 221 on reader service card

60 cps Precision SERVO REPEATER

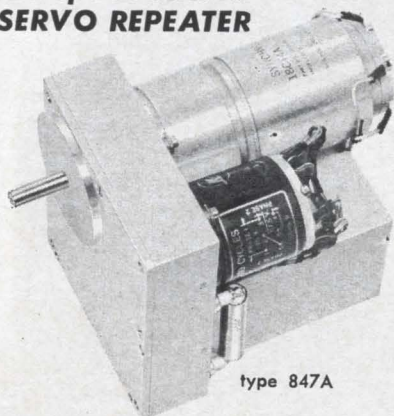

type 847A

- Follows 60 cps, 3-wire synchro data
- Power required, 117V, 60 cps
- Solid state, modular package
- 400 cps models available

WRITE FOR CATALOG

Catalog lists off-the-shelf availability of servo amplifiers, packaged servo systems, and servo testers



ICo INDUSTRIAL CONTROL COMPANY
CENTRAL AVENUE AT PINELAWN
FARMINGDALE, L. I., N. Y. • MYRTLE 4-3002

ready received in North Africa. A link runs from a station at Perpignan, near the French-Spanish border, to Mallorca in the Mediterranean. The signal is then relayed to Algeria. Another link is planned, across the Straits of Gibraltar.

Tunisia's government has asked the United States for funds to build a tv station, but so far there has been no commitment. Tunisian tv now consists of a broadcast transmitter that picks up Italian telecasts and sends them to the handful of sets in the Tunis area.

Senegal is getting educational tv. The United Nations Educational, Scientific and Cultural Organization (Unesco) is supplying two vidicon cameras and a small videotape recorder for the half-kilowatt station in Dakar.

Made in Britain. Farther south, the only other French-speaking countries that have tv are Dahomey, the Ivory Coast and the Republic of the Congo. At Brazzaville, the Congo—adjacent to the strife-torn, Belgian-speaking country of the same name—operates a half-kilowatt system made by Pye Telecommunications, Ltd., in Britain. Pye also has sold stations to Liberia and Sierra Leone, English-speaking countries on Africa's west coast.

Elsewhere in Africa, Nigeria has four tv transmitters, three made by RCA and one by Marconi Instruments, Ltd., of Britain. These serve different provinces with different programs. There are also stations in the Sudan, Kenya and Southern Rhodesia.

The computer age

Computers also are making inroads in Africa, as shown by recent IBM installations.

The Nigerian Railroad has the first computer—an IBM 1401—to be programmed and run entirely by black Africans, according to the International Business Machines Corp. It's used for accounting, inventory control, maintenance control and similar tasks.

IBM also has installed electronic data-processing facilities at Ethiopian Airlines and South African Airlines, the Development Bank of Senegal in Dakar, and at the Bank

of Ghana in Accra, the capital.

At the Liberian-American-Swedish Mining Co. in Liberia, data is transmitted and processed at Port Buchanan by an IBM 1401 from an ore mill 200 miles inland.

West Germany

Cairo calling

A new wave of German engineers is heading for the United Arab Republic. This group is largely American-trained, younger and apparently better educated in modern technology than earlier arrivals from the Federal Republic.

Israel, whose destruction is the UAR's avowed aim, has been protesting to Bonn about West German engineers flocking to Cairo to work in rocketry, aviation and electronics. As a result of talks between Bonn and Tel Aviv, about 120 engineers returned to Germany from Egypt late in 1964 [Electronics, Nov. 30, p. 111].

Fighter's phase-out. Early this year, Litton Industries, Inc., dismissed many engineers at its German subsidiaries. Bonn had curtailed production of F-104 Starfighters and seemed uncertain about future weapons systems. Production of the LN-3, Litton's inertial navigation system for the fighter plane, was nearly completed.

Egyptian agents quickly sought out the jobless engineers. They offered them three- to five-year contracts at \$900 a month and more, double the going rate in West Germany. By the end of January, 60 Germans had accepted. Most of the German engineers had worked on the navigation system at Litton's plant in Freiburg in Breisgau. Some had received special training at Litton's headquarters in Beverly Hills, Calif. About a dozen others now in Egypt had worked on airframes for the F-104 in Bavarian plants.

Capital comment. The West German government has been told by its Cairo Embassy that it's practically impossible to contact Ger-

man engineers who are employed by Egypt. A Bonn spokesman says it's doubtful that the government can do anything about the departures.

United States Embassy officials in Bonn, who had discussed the situation openly a few weeks ago, are now answering questions with "No comment."

France

Europa's plight

Serious doubt has arisen whether Europa I, a proposed six-nation satellite project, will ever get off the ground. The reason, in a word, is money.

In 1962, when the European Launcher Development Organization was formed, Europa's cost was put at \$200 million [Electronics, Nov. 30, p. 112]. Now the figure has skyrocketed to about \$400 million.

At two recent meetings in Paris, the six countries—Belgium, Britain, France, Italy, the Netherlands and West Germany—discussed Europa's future. It may be significant that no communiqué was issued when the delegates went home. There are reports that technological changes are still being considered.

Born in Britain. Europa was born in Britain. When her Blue Streak rocket failed to gain acceptance in the Western military establishment, Britain proposed using it to launch an all-European satellite. The participants agreed to use the Blue Streak for the first stage. France is working on the second stage and West Germany on the third. Italy is developing several experimental satellites, and the Belgians and Dutch are in charge of the electronic systems.

Some members of the group, notably France, believe that Europa, if it's to be continued at all, should be made more sophisticated. But some smaller countries, already alarmed at the swelling cost, are questioning the wisdom of creating an all-European system when adequate launchers can be bought more cheaply in the United States.

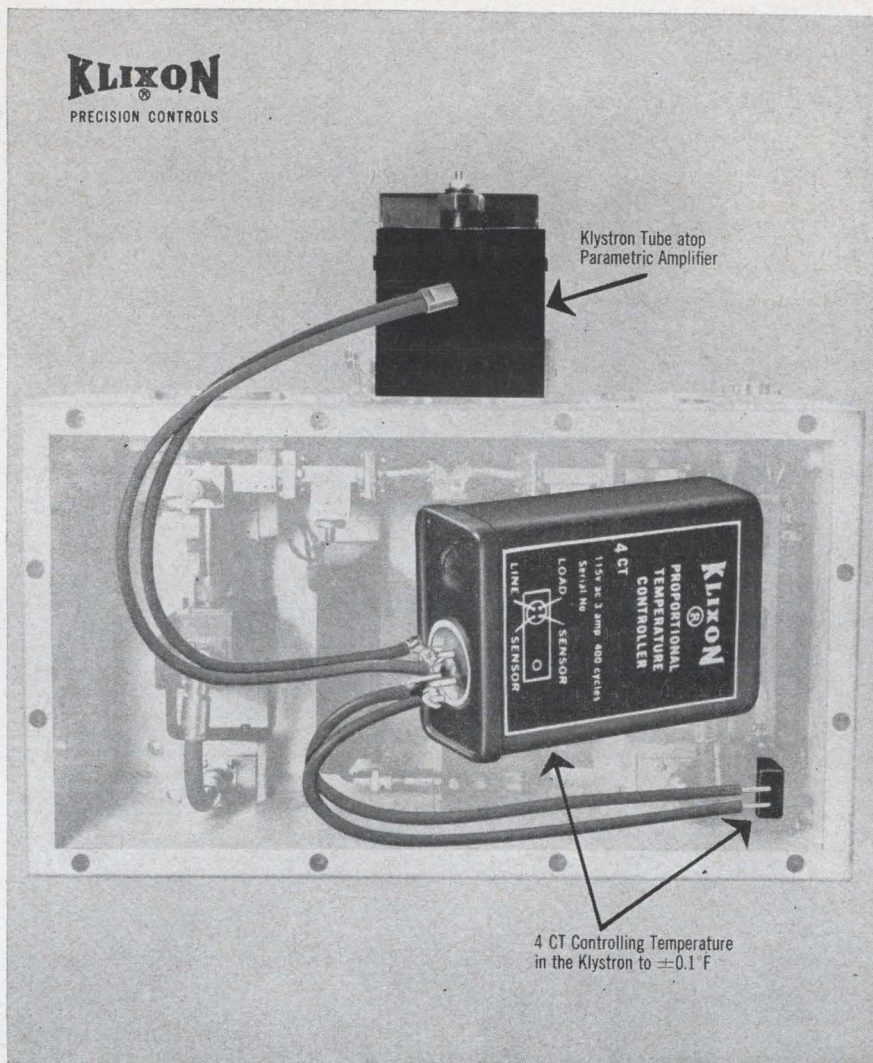

**When the demand
is for $\pm 0.1^\circ\text{F}$ accuracy...**

RELY ON T¹ FOR TEMPERATURE CONTROL

No other device so small can match the performance of the new KLIXON® 4CT Solid State Proportional Temperature Controller in electronic systems that demand stabilized temperatures.

This 70-gram package utilizes a magnetic amplifier and a silicon controlled rectifier to supply proportionally controlled power from zero to maximum output of 350 watts at 150°F. A thermistor sensor (surface element or immersion probe) provides the control signal. Since there are no moving parts, reliability is high. In fact, the 4CT passes all applicable environmental tests of MIL STD 202. For example: 20G vibration, 100G shock, 50G acceleration.

Adjustable over 75°F, this rugged controller is available with 3 amp capacity for 60 cycle or 400 cycle, 115 v-ac circuits. Calibration range is -65°F to 600°F . Response time is within one cycle of line frequency. For complete information about the KLIXON 4CT Proportional Temperature Controller, write for Bulletin PRET-10. We'll also send you the "Tunnel of Horrors" booklet telling how we test our EHR (extra high reliability) thermostats.



METALS & CONTROLS INC.
5002 FOREST ST., ATTLEBORO, MASS.
A CORPORATE DIVISION OF
TEXAS INSTRUMENTS
INCORPORATED



Investment Opportunity

The skills he's learning today he will someday put to use for you.

But it is going to take a substantial investment before the strides he takes will be sure and swift and strong. An investment of time, of love, of money and thought.

You have a stake in that investment.

You can protect it by joining with other leading American businessmen to promote the Treasury's Payroll Savings Plan for U. S. Savings Bonds. The Treasury Department's Plan encourages habits of prudence and diligence and responsibility that are

the most valuable currency of a free society and a free economy.

When you bring the Payroll Savings Plan into your plant—*when you encourage your employees to enroll*—you are investing in the skills of tomorrow's workers. In the energy and ability of youth that is our real wealth. You are investing in America's future. In freedom itself.

Don't pass this investment opportunity by. Call your State Savings Bonds Director. Or write today to the Treasury Department, U. S. Savings Bonds Division, Washington, D. C. 20226.



in your plant...promote the PAYROLL SAVINGS PLAN for U.S. SAVINGS BONDS



Electronics advertisers

February 8, 1965



■ AMP Incorporated Garceau, Hargrave & McCullough	36	■ Globe Industries Inc. Odiorne Industrial Adv. Inc.	125	■ RFD, Inc.	148
■ Acton Laboratories Inc. Engineering Writers	114	■ Gudebrod Bros. Silk Co. Inc. Lee Ramsdell & Co. Inc.	22, 23	■ Radiation Inc. G.M. Basford Company	92
■ Ad-Yu Electronics P & G Advertising Agency	138	■ Hamlin Inc. Keck Advertising Inc.	132	■ Radio Corporation of America Al Paul Lefton Company	4th Cover
■ Alden Electronics Larcom Randall Advertising Inc.	143	■ Hewlett-Packard Company Lennen & Newell Inc.	1	■ Radio Frequency Laboratories Inc. J.A. Brady & Company	104
■ Alfax Papers Larcom Randall Advertising Inc.	143	■ Hitachi Ltd. Dentsu Advertising Ltd.	21	■ Radio Materials Co. Div. of P.R. Mallory Co. Inc. Rosenbloom/Elias Associates Inc.	123
■ American Photocopy Equipment Co. Rosenbloom/Elias & Associates Inc.	87, 88, 89	■ Honeywell Semiconductor Products Div. Neals & Hickok Inc.	50	■ Rohde & Schwarz Inc. Armand Richards Advertising Agency	40
■ Bausch & Lomb Inc. Wolff Associates Inc.	115	■ Hughes Aircraft Company Foote, Cone & Belding Inc.	139	■ Shizuki Electrical Mfg. Co. New Asia Trading News Agency Ltd.	144
■ Bendix Semiconductor Products MacManus, John & Adams Inc.	9	■ IEEE Raymond Schoonover Adv.	137	■ Singer Company Metrics Division Hepler and Gibeny Inc.	31
■ Boonton, Div. of Hewlett-Packard Co. George Homer Martin Associates	2	■ Ichizuka Optical Co. Ltd Matsushita Inc.	133	■ Spectrum Instruments Inc. Chelsea Advertising Inc.	125
■ Bourns Inc. Allen, Dorsey & Hatfield Inc.	29, 45	■ Industrial Control Company Connolly Associates Inc.	152	■ Sperry Semiconductor, Div. of Sperry Rand Corporation Armand Richards Advertising Agency	41
■ Brush Instruments Div. of Clevite Corp. Carr Liggett Adv. Inc.	3rd Cover	■ Industrial Transformer Corporation ITT Wire & Cable Division West, Weir & Bartel Inc.	108 33	■ Sprague Electric Company The Harry P. Bridge Co.	5, 6, 10
■ Bulova Watch Co., Electronics Division Carpenter, Matthews & Stewart Inc.	127	■ Janitor Aero Division of Midland-Ross Corporation Odiorne Industrial Advertising	135	■ Syntronic Instruments Inc. Burton Browne Advertising	130
■ CTS Corporation Burton Browne Advertising	109	■ Janus Control Corporation L.K. Frank Co. Inc.	112	■ Tektronix Inc. Hugh Dwight Adv. Inc.	49
■ Chicago Dynamics Industries Inc. Burton Browne Advertising	44	■ LEL, Incorporated Snow & Depew Advertising	126	■ Telonic Engineering Company Jansen Associates	125
■ Christie Electric Corp. Len Wolff Co. Advertising	124	■ Lapp Insulator Company Inc. Wolff Associates Inc.	129	■ Telrex Laboratories George Homer Martin Associates	140
■ Clairex Corporation Michel Cather Inc.	137	■ Les of America Corporation Zam & Kirshner Inc.	132	■ Texas Instruments Incorporated Industrial Products Group Robinson-Gerrard Inc.	106, 107
■ Clare & Company, C. P. Reincke, Meyer & Finn Adv.	46, 47	■ Ling-Temco-Vought Inc. Wyatt, Dunagan & Williams Inc.	12, 13	■ Texas Instruments Incorporated Metals & Controls Inc. Horton, Church & Goff Inc.	153
■ Colorado, State Of Buchen Advertising Inc.	99	■ M C B Dumesnil Publicite	102	■ Thompson Ramo Wooldridge Company Fuller & Smith & Ross Inc.	43
■ Cominco Products Inc. McKim Productions Limited	140	■ Marchlett Laboratories Inc. The Fuller & Smith & Ross Inc.	8	■ Triplett Electrical Instrument Company Burton Browne Advertising	51
■ Controls Company of America The Harry P. Bridge Company	35	■ Magnetic Shield Div. of Perfection Mica Company Burton Browne Advertising	121	■ Trygon Electronics Carpenter, Matthews & Stewart Inc.	105
■ Damon Engineering Inc. L.K. Frank Co., Inc.	122	■ Mallory & Company, Inc. P.R. The Aitkin-Kynett Company	117	■ Trylon Inc. George Moll Adv. Inc.	121
■ Delta Design Inc. Barnes Chase Advertising	128	■ Markel & Sons, L. Frank George Moll Advertising Inc.	114	■ United Transformer Corporation Philip Stogel Company Inc.	2nd Cover
■ Di-Acro Corporation Charles E. Brown Advertising	98	■ Master Index Services Inc. The Powerad Company	136	■ Vulcan Electric Company Reynolds & Foster Inc.	132
■ Dixon Inc. Gail Advertising Company	134	■ McGraw-Hill Book Co. Inc.	141	■ West Penn Power Company Fuller & Smith & Ross Inc.	100
■ DuPont De Nemours & Co. Inc. E.I. Batten, Barton, Durstine & Osborn Inc.	39	■ Millen Mfg. Co. Inc. James	120	■ Winchester Electronics Div. of Litton Industries West, Weir & Bartel Inc.	48
■ Dynage Inc. F.W. Prella Advertising	142	■ Minnesota Mining & Mfg. Co. Scotchbar Division Klau-Van Pietersom-Dunlap Inc.	110, 111	■ Yutaka Electric Mfg. Co., Ltd. Nichiden Adv. Ltd.	133
■ Eagle Signal Division of E.W. Bliss Company Feeley Advertising Agency Inc.	90, 91	■ Motorola Semiconductor Products Inc. Lane and Bird Advertising Inc.	11		
■ Electronic Engineering Co. of California Barnes Chase Advertising	42	■ North Atlantic Industries Inc. Murray Heyert Associates	97		
■ Emerson & Cuming Inc.	142	■ North Hill Electronics Inc. N.S. Advertising	152		
■ Exact Electronics Inc. Format	118	■ Norton Associates J.J. Coppo Co. Inc.	144		
■ Fairchild, Electro-Metrics Corp. Herbert Lindauer Associates	101	■ Pacific Electro Magnetics Co. Inc. Sturges and Associates	113		
■ Fairchild Semiconductor Corp. Johnson & Lewis Inc.	14	■ Paine, Weber, Jackson & Curtis Doremus & Company	156		
■ Fiberfil Inc. Tri-State Advertising Co. Inc.	108	■ Phelps Dodge Electronic Products Corp. Smith, Dorian & Burman Inc.	52		
■ Florida Development Commission Alfred L. Lino & Associates Inc.	119	■ Potter & Brumfield Div. of American Machine & Foundry Co. Grant, Schwenck & Baker Inc.	16		
■ General Magnetics Inc. George Homer Martin Associates	19, 20	■ Precision Tube Company Inc. George Moll Advertising Inc.	147		
■ General Radio Company K.E. Morang Co.	2nd Cover	■ Princeton Applied Research Corp. Mort Barish Associates	24		
■ Geniscope Technology Corporation Getz and Sandborg Inc.	124, 131	■ Qualtronic Corporation Hal Lawrence Inc.	130		

■ For more information on complete product line see advertisement in the latest Electronics Buyers' Guide

Classified advertising

F.J. Eberle, Business Mgr. Employment Opportunities Equipment (Used or Surplus New) For Sale	145 146
--	------------

Classified advertisers index

■ A & A Electronics Corp.	146
■ Atomic Personnel Inc.	145
■ Edmund Scientific Co.	146
■ Engineering Associates hp Associates,	146
■ Affiliate of Hewlett-Packard Kahn and Co., Inc.	146
■ Lifschultz Fast Freight Radio Research Instrument Co.	146
■ Ruland Manufacturing Co. Semiconductor Sales of Calif.	146
■ Universal Relay Corp.	146

Executive, editorial, circulation and advertising offices: McGraw-Hill Building, 330 West 42nd Street, New York, N.Y., 10036. Telephone Area Code 212-971-3333. Teletype TWX N.Y. 212-640-4646. Cable: McGrawhill, N.Y. Officers of the Publications Division: Shelton Fisher, President; Vice Presidents: Joseph H. Allen, Operations; Robert F. Boger, Administration; John R. Callahan, Editorial; Ervin E. DeGraff, Circulation; Donald C. McGraw, Jr., Advertising Sales; Angelo R. Venezian, Marketing. Officers of the Corporation: Donald C. McGraw, President; Hugh J. Kelly, Harry L. Waddell, L. Keith Goodrich, Executive Vice Presidents; John L. McGraw, Treasurer; John J. Cooke, Vice President and Secretary. Title R registered U.S. Patent Office; © copyright 1964 by McGraw-Hill, Inc. All rights reserved, including the right to reproduce the contents of this publication, in whole or in part.

This secondary offering of Common Stock is being sold by a group of investment dealers, including the undersigned. The offering is made only by means of the official Prospectus.



▶ 350,000 Shares

George A. Philbrick Researches, Inc.

▶ Common Stock

\$1.00 Par Value

Price \$16.50 per Share

You are invited to ask for a Prospectus describing these shares and the Company's business. Any of the undersigned, including the undersigned, who can legally offer these shares in compliance with the securities laws of your State will be glad to give you a copy.

Paine, Webber, Jackson & Curtis

Glore, Forgan & Co. Goldman, Sachs & Co. Hornblower & Weeks-Hemphill, Noyes

Stone & Webster Securities Corporation

White, Weld & Co.

American Securities Corporation

Clark, Dodge & Co.

Dominick & Dominick,

Francis I. duPont, A. C. Allyn, Inc.

Estabrook & Co.

Goodbody & Co.

Hayden, Stone

E. F. Hutton & Company Inc.

W. E. Hutton & Co.

W. C. Langley & Co.

Lee Higginson Corporation

F. S. Moseley & Co.

L. F. Rothschild & Co.

Shearson, Hammill & Co.

Tucker, Anthony & R. L. Day

G. H. Walker & Co.

January 28, 1965.

Circle 156 on reader service card

"Order Your Editorial Reprints From Electronics Now In Time For the IEEE Show!"

Editorial reprints of technical articles from Electronics, carrying your companies merchandising message will make ideal handouts at the IEEE show.

Any article in this issue, or past issues of Electronics can be reprinted along with your companies message at your request. For complete information on price and delivery write to: Electronics, Reprint Department, 330 West 42nd Street, New York, N.Y. 10036. Telephone: Area code 212 971-3140.

Advertising sales staff

Gordon Jones [212] 971-2210
Advertising sales manager

Atlanta, Ga. 30309: Gus H. Krimsier,
Michael H. Miller, 1375 Peachtree St. N.E.,
[404] TR 5-0523

Boston, Mass. 02116: William S. Hodgkinson
McGraw-Hill Building, Copley Square,
[617] CO 2-1160

Chicago, Ill. 60611: Robert M. Denmead,
Daniel E. Shea, Jr., 645 North Michigan
Avenue, [312] MO 4-5800

Cleveland, Ohio 44113: Paul T. Fegley, 55
Public Square, [216] SU 1-7000

Dallas, Texas 75201: Richard P. Poole, The
Vaughn Building, 1712 Commerce Street,
[214] RI 7-9721

Denver, Colo. 80202: John W. Patten, David
M. Watson, Tower Bldg., 1700 Broadway,
[303] AL 5-2981

Houston, Texas 77025: Kenneth George,
Prudential Bldg., Halcombe Blvd.,
[713] RI 8-1280

Los Angeles, Calif. 90017: Ashley P.
Hartman, John G. Zisch, 1125 W. 6th St.,
[213] HU 2-5450

New York, N.Y. 10036:
Donald R. Furth [212] 971-3615
Frank LeBeau [212] 971-3615
George F. Werner [212] 971-3615
500 Fifth Avenue

Philadelphia, Pa. 19103: William J. Boyle,
Warren H. Gardner, 6 Penn Center Plaza,
[215] LO 8-6161

San Francisco, Calif. 94111:
James T. Hauptli, 255 California Street,
[415] DO 2-4600

London W1: Edward E. Schirmer, 34 Dover
Street, Hyde Park 1451

Frankfurt/Main: Gerd Hinske, 85
Westendstrasse Phone: 77 26 65 and
77 30 59

Geneva: Michael R. Zeynel,
2 Place du Port 244275

Paris VIII: Denis Jacob, 17 Avenue
Maignon ALMA-0452

Tokyo: Nobuyuki Sato
Shiba, Minato-ku (502) 0656

Osaka: Kazutaka, Miura, 163, Umegae-cho,
Kilta-ku [362] 8771

Nagoya: International Media Representatives,
Yamagishi Bldg., 13, 2-Chome,
Oike-cho Naka-ku

Hugh J. Quinn: [212] 971-2335
Manager Electronics Buyers' Guide

David M. Tempest: [212] 971-3139
Promotion manager

Milton Drake: [212] 971-3485
Market research manager

Richard J. Tomlinson: [212] 971-3191
Business manager

Theodore R. Geipel: [212] 971-2044
Production manager

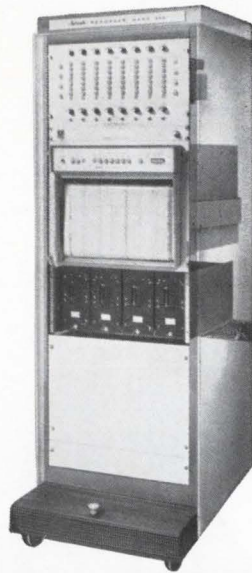

This is the Brush Mark 200, Series 1707



...and so is this



...and so is this

It's the only custom-built recorder that's standard

*Your choice of combinations is almost infinite . . . with this new generation of the pace-setting Mark 200. Now you can eliminate "special" engineering time and costs. You specify *your* recording requirements. Then Brush quickly meets them with the perfect combination of off-the-shelf modular sub-systems. What's off-the-shelf at Brush . . . isn't even on the drawing board elsewhere. All the electronics are solid state.*

Take your choice of penmotors: two channel 40 mm; high resolution 80 mm; eight channel "yes-no" event markers (all on one recorder . . . in any combination . . . on the same chart . . . on a common time base!)

Take your choice of oscillographs: vertical, pull-out horizontal or wide-view horizontal.

Take your choice of 32 different preamplifiers.

And you're way ahead with Brush innovations that set new standards in oscillography. A contactless super sensor called Metrisite . . . "polices" pen position to assure better than 1/2% accuracy. Useful frequency response to 200 cps. True rectilinear motion. Pressurized inking produces traces so crisp and accurate you can't misread the signal. All this with over 10,000 channels of field performance! A new booklet has the complete story on the Mark 200, Series 1707. Write for it. Brush Instruments, 37th & Perkins, Cleveland, Ohio 44114.

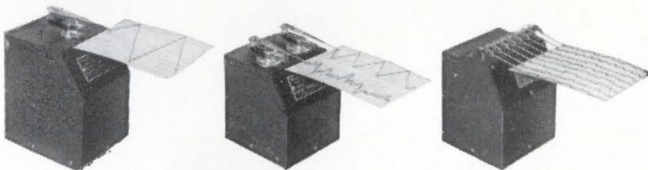

brush **CLEVITE**
INSTRUMENTS DIVISION

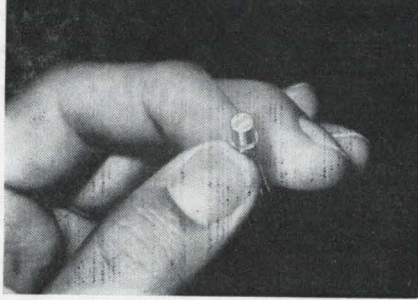

RCA 2N2857 high-frequency, low noise amplifier
 100% tested for gain and noise figure
 Designed for critical aerospace/military applications

Only 4 db NF

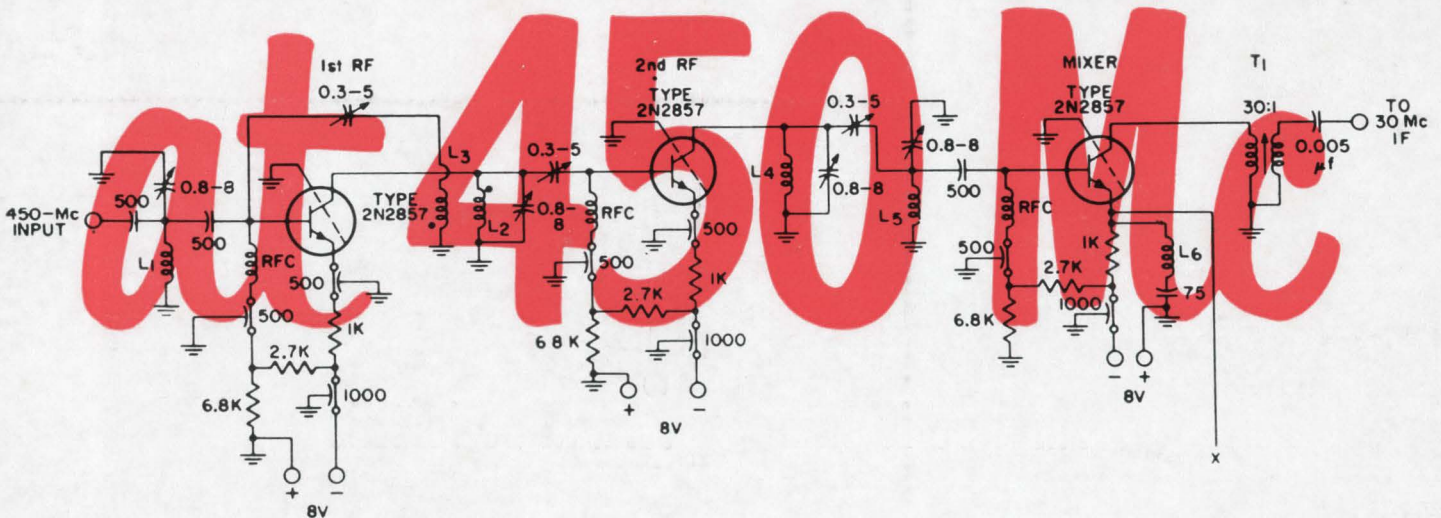

RF amplifier and mixer stages of a 450-Mc UHF communications receiver using the new RCA 2N2857 low-noise transistors

The low-noise RCA 2N2857 uses a unique miniature structure to achieve these outstanding characteristics:

- **Extremely Low Noise Figure (NF)**... 4 db typical in 450 Mc common-emitter RF amplifier
- **High Gain**... 14 db typical at 450 Mc in neutralized 20 Mc bandwidth amplifier
- **Excellent 450-Mc Mixer Performance**... NF = 7.5 db, Gain = 15 db (typical)
- **Excellent UHF Oscillator Performance**... Power Output = 40 mw typical at 500 Mc, 20 mw typical at 1 Gc
- **Maximum Ratings**... $V_{CB0} = 30$ V, $V_{CE0} = 15$ V, $P_T = 200$ mw at 25°C free air

- **Gain-Bandwidth Product** = 1200 Mc Typical

Every RCA 2N2857 is tested for maximum noise figure and minimum power gain @ 450 Mc as a part of the extensive test procedures developed to assure high reliability. Specified 2N2857 values are based on ½-inch leads. With shorter leads, gain can be improved as much as 1.5 db and noise figure as much as 0.25 db.

RCA also offers new 2N3600 npn silicon planar epitaxial transistors intended specifically for applications to 200 Mc. Here are some of the features:

- 200 Mc Wideband RF Amplifier... 17 db min, gain (neutralized common-emitter)

- NF = 4.5 db max at 200 Mc, $I_C = 1.5$ ma
- NF = 3.0 db typ. at 60 Mc, $I_C = 1$ ma
- Maximum Ratings... $V_{CB0} = 30$ V, $V_{CE0} = 15$ V, $V_{EB0} = 3$ V
- Gain-Bandwidth Product... 850 Mc min

Also available from RCA: 2N917 and 2N918
 Call your RCA Representative today for complete information on these outstanding RCA transistors. For special versions to meet particular reliability requirements or environmental conditions ask for a quotation. For further technical data, write: RCA Commercial Engineering, Section CN-22, Harrison, N. J.

AVAILABLE THROUGH YOUR RCA DISTRIBUTOR



RCA Electronic Components and Devices, Harrison, N. J.

The Most Trusted Name in Electronics

Circle 902 on reader service card