

w/c 10/15/71

NOV 1-1966

NO LONGER

Electronics

- Low-pass filters that chop rfi: page 58
- Computer with a 2½ D memory: page 83
- Other side of the recruiting coin: page 100

v.39
#22

October 31, 1966

75 cents

A McGraw-Hill Publication

Below: New instrument applies correlation to medicine, page 75



UNIV OF TENN
MOONEY NEW LIBRY
62 S DUNLAP BOX
MEMPHIS 3 TENN

For Fast Sorting, Incoming Inspection, and Production-Line Testing

NOV 1 - 1966



CURRENT SHELF

R

L

C

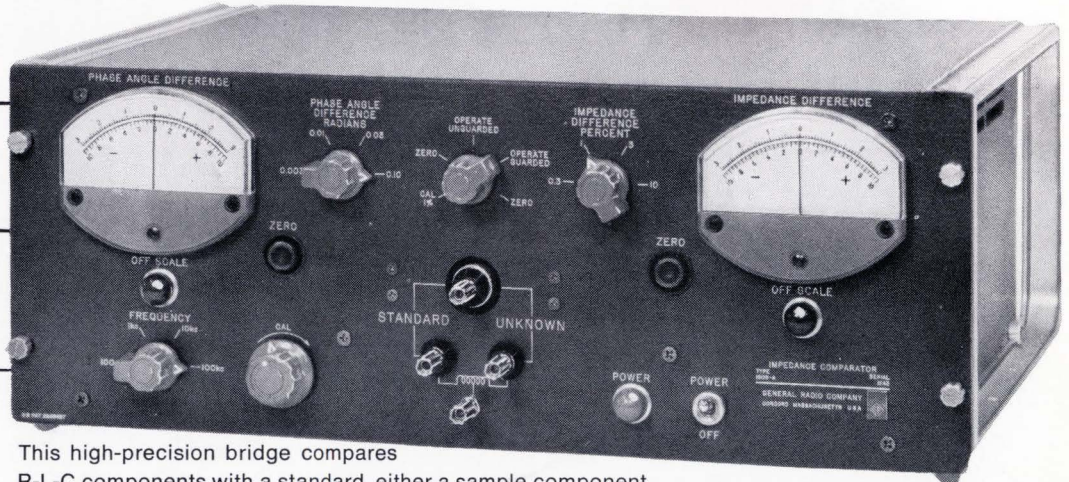

This high-precision bridge compares R-L-C components with a standard, either a sample component or laboratory standard. It is equally useful for tests on etched boards and sub-assemblies and can be operated either manually or in combination with automatic sorting equipment.

Conventional bridges can be too slow for 100% testing. For such high-volume use, a fully automatic device is often the answer, although it usually measures only one of the main parameters (R, L, or C). Where the requirements include versatility and low cost as well as speed, a third alternative, the Type 1605-A Impedance Comparator, is the best choice.

This bridge requires no manual balancing; two meters indicate the difference, in magnitude and phase, between the unknown and an external standard. Comparisons can be made with a precision of better than 0.01% for small differences. Components can be measured as rapidly as the operator can plug them into a test jig.

For matching, sorting, and production testing, the Impedance Comparator offers you the precision of manual-bridge measurements combined with the speed of the production line.

Condensed Specifications:

There are two models of the Type 1605 Impedance Comparator: the 1605-A and the 1605-AH, which differ only in range and sensitivity. Both are available in rack and bench models.

BASIC RANGES:

	Measurement	Impedance Range	Impedance-Mag. Difference Range	*Phase-Angle Difference Range
1605-A	Resistance (or Impedance Magnitude)	2Ω to 20MΩ	±0.3%, ±1%, ±3%, ±10%, full scale	±0.003, ±0.01, ±0.03, ±0.1 radian, full scale
	Capacitance	40pF to 800μF	Can be extended to as high as ±50% for limit tests	
	Inductance	20μH to 10,000H		
1605-AH	Resistance (or Impedance Magnitude)	20Ω to 20 MΩ	±0.1%, ±0.3%, ±1%, ±3%, full scale	±0.001, ±0.003, ±0.01, ±0.03 radian, full scale
	Capacitance	40pF to 80μF	Can be extended to as high as ±15% for limit testing	
	Inductance	200μH to 10,000H		

*Phase-angle difference is very nearly equal to D difference (for C & L) or Q difference (for R) when either D or Q is less than 0.1.

TEST FREQUENCY AND VOLTAGE:

Frequency (both models) — 100 Hz, 1 kHz, 10 kHz & 100 kHz, switch-selected

Voltage (across unknown & standard) — Approx. 0.3V for 1605-A
Approx. 1V for 1605-AH

PRICES:

Type 1605-A Impedance Comparator, \$995 in U.S.A.

Type 1605-AH Impedance Comparator, \$995 in U.S.A.

Write for complete information. Also ask about our completely Automatic Capacitance Bridge Assembly, the Type 1680-A.

BOSTON • NEW YORK • CHICAGO • PHILADELPHIA • WASHINGTON, D.C.
SYRACUSE • DALLAS • SAN FRANCISCO • LOS ANGELES • ORLANDO
CLEVELAND • TORONTO • MONTREAL
GENERAL RADIO COMPANY (Overseas), ZURICH, SWITZERLAND
GENERAL RADIO COMPANY (U.K.) Ltd., BOURNE END, ENGLAND

GENERAL RADIO
WEST CONCORD, MASSACHUSETTS

Circle 900 on reader service card

Push Null Read

Accuracy: 0.002% of reading + 0.0002% of range
Highest resolution (0.2 ppm of range) -1, 10, 100, 1000 v ranges
Stability: 1 ppm/hour, 5 ppm/day, 30-day calibration cycle
RATIO measurements: four ranges with 6-digit resolution
True isolation, battery operation

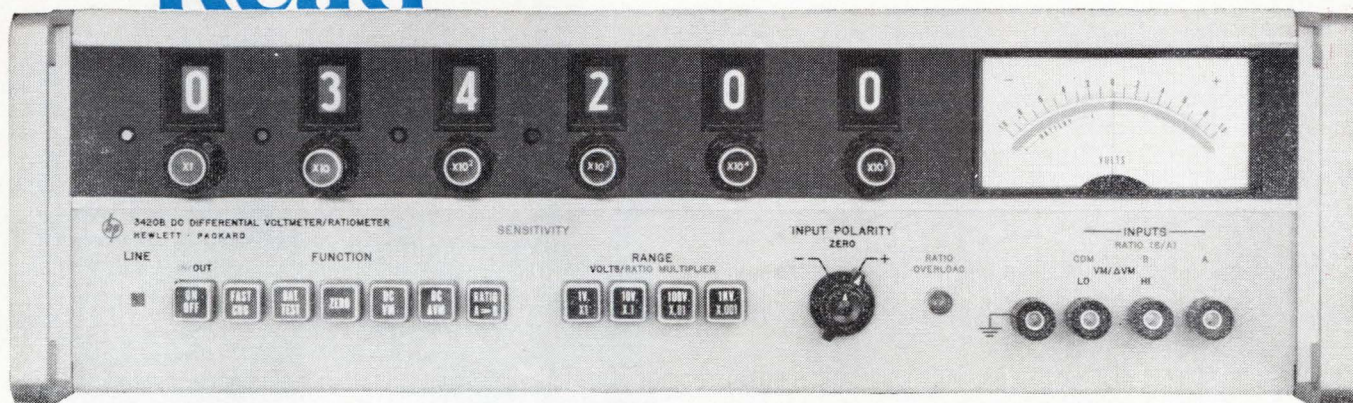

hp 3420A/B

for today's most accurate dc differential volt/ratio meter measurements!

accuracy Here's the most accurate dc voltmeter available today, backed by a minimum 30-day calibration cycle and temperature coefficient of 4 ppm/°C. With a sensitivity of $\pm 10 \mu\text{V}$ full scale, six-digit resolution is meaningful for measurements in standards and calibration labs, design labs . . . and all areas (physics, biomedical, electro-chemical, university, processes, control) where high precision and stability are essential.

ratio Then add *four ranges* of ratio capability with 0.002% accuracy and make both resistance and voltage ratio measurements. The customary precision voltage source required for resistance ratio is no longer necessary.

isolation A line/battery operated model permits true "floating" measurements and provides portability not available at this accuracy level before.

There is 10% overranging on all voltmeter functions, with overload recovery of less than three seconds, and immunity

to damage by overload. The recorder output at ± 1 volt and 1 milliamp will drive any recorder.

ease of operation Pushbutton function and range selection, plus a full in-line six-digit readout, permits convenient and time-saving measurements. Six discrete decade dividers with concentric null sensitivity pushbuttons now make nulling very simple. The zero pushbutton disconnects the input source and decades, and internally shorts input terminals . . . no need to return decades to zero.

All silicon solid-state, with plug-in circuit board design for easier maintenance in both the 3420A (line operated), at \$1175, and the 3420B (line/battery operated) at \$1300.

Ask for a demonstration by calling your Hewlett-Packard field engineer. Or get complete specifications with the same call or by writing Hewlett-Packard, Palo Alto, Calif. 94304, Tel. (415) 326-7000; Europe: 54 Route des Acacias, Geneva.

Data subject to change without notice. Prices f.o.b. factory.

HEWLETT  PACKARD
An extra measure of quality

far out

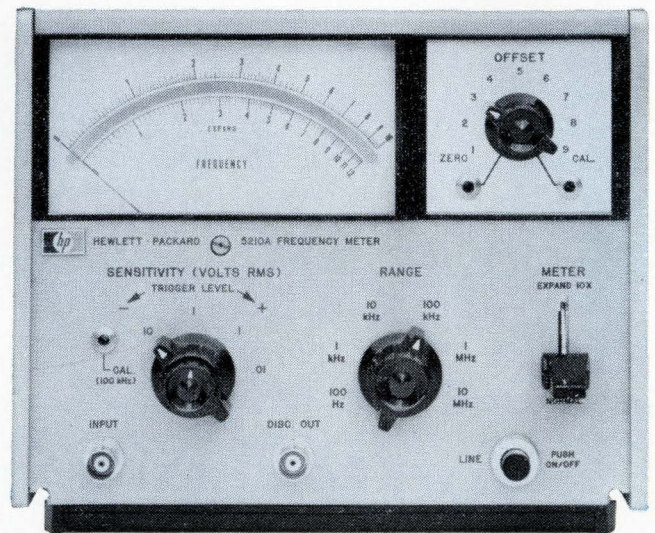

All the way out to 10 MHz! Introducing a new FM discriminator/frequency meter

Here's a new frequency meter and FM discriminator with seven times the range previously available...3 Hz to 10 MHz. Its wideband FM discriminator (3 dB at 1 MHz!) is ideal for measuring signals being FM'd or undergoing very rapid frequency changes. Linearity is 0.025% out to 100 kHz, 0.05% to 1 MHz, 0.1% to 10 MHz. Residual FM noise is 100 to 120 dB down. With an optional series of low-pass plug-in filters, measure the amount of deviation in the signals, plus the rate and components of the deviation.

You can read frequency to 1% accuracy (of reading) on the front-panel meter, record frequency and FM data from its recorder outputs, or use the 5210A for tachometer or stroboscope work and flutter and wow measurements.

Discriminator Input

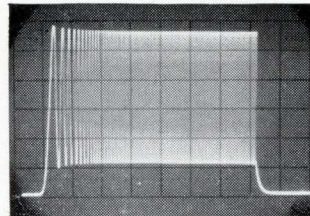

Discriminator Output

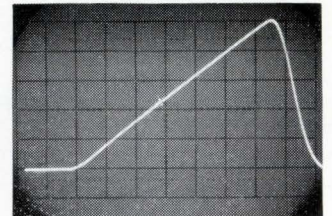

For even higher resolution, a scale expander will expand any 10% segment of the meter scale or recorder output ten times. Zero offset is continuously adjustable, 0 to full scale, or you can order Option 01 (pictured above, \$125 extra) for a calibrated 10-step offset control and 0.2% to 0.3% accuracy. Other outstanding features: 10 mV input sensitivity, 20 Hz-10 MHz...built-in 0.01% crystal calibrator...1 meg/30 pf input impedance. Price without options, \$575.

The complete story on the "far out" 5210A is in a down to earth data sheet available from your HP field engineer, or write Hewlett-Packard, Palo Alto, California 94304, Tel. (415) 326-7000; Europe: 54 Route des Acacias, Geneva. *Data subject to change without notice. Price f.o.b. factory.*

HEWLETT  **PACKARD**
An extra measure of quality

News Features

Probing the News

- 109 **Laser modulation handles high-speed pulse-code systems**
- 114 **Million-dollar insurance program**
- 119 **Automation in the test labs**

Electronics Review

- 37 **Displays:** Video on a platter
- 38 **Communications:** Handy view
- 39 **Space electronics:** What's next?
- 40 **Consumer electronics:** IC's in the old kit bag
- 42 **Computers:** IBM's new family; At the speed of light
- 44 **Advanced technology:** Solid look
- 46 **Military electronics:** Discriminating view; Jungle guide
- 48 **Electronics notes**

Electronics Abroad

- 151 **Japan:** NC with IC
- 151 **France:** Gallic logic; French nyet
- 152 **Sweden:** Looking up
- 153 **Soviet Union:** Red sales
- 153 **Great Britain:** Breakthrough in breakdown; Current limiter
- 154 **West Germany:** Faster flasher
- 154 **Around the world**

Departments

- 4 Readers Comment
- 8 People
- 14 Meetings
- 16 Meeting Preview
- 23 Editorial
- 25 Electronics Newsletter
- 51 Washington Newsletter
- 125 New Products
- 140 New Books
- 141 Technical Abstracts
- 142 New Literature
- 149 Newsletter from abroad

Technical Articles

I. Design

- Components** 58 **Tiny filters block the path of radio-frequency interference**
Low-pass filters built of lossy inductive elements fitted into ceramic capacitors sharply erode unwanted signals from 100 kilohertz to 10 gigahertz
P.A. Denes and J.J. Crittenden, Denesco, Inc.

- Circuit design** 68 **Designer's casebook**
 - Transistor switch for clickless keying
 - Amplifiers and triggers simulate blood pressure
 - High-speed wideband gate provides 70-db isolation
 - Suppressed carrier modulator with noncritical components
 - Pulse circuit fires scr pair
 - Front-end nuvistor lowers transistor amplifier noise
 - Voltage-controlled multi produces triangular output

II. Application

- Instrumentation** 75 **Correlation entering new fields with real-time signal analysis (cover)**
With new techniques, engineers can now perform correlation analysis in real-time to dig a signal from noise in many applications
Bernard LuBow, Princeton Applied Research Corp.

- Computers** 83 **Wiring design helps core memory work at rapid cycle time**
In a 2½ dimensional organization, a new core memory has a 500-nanosecond cycle, and still is inexpensive
Alexander Elovic, Burroughs Corp.

- Communications** 91 **Double phase-shift keying speeds data over voice channels**
Built with integrated circuits, a modern phase modulates binary data and bit-times signals on the carrier instead of synchronizing pilot tones
Martin Poppe, State University of New York

III. Engineering

- Opinion** 100 **The other side of the recruiting coin**
An engineer who heads a research and development division tells why it's unfair to blame only the employers for problems encountered by job-seeking engineers. Some applicants cheat

Electronics

Editor-in-Chief: Lewis H. Young

Senior editors

Design: Samuel Weber

Application: George Sideris

News: Kemp Anderson Jr.

Assistant to the editor: Sally Powell

Senior associate editors: John F. Mason, Donald Christiansen, Robert Henkel, Joseph Mittleman

Department editors

Avionics: W.J. Evezia

Communications: Leonard Weller

Computers: Wallace B. Riley

Design theory: Joseph Mittleman

Electronics abroad: Arthur Erikson

Electronics review: Stanley Zarowin

Industrial electronics: Alfred Rosenblatt

Instrumentation: Carl Moskowitz

Military electronics: John F. Mason

New products: William P. O'Brien

Special projects: Donald Christiansen

Staff writer: Jan Rahm

Regional Bureaus

Domestic

Boston: Thomas Maguire, manager; Robin Carlson

Los Angeles: William B. Wallace, manager; June Ranill

San Francisco: Walter Barney, manager; Mary Jo Jadin

Washington: Robert W. Henkel, manager; William D. Hickman, John Rhea, correspondents; Patricia C. Hoehling

Foreign

Bonn: John Gosch

Tokyo: Charles Cohen

Copy editors

James J. Moran, David Goller, William Olcott

Graphic design

Art director: Saul Sussman

Assistant art director: Ann Mella

Production editor: Arthur C. Miller

Editorial secretaries: Claire Benell, Lynn Emery, Lorraine Fabry, Kay Fontana, Patricia Gardner, Lorraine Longo

McGraw-Hill News Service

Director: John Wilhelm; **Atlanta:** Fran Ridgway; **Chicago:** Reck Johnson;

Cleveland: Arthur Zimmerman; **Dallas:** Marvin Reid;

Detroit: N. Hunter; **Houston:** Ron Lovell; **Los Angeles:** Michael Murphy, Gerald Parkinson

San Francisco: Margaret Drossel

Seattle: Ray Bloomberg; **Washington:** Arthur L. Moore, Charles Gardner, Herbert W. Cheshire, Seth Payne, Warren Burkett, Warren Kornberg

McGraw-Hill World News Service

Bonn: John Johnsrud; **London:** John Shinn;

Mexico City: Bruce Cross; **Milan:** Ronald Taggiasco;

Moscow: Howard Rausch; **Paris:** Peter Kilborn;

Rio de Janeiro: Wes Perry; **Tokyo:** Marvin Petal

Circulation and Research Manager: Milton Drake

Publisher: Gordon Jones

Electronics: October 31, 1966, Vol. 39, No. 22

Published every other Monday by McGraw-Hill, Inc. Founder: James H. McGraw 1860-1958.

Printed at 99 North Broadway, Albany, N.Y. 12207; second class postage paid at Albany, N.Y.

Executive, editorial, circulation and advertising addresses: McGraw-Hill Building, 330 W. 42nd Street, New York, N.Y. 10036. Telephone (212) 971-3333. Teletype TWX N.Y. 212-640-4646. Cable address: MCGRAWHILL N.Y.

Subscriptions are solicited only from those actively engaged in the field of the publication. Position and company connection must be indicated on orders. Subscription prices: United States and possessions and Canada, \$6.00 one year, \$9.00 two years, \$12.00 three years; all other countries, \$20.00 one year. Single copies: United States and possessions and Canada, 75¢; all other countries, \$1.50.

Officers of McGraw-Hill Publications: Joseph H. Allen, President; Bayard E. Sawyer, Executive Vice President; Vice Presidents: J. Elton Tuohig, Operations; John R. Callahan, Editorial; Donald C. McGraw, Jr., Marketing; John M. Holden, Marketing Services; Huber M. Gemmill, Circulation; Angelo R. Venezian, Production; Robert M. Wilhelm, Controller.

Officers of the Corporation: Donald C. McGraw, Chairman of the Board; Shelton Fisher, President; L. Keith Goodrich, Hugh J. Kelly and Robert E. Slaughter, Executive Vice Presidents; John J. Cooke, Vice President and Secretary; John L. McGraw, Treasurer.

Title ® registered in U.S. Patent Office; © Copyright 1966 by McGraw-Hill, Inc. All rights reserved. The contents of this publication may not be reproduced either in whole or in part without the consent of copyright owner.

Subscribers: The publisher, upon written request to our New York office from any subscriber, agrees to refund that part of the subscription price applying to copies not yet mailed. Please send change of address notices or complaints to Fulfillment Manager; subscription orders to Circulation Manager, Electronics at address below. Change of address notices should provide old as well as new address, including postal zip code number. If possible, attach address label from recent issue. Allow one month for change to become effective.

Postmaster: Please send form 3579 to Fulfillment Manager, Electronics, P.O. Box 430, Hightstown, New Jersey 08520

Readers Comment

No more cut and try

To the Editor:

In "Electronics Newsletter" [Oct. 3, p. 25], a reference was made to the use of the NET-1 circuit analysis computer program in the design of monolithic integrated circuits for Honeywell, Inc. It is interesting to see that others have shared the success that we at the Arinc Research Corp. have had in applying computer techniques to integrated circuit design.

The Arinc program has several advantages in this application, such as the ability to describe a transistor in terms of its design: i.e., junction areas, base width, resistivities, etc. The effects of component tolerances may be handled as variations in both absolute value and ratio to other components in the circuit and parasitics may early be included in the component data.

An additional feature, which Arinc Research has found quite useful, is the Monte Carlo analysis. Using this technique, actual predictions of production yield can be made based upon variations in process control.

In our integrated circuit design activities, the use of this program has eliminated the cut-and-try approach to design, and generated the data required to optimize a circuit with the first set of masks.

John R. Gliessman
Manager, Electronic
Technology Program
Arinc Research Corp.
Santa Ana, Calif.

Some reservations

To the Editor:

I was interested in your editorial "Traveler's lament" [Sept. 19, p. 23], and wonder if the millions the airlines have spent on electronic equipment of one sort or another to improve service in recent years is properly described as "lip service." My impression is that the airlines are up against state of the art problems in most of the areas you mention. The computer reservations system, as you probably know, almost didn't work. Millions in additional development were required after the purchase of the major

New from Sprague!

LOW COST HERMETICALLY SEALED SEPT[®] SILICON EPITAXIAL PLANAR TRANSISTORS

NOW AVAILABLE IN PNP TYPES!

NPN TRANSISTORS		
Type No.	Application	Features
TN53-TN54	high voltage switch	$BV_{CEO} = 45V$ (min.), $BV_{CBO} = 75 V$ (min.), $f_T = 100$ (min.)
2N4383-2N4386 (TN55-TN58)	low level switch	wide-band noise figure = 2 db (typ.), $h_{FE} = 100$ at 10 mA
TN59-TN64	high speed switch	f_T up to 100 mc, h_{FE} up to 100 at 150 mA
TN79-TN80	chopper	$V_O < 500$ mV at $I_B = 5$ mA, $R_S < 20 \Omega$ at $I_B = 5$ mA
TN81	power amplifier	600 mW P_{OUT} at 50 mA, typical gain of 9 db

PNP COMPLEMENTS
2N4412-2N4413 (TQ55-TQ56) Low Level, Low Noise (complement of TN55, TN56)
TQ59-TQ60 General Purpose, High Gain (complement of TN59, TN60)
TQ61-TQ62 High Speed Switch (complement of TN61, TN62)

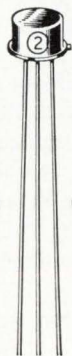

TO-5 CASE

**Hermetically-Sealed TO-5 and TO-18 Metal Cases
for Superior Moisture Resistance
and Power Capability**



TO-18 CASE

For complete information, write to Technical Literature Service, Sprague Electric Company, 35 Marshall Street, North Adams, Mass. 01247

SPRAGUE COMPONENTS

- | | | |
|-------------------------|------------------------|--------------------------------------|
| TRANSISTORS | PULSE TRANSFORMERS | CERAMIC-BASE PRINTED NETWORKS |
| CAPACITORS | INTERFERENCE FILTERS | PACKAGED COMPONENT ASSEMBLIES |
| RESISTORS | PULSE-FORMING NETWORKS | BOBBIN and TAPE WOUND MAGNETIC CORES |
| INTEGRATED CIRCUITS | TOROIDAL INDUCTORS | SILICON RECTIFIER GATE CONTROLS |
| THIN-FILM MICROCIRCUITS | ELECTRIC WAVE FILTERS | FUNCTIONAL DIGITAL CIRCUITS |

485-6140



Sprague and *®* are registered trademarks of the Sprague Electric Co.

Worlds of Clifton Quality

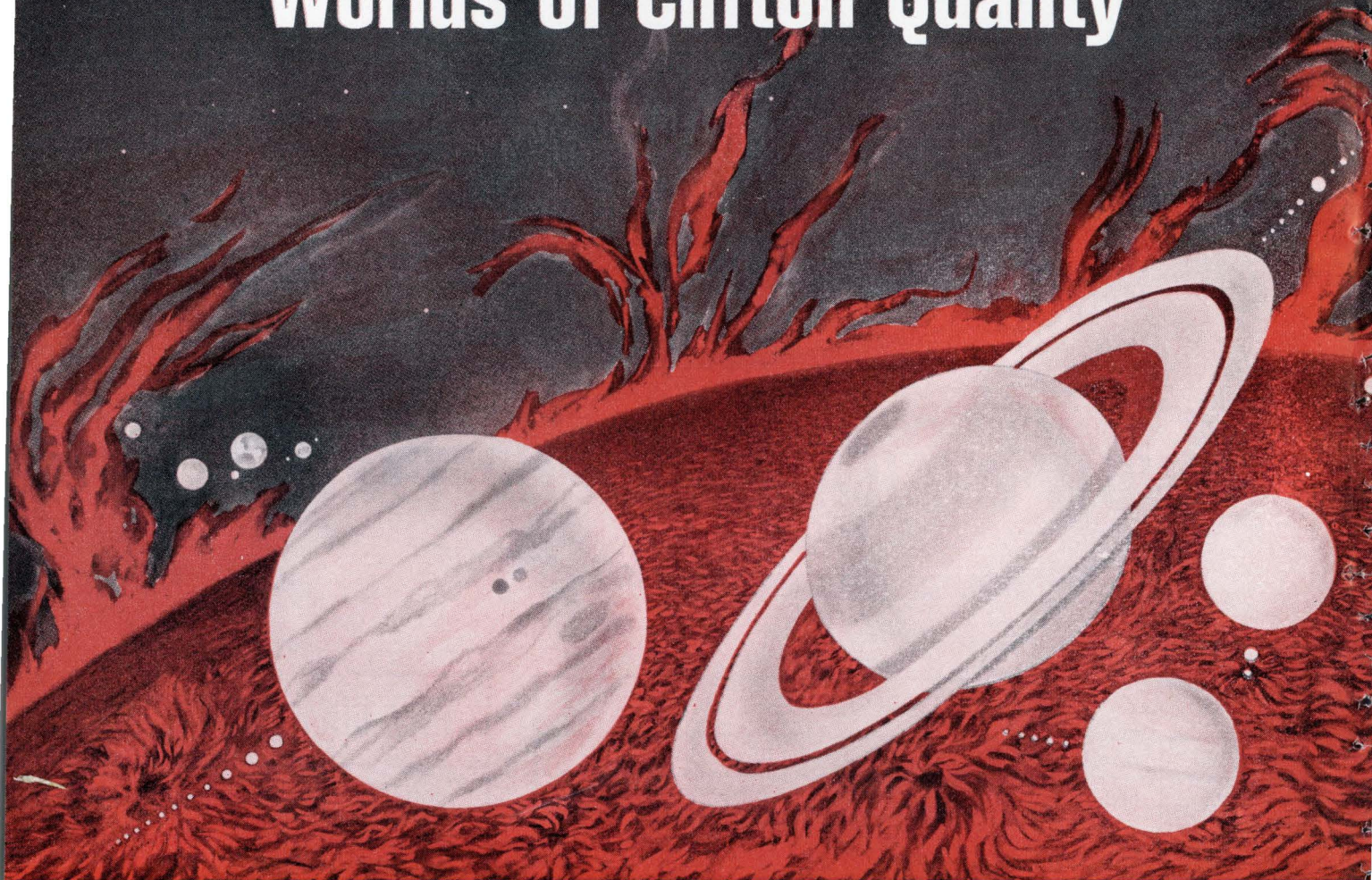

in our **NEW**, Competitively Priced DC Motors

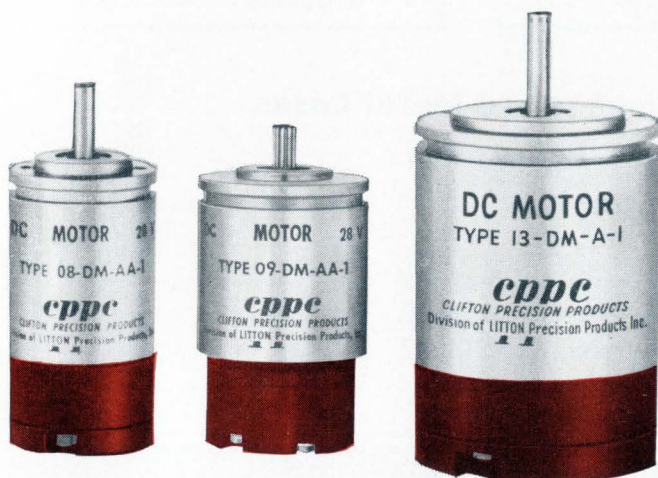

The illustration of our Solar System shows the nine planets and their 31 satellites in scale with each other and the enormous sun. The procession starts with Mercury at the left and ends with Pluto on the far right.

Built to exacting Clifton and MIL-E-5272 standards, these DC motors are a completely new design. They offer many advantages such as: stainless steel, corrosion resistant housings and ball bearings, and brush springs which maintain constant pressure over brush life. Brush life itself is up to 1000 hours depending upon environmental conditions and application.

These motors feature a five bar commutator. Due to the inherent design, the rotor produces a magnetic detent under zero excitation which minimizes gear train drift. Units available in both 14 and 28 volt excitation. Special voltages, shafts and housings available upon request.

Clifton Precision Products, Division of Litton Industries, Clifton Heights, Pa., Colorado Springs, Colo.

cppe

CLIFTON
PRECISION PRODUCTS
DIVISION OF LITTON INDUSTRIES

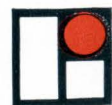

systems. I made a speech to some key computer people of one of the major companies recently and, in answer to questions, stressed that additional development was badly needed to meet ticketing and similar problems. It'll come eventually, but development takes time.

There are staggering problems in doubling the air transport network in five years and at the same time improving its system effectiveness. Much progress is being made. Obviously you couldn't physically load a 150-passenger jet with DC-3 methods. But the hardware to make more progress often doesn't exist. For example, we're a year late on the CAT-II system because, among other reasons, manufacturers haven't been able to design runway lights to FAA specifications.

Your editorial sounded a little as if all the airlines had to do was to go out and purchase hardware. We all wish it were so, but as you must know, it isn't that easy. A major part of the problem is in the state of the art—development is badly needed all across the board, and is being vigorously pursued.

John A. Creedy
Vice president, Public Relations
Air Transport Association of America
Washington, D.C.

■ We agree that you can't load a 150-passenger jet with DC-3 methods; our complaint is that too many airlines try. Airframe manufacturers tell us that, operationally, the airlines concern themselves almost exclusively with the problem of moving a cube from point A to point B. They spend billions of dollars to do it faster and more economically. Compared to such sums, the money

spent on reservations systems and passenger loading and unloading is minuscule. In addition, money is not enough. We deliberately cited American Airlines' Sabre system as an example of where an expensive system was not the answer. Yet the technologies in Sabre could solve the reservation problem. Our point is that the technology—not the hardware—is here today to solve this.

The comment about reservation systems is well taken—but out of date. What he is saying was true before multiprocessing computers, time-shared machines and huge capacity, relatively inexpensive memories were designed, built and delivered to other kinds of customers.

It turns out that most airlines do not use such techniques as facsimile to transmit documents like passenger seating charts. And some do not even use Teletype extensively to send up-dated reservation data.

An old adage

To the Editor:

C.M. Sinclair's letter about pulse-width modulation amplifiers [Sept. 19, p. 7] contained a sentence that hits hard. The sentence reads: "Circuit complexity is not really a problem because the components required are cheap."

Cheap components make cheap equipment; cheap equipment makes cheap systems; and cheap systems are expensive to maintain and in the end cost more than expensive systems.

If the schematic shown is an X-20 amplifier, buyer beware.

Robert B. Watson
Federal Aviation Agency
Tucson, Ariz.

NEW!

Commercial
wirewound trimming
potentiometers with
mil-quality windings
for only

\$1.11 Each!

(1,000 pc. qty., 10Ω to 20KΩ)

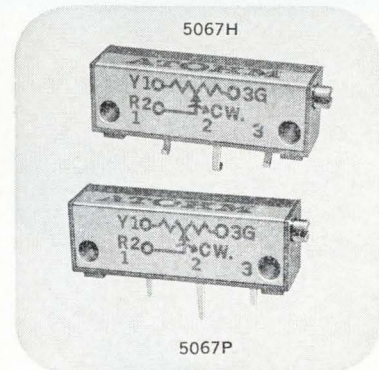

CHECK THESE SPECS!

- Dimensions:36"H. x .28"W. x 1"L.
- Operating Temp. Range: -55°C. to +85°C.
- Power Rating:5 watt at room temperature
- Total Resistance: ±10%
- Standard Resist. Range: .. 10Ω to 20K, 25K, 50K
- Temperature coefficient 70 ppm, nominal
- Exclusive Multi-Weld® mil-quality terminations

2 OTHER NEW COMMERCIAL UNITS!

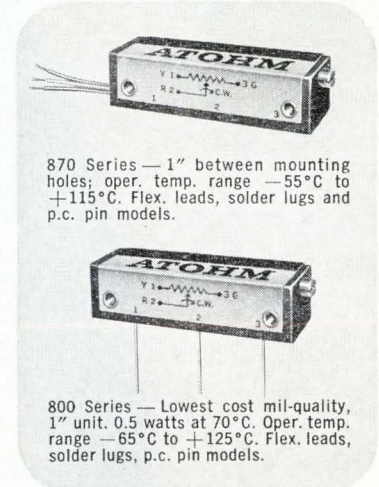

870 Series — 1" between mounting holes; oper. temp. range -55°C to +115°C. Flex. leads, solder lugs and p.c. pin models.

800 Series — Lowest cost mil-quality, 1" unit. 0.5 watts at 70°C. Oper. temp. range -65°C to +125°C. Flex. leads, solder lugs, p.c. pin models.

Ask your Atohm rep for samples, or write to:

ATOHM ELECTRONICS
COMMERCIAL PRODUCTS DIVISION
3030 Empire Ave. • Burbank, Calif. 91504

SUBSCRIPTION SERVICE

Please include an Electronics Magazine address label to insure prompt service whenever you write us about your subscription.

Mail to: Fulfillment Manager
Electronics
P.O. Box 430
Hightstown, N.J. 08520

To subscribe mail this form with your payment and check new subscription renew my present subscription

Subscription rates: in the U.S.: 1 year, \$6; two years, \$9; three years, \$12. Subscription rates for foreign countries available on request

CHANGE OF ADDRESS

ATTACH LABEL HERE

If you are moving, please let us know five weeks before changing your address. Place magazine address label here, print your new address below.

name

address

city

state

zip code

"BLUE CHIP" TRANSFORMERS NOW AVAILABLE IN CASE SIZE #7

IN STOCK—is the latest addition to the versatile family of Blue Chip transformers for printed circuit applications. This still smaller size; (Height .340 inch maximum, volume .060 cubic inches), transformer offers design engineers more flexibility for electrical and mechanical transistor circuit applications. The size #7 Blue Chip transformers provide a response of ± 2 db from 300 to 100,000 Hz in a number of impedance ranges and are designed to meet Mil-T-27B, Grade 5, Class S. Write for your copy of complete electrical and mechanical specifications.

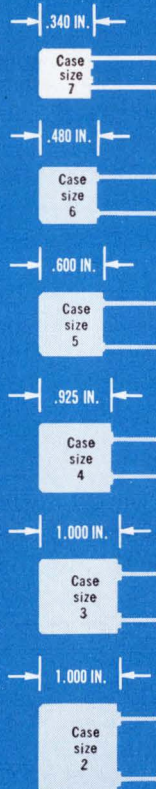
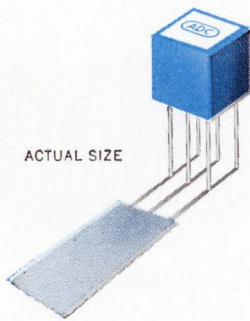

ADC

ADC PRODUCTS

A DIVISION OF MAGNETIC CONTROLS CO.

6405 Cambridge Street • Minneapolis, Minnesota 55426

People

In a sprawling old building in Waltham, Mass., **John J. Marino** and **Jonathan J. Sirota** have been working since July with six employees and an idea. The idea is the commercial production of braided electronic memories by textile loom techniques



Marino

[Electronics, April 18, p. 40]. The manufacturing approach is still under development at the Instrumentation Laboratory of the Massachusetts Institute of Technology. But 28-year-old Marino and 24-year-old Sirota have plans to leapfrog into a commercial version of the MIT method and manufacture magnetic memories that are competitive with currently available memories. The two researchers call their company Memory Technology, Inc.

In one section of their mostly empty quarters an electronically controlled loom made by the two ex-MIT engineers feeds spools of wire through rods which click up and down to fashion the zeros and ones of



Sirota

the braid. A machine company is making a loom for them based on this design and the lessons learned as they continue research on the manufacturing technique.

Too late for Apollo. The new company will take a modular approach in converting to commercial production of read-only memories. The braid memory probably would have been used in the Apollo guidance and navigation computer, but its development was not far enough along when Apollo designs had to be frozen. Apollo will have a core rope memory, designed by the same MIT laboratory group.

Marino and Sirota see the first big market for read-only memories as sequence generators to replace



Now from MACHLETT: 22 high-precision, low torque, vacuum variable capacitors for heavy duty



Each of these 22 ceramic vacuum variable capacitors from Machlett offer the following advantages:

- High rf current capability
- Stable operation at high temperature
- Structural rigidity
- Low capacitance variation with temperature change
- Wide capacitance range
- High Q factor (1000 or greater)
- Low operating torque
- High resistance to damage from over-voltage.

Capacitance values from 5-750 pF to 50-2300 pF; voltage rating to 15 kv; current rating to 75A. Custom design consultation for special applications is available from Machlett.

For full details on this new line, write to The Machlett Laboratories, Inc., Springdale (Stamford) Conn. 06879



THE MACHLETT LABORATORIES, INC.

A SUBSIDIARY OF RAYTHEON COMPANY

New from Sprague!

**5 Times the Resistance of
a Conventional Metal-Film Resistor
of Equal Size!**

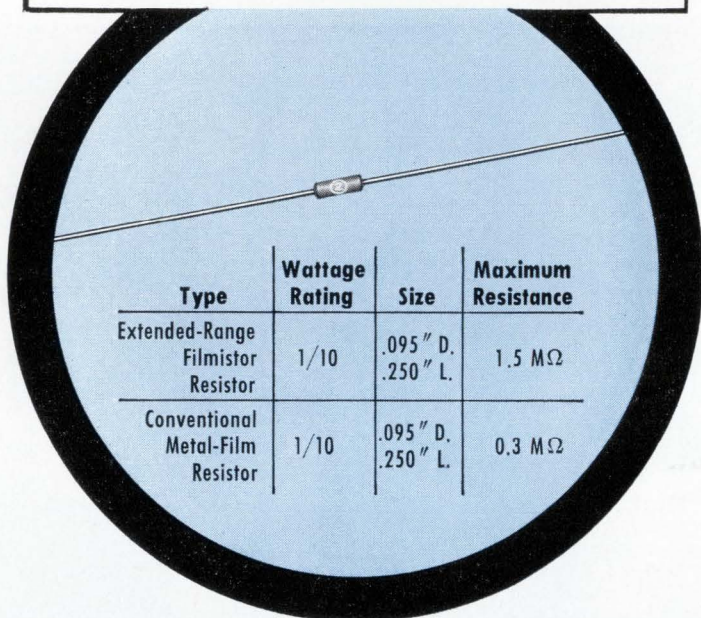

EXTENDED-RANGE FILMISTOR[®] METAL-FILM RESISTORS

**Substantial saving of space in all wattage ratings —
1/20, 1/10, 1/8, 1/4, 1/2, and 1 watt —with
absolutely NO SACRIFICE IN STABILITY!**

Extended-Range Filmistor Resistors now offer, in addition to accuracy . . . stability . . . reliability . . . resistance values in size reductions which were previously unobtainable. Size and weight advantages of Filmistor Resistors now make them ideal for applications in high-impedance circuits, field-effect transistor circuits, etc. Many designs which previously had to settle for the higher temperature coefficients of carbon-film resistors in order to obtain required resistance values can now utilize the low and controlled temperature coefficients of Filmistor Metal-Film Resistors.

Other key features are $\pm 1\%$ standard resistance tolerance, low inherent noise level, negligible voltage coefficient of resistance, and tough molded case for protection against mechanical damage and humidity.

For complete technical data, write for Engineering Bulletin 7025C to Technical Literature Service, Sprague Electric Co., 35 Marshall Street, North Adams, Massachusetts 01247.

SPRAGUE COMPONENTS

RESISTORS
CAPACITORS
TRANSISTORS
INTEGRATED CIRCUITS
THIN-FILM MICROCIRCUITS
INTERFERENCE FILTERS

PACKAGED COMPONENT ASSEMBLIES
FUNCTIONAL DIGITAL CIRCUITS
MAGNETIC COMPONENTS
PULSE TRANSFORMERS
CERAMIC-BASE PRINTED NETWORKS
PULSE-FORMING NETWORKS



Sprague and ® are registered trademarks of the Sprague Electric Co.

People

the logic chains now used for micro-program control in computer systems. Their first product will be a quarter-million bit memory module, which they are now trying to sell to Honeywell, Inc.'s Electronic Data Processing division for its 4200 and 8200 computer systems.

Marino and Sirota made one false start when, in 1964, under private financing, they planned to build complete computer systems for automated printing. Looking for new financial support this past summer, they turned to the American Research and Development Corp. in Boston. American Research officials persuaded them to concentrate on memories only and gave them \$100,000 to get the project started.

Nearly a decade ago, the same Boston investment company put \$70,000 into the ideas of two other engineers, also from MIT. Today, the investment company's shares in Digital Equipment Corp. of Maynard, Mass., are worth about \$30 million.

There is no doubt that the parallel is not lost on either the backers or the backed.

Profit motive. "We're told that Digital Equipment was making money after six months" says Marino. "If we break even after a year, we'll be ecstatic", adds the researcher.

Marino and Sirota are the youngest entrepreneurs ever to receive backing from the Boston investment concern. Neither one was directly involved in the braided memory project at MIT. Marino worked on all-magnetic computers in another part of the instrumentation laboratory. Sirota, a former MIT graduate student, left his job at the Raytheon Co. to devote all his time to the new commercial venture.

Marino, president of the company, is a University of Vermont graduate and worked for the General Electric Co. before becoming a research engineer at MIT. Sirota, vice president, is a graduate of Rensselaer Polytechnic Institute and received his master's degree in electrical engineering as a Raytheon fellow at MIT.

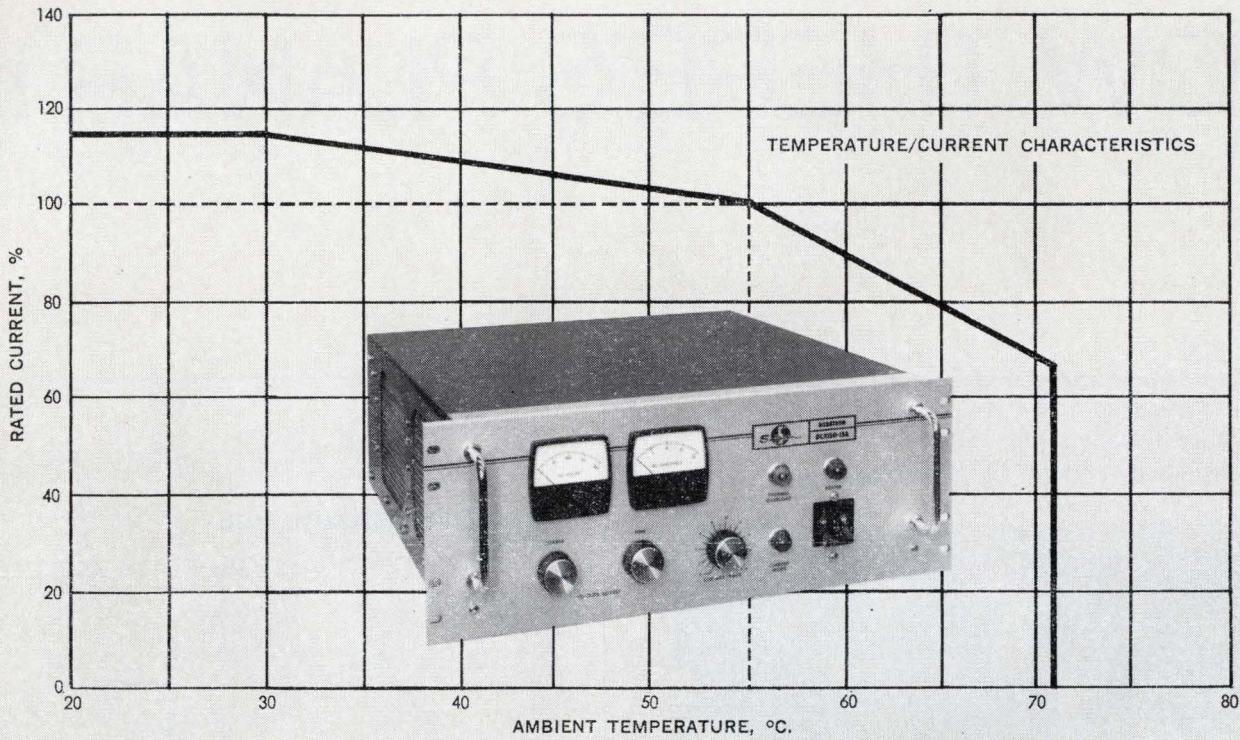

Sorensen DCR Series now with temperature capability to 71°C.

Sorensen Wide Range Power Supplies to 20 kW.

Sorensen's wide range DCR Series has been up-dated and improved. What's new about the DCR's? They are now 100% silicon; ambient temperature capability is now to 71°C. • Four 3-phase models have been added extending power capability to 20 kW; 24 models are now available with ranges up to 300 volts. • Multiple mode programming—voltage/current/resistance. • Voltage regulation, line and load combined, is $\pm 0.075\%$ for most models • Constant current range 0 to rated current. • DCR's meet MIL-I-26600 and MIL-I-6181

specifications and conform to proposed NEMA standards. • Front panel indicator for voltage/current crossover. These features of the improved DCR (model numbers will have an "A" suffix) are offered at no increase in price. For DCR details, or for data on other standard/custom power supplies, AC line regulators or frequency changers, call your local Sorensen rep, or write: Raytheon Co., Sorensen Operation, Richards Avenue, Norwalk, Connecticut 06856. Tel: 203-838-6571.

MODEL SELECTION CHART

Voltage	Amps.	Model	Price	Amps.	Model	Price	Amps.	Model	Price	Amps.	Model	Price
0- 20	125	DCR 20- 125A	\$1180	250	DCR 20- 250A	\$1550	—	—	—	—	—	—
0- 40	10	DCR 40- 10A	360	20	DCR 40- 20A	525	35	DCR 40- 35A	\$ 750	60	DCR 40-60A	\$925
0- 40	125	DCR 40- 125A	1390	250	DCR 40 250A	2100	500	DCR 40-500A	3050	—	—	—
0- 60	13	DCR 60- 13A	525	25	DCR 60- 25A	780	40	DCR 60- 40A	925	—	—	—
0- 80	5	DCR 80- 5A	360	10	DCR 80- 10A	580	18	DCR 80- 18A	780	30	DCR 80-30A	925
0-150	2.5	DCR 150- 2.5A	360	5	DCR 150- 5A	580	10	DCR 150- 10A	780	15	DCR 150-15A	910
0-300	1.25	DCR 300-1.25A	375	2.5	DCR 300- 2.5A	580	5	DCR 300- 5A	780	8	DCR 300- 8A	910



NOW THERE'S PLANAR II.

Fairchild has now added refinements to its patented Planar* process, which result in improved device stability, longer life, and greater reliability without 100% burn-in.

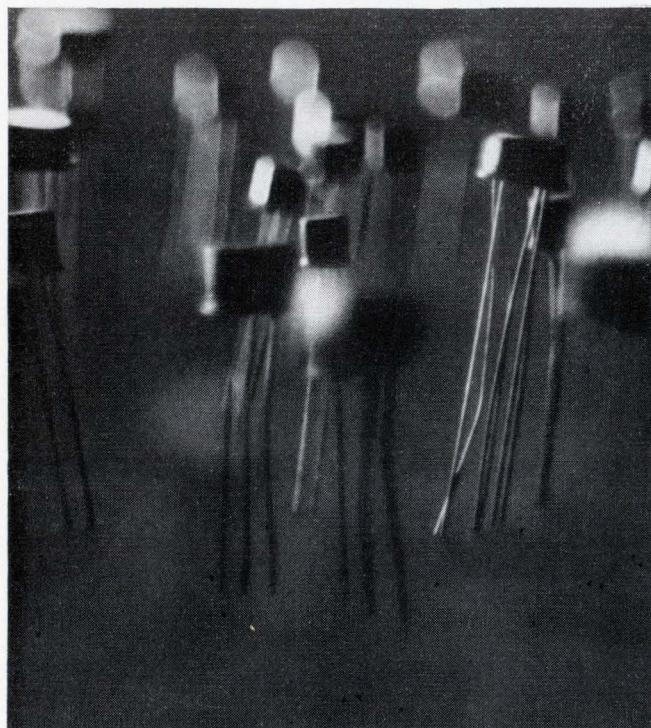

Fairchild invented the Planar process, and by doing so revolutionized the semiconductor industry. Without Planar the reliability of transistors would still be questionable, integrated circuits would not be where they are today, and the whole structure of the electronics industry would be different. But current requirements for ever more reliable systems and components have created a need for a better, purer manufacturing process. No doubt some manufacturers will soon find ways to improve the basic Planar process. We already have.

What is Planar II? Planar II is a refinement of the original Planar process. It is essentially aimed at controlling the behavior of free positive ions in the oxide layer which characterizes the Planar process. Concentration of free ions in the oxide can lead to problems that result in unstable MOS-FET devices, and to outright failure in transistors. The Planar II process keeps the number of these impurity ions to a minimum by using only ultra pure materials, utilizing better metalizing and bonding techniques, and by adding a few steps to the basic process which result in a much purer oxide layer. How does this work?

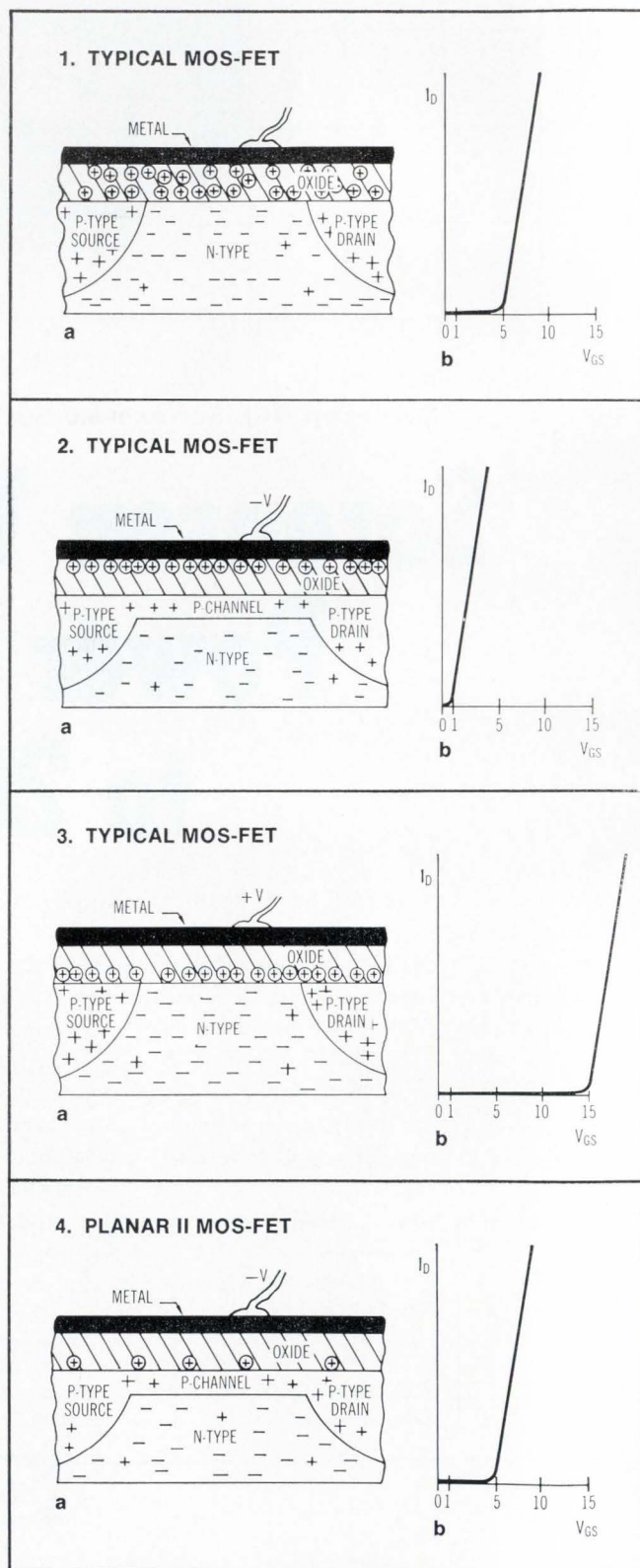

5. PLANAR II PNP TRANSISTOR

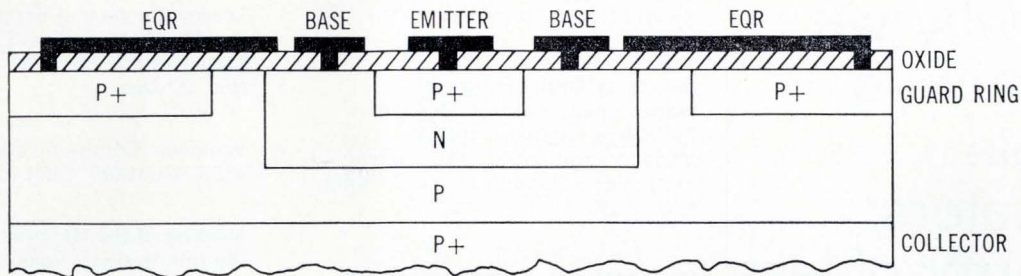

Stable MOS devices: In a typical P-channel MOS-FET (Fig. 1a) free positive ions are randomly distributed throughout the oxide layer. If a negative voltage is applied to turn the device on, it repels the free electrons in the N material and allows a P-channel to be formed and current to flow from source to drain. Initially such a voltage could be 5V (Fig. 1b).

As you can see in figure 2a, the negative voltage also attracts the free positive ions, and they concentrate near the oxide-metal interface. When a negative voltage is again applied, a much smaller voltage (about 1V) is required to form the P-channel, since the ions are already concentrated at the metal-oxide interface (Fig. 2a, 2b). Conversely, if a positive voltage preceded the negative turn-on signal, a much higher voltage (15V) is required to form the channel, since the positive ions will be at the bottom of the oxide layer, and will be attracted to the top (Fig. 3a, 3b). Thus, the threshold of the device is degraded and fluctuates between 1-15 volts, depending on the polarity of the previously applied signal.

Figures 4a and 4b show how the Planar II process helps to alleviate this problem. In the Planar II device the number of impurity ions is kept to a minimum, and the effects of their migrations is so small as to be negligible. The result is a threshold voltage that is stable and constant.

Stable PNP devices: To combat ion migrations in PNP transistors we use an equipotential ring (EQR) and a guard ring in addition to controlling the impurities (Fig. 5). The EQR and guard ring prevent the formation of inversion layers which can lead to channeling and device failure. This is accomplished by reshaping the electrical field distribution within the oxide layer to eliminate the lateral component. Ions are inhibited from moving laterally within the oxide layer, thus preventing inversion layers from forming.

The results were dramatically demonstrated in a recent test under severe High-Temperature Reverse Bias (HTRB) conditions. Epoxy devices without EQR and guard ring were subjected to conditions of $T_A = +125^\circ\text{C}$, $V_{CB} = 80\text{V}$. Over a 1000 hour period, more than 40% of the devices tested had I_{CBO} changes greater than 1000nA. An identical sample of PNP epoxy devices *with* EQR and guard ring went through the same test for the same time period. Not one of these transistors had an I_{CBO} change greater than 1nA.

Higher Voltage, lower cost: Because of the Planar II process you can now get high voltage PNP's from Fairchild. Our Series 2N4357, for example, features voltages up to 240V V_{CE0} . Even in epoxy, high voltages are now practical. Our PNP epoxy series SE7501 features collector-emitter voltages of 140V. This means you can get high voltages at lower epoxy prices. Furthermore, Planar II eliminates the need for 100% burn-in on PNP transistors. This is translated into both lower prices and faster deliveries.

Planar II summary: The benefits of Planar II processing can be summed up as follows: it allows us to make stable MOS field-effect transistors. It allows us to make reliable, high voltage, high performance PNP devices with the flexibility of low cost epoxy packaging. It even improves the stability with time (resulting in longer life) of NPN transistors and integrated circuits. In a word, it allows us to offer you better, more reliable solid-state devices at less cost. Planar II is the purest manufacturing process ever used in mass production. We suspect that in a few years everyone will be using it. You can wait. Or, get it now, from Fairchild.

FAIRCHILD
SEMICONDUCTOR

*Planar is a patented Fairchild process

ERRORS make us angry!

that's why we
manufacture
variable
attenuators
with error of less
than 0.05 db*

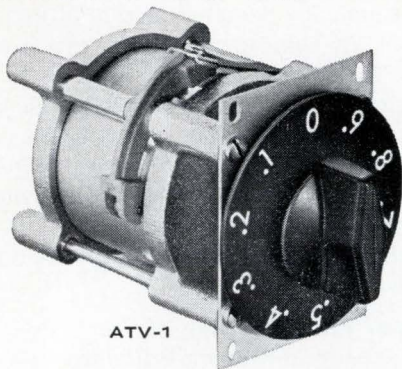

ATV-1

Think attenuators... say the words "Precision Performance"... and you must conclude Jerrold ATV-Series Turret Attenuators. Small, compact, they cost far less than you might expect.

Jerrold attenuators set the pace with intrinsic quality like coin-silver contacts for maximum conductivity, finest-quality deposited carbon disc and rod pad resistors for extreme accuracy, and positive spring-loaded detent mechanism for faultless resolution—in fact all the electrical features of "pull-and-turn" attenuators at one third the cost!

Model ATV-1,* 0-0.9 db in 0.1 db steps (Fixed Attenuation 3 db), Accuracy ± 0.05 db at max. attenuation. **\$275.00**

Model ATV-9, 0-9 db in 1 db steps, Accuracy ± 0.1 db at max. attenuation. **\$250.00**

Model ATV-50, 0-50 db in 10 db steps, Accuracy ± 0.5 db at max. attenuation. **\$195.00**

Group this with 50 ohm impedance, VSWR of 1.06:1 at 1000 MHz (1.1:1 at 1200 MHz), low insertion loss .1 db maximum, and you come up with THE BEST BUY IN THE INDUSTRY! If you're operating DC to 1200 MHz... send for complete specs today.



MEASUREMENT AND
TEST INSTRUMENTATION

JERROLD ELECTRONICS CORPORATION
Government and Industrial Division
Philadelphia, Pa. 19105

Meetings

Technical & Electronic Ceramic Manufacturer's Exhibit & Seminar; seminar committee of the Technical & Electronic Ceramic Manufacturer's Exhibit & Seminar; New York Trade Show Building, New York City, Nov. 1-3.

Northeast Electronics Research and Engineering Meeting, IEEE; Sheraton-Boston Hotel, Boston, Nov. 2-4.

Reliability Engineering and Management Institute Meeting, Reliability Engineering and Management Institute; the University of Arizona's Student Union Building, Nov. 7-16.

Symposium on Automatic Support Systems for Advanced Maintainability, St. Louis Section of IEEE; Colony Motor Inn, Clayton, Mo., Nov. 7-9.

Fall Joint Computer Conference, American Federation of Information Processing Societies; Civic Center, San Francisco, Nov. 8-10.*

Engineering in Medicine and Biology Conference, IEEE; Sheraton-Palace Hotel, San Francisco, Calif., Nov. 14-17.

National Electrical Manufacturers Meeting, National Electrical Manufacturers Association; Palmer House, Chicago, Nov. 14-17.

Aircraft Design and Technology Meeting, American Institute of Aeronautics and Astronautics; International Hotel, Los Angeles, Calif., Nov. 15-18.

Ceramic/'66 Exhibit and Seminar, Technical & Electronic Manufacturer's Association; Trade Show Building, New York City, Nov. 15-17.

Conference on Magnetic & Magnetics Materials, IEEE; Sheraton Park Hotel, Washington, D.C., Nov. 15-18.

Mid-Atlantic Engineering Conference and Tool Exposition, American Society of Tool and Manufacturing Engineers; Baltimore Civic Center, Baltimore, Md., Nov. 15-17.

National Conference on the Management of Aerospace Programs, American Astronautical Society; University of Missouri, Columbia, Mo., Nov. 16-18.

Engineering and Maintenance Conference, Air Transport Association; Century Plaza Hotel, Century City, Los Angeles, Calif., Nov. 17-18.

Symposium on Oceanography and Oceanology, Institute of Environmental Sciences; Henry Hudson Hotel, New York, Nov. 17.

Energy Conversion Exposition, American Society of Mechanical Engineers; Statler Hilton, New York City, Nov. 27-Dec. 1.

Vehicular Communications Conference, IEEE; Montreal, Quebec, Dec. 1-2.

Meeting of the National Committee of the International Scientific Radio Union; Cabana Motor Hotel, Palo Alto, Calif., Dec. 7-9.

Electronics Industry Plating Symposium, American Electroplaters' Society; Robert Treat Hotel, Newark, N. J., Dec. 8-9.

Call for papers

National Telemetering Conference, IEEE; San Francisco Hilton Hotel, San Francisco, Calif., May 16-18. **Nov. 4** is deadline for submission of abstracts to Max A. Lowy, program chairman, General Electric Co. P.O. Box 8048, Philadelphia, Pa.

National Particle Accelerator Conference—Accelerator Engineering and Technology, IEEE, Shoreham Hotel, Washington, March 1-3. **Nov. 15** is deadline for submission of 200-word abstracts to John A. Martin, program chairman, Oak Ridge National Laboratory, P.O. Box X, Oak Ridge, Tenn. 37830.

Packaging Industry Technical Conference, IEEE; Holiday Inn, New York City, May 9-11. **Nov. 15** is deadline for submission of 60-word abstracts to John T. Winship, Engineering Editor, Modern Packaging Magazine, 1301 Avenue of the Americas, New York, N.Y. 10019.

Southwestern IEEE Conference and Exhibition, IEEE; Dallas Memorial Auditorium, Dallas, Texas, April 19-21, 1967. **Dec. 16** is deadline for submission of paper to Arwin A. Dougal, University of Texas, Engineering-Science Building 112, Austin, Texas 78712.

* Meeting preview on page 16

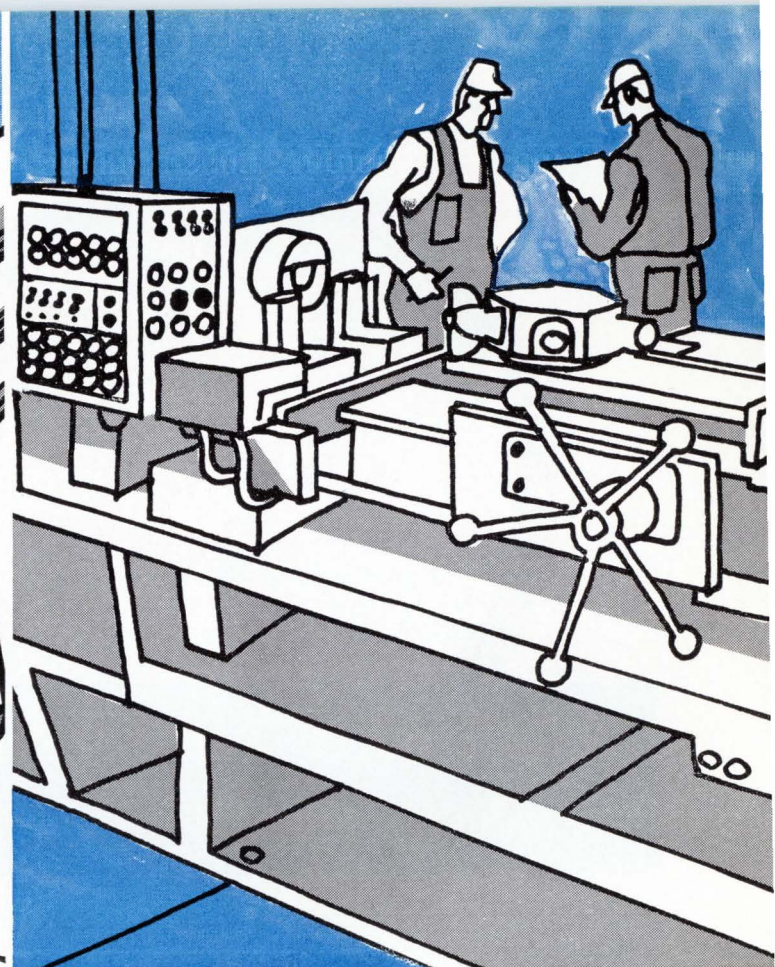
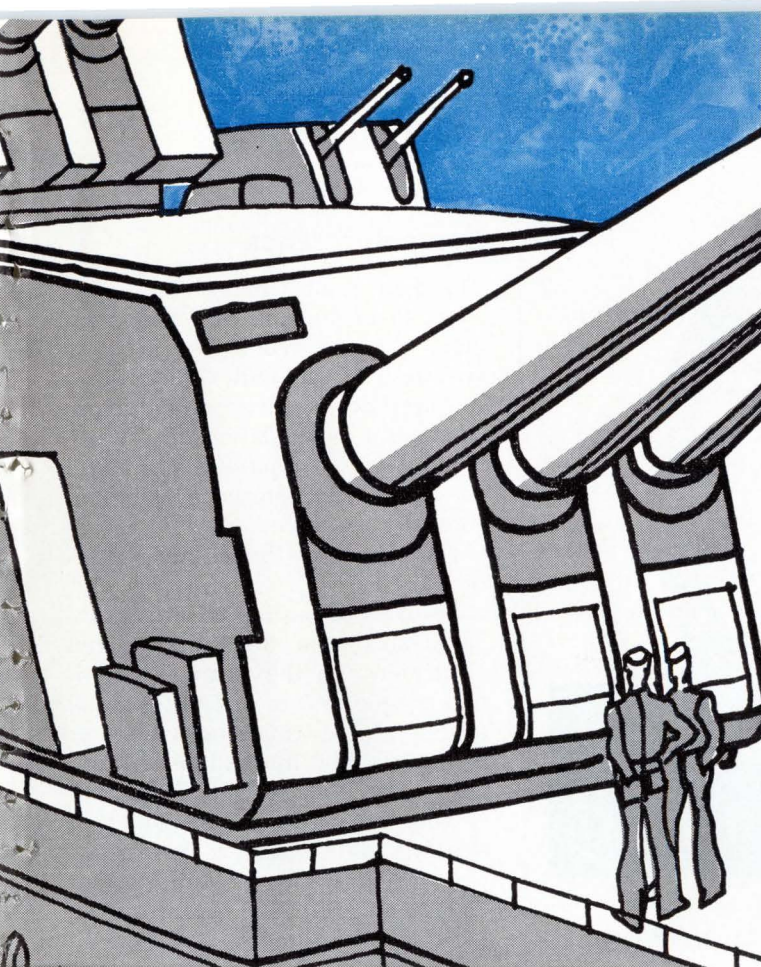

From Gun Turret to Turret Lathe... Amelco's new HNIL logic with 4 volts noise immunity helps provide accurate computer control!



SPECIFICATIONS

V _{cc}	12 volts
Logical "1"	11 volts
Logical "0"	1.2 volts
Fan Out	5
Noise Immunity	4.2 volts
Propagation Delay	60 nSec

Now you can enjoy the advantages of dependable integrated circuitry where noise and cost have been prohibitive. Amelco's new High Noise Immunity Logic is available in a full seven element family of 12 volt circuits that provide 4 volt noise immunity over a temperature range of -55°C to $+125^{\circ}\text{C}$. These same seven elements are also available in an operating temperature range of 0°C to 100°C at low, industrial prices! Use HNIL circuits in virtually any industrial or military high noise environment without fear of spurious operation.

□ Amelco HNIL is available in the following elements: 301 Dual 5-Input Buffer with Expanders, 311 J-K Flip-Flop, 321 Quad 2-Input Gate with Expanders, 322 Dual 5-Input Gate with Expanders, 331 Dual 5-Input Expander, 341 Dual Exclusive "OR" with Expanders, 361 Input Interface Circuit, 362 Output Interface Circuit.

Circle 15 on reader service card

AMELCO SEMICONDUCTOR

DIVISION OF TELEDYNE, INC. • 1300 TERRA BELLA AVENUE • MOUNTAIN VIEW, CALIFORNIA • Mail Address: P. O. Box 1030, Mountain View, California • Phone: (415) 968-9241 / TWX: (415) 969-9112 / Telex: 34-8416 • REGIONAL OFFICES: Southwest—Suite 213, 8621 Bellanca Ave., Los Angeles, California 90045, (213) 678-3146 • Northwest—1300 Terra Bella Ave., Mountain View, California, (415) 968-9241 East—P. O. Box 2091, Paterson, New Jersey 07509, (201) 696-4747; 60 Broad Hollow Rd., Melville L. I. New York, (516) 692-4070; P. O. Box 366, Kimberton, Pennsylvania, (215) 885-1755 • Northeast—805 High Street, Westwood, Massachusetts, (617) 326-6600 • Southeast—711 Magnolia Avenue, Orlando, Florida, (305) 423-5833 • Midwest—650 West Algonquin Road, Des Plaines, Illinois, (312) 439-3250; 3020 Woodlark Lane, St. Paul, Minnesota, (612) 646-1161. • Canada—Deskin Sales, Montreal, Quebec, (514) 384-1420.

New from Sprague!

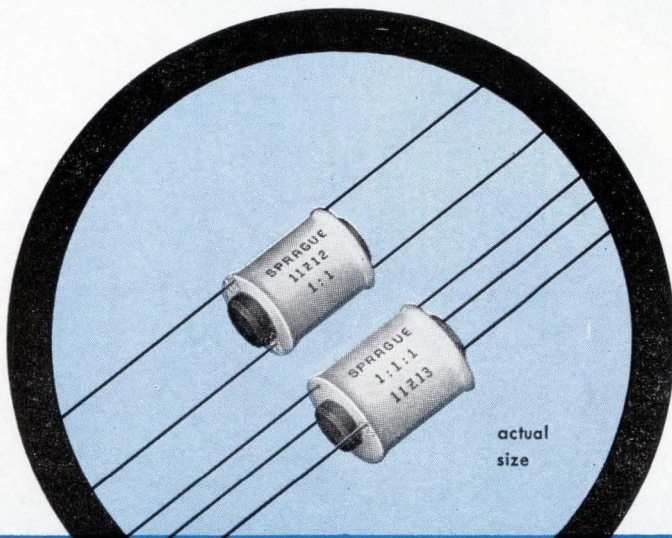

TRIGATE* PULSE TRANSFORMERS... the industry's lowest-cost SCR triggers!

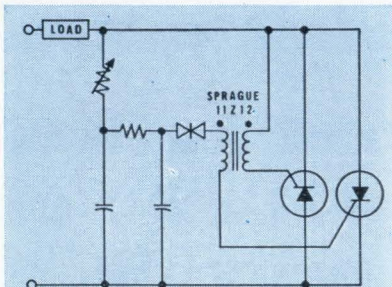

This breakdown-diode/transformer triggering circuit is a typical application for Type 11Z12 Trigate Pulse Transformers.

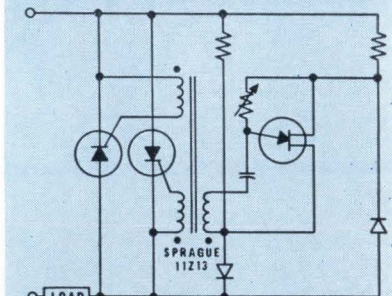

This unijunction-transistor/transformer triggering circuit is a typical application for Type 11Z13 Trigate Pulse Transformers.

Dependable enough for industrial equipment, yet priced for high-volume commercial applications

Here's good news for designers of appliances; lighting controls; air-conditioning and heating controls; industrial controls. You can actually cut costs while upgrading your present method of SCR triggering!

Type 11Z Trigate* Pulse Transformers offer these unique features:

1. Balanced pulse characteristics and energy transfer from primary to secondary and tertiary windings.
2. Minimum saturation effect to allow operation where increased pulse widths are required.
3. Fast pulse rise time and increased current capability to prevent SCR di/dt failure.
4. Increased energy transfer efficiency.

Designed for operation over the temperature range of -10 C to $+70\text{ C}$, Trigate Pulse Transformers are available in 2-winding and 3-winding configurations for half-wave, and full-wave applications. Turns ratios include: 1:1, 1:1:1, 2:1, 2:1:1, 5:1.

For complete information, write for Engineering Bulletin 40,003 to the Technical Literature Service, Sprague Electric Co., 35 Marshall St., North Adams, Mass. 01247

*trademark

SPRAGUE COMPONENTS

PULSE TRANSFORMERS
CAPACITORS
TRANSISTORS
RESISTORS
THIN-FILM MICROCIRCUITS
INTEGRATED CIRCUITS

INTERFERENCE FILTERS
PACKAGED COMPONENT ASSEMBLIES
FUNCTIONAL DIGITAL CIRCUITS
MAGNETIC COMPONENTS
CERAMIC-BASE PRINTED NETWORKS
PULSE-FORMING NETWORKS



*Sprague and ® are registered trademarks of the Sprague Electric Co.

Meeting preview

Computer trends

The Fall Joint Computer Conference, to be held in San Francisco Nov. 8 to 10, will cover a broad spectrum of computer interests—from reports on advanced hardware concepts to speculation on the impact of the computer on modern society. The conference is sponsored by the American Federation of Information Processing Societies.

Sessions of particular interest include one on the effect of integrated electronics on the future of computers, another on computer-aided design and a third on computer memories. The integrated-electronics session will feature Robert N. Noyce, a group vice president of the Fairchild Camera & Instrument Corp., L.C. Hobbs of Hobbs Associates and Michael J. Flynn of the University of Illinois.

Noyce and Hobbs will discuss the cost outlook for large scale integration. Noyce will concentrate on manufacturing versus design and Hobbs on machine organization, input-output devices and software. Flynn, who designed the International Business Machines Corp. System 360 model 90 before moving on to the university, will examine architecture and the new design criteria that future systems will require.

Ways to remember. New memory technologies will be described in a session to be chaired by J.A. Rajchman of the Radio Corp. of America. Papers will include a description of the plated-wire memory that is part of the Sperry Rand Corp.'s new Univac 9000 series computers, a 200-nanosecond thin-film memory, a 100-nsec rod memory and an integrated-circuit scratch pad memory.

Dana W. Moore of Honeywell, Inc.'s Computer Control division will discuss the cost of implementing ferrite-core memories in various organizations. Representatives of the Xerox Corp. and RCA have prepared a paper on a sonic film memory that combines the technologies of thin films and sonic delay lines to produce a nonvolatile memory system.

RESOLVER/SYNCHRO DIGITAL CONVERSION

A very short course for engineers who are concerned with converting resolver or synchro data to digits and vice versa.

Engineers working in digital computer input/output interface systems for tactical airborne equipment, aircraft and space vehicle simulation, antenna positioning or programming, and similar systems are increasingly involved in solving the digital/analog interface problem for resolver and synchro data. Accomplishing this task becomes quite simple by taking advantage of North Atlantic's family of high accuracy resolver/synchro converters. Through the use of solid-state switching and precision transformer techniques, these converters provide single-speed accuracy and resolution from 10 to 17 bits, along with solid-state reliability and calibration-free operation.

Resolver/Synchro-To-Digital Conversion

One typical North Atlantic resolver/synchro interface is the Automatic Angle Position Indicator (Figure 1), which converts angular data from both 400Hz resolvers and synchros to digits.

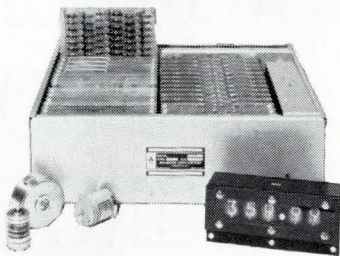

Figure 1. Model 5450 Automatic Angle Position Indicator converts resolver and synchro angles to digital form.

This device uses all solid-state plug-in cards and trigonometric transformer elements (no motors, gears or relays), and operates at all line-to-line voltages from 9 to 115 volts. It can be supplied in a wide range of configurations for specific system requirements, for example, signal frequencies 60Hz to 10KHz, binary or BCD outputs, .001° resolution with 10 arc second

accuracy, and multi-speed and/or multiplexed inputs. Its five-digit Nixie readout can be integral or remote.

The unit illustrated has an accuracy of .01°, and two basic modes of operation. They are read-on command (rapid acquisition) and tracking (least significant bit update). Prices start at \$5900.

Digital-To-Resolver/Synchro Conversion

North Atlantic's all solid-state digital-to-resolver/synchro converters (Figure 2) accept digital input data at computer speeds in either binary angle or binary sine/cosine form and convert to either resolver or synchro data. Their high accuracy and resolution (up to 17 bits) and freedom from switching transients meets an important requirement in space-mission simulation and antenna positioning systems for smooth servo performance at low rates of data change. All models are usually supplied with input storage registers.

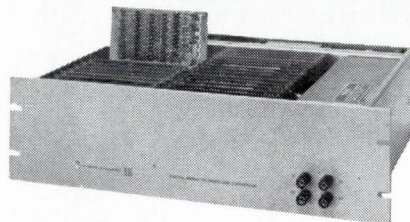

Figure 2. Series 536 Digital-To-Resolver Converters translate binary digital angle to four-wire resolver data.

Depending on the combination of features specified, prices are in the \$4500. to \$6000. range.

Modular D-R/S Converters For High-Density Systems

The plug-in converters pictured in Figure 3 were developed by North Atlantic specifically for airborne systems and for aircraft simulation systems requiring high-den-

sity multi-channel operation. The modules illustrated provide 11-bit digital-to-synchro conversion and are capable of driving up to four torque receivers. As with other North Atlantic resolver/synchro interfaces, conversion is achieved through solid-state switching and trigonometric transformers, so there are none of the stability or calibration problems associated with conventional resistor-chain/amplifier type converters. Prices, in production quantities, run about \$1100. per set. In prototype quantities about \$1500. a set.

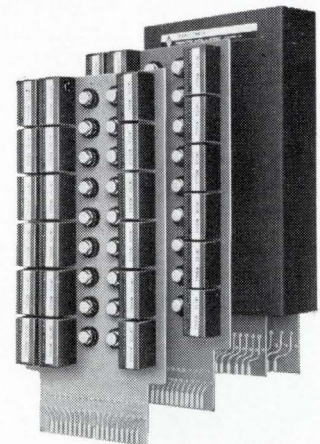

Figure 3. Series 537 D/S Converter Modules can drive multiple torque receivers from 11-bit digital data.

If you would like to take advantage of North Atlantic's state-of-art experience in resolver/synchro computer interface, we would be pleased to show you how these converters can meet your particular requirements. Or if you prefer, we will arrange a comprehensive technical seminar for your project group, without cost, in your own plant. Simply write: North Atlantic Industries, Inc., 200 Terminal Drive, Plainview, N.Y. 11803. TWX 510-221-1879. / Phone 516-681-8600.

NEW FET CHOPPER-MFE2133 FOR MILITARY/INDUSTRIAL DESIGNS

... featuring low r_{ds} "on" — 60 ohms (max)

Here is *one* high-impedance device that can dissipate 1.5 watts. In addition, Motorola's TO-39 package — with low thermal resistance ($6.7 \text{ mW}/^\circ\text{C}$) — keeps the junction relatively free of troublesome temperature swings. The MFE2133 also offers low transfer capacitance (5 pF) in proportion to the low drain-source resistance. And, the combination makes for better all-around switching performance.

The MFE2133 is suitable for large gate voltage swings as a chopper. The circuit as shown allows input voltages of 10 volts. No transformer is required. The result, of course, is circuit simplicity and savings in component costs.

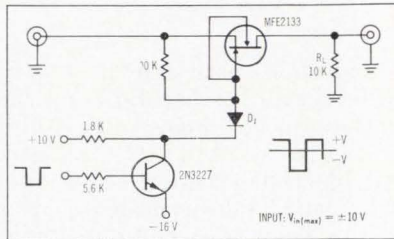

CIRCLE 308 READERS SERVICE CARD

MEDIUM-POWER AMPLIFIER JFETs FOR INDUSTRIAL & CONSUMER USES

The industry's first medium-power, high-gain, economical JFETs are Motorola types MFE2097 & MFE2098. Because of their natural high impedances, combined with a medium-power capability, you can often eliminate one transformer as well as large coupling and bypass capacitors in most designs. Even greater savings result from the low 100-up price of \$4.90 — *less than half the price of comparable devices!* While these new FETs are ideal for driver stages of audio amplifiers and other audio communications equipment, they are also well-suited for use in analog control systems.

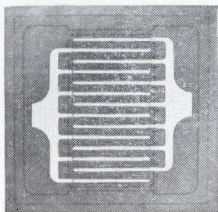

- Medium-power capability results from large geometry with many current paths.
- I_{DSS} ranges from 15 to 50 mA — MFE2097
40 — 100 mA — MFE2098
- $|y_{fs}| = 10,000 \mu\text{mhos (min)} - \text{MFE2097}$
 $14,000 \mu\text{mhos (min)} - \text{MFE2098}$
... for extremely high gain.
- High-dissipation package — TO-39 with $1\frac{1}{2}$ " leads.

CIRCLE 309 READERS SERVICE CARD



MAKE
YOUR MOVE
TO FETs
WITH
ANY ONE OF
FIVE
NEW PIECES
FROM
MOTOROLA



GUARANTEED LOW-NOISE FET FOR VHF AMPLIFIERS AND MIXERS

Now, RF receivers, including high-quality FM sets, can be virtually free from spurious responses, if you specify Motorola's new 2N3823 state-of-the-art JFET. An extremely low 100-MHz noise figure of 2.5 dB (max) is complemented by low cross-modulation and intermodulation distortion.

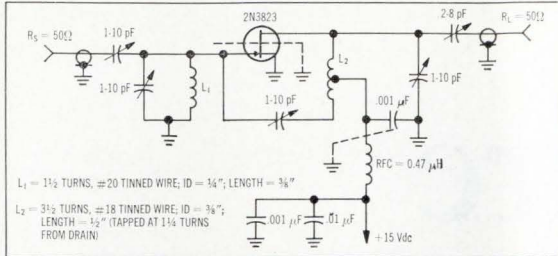

200 MHz Low-Noise Amplifier Circuit

- Symmetrical geometry in TO-72 package — can plug right into existing sockets.
- Also useful in UHF applications — up to 500 MHz.
- Low transfer and input capacitance . . . $C_{iss} = 2$ pF (max).
- $C_{rss} = 6$ pF (max).

CIRCLE 310 READERS SERVICE CARD

GENERAL PURPOSE JFETs OFFER LOW-NOISE & LOW-COST FOR INDUSTRIAL & CONSUMER USES

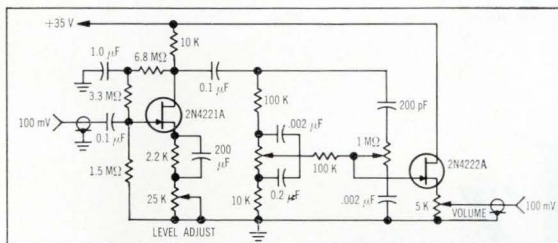

Tone Control for High-fidelity Audio Amplifiers

Ease of converting audio preamplifiers to FET designs with Motorola types 2N4220A-22A has excited the imaginations of engineers. The high input-resistance allows for "vacuum-tube" design principles in selection of tone control elements — permitting use of small, low-cost capacitors.

The low guaranteed noise figure of 2.5 dB (max) at 100 cycles/sec. provides a definite advantage over bipolar transistors. For additional savings, the cost is only \$2.90 (100-up), even lower in larger production quantities.

- N-channel for high gain $|y_{fs}| = 1,000$ μ mhos (min) 2N4220A
2,000 μ mhos (min) 2N4221A
2,500 μ mhos (min) 2N4222A

CIRCLE 311 READERS SERVICE CARD

N-CHANNEL IGFET OFFERS HIGH GAIN FOR GENERAL PURPOSE APPLICATIONS

Motorola's new MFE3001 IGFET operates in both the enhancement and depletion modes, for a broad range of applications in industrial, military, and consumer equipment. And, the 100-up price of \$3.90 makes it practical for most applications. Typical uses are audio amplifiers, switches and controls. A low drain current results from its small geometry, and the n-Channel construction provides high gain indicated by the $|y_{fs}|$ specification of 1,800 μ mhos (typ).



- Extremely high input resistance
 $I_{GSS} < 10$ pA at 10 Vdc
- High Signal-handling capability at low drain currents. $I_{DSS} = 0.5$ mA (min).

CIRCLE 312 READERS SERVICE CARD

FOUR MOTOROLA APPLICATIONS NOTES EXPLAIN NEW FET TECHNOLOGY

To explain the advantages of field-effect transistors in both digital and analog systems, Motorola's Applications Engineers prepared a series of technical papers. The information covers a broad range of applications, and includes sample circuit designs as well as operational theory. Any one or all of them can be added to your semiconductor library, simply by completing and mailing the coupon below, to Dept. T.I.C., Motorola Semiconductors, Box 955, Phoenix, Arizona 85001.

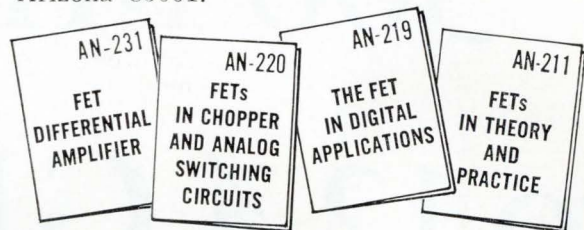

YES, I am interested in learning more about field effect transistors. Please send me the following Motorola Application Notes:

Name _____ Title _____

Company _____ Address _____

City _____ State _____ Zip _____

MOTOROLA Semiconductors

— where the priceless ingredient is care!

To measure
from
300 MHz
to 12.4 GHz...

New Hewlett-Packard 5260A Automatic Frequency Divider

Automatic measurement of frequencies, 0.3 to 12.4 GHz
Direct readout without calculations
Maintains counter accuracy
Constant 100 mV sensitivity

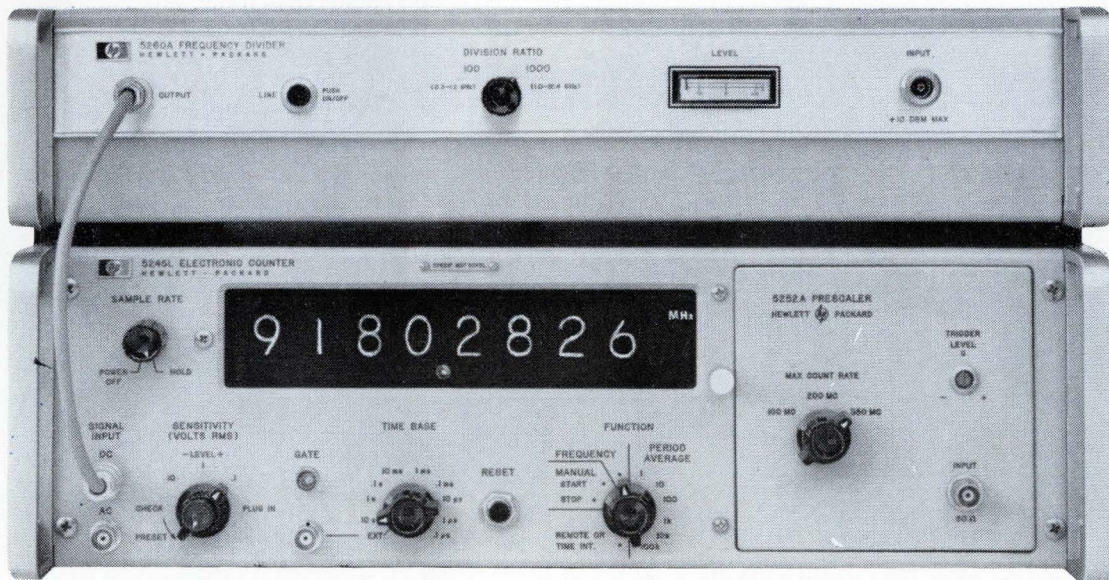

HP 5260A Automatic Frequency Divider with HP 5245L Electronic Counter (the 5252A Prescaler Plug-in is not necessary; but with it, the system covers dc to 12.4 GHz!)

try an automatic

Take any suitable electronic counter (such as Hewlett-Packard models 5245L, 5246L or 5244L), connect it to this new frequency divider, and you have an automatic system to measure microwave frequencies from 300 MHz through X-band with counter accuracy.

Measurements are accurate and simple, and no calculations are needed. A ratio switch selects $\div 100$ ratio for inputs of 0.3 to 1.2 GHz, or $\div 1000$ for 1 to 12.4 GHz. No other adjustments needed.

The Hewlett-Packard 5260A can be added to existing counters merely by connecting the output of the divider to the input of the counter.

Besides all these advantages, the 5260A is also the most economical instrument (by more than \$1000!) for automatic, high accuracy frequency measurement from 0.3 to 12.4 GHz... even when you add in the price of an electronic counter to go with it.

Check our specifications, then call your nearest HP field representative for a demonstration or write for details, Hewlett-Packard, Palo Alto, California 94304, Tel. (415) 326-7000; Europe: 54 Route des Acacias, Geneva.

BRIEF SPECIFICATIONS

Range: 0.3 to 12.4 GHz
Accuracy: Retains accuracy of electronic counter
Input sensitivity: 100 mV rms (-7 dBm)
Input impedance: 50 ohms nominal
Division ratio: Front panel switch selects $\div 100$ (for use to 1.2 GHz) or $\div 1000$ (from 1 to 12.4 GHz) operation
Output frequency: 1/100 or 1/1000 of input (1 to 12.4 MHz)

Price: \$3250

Data subject to change without notice. Price f.o.b. factory.

HEWLETT  **PACKARD**
An extra measure of quality



SPEAKING OF STEPPERS



Series 705

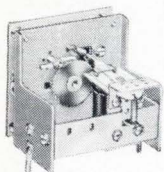

PC

Suppose you built this robot. (You might as well build it to look like this one.)

Anyway, suppose you set her stride at 24 inches and controlled her gait with a Guardian stepper (one step per step). You could program her to walk from New York to Los Angeles and on into the Pacific, with complete assurance that her Guardian stepper would still be clicking away.

You have no robots on the drawing board? No matter. The important things to remember are that Guardian steppers average over ten million operations on the life test rack—and that Guardian makes more steppers, and more different types of steppers than anybody else in the business.

It's a good idea to have all the specs on all the Guardian steppers in your file. Write for bulletin F32. Guardian Electric Mfg. Co., 1550 W. Carroll Ave., Chicago, Ill. 60607.

Guardian makes the most steppers and the most dependable steppers

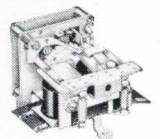

MER

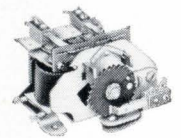

MAS

GUARDIAN  **ELECTRIC**

Editorial

What's the secret?

Nobody knows what makes the rate of technological change suddenly speed up in a country after a lull. Today, the U.S. electronics industry is again in one of those periods of rapid change. Throughout the world the secret of U.S. success is as eagerly sought as the philosopher's stone for which alchemists ardently searched 400 years ago. And for good reason. Today, technology is gold for a country.

Some people say it requires only the application of gargantuan sums of money. They believe the giant expenditure by the U.S. government is the sole force behind the current spurt in technology.

But money alone is not enough. There have been too many examples of companies or government agencies pouring money into research and development and producing nothing.

To cite just one, the Federal Aviation Agency has spent a fortune to develop computers for automatic air traffic control in projects that go back to 1959. Yet the agency is as far from success today as it was before it started, despite phenomenal advances in that same period by others in component and computer technology.

Other observers believe the rapid advance of technology depends on new buildings and much scientific equipment. But the best equipped laboratories don't necessarily produce the most spectacular results. The satirist, J. Northcote Parkinson, claims facetiously that the output of an organization is directly proportional to how old and rundown the facility is. He implies that when an organization builds a sparkling new, glass-walled structure to work in, it is the beginning of the end of the enterprise as a profitable producer. Proof that equipment and new facilities are not enough can be found in the United States. For example, in the past 10 years almost all the steel companies have constructed lavish R&D facilities, yet the major new steel processing techniques—such as basic oxygen steelmaking and continuous casting—have come from old, modest laboratories in Europe where new R&D facilities are just being built.

Still other people say that technology improvement comes from having the right scientists and engineers and giving them freedom to work. Yet stockpiles of good technical men in some of the aerospace companies in the 50's produced nothing and there are dozens of in-

dustrial and university—laboratories staffed with good people who add little to the advancement of technology.

The secret, if there is one, contains all of these elements—money, facilities and people—plus a lot more.

Among the most important additional ingredients are hard work, an overpowering urge to get things done quickly and a balance between theoretical and application effort.

Touring the world and observing technology, a traveler finds that engineers outside the U.S. believe that technological progress has come easily in the U.S. There is a strong tendency to credit money solely for it and blame the lack of funds for failure to move ahead. Foreigners tend to ignore the long backbreaking hours that U.S. engineers have spent to meet sharp deadlines for products and projects. Many make fun of the fast pace at which Americans work and live, ignoring the salutary effect such urgency produces in advancing technology.

Another aspect that is often overlooked by visitors to the United States is the careful, though unplanned, balance electronics has managed between theory and application. The scales are heavily weighted in Europe toward theoretical work, but there is no such bias in the United States.

One of the highspots in the current surge of technology in the U.S. is the way theoretical techniques are being applied to good advantage by engineers. To most practicing engineers, correlation has been a scary mathematical technique that PhD's toy with in the learned but not very useful exercises they publish in long-hair journals. Now someone has come along and made correlation practical for engineers working in a variety of down-to-earth applications by developing an instrument that performs correlation in real time. [The article on page 75 explains how to use this technique in terms a working engineer can understand.] The technique turns out to be particularly useful whenever the crux of a signal processing problem is digging a weak signal out of a morass of noise.

Another useful theoretical technique now being put to practical work is that of the scattering parameter to design high-frequency transistor circuits [Sept. 5, 1966, p. 78]. And winning rapid acceptance is the state variable approach for designing massive networks.

For the most part, engineers in the U.S. welcome suggestions and new ideas. They have to. Competitive pressures force them to keep searching for new developments which can be marketed. Until engineers in other countries feel similar pressures, they'll be unable to match the pace of technological advance in the U.S.—no matter who pays for R&D nor how much is spent.

PRECISION MOLDED MONOBLOCS

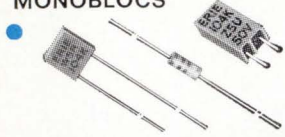

PHENOLIC COATED MONOBLOCS



HERMETICALLY SEALED-IN-GLASS MONOBLOCS



"NEW FLAT-PACK MONOBLOCS"
Five 10,000 pF. capacitors in one package



NEW HIGH VOLTAGE MONOBLOCS
1400 pF. at 3 K Volts...
in only .003 cu. in.



NEW BUTTON-TYPE MONOBLOC FILTER-CAPACITORS



MONOBLOC CHIPS
Any SIZE and shape available



WORLD'S MOST COMPACT TRIMMER CAPACITOR...
5 to 25 pF. 100 WVdc



UNMATCHED for
VOLUMETRIC EFFICIENCY,
STABILITY and RELIABILITY

In today's microcircuitry, Erie's unique MONOBLOC Ceramic Capacitors provide the answer to difficult packaging problems... particularly where high capacitance, demanding stability, great reliability and severe environmental conditions are deciding factors.

Monobloc Subminiature Capacitors are available now for a wide variety of microcircuit applications. Currently, Monoblocs are used extensively in aerospace and military control equipments, communications computers and other areas requiring the reliability of performance so characteristic of Erie Monoblocs.

You name the capacitance problem and Erie will provide a Monobloc Capacitor with better reliability... in a smaller package. Write for Monobloc Ceramic Capacitor literature.

Another Series of Components in Erie's Project "ACTIVE"
Advanced Components Through Increased Volumetric Efficiency



**IF YOU NEED
SMALLER**

**Quality
CAPACITORS...
Specify**

**ERIE
MONOBLOCS**®

ERIE

TECHNOLOGICAL

PRODUCTS, INC.



Erie, Pennsylvania

Electronics Newsletter

October 31, 1966

Through the maze to a new data storage system

The Air Force is investigating an optical technique for storing and processing data that in some respects imitates the learning process. Hardware includes a laser and an alkali crystal.

A prototype has been built by Carson Laboratories, Bristol, Conn. [Electronics, May 30, p. 35]; it uses a potassium bromide crystal impregnated with hydrogen. A red beam from a helium-neon laser writes a binary one by bleaching a tiny spot in the bluish crystal, making that spot transparent. When a subsequent infrared beam hits the spot, the one is erased by recoloring the spot purple. A lower intensity infrared beam interrogates the storage crystal.

For use as an adaptive system the crystal is divided in four equal sections. Coded throughout one section is a maze of spots. The laser randomly scans the section until it hits upon a path through the crystal. A record of all successful paths is recorded in two of the crystal's sections and a history of all the paths is stored in the fourth section.

Court orders end to pirating of engineers

One of the time-honored recruiting grounds for employees has been the competitor. And with the scramble for employees never greater in the electronics industry, the complaints about pirating of employees have been increasing. Now one company—Nexus Research Laboratory, Inc. of Canton, Mass.—has obtained judicial aid. The Middlesex County, Mass., Superior Court issued a temporary order earlier this month restraining Analog Devices, Inc., of Cambridge from contacting or soliciting employees of Nexus "otherwise than through public advertising media." **The temporary order remains in effect pending a hearing.**

Both companies manufacture operational amplifiers, the basic building block of analog data processing. Analog Devices recently completed a new plant in Canton, a town southeast of Boston. Neighboring Dedham is the home of the oldest firm in the area making analog computing equipment—George A. Philbrick Researches, Inc. The combined output of Philbrick, Nexus and Analog represents a major segment of the analog component business in the United States.

RCA uses tungsten for thin-film IC wiring

Add tungsten to the list of materials for thin-film wiring on integrated circuits. It is being used in a new process, under development at the laboratories of the Radio Corp. of America, for air-isolated IC's and arrays. **The IC's are being evaluated for use in microwave systems and other applications at frequencies above 1 gigahertz.**

RCA's technique is to diffuse devices into a silicon wafer, apply thin-film wiring, then press the wafer into molten glass, device side down. After the glass cools, the back of the wafer is etched to remove the silicon between the devices. This allows the transistors in the IC's to operate at frequencies many times the normal 200-megahertz limit for IC's.

Tungsten was chosen as the wiring film because it is a close match in thermal coefficient of expansion with silicon. This prevents the wiring from ripping loose as the glass cools. The resistance of the tungsten wiring is about the same as the usual aluminum wiring, because of the short wiring lengths and because the deposited tungsten is more dense than deposited aluminum. Tungsten also resists the silicon etchants, making the arrays easier to process.

Electronics Newsletter

NASA may ask bids on added memory for Apollo

Computer manufacturers may get a chance in the next two or three months to build a new Apollo applications subsystem—an auxiliary memory for the guidance and control computer. The Raytheon Co., which is producing the Apollo computer, has completed design specifications of the auxiliary unit under a development contract. The National Aeronautics and Space Administration is now deciding whether to give Raytheon a follow-on contract or to issue a competitive request for proposals on a flight-qualified prototype.

If approved, the auxiliary unit would contain 12,000 16-bit words of core memory and 1.5 million words of tape memory. In the Apollo Applications Program flights it would carry experiments beyond the computing capability of the current 40,000-word memory.

Electron beams etch silicon nitride

Silicon nitride has been hailed as the insulating material most likely to improve semiconductor devices and integrated circuits, but it has one major drawback—the difficulty of etching it [Electronics, Oct. 3, p. 108]. At the Electrochemical Society Meeting in Philadelphia this month, it was reported that electron-beam activation of silicon nitride allows it to be etched directly, without resist or complicated reverse-etching processes. The technique is an extension of one being developed at the Westinghouse Electric Corp. research laboratories for direct etching of the conventional IC insulator, silicon dioxide [Electronics, Oct. 17, p. 125].

Pentagon says industry must consider IC's

The trend to integrated circuits in military equipment—already moving at a rapid clip—is being accelerated by the Defense Department. The department now is circulating to both military agencies and industry associations copies of a revised draft of a proposed directive which specifies that all new research and development projects must consider the use of microelectronic technology. An earlier draft [Electronics, Oct. 17, p. 68] had limited circulation—it was sent only to military agencies.

Behind the agency's push for greater use of IC's is a growing conviction that military electronic equipment can be designed so that there is a high probability it won't fail during its lifetime.

The directive listed two key concepts to be considered:

- Electronic modules, containing "several to many" IC's, should be cheap and reliable enough so that, if and when they fail, it would be economically practical to replace rather than repair them.

- Further, there should be what the military calls "logistic self-support." This means the gear has sufficient built-in redundancy, or there should be enough plug-in replacements on hand to last the entire projected lifetime of the equipment.

Flat servomotor

The gears, sprockets, chain drives, pulleys, cables and other parts that convert rotary to linear motion in chart recorders may be a thing of the past. A chart recorder introduced by the Electro-Nite Engineering Co. last week makes use of a lineal a-c induction motor that eliminates motion conversion. The motor is flat. The conventional stator—a compact mass about 2 inches long—is the moving element, and the armature is a stationary linear bar that stretches across the top of the recorder.

IDEAS

from SYLVANIA Electronic Components Group

MICROWAVE DIODES

Voltage breakdown and switching speed requirements are met with this PIN diode

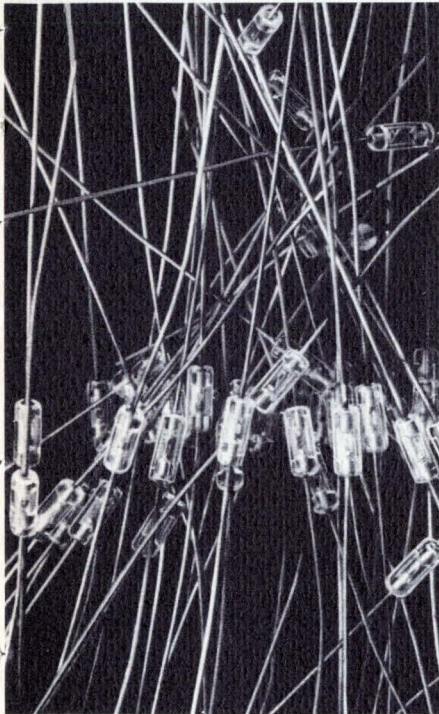

PIN microwave switching diodes are not usually characterized as fast switching devices which combine high voltage breakdown and good isolation. Improved diffusion, bonding and passivation processing techniques make Sylvania's D-5720 series an exception to the rule. Because of their unusual properties, these devices are finding wide applications in the inputs of systems which require switching of microwave power ranging from microwatts to watts CW and up to kilowatts in pulsed operation.

Take a breakdown voltage of 200 V, a switching time as low as 10 nano-seconds, an isolation of 20 db at C-band in a shunt-tuned configuration, and a series self-resonant frequency of 11-16 GHz. Combine them with extreme stability throughout a long life and you've described Sylvania's

D-5720 series of PIN diodes.

These microwave switching diodes rely on improved processing techniques for their superior performance capabilities. Sylvania has developed techniques which reduce junction capacity to maintain high isolation characteristics over a wide range of microwave frequencies. Sylvania's improved lead bonding insures reliable operation in severe environments, while improved passivation minimizes changes in electrical characteristics with life.

Characteristics of the devices which result from these improved processes are shown in the table. These silicon diodes operate as a voltage-dependent variable resistance when biased in the forward direction, and as a relatively small and nearly constant capacitance when reverse-biased. *(continued)*

SWITCHING CHARACTERISTICS OF D-5720 "FAST" PIN DIODE

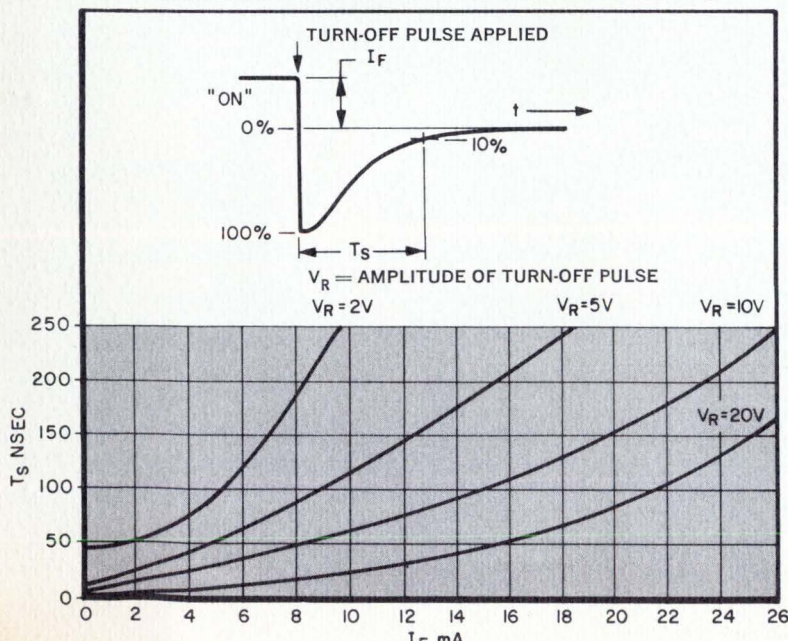

This Issue in Capsule

Integrated Circuits — A new device that shapes, detects, gates, integrates, delays, oscillates, restores, and filters.

CRTs — Preassembled, prealigned packages can insure performance while reducing downtime and costs.

Readouts — Customized Electroluminescent units solve military display problems.

Diodes — How to avoid selecting and testing when the circuit calls for matched diodes.

Transistors — Reduce noise with high-frequency NPN silicon units.

Receiving Tubes — Steadier dc with improved VR tubes.

Integrated Circuits — New dual J-K flip-flops reduce can count, boost speed.

(continued from pg. 1)

The total capacitance listed in the table includes 0.05 pf, attributable to the 075 package in which the diodes are mounted.

All the PIN diodes tabulated are capable of withstanding these environmental tests called for in MIL-STD-750: Temperature Cycle from -65°C to 150°C for 5 cycles; Thermal Shock— 100°C to 0°C ; Moisture Resistance—95% R. H., 10 cycles, 10°C to 65°C ; Shock—1500-g for 0.5 milliseconds, 5 blows in each of 3 planes; Vibration—20-g from 100 to 2000 Hg, four 5-minute cycles in each of three orientations; Constant Acceleration—20,000-g for one minute in each of three planes; and Storage Life— 150°C for 1000 hours. CIRCLE NUMBER 300

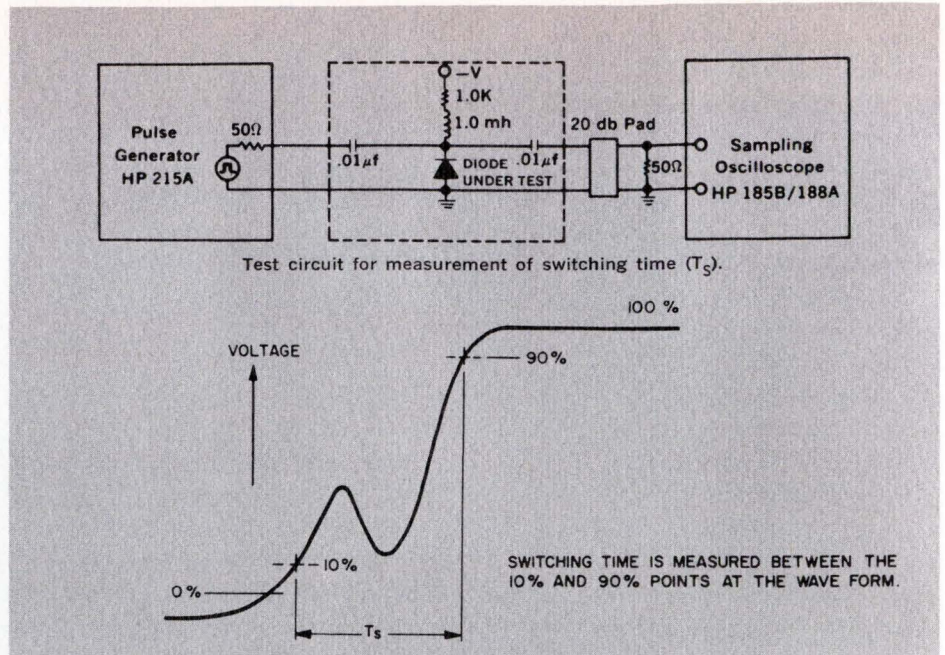

ELECTRICAL CHARACTERISTICS, D-5720 SERIES:						MAXIMUM RATINGS:	
CHARACTERISTICS	CONDITIONS	D-5720	D-5720A	D-5720B	UNITS		
V_B	@ $10 \mu\text{a}$	200	200	200	V	Total Power Dissipation	
C_T max.	@ -25 v , 1MHz	0.1	0.2	0.35	pf	$P_T = 150^{\circ}\text{C} - T_A$	
R_s max.	@ 500MHz, 100 ma	3.0	2.5	2.0	ohms	$\frac{R_{\theta D} + R_{\theta M}}$	
R_t max.	---	400	400	400	$^{\circ}\text{C}/\text{watt}$	P_T —Total power dissipation	
T_s typ.	---	10	15	20	Nsec.	T_A —Ambient Temperature.	
						$R_{\theta D}$ —Thermal resistance of diode.	
						$R_{\theta M}$ —Thermal resistance of mount.	
						Storage Temperature, T_{stg} 200°C	
						Junction Temperature, max. T_j 150°C	

CRTs

“Instant Display” package cuts downtime, insures performance, reduces cost

Critical display applications often require keeping equipment downtime to a minimum while optimizing system performance. In displays using conventional CRTs, meeting these two objectives is no easy task because optimum performance usually involves extensive alignment and ad-

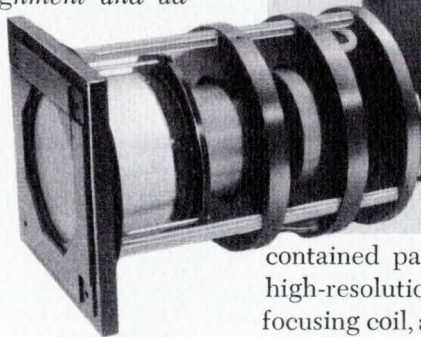

SYLVANIA'S
AT-SK-6003/5CEP

justment after the CRT has been installed or replaced. Here's how Sylvania's "Instant Display" concept uses packaged assemblies to overcome this problem.

Fully preadjusted and prealigned CRT assemblies are the key to insuring top performance in CRT display systems. Each assembly is a self-



contained package complete with a high-resolution tube, deflection coil, focusing coil, alignment magnets, mu-metal shield and associated mounting plates and supporting hardware.

Installation is easy with these devices. They just need to be plugged in. Because no further alignment or adjustment is needed, they can even be installed by non-technical people. And because the components have been prealigned, you get immediate

optimum resolution no matter who installs them.

Servicing is just as simple because the assembly is simply replaced by another complete package. You just take out the old unit and plug in the new one. Again, no alignment or adjustment is required to optimize resolution.

Typical of these packaged assemblies with "Instant Display" capability is the AT-SK-6003. It's designed for use with electrostatic focus tubes such as the 5CEP. Other Sylvania packaged assemblies include the AT-SK-6000, for use with electrostatic focus tubes like the 5ZP. The AT-SK-5053 assembly is supplied with the 10" SC-3890 or any of these 5" CRTs: 5CEP, 5ZP, SC-2782 or SC-3168.

These units are suited for any CRT display application where high resolution and continuous display are of prime consideration, including systems requiring high-resolution flying spot scanning, photographic recording, and video recording.

The Importance of New Products

When designers specify new products, often they consider that they themselves are the ones who are out on a limb. Ever think about those who develop the product? A new-product failure takes just as much time and just as much money to develop as a new-product winner.

To be worth its salt, a new product must solve or simplify a problem. Obviously, the ultimate User Benefit has to be constantly kept in mind. Without it, there's not much sense in a developmental undertaking in the first place. That's the essential Sylvania philosophy on new products: ultimate user benefit.

Much has been and is being written about the importance of new products. As we at Sylvania see it, this body of literature can be effectively grouped under three major headings: new products are a major contributor to corporate growth, new products are a primary influence on profit performance, and new products are a key factor in business planning.

Growth industries through business history have been heavily built on new products. This has been of increasing importance in recent years and will reach even greater importance in the future as competition continues to intensify and the flood of new products shortens the life-span of existing products.

New products have a characteristic pattern to their sales volume and profit margin. The profit curve tends to start descending while the sales curve is still rising. This out-of-phase relationship between the profit curve and sales curve suggests that product strategy is better planned around the profit curve than the sales curve.

A primary economic conclusion, derived from analyzing the life cycles of numerous products, is that sooner or later every product risks being preempted by another, or else degenerating into profitless price competition. This inevitable fact makes clear the necessity of careful new product planning to maintain profit margins.

Another key point is that business success tends to be governed not only by what you do, but what others do. This means that, as a business strat-

egy, a company must plan to run ahead of price competition by differentiating its products and introducing new products that can command better margins. Throughout history, the underlying secret of business success has been to be in the right business at the right time, and this strategy is expressed by the selection and development of company products. Profits generally can be sustained in the long run only by a continuing flow of successful new products, not only to replace sales volume, but also to sustain and increase profit margins.

Company plans are keyed to and made up of product plans. The projection of sales, costs, capital, facilities, and personnel needs without clear product plans can only reflect broad targets, not specific programs.

At Sylvania, as in most companies, the plans for growth in sales and profits are at the core of management interests. New products are a major factor in the growth of companies today. When a company selects and develops a product, it is determining its customers, competitors, suppliers, facilities, skill needs, and the socio-economic environment that will form the perimeter of its opportunity for success.

Before proceeding with this premise, it is necessary to establish a common understanding of a new product. As defined here, it refers to a product that is new to the company, even though it may have been made in some form by others. Whenever the product is new to the company, the problems inherent will not have previously been faced by management and must be handled as a new product.

A product has three key dimensions. *Technology*—the fund of knowledge—technical and otherwise—enabling the product to be economically produced, and *Markets*—to whom and how the product is to be sold—enabling profitable distribution. A third is *Product Evolution*, or the time it takes to bring it into existence.

The Stages of New Product Evolution

At Sylvania, we have found that the new product process can be broken

down into manageable stages for planning and control. Study of case histories reveals that there are six fairly clear stages, although the labels for such stages vary from company to company.

Exploration—the search for product ideas to meet company objectives.

Screening—a quick analysis to determine which ideas are pertinent and merit more detailed study.

Business Analysis—the expansion of the idea, through creative analysis, into a concrete business recommendation, including product features and a program for the product.

Development—turning the idea-on-paper into a product-in-hand, demonstratable and producible.

Testing—the commercial experiments necessary to verify earlier business judgments.

Commercialization—launching the product in full-scale production and sale, committing the company's reputation and resources.

Conclusions on New Product Evolution

In examining the management process of new product evolution, the conclusion is reached that heavy attention should be focused on the first three stages. As will be remembered, these are the idea or concept stages. Experience of major companies indicates that most products fail because the idea or its timing was wrong, and not because the company lacked the knowledge to develop and commercialize the product.

Therefore, well-managed companies can concentrate with advantage on the early stages of determining "what should be developed." As we said before, it takes just as long and just as much money to develop a new product failure as it does to create a spectacular winner in the marketplace. There are plenty of problems to solve in the world. The secret of success is to be working on the problems which have solutions for which there is a marketable demand.

Jack B. Clarkson

Need steadier dc?

Try these improved VR tubes

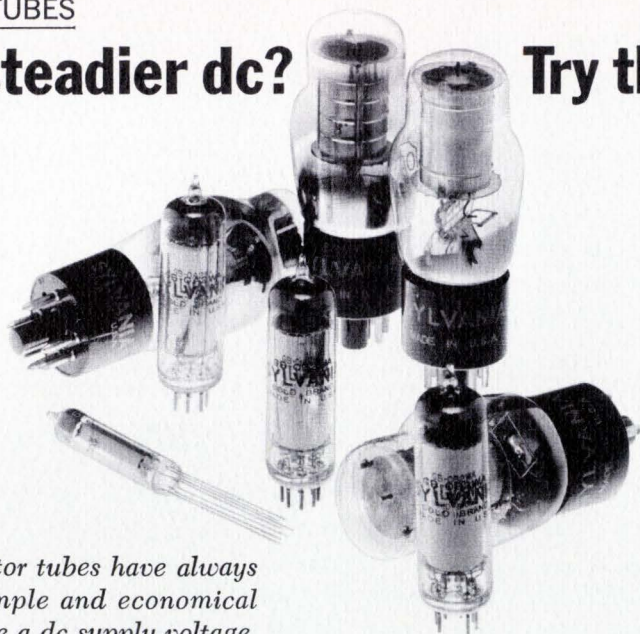

Voltage regulator tubes have always provided a simple and economical way to stabilize a dc supply voltage. But, with Sylvania's broad line of cold cathode, glow discharge VR tubes, you get more than simplicity and economy. Continuing improvement in tube design and manufacturing techniques means your Sylvania distributor has tubes with better regulation and other electrical characteristics. In addition to high quality industrial standard types, he also carries Sylvania's premium Gold Brand VRs. You'll find devices rated for use at altitudes to 120,000 feet and tubes able to take impact accelerations of 500-g for 1 msec.

No matter in what environment—commercial, industrial, or military (you may need regulated dc of 75 volts or more)—chances are there's one or a combination of Sylvania VR tubes to fill the requirement. The chart shows the many VR tubes avail-

able to meet your needs. For higher voltages than are obtainable from a single tube, connect two or more tubes in series. Of course, different types may be combined as long as the current rating of the lowest-rated tube is not exceeded.

Whichever tube is selected, the user and designer can be sure of a reliable regulated dc output. A continuous design and process improvement program sees to it that quality levels are maintained and that performance levels are improved.

Typical of this improved performance is the OB2. In this tube type, two common problems, Voltage Jump (random voltage pulses of a few milliseconds or less) and 400-cycle oscillation, have been eliminated by redesign and process improvement. Tight control of gas mixture and pressure

insures that Voltage Jump is kept within 0.1 percent of the regulated voltage.

Type 5644 is a premium device with an operating voltage of approximately 95 volts. Designed to provide dependable service under conditions of severe shock, vibration and high altitude, it can take bulb temperatures of up to 220°C. It has these radiation ratings: Total Dosage (neutrons/sq. cm)— 10^{16} nvt, Dose Rate (neutrons/sq. cm/sec.)— 10^{12} nv. This tube has three cathode leads to give a rugged mount support and additional external tie points.

Gold Brand types GB-OA2WA and GB-OB2WA provide a high level of reliability. Tested to tight acceptance criteria, these tubes are rated for altitudes to 120,000 feet and for impact accelerations of 500-g for up to 1 msec.

SYLVANIA VR TUBES

Type	DC Output Volts	Operating Current Range (mA)	DC Plate Supply Volts (Min.)	Regulation Over Specified Current Range (Volts)
0A2	150	5 to 30	185	6
*GB-0A2WA	150	5 to 30	165	5
0B2	108	5 to 30	133	3.5
*GB-0B2WA	108	5 to 30	130	2.5
0B3	90	5 to 30	130	6
0C3	105	5 to 40	133	4
0D3	150	5 to 40	185	5.5
5644	95	5 to 25	130	5

*GB Prefix—Sylvania Gold Brand Type—designed and manufactured for critical industrial and commercial applications.

CIRCLE NUMBER 302

DIODES

Avoid selecting and testing when the circuit calls for matched diodes

Sylvania's improved version of the standard 1N541 point contact germanium diode eliminates the need to specify matched pairs when circuit requirements call for precisely balanced diodes. These new units are so uniform from diode to diode that the designer gets satisfactory performance without selecting and testing devices to insure matched characteristics.

With previous versions of the 1N541, circuit designers specified the 1N542 (two matched 1N541s) while

the device manufacturer did the testing and selecting. Or, if the matching was done by the equipment manufacturer, extensive in-house device testing time upped production costs. Either way, the diode user paid a premium. With the Sylvania 1N541, this added cost is eliminated. Now all that production people need do is to pick at random the number of diodes required.

The advanced 1N541 has a greatly improved forward capacitance char-

acteristic as shown in the graph. The narrow spread of capacitance-forward voltage characteristics indicates tight control during device manufacturing. This same tight control also reduces the spread in the capacitance-reverse voltage parameter.

If the capacitance change with forward voltage were radically different from one diode to another, performance characteristics of balanced circuits would suffer. For example, in a ratio detector the characteristic de-

DIODES (continued)

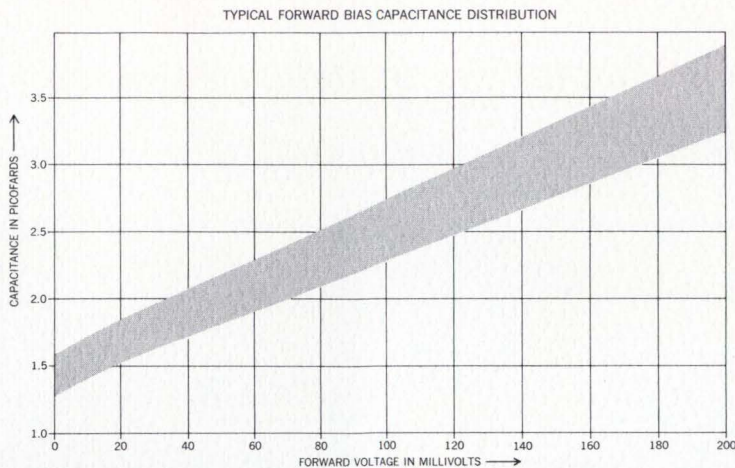
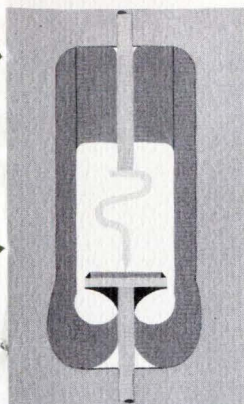

TYPICAL PARAMETER SPECIFICATIONS

Parameter	Test Conditions	Min.	Max.
Forward Voltage	$I_F = 1.0 \text{ ma}$		0.45 v
Forward Voltage	$I_F = 10 \text{ ma}$		1.5 v
Forward Voltage	$I_F = 30 \text{ ma}$		3.0 v
Reverse Current	$V_R = 2.0 \text{ v } 25^\circ\text{C}$		$3.0 \mu\text{a}$
Reverse Current	$V_R = 30 \text{ v } 25^\circ\text{C}$		$150 \mu\text{a}$
Reverse Current	$V_R = 45 \text{ v } 25^\circ\text{C}$		$350 \mu\text{a}$
Reverse Current	$V_R = 2.0 \text{ v } 55^\circ\text{C}$		$20 \mu\text{a}$
Reverse Current	$V_R = 30 \text{ v } 55^\circ\text{C}$		$250 \mu\text{a}$
Reverse Current	$V_R = 45 \text{ v } 55^\circ\text{C}$		$450 \mu\text{a}$
Dynamic Resistance	$I_F = 10 \text{ ma}$	40	80Ω
Rectification Efficiency	1.0 V eff	76	80 %
	3.0 V eff	83	89 %
	$R_L = 33 \text{ K}$		
	$C_L = 330 \text{ pf}$		

tection curve would become highly distorted. This results from detuning one secondary which in turn causes unwanted signals in the detector's output.

In addition to use in FM ratio de-

tectors, the Sylvania 1N541 is ideal for discriminators, balanced modulators and other circuits requiring two or more matched diodes.

To insure uniformity of the devices used in such circuits, the forward volt-

age and reverse current characteristics of the 1N541 are both specified at several levels. Also, tight control is maintained on the 10.7 MHz rectification efficiency.

CIRCLE NUMBER 303

READOUTS

Solve military display problems with customized EL

The Requirement: A defense display system capable of indicating the digits 1 through 9, certain alphabetical characters, and a decimal point.

The Approach: Custom-design a module to convert the available inputs to driving signals for a 5-digit, 7 segments per digit, Electroluminescent (EL) panel.

The Result: All the advantages of EL displays coupled with solid-state reliability.

Sylvania's ability to tailor EL displays to individual specifications allowed a major defense system contractor to meet the requirements outlined above. The contractor selected EL over gas-glow and incandescent devices because of EL's freedom from rf noise generation, low power consumption, compactness, and good readability. Coupling all these advantages with the inherent reliability of solid-state construction made EL the ideal choice for this defense system application.

To control the EL panel used in the system, Sylvania designed a custom modular solid-state driver circuit. The driver uses silicon controlled rectifiers to switch the 250 volts supplied to the lamp segments. Drivers and the associated circuitry are assembled as shown in the photographs.

A key factor in selecting EL panels is their reliability. EL readout panels are not inherently subject to catas-

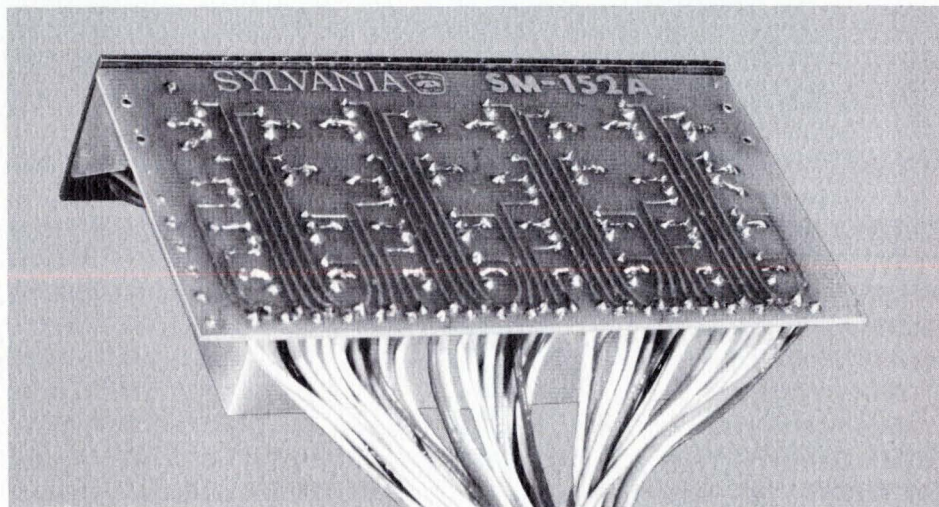
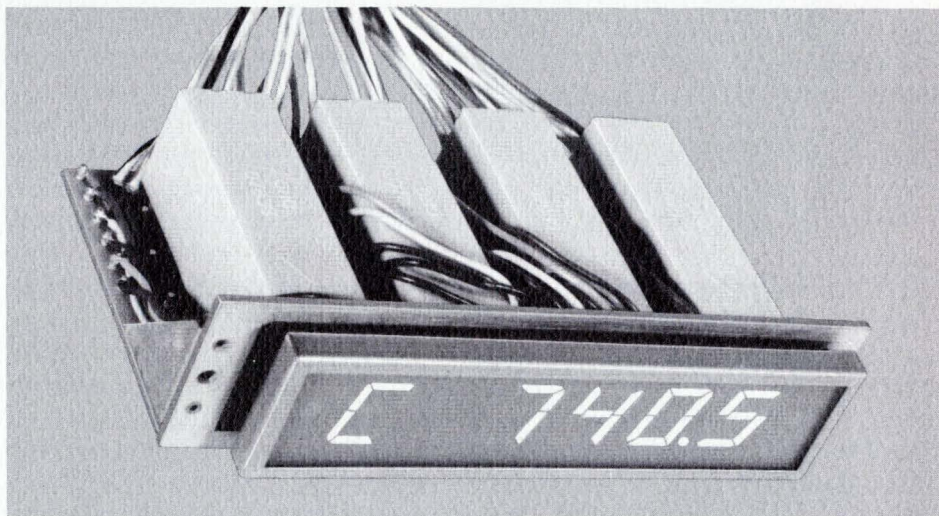

trophic failure.

The resulting display has all the other advantages of EL including a wide viewing angle of almost 180° , an easy-to-read, soft blue-green color

and fast information display.

For your custom display, EL panels in a variety of sizes (up to 6" high) of both numeric and alphanumeric characters are available.

Reduce noise with these high-frequency NPN silicon transistors

TYPICAL NOISE FIGURE vs COLLECTOR CURRENT

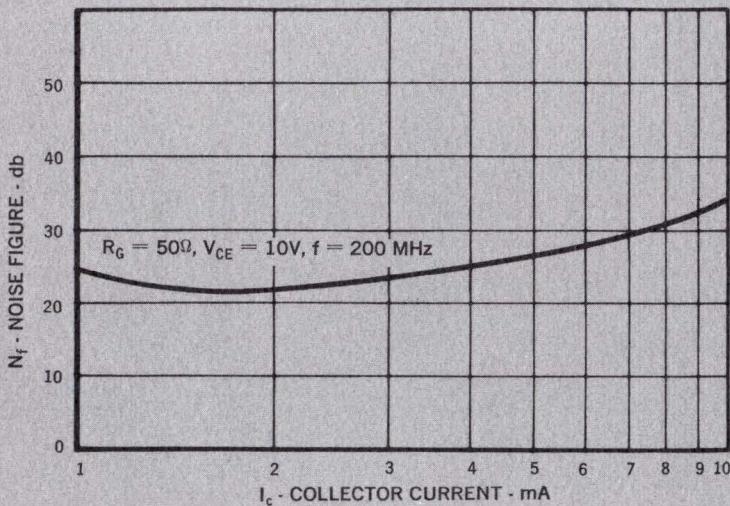

FEATURE CHARACTERISTICS OF 2N918 TRANSISTOR

Collector-Base Breakdown Voltage, $V_{(BR) CBO}$ $I_C = 1.0 \mu A$	30 Volts min.
Emitter-Base Breakdown Voltage, $V_{(BR) EBO}$ $I_E = 10 \mu A$	3.0 Volts min.
Collector-Emitter Breakdown Voltage, $V_{(BR) CEO}$ $I_C = 3.0 mA$	15 Volts min.
Forward Current Transfer Ratio, h_{fe} $V_{CE} = 10V, I_C = 4.0 mA, f = 100 MHz$	6.0 min. (9.0 typ.)
Output Capacitance, C_{ob} $V_{CB} = 10V, I_E = 0, f = 140 kHz$	1.7 pf max.
$V_{CB} = 0V, I_E = 0, f = 140 kHz$	3.0 pf max.
Noise Figure, NF $V_{CB} = 6.0 V, I_C = 1.0 mA, R_G = 400\Omega,$ $f = 60 MHz$	6.0 db max. (2.3 db typ.)
Noise Figure, NF $V_{CB} = 6.0 V, I_C = 2 mA, R_G = 50\Omega, f = 200 MHz$	2.5 db typ.
Collector-Base Time Constant, $r_b' C_c$ $V_{CB} = 10V, I_E = 8 mA, f = 79.8 MHz$	6.5 typ. ps
Power Gain	15 db min. (20 db typ.)

What good is high gain at high frequency in a silicon planar transistor amplifier if the transistor's noise level is also high? Because they feature reduced noise levels, Sylvania's 2N917 and 2N918 transistor family solve noise problems in your high-frequency circuit designs. Typical 200 MHz noise figure for these devices is 2.5 db over an I_C range of 1 to 10 ma. At 60 MHz the noise figure is 2.3 db against a registered limit of 6.0 db.

Sylvania's 2N918 family of NPN double-diffused silicon planar epitaxial transistors is expressly made for use in high-frequency amplifiers re-

quiring low noise. These low-noise units, the 2N917, 2N918, and 2N918-JAN, have a minimum f_T of 600 MHz with typical f_T values of 900 MHz.

In the 200 MHz amplifier circuit shown here, 2N918 transistors from this family yield typical power gains of 20 db against an EIA test limit of 15 db minimum.

Collector efficiency in the order of 38% allows oscillator output power of 45 mw (typ.) against a limit of 30 mw at 500 MHz, 8.0 ma collector current and 15V V_{CB} .

At a free air temperature of 25°C, these units are rated at: 200 mw

power dissipation, 30 V collector to base, 15 V collector to emitter and 3 V emitter to base. Operating collector junction temperature for this device family is 200°C. All three types are packaged in a 4-lead TO-72 hermetically sealed can. The fourth lead on the TO-72 is a shield lead connected to the can to allow grounding of stray r-f signals.

The Sylvania 2N918 is capable of meeting the full requirements of both MIL-S-19500/301 (EL) (JAN2N918) and MIL-S-19500/326 (JAN-TX-2N918).

CIRCLE NUMBER 305

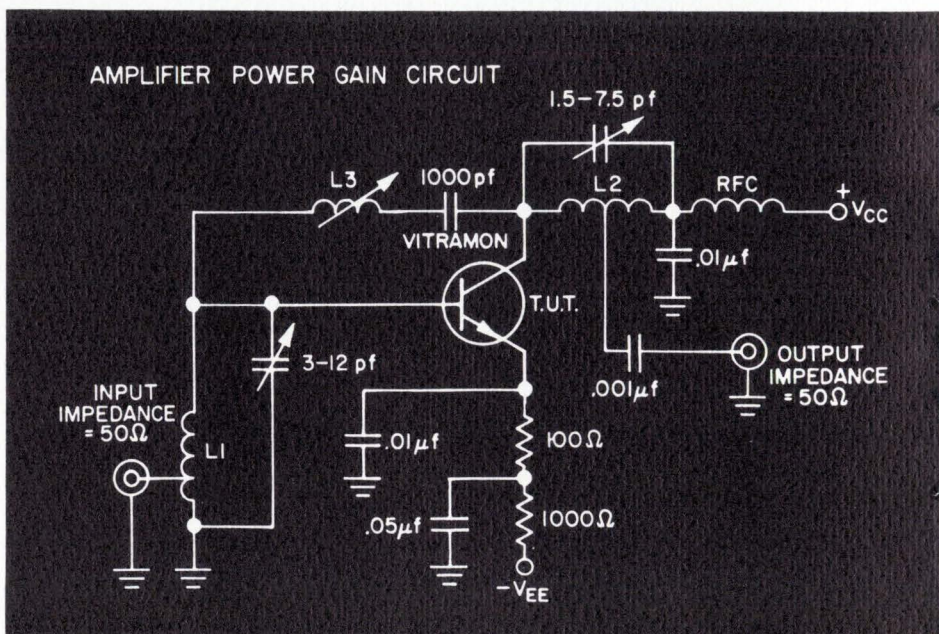
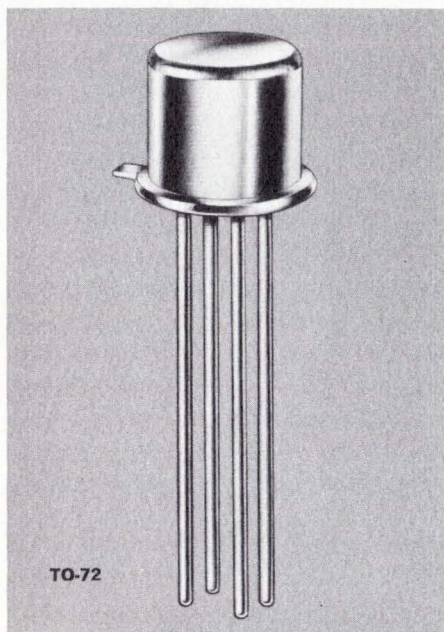

TO-72

New IC shapes, detects, gates, integrates, delays, oscillates, restores, and filters

Combine the availability of external connections on an AND gate, a Schmitt trigger and a SUHL output network in one IC and you've described an extremely versatile monolithic circuit. Combine two of these circuits in one package and you've described Sylvania's Series SG-80 Dual Pulse Shaper/Delay AND Gates. These multifunction gates allow construction of a host of circuits—wave-shapers, threshold detectors, integrators, delay generators, noise filters, oscillators, pulse restorers, line receivers, and similar system functions. Yet the device can also be used as an AND gate for conventional logic.

Each Sylvania Series SG-80 package has two separate three-input multiple emitter AND gates (Figure 1). An external tie point allows a capacitor to be connected to the bases of the input transistors of each gate. Thus, the AND function can be delayed until the capacitor is charged through an internal resistor. Leads of this internal resistor are also brought out to allow use of an external resistor in place of, or in combination with, the diffused resistor. The AND gate is

followed by a level detecting Schmitt trigger having a hysteresis of approximately 0.4 volts. The trigger drives a typical SUHL output network.

When connected without an external capacitor or resistor, the circuit functions as a conventional logical AND with high positive and negative noise immunity and high speed. Also, because of the regenerative nature of the Schmitt trigger and the hysteresis in the transfer characteristics, input signals with long edges (fall and rise times up to 5 seconds) and/or noise can be restored and shaped to conventional digital logic signals (10-nsec rise and fall time).

Threshold detection capabilities come from the regenerative Schmitt trigger. It causes the output to jump to a "1" when the input signal reaches approximately 1.2 V. The output snaps to logic "0" when the input falls to about 0.8 V. This gives a positive action for jitterless level detection.

In the delay mode, when 1 + 14 + 13 = "0," an external capacitor discharges through these inputs which present a very low impedance and a rapid discharge. When 1·14·13="1,"

the Schmitt trigger doesn't change state until the capacitor has charged to threshold. Now, regeneration causes a rapid change in the output. This configuration provides integration by averaging the time above threshold. In the same way, high amplitude, narrow pulsewise noise spikes can be filtered from a logic signal.

By using the AND, threshold and capacitor point features of the SG-80 series, a variety of integrated circuit oscillators and pulse generators can be constructed. All these timing circuits derive their delay from the RC combination on the base of the input transistors Q1 and Q. Delay times using the internal resistor and external capacitor are approximately 1.5 nsec/pf plus normal circuit delay. With external timing resistors, delay time becomes 0.35 R_T C_T plus normal circuit delay.

For capacitors greater than 0.1 mf, a series current limiting resistor of about 50 ohms is required. This resistor reduces loading on the driving gate to about 12 ma.

CIRCLE NUMBER 306

Dual Pulse Shaper/Delay AND Gate

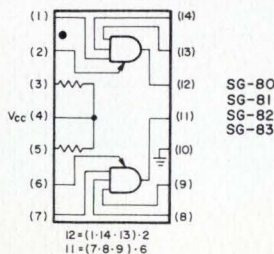

Functional Diagram of SG-80 Series Dual Pulse Shaper/Delay AND Gate

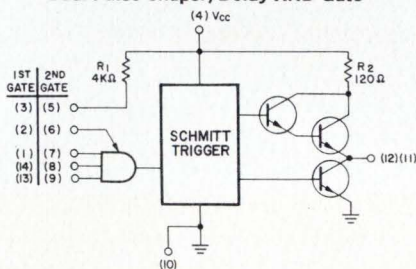

RATINGS/TYPICAL CHARACTERISTICS AT 5V 25°C

	SG-80	SG-81	SG-82	SG-83
Input Current	I _{in} 1.1	1.1	1.25	1.25 ma
Input Leakage	I _{in} 10	10	10	10 μA
Positive going threshold	V _{th+} 1.2	1.2	1.2	1.2 V
Positive going threshold coeff.	ΔV _{th+} -4	-4	-4	-4 mv/°C
Negative going threshold	V _{th-} 0.8	0.8	0.8	0.8 V
Negative going threshold coeff.	ΔV _{th-} -2	-2	-2	-2 mv/°C
Hysteresis	V _{hy} 0.4	0.4	0.4	0.4 V
Hysteresis	V _{hy} 0.25	0.25	0.25	0.25 V
Logic "0" V	V _{out} 20	10	20	10 ma
Logic "1" V	V _{out} 3.3	3.3	3.3	3.3 V
Logic "1" @	I _{out} 3.0	1.5	3.4	1.2 ma
Fan-out to SUHL I	F.O. 15	7	12	6
Fan-out to SUHL II	F.O. 12	6	10	5
Power Drain Avg.	I _{cc} 15	15	17	17 mw
Turn-on delay	t _{on} 10	10	10	10 ns
Turn-off delay coefficient	Δt _{off} 1.5	1.5	1.5	1.5 ns/pf
t _{fall}	t _r 4	4	4	4 ns
t _{rise}	t _r 2	2	2	2 ns



HOT LINE INQUIRY SERVICE

Use Sylvania's "Hot Line" inquiry service, especially if you require full particulars on any item in a hurry. It's easy and it's free. Circle the reader service number(s) you're most interested in; then fill in your name, title, company and address. We'll do the rest and see you get further information almost by return mail.

FIRST CLASS
Permit No. 2833
Buffalo, N. Y.

BUSINESS REPLY MAIL
No Postage Stamp Necessary if Mailed in the United States

POSTAGE WILL BE PAID BY

SYLVANIA ELECTRONIC COMPONENTS GROUP

Sylvania Electric Products Inc.
1100 Main Street
Buffalo, New York 14209

New dual J-K flip-flops reduce can count, boost speed

Here's how to get more than just a 50 percent reduction in the number of flip-flop packages when you use Sylvania's new dual J-K flip-flops. And you get more than the reduction in board wiring and interconnections that goes along with reduced can count. The two new families of dual J-Ks, one with a 35 MHz logic rate and the other with a 50 MHz speed (the fastest in the IC industry), provide devices with separate clock terminals (SF-100 and SF-120 series) and with a common clock and common reset terminal (SF-110 and SF-130 series).

Also, all dual J-Ks in these families have separate set terminals. With all of this, there is the added bonus of SUHL II performance characteristics.

This means high noise immunity, logic swing and fan-out, as well as low power and high capacitance drive.

The SF-100 and SF-110 series dual J-K flip-flops are rated for 35 MHz, while the ultrahigh-speed SF-120 and SF-130 series feature a logic rate of 50 MHz. Along with Sylvania's new SF-200 and SF-210 series of single 50 MHz J-Ks, the SF-120 and SF-130 series represent the fastest dual J-K flip-flops in the integrated circuit industry.

On all dual units each flip-flop has its own J input and K input. Further, both families of dual J-K flip-flops will accept synchronous or asynchronous data input at their respective logic rates (35 or 50 MHz).

Performance characteristics include

dissipation of 50 mw, noise immunity of ± 1 volt and logic offset of 3.5 volts for logic "1" and 0.2 volts for logic "0." Fan-out is from 9 to 15, with a fan-in of 3. Operation from a single 5-volt source insures system compatibility with other SUHL units.

These new J-K flip-flops aren't restricted by the clock. They can operate in conjunction with clock pulses or between them. These dual units are available in MIL (-55°C to $+125^{\circ}\text{C}$) and the industrial (0°C to 75°C) versions. They're supplied in the standard Sylvania dual in-line plug-in package and the TO-85 flat pack. They can be used just about anywhere you're using two individual J-Ks, including ripple counters, shift registers and storage registers.

CIRCLE NUMBER 307

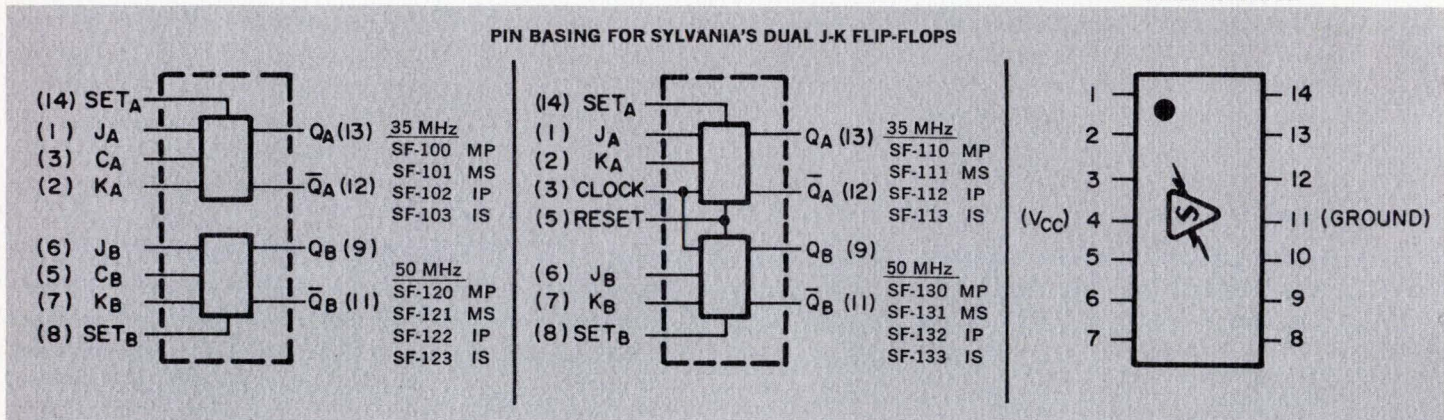

SYLVANIA

SUBSIDIARY OF
GENERAL TELEPHONE & ELECTRONICS GTE

NEW CAPABILITIES IN: ELECTRONIC TUBES • SEMICONDUCTORS • MICROWAVE DEVICES • SPECIAL COMPONENTS • DISPLAY DEVICES

This information in Sylvania Ideas is furnished without assuming any obligations.

NAME _____

TITLE _____

COMPANY _____

ADDRESS _____

CITY _____ STATE _____

Circle Numbers Corresponding to Product Item

300	301	302	303	304
305	306	307		

Please have a Sales Engineer call



HOT LINE INQUIRY SERVICE

Need information in a hurry? Clip the card and mail it. Be sure to fill in all information requested. We'll rush you full particulars on any item indicated.

You can also get information using the publication's card elsewhere in this issue. Use of the card shown here will simplify handling and save time.

**Now available in
16 different configurations
— all with 0.01% accuracy —**

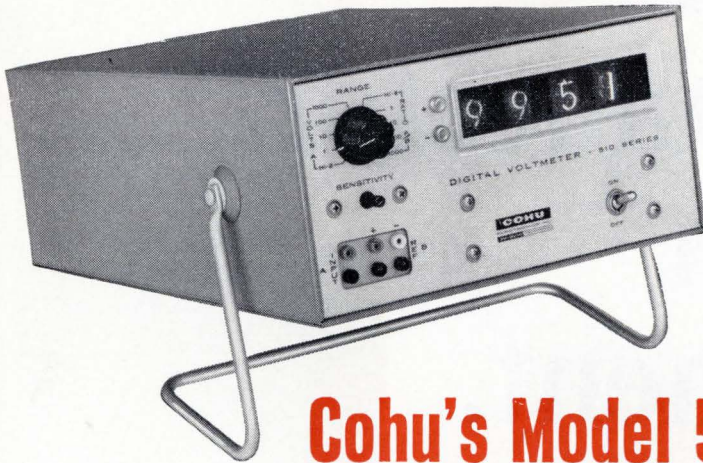

Cohu's Model 510 Series Digital Voltmeter-Ratiometer!

This highly reliable and stable instrument is now being delivered in models to meet virtually every application—laboratory, bench and assembly line. The basic cabinet model weighs only 12 lbs. and sells for \$995, while the basic rackmount model is \$1050. Both prices are FOB San Diego. Additional export charge.

The 510 series is available either with manual ranging only or optionally with both manual and automatic ranging of the four voltage ranges. Electrical output options are biquinary, 1248 BCD, or 1224 logic level outputs, enabling this DVM to drive most types of digital recording devices. An optional accessory probe is also available.

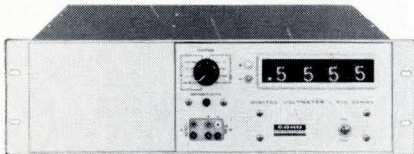

These features are common to all models in the 510 Series:

- 0.01% \pm 1 digit accuracy
- automatic polarity indication
- 4-place reading on all ranges
- 4 manual ranges, 2 functions (1V to 1000V, 1:1 to 1000:1 ratios)
- single control, range and function
- front panel sensitivity control
- high input resistance
- solid-state reference and circuitry
- bidirectional tracking logic

For full details, contact Cohu engineering representatives in major cities throughout the world.



Box 623
San Diego, California 92112
Phone 714-277-6700

About the only thing you won't find in a new Bendix "Pancake" connector is much room for improvement.

What you will find are 9 major connector improvements. All of them go together to reduce weight as much as 60% and length by about 50%, making Bendix® JT Pancake connectors the lightest, smallest, off-the-shelf models available. Put any one of them to work, and here's what you'll have going for you:

- Greater resistance to splay and bending (pin contact stability).
- Design simplicity (reduction of number of components).

- Increased reliability (lot control on sensitive components).
- Wider temperature range (cryogenic to 392°F).
- Hard face socket inserts eliminate pin contact dielectric piercing.
- Eliminated cross plugging (by alternate keying).
- Improved sealing (both main joint and rear grommet).
- Improved contact identification.
- Design versatility that offers a host

of options: crimp, solder, standard temperatures, high temperatures, grommetted and potted versions, hermetic seals in 8 shell types, 9 shell sizes, to name a few. You can choose from 34 insert patterns, 16-, 20-, 22-, and 24-contact sizes that will accept a wire range of 16 through 28 gage.

As you can see, we've been doing some great things with the Bendix line of Pancake connectors. Now it's your turn. Contact us in Sidney, N.Y.

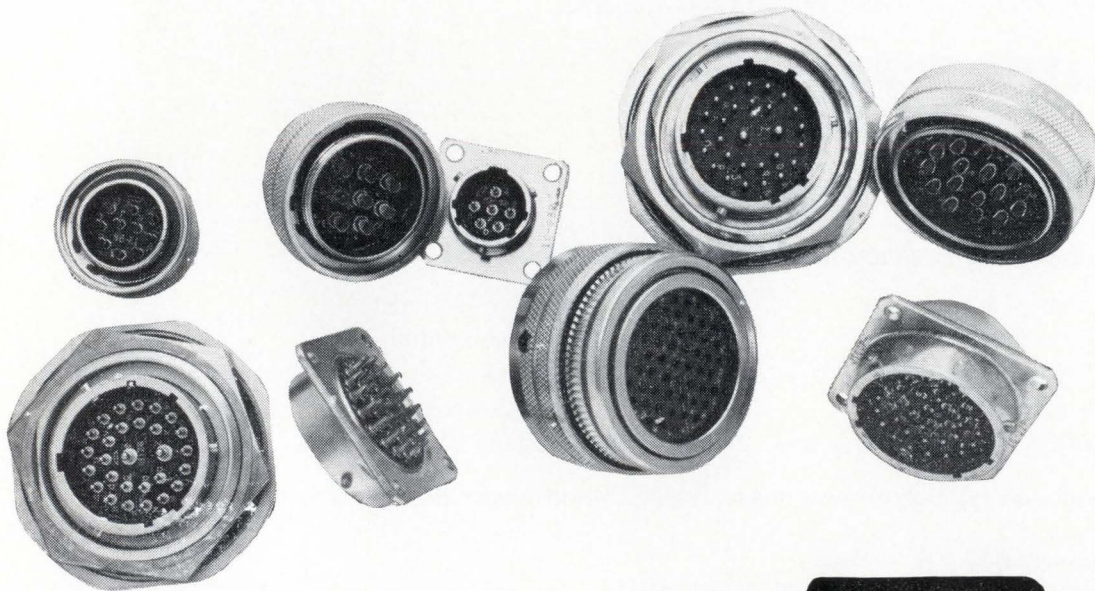

Scintilla Division



Displays

Video on a platter

Better color television pictures—and perhaps the elusive flat-screen tv—are among the potential fallouts of an Air Force program to do away with bulky electromechanical cockpit display instruments.

The Air Force is developing video-quality electroluminescent (EL) displays, backed up by solid state control circuitry, and hopes within a year or two to develop EL displays that are controlled not by circuitry but by sheets of ferroelectric materials or glassy semiconductors applied to the rear of the electroluminescent panels. The research, it is hoped, will lead to displays that will be so small and cheap that they can be replaced, like lamps, at regular intervals.

Meanwhile, the first goal of the development program has already been achieved at the Air Force Flight Dynamics Laboratory at Wright-Patterson Air Force Base, Ohio. Its aim was easy-to-read displays, such as bar-graph altimeters and numerical indicators. The achievement is largely due to a new display faceplate that filters out ambient light and allows displays to be read even in sunlight, while also allowing the EL driving power to be cut in half. This, plus an improved phosphor known as zinc sulfo-selenide, has solved brightness problems and assures long-lived displays. Capt. Carlton J. Peterson, the officer responsible for the project at the Air Force lab, hopes to see the major remaining reliability problem—long life at high temperatures—solved during 1967.

Harder and harder. The Air Force's present techniques are being adopted by the National Aeronautics and Space Administration for displays in Apollo spacecraft. At the Air Force lab, complex dis-

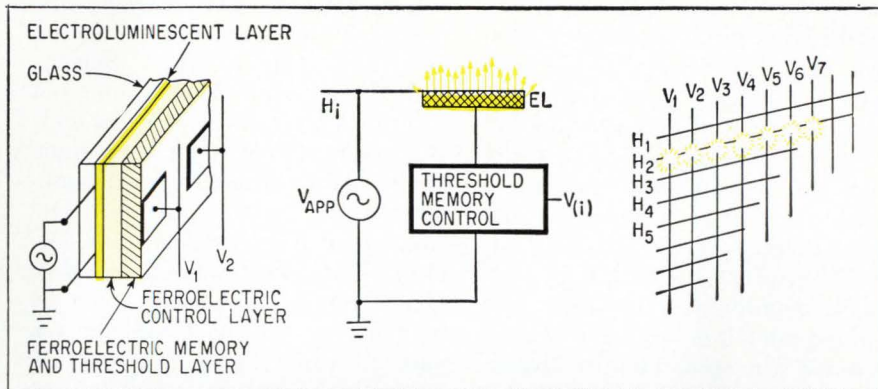

Two ways of eliminating most of the control circuitry for electroluminescent displays may be the use of ferroelectric layers, shown above, being developed by RCA, and a glassy semiconductor switching layer, at the right being developed by ITT.

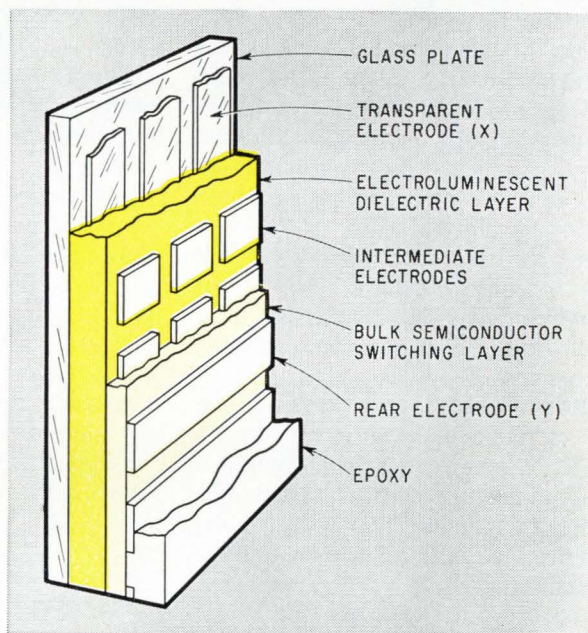

plays for radar, infrared sensor and video information have also been made, but it will be at least 1969, Peterson thinks, before such large displays can be used in aircraft.

The new filters are also helping in the development of clearer cathode-ray tube displays, among them a high-contrast image-storage tube. The filters can readily be adapted to tv picture tubes, Peterson believes, which would produce sharper pictures with less intensity.

The EL filters were developed by Lear Siegler, Inc., after Air Force scientists determined that display developers were following a false trail—they were driving the EL phosphors harder and harder in at-

tempts to raise brightness, creating burnout and control problems. The lab decided to increase contrast between lighted and unlighted display segments, rather than brightness, by using neutral density, polarized and micromesh filters—all known optical techniques.

The result was filters, applied to the front of the EL panel, that reflect only 2% of ambient light, absorbing the rest. The filters transmit only 35% of the light emitted by the phosphors, but the light is seen against a dark background and the halo effect that blurs unfiltered EL spots is eliminated. As a result, display panels that had to emit 35 foot-lamberts to be clearly read

need emit only 4.3 ft-l and transmit 1.3 ft-l through the filter. Peterson estimates that 15 ft-l will be sufficient in a cockpit, even if the pilot wears sunglasses, although this remains to be proven in flight tests.

Solid state circuits. After a computer or other system determines what the display is to show at a given time, control circuitry behind the panel accepts and stores the input signal and switches in a-c voltage to excite selected segments of the display. The voltage is applied between overlapping electrodes, usually a transparent one on the panel face and another on the back. The spots must be driven continuously, since phosphor persistence is short.

For first-generation displays, the control circuitry behind the panel will be arrays of solid state circuits containing silicon controlled rectifiers and other semiconductor devices. The circuitry costs have dropped about 90% in the past few years, but are still high—about \$15 per display segment. The cost, however, is within reason for small cockpit displays and the circuitry is proven.

Ferroelectrics and glass. To get rid of most of the circuitry the Air Force is sponsoring development of bulk-material controls. It is this work, Peterson feels, that may eventually lead to thin-wall video displays.

The Radio Corp. of America reduced control materials cost to 30 cents an element by using layers of ferroelectric material to select EL spots as shown in the diagram. It built a 1,200-element video display with coincidentally selected spots. An unanticipated cost, however, was a diode for each segment. Although this lowers the attraction of the technique, suitable second-generation displays will very probably become feasible sometime next year.

Third generation. Since last May, the International Telephone and Telegraph Corp. has been developing EL displays backed by glassy semiconductors as part of a general program to develop systems exploiting bulk-effect devices [Electronics, Sept. 19, p. 191]. Peterson

says ITT's work on improving the materials is progressing so rapidly that he hopes to see practical displays, costing about 15 cents for each of the elements, by the end of 1967.

His data on glass-backed displays, part of a report on displays presented at an Air Force Science and Engineering Symposium last month, is apparently the first outside confirmation of at least some of the claims made for such materials by the inventor, Stanford Ovshinsky, of Energy Conversion Devices, Inc. Peterson says these phase-change materials can be painted on the back of the EL panel and that some improved ITT materials can be switched in less than a microsecond from a resistance as high as 100 megohms to as little as 10 ohms—a range that easily straddles the half-megohm requirement for electroluminescent panels.

Peterson's report will soon be available as an Air Force publication [AFFDL-TR-66-123]. His personal opinion—not in the report—is that although glass semiconductors are still in their infancy, "they will become as important as the transistor and diode." Semiconductor manufacturers have generally scoffed at a similar claim made by Ovshinsky.

Communications

Handy view

Watching eye movements of astronauts and tests of rocket engines are two of the many duties planned for a new television camera-transmitter that's small enough to fit in the palm of the hand. And the manufacturer, Teledyne, Inc., is pushing the camera for a variety of other applications in which its unique features offset its cost. The company is about to market a commercial model at a basic price of \$5,500.

The National Aeronautics and Space Administration received two of the cameras this summer, under contracts totaling \$350,000, after Teledyne submitted an unsolicited proposal four years ago. [Electronics, June 28, 1965, p. 18, and July 11, 1966, p. 26.] The work was sponsored by the Biotechnology and Human Research division in NASA's office of Advanced Research and Technology. One model, without a transmitter, was sent to the agency's Marshall Space Flight Center at Huntsville, Ala., where it will be placed in a rocket test stand. Data from engine firings will be sent over wire to tv monitors.



Commercial model of Teledyne's television camera-transmitter. Unit weighs 1½ pounds and will be introduced this year.

Broad interest. The other camera, which has its own transmitter, will soon go to the Naval Aerospace Medical Institute, Pensacola, Fla., for experiments on ocular counter-rolling (the eye's response to spacecraft rotations). Data will be recorded on videotape. Other NASA organizations that have shown interest in the unit include the office of Space Nuclear Propulsion, Jackass Flats, Nev., which does all the nuclear rocket testing, and the Ames Research Center, Mountain View, Calif., which runs the biological satellite projects. NASA also plans a demonstration for congressmen at next spring's budget hearings.

The two prototype cameras were put together by Teledyne's Control Systems division, El Segundo, Calif., using integrated circuitry produced by the company's Amelco Semiconductor division, also in Mountain View. The integrated circuits are bonded onto an alumina substrate to form what Teledyne calls a Mema (for microelectronic modular assembly). Each module measures 0.66 by 1.13 by 0.105 inches and has three, five or seven integrated circuits that make up a single subsystem. With these small components, the weight of the entire camera-transmitter is held to 1½ pounds.

Eye on new business. The camera, called Micro-Eye, broadcasts standard 525-line tv pictures at 60 frames per second. Standard 31.5-kilohertz sweep-frequency signals are generated with the Mema IC modules. The video amplifier is fabricated with discrete components, which are also packaged in Mema modules.

Standard 16-millimeter optics position the image on a ½-inch glass vidicon supplied by the General Electro-dynamics Corp., Garland, Tex. Teledyne originally planned to develop a ceramic vidicon, but that turned out to be unworkable. As a result, delivery of the camera-transmitter was delayed.

The unit, which has its own telescoping antenna, has transmitted signals up to 200 feet.

A stock unit uses a 7-pound rechargeable battery, good for 10 to

12 hours; external power can also be used. Teledyne is offering as a built-in option a 1-inch cathode-ray tube viewing monitor. Potential uses, according to Teledyne, include broadcasting political conventions and sports events directly from the scene of action, security applications in which a hidden camera is needed, in underwater research, industrial process control, space medicine, offshore drilling and similar activities.

Space electronics

What's next?

Should a single goal—such as a manned landing on Mars in the 1980's—be chosen for the nation's space program once the Apollo astronauts have landed on the moon?

"It would be difficult to find an electronics company in the United States which has not in some way been involved, directly or indirectly, in Apollo," says George Mueller, manned space flight director. Since these companies are running out of work as Apollo hardware production nears completion, a decision on follow-on programs is already overdue—so far as the majority of the aerospace

industry is concerned.

To date a discussion of the goal has fallen far short of the national debate urged last spring by James Webb, administrator of the National Aeronautics and Space Administration. However, a beginning was made when the American Institute of Aeronautics and Astronautics scheduled four monthly post-Apollo symposiums in Washington, each featuring a major Apollo contractor. At the first meeting earlier this month, North American Aviation, Inc.'s Space and Information Systems division made a strong plea for a Mars trip using similar hardware throughout the program.

Live in space. The North American proposal calls for an integrated program of earth orbital flights, lunar exploration and planetary missions. It would use the follow-on Apollo Applications Program as the first step. During this program, development would begin on what the company calls a universal mission module, which would fit between the Apollo spacecraft and Saturn launch vehicle—the space that houses the lunar module for the moon trip scheduled by decade's end.

The universal module could serve as a space laboratory in orbit around earth, could house astronauts on a journey to Mars or

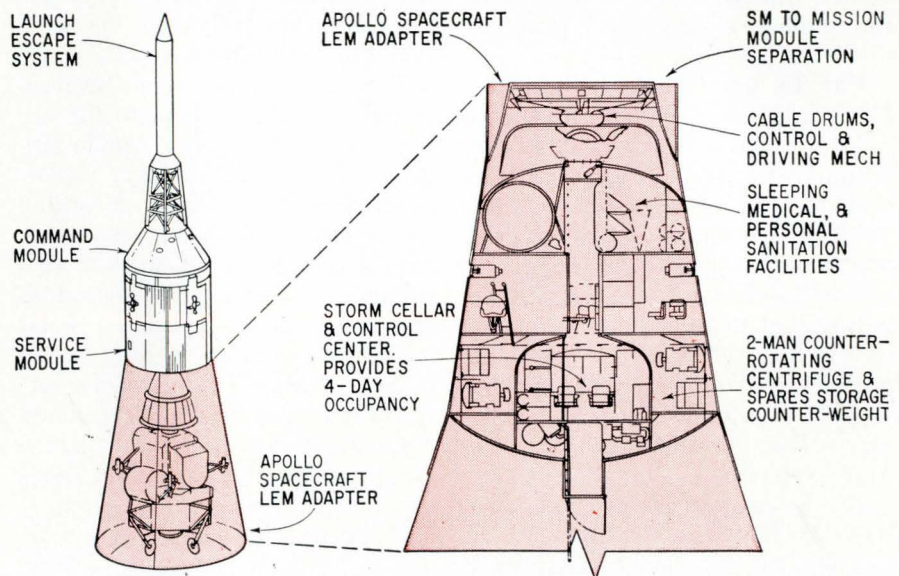

Key to keeping down costs of a Mars landing, according to North American Aviation, would be a universal module to perform a variety of missions.

could function as a lunar shelter for extended exploration of the moon.

John F. McCarthy, vice president for engineering at the North American Aviation division, stressed that present technology is adequate for large orbital space stations and a permanent operational lunar base. And McCarthy added that although present technology is not adequate for manned planetary exploration, "the nation is fully as competent to undertake

wide to land safely, according to the North American official.

Keep it going. Reliability problems become particularly severe since the round trip to Mars may take as long as three years. The question is whether reliability can be achieved best by more redundancy, carrying along spare parts that the crew can install, improving the reliability of each component or some combination of these approaches. Study programs are under way at the space agency's

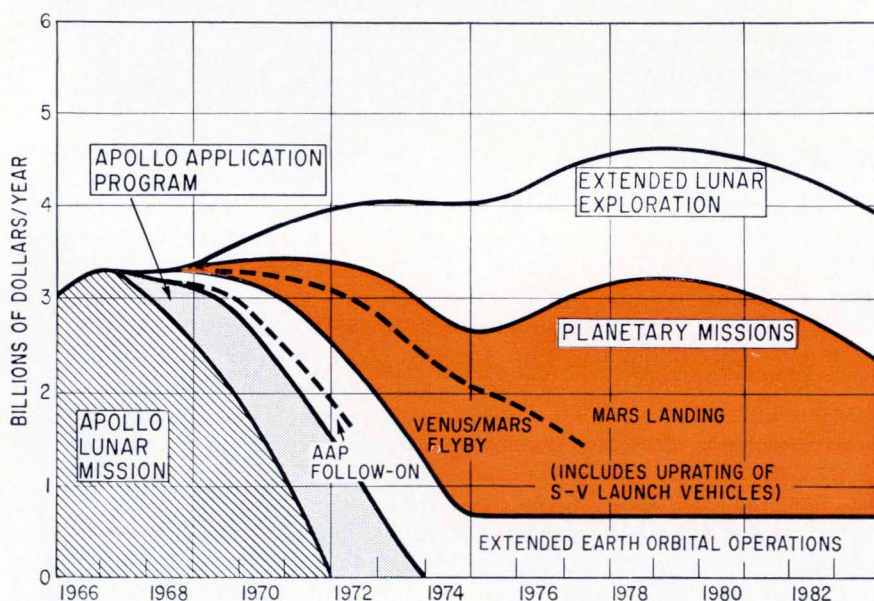

Spending for a manned flight to Mars would begin after the current Apollo lunar landing and follow-on Apollo Applications Program pass their peaks.

a manned Mars landing program at this time as it was to undertake the manned lunar landing program in 1961."

Far to go. Frank J. Sullivan, NASA's director of electronics and control, points out that the unmanned Voyager program, tentatively scheduled for sometime after 1973, will be a good test bed for electronic techniques. He lists data transmission as a prime example, noting that the Mariner 4 data rate of 8½ bits per second is far short of the million bits per second needed to provide a real-time television link between earth and the Mars explorers.

Guidance accuracies will also have to be improved. Instead of passing by the planet, a manned exploration craft will have to hit a point some 20 nautical miles

Electronics Research Center, Cambridge, Mass., but so far they have been kept at a relatively low level pending a decision on goals.

Projected costs of an over-all program could be kept to the annual rate of the current Apollo program unless a major lunar exploration program is added, according to North American estimates. Apollo recently hit its peak of \$3.3 billion annually and will soon drop steeply if Apollo application is not added. A program leading up to a manned Mars landing in the early 1980's—and including manned planetary flybys before that trip—would keep this spending level constant over the next 20 years. If a lunar exploration program is added, annual spending would climb to \$4 billion by 1971 and stay above that level for a decade.

Consumer electronics

IC's in the old kit bag

Integrated circuits, a spur to the electronics industry, may be a handicap to the \$42.5-million electronic kit market. The reason: IC's leave the kit builder little to do—a fact directly opposed to the kit philosophy of "do-it yourself." The dilemma facing the kit industry is whether to go IC's or not. One company that is apparently bucking the trend and has decided to use IC's is the Heath Co., a subsidiary of Schlumberger, Ltd.

Heath will introduce next March a stereo receiver kit with two Radio Corp. of America IC's instead of transistors in the intermediate-frequency strip. The company will also market a kit for a 12-inch portable television with an RCA integrated circuit as a sound i-f amplifier and audio detector.

Wait and see. Other major kit makers—the Knight Electronics Corp., Eico Electronics Instrument Co. and Dynaco, Inc.—are still on the sidelines. However, Knight, a subsidiary of the Allied Radio Corp., is reportedly planning to put IC's in a receiver line next year.

Richard Silberbach, general manager at Knight, says IC's may find selected applications in kits next year and in 1968, but he thinks a complete switch to IC's is not justified because of the high cost involved. He predicts that only about 20% of Knight kits will contain IC's by 1970.

Ruining the fun. Silberbach also argues that IC's reduce the number of parts in kits and thus decrease the fun of kit building.

Mark Ehren, Eico's advertising manager, also agrees that IC's could strip kits of some of their appeal by detracting from the builder's sense of personal accomplishment.

The kit concept, originally confined to test equipment, has spread to high fidelity, stereophonic, amateur radio and Citizens' band equipment. Kits pop up in industry, the laboratory and the classroom and buyers represent every segment of society, from professional men to

**Since Aug. 1,
when this ad was first run,
more than 200 computers have been ordered.
First deliveries have already been made.**

Shouldn't you look into it?



And Now, the \$10,000 Computer

PDP-8/S: A new high speed general purpose digital computer. Modular construction for repackaging. Field proven reliability. 4,096 word core memory. Microsecond speeds. Complete software including FORTRAN. Flexible input/output bus. Deliverable 90 days ARO. Teletype included.

The single unit price for the PDP-8/S is \$10,000, and there are liberal OEM discounts for multiple units.

Designed to be used in instruments or systems, the PDP-8/S can be rack mounted or repackaged.

The new PDP-8/S is a close relation of DIGITAL's PDP-8, the most successful on-line, real time computer in the history of the scientific community. At a base price of \$18,000, more than 500 PDP-8 systems have been sold. Its success results from a design concept that makes it the most flexible, versatile, adaptable digital computer ever made.

The PDP-8/S uses the same programs, the same instructions, the same operations, and the same basic design as the parent PDP-8. It has the same size memory, is equally expandable, and indeed, uses the same line of modules and components.

But the PDP-8/S is a bit slower. It takes 32 microseconds to add. For process control and analysis, you probably won't even notice.

But you'll notice the price.

digital
COMPUTERS • MODULES

DIGITAL EQUIPMENT CORPORATION, Maynard, Massachusetts 01754. Telephone: (617) 897-8821 • Cambridge, Mass. • New Haven • Washington, D. C. • Parsippany, N.J. • Rochester, N. Y. • Philadelphia • Huntsville • Pittsburgh • Chicago • Denver • Ann Arbor • Houston • Los Angeles • Palo Alto • Seattle • Carleton Place and Toronto, Ont. • Reading, England • Paris, France • Munich and Cologne, Germany • Sydney and West Perth, Australia • Modules distributed also through Allied Radio

students and hobbyists.

Expanding market. Not satisfied with the conventional electronic kit market, companies like Heath are now selling such products as electronic guitars. The guitar itself comes ready to use; only the electronic parts need be assembled.

Eico, whose sales were \$6.5 million last year, is making an effort to broaden its market base still further by introducing simple kits selling from \$3 to \$10. The idea is to attract beginners to build such items as sirens, burglar alarms, fire alarms, audio power amplifiers, code oscillators and a-c power supplies. Eico hopes that once attracted, the beginner will advance to more complex and costly kits.

Electronic kits also have carved out a sizable overseas market. Heath is so optimistic of its future that it has built plants in Gloucester, England; Frankfurt, West Germany, and Toronto. Eico, which has a Canadian subsidiary, markets kits in Europe and South America. And Allied reports that it maintains profitable markets in England, Holland and Finland—even though it doesn't advertise overseas.

Computers

IBM's new family

When work on the International Business Machines Corp. System 360 was started in the early 1960's, the aim was to develop a family of computers that could tackle a broad spectrum of scientific and business chores. That job substantially completed, IBM turned to a new family of computers to invade an entirely different market: military and aerospace. The result is the 4 Pi family of computers.

No other computer builder has approached the market so comprehensively.

The computers, ranging in size from 0.37 cubic feet to 1.88 cubic feet, are built largely from monolithic integrated circuits. They are the first military-aerospace computers to use read-only memory.

Design to fit. IBM gave special

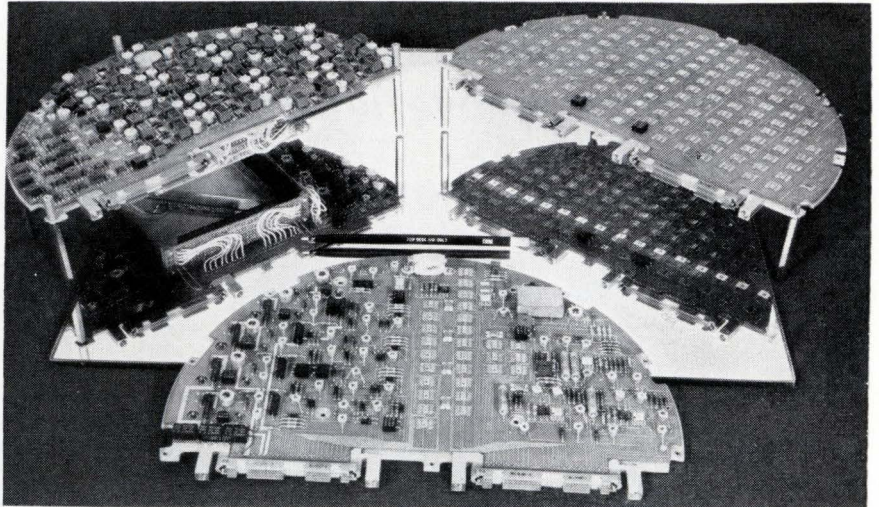

Smallest model of IBM's new 4 Pi computer family, configured for a tactical missile. For other applications, the same basic design can be repackaged.

attention to packaging and input-output flexibility in the series because military-aerospace computers must often be redesigned for specific applications—whether in a rocket or a satellite.

The smallest model can easily be built into a missile or a small aircraft for inertial guidance. In the back seat of a Jeep it could calculate reverse trajectories of enemy mortar shells, locating the mortar after only one shot. The same model could easily do the job of IBM's Gemini computer [Electronics, May 3, 1965, p. 71]; it is considerably smaller and faster because it is built with IC's, and it has more capability. Bombers, submarines or surface ships could carry larger models for more complex applications—jobs where space, power and weight are at a premium.

At the moment the series comprises three models, designated TC for tactical computer, CP for custom processor or cost performance and EP for extended processor. Other models probably will be announced from time to time, extending the series both upward and downward, as models were announced in the 360 series.

The circuits used in the prototypes of the three models are transistor-transistor NAND logic made by Texas Instruments Incorporated. Similar circuits will be used in all models, although TI is not expected to be the sole supplier.

Options, too. Read-only memory is standard in the EP model and available as an option in the CP. The memory contains microprograms that control the paths of data through the computer for the various instructions.

In the CP and EP, the memory is a plug-in unit that can be replaced in a few minutes, so that the design of either model can be quickly personalized for a special application.

The memory is arranged like this:

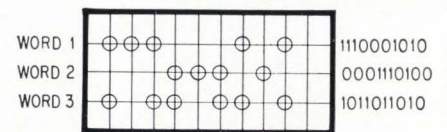

For a particular word, zinc-ferri-rite cores provide inductive coupling from the word wires to the bit wires for 1 bits; cores are omitted from the positions for 0 bits. Therefore a current pulse on a particular word wire produces voltage pulses on selected bit wires that control logic gates in data paths.

Contracts totaling over \$50 million for production of the computers have already been awarded to IBM; most of the applications are classified. One that is not secret is for the Mark 2 avionics system in the F-111 variable-sweep-wing airplane.

IBM also has a contract for the

COMPONENT COMMENTS *From Speer*

If our JXP precision resistor is so superb, how come we're reluctant to discuss its reliability?



Because we don't want you to think of the JXP as a "high reliability" resistor.

It is one, of course. But the term in this case is a bit of an understatement (rather like describing the Grand Canyon as a hole in the ground.)

For the same reason, we'd just as soon that you didn't think of the JXP as a "military" resistor, despite its RN classification.

And even the term "metal film" fails to do justice to the JXP. Our Jeffers Electronics Division's metal film resistor has characteristics and performance capabilities that surpass the best of any resistor art, past or present.

How, then, should you think of the JXP? Simply as a "precision" resistor—because it's in this area of precision that our resistor can most clearly be seen to be in a class by itself.

The JXP gives you the highest precision at a reasonable cost, with tolerances down to 0.02% available upon request. But more than that, this extreme precision is arrived at deliberately, rather than by happy accident.

We manufacture the JXP under sophisticated "white room" conditions. We employ a fanatically tight system



of process and material controls. And we limit ourselves to a narrow population of resistor characteristics (25 PPM or less). So it's no wonder that our entire resistor output is identical in precision and stability. (In fact, any pair of JXPs can be matched, time and time again, to within 0.01% !)

We'd be delighted to send you complete information about our JXP precision resistor (including its military and reliability aspects—if you insist). Just mail us the coupon.

A patent attempt to win your admiration

Even though our various electronic components already offer excellent performance, this never seems to satisfy the restless individuals in our Research Laboratory. They're constantly developing new ways to improve both our products and our manufacturing processes.

During the last six months alone, Speer Carbon Company and Air Reduction Company (our parent) have been awarded a significant variety of patents—including: 3,227,983 (U.S.) for Stacked Resistors; 3,238,151 (U.S.) for Resistor Composition; 3,240,625 (U.S.) for Semiconductor Film Resistors; 727,273 (Canada) for a Method of Capping Film Resistors; 731,781 (Canada) for a Fluorescent Lamp Starter; 648,979 (Belgium) for Resistor Manufacture; 667,242 (Belgium) for Composition Resistors; and 49,129 (Luxembourg) for Composition Resistors.

We have no patent on mere excellence, of course. But when it comes to perfection . . . well, only time will tell.

We've even been distributing Distributors

In keeping with our basic policy of quicksilver service, we have been setting up a national network of Industrial Electronic Parts Distributors covering every major market area.

These men are hip-deep in both Speer carbon composition resistors and in Jeffers molded chokes. And both inventories, needless to say, offer the latest MIL and commercial specifications.

For the name of your helpful Speer Industrial Distributor, contact your Speer representative—or use the coupon.



JEFFERS ELECTRONICS DIVISION
SPEER CARBON COMPANY

DuBois, Pennsylvania 15801

Speer Carbon Co. is a Division of Air Reduction Company, Inc.

Send *complete* information on your JXP precision resistors.

Send the name of my helpful Speer Industrial Distributor.

Name _____

Title _____

Company _____

Street _____

City _____ State _____ Zip _____

data-processing subsystem in the Manned Orbiting Laboratory. The project is tightly classified, but there is speculation that the computer will be a version of the 4 Pi EP model, which has all the characteristics that an orbiting laboratory computer would require [Electronics, Oct. 3, p. 129].

At the speed of light

A laser computer with optical gates and switching at the rate of 10 gigahertz? Fantastic? Quite so, says Dieter Roess of the Siemens' Central Laboratories in Munich, West Germany, but it is theoretically possible to make one, and he described such a computer to the Optical Society of America meeting in San Francisco this month.

Even if the optical computer could be built, he cautioned, it would be only 10 or 20 times as fast as the fastest conventional computers, and, since development costs would be enormous, such a machine might not be economically feasible.

His main point was that at the present level of technology, lasers are considered mainly as oscillators. "But," he said, "I think that in a few years we will value them for their amplifying and switching capabilities."

Most important, optical gates would be valuable in building communications systems in which the expensive task of signal processing would be done optically, rather than electronically.

Making the switch. To make a laser act as a switch, Roess would insert what he calls a saturable absorber into the resonating cavity—between the oscillating element and one of the mirrors. The transmittance of the saturable absorber increases with the light flux so that if no light shone upon the absorber, the laser could not oscillate, but a light signal from an outside source would permit it to do so.

Absorbers at both ends of the cavity would make an AND gate, since both would have to be illuminated for oscillation to take place. If the absorbers were made so that they transmitted a certain

	TC	CP	EP
Memory capacity (words x bits)	8,192 x 8	8,192 x 36	16,384 x 36
expandable to	65,536 x 8	32,768 x 36	131,072 x 36
Memory cycle	2.5 μ sec	2.5 μ sec	2.5 μ sec
Machine cycle	3.0 μ sec	0.417 μ sec	0.417 μ sec
Instructions	54	36	70
Weight	17.3 lbs	50 lbs	75 lbs
Power	60 watts	250 watts	365 watts
Volume	0.37 cu ft	0.82 cu ft	1.88 cu ft

percentage of light even when unsaturated, the same configuration would act as an OR gate.

Roess also described complex logic elements in which two or more resonators shared the same laser material. The direction of the laser beam could thus be switched by saturating suitable absorbers.

For a ruby laser certain organic dyes in solution, such as methylene blue in water, would serve as saturable absorbers. However, since thousands of logic elements would be needed to make a practical system, Roess' design would only be useful for a semiconductor laser with a length of about a tenth of a millimeter. Both he and Walter Kosonocky of the Radio Corp. of America have conducted successful experiments in logic gating with crystal lasers, Roess says, but he does not know of any material which would serve as a saturable absorber for a semiconductor laser.

Signal processing. In a ruby laser 10 centimeters long and 2 cm. in diameter, Roess says, some 3,000 independent signal channels (slender beams of light), each carrying the information of 50,000 television channels, can be amplified side by side. "The figure for semiconductor lasers is so ridiculous I can't bring myself to mention it," he adds.

"Of course it is all a fantasy now," Roess says. "It is not hard to design such a system if one is not asked to provide the hardware. A practical realization of this theory is complicated by the knowl-

edge that semiconductor lasers cannot yet be operated reliably at room temperatures and that this type of laser is not as well understood as gas or crystal lasers. For the first problem we can already see technical solutions, and the second will be solved when the applications become sufficiently broad to make it economically attractive to do so."

Advanced technology

Solid look

Last year at the Electron Devices Conference, Gene Weckler of the Semiconductor division of the Fairchild Camera & Instrument Corp. showed photographs of television pictures that had been produced on an oscilloscope. Instead of a tv camera, a linear array of photodiodes was the sensor. Since the array was one-dimensional, Weckler used a spinning prism to scan the scene and provide the second dimension. Now Weckler has replaced the diodes with phototransistors and built a square array of 10,000 phototransistors and 10,000 metal oxide semiconductor field effect transistors (MOS FET's) on a single chip that measures one-half inch by one-half inch.

The chip has not yet been "packaged," and so has not been used to take pictures. However, Weck-

**TRW
CAPACITORS
ARE
SMUG**



...especially our new metallized polycarbonates!

TRW has now extended its leadership in film capacitors to include metallized polycarbonate types. Two features of the X463UW are outstanding. Precise processing assures low TC through temperature ranges to 125° C. Metallized construction reduces size to less than one half that of film-foil designs. Other features of the line include:

- Capacity range from .01 to 10.0 mfd
- Low dielectric absorption
- Available in tolerances to $\pm 1\%$
- Humidity resistance per MIL-C-27287

For full information contact: TRW Capacitors, Box 1000, Ogallala, Nebraska. Phone: 308-284-3611 • TWX: 910-620-0321.

TRW CAPACITORS

ler says that his array, while not as sharp in resolution as a conventional vidicon, is more than 25 times as sensitive as a vidicon to unfiltered sunlight, and 10 times as sensitive to sunlight with the infrared filtered out.

The array has obvious military applications, particularly since it possesses silicon's sensitivity to infrared. It could conceivably do away with the need for a photomultiplier tube for low light level television. Fairchild says that several parties are interested in the array, but won't say who they are.

Storage mode. If a p-n diode is reverse-biased to a voltage less than its breakdown voltage and then the circuit is opened, Weckler explains, the rate of voltage decay across the junction depends on the amount of light falling on the diode. If there is no light, the rate will be very slow, for the charge stored on the junction capacitance must be removed by the generation-recombination current generated in the space charge region. Illumination, however, will give rise to a photo-generated current, which adds to the generation-recombination current and removes more capacitance per unit of time.

Weckler took advantage of this characteristic by recharging the space charge capacitance to its original condition periodically and measuring, at a load resistor, the amount of charge required to do so. The more light, the more charge necessary. If an array of these diodes were sampled sequentially, the signal across the load resistor would correspond to the spatial distribution of the light along the array.

Further, the array produces signal gain because the photodiode is always operating, but is sampled only for the brief period in which the switch is closed. The gain is equal to the ratio between the time the switch is open plus the time it is closed, to the time it is closed. Gain, and hence responsibility, can be controlled electronically by adjusting this ratio.

Operation of such an array depends not only on a storage element and a current source that is dependent on incident light—two

factors which can be supplied by the photodiode—but on a nearly perfect switch. Leakage current must be small and conductance high, and the switch must be very fast. The MOS transistor filled the bill; with no voltage on the gate, the photodiode would be shunted by the source diode of the MOS transistor, while if the gate were made sufficiently negative to invert the region under it, conductance would be established from source to drain and the photodiode could recharge. Further, the source diode itself could be used as the photodiode, thus eliminating the original p-n diode and providing a configuration which makes for very dense arrays.

Using individual source diodes and gates and a common drain, Weckler made his linear array with 400 elements to the inch. The common drain meant that a single load resistor was needed to get an output signal.

On the square. The square array, which was described at this month's Electron Devices Conference in Washington, uses phototransistors instead of MOS transistors as the sensor, though MOS devices are still used as logic elements. Applying a negative voltage to the phototransistor causes the collector to become forward-biased and the emitter to become reverse-biased. The base-collector junction acts as the storage unit and current generator, and the emitter-base junction as the switch. However, to get the signal out of a 100-by-100 array of phototransistors by sampling rows and columns would give rise to stray capacitance and crosstalk problems. Therefore, Weckler pairs each phototransistor with an MOS transistor, and, in a manner which Fairchild would rather not discuss, applies two simultaneous voltages to each MOS transistor in sequence to get the signal out of the phototransistor. Weckler also declines to discuss how the MOS transistors and the phototransistors are connected.

With only 200 devices to the inch instead of 400, the square array does not have the resolution of the linear array. Since there are

no isolation problems, though, Weckler expects to be able to cram many more devices into his arrays. The phototransistor gain, which is greater than the photodiode's, enhances the signal of the two-dimensional array.

Military electronics

Discriminating view

There's more to laser communications than meets the eye.

But meeting the eye is one of the major problems when a laser works in the atmosphere, without benefit of an optical waveguide.

"In a one-mile link," points out Gerald Ratcliffe, an engineer at Sylvania Electric Products, Inc., "the narrow beam can be bent away from the receiver optics by the heat of the sun shining on one side of a building housing the transmitter, by ground movement, by people walking across a floor, or even by expansion and contraction of tire pressure in a mobile setting."

Field link. To correct for such sensitivity, an automatic search and track technique is designed into a laser communications link ordered for Army field experiments. It will be built at Sylvania's applied research laboratory in Waltham, Mass. Sylvania is a subsidiary of the General Telephone & Electronics Corp.

The Sylvania group, headed by Ratcliffe, will deliver to the Army Electronics Research Command a pulse-code modulated duplex communications system consisting of two identical transmit-receive terminals. The 3-megahertz bandwidth will accommodate both voice and data transmission, with a data rate of at least 1 million bits per second. Employing an electro-optic crystal, the modulator will be similar to the one designed for an earlier experimental laser television link at Sylvania [Electronics, Feb. 8, 1965, p. 75].

To explore the economics and other practical aspects of replacing microwave with laser links, the

Why specify Mallory MTP wet slug tantalum capacitors?

- they're much smaller than solid tantalum types and
- they don't need voltage de-rating!

Suppose you need a high-reliability capacitor for a miniaturized circuit. You know working DC voltage, required capacitance, ambient temperature. What capacitor will meet these parameters in minimum size?

Our answer—the Mallory MTP wet slug tantalum capacitor. C x V “density” of the MTP goes up to 172,000 mfd-volts per cubic inch—about 5 times as much rating per unit size as solid electrolyte tantalum types.

Next step—pick the exact rating you need. The circuit says 30 volts. So you decide to specify a 50 volt unit. Right?

Wrong. You *don't* need to de-rate the MTP. Contrary to long-standing belief, operating at reduced voltage neither improves nor impairs performance. Not for this capacitor. We've made tests to prove it. Here is typical data:

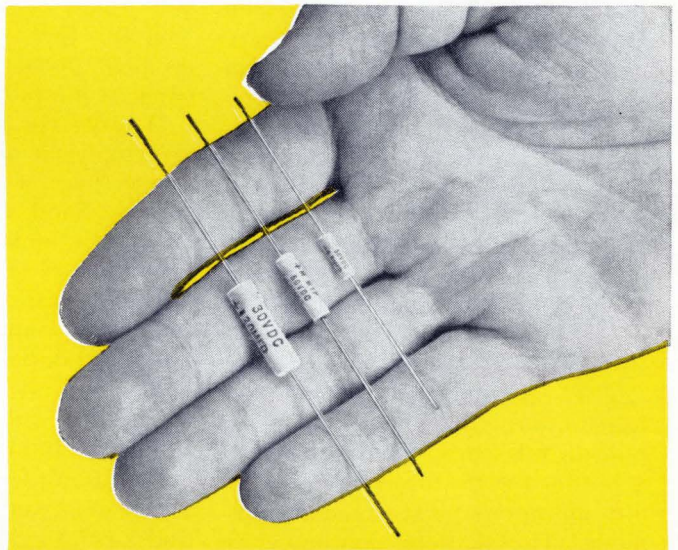

Rating	% change in Capacitance after 1000 hours								
	at 26°C			at 65°C			at 85°C		
	0% RV*	50% RV	100% RV	0% RV	50% RV	100% RV	0% RV	50% RV	100% RV
6.8 mfd, 50V	-1	-1	-1	-0.1	-0.1	0	-1.3	-0.7	-0.9
30 mfd, 50V	0	0	0	0	0	0	-1.0	-2.5	-5.2
78 mfd, 50V	0	0	0	-0.1	-0.2	-0.3	-1.2	-1.2	-1.2
450 mfd, 6V	0	0	0	-0.2	-0.7	-3.0	-1.0	-2.2	-8.0

*RV: Rated DC Voltage

Running the MTP at rated voltage can often help you make further savings in size. 33 mfd at 60 volts, for instance, goes in a “C” case, .225” in diameter and .775” long. But a 33 mfd 50 volt rating fits in the “B” case, which is only .145” in diameter and .590” long. And the cost is about 13% lower.

And that's not all. The MTP is made in the same facility as similar capacitors for Minuteman II. And like all

Mallory wet slug tantalum capacitors, it has lower DC leakage and greater freedom from catastrophic failure than solid tantalum types.

Write today for our latest engineering report on voltage rating tests on MTP capacitors, for bulletin giving complete specifications. Mallory Capacitor Company, a division of P. R. Mallory & Co. Inc., Indianapolis, Indiana 46206.



prototype equipment will be tested in a 96-channel field telephone network at Fort Monmouth, N.J. It will also provide the path for computers talking to computers in the transfer of military data under field conditions.

The Army wants to know how vulnerable such a link is to the weather and natural occurrences, as well as to battlefield shocks and jolts. A typical question: How many bits of information would be lost if a pigeon flew through the beam during data transmission?

On the beam. More important than pigeon problems, however, is making sure the narrow laser beam is always on target.

"You might solve the problem by widening the beam, but you would lose power and other benefits of the laser," Ratcliffe says.

To keep the transmitter pointed at the receiver all the time and still take full advantage of the narrow laser beam, a retroreflector, or target mirror, will be built on each terminal, probably right in the middle of the optics system.

The operator first points the transmitter manually with a built-in telescope. Then he pushes a button for the transmitter to go into an automatic search-and-track mode. This pattern continues as long as the equipment is operating and keeps the transmitter beam within 1° of the center of the receiving terminal's retroreflector.

The outgoing beam is kept on target by maintaining the image of the target in the center of an image dissector tube. Using standard servomechanism techniques, error signals from the tube control a beam-steering mirror.

Straight and level. The tracking and pointing mirror and its optics discriminates against everything except the known energy level of the signal coming back from the receiver terminal. A narrow-band optical filter blocks any wavelength other than the 6,328-angstrom output of the 1-milliwatt helium-neon laser.

The return signal bounces off the reverse side of the beam-steering mirror and is focused onto the image dissector, which provides the error signals for tracking.

To avoid interruption of communications, the tracking system must keep the beam within the ¼ milliradian laser beamwidth, which diffuses to about 18 inches at the end of one mile.

Jungle guide

Combat troops have enough to do without worrying about being lost in dense jungles and mountains. And because of their heavy reliance on air support, they need to know exactly where they are. A new man-carried loran receiver now being sought by the military will give foot soldiers the ability to fix their precise position as accurately as aircraft and ships.

A prototype has been developed by engineers at the Sperry Gyroscope Co., a subsidiary of the Sperry Rand Corp. It will work with both the loran C and the portable loran D systems.

Unsolicited proposals on such man-carried units were sent to the Army Material Command, Fort Monmouth, N.Y., in mid-October by several companies, reportedly including International Telephone & Telegraph Corp., Laboratory for Electronics, Inc., Collins Radio Co. and Lear-Siegler, Inc., as well as Sperry. Sperry says, however, it is the only one with hardware.

Untested. Sperry proposed to convert its prototype into a preproduction model meeting all environmental requirements. The company reportedly would be able to provide 12 of these units for Army field evaluation within six months to a year.

The backpack unit, resembling a walkie-talkie, would contain a battery, whip antenna and radio-frequency section. Mounted on the soldier's belt would be a module containing a control indicator, synchronizing controls and readout.

Without batteries, this equipment would weigh about 7½ pounds. The receiver could provide two lines of hyperbolic information that would be relayed to aircraft. The pilot could then feed this data into his loran gear and home directly in on the ground-based receiver.

Long range. A four-pound optional coordinate converter could also be carried to take the hyperbolic data and convert it to latitude and longitude. But this isn't necessary in many instances; all the Army needs is to tie into the same reference grid as aircraft use.

Depending on the type of standard Army battery used, the receiver and converter would weigh from 15 to 20 pounds. The receiver's digital portions employ monolithic integrated circuits; discrete devices handle analog functions.

Sperry says the man-carried receiver will have the same system positioning accuracy as do air and ground vehicle units—or within 100 meters or better. It can be operated as far away as 400 to 800 miles from the loran transmitters depending on the type of loran baseline system in use.



Electronics notes

▪ **Long life.** After several months of hinting about it, Spectra-Physics, Inc., unveiled its induction argon ion laser at the Optical Society of America convention in San Francisco this month. It is, the company claims, the first gas laser on the market that is excited by an r-f field instead of a d-c source using metal electrodes. R-f excitation provides longer tube life than d-c excitation. The company guarantees the lasers for a year. A slide bar on the laser case, which tilts a Littrow prism, permits the user to dial any of the eight frequencies between 4,579 and 5,145 angstroms. Output is 2 watts. Spectra-Physics is also working on a krypton laser which will oscillate in four colors.

▪ **Plug-in wires.** The Boeing Co. plans a unique electrical wiring system for its version of the supersonic transport. Instead of randomly marrying the wiring at the back of each shelf, connectors will take wires from related systems and related bundles will be run to a new interface box that may even use printed circuits. Thus, if one system fails, all the wiring involved could be pulled out in one simple operation, tested and replaced if needed.

The World's Best Receiver Systems use LEL Receiver Components Like These ...

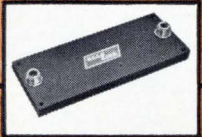
right out of LEL's Catalog!

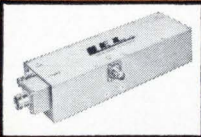
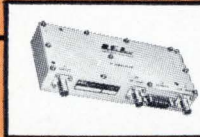
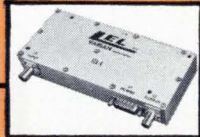
RF PRESELECTION	1st CONVERTER	2nd CONVERTER	LINEAR/LOG IF	LIM. DISCRIMINATOR
				
Strip Transmission Line RF Preselector FSB 2250-100-5-T-NF Freq. range 2200-2300 MHz Response Tchebychev Insertion loss 1 dB max. Stop band loss 40 dB Skirt shape 5 poles Tuning Fixed Price \$200	Solid-State Mixer-preamplifier Model Series -9 RF range 125 MHz-40 GHz (more than 60 coax or waveguide mixers are available within this range) N.F. (overall) 9 dB (typ.) IF cf 160 MHz Bandwidth @ 3 dB 50 MHz Gain (RF/IF) 30 dB Lin. output +10 dBm Price \$725	Solid-State High Level Converter Internal Xtal L.O. Model RTC-1 RF cf 160 MHz RF bandwidth 35 MHz IF cf 60 MHz IF bandwidth 20 MHz Gain 10 dB Noise Figure 12.5 dB Lin. input -10 dBm Price \$900	Solid-State Linear Amplifier Model ITA-34 IF cf 60 MHz Bandwidth @ 3 dB 8 MHz Gain, IF 75 dB Gain, Video 80 dB AGC 50 dB Noise figure 7 dB Price \$375 Solid-State Log Amplifier Model ITL-1 IF cf 60 MHz Bandwidth @ 3 dB 8 MHz Dyn. Range 60 dB Sensitivity 25 mV/dB Price \$575	Solid-State Limiter Discriminator Model ITF-1 IF cf 60 MHz Bandwidth 10 MHz Sensitivity 1 v/MHz Input 50 ohm Output Vid. Det. Price \$325

LEL's catalog is a good place for you to choose from thousands of standard units engineered and manufactured with special receiver applications like yours in mind. Chances are you'll find just what you need. If not, we'll modify any catalogued item in short order . . . or build to your specifications. *Why not call LEL now?*



LEL DIVISION

varian / akron street / copague / new york 11726 / 516 AM4-2200 / 516 PY9-8200 / TWX 516-691-5085

Best sellers!



When circuits need precision wirewounds, you can't beat **DALE RS RESISTORS**

When you need precision wirewounds—Dale's silicone-coated RS line offers the most for your money. For example: **Documented Reliability**—99.994% in tests patterned after Dale's famous Minuteman High Reliability Development Program (test report available). **Versatility**—There are 44 standard axial lead, radial lead and non-inductive styles plus 400 special RS variations already production engineered. **Competitive Price**—We invite you to match Dale RS wirewounds against any comparable part. Call or write us today for complete information.

LATEST RS RELIABILITY REPORT

Unit Test Hours: 32,000,000 • **Reliability:** 99.994%

Stability: Units will not shift more than initial tolerance after 1,000 hours load life.

Test Conditions: 60% confidence level, 100% rated power, 25°C ambient, 1% Δ R failure point.

RS SPECIFICATIONS

- **Applicable Mil. Spec:** MIL-R-26D, MIL-R-26C & MIL-R-23379
- **Wattage Sizes:** .4, .75, 1, 1.1, 2.5, 3, 3.25, 4, 5, 7 and 10 watt
- **Tolerances:** 0.05%, 0.1%, 0.25%, .5%, 1%, 3%
- **Operating Temperature Range:** -55°C to 350°C
- **Resistance Range:** .1 ohm to 273K ohms
- **Load Life Stability:**
 - Char. U: .5% max. Δ R after 2,000 hours at full rated power
 - Char. V: 3% max. Δ R after 2,000 hours at full rated power
- **Moisture Resistance:** .2% max. Δ R
- **Thermal Shock:** .2% max. Δ R
- **Dielectric Strength:** 500 volts, RS-¼ through RS-1B; 1000 volts RS-2 through RS-10
- **Insulation Resistance:** 1000 megohms minimum (dry)
- **Temperature Coefficient:** 20 ppm (high values); 30 ppm (intermediate values); 50 ppm (low values); 90 ppm (below 1 ohm).

Write for New Expanded Resistor
Catalog A and RS Reliability Study



DALE ELECTRONICS, INC.

1300 28th Avenue, Columbus, Nebraska
In Canada: Dale Electronics Canada, Ltd.



Washington Newsletter

October 31, 1966

Eased controls won't improve export picture

The release by President Johnson of more than 400 nonstrategic items from control lists won't do much to increase the electronics industry's sales to the Soviet Union and Eastern Europe. **Although there has been a liberalization of attitude on most items, the restrictions on the electronics industry are still stringent.** Silicon devices and high-frequency microwave equipment are still embargoed. The industry had hoped for clearance of items like videotape recorders and used computers but instead it got clearance on such things as color television sets, car antennas and tape recorders—products the Communists don't need or wouldn't buy anyway.

NASA may try manned moon shot before 1970

Hopes are growing that the 1970 goal of landing men on the moon can be beat by as much as two years as the National Aeronautics and Space Administration prepares for its first manned Apollo launching during the first week in December.

However, all depends on the success of the 1967 Apollo schedule that currently looks like this: a manned orbital flight of up to 14 days; an unmanned flight to qualify the lunar modules; one or two rendezvous missions between a manned Apollo command module and an unmanned lunar module, all using the uprated Saturn 1 and the first two unmanned flight tests of the Saturn 5 moon rocket.

If all goes well on these flights, the third Saturn 5 flight in either late 1967 or early 1968 will be a manned dress rehearsal for the lunar trip. **There is a possibility—although only a slight one at this point—that ground controllers and the astronauts could decide while this flight was in progress to actually go to the moon.**

Ideas for EROS

The Interior Department has been flooded with proposed designs for its Earth Resources Observation Satellites (EROS) even though the formal request for bids is not expected to go out to industry until next year [Electronics, Oct. 3, p. 52]. **Among the various ideas submitted to the department's Geological Survey, which is responsible for the project, was a surprise proposal from Ball Brothers Research Corp. to modify the Orbiting Solar Observatory which it designed.** As expected, the Radio Corp. of America offered its Tiros and Relay satellites while another proposal was that the Nimbus weather satellite be used.

Spy satellite may be worth \$200 million

The Pentagon's new top-secret spy satellite, still not finally approved, **will cost about \$200 million for its development and flight demonstration.** Competing for program 266, also called early warning satellite and crisis management satellite, are the Radio Corp. of America and three teams headed by the Lockheed Aircraft Corp., TRW Systems Group of TRW, Inc., and Westinghouse Electric Corp.

Congress ignores tube tariff bill

An effort to kill tariffs on tubes for radios and television sets to alleviate a shortage has failed in the final rush to adjourn Congress. Shoved aside was an industry-backed bill—approved by a House committee—suspend-

Washington Newsletter

ing tariffs until June 30 1968. With the shift to solid state, producers have reduced tube production and the removal of tariffs would have increased the flow of foreign tubes into this country. The color television industry—with skyrocketing production gobbling up growing numbers of tubes—had hoped European and Japanese imports would solve the tube shortage until color tv makes the switch to solid state in the next couple of years.

Industry to get ratings on risks from Pentagon

The Defense Department soon will approve a change in its procurement regulations that will mean less Pentagon administrative and audit controls for companies with most of their work in higher risk contracts, such as firm fixed-price awards, or commercial business.

Called contractor's weighted average share in risk, CWAS, the new guidelines will determine the degree of risk in all of a company's business by assigning a risk percentage to each type of contract, ranging from 100% for firm fixed-price to nothing for cost plus fixed fee. By averaging all contracts a company qualifies for the program with a rating of 65% or better.

With this much high-risk business the Pentagon assumes that a company is sufficiently motivated to operate efficiently and doesn't need the Pentagon looking over its shoulder. Two last minute additions to the program, however, will make it more difficult for contractors to qualify for less red tape. A fixed-price contract will be downgraded 20% if the company hasn't won the award in competitive bidding. And before a company can qualify, at least 35 points of its total rating must be from firm fixed-price awards or commercial sales.

Army delays Shillelagh missile

The Army is holding back production funds for at least six months on its Shillelagh antitank missile. An Army spokesman gives Vietnam as the reason for the delay and strongly denies reports of technical problems. Missile-carrying tanks are not playing a major role in Vietnam fighting he says, and funding priority must necessarily be directed to the most urgent requirements. The Army has \$91 million in its fiscal 1967 budget for the antitank missile.

The Shillelagh is on a Sheridan vehicle, which tracks the missile by infrared after firing it. The missile carries only receiver and control electronics. The Aeronutronic division of Philco-Ford Corp., the prime contractor, had just recently begun to build up production rates. Philco-Ford is a subsidiary of the Ford Motor Co. Earlier this year, the Martin-Marietta Corp.'s Orlando, Fla., division was named second source, but has yet to qualify its facilities for Shillelagh production. Aeronutronic will probably keep its production lines going at a reduced rate.

No change expected in key positions

Don't expect much change in the makeup of key Congressional committees of interest to the electronics industry after Election Day. In committees dealing with space and defense, the chairmen appear sure of reelection; the only changes will be in some ranking minority members.

The only electronics engineer now in Congress, Rep. Weston Vivian (D. Mich.), is being opposed by Republican Marvin Esch. Vivian, an EE with a doctorate from Michigan University and former vice president of Conductron Corp., is a slight favorite.

IS A PHOTO-CHOPPER BETTER?

PART NINE of a series on the state of the chopper art

Maybe. Us engineer types never get a decent clear cut decision. Still, if the Old Man said don't use them damn choppers maybe you'd better go photo-chopper. If you just ignore the neon bulbs you could say all solid state and get away with it.

It's like this. You'll get 1500 to 2500 ohms conducting resistance if you leave the neon lamp on. If you switch it at 60 cycles you get maybe 20 K. Dark resistance gets pretty good, about 10^9 .

The response time is not so hot. The flaw is turn-off time. The cells turn on quick and off slow. You use two, which helps, one in series with the load, one in shunt.

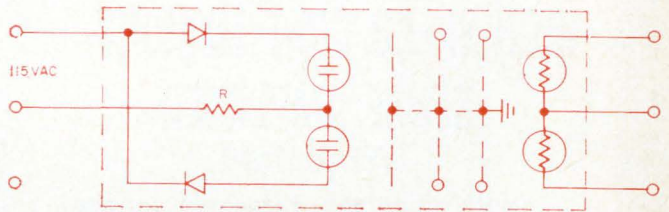
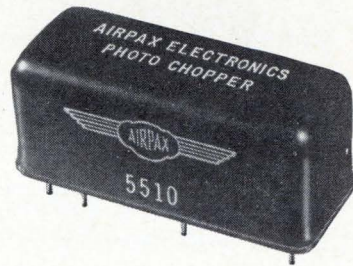

Internal schematic of AC Drive Type 5510, 60 to 400 cps. R = Limiting resistor.

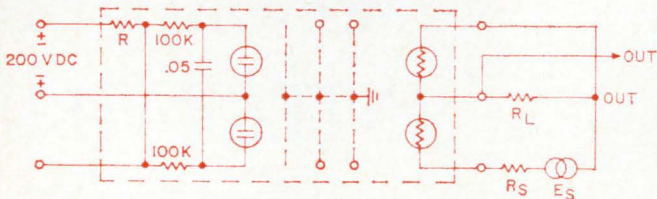

Type 5514 in a modulator circuit

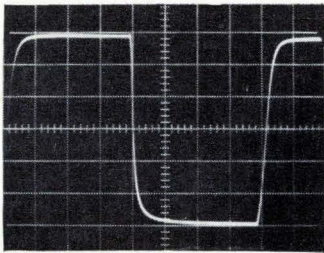

Output waveform
60 cycle square wave drive

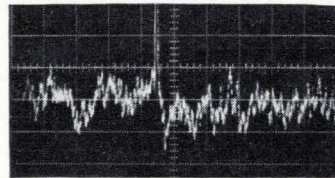

3 microvolt RMS, 50 microvolt peak noise across 1 megohm.

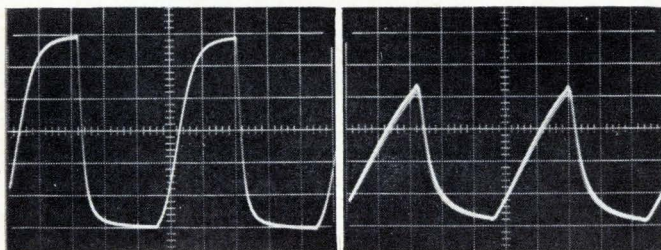

Output waveform
400 cycle square wave drive

Output waveform
1000 cycle square wave drive

You really need a square wave drive for best performance. Or you can supply DC at about 200 volts and get the neon bulbs to operate as relaxation oscillators. That's Airpax part 5514. The chopping rate will vary directly as the DC voltage.

So — sorry about that. It's still your headache. The life seems pretty good, we dunno how good yet, but it's probably up to the neon bulb if the photo-resistors are any good.

We will cheerfully sell you a couple thousand.

PEAK EFFICIENCY VS. FREQUENCY

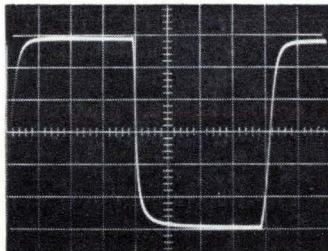
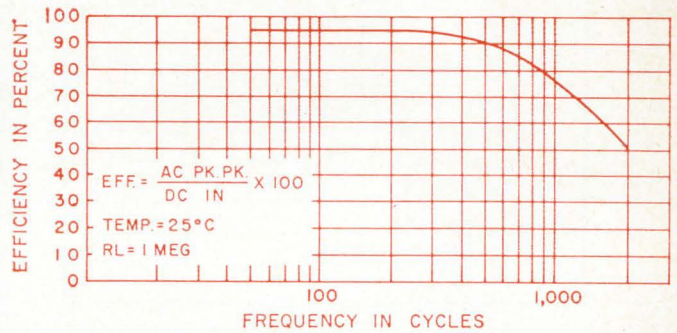

60 cps square wave drive
showing maximum efficiency.

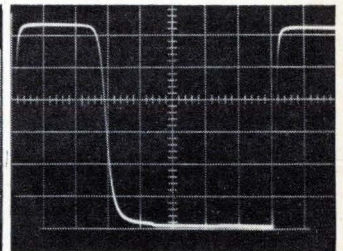

60 cps sine wave drive
showing reduced time efficiency.

AIRPAX ELECTRONICS incorporated CAMBRIDGE DIVISION, Cambridge, Maryland

Phone: 301 228-4600 • TWX: 301-228-3558 • TELEX: 8-7717

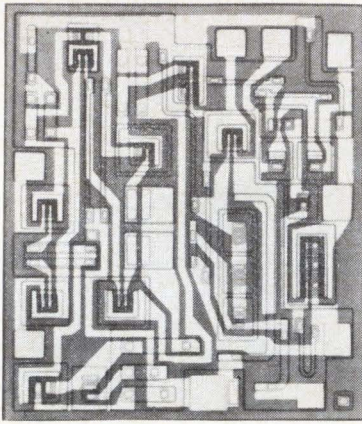

HIGH-SPEED CORE MEMORY SENSE AMPLIFIER TYPE MC1540

... with adjustable threshold voltage!

Typical performance:

- Fast recovery time — $t_r = 40$ ns compatible with 0.5 microsecond cycle time memories
- Saturated logic output signal
- Narrow uncertainty region — 6 mV
- High sensitivity — $V_{th} = 17$ mV (adjustable)

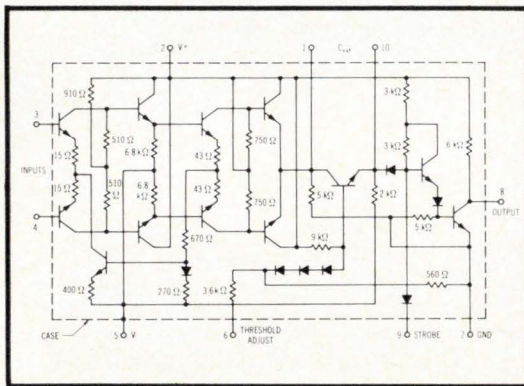

... for all applications requiring core memory signal sensing — such as, industrial control systems, data processors, and airborne computer systems.

CIRCLE 313 READERS SERVICE CARD

MOTOROLA ANNOUNCES THREE NEW STATE-OF-THE-ART MONOLITHIC INTEGRATED AMPLIFIER CIRCUITS!

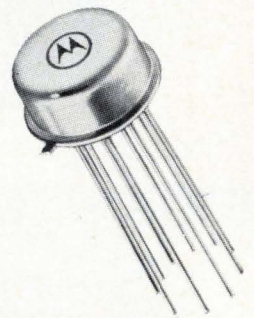

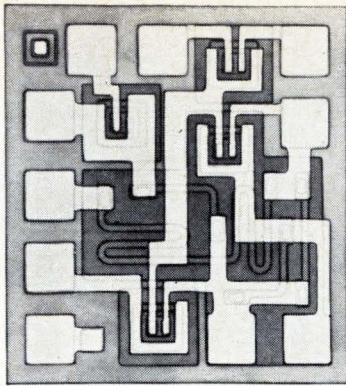

RF-IF CASCODE AMPLIFIER TYPE MC1550

... with excellent AGC performance!

Typical performance:

- Very low internal feedback ($y_{12} < .001$ mmhos) – for easy alignment and high stability
- High power gain – 25 dB@ 60 MHz
- Constant input impedance over entire AGC range
- Low noise figure – 5 dB@ 60 MHz

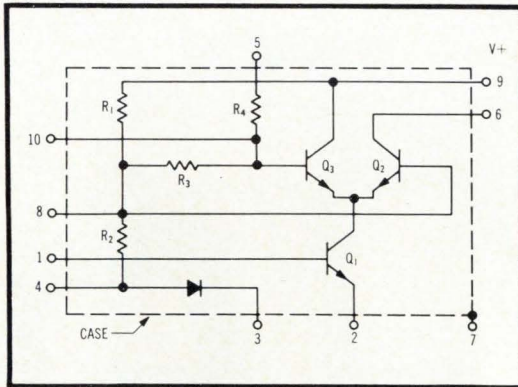

... ideal for your newest communication equipment designs.

CIRCLE 314 READERS SERVICE CARD

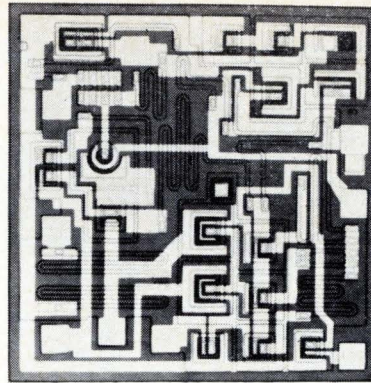

HIGH-GAIN OPERATIONAL AMPLIFIER TYPE MC1533

... with extremely low drift ($\pm 3 \mu\text{V}/^\circ\text{C}$)

Typical performance:

- Open loop gain – 60,000
- High-input impedance – Z_{in} = 1 megohm
- Adjustable input offset (set $V_{off} = 0$ volts for minimum possible error signal)
- Large-output voltage swing – 13 volts ($\pm V = 15$ volts) with 2 K load

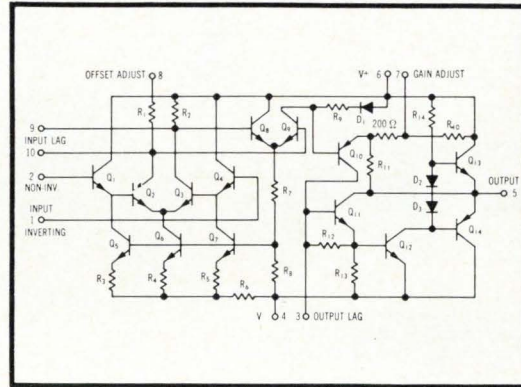

... for application in all types of low-level sensing equipment and analog computation systems.

Units for immediate evaluation are in stock at your nearest Motorola franchised semiconductor distributor. For complete technical details and/or application assistance in designing with these new integrated circuit amplifiers, contact your nearest Motorola field representative. Or write: Motorola Semiconductor Products Inc., Technical Information Center, Box 955, Phoenix, Arizona 85001.

CIRCLE 315 READERS SERVICE CARD

MOTOROLA Semiconductors
— where the priceless ingredient is care!

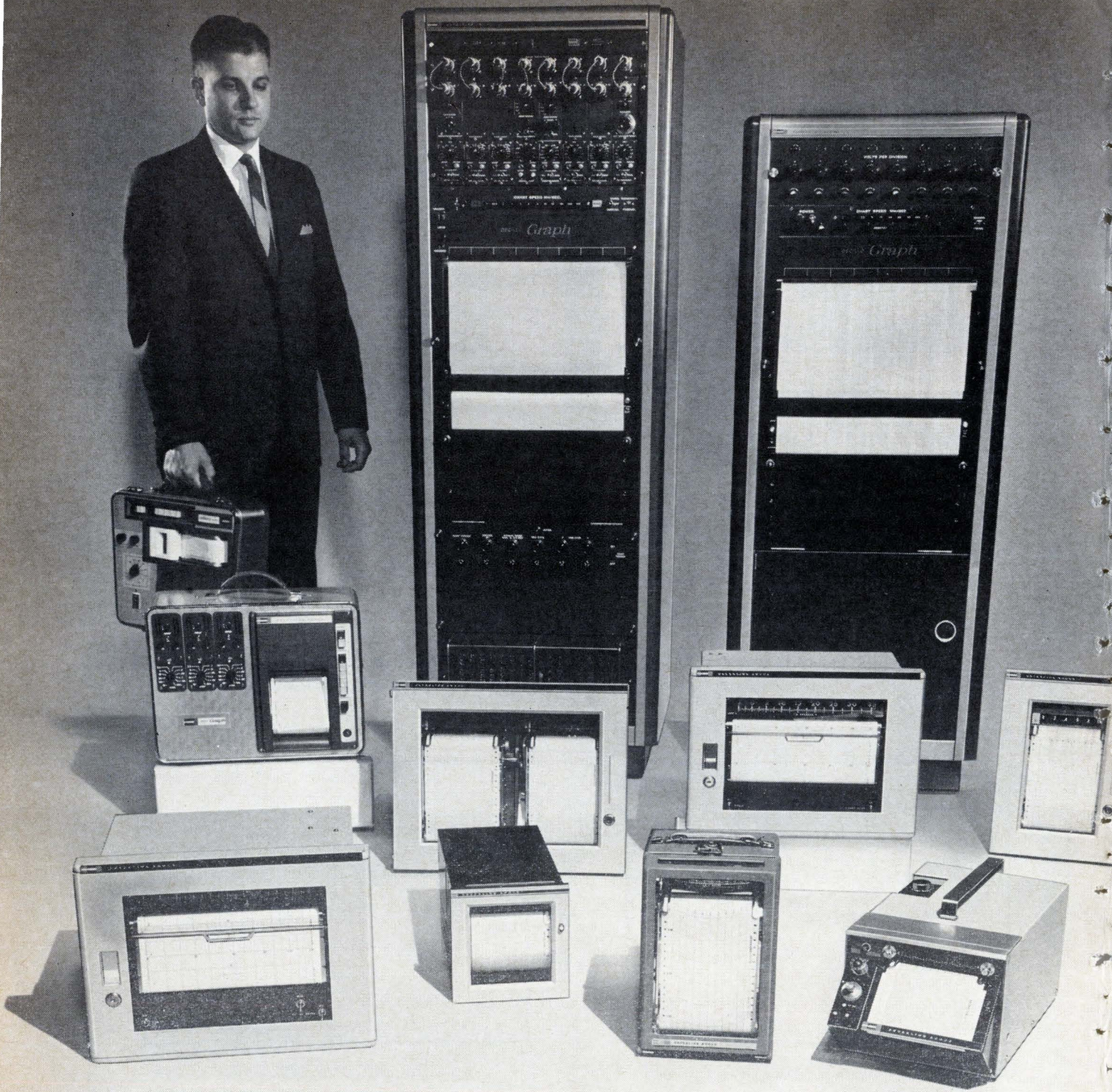

Esterline Angus doesn't keep handing you the same old line!

We keep developing new graphic recorders and new features to incorporate in established recorders . . . to satisfy your needs.

We've developed a trouble-free servo motor with only one moving part. No pulleys, drive cords or gears. It delivers 2/10 second response over a 10" span and 1/8 second response over a 4½" span.

Our new Multipoint has an exclusive Programmed Printing option. It lets you select points electrically with switches.

You can now order our Permanent-Mag-

net Moving-Coil recorders with magnetic amplifiers (to increase sensitivity) or with power transducers (to measure watts, volts, amperes, vars . . .).

We've designed a Rapid Response (1/10 second) Voltmeter. It records 100 millisecond voltage transients with full accuracy . . . especially valuable in monitoring power supplied to data processing units.

In addition to our best selling Ink Type Event Recorders are new Inkless and High Impedance Event Recorders. The high im-

pedance instrument can be bridged into low power (i.e., telephone) circuits without upsetting their operation.

Want to record more than one channel of information on the same chart? We now have six types of two-channel recorders, plus an Analog-Event Recorder which provides one channel of analog information and eight channels of event information.

Oscillo Graphs? Choose from nine units including portables and cabinet models. All with frequency response above 125 cps.

Write for our full line brochure. You'll discover we make more kinds of graphic recorders than just about anybody else.

Esterline Angus Instrument Co., Inc.
 Box 24000E • Indianapolis, Ind. 46224



ESTERLINE ANGUS
 EXCELLENCE IN INSTRUMENTATION FOR OVER 60 YEARS

Technical Articles

Tiny filters block radio-frequency interference: page 58

The small size, great power and increased complexity of modern electronic systems have greatly increased the possibility of radio-frequency interference. Filter developers are counteracting this problem with new types of low-pass filters that are smaller in size but more effective barriers to rfi.

Correlation enters new fields with real-time signal analysis: page 75

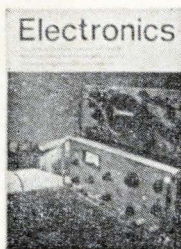

Correlation analysis is a powerful technique for analyzing signals but it takes a lot of time. Now new instruments and methods are allowing correlation to be performed on a real-time basis. It's usable in many applications where the big problem is digging a signal out of noise—applications such as medicine, geophysical search and underwater detection. For the cover, photographer Vincent Pollizzotto highlighted the new signal correlator built by Princeton Applied Research, Inc. as it processed electroencephalograms from a patient. On the 'scope is a trace generated by the instrument showing the onset of the brain's alpha rhythm.

Wiring design helps core memory work at rapid cycle time: page 83

In their schemes to speed up core memories, engineers have made the cores smaller and smaller. Now, taking a different approach, a team of computer designers have speeded up a ferrite-core memory to a 500-nanosecond cycle with an unusual layout. A new form of 2½D organization cuts 100 nanoseconds or more from the memory time of conventional designs.

The other side of the recruiting coin: page 100

It's as tough to match a job to a man as it is a man to a job, says the engineering head of one research and development division. He tells how his company hires engineers and what it costs when the wrong man is chosen.

Coming November 14

- How Japan's Sony Corp. does product planning
- A look at Sony's most interesting circuits
- Electronic pulsers for gallium arsenide diodes
- Integrated circuits in action: part 2
- Graph theory for circuit analysis

Tiny filters block the path of radio-frequency interference

New materials and design techniques have created improved devices to combat the problem of interfering signals

By Peter A. Denes and John J. Crittenden

Denesco, Inc., Albuquerque, N.M.

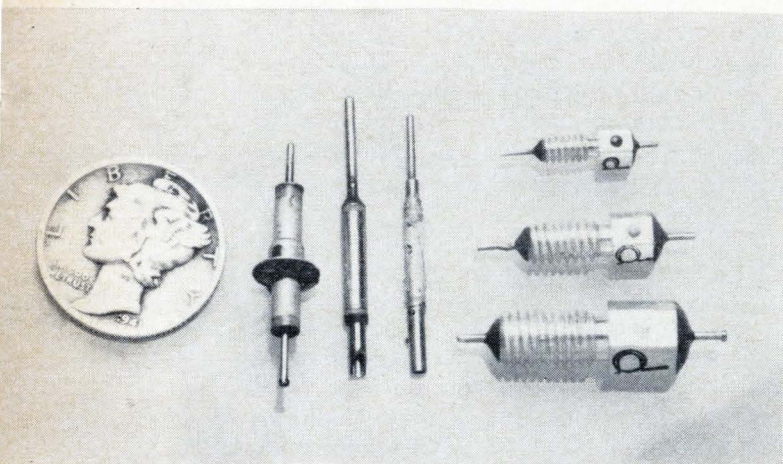

The small size, greater power and increased complexity and sensitivity of modern electronic systems have greatly increased the possibility of radio-frequency interference. However, reliability requirements have become more stringent too, demanding elimination of even the remotest chance of unwanted signals.

To combat rfi, smaller and more effective low-pass filters have been developed. They allow d-c and low-frequency power signals to pass but sharply attenuate signals at radio frequencies from about 100 kilohertz to 10 gigahertz. Work on filters was spurred by the limitations of simple commercial bypass capacitors.

The low-pass filters are built with lossy inductive elements—iron powder or magnetic-alloy dust cores—fitted into capacitors made of ceramics with high dielectric constants. Because they are lossy they have better attenuation characteristics at high fre-

quencies where the external circuit may resonate with the filter's elements. As the diagram on page 64 indicates, the inductors usually consist of a single conductor—which can be a connector pin—passing through a tube of magnetic material. The capacitors are formed around the inductor by bonding thin metal plates on the inside and outside surfaces of a ceramic cylinder.

Because the ceramics have high dielectric constants, the capacitors are very small and so are the filters. A typical filter, in the photograph at the left, is only about $\frac{3}{16}$ inch in diameter and 0.47-inch long. Nevertheless it can attenuate rfi signals by at least 65 db at 200 megahertz and 80 db from 1,000 to 10,000 Mhz. A filter can be mounted on a shielded compartment and used to conduct filament currents to high amperage circuits in the compartment. At the same time it prevents rfi signals from getting in or out of the compartment.

Inductors with ferromagnetic dust cores can maintain attenuation levels with even 10 to 30 amps flowing through the filter. Ferrite cores used in previous filters saturate with only a few amperes of current.

Smaller filters incorporating most of these characteristics are now available as pins that fit into connectors. Called pin filters, their diameters range from 0.040 inch to 0.150 inch. They are small enough to fit into a standard multipin connector without changing pin spacing or the connector's size. The connector is an excellent place for the filters because then all nonshielded inputs to a compartment are filtered.

Smaller filters—with outside diameters of 0.030 inch—can also be used as leads for integrated circuits. The d-c current rating in the smaller size is only 1 amp but this far exceeds the needs of integrated circuits.

Where good attenuation is needed at frequencies as low as 0.1 Mhz, the filters cannot be made as small as the ones in the photograph at the left. In keeping with the larger inductors and capacitors required, the filters must be larger. However, even these have typical dimensions of only about 0.32 inch by 1 inch. A typical filter would attenuate rfi signals by 40 db at 0.1 Mhz and over a 100 db from 10 to 10,000 Mhz.

General characteristics

To select the correct filter for a given task, an understanding of the performance characteristics of the low-pass filters is necessary.

Often designers first consider the attenuation versus frequency characteristics of a filter. The information is usually presented graphically, as on page 65. However, the attenuation characteristics given by such graphs are not necessarily the characteristics the filter would have in a circuit because the values plotted depend closely on the methods of measurement. Such things as isolating pads, matching resistors, load resistors, input r-f voltages level and temperature considerably influence the filter's attenuation; consequently the conditions used in measuring attenuation are usually given with the data.

A d-c and low-frequency a-c voltage rating is specified to note the maximum allowable voltage between the filter's input or output lead (feed-through terminal) and the ground terminal. The term low-frequency a-c refers usually to 25- to 400-hertz power supplies. The voltage breakdown rating of the capacitors in the low-pass filter sets the filter's voltage rating.

A d-c or low-frequency a-c current rating is the maximum current which can pass continuously through the filter. It depends on two factors principally. Because a current generates heat, it must be limited to prevent a temperature that would damage the filter. Temperatures above 125°C can crack the core materials or carbonize the insulating materials of dust cores.

The level at which the core material saturates represents the second current-rating factor. Saturation reduces the magnetic core's permeability, causing a drop in inductance and reducing the filter's attenuation. To guarantee a minimum attenuation in current-sensitive filters, the through-going current must be limited.

Another rating specifies either the maximum r-f current or voltage the filter can handle. Although in most applications the rfi amplitude will be small, unusual circumstances can produce high-level interfering signals; a low-pass filter's ability to cope with these strong signals must be known. Because capacitive input type of filters [page 60] have low input impedances, an r-f current rating is specified for them. In contrast, an r-f voltage rating is generally specified for the high-input impedance, inductive input type filters [page 60]. Sometimes the attenuations of high-level r-f signals differs from the attenuation of low-level r-f signals so that at-

tenuation at several r-f values are specified.

A so-called "bias dependence" records how the rfi attenuation varies with d-c or low-frequency a-c currents. As noted, d-c or low-frequency a-c currents can saturate the core. When a low-frequency a-c current is flowing through a bias-sensitive, low-pass filter, as a filter with a ferrite core, the current will vary the attenuation at a rate equal to the current's frequency. Consequently, the rfi level will vary at the output even if the input is constant. A bias current's effect depends on the frequency of the rfi. Generally, the attenuation variation is less at high frequencies, for example above 500 Mhz, because the ferrite core's permeability has already dropped to a low value and is less dependent on the amplitude of the d-c magnetizing field.

The terminal-to-terminal resistance—the resistance encountered by the through-going d-c or low-frequency a-c current—is specified, but most often is important only because it relates to the allowable temperature rise caused by current dissipation. In small filters the through-going resistance depends on the wire size, core size and number of turns in the inductor used in the filter. For the miniature pi-type filters described on page 64 the resistance is much less than 0.01 ohm. When large inductance values are required, as for low-frequency filters—0.1 Mhz—the through-going resistance will be 0.1 to 10 ohms.

Rfi problems and solutions

Radio-frequency interference occurs when an undesired signal appears in a circuit compartment. For example an aircraft range station signal at 250 khz might get into a superheterodyne receiver that has a 250-khz intermediate-frequency amplifier. Aside from noise, the rfi signal could saturate the amplifier, making it virtually useless.

Obviously, the first step to reduce or eliminate rfi is to shield all sensitive circuits. However, shielding is not sufficient because almost all circuits have incoming conductors that supply needed operating voltages and signals. In addition other conductors may be conducting generated signals away from the shielded circuits. Unless these are also shielded

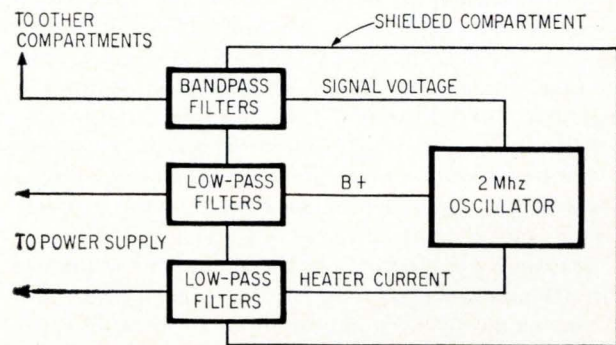

The 2-megahertz radio-frequency interference signal must be removed from the B₊ and heater lines. Low-pass filters are inserted in the power lines to attenuate the signal and its harmonics. Harmonics in the signal line are removed with either bandpass filter or a suitable low-pass filter as shown.

throughout their length, they will act as receiving antennas for the rfi signals. The rfi will be conducted into sensitive circuits, creating interference.

Filters can combat two general types of rfi—"incoming" and "outgoing" rfi. Incoming rfi refers to radiated or conducted radio-frequency signals that find their way into a restricted area or circuit. If the rfi signal has a large enough amplitude, it can cause either interference or malfunction or both in the circuit.

The appearance of radar pulses in a sensitive telemetry receiver is an example of incoming radio-frequency interferences. Although the sensitive circuit may be completely shielded, the wires which provide d-c voltages to the unit can pick up the radar pulse. Outgoing radio-frequency interference occurs when undesired signals radiate from certain areas or compartments; the cables which carry power voltages can radiate the signal.

Modern electronic systems contain numerous compartments with many circuits, so it is difficult to anticipate all rfi problems. The trend is to limit the level of rfi signals conducted by outgoing wires and to specify maximum levels of radiated frequencies. To prevent malfunctions, a circuit and its supply cables are required to operate properly even when high-level external rfi appears over a wide frequency range.

In the typical outgoing rfi problem diagrammed on page 59, the object is to keep the 2-Mhz signal and its harmonics from appearing on the conductors leading to the compartment. Low-pass filters that have high attenuation at 2 Mhz are inserted in the leads, greatly attenuating the rfi. Low-pass filters usually are bolted into a hole in the compartment wall to insure a good ground for the filter body and to reduce the level of the interfering signal; much of the filter action is obtained by shunting the rfi signal to ground.

Source impedance

The rfi's source impedance affects a filter's attenuation. Often, instead of determining the source impedance, a filter is selected which will give the needed attenuation under the worst imaginable set of conditions. With outgoing rfi source impedance is not a severe problem because the interference frequencies are known as well as the exact circuit generating these frequencies. Here, source impedances can be determined with suitable instruments.

With incoming rfi, it is considerably harder to evaluate the source impedance of interfering signals because the cables which pick up the signal represent a complicated antenna.

The source impedance of the rfi and consequently the attenuation produced by a low-pass filter, and in particular by a capacitor input type of filter as at right, depends on factors such as the frequency of the rfi signal, the cable type and length, the distance of the cable from ground, the type of termination at the end of the cable and the shape of the cable layout.

As an example, the impedances of long un-

Inductive input filters

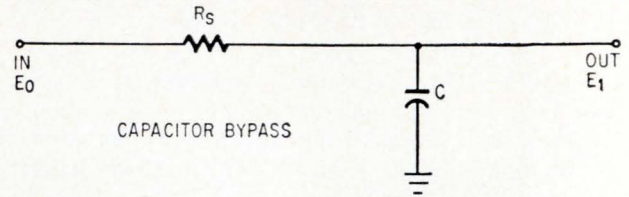

Simplest filter is the bypass capacitor to ground. R_s represents source impedance. Attenuation versus frequency is limited to 6 decibels per octave and is affected by internal resonances in capacitor, limiting useful bandwidth.

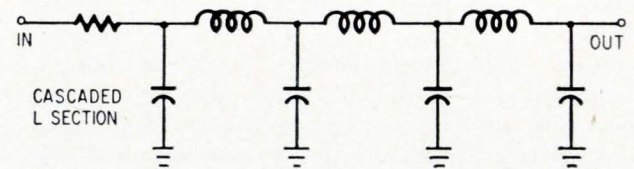
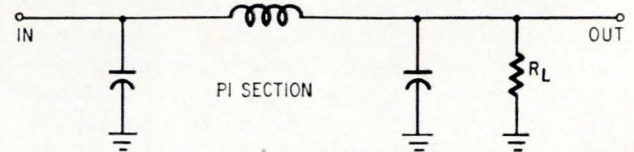
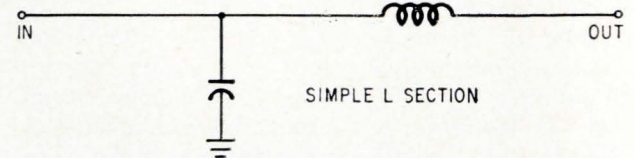

Capacitor input filters include the simple L section at the top, the pi section, center, and the cascaded L section. Simple L sections are sensitive to output impedance. Adding output capacitor as in pi section reduces this dependence. Cascaded section simplifies problems of internal resonances since components can be chosen to resonate at different frequencies.

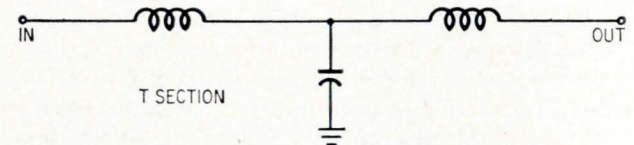
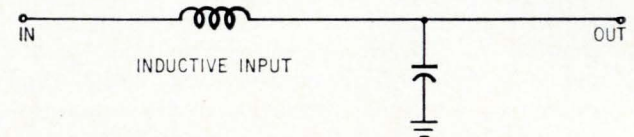

Inductive input filters have the advantage that good attenuation is obtained even with zero source impedance. Basic filter is at top. Attenuation of T-section filter, bottom, is dependent on the load impedance.

shielded lines may vary widely. If the lines are integral multiples of a quarter wavelength at the interfering signal's frequency, the lines appear as antennas that have impedances of 50 to 70 ohms. However, if the lines are even multiples of a half wavelength the impedances can exceed 1,000 ohms.

A filter would exhibit a lower attenuation to the 70-ohm source impedance than it would to the 1,000-ohm source impedance.

In these simple examples it has been assumed

that a continuous-wave signal is causing the interference and a straight, unshielded wire is picking up the interference. In practice, the interference is often a pulse with a broad frequency spectrum; the cable far from being a simple antenna may be bundled with different wire lengths and perhaps partially shielded.

Load impedance also affects a filter's attenuation characteristics. However, it is not a serious problem because load impedance can be measured or calculated. Filters with an inductor on the output require low values of load impedance to produce the highest possible value of attenuation. In a low-pass filter with a capacitor at its output the capacitive reactance is usually so low that the value of load impedance is not a concern.

Simple bypass

In early applications simple bypass capacitors, as in the top diagram at the left, were used to reduce interference on conductors entering a circuit. In the diagram R_s represents the rfi's source impedance.

The general equation for attenuation is given as

$$\Delta A = 20 \log \frac{E_o}{E_1}$$

where E_o is the output rfi signal, E_1 is the attenuated rfi signal and A is the attenuation in decibels. Since E_1 is related to E_o by

$$E_1 = \frac{E_o}{2\pi f CR_s}$$

then the bypass capacitor's attenuation is

$$A = 20 \log 2\pi f CR_s$$

The equation indicates that for large attenuations both the source impedance and the bypass capacitor should be large.

The simple bypass capacitor cannot handle many modern rfi problems. Large capacitors are required and these tend to have internal resonances which reduce the attenuation. In addition the attenuation varies with frequency at only 6 decibels per octave—a value too small to protect against most radio-frequency interference.

The limitations of a simple bypass capacitor spurred the research and development of miniature low-pass filters. As a rule, a low-pass filter combines inductors and capacitors to increase the attenuation of rfi signals. In the inductive input filter diagramed at the left, rfi signals are attenuated both by the bypass capacitor and the inductor's high series impedance. However, because of the variety of rfi possibilities, a number of miniature low-pass filters have been developed.

Capacitive input

The simplest capacitive input filter is the simple L-section filter shown in the center diagram at the left. Attenuation of undesired r-f signals depends on both the source impedance of the r-f signal and the impedance of the following circuit. Attenuation increases as the rfi's source resistance increases.

Fortunately, most rfi signals have quite high source impedances and so these simple filters are useful in many applications.

Attenuation cannot be calculated without the values of source and output impedance. However, if the attenuation of the capacitive input type filter is known at a particular frequency and source impedance then a transfer impedance can be calculated from

$$A = 20 \log \frac{\text{source impedance}}{\text{transfer impedance}}$$

The transfer impedance is defined as the ratio of the filter's input voltage to the filter's output current at a given source and load impedance. It is assumed that the output impedance remains constant. Once the transfer impedance is known, the filter's attenuation can be calculated for other source impedances by the same equation.

If the attenuation is known for a 50-ohm source impedance, the change in source impedance will produce a change in attenuation, ΔA , given by

$$\Delta A = 20 \log \frac{\text{new source impedance}}{50}$$

The attenuation of the pi-section low-pass filter [center diagram, at the left] with a relatively large capacitor on the output depends less on the output load impedance because the output capacitor's reactance is relatively low compared with the load impedance.

Series resonances between the inductive and capacitive elements can reduce the attenuation since high voltages would appear across the capacitors and inductors. However, the L and C values can be selected so that the resonant frequencies are in noncritical frequency regions.

The cascaded L-section filter in the center diagram at the left reduces the problem of resonances between filter elements. Different inductance and capacitance values are selected for each L section to prevent the sections from resonating together. One section will undergo some attenuation loss at its resonant frequency but the other sections will prevent a drastic decrease in the over-all attenuation.

Inductive input filters

Where low or unknown source impedances are faced, designers look to an inductive-input type of filter, as in the bottom diagram at the left. Both the bypass action of the capacitor and the high series impedance of the inductor attenuate rfi signals.

Attenuation depends less on the source impedance of the interfering signal because the input inductor has relatively high series impedance. In fact, good attenuations can be obtained with even zero source impedances. However, as with the capacitive input filters the higher the rfi's source impedance the greater the filter's attenuation. It is assumed in both instances that neither the imped-

ance of the source nor the input impedance of the filter is reduced by partial resonance effects—true if inductor Q is below 0.05. Again, as with capacitive input filters, relatively large filter capacitors make the attenuation depend less on load impedance.

Another common inductive input type of low-pass filter is the single T-section filter, at the bottom of the diagram on page 61. Input characteristics are similar to those of the simple L section. The attenuation however is quite independent of the load impedance. The higher the load impedance the less the attenuation.

Internal resonances

In any filter using high Q, low-loss elements such as air core inductors and Mylar capacitors, the filter elements themselves are prone to self-resonances. High Q is a relative term but as indicated in the discussion below even a Q=1 is considered too high for a good rfi filter. Self-resonance in filters can occur over a wide range of frequencies, depending on the type of capacitor and on the number of turns on the inductor. For example, a relatively large paper capacitor, with many layers of foil, may resonate with its internal

series inductances at frequencies well below 1 Mhz. Similarly, a high Q inductor with many turns has shunt capacitance that produces troublesome resonances.

Even the special capacitive input filter, described on page 64, exhibits self-resonances at frequencies at which the dielectric tube in the filter body behaves as a microwave cavity. For such filters self-resonances occur at multiples of about 500 Mhz.

However, in modern low-pass filters, lossy circuit elements are used because the low Q components reduce the attenuation variations at self-resonant frequencies, and at frequencies at which the elements resonate with one another and with the external circuit.

At these frequencies, inductive coils should have Q's less than 0.05. Capacitive Q's are generally higher than 20 because the capacitors would not function properly with lower values.

High-loss versus low-loss

Only lossy, low Q filters can guarantee a minimum attenuation over a broad frequency range. Although the amount of the losses have little effect on the passband characteristics, the higher the loss the better the filter's performance in the at-

Low Q's counteract resonances

Though most authors say an inductor's Q should be less than unity, Denesco engineers believe a better criterion is a Q of less than 0.05. This will insure that resonances with external elements will not seriously affect the filter's attenuation characteristics. Resonance with external elements is considered the worst case. The need to make Q less than 0.05 can be demonstrated by considering a simple inductor-capacitor section, which is the basic building block for all filters.

The filter would have an inductor input and capacitor output of impedances Z_L and Z_C as indicated in the center of the diagram shown below. The source's open circuit voltage and internal impedance are

V_1 and Z_S ; the impedance of the load is Z_T .

Least attenuation occurs when the source and load are purely reactive and the imaginary parts of Z_S and Z_L and Z_C and Z_T cancel each other. These conditions are represented by

$$\begin{aligned} Z_L &= R_L + jX_L \\ Z_S &= jX_L \\ Z_C &= R_C - jX_C \\ Z_T &= +jX_C \end{aligned}$$

where R_L = inductor's resistance
 X_L = inductor's reactance
 R_C = capacitor's resistance
 X_C = capacitor's reactance

When these conditions occur, the filter's input impedance Z_1 is

$$Z_1 = R_L$$

The equation indicates that the input impedance will be determined only by the inductor's series resistance which depends on its total losses. This can be expected to reduce the attenuation because of equation 1 below. The output impedance, Z_2 , can be calculated from

$$\frac{1}{Z_2} = \frac{1}{R_C - jX_C} + \frac{1}{jX_C}$$

Solving for Z_2

$$Z_2 = \frac{X_C}{R_C} (X_C + jR_C)$$

The filter's attenuation is given by

$$\begin{aligned} A &= 20 \log \frac{V_1}{V_2} \\ &= 20 \log \frac{Z_1 + Z_2}{Z_2} \end{aligned} \quad (1)$$

Substituting the values of Z_1 and Z_2 into equation 1, the attenuation in the worst case is given by

$$A = 20 \log \left[\frac{X_L}{X_C Q_L (Q_C + j)} + 1 \right] \quad (2)$$

where $Q_C = \frac{X_C}{R_C}$

$$Q_L = \frac{X_L}{R_L}$$

Equation 2 indicates that when a capacitor and inductor have no losses—impedances are purely reactive and thus Q's are infinite—the attenuation in the worst case will be zero.

To simplify equation 2, it must be kept in mind that a good ceramic capacitor must have a Q greater than 20 or else the capacitor would quickly deteriorate.

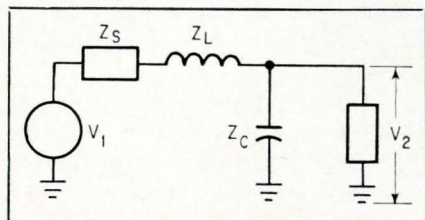

Simple L-section filter consisting of impedance Z_1 and impedance Z_C is analyzed.

attenuation band. In addition to being less sensitive to resonances the lossy filter will dissipate a greater part of the incident rfi; less rfi is therefore reflected back to preceding circuits.

Lossy low-pass filters have some disadvantages. At selected frequencies a high Q, lossless filter produces a greater attenuation than can low Q filters, if the elements are resonated properly. Because the lossy filter dissipates more of the rfi energy, the filter cannot be rated for as high a radio-frequency voltage and current level as a lossless filter.

In a low Q filter, both the filter and capacitor elements are lossy, but the inductor's core losses predominate. Nevertheless the high dielectric constant material in the capacitors offers an advantage. Since the capacitors are small, so is the filter; and this helps to maintain the filter's advantages because the smaller size results in shorter internal interconnections. Since these interconnections are high Q inductive components, reducing their length helps to maintain low Q and insure good attenuation over a wider range of frequencies.

The capacitors in the filter, made with high dielectric materials such as barium titanate ceramics, have Q's of about 20 to 50. For comparison,

Q's of dust cores

Material	Q	Frequency, f_T , for	
		$Q \leq 0.05$	μ at f_T
Iron powder	$Q = \frac{10^9}{\mu f}$	300 Mhz	60
20-80 permalloy	$Q = \frac{10^8}{\mu f}$	80	75
Isoperm powder	$Q = \frac{2.5 \times 10^7}{\mu f}$	50	55

Mylar capacitors have Q's around 200 to 300 and air dielectric capacitors have Q's in excess of 10,000.

Denesco can make a powder core with a Q less than 0.05 at frequencies at which external reactances resonate with the filter. This insures the lossy filter's attenuation exceeds that of a similarly resonant but lossless filter [see "Low Q's counteract resonances," below].

Different magnetic materials will provide Q's less than 0.05 at different frequencies. A one-turn inductor using an iron powder core with a perme-

Hence to a good approximation

$$|Q_C + j| \approx Q_C$$

If in addition, $X_L/X_C Q_L Q_C$ is much greater than 1, then

$$A \approx 20 \log \frac{X_L}{X_C} \frac{1}{Q_L Q_C}$$

Defining A_j as the filter's attenuation caused only by the reactive part of the impedances

$$A_j = 20 \log \frac{X_L}{X_C}$$

Then the filter's attenuation can be written

$$A = A_j + 20 \log \frac{1}{Q_L Q_C}$$

If it is desired to have an attenuation equal to A_j under any circumstances, it is not sufficient to keep Q_L less than 1 but rather

$$Q_L Q_C \leq 1$$

Since Q_C is generally greater than 20, the inequality above can only be satisfied if

$$Q_L \leq 0.05$$

The conclusion is that when internal resonances occur, if Q_L is less than 0.05, a very lossy filter will have higher attenuations than

a filter with only reactive components. Ferromagnetic dust cores are much lossier than ferrites which is why dust cores are chosen for rfi filters.

Core Q's. The Q factor of the magnetic core is given by equation C below. Called the modified Legg equation,¹ it is valid only for a single-turn toroid consisting of a straight wire through the core.

$$Q = \frac{2\pi}{\mu (a + bf + cf^2)}$$

where μ = the magnetic core's permeability

a = coefficient whose value depends on the core's hysteresis and residual losses

b = coefficient of eddy current losses that are proportional to frequency

c = coefficient of core losses which are proportional to the square of the frequency

f = frequency

Coefficients a and c are not constant but depend somewhat on the magnetizing field and the frequency. However, the terms a and cf^2 may be neglected between 0.1 and 10 Ghz—the frequency region of interest in practical rfi filters.

Therefore

$$Q \approx \frac{2\pi}{\mu fb} \quad (3)$$

A dust core's Q may be reliably determined as a function of frequency because the permeability is relatively independent of the magnetizing field although it varies with frequency. Using values of B published by Bozorth,² the functions in the table shown above define the Q of various ferromagnetic dust cores. The second column is the frequency threshold, f_T , at which $Q < 0.05$.

In contrast to dust cores, a ferrite core's permeability depends greatly on the value of d-c bias and magnetizing field as well as frequency. Therefore, it is impossible to express their Q using the Legg equation. Manufacturers' curves showing Q versus frequency indicates that a ferrite's Q is rarely less than 0.2 even at very high frequencies. Because the ferrite's permeability drops rapidly when a d-c current is flowing through the coil, filters containing ferrite cores will have higher values of Q during this condition; this results in a loss of attenuation and ringing because resonances are not damped effectively.

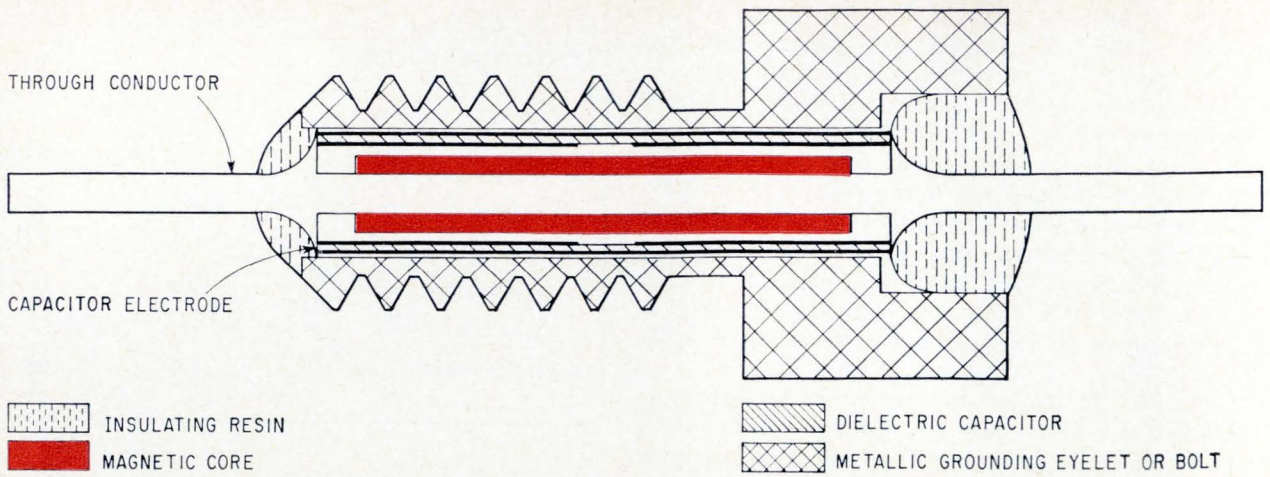

Miniature lossy filter is a pi-section capacitive input type shown in cross section. Metal on the inside and outside of ceramic tube form the capacitors. Dividing the capacitor's inside electrode into two sections forms a dual capacitor. To insure low-loss connection to ground, capacitor is soldered to grounding bolt with highly conductive solder. Terminal passing through magnetic core (color) is a single-turn coil.

ability of 60 will have a Q less than 0.05 at frequencies greater than 300 Mhz; 20-80 nickel-iron powder cores with a permeability of 75, but with greater core losses, will have the desired Q at frequencies above 80 Mhz. As a result, the 20-80 nickel iron cores are more desirable than iron powder cores for high attenuation below 300 Mhz.

Magnetic core inductors have higher inductances than air cores and also their core losses increase with frequency and result in the lower Q's. At high frequencies, core losses are so great that the inductor behaves almost like a resistor. This works out well because the resistance attenuates the rfi; at the same time, no reactive element can cause resonances.

Commercial filters

Small size, lossy filters constructed as shown in the diagram above were introduced a few years ago. The filter is a pi-section type consisting of two capacitors and one coil. The center conductor passing through the magnetic core behaves as a single-turn coil. The metal plates on the high dielectric ceramic tube form the capacitors. The inner plate is split to form the two capacitors needed for a pi-section type.

The filter's construction has desirable features. Since the coils have only one turn, parallel capacitance is minimized, allowing the filter to operate at higher frequencies. In addition, the impedance between the capacitor's outer electrode and the filter's grounding eyelet can be made extremely small. This is done by connecting the electrode to the outer shell by a thin layer of high conductivity solder.

These filters can be constructed as in the one shown in the diagram or with the magnetic core material surrounding the capacitor. Both are illustrated in the simplified cross sections in the diagram at the right. It has been found that filters with the core inside the ceramic tube always have higher attenuation. For the simple case illustrated, in which both filters are the same size, the differ-

ence in attenuation is given by

$$A_1 - A_2 = 20 \log \frac{(2 D_1 - T)^2}{(2 D_3 + T)^2} \left[\frac{(D_1 + T + D_3)}{(D_1 - T + D_3)} \right]$$

the terms are defined by

D_1 = filter's outside diameter

D_3 = diameter of the center conductor

T = thickness of the ceramic dielectric

A_1 = attenuation of filter that has core inside the ceramic tube

A_2 = attenuation when core is outside ceramic

It is assumed that both filters have identical voltage ratings, so that T is the same for both configurations. A mathematical evaluation shows that A_1 is always greater than A_2 .

In the attenuation curves for a typical ferrite core filter shown as the black curves in the graph at the right, the ceramic material and ferrite core are not very lossy. Therefore the internal resonance

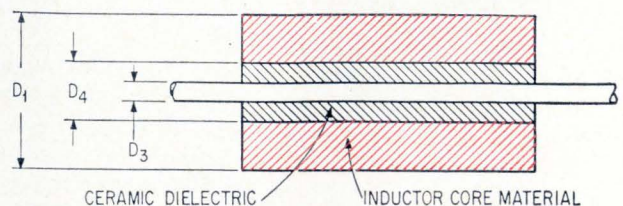
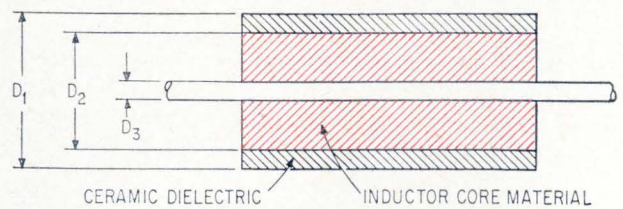

Simplified drawings of filter show two configurations of core material and capacitor. Analysis shows that a filter with core material (color) inside the ceramic dielectric always produces the greatest attenuation.

causes large bumps in the attenuation curve. Nevertheless the filter does provide good attenuation above 100 Mhz.

Aside from sensitivity to resonance because of their medium losses, another disadvantage of ferrite materials is that the cores saturate at relatively low amplitude d-c currents. Saturation results in lower values of permeability. For example, with zero d-c current, ferrites have a permeability ranging from 500 to 4,000.

However, the flux density B_{max} at which a ferrite saturates is only 2,500 to 4,000 gauss. B_{max} is reached with only a few amps flowing in the center terminal, causing the ferrite's permeability to drop as low as a 50th of its value at zero d-c. In turn, this causes the ferrite's inductance to decrease, reducing the attenuation. The higher the frequency, the less the current effect. As an example, the black curves in the graph at the right show that at 100 Mhz the attenuation may drop from 65 db to 45 db when a 10-amp d-c current is passing through the center terminal, while at 2 Ghz, the attenuation drops by only 2.5 db.

Dust cores

To combat these problems, most modern filters, such as the one shown, use iron dust cores instead of ferrite cores. A dust core consists of metal magnetic particles with an oxide or phosphate coating. The particles are suspended in a binder such as epoxy. By varying the spacing between the particles it is possible to control the materials' properties. As an example, wider spacing brings higher resistivity, smaller eddy currents and consequently higher Q. However, because the particles are farther apart, the permeability is lower. In fact, permeability multiplied by Q can be considered a constant for a given material.

Iron dust cores have values of B_{max} that are as much as five times that of a ferrite, allowing the dust cores to operate with much higher d-c currents. Their permeabilities range from 70 to 150. In practical filters that have cores with outside diameters from 0.050 inch to 0.150 inch, 20 to 150 amps are needed to saturate the dust core. As a rule, the maximum allowable current—10 to 35 amperes—is the value that will not overheat the unit rather than the saturation current.

The permeability of dust cores is lower than that of ferrites but the conductivity is higher since the dusts are metals not oxides. The dust core is made of iron or magnetic alloys such as Permalloy or Isoperm. The higher conductivity brings higher eddy currents and therefore higher core losses that more than compensate for the low permeabilities, resulting in lower Q's as desired. As a result, a minimum attenuation can be specified at frequencies as high as 10 gigahertz.

The combination of stable permeability and high losses produces the attenuation curve in color in the graph above. The curve shows that the filter is insensitive to d-c current flowing through the center conductor.

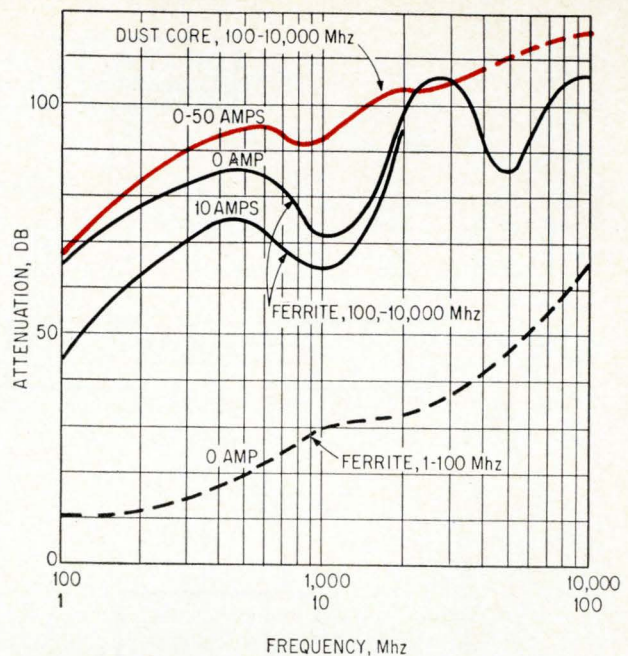

Attenuation of ferrite filter—curves in black—is sensitive to amperage of d-c current flowing through filter. In addition, internal resonances cause large dips in attenuation curve. Lossy filter made with dust cores have higher attenuation and less pronounced attenuation fluctuations. Dashed curve indicates attenuation of ferrite with no d-c current down to 1 Mhz (lower horizontal scale). Because of measurement technique all curves are 6 db higher than inherent attenuation.

Dust cores also have the advantage of having higher Curie points than ferrites have. Ferrites have Curie points ranging from about 130° to 300°C, dust-core Curie points range from 460° to 770°C. The Curie point is the temperature at which the core loses its ferromagnetic properties. It occurs when the thermal energy which causes random motion of the magnetic domains is greater than the internal field which tends to make the domains align. Because of the higher Curie points the dust cores can operate at higher r-f inputs without danger of losing their ferromagnetic properties by overheating. Dust cores also have high thermal conductivity, so they are less likely to crack due to overheating.

Ferrites plus ferromagnetics

Denesco is experimentally fabricating filters with very high permeability cores that combine metallic ferromagnetic material such as 20-80 nickel-iron with ferrite material. As in a dust core the basic material is the metallic ferromagnetic material. However, instead of the metallic powders having an oxide or phosphate insulating coating, the insulation is ferrite material. The ferrite and ferromagnetic material combination can result in permeabilities as high as 20,000 compared with about 150 for dust cores and 5,000 for ferrite cores. Because the ferrite material has lower resistance than an oxide or phosphate insulation, the resistance will be lower, increasing eddy current losses. In

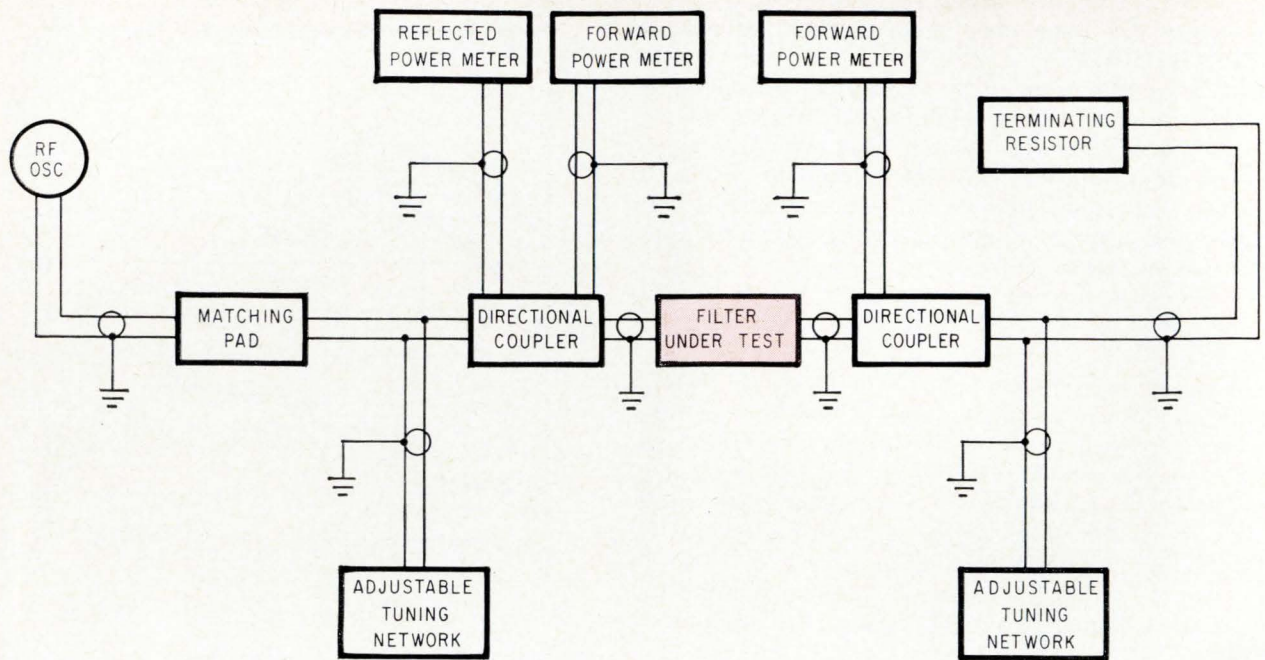

Measurement setup permits the filter to be tested under the worst conditions where the external circuit may resonate with the filter's elements. Adjustable tuning networks set up the conditions. Directional couplers and power meters measure the absorbed and reflected power that contribute to the filter's total attenuation.

addition, as in dust cores, the saturation induction will be high, allowing the filters to handle high d-c currents. However, there are problems in fabricating the cores because it is difficult to manufacture a combination of magnetic alloys and oxides.

Aside from their use in filters the material also has excellent potential as a frequency dependent attenuator. The attenuation of this material is

$$A = (c) (f) \sqrt{(\mu) (K) G(Q_m, Q_d)}$$

where c = a constant

f = frequency

μ = permeability

K = dielectric constant

$G(Q_m, Q_d)$ = a function of Q_m and Q_d

Q_m = magnetic quality factor

Q_d = dielectric quality factor

In general μ and K are high and Q_d and Q_m are low so the material will attenuate well.

The attenuation can be controlled by controlling Q_m and Q_d . Q_m can be controlled by changing the average particle size of the metallic powder and by choosing a combination of materials with the desired resistivity. Q_d can be controlled by adding material such as a high K ceramic material. For an attenuator both Q_m and Q_d would be much less than unity and the equation would become

$$A = cf \sqrt{\frac{\mu K}{Q_m Q_d}}$$

Ceramics

The ceramic dielectric used in the filter's capacitor must have a high dielectric constant, high dielectric breakdown strength and high insulation resist-

ance at all temperatures within the range specified. A high dielectric constant, titanate based ceramic operates over the temperature range from -55°C to 125°C and has the electrical properties listed in the table below.

To prevent dielectric deterioration, it is important to have a high value of insulation resistance at the highest working temperatures. The specified value at room temperature may be high, but it may drop considerably at high temperatures, indicating that ionic impurities are in the ceramic material.

To detect the effect of these impurities, life tests are run at the maximum working temperature and at a d-c voltage which is often twice the allowable working voltage for the ceramic material. Any impurities present form a solid-state electrolyte which diffuses through the material when the d-c field is applied. The reduced insulation resistance is a measure of the ceramic's life.

Dielectrics used in filters have low impurity levels so their insulation resistance shows little change in value even after 10,000 hours operation.

A recent development is the design as in the diagram at the right of a monolithic ceramic tube that produces higher capacitance and consequently greater attenuation. To maintain mechanical

Ceramic dielectric properties

Dielectric constant	3,000 to 4,000 from -55°C to 125°C
Quality factor, Q	30 to 40
Breakdown voltage	500 volts per 0.001 inch
Insulation resistance	
25°C	10^{10} ohm-microfarad
125°C	10^8 ohm-microfarad

strength the ceramic tube has the same thickness as before. However, one of the capacitor electrodes is embedded inside the tube. The thickness of the dielectric between the embedded electrode and the outer electrode is quite thin, resulting in an increase of 3 to 5 times in capacitance. As a result, rfi signals can be attenuated a minimum of 80 db from 100 to 200 Mhz and a minimum of 90 db from 200 to 10,000 Mhz. However, because the capacitor is thinner and since the breakdown voltage of the dielectric is proportional to thickness, the filter's allowable working voltage is restricted to 50 volts.

The electrode imbedded in the ceramic is a noble metal which is attached to a cap of conductive metal such as silver; the cap is soldered to the filter's center terminal.

Measurements

Attenuation measuring techniques add to knowledge of filter parameters and may aid in selecting filters for complex rfi saturation.

A filter's attenuation at a particular frequency depends on the source impedance of the device feeding the filter. At frequencies above a few Mhz most signal generators have source impedances of 50 ohms. To test the filter it is necessary to match the source to a 50-ohm load to prevent the reflections from the filter that would cause high standing-wave ratios at the generator's input. In measuring capacitive input type filters a 50-ohm resistor is usually placed in series with filter's input; with inductive input filters a 50-ohm load is placed in shunt with the filter's input.

Several manufacturers of low-pass filters, including Denesco, have standardized the use of such 50-ohm resistances in all attenuation measurements. As a result all attenuation measurements indicate an approximately 6 db greater attenuation than would normally be expected. A typical dust-core filter, such as the one in the graph on page 65, would show an attenuation of about 6 db throughout the khz region, but in fact the low-frequency attenuation is approximately zero.

Because the pi-section type filter (capacitive input) has a very low output impedance, no external loads are used during the measurement other than the load impedance of the output detector. However the inductive output type filter—a T-filter, for example—has a high impedance and requires a resistive load that is connected to ground. The attenuation of a filter with a series inductor at the output depends inversely on this terminating resistor.

Since high-loss filters are favored because they reduce the level of reflected power, it is sometimes wise to measure the actual power-absorbing characteristics with a directional coupler. The sophisticated measuring system shown in the block diagram on page 66, in addition to measuring input and reflected powers, also establishes the worst possible loading characteristic to measure the filter's characteristics. As indicated on page 62, "Low Q's counteract resonances," the worst condi-

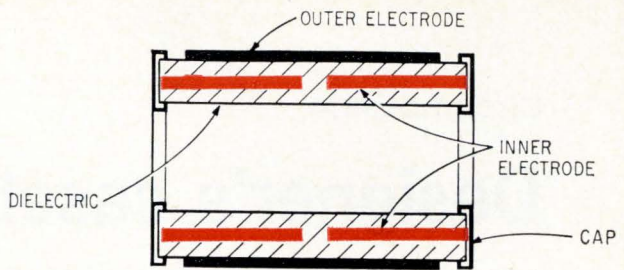

Monolithic ceramic tube contains the capacitor electrode (color). In this way higher capacitance is obtained without reducing the thickness and mechanical strength of dielectric section.

tion corresponds to external loads resonating with the filter elements. The conditions are created in a measuring setup by adjusting the tuning network. The worst input condition corresponds to a maximum reflected power; the worst output condition corresponds to maximum output power.

In this measurement the filter's attenuation is

$$A = 10 \log \frac{P_{inf}}{P_{out}}$$

Where P_{inf} is the input power in the forward direction and P_{out} is the output power. This includes attenuation caused by dissipated and reflected power. The component of attenuation caused only by power dissipation in the filter is given by

$$A = 10 \log \frac{P_{inf} - P_{inr}}{P_{out}}$$

Where P_{inr} is the reflected input power.

Usually where measurement techniques affect the filter performance the techniques are given.

References

1. B.E. Legg, "Magnetic Measurements at Low Flux Densities Using the Alternating Current Bridge," Bell System Technical Journal, Vol. 16, 1936, pp. 19-32.
2. Richard Bozorth, "Ferromagnetism," D. Van Norstrand, 1951, p. 146.

The authors



Peter A. Denes, vice president of Denesco, Inc., is a graduate of the Technical University of Budapest, Hungary. Denes has doctor's degrees in engineering and technical sciences and holds more than 25 patents. He escaped from Hungary in the 1956 revolt.



John J. Crittenden, Denesco's quality control manager, is involved closely in the design and testing of the rfi filters. A chemical engineering graduate of the University of Wisconsin, he has been a project research engineer at both the Allen-Bradley Co. and Gulton Industries, Inc.

Designer's casebook

Designer's casebook is a regular feature in Electronics. Readers are invited to submit novel circuit ideas, packaging schemes, or other unusual solutions to design problems. Descriptions should be short. We'll pay \$50 for each item published.

Transistor switch for clickless keying

By James M. Little

Rank Bush Murphy Electronics, Welwyn Garden City, Eng.

Audio tones can be switched noiselessly at rates up to 50 kilohertz with the circuit shown below. It produces a balanced output and its performance is tolerant of the value of capacitance across the operating switch contacts, permitting remote control by long cable. Only a single two-terminal power supply is required.

The circuit uses two transistors and a 1:1 transformer. Transistor Q_1 is an emitter-follower driven by continuous a-c signal. Transistor Q_2 is made of silicon. A germanium transistor is unsuitable because it does not provide a completely open circuit "off" condition with the base open circuited.

When switch S_1 is open a resistance of 10 megohms develops between Q_2 's collector and emitter, for signals of either polarity. When S_1 is closed, Q_2 is heavily saturated and offers only a few ohms of resistance between collector and emitter for currents in either direction. Therefore full signal current is passed through the transformer primary. The output voltage that results is about 0.5 volt root mean square.

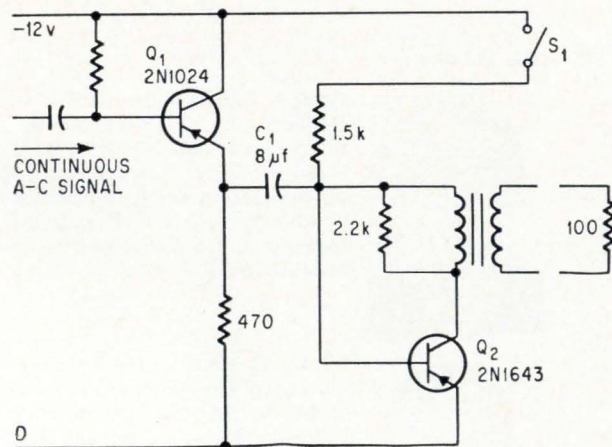

Two transistors and a 1:1 transformer accomplish audio switching without collector bias.

Capacitor C_1 preserves the d-c conditions on Q_1 and isolates the collector of Q_2 from Q_1 's bias, reducing key clicks to negligible proportions. The 2.2-kilohm resistance across the transformer primary absorbs energy spikes that might occur if the switch was operated with the output load disconnected.

The circuit operates well with up to 0.2 microfarad across the switch contacts, yielding square-signal bursts when tested at switching speeds up to 50 bauds (code elements per second). Signal suppression during the off periods is better than 70 decibels. The minimum base current required to allow distortionless transmission of a signal of 7 milliamperes peak is approximately 4 milliamperes. About twice this amount has been provided to allow for wide tolerances.

Amplifiers and triggers simulate blood pressure

By Maurice E. Swinnen

Walter Reed Army Medical Center, Washington

Blood pressure readings can be simulated with operational amplifiers coupled to Schmitt triggers. The voltage simulation is useful for calibrating devices that record the analog electrical output of a catheter. Another application will be in checking equipment to digitize such outputs.

To simulate blood pressure, a triangular wave whose frequency equals the heart rate is modulated by a second triangular wave whose frequency equals respiration rate. The modulated signal rides on a fixed d-c voltage that imitates diastolic pressure level. Systolic pressure level is indicated by the peak voltage.

Each triangular wave is generated by connecting a modular operational amplifier in an integrator configuration and feeding its output into a Schmitt trigger (Q_1 and Q_2 , or Q_3 and Q_4) with large hysteresis. The Schmitt trigger output is then integrated by the amplifier to obtain a triangular wave, whose peak values are equal to the hysteresis levels

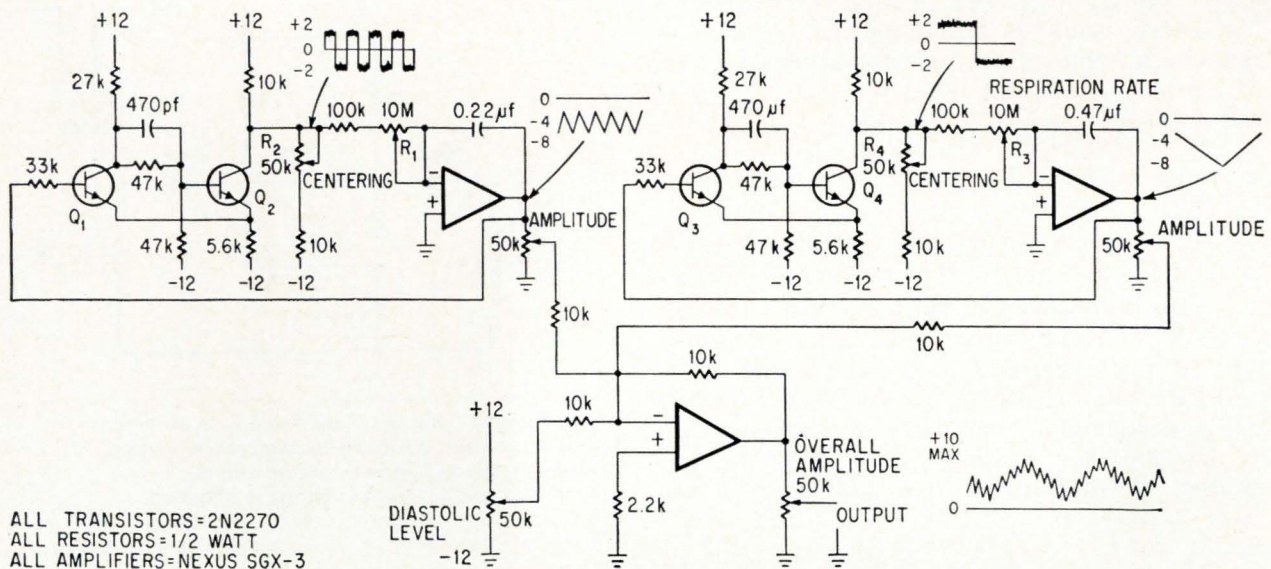

Heart and respiration rates are simulated by triangular waveforms generated by operational amplifiers and Schmitt triggers. The waveforms are combined to simulate blood pressure.

of the Schmitt trigger. The output characteristics are set by the potentiometers R_1 through R_4 .

When the negative output of the Schmitt circuit is presented to the operational amplifier the pulse is integrated in a negative direction. Thus, the trailing edge of the triangular waveform, which decreases to -8 volts, is generated. At -8 volts, the Schmitt cuts off, and its output voltage reverts to $+2$ volts. The output voltage is applied to the input of the operational amplifier, which begins generating the leading positive-going edge of the triangular waveform.

The heart rate oscillator generates a frequency ranging from 0.2 to 20 hz while the respiration rate can be adjusted from 0.1 to 10 hz. Potentiometers R_1 and R_3 set the rates. Centering potentiometers R_2 and R_4 adjust the symmetry of each Schmitt trigger pulse around the zero reference line, and consequently, the symmetry of the triangular waveforms. The signals are summed in a third operational amplifier together with an adjustable d-c voltage that represents the diastolic level to produce the composite analog signal. The output voltage reaches a distortionless peak of $+10$ volts.

High-speed wideband gate provides 70-db isolation

By Jacques Gilbert

Defense Research Board, Valcartier, Quebec

A simple gate circuit using only three silicon diodes can provide extremely high attenuation for radio frequency signals. For example, it can be used in a duplexer as a transmit-receiver switch to permit connection of the transmitter and receiver to a common antenna. The circuit, top of page 70, provides more than 70-decibel isolation over a 25-megahertz bandwidth, centered at 30 Mhz. The gate switches at rates as high as 500 kilohertz.

When the control voltage is positive, the gate is

biased on, diodes D_1 and D_2 conduct and diode D_3 is off. The output of the gate is then coupled to the input through the low forward resistance of D_1 and D_2 . When the polarity of the control voltage is reversed, diodes D_1 and D_2 are cut off and D_3 conducts. This results in very high attenuation of the radio frequency signal.

Blocking capacitor C connected in series with D_3 allows the full control voltage to be applied to the diodes in the backward direction. If the control voltage waveform is symmetrical with respect to ground, the capacitor acquires a fixed charge during the first few cycles of the control signal and maintains this charge indefinitely. Thus the charging time constant of the capacitor does not interfere with the steady state operation of the gate at high switching rates. Turn on and turn off times are about 100 nanoseconds.

A good practice is to select the transformer turns ratio, n , to match the source impedance when the

gate is on. In this circuit an n of 1.5 was chosen. Under this condition an approximate relation for isolation in terms of the transmitted power is:

$$\frac{P_{on}}{P_{off}} = \frac{1}{4\omega^4 C_r^4 R_f^2 (2R_f + R_L)^2}$$

where P_{on} = transmitted power for the on cases;
 P_{off} = transmitted power for the off case;
 C_r = depletion layer capacitance of diodes;
 R_f = dynamic forward resistance of diodes;
 ω = frequency in radians;
 R_L = load resistance.

While a matched transformer input is not necessarily the best condition for minimum insertion loss or maximum attenuation, measurements made on the gate show 85-db isolation at 20 Mhz and 75-db at 40 Mhz with less than 4-db insertion loss.

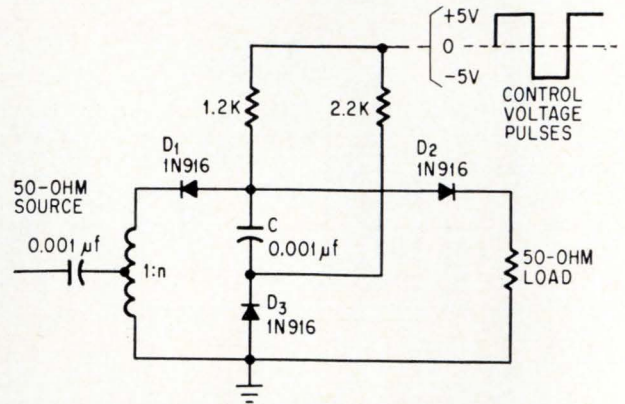

Series diodes D_1 and D_2 conduct and D_3 is off when the gate is biased positively by the control voltage. Conversely, diode D_1 and D_2 are off and D_3 conducts when the control voltage is negative.

Suppressed carrier modulator with noncritical components

By Clifford H. McDermott

Aerojet-General Corp., El Monte, Calif.

Suppressed carrier modulation at low to moderately high frequencies can be obtained without transformers or complex balancing techniques. The function is accomplished with a phase splitting network and two field effect transistors operating in a switching mode.

The carrier drive consists of a complementary pair of square-wave signals whose peak amplitude is slightly higher than the pinch-off voltage of the field effect transistors. After phase inversion, both the modulated and inverted modulated signals are inserted into the modulator by emitter-followers which maintain equal driving-point impedances. Suppression balancing is accomplished by adjusting the 1-kilohm potentiometer. The level of the modulating signal must be maintained below 1 volt peak to peak or provisions must be made to protect against forward biasing of the FET gate junctions.

For the component values shown, at a carrier frequency of 100 kilohertz and a modulation of 5 khz, carrier signal rejection is 50 decibels and modulation signal rejection is 60 db.

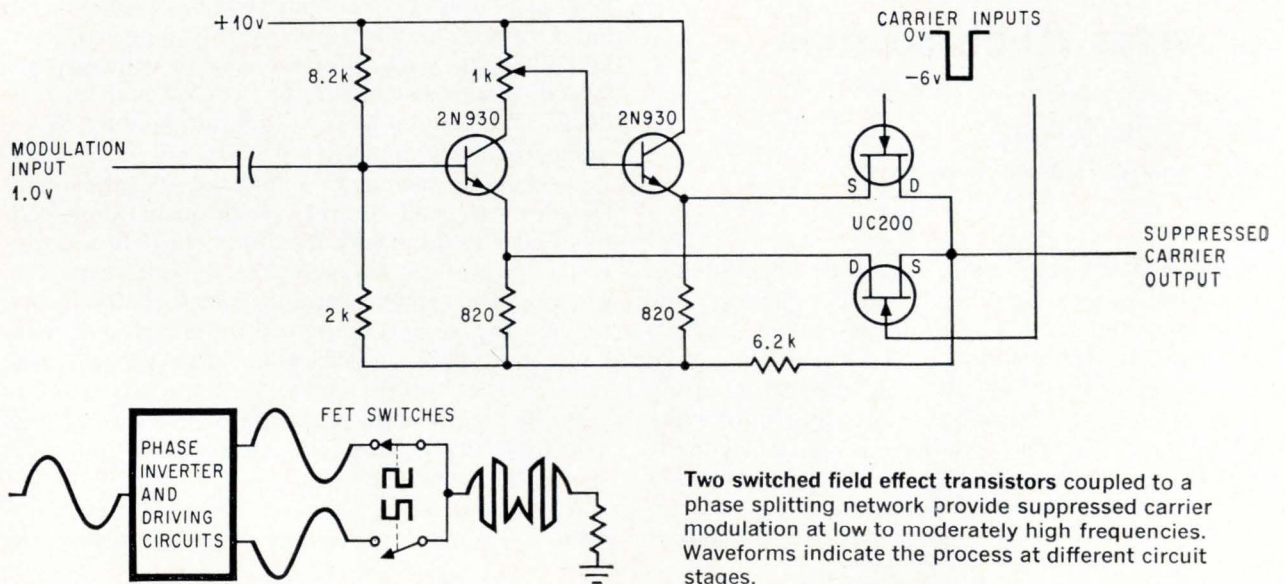

Two switched field effect transistors coupled to a phase splitting network provide suppressed carrier modulation at low to moderately high frequencies. Waveforms indicate the process at different circuit stages.

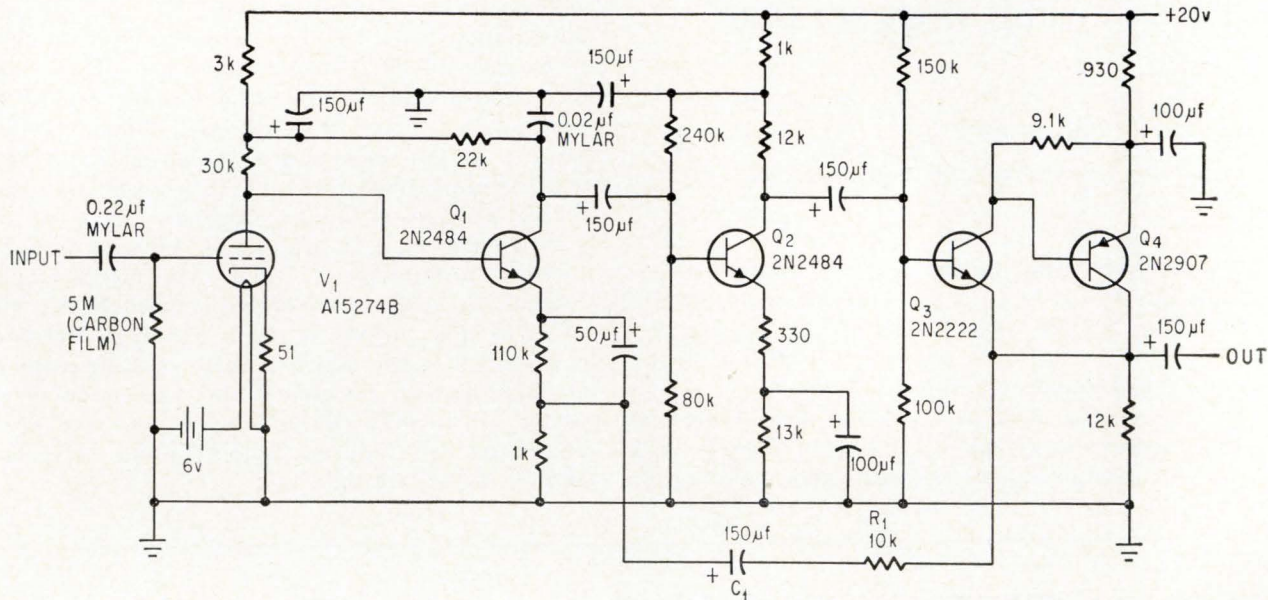

Low-noise tube at the preamplifier's input boosts signal level high enough to overcome noise introduced in the transistor stages. Direct coupling between the tube and Q_1 provides temperature stability, while feedback through R_1 and C_1 stabilizes gain.

To obtain this desired noise condition, a quiescent plate current of 400 microamperes was selected for the nuvistor, T_1 . This plate current reduces T_1 's amplification factor to 10 from the rated value of 35 and increases the dynamic plate resistance to approximately 10 kilohms, the output impedance of the first stage. The 2N2484 transistors are high-beta, low-noise devices that exhibit a minimum noise figure when the source resistance is 5 to 15 kilohms.

The direct coupling between T_1 and Q_1 provides an input impedance that does not load T_1 's output. Also, T_1 's plate voltage supplies a stable d-c bias to the base of Q_1 , making the d-c temperature stability of Q_1 excellent. The collector current of Q_1 is set at 150 μ A for optimum noise performance. Bootstrapping could also be used to achieve an input impedance that does not load the nuvistor output while retaining a good temperature stability factor.

The emitter-coupled feedback loop, R_1 and C_1

connected between the emitters of Q_3 and Q_1 , increases the open-loop input impedance and decreases the open-loop output impedance while stabilizing the a-c closed loop gain. Open-loop gain at 15 hertz is 90 decibels and the closed-loop gain is 40 decibels. This yields an excess gain for the loop of 50 decibels.

The preamplifier output stage consists of a unity gain, buffer amplifier Q_3 and Q_4 . The low output impedance of this stage assures that the feedback network will not load transistor Q_2 , in addition to providing a low-impedance source for further processing circuitry. Output impedance is 10 ohms, when an input impedance of 4 megohms is present for the preamplifier.

Preamplifier's gain is 40 db with an equivalent noise resistance of 50 kilohms measured in a 6 hz bandwidth centered at 15 hz. The gain varies less than 0.1 db over a temperature range of -40°C to 60°C . The noise bandwidth was limited to approximately 1.5-kilohertz for this circuit application.

Voltage-controlled multi produces triangular output

By Gilbert Marosi

General Precision Equipment Corp.,
Link Group, Sunnyvale, Calif.

By adding a d-c amplifier consisting of transistors Q_7 , Q_8 , Q_9 and Q_{11} to a modified astable multivibrator circuit formed of transistors Q_1 , Q_2 , Q_5 and Q_6 , triangular and square waveshapes are made available. The outputs may be linearly controlled through a frequency range of 25 to 1 by a voltage, maintaining a symmetrical triangular output.

This arrangement is inherently self-starting,

suiting to high-frequency circuits and has fast rise and fall times—typically 80 nanoseconds.

The basic astable multivibrator consists of transistors Q_3 and Q_4 . Transistor Q_{10} clamps the collectors of Q_3 and Q_4 to about 4 volts. With Q_4 on, the voltage at the base of Q_3 is

$$V_{B3} = \alpha V_{cc} + \beta V_{cc} + 2 V_D \quad (1)$$

where $\alpha = R_1/(R_1 + R_4)$ and $\beta = R_3/(R_2 + R_3)$. The voltage at the emitter of Q_3 rises linearly because of the constant current of Q_1 that charges capacitor C_1 .

When the emitter of Q_3 reaches V_{B3} , Q_3 turns on. The increase of potential at the collector is fed to the base of Q_4 and causes Q_4 to cut off. With Q_4 off, the voltage at the emitter of Q_3 drops by a decrement $(\beta V_{cc} + 2 V_D)$ to $(\alpha V_{cc} + V_{BE3})$ and the emitter of Q_4 to $\alpha V_{cc} - 2 V_D - \beta V_{cc} + V_{BE4}$.

Since the base of Q_4 is set at $V_{B4} = \alpha V_{cc} + \beta V_{cc} + 2 V_D$, Q_4 is back-biased. So Q_2 charges C_1 linearly until the emitter of Q_4 reaches V_{B4} . Transistor Q_4 then turns on and the cycle repeats. Transistors Q_5 and Q_6 insure that the outputs at the collectors of Q_3 and Q_4 are no less than 4 volts. Since the constant currents of Q_1 and Q_2 determine the frequency of operation, the voltage at the collectors of Q_3 and Q_4 would vary with frequency if no additional current were provided to raise the

voltage of resistors R_5 and R_6 .

Transistors Q_5 and Q_6 form a current-mode switch that compares the voltages at the collectors of Q_3 and Q_4 . With Q_3 on and Q_4 off the voltage at the base of Q_5 is 18 volts; at the base of Q_6 it is 15 volts. Therefore, Q_5 is off and Q_6 is on. When that's so, 10 milliamperes of current is provided for resistor R_5 in addition to the current furnished by Q_1 . When Q_4 turns on, Q_6 turns off and Q_5 turns on, driving 10 milliamperes into resistor R_6 . The presence of Q_5 and Q_6 also increases the regenerative action of the circuit. The frequency of operation is expressed as

$$f = \frac{(V_{cc} - V_e)}{(\beta V_{cc} + 2 V_D) (4 R_T C_1)} \quad (2)$$

where $R_T = R_7 + R_8 + R_9$.

The triangular voltage waveform across the timing capacitor is amplified by transistors Q_7 , Q_8 , Q_9 and Q_{11} and is referenced to ground. The high input impedance to Q_7 and Q_8 does not affect the constant-current charging of C_1 . Both the symmetry of the triangular wave and the duty cycle of the square wave may be adjusted independently by potentiometers R_9 and R_{10} . If symmetrical operation is desired throughout the frequency range, potentiometers R_9 and R_{10} are short-circuited and R_8 is adjusted.

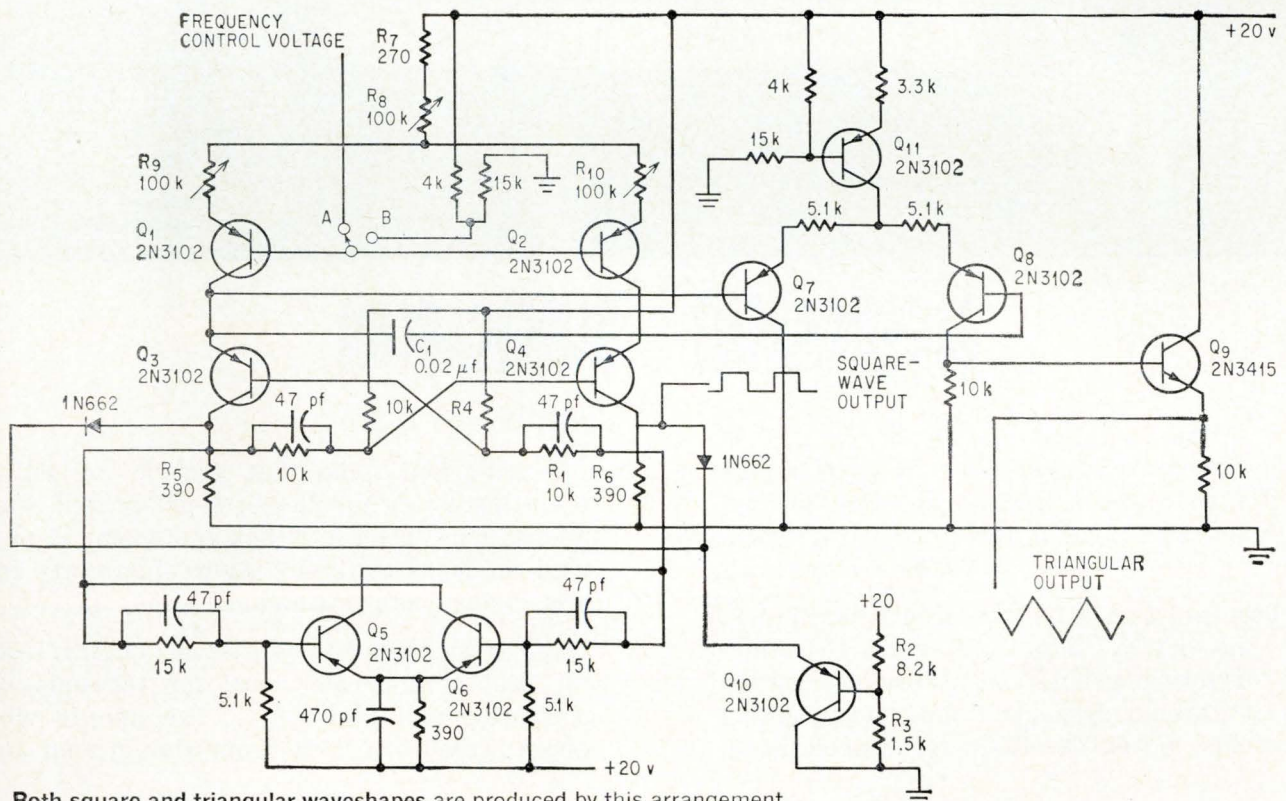

Both square and triangular waveshapes are produced by this arrangement, which has rise and fall times of 80 nanoseconds.

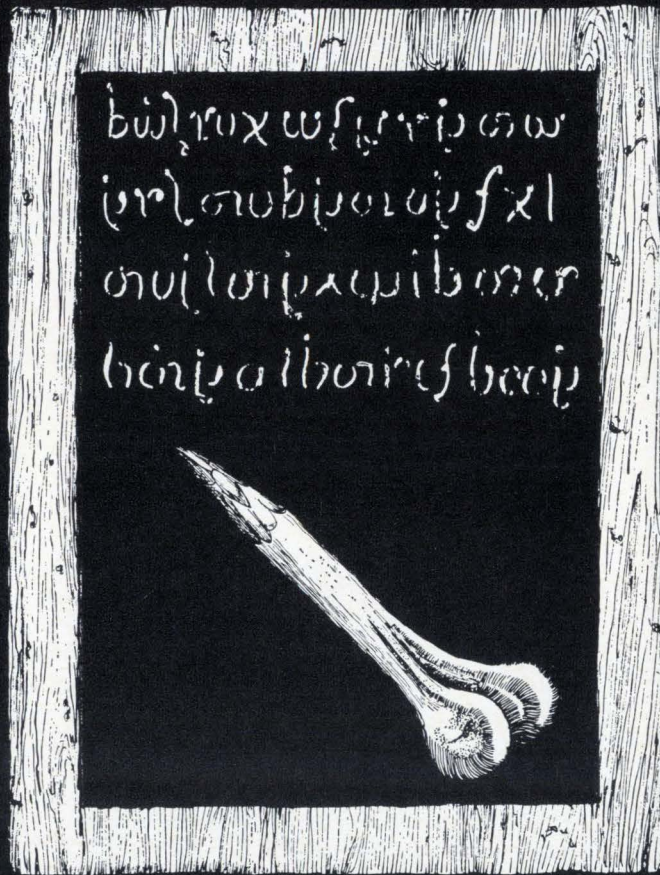

ICNHCXCKI SENCICMICKI

Early Roman messages could be garbled just by the heat of the sun. They were written on a beeswax-covered tablet called a *codex*. Such records were perishable, to say the least.

Modern messages often perish in transmission, too — needlessly, since Codex error detecting-and-correcting systems can restore information bits lost through dropouts, fading and switching transients. Codex developed the convolutional,

forward-acting codes that provide protection to an increasing number of sophisticated communications systems. Codex equipment is now used on many different types of circuits for protection of both data and telegraphy messages.

If *your* communications system suffers from the heat of a greater need for transmission accuracy, call Codex . . . the people who know error correction from the ground up.

CODEX CORPORATION

• 222 ARSENAL STREET, WATERTOWN, MASSACHUSETTS •
 ZIP CODE 02172 • (617) 926-3000 • TELEX 094-6332 •

Correlation entering new fields with real-time signal analysis

From probing for a brain tumor to exploring for oil, autocorrelation and crosscorrelation are proving invaluable when noise must be filtered from very low level signals

By Bernard LuBow

Princeton Applied Research Corp., Princeton, N.J.

Correlation analysis—the powerful but formerly time-consuming technique for analyzing signals and systems behavior in communications and radar—is leaving the laboratory and is heading to the field and operating room. Recently developed instruments and methods that permit autocorrelation and crosscorrelation to be measured on-line and displayed in real time are opening new avenues for the process and improving old ones. Correlation is being extended into radio astronomy, fluid and solid-state physics, neurology, seismology and other areas.

The expansion of correlation analysis is the result of increased exploration of phenomena that have very low level signals—brain waves and stellar radiation for example. Digging a signal out of noise is the major function of analyzing data in both geophysical exploration and underwater detection. These signals are often hidden beneath a blanket of similar signals and extraneous noise; to separate the signal from the noise, instruments of unprecedented accuracy and sensitivity are needed. Hence scientists often resort to correlation analysis to find these obscure signals. But previously this meant expensive, specially designed equipment for each specific situation. Worse yet, old methods and

equipment couldn't operate in real time and were primarily limited to low-frequency applications.

The situation is changing, however. New efficient instruments can continuously sample even the most noisy signals and compute the correlation function simultaneously—permitting the function to be observed almost immediately and continuously.

Different but alike

Correlation analysis is a convenient technique for determining the spectral characteristics of a signal or the similarity of two different signals.

One point of a correlation function is the long-term average of the product of two functions of time. The complete function is generated when a delay between the two time functions is varied. For example, if one voltage $V_1(t)$ and another voltage $V_2(t-\tau)$, where τ represents a finite and variable delay, are continuously multiplied together and the product fed into a low-pass filter, then the filter's output closely approximates the true mathematical correlation function.

If V_2 is identical to V_1 in every respect except for the delay τ , the result is the autocorrelation function. If V_1 and V_2 are totally different functions, then the result is the crosscorrelation function. The outputs in both cases are functions of the delay time, τ . Mathematically for autocorrelation:

$$C_{1,1}(\tau) = \lim_{T \rightarrow \infty} \frac{1}{2T} \int_{-T}^T V_1(t)V_1(t - \tau) dt$$

for crosscorrelation:

$$C_{1,2}(\tau) = \lim_{T \rightarrow \infty} \frac{1}{2T} \int_{-T}^T V_1(t)V_2(t - \tau) dt$$

An instrument, therefore, that does this integrating

The author



Bernard LuBow received both BSEE and MSEE degrees from Drexel Institute of Technology, Philadelphia. For six years prior to joining PAR, he did design and development work with radar receiver systems at the Radio Corp. of America.

Subject 1

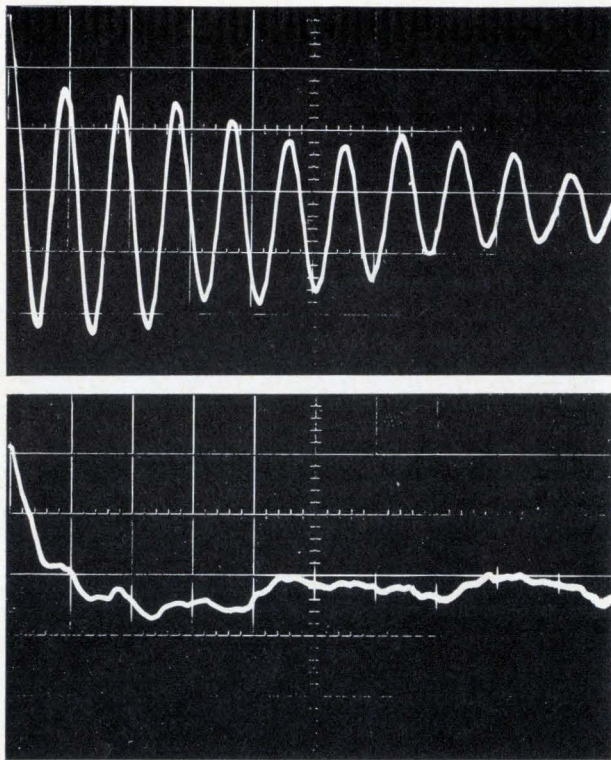

Subject 2

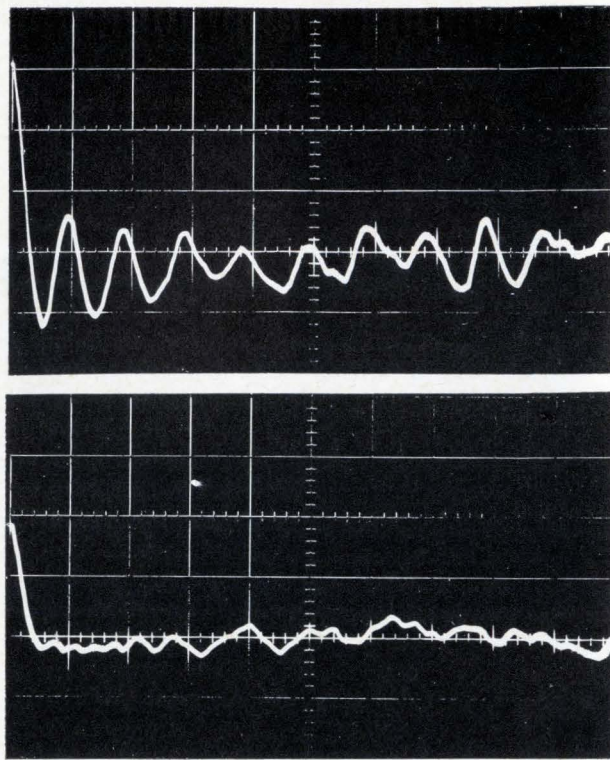

Correlation functions of EEG's of two subjects. Top traces were taken with subjects' eyes closed and clearly define the alpha rhythm's basic frequency. Rhythm is difficult to measure with conventional EEG's since it is masked by random signals. Bottom traces show how alpha rhythm disappears when subjects open their eyes.

process will show whether correlation exists between two signals and, if so, when maximum correlation takes place. [For a more detailed discussion of the correlation functions see "Mathematics of correlation," p. 78.]

Correlator reads brain waves

Measuring the similarity of two supposedly identical signals arising from a common physical phenomenon is often an invaluable tool in medicine. For instance, the basic frequency of the brain's alpha rhythm, the dominant rhythm from the adult cortex, can serve as an excellent indicator of the patient's health. A smooth alpha rhythm is normal; the presence of spikes or other extraneous activity indicates a condition for further medical analysis. With a conventional electroencephalogram (EEG), it is sometimes impossible to measure this basic frequency.

With correlation, the alpha rhythm is extracted from the EEG signals for easy interpretation. The photographs above are the autocorrelation functions of EEG's of two subjects; each taken from between the left parietal and central occipital areas. The parietal lobes above each ear control audio-language functions; the occipital area is in the back of the brain and controls sight. The upper traces show how easily the basic frequency of the alpha rhythm can be measured. These correlograms were made when the subjects were relaxing with their eyes closed. The lower correlograms were made when the subjects opened their eyes and the alpha

rhythm was blocked out—a normal occurrence with subjects having normally functioning brains.

It has also been demonstrated that there are significant changes in the correlation functions of EEG's from patients with brain tumors.¹ Since EEG's contain signals that are much like repetitive bursts of damped sine waves, a crosscorrelogram of normal EEG's from corresponding areas on the left and right hemispheres of the patient's skull would be similar to that shown in the figure on page 79. If the maximum value of the correlogram is at zero delay ($S = 0$ in the figure), this indicates that the electrical activity at both electrode locations is synchronous. An asymmetrical crosscorrelogram indicates that the two hemispheres are not producing comparable rhythmic electrical activity; this could mean the presence of a tumor.

Correlators may also locate the area of a patient's brain responsible for the uncontrollable twitching present in some diseases—epilepsy, for instance. The offending area can be identified by crosscorrelating EEG signals from various parts of the brain with signals from strain gauges applied at the location of the twitch. The brain waves are recorded with electrodes fastened to the head; it is not necessary to place probes in the brain surgically.

Turbulence measured smoothly

One of the earliest applications of crosscorrelation was in fluid physics to study the irregularities in the fluid flow of streams—hydrodynamic tur-

bulence. Turbulence studies are usually made by repeatedly inserting a velocity-responding probe into the turbulent stream of fluid at different points. Analysis of data from a single probe is of limited value. By contrast, the crosscorrelation of signals from probes of variable separation gives more meaningful information about turbulence and diffusion (the scattering of solid particles in fluids).

Crosscorrelating the a-c signals from two velocity sensors inserted into a stream produces results similar to those at the right. The signals produced by two probes in the stream are correlated as one of the probes is moved downstream relative to the other. Two things are immediately apparent. First, the time delay for maximum correlation increases in proportion to the distance between the probes. This would be expected for the general flow of the fluid in the pipe. Second, as the distance between the probes increases, the amplitude of the correlation function decreases while its width increases. This yields information about both the amplitude of the turbulating eddies and their coherence time. The coherence time is an important characteristic since it aids in defining the actual physical process. The two-probe technique for investigating turbulence and diffusion is probably the most important single tool available to investigators in hydrodynamics, rocket exhaust studies and plasma physics.

Characterizing linear systems

Many techniques have been developed for determining the behavior of linear systems. These include such methods as Nyquist and Bode plots and the use of frequency analyzers. Y.W. Lee and J.B. Weisner² showed that it is possible to obtain the unit impulse response of a linear system by driving it with broadband (white) noise and crosscorrelating this input with the system output, as on page 81. The correlogram that results gives the same information about the system as if it were excited with an approximation of a delta function and its output recorded on an oscilloscope or x-y recorder. In practice, however, the delta function is hard to achieve and, more often than not, overloads active systems. Further, the complex frequency response function of the system can be obtained as the Fourier transform of the impulse response made with such a test signal.

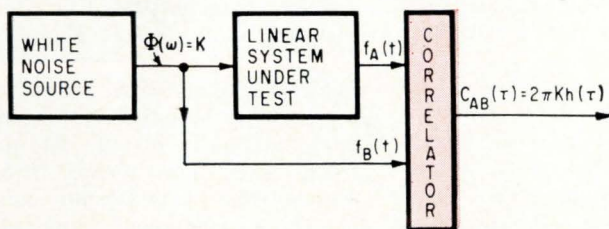

Response of a linear system to a unit impulse can be obtained as shown above by crosscorrelating the signal from a white noise source and the resulting system output. This technique can be used while the system is operating, right, despite extraneous noise sources.

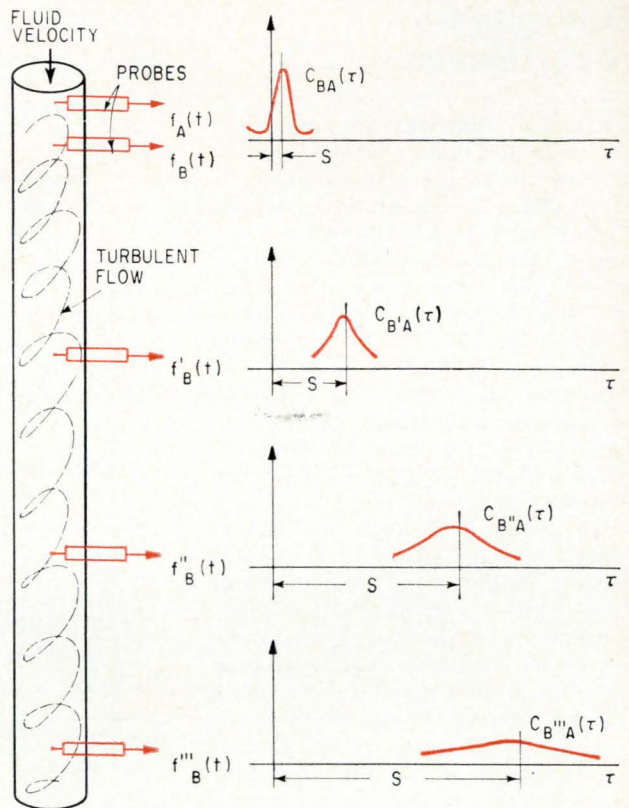

Hydrodynamic turbulence studies are aided by determining the correlation function between the electrical outputs of two velocity sensing probes. Amplitude and coherence time give distinctive data about the turbulating eddies. Similar information is difficult to obtain with single probe measurements that yield only the power density spectrum. The correlation functions between probes as one is moved downstream show how the delay time increases and the amplitude decreases as the probes separate.

This technique has important practical implications. Consider, for example, the effect of spurious noise when trying to determine an impulse response or when the system is in constant use and is being driven by external signals. Even under these circumstances it is possible to obtain the crosscorrelation function between the system output and a test white noise signal. Since there is no correlation between the test signal and the control signal or extraneous noise, the control signal and noise will not affect the crosscorrelation function obtained—which is the impulse response un-

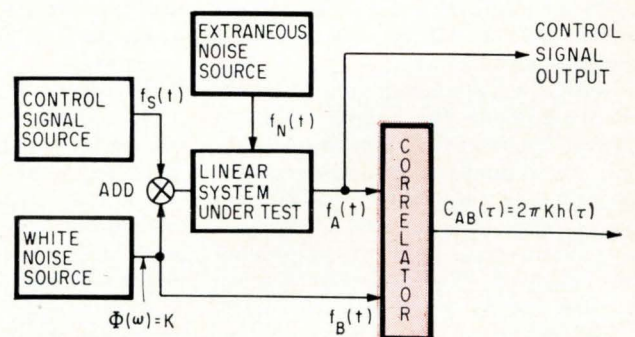

Mathematics of correlation

Correlation functions are to modern analytical techniques what frequency spectra are to the classical methods of Fourier, Heaviside and LaPlace. Unfortunately, for most engineers autocorrelation and crosscorrelation functions do not have the intuitive meaning the frequency spectra have—probably because of lack of experience in handling correlation analysis. Yet correlation functions, an outgrowth of modern information theory, are basic to the analysis of random processes and the complex signals they produce.

To better understand correlation functions, assume that some physical process produces the time functions $f_A(t)$, $f_B(t)$, ..., $f_n(t)$ simultaneously. Assume further that the physical process is not changing with time—the batteries are not running down, parts are not wearing out—in other words, a stationary situation exists. Also, it is assumed that the time functions are not zero and they do not have a d-c component. The signals may be simple or complex periodic waves or they may vary in noise-like random fashion.

Autocorrelation. Passing one of the signals, $f_A(t)$, through an ideal delay line introduces a nondispersive variable delay, τ , as shown in the block diagram on this page. The output of the line, signal $f_A(t - \tau)$, is identical to $f_A(t)$ except for the delay. If the instantaneous values of $f_A(t)$ and $f_A(t - \tau)$ are multiplied and the product averaged over a sufficiently long time, the result has the following properties:

- The product will be maximum at $\tau = 0$
 - The value at $\tau = 0$ is related to the total power of the signal. If $f_A(t)$ is a voltage, then the average of the product for $\tau = 0$ is simply $\overline{f_A(t)^2}$, or the power the signal will dissipate in a 1 ohm resistor.
 - The average value of the product will be a function of τ , the form of which will be characteristic of the original signal, $f_A(t)$.
 - If the averaging time is long compared with the reciprocal of the lowest frequency in the original signal, then repeated measurements of the product for a given τ will yield values very close to one another.
 - The average value of the product for negative values of τ is identical to that for the same positive values.
- What has been described is the autocorrelation function for any time

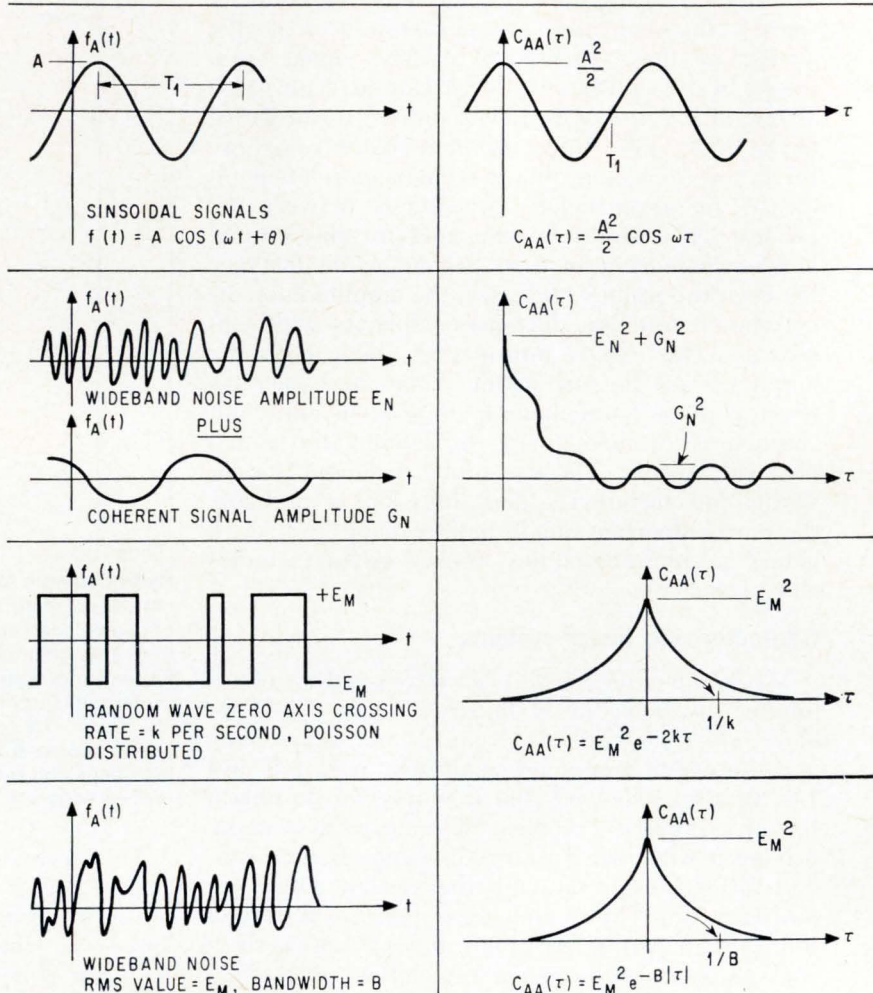
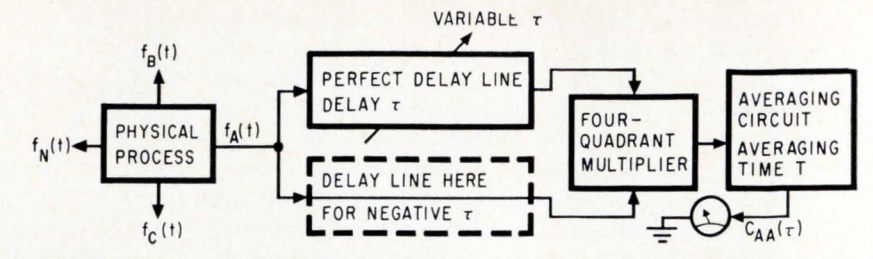

function $f_A(t)$. Mathematically the autocorrelation function is expressed:

$$C_{AA}(\tau) = \lim_{T \rightarrow \infty} \frac{1}{2T} \int_{-T}^T f_A(t) f_A(t - \tau) dt$$

Consider what information $C_{AA}(\tau)$ can give about the signal $f_A(t)$. First compare $f_A(t)$ with $f_A(t - \tau)$ for very large values of τ . Any physical realizable process that produces a time function like $f_A(t)$ will be such that the value of the signal at time t becomes more independent of the value at $t - \tau$ as τ gets larger. Thermal noise, and even the quantum mechanics uncertainty principle, will eventually introduce randomness that will cause a gradual loss of coherence in the output signal. This is true even of the oscillators in the most stable

atomic clocks. For a signal arising from a real process, $C_{AA}(\tau)$ approaches zero as τ becomes sufficiently large. The value of τ that causes a significant reduction in the function $C_{AA}(\tau)$ is a measure of the coherence time of the original signal.

Noise characteristics. Consider, for example, random noise. The autocorrelation function for very wideband, uniform (white) noise with a root mean square value of E_M is an impulse function at $\tau = 0$ with an amplitude E_M^2 . This means that one characteristic of wideband noise is that the instantaneous value of the signal is completely independent of the value at any other instant and that the coherence time of the process producing the noise is very short.

A less obvious property of the auto-

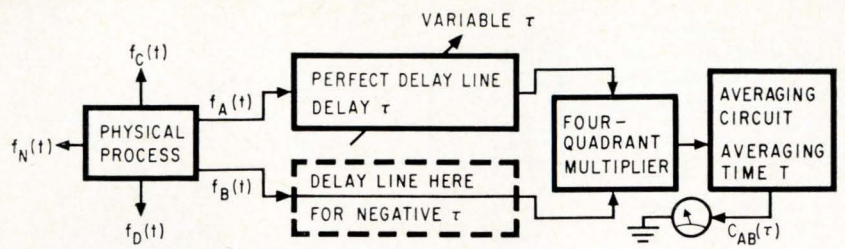

of power density spectrum analysis, there is no classical analogy for cross-correlation analysis. Crosscorrelation is concerned with the relationship between two different signals that arise in some common process. The cross-correlation function is obtained by averaging the product of one time function with a delayed replica of the second time function as shown in the block diagram on this page. Expressed mathematically, the crossrelation function is:

$$C_{AB}(\tau) = \lim_{T \rightarrow \infty} \frac{1}{2T} \int_{-T}^T f_A(t) f_B(t - \tau) dt$$

The properties of $C_{AB}(\tau)$ are, in general, quite different from those of the autocorrelation function. For example, $C_{AB}(\tau)$ is not equal to $C_{AB}(-\tau)$. However, $C_{AB}(-\tau)$ does equal $C_{BA}(\tau)$, a relationship that has practical importance in obtaining $C_{AB}(\tau)$ for negative delays. In practice, the averaging process indicated in the above equation is performed only for a time longer than the longest period in signals $f_A(t)$ and $f_B(t)$. Also, for signals that arise from real physical processes, noise and the uncertainty principle assure that $C_{AB}(\tau)$ approaches zero as τ approaches infinity. A few examples of crosscorrelation between various typical waveforms are shown at the left on this page.

The crossrelation function can be described as representing the degree of conformity between two signals as a function of their mutual delay. Hence if $f_A(t)$ and $f_B(t)$ arise from two completely separate, unrelated processes, then $C_{AB}(\tau) = 0$. As in the case of autocorrelation, a reciprocal Fourier pair exists for crosscorrelation. They are described mathematically by the following:

$$\Phi_{AB}(\omega) = \frac{1}{2\pi} \int_{-\infty}^{\infty} C_{AB}(\tau) e^{-j\omega\tau} d\tau$$

$$C_{AB}(\tau) = \int_{-\infty}^{\infty} \Phi_{AB}(\omega) e^{j\omega\tau} d\omega$$

In this case, however, the physical meaning of $\Phi_{AB}(\omega)$ is not so clear. It can be called the spectrum of crosscorrelation of the time functions $f_A(t)$ and $f_B(t)$.²

Crosscorrelation analysis provides a powerful analytical tool. The ability to measure the degree to which two signals that arise from a common physical phenomenon resemble each other as a function of the delay time between them can provide a much deeper insight into the phenomenon being studied than a separate analysis of the properties of either signal alone.

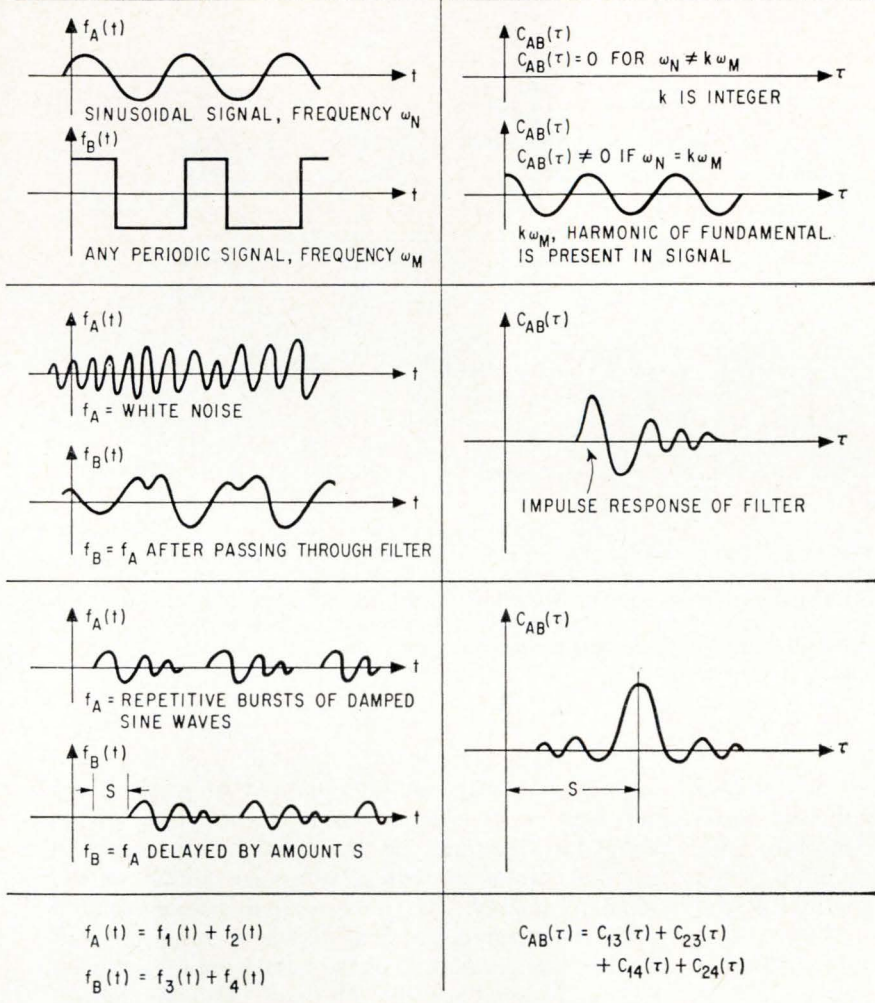

correlation function is given by the following pair of reciprocal relations:

$$\Phi_{AA}(\omega) = \frac{1}{2\pi} \int_{-\infty}^{\infty} C_{AA}(\tau) \cos \omega\tau d\tau$$

$$C_{AA}(\tau) = \int_{-\infty}^{\infty} \Phi_{AA}(\omega) \cos \omega\tau d\omega$$

These expressions are called the cosine Fourier transform pair. It can be shown that $\Phi_{AA}(\omega)$, the cosine Fourier transform of the autocorrelation function, is identical to the power density spectrum of $f_A(t)$. Hence measuring the autocorrelation function or the Fourier density spectrum yields equivalent information about a signal and the above equations can convert one to the other.

In experimental work, the measure-

ment of the power density spectrum of a complex signal has been the traditional way of obtaining information to characterize the signal for two reasons. First, construction of a wave analyzer is relatively straightforward and, second, spectral data are of paramount importance in specifying the frequency response of equipment needed to handle the signal. However, in searching for an unknown coherent signal buried in random noise, the autocorrelation method would detect the presence of the signal sooner than measuring the power density spectrum. The autocorrelation functions for a few representative time functions are given on the preceding page.

Crosscorrelation. While the autocorrelation function of a signal is equivalent to the traditional technique

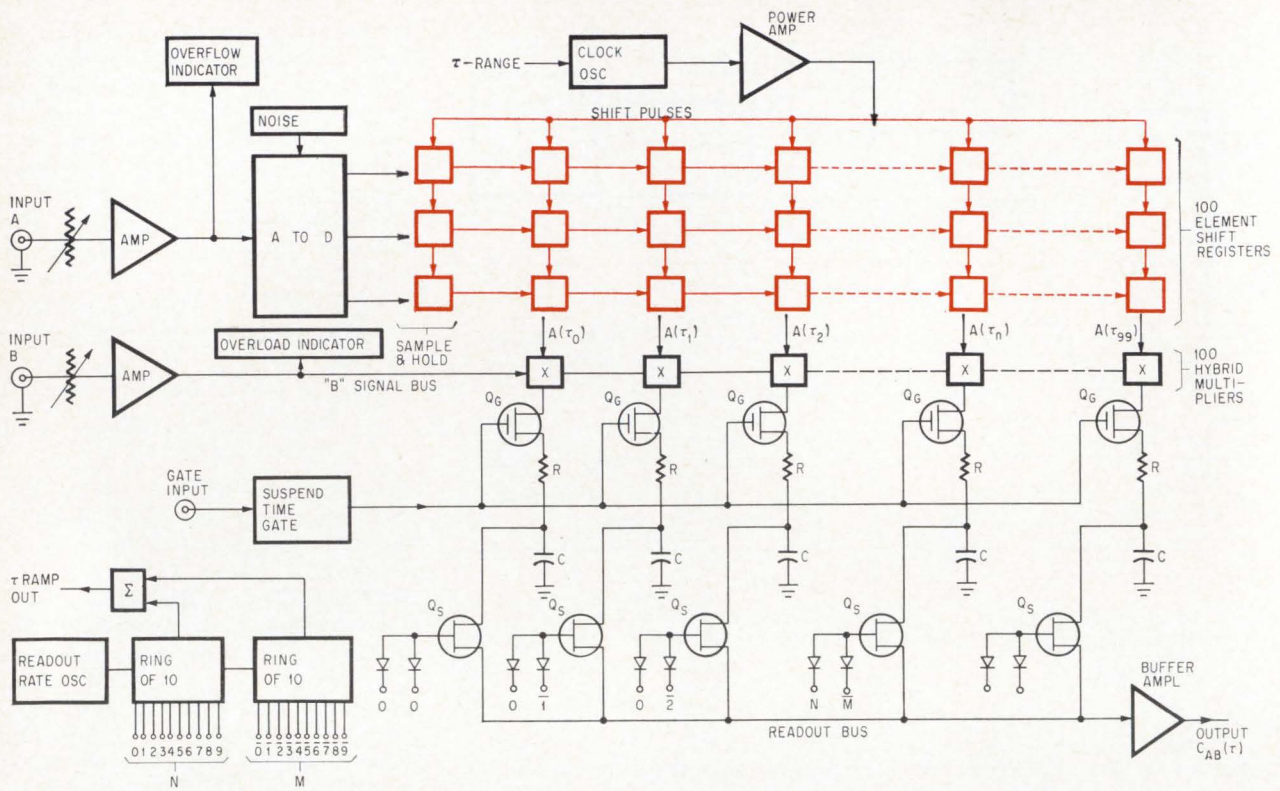

Basic to the operation of real-time correlator is the digital delay line made up of a series of flip-flops. The total delay range, from 100 microseconds to 1 second, is determined by the clock oscillator's frequency. Overload indicators in each channel indicate when the input signals are amplified sufficiently. The product of the delayed and reference signals is stored on the memory capacitors, C. The function is applied to the readout terminal as the ring counters sequentially turn on the transistor switches, Q_s , permitting the voltage stored on each capacitor to be sampled.

disturbed by the extraneous signals.

This immunity to internal system noise also allows the response to be obtained with very small exciting noise signals which do not interfere with the signals that the system normally handles. Thus the response function can be determined while the system is in operation.

With the new real-time methods of correlation it is now possible to keep the response of critical systems under constant surveillance and to make optimizing adjustments. Self-optimizing systems can be constructed by introducing feedback from a subsystem that evaluates the impulse response.

Since noise imposes the basic limit on the minimum signal that can be obtained in a given experiment, if, as is often possible, enough is known about the frequency of the signal being sought; it can be correlated with a reference signal of the same frequency. The noisy signal crosscorrelated with the reference signal yields a function that indicates the relative phase relationship between the noisy signal and the reference. Also, the amplitude of the crosscorrelogram is the product of the reference and signal amplitudes, the noise having been rejected. A special case of crosscorrelation has been applied to the design of lock-in amplifiers.³

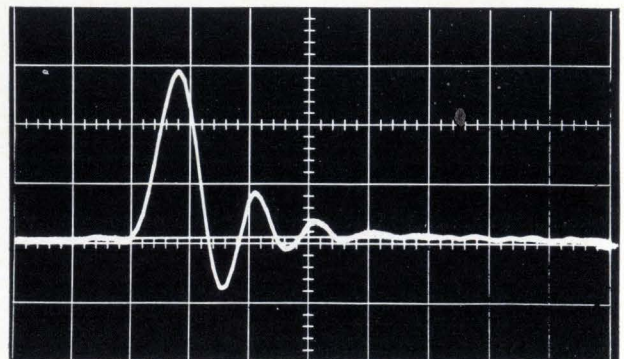
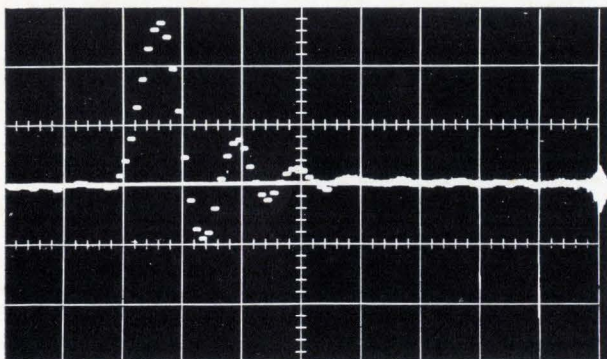

Crosscorrelation of input and output signals from a lumped-parameter delay line driven by a white noise source yields the unit impulse response of the line. Output smoothing converts the point-by-point plot to a continuous curve.

Actual equipment for obtaining correlation functions can take many forms. A technique used extensively couples the input signals to a digital computer by means of a high-speed analog-to-digital converter. The computer is programmed to crosscorrelate, point by point, two signals and to extract them from noisy backgrounds. But, this requires a sizable computer memory and a relatively large amount of computer time. Also, it is difficult to make high-speed analog-to-digital conversions. Other correlators record the signals on magnetic tape for replaying at a later time. Variable delay between the signals may be introduced by two playback heads on the recorder—one movable and the other fixed—and varying the separation between them. This technique requires point-by-point sampling of the input signal, which is time consuming and cannot be done on-line.

The advantage of being able to read correlation functions in real time can be seen in a typical example of how correlation analysis is used. In sleep research, for instance, the correlator has the ability to sense the onset of alpha rhythms with extreme sensitivity as it is occurring—without the ambiguity and delay that occurs when isolating the rhythm from normal EEG records. Researchers thus can determine more precisely the time relation between the onset of the alpha rhythm and other experimental factors.

No extras needed

The Princeton Applied Research Corp.'s instrument is a 100-point time delay correlator designed primarily for on-line use. It requires no extra equipment other than a general laboratory oscilloscope to display the final function and it can work with signals as high as 250 kilohertz. PAR's correlator combines analog and digital techniques to display a continuous picture of the correlation functions of the input signals. Since the function is computed for 100 delay times simultaneously, a continuous presentation of a slowly varying correlation function can be displayed even with inputs that are not quite stationary with respect to time.

The two signals to be correlated are fed into inputs A and B, see diagram at top left. Channel A is amplified to a level just below the point of overload. It is then mixed with noise and digitized in a relatively coarse, high-speed analog-to-digital converter. Outputs from the converter are sampled and applied to an 100-element shift register. The shift register acts as a digital delay line and has a total delay equal to 100 periods of the clock oscillator. The speed of the analog-to-digital converter limits the clock frequency to 1 megahertz producing a minimum total delay of 100 microseconds and a maximum of 1 second.

The output of each flip-flop in the 100-element delay line is tapped, and the binary number represented by the state of each stage in the register is connected as one input to a hybrid multiplier. The second input to the multipliers is the analog input signal on channel B, also amplified to approach

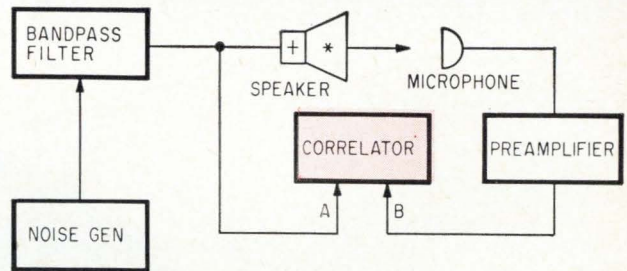
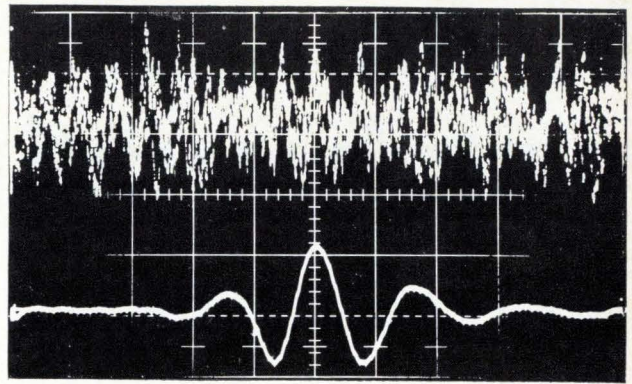

Acoustical system driven by a white noise source. Crosscorrelating the microphone output with the original source yields the system's impulse response in lower trace. The complete transfer function of the system is described by this single trace.

the point of overload.

The output of each multiplier is gated by a transistor switch Q_G so that, in effect, time may be suspended. This feature is useful where correlations are desired on pulsed signals with low duty factors. The correlator is dormant during the gated-off period. After gating, the signal, $A(t-n\tau)B(t)$, is averaged in a simple resistor and capacitor circuit with a sufficient time constant to obtain good integration.

To read out the results, the charge on each of the 100 memory capacitors, C , is nondestructively sampled by semiconductor switches, Q_s , that are turned on in sequence along the memory line. The sequencing is controlled by a pair of decade ring counters driven by a readout rate oscillator. The readout rate has no bearing on the operation of the instrument and can be adjusted to be compatible with the readout instrument; slow for an x-y recorder and fast for an oscilloscope presentation. Output smoothing is available so the 100 discrete output points can be made into a continuous curve. This is useful when complicated functions are to be observed, as demonstrated by the correlation function between the input and output of a lumped-parameter delay line on page 80. Connecting the discrete points with a smooth line makes it easier to interpret the function.

References

1. W.A. Rosenblith, *Processing Neuroelectric Data*, MIT Press, Cambridge, Mass., 1962.
2. Y.W. Lee, *Statistical Theory of Communication*, John Wiley & Sons, N.Y., 1960.
3. R.D. Moore, "Lock-in amplifiers for signals buried in noise," *Electronics*, June 8, 1962, p. 40.

Helping ESSA watch weather from space!



Keystone Thermistors

Peering from their orbits in space, RCA-built units of the first global operational weather system report continuously on atmospheric conditions around the world. In these TIROS-type weather-watchers ESSA-1* and ESSA-2*, Keystone thermistors are part of the circuitry—responding to temperature changes with precise and immediate compensation or measurement as required. □ Do you have a far-out or down-to-earth temperature measurement/control problem? Bring it to KEYSTONE CARBON COMPANY, St. Marys, Pennsylvania 15857

*Built under technical direction of NASA Goddard Space Flight Center for Dept. of Commerce, Environmental Science Services Administration.

Keystone
leads

in creative thermistor technology

Wiring design helps core memory work at rapid cycle time

An unusual layout in a 2½-dimensional organization gives a ferrite-core computer memory a 500-nanosecond cycle, and keeps cost down

By Alexander Elovic

Electronic Components Division, Burroughs Corp., Plainfield, N.J.

Can a ferrite-core memory's cycle time be pushed well below a microsecond without boosting the cost an unreasonable amount? This question confronted engineers at the Burroughs Corp. Their answer was a new design that allows a memory of 8,192 twenty-bit words to read and write in only 500 nanoseconds. The design clips more than 100 nanoseconds from previous speeds for memories in this size range.

One design considered by the engineers was the conventional 3-dimensional 4-wire design. Many large memories have this organization [see "Memory organizations," p. 85]. But certain problems cropped up. They grew more serious when engineers worked with a cycle time of less than one microsecond. The most serious difficulties, which ruled out further consideration of the 3-D organization, were the distributed capacitance between the drive and inhibit wires, and the additional time that the inhibit pulse imposed on the cycle.

Another approach considered by Burroughs was the 2½-D configuration. This design eliminated the inhibit difficulties, but other problems inherent in all high-speed memories appeared. First, the drive wires can resemble transmission lines if they are physically or electrically too long. Transmission problems were skirted by designing the memory so the wires were physically short and by keeping the inductance and capacitance on the lines as low as possible, thus minimizing their electrical length.

Second, the ferrite cores, if forced to switch back and forth too rapidly, can overheat, and heating seriously affects the magnetic characteristics of the ferrite material. Attaching the cores to an aluminum ground plane, which serves as a heat sink, overcame the heating problem.

The simplest layout for the bit plane—which con-

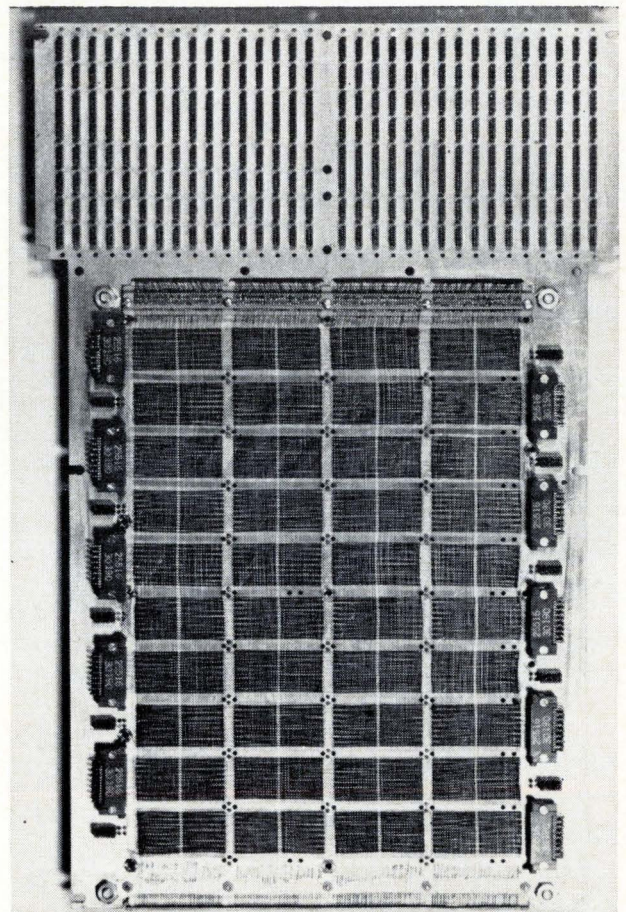

Core array for half of the 2½-D memory. Every small black square is a 32-by-32 group of cores with its own sense winding. Each group of eight small squares is one 32-by-256 bit plane, and has 16 bit windings making round trips through 32 rows. The entire memory comprises 20 bit planes on two ground plates, with 256 common word windings.

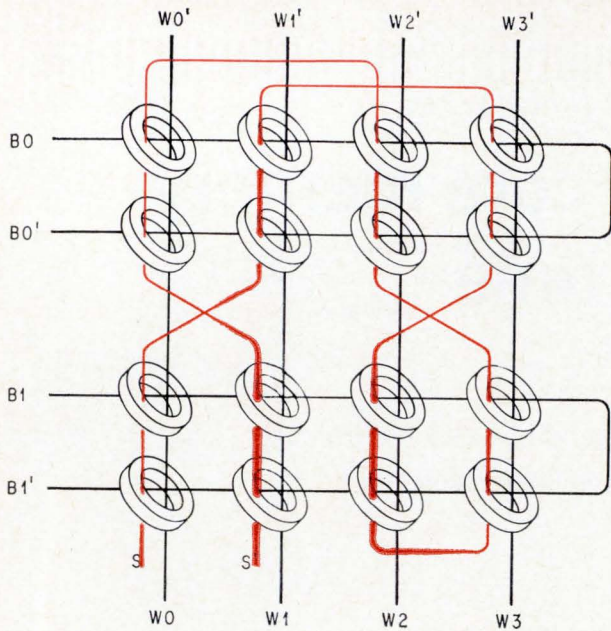

Sense winding run parallel to word windings, not bit windings as in some $2\frac{1}{2}$ -D memories. This diagram of a 4-by-4 array illustrates the winding layout and the "bow-tie" pattern. The inset shows how the bit line, lying between the sense and word lines, reduces coupling between them.

tains one bit of every word in the memory—is a square or nearly square array. But in a $2\frac{1}{2}$ -D memory the word winding must necessarily be much longer than the bit winding. The engineers reasoned that the bit plane could be made a long, narrow rectangle reducing the number of bit drive circuits and shortening the word winding considerably.

The engineers reduced inductance of the word and bit lines in two ways: they ran them close to the ground plane, thus putting the heat sink to double use; and they kept the bit line within the bit plane. The latter not only reduced loop inductance of the bit line, but eliminated the need for many solder connections required if the bit line was routed through more than one bit plane. And they reduced the capacitance of the word line by driving it from an unreferenceed transformer instead of directly from the driving circuit.

The result was the new ferrite-core memory module, which can be combined into memory systems of almost unlimited word length and capacity.

One less wire

The $2\frac{1}{2}$ -D organization was selected for the new memory primarily for technical reasons; cost advantages were considered secondary. One technical advantage is the need for fewer wires through each core. In the 3-D organization, four wires pass through each core—the x-wire, the y-wire, the inhibit wire and the sense wire. Both the x-wire and the y-wire thread through their corresponding row

and column in each bit plane. In the $2\frac{1}{2}$ -D organization, only three wires go through each core—the word wire, the bit wire and the sense wire. Only the word wire must pass through the corresponding columns in each bit plane. The bit wire terminates within the bit plane.

The inhibit wire limits the speed of the 3-D system in three major ways. First, the distributed capacitance causes degradation of the waveform, as described previously. Second, a voltage transition on the inhibit line inductively and capacitively couples unwanted signals into the sense line. Third, the current pulse on the inhibit line affects all the cores in the plane and induces delta noise in the sense winding. Delta noise is uncancelled noise from half-selected cores arising from the difference in slope between the top and bottom of the hysteresis loop; it is caused by selection currents as well as inhibit currents. Both the coupled-in noise and the delta noise impress unwanted signals on the sense winding, so that a significant interval of time must pass before the sense line recovers from the impressed noise and can again detect desired signals.

The inhibit pulse must rise before the coordinate drive pulse rises and fall after the latter falls, requiring additional cycle time. In the $2\frac{1}{2}$ -D memory organization, if a zero is to be written in the core, the current pulse on the bit drive lines is simply omitted during the write portion of the cycle. No bracketing or overlap of the pulses is necessary, reducing the cycle time.

An additional advantage realized by having only three wires through each core is that smaller cores can be used. Smaller cores require less drive current for a given switch time. In the $2\frac{1}{2}$ -D memory shorter wires threading fewer cores increase speed, because the propagation delays are shorter.

The single major advantage of 3-D organization is the economy in drive elements when compared to 2-D and $2\frac{1}{2}$ -D organization. This advantage, however, is less significant and may disappear entirely when attempts are made to increase both the speed and size of 3-D memories. Large 3-D memories need relatively long drive lines, requiring long signal propagation times. For high speed, the 3-D memory must be divided into smaller segments, each with its own complement of drive and sense circuits; and up goes the cost.

Less noise, less delay

The new memory's cycle time is short partly because arrangement of the core windings and their connections to driving circuits are designed to minimize the recovery time from noise coupled into the sense winding. Ideally, cycle time would be exactly twice the switching time of a single core—one switching action to fetch data and a second one to store new data or regenerate the old; in practice, the cycle time of any memory is longer because of address decoding, current rise times and the need to overcome noise coupling.

Address decoding and memory drive circuits were designed to reduce circuit delays as much as

Memory organizations

Computer memories can be organized in a number of different ways.

The most straightforward organization is called 2-dimensional or linear select. A 2-dimensional memory has all bits of one word in one plane. Two orthogonal sets of wires thread the plane, as shown at right; one set contains a wire for each word in the memory and the other set includes a wire for each bit in a word. At each intersection of the two sets, one word wire and one bit wire pass through the hole in a toroidal ferrite core. A third set of wires, the sense wires, is parallel to the set of bit wires and threads all the cores.

To fetch data from a 2-D memory, a full current (strong enough to switch to 0 all the cores that it threads) flows along the selected word wire. Cores that switch because they stored 1 bits generate voltage pulses in the sense wires. To store data, half the current passes in the reverse direction along the word wire and another half current passes along those bit wires threading cores that are to store 1 bits. The two currents combine to set the proper cores to the 1 state; where only the half current flows, the cores remain unswitched.

A 2-dimensional memory organization is expensive because for high speed a capacity of 2^n words requires 2^n drive elements.

A 3-dimensional, or coincident-current, memory consists of a series of stacked planes as shown at right; each plane contains one bit in each word in the memory. In each plane two orthogonal sets of wires permit any core in the plane to be addressed; the corresponding wires in all the planes are connected in series to select all the bits in a single word. In each plane a sense wire detects the change in magnetization of any core in that plane. An inhibit wire opposes the current in one of the two select wires when a zero is to be stored in the selected core in that plane.

To read data from a 3-D memory, a half current passes along one wire in each of the two orthogonal sets, in such a direction as to switch to 0 all cores that they both thread. Again, cores that switch generate voltage pulses in the sense wires; where only the half current flows, the cores remain unswitched. To write data, a half current runs through each of the two wires in the reverse direction, switching cores to the 1 state except where the inhibit current opposes them. An inhibit pulse leaves a 0 stored in the core.

The 3-dimensional organization requires many fewer drive elements than the 2-D arrangement and is therefore less expensive; but it is also slower.

The $2\frac{1}{2}$ -dimensional organization like the 3-D, is a coincident-current memory, but it may resemble the 2-D more closely in its physical appearance. One possible arrangement is shown at right. Half currents pass through the word and bit wires in the proper direction to switch the desired core to the 0 state when reading or the 1 state when writing. To store a 0, the half current in the bit wire is omitted; no inhibit wire is needed. Sense wires thread the cores to detect one bit of every word stored in the memory; their exact arrangement varies in different designs.

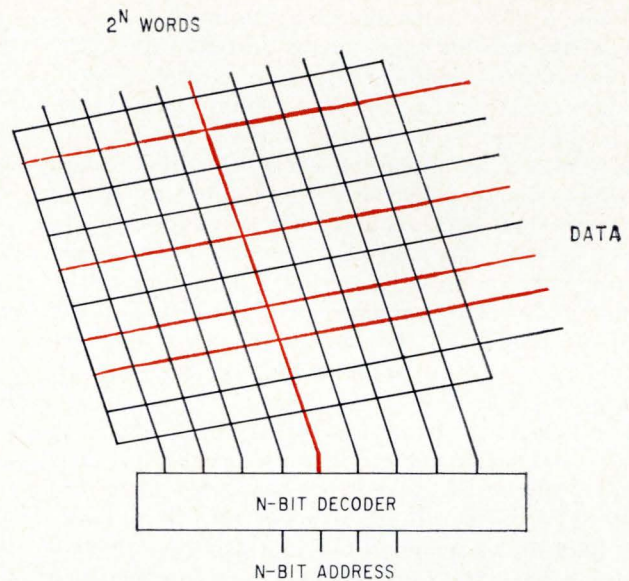

Two-dimensional memory plane.

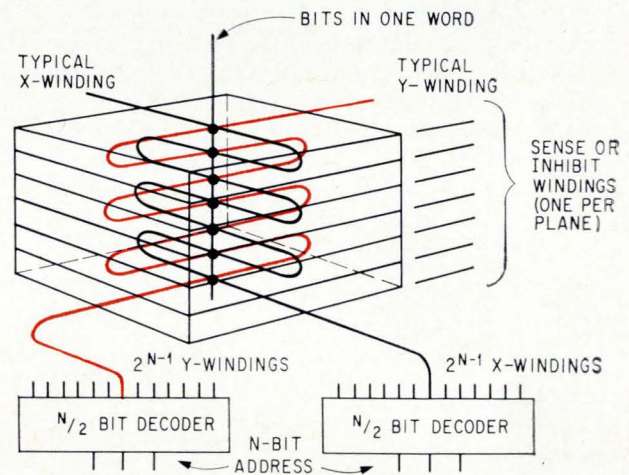

Three-dimensional memory, a stack of planes.

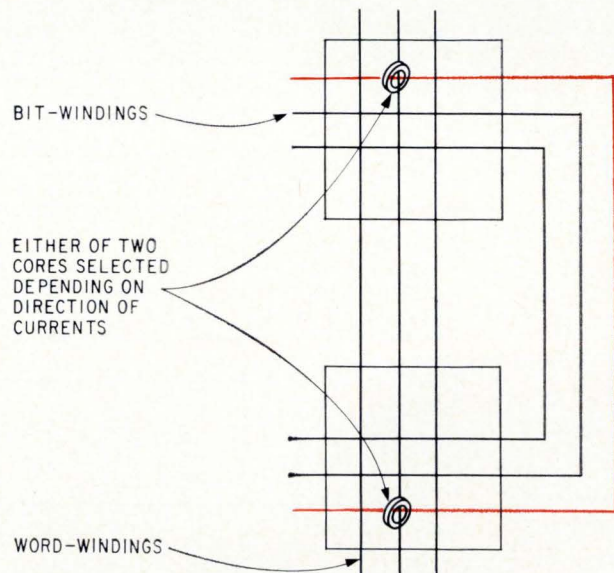

$2\frac{1}{2}$ -dimensional memory combines 2-D and 3-D features.

the state of the semiconductor art permitted.

The rise and fall times of the current waveforms account for a significant portion of the over-all memory cycle time. In the new memory, inductance of the bit wire is kept down and the current rise time reduced by threading each bit wire through two immediately adjacent rows of cores, as shown on page 84. This minimizes the loop area enclosed by the wire and also provides a very short return path for the bit currents. The inductance is further reduced by keeping both wires close to the ground plane. Loop inductance is only 0.9 microhenry, as a result; without the ground plane it would be 1.7 μ h.

The selected bit line and word line intersect at two cores because the bit wire loops back. The polarity of the bit current is always the same; the phasing of the word current relative to the bit current determines which of the two cores is selected. Looping back the bit line saves half the bit drive circuits.

Voltage and current transitions on the drive lines are capacitively and inductively coupled as noise into the sense lines. In some designs the rise of the word and bit currents is staggered to reduce the effects of this coupling and of delta noise, lengthening the cycle. In the new $\frac{1}{2}$ -microsecond memory, this staggering is not needed for three reasons: first, the sense line is perpendicular to the bit lines and parallel to the word lines, as shown

on page 84. This greatly reduces the capacitive and inductive coupling between bit and sense lines. Second, capacitive coupling between the word and sense lines is significantly reduced by driving them through transformers whose secondary windings are not grounded or otherwise referenced; they are electrically floating. The transformer drive also cuts propagation delay by about half by providing a balanced drive. Third, the inductive coupling between the word and sense lines is minimized by placing the bit lines between them, providing extra physical separation (see inset, p. 84).

The amount of delta noise depends on the number of cores coupled by the sense line and its configuration. The more nearly square the core array for a given number of cores, the less delta noise is generated. For these reasons a square core array of 32 bits by 32 was selected for the memory design.

Columns and rows

The photograph on page 83 shows how the $\frac{1}{2}$ -microsecond memory stack is put together. Each of the small squares is one of the 32-by-32 array of cores; each array is threaded by a single sense winding. Eight arrays in a horizontal row form a 256 by 32 bit plane that contains 8,192 cores, corresponding to one bit in each of 8,192 words. Word wires enter the array on the 256 side; bit wires on the 32 side. The ten horizontal rows—mounted

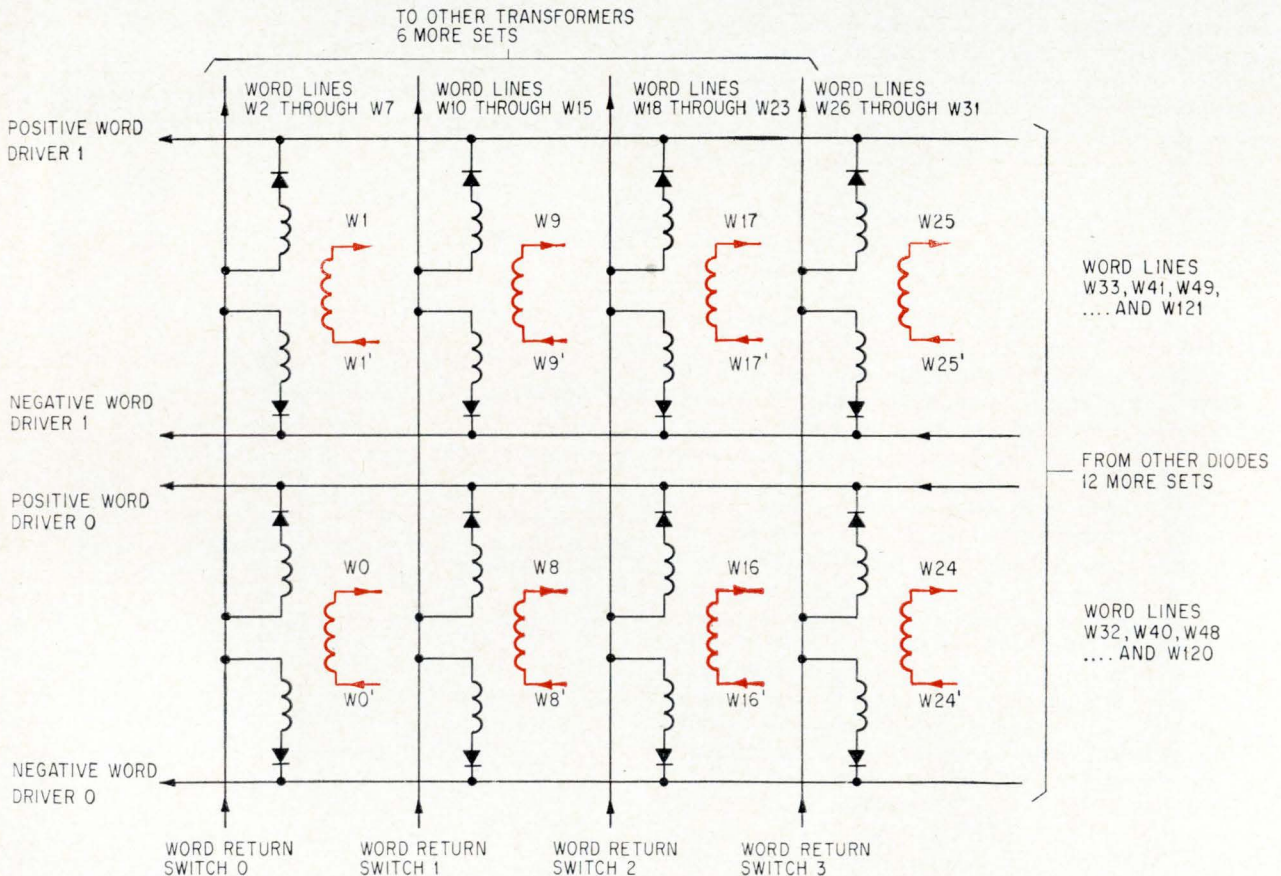

Unreferenced secondary windings of transformers generate the word current for the $2\frac{1}{2}$ -D memory. The floating secondaries reduce capacitive coupling to the sense winding and provide a balanced drive to the word winding.

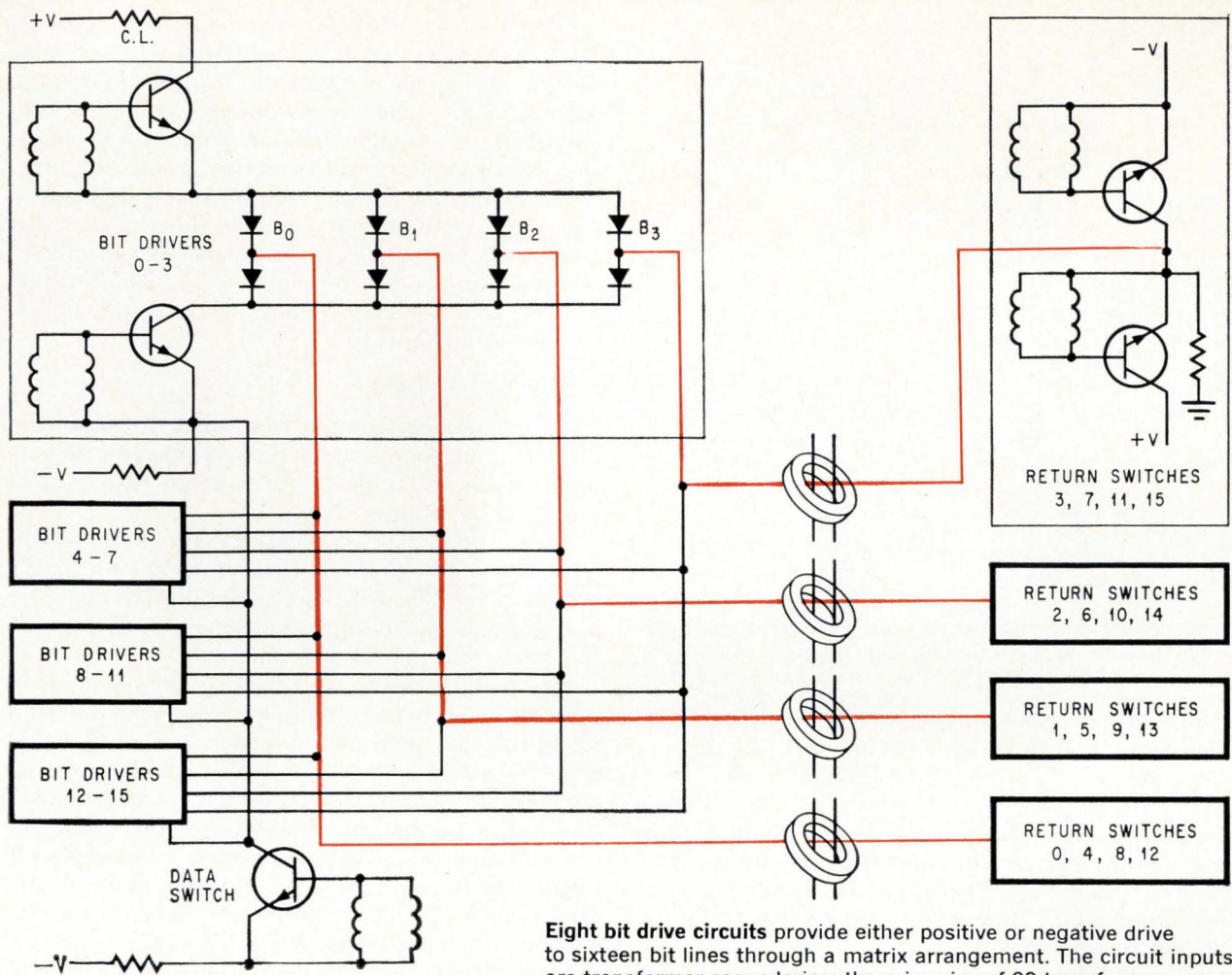

Eight bit drive circuits provide either positive or negative drive to sixteen bit lines through a matrix arrangement. The circuit inputs are transformer secondaries; the primaries of 20 transformers are connected in series to insure that all 20 bits in a memory word are fetched or stored simultaneously. The inductance shown across the secondary winding turns off the transistor quickly.

on a single base plate—contain ten bits in all the words. Two base plates together make up the complete $\frac{1}{2}$ -microsecond memory of 8,192 twenty-bit words; the 256 word wires continue through the two plates.

The cores in the memory are of 0.020-inch outside diameter and 0.012-inch inside diameter, placed 0.025 inch apart center to center. They require a nominal 840-milliamperes drive current and switch in 120 nanoseconds. Their output waveform is shown below.

Word and bit drivers

The ungrounded secondary winding of a transformer drives each of the 256 word lines in the

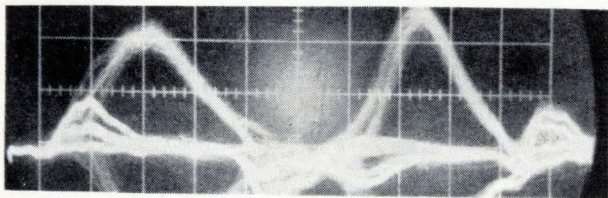

Output waveforms reading a continuous series of 1's. The scale is 40 nanoseconds per division.

memory, reducing capacitive coupling to the sense lines. Each transformer has two primary windings—one provides current for reading and the other for writing; the two currents are of opposite polarity. The transformers are arranged in two conventional matrixes of 8 by 16 transformers each, as shown on the opposite page; two separate matrixes present a smaller loop inductance to the word drive circuits than one large matrix. One constant-current driver and one switch turn on to read or write one word. Propagation delay in the word line is less than four nanoseconds.

Bit drive circuits are shown in the diagram above. Each group of 16 bit lines is driven by its own 16-way switch matrix. Baluns are used in the drive circuit, one balun for each bit line to limit power dissipation of the driver switches. The 20-bit memory contains 20 of these matrixes. Each group of 16 lines doubles back through adjacent rows of cores to provide the 32 bit lines in the 256-by-32 core group. The inputs to the drivers are another set of transformer secondaries; the transformer primaries in corresponding drive and switch circuits are connected in series to insure that circuits turn on simultaneously and minimize the

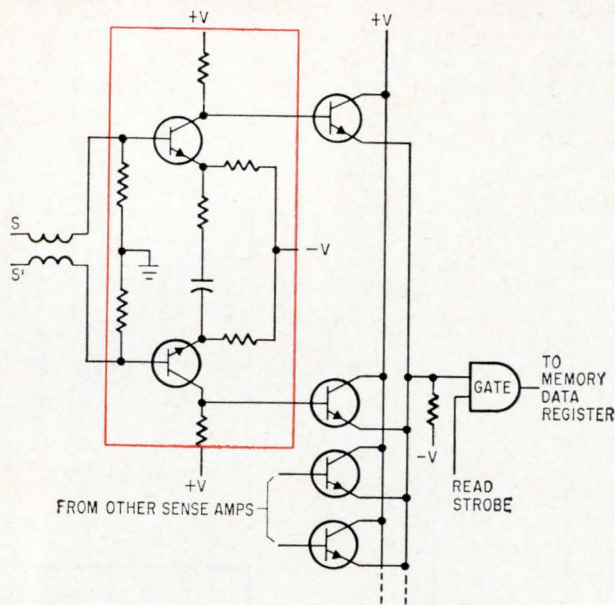

Sense amplifier connects eight sense windings to a single strobe gate through emitter-followers whose outputs share a common load. Differential preamplifiers (one of which is outlined in color) drive the emitter followers. This configuration keeps down the cost of sensing the many small sense sections in the memory.

number of decoding circuits. Corresponding drive and switch circuits turn on in all 20 matrixes to read or write one word. The current-limiting resistors (marked C.L. in the diagram) determine the current in each line. During the cycle's write portion, an independent data switch in each bit matrix controls whether a 1 or a 0 is written into the selected bit; if the data switch is not turned on, no current is available for the bit line. The propagation delay in the bit line is two nanoseconds.

Sensing data

Each sense wire is threaded through only a 32-by-32 array to make the 500-nanosecond cycle time possible. The small sense section requires eight sense preamplifiers per bit, or a total of 160 sense preamplifiers in the memory; their cost must therefore be low to keep the cost of the entire memory from getting out of hand.

A schematic of one sense amplifier is shown above, with the connections of seven other preamplifiers indicated to produce a single bit output. The input passes through a transformer connected as a balun to eliminate common-mode noise. The differential stage, outlined in color, is a hybrid circuit made of discrete transistors and screen-printed thick-film resistors on a ceramic substrate. The base-to-emitter voltage and other parameters vary from transistor to transistor; to compensate for these critical variations, the collector operating point and small-signal gain are adjusted by trimming the resistors.

Following the differential stage is a pair of emitter followers with common emitters and a single load resistor. This configuration combines the out-

puts of the differential stage's two sides as in an OR gate. Seven other emitter-follower pairs are connected to the same common load, bringing the outputs of the eight sense windings and eight preamplifiers to a single common point. Only one of the sixteen emitters will be active at any one time, because only one core in each bit plane switches at one time. A strobe gate samples the signal at the common point to reduce still further the likelihood of false outputs generated by noise. The strobed and clipped signal is then made available to the memory data register.

Packaging for speed

Memory speed depends to a great extent on the packaging arrangement, because packaging affects line lengths, grounding and voltage distribution, among other things.

The entire memory is mounted on two aluminum base plates that serve both as a heat sink and a ground plane. The cores are secured to the plate by a silicon and magnesium-oxide mixture that transfers heat from the cores to the plate.

Bit selection diodes and baluns are mounted on printed-circuit boards that plug into the connectors along the side of the core array. In the photo on page 83, part numbers are visible on the sides of these connectors; in place the cards project toward the array's center, covering up the cores. The bit drive circuits are placed on other printed-circuit boards that lie flat on top of the cards carrying the diodes and baluns; connectors establish contact between the boards. The word drive circuits are on p-c boards that plug into the connector array at one end of the core array. Boards carrying the sense amplifiers are connected in the frame that holds the rest of the assembly; these connectors are not visible in the photo. This assembly provides the shortest possible interconnections.

Voltages are distributed on strip-lines fabricated as part of the printed-circuit cards that carry drive and sense circuitry. The strip-lines reduce the liability of noise spikes and the need for filtering. Critical time pulses—the read strobe signal, for instance—are also distributed on strip-line. This line has a propagation time similar to that of the word current through the core array, so that the strobe pulse and the memory output remain fixed in time relative to each other throughout the entire memory.

The entire memory measures 26½ by 19¼ inches, and the complete assembly is 4¼ inches thick. These measurements include the core arrays, the ground planes on which they are mounted, the surrounding drive and sense circuitry, and the supporting frame.

The author

Alexander Elovic is the manager of memory systems at the Electronic Components division of the Burroughs Corp. He has had the job for about a year, having previously been the director of engineering at Indiana General Corp.

The connector Thing

A periodical periodical designed, quite frankly, to further the sales of Microdot connectors and cables. Published entirely in the interest of profit.

WIN a pot of gold!



Lepra/Cons Unite!

In celebration of the introduction of the highest density coax rack and panel and multi-pin connectors on the market today (the broadened Lepra/Con line), Microdot is awarding to five lucky winners (see contest rules below) five simulated gold pots (of the chamber variety) with your, repeat your, name emblazoned thereon. Perfect for desk top decoration. First, let's talk Lepra/Con.

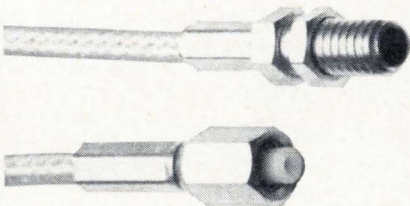

Through its stringent policy—"Never Look Back, They May Be Gaining On You"—Microdot has expanded its Lepra/Con line of ultraminiature connectors...tiny little coax jobs with an OD of only $\frac{1}{8}$ inch and a mated length of only one inch. But why stop there.

Now there's the Lepra/Con multi-pin...all crimp, no solder; high density; uses Twist/Con pin contacts; low cost; and it's the smallest full 50 ohm coax available today.

Now there's the Lepra/Con Twist/Con /say it fast fifty times) which combines all of the above advantages in a rack and panel coax connector.

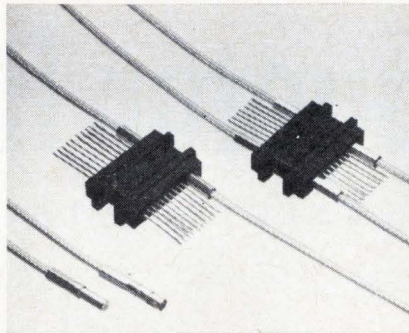

Now there's the slide-on Lepra/Con for singular ease of installation.

And, of course, there is still the old Lepra/Con (if you can call six months old).

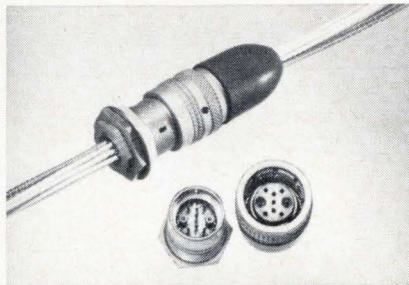

HOW TO WIN YOUR POT OF GOLD

1. First, of course, decide whether you actually want a pot of gold. In all likelihood, your place of employment has far more up-to-date facilities. However, if you decide a pot is for you, go to step two.
2. Write down all the applications you can think of for the Lepra/Con line *on your job*. And think about it. There are probably more than the twelve you can jot down immediately without hardly thinking at all.
3. Call your Microdot representative directly or drop him a note giving him all your suggested applications, your name, company, title, address and telephone number. Do not call or write Microdot. We only make connectors. Our reps sell them. Hopefully.
4. A jury of six will judge all entries for originality, number of applications and neatness. The five best will each be awarded the simulated gold pot (of the chamber variety).
5. All entrants will win a free picture of our beloved Candy inscribed passionately and personally to you.
6. This whole shoddy affair draws to an end on December 31, 1966. Happy New Year!
7. This entire offer is not valid in any state, county, township or ward where such carryings-on are generally frowned upon.



Alabama, Tennessee
REP. INC.
8100 South Memorial Parkway, Huntsville
205-881-9270

Arizona
COMPAR ROCKY MOUNTAIN AGENTS, INC.
84 West First Street, Scottsdale
602-947-4336

California (Northern)
PETERS-de LAET INC.
1606 Rollins Road, Burlingame
415-697-1800

Canada
DOUGLAS RANDALL (CANADA) LTD.
126 Manville Road, Scarborough, Ontario
416-421-5970

Colorado
COMPAR ROCKY MOUNTAIN AGENTS, INC.
300 E. Hampden, Suite 315, Englewood
303-781-0912

Florida
GEARTNER ASSOCIATES, INC.
235 Lincoln Road, Miami Beach
305-531-0200
GEARTNER ASSOCIATES, INC.
2101 Mohawk Trail, Maitland
305-647-4000

Georgia
REP. INC.
1483 Monroe Drive, N.E., Atlanta
404-876-1591

Illinois, Wisconsin
CARLSON ELECTRONIC SALES
7448 North Harlem Avenue, Chicago
312-774-0277

Indiana
O. E. M. SALES COMPANY
4165 Millersville Road, Indianapolis
317-545-1267

Kansas
IMPALA, INC.
6917 W. 76th Street, Overland Park
913-648-6901

Long Island
MICRODOT INC. (Philip J. Dolan)
P.O. Box 815, Westbury
516-333-4664

Maryland, Virginia, Washington D.C.
WARREN MOUNT CO.
7735 Old Georgetown Road, Bethesda
202-657-9312

Michigan
ROMARC
696 Adams, Plymouth
313-455-0300

Minnesota, Iowa
HOWARD W. CARLSON
100 N. 7th Street, Room 606, Minneapolis
612-336-2236

Missouri
IMPALA, INC.
47 Village Square Shopping Center, Hazelwood
314-522-1600

New England
MICRODOT INC. (Ernest W. Smith)
P.O. Box 309, Bedford
617-244-8434

New Mexico
COMPAR ROCKY MOUNTAIN AGENTS, INC.
2125 San Mateo Boulevard N.E., Albuquerque
505-265-1020

New York
ADVANCED COMPONENTS CORP., INC.
119 Luther Avenue, Liverpool
315-472-7886

Ohio
RICHARD P. CALHOUN & ASSOCIATES
40 Southmoor Circle, Dayton
513-299-4144

Pennsylvania
WARREN MOUNT CO.
837 State Road, Andalusia
215-788-2272

Texas, Arkansas, Louisiana, Oklahoma
ROBERT R. THOMAS CO.
8616 Northwest Plaza Drive,
Suite 207, Dallas
214-363-8591
ROBERT R. THOMAS CO.
4031 Broadway, Suite 105,
Houston
713-644-2369

Washington, Oregon
RAY OVER SALES
1615 103rd Avenue, S.E.,
Bellevue
206-454-9187



MICRODOT INC.

220 Pasadena Avenue
South Pasadena, Calif. 91030

Twist/Con and Lepra/Con are registered trademarks of Microdot Inc.

Double phase-shift keying speeds data over voice channels

Integrated circuit modem eliminates synchronizing pilot tones in transmission of digital data by simultaneously phase modulating binary data and bit-timing signals on the carrier

By Martin Poppe*

Electronic Communications, Inc., St. Petersburg, Fla.

Phase-shift keying a carrier signal two times provides extra dividends when it's necessary to transmit digital data over ordinary voice communications. The carrier's phase is shifted once to designate the bit time and once to indicate whether the data transmitted is a binary 1 or 0.

The shift representing bit timing—the novel feature of the technique—allows the receiver's demodulator to synchronize quickly with the transmitter's modulator. This eliminates the need for other synchronization aids, such as closely controlled amplitude modulation of the carrier signal or pilot tones. The bit-timing method can be used with amplitude-insensitive channels. The technique also permits the accurate reception of data over channels whose quality is impaired by frequency translation due to poor tuning or the doppler shifts in frequency that result when the receiver, transmitter or both are moving.

Most of the circuit functions required for modulation and demodulation are digital, allowing the modems (modulator-demodulator equipment) to be built almost entirely of monolithic integrated circuits. A prototype modem on a single printed-

circuit board totals only 30 cubic inches, excluding its power supply. The nominal data rate of this breadboard model is 1,300 bits per second, a rate compatible with any standard voice channel having a bandwidth of 3 kilohertz.

The simplicity, reliability and small size of such modems make them suitable for aircraft, space and portable communications systems. Within the modem phase-shift keying (PSK) uses transmission power very efficiently. For example, a PSK signal transmitted through a channel with white gaussian noise requires only half the power of frequency-shift keying (FSK) for a given error rate because a PSK system can tolerate a signal-to-noise ratio approximately 3 decibels lower than an FSK.

Bit timing by the angle

To generate the phase-shifted signal and to time it before transmission, the encoded data and a clock modulate a signal generated by a master oscillator as diagramed at the top of the next page. The output signal is a single-frequency carrier that has been phase shifted twice.

▪ First, the unmodulated carrier is shifted to a phase $\pm 5^\circ$ with respect to an arbitrary phase reference. It shifts $+5^\circ$ on even bit times as in the timing diagram of the encoded data on the bottom of the next page. The demodulator in the receiver recognizes the 10° phase shift as the dividing line between two bit times.

▪ Second, the data information is processed in the modulator so that the carrier is phase shifted an additional $+180^\circ$ or 0° , depending on the input binary data. Phase shifting occurs synchronously with the $\pm 5^\circ$ bit-timing shift; therefore, the output signal may have one of four phases, $+5^\circ$, -5° , 185° or 175° . The amount of shift from bit time to

*Now with the State University of New York, Stony Brook

The author



While at Electronic Communications, Inc., Martin Poppe designed space communications systems. He is now an instructor at the State University of New York, where he is continuing his graduate studies.

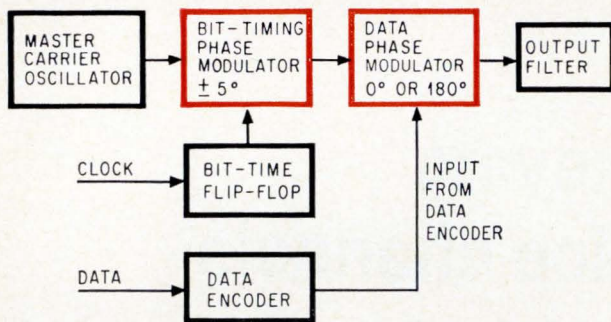

Digitally controlled modulators in the coherent phase-shift keyed transmitter provide an encoded output signal. Double phase-shift keying transmits both timing and input data on a single-frequency carrier.

bit time operates the decoding logic in the demodulator of the receiver.

Ambiguity in the received data is prevented by shifting the phase with logical rules, rather than merely assigning one phase to a logical 1 and the opposite phase to logical 0. The encoding of a sample series of data bits in the diagram shown below illustrates the differential encoding rules.¹ Only input data in the form of logical 0's change the state of the encoder; input logical 1's do not affect the encoder's output. Thus, the receiver does not have to determine the initial state of the encoder.

Encoding the output

Successive input 1's in the second and third column in the diagram produce no change in the encoder output, but three successive 0's in the input data, in the fourth through sixth columns, result in successive changes in the state of the encoder output. The changes are superimposed on the timing phase shifts and are transmitted as 0° or 180° phase shifts of the carrier frequency relative to the reference signal. Because the bit information is repre-

sented by the time at which phase changes occur, it does not matter whether the first bit causes a phase advance or delay.

The transmitter shown on page 93 accepts non-return-to-zero (NRZ) data at a rate of 1,300 bits per second plus a return-to-zero (RZ) clock signal.

Two sets of signals are generated by the carrier generator. One, a delayed set, provides signals of -5° and 175° relative phase. The other, an advanced set, provides signals of +5° and 185° phase. Bit-timing modulation is accomplished by switching the carrier input on alternate bit times between the advanced phase set and the delayed phase set of carriers. Gates, driven by a flip-flop, switch the carrier when triggered by the clock signal which supplies one pulse for each bit.

The clock signal to the encoding flip-flop is gated by the input data. When the input is a 1, the gate is disabled and the state of the flip-flop remains unchanged. A zero input enables the gate and the flip-flop changes state. The encoder flip-flop's state determines the final carrier phase representing bit timing and encoder output. The signal is then low-pass filtered to produce the PSK signal.

Synchronizing the receiver

Operation of the receiver may be broken down into two subsystems: the reference recovery and bit time demodulator and the data demodulator. A limiter at the receiver input on page 94 removes amplitude variations caused by noise in the communication channel and changes in signal strength. The received signal becomes a two-level signal processed by digital integrated circuits.

Demodulation of the PSK signal in the receiver occurs in the reference recovery and bit-timing demodulator and requires a reference signal whose phase is fixed with respect to the master oscillator in the transmitter. This reference signal is derived from the received binary encoded signal.

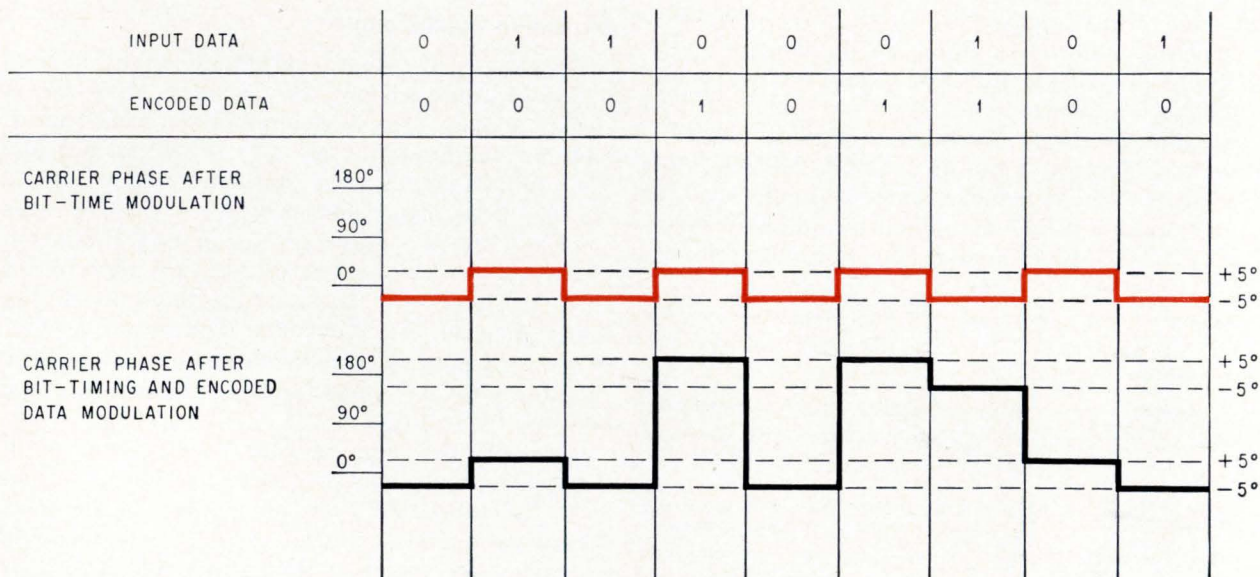

For bit timing, the encoded carrier shifts on alternate bits either +5° or -5° from a 0° reference. For signal modulation, the carrier shifts either 0° or 180° depending upon whether the encoded bit is logical 1 or logical 0.

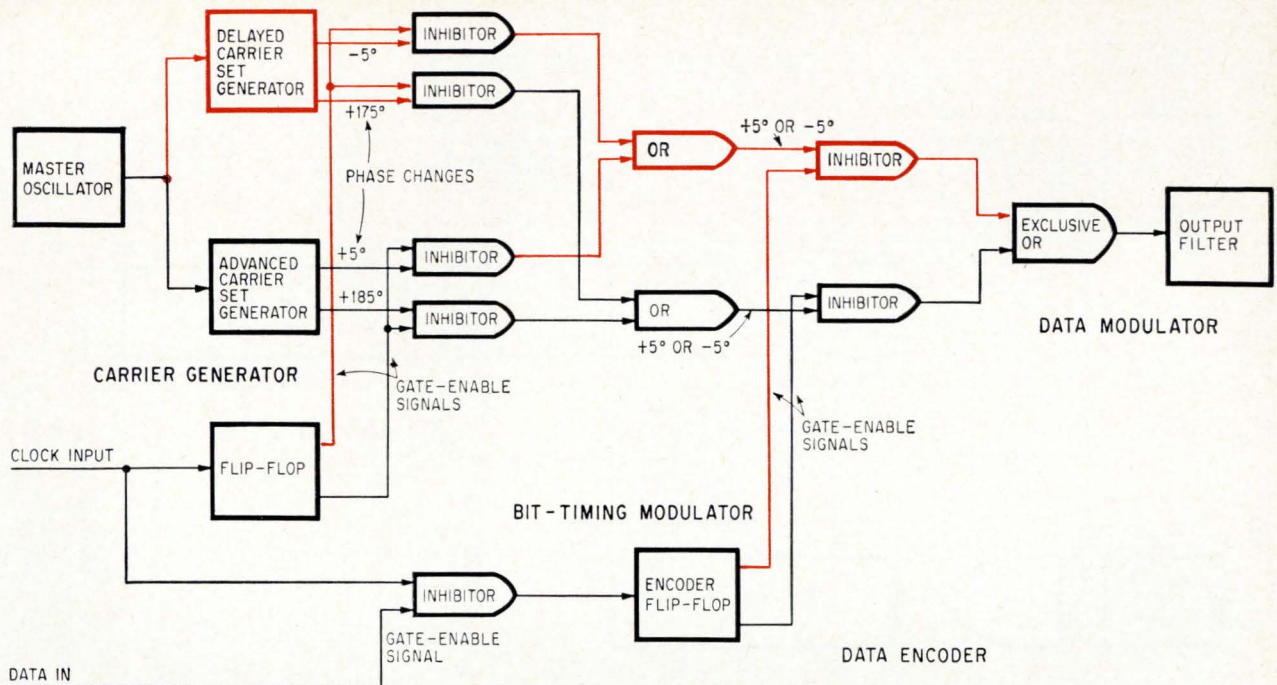

Carrier phases shifted four ways by advanced and delayed carrier generators. Color separates delayed carrier signal from the advanced. Clock input controls the bit-timing modulator to gate the carrier with the timing phase change before transmission. Subsequently, input information is encoded before transmission.

Received encoded information is somewhat random in nature. A single-bit element of the transmitted signal may be described as:

$$A(t) = A_c \cos(\omega_c t + N\pi + M\pi/36)$$

where ω_c is the carrier frequency in radians per second; $N = 0$ or 1 , depending upon the state of the data encoder; and $M = \pm 1$ depending upon the state of the modulator.

Since a random stream of binary coded signals contains as many 1's as 0's, its average energy at carrier frequency is zero. A finite component at carrier frequency is necessary, however, to establish a coherent repetitive reference. This is accomplished by doubling the input signal frequency.²

To double the input signal, a frequency multiplier generates a pulse every time the signal goes through zero. The pulse width is adjusted so that energy concentrates at the second harmonic of the carrier frequency, making it look like a square wave at twice the carrier frequency.

Ignoring d-c components and multiplier noise, an approximate expression for the resulting signal is:

$$B(t) = B \cos(2\omega_c t + M\pi/18)$$

This function contains a carrier component twice the initial carrier frequency and spectral lines resulting only from phase modulation produced by the bit-timing signal.

To recover the reference carrier and to demodulate the bit-timing information, a phase-locked loop, as shown in color in the diagram on page 94, locks onto twice the carrier frequency $2\omega_c$. The loop bandwidth is narrow so that it cannot track the phase modulation; the loop controls the frequency of an oscillator operating at eight times the desired reference frequency—which is divided until it

reaches the carrier frequency. The demodulated bit-timing information is available at the output of the reference loop phase detector³ and is separated from the noise by a second phase-locked loop.

Demodulating the data

With the carrier reference and bit-timing signal available, the absolute phase of the data with respect to the reference carrier can be determined. The coherent reference signal generated in the reference recovery phase-locked loop is compared with the received signal in another phase detector located in the data demodulation portion of the receiver. The phase of the received signal may be either $+5^\circ$, -5° , 185° or 175° . The demodulator also contains output logic which retimes and decodes the demodulated data. The data phase detector, an exclusive OR logic circuit, puts out a logic 0 if the incoming and reference signal are in phase; a logic 1 if they are of opposite phase.

An integrator accumulates this signal for the duration of a bit interval. The integrator consists of a binary ripple counter and a gate that determine whether the high-frequency pulses from the voltage-controlled oscillator in the reference recovery phase-locked loop may reach the counter.

When the output of the data phase detector is logic 0, the total in the counter increases. When the output of the phase detector is a logic 1, the count remains unchanged. The count in the binary counter is therefore proportional to the time during which the input and the reference signals are in phase.

The final count in the counter is compared with a preset count to determine whether the received signal was in phase or out of phase with the refer-

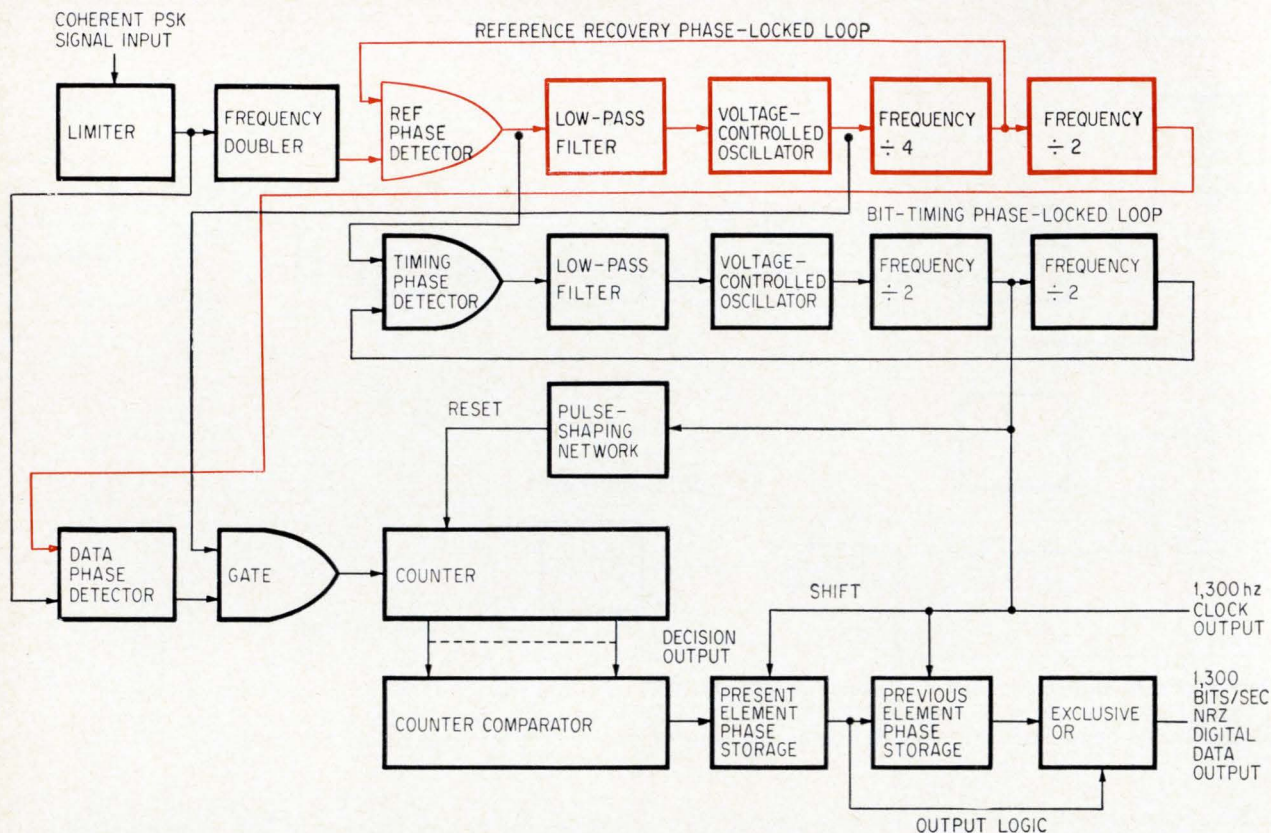

Two phase-locked loops in the receiver recover the carrier frequency for a phase reference (color) and separate the bit-timing information from the input data.

ence signal during the bit time. If final count is greater, the input signal is in phase with the reference; if less, the input signal was out of phase. The result is stored in the output logic of the receiver.

To determine whether 0 or 1 was actually sent, the phase of the incoming signal element is compared with the phase of the previous stored signal element in the output logic circuits. If the two phases agree, the input bit at the transmitter's modulator was a 1; if they differ, it was a 0.

Evaluating the modem

The performance of the reference recovery loop is evaluated by measuring the operating range of input carrier frequencies and the maximum signal-to-noise ratio at which the loop would operate. The loop can track over a range of approximately ± 100 hertz, assuring demodulation of signals that may be subject to frequency translation during transmission. The threshold signal-to-noise ratio is the point at which the loop begins to rapidly skip cycles.⁴ A skip rate of 1 hertz was selected as the threshold. This occurs at -6 db signal-to-noise ratio at the input of the data modem. This is in agreement with the expected performance, taking into account signal suppression in the multiplier and the noise bandwidth of the loop.⁵

The tracking range of the bit timing loop is ± 10 hz meaning that the modem can demodulate doppler-shifted signals. The tracking range can be increased if necessary by changing the values of the loop components. Loop threshold occurs at 0 db

signal-to-noise ratio at the modem input; the bit-timing loop does not limit modem performance.

The measured error rate is in close agreement with the theoretical prediction.^{6,7} It is thus possible to design a modem using digital techniques and integrated circuits without degrading performance beyond normal implementation losses.

Initial synchronization time of the modem—the time between the application of a signal to the receiver and correct demodulation of data—averages less than 30 milliseconds. Worst-case synchronization time is about 70 to 100 msec. Short synchronization times are vital in tactical data systems where many short messages are sent between many terminals in a limited time.

References

1. I.S. Reed and L-H Zetterburg, "Communication with Orthogonal Polyphase Signals Over a Noisy Channel with Doppler Frequency Shift," University of Southern California, USCEE Report III, June, 1964.
2. S.S.L. Chang and B. Harris, "An Optimal Self-Synchronized Communication System" Communications and Electronics (AIEE) Paper 62-47, May, 1962.
3. R.C. Bunce, "Phase-Locked Loop Theory and Practice," Jet Propulsion Laboratory, Reorder No. 63-211, July, 1964.
4. A.J. Viterbi, "Phase-Locked Loop Dynamics in the Presence of Noise by Fokker-Planck Techniques," Jet Propulsion Laboratory Report No. 32-427, March, 1964.
5. R.J. Richardson, "The Signal Suppression Threshold of a Frequency Doubler," IEEE Transactions on Communication Technology, Dec., 1964.
6. D.G. Tucker, "Synchronous Demodulation of Phase-Reversing Binary Signals and the Effect of Limiting Action," IRE Transactions on Communications Systems, March, 1961.
7. M.C. Poppe, Jr., "C.P.S.K. Data Modem Research, Final Report," Electronic Communications, Inc., Report No. 634-65-002, May, 1965.

**nor
does one
"overlay"
transistor**

**One
silicon
power
transistor
does not
a leader
make**

**nor
does one
SCR**

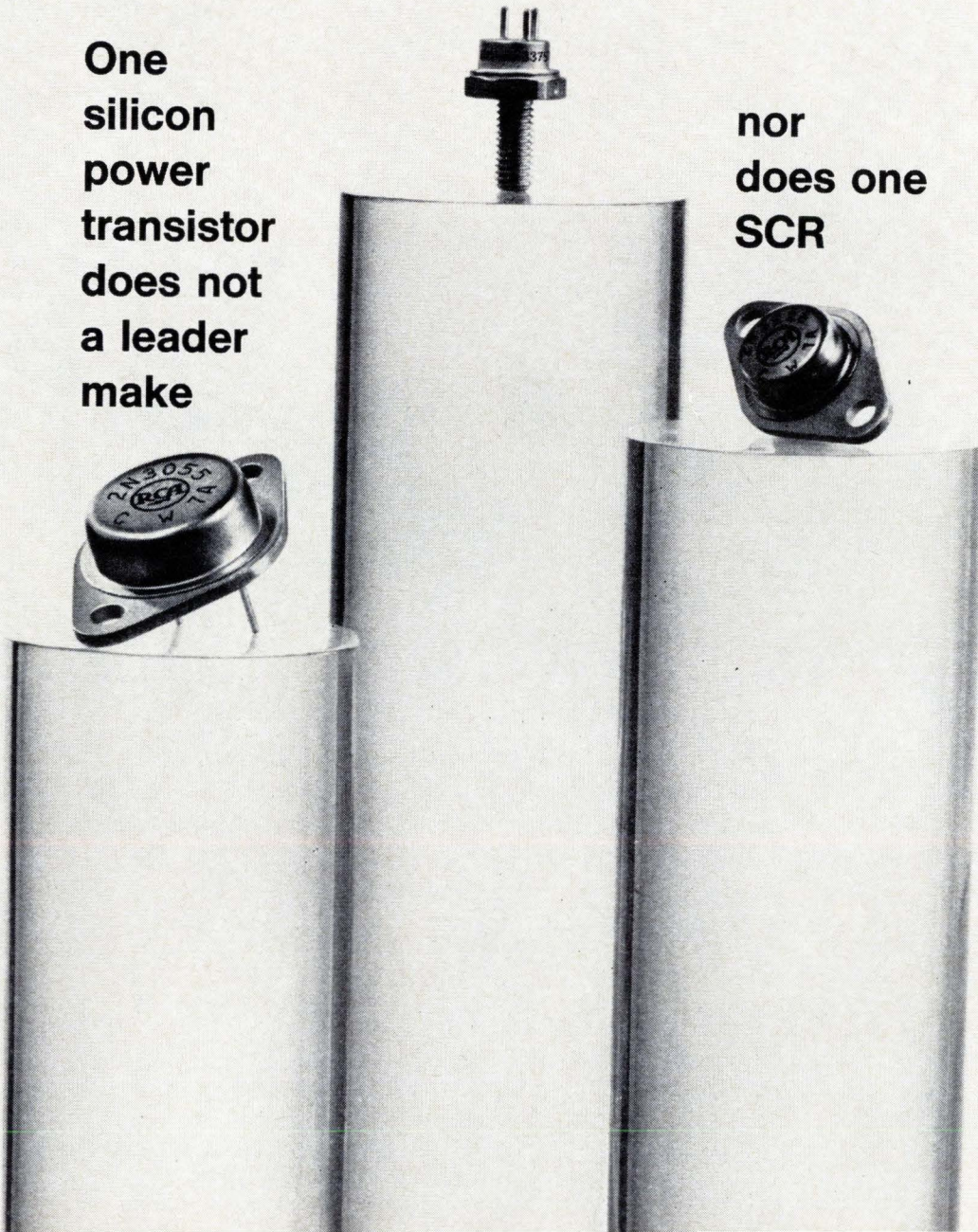

But 99 power transistors, 36 RF "overlay" devices, and 66 SCRs and Triacs do make

More than 200 *different* power devices! Each is a reason why you should look to RCA as the industry's number one source of silicon power, rf power, and SCRs and Triacs. And each offers a specific solution to your circuit needs—for total power circuit coverage through *RCA SILICON POWER*, a technology developed to serve you on all levels.

99 Silicon Power Transistors—Here's where capability counts. Of the many

major approaches to silicon power technology, only RCA uses all of them... from Hometaxial-Base to multiple epitaxial to diffused planar. This comprehensive know-how equips RCA better than anyone else to supply the best power transistor for a given application. And the designer benefits further from RCA's commanding position in the understanding of second breakdown. Whether for high-current, high-

voltage, high-speed, or audio applications, *RCA SILICON POWER* devices lead the way with an outstanding combination of ratings ranging up to 50A, 150W, and 500V.

36 RF "overlay" Transistors—*RCA SILICON POWER* originated "overlay," the multiple-emitter technology that is revolutionizing rf-power circuit design. With RCA's announcement of the 2N3375 (3W @ 400 MHz) in 1964,

Also Available Through Your RCA Distributor

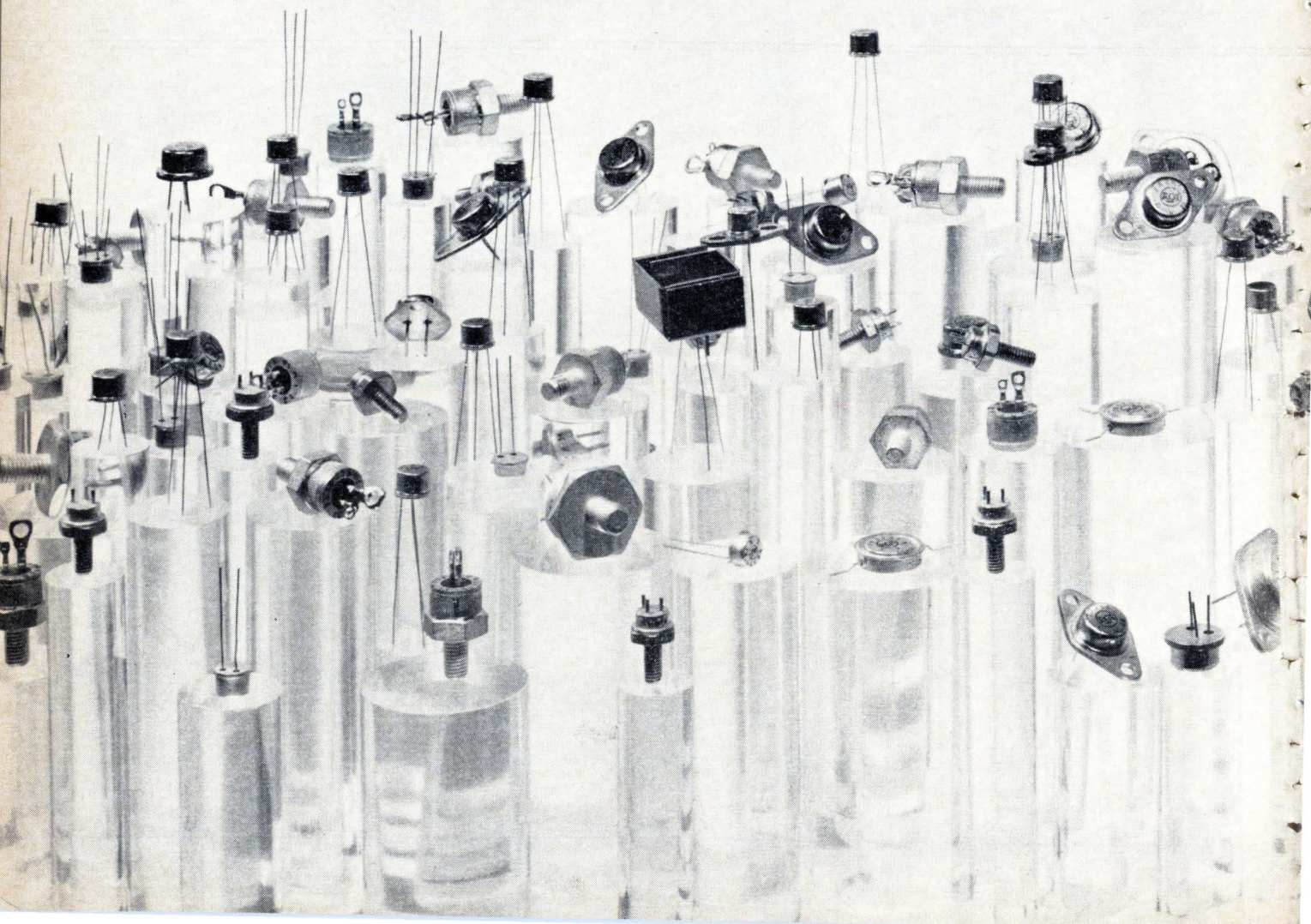

a leader of RCA SILICON POWER

the reliability and performance of solid-state rf has become a reality for the entire communications spectrum. Today, *RCA SILICON POWER* continues to pioneer with "overlay" devices, such as the TA2675 (15W @ 400 MHz), which deliver increased power, gain, and efficiency for diverse applications ranging from mobile radio to CATV to military and microwave communications including space telemetry.

66 SCRs and Triacs—*RCA SILICON POWER* introduced the 2N3228, the first SCR priced under a dollar. And today, RCA is making similar advances with low-cost Triacs, opening up new markets in the booming appliance field. From precision control of sophisticated radar to the convenience of variable-speed control for hand-held appliances, *RCA SILICON POWER* offers a broad line of SCRs and Triacs for half- or full-

wave applications with current and voltage needs up to 35A and 600V.

Look into the ways that *RCA SILICON POWER*—and its level of leadership—can help you meet your total circuit needs. Ask your local RCA Representative to help you select the type best suited to your application. For technical data on specific types, write: RCA Commercial Engineering, Section 1N10-5, Harrison, New Jersey 07029.

RCA Electronic Components and Devices



The Most Trusted Name in Electronics

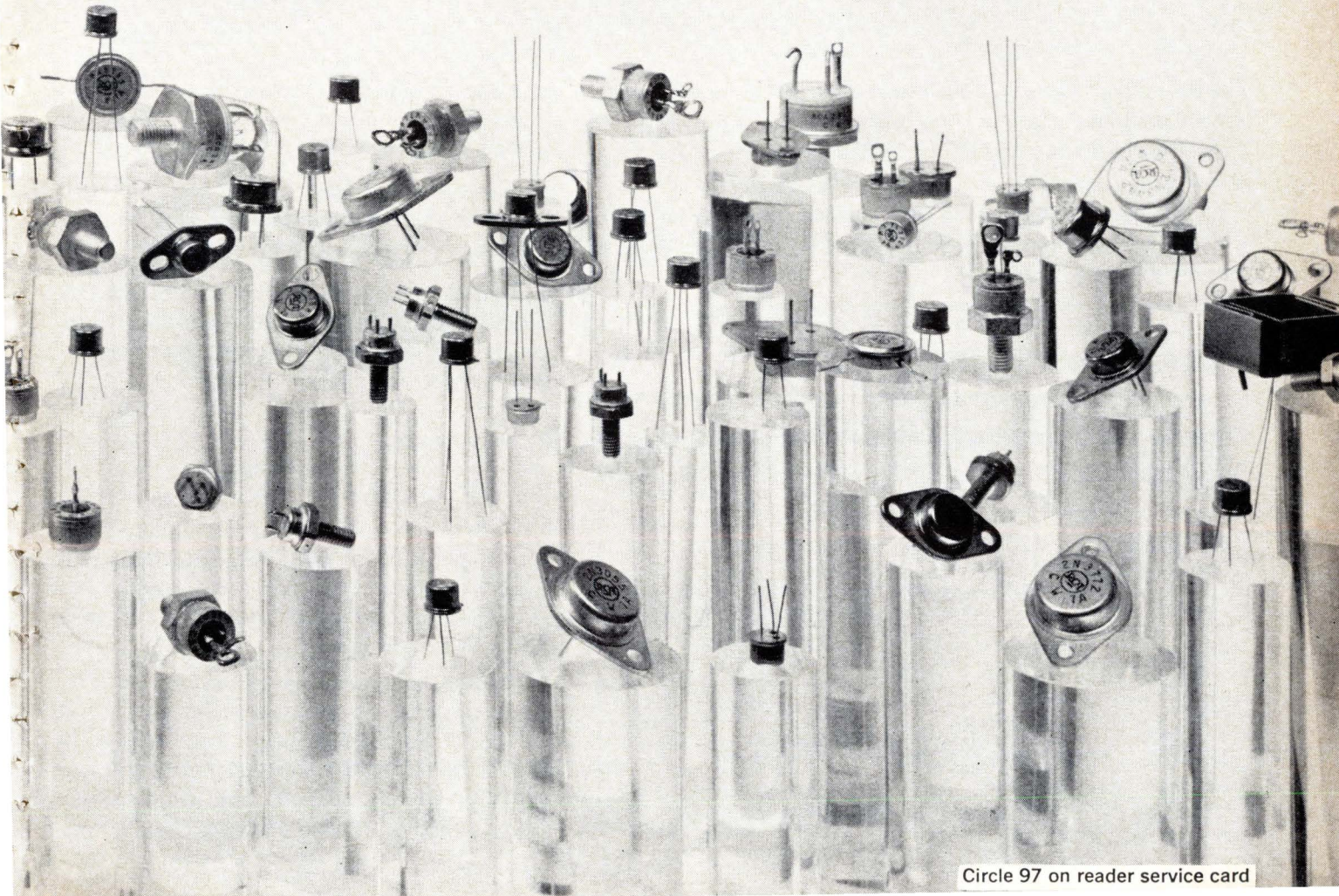

Circle 97 on reader service card

Now **2** oscilloscopes offer unique advantages of Tektronix split-screen bistable storage

1 **NEW TYPE 549 DC-TO-30 MHz with sweep delay and > 5 cm/μs writing speed; accepts letter and 1-series plug-ins**

2 **EXISTING TYPE 564 DC-TO-15 MHz accepts 2 and 3 series vertical and time-base plug-ins**

The exclusive Tektronix split-screen, bistable storage feature is now available in two oscilloscopes, the new DC-to-30 MHz Type 549 and the familiar DC-to-15 MHz Type 564.

Both offer the unique capability for simultaneous storage and conventional oscilloscope operation, plus general purpose convenience and plug-in versatility. These features add up to the kind of value you can expect from Tektronix.

Tektronix Bistable Storage Offers
Contrast of a stored trace independent of viewing time
Brightness of a stored trace independent of viewing time
Brightness of a stored trace independent of writing speed

Storage Scope		Type 549	Type 564	Type 564 Mod 08
Brightness		2.5 ft. L	6 ft. L	2 ft. L
Writing Speed	Normal	0.5 cm/μs	25 cm/ms	100 cm/ms
	Enhanced	> 5 cm/μs	> 125 cm/ms	500 cm/ms
Contrast Ratio		> 4:1	2:1	2:1
Erasure		split screen full screen remote/Auto	split screen full screen	split screen full screen
Display Area		6 cm x 10 cm	8 cm x 10 cm	8 cm x 10 cm

■ **3 display modes**—(1) split-screen combination of storage/conventional displays, (2) full-screen storage, or (3) full-screen conventional displays.

■ **saves film**—extended viewing times of stored displays permit detailed waveform analysis in many instances without photography.

■ **simplifies trace photography** — once initial camera setting has been determined, no further camera adjustments are necessary, regardless of conditions under which future stored traces are obtained.

■ **beam locate**—locate pushbutton offsets beam into a non-store area on left edge of display, permitting precise vertical positioning of beam before signal is stored.

■ **adapts easily to various applications**—accepts major plug-in lines for such applications as multi-trace, low-level differential, sampling, spectrum analysis, others.

■ **Type 549 automatic erase**—can be selected for periodic or after sweep operation with selectable viewing times from 0.5 second to 5 seconds. In addition, Erase-and-Reset pushbutton—which permits erasing display and rearming single sweep—can be controlled remotely, if desired.



TYPE 564

Storage time — Bistable Storage provides a stored display for up to one hour.

Erase time — 250 ms full cycle at normal operating level.

Type 564 Storage Oscilloscope \$875
 Size is 13½" high by 9¾" wide by 21½" deep; net weight is 33 pounds.
 Uses 2-series and 3-series plug-ins.

Rack Mount Model RM564 \$960
(same performance specifications, yet occupies only 7" standard rack height)
 (Bandwidth DC-to-15 MHz with Type 3A5 Plug-in)

Plug-ins illustrated

Type 3B3 Time-Base Unit \$585
(normal and delayed sweeps — 0.5 μs/cm to 1 s/cm, calibrated sweep delay — 0.5 μs to 10 sec, single sweep, 5X Magnifier, full passband triggering, flexible, easy-to-use — simplified trigger logic)

Type 3A6 Dual-Trace Unit \$540
(Dual-Trace—10mV/cm at DC-to-10 MHz, 5 display modes)

U.S. Sales Prices, f.o.b. Beaverton, Oregon

TYPE 549

Storage time — Bistable Storage provides a stored display for up to one hour. When applications require maximum writing speed, viewing times of 20 minutes or less are recommended.

Erase time — 200 ms maximum, complete cycle.

Time base features — **Sweep Delay** — from 1 microsecond to 10 seconds. **Sweep Range** — 5 s/cm to 0.1 μs/cm (Time Base A) and 1 s/cm to 2 μs/cm (Time Base B). X5 Magnifier extends fastest sweeps to 20 ns/cm (Time Base A) and to 0.4 μs/cm (Time Base B). **Single Sweep** — manually, automatically, or remotely. **Full Passband Triggering** — with flexible, easy-to-use facilities, and **Simplified Trigger Logic** — with lever control of trigger functions.

Type 549 Storage Oscilloscope \$2,375
 Size is 17" high x 13" wide x 24" deep; net weight is ≈ 67 pounds.
 Uses letter and 1-series plug-ins.

Type 1A1 Dual-Trace Plug-In Unit (illustrated) \$600
(Dual Trace—50 mV/cm at DC-to-30 MHz, 5 mV/cm at DC-to-23 MHz*. Single Trace—500 μV/cm at 2 Hz-to-14 MHz, 5 Display Modes, front panel signal output)*

*When used in Type 549.

For information on how Tektronix can solve your measurement problem with a storage oscilloscope, call your Tektronix field engineer. **Tektronix, Inc.**

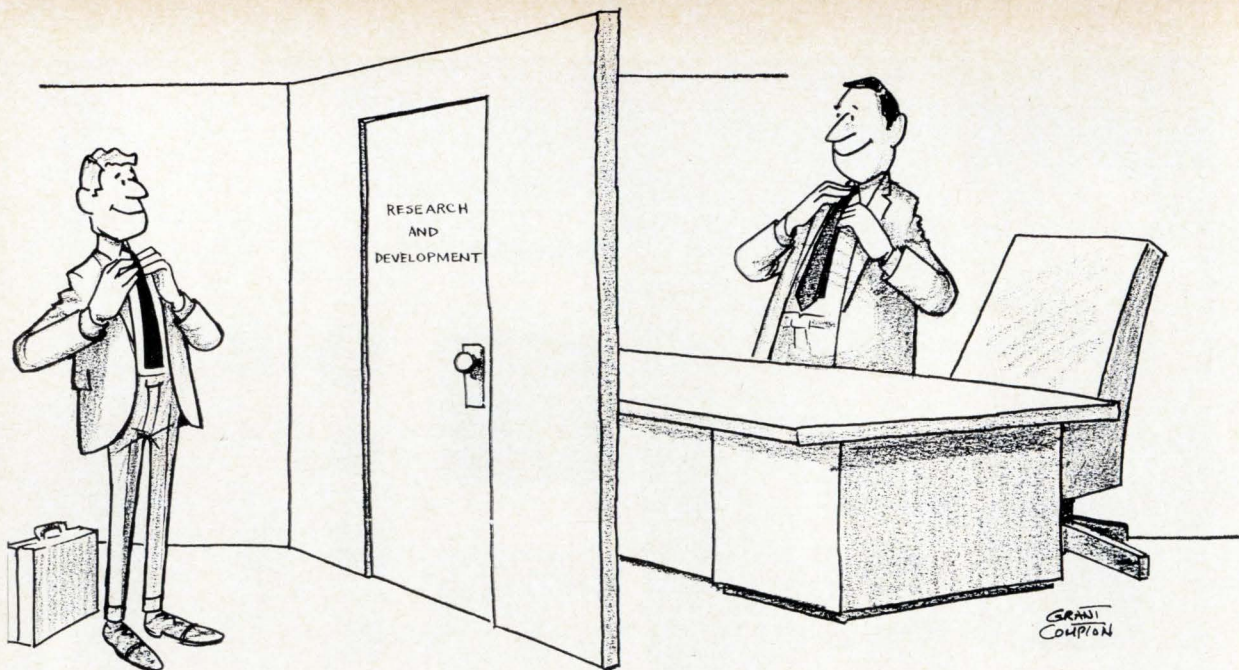

Opinion

The other side of the recruiting coin

A man who hires them tells electronics engineers how one company goes about the difficult task of finding the right man for the right job

By Alex E. Martens

Bausch & Lomb Inc., Rochester, N.Y.

Shoddy recruiting practices by some companies employing electronics engineers reflect upon the reputation of the entire industry but it is not fair to blame only the employers or agencies for all the problems encountered by job-seeking engineers. Most engineers are honest, ethical and reputable

(I am writing this with a great deal of enthusiasm and conviction, being a member of the profession) but there are some who will misrepresent their education, experience or achievements in order to land a good job. A few get away with it. Others are sooner or later exposed, after having wasted a lot of the employer's time, effort and money.

To understand Bausch & Lomb's attitudes toward the employment of electronics engineers some background on the company might be helpful. Bausch & Lomb was founded in Rochester, N.Y. at the time of the Civil War to manufacture eyeglasses. For many years Bausch & Lomb remained primarily an optical company. It continued to make spectacles and went on to produce binoculars, photographic lenses, microscopes and other optical instruments. In the 1950's, the firm embarked upon an ambitious expansion program, entering several new fields of scientific instrumentation, including

The author



Alex E. Martens joined Bausch & Lomb in 1960 and became head of the company's research and development division in 1963. He received his master's degree in electrical engineering from the University of Rochester in 1964.

electronics. A research and development division was established; it now numbers more than 250 people. An electronics department, within this organization, grew in 10 years from one lonely and harassed engineer to some 30 people, no longer lonely.

Responsible for the progress of new products from research and development into manufacturing are electronics engineers in product engineering, manufacturing engineering, and quality assurance. Because of my association with R&D, these remarks are specifically applicable to the employment policies for engineers in that division; the requirements for engineers in other divisions differ; though most of the general practices are followed.

The eyeglasses and related ophthalmic products still account for almost half of Bausch & Lomb's business. Making up the remainder are very diversified and often sophisticated instruments for analytical chemistry, biology and medicine, photogrammetry, metrology, the electronics industry, metallurgy, optics, astronomy, defense and many other fields. Most of these products are developed on company funds, but we also have contracts from the Government and private concerns for research and development of systems, usually requiring combined capabilities in electronics, optics and mechanics.

Many of these products involve electronic systems, and it is our responsibility in electronics R&D to develop them, working in close cooperation with scientists and engineers from other branches of technology. The work involves utilization of modern techniques and components in the design of analog, digital and servo systems, specialized computers, recording and numerical control equipment.

This wide range of projects calls for engineers with a strong theoretical background who desire to learn and adapt. While there is some degree of specialization, most of our engineers at one time or another will assume project responsibility that demands not only a thorough understanding of many aspects of electronics, but also the ability to communicate with people from other scientific disciplines.

All of this leads to the statement that, contrary to the general trend, we like to hire people with broad experience or broad college training, rather than specialists. The willingness to learn, and contribute, combined with sound schooling and possibly, some indication of potential inventiveness or creative ability, are the most important criteria by which we select engineers for employment. Since only a limited number of vacancies are available at any given time we have to be selective and we try our best to get the right people. Those readers who themselves hire engineers will appreciate the amount of effort necessary. It is as difficult to match a job to a man, as a man to a job.

When a vacancy exists, a form is filled out by the department head and sent to the personnel office. On it is specified the education, experience, special

skills, nature of work at Bausch & Lomb, salary range and desired availability date for the engineer to be hired. The requirement is then made known to several employment agencies. At the same time in-house files are checked for records of suitable people who have previously applied for a job and advertisements are placed in magazines and newspapers.

After a few days a trickle, then a stream of resumes begins to flow from the employment office to the department head. The resumes are screened by the employment specialists to see that they correspond with the request for help.

I prefer to receive resumes directly from the applicant, rather than from an agency. By writing to us directly the applicant shows he is not interested in just any job, but in a job with Bausch & Lomb. Moreover, by the time a resume is filtered through an employment agency, especially one catering primarily to the aerospace industry, it is frequently condensed beyond recognition, omitting much of the information that would help us make a preliminary evaluation.

A resume should be written with some regard for grammar and sentence structure. It should demonstrate that the applicant has some communication skills and cares about the impression he will make on the potential employer.

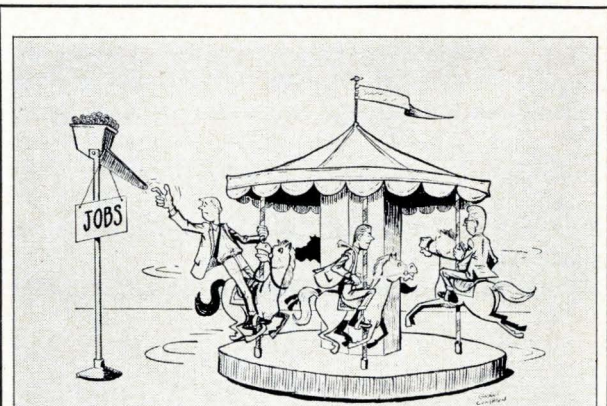

Opinion

The recruiting merry-go-round

A disillusioned engineer recounts his job-seeking experiences with the hope that others may identify and avoid misleading advertisements and deceptive claims by employers

By Anonymous

Making a satisfactory job change is not easy. Important decisions are involved and, if they are to be made intelligently, should be based on considerable study. Unfortunately, there is evidence to support the view that for the electronics engi-

The author, for reasons that are self-evident, the author of this article has asked that his identity be withheld. He is a senior engineer with 12 years experience, the author of numerous articles, holds two patents and has a master's degree.

neer, in many cases, some of the decisions in the job-changing process may be based on misrepresentation and/or misunderstanding. Despite the importance of the subject, there is practically no published material to aid the engineer who is thinking about taking a new job. I am by no means about to suggest a how-to-do-it step by step approach to making a job change. My aim is to discuss those misrepresentations which I have encountered (names of concerns withheld) in the hope that others may identify and avoid similar situations. The long-range hope is that engineers

In a sense, Alex Martens' article is a rebuttal to "The recruiting merry-go-round" published in *Electronics*, which blamed employers and agencies for the difficulties electronics engineers frequently encounter when they search for jobs.

A specific salary request should be included, rather than the frequently used "salary requirement: open." Before further consideration can be given to an applicant, we must see if we can afford him. The statement of the desired salary also indicates to us that a man has given some thought to his own value.

Job objectives should be spelled out. Frequently, an engineer seeks a change because he is dissatisfied with the kind of work he is doing. In that case, a recital of his experience is not very useful if he wants to change to another area of electronics technology. And we want to know what the applicant wants to do in order to decide whether his goals match the job content.

The least useful kind of resume, usually mimeographed and mailed out in liberal quantities by an employment agency, would make the condensing experts at the Readers Digest envious. It reads like this:

Candidate #5555—For information contact
Joe Doe at Shrdlu Agency
Salary requirement: Open
28—Married—secret—BSEE—1962
Experience: Major aerospace company since
1962. Systems Design.

Such resumes are not worth bothering with unless hundreds of engineers are to be hired, irrespective of their qualifications, in anticipation of a large contract, and this is not our practice.

Good agencies will take great pains to prepare a useful resume from information supplied by the engineer. They make sure that the papers go only to companies that have a current or anticipated job opening. A few employment agencies send along the summary of a personal interview with the applicant as well as their impression of his character and potential. Such information is extremely helpful.

When the department head at Bausch & Lomb

receives the resume it is accompanied by a printed form on which he indicates his interest, lack of it, or other disposition. For instance, the candidate may not be suitable for the job opening in one department but another opening better suited to the applicant may exist somewhere else in the company. In such a case, the papers are routed to the interested department head.

About one of every five resumes warrants further action. Frequently, more information is needed and the applicant is called, or a "personal history form" is sent out with a request for speedy completion and return. Job objective and desired salary are the two most often asked questions.

Based on the data supplied to him and somewhat on his intuition the department head may request that the applicant be invited for a visit to the plant. Scheduling such a visit is not easy, considering that both the interviewer and the candidate have many other commitments. The company reimburses the visitor for all his expenses, but a detailed breakdown is needed to satisfy the Internal Revenue Service. Hotel arrangements are made in advance.

The prudent candidate will bring along any material that would enable the interviewer to better appreciate the applicant's qualifications, such as publications, patents, records of technical accomplishments. It would be considered unethical of the applicant to show any proprietary material or to disclose confidential information belonging to his current or past employer, unless such information was previously made public. Any transaction between Bausch & Lomb and the job-seeking engineer is kept in strict confidence until the candidate gives us permission to contact his present or past employers for references.

Most of the candidates arrive the night before the interview to get a good night's sleep. The engineer is advised to report at the employment office, where he is met by an employment specialist, usu-

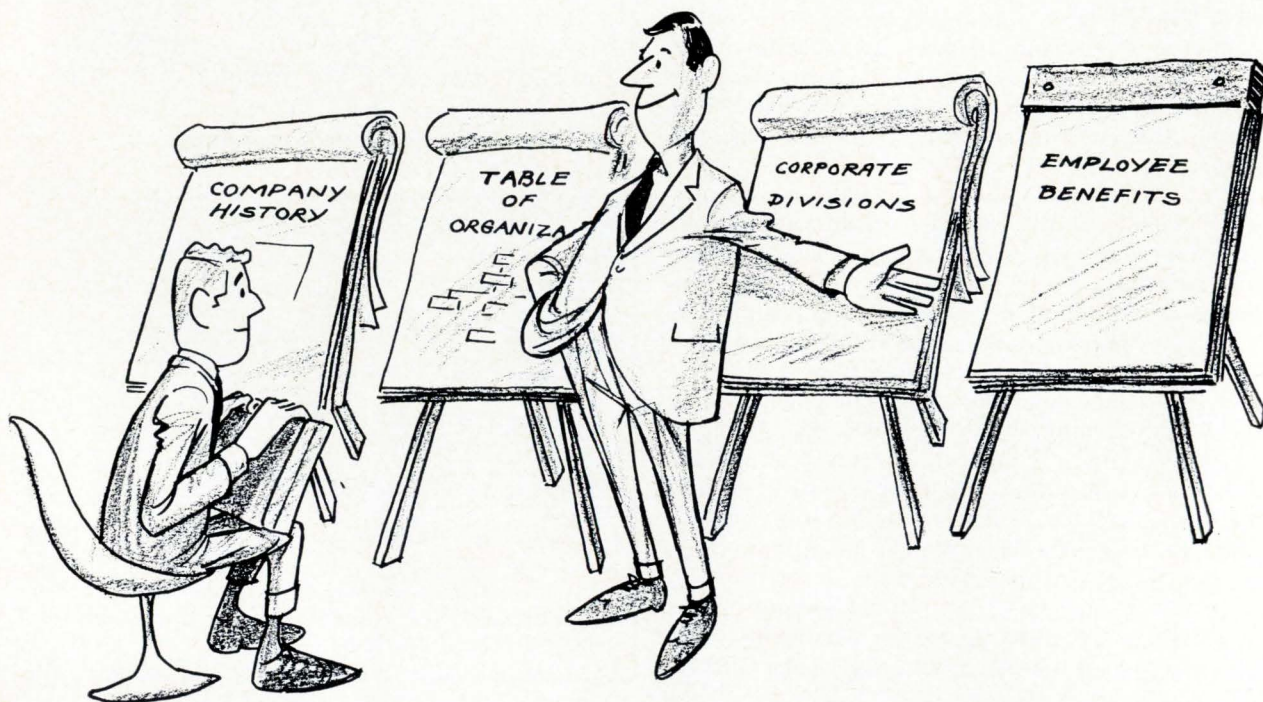

ally the man who arranged for the interview. On occasion I request permission from the employment office to call the applicant directly to either obtain or provide additional technical information or to make special arrangements, such as a visit on a weekend or a meeting during an out-of-town trip. Such direct contact may help to quickly establish the degree of mutual interest.

The employment specialist spends some time with the candidate, taking care of his expenses and transportation schedules. In the meantime I am informed of the man's arrival, which event causes me to stuff the rubbish from my desk into one of the drawers, clean the ashtray, put on my coat and what is supposed to be a friendly facial expression. While our secretary escorts the candidate into my office, I sit there wondering: "Is he going to be the right man for this job?"

The first impression is important. Did the man consider this interview to be important enough to look his best?

The interview is usually divided into two phases; the duration of each phase is dictated by the available time and the candidate's background. In the first phase I tell the candidate about Bausch & Lomb's history, organization and products, using charts we have for that purpose. Next, I explain the structure of the research and development division and describe the activities of various laboratories and departments. I specifically emphasize the cooperation and interaction among the departments. A substantial amount of time is spent in reviewing the purpose, organization and activities of the electronics department, as well as privileges and duties of its members.

Using as an example a typical completed project, the progress of a product through various stages of development is then explained, pointing out the role of the electronics engineer in each of the stages. The opportunity for continued (company sponsored) education and advancement, performance and salary review policies are discussed. During this and subsequent parts of the interview the candidate's opinions and comments are welcomed and questions are answered.

A tour of the departments and other facilities (library, computer room) follows. The applicant is introduced to our employees, and projects of a nonconfidential nature are shown and discussed. The tour has several purposes: to meet our people, to show our facilities and equipment, and to discuss projects of interest to the candidate. We find that the candidate's remarks concerning the work he is shown are helpful in evaluating his technical competence. Sometimes one can sense enthusiasm in an engineer, when he is confronted with a particularly interesting solution to a challenging technical problem.

At this time the applicant is usually introduced to the head of the section where the opening exists, to give the latter an opportunity to talk with his prospective employee about the work in which the particular section is engaged.

At lunch in the company's cafeteria the conversation continues between the candidate, the section head, the department head and other engineers. If the opportunity presents itself, the candidate is also introduced to the director (in my case, the director of the biophysics and electronics laboratory) who may want to spend some time talking to the engineer. So far, our own qualifications, job content and other topics of interest to the applicant have been discussed.

The second phase of the interview is occupied by a review of the applicant's qualifications. Any questions concerning the resume are cleared up and the candidate's current work and past experience are discussed in general terms. Of particular interest is his ability to resolve technical problems and to get things done. If the man has industrial experience I usually suggest that he select a past project of his choice to describe the problems and the solutions. A new graduate can pick a term project or his thesis.

A number of years ago we started to give every engineer applying for a job a technical quiz, including questions on network analysis, circuit design and electromagnetic theory. The questions are at about the sophomore or junior engineering college level and are selected to represent actual problems routinely encountered by people working here. No calculations are involved and no references should be necessary, since only fundamental relations are involved, like Kirchhoff's and Thevenin's theorems—which any engineer coming to work for an R&D organization should know thoroughly. About half of the applicants are able to do more than seven out of 14 questions, which is considered adequate. The test is reviewed with the applicant to find out the reasoning behind the solutions.

In addition to the technical quiz we ask new graduates without previous industrial experience to take two or three tests on ability to reason and adapt, as well as mechanical comprehension.

It can be seen that the first phase of the interview gives the applicant as much information as possible about the job. The second gives us some insight into the candidate's education, experience, motivation and job objectives. On the basis of this information we can make a reasonable judgment of the candidate's suitability for our group. Hopefully, by this time the candidate will have enough data to be able to decide whether he cares to join us.

Finally, if the candidate seems promising, the question of salary is discussed. It is our policy to hire engineers at salary levels comparable to those earned by our own people with similar education and length of experience. The final salary figure offered is decided by an administrative department but it's based on our recommendation and those of the employment department.

The offer is sometimes made while the applicant is still in the plant, especially if he shows an outstanding potential. Or it is made a few days after

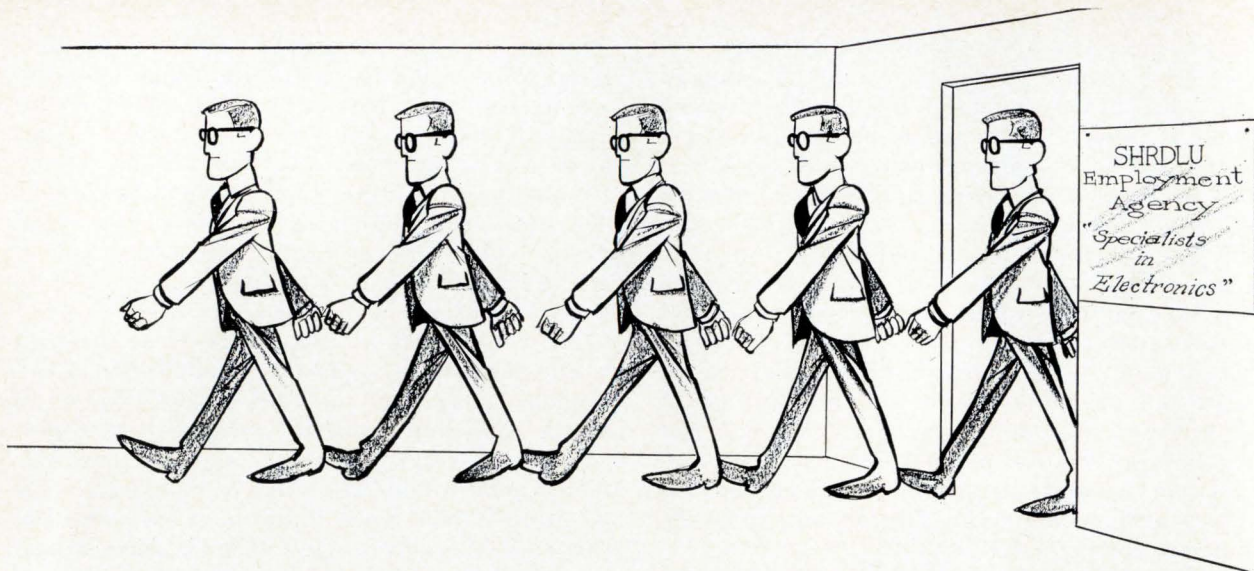

the visit, once we've compared his qualifications with those of other applicants for the same position. If there's no offer, the candidate is informed by a letter that gives our reasons. Or, if it becomes obvious during the interview that the engineer lacks the necessary qualifications, he is told so immediately. I expect the applicant to be as frank with me. This saves his time and mine. The interview with a promising candidate generally takes all day.

Why go to all this trouble? Simple arithmetic. To illustrate, let's consider an actual case. Three years ago we hired John Smith (not his real name). He had a degree in engineering, a few years experience, impressive resume, and good references. He was also a very good talker. At that time we were naive enough to judge a man's potential on the basis of his formal education, his resume (prepared by an agency), and an account of past achievements, without seriously attempting to explore the engineer's technical ability or motivation.

John received and accepted an offer of \$10,000 a year. We paid the agency's 10% fee or \$1,000. We also paid his \$800 moving expenses. On his first day, John was sent to the medical department for a checkup. His papers were processed by the personnel department, R&D administration and myself. That probably cost the firm another \$100 including overhead. And it was just the beginning.

John joined one of our sections and was assigned a project involving digital logic that seemed to fit his past experience. Some two to three months were spent by his colleagues and superiors in the department familiarizing him with our methods, facilities, standard circuits, technical reports, sources of supply, lines of communication, and thousands of other trivial matters that one has to learn to function efficiently in a new environment.

John seemed to enjoy his new work. About four weeks after he had joined us his section head inquired about his progress. John had not reached a definite decision as to the circuit configuration.

He did, however, have the problem "well in hand." Another four weeks passed—still no block diagram, the problem was still "under advisement." When finally given a deadline (the problem was later solved in a few days by one his colleagues) he produced, after a furiously busy week, some circuits that defied all laws of electricity, including Ohm's.

His patient and despairing section head explained the mistakes and asked John if he would care to try his hand at something less complicated. The result was exactly the same. Finally, when I asked him to tell me in more detail about his prior circuit design experience, he admitted that it was, as he put it, "marginal." After consulting with his section head and my boss I asked John to resign. He walked out without saying good-by.

While it is hard to put a dollar value on the time and efforts wasted, and on project delay, a figure of \$5,000 is probably very conservative. So let's add it up:

John's salary for 3 months:	\$2,500
Overhead (fringe benefit's, 100%), etc.	2,500
Agency's fee:	1,000
Moving expenses	800
Processing costs	100
Intangible losses	5,000
Total	\$11,900

This in itself is a sizable investment and we protect it as best as we know how. What can't be measured in dollars is the bad effect on the morale of John's colleagues and probably on his own.

John has had several jobs in the area since, and he is looking for work now. How do I know? A few weeks ago, we again received his resume. It was much improved.

In articles of opinion, authors are given complete freedom for the expression of their views. The editors welcome comments on this author's thesis and will publish those letters which are most interesting.

the
Huey
gave
us
a
fair
shake

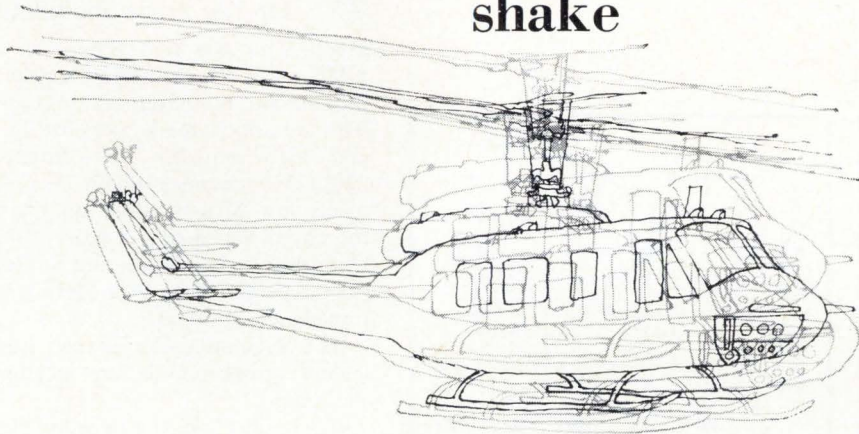

and
we
gave
it
a
steady
picture—
even
at
night

The Army tested and bought. In fact, two image orthicon cameras are now in operation for nighttime surveillance in Vietnam.

The night operation test didn't bother us since we're the largest manufacturer of low-light level TV cameras. And we know our image orthicon cameras produce high resolution pictures in near total darkness (at 1×10^{-5} foot candles). But we weren't too sure about the vibratory factor. Lab tests simply aren't like the real thing. There was no need for concern. The MTI image ortho came through with flying colors—and we mean flying. (Now we know why they call helicopters egg-beaters.)



MTI manufactures over 65 different products and a complete line of television cameras. And incidentally, our vidicon cameras will take the same kind of rough treatment. We're so particular we even make our own monitors. It's the only way we know to guarantee the best products on the market.

If you want to know anything about the closed circuit television equipment—try the specialists first.

mti

MARYLAND TELECOMMUNICATIONS, INC.

York & Video Roads, Cockeysville, Md.
301-666-2727

World's largest manufacturer of
low light level television cameras.



Five unique applications of FETs from

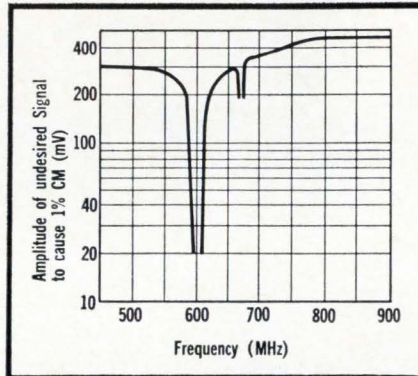
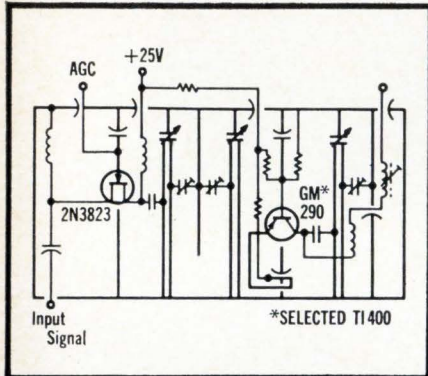

1. UHF tuner employs a TI 2N3823 N-channel silicon FET for improved cross-modulation performance

1. UHF tuner employs FET for low cross modulation

Here — for the first time — is a practical UHF tuner which offers considerable cross-modulation improvement in the RF stage. This circuit is made possible by the superior high-frequency performance of TI's 2N3823 N-channel silicon FET. In addition to its low cross-modulation characteristics, the circuit has a power gain of 12 to 15 dB from 400 to 900 MHz and a VSWR of less than 2 from 500 to 900 MHz with an input impedance of 50 Ω .

The accompanying graph shows the excellent cross-modulation performance of the tuner.

Circle 291 on the Reader Service card for application note on this tuner.

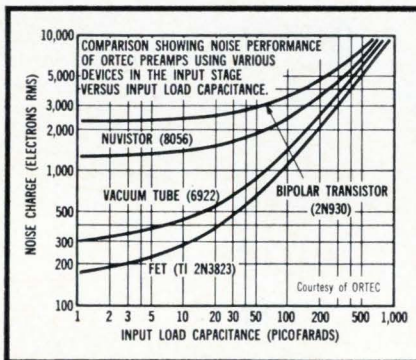
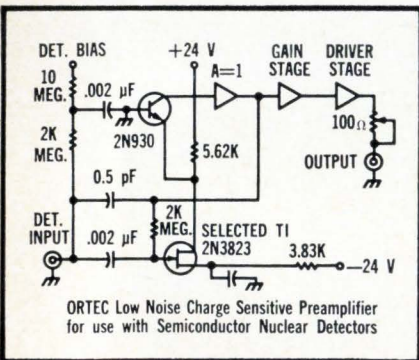

2. ORTEC charge-sensitive preamplifier uses FET for accurate measurement of low-energy radiation

2. Charge-sensitive preamplifier uses TI FET for lowest noise, highest resolution

This preamplifier, developed by Oak Ridge Technical Enterprises Corporation for nuclear detectors, limits noise to only 170 electrons rms when used with low-capacitance detectors. The extremely low noise level of field-effect transistors from TI permits detection and accurate measurement of low energy X-rays and gamma rays (less than 20 keV).

ORTEC determined that specially-selected 2N3823s resulted in superior amplifier performance. The graph at the left illustrates improvement in noise level compared with vacuum tubes, nuvistors and bipolar transistors.

Circle 292 on the Reader Service card for data sheet on the 2N3823.

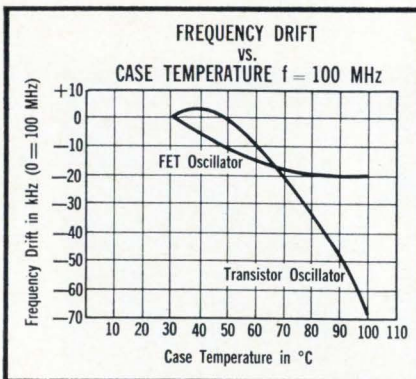
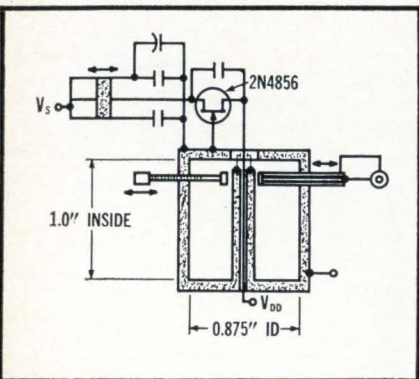

3. 500 MHz FET oscillator. Graph shows frequency stability over a temperature spread of 75°F

3. 500 MHz FET oscillator achieves frequency stability without temperature compensation

This oscillator demonstrates the excellent high-frequency characteristics of the 2N4856 N-channel silicon FET from Texas Instruments. Power output, at 500 MHz with a V_{DD} of 20 V, is greater than 140 mW.

Frequency stability is a major advantage of FET oscillators. The graph at left compares frequency drift with temperature change for a 100 MHz FET oscillator versus a bipolar transistor. FET oscillators result in simpler biasing and possible elimination of AFC circuitry.

Circle 293 on Reader Service card for Silicon Technology Seminary paper on FET oscillators.

TI cannot assume any responsibility for any circuits shown or represent that they are free from patent infringement

demonstrate versatility

Texas Instruments

4. FM tuner employing FETs has $2.0 \mu\text{V}$ sensitivity, spurious response rejection > 79 dB

This FM tuner uses both N-channel silicon and P-channel germanium FETs for high performance with simple circuitry and low component costs.

The RF stage employs a TIS34 N-channel silicon FET for better than $2.0 \mu\text{V}$ sensitivity with 30 dB quieting.

For maximum conversion gain, the RF stage is coupled to a TIXM12 P-channel germanium FET. The TIXM12, being an almost perfect "square law" device, gives better than 79 dB spurious response rejection. Image rejection of the tuner is 70 dB, 6-dB bandwidth is 525 KHz, and power gain neglecting loss of IF transformer secondary is 25 dB.

Circle 294 on Reader Service card for application information on this circuit.

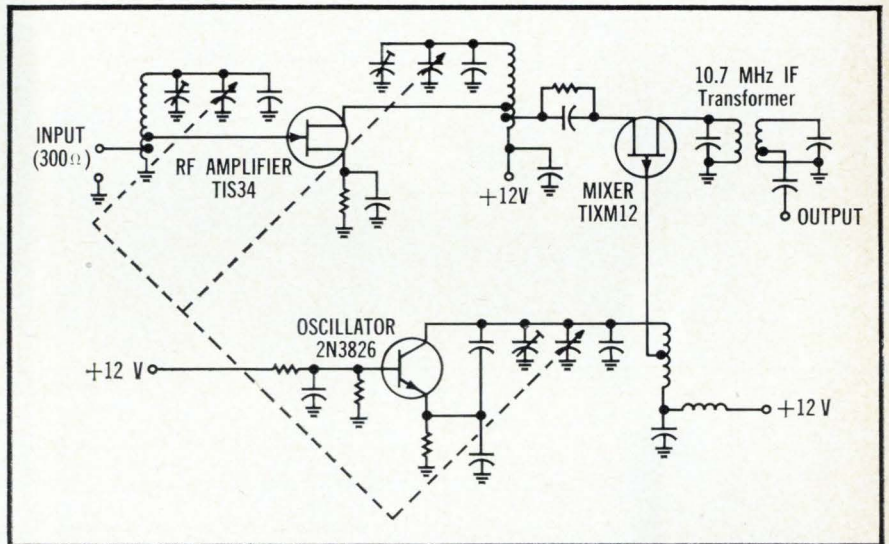

4. FM tuner employing complementary FET's features simple circuitry and low component cost

5. Wideband correlator uses complementary FETs for signal multiplication

This correlator, developed by the National Laboratory for Radio Astronomy, Bologna, Italy, employs SILECT™ FETs from TI to provide exceptional rejection of unwanted responses. A 35 dB rejection of uncorrelated components is achieved for random signals on a 10 percent band centered at 300 MHz. Previously tested correlators had rejections ranging from 15 to 30 dB.

Complementary 2N3819 and 2N3820 silicon FETs are used as direct multipliers operating in the near-zero region of the I_{DSS} vs. V_{DS} curve. Spurious responses are balanced out by the complementary characteristics of the FETs.

Circle 295 on the Reader Service card for data sheets on 2N3819 and 2N3820 plastic-encapsulated, economy FETs.

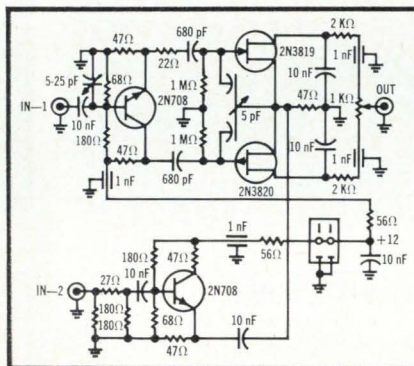

5. Wideband correlator uses complementary FETs for 35 dB rejection of unwanted responses

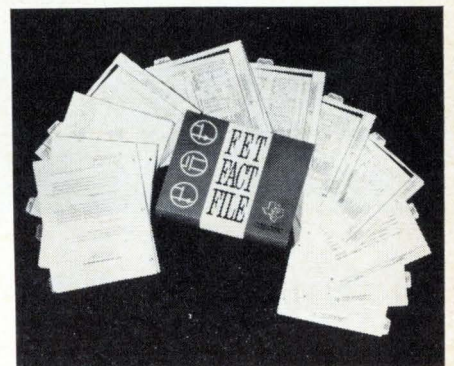

6. FET Fact File—industry's most comprehensive FET reference guide—contains 270 pages

6. FET Fact File by TI—the most complete collection of FET information available

Here, in one handy $8\frac{1}{2} \times 11$ " file folder, is 270 pages of the most up-to-date FET information. Included are data sheets, performance and reliability data, and application notes containing circuit diagrams, circuit theory, and design suggestions.

It is all yours for only five dollars. This low price includes periodic supplements which will keep your file current and continuously useful. Get your copy from any authorized TI distributor.

TEXAS INSTRUMENTS

INCORPORATED

For specific information on these circuits and devices write us at P.O. Box 5012, Dallas Texas 75222



One way to check for power loss

Visual inspection may sometimes reveal the source of a power loss. Most transmitters, however, require more sophisticated test equipment. Fortunately, the cost of wide-range power meters like Sierra's new Series 401A r-f termination wattmeters need not sound a sour note in your budget.

At prices you can appreciate (see below), Series 401A wattmeters make precise measurements of power on four selectable ranges up to 1,000 watts, with frequency coverage of 2 to 1000 Mc. Single-knob switching lets you read down to two watts on the 1,000-watt model. Sierra's "Twist-Off" connectors permit quick field changes of eight connector types. Permanent sealing eliminates coolant leakage.

You can bring on a full range of data concerning Sierra Series 401A r-f wattmeters with a note to Sierra/Philco, 3885 Bohannon Drive, Menlo Park, California 94025.

Sierra 401A R-F Termination Wattmeters

401A (120 w)	\$195.00	401A (500 w)	\$275.00
401A (250 w)	\$225.00	401A (1,000 w)	\$365.00

Circle 108 on reader service card

A better way from Sierra

SIERRA ELECTRONIC DIV.
OF
PHILCO
A SUBSIDIARY OF *Ford Motor Company*

Probing the News

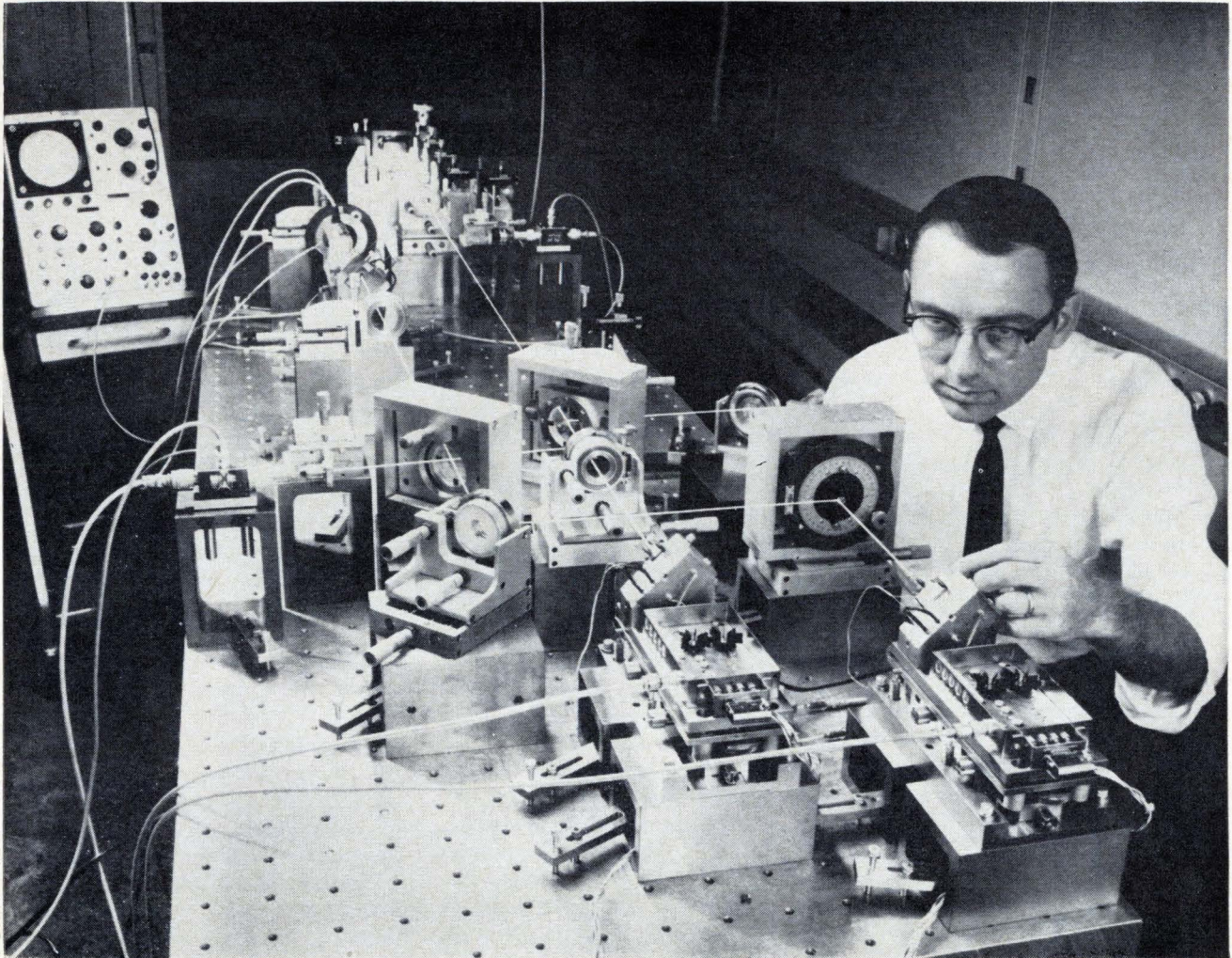

Two high-speed pulse code modulation channels are impressed on a single gas laser beam by new lithium tantalate modulators developed by group headed by R.T. Denton, shown here making fine adjustments on the multiplex system.

Communications

Laser modulator handles high-speed pulse-code systems

The big question Bell Telephone has yet to answer is whether it will ever need the tremendous channel capacity of lasers

By Samuel Weber

Senior editor

The wedding of two young technologies—lasers and pulse code modulation—was announced by Bell Telephone Laboratories last week, but the honeymoon is being delayed because the couple has no place to go.

The recent development of an optical modulator broadband enough to handle Bell's developmental T-4 pcm system, which operates at 281 megabits per second and is slated for production in the early 1970's, indicates that hardware for laser communication systems is catching up with more conventional equipment. But the knotty problem of how to transmit light beams without prohibitive losses is still to be solved. And the Bell management is uncertain whether the tremendous channel

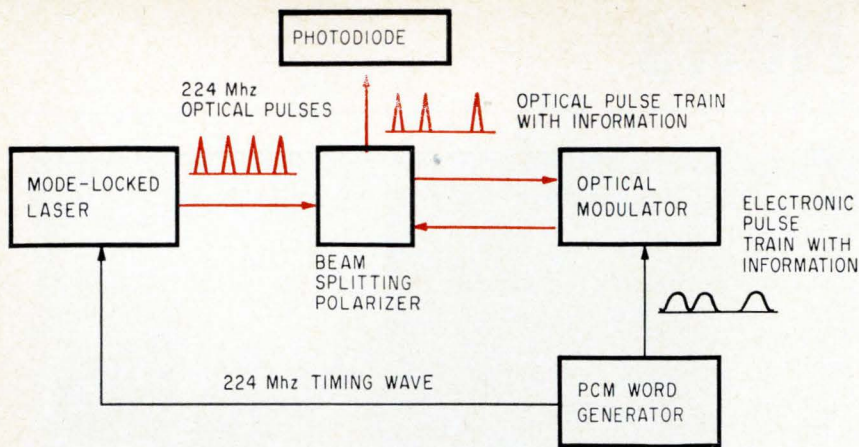

In basic optical pcm system, lithium tantalate crystal gates narrow-pulse output of gas laser.

capacity of lasers will ever be required.

For the same reason, the company is keeping on ice long-completed designs for a 70-gigahertz millimeter wave system whose capacity will be greater than will be required in the foreseeable future, according to some Bell engineers. But others, citing the growth of data transmission and the potential proliferation of Picturephone, Bell's experimental system for transmitting pictures along with conversation, think that ultimately a choice will have to be made between lasers and millimeter waves.

I. New light on pcm

The new optical modulator, described at the Electron Devices Meeting in Washington, D.C. last week, overcomes one of the big obstacles that has blocked the use of lasers in communications. The modulator is designed to operate at an information rate of 224 megabits per second, but can readily be modified to accommodate the slightly faster T-4. The lower clock rate was established for a high-speed experimental pcm system which was announced by Bell a year ago. That system had a capacity of 3,456 voice channels or alternatively, 900 voice channels and one broadcast-quality television channel. Up to four times that capacity can be handled by the modulator when it's coupled with a gas laser, and 24 such 224-megabit systems can be time-multi-

plexed on one beam from a solid state laser, an ultimate capacity of about 5 GHz. The concept of replacing 24 coaxial lines with one light beam is understandably intriguing to Bell's management.

Better material. The broadband optical modulator owes its success to the development of a new modulator material, lithium tantalate. According to Richard T. Denton, under whose direction the modulator was conceived and built, LiTaO_3 is the best electro-optical material now available.

It operates on the same principle as potassium dihydrogen phosphate (KDP) which is in common use now as a modulator material—that is, it relies on the Pockels effect, which rotates the polarization of any light beam passing through the material in accordance with the strength of an electric field applied transverse to the direction of

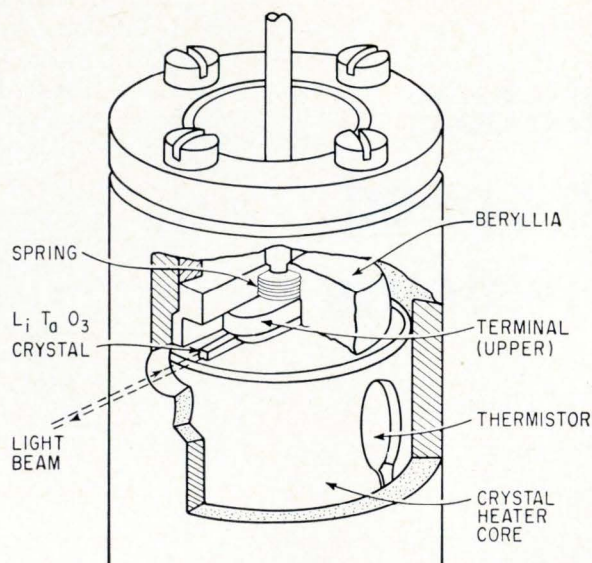

Cutaway view of modulator construction shows careful control of temperature to stabilize operation.

the beam. But lithium tantalate has an electro-optic coefficient about eight times lower than KDP, which means that for the same size crystal, lithium tantalate requires only one-twentieth the power to drive it. What's more, large single crystals of lithium tantalate can be conveniently grown from seed crystals by the Czochralski method.

Such crystals are strain-free, can be polished without danger of breaking, and resist moisture. KDP and other materials are easily strained, break easily and are prone to absorb moisture, which degrades their optical properties.

A single crystal of lithium tantalate in the form of a parallelepiped 0.025-centimeters square by 1-centimeter long is the basis of the new modulator system. The crystal has an antireflection coating on one end, and a dielectric reflecting coating on the other. The temperature is stabilized to within 0.04°C to eliminate any changes in electro-optic properties due to temperature variations. Modulating pulses are applied to the crystal through electrodes plated on opposite sides of the crystal.

With this geometry, 30 volts applied to the electrodes will rotate 90° the polarization of a light beam passing through the crystal.

Phase-locked laser. The principle governing the operation of the modulator is illustrated in the simplified diagram of a single-channel optical pcm system shown above. By a technique developed at Sylvania Electronic Systems, [Electronics, September 20, 1965, p. 101] the helium-neon laser operating at 6,328 angstroms is phase-locked at a frequency of 224 Mhz, so that the result is a continuous train of optical pulses 0.6 nanoseconds wide and 4.46 nanoseconds apart. According to Denton, the width of the pulses is a function of the laser medium, and not of the electronic circuitry; the pulses could be reduced in width an order of magnitude if a solid state laser were used. Denton points out that a recently developed neodymium-doped YAG (yttrium aluminum garnet) laser would be

ideal for this purpose. A 9-bit pcm word generator provides 10 milliwatts to a transistor pulse amplifier, which in turn drives the optical modulator crystal with about 700 milliwatts.

Optical pulses that arrive at the modulator simultaneously with the occurrence of a 1 from the word generator have their polarization rotated 90°, while those that arrive concurrently with a 0 are unaffected. The beam-splitting polarizer is designed so that 90° polarized pulses are directed toward the detector, a germanium avalanche photodiode, while the unaffected pulses emerge from another face of the polarizer.

In effect, the modulator acts as a gate for the laser pulses, allowing only those corresponding to 1's to pass through, and skipping the 0's by blocking them. At the modulator output, the power ratio between the pulse and no-pulse condition is 23 decibels, and the modulator introduces an insertion loss of 0.6 db, which includes all the associated optical components.

In the laboratory, Denton's group has set up a more elaborate sys-

tem in which two 224-megabit pcm channels are time multiplexed on a single laser beam and separated at the receiving end by an electro-optic polarization switch, also of lithium tantalate.

II. Multiplexed system

The pcm outputs of two word generators—in the system shown below—each drive separate optical modulators in the manner previously described. For illustration, the instantaneous output of word-generator 1 is shown as 1011 and that of generator 2 is 1101. The pulsing laser beam is fed through a lens and beam splitter where it is divided and each half passed through LiTaO₃ modulators. An arrangement of prisms, mirrors and beam splitters recombines the beam components at the output.

A 224-Mhz sinusoidal clock signal, derived from word generator 2 synchronizes the laser phase modulator, the polarization switch and the other word generator. The optical path length for channel 2 is adjusted so that pulses in this channel are delayed half a clock cycle. As a result, the bits from each

channel are effectively interlaced on alternate half cycles. The combined 11011011 output is observed at the detector in the center of the diagram.

The two channels are separated at the receiver end by the electro-optical polarization switch which is driven by the clock. The switch is designed so that any incident optical pulses that occur at the peaks of the clock voltage are rotated in phase 90°, and those that arrive coincident with the valleys are unaffected. The output prism separates the two channels by virtue of the difference in their polarizations and routes the beams to separate detectors.

Denton says his group has worked out schemes based on this general plan for time multiplexing three and six channels on the beam.

III. The transmission problem

Despite the availability of a broadband optical modulator, if lasers are ever to be used, some way must be found to transmit light point-to-point without excessive losses and by methods that are economically justifiable. Transmis-

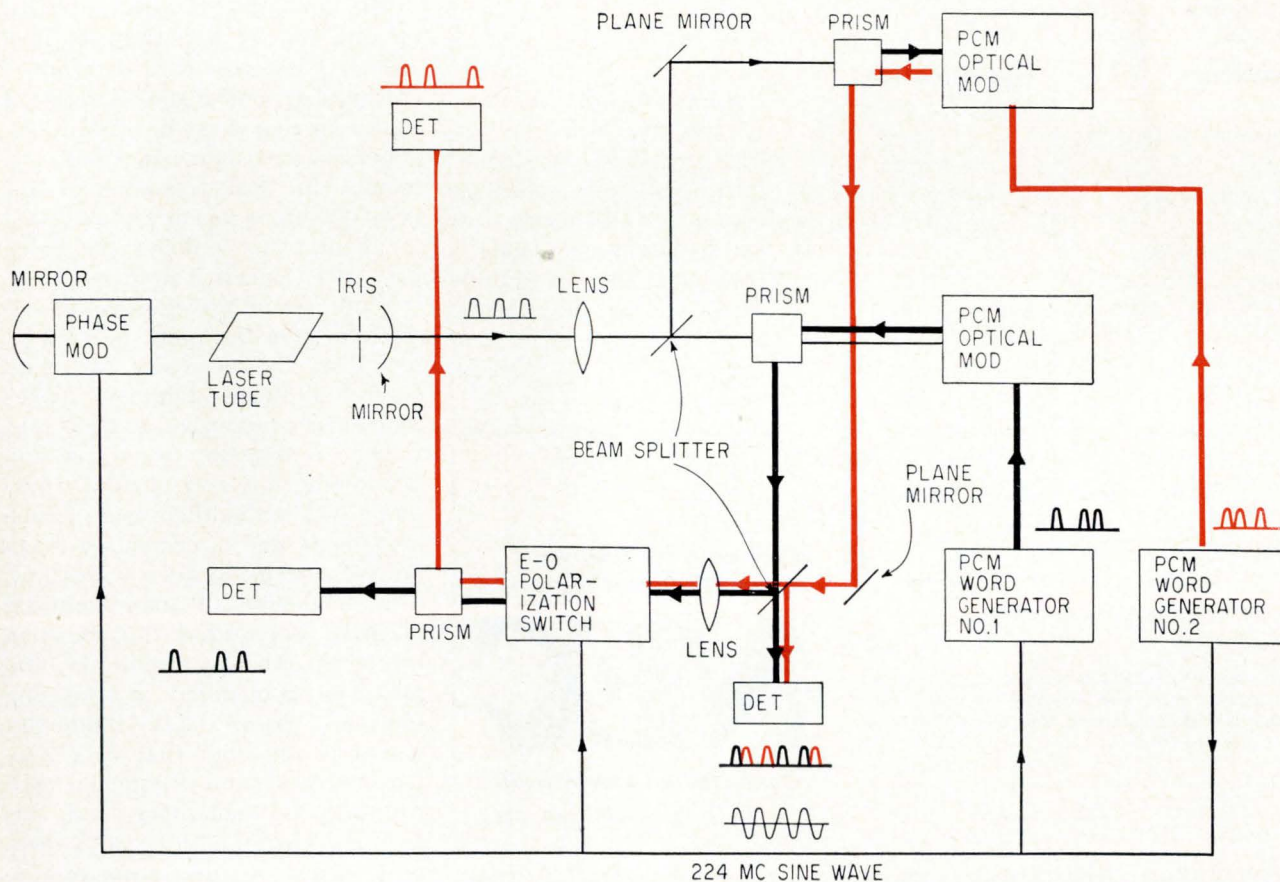

Optical signal paths in a two-channel system are differentiated in diagram by color. Additional modulators are required for each pcm channel on transmitter end, and an electro-optical switch separates combined signals at the receiver.

NEC DC-Excited Single Frequency He-Ne Laser GLG759/GLS759

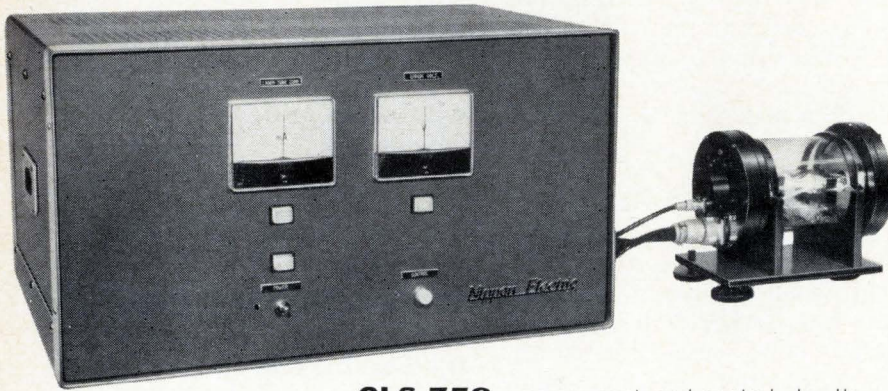

- **GLS 759**—power pack and control circuits
- **GLG 759**—FM Gas Laser

- extremely compact
- highly accurate
- exceptionally low cost
- long life

Applications

education
light detection and ranging
metrology
scientific applications
spectroscopy
laser communications
surveying

Specifications

Output—wavelength:	6,328Å (He-Ne)
—power:	0.1 mW, CW
—mode:	TEM ₀₀ Single Frequency
Long term stability, i.e. output frequency deviation from the centre of the emission line of the natural Ne:	10 ⁻⁸ /day (maximum ambient temperature variation ±1°C)
Warm up time:	40 minutes from OFF condition
Beam diameter:	approximately 1.5 mm
Beam divergence:	approximately 5 x 10 ⁻³ rad.
Servo FM deviation:	30 Mc/s P-P at a 1 Kc rate
Input power:	115 volts, 50/60 c/s, 200 VA
GLG759 dimensions:	225 x 140 x 185 mm
GLG759 weight:	8 kg

Five other types are available from over 0.1 mW to over 15 mW in power range. Also available are Laser Ruby Rods in four grades guaranteeing from about 10 MW to 30 MW peak laser output.

**Products for today—
Innovations for tomorrow**

NEC

Nippon Electric Company Limited
P. O. Box 1, Takanawa, Tokyo, Japan

MAIN PRODUCTS: electronic computers, data communication systems, electronic components, telephone, carrier transmission, radio communication, radio and television broadcasting, navigation, electronic data processing, and satellite communications equipment.

sion through the atmosphere is pretty well ruled out for long-distance optical transmission because of the varying conditions imposed by moisture, smoke and other light-absorbing elements. Thus, much of the development effort is being directed toward some type of transmission line buried under the ground, or mounted along the surface. But losses in such lines are critically dependent on beam alignment, and therefore any deviation from a straight line must be corrected by a series of built-in lenses.

Hollow pipes. Several types of optical waveguide are being investigated to solve this problem [Electronics, May 16, p. 83]. They are all variations of the basic idea of hollow pipes containing periodic lenses to redirect the beam. The lenses may be of the conventional type, or they may be gases that act like lenses by virtue of controlled temperature gradients within the pipes. The latter type are being investigated at Bell Telephone and are reportedly virtually lossless. A four-inch aluminum tube with built-in lenses has been tested at Fort Monmouth and exhibited losses of about 0.3 db per mile.

The amount of loss in the transmission line is important in pcm systems, because this determines the number, and distance apart, of repeaters that must be used to regenerate the signal between terminals. In Bell's commercial T-1 pcm system, a repeater is required at about every mile of the cable pairs over which it operates.

While beam waveguides are attractive from the point of view of low loss, the necessity for close control of beam alignment makes their cost prohibitive at this time.

The millimeter wave system would transmit over circular waveguide. While the alignment of such a guide is not as critical as in an optical system, to keep losses low, a high degree of manufacturing accuracy is required, thus pushing up costs. Another trade off that must be considered in choosing between lasers and millimeter waves, is the fact that in a mm-wave pcm system, frequency multiplexing is mandatory and this requires costly filtering and complex mixer circuitry, compared to the relatively simple time-division multiplexing of the laser system.

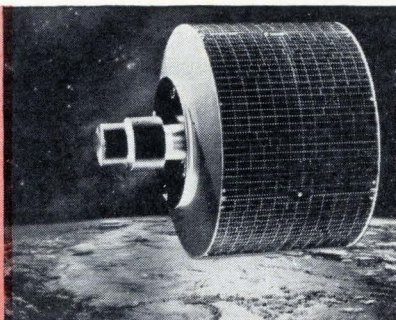

*De-spun Antenna System
for Global Communication*

GET THE MESSAGE THROUGH . . .

. . . the depths of space, through jungle brush and canopy, through intricate computer networks. Use VHF, microwaves, lasers. Across the complete spectrum of communications, Sylvania Electronic Systems gets the message through.

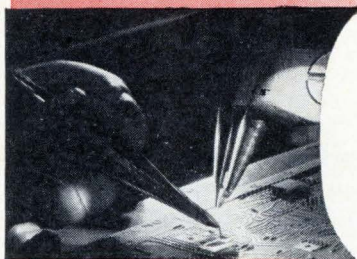

Microminaturization Circuit Techniques

Doing this job demands the best of scientists, engineers, and technical managers of many disciplines, working in the best of facilities, where the climate is strictly professional and optimal toward new ideas and advancement.

With locations in suburban Boston, Buffalo, and San Francisco — close to major universities where you can further your education — Sylvania Electronic Systems offers the complete spectrum of job opportunities.

Got the message? Then get through to the Manager, Professional Staffing, Sylvania Electronic Systems, Division of Sylvania Electric Products Inc., 59 Sylvan Road, Waltham, Mass. 02154.

The complete spectrum of opportunity — job diversification, geographic location, professional satisfaction — is awaiting you at Sylvania Electronic Systems.



Laser Acquisition and Tracking System

GTE

GENERAL TELEPHONE & ELECTRONICS
Total Communications from a single source through

SYLVANIA ELECTRONIC SYSTEMS

RESEARCH • SYSTEMS DEVELOPMENT • PRODUCT & FIELD ENGINEERING

An equal opportunity employer

Million-dollar insurance program

Expecting microelectronics to dominate microwave in the 1970's, RCA is investing millions in an integrated-circuit transceiver module for systems ranging from low-power links to array radar

By George Sideris

Senior editor

In the 1970's microelectronics will rule in microwave systems. That's what the Radio Corp. of America believes—and it's backing its forecast with a million-dollar-a-year program called Blue Chip. Its object is to develop an all-purpose transmit-receive module and to design systems to use the module by the thousands.

The integrated circuits in each module would put out only a few watts. But large combinations of the modules, backed by digital control, signal processing and distribution subsystems are expected at the outset to provide phased-array radar systems with beam powers of 10 kilowatts. At the other end of the power scale one or two modules would form a line-of-sight microwave relay system. Between would fall most other types of microwave equipment: telemetry links, airborne terrain-avoidance radar, some types of ship radar, phased communications systems

and transponders for satellites.

Solid-state multipliers have been designed to convert the S-band frequencies of the basic module to C or X bands—a range from 2 Ghz to about 8 or 9 Ghz.

Blue Chip is more than a million-a-year bet for RCA; it is necessary insurance. Several of RCA's competitors are also developing integrated microwave systems. However, the RCA program is unique in the amount of company money being invested and in the versatility that RCA expects of the modules.

I. Competition grows

The full impact of integrated circuits on microwave technology and sales won't be felt until after 1970, according to Leon S. Nergaard, director of the microwave research laboratory at the RCA Laboratories in Princeton, N. J. Military experts agree on the estimate, he says, but feel that if production orders are to be booked, operating prototypes

will be required before 1970.

Competition is already heavy at the laboratory level in companies such as Motorola, Inc., Bell Telephone Laboratories, Inc., and in many military research programs. The largest program previously made known is the three-year, \$3-million effort at Texas Instruments Incorporated to build an airborne, terrain-avoidance radar with 600 1-watt, X-band modules [Electronics, Feb. 21, p. 138]. The Air Force is underwriting 75% of the cost.

Microwave developers can scarcely be unaware of the prospects of integrated microwave devices and circuits. Reports by TI and other military contractors amount to a fair-sized book on the subject. RCA, however, has kept Blue Chip under wraps, although it has reported on some foundation studies that began in 1963. A report on microstrip transmission lines appeared in the September, 1966, RCA Review. Microstrip is vital to Blue Chip design, since it eliminates microwave plumbing and forms much of the circuitry.

TI got a head start of nearly a year in actual integration of its module circuitry. At last report, TI had worked its way to the transmit-receive switch, the stage before the antenna. RCA put its circuit development into high gear in January, 1966. This month, Nergaard and Harold Sobol, who heads the microwave integrated-circuit group at RCA Labs, were able to disclose breadboards of their essential circuits. There are still a few missing links: as yet undeveloped is a flat-plate antenna that could be fabricated as part of the module. Also under study is the possibility of building digitally con-

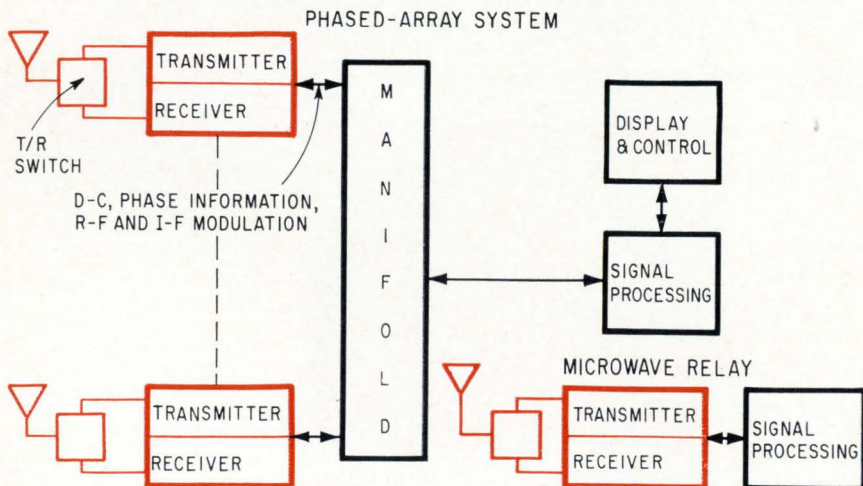

Basic building block of both complex and simple systems would be transmitter-receiver module (color). Only the subsystems that control module operation would be custom built in next-generation microwave equipment.

Second breakdown? Old Reliable laughs it off.

With the Westinghouse 2N1016 series silicon power transistor, you'll never have cause to get neurotic about second breakdown. Long experience has proved the reliability of this device when operated within established ratings. Check the curve! What other 7.5 amp. power transistor can withstand such conditions without fear of second breakdown? And Westinghouse backs this series with its lifetime guarantee† by putting this symbol  on the case.

Behind this unique lifetime guarantee stand the 2N1016's special construction features that foil second breakdown. Large cross-section wide-

base junctions eliminate high energy concentration. Heavy gold-metallized contacts provide rapid heat conduction, cutting thermal stresses at elevated junction temperatures. And each transistor is tested to MIL-S-19500.

Put 2N1016 series to work in your regulators, power supplies, and inverters now. Its low saturation resistance, high collector voltages, and reliability at elevated temperatures are just what you want.

Get all the data now. Call your Westinghouse salesman or distributor and ask for Technical Data 54-661. Westinghouse Semiconductor Division, Youngwood, Pennsylvania 15697.

†Westinghouse warrants to the original purchaser that it will correct any defect or defects in workmanship, by repair or replacement f.o.b. factory, for any silicon power semiconductor bearing this symbol  during the life of the equipment in which it is originally installed, provided said device is used within manufacturer's published ratings and applied in accordance with good engineering practice. This warranty shall constitute a fulfillment of all Westinghouse liabilities in respect to said products. This warranty is in lieu of all other warranties expressed or implied. Westinghouse shall not be liable for any consequential damages.

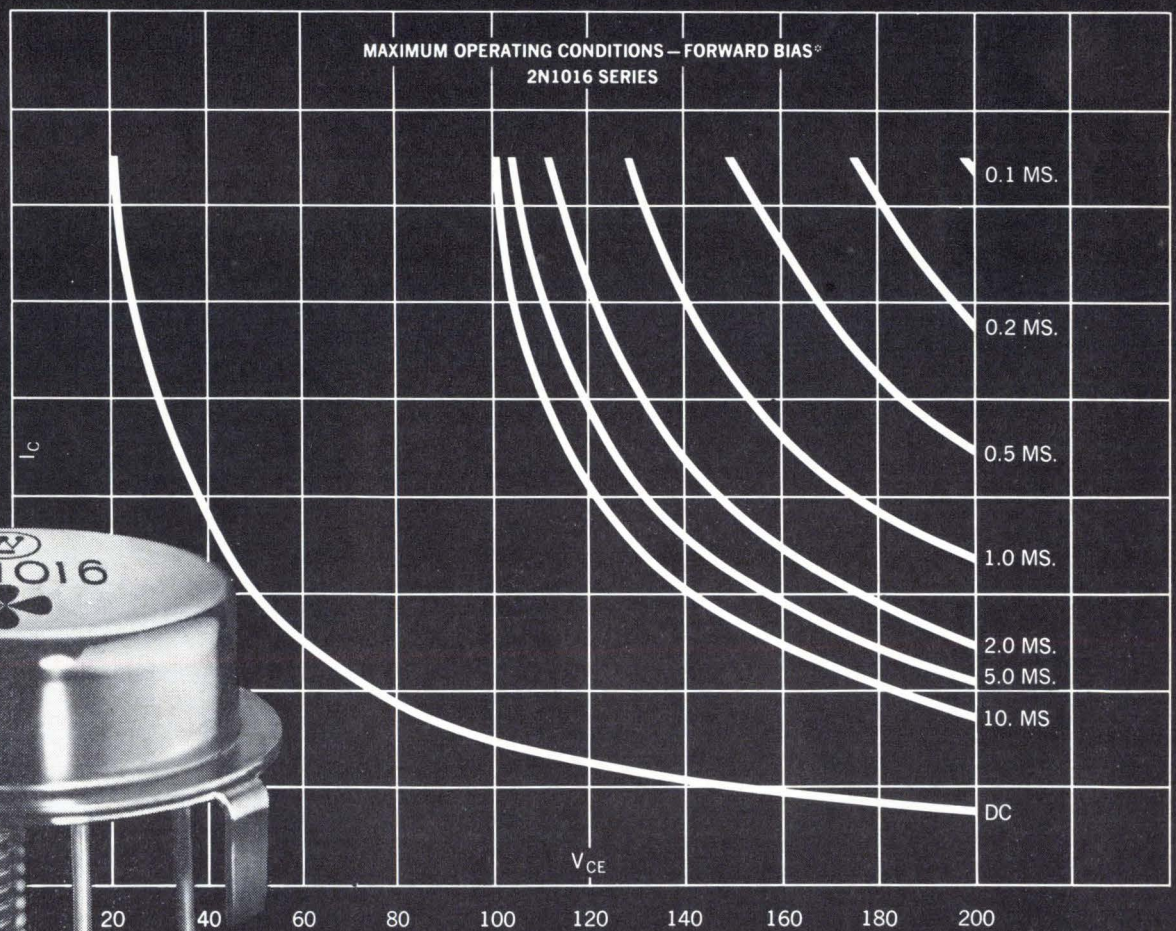

*These operating curves are typical of those available on all Westinghouse power transistors.

You can be sure if it's Westinghouse

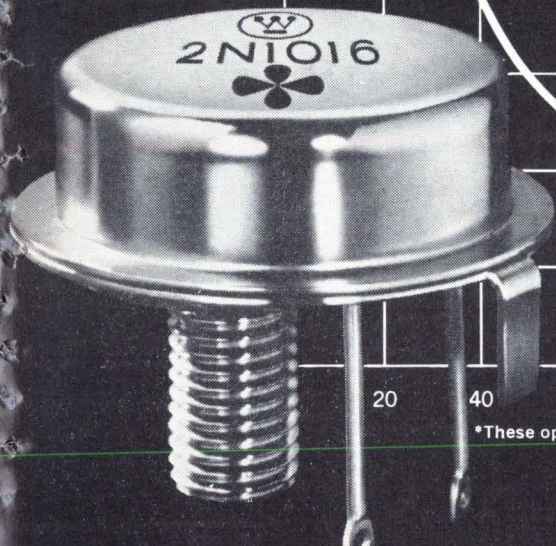

**SINCLAIR'S YAGI
ANTENNAS**

**RUGGED
RELIABILITY...
WHEN IT
COUNTS!**

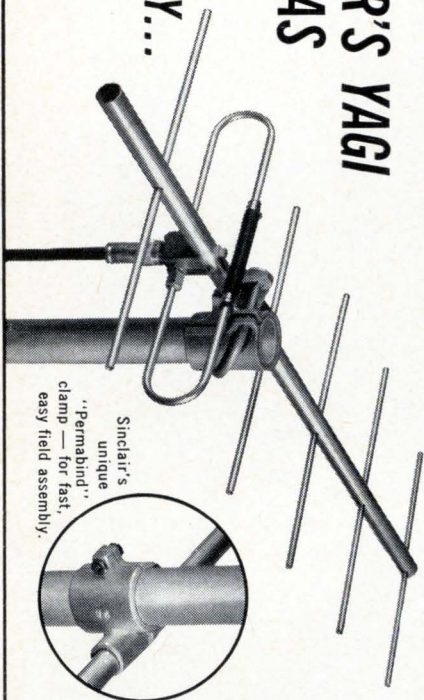

Sinclair's unique "PermaBind" clamp — for fast, easy field assembly.

Sure, most UHF-VHF yagi antennas function effectively — when the weather's good! It's when the wind starts to howl and the weather turns from bad to worse that the unmatched rugged reliability of a Sinclair yagi really counts. Every standard Sinclair yagi is designed to withstand 110 mph winds with a 1/2" radial ice coating. An integral part of this rugged construction is Sinclair's unique "PermaBind" clamp that makes for fast, permanent field assembly.

Standard Sinclair yagis are available in a wide frequency range from 30Mc. to 470Mc. . . . gains from 6.5db to 17.0db . . . power ratings up to one KW. Send coupon today for complete FREE literature and prices.

SINCLAIR RADIO LABORATORIES, INC.
523 FILLMORE AVENUE DEPT. 101B TONAWANDA, NEW YORK

FREE LITERATURE

TO: SINCLAIR RADIO LABORATORIES, INC.
Dept. 101B 523 Fillmore Avenue
Tonawanda, New York 14152

Name: _____
 Title: _____
 Company: _____
 Address: _____
 City: _____
 State: _____ Zip: _____

trolled ferrite phase shifters into the modules.

Work is moving along rapidly, however, helped by five other RCA divisions: Aerospace Systems, Astro-Electronics, Electronic Components and Devices, Missile and Surface Radar and Communications Systems. Planning for the use of the modules in systems is centered at the Aerospace division, in Burlington, Mass.

II. A systems philosophy

RCA chose to develop a universal transmitter-receiver because of a basic conflict between microwave needs and integrated-circuit production costs. Microwave is a custom business, explains Nergaard, but development of integrated circuits doesn't pay except for mass production.

The module represents a mass-producible building block for many types of systems. Custom work is confined to circuits that perform the signal modulation, processing and control, represented by the uncolored blocks in the diagram on page 114. The special-purpose circuitry for a low-power communications system would be simple; for a powerful phased array, it would be complex, including a computer to phase the signals to point and combine the multiple output beams and do other chores.

III. A choice of technologies

Sobol and his staff are keeping an open mind on which circuits to make monolithic, which to make as hybrid integrated circuits and which to make as microstrip transmission-line circuits—actually a

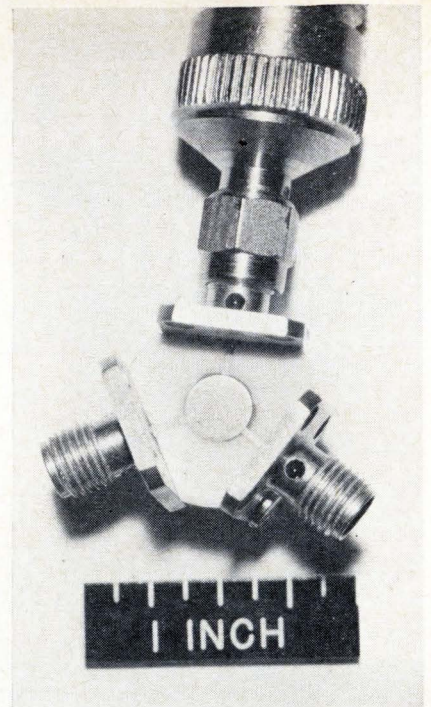

X-band circulator is made by burying ferrite or garnet in microstrip.

form of hybrid IC—or monolithic IC. A prime objective of the research program is to identify the cost and performance trade offs.

Tuned circuits, for instance, can be made in at least four ways:

- Integrated circuits can have thin-film coils and capacitors for the tuning function. Thin-film coils only 40 mils in diameter have been made.
- Lead inductances of components in hybrid IC's can take the place of the coils. Sobol, however, prefers the coils.
- Resonant sections of microstrip can be used for filtering.
- External filters can tailor the bandwidth of wideband monolithic

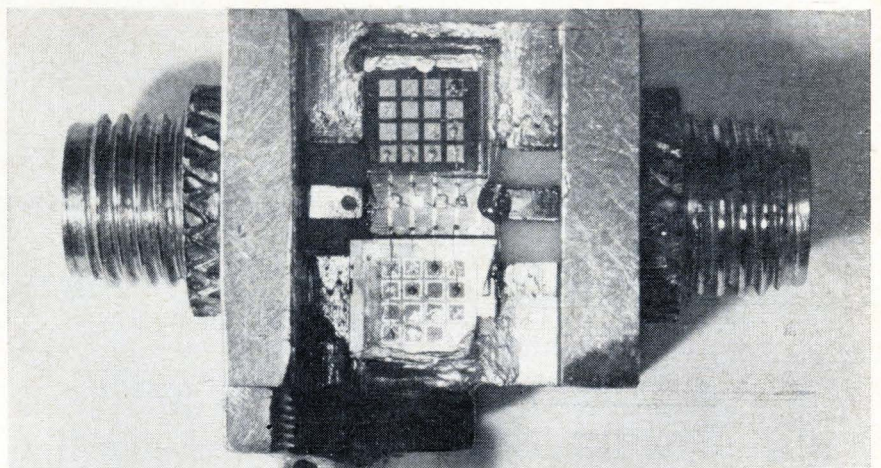

Hybrid integrated circuit is breadboard model of i-f strip that will be produced as a monolithic IC. The center strip contains four transistors.



Confusing? Not to Sperry ESR.

The multiple target tracking requirements of tomorrow's defense systems have made today's radars obsolete. Hundreds of targets, all traveling faster than ever, may have to be tracked almost simultaneously. Computer-controlled ESR (Electronically-Scanned Radar) is the system for this new multi-function task. ESR delivers position and velocity at greater ranges with higher data rates and reliability than mechani-

cally-scanned radars. ESR can be installed in the nose of fighters for terrain mapping and avoidance, search and track of ground and air targets, air-to-ground ranging and air-to-air fire control. On bombers or for early warning in ASW. On ships or mobile ground stations. HAPDAR, Sperry's ESR now in successful operation at White Sands, is a prime example of this new breed of radar. ESR could be the answer to your problem.

RADIATION DIVISION, Sperry Gyroscope Company, Great Neck, N. Y. 11020

SPERRY
DIVISION OF
SPERRY RAND
CORPORATION

**Where can you
get a power supply
designed to furnish the
EXACT CURRENT
& VOLTAGE
you need for that
beautiful system you
are designing?**

CAL POWER
CORPORATION

Formerly Perkin Electronics Corp. & Power Instruments Corp.

**delivered
when you
need it** To provide your electronic power package, select a successful organization that puts technical integrity first — an organization with a solid history of performance.

Select Cal-Power. Our power supplies are riding in space, probing the oceans, performing in laboratories, assisting in automatic checkouts, keeping production lines humming. Precision power packages — from milliwatts to megawatts — standard lab supplies or custom-packaged to fit your specific requirements. Whether it's a 28-volt dc bench supply or an exotic multiple-output power package, we can design, develop and manufacture the power sources you need. Toss us your challenges.

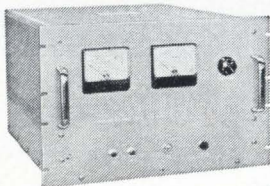

**try this
experienced
solid state
organization**

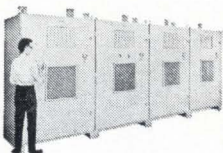
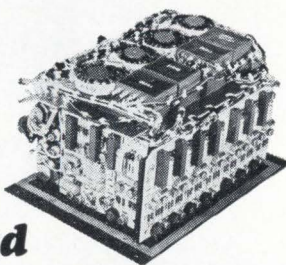

Cal-Power Corporation

140 Kansas • El Segundo, California • Tel. (213) 772-2171 / 322-5320 • TWX 322-4604

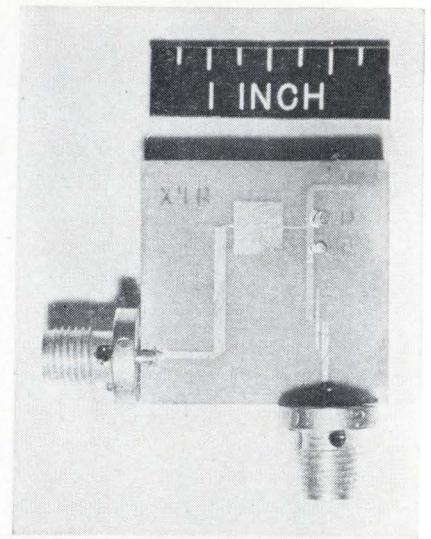

Times-four multiplier built as microstrip raises frequency from S band to X band. It was made at the Communications Systems division.

integrated circuits.

The thin-film and microstrip approaches look like winners since either can be fabricated on the ceramic dielectrics of microstrip or on semiconductor substrates containing active devices.

Microstrip-based hybrid circuits form several stages of the module. For power amplification at S band, overlay transistors are inserted in the ceramic. The primary S-band frequency is raised to C and X band by microstrip multipliers. The times-four multiplier in the photograph above contains an inserted diode, thin-film resistor and a double-tuned filter, formed by the three parallel lines. To make the S-band circulator on page 116, ferrite —or yttrium-iron garnet—is inserted in the ceramic. Mixers are presently microstrip with inserted diodes, but mixers may later become monolithic integrated circuits composed of thin-film microstrip on semiconductor.

Eventually, compatible microstrip circuitry will probably be combined on common substrates. The bulky connectors in the photos are needed now only to make tests.

Plans are to make the driver chain in the transmitter and the i-f strip in the receiver monolithic IC's. The 500-megahertz i-f circuitry has been breadboarded as a hybrid integrated circuit. It contains four transistors in the center strip, which is 120 mils across, and thin-film capacitors and resistors on the adjoining substrates.

Automation in the test labs

Help is on its way to the harried medical technician in the form of electronic equipment for rapid, accurate testing of blood and other body fluids

By Carl Moskowitz

Instrumentation editor

Anxious patients, overburdened doctors and understaffed hospitals know the frustration of waiting for test reports. Now, with Medicare adding to the work load, the nation's labs are facing a gigantic problem, intensified by the shortage of technicians and adequate equipment. Tests are still performed manually and, even in emergencies, reports may take hours to complete. Often doctors request repeats because they have lost confidence in the labs' results. This snag has doubled the number of tests required in the last few years, according to Robert S. Melville, program administrator of the National Institutes of Health's research branch.

Now the electronics industry is helping to solve this vast problem. Three companies have developed equipment for automatically analyzing blood and other body-fluid samples that will permit hospitals and labs to make hundreds of tests every hour. The lab cost of a typical series of such tests will be sharply reduced from an average of \$100 to an amazingly low \$2.

These devices could go a long way toward breaking the testing logjam. Dr. Kamill Gal, director of clinical pathology at the hospital of Albert Einstein Medical College in New York, reports, "one instrument, serviced by one technician does the work of almost 20 technicians. The equipment occupies less premium hospital space and the cost is less than half that of conventional equipment needed to do the same work. The automatic analyzer at Einstein has given the doctors something that was never before feasible—full lab service around the clock."

A word of caution. Although

these instruments have provoked wide interest, one NIH expert warns that they are by no means the final answer. Changes in test procedures, for example, could obsolete many of the electronic modules in this type of laboratory equipment.

Technicon Instruments Corp. has already installed 85 of its SMA-12 Autoanalyzers which sell for about \$30,000 each. A company spokesman says that another 125 have been ordered and are being readied for delivery. Warner-Chilcott Laboratories, on the other hand, will ship the first production unit of its Robot Chemist shortly. Pre-production prototypes, however, have been evaluated at Kaiser

Foundation Hospital in San Francisco and Norfolk (Va.) General Hospital. Hycell Corp. will not ship the first units of its Mark X until early in 1967.

I. Continuous flow

Technicon's Autoanalyzer is a continuous flow analyzer. The SMA-12 performs 12 different chemical tests simultaneously on each sample. Samples are analyzed at a rate of 30 per hour and the machine provides a complete 12-determination analysis on each sample [see page 120]. The cost of such a report, according to a Technicon official, is about \$1.70 at a rate of 100 samples per day. This includes the machine's amor-

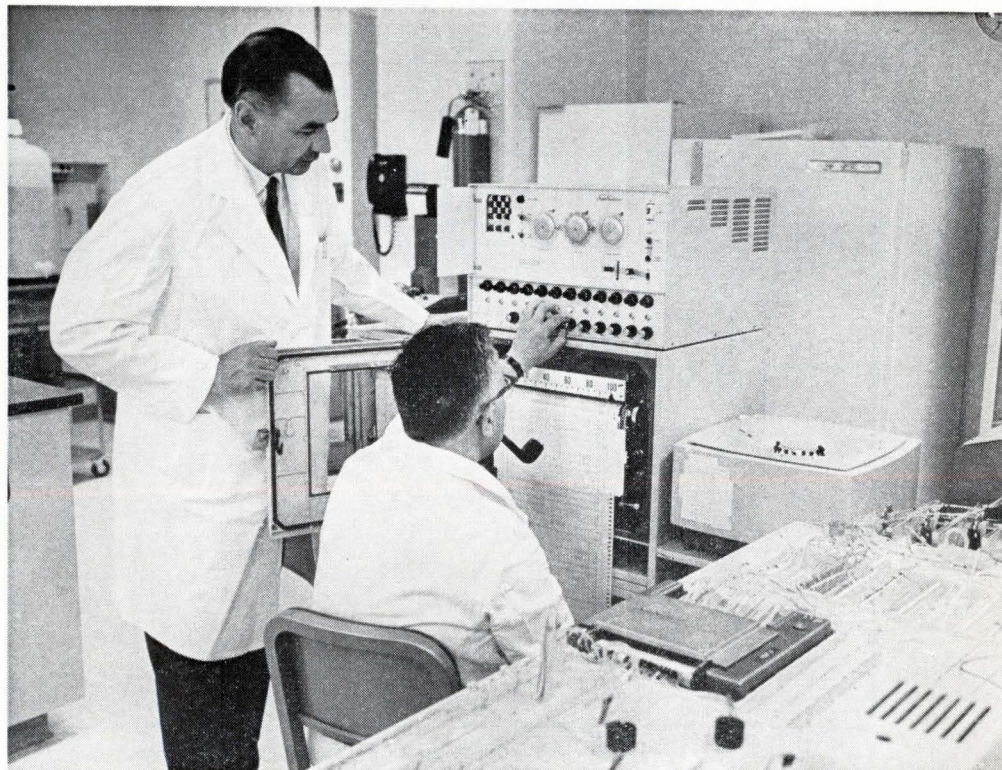

Dr. Kamill Gal, left, chief pathologist at the Albert Einstein hospital, says "one Autoanalyzer does the work of 20 technicians."

tization, the cost of reagents and \$40 per day for a technician. The hospital model determines the concentration of sodium, potassium, chloride, carbon dioxide, total protein, albumin, urea, glucose, calcium, bilirubin, alkaline phosphatase and glutamic oxalacetic transaminase in the blood. These tests comprise nearly 90% of a typical hospital's biochemical job load.

The sample to be analyzed is inserted into a continuous stream of diluent flowing through the SMA-12. Air pumped into the stream produces bubbles that segment the stream into discrete quantities and separate the samples. The smaller samples are mixed with the necessary reagents

and the readout is made by colorimeters, or, in the case of potassium and sodium, by a flame photometer. The instrument is programed to record each test only when a steady signal plateau is reached by the colorimeters or photometer.

Promising, but not perfect. Although unofficial evaluations indicate the Autoanalyzer is a promising development, it does have problems. A basic difficulty has even created some doubts about the continuous flow concept. All 12 channels of the SMA-12 are tightly interlocked in the sense that reagents and temperature controls for each test must follow in a strict sequence. It is therefore impossible to lift one test out of the

system and substitute it with another without affecting the 11 other channels.

II. Batch principle

Another device is Warner-Chilcott's Robot Chemist. This instrument operates on the batch principle. One single test is made on up to 1,000 samples and then the machine goes back to the beginning and makes additional tests, one by one, until the required number have been completed on the entire batch. A spectrophotometer reads out the absorbance of reagents in the samples, and a programmer controls the sequencing of tests. The Robot Chemist sells for about \$16,000 and makes two determinations per minute.

Digital output. While each determination is made and the results printed out within 30 seconds, the final result for any one patient is not available until all the determinations for a group of 100 is complete—about five hours.

The Robot Chemist seems better suited for a huge number of samples where prompt readout is not a particular virtue—as in preventive care medicine. Samples can be removed at any point without disturbing other samples. If one channel breaks down it will not destroy the results received from the other channels.

Even though Warner-Chilcott has yet to ship the first production models of the Robot Chemist, Edwin O. Brown, W-C's marketing manager of instruments, reports Kaiser and some clinical labs have placed orders for the machine.

III. Batch and flow

A third instrument is the Hycell Corp.'s Mark X. Combining both batch and continuous flow analysis, it can perform 10 chemical analyses on a sample and make almost 400 determinations per hour with colorimeters and photocells. Hycell will ship its first unit costing \$45,000 in 1967.

A company spokesman claims that although the Mark X operates on the continuous flow principle, it is possible to break in cleanly at any point. Also it can be programed to leave out a specific test for a specific patient without upsetting the delicate mix and sequence of reagents.

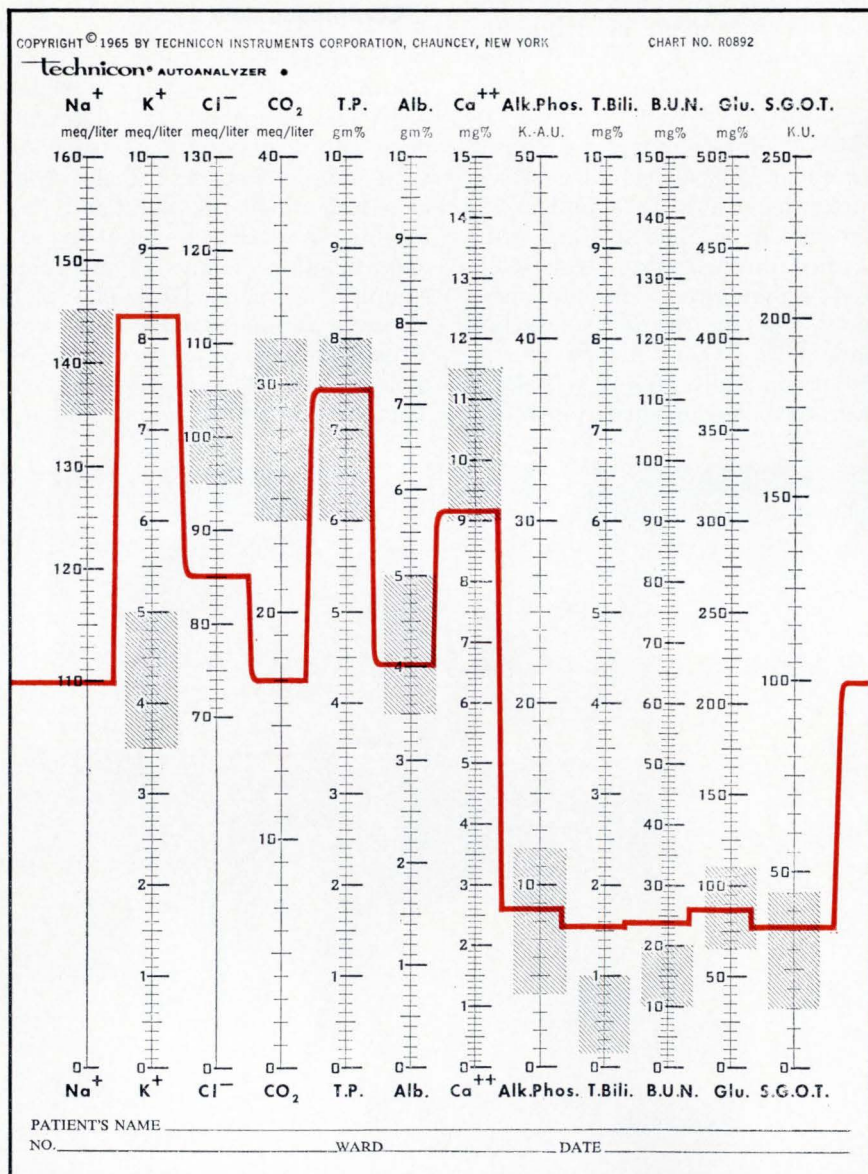

Typical readout of the constituents in a patient's blood sample processed by the Autoanalyzer. Thirty such reports can be done an hour with the machine. The gray areas on the chart indicate normal values for each concentration so a doctor can spot discrepancies immediately.

This \$1800 counter won't do everything our \$2950 model will.

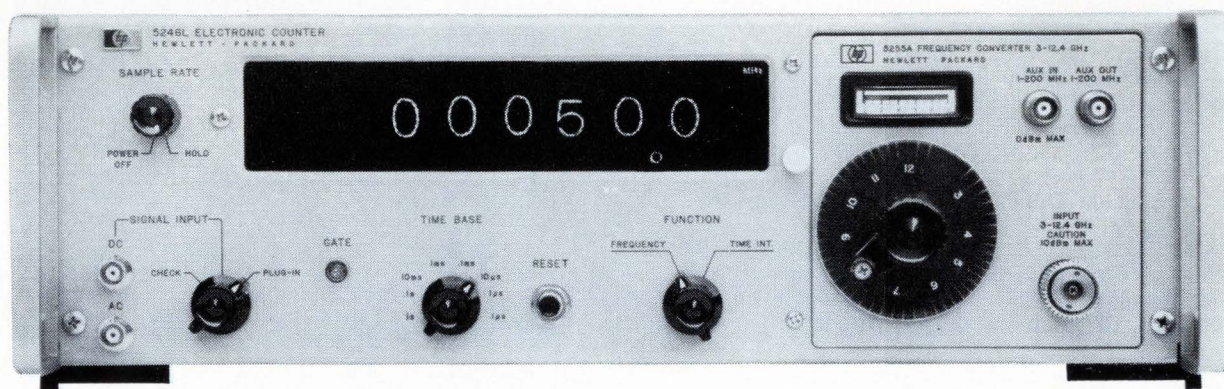

But it takes the same plug-ins.

And one of those plug-ins can take you directly to 12.4 GHz with 1 Hz resolution. But that's not all. Look at some of the other nine plug-ins you can use with this remarkable counter:

- Direct readout prescaler, dc to 350 MHz
- Time interval, 1 μ sec to 10^6 sec.
- Video amplifier with 1 mv sensitivity
- Preset counting and normalizing
- Digital voltage measurement to 1000 v
- Four frequency converters—up to 12.4 GHz

The 5246L is an economy instrument that can't be matched in performance for dollar. It can use every one of the high-performance plug-ins we developed for our 5245L Counter. Hewlett-Packard's counter experience is built into the new 5246L, along with traditional HP reliability. And you can't beat the price.

SPECIFICATIONS:

Frequency Range:	dc to 50 MHz
Gate Times:	1 μ sec to 1 sec
Readout:	6 digits (7 and 8 optional)
Input Coupling:	ac or dc
Input Impedance:	1 meg/25 pf
Max. Sensitivity:	100 mv rms
Readout Storage:	yes
BCD Output:	optional
Time Base Aging Rate:	< \pm 2 parts/107/month (< 3 parts/10 ⁹ /day optional)
Price:	\$1800

Want more information? Call or write your Hewlett-Packard field engineer for complete data, Hewlett-Packard, Palo Alto, Calif. 94304, Tel. (415) 326-7000; Europe: 54 Route des Acacias, Geneva.

Data subject to change without notice. Price f.o.b. factory.

HEWLETT  **PACKARD**
An extra measure of quality

Meet any programable or fixed voltage need

Up to 150 volts • Up to 95 amps

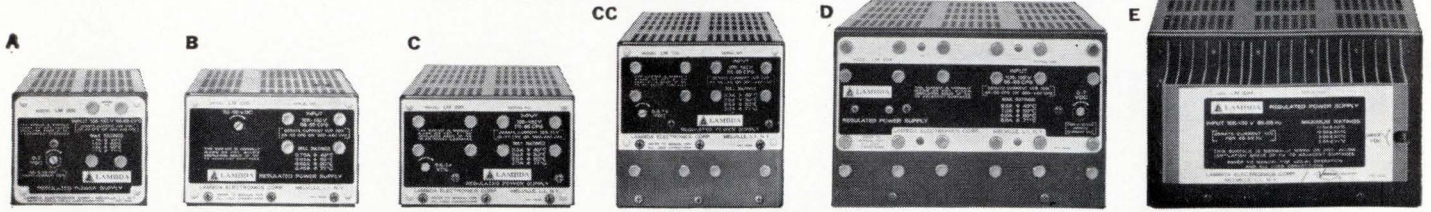

FEATURES and DATA

Full line of accessories and options to meet your system needs. Meet Mil. Environment Specs. RFI—MIL-I-16910: Vibration: MIL-T-4807A: Shock: MIL-E-4970A • Proc. 1 & 2: Humidity: MIL-STD-810 • Meth. 507: Temp. Shock: MIL-E-5272C • (ASG) Proc. 1: Altitude: MIL-E-4970A • (ASG) Proc. 1: Marking: MIL-STD-130: Quality: MIL-Q-9858: Fungus Proofing (optional) all models available with MIL-V-173 varnish for all nutrient components. Convection cooled—no heat sinking or forced air required Wide input voltage and frequency range—105-132 VAC, (200-250 VAC, optional at no extra charge) 45-440 cps Regulation (line) 0.05% plus 4MV (load) 0.03% plus 3MV: Ripple and Noise—1 MV rms, 3MV p to p Overvoltage protection available for all models up to 70 VDC High Performance Option—All models available with these specifications for \$25.00 extra: Line regulation—.01% + 1MV; Load regulation—.02% + 2MV: Ripple and Noise—½MV rms; 1½MV p to p: Temp. Coef.—.01%°C

ACCESSORIES and OPTIONS



System Rack Adapters

LRA-5 • 3½" height by 27/16" depth. Price \$35.00
LRA-4 • 3½" height by 14" depth. (For use with chassis slides) Price \$55.00

LRA-5 and **LRA-4** mount the following combinations of LM models: up to 4 A package sizes • 3 B or 3 C package sizes • 2 A and 1 B or 1 C package sizes

LRA-3 • 5¼" height by 27/16" depth. Price \$35.00

LRA-6 • 5¼" height by 14" depth. (For use with chassis slides) Price \$60.00

LRA-3 and **LRA-6** mount the following combinations of LM models: up to 4 A, B or C package sizes • 3 CC package sizes • 2 D or 2 E package sizes • 2 A, B or C and 1 CC or 1 D or 1 E package sizes • 1 CC and 1 D or 1 E package sizes • 1 D and 1 E package sizes

Metered Panels • 3½" Metered panel MP-3 is used with rack adapters LRA-4, LRA-5 and packages A, B and C. Price \$40.00

5¼" Metered panel MP-5 is used with rack adapters LRA-6, LRA-3 and packages A, B, C, CC, D and E. Price \$40.00 To order these accessory metered panels, specify panel number which MUST BE FOLLOWED BY THE MODEL NUMBER of the power supply with which it will be used.

F and G LM Packages are full rack power supplies available metered or non-metered. For metered models, add suffix M to the Model No. and \$30 to the non-metered price.

Other Options • Also available are Overvoltage Protectors, Fungus Proofing, and High Performance Options at moderate surcharges.

WIDE VOLTAGE RANGE PROGRAMABLE LM SERIES MODELS

PACKAGE A 3½"x3¾"x6½"	ADJ. VOLT. RANGE VDC	*MAX. AMPS AT AMBIENT OF:				Price**
		40°C	50°C	60°C	71°C	
LM 251	0-7	0.35	0.31	0.29	0.27	\$ 69
LM 201	0-7	0.85	0.75	0.70	0.55	79
LM 202	0-7	1.7	1.5	1.4	1.1	89
LM 252	0-7	2.0	1.8	1.4	1.1	99
LM 257	0-14	0.27	0.24	0.23	0.22	69
LM 203	0-14	0.45	0.40	0.38	0.28	79
LM 204	0-14	0.90	0.80	0.75	0.55	89
LM 258	0-14	1.2	1.1	1.0	0.80	99
LM 259	0-24	0.18	0.16	0.15	0.14	69
LM 260	0-24	0.35	0.30	0.25	0.20	79
LM 261	0-24	0.70	0.65	0.60	0.45	89
LM 262	0-24	0.80	0.75	0.70	0.60	99
LM 263	0-32	0.14	0.12	0.11	0.10	69
LM 205	0-32	0.25	0.23	0.20	0.15	79
LM 206	0-32	0.50	0.45	0.40	0.30	89
LM 264	0-32	0.66	0.60	0.50	0.32	99
LM 265	0-60	0.08	0.07	0.07	0.06	79
LM 207	0-60	0.13	0.12	0.11	0.08	89
LM 208	0-60	0.25	0.23	0.21	0.16	99
LM 266	0-60	0.35	0.31	0.28	0.25	109
LM 267	0-120	0.10	0.09	0.08	0.07	109
LM 268	0-120	0.13	0.12	0.10	0.09	119

PACKAGE B 3½"x4½"x6½"	ADJ. VOLT. RANGE VDC	*MAX. AMPS AT AMBIENT OF:				Price**
		40°C	50°C	60°C	71°C	
LMB-0-7	0-7	2.8	2.6	2.3	1.5	\$109
LMB-0-14	0-14	1.6	1.5	1.3	1.2	109
LMB-0-32	0-32	0.80	0.70	0.60	0.5	109
LMB-0-60	0-60	0.45	0.40	0.35	0.3	109
LM-217	8.5-14	2.1	1.9	1.7	1.3	119
LM-218	13-23	1.5	1.3	1.2	1.0	119
LM-219	22-32	1.2	1.1	1.0	0.80	119
LM-220	30-60	0.70	0.65	0.60	0.45	129

PACKAGE C 3½"x4½"x9½"	ADJ. VOLT. RANGE VDC	*MAX. AMPS AT AMBIENT OF:				Price**
		40°C	50°C	60°C	71°C	
LM-225	0-7	4.0	3.6	3.0	2.4	\$139
LMC-0-14	0-14	2.2	2.0	1.8	1.5	139
LMC-0-32	0-32	1.1	1.0	0.90	0.80	139
LMC-0-60	0-60	0.60	0.55	0.50	0.45	139
LM-226	8.5-14	3.3	3.0	2.5	2.0	139
LM-227	13-23	2.3	2.1	1.7	1.4	139
LM-228	22-32	2.0	1.8	1.5	1.2	139
LM-229	30-60	1.1	1.0	0.80	0.60	149

PACKAGE D 4½"x7½"x9½"	ADJ. VOLT. RANGE VDC	*MAX. AMPS AT AMBIENT OF:				Price**
		40°C	50°C	60°C	71°C	
LM-234	0-7	8.3	7.3	6.5	5.5	\$199
LMD-0-14	0-14	4.9	4.2	3.4	2.7	199
LMD-0-32	0-32	2.5	2.1	1.7	1.3	180
LMD-0-60	0-60	1.3	1.1	0.95	0.75	239
LM-235	8.5-14	7.7	6.8	6.0	4.8	199
LM-236	13-23	5.8	5.1	4.5	3.6	209
LM-237	22-32	5.0	4.4	3.9	3.1	219
LM-238	30-60	2.6	2.3	2.0	1.6	239

PACKAGE E 4½"x7½"x11½"	ADJ. VOLT. RANGE VDC	*MAX. AMPS AT AMBIENT OF:				Price**
		40°C	50°C	60°C	71°C	
LME-0-7	0-7	12.0	10.5	8.5	6.8	\$249
LME-0-14	0-14	7.4	6.4	5.2	4.1	249
LME-0-32	0-32	3.7	3.2	2.6	2.1	249
LME-0-60	0-60	2.1	1.7	1.4	1.1	249

PACKAGE F 3½"x19"x16½"	ADJ. VOLT. RANGE VDC	*MAX. AMPS AT AMBIENT OF:				Price**
		40°C	50°C	60°C	71°C	
LMF-0-7	0-7	25.0	21.0	17.0	14.0	\$425

PACKAGE G 5½"x19"x16½"	ADJ. VOLT. RANGE VDC	*MAX. AMPS AT AMBIENT OF:				Price**
		40°C	50°C	60°C	71°C	
LMG-0-7	0-7	35.0	29.0	24.0	20.0	\$575

with Lambda Modular Power Supply Systems

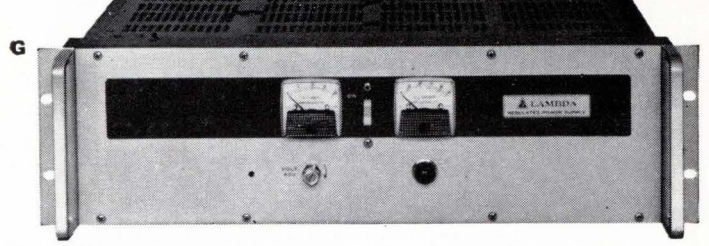
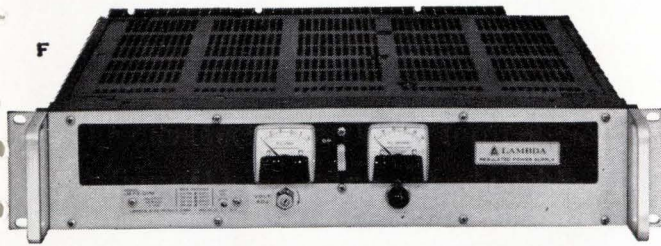

FIXED VOLTAGE RANGE LM SERIES MODELS

PACKAGE B 3 3/8" x 4 1/2" x 6 1/2"	ADJ. VOLT. RANGE VDC	*MAX. AMPS AT AMBIENT OF:				Price**
		40°C	50°C	60°C	71°C	
LM B3	3 ±5%	3.8	3.3	2.6	1.6	\$119
LM B3P3	3.3±5%	3.8	3.3	2.6	1.6	119
LM B3P6	3.6±5%	3.8	3.3	2.6	1.6	119
LM B4	4 ±5%	3.8	3.3	2.6	1.6	119
LM B4P5	4.5±5%	3.7	3.2	2.5	1.5	119
LM B5	5 ±5%	3.7	3.2	2.5	1.5	119
LM B6	6 ±5%	3.2	2.9	2.4	1.4	119
LM B8	8 ±5%	3.2	2.9	2.4	1.4	119
LM B10	10 ±5%	2.7	2.5	2.2	1.4	119
LM B12	12 ±5%	2.5	2.3	2.1	1.3	119
LM B15	15 ±5%	2.2	2.0	1.8	1.3	119
LM B18	18 ±5%	2.0	1.8	1.7	1.3	119
LM B20	20 ±5%	1.8	1.6	1.5	1.2	119
LM B24	24 ±5%	1.4	1.3	1.2	1.1	119
LM B28	28 ±5%	1.3	1.2	1.1	1.0	119
LM B36	36 ±5%	1.1	1.0	0.90	0.85	129
LM B48	48 ±5%	0.9	0.85	0.80	0.75	129
LM B60	60 ±5%	0.7	0.65	0.60	0.54	129
LM B100	100 ±5%	0.37	0.34	0.30	0.28	139
LM B120	120 ±5%	0.30	0.28	0.25	0.23	139
LM B150	150 ±5%	0.25	0.23	0.20	0.19	149

PACKAGE C 3 1/8" x 4 1/2" x 9 3/8"	ADJ. VOLT. RANGE VDC	*MAX. AMPS		Price**
		40°C	60°C	
LM C3	3 ±5%	5.3	3.7	\$139
LM C4	4 ±5%	5.2	3.6	139
LM C4P5	4.5±5%	5.1	3.5	139
LM C5	5 ±5%	5.1	3.4	139
LM C6	6 ±5%	4.8	3.3	139
LM C12	12 ±5%	4.0	2.9	139
LM C15	15 ±5%	3.5	2.8	139
LM C20	20 ±5%	3.1	2.6	139
LM C24	24 ±5%	2.5	2.2	139
LM C28	28 ±5%	2.3	2.0	139
LM C48	48 ±5%	1.6	1.3	149
LM C150	150 ±5%	0.39	0.33	169

PACKAGE E 4 1/8" x 7 1/2" x 11 7/8"	ADJ. VOLT. RANGE VDC	*MAX. AMPS		Price**
		40°C	60°C	
LM E3	3 ±5%	22.0	16.5	\$269
LM E4	4 ±5%	21.0	16.5	269
LM E4P5	4.5±5%	20.0	16.4	269
LM E5	5 ±5%	20.0	16.4	269
LM E6	6 ±5%	19.0	15.6	269
LM E12	12 ±5%	15.0	12.3	269
LM E15	15 ±5%	14.0	11.5	269
LM E20	20 ±5%	12.0	9.8	269
LM E24	24 ±5%	11.0	9.0	269
LM E28	28 ±5%	10.0	8.0	269
LM E48	48 ±5%	6.0	4.9	299
LM E150	150 ±5%	1.4	1.2	299

NEW PACKAGE CC 4 1/8" x 4 1/2" x 9 3/8"	ADJ. VOLT. RANGE VDC	*MAX. AMPS		Price**
		40°C	60°C	
LM CC3	3 ±5%	11.0	8.2	\$179
LM CC4	4 ±5%	11.0	8.2	179
LM CC4P5	4.5±5%	10.5	8.0	179
LM CC5	5 ±5%	10.5	8.0	179
LM CC6	6 ±5%	9.0	7.7	179
LM CC12	12 ±5%	7.3	5.9	169
LM CC15	15 ±5%	6.0	5.1	169
LM CC20	20 ±5%	5.0	4.2	169
LM CC24	24 ±5%	4.0	3.4	169
LM CC28	28 ±5%	3.5	3.1	169
LM CC48	48 ±5%	2.5	2.2	189
LM CC150	150 ±5%	0.7	0.62	199

PACKAGE F 3 1/2" x 19" x 16 1/2"	ADJ. VOLT. RANGE VDC	*MAX. AMPS		Price**
		40°C	60°C	
LM FA3	3 ±5%	31.5	24.0	\$375
LM FA4	4 ±5%	31.5	24.0	375
LM FA4P5	4.5±5%	31.5	24.0	375
LM FA5	5 ±5%	31.5	23.7	375
LM FA6	6 ±5%	30.5	22.0	375
LM FA12	12 ±5%	22.0	16.2	375
LM FA15	15 ±5%	19.4	15.2	375
LM FA20	20 ±5%	16.0	12.6	350
LM FA24	24 ±5%	14.0	11.4	350
LM FA28	28 ±5%	13.5	10.4	350
LM FA48	48 ±5%	8.1	6.5	375
LM FA150	150 ±5%	2.4	1.8	410
LM F3	3 ±5%	48.0	34.0	425
LM F4	4 ±5%	48.0	34.0	425
LM F4P5	4.5±5%	48.0	34.0	425
LM F5	5 ±5%	48.0	33.0	425
LM F6	6 ±5%	47.0	32.0	425
LM F12	12 ±5%	33.0	22.0	425
LM F15	15 ±5%	28.0	19.0	425
LM F20	20 ±5%	23.0	17.0	395
LM F24	24 ±5%	20.0	14.0	380
LM F28	28 ±5%	19.0	13.0	380
LM F48	48 ±5%	10.0	7.5	425
LM F150	150 ±5%	3.1	2.1	460

PACKAGE D 4 1/8" x 7 1/2" x 9 3/8"	ADJ. VOLT. RANGE VDC	*MAX. AMPS		Price**
		40°C	60°C	
LM D3	3 ±5%	13.1	9.2	\$199
LM D4	4 ±5%	13.1	9.2	199
LM D4P5	4.5±5%	13.1	9.2	199
LM D5	5 ±5%	12.6	9.2	199
LM D6	6 ±5%	12.4	8.9	199
LM D12	12 ±5%	10.0	8.3	199
LM D15	15 ±5%	9.0	7.9	209
LM D20	20 ±5%	7.4	6.5	209
LM D24	24 ±5%	6.7	5.8	219
LM D28	28 ±5%	6.0	5.2	219
LM D48	48 ±5%	4.1	3.6	239
LM D150	150 ±5%	1.1	0.90	254

PACKAGE G 5 1/4" x 19" x 16 1/2"	ADJ. VOLT. RANGE VDC	*MAX. AMPS		Price**
		40°C	60°C	
LM G3	3 ±5%	95.0	62.0	\$575
LM G4	4 ±5%	85.0	62.0	575
LM G4P5	4.5±5%	85.0	62.0	575
LM G5	5 ±5%	80.0	62.0	575
LM G6	6 ±5%	80.0	62.0	525
LM G12	12 ±5%	56.0	37.0	525
LM G15	15 ±5%	45.0	36.0	525
LM G20	20 ±5%	35.0	28.0	525
LM G24	24 ±5%	32.0	21.0	480
LM G28	28 ±5%	28.0	21.0	480
LM G48	48 ±5%	17.0	12.0	575
LM G150	150 ±5%	5.5	4.5	675

NOTE:

Space does not permit listing all LM Series fixed-voltage power supplies. In every package size there are models for each voltage range listed under the B package and all units are multi-current-rated for 40°C, 50°C, 60°C and 71°C. Call or write for data and prices.

* Current rating is from zero to I max. at ambient. Current rating applies over entire output voltage range.

Current rating applies for input voltage 105-132 VAC 55-65 cps.

For operation at 45-55 cps derate current rating 10%.

For operation at 360-440 cps consult factory for ratings and specifications.

** Prices F.O.B. Factory, Melville, N. Y. All specifications and prices subject to change without notice.



SEND FOR NEW CATALOG ON FIXED VOLTAGE
AND WIDE RANGE MODULAR POWER SUPPLIES

The devil's advocate



That's one of the many roles played by our Corporate Director of Reliability. He's responsible for the reliability of all IRC products. He double-checks basic designs. Keeps an eagle eye on production. Never goes easy on inspection and testing.

He's not above stopping a shipment at the door if it doesn't meet IRC's standards. Even if it *does* meet the customer's specifications.

This IRC attitude toward total reliability has practical advantages for you. Now you can choose from several optimum economical levels of reliability in resistors, potentiometers and semiconductors. And IRC is the

first to *publish* prices for standard metal films at three reliability levels.

At IRC, reliability is a management responsibility . . . not just a specification gesture. For top management attention, address your questions on reliability to our Director of Reliability.

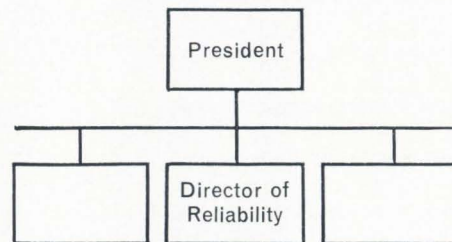

IRC, Inc., Philadelphia, Pa. 19108



Field effect multiplies tube's gain 100 times

Eliminating the grid and channeling electrons with a magnetic field gives a simple but rugged triode with high gain and efficiency

Many problems associated with using vacuum tubes as a high-power source are eliminated in a triode, called a field effect tube, introduced at the Electronic Devices Conference in Washington last week. Since many of the vacuum tube's problems stem from the fine wire grid in the path of electron flow, the manufacturer, the Amperex Electronic Corp., has eliminated the grid in the path of electron flow, between and are controlled by two parallel plates, called the gate; other versions have a concentric cylinder for the gate, with the electron flow along the axis.

In conventional vacuum tubes, electrons striking the grid reduce the tube's gain, cause secondary emissions that reduce the grid's control and may cause the grid to emit gases that poison the cathode. Grids also present problems of thermal deformation and mechanical damage.

In the Amperex tube, a magnetic field applied parallel to the gate-plates or along the cylinder axis prevents most emitted electrons from hitting the gate structure. The result: the tube's gain increases by a factor of over 100, and gassing and secondary emission are reduced.

Because the gate is solid metal, it is extremely rugged and has better heat conductivity than a grid. Because of the tube's simplicity, Amperex expects it to be cheaper to build than other power amplifier tubes. And because the gate can handle high input powers without overheating, Amperex says it is possible to build tubes with continuous wave outputs as high as 1 megawatt. In a conventional tube, the power that the grid can handle limits the maximum power output of the tube.

Amperex claims that the power gains are in the order of 5,000 to 10,000 and power outputs are in

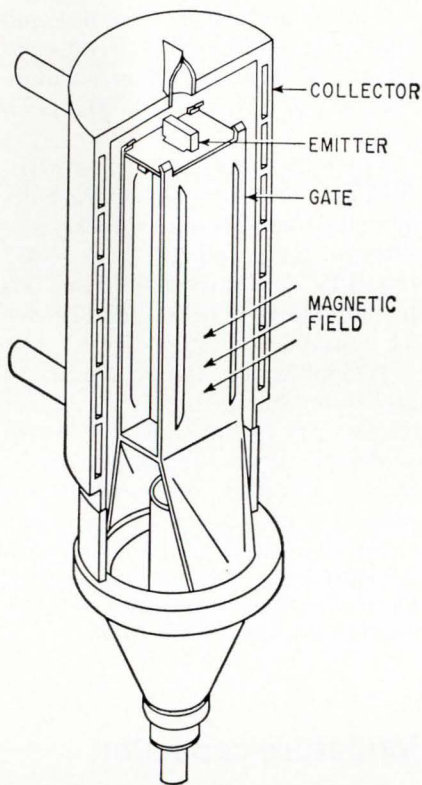

In the field effect triode, the emitter, gate and collector correspond to a conventional tube's cathode, grid and plate. Gate structure is solid metal, however, and therefore is very rugged. Magnetic field prevents electrons from hitting gate and increases tube's gain.

the kilowatt range. Conventional triodes have gains of 10 to 40 while tetrodes have gains less than 500. According to Eduard G. Dorgelo, Amperex's vice president of research and development, pentode power amplifiers can have gains in excess of 10,000, but they also have all the problems of a multi-grid tube.

Dorgelo indicates that the basic principles in the new design have been known for years and says he considers the field effect tube as the simplest three-electrode tube that can be built.

Amperex will market the first field effect tube early next year. It

will be a 1.2 kw tube with a gain of 5,000 and an efficiency of 80% to 85%. Dorgelo indicates that the tube's efficiency is as much as 20% greater than conventional triodes because fewer electrons are intercepted by the gate and the magnetic field reduces the effect of secondary emission from the plate.

Machlett Laboratories, Inc., Springdale, Conn., an affiliate of the Raytheon Co., also produces tubes with a magnetic beaming principle that reduces the number of electrons that the grid intercepts from about 20% to 25% to about 2% or 3% [Electronics, July 27, 1965, p. 32]. The tubes have gains of about 500 and supply powers of up to 200 kw. However, the tubes still have grids.

Amperex began developing its tube in 1964. In July, 1965, it received a contract from the Navy Bureau of Ships' electronic division to determine if the tube would surpass commercially available tubes. The Navy is considering it for shipboard applications such as sonar.

The tube has also been tested at frequencies as high as 450 megahertz for an Air Force application. Dorgelo says that the large spacings in the tube result in large transit times—the time it takes for an electron to get from the emitter to the collector—and consequently the tube is not suitable for microwave frequencies.

Amperex says that the tube also has applications in amplitude-modulated broadcasting, induction and dielectric heating and as a power switcher for a radar modulator. Applications in frequency-modulated broadcasting are also possible although the tube has not been tested in this field.

Amperex Electronic Corp. 230 Duffy Ave. Hicksville, L.I., N.Y.,

Circle 350 on reader service card.

New Components and Hardware

Nonmagnetic guides hold p-c boards

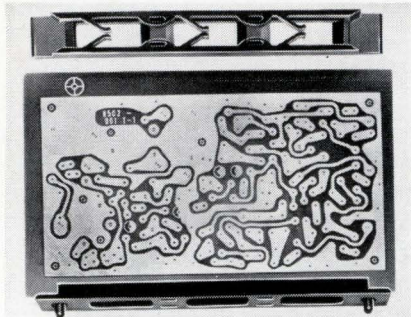

Board guides for printed circuits include integral cantilever spring grips that prevent lateral motion and provide high retention under severe stress, shock and vibration. The series 30 units are polycarbonate, nonmagnetic, one-piece, and lightweight. Gauges from 0.050 to 0.125 in. can be held. Integral press lugs let the guide snap into place without fasteners.

The corrosion-proof guides withstand temperatures up to 250°F. Open areas in the holders permit air to flow easily to the circuits.

The guides, which recover rapidly from stress, are priced at 15 cents each in quantities of 5,000. Taurus Corp., Academy Hill, Lambertville, N.J., 08530. [351]

Small relay provides clean switching action

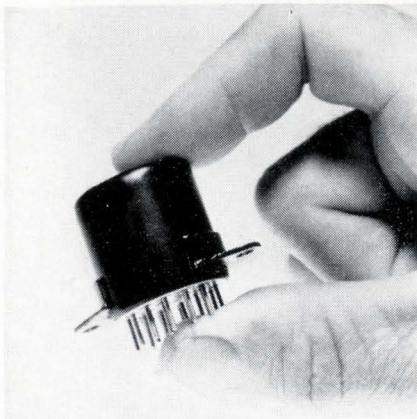

Miniature 4pdt relays provide extremely low contact resistance of 0.05 ohm maximum at first and

0.10 ohm maximum after life. Measuring 1 in. in diameter by 1 in. high, the series 350 relay offers optimum operation for dry circuit (low-level) to 2-amp applications.

A wedge action contact mechanism and a linear solenoid motor for minimum contact bounce and chatter provide a dry-circuit confidence of 90% based on a failure rate of 0.001% per 10,000 operations.

The relays meet or surpass MIL-R-5757/7 requirements and are designed to operate under these conditions: temperatures from -65° to +125°C, vibration, 30 g to 3,000 hz, and shock of 100 g for 11 msec (± 1 msec).

Weighing only 2.2 oz, the relays are interchangeable with other makes. They are offered with solder hook or plug-in terminals. Standard sockets are available for plug-in types. Contact surfaces are electrodeposited gold over electrodeposited fine silver.

Electro-Tec Corp., P. O. Box 667, Ormond Beach, Fla., 32074. [352]

Miniature capacitor inserts automatically

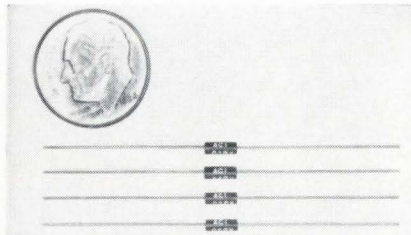

A microminiature ceramic capacitor of rugged molded construction and uniform size is intended for automation insertion and use in any application that must meet MIL-C-11015C. Layers of dielectric are controlled so uniformly that voltage breakdown runs as much as 15 times the rated voltage.

The C-02 capacitor measures 0.195 in. long by 0.070 in. in diameter. Leads of tinned copper or gold-flashed dumet, which can be welded or soldered, are 1 in. long and 0.015 in. in diameter.

Capacitance ranges from 100 to 2,200 pf and 2,700 to 4,700 pf at 100 and at 50 v, respectively, with operating temperature from -55° to +125°C for all conditions. Standard tolerances are $\pm 10\%$ and $\pm 20\%$, with closer tolerances, including unbalanced tolerances, on request.

Prices range from 41 cents to \$2.54. Small quantities are available from stock; production quantities, 4 to 5 weeks' delivery. A sample of the C-02 and a technical bulletin are available.

American Components, Inc., 8th Ave. at Harry St., Conshohocken, Pa., 19428. [353]

Metal film resistors feature low values

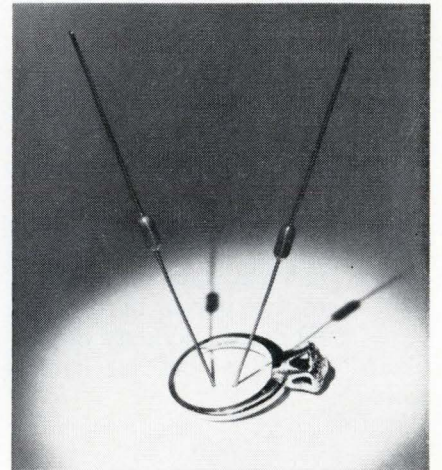

The PME metal film resistors feature a temperature coefficient of ± 10 ppm/°C and values as low as 10 ohms. They are also available in temperature coefficients of ± 25 , 50 and 100 ppm/°C and resistance values up to 3 megohms.

The resistor, rated at 1/10 watt, measures only 0.250 in. long x 0.095 in. in diameter. It features the manufacturer's Pyroclad protective covering and a special end cap construction which the company says offers exceptionally high protection against moisture and environmental extremes. Their small size suits the units for precision miniaturized equipment with either conventional wiring or p-c boards. The PME 55 is designed to meet all the requirements of MIL-R-10509.

Pyrofilm Resistor Co., Inc., 3 Saddle Road, Cedar Knolls, N.J. [354]

GRAPHS AND CHARTS ARE INTERESTING DON'T YOU THINK?

The ones appearing below feature our 2SC684 transistor and 1S750 diode, both recommended for use in UHF TV sets.



The 2SC684 is an epoxy-housed silicon NPN epitaxial transistor for use as a local oscillator on UHF tuners.

MAXIMUM RATINGS ($T_a = 25^\circ\text{C}$)

Item	Symbol	2SC684	Unit
Collector to Base Voltage	V_{CBO}	30	V
Collector to Emitter Voltage	V_{CEO}	19	V
Emitter to Base Voltage	V_{EBO}	2	V
Collector Current	I_C	50	mA
Emitter Current	I_E	-50	mA
Collector Dissipation	P_C	200	mW
Junction Temperature	T_j	125	$^\circ\text{C}$
Storage Temperature	T_{stg}	-55~+125	$^\circ\text{C}$

ELECTRICAL CHARACTERISTICS ($T_a = 25^\circ\text{C}$)

Item	Symbol	Condition of Measurement	min.	typ.	max.	Unit
Collector Cut-off Current	I_{CBO}	$V_{CB} = 10\text{ V}, I_E = 0$	—	—	0.5	μA
DC Current Transfer Ratio	h_{FE}	$V_{CE} = 10\text{ V}, I_C = 10\text{ mA}$	20	40	—	—
Collector to Emitter Saturation Voltage	$V_{CE(sat)}$	$I_C = 20\text{ mA}, I_B = 4\text{ mA}$	—	0.2	1.0	V
Collector Output Capacitance	C_{ob}	$V_{CB} = 10\text{ V}, I_E = 0, f = 1\text{ MHz}$	—	1.0	2.0	pF
Gain Band Width Product	f_T	$V_{CE} = 10\text{ V}, I_C = 10\text{ mA}$	600	1100	—	MHz
Base Time Constant	$\tau_{bb'} C_{cb}$	$V_{CB} = 10\text{ V}, I_C = 10\text{ mA}, f = 31.8\text{ MHz}$	—	10	25	ps
Oscillation Power Output	P_{out}	$V_{CB} = 10\text{ V}, I_C = 10\text{ mA}, f = 930\text{ MHz}$	3	8	—	mW

MAXIMUM RATINGS ($T_a = 25^\circ\text{C}$)

Item	Symbol	1S750	Unit
Peak Reverse Voltage	$V_{R\ peak}$	-2	V
Average Rectification Current	I_O	20	mA
Storage Temperature	T_{stg}	-55~+120	$^\circ\text{C}$
Lead Temperature (Note)		300	$^\circ\text{C}$

Note Value at the point 5 mm far from the lead root.
The diode should not be kept at this value over 10 seconds.

ELECTRICAL CHARACTERISTICS (I) ($T_a = 25^\circ\text{C}$)

Item	Symbol	Condition of Measurement	Min	Typ	Max	Unit
Forward Current	I_F	$V_F = 0.5\text{ V}$	8	15	—	mA
Reverse Current	I_R	$V_R = -0.5\text{ V}$	—	-8	-25	μA
Diode Capacitance	C	$V_a = -0.5\text{ V}, f = 1\text{ MHz}$	—	0.4	0.85	pF

ELECTRICAL CHARACTERISTICS (II) ($T_a = 25^\circ\text{C}$)

Item	Symbol	Condition of Measurement	min.	typ.	max.	Unit
Total Noise Figure	NF	$f_s = 887\text{ MHz}, N_{IF} = 2.8\text{ dB}$ $I_O = 2\text{ mA}, Z_{IF} = 155\ \Omega$ $R_L = 6.3\ \Omega, f_{IF} = 44\text{ MHz}$	—	11	15	dB
Conversion Loss	I_L	$f_s = 887\text{ MHz}, N_{IF} = 2.8\text{ dB}$ $I_O = 2\text{ mA}, Z_{IF} = 155\ \Omega$ $R_L = 6.3\ \Omega, f_{IF} = 44\text{ MHz}$	—	8	—	dB

If you found all this informative you may like to inquire further to:



HITACHI SALES CORPORATION: 333 N. Michigan Avenue, Chicago, Ill. 60601, U.S.A. Tel: 726-4572/4/666, 5th Avenue, New York, N.Y. 10019, U.S.A. Tel: 581-8844 / HITACHI, LTD., DUESSELDORF OFFICE: 4 Duesseldorf, Graf Adolf Strasse 37, West Germany Tel: 10846

Dual-gate MOS FET mimics cascode tubes

A transistor that acts like a pair of triode electron tubes in a cascode circuit arrangement has been developed by the Radio Corp. of America. An insulated double-gate field effect transistor, it may offer better performance characteristics than any bipolar or single-gate field effect transistor on the market, RCA says. It could mean a whole family of new transistors. Sample quantities of two versions are available.

Model TA7010 is designed for military and industrial communications receivers in the very high frequency and ultrahigh frequency ranges up to 500 megahertz. Model TA2644 is intended for mobile communications receivers in the vhf range, up to 275 Mhz. Although this unit could be used for radio and television receivers, RCA is planning to market a specialized version for consumer applications.

All versions are n-channel, metal oxide semiconductor, field effect transistors. Each contains two insulated gates effectively connected in a series cascode configuration on the silicon base. RCA believes it is the first transistor with dual gates integrated in this fashion. The substrate or junction gate is not used; it is shorted out by tying it back to the source.

What makes the new FET superior, RCA says, is its combination of characteristics. In addition to the wide dynamic ranges, both versions have low cross-modulation characteristic [see curve] and low noise

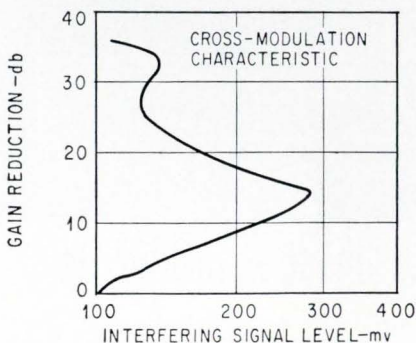

Cross modulation for common source circuit in which desired signal frequency is 200 Mhz and interfering signal is 150 Mhz.

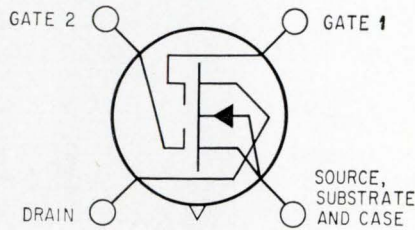

figures. For the high-reliability unit the noise figure is 4.5 db at 400 Mhz; for the lower-level unit, it is 3.5 db at 200 Mhz. Typical power gain for both units at 200 Mhz is 20 db; at 400 Mhz for the military unit, it's 14 db.

When used as an amplifier, the input signal is applied to gate 1 and automatic gain control to gate 2. Because of the series arrangement of the two gates in relation to the channel, two separate inputs can be fed to the two gates. Therefore the transistor can be operated as a product detector. What's more, the good isolation between gates makes the unit usable as a mixer, converter or demodulator.

RCA expects to have production

quantities of the TA7010 by next July. Sample quantities of 1 to 99 cost \$35 each.

Each TA2644 costs \$8 in any quantity. Samples of the consumer version, as yet without number or price, will be available later this year. Both vhf units will be off the production lines in the first quarter of 1967.

Specifications

Model	TA7010	TA2644
Frequency range	D-c to 500 Mhz	D-c to 275 Mhz
Noise figure	4.5 db at 400 Mhz	3.5 db at 200 Mhz
Gate leakage current	0.001 na	0.001 na
Forward transconductance from gate 1 to drain	10,000 μ mhos	8,000 μ mhos
Package	TO-72 can, 4 leads	TO-104 can, 4 leads
Operating temperature range	-65° to 85° C	-65° to 85° C
Drain-to-source voltage	22v, max.	22v, max.
Gate 1-to-source voltage	+5 to -20 v, max.	+5 to -20v, max.
Gate 2-to-source voltage	\pm 20 v, max.	40 v, max.
Transistor dissipation	150 mw, max.	100 mw, max.

Electronic Components and Devices division, Radio Corp. of America, Harrison, N.J. [361]

Hot carrier diodes exhibit low noise

Subminiature hot carrier diodes are optimized for low-noise performance in mixer/detector service at frequencies beyond 8 Ghz. Series 2600 diodes have maximum single sideband noise figure specifications of 7 and 7.5 db (depending on type) with a local oscillator of 1 mw at 8 Ghz, using a 30 Mhz, 1.5 db i-f amplifier. The 1/f noise characteristics are similarly low. Series 2600 is useful well into the X-band.

The devices are metal-silicon Schottky barrier diodes, optimized for use as r-f mixer/detectors from low frequencies through 10 Ghz, intended primarily to replace point contact diodes in critical receiver applications.

In the manufacturer's Style 15 glass package, the series 2600 diodes measure only 150 mils in

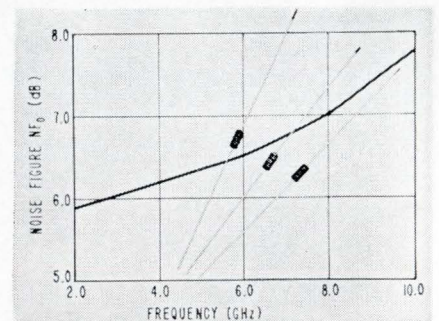

length and 68 mils in diameter. They are also available in Style 19 ferrule packages of similar dimensions for easy replacement without soldered connections, and in Style 20 configuration, which is mechanically interchangeable with the 1N23WE cartridge package.

Operating temperature range is -60 to +125°C. C-w power dissipation at 25°C is 125 mw. Peak power dissipation (for 1 μ sec pulse, duty cycle 0.001) is 0.8 watt.

HP Associates, 1501 Page Mill Road, Palo Alto, Calif., 94304. [362]

WHEREVER COMPUTER PEOPLE MEET—THE TALK IS...

THE NEW COMCOR Ci-500

SAME COMPONENTS AS CI-5000



ALL SOLID-STATE

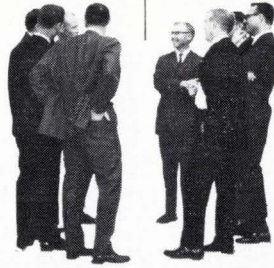

IT'S MEDIUM SIZE

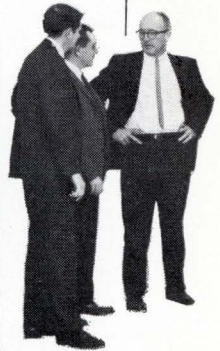

160 OPERATIONAL AMPLIFIERS

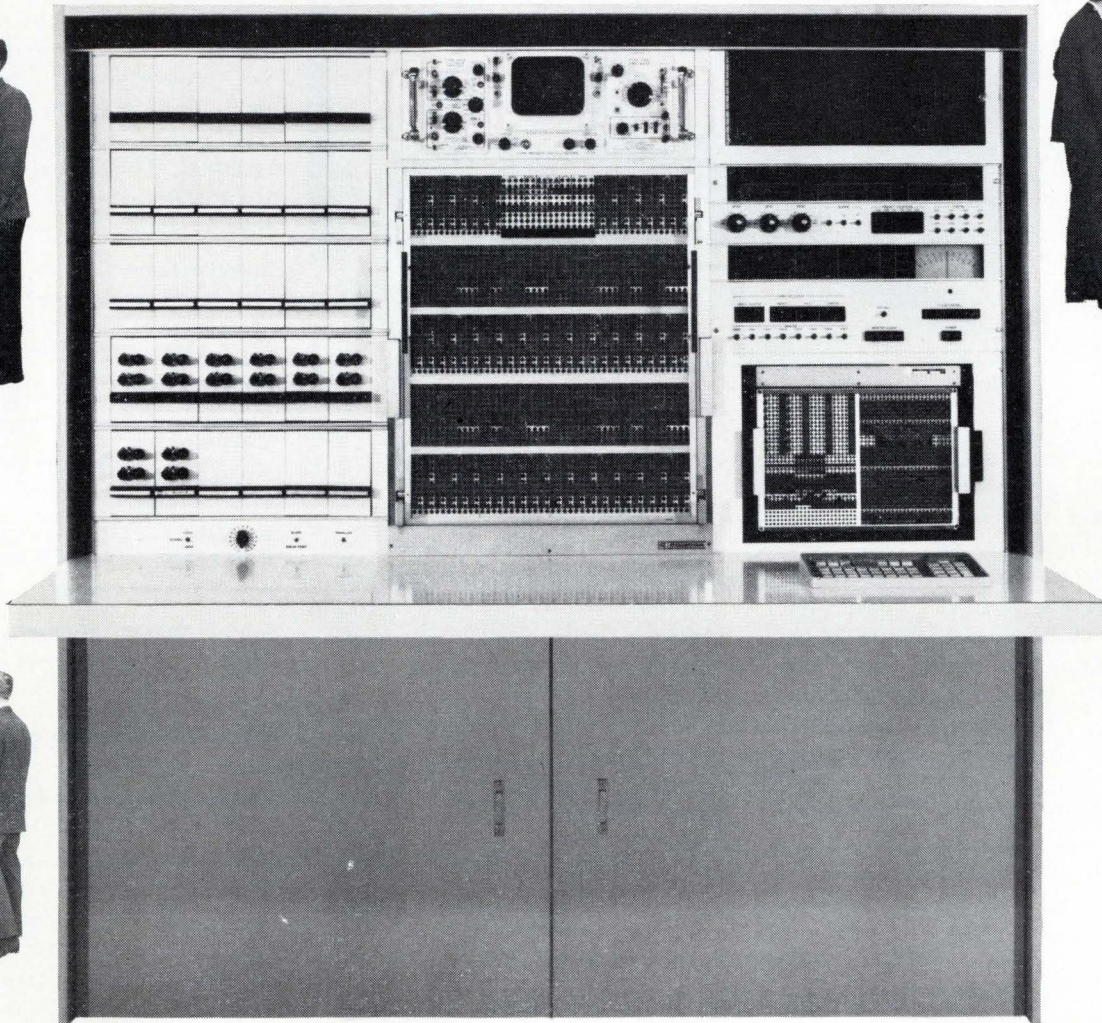

ANALOG/HYBRID



FLEXIBLE



First delivery of our newest system, the Ci-500 took place in October 1966. The Ci-500 is a medium-scale general-purpose analog/hybrid computer that will accommodate up to one-hundred and sixty 100-volt, 50-ma operational amplifiers. All computing components are identical to those used in the larger field-proven Ci-5000 system. High-speed digital logic circuits are used for address and

control functions—the flexibility inherent in all COMCOR systems makes interface with digital equipment for hybrid operation simple and inexpensive. The Ci-500 is the perfect system for simulating and solving your research, development, production, and processing problems. For delivery date, see your COMCOR representative or contact COMCOR direct. (714) 772-4510 TWX: 714-776-2060.



COMCOR

A SUBSIDIARY OF ASTRODATA, INC.

1335 SOUTH CLAUDINA STREET / ANAHEIM, CALIFORNIA 92803

Career opportunities available now in engineering and marketing.

SEE IT AT THE FALL JOINT COMPUTER CONFERENCE



Finding phase angles to 100 khz

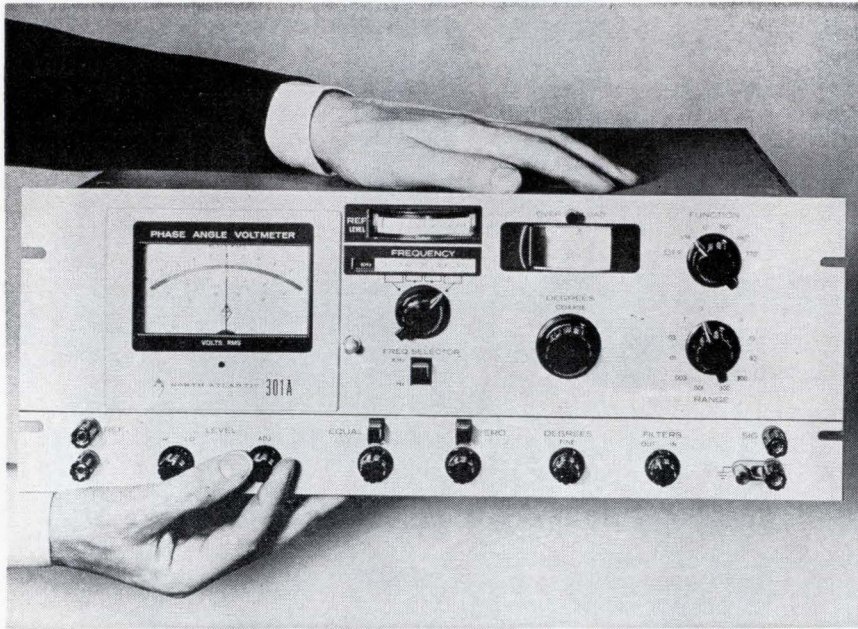

Exploiting a new broadband phase shifter, North Atlantic Industries, Inc., has developed a phase angle voltmeter that overcomes a traditional limitation of these instruments—operation only at discrete frequencies. NAI's voltmeter, model 301A, can operate over a continuous frequency range from 10 hertz to 100 kilohertz and is accurate to within 15 minutes of arc over its full 0° to 360° range, even with distorted input signals.

The new 90° phase shifter, for which the company seeks patents, is in the reference channel of the instrument. It allows half-decade frequency variations without component switching and, as a result, the voltmeter covers the four-decade frequency band in only eight steps with only one variable component. Instruments of comparable accuracy divide the same frequency band into hundreds of spot frequencies.

Basic measurements include determining the phase angle between an input and reference signal, determining the in-phase and quadrature components of an input signal with respect to a reference and the absolute value of the fundamental frequency and the absolute value of the total input voltage.

But, the instrument has hidden features which broaden its applicability, the company reports. The demodulation process, basic to phase-sensitive voltmeters for measuring in-phase and quadrature components of a-c signals, also enables the instrument to function as a very-narrow bandwidth filter—typically 2 hz—tunable over its operating frequency range. This signal selection capability makes it possible to measure signals immersed in heavy noise. The voltmeter inherently rejects harmonics of signals being measured. The phase-sensitive demodulation process cancels even harmonic components and reduces odd harmonics by a factor equal to the order of the harmonic.

Many phase-angle voltmeters display the phase angle readings on the moving coil meter used for voltage readings, thereby limiting phase measurements to the meter's accuracy—usually about 2%. Readings made with the model 301A are taken directly from a calibrated dial mounted on the shaft of the wideband phase shifter. Optical magnification allows dial readings to 0.1°. The phase shifter is calibrated from 0° to 90° and additional 90° phase shifting networks

can be switched into the reference channel to span the range from 0° to 360°.

To make a measurement, the input and reference signals are applied. The instrument is switched to its quadrature reading mode by introducing a fixed 90° phase shift into the reference channel and the quadrature voltage is measured. Next the calibrated phase shifter in the reference channel is adjusted to reduce quadrature voltage to zero. The instrument's sensitivity is progressively increased by switching to lower voltage ranges until the accuracy desired is reached. The actual phase shift is then read directly from the calibrated dial.

Specifications

Voltage range	1 mv to 300 v full scale
Phase angle range	0° to 360° in four quadrants
Frequency range	10 hz to 100 khz
Phase dial	0° to 90°, 0.2° divisions
Accuracy	
Voltage	± 2% full scale over full frequency range
Phase angle	± 0.25°, 31.6 hz to 31.6 khz derating to ± 1° at 100 khz and ± 0.6° at 10 hz
Overload	10 times full scale rating
Input power	115/220 volts, 50 to 400 hz, 80 w
Price	\$2,290

North Atlantic Industries, Inc., 200 Terminal Dr., Plainview, N.Y. [371]

Audio voltage standard cooled by convection

Solid-state audio voltage standard, model 631, is convection cooled and offers variable output voltage from 1 mv to 1011.0 v. An internal oscillator provides full frequency coverage from 50 to 10,000 hr.

Output is automatically protected against overload damage with pushbutton reset. Basic absolute accuracy, including stability for one year, is ±0.035%.

Model 631 is capable of 10 volt-amps of power with less than 0.1% distortion. A three-digit voltage deviation system permits calibrated plus and minus offsets at any voltage setting.

Price will be under \$6,500; delivery, 60 days.

Holt Instrument Laboratories, P.O. Box 230, Oconto, Wisc., 54153. [372]

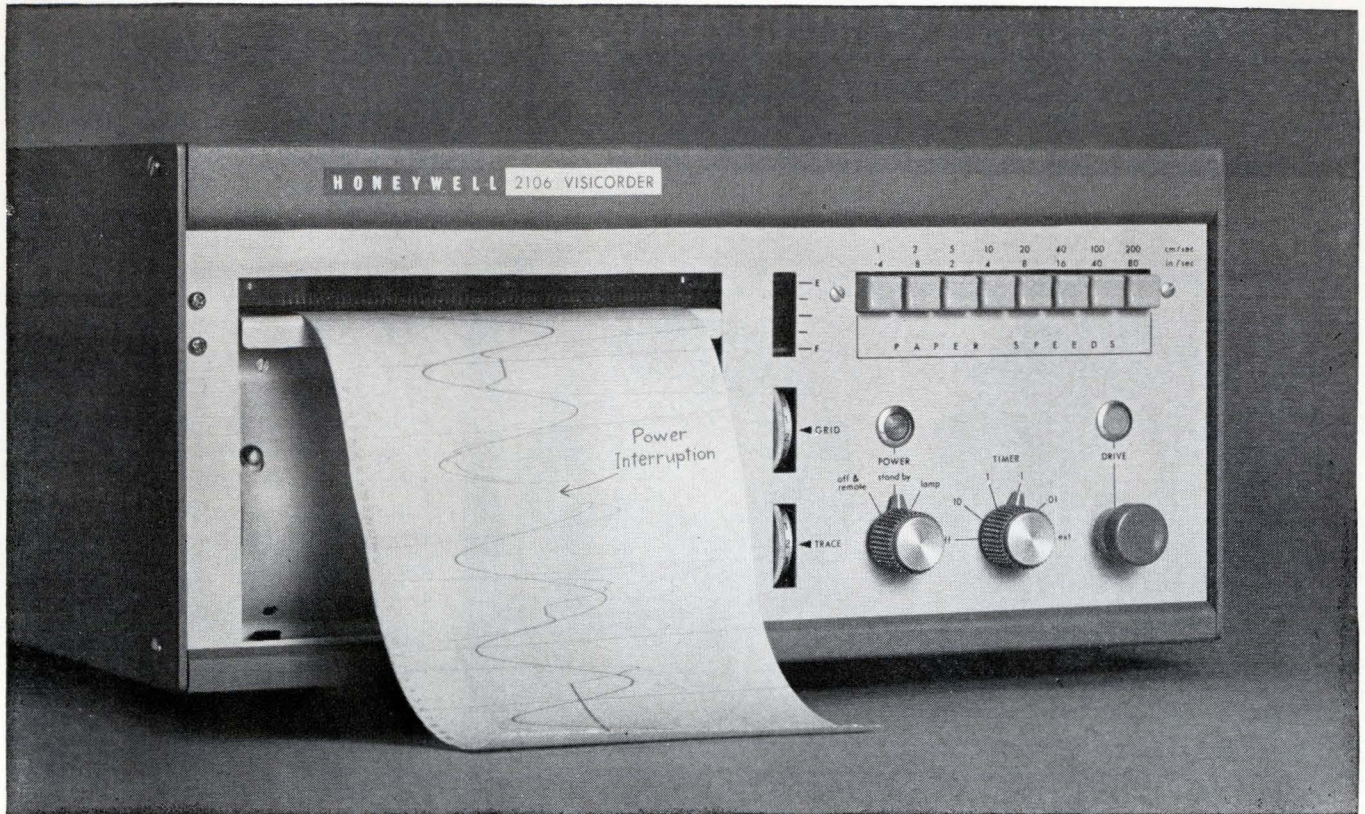

Honeywell introduces Hot Start in a new, low-cost Visicorder

Fast restart ends data loss due to momentary power failure!

No more waits for restarts after a power interruption with the new Honeywell 2106 Visicorder! This compact, low-cost direct recording oscillograph features Hot Start — a new starting circuit which allows resumption of recording with a mercury vapor lamp within $\frac{1}{4}$ second after a momentary power failure. Tests can be resumed without losing irretrievable data and valuable time.

Like all Honeywell Visicorders, the new 2106 produces permanent, immediately readable records of dynamic data by means of ultraviolet light and sensitized recording paper. No inks, styli, vapors, chemicals, or developing solutions are used.

Feature for feature, no other oscillograph in its price range offers the convenience and versatility of the 2106:

- 12 recording channels; DC-13,000 Hz response; 6" wide paper
 - Writing speed in excess of 50,000 inches per second
 - 8 paper speeds from 0.4 to 80 inches per second; fast, convenient pushbutton selection
 - Built-in 4-speed time line system; manually adjustable trace and grid intensity controls on the 2106's front panel
 - Complete remote control capability: power; lamp start; paper drive; chart speed selection; time line interval selection; external time line drive
 - Optional Integral Latensifier available
 - Low profile — just 8.5" high in bench cabinet; 8.75" high in rack mount
 - 120° thermostatically controlled magnet bank is a standard feature
- For dynamic data applications that do not require the sophistication or capacity of larger Visicorder models, the new 2106 has no equal! See your Honeywell Representative for a demonstration of the 2106, or mail the coupon for comprehensive literature.

9-11B

Honeywell, Test Instruments Division
 Denver, Colorado 80217

Please send 2106 Visicorder literature to:

Name _____

Company _____

Address _____

City _____ State _____ Zip _____

DATA HANDLING SYSTEMS

Honeywell

Wide highway into a computer

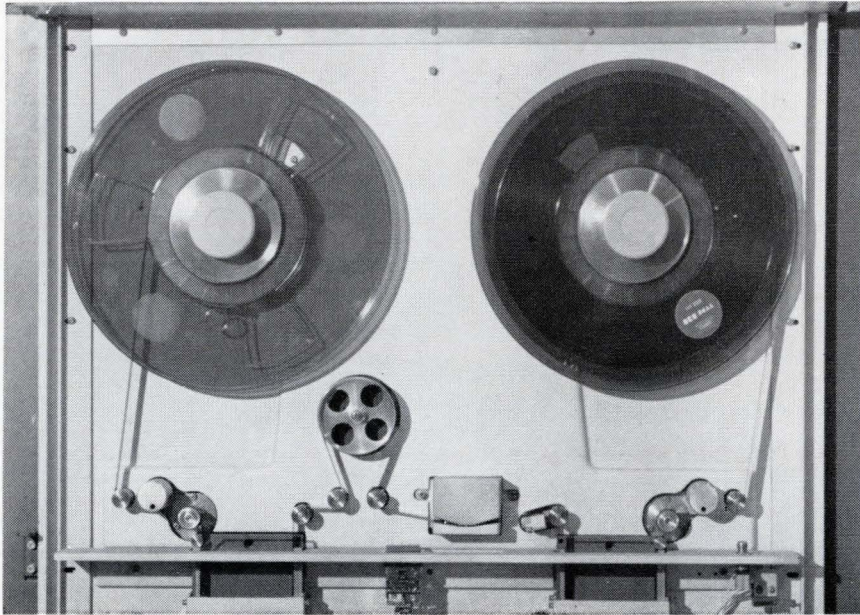

A digital magnetic tape transport that triples the amount of data that can be recorded by conventional transports has been introduced by the Ampex Corp. Built specifically to meet the requirements of oceanographic sounding vessels used in undersea oil prospecting, the transport is also applicable in any instrumentation situation where the outputs of many transducers are being recorded. Seismic and medical data are examples cited by the company.

The new transport, a special model of Ampex's standard TM-11 magnetic tape drive, records 21 channels of data on a one-inch tape. Bit density per track is 356 bits per inch with the tape traveling at 90 inches per second. The standard TM-11 records up to 800 bits per inch on half-inch tape at up to 120 inches per second. The packing density and speed provide the maximum practicable data rate without exceeding the transport's skew-compensating capability.

Skew is a major problem in any magnetic tape transport, and particularly so when wide tape is used. Ideally, the bits in all tracks on the tape would be read at the same instant as the tape passed over the

read-write head, entering the computer exactly in step, like a rank of well-drilled soldiers on parade. But just as soldiers of varying height parading on rough ground are likely to get out of step, so one "frame" of bits written at the same instant across the width of tape is likely to be read at slightly different instants. This can throw off the processing of the data in the computer, which operates under control of a clock and requires all the bits in a character or word to be available at once.

Mechanical skew is caused by misalignment of the read-write heads and tape guides, and by fluttering of the tape in motion; electronic skew arises from variation in the electrical parameters of the read-write circuitry and from complexities in the pick-up of recorded data at high packing densities. The skew is small in Ampex's TM series tape transports because a single capstan controls the tape motion without squeezing the tape between pinch rollers, as do some competitive machines. Skew that does occur is corrected by the standard "character gate," which opens to set bits at random intervals into a

register, and closes while those bits are transferred in parallel to the computer.

Tape transports ordinarily feed data into computers from seven or nine tracks at once, in parallel. No standard computer can accept data from as many as 21 tracks at once; Ampex expects its customers who buy the new 21-track machine either to process the data serially from one track at a time or to provide a special control unit that can funnel the data from 21 tracks into the usual format for computer processing. Ampex does not build control units for any of its tape drives.

Specifications

Speed	90 inches/sec
Packing density	356 bits/inch
Tape width	1 inch
Tape thickness	1.5 mil
Rewind speed	180 inches/sec
Start/stop time	7 milliseconds
Instantaneous speed variation	±3%
Voltage and frequency	105-127 or 205-250 volts a-c, 48-62 hz
Environment	40° to 110° F., 20% to 80% relative humidity
Dimensions	68½ in. high, 28½ in. wide, 29 in. deep

Ampex Corp., 401 Broadway, Redwood City, Calif. [381]

Position indicator for machine tools

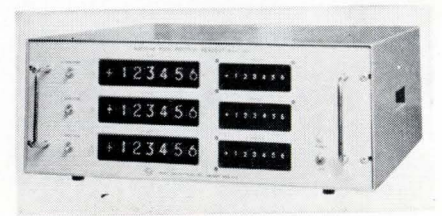

A compact, solid-state position indicator has been designed for application on any machinery with lead screw drive or precision rack-and-pinion position take-off. The system provides reliable, direct-reading digital indication of tool position. Linear or angular position in either two or three axes can be indicated with separate displays for each axis.

The new system employs optical absolute, nonambiguous shaft encoders which provide fixed mechanical zero reference. A built-in electronic calculator continuously

computes the difference between encoder position and a preset reference point for full floating zero.

A unique circuit design time-shares calculator and electronics with two or three encoder inputs, resulting in minimized circuitry, package size and cost.

The circuitry is all silicon solid state for dependability, and consists of replaceable plug-in modules for simple field service.

The system can be used with milling and grinding machines, boring mills, lathes, jig borers, coordinate measuring machines and other tools.

Wang Laboratories, Inc., 836 North St., Tewksbury, Mass. [382]

Reference source boasts high stability

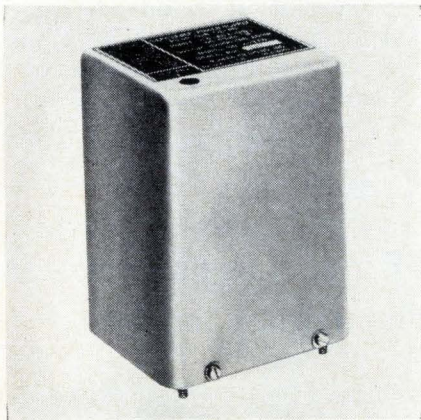

A high-stability, low-impedance reference source is announced. The output voltage of the model X-336 is nominally 10,000 ∇ d-c, adjustable over a ± 50 -mv range by a multiturn potentiometer with a resolution better than 25 μ v. Load regulation is better than 10 μ v for a 10-ma step change.

The unit features a stability of 0.005% per month, a source impedance of 0.5 milliohm and a maximum current rating of 25 ma. It also features remote voltage sensing provisions, self-restoring electronic overload, short-circuit protection and complete repairability.

The unit operates from a 115-v $\pm 10\%$, 60-hz input and weighs 2 $\frac{1}{4}$ lbs. It is housed in a gray enamel case, 3 x 3 $\frac{1}{2}$ x 5 $\frac{1}{4}$ in. (MIL-T-27A) with a solder-lug header. Price is \$275; delivery, 3 to 4 weeks. Power Designs Inc., 1700 Shames Drive, Westbury, N.Y. [383]

NEW Voltage-Controlled Variable-Bandwidth Crystal Filter

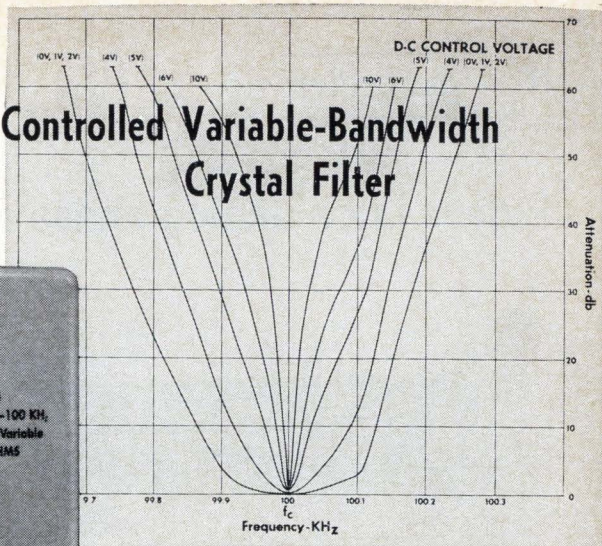

Reeves-Hoffman's new filter performs the functions of several filters of different bandwidths, making it ideal for applications where space is a problem. Bandwidth at 3 db can be varied from 5 to 200 Hz by regulating input voltage from 0 to 10, either linearly or in a series of discrete steps. Center frequency of 100 KHz is standard, but other center frequencies can be provided upon request. We invite your inquiry.

Curves above for Model F3264 (illustrated) show transfer functions of two basic variable-bandwidth sections and a standard fixed bandwidth filter, which limits the 60 db bandwidth. Model F3264 is 4 $\frac{1}{4}$ " x 2" x 3 $\frac{3}{8}$ " high.

REEVES-HOFFMAN DIVISION OF **DCA**

400 WEST NORTH STREET, CARLISLE, PENNSYLVANIA 17013

Circle 171 on reader service card

NEW! FREQUENCY-STABILIZED POWER INVERTER 2 TUNING FORK OSCILLATORS

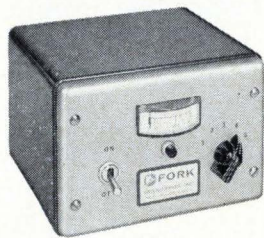

PRECISION POWER INVERTER
60 to 400 CPS, 115 VAC—10 to 200 watts, accuracy to .001%. Power inverter employs precision Oscillator as a time base. Can be used to drive motors for clocks, tape decks, facsimile machines, etc.

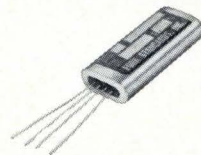

SMALLEST COMPLETE OSCILLATOR
Model MO, in a crystal can, with a frequency range of 800 CPS to 10 KC and accuracy to .005%. Size: 3/4" x 1 $\frac{1}{32}$ " x 1 $\frac{5}{8}$ ".



ECONOMY OSCILLATOR
Model T—gives long-term stability . . . 800 to 7000 CPS. Priced singly from \$29.00 each. Measures 1" x 1" x 2 $\frac{1}{4}$ ".

FORK STANDARDS, INC.
221 Main Street, West Chicago, Illinois 60185

Pulses latch analog phase shifter

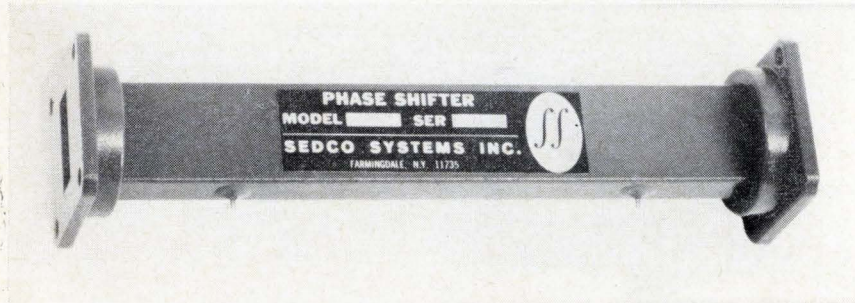

The established latching, ferrite phase shifter may warrant a fresh look as a result of a new technique called flux transfer. By operating the unit at magnetic states intermediate between the ferrite saturation levels, it is possible to reduce the insertion loss to 0.6 db, maintain voltage standing wave ratios of 1.2 over a 20% frequency band, and make the change in phase relatively insensitive to temperature. Furthermore, the phase shifter operates as a continuously shifting analog unit or a discretely shifting digital unit. Pulsed by a transistorized driver, the unit requires only two terminals to achieve any phase shift from 0° to 360°.

Irwin Bardash, an engineer at Sedco Systems, Inc., says the phase shifter was conceived about a year ago at the Massachusetts Institute of Technology's Lincoln Laboratory, and that Sedco experimented with the device for a phased array antenna the company was designing. "It had so many advantages over conventional latching devices that we decided to build and use it," Bardash reports.

A driver circuit "transfers" flux to the ferrite, changing the material's remanent state and consequently the phase shift. The amount of flux, $\Delta\phi$, transferred to the ferrite is proportional to the integral of the pulse voltage, V , and the differential time, dt —that is, $\Delta\phi \propto \int V dt$. Since the pulse voltage is held constant, the change in flux, and consequently the change in phase, is proportional to the time duration of the pulse. When the pulse is removed the ferrite remains

Specifications

Unit	Latching, ferrite phase shifter
Type	2003
Typical frequency range	8 to 10 gigahertz
Operating mode	Analog or digital
Insertion loss	0.6 db
Voltage standing wave ratio	1.2
Power handling	
Peak	2 kilowatts
Continuous wave	20 watts (without cooling)

in its new magnetic state. A full 360° phase shift requires about 10 microseconds.

Since the flux transfer is dependent only on the pulse's magnitude and duration, temperature variations which might change the ferrite's characteristics have little effect on the phase shift. In contrast, conventional phase shifters are temperature sensitive because the ferrite is driven between two temperature-sensitive saturation levels.

For a 360° unit, the maximum change in phase shift in Sedco's unit is only about 11° from dry ice temperatures to 160°F. Bardash says it is possible to temperature compensate the unit by using a thermistor and controlling the driver's pulse duration.

Bardash points out that only two driver terminals are needed to switch the ferrite. In conventional digital phase shifters, there are at least as many terminals as there are bits. The new design significantly cuts the amount of wiring needed in large arrays which might use thousands of phase shifters.

The phase shifters are not stock items, but are designed to special

order. Bardash says that a single unit including the phase shifter and driver would cost about \$400 to \$500. Units can be designed for C, S and X band.

Sedco Systems, Inc., 130 Schmitt Blvd., Farmingdale, N.Y. [391]

Elliptical waveguide for 1.7 to 2.4 Ghz

Type EW17 Heliax elliptical waveguide designed for 1.7- to 2.4-Ghz scatter communication systems will take the place of WR-430 rigid waveguide. The flexible waveguide has an attenuation of 0.29 db/100 ft and an average power rating of 27 kw. With tuned connectors, a 200-ft length has a guaranteed vswr of 1.10 or less.

Available in continuous lengths of up to 500 ft, type EW 17 may be easily formed to a radii of 28 inches in the E plane.

Andrew Corp., P.O. Box 807, Chicago, Ill., 60642. [392]

F-m/c-w transmitter is compact and light

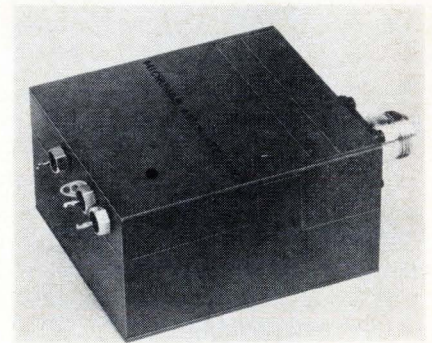

An f-m/c-w tunable, solid-state source that can accept f-m inputs has been designed for operation in communications equipment and other f-m/c-w applications. The transmitter, the MA-82C10, is well suited for wideband television transmission.

The unit provides power output of 200 mw at 4 Ghz. Frequency response is flat within ± 1 db from 5 Ghz to 5.5 Ghz. Linearity is within 2% for 5-Mhz peak deviation. Modulation sensitivity is 30 Mhz per volt.

Compact and lightweight, the

transmitter-exciter operates from +28 v at 300 ma, -28 v at 250 ma and +5 to +10 v for frequency tuning.

Microwave Associates, Inc., Northwest Industrial Park, Burlington, Mass. [393]

Solid-state switch acts in 10 nsec

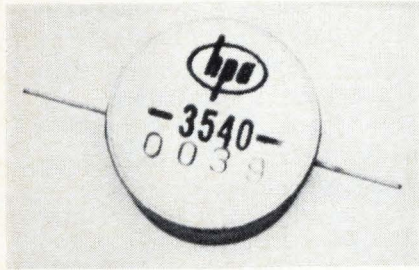

A broadband, solid-state switch operates within 10 nsec, maximum. It is useful from d-c to more than 12.4 Ghz; its insertion loss is low (0.5 to 2.0 db); and its isolation, high (20 to 45 db).

The model 3540 characteristics include miniature size (562-mil diameter, 170-mil thickness, 4.3-gram weight) and hermetic sealing; every unit is helium-leak tested.

The switch, as an electrically actuated control element, is suited for high-frequency and microwave applications in pulse modulators, amplitude modulators, phase shifters, multiple-throw switches, phased-array antennas, power-leveling circuits and pulse shapers.

Switching is accomplished by changing the bias on either center conductor. Signal is passed when the bias voltage is zero or negative. When the two diodes in the switch are forward-biased the matched pair divides current equally. The magnitude of the forward bias current determines the attenuation. Full isolation is obtained with bias currents of the order of 100 ma.

The 3540 consists of two-oxide-passivated silicon p-i-n diodes which are integrated into a broadband 50-ohm microwave structure. The dimensions are optimal for 50-ohm strip line.

The switches are priced at \$175 each in small quantities; \$166.25 in quantities of 10 to 24; and \$157.50 in quantities of 25 to 99. Delivery estimates are two weeks. HP Associates, 1501 Page Mill Rd., Palo Alto, Calif., 94304. [394]

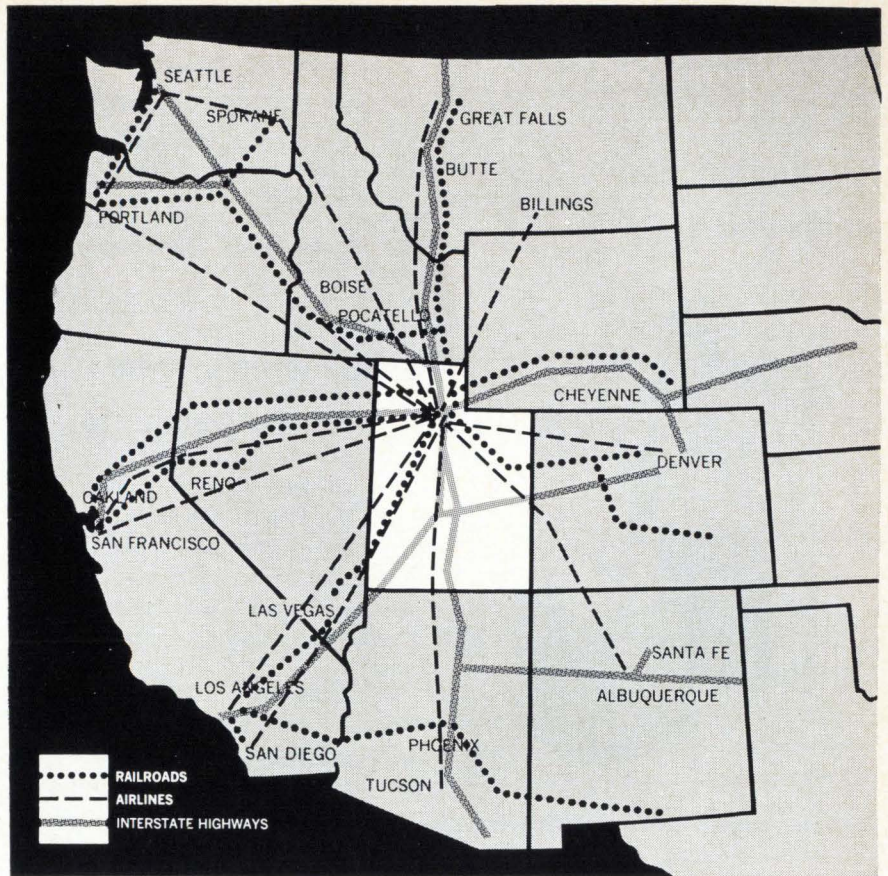

Western distribution problems? Call us, we've got connections.

The shortest distance to ALL major markets of the West is from UTAH... because it's right in the middle. • Locating your plant or distribution center in Utah puts you just a day away from the major cities in a market of 30 million people. This market is growing 30% faster than all America for both population and industry. It's the area of the future. •

FREE: Write for information on "The New Industrial Utah" to Utah Industrial Promotion Commission, Dept. 119, 167 Social Hall Ave., Salt Lake City, Utah 84111.

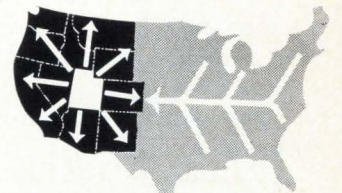

Win the WEST .. from
Utah

Circle 135 on reader service card

To order reprints: Fill in, cut out coupon below, insert in envelope and mail to: **Electronics Reprint Dept., 330 W. 42nd Street, New York, N.Y. 10036**

Reprint order form

For listing of reprints available see the Reader Service Card.

Communications Satellites Part II

Send me reprints of Key no. R-90 at 75¢ each.

For reprints of previous special reports fill in below:

Send me reprints of Key No.(s) @ ¢ each.

(For prices, see Reader Service Card)

Name

Number of street

City, State, Zip code

New Production Equipment

Production laser welds and drills

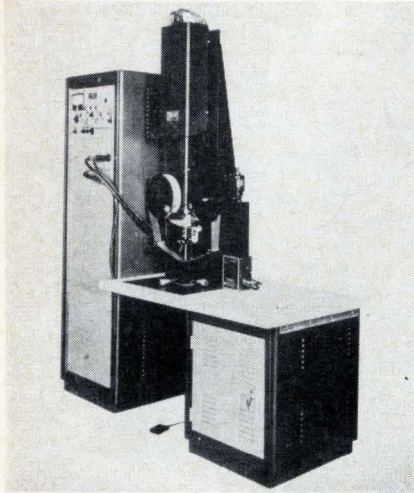

A water-cooled laser welder—with the pulse length variable in six steps—is suitable for micro-spot welding applications. A production unit, equipped with a 10-kw power supply, it produces pulse lengths up to 4 msec and is capable of operation at 1 pulse per sec. With these pulse rates and a feedback to the power supplies, the system is compatible with numerical control systems and complete automation, say the manufacturers. Output energies and pulse lengths are reproducible to 5%.

A microscope with infinity-corrected lenses has par focal focusing ability, that is, viewing is coincident with impact point of the laser beam. It can position within 0.0002 inch; spot size of 0.001 inch can be obtained.

The manufacturer's split cavity design allows interchanging of components without disturbing the alignment with the microscope.

Long pulses up to 20 joules and short pulses to 50 joules are practical as well as pulse reproducibility and low pulse energies. The welder can be operated either automatically or manually. Equipped with safety interlocks, it has protective tape between lens and workpiece to protect the focusing lens from material sputtering off the workpiece. The variable pulse lengths make the laser suitable for

drilling as well as welding.

Prices start at \$12,000.

Applied Lasers division of Spacerays, Inc., 72 Maple St., Stoneham, Mass. [401]

Sequencing system selects and packages

A punched-tape-controlled sequencing system for axial lead components selects parts from up to 39 individual input stations and reel-packages them ready for automatic insertion into printed-circuit boards.

Controlled by a conventional 8-channel punched tape, the sequencer operates at 12,000 cycles per hour regardless of length or complexity of sequencing, or varied sizes of components. Sequence length is not limited to the number of input stations, nor is it necessary to load the stations in the sequence order as in mechanically programed in-line and carousel-type systems.

Where a new sequence utilizes components already loaded in the input stations, only the few minutes needed to change punched tape and take-up reel are required for changeover.

Well suited for long and short production runs, the self-contained system achieves labor savings through nominal operator attendance. Interchangeably dispensing stations are available for lead taped parts as well as magazine loaded and corrugated cardboard packaged parts. All transport of sequenced components is conveyORIZED.

Universal Instruments Corp., East Frederick St., Binghamton, N.Y., 13902. [402]

Solder reflow machine for flatpack operation

A solder reflow machine joins flatpacks or miniature components to p-c boards. Basically, model 950, type SRM consists of an a-c power supply, a programmer and controller for the head actuation, a dual re-

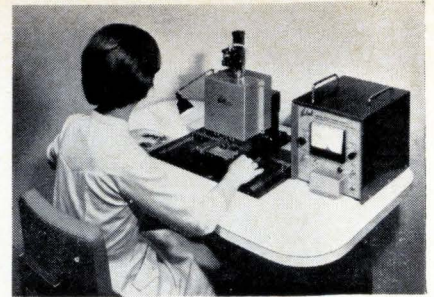

flow solder head which will handle all 14 leads of a flatpack at one time, a p-c board holding and locating fixture, a swing-away component loading device, cooling equipment, and a "white-room" Formica-topped table.

The operator manually positions a flatpack in the loading device, shoves it under the solder reflow head and then actuates the machine for automatic pickup, positioning and reflow soldering of the flatpack to a predetermined location on a p-c board. The entire cycle, including loading, takes 10 to 11 seconds. The machine will accommodate a p-c board up to 5 in. x 7 in.

The programmer/controller guides the operation of the pick-up quill, the reflow solder arms and the cooling mechanism.

P-c board locating fixtures are customized for individual applications.

The cost is \$5,935. Manufacturers who use more than 25,000 flatpacks a year can justify the use of the machine, according to the company, which says the machine will pay for itself in 6 to 10 months. Delivery on the standard console is 6 to 8 weeks.

Weltek division, Wells Electronics, Inc., 1701 S. Main St., South Bend, Ind., 46623. [403]

Soldering station is foot-operated

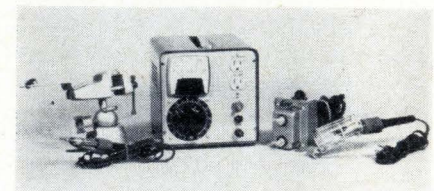

A soldering work station has been developed for training and as a production line tool for Catalog

No. 3 soldering to NASA specification NPC-200-4. It can be bench mounted or used as a semiportable unit for high-quality soldering inside aircraft assemblies, on airborne missile equipment and in similar applications.

The station has a minimum life of 100,000 hours and is foot-operated, freeing the operator's hands. A safety fuse and grounded circuitry safeguards the equipment and operator, an asset in training sessions.

Included is a power supply with a meter accurate to $\pm 1\%$, a 360° ball-mounted vise with positive azimuth control for locking in any position, insulated vise jaws, safety can, cutters, pliers, heat sinks, resistance soldering iron with transformer, conduction soldering iron, foot-operated switch and other equipment and supplies. Florida General Electronics, Inc., P. O. Box 948, Daytona Beach, Fla. [404]

Laser metalworker in modular design

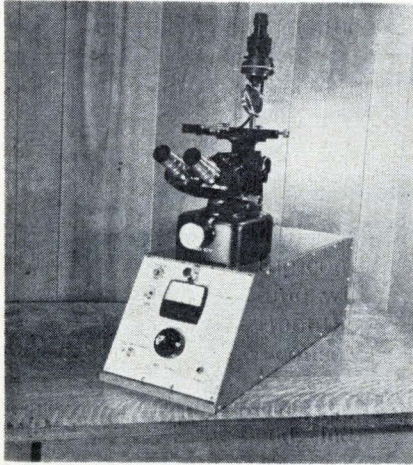

The 9000 series of modular laser metalworking system has been introduced. The basic 9001 system shown is designed for microperforation, for micromachining and for microwelding. It includes a proven, efficient laser head, heavy-duty power supply, binocular microscope with X-Y-Z work stage and pulse-forming module, all at a base price of \$3,770.

Other laser head and power supply configurations are available along with options to suit any customer requirement.

Maser Optics, Inc., 89 Brighton Ave., Boston, Mass., 02134. [405]

PHASE METERS

0.001 CPS TO 18 GC
DIRECT READING IN DEGREES,
PLOT PHASE CURVES

DIRECT READING PHASE METERS TYPE 406 SERIES

1 CPS To 500 KC, Accuracy ± 0.25 Degree



WIDE-BAND PHASE STANDARD

TYPE 209
50 CPS Up
To 10,000 CPS
Accuracy
 ± 0.015

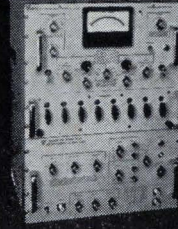

DIGITAL PHASE METER — TYPE 524A3

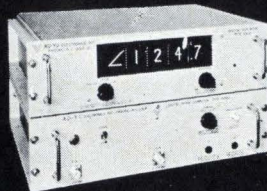

20 CPS Up
To 500 KC
Accuracy
 ± 0.03
Degree

MICROWAVE PHASE and TIME DETECTOR TYPE 206A SERIES

1 GC Up To 8.2 GC, Accuracy $\pm 0.1^\circ$ or $\pm 1\%$

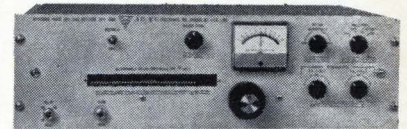

TYPE	1002	406	202,203	205A1-2	422A	205B1-5
FREQUENCY	0.0001 CPS - 2.78 KC	1 CPS - 500 KC	25 CPS - 40 KC	100 KC - 15 MC	50 CPS - 10 MC	15 MC - 1700 MC
ACCURACY	$\pm 0.5^\circ$	$\pm 0.25^\circ$ or $\pm 2\%$	$\pm 0.004^\circ$ or $\pm 2\%$	$\pm 0.25^\circ$ or $\pm 1\%$	$\pm 0.25^\circ$ or $\pm 2\%$	$\pm 0.05^\circ$ or $\pm 1\%$
INPUT AMPL.	2v - 120v	0.05v - 90v	0.4v - 100v	0.1v - 10v	0.3v - 20v rms	5 mv - 10v
READABILITY	0.01°	1/12°	0.002°	0.1°	0.5°	0.1°

ADYU

ELECTRONICS INC.
249 TERHUNE AVE., PASSAIC, N. J.

PHONE: 472-5622
CABLE: ADYU PASSAIC

SEE OUR BOOTH # 1A70 AT THE NEREM SHOW

Circle 137 on reader service card

ELECTRICAL / ELECTRONIC ENGINEERS DESIGN · ANALYSIS · TEST

BSEE, plus appropriate experience in any of the following areas:

- Communications
- Computer Software
- AGE Systems
- Field Engineering
- Circuits/Systems
- Electro-optics
- Microwaves
- Power Systems
- Propulsion
- Instrumentation
- Guidance & Controls
- Batteries

Write: Lockheed Missiles & Space Company,
Professional Placement Staff, Suite 456, 599
North Mathilda Avenue, Sunnyvale, California.

LOCKHEED
MISSILES & SPACE COMPANY
A GROUP DIVISION OF LOCKHEED AIRCRAFT CORPORATION

AN EQUAL OPPORTUNITY EMPLOYER

NEW EG&G SILICON DIFFUSED PHOTODIODE

- HIGH QUANTUM EFFICIENCY
- WIDE SPECTRAL RANGE • FAST RESPONSE TIME • LOW NOISE

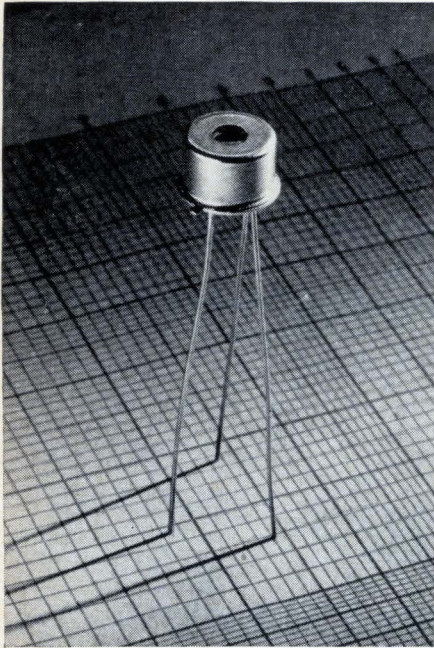

SGD-100 PHOTODIODE

The SGD-100 Photodiode — successor to the popular SD-100 — offers greater sensitivity and lower noise characteristics. Embodying EG&G's improved diffused guard ring design, the SGD-100 has a wide spectral range with an unusually high response in the "blue" region, fast response time and high quantum efficiency. The photodiodes are hermetically sealed in a TO-5 package.

Sensitivity $0.5 \mu\text{A}/\mu\text{W}$ at 0.9 microns
(70% quantum efficiency)

Spectral Range 0.35 to 1.13 microns

Capacitance 7 picofarads at 90v

Rise Time 4 nanoseconds

Leakage $0.2 \mu\text{A}$ at 90v

NEP ($0.9 \mu, 10^2, 1$) 7.9×10^{-13} watts

Linearity of Response over 7 decades

Applications include CW, pulsed light and laser detection and measurement, star tracking, optical navigation, communication and guidance, and range-finding systems. The new SGD-100, also available in calibrated versions, is in quantity production for fast delivery at low price.

For information, write: EG&G Inc., 166 Brookline Avenue, Boston, Massachusetts 02215. Telephone: 617-267-9700. TWX: 617-262-9317.



New Materials

Lead metaniobate for transducer use

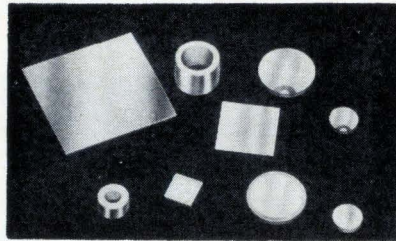

A new ferroelectric ceramic transducer material, lead metaniobate, has low mechanical Q, high Curie temperature and negligible aging characteristic, making it useful for delay lines, thickness gauges, flaw detectors and accelerometers. Suited to wide bandwidth applications, the material complements the company's existing lines of barium titanate, and lead titanite-lead zirconate.

Designated Glennite G-2000, the lead metaniobate ceramic has electromechanical properties similar to barium titanate. However, the new ceramic also exhibits several superior characteristics which are important in many transducer applications.

The material is available in most standard ceramic shapes including thin plates, thin disks and cylinders.

Gulton Industries, Inc., 212 Durham Ave., Metuchen, N.J., 08840. [406]

Lightweight resin casts and encapsulates

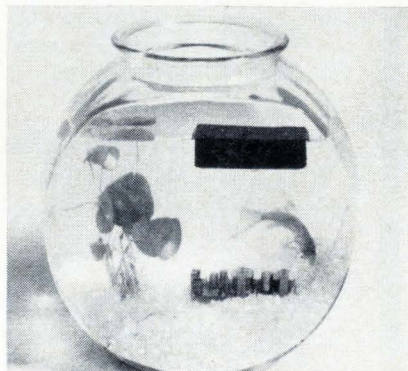

Stycast 1090 is a lightweight casting and encapsulating resin suited

for space applications. Cured specific gravities of 0.85 are realized in contrast to 1.25 for an unfilled epoxy and higher still for conventional filled systems.

The material also provides protection against mechanical shock. In tests a transmitter encapsulated in Stycast 1090 emerged undamaged and still operating after exposure to forces up to 50,000 g. Another transmitter embedded in Stycast 1090 was fired from a 5-in. gun into a lead block and continued to operate. Estimated forces were in excess of 50,000 g. Illustrated is an encapsulated module floating in water.

Stycast 1090, which is called out in Navy Specification OS-11891-B for the encapsulation of flight control modules, has been exposed for 100 hours to 250°F at a pressure of 10^{-6} torr. Weight loss was 0.3% to 0.4%. The combination of low density, ruggedness and low outgassing makes the product ideal for the encapsulation of modules for outer space, the company says. Emerson & Cuming, Inc., Canton, Mass. [407]

Insulation coating in aerosol container

An electrical insulating coating, HumiSeal type 1B12, is available in 16-oz aerosol cans, a packaging that permits rapid coating of repaired areas.

In aerospace programs the coating can insulate printed circuits and electrical assemblies. The product has low outgassing and super-fast drying at room temperature, which contributes to high-speed production.

It is used as a masking material for silicone elastomers when inhibition of the curing system is caused by contact with certain types of materials, such as amine-cured epoxies.

The cans are available from stock at approximately \$2.70 per can in carton quantities.

Columbia Technical Corp., 24-30 Brooklyn-Queens Expressway, Woodside, N.Y., 11377. [408]



Great editorial is something he takes home

(What a climate for selling!)

Electronics

A McGraw-Hill Market-Directed Publication
330 West 42nd Street, New York, N.Y. 10036



New Free Handbook on Servo Packages

Getting our new Servo Package catalog is almost like getting a servo design engineer through the mail. It gives you details about integrators, in-line servos, geared assemblies, data converters, synchronizers, and custom units, *pre-engineered* by Cedar. Write or call us for your free copy.

CEDAR **CONTROL DATA**
ENGINEERING DIVISION CORPORATION

5806 West 36th Street, Minneapolis, Minn. 55416
Phone: (612) 929-1681

Circle 172 on reader service card

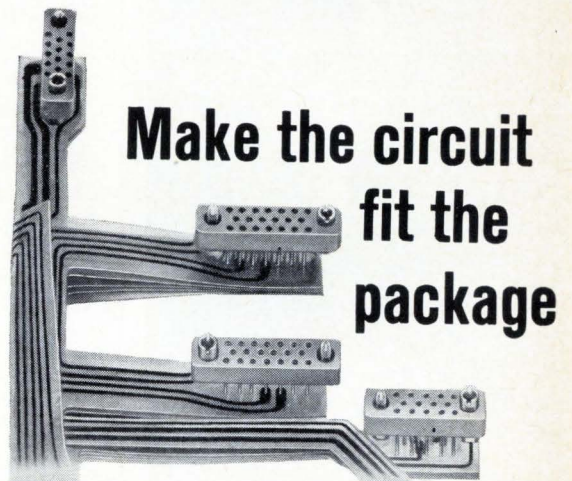

Make the circuit fit the package

FLEXPRIENT® circuitry solves interconnection problems . . . it fits the package and lowers installed costs. It also offers repeatability, ease of assembly, reliability and reduction of rework. Got a circuit interconnection problem? Call us (area code 603) 627-3811. Free literature. Sanders Associates, Inc., FLEXPRIENT Products Division, Grenier Field, Manchester, New Hampshire.

SANDERS ASSOCIATES, INC.
FLEXPRIENT PRODUCTS DIVISION



Creating New Directions in Electronics

*T.M., Sanders Associates, Inc.

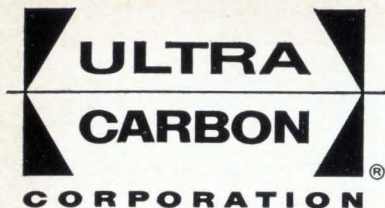

The shape of tomorrow, today

For more than 20 years, Ultra Carbon consistently has provided industry with advanced graphite technology. "F" purity graphite for the AEC . . . semiconductor crystal crucibles, boats, headers and fixtures made from *Ultra purity* graphite—these are typical of our past contributions to the electronic industries.

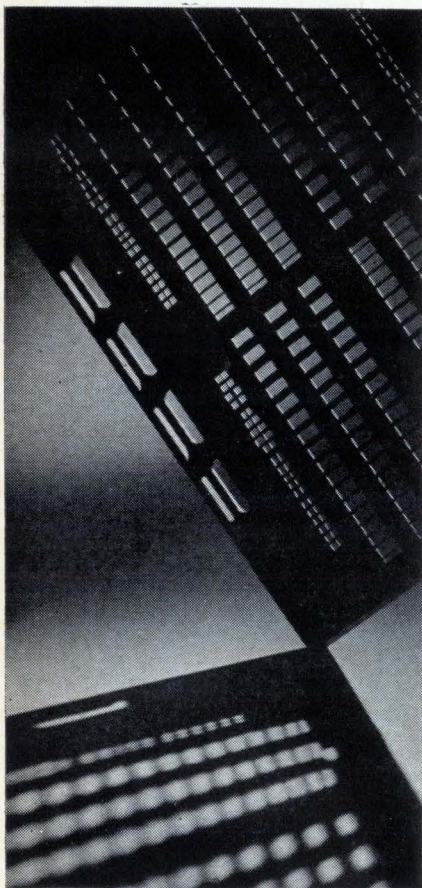

ULTRA/GRAPHITE masks, for processing thin film deposition circuits, are precisely machined. Write for information to Ultra Carbon Corporation, Box 747, Bay City, Mich. 48709.

New Books

How to use IC's

RCA Linear Integrated Circuit Fundamentals
RCA Technical Series IC-40,
Radio Corp. of America, 240 pp., \$2

It is always gratifying when the content of a book lives up to its title. The Radio Corp. of America's manual provides this kind of satisfaction.

The book was intended to guide system designers in the use of RCA's silicon integrated circuits. By explaining the basic principles of linear IC's, along with their performance requirements and capabilities, the book will help engineers to determine optimum design specifications of IC systems.

After a discussion of general IC theory, the basic differential amplifier is thoroughly analyzed as the building block for RCA's IC's. Of considerable value is a discussion of the operational amplifier; its versatility makes it adaptable to IC synthesis. Operational amplifiers can provide solutions to specific circuit problems and perform a variety of mathematical functions. The book ends with an examination of practical circuits for specific applications.

The text is clear and enlightening; all relationships and equations are derived from fundamental principles. Circuit diagrams and performance curves help to explain the ideas.

Edward Keonjian

Grumman Aircraft
Engineering Corp.
Bethpage, N.Y.

High-frequency heating

Heating with Microwaves
H. Puschner
Philips Technical Library,
Springer-Verlag New York Inc., 320 pp.,
\$10.80

The potential of microwave heating is limited in scope only by human imagination. This point is emphasized by Puschner in his readable, well-organized work that will prove valuable to anyone concerned with microwave heating. Unfortunately, however, his applications are limited to those undertaken by the Philips Gloeilampenfabrieken NV.

It is too bad, for the sake of completeness, that contributions by other companies to magnetron inventions, research and development were not included.

Since this is a book on applications it would have been better if the author had stated the design equations for magnetrons rather than provide incomplete derivations.

Applications are presented in an order that allows easy assimilation of new ideas. First come applications of heating in the radiated fields of such devices as spiral antennas, parabolic feeds and waveguide feeds. Next, waveguide theory serves as the basis for introducing cavity resonator concepts. Approximate methods for determining the most effective cavity dimensions are given, and there is a table useful in calculating unloaded resonances. The reader is warned that the insertion of a load changes the resonance patterns, making experimentation necessary before finishing a design. A cavity with one feed and another with two feeds are described to illustrate how multiple feeds improve heating uniformity.

The logical flow of ideas continues throughout the book. A chapter on using triodes in diathermy apparatus at 435 and 915 megahertz is followed by a chapter on the biological effects of microwave energy. The maximum legal exposure limits for the United States and many European countries are listed. The author concludes with techniques for measuring microwave energy, including calculating leakage fields as a safety precaution.

The appendixes give loss factors and dielectric constants for a number of common materials and descriptions of Philips' continuous-wave magnetrons. There is also an extensive bibliography.

The translation from German is good, with only occasional lapses, such as the use of "slight resonances" for "few resonances."

Paul W. Crapuchettes
Electron Tube division,
Litton Industries, Inc.
San Carlos, Calif.

Technical Abstracts

Defense radar

Hard point demonstration array radar
P.J. Kahrilas and Dale N. Jahn
Sperry Gyroscope Co.,
division of the Sperry Rand Corp.,
Great Neck, N.Y.

A unique thinned aperture computed lens (Tacol) antenna makes the hard point demonstration radar (Hapdar) an attractive and practical phased array antenna system. The lens, a passive array capable of collimating a radar beam and steering it in the desired direction, was built for Project Defender, an anti-missile radar study sponsored by the Army's Advanced Research Projects Agency and the Army Missile Command.

Hapdar is a computer-controlled multifunctional array radar system capable of electronically sweeping a pencil beam in two dimensions—azimuth and elevation. A single transmitter illuminates the Tacol lens through a monopulse feed, and electronic scanning is obtained by three-bit diode-controlled phase shifters. Search acquisition and track functions are time shared in the single beam. The result is an inexpensive, highly flexible system that is completely automatic, although Hapdar has provisions for test and manual modes. Since January, Hapdar has tracked controlled aircraft and random aircraft in the system area as well as numerous Athena missile shots.

Hapdar's subsystems were especially designed to work with a very rapidly moving inertialess pencil beam. A conventional monopulse receiver was modified to obtain single-hit normalization and computer-controlled automatic gain control. None of the receiver's circuits has a memory or transients that carry over to the following pulse period; this permits independent data samples on each tracked object each pulse period. Hapdar's general-purpose digital computer processes all tracking data and controls and integrates the system's elements.

The transmitter and the microwave equipment are conventional, though several novel techniques in the receiver provide for better computer control. The computing

subsystems are a Univac 1218 computer, a Univac 1232A input/output console and a Univac 1240 dual tape transport, all made by the Sperry Rand Corp.

At the beginning of a mission, the Hapdar is given a target to track by the White Sands Missile Range data system. The designation coordinates are those of another radar, the discrimination radar, and referenced to its location. The Hapdar computer converts the coordinates so they are referenced to the Hapdar site, and it computes beam steering commands for the beam steering unit. After the coordinates have been converted, the radar executes a limited search of the designated position. The search scan stops when a return signal exceeds threshold level. Additional transmissions verify the existence of a target.

Target amplitude, range and angular signals of the monopulse receiver are in analog form and are converted by the video data processor into digital data. The computer smooths the data for best estimates of position and velocity.

Development of the Hapdar provides a basis for future design of low-cost radar systems that must track many targets and perform several functions with high performance.

Presented at the Aerospace and Electronic Systems Convention, Washington, Oct. 3-5.

Checkup for IC's

New test techniques for digital integrated circuits
William T. Rhoades
Hughes Aircraft Co., Fullerton, Calif.

Integrated-circuit manufacturers haven't standardized on the characteristics of monolithic digital circuits and the user can't take the IC's apart to probe the quirks of individual elements, so the system designer needs adequate techniques for evaluating IC performance in systems. Manufacturers' specifications are not necessarily meaningful when a number of circuits are uniquely combined in a system.

Variations in definitions of such values as "normal" on or off volt-

age make noise margin specifications an inaccurate means of comparing different gate circuits. The amounts of noise energy that produce a given change in input voltage also vary from one type of gate to another. So, direct-current noise margin is useful as a figure of merit, but not to accurately determine true noise margin in a system.

Noise margin is properly the magnitude of an extraneous input that will cause an error in a logic chain when added to the worst-case input level. The point at which a gate changes state depends greatly upon fan out and other in-use characteristics. Breakpoints in the gate transfer curves are likely to be different from threshold points. The author illustrates this by showing the transfer curves, and variations in curve slopes, for a typical high-level transistor-transistor-logic gate.

The uncertainties can be made insignificant by measuring the transfer curves across a pair of gates. A pair of HLTTTL gates exhibits sharp transition points in the transfer curve. Tests which simulate dynamic conditions in the system are also needed. A standard method is to cascade the gates and subject them to worst-case d-c noise. The designer should ascertain that gain through the circuits does not raise the noise level to a point that causes a gate to switch in error. If the noise is attenuated as it propagates through the chain, it can be kept low enough to prevent errors.

Testing of a pair of gates is also useful in determining ground-noise margins, the amount of noise signal that can safely be added to or subtracted from ground. Tests can be made at worst-case polarities as well as under worst-case noise, again making uncertainty low.

The author also reviews d-c and a-c noise margins under dynamic system conditions, dynamic impedances for matching gates to transmission lines, the capacitance factor in propagation delay and the inductance factor that affects current drain.

Presented at National Electronics Conference, Chicago, Oct. 3-5

MINIATURE delay lines

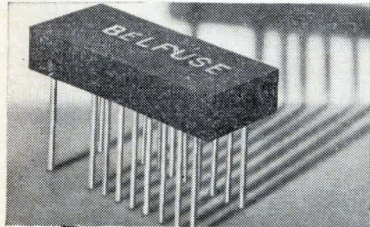

One of a series of miniature delay lines compatible with high density computer circuitry.

BF-14-155. Delay: 15 nsec tapped every nsec.
Impedance: 93,200 or 500 ohms.
Bandpass: 60 megacycle.
Size: Under ¼ cubic inches.

For delay line miniaturization where reliability, bandpass, and quality must be maintained at reasonable cost, let us show you what can be, and has been done.

Price: Under \$8. ea. (prod. qty.). Avail.: Stock to 2 wk.

CATALOG AVAILABLE ON REQUEST

bel FUSE, INC.
198 Van Vorst St.
Jersey City 2, New Jersey

Circle 173 on reader service card

New Literature

Sealed capacitors. The Gudeman Co., 340 W. Huron St., Chicago, Ill., 60610. Engineering bulletin No. 410 covers a series of miniature metalized polycarbonate capacitors in hermetically sealed (glass-to-metal) tubular metallic cases.

Circle 420 on reader service card.

Interval timers. Eagle Signal division of E.W. Bliss Co., 736 Federal St., Davenport, Iowa, has available a two-page bulletin describing the CE11 series transistorized interval timers. [421]

High-voltage supply. Keithley Instruments, Inc., 12415 Euclid Ave., Cleveland 6, Ohio, has published a two-page engineering note on the model 240A, a compact, accurate high-voltage supply for laboratory and production testing. [422]

Sweep oscillator. Spectral Dynamics Corp., P.O. Box 671, San Diego, Calif., 92112, has an eight-page manual describing 12 distinct applications for a linear or log sweep oscillator. [423]

Operational amplifiers. Analog Devices Inc., 221 Fifth St., Cambridge, Mass., 02142. Nine operational amplifier types, ranging from \$19 to \$85, with most listed below \$60, are described in a short-form catalog. [424]

Module tester. Radio Engineering Laboratories, a division of Dynamics Corp. of America, 29-01 Borden Ave., Long Island City, N.Y., 11101. A technical data sheet discusses a module test fixture that permits easy testing of printed circuits, subassemblies and other modules of REL's 2600 series radio relay equipment. [425]

Pushbutton switch. The Arrow-Hart & Hegeman Electric Co., 103 Hawthorn St., Hartford, Conn. Bulletin PB-1 gives information on the advantages and operating characteristics of the type PMQ subminiature, pushbutton snap-action switch. [426]

Power spectral density analysis. Spectral Dynamics Corp. of San Diego, P.O. Box 671, San Diego, Calif., 92112. A four-page data sheet deals with the SD1001-1 and SD1001-2 automatic power spectral density analysis systems. [427]

Acetone soluble adhesive. Aremco Products, Inc., P.O. Box 145, Briarcliff Manor, N.Y., 10510, has published a bulletin on Crystalbond 509, an acetone soluble adhesive suited as a temporary bond for delicate crystals, glass components and ceramic substrates during machining, slicing, dicing, grinding and polishing. [428]

Limiter-attenuator. Microwave Associates, Burlington, Mass. Bulletin 7034 gives complete specifications for the MA-8446-S1T limiter-attenuator which provides receiver protection over the 2.2-gigahertz to 2.3-Ghz range with a maximum insertion loss of 1 db. [429]

Switch selection guide. MicroSwitch, a division of Honeywell, Inc., 11 W. Spring St., Freeport, Ill., 61032. Said by the company to be the most complete switch selection guide ever assembled, the 72-page catalog, 50b, is border-indexed for reference to more than 1,000 switches. [430]

Facilities brochure. Superior Manufacturing & Instrument Corp., Long Island City, N.Y. A 16-page brochure contains a description of the company's engineering and quality assurance programs and a list of facilities for the production of components and systems. [431]

Variable leak valve. Vacuum division of Varian Associates, 611 Hansen Way, Palo Alto, Calif., 94303, has released a four-page data sheet showing features, specifications and drawings of a variable leak valve. [432]

Shipboard recorder. Leach Corp., 1123 Wilshire Blvd., Los Angeles, Calif., 90017. Bulletin MTR-4200-866 covers a rugged shipboard tape recorder, with signal-to-noise performance of better than 40 decibel broadband and better than 75 db single cycle. [433]

Germanium detectors. Technical Measurement Corp., 441 Washington Ave., North Haven, Conn., 06473. Specifications and a reduced price schedule for lithium-drifted germanium detectors are contained in product bulletin No. 45. [434]

Filters. Spectrum Systems, Inc., Bear Hill Industrial Park, 11 Fox Road, Waltham, Mass., 02154, has issued a two-page bulletin describing and showing curves for visible light and near infrared filters. [435]

Time code generators. The A.W. Haydon Co., 232 North Elm St., Waterbury, Conn., 06720. Product information sheet No. 133 contains essential technical data on series K42601 and K42602 low-cost electromechanical time code generators. [436]

Operational amplifiers. Melcor Electronics Corp., 1750 New Highway, Farmingdale, L.I., N.Y., 11735. A condensed two-page catalog, No. C1002, describes an economy line of high-performance, miniature operational amplifiers. [437]

LOW LOSS CASTING RESINS

EMERSON & CUMING, INC. PRELIMINARY TECHNICAL DATA SHEET

Low Loss Resin Temperature Cycling Test

	Stycast 35	Stycast 35D	Stycast 35PE	Stycast 3518
Material	Polystyrene	Cross-linked Polystyrene	Cross-linked Polystyrene-ethylene	Cross-linked Low Density
Color	Clear	Clear	Opaque	Opaque
1.0 cps	1.85	1.95	1.9	1.9
0.10 cps	2.6	2.6	2.5	1.9
tan δ	<0.001	<0.001	<0.001	<0.001
Temp. °F	-20 to +170	-20 to +300	-65 to +300	-65 to +300
% (Relative)	Fair	Fair	Good	Good
(Relative)	Fair	Fair	Good	Good
	Good	Excellent	Excellent	Excellent
psi	13,000	14,000	11,000	5,000

FREE CHART

Ten Low Loss systems are offered for both room and elevated temperature cure. Dissipation factors are below 0.001 for minimum effect on circuit operation. Dielectric Constants as low as 1.7. Temperature capability to 400°F.

This valuable Chart is yours. Write or Use Reader Service Card

EMERSON & CUMING, INC.

CANTON, MASS.

604 W. 182nd St.
Gardena, Calif.

3450 Commercial Ave.
Northbrook, Ill.



Tired of building "paper" phased arrays?

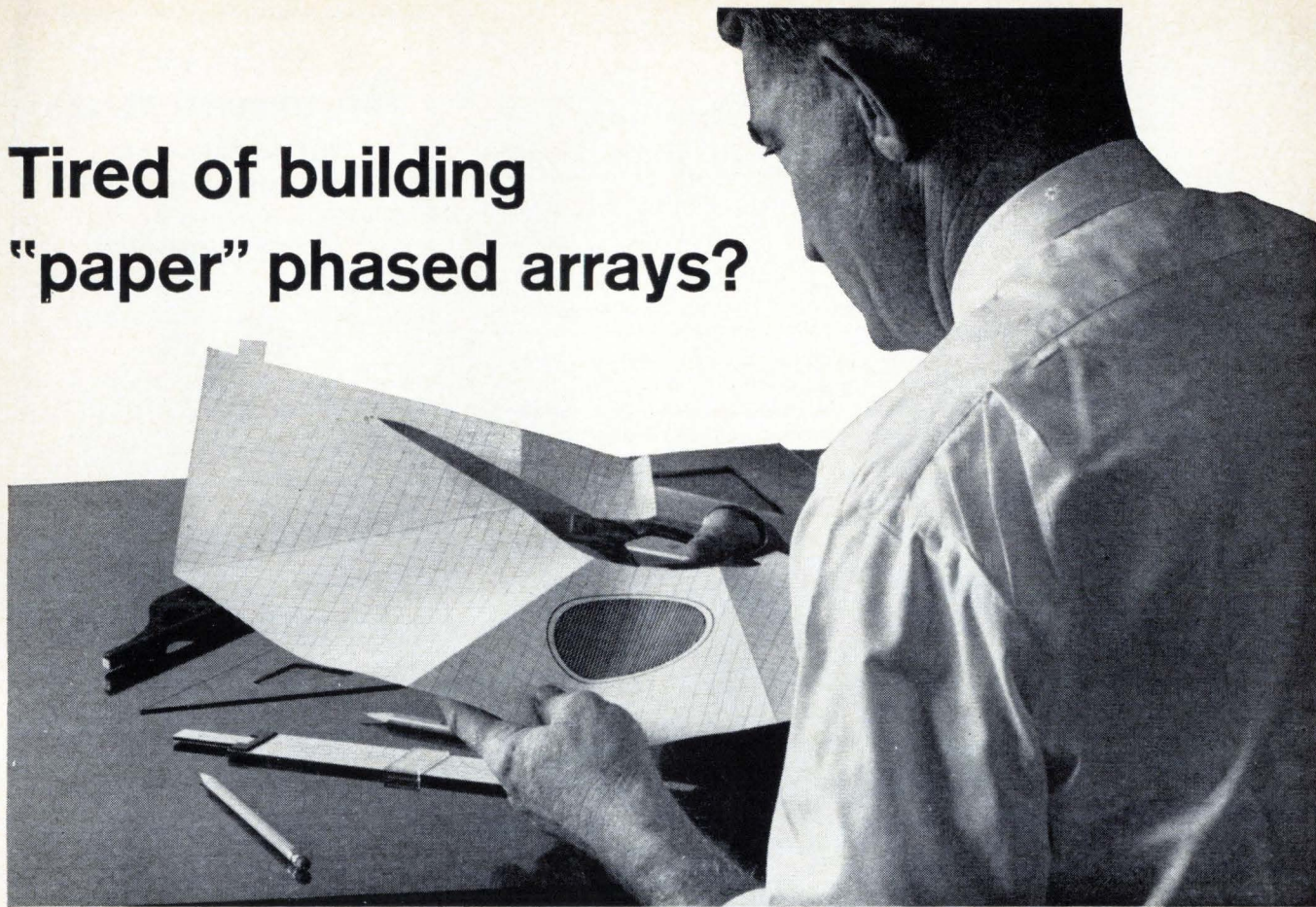

GET HARDWARE-ORIENTED. Move to where the action is . . . at Raytheon. We have worked on Phased Array systems for airborne, shipboard and ground-based applications. We've developed, built and tested radomes, arrays, beam steering computers, and components of all sizes and shapes. We have accumulated more hardware experience in this field than any of our competitors.

If you are tired of being a "paper tiger", you'll enjoy helping us build the hardware that is changing the face of radar. A variety of funded Phased Array programs are in urgent need of superior engineering skills: Nike-X (Missile Site Radar); NOTS Test Array; Overland Radar Program; RARF (Radome, Antenna & RF Circuitry).

Why spin your wheels on paper projects? Move into one of the exciting, hardware-based career openings that exist at Raytheon now for:

- Microwave Engineers (antennas & components)
- Digital Engineers (circuit & logic design)
- Radar Systems Engineers
- Product Designers
- Transmitter Engineers
- Mechanical & Structural Engineers

Investigate the **changing face of radar** at Raytheon today. Call or send resume to: *Frank DeChristopher, Employment Manager, Raytheon Company, Missile Systems Division, Hartwell Road, Bedford, Mass. Tel: (617) 274-7100 collect.*

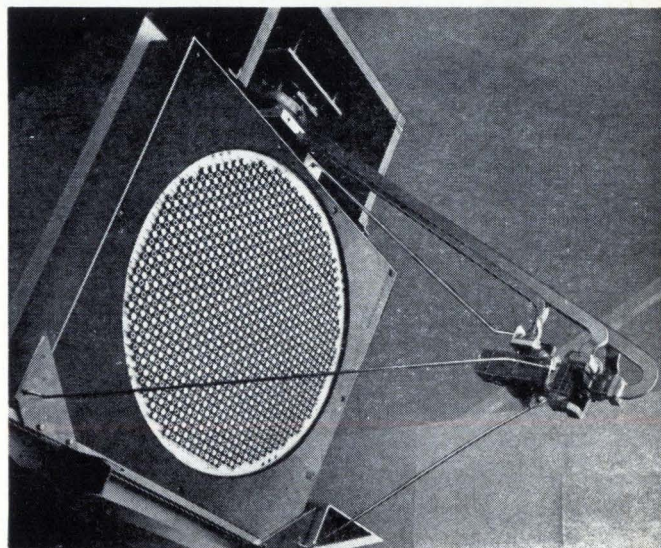

Ferrite array demonstration in operation for over 18 months to prove out advanced concepts.



AN EQUAL OPPORTUNITY EMPLOYER

CIRCUIT DESIGN ENGINEERS
 TEST EQUIPMENT
 DESIGN ENGINEERS
 NAVIGATION & COMMUNICATIONS
 SYSTEMS ENGINEERS
 A.G.E. DESIGN ENGINEERS

Exercise and elbow room.
 You'll find both at Lear Siegler

You'd like it here. Plenty of latitude at LSI. A solid, dynamic company that likes creative thinking. Actively applying new concepts, seeking new ideas in guidance and navigation systems for sub-, super- and hyper-sonic air and spacecraft. You can grow professionally on long-term programs for design and production of advanced flight reference and navigational systems . . . in a half-million square feet of newly-completed aerospace engineering facilities. Send your resume in confidence or write for information to:



E. A. Mellinger
 Professional Employment Manager

LEAR SIEGLER, INC.

INSTRUMENT DIVISION

4141 EASTERN AVE., S.E., GRAND RAPIDS, MICHIGAN 49508

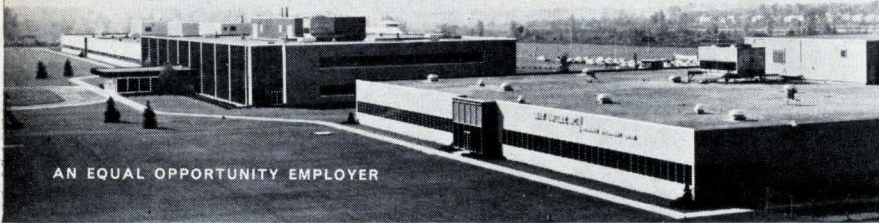

AN EQUAL OPPORTUNITY EMPLOYER

EMPLOYMENT OPPORTUNITIES

THE MARKET-PLACE
 FOR ALL EMPLOYMENT NEEDS

Send new ads or inquiries to:

ELECTRONICS

Class. Adv. Div., P.O. Box 12, N.Y., N.Y. 10036

POSITION VACANT

Electronic Shop Supervisor 3 years experience in nuclear instrumentation including multichannel analyzers. Job includes maintenance of nuclear reactor and counting room systems, and requires experience in interfacing. Position is with a university owned non-profit corporation with liberal fringe benefits. (An Equal Opportunity Employer) Contact: Mr. Paul T. Burnett, Operations Manager WNY Nuclear Research Center Power Drive, Buffalo, New York 14214.

PROFESSIONAL SERVICES

GIBBS & HILL, Inc.
 Consulting Engineers

Systems Engineering
 Operations Research • Development
 Field Studies • Design • Procurement
 Power • Transportation • Communications
 Water Supply • Waste Treatment
 393 Seventh Avenue New York 1, N. Y.

EMPLOYMENT

Electronics

OPPORTUNITIES

QUALIFICATION FORM FOR POSITIONS AVAILABLE

ATTENTION: ENGINEERS, SCIENTISTS, PHYSICISTS

This Qualification Form is designed to help you advance in the electronics industry. It is unique and compact. Designed with the assistance of professional personnel management, it isolates specific experience in electronics and deals only in essential background information. The advertisers listed here are seeking professional experience. Fill in the Qualification Form below.

STRICTLY CONFIDENTIAL: Your Qualification form will be handled as "Strictly Confidential" by Electronics. Our processing system is such that your form will be forwarded within 24 hours to the proper executives in the companies you select. You will be contacted at your home by the interested companies.

WHAT TO DO. (1.) Review the positions in the advertisements. (2.) Select those for which you qualify. (3.) Notice the key numbers. (4.) Circle the corresponding key number below the Qualification Form. (5.) Fill out the form completely. Please print clearly. (6.) Mail to: Classified Advtg. Div., Electronics, Box 12, N. Y. 10036.

COMPANY	Page #	KEY #
ATOMIC PERSONNEL, INC.	147	1
CONDUCTRON-MISSOURI	147	1
GENERAL DYNAMICS Electronics Div.	145	3
GENERAL DYNAMICS Fort Worth	165*	4
GENERAL ELECTRIC CO.	146	5
HUYCK SYSTEMS CO.	214	6
IBM CORP. Boulder, Colo.	146	7
IBM CORP. Federal Systems Div.	213*	8

COMPANY	Page #	KEY #
LEAR SIEGLER, INC.	144	9
LOCKHEED-CALIFORNIA CO.	208*	10
LOCKHEED MISSILES & SPACE CO	137	11
MARTIN COMPANY	153*	12
MITRE CORP.	148*	13
NAVAL LABORATORIES	211*	14
NEWPORT NEWS SHIPBUILDING & DRY DOCK CO.	169*	15
RAYTHEON CO.	143	16
SANDERS ASSOCIATES	215*	17
SAN FRANCISCO BAY NAVAL SHIPYARD	212*	18
SERVO CORP OF AMERICA	212*	19
SYLVANIA ELECTRONICS PRODUCTS, INC.	113	20
UNION CARBIDE CORP.	214*	21
V-M CORP.	147	22

*These advertisements appear in the October 17th issue.

PERSONAL BACKGROUND

Name
 Home Address
 City Zone State
 Home Telephone

EDUCATION

Professional Degree(s)
 Major(s)
 University
 Date(s)

FIELDS OF EXPERIENCE (Please Check) 10/31/66

- | | |
|--|---|
| <input type="checkbox"/> Aerospace | <input type="checkbox"/> Medicine |
| <input type="checkbox"/> Antennas | <input type="checkbox"/> Microwave |
| <input type="checkbox"/> ASW | <input type="checkbox"/> Navigation |
| <input type="checkbox"/> Circuits | <input type="checkbox"/> Operation Research |
| <input type="checkbox"/> Communications | <input type="checkbox"/> Optics |
| <input type="checkbox"/> Components | <input type="checkbox"/> Packaging |
| <input type="checkbox"/> Computers | <input type="checkbox"/> Radar |
| <input type="checkbox"/> ECM | <input type="checkbox"/> Radio-TV |
| <input type="checkbox"/> Electron Tubes | <input type="checkbox"/> Simulators |
| <input type="checkbox"/> Engineering Writing | <input type="checkbox"/> Solid State |
| <input type="checkbox"/> Fire Control | <input type="checkbox"/> Telemetry |
| <input type="checkbox"/> Human Factors | <input type="checkbox"/> Transformers |
| <input type="checkbox"/> Infrared | <input type="checkbox"/> Other |
| <input type="checkbox"/> Instrumentation | <input type="checkbox"/> |

CATEGORY OF SPECIALIZATION
 Please Indicate number of months experience on proper lines.

	Technical Experience (Months)	Supervisory Experience (Months)
RESEARCH (pure, fundamental, basic)
RESEARCH (Applied)
SYSTEMS (New Concepts)
DEVELOPMENT (Model)
DESIGN (Products)
MANUFACTURING (Product)
FIELD (Service)
SALES (Proposals & Products)

CIRCLE KEY NUMBERS OF ABOVE COMPANIES' POSITIONS THAT INTEREST YOU

1	2	3	4	5	6	7	8	9	10	11	12	13	14	15
16	17	18	19	20	21	22								

Lots of new openings in many active categories

Aerospace Ground Equipment Engineers

BSEE with two or more years experience in electronics support of airborne weapons systems. Two types of assignments requiring: (a) systems integration with specific experience in one or more of the following: RF, video, pulse techniques, computer and digital techniques, attack radar, penetration aids, flight control systems; (b) design experience in AGE radar (indicator, synchronizers), IR electronic equipment receivers (IF, video, RF), ECM (threat simulation) and HF SSB communication equipment.

Engineers — Radio Communications

BSEE with a minimum of three years design experience in military radio communications equipment design. Will be assigned as project leaders in the design of single sideband radio equipment. Must be thoroughly experienced in the areas of receivers, exciters, synthesizers and modulation techniques.

Mechanical Engineers

Requires minimum BS/ME plus two to six years experience in mechanical design of electronic equipment for both R&D and production use. Should be capable of overall electronic packaging design and equipment design to meet electrical, maintainability, structural and overall thermal requirements.

Reliability Engineers

BS plus two or more years experience with emphasis on electronic circuitry design and overall equipment design analysis and review, experience in certain aspects of component engineering, prototype development and test evaluation. Experience in developing and implementing total Reliability Programs for proposal activity, including predictions, reliability demonstrations, tests and design review.

Human Factors Specialists

Degree plus 2 to 8 years experience. Positions will involve system analysis, optimizing man-machine relationships, design inputs, maximizing maintainability, task analysis and specifying qualitative and quantitative personnel requirements.

Maintainability Engineers

BSEE plus two or more years experience in Maintainability Engineering — the concept, maintenance flow, throwaway vs. repair criteria, etc. Positions involve design input, analysis (MEARS), documenting, reporting, auditing and demonstration testing.

Value Engineers

BSEE, ME, IE. Assignment requires the analysis of both design and manufacturing procedures to improve overall product cost effectiveness. Will work in close conjunction with Design Reliability and Maintainability Engineers.

Administrative Engineers

BSEE or BSME plus graduate work in Business Administration plus 3 to 5 years experience in engineering project control or major program scheduling and control. Basic knowledge of financial, PERT and similar techniques required.

Electronic Components Engineers

BSEE with 3 to 5 years experience in the application and specification of electronic parts for advanced military products. Speciality may be in computer peripherals, major electronic devices, magnetic devices, solid state components or general electronic components.

Quality Control Engineers

BS degree with 5 years military equipment quality control experience related specifically to electronic equipment or components. Assignments available in: Design Review, Vendor Quality Control, Test Audit and Evaluation, Configuration Control and Planning.

Manufacturing Engineering Specialists

Advanced manufacturing development staff positions requiring a BS degree, with specialization in one of the following: Microelectronic Equipment Packaging, Numerically Controlled Machine Tool Operations and other Automated Production Techniques, Advanced Production Test Techniques, Electromagnetic Component Manufacture, Chemical/Metallurgical Process Engineering related to electronic equipment manufacture.

Product Planning Engineers

BS degree in EE, ME, IE or Industrial Management. At least 3 years experience in electronic manufacturing involving engineering liaison with production departments, manufacturing methods, pre-release design review, production area layout, process detail preparation, and technical assistance to assembly operations.

Industrial Engineers

BS degree or the equivalent and five years experience in process specification, PCB fabrication or coil manufacturing and potting.

Test Equipment Engineers

BSEE plus three years of extensive experience in the design of specialized production test equipment.

Test Engineers

BSEE or Physics, experienced in electronics manufacturing test or environmental test. Specific background in low frequency vibration, temperature, humidity and altitude environmental test techniques required.

Plant Engineers

Three positions: (a) wire communications specialist — with BSEE and 3 to 5 years experience in telecommunications equipment installation, traffic studies and system layout; (b) power distribution specialist — with BSEE and 3 to 5 years experience planning and laying out internal plant electrical power systems for electronic laboratories, manufacturing facilities and plant conditioning; (c) plant layout specialist — with BSME or BSCE and 5 years experience planning and implementing the construction and relocation of manufacturing and engineering facilities.

Procurement Specialists

BS in Business Administration or Engineering with three to five years experience purchasing electronic components for military product manufacturing. Specialization in solid state components preferred.

Lots of expansion, that's why.

Send your resume, in confidence, to Lewis A. Corwin, Dept. 167

GENERAL DYNAMICS

Electronics Division

1400 N. Goodman St., Rochester, New York 14601
An Equal Opportunity Employer (M&F)

TV/CRT: Engineering and Manufacturing

Want to be part of our next innovation? We're going places. We can get you growing, too.

Innovation means growth in this business. And our engineers—in circuit, set, CRT design and manufacturing engineering—work in a climate that's aimed at producing the new and different approach *right now*. Successful designs like the 12" personal portable; the 9" battery set, and our sensational low-cost Porta-color set are putting a steep pitch in our growth curve. Further growth examples: expansion in our Electronics Park Headquarters Operation plus a brand new facility now expanding in Portsmouth, Va. We have other plans, too. You can figure in them—to your long-range personal profit. You can expect a full package of G.E. benefits, including our Savings and Security Plan; efficient work surroundings; a place in a diversified company with a history of 37 years in television research, design and production; and excellent local living conditions in Upstate New York or Eastern Virginia. Interested in our kind of growth—Investigate this partial list of openings now:

CRT DESIGN, MFG., PROCESS AND QUALITY CONTROL ENGINEERING: design, develop and manufacture cathode ray tube products for both monochrome and color, including element, materials application, mfg. techniques, and QC. BS degree plus 2-10 years' related experience desired.

TV MANUFACTURING, PROCESS AND QUALITY CONTROL ENGINEERING: establish, plan and attain quality control programs. Apply producibility, manufacturability and quality control principles to engineering designs. Requires BS degree plus 2-10 years' related manufacturing, QC or reliability experience.

CIRCUIT DESIGN ENGINEERING (BOTH SIGNAL AND DEFLECTION): to conceive, develop and apply TV signal processing circuits, deflection yokes and related components. BS degree plus 2 or more years' related experience.

MECHANICAL PRODUCT DESIGN: requires BS degree plus 2-10 years' experience or equivalent in consumer electro-mechanical product design and packaging.

COMPONENT DESIGN AND/OR APPLICATION: conceive, design and apply electronic components for monochrome and color TV receivers. Needs 2-4 years' component design or application experience.

For more information, or to arrange a personal interview, send a resume of your experience in confidence to M. H. FitzGibbons, Manager, Professional Relations, Television Receiver Dept., Section G, General Electric Co., Electronics Park, Syracuse, N.Y. 13201.

GENERAL  ELECTRIC

An Equal Opportunity Employer

**Skiing, Hunting,
Beautiful Surroundings,
Hiking, The University
of Colorado, Culture,
Stimulating People,
A Tremendous Climate . . .**

And IBM Boulder, Colorado

Who could ask for anything more? You could, if you're looking for a career with a future.

And that's what you'll find at IBM's New Boulder, Colorado facility—an opportunity to develop and grow in your career as rapidly and as far as your talents and ambitions will allow.

You'll be working for one of America's leaders in science and technology. And you'll be working on almost everything new in the world today. New knowledge, new problems, and new solutions to older problems. But most of all you'll be working in a climate of creative freedom and career opportunity.

So ask for one thing more. An interview with an IBM representative. Openings exist in the following areas:

Magnetic Head Design: BSME or BSEE. Must have two years' experience in magnetic head design. Must be familiar with procedures required in magnetic head development, building and evaluation. Ferrite experience desired.

Magnetic Head Manufacturing: BSME or BSEE. Must have three years' experience in magnetic head manufacturing, including initial tooling and process control for product engineering work on magnetic heads in production.

Electrical Engineers: Must have experience in circuit design, digital and linear amplifiers, plus experience in magnetic recording, encoding and detection circuits.

Quality Engineers: BSEE, BSME with at least 2 years' experience in quality control. Must plan quality programs, perform design analysis, define quality oriented product. Experience in evaluation of data processing systems and statistical applications desirable.

Please write, outlining your qualifications and interests, to: Mr. K. E. McIntyre, Dept. 554-X5M, IBM Corporation, P.O. Box 1900, Boulder, Colorado. IBM is an equal opportunity employer.

IBM

CLASSIFIED ADVERTISING

SEARCHLIGHT SECTION

BUSINESS OPPORTUNITIES
USED OR SURPLUS EQUIPMENT

Color DIAL TELEPHONES \$10.95

Factory rebuilt Western Electric in white, beige, ivory, pink, green, or blue. If 4 prong plug is required add \$2.00. Fully guaranteed. Write for free list. All shipments FOB.



SURPLUS SAVING CENTER
Dept. E-10316
Waymart, Pa. 18472

CIRCLE 467 ON READER SERVICE CARD

RADAR AUTO-TRACK & TELEMETRY ANTENNA PEDESTALS
3 & 10 CM. SCR 584 AUTOTRACK RADARS. M-33 RADAR
TPS-1D SEARCH. APS-45 TPS-10D HT. FINDERS. WX RADARS.
FPN-32GCA. APS-10 APS-15B APS-27 (AMTI) SEARCH. ■ ■
APN-102 DOPPLER. DOZENS MORE CARCINOTRONS. PFN'S.
25-5-1-2-3-6 MEGAWATT PULSE MODULATORS. CAVITIES.
PULSE TRANSFORMERS. IF STRIPS. WAVEGUIDE. BENDS
200 MC. 1 KMC. 3 KMC. 6 KMC. 9 KMC. 24 KMC. RF PKGS.

RADIO RESEARCH INSTRUMENT CO.
550 5TH AVE., NEW YORK 36, N. Y. JU 6-4691

CIRCLE 468 ON READER SERVICE CARD

Solder PREFORMS & WASHERS

Indium pellets, Aluminum Discs, Silver, Gallium, Exotic metals, etc. 100mm Washers .156 ID x .218 OD x .020 (Sn-63%, Pb-37%) Total Impurities .1% Max. \$1.10 M

SOLDERTRON

2711 Military Ave, West L. A., Calif.

CIRCLE 469 ON READER SERVICE CARD

New **VACUUM PENCIL**

for picking up miniature parts

\$7.50 ea.

Selected Distributorships available.

PHILIP FISHMAN COMPANY
7 CAMERON ST., WELLESLEY, MASSACHUSETTS

CIRCLE 470 ON READER SERVICE CARD

FOR SALE: ELECTRIC, GAS, and VACUUM FURNACES

Forming Gas Generators. Nitrogen Generators. Endothermic Generators. Ammonia Dissociators. Induction Heaters. Vacuum Metallizers. Strip Chart Recorders. Temperature Controllers. Programmers. Mass Spectrometers. Spectrophotometers. Refractometers. Gas Purifiers. Electron Tube Manufacturing. Aging, and Testing Equipment.

INSTRUMENTS & MACHINES INC.

1200 Grove Street Irvington, N.J.
201-371-7900

CIRCLE 471 ON READER SERVICE CARD

DEQUITE BUYERS TURN TO THE SEARCHLIGHT SECTION IN ELECTRONICS NEJULIO

WHEN YOU TALK SIMULATION, YOU'RE TALKING CONDUCTRON

Conductron is the company that developed the Gemini Simulator and the Mercury Trainer, the 737 Simulators and Trainers, the Orbital Timing Device, the Lockheed C5A Simulator, and the Bio-Medical Critical Monitoring Device. From our aircraft and spacecraft avionics comes auto-pilots for missiles, side-looking radar displays and Marine battlefield coordination computers. Current projects include making simulators for commercial aircraft, an operation which is expanding into helicopter and engineering flight simulators.

Conductron has facilities in St. Louis, Los Angeles, Houston and Ann Arbor, with programs in Airborne Collision Avoidance Systems, Airborne Digital Navigation Aids and Holography.

Right now Conductron needs experienced simulator specialists who want above-average compensation, generous benefits and liberal tuition aids. Current opportunities include openings in the following categories:

- ELECTRICAL ENGINEERS • ELECTRONIC ENGINEERS
- DESIGN ENGINEERS • MECHANICAL ENGINEERS
- OPTICS • SCIENTIFIC PROGRAMMERS
- COMMUNICATIONS SPECIALISTS

Send your resume in complete confidence to:
Mr. Richard Ayres, Personnel Office, Dept. E

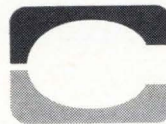

CONDUCTRON - MISSOURI

Division of Conductron Corporation

2600 N. Third Street • Box 426 • St. Charles, Missouri 63301

We are and always have been an equal opportunity employer

ENGINEERING OPPORTUNITIES

Write Personnel
V-M CORPORATION

Voice of Music Benton Harbor, Mich.

R.U. 1

answering more than
advertisement? Then please send a
separate reply to each box number. It
will help you get an answer sooner.



E.E.'s

For FEE PAID positions
throughout U.S.

Send Coupon Today

ATOMIC PERSONNEL, INC.

Suite L, 1518 Walnut St., Phila., Pa.

Experienced Engineers... Working
"Full Time"... For You!

Send resume today. (If none, send
coupon for confidential application.)

Name _____

Address _____

City _____ State _____

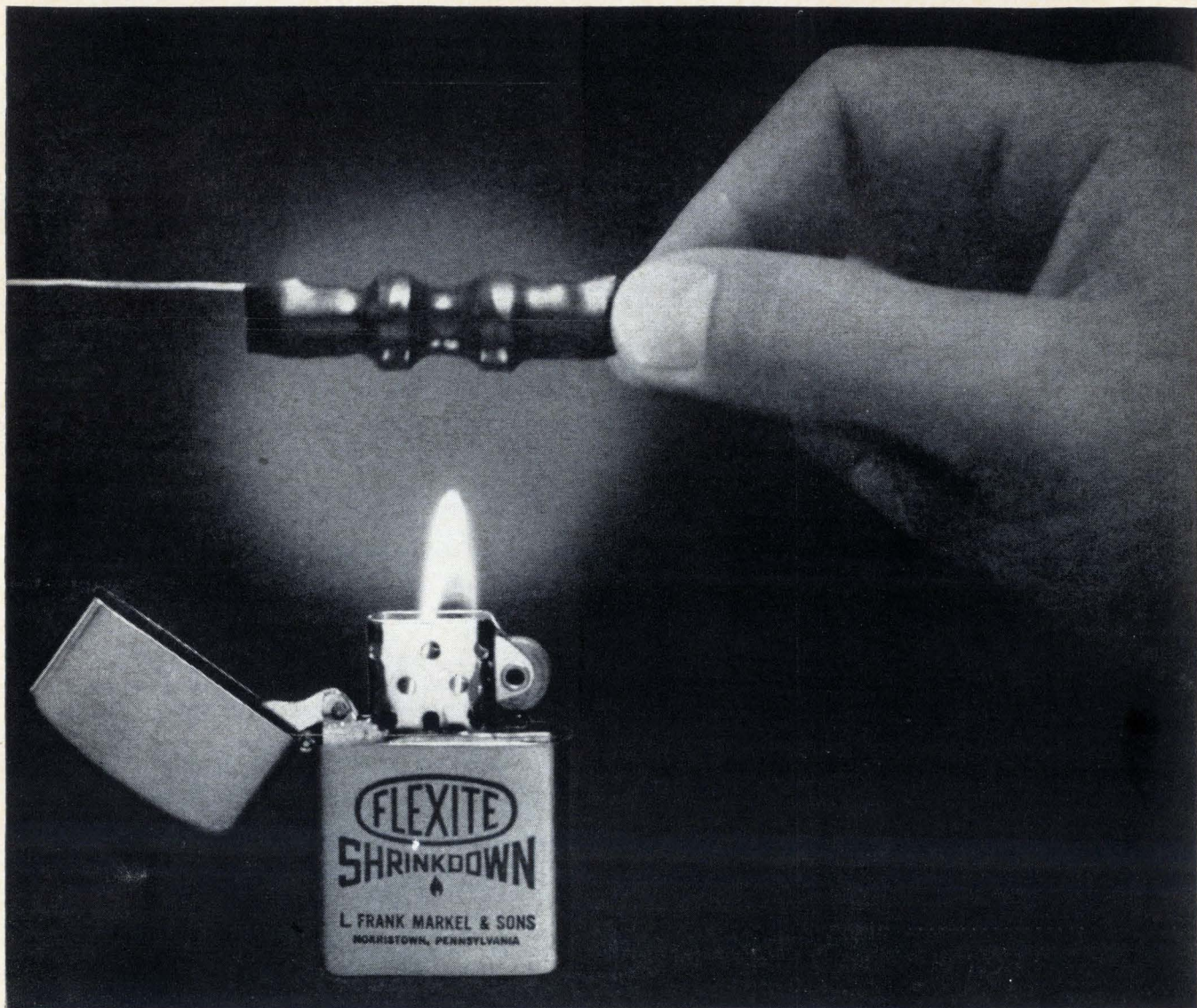

Ingenious uses for a **hot idea!**

You design engineers are coming up with all sorts of ingenious uses for Flexite Shrinkdown plastic tubing.

Three years ago, Markel Shrinkdown was introduced as a better, more easily applied insulation for electrical components, connections and assemblies of irregular shapes. It still is . . . only more so!

But new uses, in countless applications, are being discovered every day. For instance: to bind things together—add strength and rigidity—seal against leaks—identify wires and parts—protect against abrasion, wear and breakage—resist corrosion, heat and moisture—keep out dirt, water, grease and chemicals—cover rough or sharp protrusions—prevent vibration—reduce noise—improve appearance—and so on ad infinitum.

Put your ingenuity to work. See where a skin-tight sheath of tough, flexible, heat-resistant plastic would improve performance, prolong life or cut the cost of your products.

There are four types of Shrinkdown to meet your requirements. One is of Teflon*, for use at temperatures

up to 250°C. Two have shrinking temperatures under 200°F for use where higher heat would injure components. All have excellent electrical characteristics . . . meet military and commercial specifications. All shrink 50% in diameter—less than 10% in length.



To stimulate your thinking, we'll be glad to send you our "Hot Idea" experimental sample kit of Markel Flexite Shrinkdown Tubings. No cost—no obligation—just write.

*DuPont Trademark



L. FRANK MARKEL & SONS
Norristown, Pa. 19404 • Phone: 215/272-8960
INSULATING TUBINGS AND SLEEVINGS
HIGH TEMPERATURE WIRE AND CABLE

Newsletter from Abroad

October 31, 1966

IC technology lag troubles Europeans

A wave of anxiety is building up in the West European electronics industry over the growing lead of the United States in integrated circuit technology. Although European companies feel they're about on a par in basic IC research, they frankly admit they're running into trouble getting IC production lines on stream.

At last week's second International Symposium on Microelectronics at Munich, the consensus was that the U.S. now has a lead of nearly four years in IC manufacturing techniques. A few years ago, the prevailing estimate was a two-year lead.

The outlook for closing the gap is bleak. With few exceptions, European companies still are using what amounts to large-scale laboratory methods to turn out IC's. The few companies with full-fledged IC production facilities for the most part have bought their know-how and production machines from U.S. companies.

European companies say the gap stems to a large extent from a lack of government support for IC research and development. And even in their own domestic military markets, they're up against the handicap of American companies that have manufacturing plants in Europe. But for many a product-development engineer, the complaint is against management that failed to realize in time the revolution that IC's meant for electronics. As a result the European market for IC's is still piddling. Even with an expected 10-fold growth, the market in West Germany will total only \$8 million next year. By contrast, the U.S. market for IC's is expected to run about \$157 million this year.

Russia's 1970 goal for color tv: million sets a year

The Soviet Union's plans for color television apparently include a production target of between 1 million and 1.5 million sets annually by 1970. Russian officials have informed Compagnie Francaise de Television they'll need know-how for a color-tube plant of that capacity. Under the deal in which the Russians adopted the French Secam color tv system, the French agreed to provide—for a fee—manufacturing information as well as key components to tide the Russians over until they can get into production.

Unless a hitch develops, the Russians will produce a low-cost tube developed by CFT. Instead of a shadow mask, the tube uses a wire grid and brightener electrodes [Electronics, May 3, 1965, p. 157]. CFT expects to have the tube in production in France by mid-1969.

Philips to market broad computer line

Executives at Philips Gloeilampenfabrieken NV are scotching recent rumors that the company has decided against entering the big-computer market. They insist the company will go into the market in 1968 or 1969 with a broad line of general-purpose computers, backed up with software, for both business use and industrial controls.

At the outset, Philips won't offer a business machine competitive with the larger models in the 360 series of the International Business Machines Corp. But, says a Philips planning executive, "We cannot abstain from big computers." To prepare for the move, Philips this year bought whole ownership of NV Electrologica, a small Dutch computer maker that manufactures business and scientific machines. Philips has a large research staff working at its own computer division at Apeldoorn, the Netherlands, and is now building a marketing staff.

Newsletter from Abroad

British hopes for China market suffer setback . . .

The cultural revolution in Red China has taken the zing out of a promising market for British instrument makers. With the Red Guard on the rampage, few senior scientists and factory officials dared visit an exhibit mounted last month at Tientsin by the British Scientific Instrument Makers Association. **Instead of selling nearly all the equipment off the stands as they did last year, the 53 companies that displayed brought back to Britain some 90% of the instruments they'd shipped to Communist China for the show.**

The flop flabbergasted British manufacturers, who up to last month's show thought they had a burgeoning market in Red China. Instrument sales for the first half of the year totaled more than \$7 million, up from \$3.4 million last year. And earlier this year, a Red Chinese trade mission visiting London disclosed that more than \$22 million had been earmarked to buy scientific instruments from Britain. Now prospects are that instrument sales to Red China this year will wind up at last year's level, rather than doubling as the British had expected.

. . . but big sales in East Europe cheer computer makers

British computer makers now see East Europe as one of their best export markets. All the heavyweights in the industry are either closing deals with prospects lined up during the international computer show at Prague last May or already have firm orders.

English Electric-Leo-Marconi Computers Ltd. has picked up the contract for a Leo 326 system—worth just over \$1 million—from Czechoslovakia's Ministry of Social Security. The British company will deliver its system late next year for administration of the social security accounts of some 10 million workers.

International Computers & Tabulators Ltd., the industry leader, also closed a big sale this month—an ICT 1904 computer for Bulgaria.

The computer will be used in the first of a network of local government data-processing centers that is planned to eventually include 20 cities. The sale brought to nearly \$4 million the backlog of orders ICT has from Bulgaria, Czechoslovakia, Hungary and Rumania. Elliott-Automation is well along with negotiations for the sale of a 4120 NCR-Elliott machine and the rash of orders from East European countries figures to spread over the next few months.

U.S. lifts embargo on large-computer exports to France

President Charles de Gaulle's knack for getting most of what he wants has spilled over from diplomacy to data-processing. The French this month agreed to a procedure that will make certain that large U.S. computers they get will not be used for nuclear weapons development. As a result, the Johnson Administration cleared for export 11 big machines, including a Control Data Corp. 6600 computer and an International Business Machines Corp. 360-92. The export licenses had been held up because of U.S. commitments under the nuclear test ban treaty.

The batch of U.S. machines will supplement a line of medium computers the French intend to develop themselves as part of de Gaulle's plan to free the country as far as possible from dependence on U.S. technology [Electronics, Oct. 17, p. 223]. De Gaulle, though, still needs one more large computer to develop nuclear weapons for his "force de frappe." The French Atomic Energy Commissariat is making do with an IBM Stretch computer for the nuclear weapons program and badly wants a CDC 6600. But there's no chance a CDC 6600 intended for weapons research will be cleared for export.

Electronics Abroad

Volume 39
Number 22

Japan

NC with IC

In the scramble for market leadership in numerical controls for machine tools, Fujitsu Ltd. apparently has outdistanced its Japanese rivals.

At the Third Japan International Machine Tool Fair this month, some 40 machines had NC controls and nearly 75% of the control hardware carried the Fujitsu label. If this weren't enough, Fujitsu further stunned the competition by showing the prototype of an improved version—with integrated-circuit logic—of its Fanuc 260 unit, already a best seller. Fanuc is the acronym for Fujitsu automatic numerical control.

Fujitsu will start delivering the improved IC version next June. In so doing, the company will become the first Japanese producer to offer NC with IC. However, the Westinghouse Electric Corp., Bunker-Ramo Corp. and Cincinnati Milling Machine Co. all have control systems using IC's on the market. And other NC producers in the United States will follow suit soon.

Although the 150 transistor-transistor-logic packages in the IC version of the Fanuc 260 will cost more at the outset than the discrete transistors they replace, Fujitsu will sell the improved version for about the same price as the current model—\$3,400 for a two-axis control and \$5,000 for a three-axis control. Fujitsu anticipates savings in assembly costs with the IC's will more than offset the added component expense. And Fujitsu is so convinced the improved Fanuc 260 will sell well that it plans to produce the units in batches of 100.

Versatile package. The TTL packages that Fujitsu designed into its NC system are the same ones it will use in a control and scientific computer to be introduced next month at the Japanese computer

show. As a hedge against unforeseen troubles on its own IC production lines, Fujitsu has made the circuits compatible with the Series 7400 units produced by Texas Instruments Incorporated.

Like its predecessor, the IC version of the Fanuc 260 positions only one axis at a time, a cost-cutting approach to NC since it requires only a single register for positioning instructions. And Fujitsu has retained open-loop control through pulse motors that rotate the machine-tool lead screws 1.5° for each output pulse from the driving cir-



Lighter load. A switch to IC's for the logic circuits slashed the size and weight of Fujitsu's Fanuc 260 NC unit.

dividual driving circuits for each of the three five-phase pulse motors. Before, there was a single set of five driving circuits switched onto each motor in turn. To hold the old motors locked when they weren't powered, electromagnetic detents were needed, plus control circuitry for them. In the IC version the motors are locked through their individual driving circuits when they are not receiving positioning pulses. With this arrangement all three motors can operate simultaneously in manual control.

Above all, the switch to IC logic packages has slashed the over-all size and weight of the unit. The original Fanuc 260 was about the size of a small refrigerator and weighed nearly 300 pounds. The IC version is about a third as big and weighs 120 pounds.

France

Gallic logic

A major goal of President Charles de Gaulle's effort to build a French computer industry is development of a strictly-French medium computer for industrial and scientific use. The most likely choice for the computer's basic logic seems to be a new family of circuits conceived in France and called current mode complementary transistor logic.

Compagnie Européenne d'Automatisme et d'Electronique (CAE) developed the CMCTL circuits. CAE says the logic bests classic high-speed digital circuits in speed, package count and power consumption.

A small central processing unit, CAE claims, would use 440 CMCTL integrated-circuit packages. The processor would consume 80 watts and have a maximum delay time of 8 nanoseconds. An identical processor with emit-

cuts [Electronics, May 17, 1965, p. 162].

Power cut. However, Fujitsu has reworked the motors, cutting their power requirements from 3.5 amperes per phase to 0.5 ampere. The power requirement still is too high for direct drive from a monolithic IC but the change has enabled Fujitsu to switch from high-power germanium transistors to medium-power silicon transistors for the output stages.

The reduced driving power also allows another improvement—in-

ter-coupled logic would need 560 packages, consume 100 watts and have a maximum delay time of 13 nanoseconds, according to CAE's comparative study. Straight complementary transistor logic ran third—600 packages, 120 watts and 16 nanoseconds maximum delay time.

This comparison alone suggests that CMCTL will be the choice for upcoming French computers. Tipping the scales further in CMCTL's favor is the fact that CAE and Société d'Electronique et d'Automatisme are jointly developing the French medium computer line [Electronics, June 27, p. 198]. CSF-Compagnie Générale de Télégraphie sans Fil is developing the integrated-circuit packages based on the CAE circuits. CSF, along with Compagnie Générale d'Electricité, is a parent company of CAE.

Gates. The basic circuit in the CMCTL family is an AND/OR gate that uses both coupled emitters and a current-mode amplifier. Logic decisions are made by a coupled-emitter pair made up of complementary npn and pnp transistors. The output signal is transmitted through complementary emitter-followers and the voltage level is restored by a current-mode amplifier.

With this arrangement (see schematic) the CMCTL circuit provides a two-level logic output with a swing of 1.1 volts, nearly 50% higher than the 0.8-volt swing for emitter-coupled logic. And the circuit gives both true and complementary logic outputs, simplifying over-all computer design. Fan outs up to 20 are possible on both outputs. Average delay time is 4 nanoseconds for the gate and its amplifier with a fan out of 4. The circuit needs only one voltage supply, -4.5 volts. For complementary transistor logic, two are needed. And the CMCTL configuration permits a margin of $\pm 10\%$ in the supply voltage.

Connections. Because the output of the CMCTL circuit is by emitter-follower, there's no need for impedance matching when the delay time through a wiring interconnection to an IC package is less than

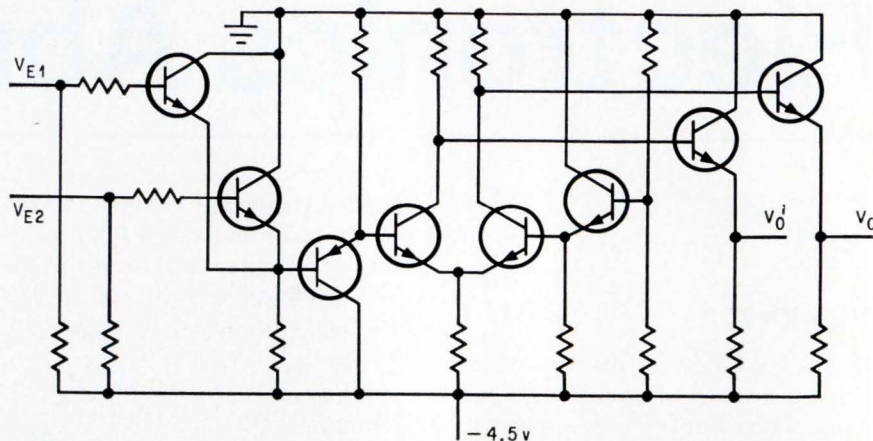

CMCTL gate combines coupled emitters and a current-mode amplifier. Both true (V_0) and complementary (V_0') outputs can be picked off emitter-followers cascaded with coupled-emitter pair that makes logic decisions.

one-fourth the signal rise time. For longer connections, matching resistors are incorporated in the package along with a low-impedance bias driver; this arrangement avoids a second supply voltage inside the computer. Unused inputs in the gates are internally connected to the single negative supply voltage, again saving external wiring among packages.

Packages. For its CMCTL logic, CAE settled on two series of five standard units ranging from a twin two-input gate to a single gate with 10 inputs. In the 100 series, the two-level logic circuitry is packaged separately from the amplifier. In the 200 series, the logic and amplifier are in the same package. For large computing systems, the 100 series has lower power consumption but the package count is about 25% higher than for the 200 series.

The CMCTL family also includes a fast flip-flop that can serve either as a delay memory element or as a counting memory element. The flip-flop has a propagation delay time of 6 nanoseconds and operates at clock speeds up to 120 megahertz. Power consumption is 250 milliwatts.

French nyet

The Franco-Soviet 10-year scientific cooperation agreement signed in Moscow with a flourish by President Charles de Gaulle last June has foundered somewhat over a Russian proposal to launch a French satellite.

The Russians offered to launch a deep space probe with a French-built spacecraft in the late 1960's. But France declined since the program would cost her \$22 million and her space funds are already committed until 1970. What's more the French want the same treatment they receive in joint launches with the United States. But Soviet officials have said that it's not likely French technicians would be allowed to live and work at Russian space installations.

This month the two nations did arrive at one space agreement. Beginning in 1967 the Soviet satellite Molniya will transmit French Secam color television programs between the two countries. To capture Molniya's signals, the French will modify their receiving station at Pleumeur-Bodou, in Brittany.

Sweden

Looking up

Except for data-processing peripheral equipment, Sweden hasn't been much of an electronics exporter. The country's military hardware producers, especially, are handicapped because Sweden is neutral and thus doesn't come in for a cut of the military business generated by joint equipment programs of the North Atlantic Treaty Organization to which most Western European countries belong.

This month, though, Standard

Radio and Telefon AB booked—for military equipment—the largest electronics export order ever received by a Swedish company. SRT, an affiliate of the International Telephone and Telegraph Corp., will supply to Denmark a computer-controlled air-defense system. The Danish Ministry of Defense, of course, is keeping the cost of the system secret, but it's estimated the order is worth at least \$5 million to SRT.

The system SRT will build for Denmark is similar to one the company is supplying to Sweden. And the SRT equipment may well turn up elsewhere in Europe. The company says it is negotiating with a half-dozen other countries—some of them NATO members—for similar systems.

Mufti to khaki. By and large, SRT's military air-defense system is built up from units used in the company's Digitrac civil air-traffic control system. Signals from a nationwide network of radar stations are fed into an air-defense center and digitized for computer processing and display; even the plan position indicators use digital sweep.

The computer that calculates target tracks and interception courses can handle up to 200 tracks. That capability can be extended by adding computers, linking them with a data bus-line that has a capacity of 166,000 forty-bit words per second. There are both permanent and semipermanent program memories. For the semipermanent program, faster of the two, addition time is

0.75 microsecond, multiplication time 16 μ sec and division time 17 μ sec.

Soviet Union

Red sales

The Soviet Union's electronics industry doesn't always reflect the political moods of the Kremlin and sometimes the differences are striking. As expected, instrument sales to North Vietnam are skyrocketing, but surprisingly so are sales to Communist China.

Despite the increasingly bitter relations between Moscow and Peking, the Soviets quintupled their sales of instruments to Red China last year. Exports jumped to \$656.6 million compared with \$127.8 million in 1964. Sales to North Vietnam soared even higher proportionately.

Hanoi bought \$271.3 million worth of instruments in 1965 compared with \$10.1 million in 1964, according to official Russian figures. Soviet sales of radio sets and record players to North Vietnam surged to 5,555 units valued at \$122.2 million, up sharply from 1,300 sets and \$26.6 million in 1964. Hanoi also bought \$47.8 million worth of relays, compared with \$45.6 million the previous year.

Custom from Castro. Communist Cuba, however, remained Russia's best customer for instruments, buying \$690 million, down slightly from

\$726.6 million. East Germany was the only Communist country whose instrument sales to Russia exceeded purchases last year. German exports totaled \$163.3 million, up from \$146.6 million.

The official figures do not tell the full story however. There is, for example, no indication in the figures that the Russians imported any computers although it is known that they did. Computer exports slipped from 22 units in 1964 to 19 last year. However, the dollar value of the machines rose from \$1.95 million to \$3.2 million. And in their bookkeeping the Russians peg the ruble at \$1.11, but exchange rates among Communist countries are usually more realistic with ruble credit set at about 60 cents.

Great Britain

Breakthrough in breakdown

By any standard, the planar technique of fabricating silicon semiconductor devices rates as an epoch-making technology. More than anything else, the technique made possible the monolithic integrated circuit, which is revolutionizing electronics.

But the planar process does have a drawback, especially when it comes to diodes. The junctions of planar devices break down at reverse voltages of about 200 volts.

Now a British company, Associated Electrical Industries Ltd., has

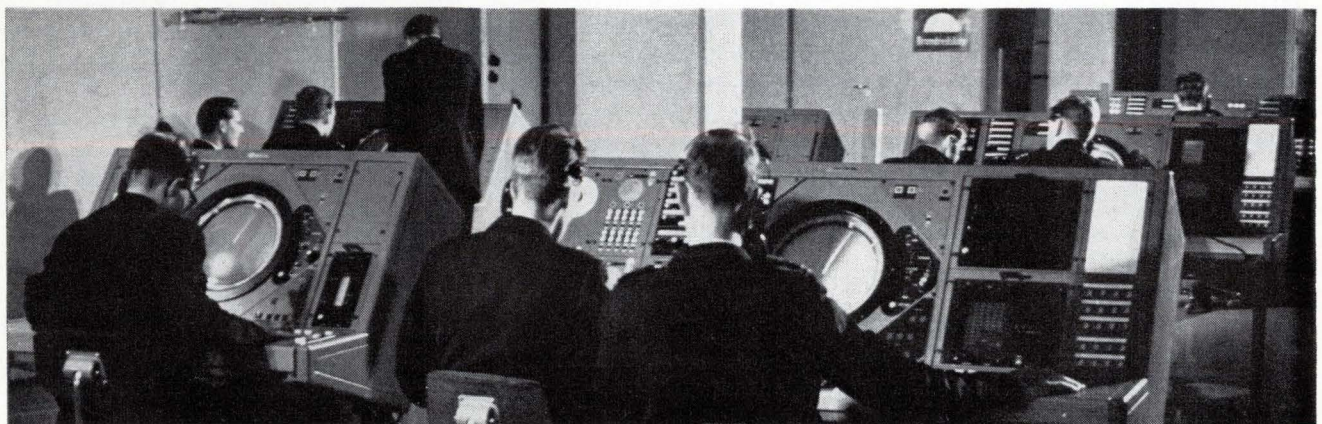

Scandinavian scene. Both Sweden and Denmark have ordered air-defense systems from Standard Radio and Telefon AB. Each operator has access to all the targets tracked by the system.

found a way to produce planar silicon diodes that can take reverse voltages as high as 900 volts. That means new applications for planar silicon diodes in rectifying circuits where high transients occur. What's more, the diodes have very low leakage current—1 nanoampere or less—so they can be used in telephone exchange equipment where thousands of diodes operate in parallel.

Gradual. In diffused junction diodes, the breakdown voltage of the junction depends on the maximum electric field that the junction and the surrounding bulk material can withstand. The field, at a given applied voltage, in turn, depends on the impurity gradient near the junction and its radius of curvature—the smaller the radius the larger the field.

For its diodes, AEI uses a slow, deep diffusion; exact values are proprietary. The diffusion moves more rapidly along the interface between the silicon surface and overlying oxide layer; as a result, the junction meets the silicon surface on a slant rather than at right angles. Because of the angle, the diode breaks down in the bulk material instead of at the surface. Also, the deep diffusion smooths out irregularities that cause small radii of curvature in the junction and thus lead to local regions of high field. And with a deep diffusion, the impurity gradient near the junction drops.

Along with the junction geometry, AEI uses a high-resistivity bulk material to help obtain the unusually high reverse breakdown characteristics.

Current limiter

Like most facilities researching microwaves, the Services Electronics Research Laboratories of Britain's Ministry of Defense is developing Gunn-effect oscillators.

So far SERL hasn't reported anything in advance of the field but it has come up with some unexpected fallout—a current limiter without a junction.

It consists simply of a wafer of bulk gallium arsenide with gold-

indium ohmic contacts mounted in a cavity made up of a pair of copper plates. A thin layer of barium titanate separates the plates. In effect, the plates and the barium titanate form a capacitance shunt around the wafer to damp out the microwave oscillations that otherwise would develop when an electric field is applied across bulk GaAs. To further inhibit oscillation, the cavity is lossy.

The saturation curve for the limiter is symmetrical and the saturation current depends on the cathode area of the GaAs wafer. In an experimental unit with a 0.001-inch-thick wafer measuring 0.015 inch square, the saturation current was 0.3 ampere and the knee voltage of the curve 15 volts.

Power density in the wafer runs high, about 10^7 watts per cubic centimeter, so the limiter has limitations in duty cycle. However, SERL sees possibilities for the device as a protector for transistor circuits. And since it limits current at both positive and negative saturation voltages, the device can convert sine waves into square waves.

West Germany

Faster flasher

Many times the quickest way to find the answer to a research problem is simply to photograph a phenomenon at high speed. Now a Hamburg electronics firm, Impulsphysik GmbH, is promising to brighten researchers' days by throwing light on the subject faster. The company is marketing a high-powered flasher that delivers light pulses at rates up to 300,000 pulses per second—about three times faster than the best flashers previously available.

At 300,000 pulses per second, the repetition rate of the flasher can't be precisely controlled. But at speeds up to 50,000 flashes per second, Impulsphysik's "Strobokin" has a timing accuracy better than 3×10^{-7} seconds. Energy output per flash ranges from 1 to 10 joules, depending on the repeti-

tion rate; pulse length is 1 μ sec.

Sparking. The system uses a high-pressure spark in a rare gas—argon or krypton-helium—to obtain a brilliant point source of light. To fire the main spark, a starting spark of about 20,000 volts is applied to a triggering electrode. The spark ionizes the gas between the main electrodes, which then discharge when a 40-megawatt, high-voltage pulse is applied across them. The peak light emission is reached in 0.2 μ sec and drops to about 30% of the maximum after 1 μ sec. A trace of hydrogen in the rare gas suppresses afterglow.

One key requirement for the flasher is to make the deionization time between successive spark discharges as brief as possible. In the Strobokin, this is done by a quenching gap in series with the spark chamber. The quenching gap is made up of a row of tungsten disks spaced about 0.2 millimeter apart in a hydrogen-filled discharge tube.

Essentially, the gap functions as a high-frequency switch that discharges residual energy in the low-ohmic main spark chamber. The quenching gap can handle peak currents up to 10,000 amperes and peak inverse voltages to 12,000 volts at repetition rates up to more than 300,000 pulses per second.

Around the world

India. A \$1.6 million satellite communications center now under construction at Ahmadabad, 200 miles north of Bombay, is scheduled to start operating in June, 1967. In addition to use as a working ground station, the facility will serve as research and training center. The Nippon Electric Co. of Japan has the contract for the communications equipment.

Sweden. Stockholm may soon join the growing list of cities where traffic is computer controlled. The traffic police division is installing computer-controlled signals in a test area. If the test is successful, all the traffic lights in the city will be timed by a central computer.

RCA Announces the NEW 3N128 (MOS) FET for VHF applications

features: □ low feedback capacitance (0.2 pF max.) □ high power gain (18 dB typ. at 200 MHz) □ high forward transconductance (5,000 μ mho min.) □ low noise (4 dB typ. at 200 MHz) □ low cross-modulation distortion □ a hermetically sealed metal case

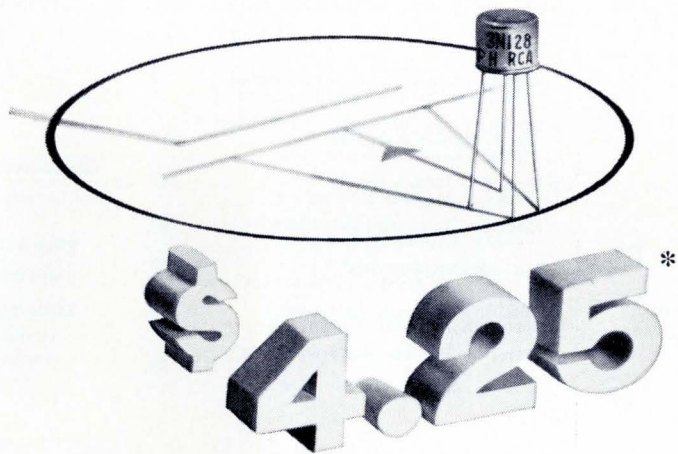

*Price in quantities of 1,000 and up

RCA's 3N128 N-channel, depletion type, MOS field-effect transistor is now available in production quantities for communications and industrial applications. This new insulated gate MOS transistor exhibits (1) extremely low gate-leakage current (0.1 pA typ.) which permits stable operation over wide temperature ranges, (2) feedback capacitance substantially lower than that of conventional junction-gate devices, and (3) extremely high input resistance of 10^{14} ohms typ.

The RCA 3N128 simplifies your designs because you can use conventional electron-tube type biasing techniques. In

addition, the drain current exhibits a negative temperature coefficient which makes thermal runaway virtually impossible. These attributes, combined with a large signal-handling capability and low cross-modulation distortion, make the 3N128 MOS a "must" for critical front-end designs.

Call your RCA Field Representative for complete technical information, price and delivery on the new 3N128 (MOS) FET. For Application Note AN-3193, or for a technical data sheet, write RCA Electronic Components and Devices, Commercial Engineering, Section EN10-5, Harrison, N. J. 07029. SEE YOUR RCA DISTRIBUTOR FOR HIS PRICE AND DELIVERY

RCA Electronic Components and Devices



The Most Trusted Name in Electronics

Electronics advertisers

October 31, 1966



ADC Products John Gompper & Associates	8	Hewlett Packard, Loveland Division Lennen & Newell Incorporated	1	Sorensen Operation/Raytheon Company James Advertising Incorporated	11
Ad-Yu Electronics Incorporated P & G Advertising Agency	137	Hitachi Ltd. Dentsu Advertising Inc.	127	Speer Carbon Company Hazard Advertising Company Incorporated	43
Airpax Electronics Inc. Welch, Mirabile & Company Inc.	53	Honeywell Test Instruments Campbell Mithun Incorporated	131	Sperry Gyroscope Company Reach, McClinton Company	117
Amelco Semiconductor Incorporated Sturges & Associates	15	I R C Incorporated Gray & Rogers Incorporated	124	Sprague Electric Company The Harry P. Bridge Company	5, 10, 16
Atohms Electronics Div. of Technical Industries Incorporated Van Der Boom, McCarron Inc.	7	ITT Semiconductor Neals & Hickok Incorporated	158	Sylvania Electric Products Incorporated Tatham-Laird & Kudner Incorporated	27 to 34
Bel Fuse Incorporated Adrian E. Clark Jr. Incorporated	142	Jerrold Corporation Lescarboura Advertising	14	Sylvania Electronics Systems Briant Advertising	113
Bendix Corporation, Scintilla Division MacManus, John & Adams Incorporated	36	Keystone Carbon Company Downing Industrial Advertising	82	TRW Capacitors Fuller & Smith & Ross Incorporated	45
Cal-Power Corporation Jordan Farrell Inc.	118	Lambda Electronics Corporation Michel-Cather Incorporated	122, 123	Tektronix Incorporated Hugh Dwight Advertising Inc.	98, 99
Cedar Engineering Div. of Control Data Corporation Colle & McVoy Advertising Inc.	139	LEL Division of Varian Associates Snow & Depew Advertising	49	Texas Instruments Incorporated Don L. Baxter Incorporated	106, 107
Clifton Precision Products Company, Div. of Litton Industries Inc. Ivey Advertising Agency	6	Lockheed Missiles & Space Company McCann-Erickson	137	Ultra Carbon Corporation Church & Guisewite Advertising	140
Codex Corporation Weston Associates Incorporated	74	Machlett Laboratories Incorporated Fuller & Smith & Ross Incorporated	9	Utah Industrial Promotion Commission David W. Evans & Associates	135
Cohu Electronics Erwin Wasey Ruthrauff & Ryan Inc.	35	Mallory Capacitor Company, Division of P.R. Mallory & Co. Inc. Aitkin-Kynett Company Inc.	47	Westinghouse Semiconductor ITSM Division of McCann-Erickson	115
Comcor Incorporated Marketing Directions	129	Markel & Sons, L Frank George Moll Advertising Inc.	148		
Dale Electronics, Incorporated Swanson, Sinkey, Ellis Incorporated	50	Maryland Telecommunications Inc. Ray E. Finn Advertising	105		
Digital Equipment Corporation Kalb & Schneider Incorporated	41	Microdot Incorporated Gumpertz, Bentley & Dolan Advertising	90		
E G & G Incorporated Culver Advertising Incorporated	138	Mitsubishi Electric Corporation Hakuhodo Incorporated	157		
Emerson & Cuming Incorporated Edwin F. Hall, Marketing Public Relations	142	Motorola Semiconductor Products Incorporated Lane & Bird Advertising Inc.	18, 19, 54, 55, 89		
Erie Technological Products Company Incorporated Altman-Hall Associates	24	Nippon Electric Company Ltd. Hakuhodo Incorporated	112		
Esterline Angus Instrument Company Caldwell, Larkin & Sidener-Van Riper Incorporated	56	North Atlantic Industries Incorporated Murray Heyert Associates	17		
Fairchild Semiconductor Incorporated Faust/Day Incorporated	12 & 13	Radio Corporation of America Al Paul Lefton Company	95, 96, 97, 155, 4th Cover		
Fork Standards Incorporated K & A Incorporated	133	Reeves Hoffman Division of Dynamics Corporation of America Adams Associates Incorporated	133		
General Radio Company K. E. Morang Company	2nd Cover	Sanders Associates Chirurg & Cairns Incorporated	139		
Guardian Electric Mfg. Company K & A Incorporated	22	Sierra/Philco Hal Lawrence Incorporated	108		
Hewlett Packard, Colorado Springs Division Tallant/Yates Incorporated	3rd Cover	Sinclair Radio Laboratories Incorporated John E. Hayes Company, Incorporated	116		
Hewlett Packard, Frequency & Time Division Lennen & Newell Incorporated	2, 20 & 21, 121				

Classified Advertising

F.J.Eberle, Business Mgr.

PROFESSIONAL SERVICES	144
EMPLOYMENT OPPORTUNITIES	143-147
EQUIPMENT (Used or Surplus New) For Sale	147

ADVERTISERS INDEX

Atomic Personnel, Inc.	147
Conductron-Missouri	147
Fishman Co., Philip	147
General Dynamics, Electronics Div.	145
General Electric Co.	146
Instruments & Machines, Inc.	147
IBM Corp.	146
Lear Siegler, Inc.	144
Radio Research Instrument Co.	147
Raytheon Co.	143
Soldertron Specialties Co	147
Surplus Saving Center	147
V-M Corp.	147

For more information on complete product line see advertisement in the latest Electronics Buyers' Guide



Advertising sales staff

Frank E. LeBeau [212] 971-6464
Advertising sales manager

Atlanta, Ga. 30309: Michael H. Miller, 1375 Peachtree St., N.E., [404] TR 5-0523

Boston, Mass. 02116: William S. Hodgkinson McGraw-Hill Building, Copley Square, [617] CO 2-1160

Chicago, Ill. 60611: Robert M. Denmead, J. Bradley MacKimm, 645 North Michigan Avenue, [312] MO 4-5800

Cleveland, Ohio 44113: William J. Boyle, 55 Public Square, [216] SU 1-7000

Dallas, Texas 75201: Richard P. Poole, 1800 Republic National Bank Tower, [214] RI 7-9721

Denver, Colo. 80202: Joseph C. Page, David M. Watson, Tower Bldg., 1700 Broadway, [303] 255-5484

Detroit, Michigan 48226: J. Bradley MacKimm, 856 Penobscot Building [313] 962-1793

Houston, Texas 77002: Kenneth George, 2270 Humble Bldg., [713] CA 4-8381

Los Angeles, Calif. 90017: Ian C. Hill, John G. Zisch, 1125 W. 6th St., [213] HU 2-5450

Minneapolis, Minn. 55402: J. Bradley MacKimm, 1104 Northstar Center [612] 332-7425

New York, N. Y. 10036: Donald R. Furth [212] 971-3615
James R. Pierce [212] 971-3615
George F. Werner [212] 971-3615
500 Fifth Avenue

Philadelphia, Pa. 19103: William J. Boyle, Warren H. Gardner, Jeffrey M. Preston, 6 Penn Center Plaza, [215] LO 8-6161

Pittsburgh, Pa. 15222: Warren H. Gardner, 4 Gateway Center, [412] 391-1314

Portland, Ore. 97204: James T. Hauptli, 218 Mohawk Building, 222 S.W. Morrison Street, Phone [503] 223-5118

St. Louis, Mo. 63105: Robert M. Denmead The Clayton Tower, 7751 Carondelet Ave. [314] PA 5-7285

San Francisco, Calif. 94111: James T. Hauptli, 255 California Street, [415] DO 2-4600

London W1: John W. Patten, Edwin S. Murphy Jr., 34 Dover Street, Hyde Park 1451

Milan: 1, via Baracchini Phone: 86-90-617 86-90-656

Frankfurt/Main: Gerd Hinske, Dieter Rothenbach, Elsa-Brandstroem Str. 2 Phone: 72 01 81

Geneva: Michael R. Zeynel, 1, rue du Temple Phone: 31 95 60

Paris VIII: Denis Jacob, Kenneth Davey, 17 Avenue Matignon Phone: 359 6637

Tokyo: Nobuyuki Sato, 1, Kotohiracho Shiba, Minato-Ku [502] 0656

Osaka: Ryosi Kobayashi, 163, Umegee-cho, Kita-ku [362] 8771

Wallace C. Carmichael [212] 971-3191
Manager Electronics Buyers' Guide

David M. Tempest [212] 971-3139
Promotion manager

Milton Drake [212] 971-3485
Research and circulation manager

Wallis Clarke [212] 971-2187
Assistant to sales manager

Wallace C. Carmichael [212] 971-3191
Business manager

Stephen R. Weiss [212] 971-2044
Production manager

Thomas M. Egan [212] 971-3140
Production manager Electronics Buyers' Guide

Miniaturization by Mitsubishi!

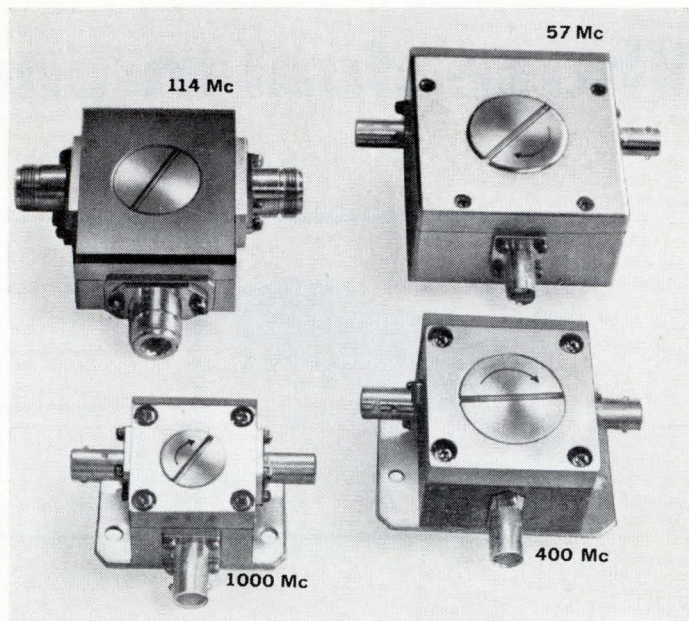

VHF—UHF circulators (isolators) small enough to fit in the palm of your hand!

Performance						
Frequency (Mc)	57	114	170	413	680	1000
Power (W)	50	40	30	30	15	10
Forward Loss (dB)	1	0.7	0.7	0.6	0.6	0.5
	(0.8)	(0.5)	(0.5)	(0.4)	(0.4)	(0.35)
Backward Loss (dB)	15	15	15	20	20	20
	(20)	(20)	(20)	(20)	(20)	(20)
Input VSWR	1.4	1.4	1.4	1.3	1.3	1.3
	(1.3)	(1.3)	(1.3)	(1.3)	(1.3)	(1.3)
Band Width (Mc) at 25°C	1	2	3	15	20	40
Temperature Range (°C)	-10 ~ +40 (usable up to +60)					
Dimensions (mm)	(approx. 50 x 70 x 33)					

These new Mitsubishi circulators stabilize amplifiers, oscillators, and multipliers in solid state circuits and reduce transmitter intermodulation. The special inner fabrication devised by Mitsubishi engineers

reduces size and weight, yet permits these circulators to be used in extremes of high and low temperature. They are protected against magnetic interference and constructed to withstand severe vibration. For complete information on the frequency ranges listed (or, for that matter, any other frequency) write to Mitsubishi's head office in Tokyo or cable directly to MELCO TOKYO.



MITSUBISHI ELECTRIC CORPORATION
Head Office: Mitsubishi Denki Bldg., Marunouchi, Tokyo. Cable Address: MELCO TOKYO

Circle 157 on reader service card

To order reprints: Fill in, cut out coupon below, insert in envelope and mail to: **Electronics Reprint Dept., 330 W. 42nd Street, New York, N.Y. 10036**

Reprint order form

For listing of reprints available see the Reader Service Card.

Communications Satellites Part I

Send me reprints of Key no. R-89 at 50¢ each.

For reprints of previous special reports fill in below:

Send me reprints of Key No.(s) @ ¢ each.
(For prices, see Reader Service Card)

Name

Number of street

City, State, Zip code

Whose dual in-line 930 DTL?

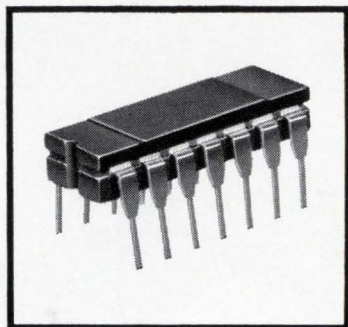

ITT



OTHERS

**Only your
purchasing agent knows
for sure!**

ITT offers all series 930 DTL circuits in a dual in-line package. Circuits manufactured by ITT are identical to and perfectly interchangeable with the other leading brand.

If you're convinced that dual in-line packaging is your answer — if you want

the lower component insertion cost, heavier leads and all-ceramic construction that only dual in-line can give you, evaluate ITT.

You can order any series 930 DTL in dual in-line today! Call your ITT distributor or factory representative.

ITT
SEMICONDUCTORS

ITT SEMICONDUCTORS IS A DIVISION OF THE INTERNATIONAL TELEPHONE AND TELEGRAPH CORPORATION
FACTORIES IN WEST PALM BEACH, FLORIDA; PALO ALTO, CALIFORNIA; LAWRENCE, MASSACHUSETTS; HARLOW AND FOOTSCRAY, ENGLAND; FREIBURG AND NURENBERG, GERMANY