

Electronics

Measuring field effect transconductance: page 88

Testing circuits with infrared: page 100

Assembling IC's into systems: page 139

April 3, 1967

\$1.00

A McGraw-Hill Publication

Below: Linotron tube sets type
as quick as a wink, page 113

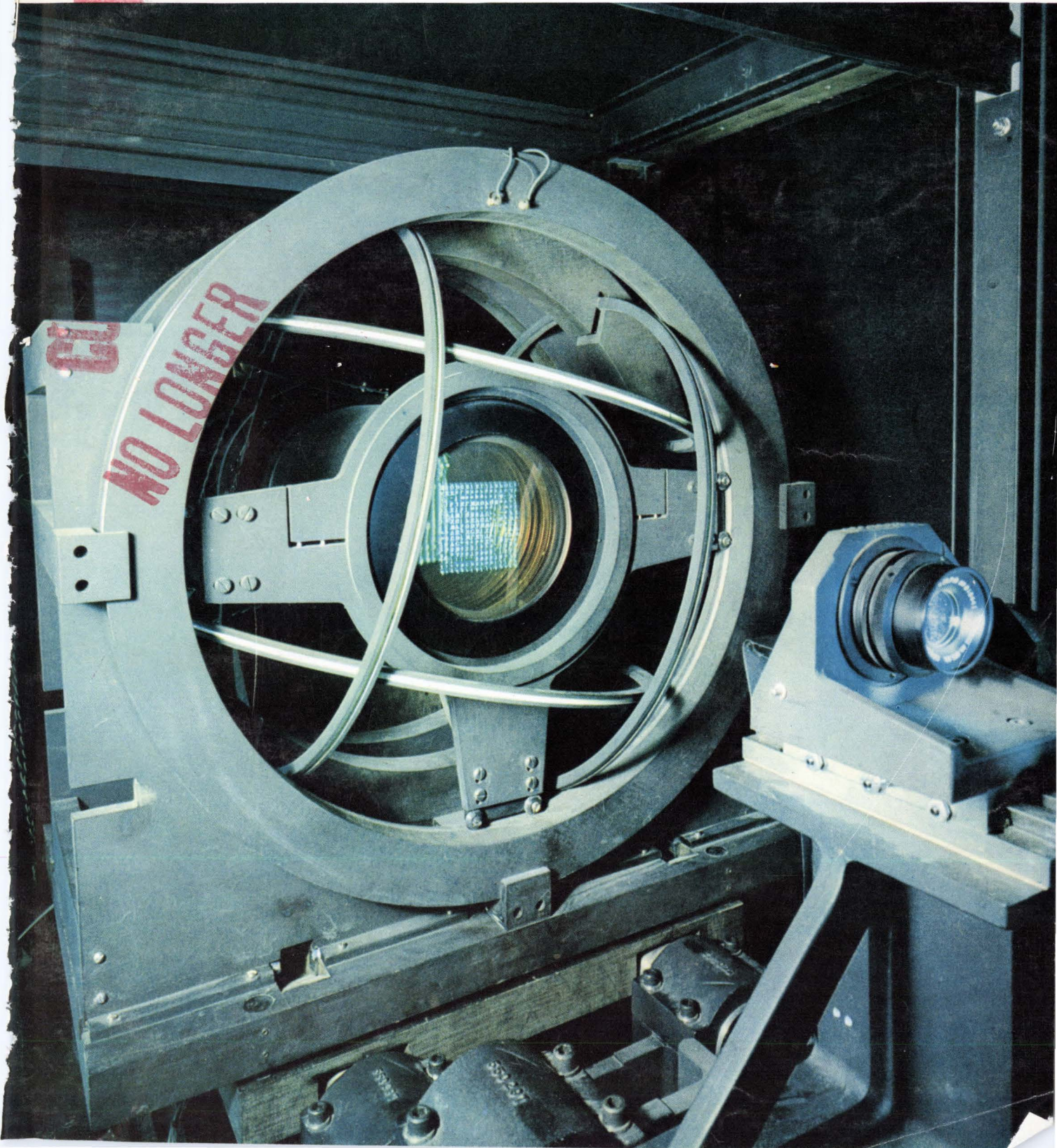

AUDIO TRANSFORMERS

DO-T No.	Pri. Imp.	D.C. Ma.† in Pri.	Sec. Imp.	Pri. Res. DO-T	Pri. Res. DI-T	Mw Level	DI-T No.
DO-T44	80 CT 100 CT	12 10	32 split 40 split	9.8	11.5	500	DI-T44*
DO-T29	120 CT 150 CT	10 10	3.2 4	10		500	
DO-T12	150 CT 200 CT	10 10	12 16	11		500	
DO-T13	300 CT 400 CT	7 7	12 16	20		500	
DO-T19	300 CT	7	600	19	20	500	DI-T19
DO-T30	320 CT 400 CT	7 7	3.2 4	20		500	
DO-T43	400 CT 500 CT	8 6	40 split 50 split	46	50	500	DI-T43*
DO-T42	400 CT 500 CT	8 6	120 split 150 split	46		500	
DO-T41	400 CT 500 CT	8 6	400 split 500 split	46	50	500	DI-T41*
DO-T2	500 600	3 3	50 60	60	65	100	DI-T2
DO-T20	500 CT	5.5	600	31	32	500	DI-T20
DO-T4	600	3	3.2	60		100	
DO-T14	600 CT 800 CT	5 5	12 16	43		500	
DO-T31	640 CT 800 CT	5 5	3.2 4	43		500	
DO-T32	800 CT 1000 CT	4 4	3.2 4	51		500	
DO-T15	800 CT 1070 CT	4 4	12 16	51		500	
DO-T21	900 CT	4	600	53	53	500	DI-T21
DO-T3	1000 1200	3 3	50 60	115	110	100	DI-T3
DO-T45	1000 CT 1250 CT	3.5 3.5	16,000 split 20,000 split	120		100	
DO-T16	1000 CT 1330 CT	3.5 3.5	12 16	71		500	
DO-T33	1060 CT 1330 CT	3.5 3.5	3.2 4	71		500	
DO-T5	1200	2	3.2	105	110	100	DI-T5
DO-T17	1500 CT 2000 CT	3 3	12 16	108		500	
DO-T22	1500 CT	3	600	86	87	500	DI-T22
DO-T34	1600 CT 2000 CT	3 3	3.2 4	109		500	
DO-T51	2000 CT 2500 CT	3 3	2000 split 2500 split	195	180	100	DI-T51
DO-T37	2000 CT 2500 CT	3 3	8000 split 10,000 split	195	180	100	DI-T37*
DO-T52	4000 CT 5000 CT	2 2	8000 CT 10,000 CT	320	300	100	DI-T52
DO-T18	7500 CT 10,000 CT	1 1	12 16	505		100	
DO-T35	8000 CT 10,000 CT	1 1	3.2 4	505		100	
*DO-T48	8,000 CT 10,000 CT	1 1	1200 CT 1500 CT	640		100	
*DO-T47	9,000 CT 10,000 CT	1 1	9000 CT 10,000 CT	850		100	
DO-T6	10,000	1	3.2	790		100	
DO-T9	10,000 12,000	1 1	500 CT 600 CT	780	870	100	DI-T9
DO-T10	10,000 12,500	1 1	1200 CT 1500 CT	780	870	100	DI-T10
DO-T25	10,000 CT 12,000 CT	1 1	1500 CT 1800 CT	780	870	100	DI-T25
DO-T38	10,000 CT 12,000 CT	1 1	2000 split 2400 split	560	620	100	DI-T38*
DO-T11	10,000 12,500	1 1	2000 CT 2500 CT	780	870	100	DI-T11
DO-T36	10,000 CT 12,000 CT	1 1	10,000 CT 12,000 CT	975	970	100	DI-T36
DO-T1	20,000 30,000	.5 .5	800 1200	830	815	50	DI-T1
DO-T23	20,000 CT 30,000 CT	.5 .5	800 CT 1200 CT	830	815	50	DI-T23
DO-T39	20,000 CT 30,000 CT	.5 .5	1000 split 1500 split	800		50	
DO-T40	40,000 CT 50,000 CT	.25 .25	400 split 500 split	1700		50	
DO-T46	100,000 CT	0	500 CT	7900		25	
DO-T7	200,000	0	1000	8500		25	
DO-T24	200,000 CT	0	1000 CT	8500		25	
DO-TSH	Drawn Hipermalloy shield and cover 20/30 db						DI-TSH

†DCMA shown is for single ended usage (under 5% distortion—100MW—1KC) ... for push pull, DCMA can be any balanced value taken by .5W transistors (under 5% distortion—500MW—1KC) DO-T & DI-T units designed for transistor use only. U.S. Pat. No. 2,949,591; others pending.
§Series connected; §§Parallel connected → *Units newly added to series

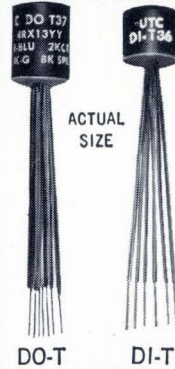

DO-T & DI-TTM

Transistor TRANSFORMERS and INDUCTORS

ALL ITEMS SUCCESSFULLY TESTED TO COMPLETE MIL-T-27B ENVIRONMENTAL REQUIREMENTS

*16 New Items Added to Stock Line
IMMEDIATE DELIVERY FROM STOCK

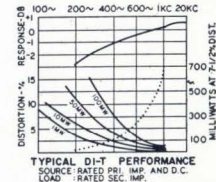
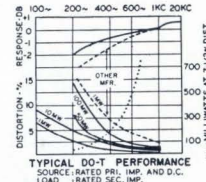

- High Power Rating up to 10 times greater
- Excellent Response twice as good at low end
- Low Distortion reduced 80%
- High Efficiency up to 30% better . . . compare DCR
- Moisture Proof hermetically sealed to MIL-T-27B
- Rugged Grade 4, completely metal cased
- Anchored Leads will withstand 10 pound pull test
- Printed Circuit Use (solder melting) nylon insulated leads
- Suited to Clip Mounting use Augat #6009-8A clip

INDUCTORS

DO-T No.	Inductance Hys @ ma	DO-T DCR Ω	DI-T DCR Ω	DI-T No.
*DO-T50 (2 wdg.s.)	\$.075 Hy/10 ma, .06 Hy/30 ma \$.018 Hy/20 ma, .015 Hy/60 ma	10.5 2.6		
DO-T28	.3 Hy/4 ma, .15 Hy/20 ma .1 Hy/4 ma, .08 Hy/10 ma	25	25	DI-T28
DO-T27	1.25 Hys/2 ma, .5 Hy/11 ma .9 Hy/2 ma, .5 Hy/6 ma	100	105	DI-T27
DO-T8	3.5 Hys/2 ma, 1 Hy/5 ma 2.5 Hys/2 ma, .9 Hy/4 ma	560	630	DI-T8
DO-T26	6 Hys/2 ma, 1.5 Hys/5 ma 4.5 Hys/2 ma, 1.2 Hys/4 ma	2100	2300	DI-T26
*DO-T49 (2 wdg.s.)	\$.20 Hys/1 ma, 8 Hys/3 ma \$.5 Hys/2 ma, 2 Hys/6 ma	5100 1275		

POWER TRANSFORMERS

*DO-T400	Pri 28V 380-1000 cycles, Sec 6.3V @ 60 ma
*DO-T410	Pri 28V 380-1000 cycles, 2-Sec 6.3 @ 30 ma each
*DO-T420	Pri 28V 380-1000 cycles, Sec 28V @ 20 ma (Isol. Electrostatic Shld.)

Write for catalog of over 1,300 UTC TOP QUALITY STOCK ITEMS IMMEDIATELY AVAILABLE from your local distributor.

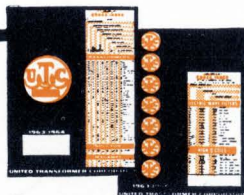

UNITED TRANSFORMER CO.

DIVISION OF TRW INC. • 150 VARICK STREET, NEW YORK, N. Y. 10013

Circle 900 on reader service card

the HP 8551B/851B costs \$10,000

CURRENT SHELL

LIBRARY
UNIVERSITY of TENN. MED. UNITS
MEMPHIS

APR 4 - 1967

It's worth it.

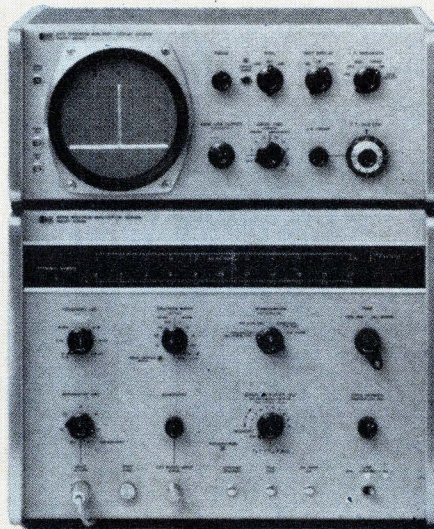

Other spectrum analyzers cost about half as much. And they're worth it.

The fact is, the Hewlett-Packard spectrum analyzer is in a class by itself. Consider these typical features not offered on the lesser instruments: RF attenuator for detecting overdriven input and setting level; 60 dB calibrated display range for comparison of signals of widely different amplitudes; swept front end, high-frequency IF to see through the clutter of intermodulations, images, spurious and multiple responses; 2 GHz sweeps with ± 1 dB flat-

ness (fundamental mixing, $< \pm 3$ dB for harmonic mixing); just one input connection for 0.01-12 GHz coverage. These are just a few examples. For more . . . and to learn how the 8551B/851B can solve your most complicated spectrum measurement problems—why it's in a class by itself—call your local Hewlett-Packard field engineer; or write for information: Hewlett-Packard, Palo Alto, California 94304; Europe: 54 Route des Acacias, Geneva.

HEWLETT  PACKARD

HEWLETT-PACKARD MAGNETIC RECORDING SYSTEMS THRIVE ON ANYTHING YOU FEED THEM

Hewlett-Packard 3900 Magnetic Recording Systems are ideal for everything from storage of simple physical phenomena to applications in complex telemetry ground stations. You cannot buy better record, storage and playback performance for your money.

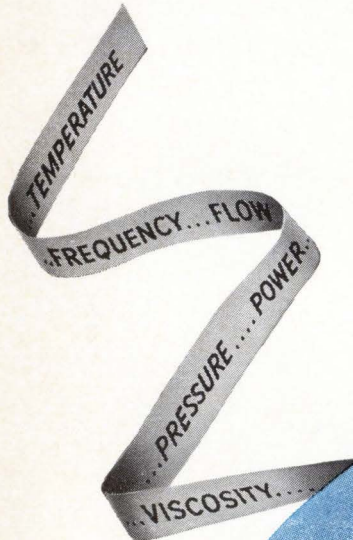

Hewlett-Packard's advanced tape transport design delivers reliable, maintenance-free operation. Three-mode recording — FM, Direct and Pulse — covers all your simple and complex data storage and playback needs. The HP 3900 Systems include 7- or 14-channel recorders in low or intermediate bandwidths. Low bandwidth direct mode is 50 Hz to 100 kHz and FM mode is DC to 10 kHz. Intermediate bandwidth direct mode frequency range is 50 Hz to 250 kHz and FM mode is DC to 20 kHz. Signal/noise ratio is 40 db or better and harmonic distortion is 1% typical 1 kHz per second at 60 ips with 0.2% peak-to-peak flutter. Six pushbutton-selected tape speeds range from 1⁷/₈ ips to 60 ips. HP tape systems are completely IRIG compatible.

Optional equipment includes: closed loop recording adapter, frequency-compensating plug-ins for FM and Direct mode record/reproduce circuits, remote control, voice commentary channel amplifier, input signal coupler, portable cases and rack adapter.



For complete information on the 3900 Systems, their variations and optional equipment, contact your local HP Field Office or write Hewlett-Packard Co., 175 Wyman Street, Waltham, Mass. 02154.

HEWLETT  PACKARD
measuring instruments
for science and industry

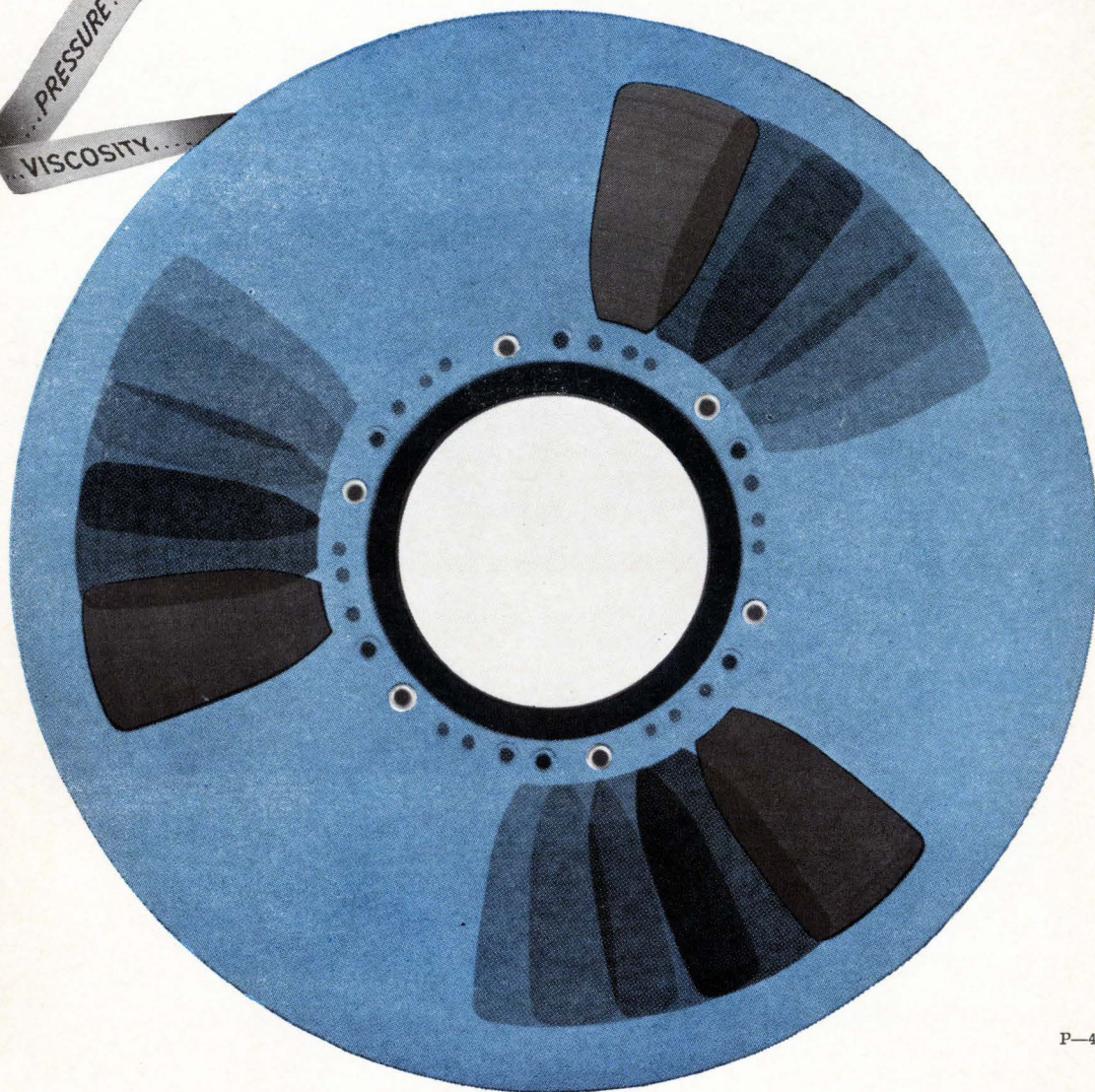

P-450

News Features

Probing the News

- 163 **French press baits Bull**
168 **Electronic cops to monitor satellites**
177 **Sony scores with IC for small radio**

Electronics Review

- 39 **Advanced technology:** Cool memory's hot; How high the sea
41 **Military electronics:** Navy checks bearings; Tacsat backpack
42 **Integrated electronics:** Frozen FET's; Another Epic chapter; Hard cell
44 **Consumer electronics:** Color them blue
46 **Industrial electronics:** Razzle-dazzle replay; You can be sure if it's . . .
50 **Computers:** Patents for programs?
52 **For the record**

Electronics Abroad

- 263 **Great Britain:** Firing-line computer; Better grasp; High-powered market
264 **France:** Laser-beam monitor
265 **Japan:** Best possible speed; Ohayo gozaimasu
266 **East Germany:** Coming up fast
270 **West Germany:** Best on the field

Departments

- 4 Readers Comment
8 People
14 Meetings
16 Meeting Preview
23 Editorial
25 Electronics Newsletter
65 Washington Newsletter
183 New Products
184 New Products Index
234 New Books
240 Technical Abstracts
246 New Literature
257 Newsletter from Abroad

Title R registered U.S. Patent Office; © copyright 1967 by McGraw-Hill, Inc. All rights reserved, including the right to reproduce the contents of this publication, in whole or in part.

Technical Articles

I. Design

- Solid state** 88 **Taking the measure of FET transconductance**
Calibration scheme automatically compensates for errors and aids in determining voltage gain
Carl D. Todd
- Reference sheet** 93 **Nomograms pick FET biasing values**
Charts help the engineer pick field effect transistor parameters easily and quickly
J. Watson and W.E. Eder, University College of Swansea
- Circuit design** 96 **Designer's casebook**
▪ Oscillator synchronizes with all pulses
▪ Exact temperature control with operational amplifier
▪ Multivibrator gives short pulses, wide spacing
▪ A simple way to count with integrated circuits
- Instrumentation** 100 **Infrared exposes hidden circuit flaws**
Thermal problems that escape conventional electronic tests cause a lot of IC rejects
Riccardo Vanzetti, Raytheon Corp.
- 105 **Troubleshooting: the heat's on**
An automated system finds circuit failures with infrared
J. Fred Stoddard, Raytheon Corp.

II. Application

- Industrial electronics** 113 **A picture that's worth a thousand words (cover)**
A new phototypesetting system can set up 10,000 characters a second, making it the fastest in the world
J. Kenneth Moore and John F. Cavanaugh, CBS Laboratories
- 122 **Generating characters with Linotron**
Tube converts printing characters into a sequence of video signals that trigger high-resolution cathode-ray-tube display
Robert A. Botticelli, Patrick F. Gross, and Arthur Sansom, CBS Laboratories
- Avionics** 131 **Terrain-following radar that doesn't scan continuously**
After 90,000 miles of test flight, engineers say a beam at a fixed angle below the plane's flight path is safe for terrain-following
Ellsworth O. Snyder, General Dynamics Corp.

III. Manufacturing

- Assembly** 139 **Batch packaging speeds system assemblies**
A new approach speeds the assembly of bits and pieces of integrated circuits into systems. Its efficiency matches that of processing techniques
Robert B. Lomerson, Flying L Co.

Electronics

Editor-in-Chief: Lewis H. Young

Associate managing editors

Design: Samuel Weber

Application: George Sideris

News: Robert Henkel

Copy: Sally Powell

Senior editor

Special projects: Donald Christiansen

Senior associate editors

John F. Mason, Joseph Mittleman, Stephen E. Scrupski

Department editors

Advanced technology: Stephen E. Scrupski

Avionics: W.J. Evanzia

Communications: Leonard Weller

Computers: Wallace B. Riley

Design theory: Joseph Mittleman

Industrial electronics: Alfred Rosenblatt

Instrumentation: Carl Moskowitz

Military electronics: John Mason

New products: William P. O'Brien

Staff writers: Paul Dickson, Jan Rahm

Section editors

Electronics abroad: Arthur Erikson

Electronics review: Stanley Zarowin

Probing the news: Eric Aiken

Regional bureaus

Domestic

Boston: Thomas Maguire, manager; Robin Carlson

Los Angeles: Lawrence Curran, manager; June Ranill

San Francisco: Walter Barney, manager; Mary Jo Jadin

Washington: William D. Hickman, Patricia C. Hoehling, correspondents

Foreign

Bonn: John Gosch

London: Michael Payne

Tokyo: Charles Cohen

Copy editors

Albert Tannenbaum, James Chang, Frederick Corey

Graphic design

Art director: Saul Sussman

Assistant art directors: Ann Mella, Valerie Betz

Production editor: Arthur C. Miller

Editorial secretaries: Marlene Angrist, Claire Benell, Lynn Emery, Lorraine Fabry,

Kay Fontana, Patricia Gardner, Lorraine Longo

McGraw-Hill News Service

Director: John Wilhelm; Atlanta: Fran Ridgway; Chicago: James Rubenstein;

Cleveland: Arthur Zimmerman; Dallas: Marvin Reid;

Detroit: N. Hunter; Houston: Robert E. Lee; Los Angeles: Michael Murphy, Gerald Parkinson

Pittsburgh: Louis Gomolak

San Francisco: Margaret Drosse!

Seattle: Ray Bloomberg; Washington: Arthur L. Moore, Charles Gardner,

Herbert W. Cheshire, Seth Payne, Warren Burkett

McGraw-Hill World News Service

Bonn: John Johnsrud; London: John Shinn;

Mexico City: Bruce Cross; Milan: Ronald Taggiasco;

Moscow: Howard Rausch; Paris: Peter Kilborn;

Rio de Janeiro: Wes Perry; Tokyo: Marvin Petal

Reprints: Susan Nugent

Publisher: Gordon Jones

Electronics: April 3, 1967, Vol. 40, No. 7

Published every other Monday by McGraw-Hill, Inc. Founder: James H. McGraw 1860-1958.

Printed at 99 North Broadway, Albany, N.Y. 12207; second class postage paid at Albany, N.Y.

Executive, editorial, circulation and advertising addresses: McGraw-Hill Building, 330 W. 42nd Street, New York, N.Y. 10036. Telephone (212) 971-3333. Teletype TWX N.Y. 212-640-4646. Cable address: MCGRAWHILL N.Y.

Subscriptions are solicited only from those actively engaged in the field of the publication. Position and company connection must be indicated on orders. Subscription prices: United States and possessions and Canada, \$8.00 one year, \$12.00 two years, \$16.00 three years; all other countries, \$25.00 one year. Single copies: United States and possessions and Canada, \$1.00; all other countries, \$1.75.

Officers of McGraw-Hill Publications: Joseph H. Allen, President; Bayard E. Sawyer, Executive Vice President; Vice Presidents: J. Elton Tuohig, Operations; John R. Callahan, Editorial; John M. Holden, Marketing; Huber M. Gemmill, Circulation; Angelo R. Venezian, Production; Robert M. Wilhelmy, Controller.

Officers of the Corporation: Donald C. McGraw, Chairman of the Board; Shelton Fisher, President; L. Keith Goodrich, Donald C. McGraw, Jr. and Robert E. Slaughter, Executive Vice Presidents; John J. Cooke, Vice President and Secretary; John L. McGraw, Treasurer.

Title © registered in U.S. Patent Office; © Copyright 1967 by McGraw-Hill, Inc. All rights reserved. The contents of this publication may not be reproduced either in whole or in part without the consent of copyright owner.

Subscribers: The publisher, upon written request to our New York office from any subscriber, agrees to refund that part of the subscription price applying to copies not yet mailed. Please send change of address notices or complaints to Fulfillment Manager; subscription orders to Circulation Manager, Electronics at address below. Change of address notices should provide old as well as new address, including postal zip code number. If possible, attach address label from recent issue. Allow one month for change to become effective.

Postmaster: Please send form 3579 to Fulfillment Manager, Electronics, P.O. Box 430, Hightstown, New Jersey 08520

Readers Comment

Frequency shift

To the Editor:

In the Newsletter item "VLF broadcasts from Red China threat to Navy" [March 6, p. 352] you mention 16 megahertz. Now 16 megahertz is not usually classified as very low frequency, and the rest of the context indicates that you are talking about frequencies in the neighborhood of 16 kilohertz, which is where you can usually pick up coded continuous-wave signals, and sometimes something that sounds like Russian Morse.

Ronald L. Ives

Palo Alto, Calif.

▪ Reader Ives is right. Gremlins upped the frequency from its correct wavelength of 16 kilohertz.

Longer life

To the Editor:

It was interesting to read about image orthicon camera tube improvements made by the Japanese television industry ["Smaller camera tubes feature better targets and cathodes," Feb. 6, p. 106]. We feel that it might be possible to increase the lifetime of present glass-targeted image orthicons, thus increasing their usefulness until the time that the improved composite-target tubes are generally available.

The problem with glass targets appears to be due to a change in the charge-carrying sodium ion gradient across the target; ions migrate by thermal diffusion (requiring a heated target) to the beam side of the target, where they remain upon neutralization of charge. After several hundred hours of tube use, ions are more reluctant to travel against this gradient, producing negative after-images in heavily depleted regions of the target.

It is well known that storing the tube for long periods of time will prolong the life by a small amount; this is probably due to the reduction in charge carrier gradient by long-period thermal diffusion.

One possible solution to this

Did you know Sprague makes a wide variety of components for industrial control equipment?

FAST RISE TIME SCR GATE DRIVES

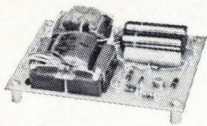

Rise time less than 1 μ S. Full 180° phase shift for inductive load. Fail-safe—if contact signal is lost, SCR gate pulse is instantly suppressed.

ASK FOR BULLETIN 85,525

Circle 496 on reader service card

PROPORTIONAL TEMPERATURE CONTROLS

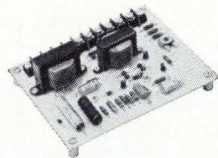

Feature temperature control to $\pm 1/2^\circ$. Conductive only when anode voltage goes through Zero. EMI-free. Also available for on-off applications.

ASK FOR BULLETIN 89,000

Circle 497 on reader service card

ZERO VOLTAGE SWITCHES

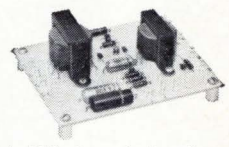

Low-cost EMI-free device for use as on-off switch, proportional temperature control, motor speed control, circuit breaker, etc. Controls resistive or inductive loads. No mechanical contacts to wear, no points to burn.

ASK FOR BULLETIN 87,500

Circle 498 on reader service card

MOLDED-CASE TRIGGER TRANSFORMERS



Molded construction for superior humidity resistance. Rated for operation where line voltages range up to 550 volts a-c. Decreased coupling capacitance reduces likelihood of false triggering by line transients.

ASK FOR BULLETIN 40,004

Circle 499 on reader service card

COMMUTATING CAPACITORS for SCRs



High capacitance, capable of delivering large peak currents with fast rise time at high repetition rates. Low inductance, low dissipation factor. Available with paper, metallized paper, film, or metallized film dielectrics.

ASK FOR BULLETIN 2875

Circle 500 on reader service card

CLORINOL® CAPACITORS for A-C Applications



Askarel impregnant has low power factor, high dielectric constant, high dielectric strength. Drawn metal cases—no soldered seams to leak. Available in ratings to 660 V, 60 cy a-c.

ASK FOR BULLETIN 4500C

Circle 501 on reader service card

For additional data, write Technical Literature Service, Sprague Electric Co., 35 Marshall St., North Adams, Mass. 01247, indicating the Engineering Bulletins in which you are interested.

SPRAGUE COMPONENTS

CAPACITORS
TRANSISTORS

RESISTORS
INTEGRATED CIRCUITS

THIN-FILM MICROCIRCUITS
4800-6150

PULSE TRANSFORMERS
INTERFERENCE FILTERS
PULSE-FORMING NETWORKS
TOROIDAL INDUCTORS
ELECTRIC WAVE FILTERS

CERAMIC-BASE PRINTED NETWORKS
PACKAGED COMPONENT ASSEMBLIES
BOBBIN and TAPE WOUND MAGNETIC CORES
SILICON RECTIFIER GATE CONTROLS
FUNCTIONAL DIGITAL CIRCUITS

SPRAGUE®

THE MARK OF RELIABILITY

*Sprague® and ®(C) are registered trademarks of the Sprague Electric Co.

OSCILLATOR
10 Hz to 50 kHz

SERIAL 125



GENERAL RADIO
MASSACHUSETTS



10 Hz to 50 kHz with one dial turn



With our new Type 1313-A Oscillator, you can manually sweep through its entire frequency range with one turn of the main dial. There are no range-switching transients or ambiguous dial multipliers to contend with; frequency changes can be made quickly and conveniently. The all-solid-state 1313-A provides both sine- and square-wave outputs, has a calibrated 60-dB step attenuator with a zero-volts-behind-600 Ω output position, and a 20-dB continuously adjustable attenuator. Distortion is only 0.5% from 100 Hz to 10 kHz.

The 1313-A is the fourth in our new line of "sync-able" oscillators. Like

the others, the 1313-A has a SYNC jack for external synchronization, is completely self-contained, and is small and lightweight (8 by 6 by 8 in., 7 lb). Even the price is a feature — it's only \$325*!

For complete information, write General Radio Company, W. Concord, Massachusetts 01781; telephone (617) 369-4400; TWX 710 347-1051.

*Price applies in USA only.

GENERAL RADIO

problem might be to run the image orthicon "in reverse" during camera warmup periods and at other times. Instead of operating the image section at high potential and slowing the scanning beam down at the target, the scanning beam would be operated at high potential, creating positive ions on the beam side of the target. A light source on the photocathode and a very low potential on the mesh would then provide slow-speed electrons for neutralizing the ions on the mesh side of the target. This should, in time, change the gradient in the target to permit normal operation of the tube. Any problem in electron transmission of the mesh with such low energy electrons might be cured by applying an ultrahigh-frequency voltage to the mesh which would accelerate electronics emitted by the photocathode but provide a zero potential by the time some of them arrived at the mesh.

Robert G. Culter
Department of Physics
University of Oregon
Eugene, Ore.

Navy film

To the Editor:

The U.S. Navy has prepared a film entitled "Why Calibrate?". The film is concerned with the subject of calibration and is used to motivate Navy personnel to maintain the reliability of test and measuring equipment. After it was viewed by personnel associated with the measurements field, the film was well received and numerous requests were made for it either by purchase or by loan.

The Navy has recently obtained appropriate Department of Defense release authority for the film and we felt your readers might be interested in knowing how it could be obtained.

J.L. Hayes
Naval plant representative,
General Dynamics Pomona Division
Pomona, Calif.

▪ To borrow the film, contact the Public Affairs Office in the nearest Naval district. Headquarters of districts are located in Boston, Philadelphia, Norfolk, Charleston, S.C., New Orleans, Great Lakes, Ill., San Diego, and Seattle, Wash. Copies may be purchased from DuArt Film Laboratories Inc., 245 W. 55th Street, New York, N.Y.

Gunn data

To the Editor:

In the article "Worldwide look at the Gunn effect" [March 6, p. 134], the figure 140 mw continuous-wave at 6 Ghz which I quoted as the state of the art was obtained by Uenohara's group at Bell Telephone Labs. At Texas Instruments, we have obtained 50 mw c-w in the 4 to 12 Ghz range.

The lifetime data quoted in the article was for a Texas Instruments Incorporated unit, which has now passed 4,500 hours.

Shing Mao
Semiconductor Research and
Development Laboratory
Texas Instruments Incorporated
Dallas

Letters from readers should be addressed:

To the Editor, Electronics, 330 W. 42nd Street, New York, N.Y. 10036

at 500 watts
or 30KW...

PEK

means reliability in high pressure Xenon Arc Lamps

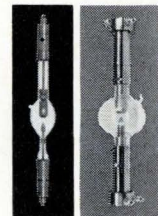

PEK high wattage xenon arc lamps are manufactured with just one criterion in mind—

reliable performance. And, when we say performance we mean performance up to and beyond today's exacting requirements in solar simulation, color projection, instrumentation, or wherever high order radiant energy sources are employed. □ Whether your need is 500 watts or as high as 30KW, you can count on dependable glass-to-metal seals, maximum arc stability and long life when you specify PEK. □ Send for our new Product Reference Guide or tell us what your special need is. There's a PEK lamp to fit your application.

PEK

PEK / 825 E. Evelyn Avenue
Sunnyvale, California
(408) 245-4111 / TWX 737-9973

SUBSCRIPTION SERVICE

Please include an Electronics Magazine address label to insure prompt service whenever you write us about your subscription.

Mail to: Fulfillment Manager
Electronics
P.O. Box 430
Hightstown, N.J. 08520

To subscribe mail this form with your payment and check new subscription renew my present subscription

Subscription rates: in the U.S.: 1 year \$8; two years, \$12; three years, \$16. Subscription rates for foreign countries available on request

CHANGE OF ADDRESS

ATTACH
LABEL
HERE

If you are moving, please let us know five weeks before changing your address. Place magazine address label here, print your new address below.

name

address

city

state

zip code

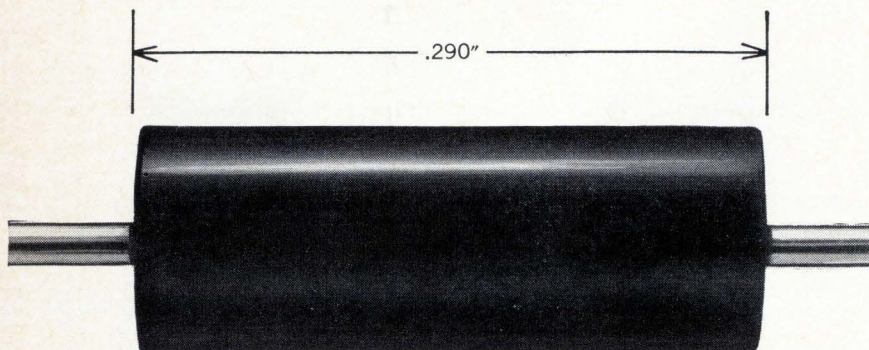

New space-saving molded tantalum capacitor

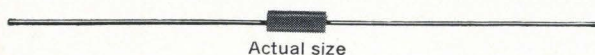

TAC miniature solid tantalums are precisely molded for automatic insertion; tubular axial-lead epoxy case is only .105" dia. by .290" long.

Test proved for excellent stability of capacitance, DC leakage and dissipation factor on extended life and humidity exposure.

Rated -55°C to $+85^{\circ}\text{C}$ at full voltage, $+125^{\circ}\text{C}$ at $\frac{2}{3}$ nominal voltage. Values from 18 mfd, 3 volts to .47 mfd, 50 volts.

Get all the news on new TAC's from Mallory. Write for Bulletin 4-82. Mallory Capacitor Company, a division of P. R. Mallory & Co. Inc., Indianapolis, Indiana 46206.

MALLORY

People

"We're going from a systems and components house to engineering and manufacturing," says **John C.**

Keyes about the Santa Clara, Calif., plant of the Philco-Ford Corp.'s Microelectronics division. Keyes, as newly appointed Western operations



J. C. Keyes

director for the division, will also have jurisdiction over Microelectronic's Taiwan plant, but his principal responsibility will be operations at Santa Clara.

Before the current reorganization of the division, the Santa Clara facility—the home of General Micro-electronics Inc. before that firm was acquired by Philco-Ford early last year—concentrated its research and development efforts on metal oxide semiconductor technology while devoting 90% of its production to bipolar devices. Keyes recalls that as Microelectronics' system director before the reorganization, "I had responsibility for manufacturing the Victor calculator but not for manufacturing the components."

Now the reorganization program has shifted all bipolar integrated circuit work to the Microelectronics division's Pennsylvania plant, and the Santa Clara facility is clearing its decks for a full-scale push in MOS technology. Keyes himself has no background in MOS, but he believes that "if you can run one field, you can run another." Besides overseeing increased efforts in the area of MOS epoxy transistors and high-speed devices, Keyes will be responsible for logic, circuit, and process development.

The 47-year-old executive joined Philco-Ford only six months ago, but he once worked for the company on the Advent program—the first military satellite project—at the Western Development Laboratory. He later formed his own concern, the Astro Technology Corp., and stayed on as Astro's president after the firm was purchased by Page Communications Engineers Inc., a subsidiary of the Northrop

**...until one of our
 smartest competitors recognized
 that Signetics had been selling
 "a good thing" in the 8000 series for
 the past six months.
 He bid them "welcome aboard!"*

~~We~~ ^{had*}
 have
 the
 only
 fully compatible
 family of
 high speed
 and
 low power
 TTL
 circuits.

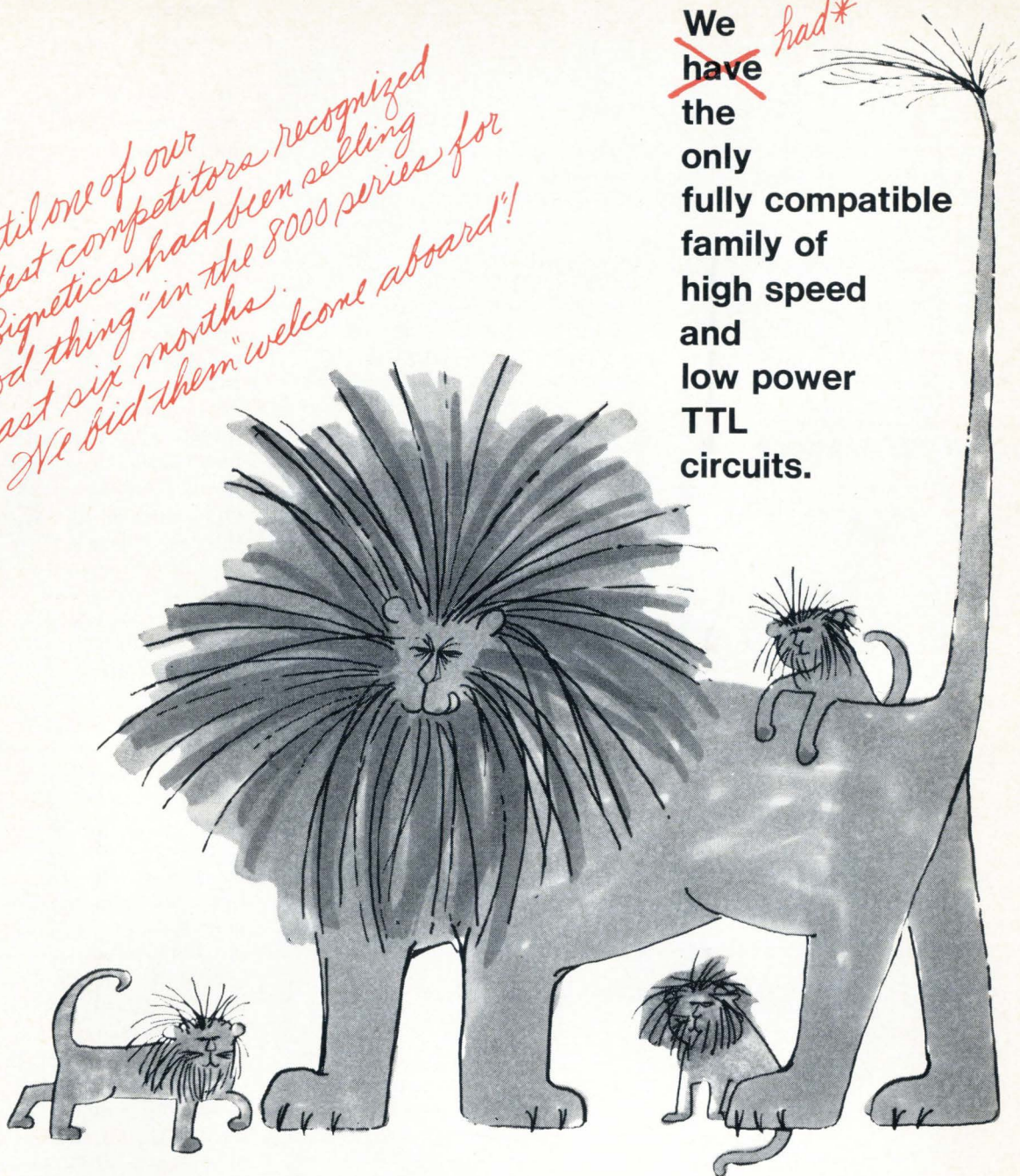

You can go wild with Signetics new Designer's Choice 8000 Series: it gives you the widest selection of design trade-offs in speed, power, noise immunity and price ever offered in a TTL family. The family consists of a very high speed set (the 8800's) and a fully compatible but slower low power set which offers very high AC noise immunity. Now TTL system designs can be optimized without laborious calculations, unusually expensive and time-consuming special ground-plane designs, or extensive use of outboard discrete components in areas where the highest possible speed is not required. All you do is follow the published S8000-series usage rules. All circuits are compatible over the full MIL temperature range of -55°C to $+125^{\circ}\text{C}$ and are available off-the-shelf in Signetics 14-lead glass-Kovar flat pack. Hunt up your local Signetics distributor. For further information on the Designer's Choice 8000 Series, write Signetics, at 811 E. Arques Avenue, Sunnyvale, California 94086.

■ At the IEEE Show, be sure to check into Rooms 3000A & B at the New York Coliseum, for latest Signetics news.

TYPE	DESCRIPTION		
S8416	Dual 4-Input Nand Gate	S8816	Dual 4-Input Nand Gate
S8417	Dual 3-Input Nand Gate	S8825	DC Clocked J-K Binary Element
S8424	Dual AC Binary Element	S8826	Dual J-K Binary Element
S8440	Dual Exclusive-Or Gate	S8840	Dual 4-Input Exclusive-Or Gate
S8455	Dual 4-Input Buffer/Drive	S8855	Dual 4-Input Power Gate
S8480	Quadruple 4-Input Expander	S8870	Triple 3-Input Nand Gate
S8806	Dual 4-Input Expander	S8880	Quadruple 2-Input Nand Gate
S8808	8-Input Nand Gate		

**SIGNETICS
 INTEGRATED
 CIRCUITS**



A SUBSIDIARY OF CORNING GLASS WORKS

Did You Know Sprague Makes 32 Types of Foil Tantalum Capacitors?

125 C TUBULAR TANTALEX® CAPACITORS



- Type 120D polarized plain-foil
- Type 121D non-polarized plain-foil
- Type 122D polarized etched-foil
- Type 123D non-polarized etched-foil

ASK FOR BULLETIN 3602C

Circle 332 on readers
service card

85 C TUBULAR TANTALEX® CAPACITORS



- Type 110D polarized plain-foil
- Type 111D non-polarized plain-foil
- Type 112D polarized etched-foil
- Type 113D non-polarized etched-foil

ASK FOR BULLETIN 3601C

Circle 333 on readers
service card

RECTANGULAR TANTALEX® CAPACITORS



- Type 300D polarized plain-foil
- Type 301D non-polarized plain-foil
- Type 302D polarized etched-foil
- Type 303D non-polarized etched-foil

ASK FOR BULLETIN 3650

Circle 334 on readers
service card

TUBULAR TANTALUM CAPACITORS TO MIL-C-3965C



- CL20, CL21 125 C polarized etched-foil
- CL22, CL23 125 C non-polarized etched-foil
- CL24, CL25 85 C polarized etched-foil
- CL26, CL27 85 C non-polarized etched-foil
- CL30, CL31 125 C polarized plain-foil
- CL32, CL33 125 C non-polarized plain-foil
- CL34, CL35 85 C polarized plain-foil
- CL36, CL37 85 C non-polarized plain-foil

Circle 335 on readers
service card

RECTANGULAR TANTALUM CAPACITORS TO MIL-C-3965C



- CL51 polarized plain-foil
- CL52 non-polarized plain-foil
- CL53 polarized etched-foil
- CL54 non-polarized etched-foil

Circle 336 on readers
service card

For comprehensive engineering bulletins on the capacitor types in which you are interested, write to:
Technical Literature Service
Sprague Electric Company
35 Marshall Street
North Adams, Mass. 01248

45C-5161 R1

SPRAGUE®
THE MARK OF RELIABILITY

*Sprague® and ® are registered trademarks of the Sprague Electric Co.

People

Corp. Keyes holds a bachelor's degree in chemical engineering and a master's in electrical engineering, which, he says, "happens to fit the semiconductor field very well."

"The swing to electronic desk calculators is happening quicker than anyone expected," says Alan K.

Jensen, newly appointed vice president in charge of research and product development at the Monroe International division of Litton Industries Inc.



Alan K. Jensen

"My job is to make sure the swing is quick at Monroe, too." Jensen is clear on Monroe's tactics: "We will make as heavy a commitment to electronic calculators as we did to mechanical ones."

Monroe is currently producing two electronic calculators with programable routines, and one of Jensen's first duties will be to expand this line. Behind the rapid shift to electronics, according to Jensen, is the market threat posed by Japanese firms. He concedes that the U.S. is lagging behind Japan in the production and pricing of electronic calculators, but asserts that American manufacturers at this point hold an edge in marketing ability.

Another factor Jensen cites in the swing to electronic calculators is the faster-than-expected development of integrated circuitry and recent reductions in IC prices. The two electronic calculators currently marketed by Monroe don't employ integrated circuits and fall in the \$2,000 price range. Jensen indicates that U.S. concerns will introduce electronic calculators this year priced around \$1,000, and it's into this market area that he intends to push Monroe.

Jensen is a former chief engineer at Litton's Electronic Systems division. Before joining Litton in 1956, he helped design Tradic, the first transistorized computer, for the Bell Telephone Laboratories. He holds more than a score of patents for computer innovations.



Panoramic SPECTRUM ANALYZER
MODEL SB-12

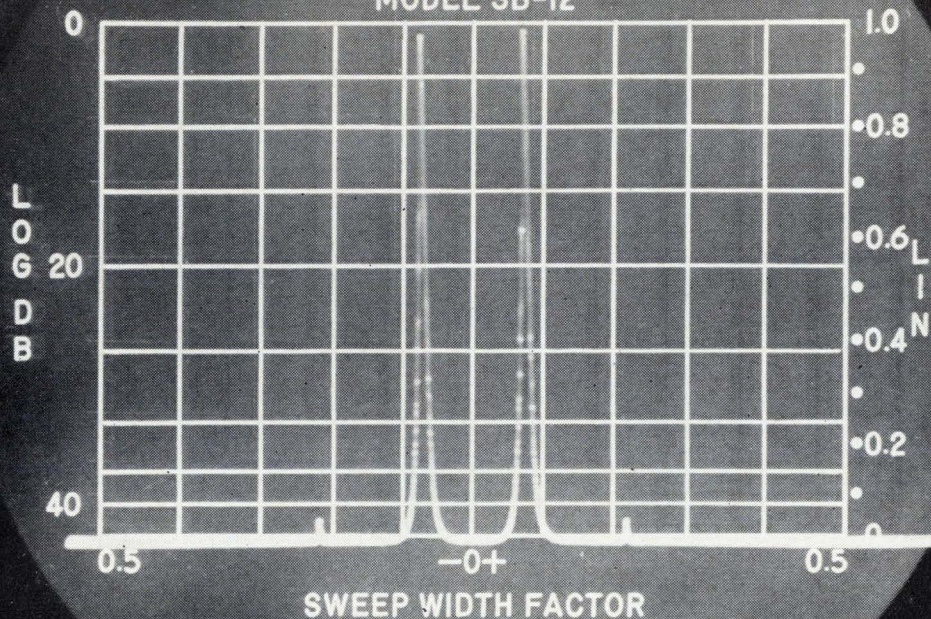

THE SINGER CO.
METRICS DIVISION

With a -40 db 3rd order distortion at 300 W PEP, the PL-8583/267 beam pentode outperforms any comparable tube, by -10 db or better.

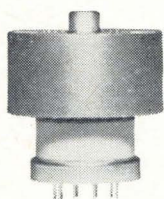

PL-8583/267
Height: 2.16"
Diameter: 1.75"

-40 db 3rd order IM distortion without feedback in linear amplifier service (300 W PEP) is offered by the PL-8583/267 beam pentode... fifth and higher order distortion products more than 50 db below one tone. In multiplex service, reduction of co-channel interference—a result of the low PL-8583/267 distortion figure—allows new equipment designers to meet the stringent low distortion requirements demanded of present-day transmitters.

Max. ratings, CCS: DC Plate Volts 2000V; DC Plate Current, 350 ma; Anode Diss., 300 watts.

For details, write: The Machlett Laboratories, Inc.—
Penta Plant, 312 N. Nopal St., Santa Barbara, California 93102.

The Machlett Laboratories, Inc., welcomes resumes from engineers and scientists.

RAYTHEON

THE MACHLETT LABORATORIES, INC.

A SUBSIDIARY OF RAYTHEON COMPANY

COMPUTER

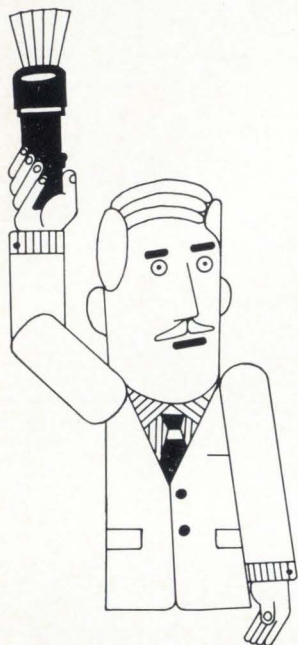

Signal Fairchild
for small signal devices
PRODUCT SELECTOR

MILITARY



Signal Fairchild
for small signal devices
PRODUCT SELECTOR

INDUSTRIAL

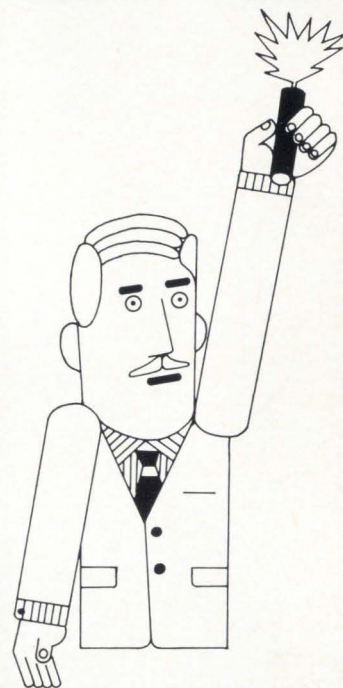

Signal Fairchild
for small signal devices
PRODUCT SELECTOR

CONSUMER

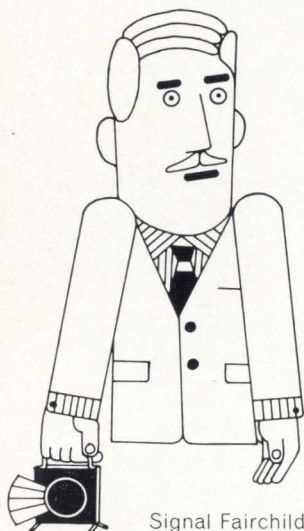

Signal Fairchild
for small signal devices
PRODUCT SELECTOR

FAIRCHILD
SEMICONDUCTOR

Please send me

- Military small-signal device selection guide
(Military computers, radar, etc.)
- Industrial small-signal device selection guide
(Instruments, test equipment, etc.)
- Consumer small-signal device selection guide
(AM, FM, TV, etc.)
- Commercial computer small-signal device selection guide
(Core drivers, logic switches, lamp drivers, etc.)

Name _____

Company _____

Title _____

Address _____

City _____ State _____ Zip _____

Four new, Fairchild selection guides for small-signal transistors and diodes. The easiest way to choose the optimum device for your new design.

Free.

Fairchild Semiconductor ■ A Division of Fairchild Camera and Instrument Corporation ■ 313 Fairchild Drive, Mountain View, California 94040 (415) 962-5011 ■ TWX: 910-379-6435

PRINTED CIRCUIT APPLICATIONS

L.B. SERIES

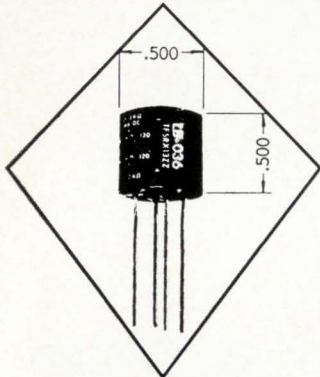

MINIATURE TRANSISTOR TRANSFORMERS

"L.B.'S" ARE MANUFACTURED TO MIL-T-27A, GRADE S, CLASS R SPECIFICATIONS, WITH 20AWG TINNED HARD DRAWN COPPER LEADS. ALSO AVAILABLE, ON SPECIAL REQUEST, WITH DUMET WIRE. MAGNETIC SHIELDS MAY BE SUPPLIED FOR ALL TYPES.

24 HOUR DELIVERY

L.S. SERIES

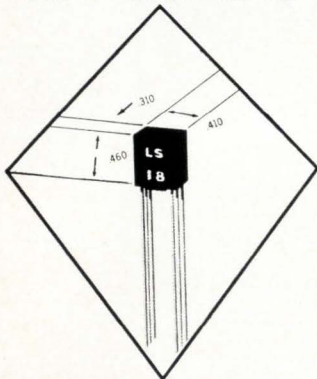

SUBMINIATURIZED TRANSFORMERS

THE "L.S." ARE MANUFACTURED TO MIL-T-27A, CLASS R, GRADE S, WEIGHT LESS THAN 0.1 OZ., GRID SPACING IDEAL FOR TRANSISTOR APPLICATION UTILIZING PRINTED CIRCUIT BOARD DESIGN, EXTERNAL MAGNETIC SHIELD AVAILABLE FOR ALL TYPES.

MAY WE QUOTE ON YOUR:
PULSE TRANSFORMERS, FILTERS,
DELAY LINES, AND INDUCTORS
WRITE FOR OUR COMPLETE CATALOGUE

TOROTEL INC.

13402 SOUTH 71 HIWAY
GRANDVIEW, MO. 64030
PHONE: SO 1-6314

Meetings

Business Aircraft Conference and Engineering Display, Society of Automotive Engineers; Broadview Hotel, Wichita, Kan., April 5-7.

Intermag Conference, Magnetics Group of the IEEE; Shoreham Hotel, Washington, April 5-7.

Symposium on the Ocean from Space, American Society for Oceanography; Rice Hotel, Texas, April 5-7.

American Nuclear Society Meeting on Fast Reactors, American Nuclear Society; San Francisco Hilton, San Francisco, April 10-12.

International Electronic Components Show, FNIE; Porte de Versailles, Paris, April 5-10.

Technical Meeting and Equipment Exposition, Institute of Environmental Sciences; Washington, April 10-12.

International Conference on Electronics and Space, Electronic Industries Association of France; Paris, April 10-15.

Electronics Conference, IEEE; Cleveland, April 11-13.

International Measurement, Testing, Control and Automation Exhibition and Congress, Mesucora; Paris, April 14-21.

Technical Conference of the Society of Motion Picture and Television Engineers, Society of Motion Picture & Television Engineers, New York Hilton Hotel, New York, April 16-21.

Meeting of the Anti-Missile Research Advisory Council, Advanced Research Projects Agency; Institute for Defense Analyses, Arlington, Va., April 17-19.

Region III Meeting, IEEE, Heidelberg Hotel, Jackson, Miss., April 17-19.

Thermophysics Specialist Conference, American Institute of Aeronautics and Astronautics, New Orleans, April 17-19.

Physics Exhibition, Institute of Physics; Alexandria Palace, London, April 17-20.

American Society for Testing and Materials National Technical Meeting on Applications-Related Phenomena in Titanium Alloys, American Society for Testing and Materials; International Hotel, Los Angeles, April 18-19.

Spring Joint Computer Conference, IEEE; Atlantic City, N.J., April 18-20.

Southeastern Instrument Conference, Instrument Society of America; Cocoa Beach, Fla., April 18-20.

Southwestern IEEE Conference and Exhibition, IEEE; Dallas, Texas, April 19-21.

Semiconductor Device Research, IEEE; Bad Nauheim, West Germany, April 19-22.

Symposium on Vacuum Science & Technology, New Mexico Section of the American Vacuum Society, Holiday Inn, Albuquerque, New Mexico, April 19-21.

Textile Industry Technical Conference, IEEE; Charlotte, N.C., April 20-21.

Symposium on Advanced Technology Available for Commercialization, North Carolina Science & Technology Research Center; Research Triangle Park, N.C., April 26-27.*

National meeting, the Electrochemical Society Inc.; Dallas, Texas, May 7-12.*

Call for papers

Technical Conference, Electronic Materials Committee of the Metallurgical Society of American Institute of Mining, Metallurgical, and Petroleum Engineers; Statler-Hilton Hotel, N.Y.C., Aug. 28-30. **May 1** is deadline for submission of abstracts to C.D. Thurmond, Bell Telephone Laboratories Inc., Murray Hill, N.J. 07971.

Technical Symposium, Society of Photo-optical Instrumentation Engineers; International Hotel, Los Angeles, Aug. 7-11. **April 15** is deadline for submission of abstracts to John H. Atkinson, technical program chairman, S.P.I.E. Symposium, P.O. Box 288, Redondo Beach, Calif. 90277.

National Electronics Conference, IEEE; Chicago, Oct. 23-25. **May 1** is deadline for submission of abstracts to Paul Mayes, Electrical Engineering Dept., University of Illinois, Urbana, Ill. 61801.

* Meeting preview on page 16.

The Connector Thing

A periodical periodical designed, quite frankly, to further the sales of Microdot Inc. connectors and cables. Published entirely in the interest of profit.

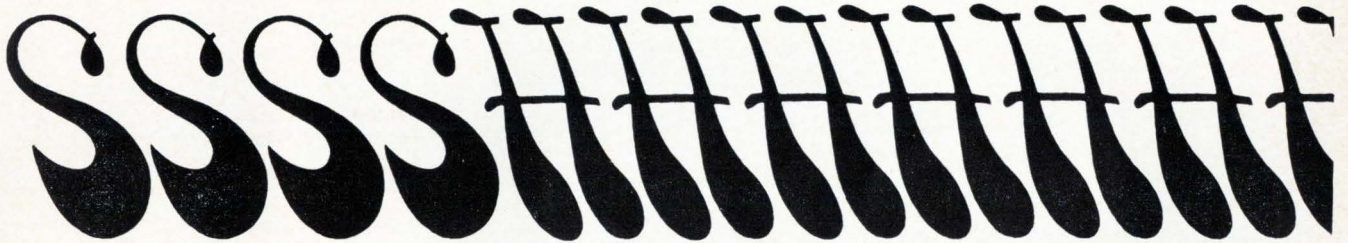

In order to inform you about (very quietly, please) our Mini-Noise coaxial cable, Microdot Inc. is extending a bribe to catch your interest. We are offering as a beautiful prize in this contest a little teeny weeny Sony television set so that you can watch Peyton Place in the office. We are doing this, quite frankly, to impress you with the fact that Microdot Inc. makes the best coaxial cable in the whole wide world, and you won't really know that for sure until you ask, will you? You see how evil we are.



This is the Sony TV you will win

Entering this contest is terribly simple. See this illustration? Many of you are probably too young to remember it, but this fine broth of a man used to decorate the cover of almost every telephone book in the country. As the symbol of Electricity, he also perches atop the American Telephone and Telegraph Building in New York City. All you have to do is hold back tears of memory while you write your own original caption for this illustration. Then send it to Microdot Inc., Great American Cable Contest, 220 Pasadena Avenue, South Pasadena, Calif. 91030. The best caption (judged by a panel of men over forty) will receive the television set. Everybody entering will receive (a) an 11 x 14 repro-



This is the illustration you have to write the caption for

duction of the gentleman surrounded by his miles and miles of cable (b) a free 16-page, two-color catalog of Microdot Inc. miniature coaxial cable and cable assemblies, and (c) a lot of laughs.

To enter this contest, you should have a smattering of knowledge about Microdot Inc.'s Mini-Noise engineer, you are probably often faced with the problem of performance degradation under increasingly severe environmental conditions. Also, you've probably found that the transmission of extremely small signals through coaxial cable is often made unintelligible by audio frequency noise generated in the cable through shock and vibration. No longer. Through a unique proprietary treatment, the noise voltage magnitude in Mini-Noise cable has been reduced by a factor of more than 100 to 1 in comparison to untreated cable.

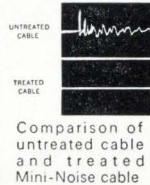

Comparison of untreated cable and treated Mini-Noise cable

Some quick facts about two other Microdot Inc. cable products:

Miniaturized instrumentation means miniature coax cable (in most instances). By using a fine silver-plated copper covered steel wire, Microdot Inc. has been able to manufacture a miniature coax cable with an impedance of 50 ohms that—even with the addition of dielectric, outer shield and and protective jacket—does not exceed nominal OD of .080".

Compare, please.

When you find it necessary to send two signals from a single source which must both terminate at a central point, use Microdot Inc. Twinaxial. No need to use two coax cables; therefore, greater flexibility at reduced cost.

One more point about Microdot Inc. cable products: if you've ordered them in the past, it will help you to know that we can now make more of them and make them faster. The reason is our recently completed new facility for cable products, which includes new braiders, new extruders—in short, new equipment and increased capacity for even faster deliveries.

There you have it. Be certain to enter the contest today (April 30, 1967 is your last day). Remember, just caption the illustration and send it to Microdot Inc., 220 Pasadena Avenue, South Pasadena, California 91030. We would hate for you to have to miss even one segment of Peyton Place.



Just because



MICRODOT INC. *Mini-Noise is a registered trademark of Microdot Inc.*



The new, improved model of our Type A time-delay relay has gold-diffused contact surfaces, heavier contact blades, and a more efficient magnetic circuit. Performance is better, but the price is still remarkably low. Our enclosed and plug-in time-delay relay models have been similarly upgraded. All can be had in a diversity of standard timings from 1/4 to 120 seconds, with SPDT or DPDT switching. All have continuous-duty coils and can thus be used without an auxiliary load relay for the majority of applications. Our Bulletin 5006 will give you full technical information on the entire line. Write us for a copy. Heinemann Electric Company, 2600 Brunswick Pike, Trenton, N.J. 08602.

 **HEINEMANN**

Meeting preview

A look at the future

New semiconductor and thin-film materials and processes will share top electronics billing at the Dallas meeting of the Electrochemical Society, May 7 through 12. This conference is considered the showcase of the future in electronic materials.

Semiconductor sessions will cover passivation, p-n junctions, and epitaxy, while thin-film sessions will investigate mechanisms of growth, failures, and conduction in dielectric films. Among other subjects to be discussed are the theory of charge distribution in metal oxide semiconductor oxides, dielectric isolation, and analysis of interface states.

Westinghouse Electric Corp. researchers will discuss films made of mixtures of silicon nitride and silicon dioxide, and Raytheon Co. researchers will report on dielectrically isolated matched transistor pairs. Semiconductor doping by high-energy ion implantation will be described by members of the staff of the Air Force's Cambridge Research Laboratory.

Seeking applications. In an effort to bring together inventors and industry's innovators, the North Carolina Science and Technology Research Center is sponsoring a symposium at Research Triangle Park, N.C., April 26-27, on advanced technology available for commercial applications.

Developments to be presented come from North Carolina State University, the research labs of the Avco Corp.'s Space Systems division, and the nonprofit Research Triangle Institute.

Among the electronic developments to be described are: low-pressure gas discharges, produced by radio frequency fields, that affect chemical reactions; ferrofluids—magnetic liquids composed of submicron sized ferrite particles suspended in an organic carrier such as kerosene; plastics that can be made electronically conductive without altering their physical and mechanical properties, and temperature-sensing alloys.

SEE MORE! DO MORE! WITH THE NEW GO-ANYWHERE hp 180A OSCILLOSCOPE!

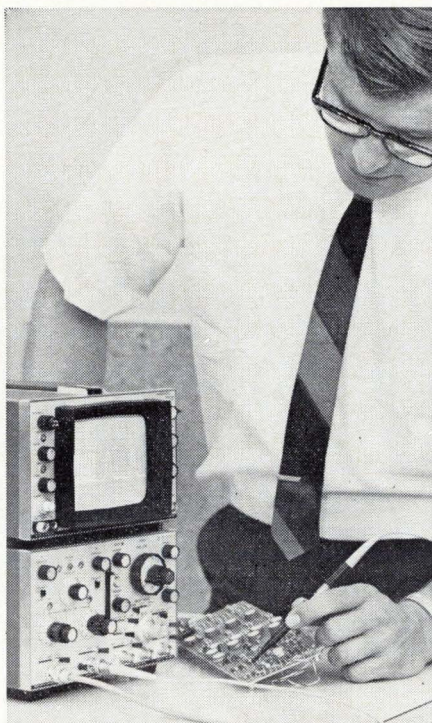
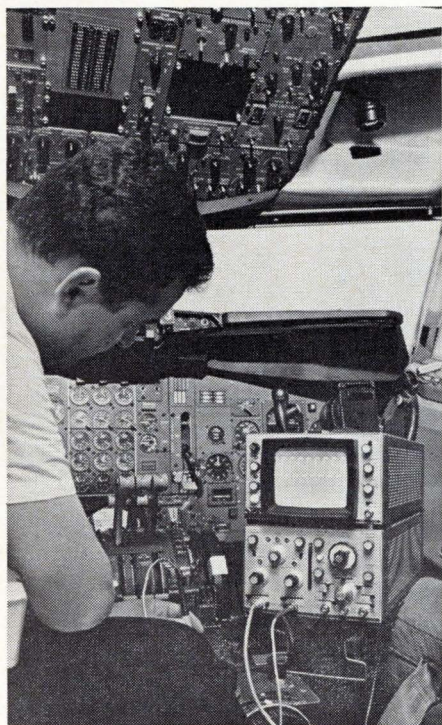

*Weights only 30 pounds! Specified Performance at -28°C to $+65^{\circ}\text{C}$!
50 MHz at 5 mv/cm! 8x10 cm CRT! All-solid-state!*

You can see more, do more with this high-frequency (50 MHz) 30-pound oscilloscope that goes anywhere—field, laboratory, or production line! Designed with aircraft-type frame construction for maximum ruggedness and minimum weight, this scope will give you specified performance at -28°C to $+65^{\circ}\text{C}$, 95% relative humidity to 40°C , and up to 15,000 feet! Built to withstand rigors of field and mobile use, the hp Model 180A Oscilloscope also is designed to give big picture CRT, plug-in versatility and step-ahead all-solid-state performance. These features add up to *more total performance, more usability than any other scope on the market!*

Mainframe and plug-ins of the hp 180A are all-solid-state. Mainframe is the first with power supplies specifically designed for solid-state circuitry—gives you full performance benefits from solid-state devices in all present and future plug-ins. New horizontal amplifier has wide bandwidth with X10 magnification to provide linear 5 nsec/cm sweeps, giving you greater resolution of high frequency signals and fast pulses.

The dual channel 50 MHz at 5 mv/cm vertical amplifier has low-drift FET input stages for accurate DC measurement . . . plus quick, 15-second warm-up. Vertical attenuation, which sets vertical deflection factor, is ahead of the amplifier. This prevents trace jump as you change ranges; bandwidth is maintained on all ranges even when verniers are used.

Time base plug-ins offer new easy-to-use delayed sweep for examining complex waveforms in detail. Tunnel diode triggering circuits lock-in waveforms to beyond 90 MHz. Exclusive hp mixed sweep feature combines display of first portion of trace at normal sweep speeds, and simultaneously expands

trailing portion of trace at faster delayed sweep speed to allow magnified examination.

Accurate measurements are easier to read and view on the new hp 180A scope, because a new design breakthrough offers a compact 17-inch long, high-frequency 8 x 10 cm CRT with extra-large picture area—30% to 100% larger than any other high-frequency scope! With the black internal graticule, calibrated in centimeters, the bright trace, and a 12 kv accelerating potential, you get sharp, crisp traces for accurate resolution of waveform details—even at 5 nsec/cm sweeps.

Call your nearest hp field representative for full specifications and a demonstration of how you can see more, do more with this new versatile, go-anywhere hp Model 180A Oscilloscope. Or, write to Hewlett-Packard, Palo Alto, California, 94304. Tel (415) 326-7000; Europe: 54 Route des Acacias, Geneva. Price: hp Model 180A Oscilloscope, \$825.00; hp Model 180AR (rack) Oscilloscope, \$900.00; hp Model 1801A Dual Channel Vertical Amplifier, \$650.00; hp Model 1820A Time Base, \$475.00; hp Model 1821A Time Base and Delay Generator, \$800.00.

106C

HEWLETT  **PACKARD**
An extra measure of performance

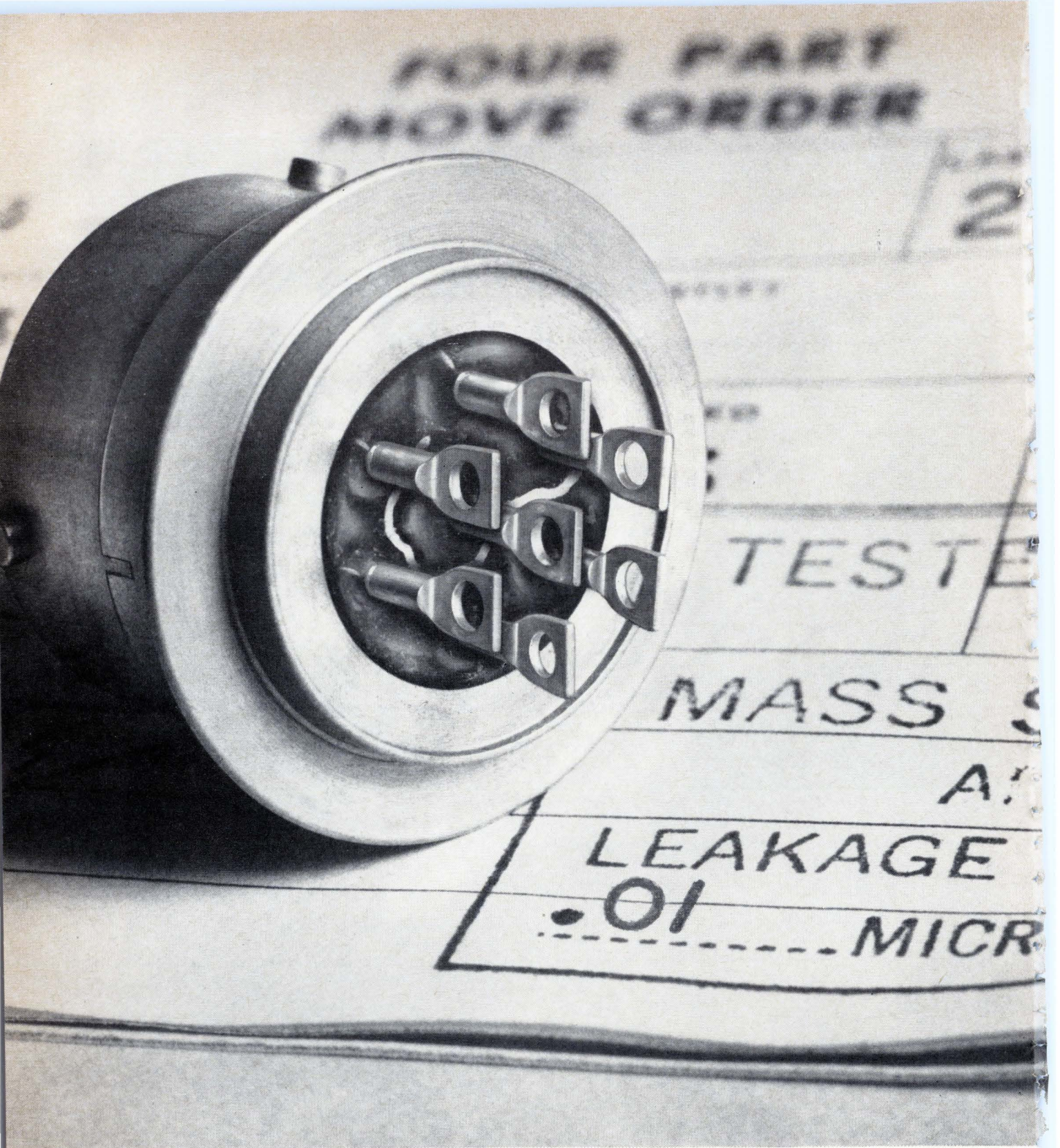

**No more premium
for leakproof connectors!**

O E
 133
 OF BOXES, CARTONS, ETC.
 IPC
 BALANCE FOR LEAK
 ON
 SPECTROMETER
 ER FIRING
 RATE LESS THAN
 CUBIC FT. PER HR.

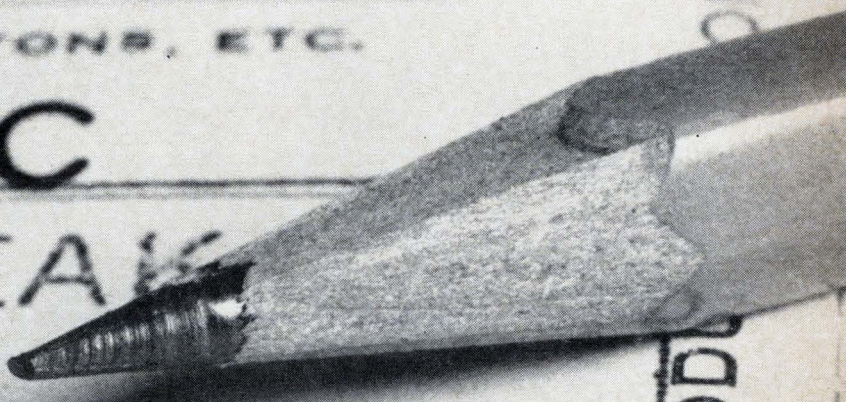

CONTROL
 PRODU

Until now, price was a sign of MIL-C-26500 hermetic seal performance. Amphenols changed that.

Priced Under \$7. Saves up to 23% on over 700 Amphenol 48 Series hermetic seal connectors (ones that meet MIL-C-26500). Buy size 14-7 bayonet connectors for less than

\$7.00 in quantities over 100.

.01 Micron Guaranteed. Using a full glass insert instead of beads around the contacts, we guarantee a leakage rate under .01 micron cubic foot of helium per hour.

Immediate Delivery. Chances are Amphenol has the hermetic seal con-

connector you need. Call your Sales Engineer or distributor. Or write **Amphenol Connector Division**, 1830 S. 54th Ave., Chicago, Illinois 60650.



AMPHENOL

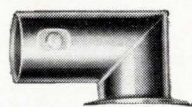

From RF to IF in one
integrated package

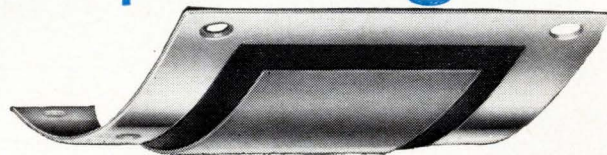

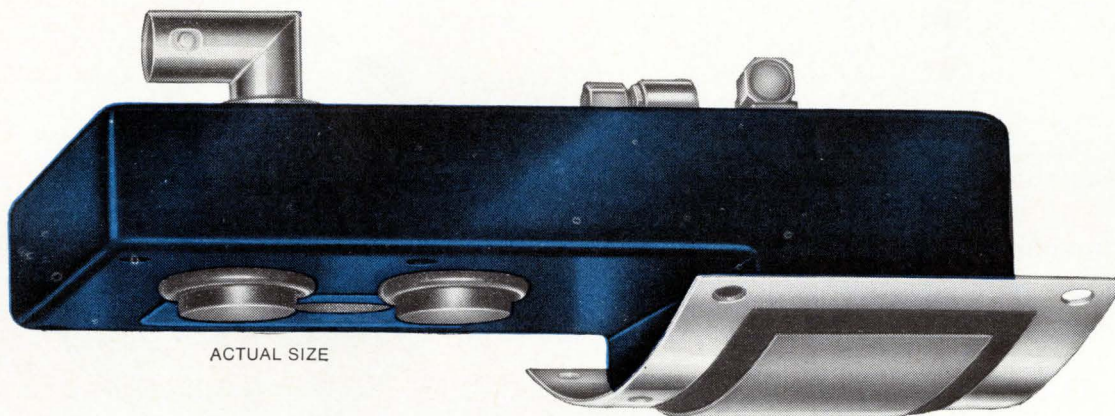

and no interface problems

It's the front end of a Di-Pole Altimeter. Light enough to carry in a missile, compact enough to fit in restricted space and with an antenna shaped to fit the outside skin surface.

The product of Sanders exclusive TRI-PLATE® Strip Transmission Line techniques, this small, lightweight unit packs six functions into a fully integrated microwave system from RF to IF . . . and with no interface problems in between.

It transmits 10 kw pk power at 4.2 GHz . . . has an overall system noise figure of 10.5 db . . . provides a T-bar slot antenna with 120° E plane pattern and fits neatly into 4³/₄" x 3¹/₄" x 3³/₄".

If eliminating interface problems, shrinking size and weight, packaging more complex microwave functions in a restrictive form factor will help you with your system, why not call us. The front end shown here is but one example of what

Sanders can do with TRI-PLATE techniques in assemblies components or systems. Our number in Nashua, New Hampshire is (603) 883-3321. TWX: 228-1887 SA Microwave.

SANDERS ASSOCIATES, INC.
MICROWAVE DIVISION



Creating New Directions in Electronics

*T.M., Sanders Associates, Inc.

Stable transconductance

FROM -55°C TO $+250^{\circ}\text{C}$

RCA-7586 nuvistor
 Heater Voltage $E_h = 6.3\text{ V}$
 Plate Supply Voltage (E_{bb}) = 75 V
 Cathode Resistor (R_k) = $100\ \Omega$

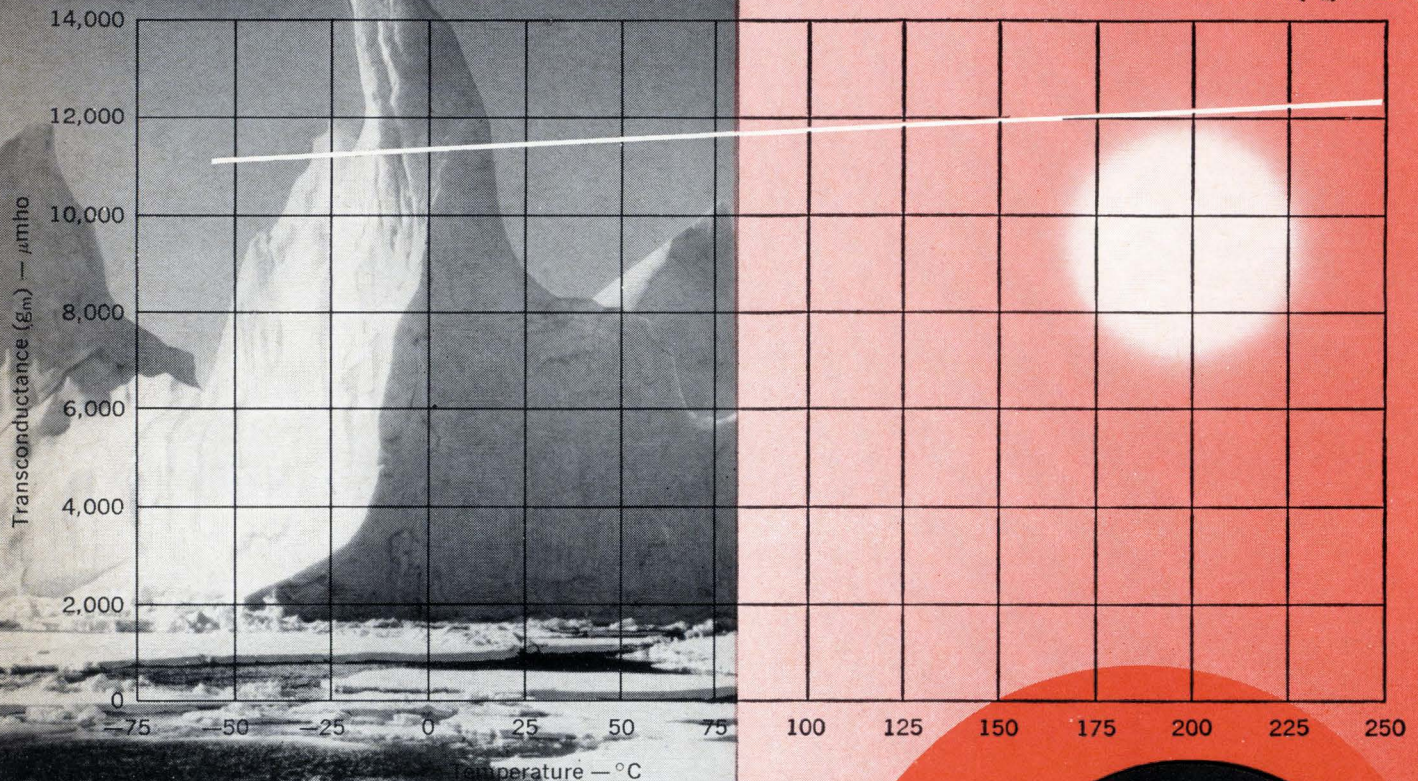

Temperature stability of highly-reliable RCA nuvistors minimizes frequency drift in electronic equipments and permits operation over wider temperature ranges. Change in transconductance per degree change in shell temperature is approximately 4 micromho per degree C.

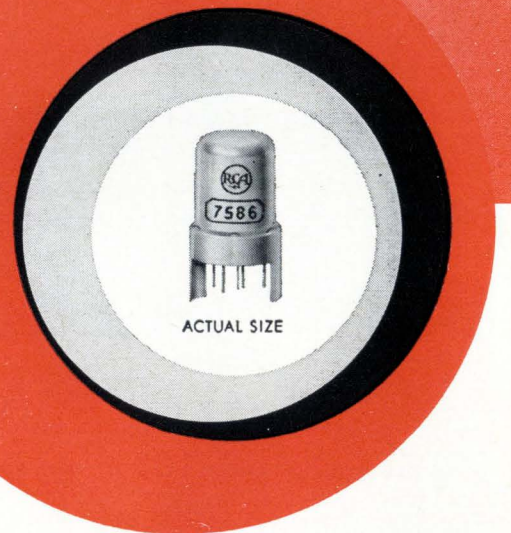

RCA nuvistors are exceptionally reliable in other ways, too: RCA-7586 nuvistors have demonstrated life-test reliability of 99.901% per 1,000 hours to 30,000 hours of operation.

Whenever you need a device that will provide high-level performance at practical costs in sophisticated applications, be sure to evaluate nuvistors. For specifics, call your nearest RCA District Office or write to RCA Commercial Engineering, Harrison, N.J. 07029.

RCA DISTRICT OFFICES—OEM SALES: EAST, 2075 Millburn Ave., Maplewood, N.J. 07040, (201) 485-3900 • MID-ATLANTIC: 605 Marlton Pike, Haddonfield, N.J. 08034, (609) 428-4802 • MID-CENTRAL: 1600 Keith Bldg., 1621 Euclid Ave., Cleveland, Ohio 44115, (216) 241-3450; 2511 East 46th St., Bldg. Q2, Atkinson Sq., Indianapolis, Ind. 46205, (317) 546-4001 • CENTRAL: 446 East Howard Ave., Des Plaines, Illinois 60018, (312) 827-0033 • WEST: 6363 Sunset Blvd., Hollywood, Cal. 90028, (213) 461-9171 • INTERNATIONAL OPERATIONS, RCA International Division: Central and Terminal Aves., Clark, N.J. 07066, (201) 485-3900 • 118 Rue du Rhone, Geneva, Switzerland, 35 75 00

RCA nuvistors are also available through your local RCA distributor.



RCA ELECTRONIC COMPONENTS AND DEVICES, HARRISON, N. J.
The Most Trusted Name in Electronics

Editorial

Disappointing three months

After activity—sales and technical progress—had taken off like a rocket in 1966, most executives in the electronics industry expected the high-acceleration ride to continue in 1967. Reflecting their optimism, Electronics' 1967 market survey [Jan. 9, p. 129] predicted a 9.4% increase in total sales. So to some segments of the industry the first quarter has been a crushing disappointment. Although the rocket hasn't come crashing to earth, it hasn't gone into orbit either.

Most disappointed have been the consumer electronics industry and its components suppliers, discrete-semiconductor producers, and the makers of complex sophisticated instrumentation for the space agency and its contractors. Suppliers of equipment for Vietnam, on the other hand, have seen sales maintain a frenetic pace.

Looking back—and hindsight is so much clearer than foresight—executives now realize that the rocket started to slow last September.

Inflation caused by an unexpectedly large Federal deficit—the result of the Pentagon's spending \$24 billion in Vietnam last year, instead of its earlier announced \$12 billion—and tight money curbed consumer demand for expensive electronic products.

In addition, electronics producers caused some of their own problems. Happily surprised by the spectacular rate of sales in the first half of 1966, many manufacturers of consumer entertainment products built up giant inventories of components and parts, anticipating that the rocketing rate of growth would continue or even speed up. When consumer buying slowed, inventory accumulation suddenly became inventory liquidation.

If you examine the sales figures, you can't help but feel the situation is not as bad as the marketing men are saying. In most cases, sales are every bit as good as last year, or better. But the crux of the concern is that capacities and facilities were enlarged greatly to handle far more sales than last year's, so companies have had to lay off workers and engineers, and executives are looking at expensive plant additions lying idle.

A superb illustration is color television, whose sales picture is examined on page 44. Sales are running at a clip almost 25% above last year; still, executives are wringing their hands because capacity was planned for an 80% increase.

On top of this, the impact of the decision by

Congress to drop the 7% tax allowance for investment in new capital equipment last year is now being felt. Suppliers of industrial electronics equipment are finding sales of their equipment slowing as customers reduce their buying. Congress reversed its field last month and reinstated the allowance, but any stimulating effect probably won't be felt for another six to 12 months.

In spite of discouraging news, the outlook for 1967 has to be optimistic. The forces for growth of the electronics industry are still working. Even executives at those companies hardest hit are predicting that the slump will reach bottom before spring is over, and that the last six months of 1967 will be almost as good as predicted last autumn.

Mergers sound warning

When the directors of North American Aviation in California and Rockwell-Standard in Pittsburgh agreed to a merger last month, alarm bells sounded in the executive suites of many electronics firms. For years semiconductor companies have watched uneasily while North American's Autonetics division has built up a tremendous technical capability in integrated circuits and a pilot production capacity to match. Only the knowledge that North American had no marketing organization capable of selling computer, industrial, or commercial customers gave the IC suppliers any sense of assurance. Now the proposed merger will give the big aerospace company just such an organization.

The merger is significant because it may be indicative of something that's going to happen in the electronics industry on a wide scale—the movement of systems houses into semiconductor manufacture. The advent of integrated circuits—especially large-scale integration—has already encouraged semiconductor companies to expand from materials processing and device building to systems designing and assembling. Similarly, the big systems companies will grow in the opposite direction, down into semiconductor production. All the major aerospace and systems companies have some in-house capability to design and produce integrated circuits. In addition, they may even have an edge over current IC producers in application know-how and systems assembly of integrated electronics equipment. Most of them, like North American Aviation, have lacked only marketing organizations.

Merger with a well-thought-of industrially oriented company, even one not solely in the electronics field, could be the route for a systems company to enter the selling of a broad line of electronics products.

Detroit has discovered permanent magnet motors made with ceramic magnets. So has the small appliance industry, communications, computers, the military and the space program. This sudden increase in demand is consuming ceramic magnets at a rate that is beginning to hurt all users. Except those that depend on Indiana General.

We've always produced more ceramic magnets than anyone. And now, as a result of an expansion program that began

last year, our production capacity is doubled. We can take care of all our customers' needs for a long time to come.

How come we anticipated the demand when others didn't? Probably because we know a little bit more about the ceramic magnet industry. After all, we practically invented it when we pioneered Indox[®] ceramic magnets, including the first grades specifically for PM motors.

Right now we make more different types

of Indox ceramic magnets than anyone. And we make more of them, too. Lots more. So if you have an application for ceramic magnets, don't worry. Indiana General has the materials, the engineering and the production to take care of you. For information, write Mr. Chuck Repenn, Manager of Sales, Indiana General Corporation, Magnet Division, Valparaiso, Indiana.

INDIANA GENERAL 

What multiplies faster than the demand for ceramic magnets? Our capacity to produce them.

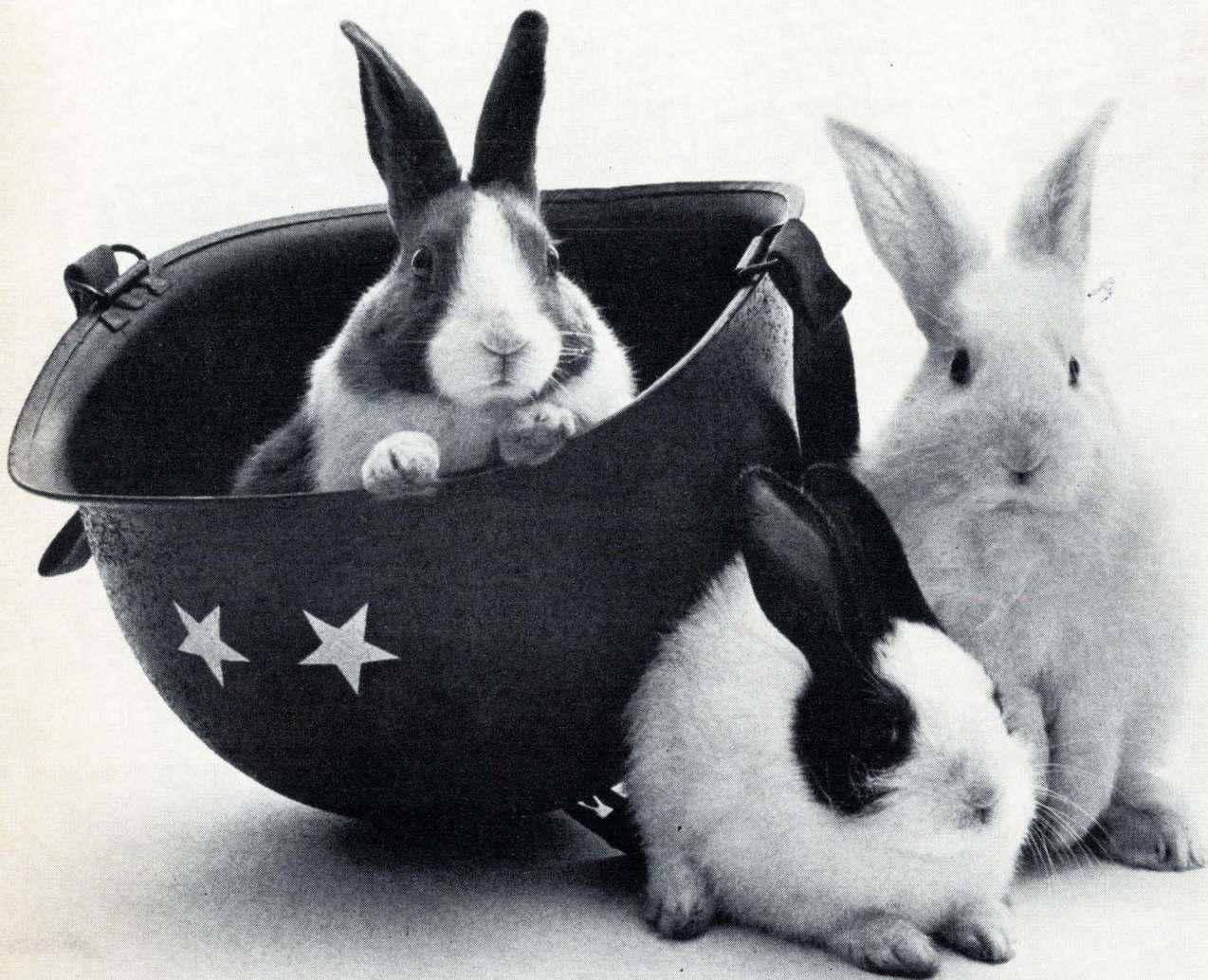

Electronics Newsletter

April 3, 1967

Navy may put lasers under water

Despite earlier pessimism, the Navy hasn't given up on lasers for anti-submarine work. A portable neon laser developed by an Avco Corp. division is about to be tested by the Navy as an underwater ranging device. The laser, which emits blue-green light, has produced 80-kilowatt pulses at a repetition rate of 300 pulses per second in laboratory experiments. **It may be used in combination with sonar for such tasks as torpedo guidance and decoy discrimination.**

The Navy is also studying the absorption and scattering properties of water with a green-emitting yttrium aluminum garnet laser built by the Korad Corp. under a \$68,000 contract. Besides the laser, the system—which is carried by a surface ship—consists of a transmitter, two receivers, and control boxes. The 2-megawatt pulsed laser, which Korad says will be used for other classified applications is designed to operate at depths of 300 feet at 5,300 angstroms, a wavelength affording maximum light penetration in water. A frequency doubler in the unit can boost the wavelength to 1.06 microns.

Workhorse transistor ready for pasture?

A popular transistor that's been around for years may be nearing the end of the line although it's still selling by the hundreds of thousands. Now being produced primarily for military communications equipment, the microalloy diffused germanium transistor—the 2N502A—has been riding on what some call a "grave train." **But it may soon be replaced by a mesa version, probably priced under \$1 in quantity orders, now being readied by several firms. By comparison, the older workhorse costs \$1.50.**

The switch was signaled a few months ago when the Army changed the 502A specifications to permit the use of an isolated element TO-5 package along with the microalloy "barrel" package.

House hearings won't slow Apollo

Hearings before a House subcommittee this month on the Jan. 27 Apollo spacecraft fire may be critical of past NASA and contractor performance but aren't expected to force any further delays in the space agency's manned lunar landing schedule. **By the middle of this month, NASA expects to announce a new Apollo schedule,** but plans will be conditional upon the satisfactory flight testing of spacecraft modifications resulting from the accident. NASA administrator James E. Webb privately estimates that if two unmanned Saturn-5 hardware tests on flights later this year are successful, the first manned Apollo launch could be made this fall with the already man-rated Saturn IB rocket [Electronics, March 20, p. 59]; otherwise, it will come late this year or early in 1968 with the third Saturn-5 shot.

A wrong number for time-sharing

A pioneer in the multiaccess computer field, has blasted AT&T for not moving fast enough to meet the growth and needs of computer time-sharing in the areas of technology and rates.

Richard J. Mills, assistant director of Project MAC at Massachusetts Institute of Technology, makes no bones about the way he feels. He says "the carrier has a \$30 billion plant investment and is interested in recovering this investment rather than in making radical changes necessary to

Electronics Newsletter

proper handling of information technology. Its facilities are not matched to needs." He thinks the Federal Communications Commission should needle the giant communications firm into action.

Ion process sought as a Corning ware

Corning Glass Works, which moved into the semiconductor field last year with its purchase of Signetics Corp., may now be planning further advances. Corning's Electronic Products division is said to be negotiating with the Ion Physics Corp. for rights to an "ion-implantation" semiconductor-doping method. With this process, p-n junctions are formed in semiconductors by ion bombardment. Ion Physics first used the process to build solar cells four to five years ago and has since successfully fabricated diodes and transistors using the technique.

IC image in masking

The Hewlett-Packard Co. is producing integrated-circuit master masks with the first operational masking camera to use laser interferometry. The interferometric plate-positioning technique allows IC image placement within 12.5 microinches, while digital comparators and reversible counters automate the masking process. The increased level of positional accuracy permits the fabrication of more high-speed IC's per chip.

The company doesn't plan to sell the camera system, but the first commercial laser masking camera may come late this year from the Spectra Physics Corp.

Holograms to get IC picture

To study the failure mechanisms of integrated circuits, NASA's Electronics Research Center in Cambridge, Mass., has asked industry for research proposals on combining holography and microscopy. The technique would enable investigation of circuits from several angles simultaneously. There are two basic methods: either magnifying the hologram image of the circuit with an electron microscope or magnifying the circuit before the hologram is made.

Recruiting fizzles, sizzles at IEEE

How good was the recruiting at this year's IEEE convention? It all depends on who's doing the answering. Some recruiters claim the supply of prospects was so short that they gave up and left New York City before the show was over. Says A. C. Sugalski of Interstate Staffing Inc.: "The game was over before we even got started. What a fiasco!"

Not so, says William A. Douglass, president of Careers Inc. He calls his results "wildly successful." Careers, recruiting for 36 companies, claims it attracted between 1,300 and 1,400 applicants, and arranged 3,000 interviews. National Manpower Register reports 1,600 interviews during the four-day show.

Motorola claims it can count on plastic transistors

Reliability "rapidly approaching" that of metal cans will be claimed by Motorola Inc. in an upcoming report on its small-signal plastic transistors. The company's data shows a failure rate of 0.32% per 1,000 hours at 60% confidence level based on continuous tests at full rated power for more than a year.

Motorola sees a failure rate of better than 0.01% per 1,000 hours at normal operation which is 30% of rated power.



*Charles-Francois de Cisternay Dufay
Dangled from the ceiling in a very quaint way;
Charged electrically in this odd pose,
He shot off sparks from the end of his nose!*

One of a series of...
Vignettes in Electronic History

A limited number of full-color reproductions of the Dufay painting, along with the story of his experiment, are available upon request.

In his own peculiar manner, Dufay discovered positive and negative electric charges and helped pioneer the way to our wonderful world of electronics. Today, with better scientific procedure, Spectrol tackles the most challenging assignments in electro-mechanical components. Typical of Spectrol's capability in "specials" and "high reliability" components are its precision potentiometers on the Command Module for the Apollo man-on-the-moon program. That kind of capability explains why Spectrol precision potentiometers are found on more systems throughout the world than any other pots.

And, although the "spec" in "Spectrol" stands for "special," we still offer our customers over two-hundred-million options to choose from in our line of *standard* precision potentiometers and trimmers. That's why more and more engineers are calling Spectrol "the component man's component company." If you're a component man shouldn't you be using our products, or helping us make them?

Spectrol Electronics Corporation
A subsidiary of the Carrier Corporation
17070 E. Gale Ave., City of Industry, Calif. 91745
Copyright © 1967



Better Components for Better Systems: precision potentiometers • trimming potentiometers • turns-counting dials • miniature switches

Hello, world.

To reach out through soundless space in order to be heard in the most remote corners of the earth . . . to design the systems, provide the technology for far-reaching communications . . . to put voices in the wilderness. This is a MITRE mission.

Among MITRE's current communications activities are included: conceptual design of new communications systems and analysis of their performance; analysis, investigation and development of advanced communication techniques; analysis and projection of Air Force tactical communications needs; and development of sophisticated simulation techniques for communications systems synthesis and evaluation.

Immediate staff and management level openings exist for: Communications Engineers and System Analysts experienced in the systems analysis and design of communications networks, modulation and signal processing techniques, switching systems and voice and data transmission; Operations Analysts with experience in simulation

techniques and capable of establishing communications requirements and performing cost effectiveness trade-offs; Project Engineers for detailed engineering and specification of satellite communications systems; and specialists in airborne antenna and multiple access signal processing techniques.

NATIONAL AIRSPACE SYSTEM

MITRE is currently augmenting its top-flight team of systems men in the suburban Washington, D.C. Atlantic City, N. J. areas. Their mission: to provide the system engineering to the Federal Aviation Agency on the new National Airspace System — an air traffic control system for the 1970's. Their job encompasses such technical areas as broad level system analysis, computer program analysis, system specifications, system logical design, system test planning for design verification, and configuration management.

Working on this project you would engage in such activities as: translating system operational

objectives into technical requirements for the system's subsystems; synthesizing the technical characteristics of equipment sub-systems of balanced reliability, and analyzing alternatives; reviewing and analyzing, at the logic level, design submissions of system hardware contractors; conducting design optimization studies with respect to cost, reliability, and technical suitability; or synthesizing software designs for a multi-processing computer environment.

If you have three or more years' experience and a degree in electronics, mathematics or physics, write in confidence to Vice President — Technical Operations, the MITRE Corporation, Box 208 BC, Bedford, Massachusetts.



THE
MITRE
CORPORATION

An Equal Opportunity Employer (M & F)

Pioneer in the design and development of command and control systems. MITRE was formed in 1958 to provide technical support to agencies of the United States Government. MITRE's major responsibilities include serving as technical advisor and systems engineer for the Electronic Systems Division of the Air Force Systems Command and providing technical assistance to the Federal Aviation Agency and the Department of Defense.

Some of our work is positively brilliant.



In fact, one of our lasers throws a beam 250 billion times brighter than the sun.

It's the brightest laser in the world.

As leaders in lasers, we've made all kinds, up to giants with 1000 megawatts per pulse. And laser welders. And, of course, a full family of laser accessories.

But lasers are only one of the up-front activities that keep Union Carbide on the frontiers of electronics. We are also leaders in the research, development and production of solid state devices, solid tantalum and foil-film capacitors, fuel cells, and single crystals and related products.

They're reasons to keep Union Carbide in mind before your projects reach the breadboard stage.

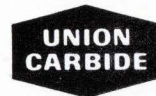

ELECTRONICS

Union Carbide Corporation, Electronics Division
270 Park Avenue
New York 10017.

THE NEW IDEA

IS

It's the right electronic component plus circuit specialists trained in finding total circuit solutions for your product problems

Straight talk! General Electric's new idea is the Electronic Components Sales Operation—a team uniquely oriented to the special needs of this growing and changing market.

It's a circuit specialist who can find total circuit solutions for your product problems . . . a specialist who can stay on top of trends in electronics and apply the right combination of technical ideas when you need them.

It's unmatched technical backup assistance plus the widest product range in the world. You name it, and it's available through one man. To mention just a few of the component types he offers:

- silicon controlled rectifiers
- nickel cadmium batteries
- high power klystrons
- specialty a-c, d-c and Hyper-servo* motors and generators
- germanium and silicon transistors
- film and paper-oil capacitors
- TV camera tubes
- sealed relays
- unijunction transistors

- aluminum electrolytic capacitors
- ignitrons and thyratrons
- voltage regulators
- tunnel and back diodes
- cathode ray tubes
- thermistors and Thyrite* varistors
- panel meters and meter relays
- transformers
- terminal boards, push buttons, indicating lights

*Reg. Trademark of General Electric Co.

Put GE's total electronic capability to work today. A call to your Electronic Components Sales Operation office is the way to start. There's one in every major market area.

285-22

ELECTRONIC COMPONENTS SALES OPERATION

GENERAL  **ELECTRIC**

THE

IN ELECTRONICS

**MUCH
MORE THAN
PRODUCT
YOU BUY**

Circle 31 on reader service card

Portrait of a most reliable family



More accurately, the portrait shows only *part* of a most reliable family. The E. F. Johnson Company makes hundreds of fine quality electronic components, including:

CAPACITORS—A dozen basic series of air variable capacitors, each in a wide choice of capacity values. They range from sub-miniature machined plate capacitors with maximums of 4.2 to 24.5 pf., to larger, heavy-duty types with capacity values to 1700 pf. and voltage ratings to 9000 volts peak.

There is a reliable Johnson capacitor to fit your application. Whatever the size, it offers excellent stability, high Q, low temperature coefficient, uniform capacitance, and excellent overall performance at competitive prices.

CONNECTORS—The Johnson line of jacks, plugs and terminals meets the needs of both military and commercial designers effectively and economically. For printed circuit applications, there are sub-miniature insulated tip plugs and jacks, plus the unique Test Point Strip/Handle for fast, efficient circuit testing.

Johnson's line of standard insulated connectors includes tip, banana and dual banana plugs, tip and banana jacks, military tip jacks, and binding posts.

RIB-LOC™ components consist of new miniature, one-piece, insulated terminals and jacks that press-mount with excellent retention characteristics.

TUBE SOCKETS, INSULATORS, PILOT LIGHTS, RF COMPONENTS AND HARDWARE

—Dependable Johnson tube sockets include HF, VHF and UHF types for tubes of various power levels.

Low-loss, high-voltage-breakdown insulators are available in either steatite or porcelain.

Johnson offers 47 pilot light assemblies in neon and incandescent types. Standard and wide angle lens caps are available in glass and acrylic.

Other hardware includes panel bearings, shaft couplings, crystal sockets and RF chokes, plus a number of heavy-duty RF components for broadcast transmitting, RF heating, antenna phasing and other commercial applications.

FREE CATALOG gives complete details and specifications, including net prices, of E. F. Johnson quality electronic components. Write for your copy today, or ask us about your specific application requirements. Special components, to your exact requirements, may be available in production quantities.



E. F. JOHNSON COMPANY

3033 Tenth Ave. S. W., Waseca, Minnesota 56093
Providing nearly a half-century of communications leadership

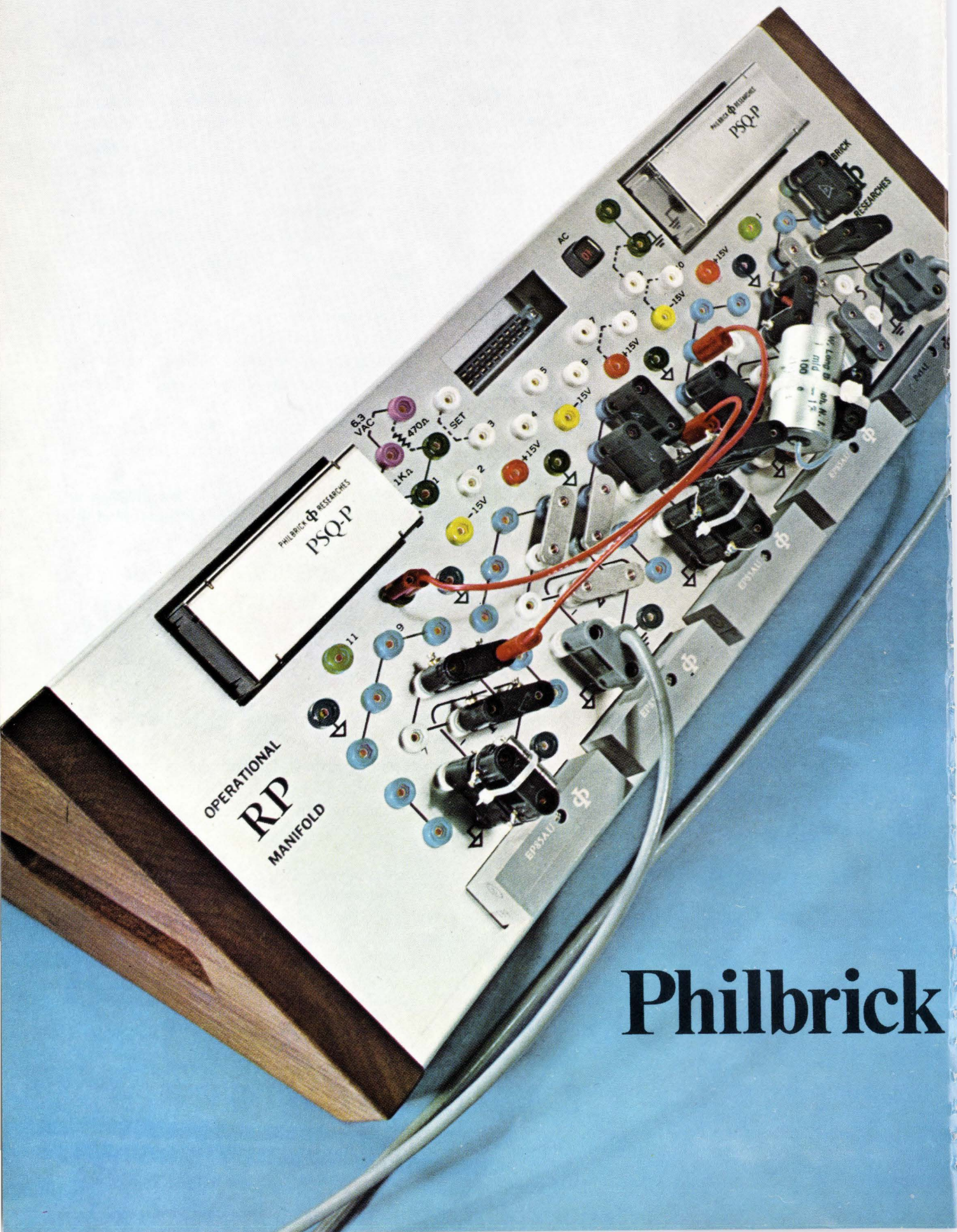

OPERATIONAL
RP
MANIFOLD

Philbrick

Model RP is an all-in-one analog instrument. With it you can assemble operational amplifier circuits in *minutes* instead of hours or days. It's ideal for experimentation, simulation and instruction in the practical application of solid-state analog circuitry. The RP combines the convenience and freedom of old-fashioned breadboards with a technique that provides logical organization, shielding, grounding, isolation and stabilization to temporary or experimental circuits. Philbrick Operational Manifolds make it easy to build stable operational amplifier circuits that are free of "bugs," "strays" and other parasitic happenings.

The Model RP Operational Manifold has five receptacles for plug-in solid-state operational amplifiers of the Philbrick "EP" type, an integral regulated DC power supply and a jack panel on which circuitry can be assembled conveniently and quickly. In addition, two extra receptacles accommodate a Philbrick Operational Circuit Plug-in — such as a Quadratic, Logarithmic or Sinusoidal Transconductor or a chopper-stabilized high-gain amplifier. An electrically "free-floating" receptacle included on the panel accepts an additional 10-pin plug-in module such as an EP or P-size Operational Amplifier, a Booster Amplifier, an Operational Circuit Plug-in or any arbitrarily selected set of circuit elements preassembled on an OP-O Uncommitted Plug-in unit.

Mounted on the front panel of the RP Operational Manifold are 106 tip jacks, spaced $\frac{3}{4}$ " apart in a pattern of equilateral triangles. They accommodate standard twin-tip plugs and are used for mounting

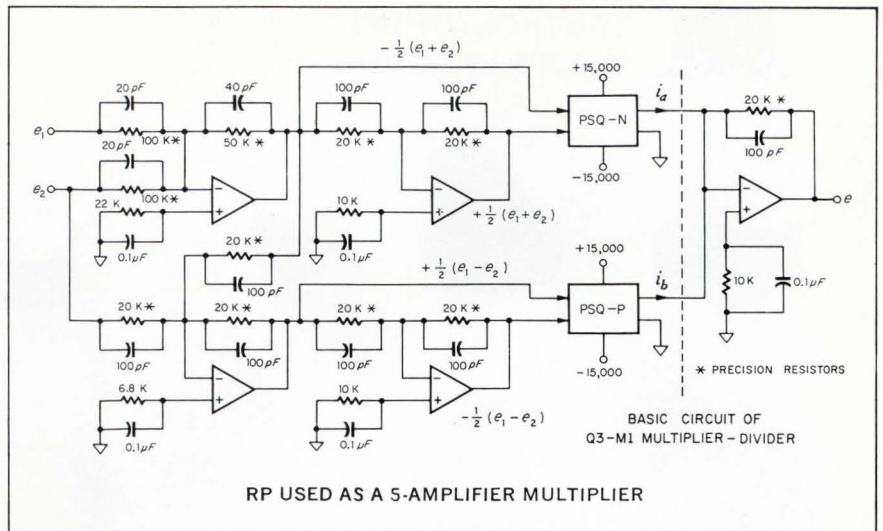

passive components, shorting bars and as terminations for shielded input and output cables. Jacks are color-coded. Functional interconnections are printed on the panel.

The 5-amplifier multiplier-amplifier circuit diagram shown above is typical of the many analog circuits that can be constructed on the RP Operational Manifold. Virtually all of the 125 circuits described in Philbrick's Applications Manual for Operational Amplifiers can be assembled quickly and easily on the instrument. The RP is not limited to use as a breadboard for experimental circuits. It may also be used for permanent or semi-permanent circuits that must be built to seemingly impossible schedules.

The RP Manifold is sturdily built, attractively packaged and wired to Philbrick's usual high standard of quality. The simple, clear-anodized sheet-aluminum enclosure provides effective shielding and a firm base for the solid mounting of electrical components. It is available in a style for rack-mounting or with hardwood ends for bench use.

Philbrick Model MP Operational Manifolds may be used when a lesser degree of sophistication is required. They contain four Type P plug-in amplifiers and have an interconnection panel with 66 jack tips. The MP provides wide flexibility and a high degree of reliability at relatively low cost.

A complete line of accessory hardware is available for both the RP and MP Operational Manifolds. Uncommitted plug-in component boards are also available.

A 4-color, 6-page brochure contains more detailed information on the Philbrick RP and MP Operational Manifolds. For your copy, phone your nearest Philbrick engineering representative or get in touch with Philbrick Researches, 22-A Allied Drive at Route 128, Dedham, Massachusetts 02026. Phone (617) 329-1600.



PHILBRICK

Operational Manifold— the most sophisticated and economical way to breadboard operational amplifier circuits



CONTROL KNOBS FROM RAYTHEON

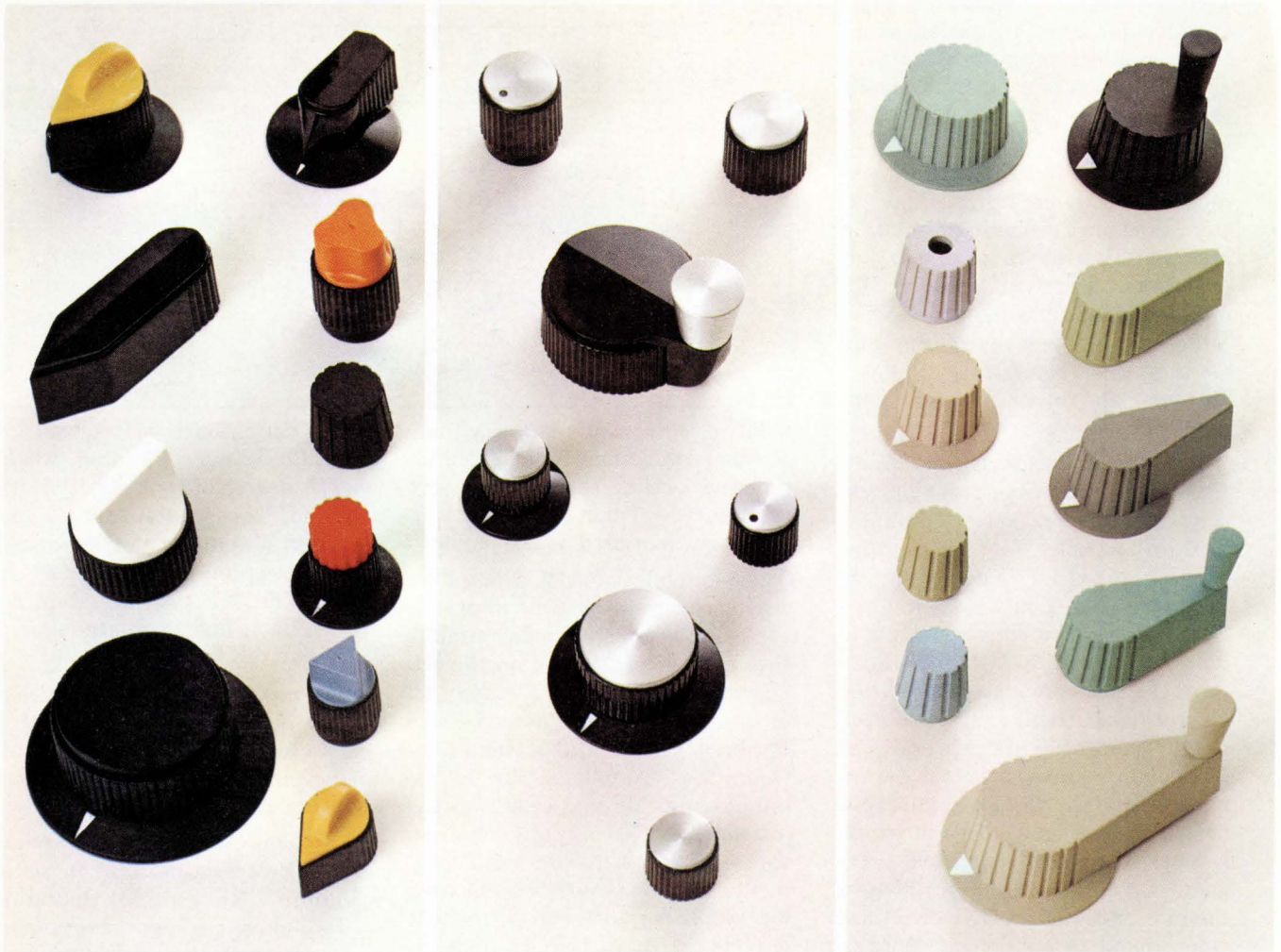

Military knobs, aluminum cap knobs, color knobs for every panel requirement

You can meet military specs, select styles and colors that harmonize or contrast with any panel design and decor — when you specify Raytheon control knobs.

Because, Raytheon offers the largest selection of military and commercial knobs. And *makes them promptly available to you through distributors from coast to coast.*

Meet MS91528C Military Specifications from more than 300 standard types. Raytheon has custom designed over 2,000 "specials."

Every knob in the Standard Series is functionally designed. All styles have an integrated design to give uniformity to your panel. And each knob meets MS91528C for resistance to flame, torque, temperature and humidity extremes, salt spray and

ultraviolet radiation. Colors include black, red, gray or to your special order.

Or, specify aluminum-cap knobs. These handsome knobs are made of strong plastic with satin finish aluminum caps. Raytheon aluminum caps are treated with an epoxy coating for corrosion resistance. Colors: black, gray, or to your order.

Color knobs highlight panels. Choose from eight colors plus black — in ten styles — to harmonize or contrast with commercial equipment design. Raytheon makes these 400 Series Knobs of durable high-impact ABS.

Call your distributor or nearest Raytheon regional sales office for catalogs and data sheets. Or, circle the reader service card. *Raytheon Company, Components Division, Quincy, Mass. 02169.*

Industrial Components Operation—A single source for Circuit Modules/Control Knobs/Display Devices/Filters/Hybrid Thick-Film Circuits/Industrial Tubes/Optoelectronic Devices/Panel Hardware

RAYTHEON

Soliton's low cost ISOLTAXIALTM

NPN SILICON TRANSISTORS

PAT. PENDING

GUARANTEE RELIABILITY

with...

- All aluminum metalization-die and leads
- Molybdenum pedestal mounting for matching thermal coefficients
- Alloy mounting to eliminate thermal fatigue
- Copper base assembly providing low thermal resistance

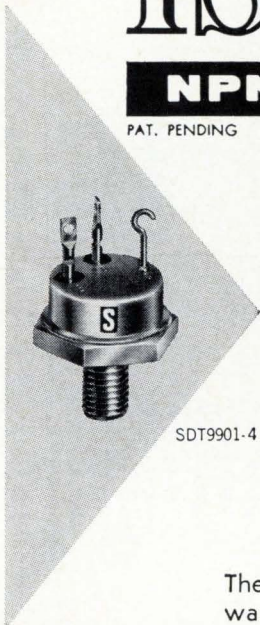

SDT9901-4

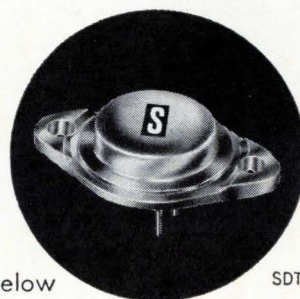

SDT9801-4

The gain and V_{CE} (sat) comparison curves shown below warrant your inspection. They illustrate Soliton's new ISOLTAXIAL NPN Silicon Power Transistors which have characteristics of low-leakage planar units, combined with resistance to secondary breakdown offered by homogeneous devices. Developed with the high reliability standards associated with Soliton, these ISOLTAXIAL devices may be used in power supplies, audio amplifiers, inverters, converters, relay drivers and series regulators. Available in TO-3 and TO-61 cases, the ISOLTAXIAL transistors are priced lower than epitaxial or triple-diffused planar devices.

COMPARISON OF ISOLTAXIAL DEVICE TO COMPETITIVE 2N3055

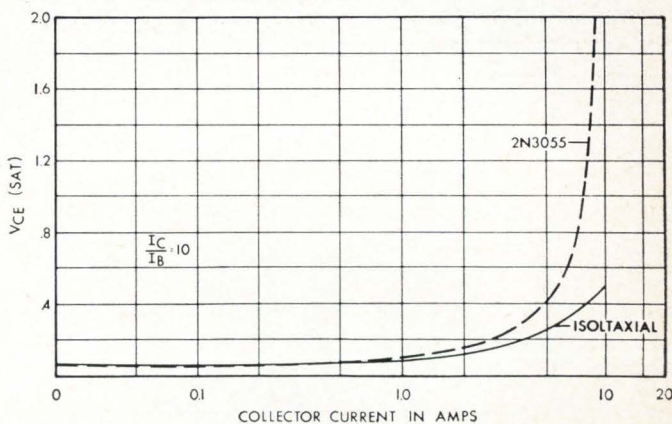
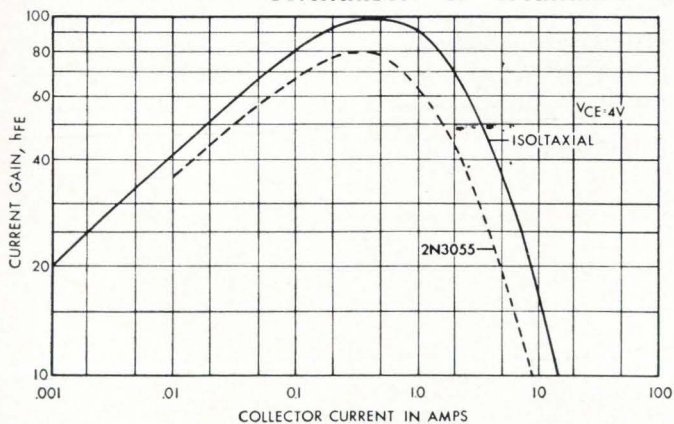

CONTACT US TODAY FOR COMPLETE INFORMATION

TRANSISTOR DIVISION

Soliton DEVICES, INC.

1177 BLUE HERON BLVD. / RIVIERA BEACH, FLORIDA / (305) 848-4311 / TWX: (510) 952-6676

Leader in Germanium and Silicon Power Transistors, Cryogenic Thermometers, High Voltage Rectifiers, Hot Carrier Diodes, Temperature Compensated Zeners, Voltage Variable Capacitors, Random/White Noise Components, Microelectronic Circuits, and Power-Sink Interconnection Systems.



Tuned Amplifier/Oscillator is Six Instruments in One

- LOW-NOISE AMPLIFIER
- WAVE ANALYZER
- DISTORTION ANALYZER
- LOW-DISTORTION OSCILLATOR
- SENSITIVE AC VOLTMETER
- ALLPASS DELAY PHASE SHIFTER

The PAR Model 110 Tuned Amplifier/Oscillator is a versatile high-gain, low-noise, low-distortion frequency selective amplifier operating over the frequency range of 1 Hz to 110 kHz with Q variable from 1 to 100 with no gain change. It provides four outputs simultaneously: a second order (resonance) bandpass; a second order band-reject (notch) providing rejection of the center frequency in excess of 100 dB; a second order allpass which is characterized by an amplitude response which is flat with frequency and a phase lag which increases monotonically with frequency; and a flat output. Each of the 600 ohm outputs is capable of providing 5 volts rms into a 5K ohm load. A front panel AC voltmeter permits measurement of any one of the four outputs.

The instrument can function as a wave analyzer with bandwidth adjustable from 1% to 100%; as a flat

or selective AC voltmeter with sensitivity ranging from 10 microvolts to 5 volts rms full scale; as a distortion analyzer to measure distortion levels as low as 0.1% (as low as 0.001% when used in conjunction with a second Model 110); as a low-noise amplifier (typical noise figure of 1 dB) with voltage gain ranging from 1 to 10^4 ; as a stable general-purpose low-distortion oscillator providing up to 5 volts rms into 600 ohms, capable of being synchronized by an external signal; and as an AC-DC converter with ground-based output.

Price: \$1195. Export price approximately 5% higher (except Canada).

For additional information, write for Bulletin T-140 to Princeton Applied Research Corporation, Dept. D P.O. Box 565, Princeton, New Jersey 08540. Telephone: (609) 924-6835.



PRINCETON APPLIED RESEARCH CORP.

Advanced technology

Cool memory's hot

For more than a decade, the potential low cost and small size of superconductive memories has tantalized memory researchers and produced only frustration. Now, by taking a new tack on the technical problems that have stymied attempts to make cryoelectric memories practical, the Radio Corp. of America has brought the concept within sight of the marketplace.

Working at the RCA's Laboratories in Princeton, N.J., Robert A. Gange of the firm's Electronic Components and Devices division has built an experimental 14,000-bit cryoelectric memory contained on four 2- by 2-inch planes, each with a bit density of 6,500 per square inch. Operating at 3.5°K, the memories have a cycle time of 4 microseconds. With a newer, larger-capacity plane now under development, RCA expects to be able to make practical, fast mass-storage systems to replace the slow, bulky magnetic tape and disk systems now used. Memories with capacities as high as 100 million bits are within reach, the developers say.

New concepts. Gange and his group launched their attack on several fronts. After studying the approaches that previous researchers had taken, they concluded that many of the old concepts of memory organization and device design had to be abandoned. Specifically, they found that they needed:

- A new storage element that was less dependent on dimensional tolerances and critical manufacturing processes.
- A new organization that would reduce the number and length of the sense lines required, thus decreasing attenuation and noise.
- Room temperature address decoders separated from the superconductive memory elements to

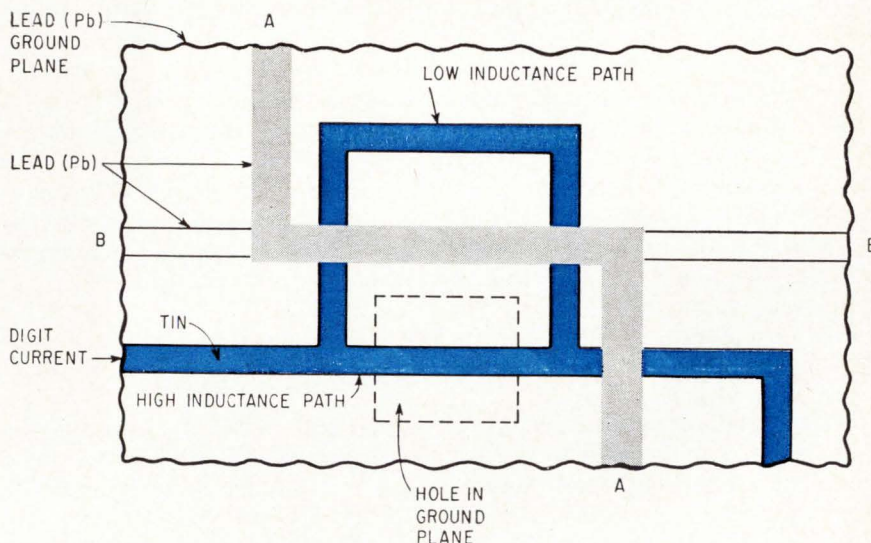

Loop memory cell in cryoelectric memory is selected by coincident currents in the A and B lines, and delivers an output on digit, or sense, line. Select currents switch the loop to the resistive state and the digit current is forced into high inductance path over hole in ground plane. The flux creates a circulating current, representing a stored "one."

eliminate complicated processing and testing, while increasing the storage capacity of a plane.

The new memory cell is in the form of a tin loop that stores a binary 1 as a circulating current in the superconductive state; absence of a circulating current corresponds to a binary 0. The current is a result of a high inductance path caused by a section of the loop passing over a hole in a lead ground plane. A low inductance path is made up by the rest of the loop. When the address coincident currents switch the selected loop from the superconductive to the resistive state, the loop current is forced into the high inductance path, where it sets up a flux in the loop. When the address currents are removed, the loop returns to the superconductive state and the flux sets up the circulating current.

Variable factors. In earlier cryoelectric cell structures, the film thickness determined the critical magnetic field needed to switch the memory cell. Other factors such as grain size and orientation, impur-

ity concentration, dislocations, interstitial atoms, vacancies, and point defects also seriously affected cell operation. The state of the art still hasn't reached the point where such variations can be controlled closely enough in thin films for reliable operation.

Gange and his group, working under laboratory head John J. Carrona, therefore made the films thick enough to let the critical field depend on the bulk material properties rather than on the thickness and point-to-point variations. However, Gange notes, too thick a film results in an increase in the inductive time constant and a reduction in cycle time.

For the new memory, Gange devised a hybrid of word and bit organizations, two types commonly used in conventional ferrite core memories.

In a bit-organized memory, the digits of the same order for all the words are stored on one plane, so that there are as many planes as there are digits in a word. The digits are selected by coincident

currents. In a word-organized memory, all the digits of a particular word lie on the same plane and each is read out simultaneously on individual sense lines.

In the hybrid word-bit organization, all bits of a word are stored on the same plane, as in word organization, but the digits are selected with coincident currents. With the hybrid system, the sense line is substantially shorter than would be needed in the bit-organized system—allowing increased yields, and reduced signal attenuation and write noise. The hybrid system also lends itself to modular construction of the memory. The planes can be checked out individually and can operate independently of each other.

Eliminates cryotrons. Going a step further, RCA researchers eliminated the superconductive address decoders that were used in the earlier cryoelectric memories. Previous researchers, attracted by the low cost made possible by fabricating both the address decoding circuitry and the memory cells through batch fabrication, accepted almost without question the concept of thin-film cryotron decoders. (A cryotron is a superconductive current-controlled switch that has two superconductors—one passing over the other so that a current in the upper conductor produces a flux that switches the lower superconductor to the resistive state, cutting off the current flow; it thus is essentially a thin-film, superconductive relay.)

The major problem was that once the decoders were placed on the same substrate as the memory cells, they couldn't be evaluated independently. In the new RCA system, using room temperature address decoders, the conventional electronic portions and the memory planes can be evaluated separately. Cell currents can also operate with wider tolerances and the space gained by eliminating the cryotron decoders can be used to increase the bit capacity of the memory plane.

Heat load cooled. With room temperature decoders, many more wires run down into the Dewar, since the room temperature portion

of the system is communicating with individual cells on the memory planes, rather than simply with the inputs to cryotron decoding circuits. The decision to eliminate the cryotron decoders was questioned by others at this point. Would the heat load on the cryogenic refrigerator be excessive with so many wires running into the Dewar? Gange's group showed that it would actually be reduced with the new system, because only a few of the wires are carrying current at a time and the current levels are much lower than would be required with cryotron decoders.

How high the sea

New light will be shed on the ocean's surface when a prototype laser scanning system built by Electro-Optical Systems Inc. for the Naval Air Systems Command is tested from a Texas tower off the coast of California in about six months. Further tests from an aircraft may be conducted before the year is out. Laboratory tests of the feasibility of the approach were completed late last year.

Basically, the prototype will be made up of a neodymium-doped yttrium aluminum garnet laser transmitter, an optical scanner, a modulator, and a receiver. It will weigh approximately 50 pounds. The airborne version will sit on a stable platform similar to the type used for aerial cameras.

Measure waves. With a beam having a maximum continuous-wave output of 1 watt at 1.06 microns, the laser will transmit in two modes—directly from a reflective surface to determine wind definition, and in an amplitude-modulated mode where the signal is deflected by a movable mirror through a modulator to determine the height, length, and direction of waves. The returning signals will be received and routed through subsystems to produce either cathode-ray tube or numerical displays.

Wind velocity is determined from the small capillary waves on the water's surface. The sea is illuminated by the laser and the re-

flected signal is picked up, amplified, correlated in a computer, and displayed.

To measure wave height, an r-f signal is imposed on the laser beam. When the beam is returned from the ocean's surface, the signal is demodulated and compared with a local oscillator reference. The phase displacement between transmitted and received signals gives an indication of wave height. According to Ronald L. Kirk, who directed the feasibility study at Electro-Optical, a subsidiary of the Xerox Corp., an amplitude-modulated frequency of 20 megacycles will measure phase variations within 0.2° accuracy for waves up to 12.5 feet high.

The feasibility study was conducted at the firm's Pasadena, Calif. Laboratory using an ionized argon laser. Ocean conditions were simulated in a specially built wind-wave chamber. It was determined experimentally that such a system wouldn't be significantly affected by either density variations beneath the ocean's surface or temperature variation.

Sky's the limit. The system's light weight makes it easily adaptable to most naval aircraft. However, because it's an optical system, planes fitted with it will have to be flown under cloud level. With clear skies, the system can be used at the high altitudes flown by reconnaissance aircraft.

Possible military applications include:

- Providing oceanographic data for amphibious landings.
- Aiding aircraft carrier skippers in locating wind belts for launching and retrieving aircraft.
- Guiding submarine commanders to areas of heavy seas to avoid enemy radar.
- Supplying data for ship deployment.

Civilian applications include forecasting weather and routing commercial vessels away from heavy seas.

Although Electro-Optical Systems won't say how much an operational system would cost in production quantities, Kirk says the price would be low enough to allow wide use of the system in such

applications as Coast Guard air patrolling.

If Kirk's optimism is borne out, the airborne laser system will offer stiff competition to a proposed sensor buoy network. Experiments are now being conducted with prototype buoys capable of measuring ocean data [Electronics, July 25, 1966, p. 48].

Military electronics

Navy checks bearings

Shipboard installations of inertial navigation systems have been largely limited to Polaris missile-carrying submarines. One reason is the great expense of such equipment; another is the fact that surface warships don't require the same degree of accuracy in their navigational gear as do underwater missile craft. Now, however, the availability of less costly gear is making the Navy take a closer look at the possibility of upgrading the navigation equipment of its surface fleet. Two self-contained models of a ship's navigation system have just been delivered by the AC Electronics division of the General Motors Corp. under the terms of a \$4 million development contract.

One of the new units will be tested ashore at the Naval Applied Science Laboratory in Brooklyn, N.Y., beginning in September. The other will probably be installed aboard the testbed vessel for the original ship's inertial-navigation system (SINS) for subs.

Surface savings. Designed to furnish the greatest positional accuracy for the lowest possible price, the new units will cost \$250,000 apiece, a price about one-third that of the operational SINS. But the submarine system must be precise enough to permit accurate aiming of Polaris missiles and must run for lengthy periods without position fixes.

To lower the costs of its units, AC uses gyroscopes less expensive and much less accurate than those in SINS. But the firm compensates for this by adding a radiometric

sextant built by the Collins Radio Co. to feed current data to the system's computer.

To obtain a position-reference fix, the sextant's antenna is pointed at the sun or moon; an operator uses the elevation and azimuth angles thus determined to update the AC Magic III Model 321 digital computer, which is built exclusively with integrated circuits [Electronics, Feb. 20, p. 203]. Until the next update, the computer depends on the system's inertial platform for positional data.

The inertial platform has three gyroscopes supplied by AC, and accelerometers from the Bell Aerosystems division of Textron Inc. Operating serially, the computer performs all navigational calculations.

Shooting the sun. The Collins sextant uses a three-foot-diameter parabolic antenna to focus on a narrow band of microwave frequencies radiating from the sun and moon. Since these frequencies aren't attenuated by cloud cover, the sextant can supply data in nearly any weather.

Microwave portions of the sextant's circuitry are immediately behind the antenna. Here the received energy is converted to analog signals for transmission below decks. The inertial platform is used as a horizon reference to assure antenna-pointing accuracy.

Solid state throughout, with plug-in circuit boards, the new sys-

tem features built-in test fixtures to speed maintenance.

Although less accurate between updates than SINS, the AC navigation system is said to be five times as accurate as the present dead-reckoning navigation techniques used on surface ships. AC's system is also smaller than SINS, requiring only about 15 cubic feet of below-decks space.

If the Navy decides to buy the new system, first installations would be made aboard destroyers. There is, however, no money for the system in the fiscal 1968 budget.

Tacsat backpack

By adding 37 pounds of microwave gear to his pack, a soldier carrying a man-pack radio will soon be able to receive messages from half way around the world. The new unit consists of an antenna, microwave amplifier, and down converter developed by the Hughes Aircraft Co. as an add-on to its AN/PRC-74 very-high-frequency radio.

The Hughes Ground Systems group is vying for the contract for one of six types of tactical satellite-communications terminals sought by the Army Electronics Command [Electronics, Dec. 26, 1966, p. 26]. The terminals would tie in with the Air Force's synchronous tactical communications satellites, now being built by Hughes for a demonstration launch

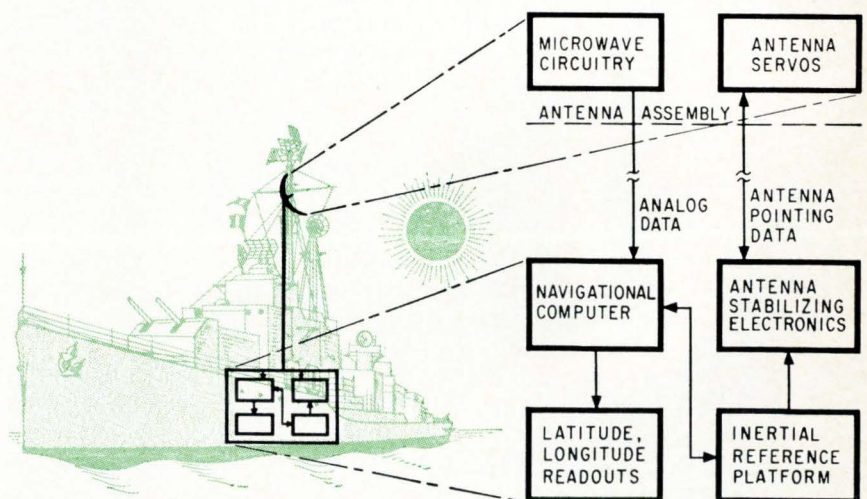

Super sextant. A radiometer antenna updates inertial reference platform with positional data derived from sun's azimuth and elevation.

sometime next year.

Sky high. Locating a 23,000-mile-high satellite from the battlefield would be a difficult task. After leveling the module and aligning it with true north by using a built-in compass, the operator determines the satellite's angle and direction from his location by referring to a chart. The dish antenna has a 9° beamwidth, sufficient to allow for some error in aligning the antenna with the satellite.

The antenna, built of fiberglass honeycomb, is a 12-inch diameter parabola with a focal-point feed and 25 decibels gain in the 7.25- to 7.75-Ghz tactical-satellite band. Behind the dish is a tunnel-diode amplifier similar to the Hughes scc-3 shipboard satellite terminal. The amplifier feeds a down converter that drops the microwave signal to the 260-Mhz level needed by the AN/PRC-74's front-end. The rest of the receiver circuitry is in the man-pack radio.

Flashlight power. Although the set hasn't been tested with a satellite—present satellites have insufficient output—the miniature terminal has performed successfully in ground simulation. An X-band sig-

nal source was used in the tests to supply the few milliwatts of power necessary for simulation at ranges to 1,500 feet.

The power supply is 28 flashlight batteries. Most of the transistors require about 20 volts, but this would probably be reduced in a redesign. Power drain could also drop by up to two thirds. In a future model, the "dry cells" would be replaced with nickel-cadmium or silver-zinc cells.

At 37 pounds the module is not as light as was desired, but Hughes wanted to respond quickly to show what the firm could do with existing hardware. The firm used relatively heavy parts developed for its AN/PRC-74 and scc-3. Project manager Harold V. Lind figures that a third of the weight of the unit could be lopped off by redesigning.

Using on-hand components does have its advantages; Hughes invested only \$10,000 and eight weeks of engineering time developing the terminal. A transmit capability to the terminal could be added, says Lind, but Hughes isn't working in that direction yet and has no plans to do so.

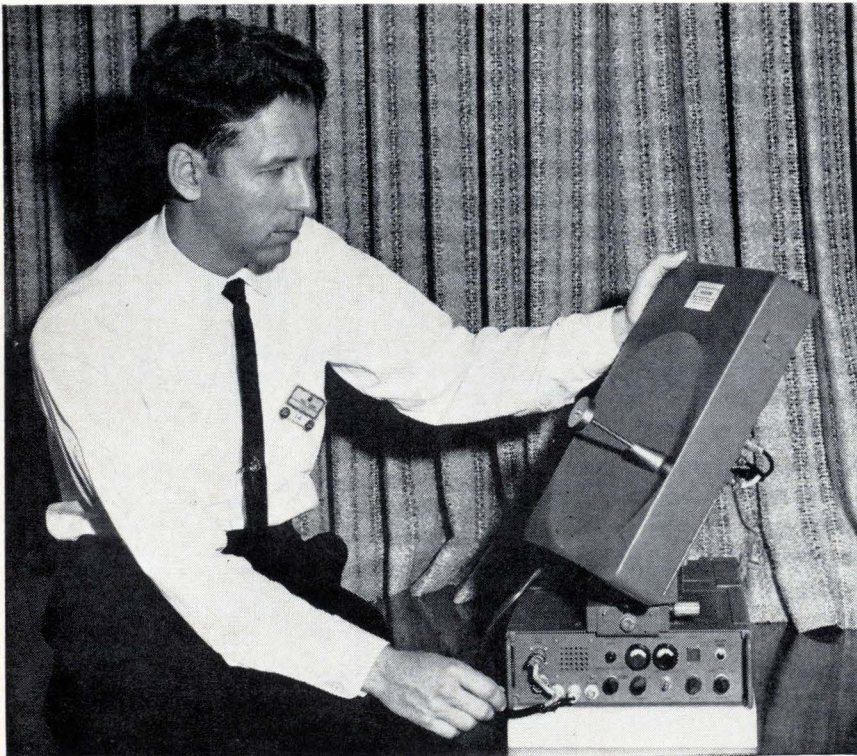

Small wonder—Harold V. Lind, program manager, adjusts antenna elevation of tiny terminal built by Hughes Aircraft.

Integrated electronics

Frozen FET's

Next stop for metal oxide semiconductor integrated circuits is the deep freeze. Since designers of optical imaging arrays—such as airborne infrared image or target detection systems—must supercool the sensors to obtain the necessary sensitivity, they are now taking a look at placing sensor-supporting MOS integrated circuits inside the detector's cryogenic cooling system.

This would improve the performance of the IC's and greatly reduce the number of leads going in and out of the Dewar—the vacuum bottle filled with liquid gas to cool the detectors.

At least two companies are trying out the approach with infrared detectors—the Electronics division of the Avco Corp., Cincinnati, and the Autonetics division of North American Aviation Inc., Anaheim, Calif.

Robert Downing, leader of a group working on device and IC development at Autonetics, notes that the pinhead-sized field effect transistors used in MOS circuits operate better at a cold and constant temperature.

Infrared tv. Avco is working on two-dimensional, point-by-point imaging arrays in an effort to improve its infrared systems. A line scanner now provides an airplane pilot with a television-like image of objects on the ground. It can distinguish between cars and trucks and has a range greater than a mile. It's a passive reconnaissance system, dependent only on temperature variations in the scene viewed rather than some means of illuminating the terrain.

The system gathers the infrared picture in real time by scanning the scene through a line of detectors fabricated in an indium-antimonide chip. The line resembles two rows of gear teeth that mesh in a narrow opening in a deposited gold mask. Each detector is a mesa-type device with a diffused junction. Meshing two strings of detec-

tors leaves essentially no gap between detector outputs. The detectors are cooled to 77° Kelvin in liquid nitrogen.

Sealed bottles. It won't be difficult to make 5-by-5 and 10-by-10 two-dimensional arrays, according to Norman Gri, senior engineer for solid-state development at Avco's infrared group. But he says that getting data out of the Dewar will be difficult because of the large number of leads that will have to be passed through vacuum seals.

Gri wants to obtain information from the arrays by a method called aperture filtering; the technique consists of interrogating the detectors with pulse streams and processing the output bursts. He believes it will be practical to provide the sampling circuitry required—and at the same time reduce the number of sealed leads—by putting MOS IC's inside the Dewar. The circuitry will be made on silicon substrates, rather than indium-antimonide detector substrates; indium-antimonide's oxide is a conductor, Gri explains, while MOS devices generally require an insulating oxide. Avco plans to keep the amplifiers outside the Dewar; only a few signal leads, plus supply and ground leads, will have to enter the array housing.

Sapphire base. Autonetics, on the other hand, proposes to put FET's and silicon resistors for the amplifiers, plus lead-sulfide detectors, onto a common sapphire substrate. At present the company isn't attempting to build signal processing into the arrays because it first wants to determine if the FET's can survive the high temperatures of the deposition process used to fabricate detectors. It also wants to determine if sapphire is a good substrate for the detectors, Downing says.

Autonetics' plan is to make 10 arrays of 10 detectors—together with their buffer amplifiers—on each substrate, and then cut the substrate into modules. The amplifiers will be used to match the impedances of the arrays and external circuitry rather than for gain.

Each amplifier will require resistors ranging in value from 0.2

to 2 megohms. The research specialist developing the processes, Ron Harris, says these will be made as lines of silicon 300 mils long and 1/8 mil wide. He has devised a unique way of adjusting the value. Instead of changing the line dimensions—the usual approach—Harris shorts out the excess line length. The silicon, which normally has a bulk resistivity of several kilohms per square, is made conductive by n+ diffusion through a standard mask with slot-like windows. Adjustments are made by varying diffusion length.

It isn't a good practice to use silicon resistors under normal circumstances, Harris points out, because silicon has a high temperature coefficient and the resistor values would vary widely with temperature changes. However, the constant low temperature again makes for stable values.

Another Epic chapter

With a dozen or more dielectric isolation schemes battling for acceptance in the integrated-circuit marketplace, Motorola Inc.'s Semiconductor Products division has opted for glass. Motorola's new Epic-G approach is the successor to the company's original Epic process, in which polycrystalline silicon and oxide dielectrics were used to isolate IC elements. Like some other IC researchers, Motorola engineers prefer glass because it outperforms silicon in reducing interisland capacitance and has a higher breakdown voltage, [Electronics, March 20, p. 93].

However, the right glass is hard to find. Its softening point must be low enough to allow it to flow at temperatures below silicon's melting point but high enough to keep it solid during diffusion. Motorola scientists settled on a glassy mix of oxides of silicon, aluminum, magnesium, calcium, and barium. The mixture's dielectric constant is 6.5, while the dissipation factor at 1 kilohertz is 2.5×10^{-3} . Conductance is 1×10^{-8} mhos; capacitance in 1.8-mil thicknesses is 125 picofarads per square centimeter.

Impurities. Even when great care

Motorola's method

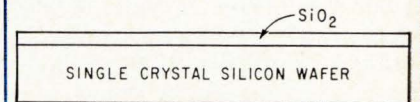

Fabrication of an Epic-G device starts with a single-crystal silicon wafer with one surface oxidized.

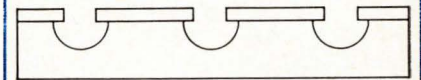

Isolation moats are etched.

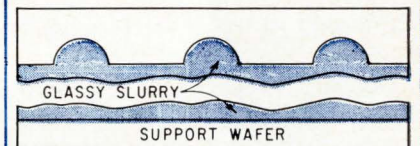

After etched wafer is flipped, a glassy slurry is applied. The SiO_2 blends with the glass.

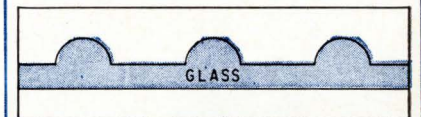

The two wafers are sandwiched together and fired.

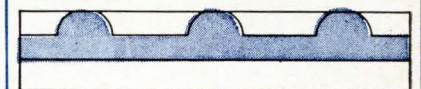

Excess silicon is lapped off leaving islands—the next step is device fabrication.

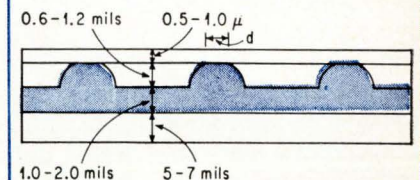

Schematic cross section. Top layer is oxide.

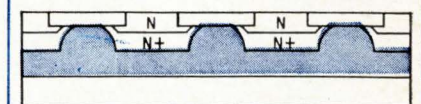

Circuit using an n+ buried layer.

is taken in compounding the glass, impurities remain that can contaminate the silicon. In some of Motorola's devices using npn transistors, p-type impurities in the glass required a minimum of 10 microns of n + silicon under and around each lightly doped n region to prevent its conversion to p-type material. With pnp devices there was no problem.

The Epic-G approach would apply itself equally well to both linear and digital ic's. The Motorola fabrication technique resembles a combination of polycrystalline-silicon construction and RCA's mosaic approach, but makes unnecessary the extra step of applying barrier layers.

So far, all work on Epic-G has been in the lab. The company hasn't decided when or if it will move from the pilot stage to production assembly of Epic-G circuitry.

Hard cell

Borrowing an idea from linear circuit designers, the Signetics Corp. has developed a unique monolithic bipolar cell structure. The work is part of the Corning Glass Works division's quest for an approach to large-scale integration that would make sense both technically and economically.

Engineers at Signetics feel the new cell may eventually become the basis for a standard line of LSI products. According to Orville Baker, vice president for product development, success in LSI—at least for his company—will depend on the introduction of a versatile line of standard products with a wide range of applications. The new cell meets the test of versatility because it can be used in both memory and logic circuitry. It also possesses another virtue essential to LSI—small size; it measures only 12 mils square, making high densities possible.

Successful pairing. Signetics designers combined a lateral geometry pnp complementary transistor with a standard planar npn to form the basic bistable element. The complementary pair provide a simple but fast storage circuit that is

self-latching, yet uses few components.

Conventional ic's, such as the roughly equivalent D-type flip-flop designed to perform the same function, would require two back-to-back inverters to form the basic flip-flop, plus a gate and an additional inverter.

The first applications of the cell

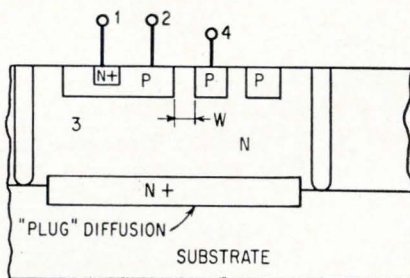
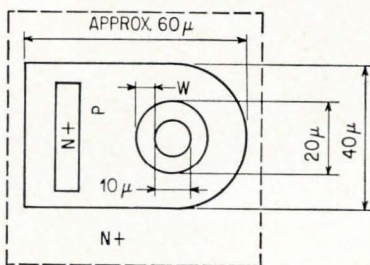
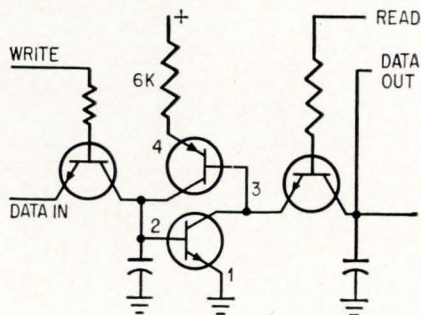

Basic memory cell developed by the Signetics Corp. includes complementary transistor pair that forms fast very small storage element with potentially high density. Geometry of lateral pnp-npn combination is displayed in plan and cross-sectional views. Buried n "plug" diffusion layer isolates upper pn regions from a p type substrate.

is in an experimental scratchpad memory organized as an 8-by-8 matrix. The array of 64 cells interconnected by two layers of metal, together with a row of eight buffer amplifiers, is formed on a single chip only 96 by 120 mils. Performance of the memory can be classi-

fied as moderately high speed, says Baker.

Two versions. There are two versions of the memory in development. One with a limited temperature range from 15° to 55°C has an access time of 40 to 50 nanoseconds, and is designed for commercial applications. In the second, designed for operation over the full military range of -55° to +125°C, access time is reduced to about 150 nsec.

The basic cell can be modified for use as a logic gate by making the input transistor a multiemitter device; the circuit then resembles a TTL gate. Fanout of the circuit without additional gain is about 3.

If the decision to market some version of the memory is made, the chip will probably be packaged in a 40-lead ceramic package that Signetics plans to introduce in the near future.

Consumer electronics

Color them blue

Sales expectations of color television manufacturers last December were as bright as the plumage of the NBC peacock. They were predicting 1967 volume of 8 million sets at that time [Electronics, Jan. 9, p. 139], but the picture has dimmed since then and the estimates have been toned down. Manufacturers now expect to sell 6 million sets to distributors this year—off sharply from the projected figure, but still a 27% gain over last year's 4.7 million unit sales.

Why the sudden change in the market? "Buyer concern over inflation, a possible tax increase, and price resistance," says the Philco-Ford Corp.'s Armin E. Allen, vice president in charge of the Consumer Electronics division. Most companies agree, blaming the current market on tighter money and growing consumer resistance to high-priced sets.

Overproduction. Part of the problem lies with the industry itself. Production of picture tubes early last year trailed demand for color

TRW TRANSISTORS announces another member of the Gigahertz family

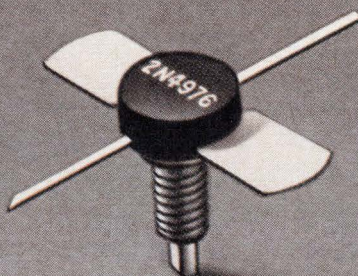
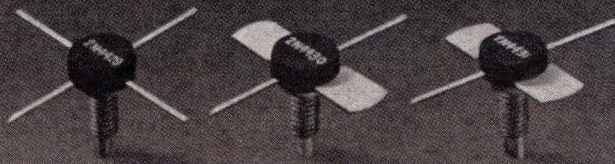

1 Watt
2 GHz

6-32

1 Watt output ... 5dB gain!

TRW again breaks the Gigahertz barrier with this new 2 GHz addition to the TRW family of Ultra High Frequency transistors! They are the finest broadband transistors you can buy—the only power transistors capable of GHz operation in simple, straight through circuits.

As doublers or triplers these transistors will reach 3 GHz with cool efficiency. In the 600 to 700 MHz range their gain and efficiency are phenomenal!

And you get this remarkable performance from a 28 volt power source, 1 Watt output, 5 dB gain!

Contact any TRW distributor or TRW Semiconductors Inc., 14520 Aviation Blvd., Lawndale, Calif. 90260. Phone: 213-679-4561. TWX: 910-325-6206. *TRW Semiconductors is a subsidiary of TRW INC.*

TRW

sets by as much as 30%. In its zeal to catch up to the demand, the industry sharply expanded its tube capacity. Says a spokesman for the Radio Corp. of America: "The prediction of 8 million [sales] this year was based on the increase in tube production." Components suppliers, who shared the late-1966 optimism of the set and picture-tube makers and boosted capacity, are also beset with overproduction problems.

Adding to the industry's woes is consumer demand for a greater variety in tv screen sizes and price ranges. Consumers, retailers observe, are becoming choosier. Says Henry E. Freedman, tv purchasing agent for Rich's Department Store in Atlanta: "They are a different type of customer than the ones who bought last summer. They want more for their money and won't rush into color."

Martin Sheridan, a vice president of the Admiral Corp., concedes that his company entered 1967 with a "poor model mix," but says new 14-, 18-, and 20-inch models will be introduced this year. A new line slated by Motorola Inc. for June introduction may also feature new screen sizes. The only U.S. firm to manufacture a 10-inch portable color set, the General Electric Co., is planning to add two new 10-inch models to its line, as well as several larger models.

Pricing. Most makers are stepping up their advertising to lure buyers, and, although most companies deny that they are lowering prices, some concede they are trying sales gimmicks that, in effect, reduce prices on certain models. A recent Philco-Ford "promotion" involved a \$50 cut in the price on a 20-inch model. Others who have offered bargains recently are Admiral and the Magnavox Co. Retailers, too, have pared prices in an attempt to move sets from showroom floors to consumers' homes.

RCA is holding the line on prices. A spokesman says RCA's policy is to "cut production before it cuts prices;" the company has already slowed production of color tv and receiving tubes—but not cut prices. The National Video Corp., another large producer of tubes, admits the

possibility of price cuts, but says none are planned for the near future.

Complicating the industry's woes at the start of 1967 was the high level of inventories. Says S.R. Herkes, president of Motorola Consumer Products Inc.: "Dealers had a lot more sets in stock at the end of 1966 than anyone cared to admit, so we started the year with an inventory problem." A spokesman for the Montgomery Ward Co. estimates that a "million sets were left in the pipeline at the end of 1966." He goes on to predict total 1967 retail sales of only 4.7 million sets, a forecast that points to more full warehouses at the end of this year.

Industrial electronics

Razzle-dazzle replay

The color video disk recording system developed by the Ampex Corp. and used for the first time last month by the American Broadcasting Co., is a second cousin to a computer. In fact, it uses what amounts to a small computer to produce color quality that meets U.S. standards, and the recording medium—a metal disk—is analogous to a computer memory disk.

Making a big month of it, Ampex will show this week, at the National Association of Broadcasters convention in Chicago, its battery-powered portable videotape recorder-camera combination weighing less than 50 pounds and a compact color videotape recorder priced at \$4,995. Ampex says the recorder is the smallest four-head unit on the market.

The video disk was developed for ABC's instant replays and stop-action pictures in color when televising sports events. Tape, explains Ampex's Lawrence Weiland, product management chief, does not lend itself well to slow-motion use because the four spinning recording heads tend to grind through the tape itself, which is only 1 mil thick. Moreover, the operator must rewind the tape to find the right starting point. The disk has a strong surface made of what Wei-

land would only call "exotic metals."

With the disk, an operator always has a record of the last 30 seconds of action because the head is continually recording and erasing. The head traverses the disk in a manner that Ampex considers proprietary, but it is apparently similar to the operation of a computer memory operation. It also is similar to the video disk that acts as a buffer in Ampex's million-dollar videofile—an information retrieval system using videotape recorders.

The disk system has a bandwidth of 4.5 megahertz, but Weiland emphasizes that bandwidth is not the problem in recording color. "The National Television Standards Code is subject to errors in differential phase and gain," Weiland says. "The chief problem is to get good time-base stability when you are taking a very complex signal, putting it through a mechanical system, and reproducing another very complex signal."

Nothing fancy. The digital integrated circuitry, mostly off-the-shelf flip-flops and gates, that preserves this signal, uses standard computer techniques, says Weiland. The logic system also controls reproduction modes so that the system, known as the HS-100, can reproduce at normal speed, at continuously variable slowdown speed, at twice normal speed, and frame by frame—all in both directions. Cueing is accomplished in four seconds—about the time for an announcer to say "let's see how that looked on the isolated camera."

The company is working on versions that also will be compatible with Europe's two color tv systems, Secam and PAL.

Because it wanted to make the portable tape recorder system compatible with studio equipment, Ampex was stuck with 8-inch reels and tape 2 inches wide, plus normal-sized recording heads. It has shrunk everything else.

Power for 20 minutes of operation plus 20 minutes of previewing or live telecasting, is supplied by nickel-cadmium batteries. IC's are used in the recording circuitry

New! 100 MHz in a ruggedized oscilloscope with 3.5-ns risetime at the probe tip

DC-to-100-MHz bandwidth at 10 mV/cm
is NOW AVAILABLE
in a plug-in oscilloscope
with solid-state design . . .
the Tektronix Type 647A and R647A.



New Type 10A2A Dual Trace Amplifier. The risetime and bandwidth are specified where you use it — at the probe tip. The vertical system performance with or without the new miniature P6047 10X Attenuator Probe is DC-to-100 MHz bandwidth with 3.5-ns risetime at ambient temperatures of 0° C to +40° C (+32° F to +104° F). Bandwidth is DC-to-90 MHz with 4.1-ns risetime over its entire operating range, —30° C to +65° C. The calibrated vertical deflection range (without probe) is from 10 mV/cm to 20 V/cm.

Bright Displays. The Tektronix CRT provides bright displays with its advanced design and 14-kV accelerating potential. It has a 6-by-10 cm viewing area and a no-parallax, illuminated, internal graticule.

New Type 11B2A Delayed Sweep Time Base. The Type 11B2A triggers to above 100 MHz internally and provides a calibrated delayed sweep. Calibrated sweep range is from 100 ns/cm to 5 s/cm, extending to 10 ns/cm on both normal and delayed sweeps with X10 magnification. Calibrated sweep delay is from 1 μs to 50 s and the plug-in also provides single sweep operation.

Rugged Environmental Capabilities. These instruments are capable of accurate measurements in severe environments and offer an extra margin of dependability and even greater accuracy in normal environments. Temperature: Operating —30° C to +65° C. Non-Operating —55° C to +75° C. Shock: Non-Operating 20 G's max, 2 shocks, each direction, along each of the 3 major axes. Vibration: Operating or Non-Operating 0.025" p-to-p, 10-55-10 Hz, (4 G's) 1 min cycles, 15 min each major axis. Humidity: Non-Operating meets MIL-STD-202B, Method 106A, except freezing and vibration, through 5 cycles (120 hours). Altitude: Operating 15,000 ft. Non-Operating 50,000 ft.

New Type R647A Rack Mount. The same DC-to-100 MHz performance also is available in a 7-inch-high rack mount oscilloscope, the Type R647A. Additional plug-ins include the Type 10A1 Differential Amplifier and the Type 11B1 Time Base.

Type 647A Oscilloscope (includes 2-P6047 Probes)	\$1500
Type R647A Oscilloscope (includes 2-P6047 Probes)	\$1625
Type 11B2A Time Base	\$ 850
Type 10A2A Dual Trace Amplifier	\$ 775

U. S. Sales Prices FOB Beaverton, Oregon

For complete information, contact your nearby Tektronix Field Engineer or write: Tektronix, Inc., P. O. Box 500, Beaverton, Ore. 97005.



Environmental testing



*. . . part of the Tektronix commitment
to technical excellence*

AMPERITE

Thermostatic DELAY RELAYS

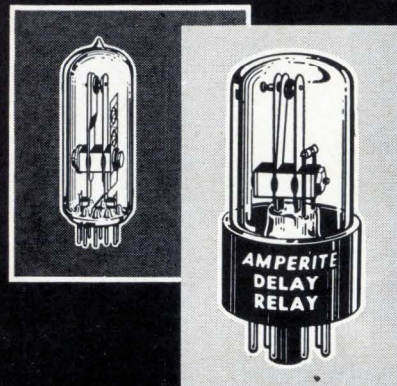

Only a glass seal
offers true hermetic sealing
... assuring maximum stability and life!

Delays: 2 to 180 seconds . . . Actuated by a heater, they operate on A.C., D.C., or Pulsating Current . . . Being hermetically sealed, they are not affected by altitude, moisture, or climate changes . . . SPST only—normally open or normally closed . . . Compensated for ambient temperature changes from -55° to $+80^{\circ}$ C. . . Heaters consume approximately 2 W. and may be operated continuously . . . The units are rugged, explosion-proof, long-lived, and—inexpensive!

TYPES: Standard Radio Octal, and 9-Pin Miniature.
List Price, \$4.00

PROBLEM? Send for Bulletin No. TR-81

AMPERITE

BALLAST REGULATORS

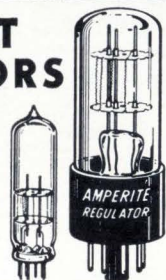
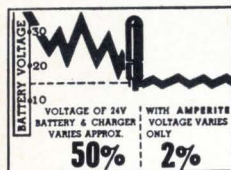

Hermetically sealed, they are not affected by changes in altitude, ambient temperature (-50° to $+70^{\circ}$ C.), or humidity . . . Rugged, light, compact, most inexpensive . . . List Price, \$3.00.

Write for 4-page Technical Bulletin No. AB-51

AMPERITE

600 PALISADE AVE., UNION CITY, N.J.
Telephone: 201 Union 4-9503
In Canada: Atlas Radio Corp., Ltd.,
50 Wingold Ave., Toronto 10

except where high-power linear signals are present. The system even has its own sync generator to set basic pulse rates. This piece of equipment, not normally present in a tape recorder, takes up about a cubic foot of space in the studio; the IC version in Ampex's VR-3000 takes up about a cubic inch.

Light burden. The 35-pound recorder is strapped to the operator's back; the camera, weighing 13 pounds, has its own video-level meter on the face of the view-finder tube.

Since the tape is compatible with studio equipment—the reels can be lifted out and placed into a studio playback machine—it is also able to record color. No color camera yet exists, however, that an operator could lug around.

Ampex says that its new helical videotape recorder, the 7500-G, is the first available for under \$50,000. A higher performance model 7800, with advanced features for production of finished industrial and educational programs, will be available in September for \$7,995.

You can be sure if it's . . .

When tests of train-control equipment for the San Francisco Bay Area Rapid Transit District (BARTD) began nearly two years ago [Electronics, July 26, 1965, p. 71], the Westinghouse Electric Co., alone among the four companies then competing, proposed centralized control and a wiggly-wire loop between the rails for signal transmission. Last month, BARTD accepted the Westinghouse bid of \$26,199,959.32 for train controls and communications—but the system it bought was a far cry from the equipment originally tested.

Gone, for instance, is the wiggly-wire circuitry. Gone too are the 40 Prodac-50 computers that were to be placed along the wayside. And gone is the concept of total centralized control.

The revised system will use the tracks themselves for train-control command transmission and will retain a Prodac-250 central digital computer for scheduling and train-interval control; the computer is a

Control Data Corp. main frame with inputs, outputs, software, and peripheral hardware by Westinghouse. And the wayside computers have been supplanted by smaller digital units installed in control cars.

Acoustic-frequency commands received from the tracks will now be fed to a control car's speed controller—"a wired-logic device" according to Philip Gillespie, Westinghouse's transit systems sales manager. When a train enters a station, control will be transferred from the speed controller to the control car's small digital computer. Speed and acceleration with the new track control circuits will be "conventional," states Gillespie.

Cutback. A cost-cutting redesign of BARTD's rolling stock made central train control using the Prodac 50's and the wiggly wire less attractive. Gillespie explains that BARTD originally planned to have detachable control pods on their cars so that there would be as many as 450 control cars. Now there will be only 175 control cars and no removable pods. Elimination of the pods made it economical to add the small digital computers. Even with the computers aboard, the cars will carry less equipment than called for in competing firms' designs. The car redesign scheme and the dropping of the wiggly-wire circuitry made the wayside computers unnecessary; "We abandoned them because they were an integral part of the wiggly-wire system," says Gillespie.

Wire scotched. Westinghouse's original 2-foot-wide wiggly-wire loop circuit, which was to have been laid between the rails, was hard to fit to the several types of railroad ties planned for the transit system. The company's initial solution was to shrink the circuitry to a 3-inch-wide strip to be run like Scotch tape along the side of the rails. This technique worked but proved only temporary. Gillespie says that because of its interpretation of BARTD's specifications, Westinghouse felt that the transit district would prefer conventional track control circuits, "although nothing was said to us that would indicate that we didn't comply

Need fast, fast, fast recovery? Try a couple of these...

Maybe there's nothing particularly unusual about an ultra-fast recovery rectifier. But we would like to modestly point out that a 2 amp ultra-fast recovery, controlled avalanche rectifier the size of this one is very unusual indeed.

Size isn't the only reason.

Because this little diode not only has a typical recovery under 50 nanoseconds (with a 25 amp surge rating, and PIV's to 250 volts), but it's radiation-tolerant, too. And, like every Unitrode, it's practically indestructible. It will last virtually

forever with no change in electrical parameters, and that *is* unusual, isn't it?

Nevertheless, it's not hard to believe when you consider how a Unitrode is made.

Consider that the silicon is metallurgically bonded between the two terminal pins in a bond that's stronger than the silicon itself. Then the entire unit is fused in hard glass at over 800°C.

Result? It's voidless, so all contaminants are excluded.

Because the terminal pins are bonded over the full face of the silicon die, heat due to surge is carried away quickly from the silicon into the pins. So even this tiny 2 amp job can withstand a 25 amp surge. And like every Unitrode, it still meets initial spec limits after 2000 hours of life testing.

As far as we've been able to find out, the machine hasn't yet been built that can fail a Unitrode in acceleration, vibration, and shock tests. We keep looking, but until we find it, we can virtually guarantee our parts will never fail. Ever.

Now that does qualify our diodes as unusual, doesn't it? And while we'll admit that not every design needs these unique characteristics and reliability, maybe yours do.

So if you need fast, fast, fast recovery, try our remedy. We'll be glad to send you samples and complete information. We're at 580 Pleasant St., Watertown, Mass. 02172. Telephone (617) 926-0404. TWX (710) 327-1296.

UNITRODE®

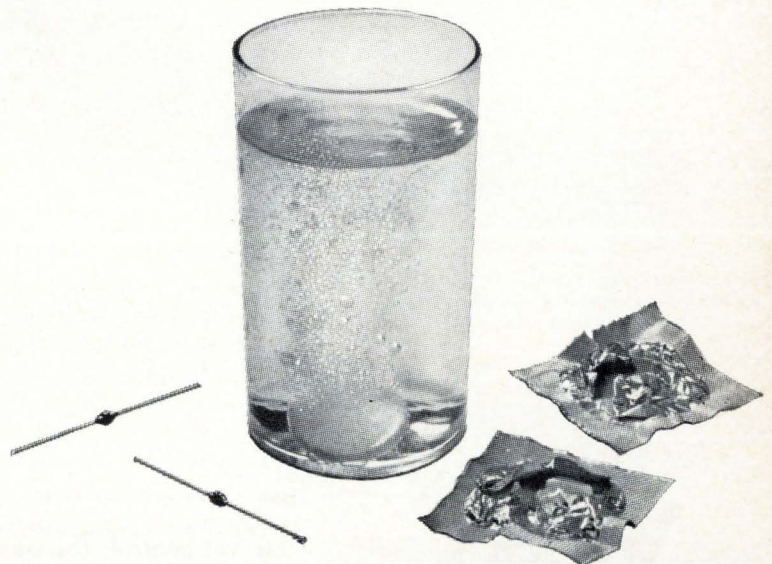

CONVERT COMPUTER DATA TO TV DISPLAY WITH THE ELECTROSTORE®

This TV Display shows a high resolution alphanumeric presentation derived from

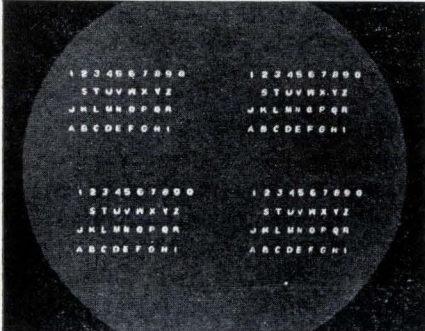

a computer. It is only one example of a computer display using the Electrostore, Model 221.

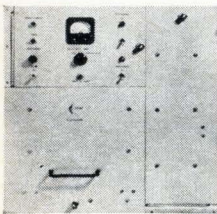

Model 221 Electrostore
single-gun storage tube
Input/Output Response
10 MHz or 20 MHz
Input Amplitude
Required 0.7 volts to
2.0 volts p-p
Deflection Amplitude
5 volts p-p
Deflection Response
DC to 800 KHz
Programmer Optional

The Model 221 scan-converter utilizes a cathode-ray recording storage tube. Input video signals and deflection information are applied to the tube through various amplifiers and control circuitry. Data is stored within the tube in the form of a raster, circular, or spiral scan. This information can be read off periodically through appropriate amplifiers without destroying the stored data. The input can be up-dated periodically and the stored information erased partially or in its entirety. By introducing the proper signals, the Electrostore can convert a variety of formats to TV display, i.e. computer-to-TV, radar-to-TV, IR-to-TV, or sonar-to-TV.

Write for technical memos and application notes covering the Electrostore.



Electronics Review

with the specs in using the wiggly-wire system." The Scotch-tape-like wiring will now be used only at stations.

Finally, when BARTD relaxed its specs last summer, the company found, according to Gillespie, that the wiggly-wire system would have provided much more flexibility than necessary. Westinghouse denies that cost was a factor in the demise of the wiggly-wire control approach; their bid was more than \$3.5 million below that of the nearest competition and would have allowed for any extra expense.

"The wiggly wire might have presented some maintenance problems if it were used throughout the system," says Deane Aboudara, electronics and equipment design engineer for BARTD. "But the track-circuit design, multiplex equipment, and the integrated-circuit computer show that Westinghouse really did its homework on costs," he adds.

Standing fast. Westinghouse's competitors are still interested in securing subcontracts for the San Francisco-area transit system and generally they are standing by their original design approaches.

L.T. Freed, vice president, sales, of the General Railway Signal Co., states that the company will continue with its basic designs, but observes that since different systems have different conditions, flexibility will be needed. Freed thinks that Westinghouse may purchase relay-type interlocking systems from General Railway Signal, but concedes that it might buy from the Union Switch & Signal division of the Westinghouse Air Brake Co.

Westinghouse Air Brake expects to supply "a lot of the equipment for BARTD" according to Gene Shaffer, the firm's director of mass-transit operations. The company would probably sell car-control equipment and safety gear to Westinghouse Electric.

A General Electric Co. spokesman says his company plans to stick with its decentralized-control approach. The company declined to comment on possible BARTD subcontracts.

GE is now supplying propulsion and control equipment for the

Delaware River Port Authority rapid transit system. The first section of this system is a \$62 million, high-speed 11.6-mile link between Philadelphia and Lindenwold, N.J. If completed on schedule in 1968, it would be the country's first operating automated transit line.

Computers

Patents for programs?

The opening salvo has been fired in what could become a bitter battle between the big computer manufacturers and the software industry over the Administration's patent reform bill, which, among other things, would exclude computer programs from patent protection. Opponents of the measure argue that it's unfair to distinguish between the computer—as a patentable device—and the programs that go into it.

Says J. R. Pierce, executive director of research communications at the Bell Telephone Laboratories: "Software is every bit as necessary as hardware. If there is no software, the computer—the hardware—can't do anything. The software makes the hardware more valuable; it may open up an entirely unforeseen market for the hardware, so it tends to sell computers."

Congressional hearings on the bill are about to get under way—April 17 in the House and May 18 in the Senate.

Federal case. The Administration claims that patents aren't needed to stimulate the development of software, and could stifle its spread. The Government also contends that it's too difficult to judge the patentability of computer languages by the criterion of novelty.

Although the International Business Machines Corp. refuses to comment, Honeywell Inc. is opposed to any patenting of computer programs in any form. The company takes the position that the lack of patents prevented rapid advances in computer programming. It believes appropriate treatment for software falls within the frame-

gaf

What's behind this new name?

General Aniline & Film Corporation—or GAF—is in many fields. And our customers in each called us by a different name. For example, our x-ray and photo customers knew us as "Ansco" a manufacturer of medical and industrial x-ray films and chemicals, as well as amateur, graphic arts, and professional photo products. In the duplication field we were known as "Ozalid." Our chemical customers called us "Antara." Users of dyes and

pigments knew us as "General Dye."

To make it clear that we are all the same company, we have consolidated all our brand names under our corporate symbol GAF.

So the next time our x-ray representative in your area calls . . . call him the man from GAF.



GENERAL ANILINE & FILM CORPORATION

140 WEST 51 STREET, NEW YORK, NEW YORK 10020

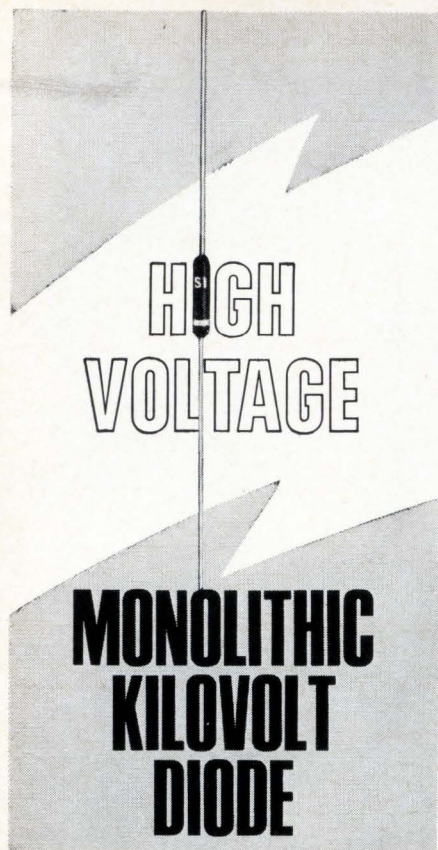

New horizons of high voltage diode properties have been established by the introduction of a monolithic chip having breakdown ratings from 1 Kv. to 8 Kv.

These high voltage characteristics are built into a single crystalline structure in a glass axial lead package by a unique multidiffusion process. Resulting electrical properties of Semicon's new High Voltage Diodes are:

- $I_r = 25$ nanoamps @ 8 Kv.
- C_j max. = 1 pfd. @ 0 volts
- C_j typ. = 0.2 pfd. @ 8 Kv.
- $T_{rr} = 200$ nanosecs. max.
- $V_f = 10$ volts max. @ 15 Ma.

Designed specifically for Voltage Multipliers, the combination of low junction capacitance, low reverse current, low forward voltage, and fast recovery makes these diodes ideal for laser and flash tube power supplies, fiber optic image amplifiers, ion pulse sources, radiation and pulse detection, deflection systems, solar plasma experimentation and infrared and RF power supplies.

Write for Bulletin 651A

Tomorrow's Needs/Today's Design



Semicon
INC.

Sweetwater Ave., Box 328, Bedford, Mass. 01730
Tel: (617) 275-8542. TWX: 710-326-1919

work of the copyright laws.

Pierce says it isn't surprising that the larger computer firms favor the bill because "as it stands now, much of the work on software is done outside" and the computer makers "get it for nothing." He also rejects the notion that the spread of software has been sufficient under a system that has permitted its patenting but hasn't actually resulted in any patents.

"Software," Pierce says, "is a terrible bottleneck in all computer usage. The new generation of computers is incompatible with the old and is short of software."

Bell Labs has a big stake in the patenting issue. It owns a large library of computer programs and has applied, unsuccessfully, for patents on several.

The move to divorce programs from patents first came to light last October in a memo from Assistant Attorney General Donald F. Turner to Patents Commissioner Edward J. Brenner. Turner, who heads the Justice Department's antitrust division, told Brenner that the department frowns on issuing patents on computer programing methods because the growth of the software industry "has been facilitated by a remarkably free and easy exchange of ideas, concepts, and programs."

Said Turner: "Many small software companies have achieved financial and technical success by producing more efficient versions of widely used manufacturer-developed programs . . . benefitting other software producers, computer manufacturers, computer users, and the general public . . . Any step which could upset the vital interchange of programing material should be approached with the utmost caution."

A patent examiner, he continued, "would have extraordinary problems in determining the originality of a programing [patent] claim, which could cause serious delay in the issuance of patents."

Panel agrees. A month later, a Presidential panel studying the patent system issued a report calling for reforms, including the elimination of patents for computer programs.

The President's commission declared that "the creation of programs has undergone substantial and satisfactory growth in the absence of patent protection, and copyright protection for programs is presently available."

But Pierce will have none of it. He pooh-poohs the notion that it's too difficult to determine the originality of a computer program ("the same argument could be used against patenting anything"), and insists that software belongs in the patent system because "there are real inventions in software, just as there are in hardware."

He adds: "If we could patent software . . . we could see some real breakthroughs."

For the record

G-2 role for tv. A high-resolution closed-circuit television system has been developed for the Air Force's tactical intelligence processing and interpretation program (TIP). Developed by the Fairchild Camera & Instrument Corp.'s Space & Systems division, it will transmit aerial photographs from an airfield to remote receiving stations via cameras and monitors operating at a resolution of 1,323 lines per frame. Film can be magnified up to 200 times, moved in an x-y coordinate, and switched from positive to negative display at the receiving stations. Developed under a \$158,000 Air Force Systems Command contract, the system is being evaluated at Rome Air Force Base in New York State.

Picture this. Conceptualized objects may be subjects of future holograms with a computer performing the trick. Experimenters working with two-dimensional objects at the International Business Machine Corp.'s Scientific Center believe digital holograms can be produced from mathematical terms dictated to a computer enabling, for example, an architect to see a house while it's still in the blueprint stage. The possibilities were discussed by IBM researchers who

From RCA "overlay"...

The industry's best performing plastic RF-power transistor...

15 Watts min at 400 MHz

2N5017

Now... get in on the action with the rf-power advantages of RCA "overlay" in plastic!!

RCA's new 2N5017 stud-mounted plastic transistor provides 15 watts at 400 MHz... 22 watts typ. at 225 MHz... operates from 28-v supply! And this circuit capability is delivered in a unique package that sets new standards for performance, ruggedness, and versatility at VHF and UHF frequencies.

Performance—the industry's lowest emitter and base inductances (0.1 nH and 0.2 nH respectively) result in optimum gain and power

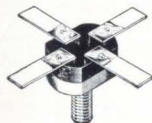

Strip-line leads can be easily soldered to terminal block with pins providing additional mechanical strength.

capability right up to 700 MHz... efficient for broadband and narrowband transmitters.

Ruggedness—unexcelled mechanical strength with short "anchor" pins eliminating problems due to lead breakage or vibration.

Versatility—"terminal block" structure permits choice of stripline, printed circuit (both flush and bottom-mounted), or lumped circuit mounting.

Call your RCA Representative today for more information on the 2N5017 for military, microwave, and industrial communications usage. If your applications still call for hermetically sealed packages, ask him about the RCA 2N5016—it offers similar electrical performance but in the popular TO-60 case. For technical data, write RCA Commercial Engineering, Section IN4-1, Harrison, N.J. 07029.

Also Available From Your RCA Distributor

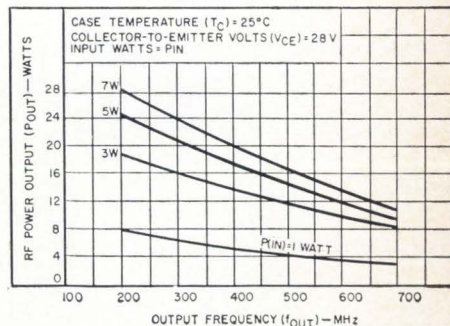

RCA Electronic Components and Devices



The Most Trusted Name in Electronics

Circle 53 on reader service card

Design Brochure

Cable Assemblies & Coaxial Delay Lines

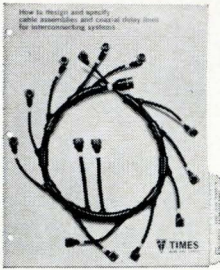

This 4-page brochure details specifications and multiple design possibilities of cable assemblies and coaxial delay lines. It also follows through with evaluation, production and test procedure info.

For your copy write or phone:
Times Wire & Cable, Wallingford, Conn. (203) CO 9-3381

Circle 502 on reader service card

Seamless Metal Tube Sheathed Coaxial Cable

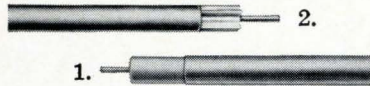

Times' new semiflexible coaxial cable with seamless aluminum tube sheath conductor is available in two standard versions:

1. ALUMIFOAM® — Foam polyethylene dielectric where pressurizing isn't practical.
2. ALUMISPLINE® — Air dielectric where pressurizing is practical. These cables offer more isolation—at 80 < db more than ordinary coax. Uniformity average — VSWR 1.1 or less. Stability — 10 times better. Lower loss — 30% less. Pulse reflection — less than 1%. Less distortion. Also avail. in solid dielectric and high temp. constructions.

For prices & data write or phone:
Times Wire & Cable, Wallingford, Conn. (203) CO 9-3381

Circle 503 on reader service card

Connectors for Solid Sheathed Cable

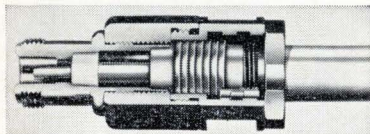

Only one step required to use the new one-piece TIMATCH® Connector with its own pat. CoilGrip® clamp—just unpack it. Its reusable and repeated assembly and disassembly does not impair either the RF or physical characteristics of the connector or the cable. Available in all popular sizes and fits all metal tube sheathed coaxial cables.

For prices & data write or phone:
Times Wire & Cable, Wallingford, Conn. (203) CO 9-3381

54 Circle 54 on reader service card

Electronics Review

have, thus far, programed a System 360 computer to calculate the interference patterns created by light waves reflected from a real object.

Two for the tv show. Two high-voltage silicon transistors for the deflection stages of large color television receivers have been developed by the Delco Radio division of the General Motors Corp. The DTS-0174 is the higher voltage offering, with a VCEX rating in the 1,200-volt range. It can switch the 3,800-volt-ampere load line from the 120 volts dc necessary to operate a 25-inch color deflection system. Weighing in with a 700-volt VCEX rating is the DTS-402. In a 25-inch set, one 402 can handle vertical deflection and two can handle the horizontal deflection that the 0174 can do alone.

Watching the watchers. A committee is being formed by the Institute of Electrical and Electronics Engineers to keep an eye on the Federal Communications Commission and interpret the moves of that agency for the engineer in the field. Heading the new panel will be Joseph Eachus, senior staff scientist at the Electronic Data Processing division of Honeywell Inc. Eachus disavows any intention of trying to influence the FCC.

Another departure. Albert J. Kelley, 42, deputy director of the National Aeronautics and Space Administration's Electronics Research Center in Cambridge, Mass., will leave his post to become dean of the College of Business Administration at Boston College, June 1. Kelley says the college sought him for the post and denies any dissatisfaction with conditions at the research center. In fact, he will continue as a consultant to NASA. Kelley's move is the fourth in a series of high-level resignations at the center. First to leave was Winston E. Kock, the center's first director; he was followed by Walter Slater, general counsel; and William Ricci, assistant director for industry affairs.

Safe landing. The Burroughs Corp. has been awarded a \$22.4 million contract to develop and build 177 digitizers for the FAA's upcoming automated air traffic

control system [Electronics, March 6, p. 67]. The devices will convert radar signals into digital data to be relayed via telephone lines to computers at FAA control centers where they will be reprocessed and displayed on master radar screens. Burroughs joins the Raytheon Co. and the International Business Machines Corp. to complete the manufacturing lineup for the National Aerospace System.

Taking up position. The Communications Satellite Corp.'s third Intelsat II, launched March 22, achieved its stationary orbit over the Atlantic March 25. The 192-pound satellite—nicknamed Canary Bird—will initially provide at least 240 voice channels between the U.S. and Europe.

Ku-band CATV. Theta Com, a joint venture of the Hughes Aircraft Co., and the TelePrompter Corp., has applied for commercial licensing of an amplitude-modulated, 18-gigahertz, "color-quality" community television relay system. Unlike cable tv systems, Theta Com plans a point-to-point relay approach. In year-long tests just completed, laboratory-type equipment was used to boost a broadcast band of 56 to 216 magahertz to Ku band, while receivers at the other end of the links fed down converters that dropped the frequency to that of normal vhf tv and f-m radio channels. According to Hubert G. Schlafly, TelePrompter senior vice president, tests over a six-mile path during normal weather conditions showed that 12 conventional tv channels could be received without noticeable cross modulation or increase in picture noise.

Satellite fixes. A portable ground-receiver system that translates satellite signals into survey fixes has been developed for the Navy at Johns Hopkins University's Applied Research Laboratory. Under the system, two 50-pound, man-pack receivers pick up, at different points, the doppler shift from the Navy's navigation satellite, and a general-purpose digital computer uses the readings to determine the location of the two receivers. The Navy has delivered two prototype models to the Army for evaluation.

85 MHz J-K FLIP-FLOP

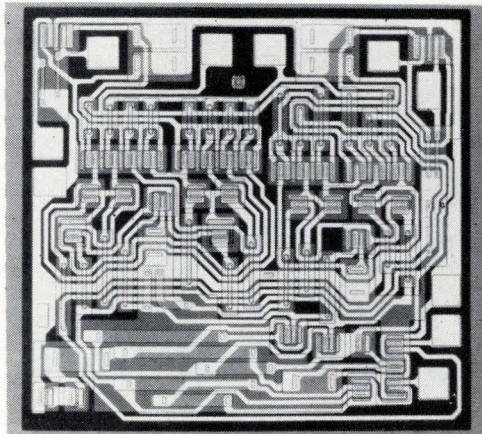
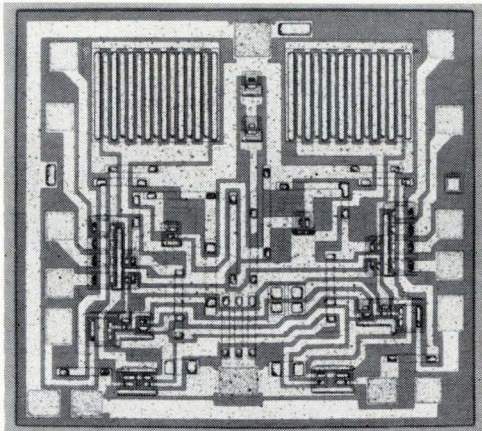

8 ns FULL ADDER

**...you're in
fast company
with MECL II
Integrated Circuits!**

The impressive speed credentials of Motorola's new MECL II* integrated circuit logic are well represented by the ultra-fast 85 MHz (typ) J-K Flip-Flop and the complex 12-gate-array Full Adder (and Subtractor, too) with 8 nanosecond typical propagation delay.

These circuits command the attention of any designer who needs *speed* in his design. And, you can count on the entire line of multifunction MECL

II circuits to deliver state-of-the-art performance for fastest overall system operation.

And, if you're already designing with MECL I* circuits, you'll find these new MECL II types fit right in your present designs — with identical logic levels and power supply requirements. (They are compatible with the 1.0 ns MECL III* gates we're presently developing, too.)

If your design doesn't require highest speed, ask your Motorola representative about our other digital integrated logic families . . . MTTL*, MDTL*, MRTL*, MVTL*, MHTL* (high threshold), mWRTL*. We make them all.

See your nearest Motorola distributor for evaluation quantities of new MECL II circuits for prototyping. For complete details, write Motorola Semiconductor Products Inc., Box 955, Phoenix, Arizona 85001.

*Trademark of Motorola, Inc.

	Min.	Max.	Unit
J-K FLIP-FLOP (MC1013P [†] , MC1213F [†]) Toggle Frequency (50% duty cycle) AC Fan-out	70 15	— —	MHz —
FULL ADDER (MC1019P, MC1219F) FULL SUBTRACTOR (MC1021P, MC1221F) Propagation Delay (Carry-in to sum) AC Fan-out	— 15	8 —	ns —

[†]"P" suffix for plastic package (0 to +75°C temp. range)
"F" suffix for flat package (-55°C to +125°C temp. range)

— where the priceless ingredient is care!



MOTOROLA
Semiconductors



Now that you're going to buy
a dc voltmeter, get hp's
extra measure of

Performance

When you buy a dc voltmeter, you look for the least costly instrument that will give the accuracy you need for your measurements.

Only Hewlett-Packard can offer a complete line of dc voltmeters— analog, digital, and differential— each designed to give you the *exact* performance you need... the maximum performance per dollar invested!

ANALOG hp Model 419A:— High sensitivity null meter and wide range dc voltmeter in one compact package.

ANALOG/DIGITAL hp Model 414A:— Touch-and-read speed of digital autoranging eliminates range switching bother. Linear volt/ohms scale gives high resolution.

DIGITAL hp Model 3430A:— Provides accurate digitized measurements with error-free readability— at a low price!

DIFFERENTIAL hp Model 3420A or 3420B:— For precision measurements: $\pm 0.002\%$ accuracy, 0.2 ppm resolution, 1 ppm stability.

Whatever your requirements, whatever your applications— only Hewlett-Packard can offer you a *complete line of voltmeters!*

hp Model 419A
for High Sensitivity

Performance

The hp Model 419A DC Null/Voltmeter is your best choice for high sensitivity volts/current measurements such as thermocouple voltages and other low level transducer sources, nerve potentials in biological studies, galvanic responses in chemically-generated emf's, education—or use it as a null voltmeter in dc standards and calibration work. This low cost instrument is ideal for schools, maintenance departments and accurate enough for design benches. The $3\ \mu\text{V}$ range gives $0.1\ \mu\text{V}$ resolution for extremely low level measurements.

And, you need not be concerned with source impedance! The variable internal nulling supply allows you to derive an essentially infinite input impedance on the $3\ \mu\text{V}$ through 300 mV ranges. You simply buck out the input voltage, then measure the internal supply by pushing a button!

To eliminate common mode voltages—such as those found where transducers and long lead lengths are being measured—unplug the instrument from the ac source, and operate on the internal rechargeable batteries.

For leakage current measurements such as in semi-conductors, the 419A has 30 pA to 30 nA full scale ranges.

The hp neon oscillator/photocon-

ductor chopper amplifier combined with high-feedback has $<0.3\ \mu\text{V}$ noise and $<0.5\ \mu\text{V}$ drift per day. You get readings that are dependable—and repeatable!

For high sensitivity performance, get the hp Model 419A DC Null/Voltmeter! Check the dc sensitivities in the table.

hp Model 414A
for Touch/Read Autoranging

Performance

It takes less than 300 msec for hp Model 414A to select and indicate the correct range and polarity! You're free of the tedious job of constantly changing ranges and of the worry of overloading the instrument. You can, whenever you need, over-ride the automatic ranging and manually select your range. When you specify the hp 414A, you get the "touch and read" convenience of autoranging!

You'll find this instrument is the most accurate analog voltmeter available! Measuring accuracy for dc voltage is $\pm 0.5\%$ of reading, $\pm 0.5\%$ of full scale. For resistance, accuracy is $\pm 1\%$ of reading, $\pm 0.5\%$ of full scale.

The $100\ \text{M}\Omega$ input resistance (on 50 mV range and above) allows more accurate measurement with less dependence upon source impedance. For example, a $100\ \text{k}\Omega$ source introduces only a 0.1% measurement error.

For Vdc and ohms measurements where speed, accuracy and "hands-free" operation are needed, pick the solid-state hp Model 414A Autovoltmeter. Comparative specifications are given in the table.

HEWLETT  PACKARD
An extra measure of performance

PERFORM



*hp Model 3430A
for Easily Readable*

Performance

Easy to read! Easy to operate—even by inexperienced personnel! Accurate enough for production testing, laboratory, repair shops, quality control, incoming inspection—and digital transducer measurements! These are the performance features you get from hp Model 3430A DC Digital Voltmeter.

The 3430A features 100 μ V resolution to give you low level dc measurements with digital accuracy ($\pm 0.1\%$ of reading). A flashing overload indication prevents false readings when in overload. Amplifier output is accurate to within 0.1% and can be used while making measurements if load is 10 k Ω or greater. Output will drive dc recorders to give you permanent records. Both accuracies hold for 90 days—save you costly calibration time.

Model 3430A has a voltage ratio option, (01). The readout display is proportional to the ratio of the input voltage (front terminals) to the reference voltage (rear terminals). A rear panel slide switch permits either normal or ratio mode operation.

Specify hp Model 3430A DC Digital Voltmeter when you need a solid-state, easily-readable instrument for continuous service under rigorous operating conditions. See the table for full specifications.

	414A	419A	3420A 3420B	3430A
DCV	5 mV— 1500 V	3 μ V— 1000 V	1 V— 1000 V	100 mV— 1000 V
Accuracy	$\pm 5\%$ Rdg., $\pm 5\%$ FS	$\pm 0.1 \mu$ V on 3 μ V range, $\pm 2\%$	$\pm 0.002\%$ Rdg., $\pm 0.0002\%$	$\pm 0.1\%$ Rdg., ± 1 digit
Ohms/Current	5 Ω — 1.5 M Ω	30 pA— 30 nA	—	—
Accuracy	$\pm 1\%$ Rdg., $\pm 0.5\%$ FS	$\pm 3\%$ end scale ± 1 pA	—	—
Zdc	10-100 M Ω	100 k Ω —100 M Ω	10 M Ω —10 ¹¹ Ω	10 M Ω
Ratiometer	—	—	0.00000001:1— 0.999999:1	0.0001:1— 1000:1
Accuracy	—	—	24 ppm	$\pm 0.15\%$ reading ± 1 digit
Recorder	—	± 1 Vdc 1 mA	± 1 Vdc 1 mA	± 16 Vdc 1 mA
Output	—	—	—	—
Power	50-1000 Hz	50-1000 Hz	3420A, 50-1000 Hz 3420B, Battery/Line	50-1000 Hz
Type	Autoranging Analog	Analog	Differential	Digital (3-digit)
Price	\$650.00	\$450.00	3420A-\$1175.00 3420B-\$1300.00	\$595.00 Ratio Opt. \$80.00

*hp Model 3420A or 3420B
for Precision*

Performance

For making highly stable dc measurements and measuring precision voltage ratios, select either precision solid-state hp Model 3420A or 3420B. Use it for calibrating digital and potentiometric voltmeters; line and load regulation of dc standards measurements; calibrating precision resistance dividers; making thermistor, thermocouple or transducer measurements.

The hp Model 3420B differential voltmeter is line/battery operated so true floating dc measurements can be made by disconnecting the line cord. Readings cannot be affected by ground loops.

The hp 3420A or 3420B can be used to measure resistance and voltage ratios rapidly without using the conventional method of tedious math-

ematical computations and without an outside precision voltage source. Voltage and resistance ratios from 0.00000001:1 to 0.999999:1 can be measured in four ranges.

You won't need a highly skilled technician from a standards laboratory to make parts per million measurements when you specify the hp 3420A or 3420B! Engineers and line technicians can press the front panel pushbutton, adjust the high resolution decades and read the results!

For a resolution of 0.2 ppm and an accuracy of 0.002% of reading, get the hp 3420A or 3420B. See the table for specifications.

For data sheets giving full specifications on these dc voltmeters with the hp extra measure of performance, contact your nearest hp field engineer. Or, write to Hewlett-Packard, Palo Alto, California 94304, Tel. (415) 326-7000; Europe: 54 Route des Acacias, Geneva.





Unit Citation

We're honored! Not that we've won our crusade yet...just another battle ribbon. A while back we scored a military victory with our Model 880, the *first* solid state Mil Spec counter. This time it's a fully-militarized 5MHz all-silicon solid state universal counter-timer. Call it USN/AN-245, sir.

There's a good reason you should be interested. You see, the military model had its basic reliability well proved by our original commercial version, Model 607A. Now *there's* the one for *you!* It offers more features and capabilities than even the Admirals asked for. And it's available on-the-double.

Now hear this: Our lowest-bidder-type price is only \$1,575. (Check *that* saving against our competitor!) Then check these features: Model 607A is ideal for wide-range frequency measurements, frequency ratio determination, period and multiple period or time interval measurements, and pulse count totalizing. Time base is a 1 MHz crystal oscillator (for 1 microsec resolution). Display is six decade inline with display storage. BCD output transfers directly to CMC Model 410 tape printer, computer systems, etc. Automatically positioned illuminated decimal. Either ac or dc coupling of input signal. Front and rear A and B channel inputs. Rugged, compact (approx. 3½" high). Available for bench or rack.

THANKS

With all our pride and excitement over our USN/AN-245 award, and other new products, we haven't forgotten our fellow Crusaders who've made this success possible...YOU. A FREE Crusading Engineers medal is our fun-loving way of saying thanks. Get yours by writing for data so you can "Check the Specs" of our 607A. Your "chief" will be so proud of you at mail call!

12981 Bradley/San Fernando, California
Phone (213) 367-2161 / TWX 910-496-1487





This type of single conductor Beldfoil Shielded Cable is used in Motorola TV set production. It is stripped clean on an Artos stripper and, as one engineer commented, "our leads never need a haircut."

BELDFOIL® SHIELDED CABLE

SOLVED

STRIPPING PROBLEMS FOR MOTOROLA

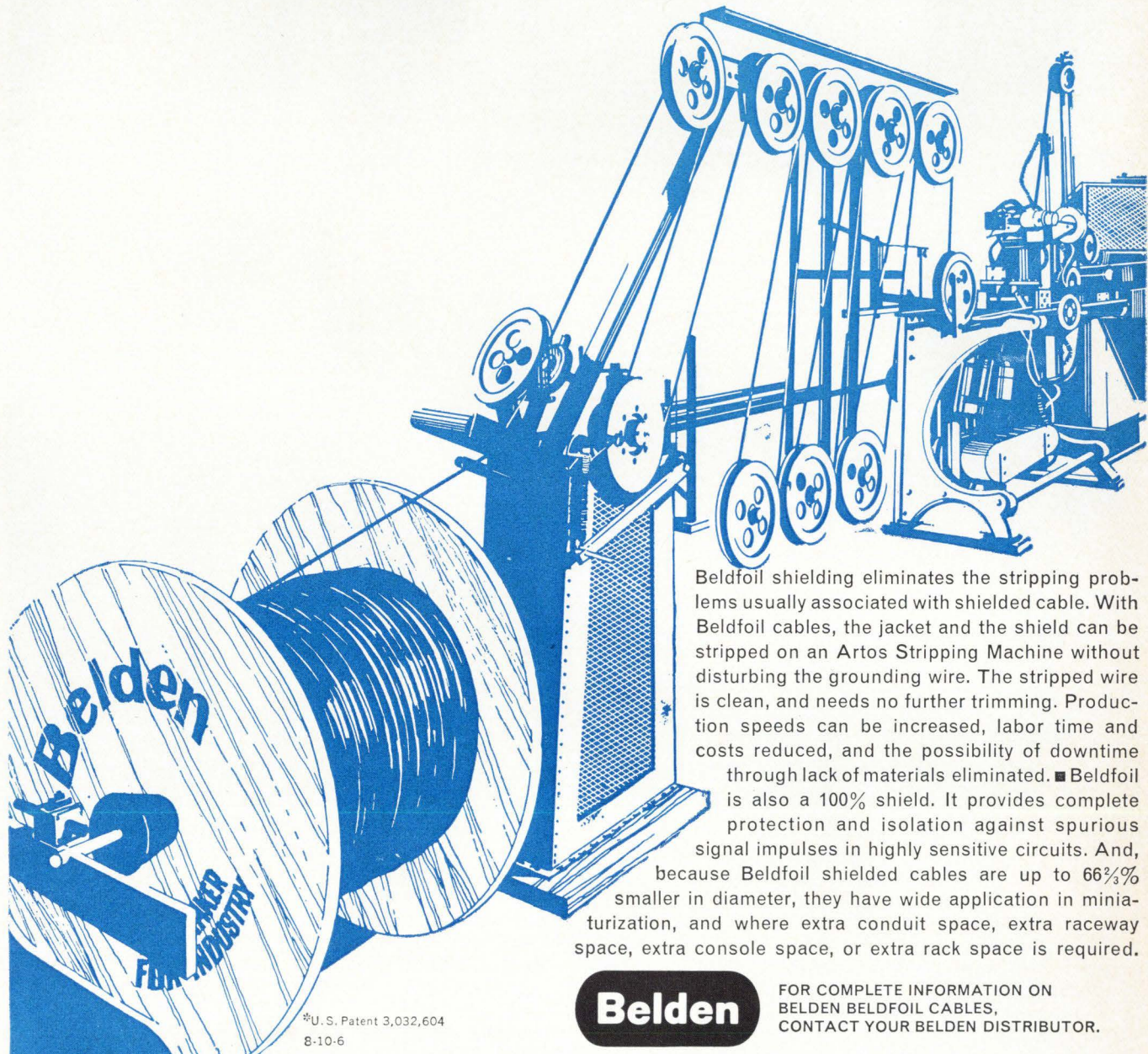

Beldfoil shielding eliminates the stripping problems usually associated with shielded cable. With Beldfoil cables, the jacket and the shield can be stripped on an Artos Stripping Machine without disturbing the grounding wire. The stripped wire is clean, and needs no further trimming. Production speeds can be increased, labor time and costs reduced, and the possibility of downtime through lack of materials eliminated. ■ Beldfoil is also a 100% shield. It provides complete protection and isolation against spurious signal impulses in highly sensitive circuits. And, because Beldfoil shielded cables are up to 66⅔% smaller in diameter, they have wide application in miniaturization, and where extra conduit space, extra raceway space, extra console space, or extra rack space is required.

*U.S. Patent 3,032,604
8-10-6

Belden

FOR COMPLETE INFORMATION ON
BELDEN BELDFOIL CABLES,
CONTACT YOUR BELDEN DISTRIBUTOR.

BELDEN MANUFACTURING COMPANY • P.O. Box 5070-A • Chicago, Illinois 60680



**IBM SYSTEM/360...
a high-performance,
high-reliability**

**computer...uses flat flexible cable
interconnections of TEFLON® FEP FILM**

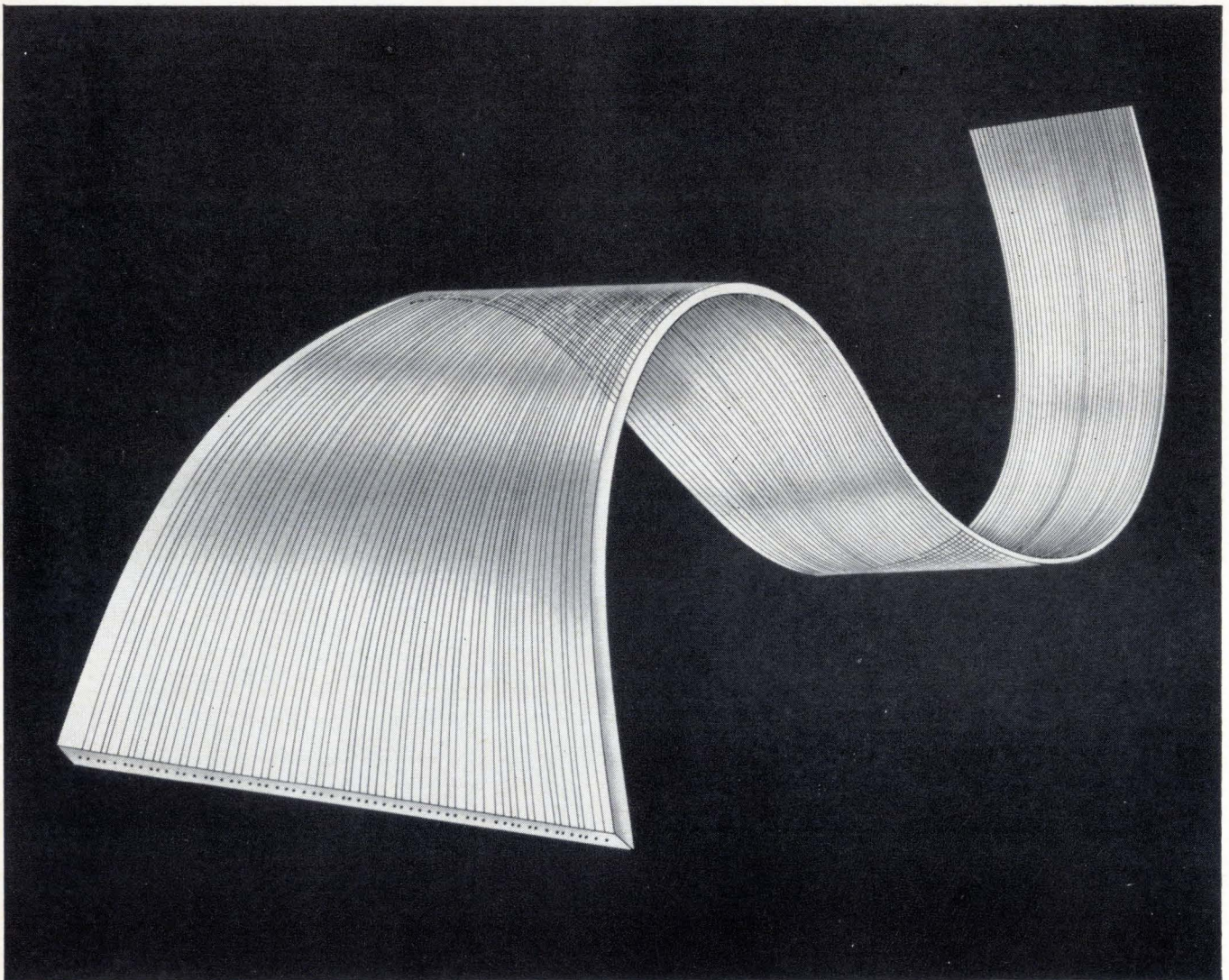

The IBM SYSTEM/360 is a versatile, flexible data-processing system able to handle a broad range of applications. It offers a wide choice of central processors, files, printers, terminals, and input and output units. In developing this system, IBM designers put special emphasis on ease and reliability of interconnections. They chose the flat flexible cable concept, with up to 60 conductors per cable, in preference to conventional cables that take more space.

And to insure the reliable performance of the flat flexible cable, they chose insulation of non-flammable Du Pont TEFLON* FEP fluorocarbon film—an easy-to-work-with, transparent dielectric film with all the electrical properties,

environmental resistance and unsurpassed reliability of Du Pont TEFLON resins.

If you or your designers are considering flat flexible cable for your products, be sure to evaluate TEFLON FEP FILM for the insulation: the surest way to realize the full advantages of reliability, convenience and performance in this type of wiring. For complete information, write: Du Pont Company, Room 236, Wilmington, Delaware 19898.

*Du Pont's registered trademark.

TEFLON® FEP FILM
A new dimension in TEFLON



Better Things for Better Living
... Through Chemistry

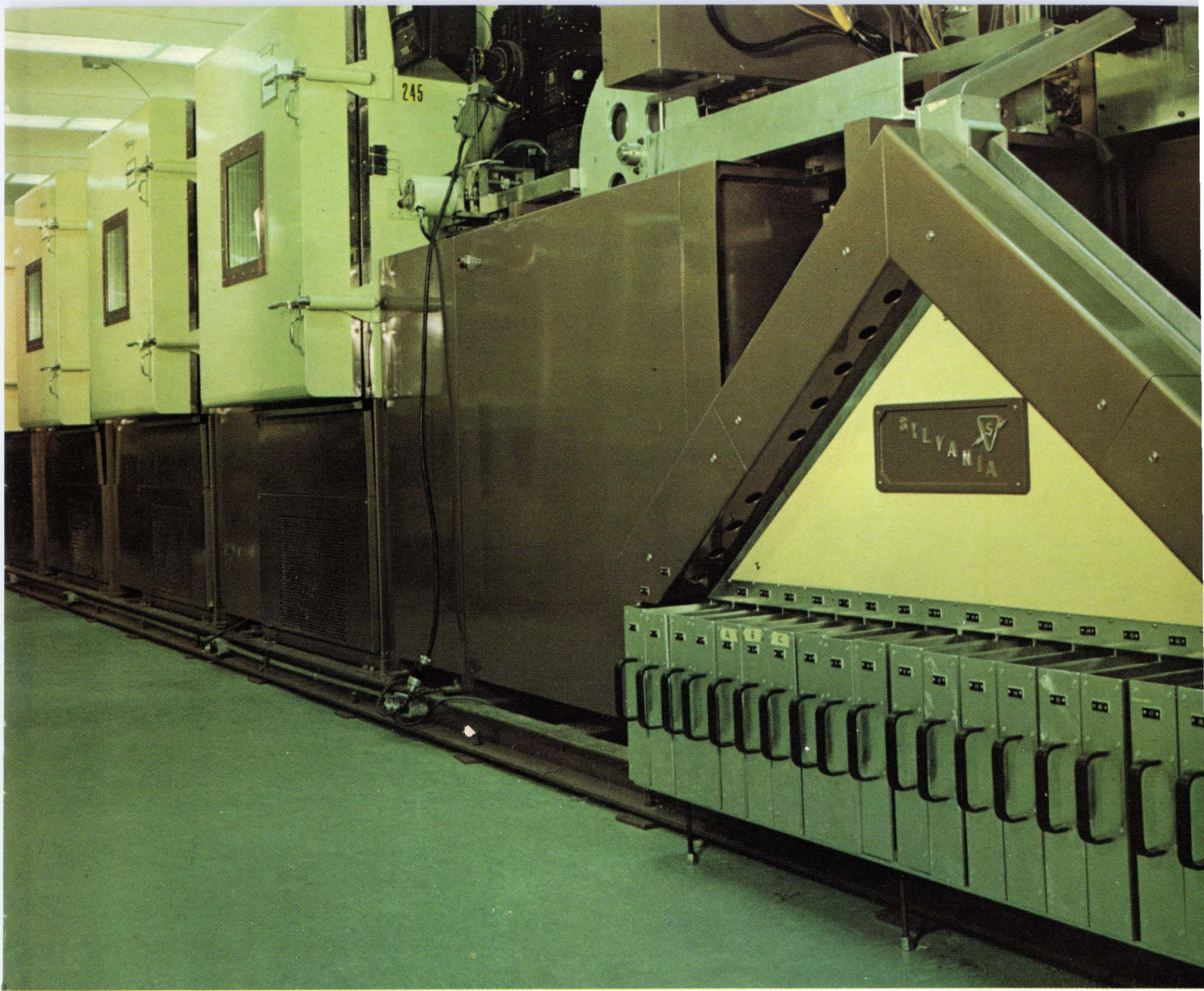

Every military IC must operate at temperatures from -55°C to 125°C in our test chambers.

In order to pass its final test, each Sylvania IC must operate in four consecutive temperature-controlled chambers while a computer records the parameters of each circuit. We call this ultimate testing equipment "Mr. Atomic"—a system with a capacity of about a quarter-million ICs a week.

In each "torture chamber," the ICs are automatically inserted in a wheel that rotates them to the testing point while they're stabilized at test temperature.

The temperature of the first chamber is 75°C . The second is 0°C . The next is 125°C . Then, -55°C . In these four chambers, up to 100 D.C. tests are automatically performed. A fifth testing station, maintained at 25°C , tests up to 30 switching parameters

accurately down to a few nanoseconds. (See inset). Each input is individually tested.

Then Mr. Atomic (for Multiple Rapid Automatic Test of Monolithic Integrated Circuits) directs the circuits to any of 20 bins, according to the computer's priority programs. You get only circuits that are fully guaranteed at temperature extremes—not at just room temperature only.

Sylvania Semiconductor Division, Electronic Components Group, Woburn, Massachusetts 01801.

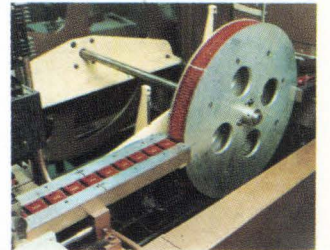

SYLVANIA
SUBSIDIARY OF
GENERAL TELEPHONE & ELECTRONICS GTE

Circle 61 on reader service card

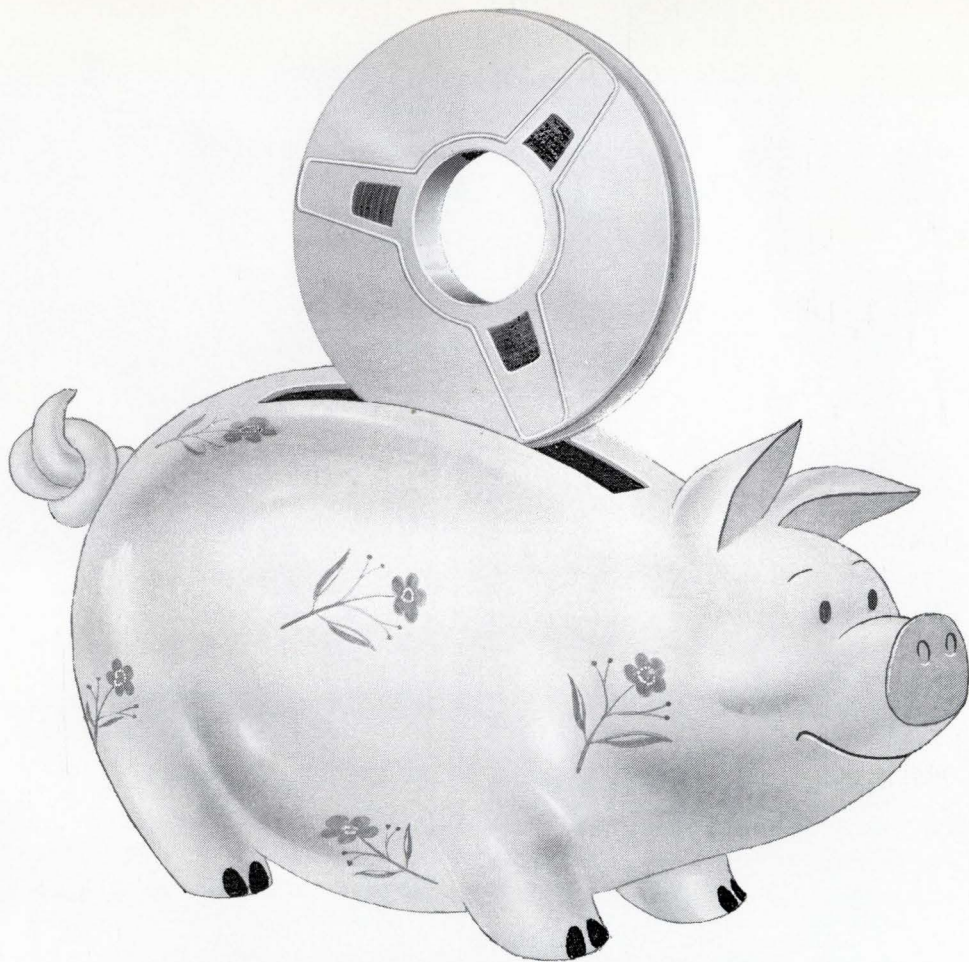

For people who wish to save dollars and data

CEC's DR-3000 Digital Magnetic Tape System is a minor phenomenon in an age of high cost instrumentation.

Not only does the DR-3000 cost less than any other digital tape handler, but it offers a combination of versatility and reliability unmatched by the majority of today's most expensive systems.

Compare these advantages:

- Highest performance specifications at lowest cost of any tape transport available.
- The DR-3000 is fully IBM compatible with assured machine-to-machine compatibility at all speeds and all densities, 7 or 9 channel.
- The DR-3000 is the only low cost transport with straight-line loading for rapid, easy tape loading.
- CEC's unique, all-metal-front-surface heads guarantee 2500 hours head life—the highest in the industry.
- Fully computer compatible command structure and selectable logic levels provide wide flexibility of interfacing.
- Dual capstans with positive drive precludes tape slippage and assures gentle tape handling.

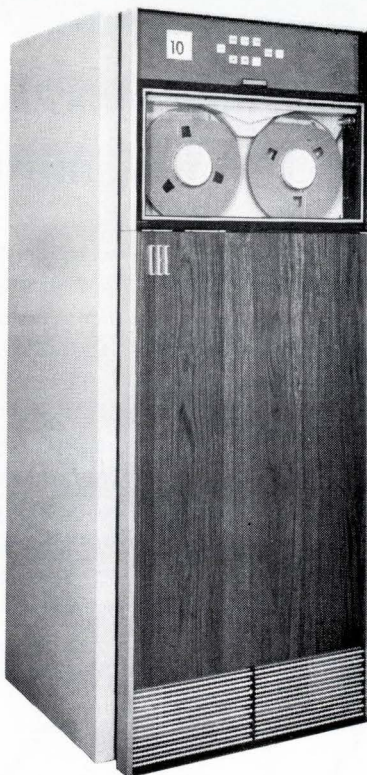

- Simplified parts provisioning and service with complete interchangeability of parts, regardless of speed requirements.

- There is one basic model with tape speeds from 37½ to 112½ ips—and a choice of cabinet configurations: horizontal for computer applications; vertical for data acquisition systems. And, due to its rugged compact construction, the DR-3000 is also ideally suited for mobile assignments.

- Each system is supported by prompt local service and assistance available through CEC's nationwide resident field force.

Is it any wonder that the DR-3000 is considered the "best buy" in digital tape recording?

For complete information, call your nearest CEC Field Office. Or write Consolidated ElectroDynamics, Pasadena, California 91109. A subsidiary of Bell & Howell. Bulletin 3000-X14.

CEC
DATATAPE PRODUCTS
 **BELL & HOWELL**

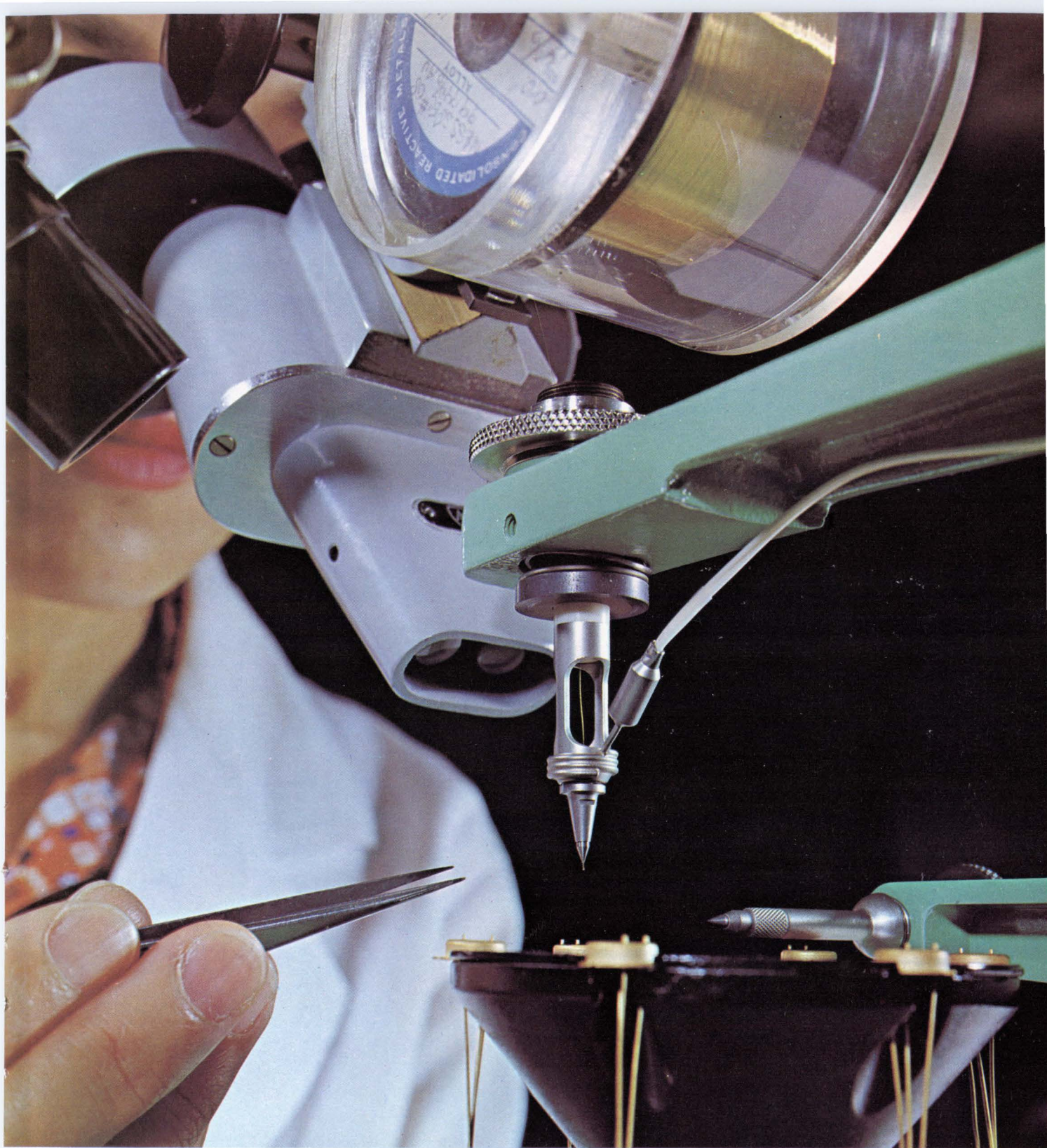

At .0008" dia., Craftsmanship is paramount

LEAD-BONDING CAPILLARY TUBES OF TUNGSTEN CARBIDE, with bore sizes as small as .0008", are made possible by Tempress' unique ability to machine and polish ultra-hard materials in microdimensions. This has brought a new efficiency to semiconductor manufacturing. Bonding tips are held in shank by a magnetic system, permitting instant replacement, even while heated. Heated shank maintains constant tube temperature from 0° to 350°C. This unique system for thermal compression

bonding of leads to semiconductors has brought important savings in time, tools, and materials to the nation's leading semiconductor manufacturers. Equally fine craftsmanship is applied to the Tempress line of diamond scribes, lead-bonding wedges, diamond lapping points, and other miniature semiconductor manufacturing tools.



TEMPRESS

Tempress Research Co., 566 San Xavier Ave., Sunnyvale, California

Circle 63 on reader service card

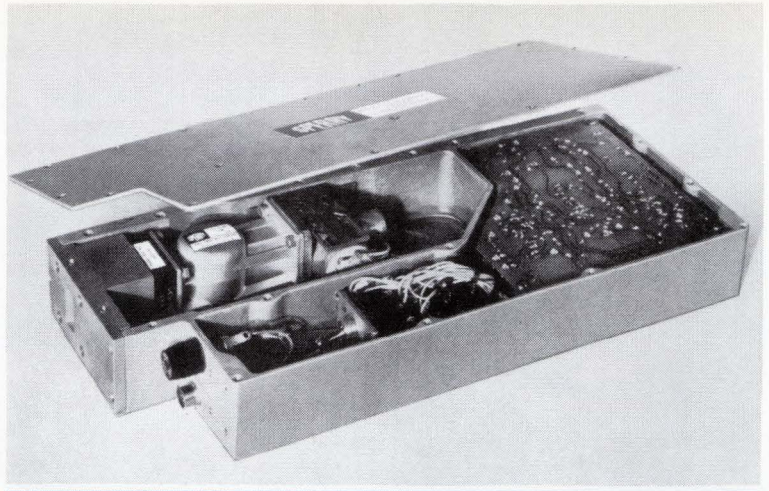

SPERRY RAND CORPORATION has brought its extensive technical resources to bear on the problem of side-looking radar for the RF-111A.

Under contract to Westinghouse Aerospace Group, Baltimore, Maryland, Sperry is providing a complete microwave source, consisting of a klystron oscillator, a stalo cavity and a carefully matched power supply. All these are housed in a single 2½" x 3" x 11" package weighing only six pounds. The unit serves as the radar's local oscillator.

Why Sperry? Because the low-noise, high-environment specifications for RF-111A generated several difficult interfacing problems among tube, stalo, and power supply. Westinghouse engineers elected to buy the entire source as a unit, allowing Sperry to solve the interface problems with techniques available from the "Storehouse of Knowledge." It was a decision which produced an optimum source package, while freeing Westinghouse people to handle the larger, more complex aspects of system integration.

Are there tube/power supply interfaces that annoy and distract you? Why not let Sperry handle them? Contact your Cain & Co. man, or write

SPERRY ELECTRONIC TUBE DIVISION,
Sperry Rand Corp., Gainesville, Florida 32601.

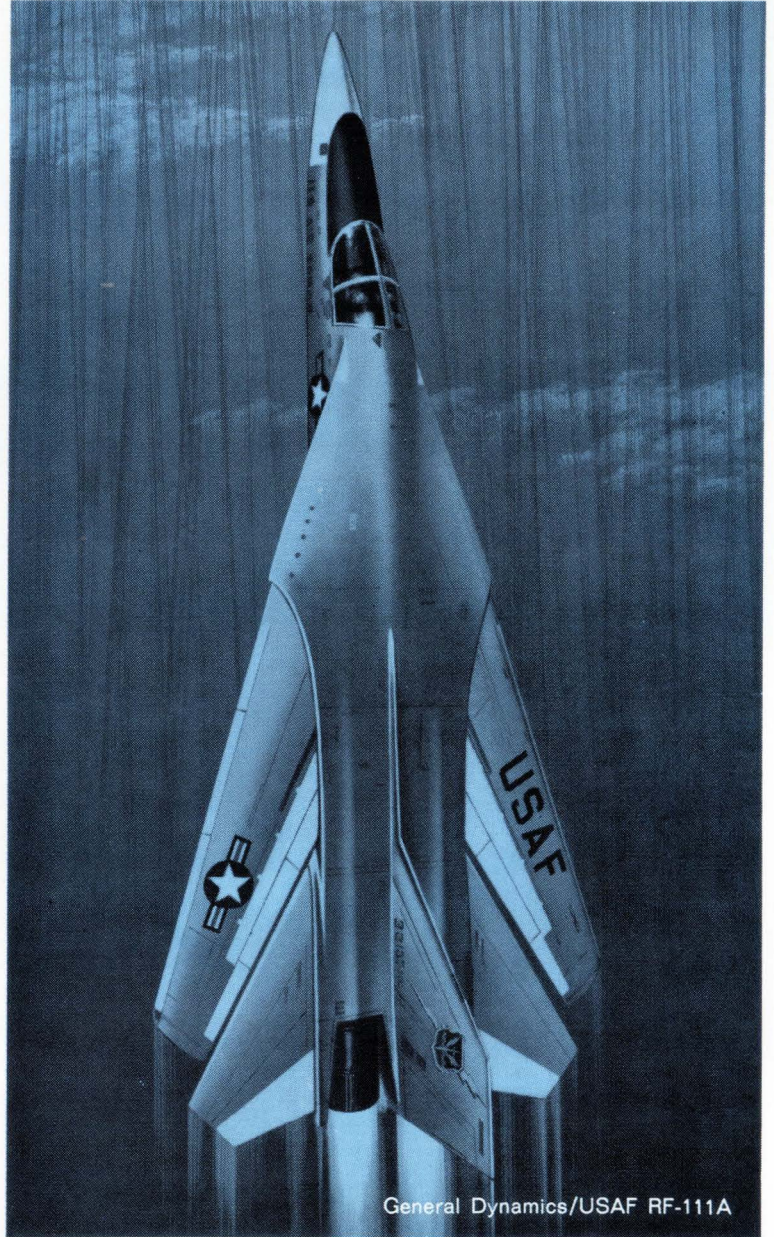

General Dynamics/USAF RF-111A

Why RF-111A taps Sperry's Storehouse of Knowledge.

Washington Newsletter

April 3, 1967

Speedy data link slated for MOL

The Air Force's Manned Orbiting Laboratory will have a 20-million-bits-per-second data link to communicate with ground stations when it goes into orbit sometime in 1969. The advanced space-ground link subsystem will use wide bandwidth and high-speed pulse-code modulation to achieve this rate and will integrate at least three communications links—telemetry, tracking, and command—into one S-band channel. Cryptographic encoding is also planned to keep transmissions secure.

Industry bids are being sought on nine tape recorders to store data transmitted from the MOL; the rotary-head machines will be located at remote tracking stations. The Air Force Space Systems division will award the contract to build the initial data link sometime this spring [Electronics, Feb. 20, p. 54]. Designed to support military satellites, the subsystem will handle 1 million bits per second of pcm data.

House panel waits in wings to probe IBM market share

A powerful House panel will hold investigative hearings on the computer market if the Justice Department's current probe of the IBM Corp.'s sales methods and its dominance of the market [Electronics, Jan. 23, p. 25] doesn't produce a monopoly suit against the company. The House Judiciary Committee's antitrust subcommittee, headed by Rep. Emanuel Celler (D., N.Y.), is asking computer manufacturers, including IBM, to supply market information; though the panel declines to comment on the scope of its study, its letters to the industry indicate that it will cover market conditions back to 1962.

Package approach to ship buying would survive FDL defeat

Don't write off the Pentagon's plan to buy ships on a "total package" basis, even though the Fast Deployment Logistic Ship program—which was to initiate this practice—probably will be rejected by Congress.

The Navy had expected to win its battle for the billion-dollar FDL fleet [Electronics, Dec. 12, 1966, p. 73], but opposition from merchant-ship operators, who feared competition from the projected floating warehouses—and from conventional shipyards that were shut out of the final bidding—has been severe, and the Senate has turned down the plan. The Pentagon is making a major effort to win House approval, but chances appear dim.

Congressional opposition is concentrated on FDL itself, not on total package buying which the Pentagon is pushing in order to spur shipyard modernization. Although it rejected FDL, the Senate approved initial funding of a new type of helicopter-carrying assault ship on a total package basis, an approach that combines the design, development, production and maintenance of a ship in one contract.

Data warranty causes howls

Industry is loudly protesting a Defense Department proposal that would require contractors to give the Government warranties on technical data. Extending the warranty concept is part of the Pentagon's insistence that contractors assume responsibility for the performance of their equipment, be liable for defects, and make corrections.

Voicing its opposition, the Council of Defense and Space Industries (Codsia) claims that extending warranties to engineering drawings, specifications, standards, and test results is unrealistic. But if the Pen-

Washington Newsletter

tagon insists on them, Codsia—which includes major electronics industry associations—wants the technical data warranty carefully considered and handled as a separate regulation.

Congress puts heat on conversion . . .

The Pentagon's controversial conversion program—switching from contractors to Civil Service for the operation and maintenance of military systems—will get a thorough going over by Congress. **At issue: should the Government compete with private enterprise?**

A Senate operations subcommittee is about to investigate last year's cancellation of a support services contract held by the RCA Service Co., covering Government-owned communications, frequency management, and data-transmission systems at White Sands, N.M., missile range. More than 600 similar contracts—many held by electronics firms—have been canceled by the Defense Department since 1965. Some, but not all, of the 10,000 employes affected have been added to the Civil Service.

. . . and Pentagon is sweating it out

With the Senate about to take a critical look at the conversion program, the Pentagon finds itself caught in a squeeze. The House Post Office and Civil Service Committee is weighing the possibility of conducting its own hearings to see if the conversion policy is moving fast enough.

Armed with an opinion from the Civil Service Commission, the House Committee claimed two years ago that the Pentagon in many cases violated Government employment regulations by hiring contractors who furnished specialists. The Pentagon's decision to shift most of the \$8 billion support services contracts to Civil Service jurisdiction stemmed from the heavy pressure from the committee and the Government's General Accounting Office.

Army must wait for AAFSS radar

Early production models of the Army's Advanced Aerial Fire Support System (AAFSS) won't carry the terrain-following or station-keeping radar being developed for the Navy's Integrated Helicopter Avionics System (IHAS). Until last month, the Army was hoping that the entire IHAS would be ready for inclusion in the first AAFSS helicopters when the craft go into production in 1970. It now appears that only the central computer can be included.

The Army's decision on whether to buy AAFSS production models is being held up by a squabble with the Air Force over project control. The Army claims the program because the aircraft uses rotors; the Air Force cites the craft's small fixed wings. Most observers agree that the Army will not buy production models if the Air Force gains control. Lockheed-California is currently building 10 prototypes.

Addenda

The second in the Advanced Technology Satellite series—designated the ATS-A—will be launched April 4 and be put into a 6,900-mile-high orbit. Its gravity-gradient stabilization system [Electronics, Nov. 28, 1966, p. 121] is expected to provide a pointing accuracy of 2.7° in pitch, 1.4° in roll, and 4.6° in yaw. **Such stabilization may permit the use of conventional parabolic antennas on future spacecraft.** . . . Congress ignored approval by its armed services committees and erased \$81 million earmarked for the Marine Corps' EA-6A aircraft from the special Vietnam appropriation bill [Electronics, March 20, p. 60]. It is now expected that the funds will be added to the regular fiscal 1968 budget.

If FREON® is the "high-priced" cleaning agent ...how come it saves IBM \$19,000 a year?

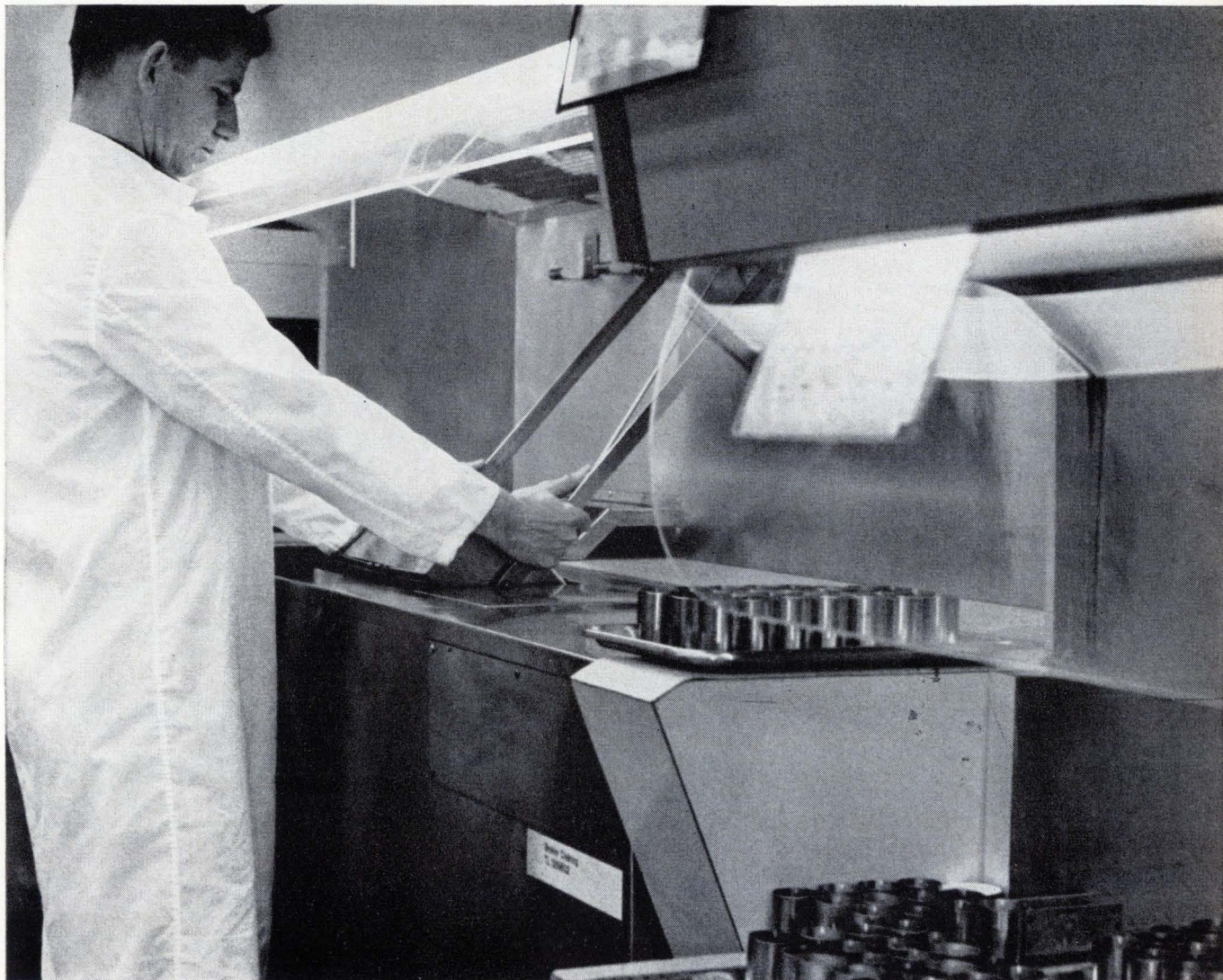

In their new East Fishkill plant near Poughkeepsie, N.Y., where IBM makes microminiature circuits for their newest lines of computers, System/360, engineers made this discovery:

They could save *big* money by spending *more* for the cleaning agent used to decontaminate stainless-steel beakers.

These steel beakers are used in the process of manufacturing semiconductors... and they must be completely free of contamination or be rejected. This care is vital because

each beaker holds a wafer that is later made into a transistor. The slightest degree of contamination to the wafer makes it unusable.

The former 3-step method—water ultrasonic, acetone, hot plate—required 6 minutes for each step. Even then, a sizable number of beakers was rejected. When the East Fishkill plant switched to FREON*, cleaning time decreased 30% and rejections were cut to 5%. Overall labor was reduced from 27 to 13 hours. Annual savings totaled \$19,000.

One way FREON saves money is by combining cleaning and drying—formerly two operations—into one. Another way is through the re-use of FREON many times a day. Even at the end of a workday, FREON is still

free from contamination. The former cleaning agent was contaminated after one use.

How much can FREON, the "high-priced" cleaning agent, save you? Your first step in finding out is to write: Du Pont Co., Room 100, Wilmington, Del. 19898. (In Europe, write: Du Pont de Nemours International S.A., FREON Products Div., 81 route de l'Aire, CH 1211 Geneva 24, Switzerland.)

FREON®
solvents



Better Things for Better Living
... through Chemistry

*Du Pont registered trademark for its fluorocarbon cleaning agent.

We'll stop at nothing to help you select the right memory system

...we'll even lend you one (with or without the applications engineer) for a free trial

We can help if you have no experience with core memories, but are designing industrial control systems that must handle and store data. To see how they can profit by the use of a low cost core memory, give us a call. We'll send an applications engineer around with the system best suited to your needs. He'll help you get it on line for evaluation.

We can help if you're familiar with core memories, but don't see how a standard off-the-shelf design could satisfy your requirements. Send us your block diagram. We'll study it and send you back a complete blueprint showing you how a general purpose core memory can be used as a versatile data-manipulating system capable of many

more logic functions than storage. (We may even be able to eliminate some redundant functions required by less versatile storage techniques.)

We can help even if you're already using core storage, but aren't convinced that a mass produced memory can provide many of the control, access and operating mode functions formerly associated (usually one at a time) with custom design. Drop us a line. We'll lend you a small system for a 10-day free trial. See for yourself what it

can do. If at the end of the trial period you can't bear to part with it, we'll work something out.

Our point—to prove that our line of catalog standards is broad enough to satisfy most data storage requirements and that we'll do almost anything to help you apply them to your system. Our FX-12 and FX-14 Series Systems are available in some 200 types. Sizes range from 128 words x 8 bits to 4K x 32, with cycle times from 4 to 8 microseconds. Prices start at \$1,190. If you'd like to check details and specifications before we talk, write for Bulletins M6612 and M6614.

Ferroxcube 
Systems Division Englewood, Colorado



FERROXCUBE
CORPORATION
OF AMERICA
Systems Division
5455 S. Valentia Way
Englewood, Colorado
303-771-2000

Boston
617-899-3110

Chicago
312-261-7880

Dallas
214-255-0441

Los Angeles
213-837-1484

Minneapolis
612-888-4681

New York Area
201-267-5888

Phoenix
602-265-1792

Philadelphia
215-927-6262



For those who think big—about availability, that is. Babcock's 1/6-size Model BR10 with unique universal contacts gives you "nonstop" load performance dry circuit to 1 amp. in the same unit. Now, you can order *one* relay to meet all your high-density circuit-board requirements—at no cost premium. And you'll find that this subminiature unit has everything...MIL-R-5757 conformance, unitized construction, solder-sealed or welded versions, standard circuit-board grid pattern, and a wide choice of terminal and mounting styles. Get more information about

the BR10, and the complete Babcock line of relays, all with universal contacts. Write Babcock Relays, Division of Babcock Electronics Corp., 3501 Harbor Blvd., Costa Mesa, Calif.; (714) 540-1234.



SPECIFICATIONS

SIZE: .405" h. x .500" l. x .230" w.	PULL-IN POWER: Low as 80 mw.
WEIGHT: Approx. 0.15 oz.	LIFE: To 150,000 operations
CONTACT ARRANGEMENT: DPDT	TEMP. RANGE: -65° C + 125° C

**Babcock
model BR10
1/6-size relays**

**dry circuit
to 1 amp
universal
contacts**



0.1% ACCURACY

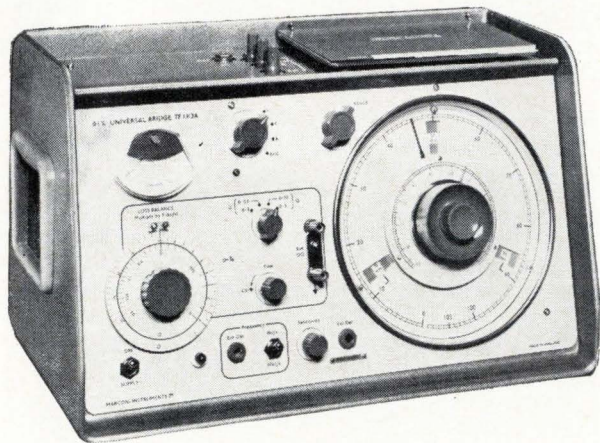

MODEL #1313A

use the **NEW**
MARCONI
UNIVERSAL
BRIDGE

- **Extremely High Accuracy:** 0.1% of Reading
- **No Factors:** Dial callouts automatically change when function and range is selected.
- **High Resolution:** Discrimination 0.01% of full scale; 10,900 division/range (Dial Reads 46.66 mH)
- **Wide Temperature Range Without Corrections**
- **Built-In Oscillator:** 1kHz and 10kHz, 20Hz — 35kHz with external oscillator
- **Capacitor Bias:** Up to 350VDC can be applied to polarize electrolytics

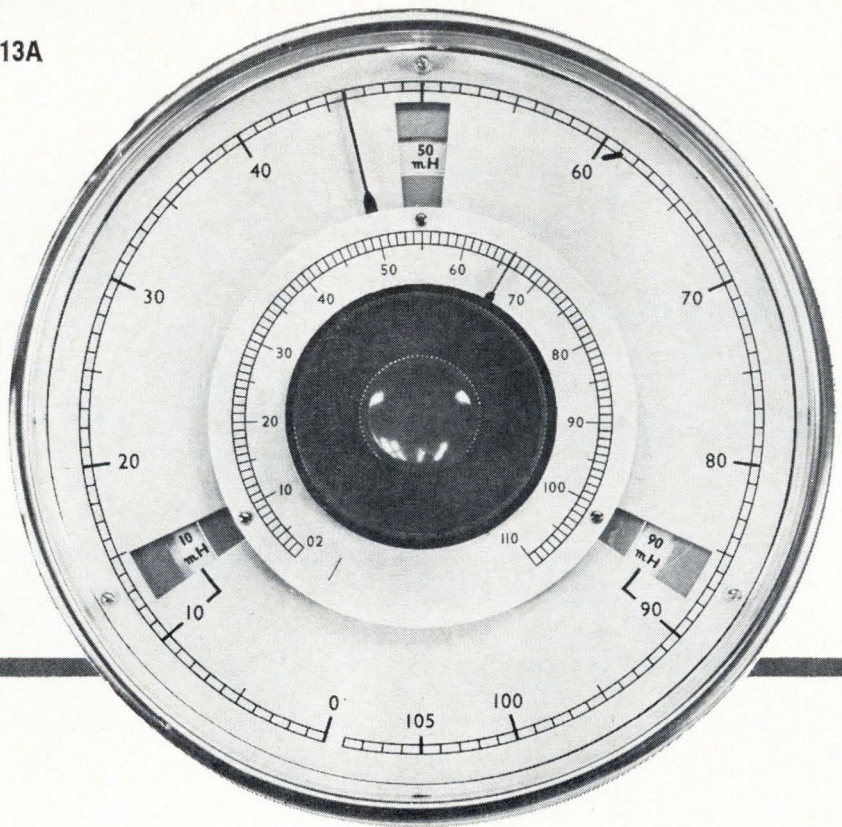

MEASURES

Inductance: ..0.1 μ H to 11H @ 1 and 10kHz
Capacitance: 0.1pF to 110 μ F
Resistance:003 Ω to 110M Ω
Q Range: 0 to 310
D Range:0005 to 30

Accuracy high, interpolation precise, familiarization time minimal . . . the model 1313A, latest in Bridges, is designed for use by engineers and production personnel alike. Ask your Marconi representative to show you.

MARCONI

111 Cedar Lane • Englewood, N. J.

INSTRUMENTS

Telephone: 201-567-0607

Division of English Electric Corporation



COMPONENT CAPSULES

New economy breakthrough for UHF TV oscillators

Just specify GE D16G6 silicon planar transistors—priced now at less than 25¢ in volume quantities. The D16G6 comes in GE's familiar T098 economy package and features an injection current of 0.5 ma at 940 mHz and low output capacitance of typically 1.2 pf. Circle **Number 90** for more details.

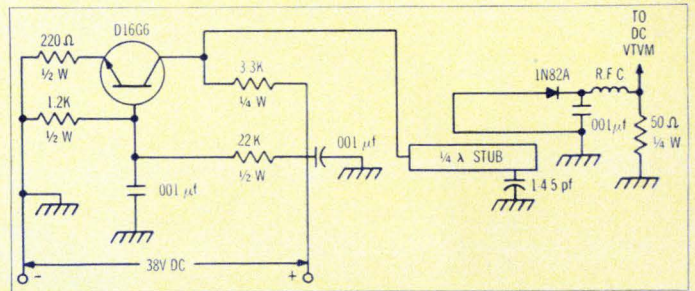

Test circuit—940 mHz oscillator

Out front . . . meeting more of your tube requirements



Look to the leader. General Electric is your number one supplier and number one innovator of tubes for entertainment-type products such as radio and TV. GE developed more than twice as many new tube types in 1966 as any other manufacturer. GE now offers over 125 different compactrons you can apply to reduce assembly time and related costs. Circle **Number 91** for more information on GE compactrons and other tube innovations.



Typical GE compactron

Automatic de-gaussing for color TV sets

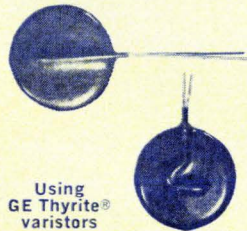

Using GE Thyrite® varistors

Used in conjunction with a thermistor, GE disk-type Thyrite varistors will develop, automatically, an ideal de-gaussing waveform in your color television receivers. Many have hailed this as one of the most important circuit developments in the TV industry, since it can eliminate so many costly service calls. Contact General Electric for these and all other varistor and thermistor requirements. Circle **Number 92** on the Reader's Service Card.

Rechargeable nickel cadmium batteries last so much longer

Available types—suitable for many commercial applications—include sealed, pressure relieved, and vented cells nominally rated from 0.5 amp-hours to 160 amp-hours at the one hour rate. Shock-resistant GE nickel cadmium batteries operate over a wide temperature range and have a high discharge rate capability with constant voltage output. Custom designs are also available. Circle **Number 93** for more facts.



Can last hundreds of times longer

New 2-transistor Darlingtons amplifier costs as low as 35¢*

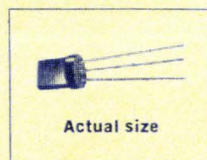

Actual size

Use GE's new D16P NPN device (in monolithic structure) to simplify your audio amplifier circuits in pre-amps for phonographs and tape recorders. One D16P actually costs less than its discrete counterpart in these applications—two 2N3394's. D16P's provide single stage input impedance over 2 megohms with a 6-to-1 voltage gain at negligible distortion (less than 0.1%). For more information, Circle **Number 94**.

*In lots of 1,000 and up

WE MAY NOT OFFER EVERYTHING YOU WANT FROM ONE COMPONENTS SUPPLIER. BUT WE DO COME A LITTLE CLOSER THAN ANYONE ELSE.

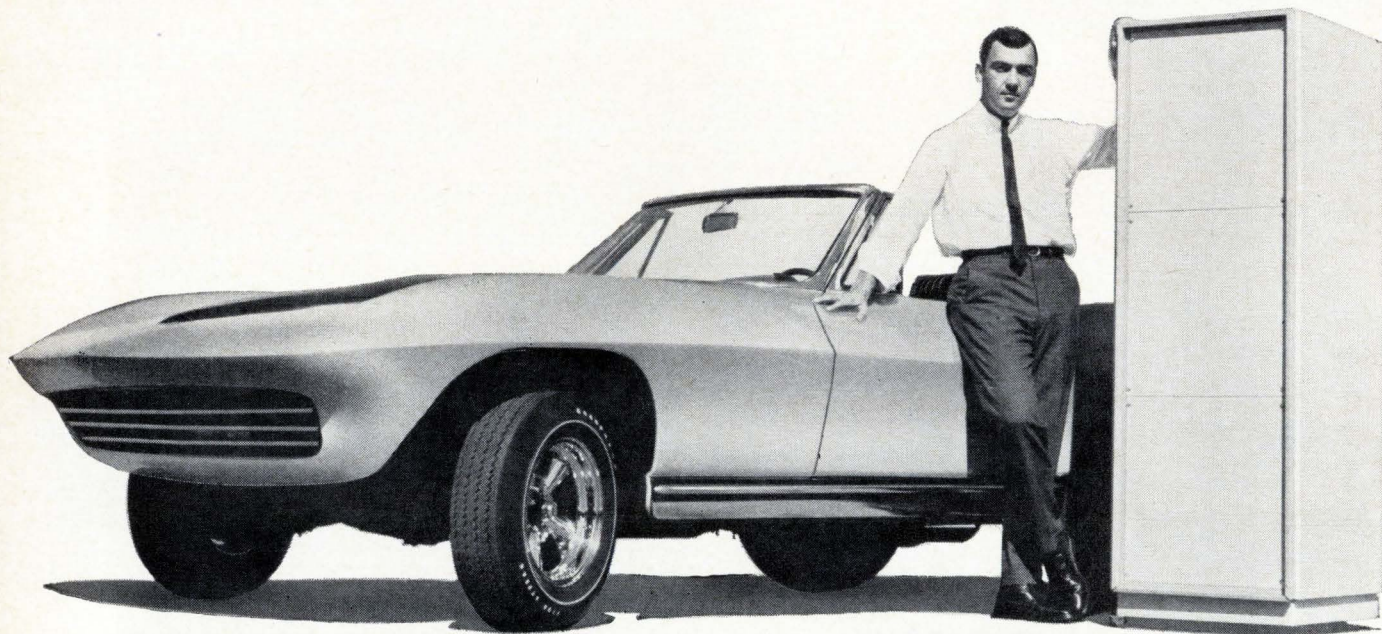

EMCOR® II— for people with custom ideas

EMCOR II is custom cabinetry at popular prices . . . as close to perfection as electronic enclosures can be. With EMCOR II, you can customize each and every piece with the use of personalized nameplates, hardware, and other components. You make your own designs and give them a personal touch.

The custom look of EMCOR II will compliment the quality of your instrumentation in every way. Fine

EMCOR/distinguished cabinetry

materials and exacting craftsmanship are applied to each component, providing tolerances that are precise, not flexible. On the outside—no blisters, paint runs, or rough surfaces. And, the color of your choice is carefully baked on.

When you need a cabinet, or a complete system, call your local EMCOR Sales and Service Engineer. Or write for our new EMCOR II catalog.

Albany: 436-9649; Albuquerque: 265-7766; Alexandria: 836-1800; Atlanta: 939-1674; Baltimore: 727-1999; Binghamton: 723-9661; Bridgeport: 368-4582; Buffalo: 632-2727; Chicago: 676-1100; Cleveland: 442-8080; Dallas: 631-7450; Dayton: 298-7573; Del Mar: 454-2191; Denver: 934-5505; Detroit: 357-3700; Fort Lauderdale: 564-8000; Ft. Lee (No. N. J.): 944-1600; Ft. Walton Beach: 243-6424; Houston: 526-2959; Huntsville: 539-6884; Indianapolis: 356-4249; Kansas City: 444-9494; Los Angeles: 938-2073; Minneapolis: 545-4481; Newport News: 245-8272; N.Y.C. area: 695-0082; Orlando: 425-5505; Palo Alto: 968-8304; Philadelphia: 242-0150; Pittsburgh: 884-5515; Phoenix: 273-1673; St. Louis: 647-4350; Seattle: 722-7800; Syracuse: 471-7274; Tulsa: 742-4657; Utica: 732-3775; Valley Forge (So. N. J.): 265-5800; Wilmington, Mass.: 944-3930; Winston-Salem: 725-5384. EMCOR Reg. U.S. Pat. Off. . . .

Ingersoll Products 1002 West 120th St., Chicago, Illinois 60643

DIVISION OF BORG-WARNER CORPORATION

**electronic
equipment**





TEST BOARD BEFORE...



AND AFTER SOLUTEC PROCESSING

New Solutec system cleans IC's, PCB's and components, faster and more economically than ultrasonics or vapor degreasing

Are you looking for a cleaning system that will improve productivity, cut investment and get uniform results time after time? Get all the facts about Solutec's "Hydrogen Scrubbing" process. It's simple, requiring only one cleaning solution and generating no fumes, films or toxicity problems.

If cleaning takes you more than three minutes — whether you use ultrasonics, vapor degreasing or manual methods — you need to learn more about the Solutec system! In the presence of "Hydrochemex", Solutec's proprietary activated detergent, contaminants are removed by the generation of hydrogen bubbles on or near the surfaces being cleaned. The process is rapid and safe, leaving

the surfaces chemically clean! It will remove silicon lubricants, oils, greases, flux, dirt and acid fingerprints from IC's, PCB's PCB assemblies, connectors (both before and after soldering), components and other plastic or metal surfaces.

Solutec also offers a complete line of chemicals for processing PCB's, removing surface oxides, chemically deburring aluminum, improving plating and soldering adhesion, cleaning silk screens, etc. Among the chemicals available are deoxidizers, strippers, sensitizers, polishes, and electroless copper solutions.

To start improving the reliability of your product, send this coupon for more information.



THE SOLUTEC Model 900 is a bench-type hydrogen scrubber. The device is also available in larger capacities for production line use.



SOLUTEC

SOLUTEC CORPORATION
5903 Seminole Boulevard
Largo, Florida 33540 • Phone 813/392-4268

- Please send me more information about the Solutec PCB cleaning system.
- Please have your representative call me to arrange a demonstration.

NAME _____ TITLE _____

COMPANY _____

ADDRESS _____

CITY _____ STATE _____ ZIP _____

DURANT'S NEWEST!

... in a growing line of count/control instruments



49600 UNISYSTEM®

New, single-level predetermining count/control system developed to meet the need for a small, inexpensive digital counter or timer. It provides direct digital reading, eliminating dial interpolation. Ideal for installation on control panels for machine tools, textile machinery, wire, machinery, metering and scaling equipment. This exceptionally compact unit is available as a standard unit equipped with 2, 3 or 4 Unipulser decades. Design permits it to be used equally well as a desk or panel mount without change. Important advantages include ease of presetting and resetting (panel or remote) . . . set-up and wiring simplicity . . . pre-determined visual setting is always retained. Count life and reset life proven for over 100 million counts. Count speed up to 30 cps. 115V — 230V, 50-60 cycles.

For more information circle No. 491 on Reader Service Card



6 YE SERIES ELECTRIC COUNTERS

These new 6 figure electric units have been developed for instrument or control systems, office machinery, data processing equipment where long life and high count speeds are required. Reset is optional, manual push-button or electric, with entire mechanism housed within the case. The 6 YE Series is available for base or panel mounting, providing permanent tamper-proof installation without extraneous hardware.

High accuracy and reliability are assured by an exclusive Durant drive feature: the power impulse cocks, power release counts, resulting in a uniform indexing force and smooth counting action.

Count speed is 2400 cpm DC — 1800 cpm AC (rectified). Models available for 115V, 230V AC or DC — other voltages on request.

For more information circle No. 493 on Reader Service Card

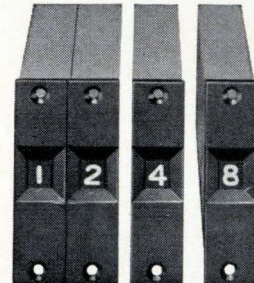

BCD UNIPULSER®

Durant Unipulsers are now compatible with count/control equipment using binary coded decimal systems. They are especially suited for use in data processing equipment, medical instrumentation, business machinery and more.

BCD Unipulsers use the 0-1-2-4-8 code and hook up easily with only 5 wires using standard connectors. Drive and visual readout is digital. Electrical readout is automatically encoded from digital to binary, eliminating the need and expense of code converters.

Important advantages include high count speed (40 cps), large readable figures, high current carrying capacity, and long life (proven for over 100 million counts). The BCD Unipulsers are the latest addition to the growing line of Durant decade modules, permitting you to count or control practically anything; hours, minutes, units, ounces, pounds, etc.

They are available in three models — 400 BCD non-polarized, 401 BCD with a common negative, 402 BCD with a common positive.

For more information circle No. 492 on Reader Service Card

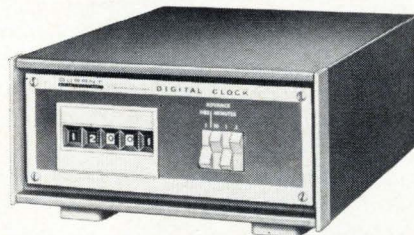

DIGITAL CLOCK — ELECTRICAL READOUT

Hours, minutes, seconds or decimal combinations of any time period can be readout visually and electrically by this highly dependable unit. It can be used in data reduction systems . . . for controlling batching where timed mixing is important . . . to aid in computing piece rate in all production processes . . . for use in all types of data or material handling where a time base is required.

Three, four, five and six digit models are available as shown or without cabinet for 9½" panel or 19" relay rack mounting. 115V or 230V AC, 50 or 60 cycle. Prices start at \$280.00.

For more information circle No. 494 on Reader Service Card

DURANT
MANUFACTURING COMPANY

MILWAUKEE, WISCONSIN
In Europe: Durant (Europa) N.V. Barneveld, Netherlands

Model CFI-3
Transistorized Microwave RI/FI Meter

Specification Highlights

Model TR-3
0.95-21.0 GHz

Portable, compact, ruggedized, versatile, AM/FM/CW/MCW/PULSE

- AFC, AGC circuits
- Digital frequency dial
- Unidial® Tuning
- Output calibrated directly in db.
- Preselection on all tuning units

6 Plug-in Tuning Units Cover 0.95-21.0 GHz

Min. Sensitivity Ranges from -90 to -77 dbm (1 MHz BW)

Impulse bandwidth: 1 MHz, 5 MHz, wideband

Linearity: ± 1 db over 70 db range

Meter Scales: μv , db above 1 μv /MHz, db above 1 μv /5 MHz, 0-70 db relative, 0-10 linear relative

Outputs: audio, AM/FM video, recorder

Image Rejection: 60 db minimum

12V DC or 115V/230V AC line operation

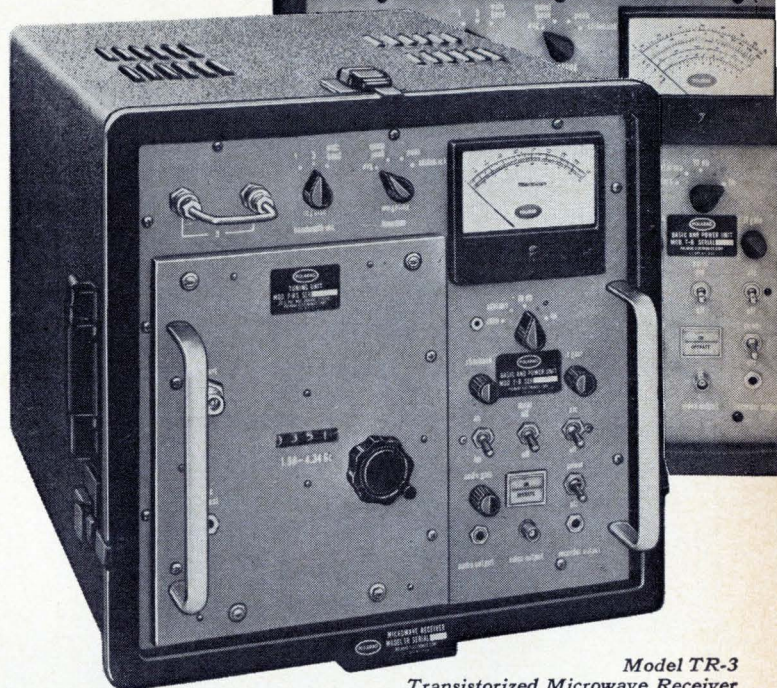

Model TR-3
Transistorized Microwave Receiver

Specification Highlights

Model CFI-3
1.0-21.0 GHz

Full category A Air Force Approval per MIL-I-26600, MIL-1-6181 and MIL-STD826 to 10 GHz

Portable, compact, ruggedized. Combines an impulse calibrator, field-intensity meter, and calibrated antenna system.

Provides accurate measurements of frequency and absolute power level of conducted or radiated microwave energy.

UNIDIAL® tuning; direct-reading digital dial; $\pm 1\%$ frequency accuracy; output level direct-reading in db... no calculations or correction charts!

Calibrated AM, FM, CW, MCW, and Pulse Receiver; calibrated impulse Gen.; calibrated antenna system.

6 Plug-In Tuning Units Cover 1.0-21.0 GHz

Min. Sens. -90 to -77 dbm (1 MHz BW)

KS and KU band units have self-contained impulse calibrators

Maximum RF input: 3v

Image Rejection: 60 db

Impulse bandwidth: 1 MHz, 5 MHz, wideband

Signal Attenuation: 0-80 db in 1 db steps

Calibrating Signal: Impulse, 1 MHz to 21 GHz

Meter Scales: μv , db above 1 μv /MHz, db above 1 μv /5 MHz, 0-70 db relative, 0-10 linear relative

Outputs: audio, AM/FM video, recorder

12V DC or 115V/230V AC line operation

Third Lap ... and still miles ahead

These Modern Classics are now in their third generation.

For many years, the CFI and TR were the *only* transistorized, truly portable microwave receivers and RI/FI meters. They are still the best, by far. Why? For many reasons. Consider, for example:

- a *decade* of field experience...since the first CFI/TR was introduced in 1956.
- *dozens* of design improvements
- *three generations* of design refinement
- *unequalled* calibration stability and longevity
- Polarad's unique manufacturing and applications-engineering experience

Check the specification highlights given here. Then send for the full data on these rugged, thoroughly dependable, highly polished "instrumentation classics". Better yet, call PEI Sales at (212) EX 2-4500, and arrange for a prompt demonstration...*from stock.*



POLARAD ELECTRONIC INSTRUMENTS

A Division of Polarad Electronics Corporation

34-02 Queens Boulevard/Long Island City, New York 11101

World Leader in Microwave Instrumentation

COULD YOU SLICE THIS ANGLE INTO 300 EQUAL PARTS?

MCCOY DOES EVERY DAY!

That's the final step in cutting crystal blanks at McCoy. Prior to this several cuts are made with diamond saws...and after each cut, blanks are X-rayed to assure proper angle.

X-ray inspection equipment is accurate to 1/300 of 1° of angle. Angle accuracy is vital because it influences crystal behavior under varying temperatures.

Blanks are then lapped—a few millionths of an inch at a time—to the desired thickness, accurate within 10

millionths of an inch. Crystals are then coated with metal films (in high vacuum evaporation platers) only a few millionths of an inch thick to provide the exact frequency required.

These are but a few of the precision operations that assure you of the highest quality available when you specify McCoy crystals, oscillators and filters.

For full details on these precision components, write for our new product catalog.



MCCOY ELECTRONICS COMPANY

A Subsidiary of OAK ELECTRO/NETICS CORP
Mt. Holly Springs, Pennsylvania 17065

**At National Water Lift,
when FLEXPRINT® circuitry
goes in, reliability goes up
...and costs go down**

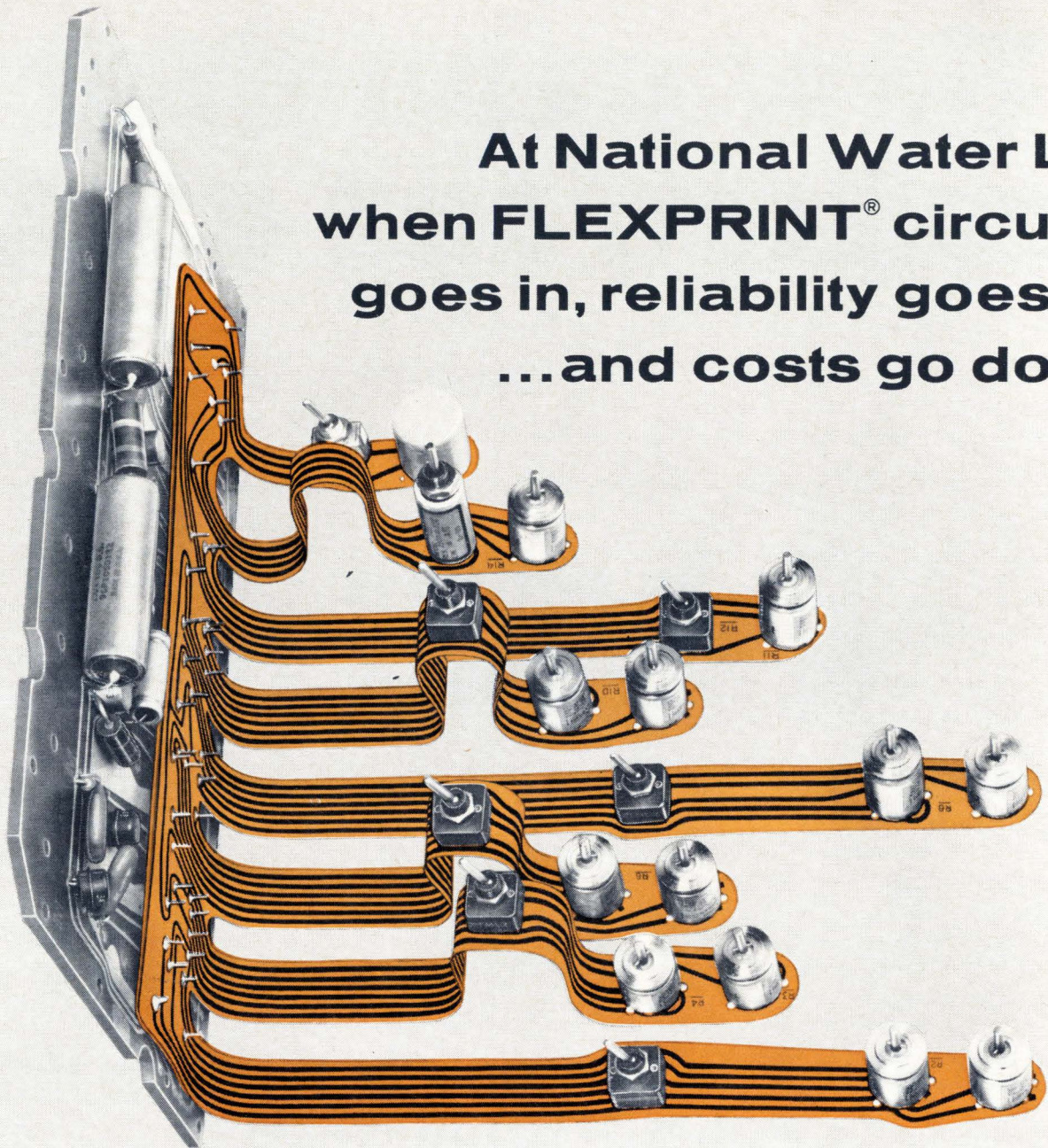

With FLEXPRINT circuitry, National Water Lift gets increased reliability *plus* a 20% saving on installed wiring costs on every STOW weight-and-balance computer produced for the C-130 transport.

Because the FLEXPRINT circuit is made of strong, flexible KAPTON† film, it withstands vibration better than ordinary wire . . . even under extreme conditions. And because it is custom-engineered for the National Water Lift application, wiring errors and troubleshooting are virtually eliminated. Greater reliability is built right into the entire circuit system.

Production economies, too, are a built-in feature of the FLEXPRINT circuitry. The STOW computer circuit lies flat for easy insertion of 21 individual components — then folds neatly into the exact space allowed in the package. Assembly time, quality control and rework are reduced to a minimum, and the completed assembly always fits the package.

If you have a similar assembly or packaging problem, call a Sanders FLEXPRINT expert. Our representatives cover the country. Ask them about FLEXPRINT circuitry, FLEXMAX flexible multilayer circuitry, and INTRAMAX* multilayer hardboard. For detailed information, call or write Sanders Associates, Inc., FLEXPRINT Products Division, Grenier Field, Manchester, New Hampshire 03103. Phone: (603) 627-3811.

SANDERS ASSOCIATES, INC.
FLEXPRINT PRODUCTS DIVISION



Creating New Directions in Electronics

How capacitor makers cut costs

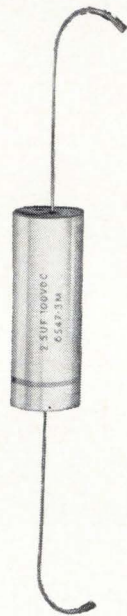

**by switching
to a modern
dielectric**

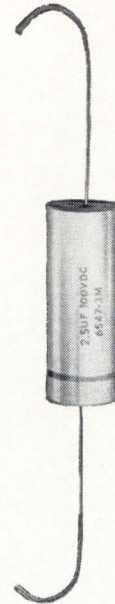

**Scotchpar[®] Polyester Film saves money, time;
makes better products**

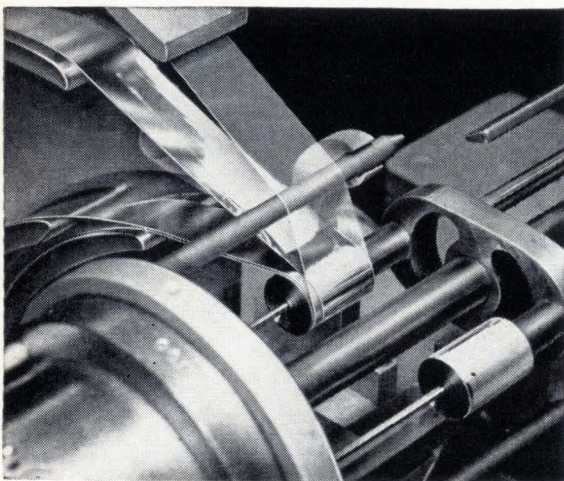

"Scotchpar" capacitor film can be wound at high speeds — eliminates paper problems.

Capacitor manufacturers for years used kraft paper tissue for a dielectric. Now, most use polyester film . . . even though initial costs are slightly higher. "Scotchpar" Polyester Film actually reduces end costs. It doesn't require long oven drying or vacuum impregnation. It is not moisture sensitive like paper and needs no liquid impregnant. Permits fast, low cost pressure-sensitive tape wrapping . . . eliminates costly metal or ceramic cases! Expensive glass-to-metal hermetic seals can also be replaced by low cost resin end fills. Production time is cut. And, the capacitor has superior quality due to the higher dielectric strength, greater temperature resistance and electrical stability of "Scotchpar" Film. To get more facts on the benefits of this modern dielectric, write: Film & Allied Products Div., 3M Co., 2501 Hudson Rd., St. Paul, Minn., 55119, Dept. ICL-47



"SCOTCHPAR" IS A REG. T.M. OF 3M CO.



SCR SERIES POWER SUPPLIES



NEW styling...

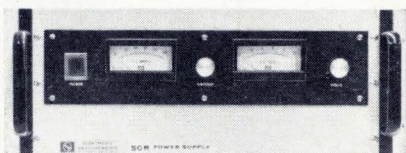

SMALLER size...

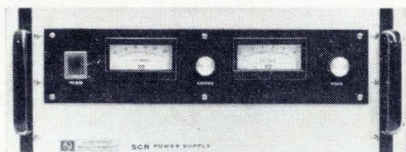

LESS ripple...

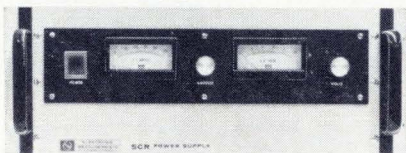

Brand new design and a new concept and production of proprietary electronic filtering, all in the SCR from the oldest sole-manufacturer of power supplies, guarantees quality, highest performance and lowest cost.

Model No.	Voltage Range	Current Range	Voltage Regulation Line or Load
SCR 10-1000	0 to 10	0 to 1000	0.1% or 5MV
SCR 10-500	0 to 10	0 to 500	0.1% or 5MV
SCR 10-250	0 to 10	0 to 250	0.1% or 5MV
SCR 20-500	0 to 20	0 to 500	0.1% or 10MV
SCR 20-250	0 to 20	0 to 250	0.1% or 10MV
SCR 20-125	0 to 20	0 to 125	0.1% or 10MV
SCR 40-250	0 to 40	0 to 250	0.1% or 20MV
SCR 40-125	0 to 40	0 to 125	0.1% or 20MV
SCR 40-60	0 to 40	0 to 60	0.1% or 20MV
SCR 120-80	0 to 120	0 to 80	0.1% or 60MV
SCR 120-40	0 to 120	0 to 40	0.1% or 60MV
SCR 120-20	0 to 120	0 to 20	0.1% or 60MV
SCR 160-60	0 to 160	0 to 60	0.1% or 80MV
SCR 160-30	0 to 160	0 to 30	0.1% or 80MV
SCR 160-15	0 to 160	0 to 15	0.1% or 80MV
SCR 500-20	0 to 500	0 to 20	0.1% or 250MV
SCR 500-10	0 to 500	0 to 10	0.1% or 250MV
SCR 500-5	0 to 500	0 to 5	0.1% or 250MV

RMS Ripple: 10MV Transient Resp: to within 2% in 50 M/S



Write for more information.

THE ROWAN CONTROLLER COMPANY

OCEANPORT, N. J. 07757



a TCXO that fits almost anywhere

and offers exceptional frequency stability between -55°C and $+85^{\circ}\text{C}$

Only about $\frac{1}{2}$ of a cubic inch in size, this TCXO (temperature compensated crystal oscillator) offers excellent frequency stability; 5 ppm over a temperature range of -55°C to $+85^{\circ}\text{C}$. It's one of four new miniature TCXO's from Motorola. The slightly larger models offer stabilities as low as ± 1 ppm. Zener diode regulated compensating circuits provide on-frequency operation the instant they're turned on. All-silicon solid-state construction provides exceptional reliability. Take a look at these facts.

SMALL SIZE: Sizes range from 0.58 cubic inch to 3.4 cubic inches.

WIDE TEMPERATURE RANGE: From -55°C to $+85^{\circ}\text{C}$.

HIGH FREQUENCY STABILITY: Available as low as ± 1 ppm.

WIDE FREQUENCY RANGE: From 1 MHz to 30 MHz.

LOW POWER CONSUMPTION: As low as 100 milliwatts.

NO WARM-UP TIME: Adjusts instantly to temperature conditions.

FOR MORE INFORMATION contact your Motorola representative. Or write for bulletin TIC-3213.

MOTOROLA COMMUNICATIONS AND ELECTRONICS INC.

4900 West Flournoy Street

Chicago, Illinois 60644. A subsidiary of Motorola Inc.



MOTOROLA
PRECISION
INSTRUMENT
PRODUCTS

First come first served.

You can have all the SDS T Series integrated circuit modules you want now. We're in full production.

All T Series active elements are integrated circuits and guarantee reliable operation at clock rates to 10 mc. Each circuit output drives 14 unit loads, even after generous allowances for wiring capacitance.

Outputs switch 60 ma (4 times more than standard IC's). Noise rejection is at least 1.5 volts at the 0 and 4-volt logic levels.

SDS Natural Logic gives you AND and OR as well as NAND and NOR —

Each card uniquely keyed for proper installation.

Test points.

Ground plane laminated through middle of entire glass-epoxy board.

Load resistors separate from IC's for heat isolation.

Discrete diode-resistor inputs for gating flexibility, high noise rejection.

Four pins reserved for ground lines.

Four integrated-circuit buffer amplifiers in each hermetically sealed TO-5 can.

52 ribbon connectors (26 each side) for easy access to all circuits.

All components clearly identified.

Individual power line filters.

Actual size 4¼ x 4¾.

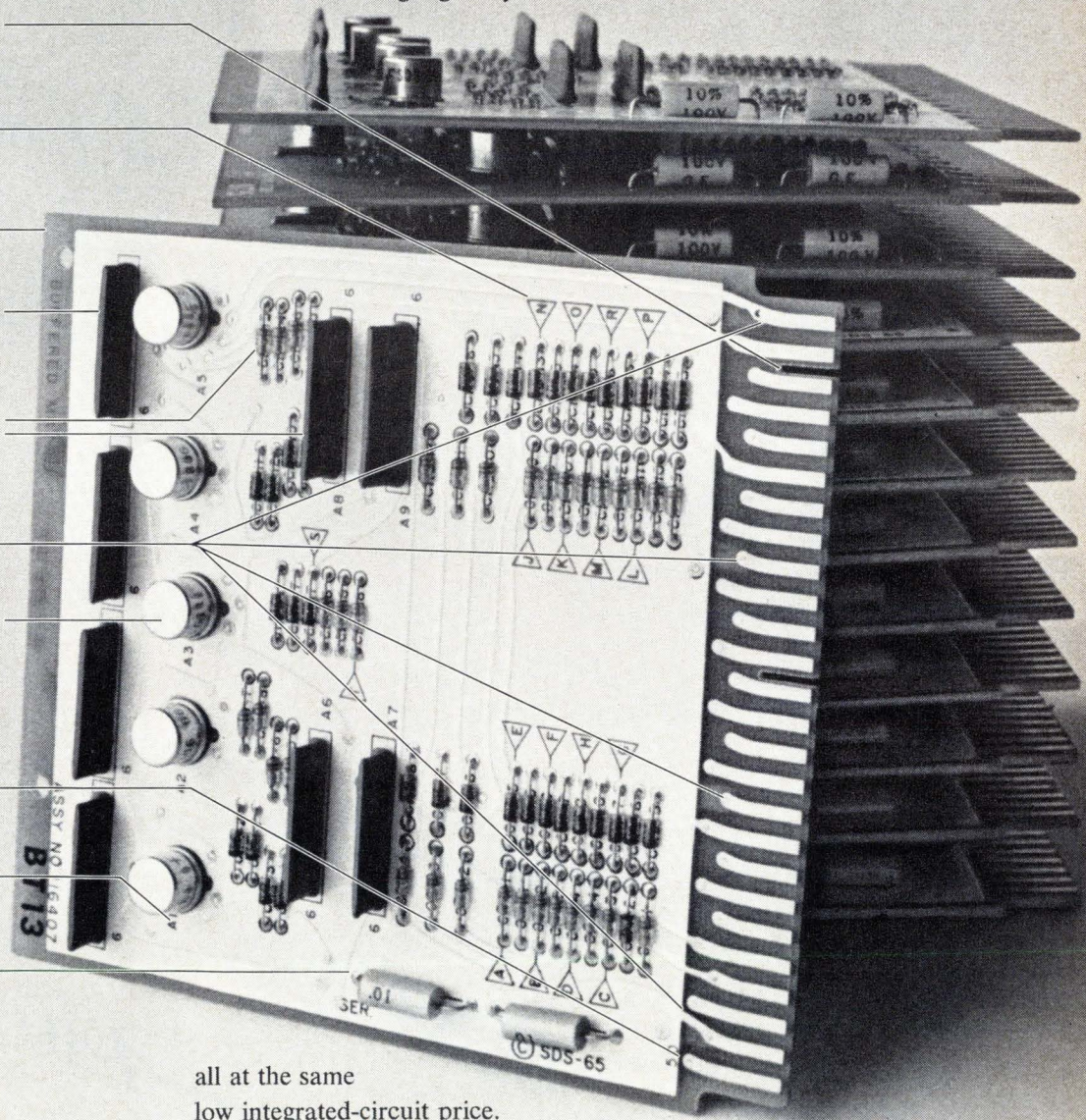

all at the same low integrated-circuit price.

We designed these modules for our new Sigma computers, but we also intend to become the largest manufacturer of logic modules for system designers.

We don't want to give away any of our Sigma secrets. But we'll sell them pretty cheap.

SDS

Scientific Data Systems,
Santa Monica, California

Adage makes the fastest A-to-D converter on the market

8 bits at 1 Mc, 1 μ s conversion time (Model VT7-AB)
14 bits at 200 Kc, 4 μ s conversion time (Model VT13-AB)

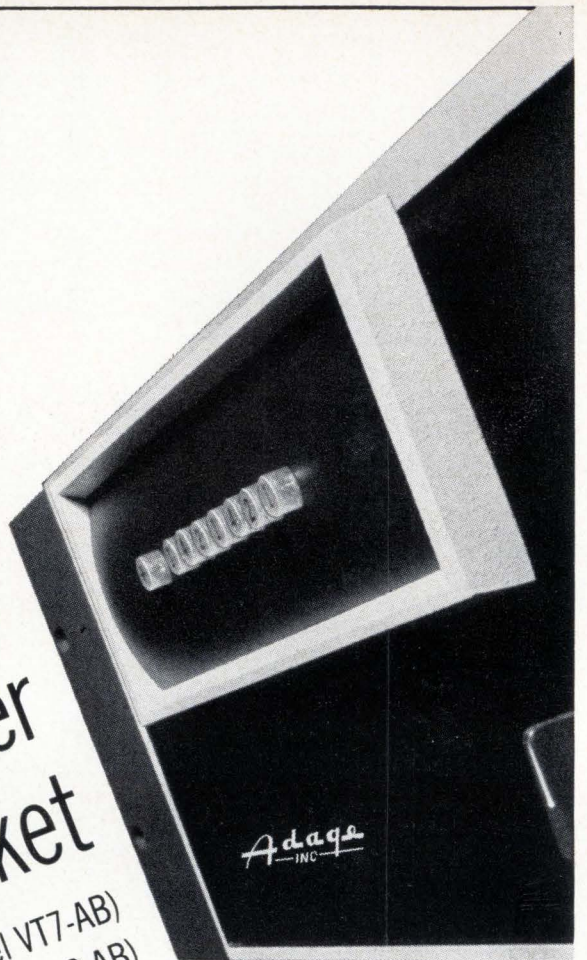

Adage has been making solid-state analog-to-digital converters, and compatible sample-and-hold amplifiers, multiplexers, and D-to-A converters, since 1957 — longer than anyone else. We like to think our record of performance is also unmatched.

May we send you literature describing our products — or an applications engineer to help you with your problem? Write Leon Dall, Product Manager, Adage, Inc., 1079 Commonwealth Ave., Boston, Mass. 02215, (617) 783-1100.

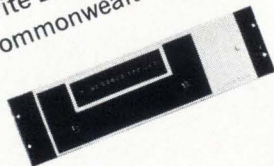

Adage
INC

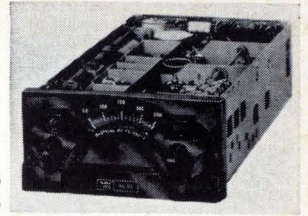

King Radio needed: capacitors that stay reliable even with extreme cold, humidity and vibration.

So King Radio chose: capacitors of MYLAR.

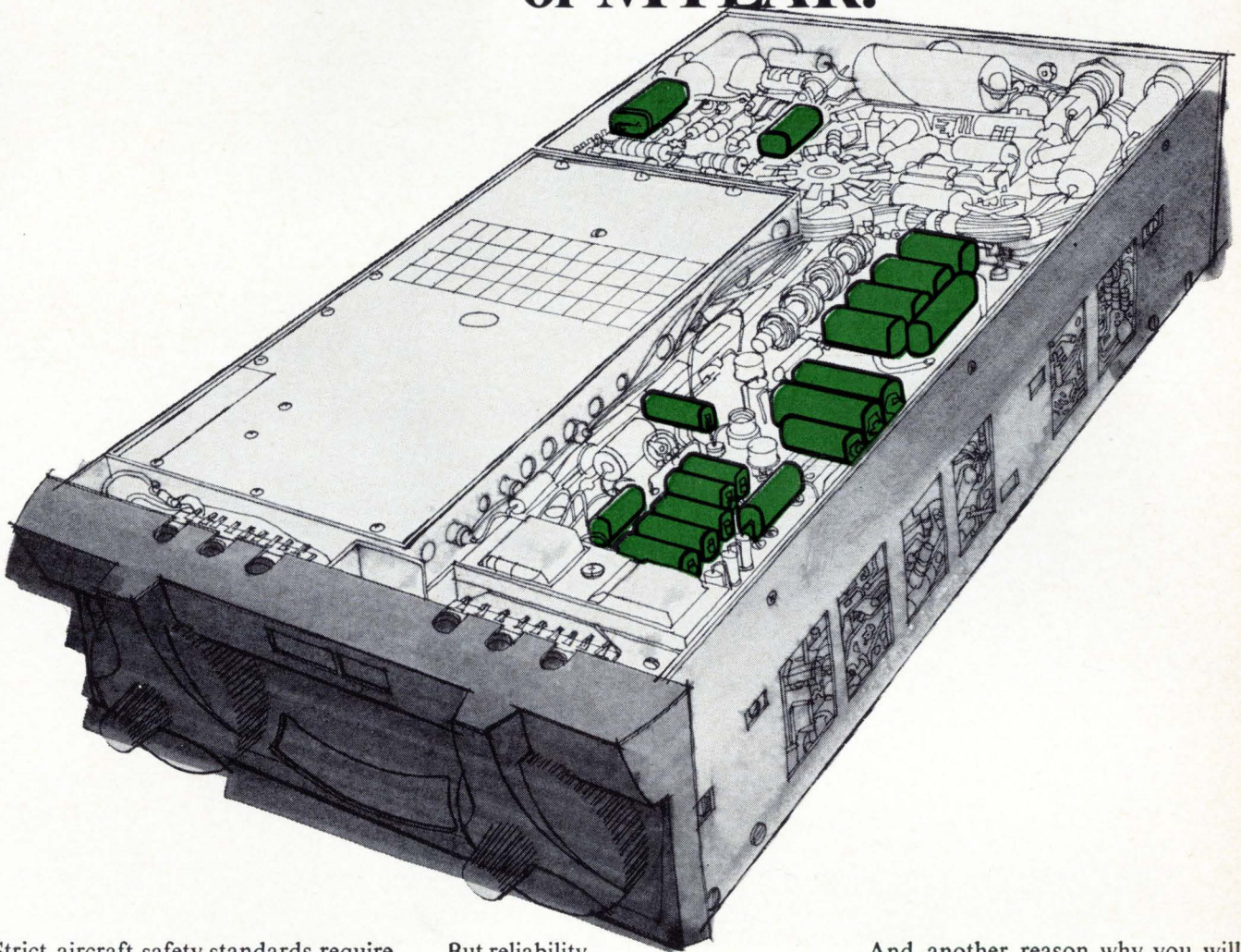

Strict aircraft safety standards require the most reliable navigation equipment available. That's why King Radio Corporation uses capacitors of MYLAR* for their Distance Measuring Equipment. MYLAR can take temperature extremes from -60° to $+150^{\circ}\text{C}$; MYLAR remains constantly stable under humid conditions.

But reliability isn't the only reason King Radio chose MYLAR. The extremely high dielectric strength of MYLAR permits its use in thinner film, thus helping King Radio to build the lightest and most compact distance measuring unit on the market. MYLAR is available in films as thin as 15 gauge.

And another reason why you will want to investigate using capacitors of MYLAR: they usually cost no more than others. Write for complete technical data to DuPont Company, Room 4960A, Wilmington, Delaware 19898. (In Canada, for information write Du Pont of Canada Ltd., Post Office Box 660, Montreal, Quebec.)

DU PONT MYLAR®
REG. U.S. PAT. OFF.

*DU PONT'S REGISTERED TRADEMARK FOR ITS POLYESTER FILM.

Are design engineers choosy?

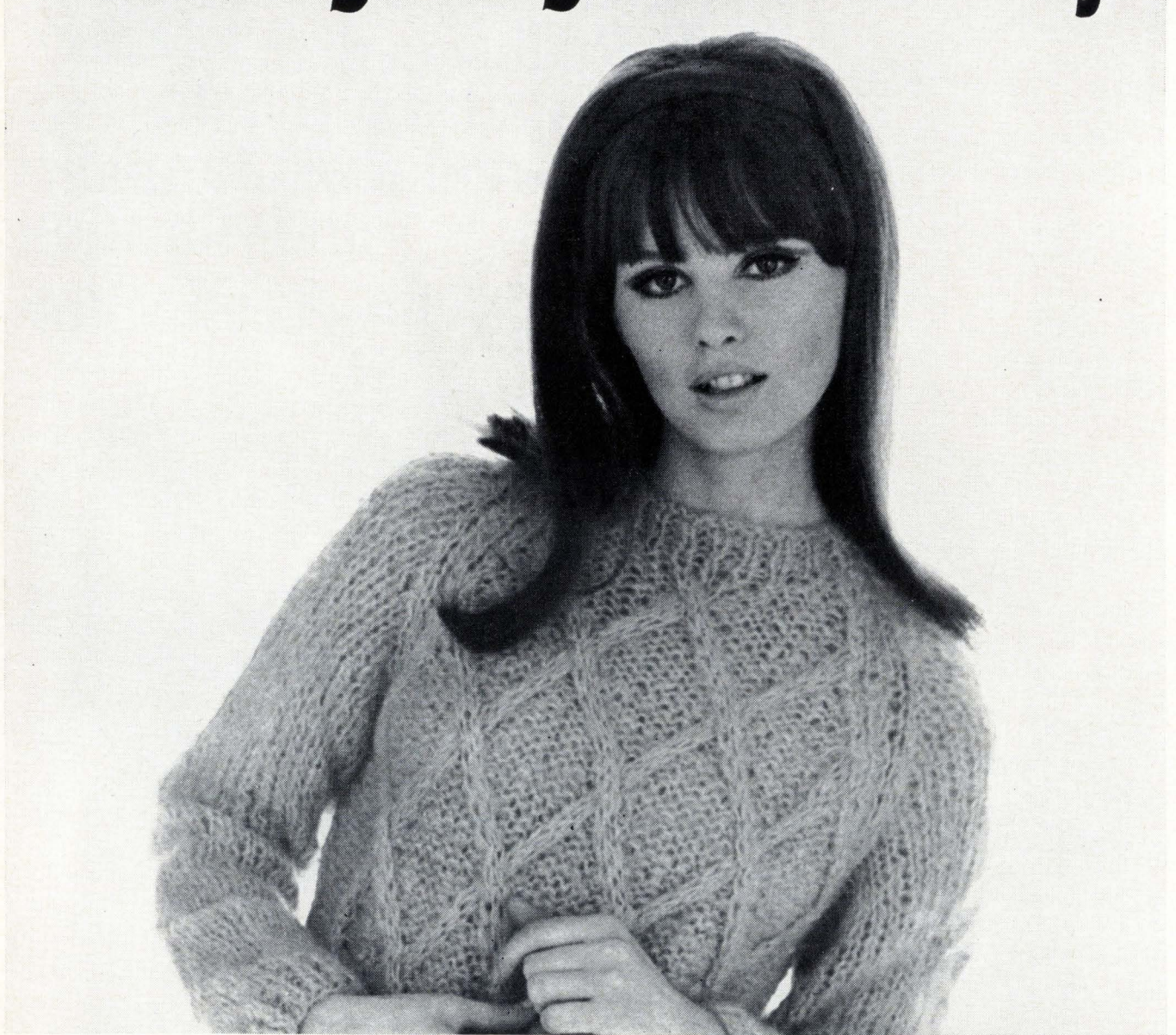

You bet they are! And the more discerning they are the better we like it.

That's why CAMBION® RF chokes molded with epoxy resins offer triple the advantages of competitive chokes. They provide greater resistance to external contaminants, cooler operating temperatures and tighter electrical tolerances. They are five times more water resistant, have 50% more dielectric strength and develop only half the heat of chokes encapsulated with alkyd resins.

Because they run cooler, CAMBION chokes last longer . . . achieve greater reliability. And by radiating less heat to neighboring components, these chokes improve the total reliability of your circuit assemblies.

CAMBION quality is a tangible thing. Special techniques, new equipment and our quality control program assure precise winding and careful handling of epoxy resins.

Seals are stronger, too. There is a more uniform bond between the epoxy, the windings and the terminal leads. Our molded RF chokes are rugged . . . built to take rough treatment both in production and in the field.

What's more, CAMBION advanced techniques in epoxy molding

permit winding with larger diameter wire to give you reduced d-c resistance and high Q.

And you can specify tolerances to 5% or 10%. Standard CAMBION RF chokes combine consistency and uniformity in a variety of values, styles and sizes. There's a CAMBION choke built to meet your particular requirements, ready for immediate delivery off the shelf. We also produce many popular styles of RF chokes in conformance with Military Specifications. All CAMBION chokes are guaranteed for quality regardless of quantity.

Contact your nearest CAMBION distributor. Be choosy — there are 18 styles of CAMBION RF chokes in over 500 different inductance ratings, stocked and ready for shipment. For complete technical data, write Cambridge Thermionic Corporation, 402 Concord Avenue, Cambridge, Massachusetts 02138. In Los Angeles, at 8703 La Tijera Boulevard, 90045.

®REG. U.S. PAT. OFF.

CAMBRIDGE THERMIONIC CORPORATION
CAMBION®

Standardize on CAMBION . . . 21,541 guaranteed electronic components

First from Westinghouse: 1.5 to 40 amp plastic rectifiers with more hermeticity than you need.



WESTINGHOUSE PLASTIC RECTIFIERS CHARACTERISTICS

Type	Suggested Resale Price*	Fwd. Current @ Temp °C	Surge Amps	Max. T _J	I ² t	Voltage
384	.30	1.5 40°T _A	50	175°C	10	50-1000
359	.30	1.5 40°T _A	50	175°C	10	50-1000
(1N4816)						
398	.42	3.0 50°T _A	200	175°C	167	50-1000
407	.57	5.0 150°T _C	125	175°C	65	50-600
408	.60	10.0 150°T _C	175	175°C	127	50-600
409	.64	15.0 125°T _C	250	175°C	260	50-600
417	1.57	20 150°T _C	350	175°C	490	50-600
418	1.61	25 145°T _C	400	175°C	640	50-600
419	2.01	40 120°T _C	500	175°C	1000	50-600

Price in 100 piece quantities for 200 PRV device

Our 1.5 to 3 amp plastic lead-mount diodes are becoming the industry standard. And now, only from Westinghouse, you can get plastic stud-mount rectifiers from 5 to 40 amps.

We give you plastic economy with metal case performance for all your rectifier needs. Voltages range from 50 to 1000 V, forward or reverse polarity. No matter what your application, Westinghouse is the first place to go for the broadest line of plastic rectifiers.

Hermeticity? These rectifiers could easily work in a fishbowl. They're tested in live steam at 15 psig for 2 hours. In other performance parameters, they measure

up equally well. Look over the characteristics table here.

Why pay a premium for a metal case? In virtually all applications, there is no need. Westinghouse plastic rectifiers are a totally practical equivalent. Advanced

manufacturing techniques and a proprietary junction coating combine to produce a completely stable device at lower cost.

Send for our brochure SA-9892 on the Westinghouse plastic rectifier line. These, plus other rectifiers, thyristors, and power transistors can help keep your products competitive into the 1970's. Call your Westinghouse Semiconductor Distributor. Or write Westinghouse Electric Corporation, Semiconductor Division, Youngwood, Pa. 15697.

You can be sure
if it's Westinghouse



SC 2090

now... you can package a **5-DIGIT** display with **DECODING** in

2 $\frac{1}{2}$ inches

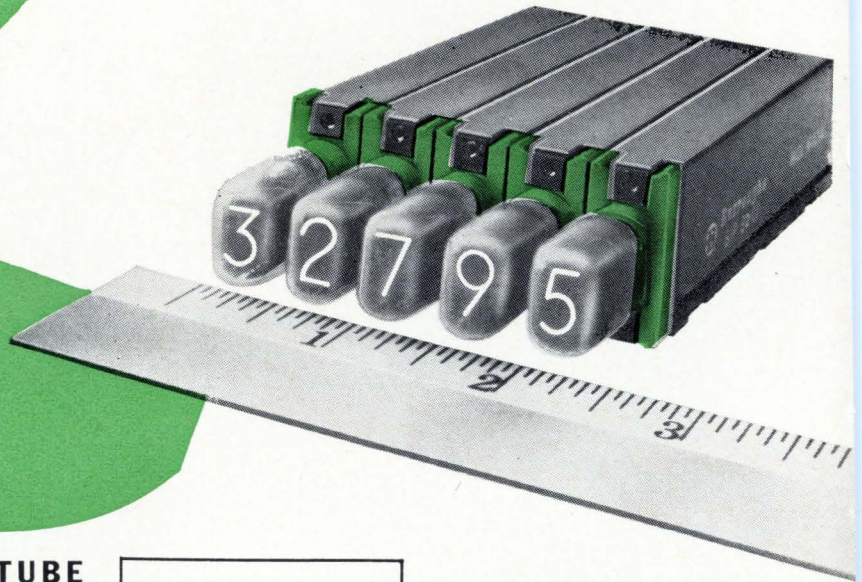

BURROUGHS MINIATURE NIXIE® TUBE DECODER DRIVERS, BIP-9203/BIP-9201

- Compatible with integrated circuits
- Accept 4-line 8-4-2-1 BCD inputs (positive or negative logic)
- 0.3" character display

Standard Size NIXIE tube decoder/drivers

- Accept 4-line or 8-line 8-4-2-1 BCD inputs (positive or negative logic)
- Complete assemblies available
- 0.6" character display
- Have dimming and blanking capabilities
- Compatible with integrated circuits.

For additional information contact Burroughs Corporation, Electronic Components Division, P.O. Box 1226, Department D, Plainfield, New Jersey 07061.

 **Burroughs Corporation**

Circle 86 on reader service card

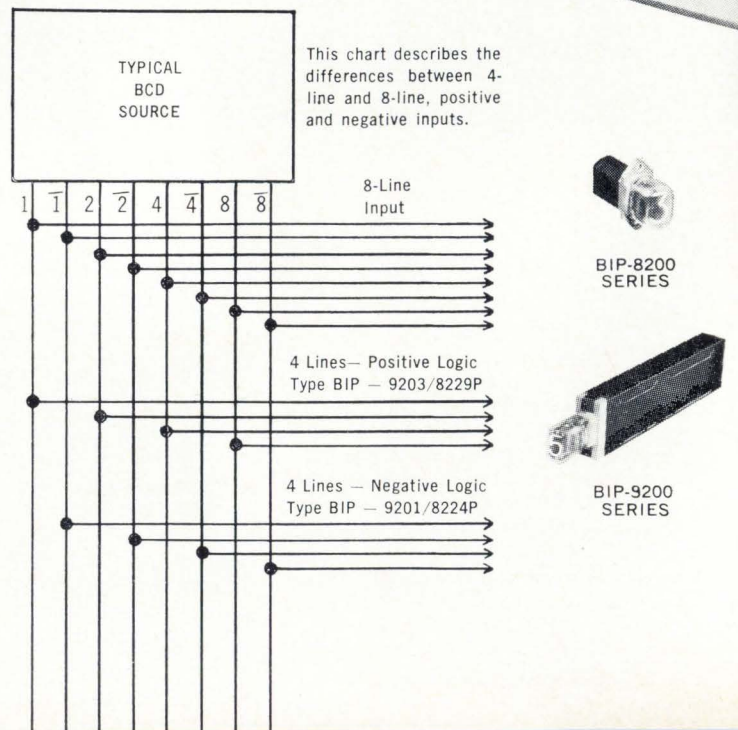

Technical Articles

**Taking the measure of
FET transconductance**
page 88

Transconductance is the primary parameter for determining voltage gain. Until now methods of measuring it were limited to certain load and bias conditions. A new calibration scheme that automatically compensates for error sources, extends the measurement across a broad range of values, even under abnormal bias conditions. The information tells an engineer how the field effect transistor will operate in the circuit.

**Infrared exposes
hidden circuit flaws**
page 100

Electrical tests of components and integrated circuits don't detect all the flaws, so many engineers are turning to infrared testing to catch a kind that might slip by. Investigation shows that thermal problems account for a large number of integrated-circuit failures. In this two part article:

1. An examination of infrared testing
2. A description of a system for infrared testing on the production line

**Electronic typesetting with
television techniques**
page 113

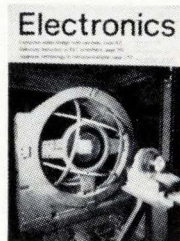

Several electronic systems have already been designed for electronic typesetting, but the blockbuster of them all is going through final checkout now. To be shipped to the Government Printing Office in Washington, the new system can set as many as 10,000 characters a second. For the cover, Vincent Pollizzotto photographed the special Linotron tube, developed by CBS

Laboratories, on which is displayed the characters that can be set. In this two part article:

1. A picture that's worth a thousand words—the over-all system is described
2. Generating the characters—a detailed description of the tube and driving circuits

**Terrain-following radar
that doesn't scan**
page 131

For years, engineers have been insisting that a terrain-following radar system would have to scan continuously to keep aircraft from colliding with the ground. Here is a system that doesn't. It works by pointing a beam at a fixed angle below the plane's flight path. After 90,000 miles of flight tests, the developers have proved that continuous scanning is not necessary.

**Coming
April 17**

- Solving shielding problems with nomograms
- A cryogenic memory for computers
- How plastics affect semiconductors
- Transient analysis with a computer
- Cooling IC's with liquids
- New antenna designs for the moon flight

Taking the measure of FET transconductance

New test set automatically compensates for sources of error in calculating a broad range of values

By Carl D. Todd
Costa Mesa, Calif.

An important parameter of field effect transistors can now be measured with greater accuracy by a new test set. Until now, methods of measuring transconductance—the ratio of the device's output current to the control, or input, voltage, and a description of transfer characteristics—were restricted to certain load and bias conditions. However, with a calibration scheme that automatically compensates for error sources, the new set can accurately measure a broad range of transconductance (g_{fs}) values, even under abnormal bias conditions.

Transconductance is the primary parameter for determining voltage gain. As with a pentode, knowledge of a field effect transistor's transconductance enables design engineers to predict how the device will operate in a circuit, especially as a voltage amplifier. The measurements can also be used in quality control. As a rule, a manufacturer's published data of the value of g_{fs} is of little value to a circuit designer because the maker usually treats the parameter as a minimum-maximum spread of values, say from 200 to 1,000 μ mhos for a 2N3068, and relates these values to a specific bias point, usually $V_{gs} = 0$.

Small-signal a-c transconductance is, by defini-

tion, the partial derivative of the FET's drain current with respect to the gate-to-source voltage under an a-c short circuit condition from drain to source. This is expressed as:

$$g_{fs} = \left. \frac{\partial i_d}{\partial v_{gs}} \right|_{v_d = 0} \quad (1)$$

The value of g_{fs} may be approximated by restricting the excursion of the input signal to a fractional part of the bias. For instance, applying a very small voltage to the gate and measuring the a-c signal current in the drain under a-c shorted output conditions results in the following value for g_{fs} :

$$g_{fs} \approx \left. \frac{I_d}{V_{gs}} \right|_{V_D = 0} \quad (2)$$

A measurement test circuit based on this approximation is at top of page 89. Signal voltage, V_1 , is applied to the gate in series with any required bias voltage. The drain voltage is measured by passing the FET's output through a small current-sampling resistor, R_L , and transformer-coupling the resultant voltage drop to a meter. The meter reading is a direct function of g_{fs} since the values of V_1 , R_L , and the transformer's turns ratio are known. Unfortunately, this simple scheme introduces sources of error that can cause the measured value to depart from the actual by 10% or more.

Sources of error

Some of the sources of error are:

- inability to establish the input voltage V_1 accurately;
- ignorance of the exact values of the impedance across the transformer primary and the turns ratio;
- effects of the power supply impedance and non-zero loads.

The author



As an electronics consulting engineer, Carl D. Todd specializes in automated production control, special test systems, instrumentation, semi-conductor testing and special-purpose computers, as well as general circuit design. He is the author of more than a hundred articles on these subjects.

Errors stemming from the inability to determine the input voltage accurately can be cancelled somewhat by using the same meter that sets V_1 to read g_{fs} . But even this isn't completely satisfactory since the two voltages normally differ widely in magnitude and are read on two separate, independently calibrated ranges. A way around this is to install a precision resistive voltage divider to enable the reading of V_1 on the same voltmeter range as g_{fs} .

The effect of errors stemming from a lack of exact knowledge about the impedance across the primary, including any contribution of the transformer in shunt with R_L and the turns ratio of the isolation transformer, can be reduced, but only by using expensive, high-quality components.

Errors resulting from power supply impedance are small in most instances. They only become significant as the total load impedance seen by the drain is increased by using the transformer.

The definition of g_{fs} was based on the assumption that the drain signal voltage is maintained at zero. The problem that results from non-zero loads can be clarified by studying the FET equivalent circuit, lower right. The output voltage may be considered the result of an equivalent current generator, $V_{gs} g_{fs}$, applied to R_L in shunt with r_{ds} . This means that if r_{ds} is 10 times larger than R_L , an error of more than 9% results, and if r_{ds} equals R_L , the error increases to 50%. Though r_{ds} is normally much greater than $100 R_L$, this source of error may arise when making measurements in the low V_{ds} range, where r_{ds} drops sharply.

Calibration and test

The schematic diagram for a broad-range g_{fs} test set with automatic error-compensation is on page 90. This set achieves accurate results, even when the value of drain resistance approaches that of the load resistor R_L .

Automatic compensation for possible error sources entails switching the test set to the calibrate mode. As indicated in the figure at top of page 91, the field effect transistor to be tested is part of the calibrate circuit and, although not an active element, does load the meter circuit in a manner similar to the test mode.

The input voltage, V_1 , is adjusted until the current through R_8 produces a full-scale reading on the 10-millivolt range of the meter. The calibration current flows through several paths: in addition to R_8 , there is the 100-ohm current sampling resistor, R_L , and several possible shunt paths consisting of the primary impedance of T_2 , resistor R_7 , and the drain resistance of the transistor.

Resistor R_7 is chosen to equal the sum of resistors R_8 and R_9 to establish the same shunt path present when the set is put to the test mode. Resistor R_9 , on the other hand, replaces the total loading in the test mode of the range attenuator on the voltage V_1 . Thus, V_1 remains constant during both the calibration and test modes.

In the equivalent circuit of the tester operated in the test mode, a precision voltage attenuator acts

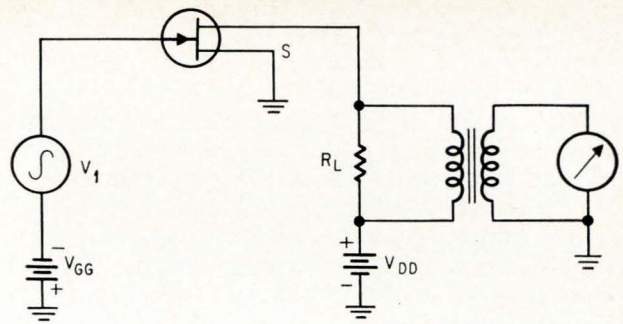

Simple arrangement for measuring g_{fs} . The field effect transistor's output current is coupled to the readout meter through the transformer. Errors in the measurement stem from inability to accurately set the voltage V_1 and from loading across the transformer primary.

as a range switch to keep the gate input signal small. The actual voltage applied to the gate of the device under test is therefore KV_1 , where K is the division ratio of the attenuator. The a-c equivalent current generator, the value of which is a product of g_{fs} , and the a-c gate signal voltage produce a current through r_{ds} , R_L , the primary impedance of T_2 , and the resistor in series, R_8 and R_9 .

Since the value of R_7 in the calibration circuit was chosen to equal the sum of R_8 and R_9 , the same effective shunt load is placed on both the calibration current source of V_1 and R_8 and the transistor's equivalent current generator in the test mode. This is the key to the compensation technique.

The value of g_{fs} is read on the a-c meter. The meter scale isn't changed from its calibration-mode setting when switched to the test mode. Only the gate attenuator is changed to bring the g_{fs} reading within the meter's range. The actual value of g_{fs} is obtained by multiplying the full-scale value of the meter setting during calibrate by the new attenuator setting.

If a transistor with a rather low value of r_{ds} is tested, it is necessary to increase the value of V_1 during calibration so there will be the proper amount of current through R_L to deflect the meter to full scale. With the increased gate voltage, the transistor will have enough extra current drive in the test mode to supply the proper current to R_L . This method of compensation permits accurate transconductance measurements even with exceptionally low drain resistances.

Transformer T_2 should be a toroidally wound unit

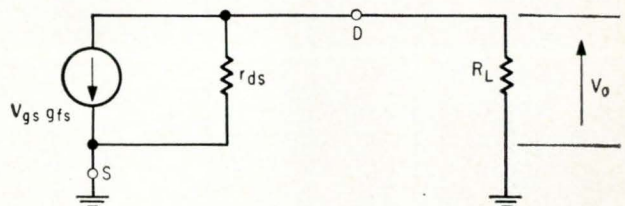

Shunting effect of the FET's drain resistance can lead to large errors in the transconductance measurement. As the value of r_{ds} approaches that of R_L , the error increases.

to minimize pickup, and should have a low d-c primary resistant to minimize the drain voltage drop when the transistor conducts. The turns ratio of T_2 needn't be precise—the 1:10 step-up ratio indicated on the schematic provides the small amount of amplification needed to boost the FET's output to a level appropriate to the a-c voltmeter's 10-millivolt range. Raising the signal level further reduces the test set's susceptibility to stray signals. The primary resistance in shunt with the 100-ohm resistor R_L , no longer critical, can be as low as five or 10 times R_L without causing an error.

A theoretical analysis of the compensated measurement technique involves establishing the equations for the output voltage under the separate conditions of calibration and test, and then relating them by choosing the critical constants.

To simplify the mathematics, let Z equal the parallel equivalent impedance of R_L , R_7 , R_8 , and the primary shunt impedance of T_2 . Z' designates the total parallel equivalent impedance of all those paths contained in Z with the addition of the drain resistance of the device under test, r_{ds} .

The equation for V_{oc} , the output voltage seen by the meter under calibrate conditions, is:

$$V_{oc} = N \left[\frac{V_1}{(R_8 + Z')} \right] Z' \quad (3)$$

where N is the transformer voltage ratio. Solving for V_1 :

$$V_1 = \frac{V_{oc} (R_8 + Z')}{NZ'} \quad (4)$$

Now the equation for V_{ot} , the output voltage under test conditions, becomes:

$$V_{ot} = NKV_1 g_{fs}' Z' \quad (5)$$

Again, Z and Z' represent the parallel equivalents. (Z is made equal for the two conditions of calibrate and test by choice of resistor values.)

Substituting the value for V_1 under calibrate conditions (equation 4) and simplifying yields:

$$V_{ot} = K g_{fs}' V_{oc} (R_8 + Z') \quad (6)$$

Now, assume that K , the voltage division ratio for the gate signal attenuator, is chosen to make V_{ot} exactly equal to V_{oc} where g_{fs} under test conditions equals the full-scale range value of the transconductance under calibrate conditions, g_{fs}' . Assume also that r_{ds} is infinite when choosing K . Therefore,

$$V_{ot} = V_{oc} = K g_{fs}' V_{oc} (R_8 + Z') \quad (7)$$

and

$$K = \frac{1}{g_{fs}' (R_8 + Z')} \quad (8)$$

Then,

$$\frac{V_{ot}}{V_{oc}} = \left[\frac{g_{fs}}{g_{fs}'} \right] \left[\frac{R_8 + Z'}{R_8 + Z} \right] \quad (9)$$

The above equation may be rewritten to separate the error term:

$$\frac{V_{ot}}{V_{oc}} = \frac{g_{fs}}{g_{fs}'} \left[1 - \frac{Z - Z'}{R_8 + Z} \right] \quad (10)$$

Since Z and Z' are always less than 100 ohms,

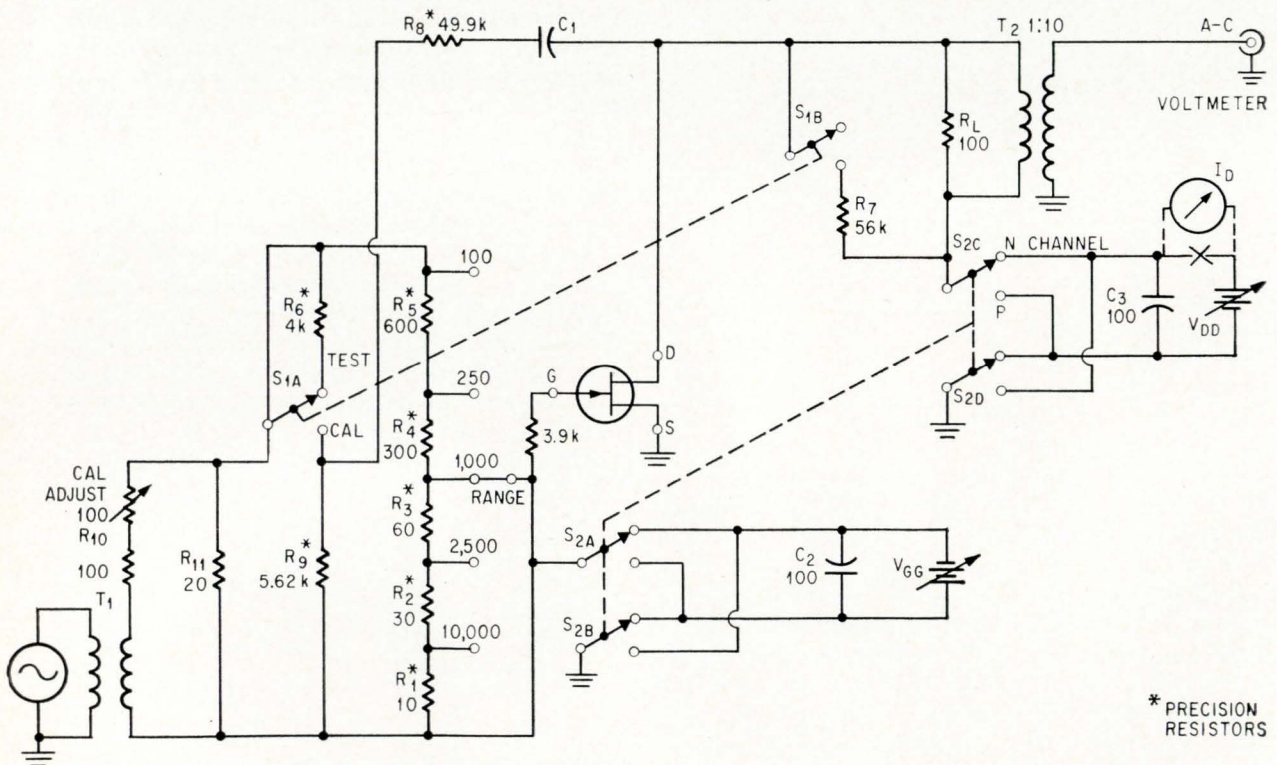

Improved test set for measuring g_{fs} includes a circuit that automatically compensates for most of the sources of errors. The new test set accurately measures a wide range of values of transconductance. The range switch at the gate of the device being tested accommodates the test circuit to the type of voltmeter used.

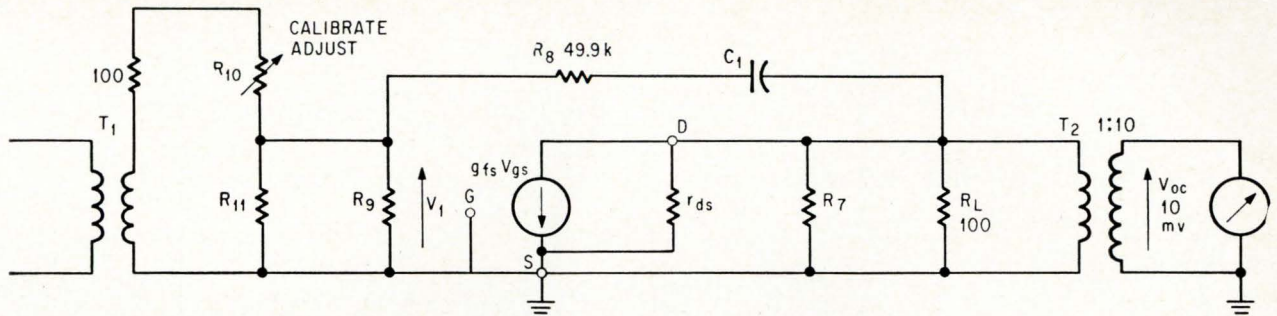

Simplified a-c circuit represents the test set in the calibrate mode. V_1 is adjusted for a full-scale deflection on the meter, and R_0 is selected to simulate the loading of the range attenuator when the set is placed in the test mode. This prevents V_1 from changing when the mode is switched.

and $(Z-Z')$ is less than 50 ohms when r_{ds} is 100 ohms or more, the error is only 0.1%, even in the extreme case where r_{ds} is equal to R_L . This is a substantial improvement from the 50% error incurred with the simpler scheme shown on page 89.

Under normal conditions, when r_{ds} is greater than R_L , the error due to drain resistance is negligible and the equation above may be rewritten

$$\frac{V_{ot}}{V_{oc}} \approx \frac{g_{fs}}{g_{fs}'} \quad (11)$$

This means that when the test circuit is calibrated with the transistor in place and the desired bias is applied, the ratio of the output voltage in the test mode to the full-scale calibrate voltage equals the ratio of g_{fs} to the full-scale value of g_{fs}' .

Since the same meter, and normally the same range, is used for both calibration and testing, all reading errors but those resulting from scale non-linearity have been eliminated. For a go, no-go situation, the calibration point can be set to correspond to the test limits, eliminating the problem.

Measurement accuracy is no longer dependent upon the exact level of V_1 , which, in fact, varies as the value of r_{ds} changes with each transistor tested. All that is necessary to maintain accuracy is that the level of the input voltage not vary between the calibration adjustment and the g_{fs} reading.

Since any errors are common to both the calibrate and test modes, neither the precise value of R_L nor that of the transformer turns ratio need be known. Similarly, any errors stemming from the power supply impedance are common to both modes and are also compensated for.

The only significant sources of error in the new circuit are those from the resistors that form the range attenuator—the calibration resistor R_8 and compensating resistors R_7 and R_9 . Precision wire-wound resistors may be used here, as the usual measuring frequency is only 1 khz.

With this improved circuit, therefore, the g_{fs} test set is limited primarily by the linearity of the output voltmeter. With an a-c digital voltmeter, an over-all accuracy of 0.5% is practical if care is taken to avoid excess pickup and ground loops.

In the key stage of designing the range switch and determining the voltage divider resistance

values, there are two attenuators available: a single-range or parameter-limit test set, or a multirange instrument covering a broad spectrum of g_{fs} values.

In the following examples it will be assumed that the output voltages for full-scale meter deflection is a constant 10 mv unless stated otherwise, and that V_1 has a nominal value of 500 mv.

A general case

The first step in the design process is the choice of resistors capable of giving the necessary division ratio between V_1 and the voltage actually applied to the gate of the transistor. For the general case, it can be assumed that the divider is made of two resistors, R_A and R_B , as shown in the figure below.

The required value of K is determined from equation (8).

But Z , as previously defined, is the parallel equivalent impedance of R_L , the primary impedance of T_2 and R_7 (which is equal to $R_8 + R_9$), and therefore has negligible influence on the total divider resistance ($R_A + R_B$). Assume a total divider resistance, R_T , of 5 kilohms. The value of R_9 is then 5.56 kilohms, since R_9 in parallel with $R_8 + R_L$ should be equal to R_T . But according to the definition for Z ,

$$Z = (100 \pm 5\%) \parallel (49.9 \text{ k} + 5.56 \text{ k}) \parallel Z_p \quad (12)$$

It therefore becomes evident that unless the primary impedance Z_p is less than about 400 ohms, the value of Z is determined almost entirely by R_L and, for all general considerations, may be assumed equal to R_L , 100 ohms.

Substituting known values in equation (8) and

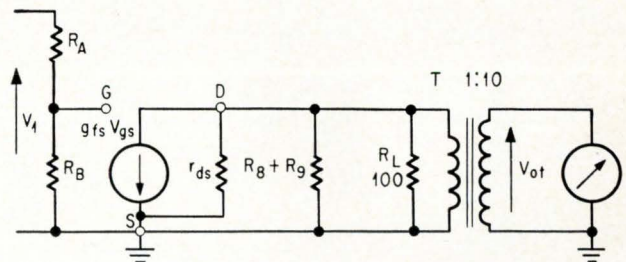

Simplified circuit of test set in test mode. The loading of the resistor R_L doesn't change from the calibrate-mode level, since $R_8 + R_9$ equals the value of R_7 .

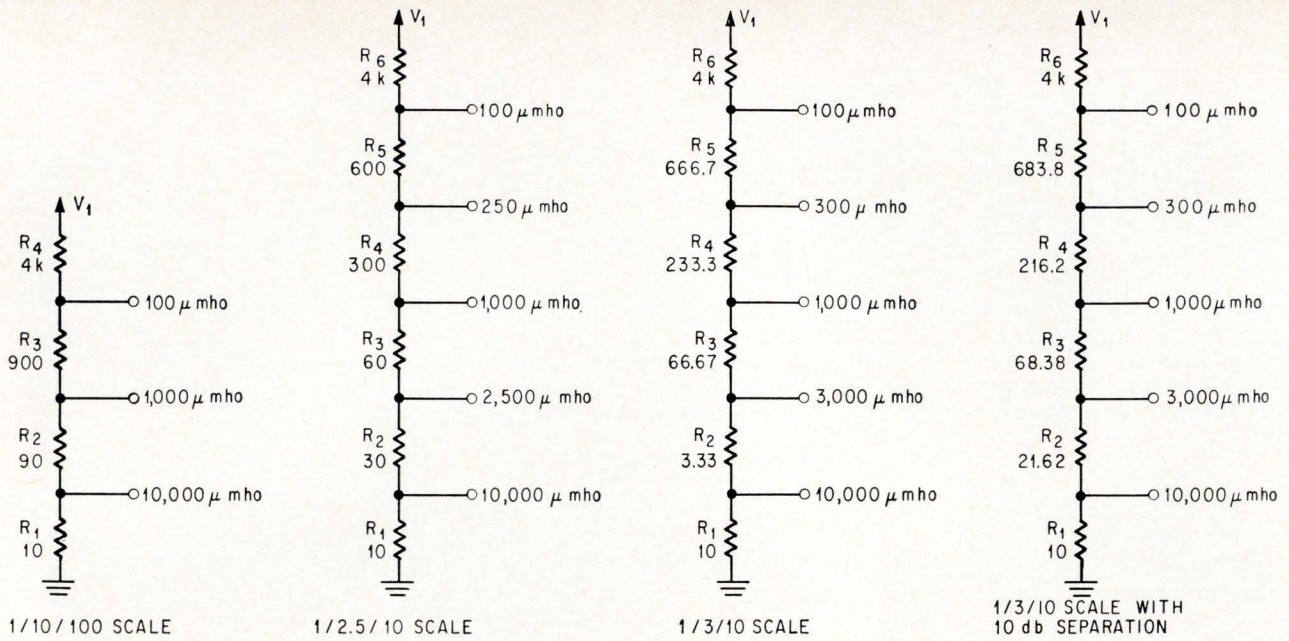

Range resistors calculated for various scale requirements.

simplifying gives:

$$K = \frac{1}{g_{fs}' (50,000)} \quad (13)$$

As far as the divider is concerned:

$$K = \frac{R_B}{R_A + R_B} = \frac{R_B}{R_T} \quad (14)$$

But, since the total divider resistance has been fixed $-R_T = 50,000 - R_B$ is found directly from:

$$R_B = \frac{1}{g_{fs}' (10)} \quad (15)$$

Once R_B is known, R_A , the remaining part of R_T , is determined.

This approach permits the calculation of the two resistors required for any range or limit value.

Consider the divider resistors needed to give decimally scaled ranges from 100 to 10,000 micromhos, a simple 1/10/100 range; such a divider might be required if the output meter was an a-c digital voltmeter.

Equation (15) is used to compute R_1 in the figure shown above for the highest full-scale g_{fs} value of 10,000 μ mhos:

$$R_1 = \frac{1}{(10,000 \times 10^{-6}) (10)} = 10 \text{ ohms} \quad (16)$$

For the 1,000- μ mho range, R_B becomes the sum of R_1 and R_2 —100 ohms. The value of R_2 therefore is 90 ohms.

Similarly, the value of R_3 is found to be 900 ohms, and R_4 4,000 ohms.

In the case of a-c voltmeters having ranges with full-scale values of 1.0 and 2.5, the range resistors required to cover the same g_{fs} spread as before are above.

The value of R_1 remains the same. This time, the combined values $(R_2 + R_3)$, $(R_4 + R_5)$ and R_6 are equal to R_2 , R_3 , and R_4 , respectively, of the previous example since they cover the same range. The values of R_1 and R_2 are computed from equation (15) where R_B is now the sum of R_1 and R_2 . The other resistors are found in a similar manner.

The same technique is used to calculate the resistor values for voltmeters that have ranges with full-scale values in a 1/3/10 ratio. But voltmeters with 1/3/10 scales normally have full-scale deflection points on the meter scale set to give a 10-db difference between the two range readings instead of the simple ratio indicated. Since only the different sets of numbers on the two scales are being used, a change between the 1,000- and 3,000- μ mho ranges, for example, would require a change in the full-scale calibration adjustment. This bit of inconvenience leads to the final range design.

For meters with a 10-db separation between basic ranges (the Hewlett-Packard Co.'s 400E, for example), it becomes convenient to adjust the calibration for a full-scale deflection on the 1.0 scale of the meter, regardless of the g_{fs} range. As the 3.0 scale is used only when reading a value of g_{fs} near 300 or 3,000 μ mhos, it's therefore necessary to modify the values of the range resistors.

Since 10 db corresponds to a ratio of 3.1623, calibrating the test set in the 300- or 3,000- μ mho range is the same as calibrating to a full-scale value of 316.2 or 3,162 μ mho, respectively. These values must be substituted for g_{fs}' in equation (15) to calculate the resistor values.

Thus, for the 3,000- μ mho range $(R_1 + R_2) = 31.62$ ohms and the value of R_2 is then 21.62 ohms, since $R_1 = 10$ ohms as determined previously.

The 100-, 1,000-, and 10,000- μ mho ranges are calculated in the normal manner.

Nomograms pick FET biasing values

Circuit parameters are determined rapidly and conveniently with charts, freeing the designer from tiresome calculations

By J. Watson and W.E. Eder

University College of Swansea, Swansea, United Kingdom

Tedious calculations are the engineer's lot when he has to select the appropriate components for circuits that bias junction field effect transistors because these devices have wide parameter spreads. Fortunately, the transconductance curve of a field effect transistor provides the basis for a set of nomograms that sharply reduce design tedium. Such nomograms account for both field effect transistors and bias resistor tolerances and define the practical limits of operation for a particular field effect transistor.

The transconductance curve is expressed by

$$I_D = I_{DSS} (1 - V_{GS}/V_P)^2 \quad (1)$$

where:

- I_{DSS} = drain current at $V_{GS} = 0$
- I_D = drain current
- V_{GS} = gate-source voltage
- V_P = pinch-off voltage

Usually, the maximum and minimum limits of I_{DSS} and V_P are given by the manufacturer, if the V_P limits are omitted they can be obtained from

$$V_P = -2 I_{DSS}/g_{fso} \quad (2)$$

since g_{fso} is always available. The constant g_{fso} represents the common-source forward transfer conductance and is defined as the slope of the I_D characteristic at $V_{GS} = 0$. A typical pair of I_D curves are below, left. The upper curve represents the maximum values of I_{DSS} and V_P ; the lower curve denotes the minimum values.

The conventional bias circuit directly below is applied for establishing the FET's operating point. The gate-bias voltage V_G is established by the voltage divider R_1 and R_2 and the drain-supply voltage V_{DD} . Both R_1 and R_2 are much smaller than resistor R_G . If the gate current is considered zero, the load-line equation is obtained by summing the voltage drops around the input loop:

$$V_{GS} = R_S I_D - V_G \quad (3)$$

Usually, the acceptable upper and lower limits of quiescent drain current, $I_{Q(max)}$ and $I_{Q(min)}$, or of quiescent drain-source voltage, $V_{Q(max)}$ and $V_{Q(min)}$, are defined by the circuit application. Knowing one pair enables the engineer to find the other by ap-

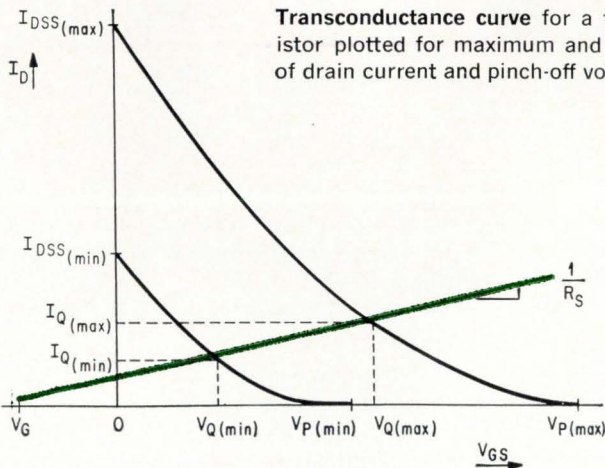

Transconductance curve for a field effect transistor plotted for maximum and minimum values of drain current and pinch-off voltage.

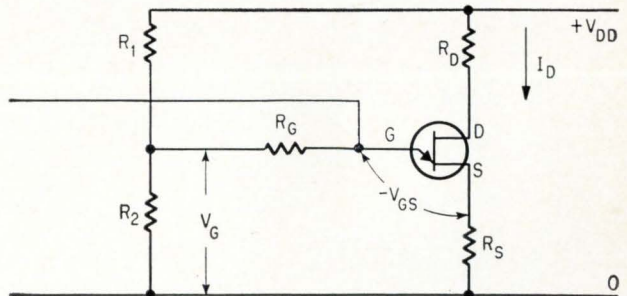

Gate-supply voltage, V_G , is determined from the voltage divider, R_1 and R_2 in typical FET biasing circuit.

Quiescent drain-source current and voltage

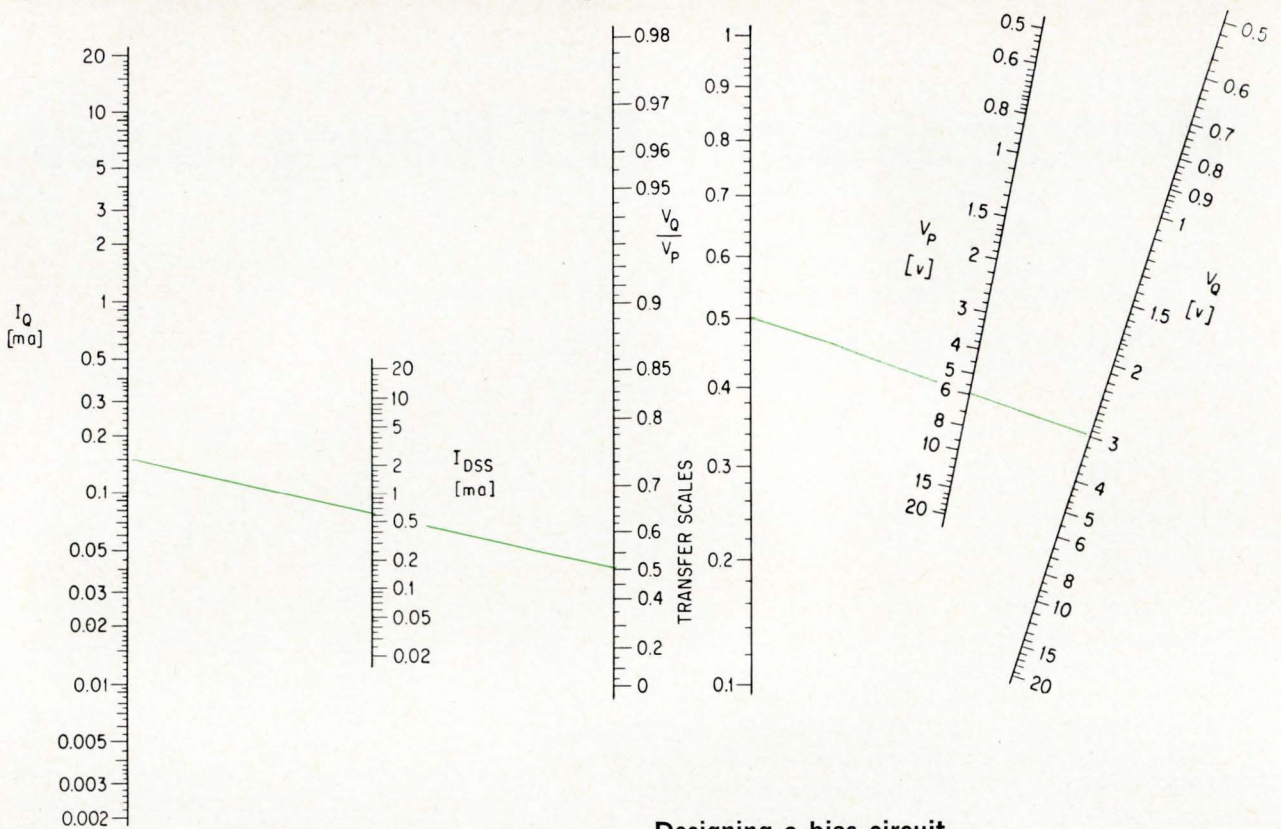

plying equation 1. This process is simplified with the nomogram directly above. The slope of the load line defines the source resistor, R_s , where

$$R_s = \frac{V_{P(\max)} \left[1 - \sqrt{\frac{I_{Q(\max)}}{I_{DSS(\max)}}} \right] - V_{P(\min)} \left[1 - \sqrt{\frac{I_{Q(\min)}}{I_{DSS(\min)}}} \right]}{I_{Q(\max)} - I_{Q(\min)}} \quad (4)$$

or

$$R_s = \frac{V_{Q(\max)} - V_{Q(\min)}}{I_{Q(\max)} - I_{Q(\min)}} = \frac{\Delta V_Q}{\Delta I_Q} \quad (5)$$

The value for the gate-bias voltage, V_G , is determined from the intersection of the load line and the abscissa. The relevant equation is given by

$$V_G = \frac{I_{Q(\max)} V_{P(\min)} \left[1 - \sqrt{\frac{I_{Q(\min)}}{I_{DSS(\min)}}} \right] - I_{Q(\min)} V_{P(\max)} \left[1 - \sqrt{\frac{I_{Q(\max)}}{I_{DSS(\max)}}} \right]}{I_{Q(\max)} - I_{Q(\min)}} \quad (6)$$

or

$$V_G = \frac{I_{Q(\max)} V_{Q(\min)}}{\Delta I_Q} - \frac{I_{Q(\min)} V_{Q(\max)}}{\Delta I_Q} \quad (7)$$

The nomograms on page 95 can be used to solve equations 5 and 7.

Designing a bias circuit

To illustrate the procedure for determining the bias circuit values consider a Siliconix 2N4119 n-channel FET. The manufacturer's parameter values are: $I_{DSS(\max)} = 0.6$ milliamperes, $V_{P(\max)} = 6$ volts, $I_{DSS(\min)} = 0.2$ milliamperes, and $V_{P(\min)} = 2$ volts. It is desired to find: $V_{Q(\max)}$, $V_{Q(\min)}$, ΔI_Q , ΔV_Q , R_s , and V_G from the nomograms.

Step 1. Assume the application requires that $I_{Q(\max)} = 0.15$ milliamperes and $I_{Q(\min)} = 0.10$ milliamperes. On the nomogram for quiescent drain-source current connect a straight line between the values of I_{DSS} and I_Q . The result is $V_Q/V_{P(\max)} = 0.5$. Connecting this value of $V_Q/V_{P(\max)}$ with $V_{P(\max)}$ produces the value of $V_{Q(\max)} = 3.0$ volts. Repeating the procedure for the minimum values of I_Q and I_{DSS} produces $V_Q/V_{P(\min)} = 0.3$ and $V_{Q(\min)} = 0.6$ volts.

Step 2. Determine the values for ΔI_Q and ΔV_Q from step 1.

$\Delta I_Q = I_{Q(\max)} - I_{Q(\min)} = (0.15 - 0.10) = 0.05$ milliamperes

$\Delta V_Q = V_{Q(\max)} - V_{Q(\min)} = (3.0 - 0.6) = 2.4$ volts

Step 3. Determine the value of R_s from the source-resistance nomogram. Connect the values of ΔI_Q and ΔV_Q and read 48 kilohms for the value R_s on the right-hand scale.

Step 4. Solve for V_G with the gate-voltage nomogram. Draw a line between the minimum value of I_Q and the maximum value of V_Q . This produces a value of 6 volts for V_{G2} . Next draw a line between the maximum value of I_Q and the minimum value of V_Q . Where this line crosses the pivot line, draw

Drain-source current and gate voltage

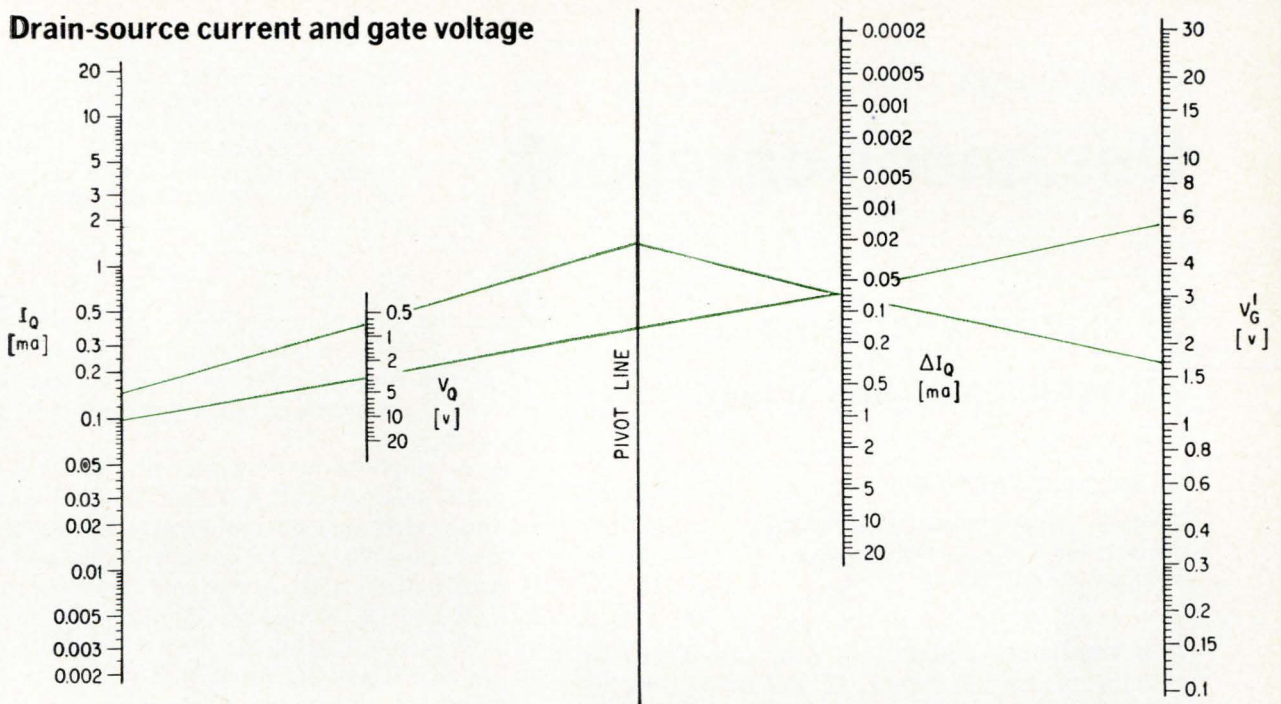

another line through ΔI_Q , intersecting $V_{G1'}$ at 1.77 volts. Finally, $V_G = V_{G1'} - V_{G2} = 1.77 - 6.0 = 4.23$ volts.

Values of I_{DSS} and V_P (or g_{fs0}) are usually specified at various temperatures. If not, they can be approximated by assuming that I_{DSS} decreases by 0.6% per $^{\circ}\text{C}$ and V_P increases 2.2 mv per $^{\circ}\text{C}$.

Drain-source current and source resistance

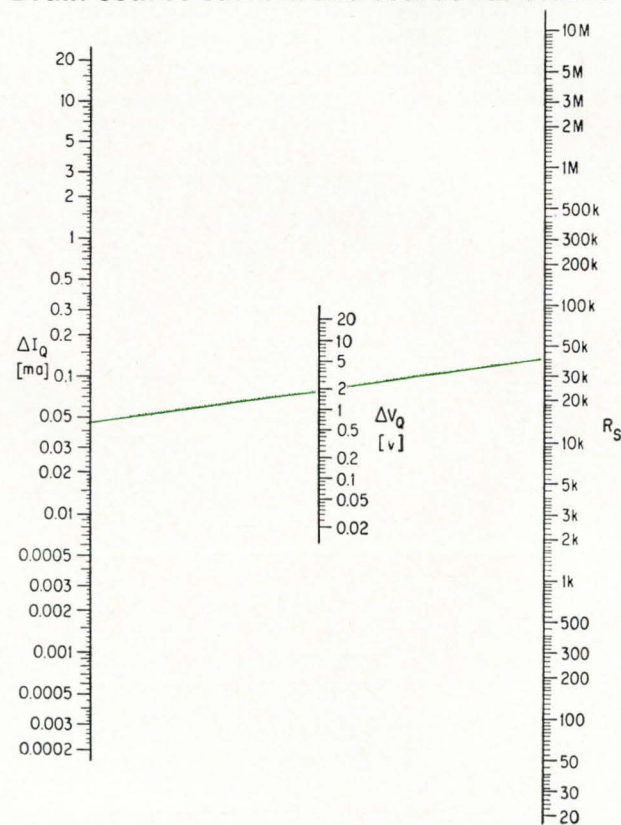

As mentioned earlier, the value of V_G is a function of R_1 and R_2 . The tolerances of R_1 and R_2 are kept high with 2% resistors. The spread in V_G produced by the tolerance limits is determined easily by assuming two parallel bias lines, starting respectively at each of the limits of this spread. The limits of V_G are found by setting R_1 at its maximum possible value and R_2 at its minimum. This assumption yields $V_{G(\min)}$; the process is then repeated for the converse case, $V_{G(\max)}$.

Note that both R_1 and R_2 can have very low values because R_G prevents them from shunting the input signal.

Although it is usually assumed that $I_G = 0$ in practice, a small but finite value of gate-leakage current, I_{GSS} does have a significant effect on bias if R_G is very large. The voltage drop, $I_{GSS}R_G$ adds to V_G and causes I_D to increase.

Further, since I_{GSS} is a function of temperature, V_G and I_D are also temperature dependent. For the Siliconix 2N4119 the values given by the manufacturer are $I_{GSS} = 10$ picoamperes at 25°C , and $I_{GSS} = 25$ nanoamperes at 150°C . Thus, if $R_G = 100$ megohms at 25°C , $V_{RG} = 10 \times 10^{-12} \times 10^8 = 10^{-3}$ volt; at 150°C , $V_{RG} = 25 \times 10^{-9} \times 10^8 = 2.5$ volts.

This change in V_G shifts the bias line to the left by some 60%. If R_G is made much lower, say 1 megohm, then the voltage drop across it by I_{GSS} has little effect. In a simple common-source stage, R_G is likely to be low because a FET has a high input capacitance, and high R_G leads to a very poor bandwidth. If I_{GSS} is specified only at 25°C , assume that it will double for every 9°C temperature rise.

By selecting different tolerances for R_S , divergent bias lines are constructed on the transfer characteristic to represent the upper and lower limits of R_S that are possible.

Designer's casebook

Designer's casebook is a regular feature in Electronics. Readers are invited to submit novel circuit ideas, packaging schemes, or other unusual solutions to design problems. Descriptions should be short. We'll pay \$50 for each item published.

Oscillator synchronizes with pulses of any phase

By John S. Chomicki*

Advanced Systems Development Division
International Business Machines Corp.,
Yorktown Heights, N.Y.

Two transistors added to a conventional multivibrator permit synchronizing pulses to turn the multivibrator off for a specified time and restart it on a desired cycle. Thus, the oscillator is synchronized regardless of its phase with respect to incoming pulses.

The application required a low-frequency oscillator (150 hertz) having a stability of $\pm 3\%$ which operates start-stop and, when free-running, could be synchronized to a pulse that is produced mechanically. The sync pulse occurs approximately every sixth oscillator pulse, and its period varies by as much as half the period of oscillation. A conventional multivibrator can only be synchronized during a particular portion of its cycle, and the syn-

chronizing pulse must always occur during this portion. Usually, the multivibrator is adjusted to run freely at a frequency (lower than the desired) that ensures the occurrence of the sync pulse at an appropriate time.

In this application, the large variation in synchronization pulse period and the required oscillator stability ruled out conventional multivibrators.

Transistors Q_4 and Q_5 form a multivibrator that is synchronized with an external signal by transistors Q_2 and Q_3 . Transistor Q_2 turns the oscillator off and clamps it while Q_3 turns the multivibrator on quickly when the input pulse has terminated. Transistor Q_1 inverts the synchronizing signal.

Normally, the synchronizing signal is maintained at the +12-volt level; transistor Q_1 is saturated and transistors Q_2 and Q_3 are off. With Q_2 and Q_3 off, the multivibrator oscillates at a free-running frequency determined by time constants R_3C_1 and $(R_1+R_2)C_2$. The stability of $\pm 3\%$ is achieved by employing temperature-compensating components to fix the time constants and by adding zener diode D_1 to reduce power supply variations.

Potentiometer R_2 provides a fine frequency adjustment to compensate for variation in initial component tolerances, so the multivibrator's free-running frequency can be set exactly. Since frequency is not changed to permit synchronization, stability

*Now with Data Processing Division

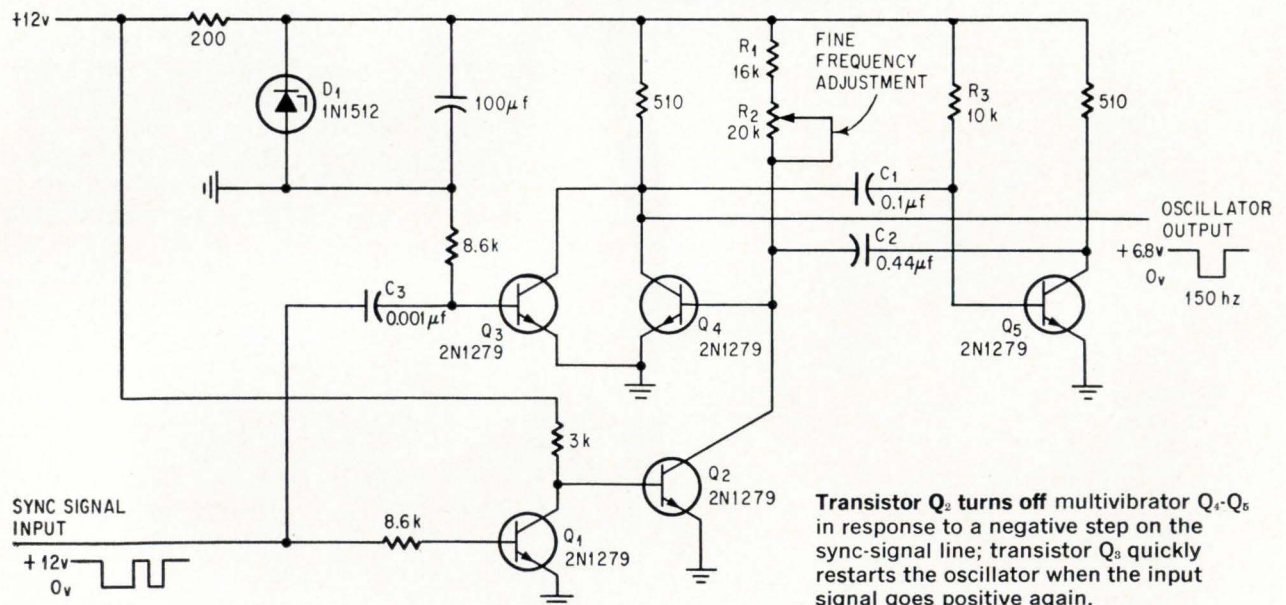

Transistor Q_2 turns off multivibrator Q_4 - Q_5 in response to a negative step on the sync-signal line; transistor Q_3 quickly restarts the oscillator when the input signal goes positive again.

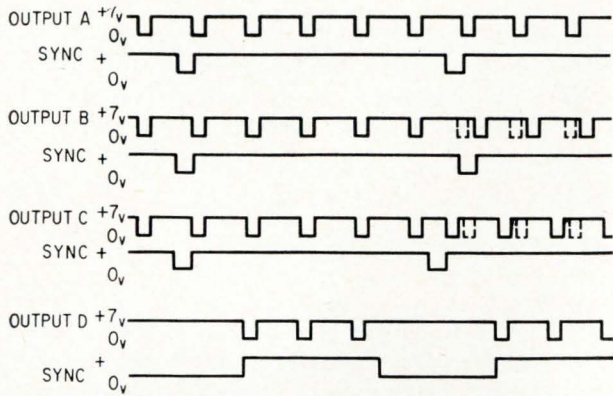

Output A is the oscillator's output when the synchronizing signal occurs at every sixth pulse. Outputs B and C are the synchronizing pulses retarding and advancing the oscillator's phase, respectively. Output D is the start-stop operation.

is designed into the circuit initially.

Incoming signals synchronize the multivibrator by shutting it off and restarting it at the proper moment. When the voltage level on the sync-signal input line drops to zero, transistor Q_3 is unaffected but Q_1 cuts off, saturating Q_2 . Transistor Q_2 discharges C_2 and cuts off Q_4 by virtually grounding

its base. As Q_4 cuts off, its collector voltage approaches the 6.8 volts supplied by the zener, D_1 . This positive voltage step turns on Q_5 .

The oscillator is now stopped and its internal state is known (Q_5 is on, Q_4 is off). Regardless of when the input goes to zero, the multivibrator will be stopped and clamped in the known condition and remain off as long as the input remains at zero.

To restart the oscillator, the input voltage is raised to +12 volts. This turns on Q_1 and cuts off Q_2 , releasing the clamp. Then, as soon as C_2 discharges, Q_4 begins to conduct. Without waiting for C_2 to discharge, the positive shift in the synchronizing input signal turns on Q_3 . With Q_3 on, the collector voltage at Q_4 drops and Q_4 turns on. Capacitor C_3 must be large enough to couple a current to the base of Q_3 , large enough to saturate Q_3 , yet small enough that Q_3 turns off before Q_4 .

For start-stop operation the synchronizing and control signals can be applied to an OR gate whose output then controls the multivibrator. The short synchronizing pulse can still stop and restart the multivibrator at any point in its cycle.

The waveforms show the effect of synchronizing input signals of different phase.

Exact temperature control with operational amplifier

By H. D. Valliant

Dominion Observatory, Ottawa, Canada

Feedback between an operational amplifier and a temperature-sensing bridge circuit produces proportional temperature control with long-term stability. The amplifier operates as an oscillator, furnishing output power which increases as the sensed temperature decreases within a range of 0.01°C .

With amplification and rectification, the output may be used as a heater-power source. As the measured temperature falls below a preset value, heat is generated until an equilibrium condition is reached when the output power equals the heat loss.

Any resistive type of transducer can be the sensing element; for this application, a thermistor, R_T , with a resistance of 100 kilohms at 25°C is used.

The output of the bridge circuit consisting of

R_3 , R_T and transformer T_1 is fed back to an operational amplifier whose gain ($A = R_2/R_1$) is adjustable from 2,000 to approximately 40,000. The feedback ratio, β , of the bridge loop is given by

$$\beta = \frac{R_T - R_3}{2n(R_T + R_3)}$$

where n is the transformer turns ratio. When R_T

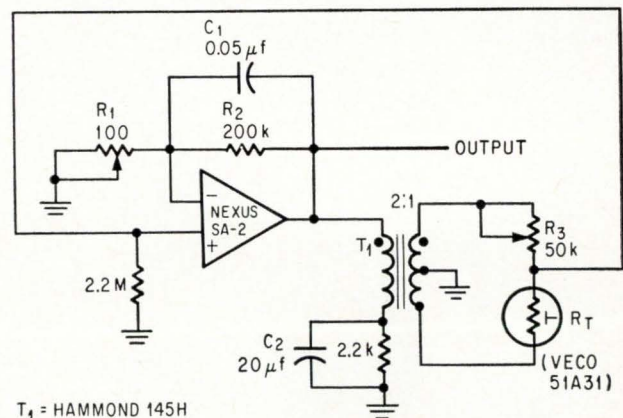

T_1 - HAMMOND 145H

Oscillating output of operational amplifier is controlled by feedback from bridge containing thermistor temperature sensor, R_T . Capacitor C_1 determines oscillation frequency.

is less than R_3 (high temperature value), β is negative, and the circuit does not oscillate. When R_T is greater than R_3 (low temperature value), β is positive, and the circuit oscillates.

The 100-hertz oscillating signal increases

smoothly from zero to 20 volts peak-to-peak over a temperature bandwidth controlled by R_1 .

If C_2 is removed from the circuit, the transition into oscillation is more abrupt, and the output can trigger an SCR or relay for on-off control.

Multivibrator provides short pulses, wide spacing

By Erich A. Pfeiffer

Veteran's Administration, Southern Research Support Center, Little Rock, Ark.

Usually, the on-off ratio of a transistor astable multivibrator can't exceed 10. For larger duty cycles, a separate monostable multivibrator is required as a pulse shaper, triggered by an astable multivibrator that controls the repetition rate.

With the aid of a field effect transistor, the single circuit shown below operates with an on-off ratio that can be varied from 20 to 300. It was developed for a biomedical application which required 3-millisecond pulses at variable repetition rates of from 1 to 15 pulses per second. The FET eliminates the large electrolytic capacitors usually required at these low repetition rates.

Because the FET is a voltage-controlled device with an inherently low gate current, it is possible to use a large 10-megohm resistor, R_5 , and a small 0.1-microfarad timing capacitor, C_3 . Low input impedance of ordinary transistors limits the base resistor size so that large electrolytic capacitors are needed to obtain long time constants. Here, time constant R_5C_3 is 1 second.

When Q_1 is driven into conduction, the negative-going step at the drain of Q_1 is coupled by C_2 to

the base of transistor Q_2 , shutting it off. The positive voltage step created at the collector of Q_2 comes back to the gate of Q_1 via C_3 , and R_5 maintains Q_1 's gate voltage, V_{GS1} , at +1 volt.

When Q_1 first turns on, capacitor C_2 is charged to nearly 12 volts on the left through the 10-kilohm resistor. Since the conduction of Q_1 virtually shorts the left side of C_2 to ground and the charge on C_2 cannot change instantaneously, the right side of C_2 drops to -10 volts. Because this voltage exceeds the maximum base-emitter voltage of Q_2 , diode D_2 was included to protect Q_2 from destruction.

With Q_1 on, C_2 is charged through R_6 until the voltage at the base of Q_2 reaches +0.6 volt and Q_2 begins conducting. The negative-going voltage at the collector of Q_2 is coupled back to the gate of Q_1 by C_3 and shuts off Q_1 . When Q_1 turns off, the positive voltage at the drain of Q_1 returns to the base of Q_2 , quickly driving Q_2 into saturation.

The negative-going 10-volt step at Q_2 's collector, acting alone, would cause Q_1 's gate voltage, V_{GS1} , to drop from +1 to -9 volts. However, the clamping diode, D_1 , limits V_{GS1} by turning on when this voltage exceeds the sum of the negative voltage at R_1 and the 0.6-volt drop across D_1 .

While Q_2 is conducting, capacitor C_3 is charged through R_5 until the gate-source voltage reaches approximately -0.7 volt. At this value, Q_1 starts conducting and the cycle repeats.

The repetition rate can be adjusted by varying R_1 to set the bias voltage at the cathode of D_1 ; this fixes the time required to charge C_3 through R_5 by determining the starting voltage at the ca-

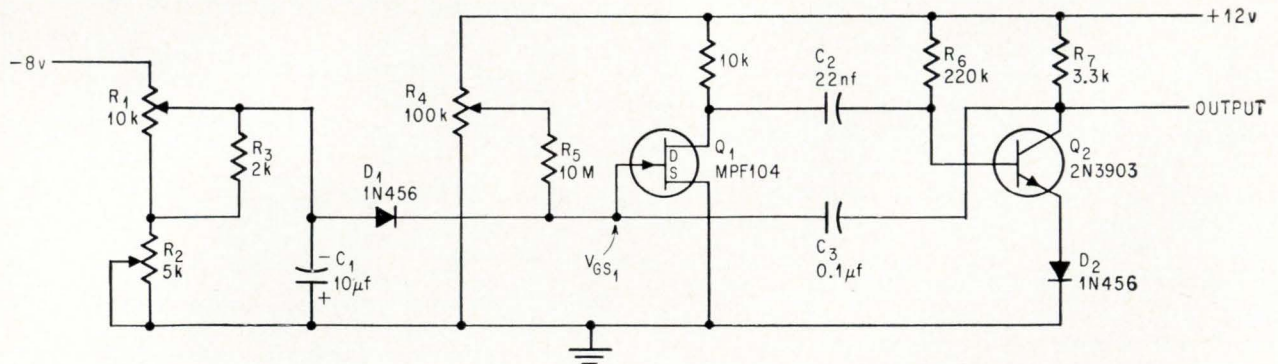

Field-effect transistor Q_1 replaces an ordinary transistor to make a conventional multivibrator nonsymmetrical.

pacitor. The waveforms at the right show the voltage at the gate of Q_1 , V_{GS1} , for repetition rates of 1 and 15 hertz, respectively.

The gate-bias voltage is obtained from potentiometer R_1 (A-taper). Resistor R_3 shunts R_1 so that a logarithmic scale calibration can be obtained. The lowest frequency is set by R_4 which controls the largest current allowed to charge C_3 ; the highest frequency is set by R_2 which determines the smallest starting voltage at C_3 . To control the pulse repetition rate by an external signal, R_1 , R_2 , R_3 , and C_1 can be replaced by an emitter follower. The rise time of the output pulse was $700 \mu s$ as determined by $R_7 C_3$.

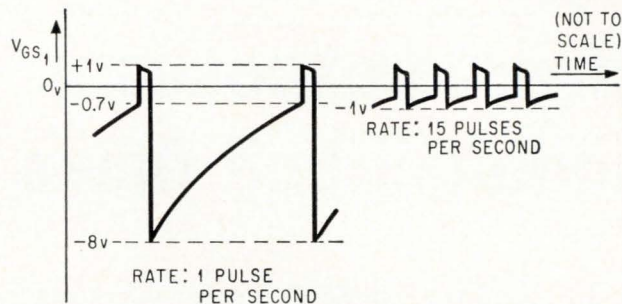

Waveforms represent the voltage at the gate of Q_1 , V_{GS1} , for repetition rates of 1 and 15 pulses per second. The repetition rates are controlled by adjusting resistor R_1 . Time axis is not to scale.

A simple way to count with integrated circuits

By Irwin Math

Frequency Electronics Inc., Lake Success, N.Y.

A digital counter with a total capacity of some number other than a power of two is easily constructed by applying the "override reset" function available in commercial ic flip-flops. This method eliminates the various feedback paths usually required by such a counter.

As an illustration, consider a circuit that counts to 28. The designer first determines the number of

flip-flops required to count to the next power of two above the desired number. Thus, for a 28 count, five flip-flops are cascaded by connecting the "1" output of each flip-flop to the input of the next. Determine which of the "1" outputs will be "1" when a count of 27 is reached, and connect these with the counter input to an AND gate. Next, connect the gate output system to the override inputs, R , of all the flip-flops. The system then counts to 27 in the conventional manner. On the 28th input pulse all the inputs are present at the AND gate, the flip-flops are reset, and the sequence begins again. Note that the output of the counter isn't a squarewave. For squarewave-outputs, a circuit that counts to half the desired total is constructed following this procedure and the output is fed to a conventional flip-flop.

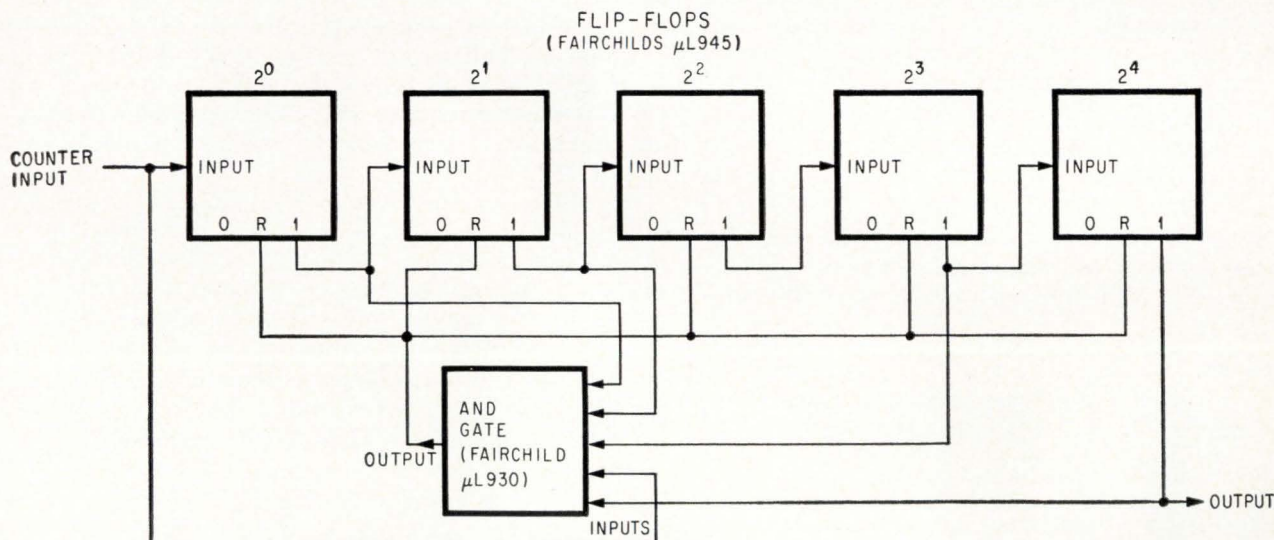

All flip-flops are automatically reset by output from AND gate on 28th pulse.

Infrared exposes hidden circuit flaws

Measurements of the radiation emitted by electronic systems are pinpointing trouble spots ordinary electrical tests miss

By Riccardo Vanzetti

Raytheon Co., Wayland, Mass.

When the integrated circuit moved down the production line at the Raytheon Co. and was tested electrically, it performed perfectly. But when its infrared profile was measured, a resistor showed up hot—indicating poor bonding to the substrate. The circuit had a hidden flaw that would have burned it out in 100 hours. It was immediately junked.

Infrared detection has proved a valuable tool for spotting deficiencies in circuits that ordinary electrical testing can't detect. Infrared techniques are being used to analyze packaging schemes, inspect and test circuits and assemblies, gauge reliability, and predict life expectancies.

Because thermal problems have accounted for a large percentage of integrated-circuit failures, gunshy designers often set excessively conservative heat-dissipation limits. By using infrared measurements to determine the amount of heat that can be safely dissipated in an area with a given component placement, the designer can establish more realistic limits.

During manufacturing, infrared techniques can be used to locate poor connections or bonds, and to detect incomplete adhesion of circuit elements and voids in deposited materials.

These techniques are particularly well suited to integrated-circuit testing because they don't involve contacts. Thermocouple measurements of tempera-

tures at various points on an IC are impractical because thermocouples are too big and contact resistance varies. Also, thermocouple wires conduct heat away from the measurement area.

Radiation sensors

Infrared radiation is emitted by all physical matter, according to laws correlating the spectral band and peak wavelength with the temperature and emissivity of the radiating surface. Instruments capable of detecting and measuring such radiation are broadly grouped under the general term of radiometers. These, in turn, can be subdivided into point-detectors, line-scanners, and area-scanners, all of which can be optically telescopic or microscopic.

Telescopic radiometers are used for work with such targets as electronic assemblies and for materials evaluation; microscopic gear can scan, with adequate spatial resolution, such small objects as semiconductor chips. Since the optics compensate for differences in target size, infrared techniques are applicable to components and assemblies of almost any size.

An object can be examined by infrared techniques only if its temperature differs from that of the background against which it is viewed. The necessary thermal gradient is created either by energizing the object externally—by introducing heat into the target by conduction or radiation—or by electrically energizing it internally so that the electrical power dissipated within the object produces a temperature rise. In either case, the temperature of the target begins to increase the instant it is energized, and gradually reaches thermal stabilization—the point at which the heat introduced exactly counterbalances the heat lost through conduction, convection, and radiation.

A radiometer observing this object will indicate

The author



Riccardo Vanzetti is manager of the infrared techniques and systems group at Raytheon's Advanced Development Laboratory. He is also the founder of the Infrared Techniques for Electronics Committee, now part of the Society for Nondestructive Testing.

an electrical output that increases from the ambient temperature level until thermal stabilization is reached.

A radiometer of the scanning type produces an output signal proportional to the instantaneous power radiated by the elementary area viewed. This output signal—in analog form—can be displayed in such ways as an oscilloscope waveform trace or an intensity-modulated picture of the target area. Conversion of the analog signal into digital form adds the advantage of computer processing, which could include the display of thermal maps, or automatic comparison with prestored data to identify the operating mode of the subject.

Energizing from outside

External energizing of a target is useful in evaluating the physical structure of materials, determining bond quality, detecting such hidden defects as cracks, voids, or entrapped materials, and inspecting welded and soldered joints. Methods of external energizing vary according to the application and target size.

In one, a thermal differential is introduced between two points on the target. These points are chosen so that the heat flow between them is affected by the characteristics of the element under evaluation. A thermal map of the surface between the two points depicts the heat flow, and therefore discloses the presence of any anomaly hidden under the surface.

In the example of this method shown above, a good soldered joint is characterized by a large area of metal fusion and the absence of narrow cross

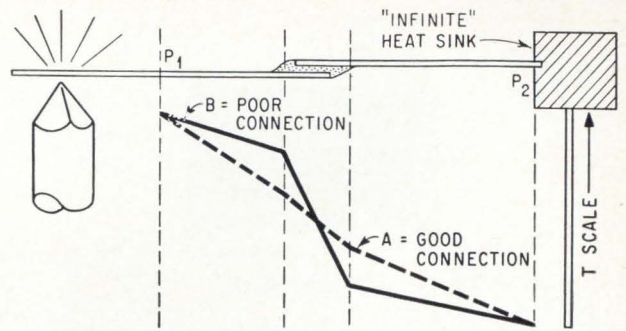

Spot weld quality is checked by infrared determination of the thermal resistance of the joint. A large thermal differential across the weld, line B, indicates a poor connection; a linear differential, line A, indicates a good one. The heat sink at the right speeds the transfer of heat through the joint.

sections. These characteristics correspond to a very low value of thermal resistance and are reflected in an almost linear temperature variation between points P_1 and P_2 on line A. On the other hand, a poor bond presents a narrow cross section that restricts the flow of heat through the joint. The thermal resistance at this point is high, with the result that the temperature differential across the joint is large, as shown in line B.

This situation doesn't require a complete thermal plot between points P_1 and P_2 ; measurements at two points on either side of the bond are enough to determine whether a temperature drop exists across the joint, as shown below. A good spot weld allows heat transfer from the electrically heated wire to the wire welded to it. A scope display of the output

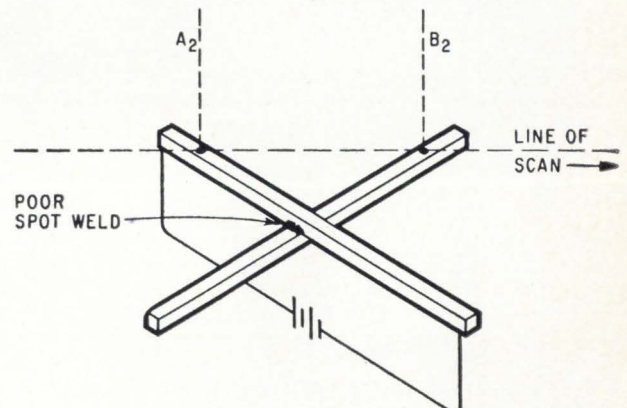
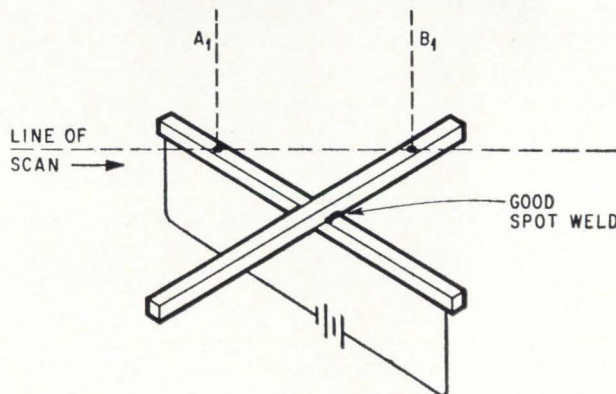
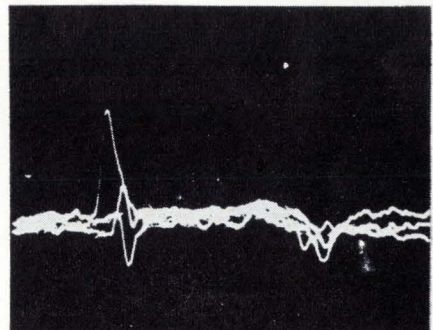
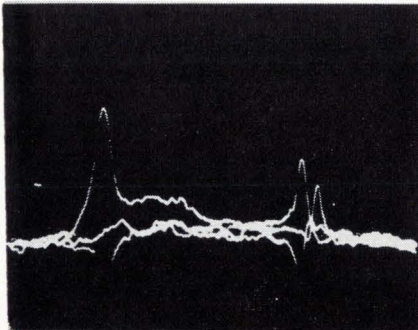

In energizing the test assembly with current, heat generated in one wire is transferred through the weld to the other. A bad weld is indicated by low infrared emission in the second wire.

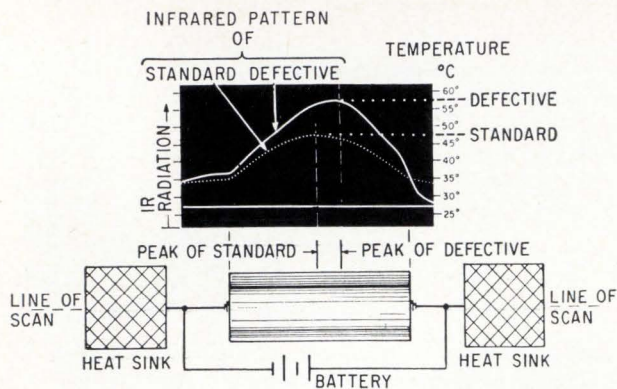

Scanning a carbon-composition resistor with infrared equipment discloses flaws that restrict heat transfer through the leads to the heat sink. The upper curve shows heat buildup near a poorly connected lead.

of an infrared detector that scanned the assembly along the line shown in the diagram has two peaks, A and B, corresponding to the temperature of the two wires as they are crossed.

Thermal resistance at the joint of a poor weld inhibits the transfer of heat and results in a large thermal gradient. This condition is shown in the second oscilloscope display, where point B₂ remains at ambient temperature while the temperature at point A₂ is rising.

The technique used here is valid for evaluating brazed or soldered connections, multiple joints connected either in series or in parallel, and seam welds of any configuration. For this application, the target can be heated by radiant energy from a light focused by an optical system mounted on a carriage that also supports two infrared detectors. The detector outputs are fed continuously into a

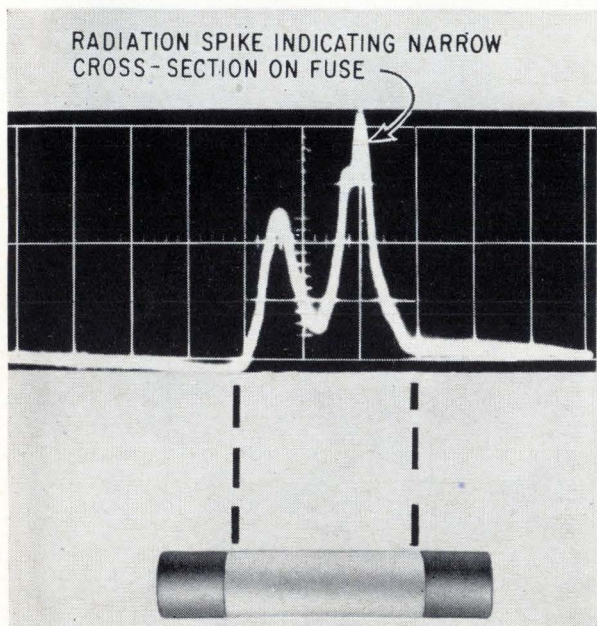

Axial scan of a fuse with infrared equipment discloses a narrow section that abnormally restricts the flow of current and might cause failure at a level much below rated current.

discriminator to display the gradient between the two points. Variations in surface emissivity could be detected by a preliminary scan of the preheated target, since it is at a uniform temperature. Even better, the emissivity could be equalized with one of the several coatings available for this purpose, thermoplastic or thermosetting materials that include polyesters, epoxies, silicones, and polyurethanes.

In another method for externally inducing a thermal gradient, one of the target's surfaces is flooded with radiant heat and the temperature distribution on the opposite surface is mapped. This technique tracks heat diffusion through subsurface material, detecting flaws in the diffusion path.

Physical discontinuities—an unbonded area, a void, or entrapped impurities—reduce the heat transfer from the heated surface to the surface being scanned by an infrared detector. The temperature in the region of the discontinuity is therefore lower than where the bond is strong. Air-cooling of the target's unheated surface widens the temperature differential between unbonded and bonded areas, making it easier to detect this kind of flaw.

The technique can be used in applications ranging from checking plated layers to examining spot welds. It's currently incorporated in programs to evaluate rocket motor cases, honeycomb panels, and rotor blades for helicopters and jet engines.

In a third technique, the target is soaked in an oven-like environment at a known higher-than-ambient temperature and the thermal distribution on its surfaces is mapped. The physical characteristics along the heat-flow path from the target's core to its outside surfaces are revealed in the thermal map, along with any hidden anomalies. This method is best for checking objects of considerable thickness, since the oven-like environment in effect places the heat source at the core of the target.

Inside job

In internal energizing, power dissipation converts into heat a fraction of the current flowing in any electrical or electronic component having a finite resistance. The resulting thermal rise produces a proportional increase in the radiated power emitted from the surface of the element, and this power can be taken as a parameter representing the electrical regime of the component. Any deviation from a standard radiation pattern indicates a variation in the electrical or physical characteristics of the component.

For instance, the figure shown above indicates the standard infrared profile of a carbon-composition resistor dissipating its rated power—the lower curve. The profile shows a peak temperature at the center with symmetrical slopes to either side. The lead wires are at 34°C.

The infrared profile of a defective resistor dissipating exactly the same amount of power is indicated by the other curve in the same figure. Its peak is about 10°C above the temperature of the

standard and is off-center. Also, the temperature of the right-hand wire is closer to ambient.

The diagnosis is simple: there is a poor mechanical connection between the resistor body and the right-hand lead wire that is preventing an adequate heat loss by conduction at the right end and is causing the resistor body to overheat. Conventional test procedures wouldn't be able to spot flaws of this type, while infrared can't miss them.

Another instance of this is the examination of an array of diodes connected in parallel. If one diode is defective, an infrared scan trace will show a missing peak corresponding to that diode.

Similarly, axial scanning of a component's heat distribution can disclose the presence of overheated points corresponding to narrow cross sections that eventually will cause failure at a current level below rated capacity, as in the lower figure on page 102. Such scanning may provide some answers concerning those mysterious failures all too often

blamed on hypothetical voltage surges.

Designers and quality-control engineers must, of course, exercise some care when applying infrared measurements. Data on electrically identical units, for instance, will be significant only if the physical configuration of all the assemblies is the same.

Correlation between the electrical power dissipated within a component and the infrared radiation emitted by it can be affected by many factors, including heat sinks and interaction with other components or the environment. These factors should be constant whenever infrared measurements are compared. For example, charts exist for correlating the relationship between the power dissipated within transistors and their respective case temperatures. These correlation charts are equally valid for transistors of different types and designation as long as they are enclosed in the same envelope.

In practice, the use of infrared techniques re-

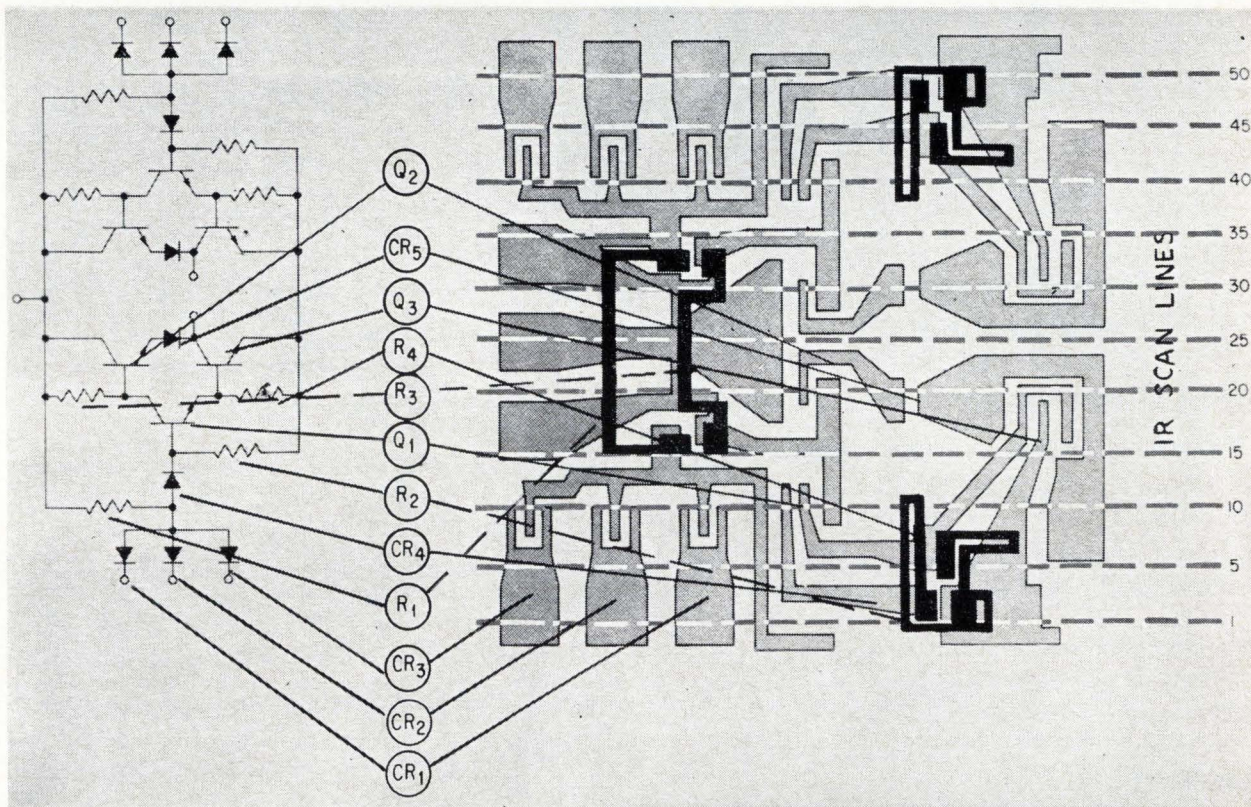

Analog traces of a 50-line scan of the IC with 24 active elements. Scanning is performed with an infrared microscope developed by Raytheon for the National Aeronautics and Space Administration. Designed to produce thermal maps of transient conditions in IC's, the microscope monitors infrared radiation at each device junction to detect such physical and electrical anomalies as current crowding, secondary breakdown, faulty die attachment, cracks and discontinuities, and defects in deposited materials.

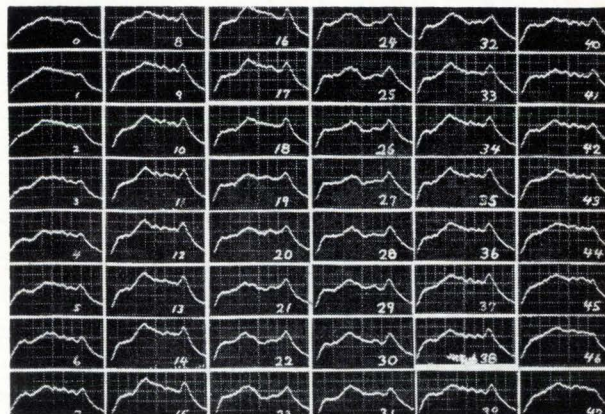

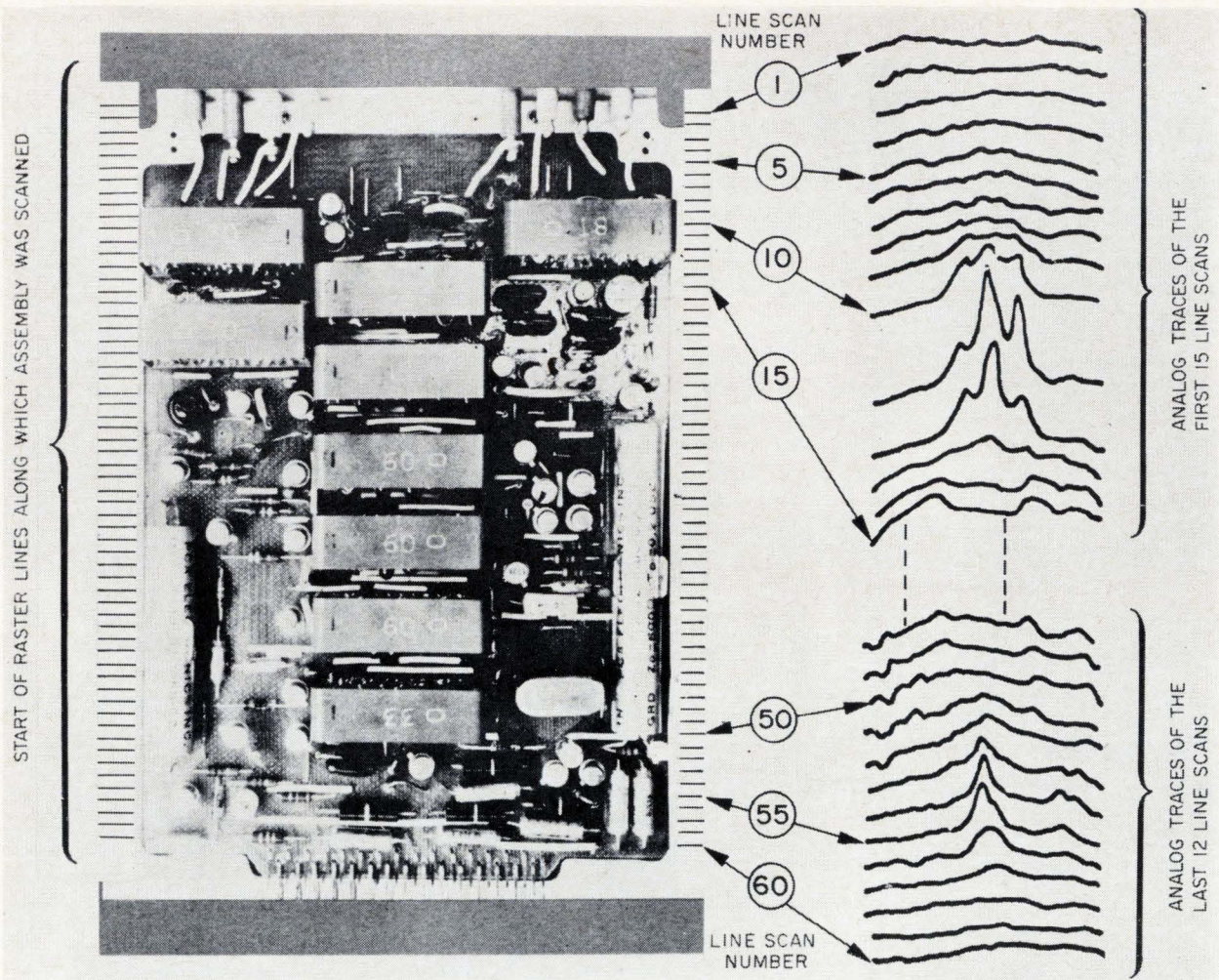

Raster produced by scanning an electronic assembly with infrared sensing equipment. Peaks in the scan lines indicate components dissipating abnormal amounts of heat. The circuit is energized, simulating operating conditions.

quires a draft-free, temperature-controlled environment and a consistent way of mounting the target. The emissivity of the target's surface need not be known as long as it also is consistent. This is normally the case for items produced by the same manufacturing process, but consistency can also be achieved with a special emissivity coating.

Check list

To perform its sleuthing task, infrared equipment must have the following characteristics:

- A spatial resolution fine enough to distinguish individual active elements.
- A temperature resolution adequate to measure thermal gradients produced by the lowest power dissipation levels to be detected.
- A temperature range wide enough to cover the thermal spread in the target to be evaluated.
- Thermal calibration reference points.
- Aiming and focusing capabilities sufficient to allow consistent, repeatable measurements to be taken at any time.
- A scanning speed compatible with the aim of

the desired evaluation—slow to moderate for thermally stable targets and fast for the detection of transient conditions.

- A signal display system providing the absolute thermal values of the elements being measured, or deviations from preselected standards.

In the figure shown above, an energized electronic assembly is scanned by infrared test equipment. The mechanical configuration from assembly to assembly is kept constant because the placement of the components is fixed by a printed circuit board. The corresponding edges of the 60-line scan raster are marked, and analog traces representing the intensity of the infrared radiation along each scan line are on the right. For simplicity, the display shows only the first 15 and the last 12 lines of the scan. Hot components show up as peaks in the analog profiles, and can be located easily.

The same approach can be applied to integrated circuitry. The IC manufacturing process results in smaller differences in the physical configuration of electrically identical units than are possible with discrete components.

Troubleshooting: the heat's on

Infrared detecting system enables speedy repair of faulty circuit by indicating the failure's cause

By J. Fred Stoddard

Raytheon Co., Wayland, Mass.

Infrared detecting devices make possible an almost completely automated troubleshooting process for electronic circuits and assemblies. The first system designed specifically for this application is called Compare, for console for optical measurement and precise analysis of radiation from electronics.

Compare scans faulty circuits and provides a digital readout that indicates a pattern of the failure. Basically a radiometer, it measures the temperature of the individual components, stores the data, and then matches it to previously stored patterns. Testing, troubleshooting, and even maintenance are thus reduced to an electronic function—pattern comparison and recognition. All the technician need do to pinpoint the problem is refer to a chart and schematic, or compare the pattern with those of other known defects to locate the components involved. He then repairs the circuit.

Developed by the Raytheon Co., Compare is based on the phenomenon that every operating mode of an electronic assembly is characterized by a unique infrared radiation pattern, or signature. Therefore, a standard can be established for a properly operating unit. Infrared patterns also can be established for defects or malfunctions. Any operating mode—good or bad—of the circuit can be recognized by comparing its infrared pattern with the standard or, in the case of a mismatch, with failure patterns until a match is found.

The author



J. Fred Stoddard is a senior project engineer in the infrared techniques and systems department at Raytheon's Equipment division. He has been involved in the development of infrared systems and data presentation techniques for the past 12 years.

Besides analyzing failures found by conventional test equipment, Compare discloses faulty conditions not otherwise detected but likely to cause a failure. These include components with improper power dissipation ratings, incorrect resistor values, reversed electrolytic capacitors, and mismatched elements.

Maintenance also is simplified. Because the infrared pattern of a circuit can be checked periodically against its standard, deteriorating trends or parameters can be detected. When the deterioration is judged severe enough to indicate the likelihood of a possible malfunction, the circuit can be replaced.

How it works

Compare was designed originally to troubleshoot seven-inch printed-circuit panels found defective in an electrical test. But the results proved so encouraging that they indicated the system could be used to pinpoint faulty circuits as well.

The system consists of three main building blocks—a scanning radiometer, an electronic data processing unit, and a continuous-feed rotary table.

Printed-circuit panels are mounted on the table, which has 16 positions. A connector similar to a programing matrix, is used at each test position, permitting the function of the individual connector pins to be changed to accommodate the various types of circuits tested. It takes about 15 minutes for the rotary table to turn the circuit from the loading point to the radiometer position, sufficient time for the circuit to warm up and reach thermal stabilization.

The test position connectors are electrically connected to the measuring instruments, power supplies, input signal generators, and loads through a slip-ring assembly at the center of the table.

The radiometer is equipped with a mercury-doped germanium detector and a cryogenic generator system. It's focal point is swept across the circuit by an optical system, consisting of a series

Tracking down circuit failures with infrared

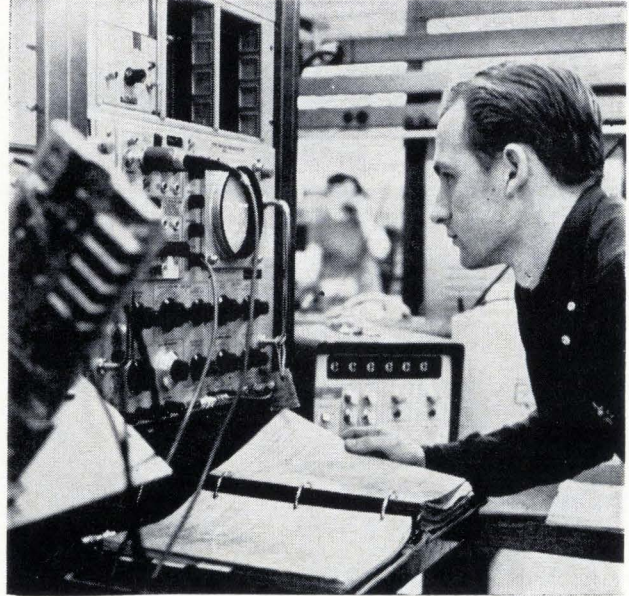
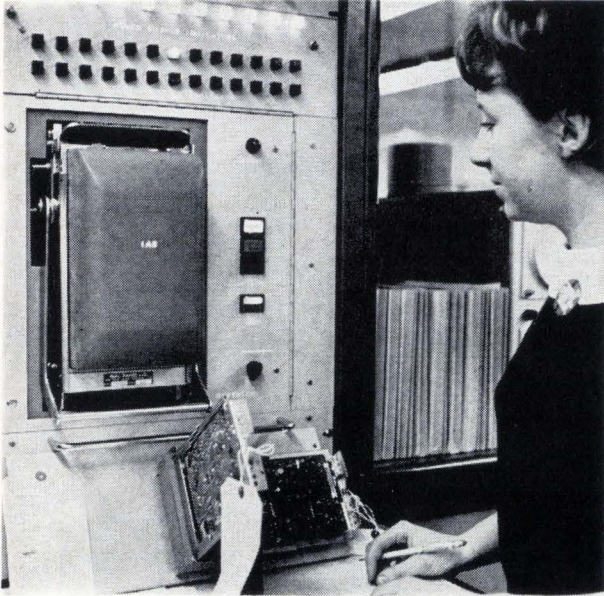

1 Assemblies for an r-f communication system are first electrically tested at the end of the production line at Raytheon's North Dighton, Mass., plant. Go, no-go tests, left, disclose gross defects while dynamic tests, right, detect less obvious failures. Then defective circuit boards are grouped together according to type number and set aside for troubleshooting with the Compare infrared system.

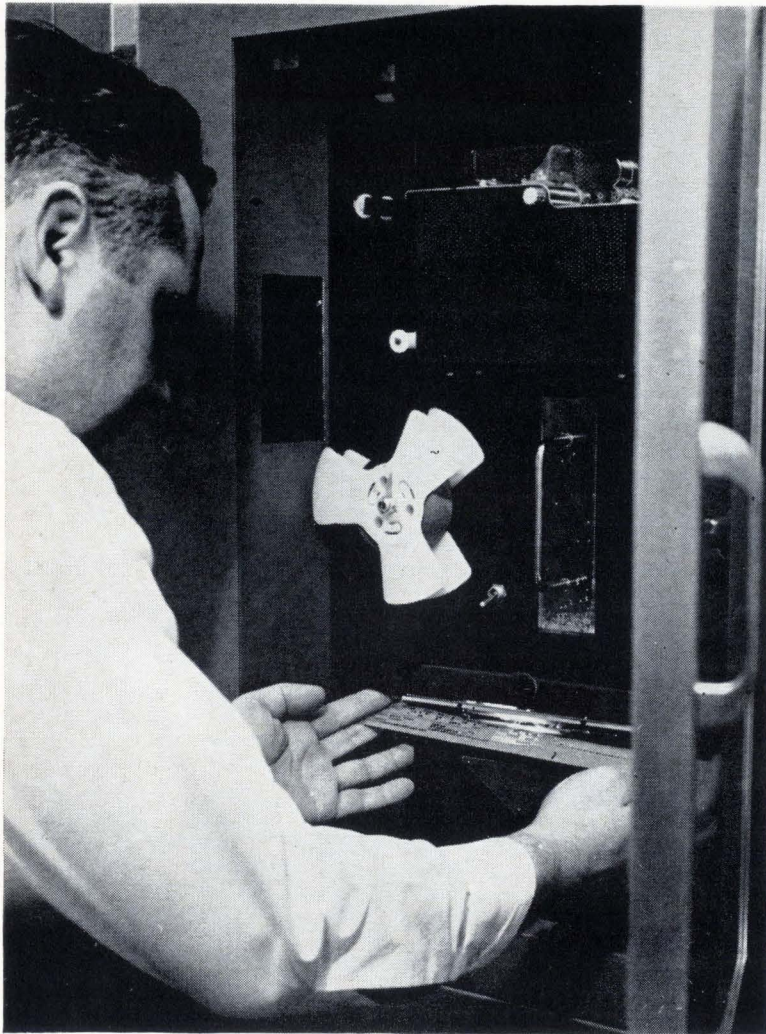

2 Data on punched paper tape makes Compare ready to pinpoint causes of failure in defective units culled from production line. Tape holds test instructions and infrared profiles that serve as references.

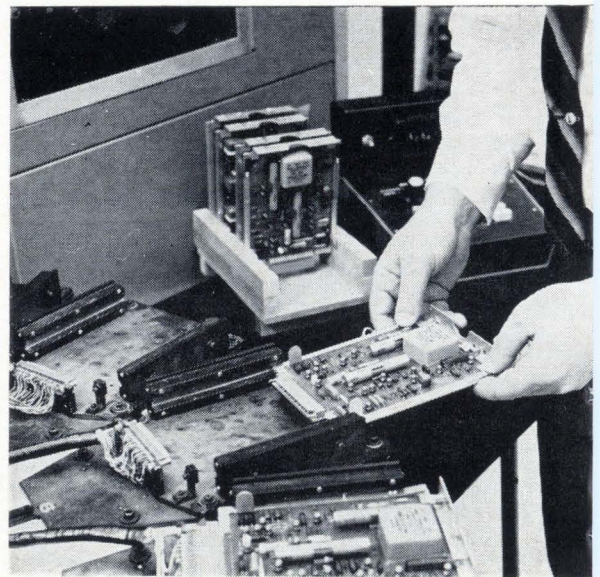

3 Printed-circuit boards are loaded onto the rotary feed table and are carried under the scanning radiometer. Each board is energized to simulate its operating condition.



4 After scanning, the Nixie readout displays the number of the stored profile that most closely matches the failure mode of that board. The display also includes how close the match is. At operator's option, printout will provide data on every measured point, only points that differ from standard profile, or only points that exceed standard profile by preset limit.

6 Digital printout and diagnostic chart are compared by a data analyst to pinpoint the components responsible for the failure. The board and the analysis then are turned over to a technician for repair of the circuit.



5 Sampled points of the radiometer scan that differ from an acceptable profile are printed out digitally for matching against a diagnostic chart.

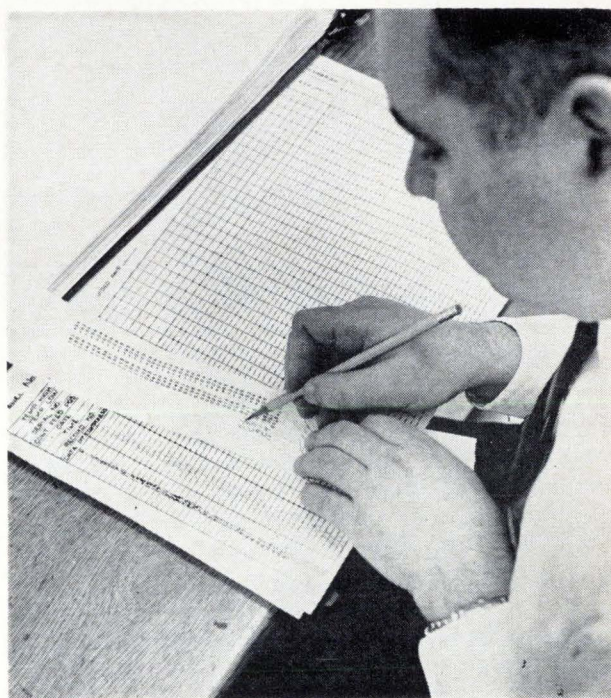

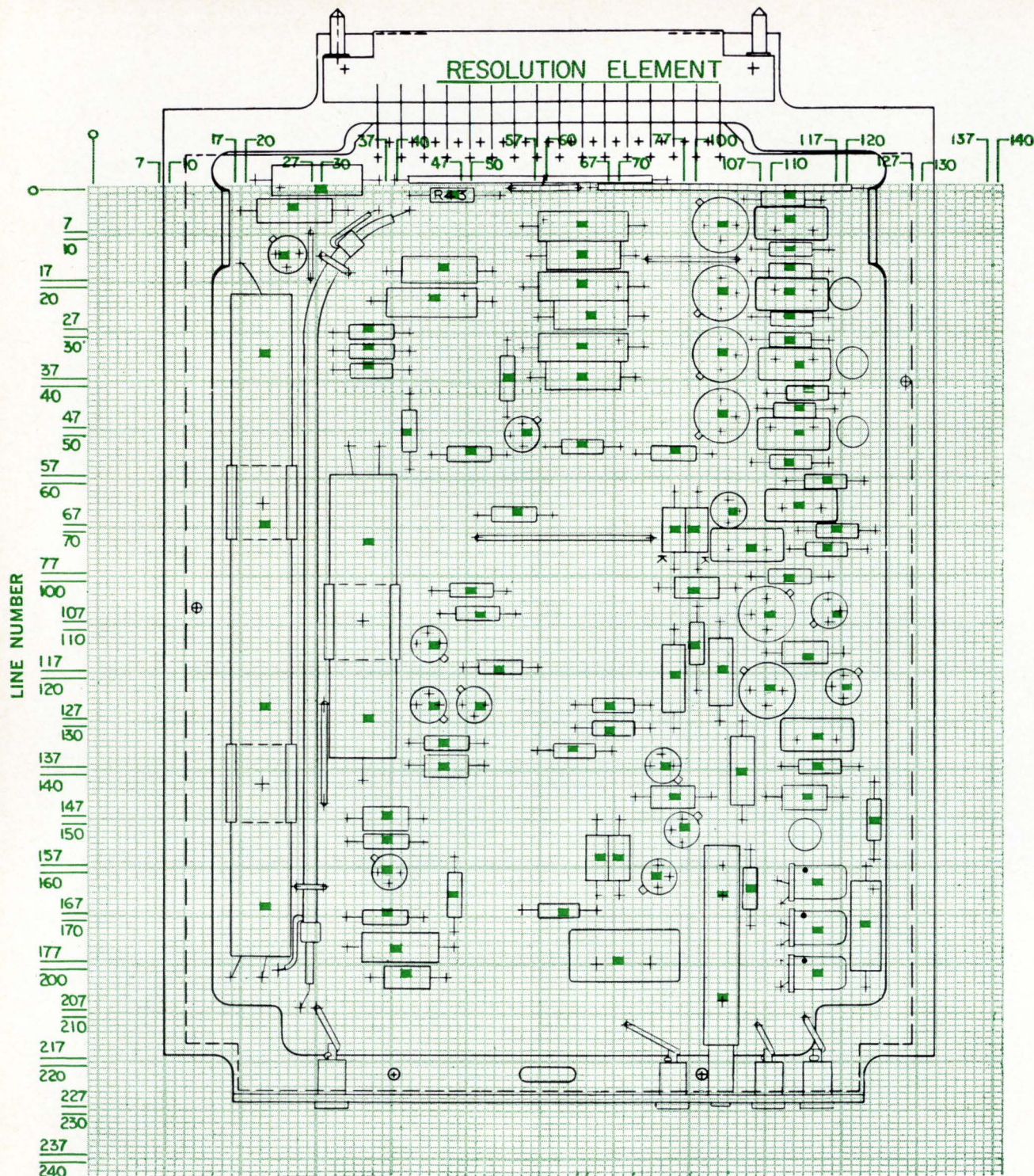

Layout of printed-circuit board and grid overlay used to select the points to be sampled from the radiometer scan. The dark squares in the overlay define the line and element numbers to be programmed into punched tape.

of mirrors, that also steps the scan line sequentially down the length of the circuit as each scan is completed. The spacing between scan lines is 0.040 inch, the spot size of the detector. Scanning is done at a rate of four lines per second.

As the radiometer scans an active circuit, measuring the infrared radiation with a temperature resolution of 0.05°C, an output in the form of a raster display is produced. The entire raster repre-

sents the thermal distribution of the circuit. Total scan time is 100 seconds—45 seconds of active scan and 55 seconds for retrace.

The electronic data processor has a magnetic-core memory and associated circuitry, a tape reader, a tape punch, and a keyboard. The tape reader reads the stored program for a particular circuit; the keyboard and punch enable additional data to be written into the circuit's program, including

new failure profiles or updating the standard profile.

During the active scan, the measured data is entered into the data processing unit's magnetic core memory and then is either punched onto tape, printed out digitally, or automatically compared with data stored in the memory.

A Nixie readout displays the prestored infrared pattern number most closely resembling the input profile along with the sum of the absolute differences of the two. If the difference is zero, then the defect profile has been observed before; if a difference is indicated, the profile is analyzed, identified, and entered into the memory bank. Up to 128 profiles per circuit can be stored; the first is of the standard that identifies an acceptable unit, the rest are of the defects.

Selecting the measuring points

Before a printed-circuit panel can be tested, points of the radiometer's analog output to be sampled by the data processing unit must be selected. This is done by placing a grid overlay on an enlarged drawing of the printed-circuit board. The grid is formed by 180 lines of 97 resolution elements each, representing a total of 17,460 elements or words. The lines represent the radiometer scan lines. Radiometer resolution is better than the size of each square element. An octal-code format is utilized so the line and resolution element numbers contain no eights or nines, for example, 1, 2, 3, 4, 5, 6, 7, 10, 11. . .

Except for large components, it is necessary to scan only one point on each component in the circuit. The data processor can sample any of the 97 resolution elements on each line. But the memory limits the system to 250 of the 17,460 words for any raster scan. This is adequate, since, on the average, it takes only 130 points to evaluate the seven-inch circuit panels.

The x and y locations of these data points, represented by the line and resolution element numbers, is entered into the circuit's program. As the radiometer scans the circuit, the data processor samples only the programmed points.

To make certain the data processor samples the same points from identical circuits for comparison with the corresponding points in the standard profile, the mounting brackets are equipped with precision adjusting devices for aligning the boards with the overlay.

Self Calibrating

The system has a gain adjustment which limits the radiometer output to a range of 0 to 10 volts. For calibration, the first and 97th elements are reference levels representing fixed temperature difference settings. These magnitudes vary according to the gain setting and calibrate the 0 to 10-v scale in °C. The thermal resolution of the system permits resolving the voltage range into 64 elements, numbered from 0 to 77 in octal code. The octal value of the sampled points are entered into

114 +05	114 +03	106 +05
113 +06	113 +01	105 -15
112 +07	112 +03	101 -07
111 +05	111 +03	100 +07
110 +07	110 +00	076 +11
107 +10	107 +01	075 +05
106 +14	106 +07	062 +07
105 +06	105 -14	061 +06
104 +04	104 +00	
103 +04	103 +01	
102 +07	102 +03	
101 +03	101 -07	
100 +13	100 +10	
077 +12	077 -01	
076 +52	076 +11	
075 +13	075 +06	
074 +10	074 +04	
073 +07	073 +02	
072 +10	072 +00	
071 +11	071 -00	
070 +14	070 +03	
067 +26	067 -02	
066 +04	066 +01	
065 +04	065 -01	
064 +06	064 +00	
063 +10	063 +00	
062 +15	062 +11	
061 +12	061 +07	
060 +16	060 -01	
057 +47	057 -00	
056 +04	056 +00	
055 +05	-	
054 +05	-	
053 +05	-	
052 +03	020 -02	
051 +03	017 -01	
050 +06	016 -01	
-	015 +01	
-	014 -01	
-	013 -01	
012 +06	012 +00	
011 +04	011 -02	
010 +03	010 -01	
007 +02	007 -01	
006 +04	006 -01	
005 +03	005 -01	
004 +04	004 +01	
003 +03	003 -01	
002 +02	002 -01	
001 +02	001 +00	

Sample of the three types of digital printout techniques available.

the data processor.

Results are printed out during the retrace scan. Three different printout techniques are available and can be selected at the operator's discretion. The 250 possible data points are numbered from 0 to 372, and the 64 voltage levels from 0 to 77.

In the simplest technique, the data points and their associated voltage levels are printed out and simultaneously placed in the punched tape memory.

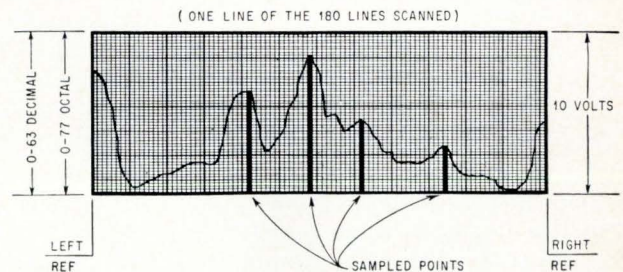

A typical oscilloscope trace of one scan line from the radiometer containing all 97 resolution elements. A complete scan for a circuit usually consists of 180 of these analog traces. The heavy lines indicate the four sample points in this trace whose values are entered into the processor's core memory. The left and right elements are reference values used to continuously calibrate the trace.

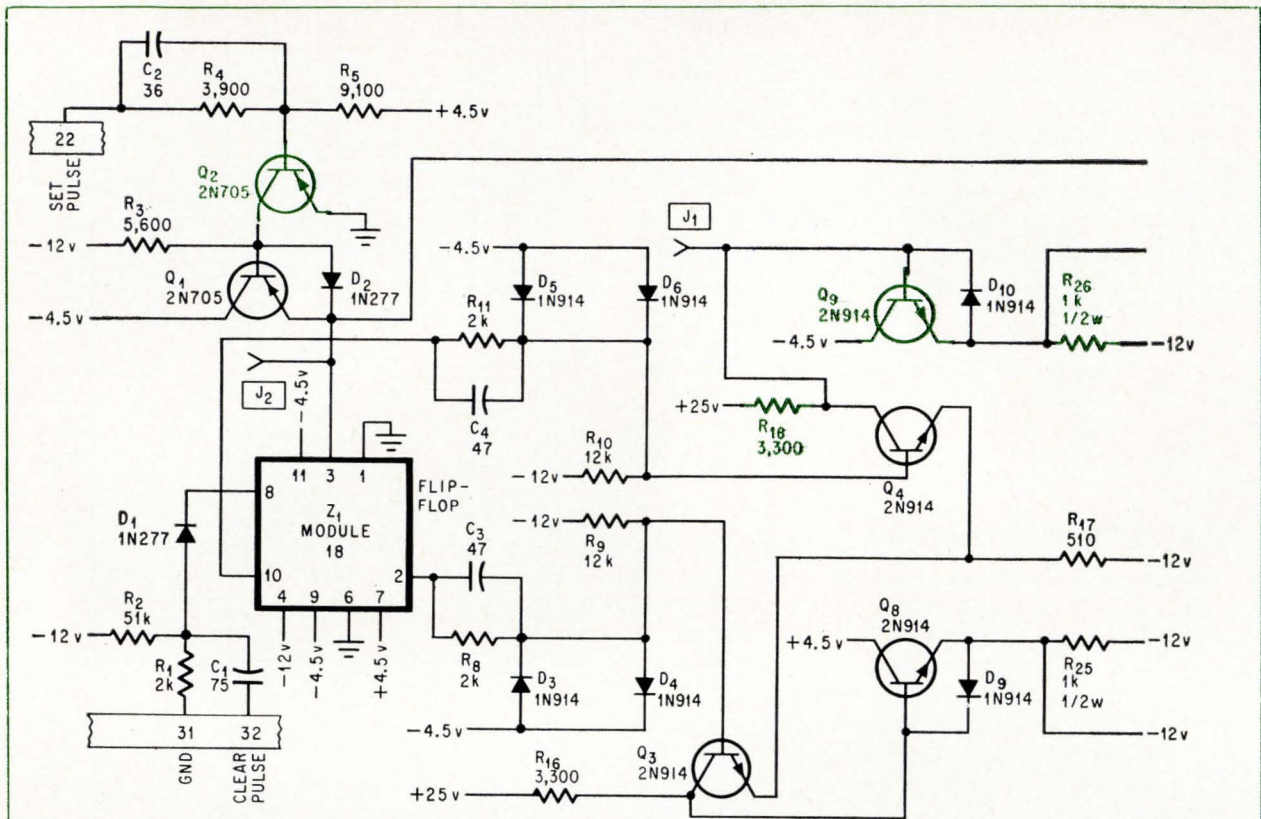

Zeroing in on electrical defects

The following examples illustrate how easily Compare locates the components involved in an electrical failure.

The schematic of a digital timing circuit is shown above. This circuit failed an electrical test and, when analyzed, was found that the transistor Q_2 was open circuited from base-to-emitter. Data obtained when the circuit was scanned in-

dicated abnormal temperature differentials at the transistors, Q_2 and Q_9 and resistors R_{18} and R_{26} . The large deviations from the normal readout were a result of the open in Q_2 . This transistor drives Q_1 , setting the flip-flop in module Z_1 . When Q_2 opened, however, the flip-flop failed to set properly and the transistors Q_9 and Q_4 were subsequently turned off. This ef-

fect was reflected by the abnormal readings from Q_9 , its emitter resistor R_{26} , and Q_4 's collector resistor R_{18} . This particular defect not only illustrates the thermal effect on the failed components but also on associated circuitry.

In another circuit, a transistor was found to have a collector-to-emitter short. This defect was diagnosed when the infrared scan showed the transistor's emitter resistor operating at a temperature differential of 19.6°C , well above its normal value of 10.2°C .

This method is used when no previous data about a printed-circuit panel is available. This printout provides the original profiles for the Compare system to use for troubleshooting electronic assemblies.

When data is already on hand, a second technique can be brought into play. The number of the data point is printed along with the difference between it and the standard. By averaging the results from several good panels, the amount of data presented for interpretation is reduced and a better standard profile is obtained. A plus or minus sign is included in the printout to indicate whether the measured value is more or less than the standard.

A third technique is the threshold method. The measured voltage level is printed out only when it differs from the standard within preset limits. This difference value is analogous to the mean and standard deviation employed in statistical analysis.

The threshold method is utilized best when evaluating defective panels.

The threshold can be varied according to the degree of flexibility desired. Usually, the data is divided into eight octal levels—from 0 to 7, 10 to 17, etc.—with a threshold assigned to each. These assigned values can differ from level to level if required.

Even circuits that do not fail electrical tests sometimes contain potential trouble spots which can be discovered by infrared testing. A good example is the reversed electrolytic capacitor. This defect often is overlooked since it takes from 2 to 20 minutes for an electrolytic capacitor with polarity reversed to affect the electrical operation of the circuit. In fact, in some cases, it may never be detected with conventional electrical tests. But it draws enough excess current when connected backwards to look different to an infrared detector.

Can You Imagine A PNP Silicon Power Transistor That Gives Faster, More Efficient Performance Than Any Other Type? WE DID! Meet the 30-Amp 2N4398.

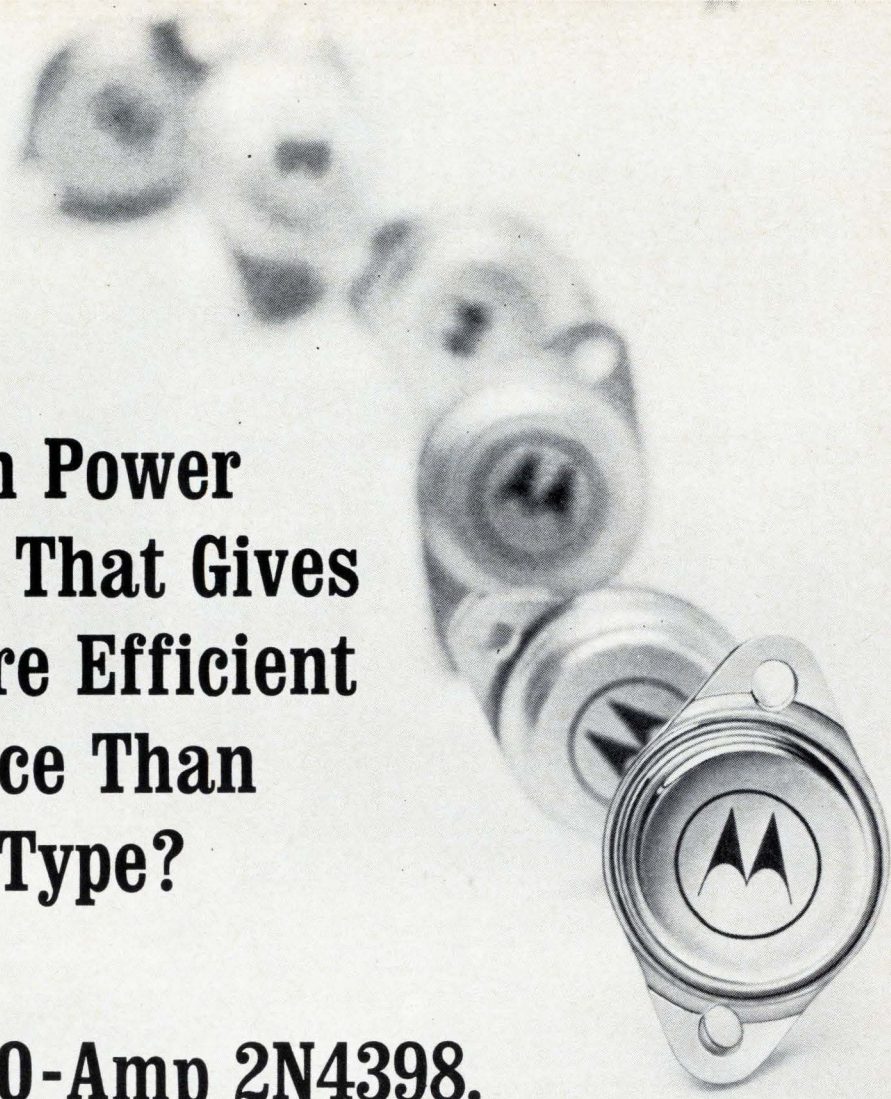

Now, you can specify state-of-the-art power, speed and efficiency with a true industry first: the Motorola 30-ampere PNP silicon power transistor! Here's what's in it for you:

1. 200 watts of dc power to 30 volts V_{CE} .

The best PNP silicon power-handling capability in the business! Use them to replace germanium devices in those "extra tough" industrial/military high-power audio and servo amplifiers, voltage regulators and modulator applications. And you realize lighter, simpler, less-costly heat sinking in all designs through low thermal resistance — θ_{jc} of 0.875° C/W max.

2. 400 nsec rise time at 10 amperes.

There's no power/speed trade-off with the 2N4398-99 devices. At 10 amperes I_C and 30 volts V_{CE} , the delay and rise time is only 400 nsec maximum . . . an unmatched figure of merit that affords minimum switching losses.

3. 0.75 volt max $V_{CE(sat)}$ at 10 amperes.

Ensure efficient, low power loss performance in all your applications . . . plus, have the added capability to swing down in voltage without loss of current gain to 1 volt @ 10 amperes — important in low-distortion audio amplifiers.

Add excellent gain linearity over a 5 to 20-ampere range, 50-ampere peak current, a low-silhouette TO-3 package, *low price* — and you've got the answer to superior silicon power circuit performance in many of today's demanding circuit designs!

Available in both premium and economy types:

PREMIUM TYPES

Type	V_{CE0} Volts	I_C Amps	P_D @ $T_c, 25^\circ C$	h_{FE} @ I_C, V_{CE}	$V_{CE(sat)}$ @ I_C	Price 100-999
2N4398	40	30	200 W	15-60 @ 15 A, 2 V	0.75 V @ 10 A	\$7.50
2N4399	60	30	200 W	15-60 @ 15 A, 2 V	0.75 V @ 10 A	9.05

ECONOMY TYPE

MJ450	40	30	175 W	20 min. @ 10 A, 2 V	1.0 V @ 10 A	6.35
-------	----	----	-------	---------------------	--------------	------

Contact your franchised Motorola distributor now for evaluation units or write Box 955, Phoenix, Arizona 85001 for complete 30-ampere state-of-the-art silicon power technical data!

— where the priceless ingredient is care!



MOTOROLA Semiconductors

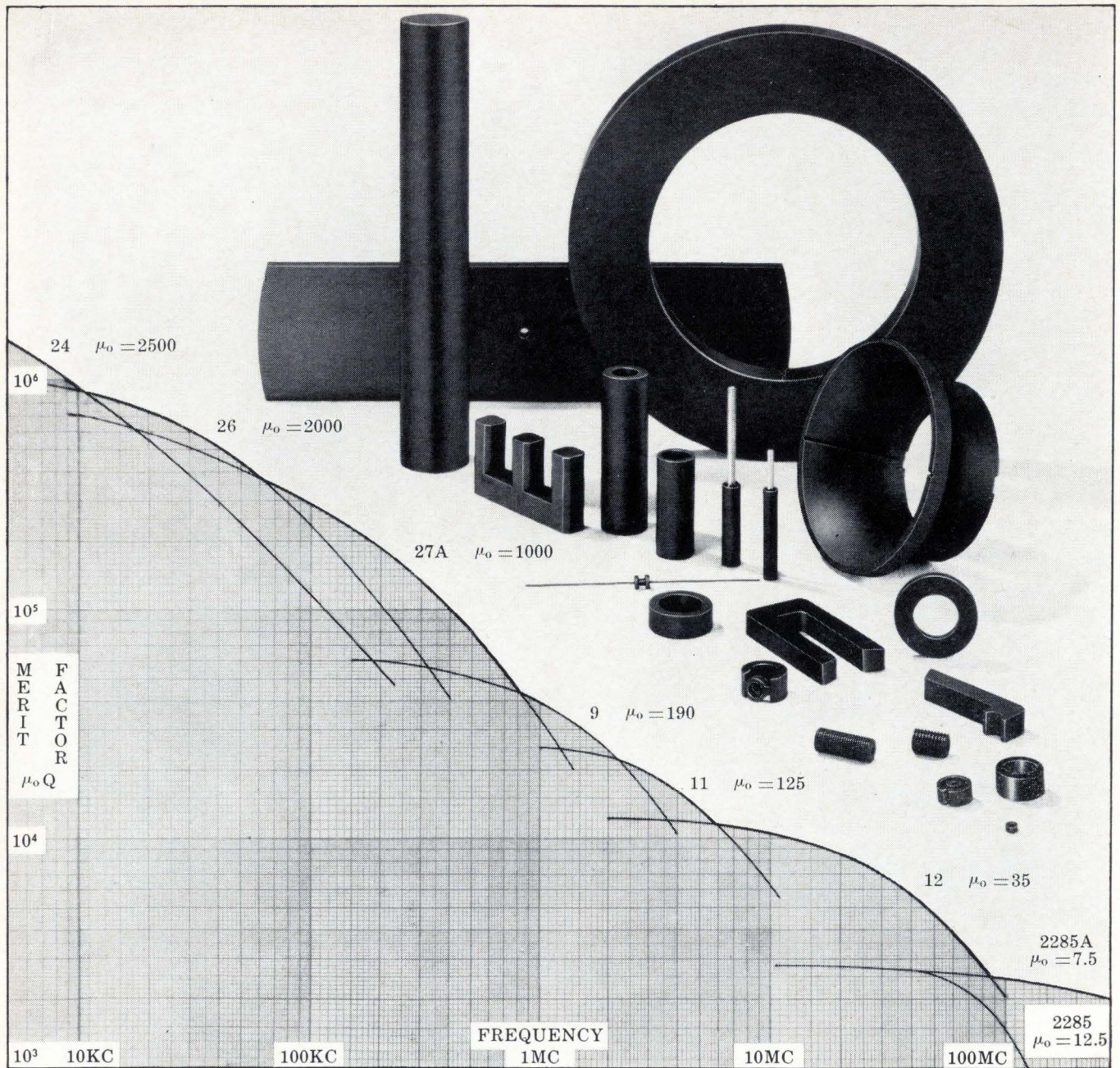

CERAMAG® FERRITE PARTS ARE CONSISTENT

Stackpole offers over 30 grades of Ceramag® material. More are being developed continually. Such up-to-the-minute technology permits you to specify Ceramag® on every new application. Discover the unique advantages of the versatile Ceramag® ferrites: complete moldability to virtually any shape, and the important savings over steel alloys for low frequency applications. When high permeability is an important factor, Ceramag® is the answer.

Hundreds of Ceramag® parts are already tooled as toroids, cup cores, insert cores, transformer cores, deflection yokes and rectangular solids. Special tooling is also available.

Stackpole is a name long associated with quality components in the electronic field. Only the closest attention to every production detail can result in the kind of product uniformity available with Ceramag® ferrites. As one of our customers

put it, "Your ferrite cores are more consistent from order to order than any of your competitors."

If you are about to select a ferromagnetic material for a new application, or if you are dissatisfied with the performance and service of your present ferrite supplier, why not investigate Stackpole's Ceramag®? To discover how you can save and still insure superior performance, write for our Bulletin 1-A, Stackpole Carbon Company, Electronic Components Division, St. Marys, Pennsylvania 15857. Phone: 814-781-8521 — TWX: 510-693-4511.



A picture worth a thousand words

Using new character-generating tube and a crt, photocomposition system for printing is capable of setting type at speeds of 1,000 to 10,000 characters per second while making up the page in the same process

By J. Kenneth Moore and John F. Cavanaugh

CBS Laboratories, Columbia Broadcasting System Inc., Stamford, Conn.

Within the next three months, the fastest photocomposing system ever devised will be installed at the world's largest printing plant, the U.S. Government Printing Office (GPO) in Washington. Combining phototypesetting and page composition by a computer, the system is capable of setting type electronically for an entire page of this magazine in about five seconds via a new character-generating tube and a specially designed cathode-ray tube.

Called Linotron, it can set 1,000 characters a second with the clarity required for quality printing [see "Quality in electronically set type," page 118]. Pages for proofreading before final page copy is set can be composed at several thousand characters a second; speeds up to 10,000 characters a second can be achieved for typewritten-like pages.

The system was a joint undertaking by the Mergenthaler Linotype Corp., a division of the Eltra Corp., and the Columbia Broadcasting System Inc.'s CBS Laboratories division. Mergenthaler is

responsible for the over-all system management, programing, and installation. The photocomposing equipment was developed by CBS. Its key elements are the character-generating tube¹ and crt, described in detail in the article on page 122. Development began in 1962. More than \$6 million has been invested to date.

Unlike conventional linecasting machines — standard in the printing industry — and phototypesetters, the Linotron does not require mechanical motion or motion of film to set a full page of type. It sets the page, character by character, and is not restricted to line-at-a-time composition. Letters and numbers from three type fonts, or styles, are exposed on film at locations selected by a computer. If another type should be required, characters from this font can be exposed at spaces left open for them. This eliminates constant shifting back and forth of different fonts. Ruled lines, graphic material, and other information can also be put on the page.

This technique gives the editor greater freedom in selecting type style, page size, and page format without sacrificing the speed inherent to the system. Line-at-a-time systems require mechanical motion and are slower than electronic systems. The films exposed by the Linotron's output, the crt display, can be automatically processed off-line and can be used to prepare plates for offset, letterpress or gravure printing.

Applications of the Linotron system in computer peripheral equipment and automatic drafting systems are also feasible. For example, information could be selected from "fonts" that are actually electro-optical read-only memories. These memories could be used by a computer as fast-access lookup tables or data files. The scanning systems employed in the Linotron permit the equivalent of 5,750,000 binary bits of data to be stored in a volume of only 2 cubic inches, accessible in 100 microseconds. The

The authors



J. Kenneth Moore, general manager of the graphic systems department at CBS Laboratories, is responsible for the application of new technologies to information display and the graphic arts. He holds a master's degree in physics from Williams College.



John F. Cavanaugh, a manager of the photocomposing system section in the CBS Labs' graphic systems department and is engineering manager of the Linotron program. He has had 20 years experience in circuit and system development.

readout rate would be 5 megahertz.

The crt subsystem could also be used as an extremely accurate flying-spot scanner for pattern recognition and filmed data retrieval. In such applications, a negative would replace the film and the crt beam would be modulated by the information on the negative and detected by a photomultiplier.

In one of its operating modes—the one used to start a line at a selected point on a page—the Linotron functions as an X-Y plotter under control of a computer-prepared program. It can draw lines at the sweep speed of a crt, or by making points at a rate of 10,000 a second. As a plotter, it could be used, for example, to prepare integrated circuit metalization masks under computer control.

Generation to display

The Linotron system looks at an optical analog of a type font, generates video signals corresponding to the characters and their lateral position with respect to adjacent characters in line. It then displays the characters on a crt at selected locations within a page format. As each character is displayed, it is exposed on the film. Linotron, system diagram on page 115, resembles a special-purpose, closed-circuit television scanner and kinescope film recorder.

Instructions for selecting and placing characters, and other typographical effects, are recorded digitally on magnetic tape. Another system, under development for the Air Force Logistics Command, will have a video tape input as well, enabling the system to compose artwork and photographs on the page of type.

At the GPO, preparation of the magnetic tape will be handled by a specially programmed IBM-360/50 computer. Material to be printed will be fed into the computer from data banks updated by punched cards. The computer will do such typesetting chores

Words, words, words

Why does the Government Printing Office require a high-speed photocomposing system? The answer can best be told in numbers.

Last year alone the GPO set 110 million lines of type (calling for more than 3.2 billion characters). It processes on the average 1,000 printing orders per day, ranging from Congressional stationery to the 16-volume U.S. legal code. Through the Superintendent of Documents, more than 27,000 different titles are available for sale to the public. Better than half of this printing is done by the GPO; commercial printers do the balance under contract.

as spacing out the lines and hyphenating words. The tape will also contain instructions for page makeup, paragraph indenting, type font changes, and so on.

In the Linotron, the tape is read out in data blocks into buffer core storage. A dual buffer is used so that while one is being loaded from the tape, the other is providing instructions to the rest of the system.

Control logic decodes the tape information into a variety of signals which determine such printout properties as the character to be generated, its position, size, and type style.

Special precedence codes enable the system to specify the complex requirements of the graphic characters. The logic also controls auxiliary system functions such as determining the length of film on which the display from the crt is to be printed and whether a standard information overlay is to be projected onto the film.

After the page is composed on the crt, the display is optically enlarged 2.3 times to a maximum of 8¼

Text and instructions for the system are produced by typist on punched tape

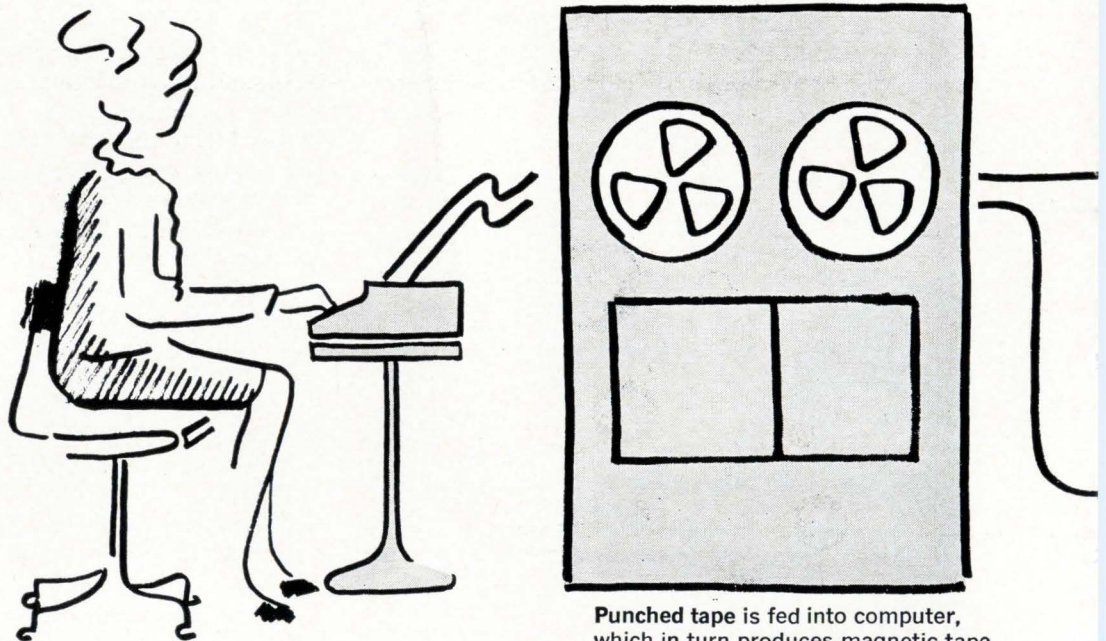

Punched tape is fed into computer, which in turn produces magnetic tape.

x 10½ inches before the film is exposed. This is the largest page size generally used by the GPO. Larger pages can be composed by programming the information so a complete page is represented by placing film pages side by side.

Part of the attraction of the Linotron's full-page composition is that the computer preparing the text can call for a character to be located anywhere on the page. In a conventional phototypesetter, the computer would have to complete one line before going on to the next, or rewind the film. This is both bothersome and time consuming, particularly with multicolumn formats. The computer would have to complete lines with contributions from each of the columns rather than follow the natural flow along a single column.

Character store

It was recognized early in the development of the system that character generation required a special type of read-only memory. Information retrieved from this store is used but not changed.

Many kinds of read-only character generators have been described over the past 20 years.^{2, 3, 4} Although some had been tailored for high-speed writing, none had to generate characters that would photograph with the high resolution required in this photocomposing system.

Clearly, the best character source for the Linotron system is a photograph. It has high resolution, costs little and takes up little space. In addition, the original artwork prepared by the type designers can be used directly, and large groups of characters can be changed quickly.

The basic element of the photographic store in the character-generating tube is a grid printed on a glass plate, top of page 117. It stores a 16 x 16 array of 256 characters; a single array contains the equivalent of three type fonts. The plate is mounted

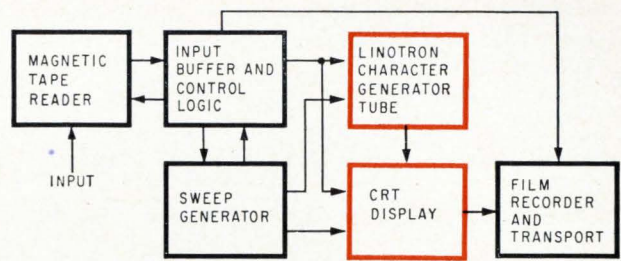

Linotron photocomposing system accepts instructions on magnetic tape, generates electronic analogs of characters in the Linotron tube and displays 1,000 characters per second on the cathode-ray tube. Printing plate is made from photograph taken of crt faceplate.

in a precision stainless steel frame. Access time to any character is of the order of a few nanoseconds. Information transfer from the grid occurs at a 5 Mhz rate after a 100-microsecond servopositioning cycle.

A character, shown in detail on page 119, appears on the glass plate with a reference mark at the lower left. Information bits that follow the mark store data related to the character's position with respect to adjacent characters. This information isn't on the magnetic tape.

The 256 characters in a grid can be reproduced in eight sizes, sufficient for most printing jobs. When a fourth font is required, a grid changer holding four separate grid plates is used. The changer can switch any one of the plates into the system in a half second. Thus, 8,192 characters in different sizes and fonts are actually available to be reproduced.

Linotron tube

The character grid is illuminated by a mercury arc lamp and its image is projected onto the Linotron tube's photosensitive faceplate. Each character image is converted into a video signal in the

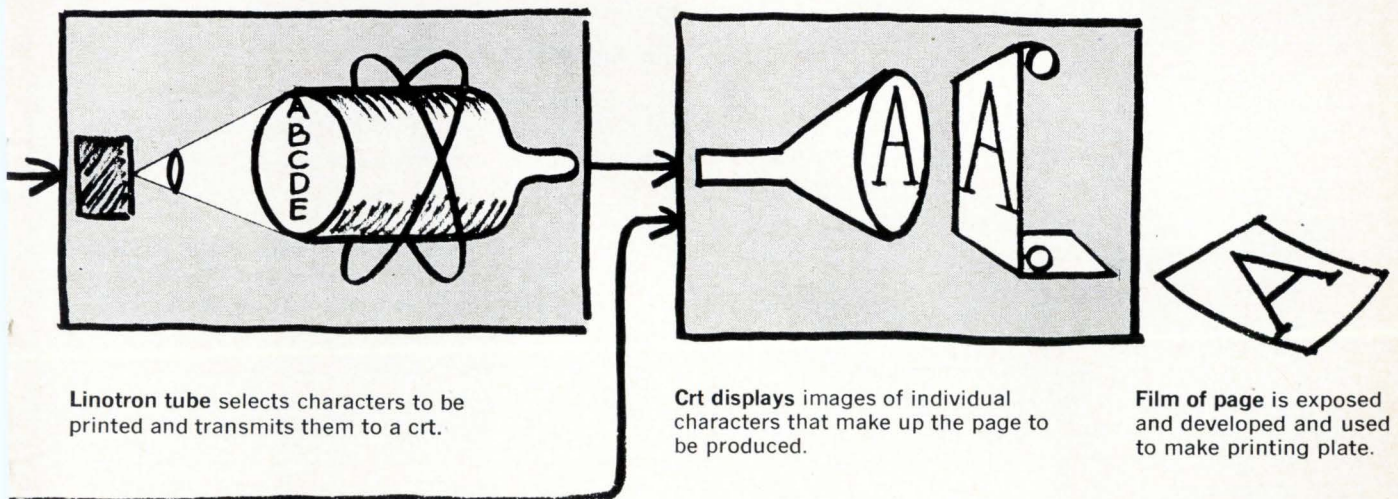

Linotron tube selects characters to be printed and transmits them to a crt.

Crt displays images of individual characters that make up the page to be produced.

Film of page is exposed and developed and used to make printing plate.

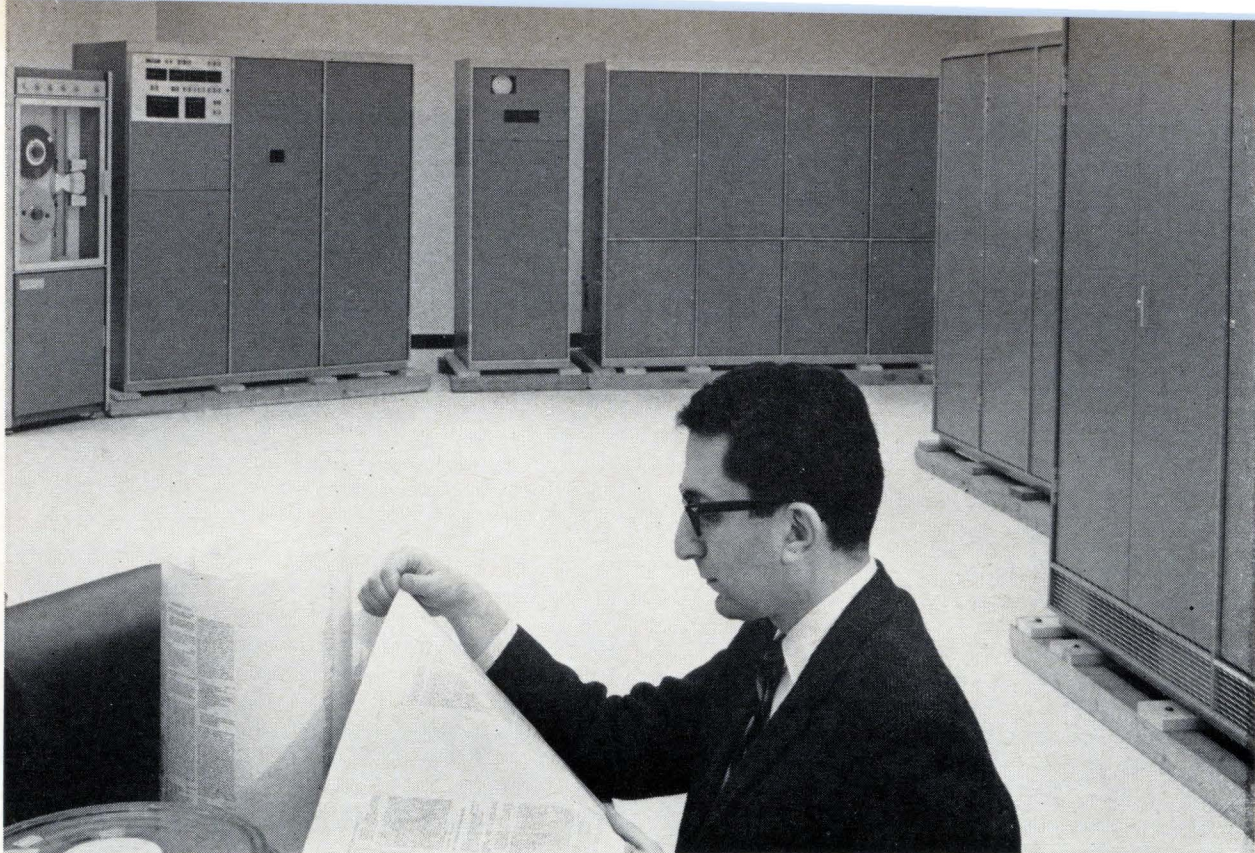

Engineer reads pages with several different type sizes printed from plates prepared from film. System cabinets are in the background.

tube. One signal at a time is amplified in the electron multiplier section, then transmitted to the crt.

The video output is an instantaneous and accurate analog of the character's shape. There are none of the settling time or hysteresis problems associated with flying-spot scanners. Furthermore, there is no time constant analogous to the decay in crt phosphors to limit the video bandwidth, which is 5 megahertz.

Helmholtz coils are used in the Linotron tube to produce uniform magnetic fields for focusing and deflection. High-power deflection amplifiers supply the sweep currents. The smaller the character, the higher the deflection frequency, which reaches 125 kilohertz.

After a character is selected by the input buffer, the video output from the Linotron tube is connected to a servosystem, shown in the block diagram, page 119. The servo drives the deflection amplifiers of the Linotron and locks the scan to the coordinates of the reference mark on the character grid. The techniques used are similar to those in star-tracking systems.

The servosystem aligns each character scan to the character and corrects errors introduced by variations in positioning the grid changer, manufacturing tolerances in fabricating the character grids, drift in the sweep generators, and deflection amplifiers. Alignment accuracy is about 0.0001 inch.

Cathode-ray tube

A 7-inch crt, type CL1242 P24, with an additional optical magnification of 2.3, exposes standard photo-

typesetting film. The useful phosphor area of the tube actually has about a 6-inch diameter. Spot size is typically less than 1.5 mils at beam currents of 20 microamps and accelerating potentials of 30 kilovolts. Deflection defocusing introduced by the 20° deflection system is kept below 10%.

The crt uses a dual magnetic deflection system, shown in the block diagram on page 120. A major deflection yoke, driven from a precision digital-to-analog converter, positions the character and a minor deflection yoke writes it out. Deflection amplifiers similar to those used in the character generator drive the minor deflection yoke.

Digital-to-analog conversion

Digital-to-analog converters take the digitally coded position address supplied by the control logic and place the 1.5-mil diameter crt spot at the character starting point on the crt. Both the horizontal and vertical converters are driven by 5-digit binary coded decimal inputs. The least significant digits represent a deflection of 1/18th of a point (a point is a measuring unit for type) or 0.0007687 inches on the film.

Groups of weighted current sources controlled by current switches make up the digital-to-analog converters. Their long-term stability is high, 0.01%. They are modulated by a signal that is a function of the deflection current. The deflection current is fed back into the converters and modulates their output as a function of the crt spot position. The modulation is controlled by a function generator that corrects the signal to obtain a differential linearity distortion of only 0.01%.

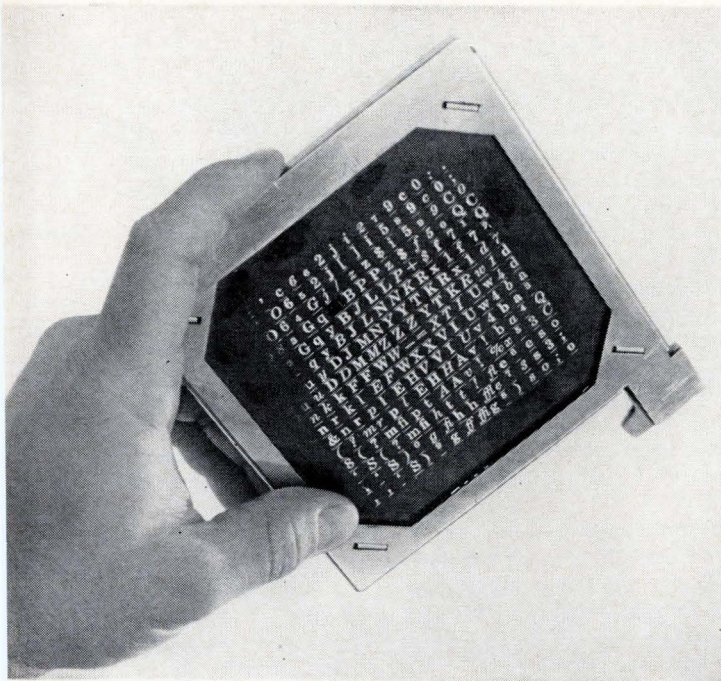

Character grid is a photographic store of 256 type characters. Linotron tube selects one character at a time which is transmitted as a video signal for projection onto crt display.

With the suitably shaped deflection current signal, the spot is placed within 0.02% of its required position. Linearity correction is possible because precise pincushion correction makes the crt's deflection sensitivity independent of axes.

Sweep generation

The sweep generator in the Linotron system synchronizes the character generator with the crt display. The system has:

- Constant video bandwidth of about 5 Mhz, independent of character size for a given resolution at the film plane.
- Constant energy density at the film independent of the type size.
- Typesetting speed constant for a given area of composition; if type is not required on some areas of a page, the page is set more rapidly.
- Asynchronous operation with small characters printed at a high speed and larger characters printed at slower speed.

The number of scan lines on the output film is 835 per inch. This is large enough to take advantage of the 1.5-mil spot size available from the crt, since with a conservative Kell factor (a measure of the overlap of scan lines) of 0.6, the resolution is about 500 lines per inch. Very high contrast prints—up to a film density factor of 3—are obtained with a spot velocity of 13,000 inches per second.

The largest size character to be printed in the cpo's Linotron is 18 points—up to ¼ inch high. (Larger characters can be produced by modifying the circuitry.) The smallest will be a 5-point character.

As the character gets smaller, the period of time in which it's swept out on the crt decreases, too. The time ranges from 5,016 microseconds to sweep an area 18 points square (called an 18-point em square) down to 597 microseconds for an area 5 points square. These times include a constant 5-microsecond retrace time for each scan. However, to achieve the same recording density, the slope of the crt sweeps are the same for all characters (see wave diagram below).

In the character generator, sweep amplitude is independent of point size. Since the sweep times are determined by the crt requirements, the slope of the signal increases in the Linotron tube as the point size gets smaller.

In most cases, a complete em square is not swept by the Linotron tube. Complete sweeps would cause unnecessary delays because most characters, as shown on page 121, cover only a portion of the square. For example, an i is short and narrow, a d is high, and a p descends to the bottom.

Each em square is divided into 12 sweep areas, corresponding to different groups of letters. Instructions directing the scan to the proper area are coded digitally in dots beneath each character in the grid. Typesetting speed is between 30% and 50% faster than if the entire square were scanned.

The distance each character should be set from its neighbor in a line of type is also coded beneath each character. This method of positioning in the Linotron system is called implicit positioning because no explicit commands come from the computer. Anywhere from four to 18 dots correspond to the character width. These width dots are scanned a number of times equal to the point size being used. The result is a series of pulses equivalent to the required spacing to the next character in units of 1/18th of a point or 0.0007687 inch.

The pulses, fed into the horizontal position register in its counter mode, increase the horizontal position address to reach the address required for the next character. Therefore, the least significant digit of the digital-to-analog converter must provide a current sufficient to deflect the crt spot 0.0007687 inch on the film plane.

The film transport carries film from a supply

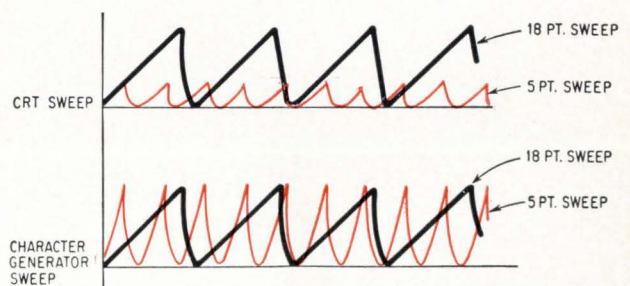

Sweep slopes on the crt must be the same for all type sizes so phosphor brightness won't vary. Sweep slope in the Linotron tube becomes steeper as the point size gets smaller because the crt determines sweep time. The Linotron's sweep amplitude remains constant.

Quality in electronically set type

Electronics has been involved in the printing industry since the 1930's when punched tape for linotype machines was introduced. Speed and economy have been the main reasons. But it has only been within the last few years that truly impressive jumps in speed have been made in typesetting.

From rates of 20 and 40 characters per second, adequate for many newspaper operations, electronic typesetters are today pressing to speeds of 1,000 characters per second and are headed even higher [Electronics, Feb. 6, p. 34; June 13, 1966 p. 255]. Such rates are being reached by combining computers, special character-generating techniques, and high-speed film-processing systems.

However, for the printing industry, speed alone is not enough. High quality is needed, too. What does high quality in printing mean?

Resolution. Thousands of different type styles have been developed since the invention of movable type by Gutenberg in the 15th Century. They are selected for such reasons as the content of the text, the type of paper, the print-

ing press to be used, and the taste of the publisher. Styles are differentiated by the form of the letters and, more particularly, by the fine detail associated with each letter—boldness of strokes, shape of the serifs, squareness of the corners, etc. For high quality printing the type must be reproduced with a resolution of about 10 pairs of optical lines per millimeter (500 television lines per inch).

Precision. If letters are not set accurately with respect to each other—if they bobble up and down or sideways—it impedes the natural reading process, where letters are grasped as groups forming words and phrases.

One of the major functions of serifs on letters is to provide an average reference line for the eye to follow. If the letters and therefore the serifs are not placed accurately, this average reference line will be poorly defined and disjointed.

High quality is obtained when each letter is placed to an accuracy of 1 mil with respect to adjacent letters. For a typical page size, this represents a differential accuracy of 0.01%. This requirement is particularly important for small sizes of type faces where space between letters is very small.

Uniformity. Printers and typog-

raphers often refer to the "color" of a page. By this they mean the average density of type over areas large compared to a letter. On that scale, one part of a page should appear to a reader the same as another part of a page. Variations in color provided by a bold face, italics, indentation, or other techniques give emphasis or guide a reader's attention.

A typesetting machine must reproduce letters with uniform resolution, accuracy and exposure intensity at all positions on a page. This differs from the practice in tv or in conventional photography where the resolution at the corners may be substantially lower than the resolution at the center.

Flexibility. There are enormous differences in materials printed for advertising, mathematics texts, and dictionaries. Type faces and styles change and even intermix, sizes vary, and formats change. Type may be set across a page or on its side, lines may be full or left blank, they may be set tightly or widely spaced.

A machine that sets type may be very fast for pages set densely, but uneconomically slow for pages with large open spaces. A typesetter should therefore provide wide flexibility for page formats with little loss of processing speed.

cassette to the image recording plane where it's exposed and then fed into a take-up cassette. Separate automatic processors develop the film off-line. Photographic paper, rather than film, is normally used for proofreading copies.

Directed by the information from the magnetic tape input, the transport pulls down film from rolls up to 12 inches wide. Film lengths for printed pages of 6, 7, 8 and 8½ inches long are programmable through the computer.

To control film length, a reference hole, whose position depends on the page length desired, is punched at the top of the film as it is being exposed. At the next pull-down command, the film moves down until the hole is centered between two light sensing photocells, which are part of a servosystem, shown at the bottom of page 120. The film can be positioned to accuracies of better than ±2.5 mils, which is needed to make up over-sized pages.

The film transport must be ruggedly constructed because a full roll of 500 feet of film can weigh as much as 30 pounds. Slack loops with dancer control at the cassettes decouple the load from the drive system so that the film can be pulled down in less than one second.

The Linotron system also has a second transport for making page proofs. This equipment develops photographic paper a page at a time in the machine.

Higher speed modes

For some requirements, proof copies for example, printing quality can be sacrificed for higher speed. The Linotron system has two higher speed modes.

In the proofing speed mode, the system operates at three to four times the normal speed. To compensate for this, the characters are scanned at about 280 scan lines per inch instead of the normal 835. The system performs all the normal operations but the letters are not as crisp as when copy is set at normal speeds.

In the other high-speed mode, the system simulates a computer's line printer and produces copy resembling that from a typewriter at speeds approaching 10,000 characters per second. It uses a special grid with small characters. They are swept with lower amplitudes of deflection current so that sweep speed is faster and retrace times are shorter. The implicit spacing logic circuits are bypassed and the characters are printed with fixed spacing increments.

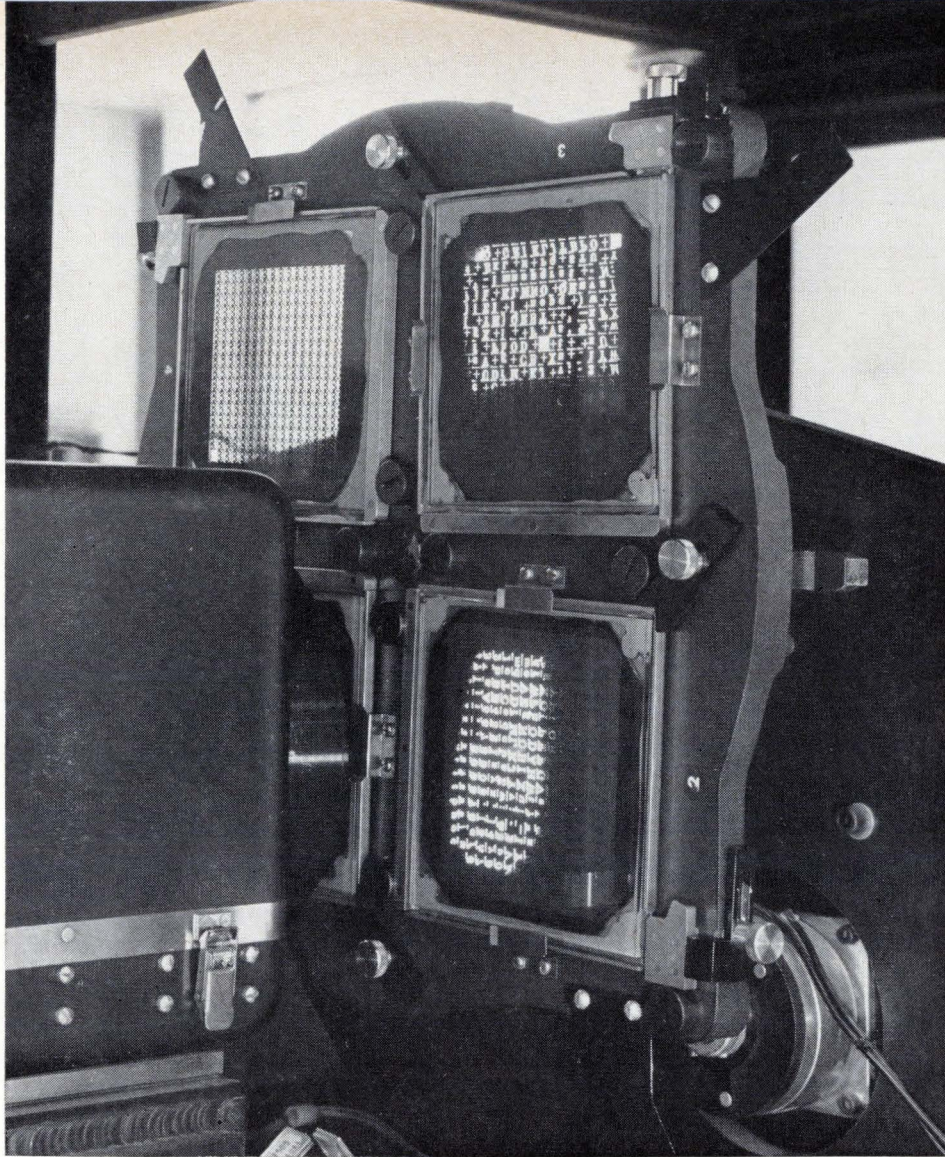

Grid changer holds four character grids, each of which can be switched into the Linotron tube in a half second.

A turn-page mode, one in which pages are composed and printed with a 90° rotation, can also be programmed. This can only be done with an area composing system (see bottom of page I21).

When a computer instruction calls for a turn-page mode, switches and gates within the system produce the following changes:

- X and Y positioning codes are transferred respectively to the vertical and horizontal position-

ing digital-to-analog converter inputs.

- Horizontal character raster deflection sweeps are transferred to the vertical deflection amplifier; the vertical sweeps are transferred to the horizontal amplifier.

- Vertical positioning yoke leads are reversed.
- Horizontal character raster deflection yoke leads are reversed.

Ruled lines may be drawn by the crt under

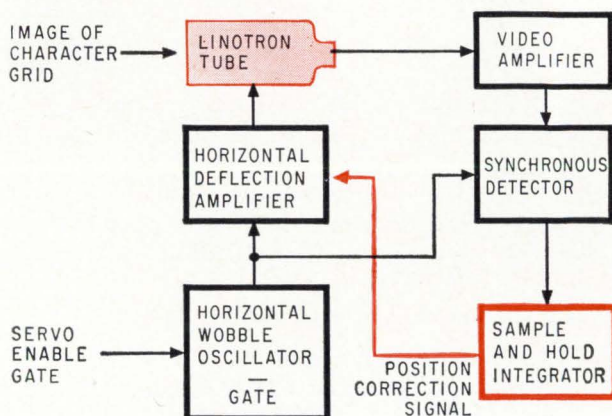

Servo system for horizontal axis control generates a position correction signal that locks the scan to the reference mark beneath the character. Reference and coding marks indicate how the character should be scanned and spaced.

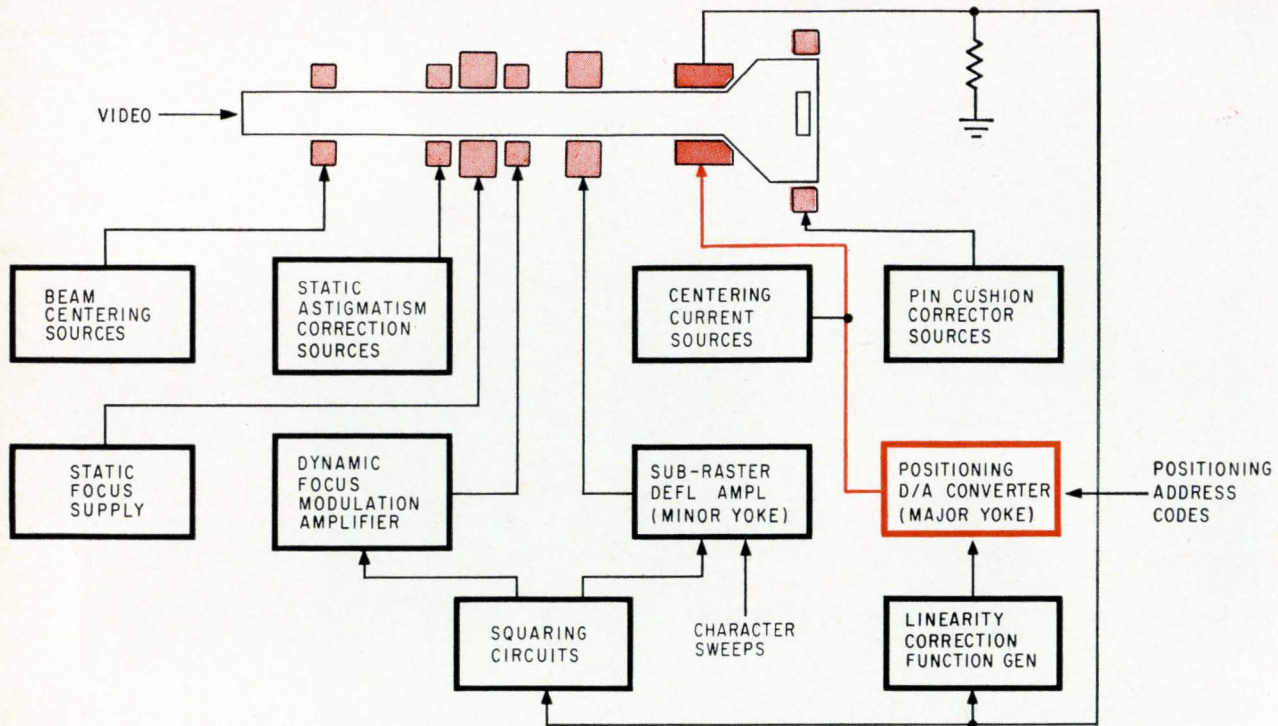

Major yoke (dark color) is controlled by the digital-to-analog converter to place the character at a selected spot on a page.

computer instruction. The computer specifies the coordinates for the origin of a line, its direction (horizontal or vertical), length and thickness. The origin of the line is set into a position register and counter which drives the digital-to-analog converter.

Upon command, the crt spot is unblanked and an oscillator is gated into the register. The oscillator pulses are also applied to a backwards counter which has been preset to a value corresponding to the length of the line. The response time of the positioning system limits the spot travel to a

constant velocity as the register is advanced. When the backwards counter reaches zero, the oscillator is gated off and the crt spot is blanked.

While the spot is moving across the crt face to produce the line, an orthogonal spot wobble is applied. Line width varies with the amplitude of this wobble and spot brightness is adjusted to achieve a constant energy density on the recording film that is independent of the width of the line.

Format overlay projector

The computer is employed for drawing line formats that are not used regularly. But for formats repeated often, like column rules, the Linotron may use its format overlay projector—a digitally addressed, random access slide projector. It holds 96 slides which contain pictorial or typeset information, as well as ruled lines. The slides are 2 inches square and are magnified to page size.

A format slide is normally selected while the type is being generated on the crt. A pivoting reflecting mirror drops into position at the completion of the typesetting and flash lamps fire and expose the projected format on the recording film. Each slide can be changed in 3.5 seconds. Formats are positioned with a repeatability of about 4 mils. Most of the operating cycle for the overlay projector is shared by other system functions so that time delays are minimized.

Linotron as an X-Y plotter

The implicit positioning system of the Linotron normally positions characters within a word after the starting point of the word has been

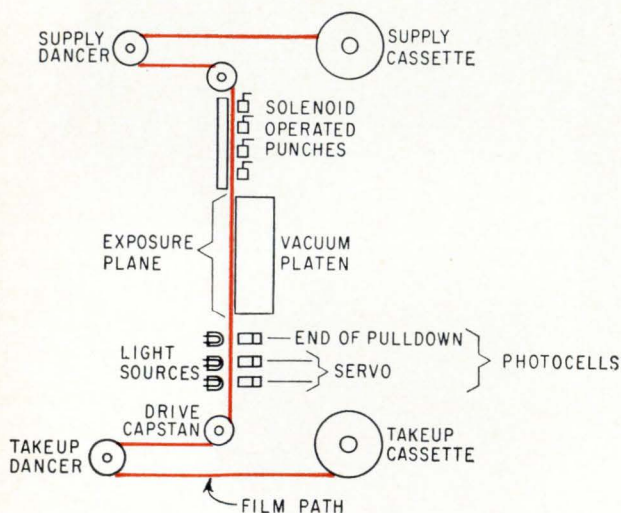

Light passing through hole punched in the film by solenoid-operated punches is sensed by servo system to determine when film has been pulled down to its selected length. Film lengths range from 6 to 8½ inches.

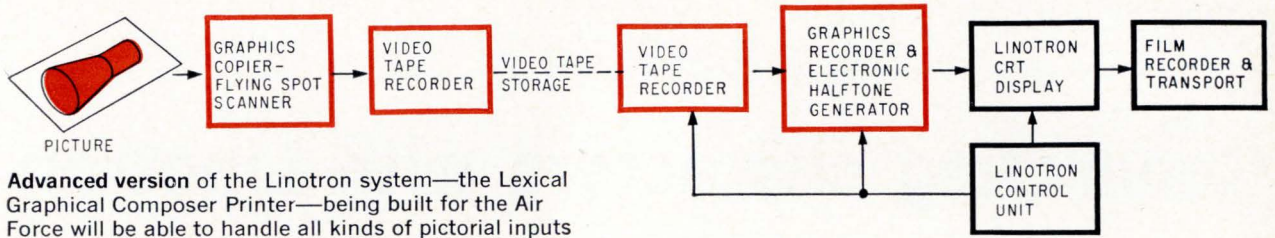

Advanced version of the Linotron system—the Lexical Graphical Composer Printer—being built for the Air Force will be able to handle all kinds of pictorial inputs with the additional subsystems shown in color.

obtained from the instructions in the tape. Under such explicit control, the system behaves like an X-Y plotter.

Coordinates for the start of columns, paragraphs, lines, and words are transferred from the tape as a 5-digit binary coded decimal words. The last significant figure corresponds to 1/18th of a point.

Explicit position codes preset the position registers and the blanked crt spot is moved to the required location by the deflection currents generated by the digital-to-analog converter.

When explicit positioning is used, the computer must calculate the correct coordinates for a word or line with respect to an origin on the page. Often it is more convenient for the computer to calculate an address as a differential change of

location from the last position in the registers. To do this, a delta positioning capability has been designed into the control system. This allows a number to be added to the position registers so that the location of the crt spot will advance from the last position by the delta address.

Another positioning method reads the implicit positioning coding only and doesn't scan the letters. The width code is converted into spacing pulses. This allows the computer to call out spacing with fewer coded instructions.

Advanced Linotron

An advanced version of the Linotron system, called the Lexical Graphical Composer Printer shown in block diagram above, is being built for the Air Force Logistics Command. In addition to all of the capabilities of the Linotron, this system will be able to process photographs. The techniques used are adaptable to a wide range of illustrations. They can even be expanded to include color separations for printing illustrations in color.

The graphic input consists of a high resolution crt flying-spot scanner which converts picture information to video signals. The video is stored on a standard broadcast video tape recorder modified to provide high resolution at slower than standard scan rates. Digital codes that describe the pictures for retrieval are also added to the tape.

The video signals corresponding to a desired picture are read out of the video tape reader into the graphics copier electronics which processes them for display on the system's crt. Precision linear sweeps are generated instead of the asynchronous jump-scan sweep used for character positioning.

The control system receives commands from the computer composition system which define the coordinates of a picture to be copied from the video tape file. As the type is set on a page, areas on the film are left blank for the pictures to be added. The blanked crt spot is moved to the space and the picture is then recorded in accurate registration with the typeset copy.

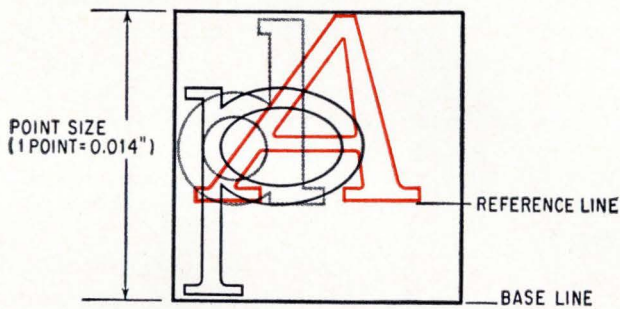

Most characters cover only a portion of the em square for a given point size. Only the segment of the square in which the character fits is scanned.

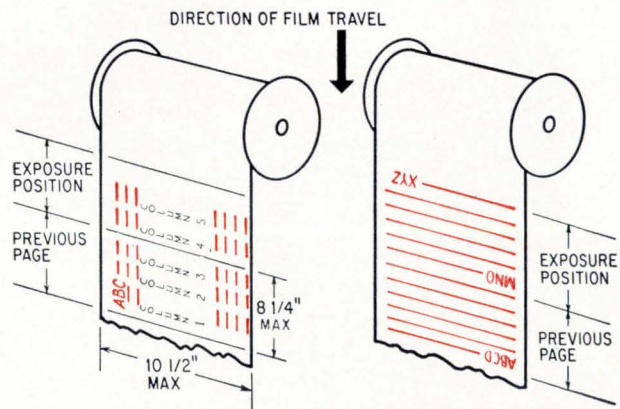

Normal printing mode on film (left) has crt display positioned on its side. This allows wide, multi-column pages to be printed. In turn-page mode (right) pages are composed after being rotated 90° so long lists of information can be printed.

References

1. J.K. Moore, et al., "Image Scanning Apparatus," U.S. Patent No. 3,274,581, Sept. 20, 1966.
2. J.K. Moore, M. Kronenberg, "Generating high quality characters and symbols," *Electronics*, June 10, 1960, p. 55.
3. S.H. Boyd, "Digital-to-Visible Character Generators," *Electro-Technology*, January 1965, p. 77.
4. R.T. Loewe, R.L. Sisson, P. Horowitz, "Computer Generated Displays," *Proceedings of the IRE*, January 1961, p. 185.

Generating characters with Linotron

Generator tube converts printing characters into sequence of video signals that trigger high-resolution crt display

By Robert A. Botticelli, Patrick F. Grosso, Arthur Sansom and Robert E. Rutherford Jr.

CBS Laboratories, Columbia Broadcasting System Inc., Stamford, Conn.

Because Linotron photocomposition is a special kind of closed-circuit television hookup, the system requires a special camera and receiver—the Linotron character-generating tube¹ and a high-resolution cathode-ray tube.

The Linotron tube resembles an array of 256 cameras, each focusing on a particular character. The characters are projected optically onto the tube's photocathode (see cover) and a beam of electrons is emitted for each. Focused through holes in an aperture plate, the beams are dissected and converted into video signals.

A switching section blocks all but one of the signals and propels the surviving signal—chosen by the Linotron system—into an electron multiplier section, from which it is routed to the crt where the character is regenerated and projected on film.

Start with 256 beams

The character grid, projected on the photocathode by a mercury arc lamp, consists of the 16 x 16 matrix of transparent symbols on a black background. When the photocathode is struck by the images of the symbols, an energy exchange releases beams of photoelectrons that have the same cross sections as the characters. These space-modulated beams are accelerated by an electrostatic field toward the aperture plate.

The photocathode, occupying a 5-inch diameter area of the 7-inch faceplate, is of semitransparent cesium-antimony with an S-11 spectral response. It has a typical sensitivity of 40 microamps per lumen, and operates at a current density of 100 microamps per square centimeter. Neutral density filters in front of the mercury lamp control the cathode illumination. Although sensitivity slowly decreases with tube operation—limiting its life—tubes have lasted upward of 1,500 hours when the photocathodes are deposited on transparent

conductive substrates.²

As the electron beams travel from the photocathode through the image section of the Linotron tube, they are focused and deflected at the aperture plate by three pairs of Helmholtz coils.³ Each electron image is scanned across a 1-mil square aperture to generate video information. The apertures convert the original 256 character images into video signals. Thus, the Linotron tube is fundamentally a multiple aperture image dissector.⁴

The coils make the focus and deflection fields uniform to within 0.1%. The focusing coil pair is about 20 inches in diameter, concentric with the tube and centered about the image section. It generates a 24-gauss field.

Varying horizontal and vertical deflection fields are produced by the other pairs of coils. The sweep fields of the deflection coils are generated by currents supplied by high-power deflection amplifiers. Linearity and stability of these amplifiers are approximately 0.1%, and they have a 1-megahertz signal bandwidth. The highest deflection-signal frequency, used for the smallest characters, is approximately 125 kilohertz. Total current in the horizontal deflection coils is 16 amperes and coil inductance is 10 microhenrys.

A mutually orthogonal arrangement of the coil pairs readily eliminates stray fields. The earth's field, for example, can be canceled simply by creating opposing fields which neutralizes its effect.

Both the magnetic and electrostatic fields must be uniform in the image section. Distorted electrostatic fields can cause the beams coming from the photocathode to be out of focus, especially beams that aren't close to the axis of the tube, shown in the schematic at the bottom of page 125.

An off-axis beam would pass through the aperture plate incorrectly, causing the crt to reproduce the character in a shifted position. In the switching section, the beam would be further effected. Part

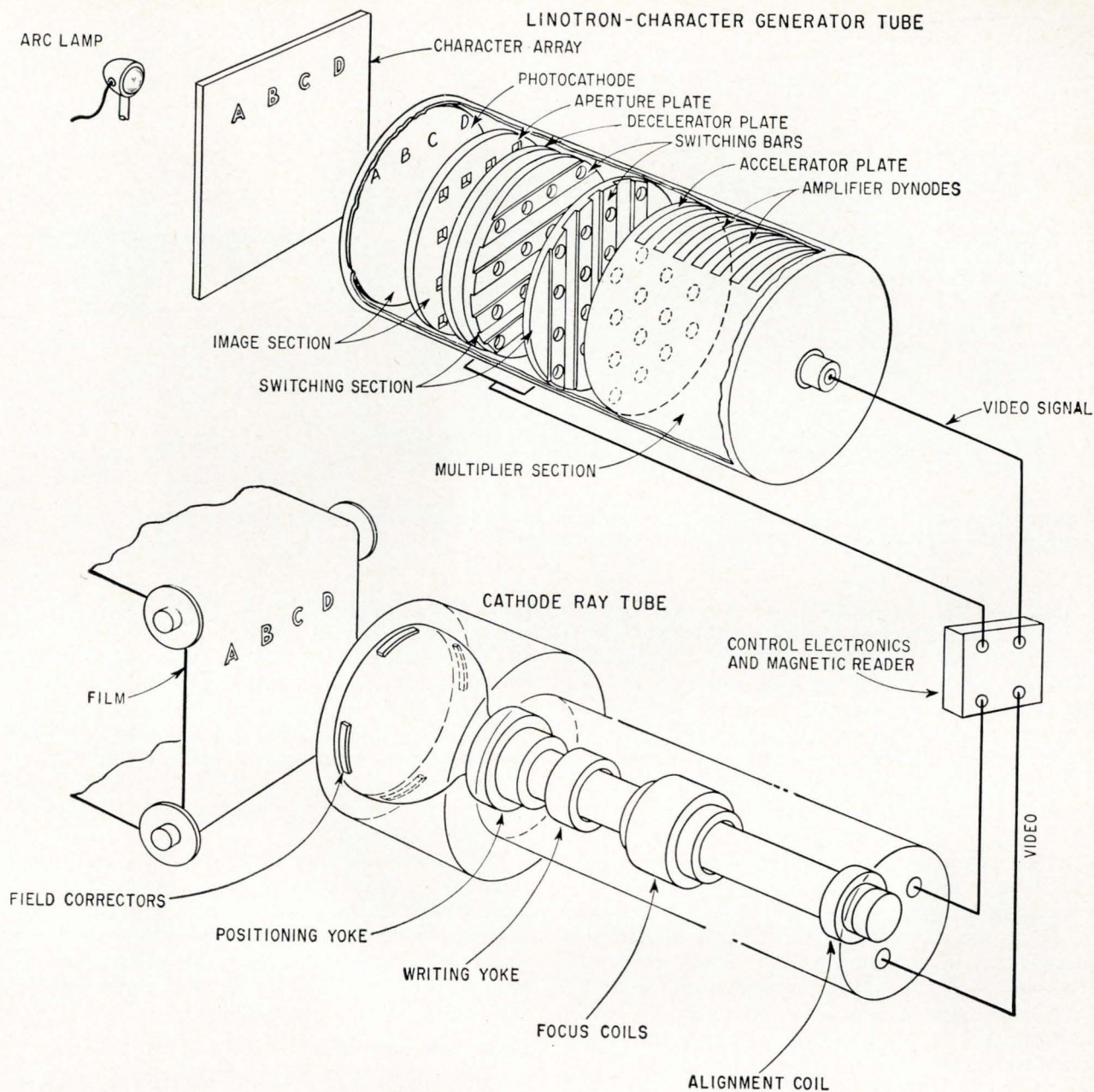

Character generator's switching section selects one of the 256 video signals representing the characters that have been projected on the tube's photocathode. The video signal is then sent to the cathode-ray tube where it sweeps out the character in its proper position on the page to be printed. The characters expose film which is developed off-line and used to make printing plates.

of it might strike the switching grids instead of passing straight through. This would result in a shaded output character or, in a severe case, no output at all.

Image at the aperture

Each symbol of the character grid has its own aperture, a hole 1 mil square, in the aperture plate. The apertures dissect the images into incremental video signals with a 5-Mhz bandwidth, when the beam scans them.

Although each of the 256 high resolution image dissector scanning tubes within the Linotron tube is associated with a single character, all are scanned in parallel. Scanning angle is only that

required to scan a single character (1.5°) so that geometric distortions are negligible.

Resolution of the tube depends almost entirely upon the size of the scanning aperture in the Linotron tube. The 1-mil-square apertures limit resolution to 20 line-pairs per millimeter. Higher resolution is not required, but could easily be obtained by reducing the aperture size. Tradeoff for this would be a reduction in the output current and a decrease in the signal-to-noise ratio.

Switching section action

The switching section—which allows only one of the 256 video signals to be accelerated toward the multiplier section where it is amplified before

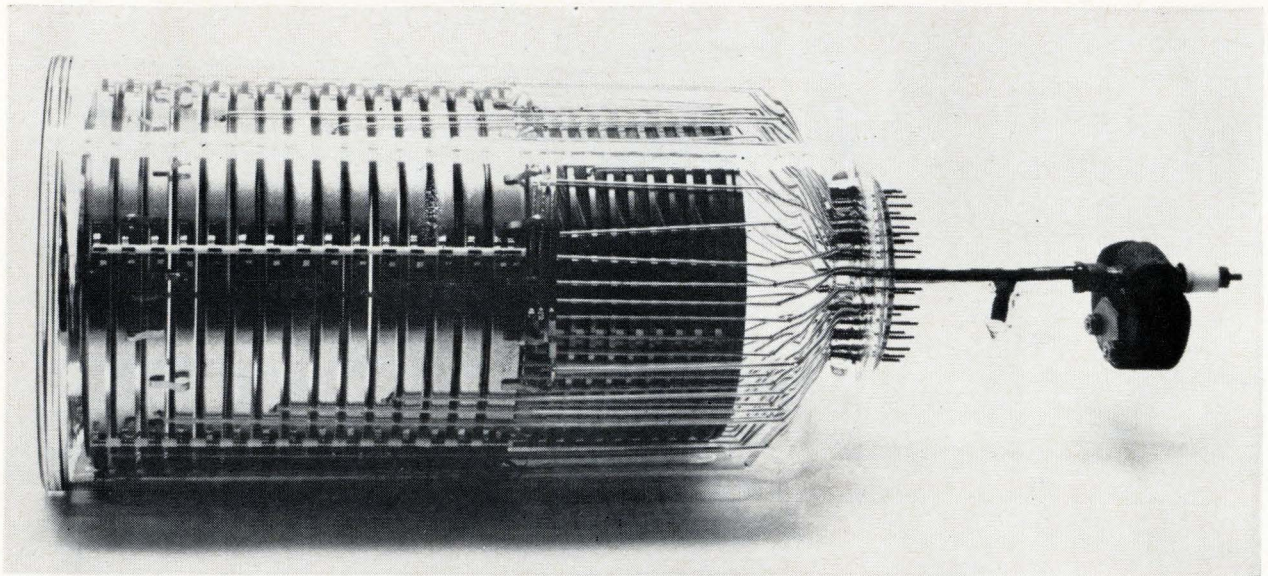

Linotron tube has 65 leads that control character selection and signal amplification. An ion getter pump, right, maintains a hard vacuum in the 13½-inch-long glass tube.

going on the crt—consists of 16 vertical and 16 horizontal stainless steel bars. Insulated from each other and placed between two field plates, the bars are 100 mils wide and 50 mils thick. In the bars are holes 60 mils in diameter that line up with the holes in the field plates and apertures, as in the partial schematic at the top of page 127.

The first field plate, directly behind the apertures, decelerates the electrons so that they pass through the section slowly and are easier to control. The second plate is held at the same potential as the first, creating a field-free region within the switching section.

The beam representing the desired character is accelerated by applying a high voltage, 100 volts compared with 30 volts on the photocathode, to one vertical and one horizontal switching bar. The other bars are kept at zero voltage. In effect, this opens only one of the holes in the switching section—at the crossing point of the energized bars—and closes the others, while propelling the selected signal through the second field plate and into the multiplier section of the tube.

Electron multiplier

A 10-stage electron multiplier amplifies the small currents obtained from the photocathode. The intensity of light falling on the photocathode and the voltages on the multiplier chain are adjusted so that the anode current at the output is 25 microamperes.

The multiplier has a venetian blind structure which is less sensitive to magnetic fields than other types.

Another advantage of this structure is that the vanes of each dynode can be spaced to match the period of the aperture rows. Each input signal enters the common multiplier at a different point and travels to the anode through its own section.

A partitioned effect is created. Each partition

is identical, minimizing the variation in anode current from different apertures.

The signal-to-noise ratio is also enhanced by this type of structure because primary electrons are focused on the lower edge of the first dynode where the withdrawal field is strongest. Secondary electrons are drawn off this emitting surface to the next dynode. The high yield of secondaries from the first dynode results in an over-all improved signal-to-noise ratio.

The transit-time spread between the individual electrons as they pass through the multiplier is large. While this spread might be a disadvantage in some electron-multiplier applications—since it limits operating frequency—it is of no consequence in the Linotron system. The tube easily handles the system's 5-Mhz bandwidth.

Long, slim receiver

The shape of the photocomposing crt contrasts sharply with the modern, 110° scan-angle, ultra-short television tube. It is approximately 26 inches long, with a nominal screen diameter of 7 inches,

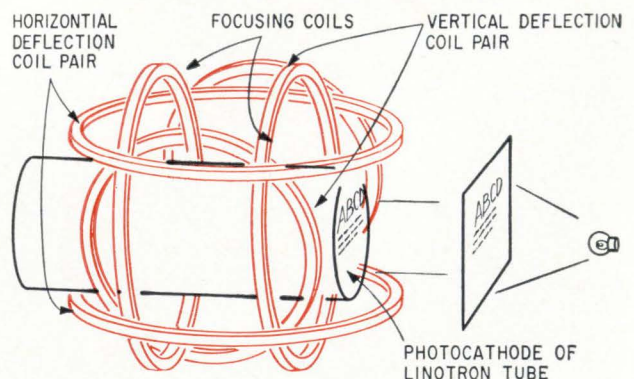

Helmholtz coils over the image section focus the beams at the aperture plate and scan them across the aperture holes.

shown at the bottom of page 127. An area with a diameter of only about 6 inches is used to display the information, which reduces the scanning angle to approximately 40°.

This smaller angle helps to keep the spot size of the beam uniform. The image on the screen is magnified 2.3 times, to a rectangular area with a 14-inch diagonal, before it is projected on the printing film.

The single-beam, high-resolution electron gun is of tetrode design and has an oxide-coated cathode. Angular spread is approximately 0.03 radians. Anode voltage is typically 30,000 v and can go as high as 45,000 v. The gun is fabricated without the limiting apertures often used to reduce the diameter of the electron beam. This means that the beam current can be high.

The beam diameter is 1/3 in. at the main focus coil. Yet at a beam current of 20 microamperes, the resolution is 24 line pairs per millimeter—a better resolution than the eye can distinguish when the film is inspected.

Extra focusing

Dynamic refocusing keeps the spot size at 1.5 mils in diameter any place on the faceplate, although the beam diameter is large as it passes through the deflection coils.

The main focus coil is 2 inches in diameter. Its large inductance makes it unsuitable for the rapid changes of focus needed to position characters at different locations on the tube's faceplate. The faceplate is flat, rather than curved so the image can be projected on the flat film. Thus, beam length changes with each character location. Without

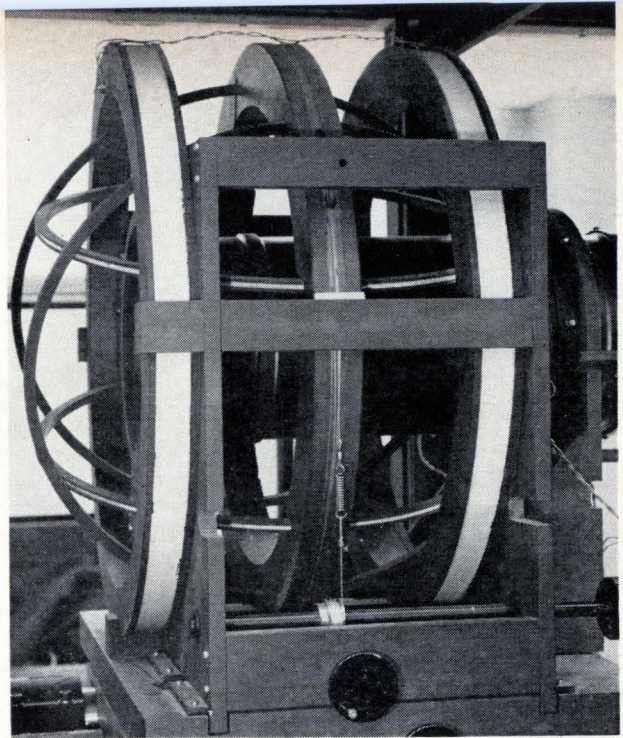

Large Helmholtz coils at the ends of the image section are the focusing coils. Between them is support ring. Two smaller pairs of coils are for vertical and horizontal deflection.

dynamic focusing, spot size would not be constant. A dynamic focus coil, driven from high-speed squaring circuits, compensates for this change in the path length of the deflected beam.

The coil is built in a low-loss ferrite case with an air gap close to the major focus coil. Sharing the major focus gap, and therefore its core material, can lead to serious problems of hysteresis and eddy currents when the focus modulation

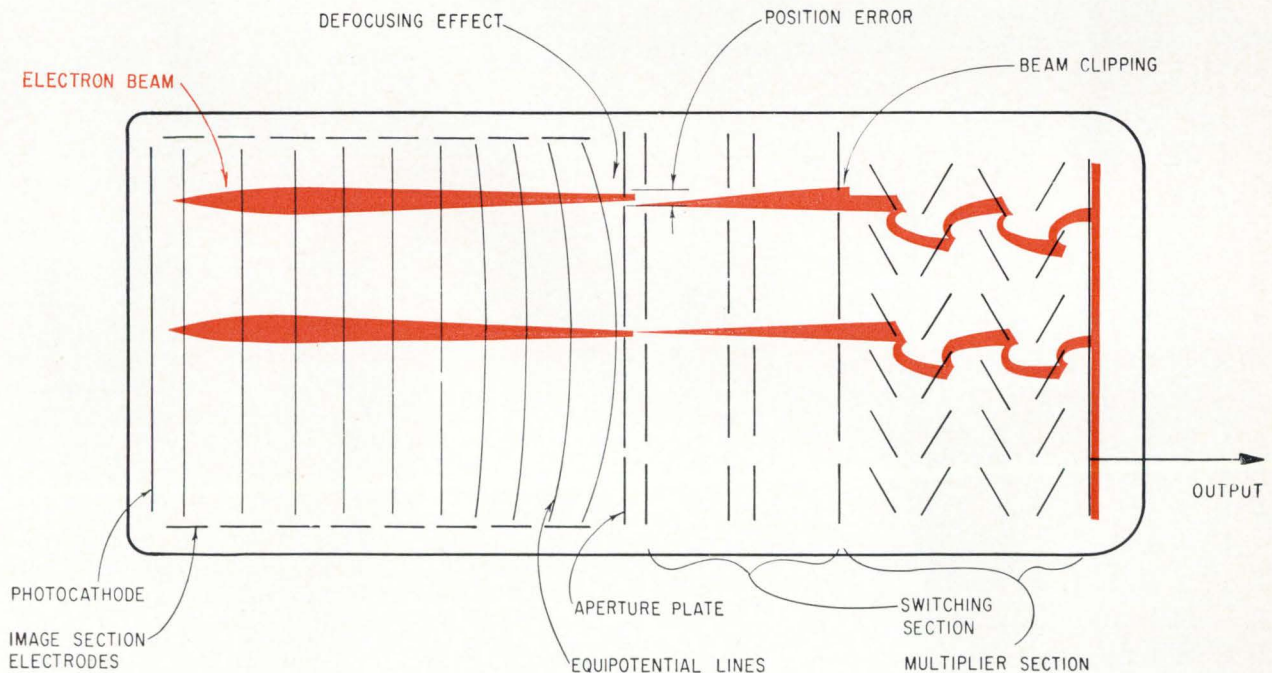

A uniform electrostatic field in the image section and the switching and multiplier sections (the beam at the center). If the field were not uniform, an off-axis beam (the upper beam) would not be focused exactly at its aperture. The result would be characters printed out of focus or with nonuniform intensities.

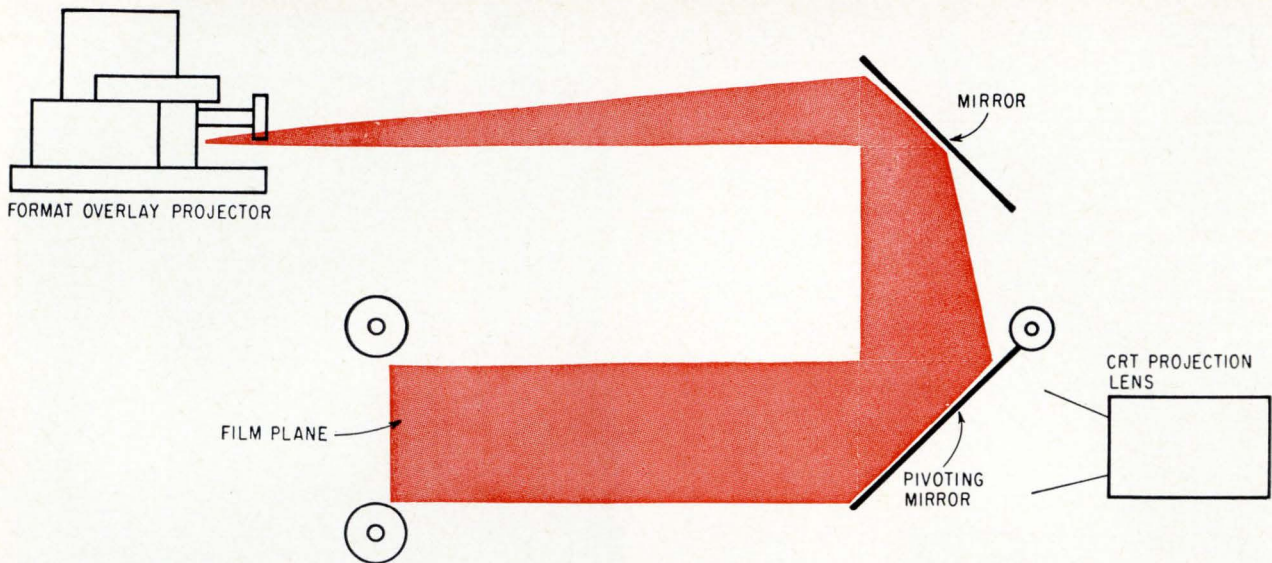

Standard overlays may be projected onto film after completed page has been composed. Pivoting mirror drops into place so that it reflects slide image from format overlay projector.

changes rapidly. Hence, both the major and minor focus current supplies must be highly regulated and stable.

This auxiliary coil has negligible residual magnetism so that central focus is regained when the dynamic coil current is removed. Astigmatism isn't introduced during refocusing. However, some may occur because of lack of circular symmetry in the main focusing field. This is corrected by a magnetic quadrupole astigmator that acts as a cylindrical lens. Now perfectly circular, the undeflected beam is directed along the axis of the tube by an alignment coil.

Character positioning

The major deflection yoke moves the electron beam into the position on the crt faceplate at



Character grid has letters and numbers in roman, italics and bold face.

which the character is to be written and holds the beam there. This position is selected by the Linotron system. The character is written by the minor deflection yoke that scans the electron beam at high speed over the small area required to display the character.

Because the deflecting fields are so well balanced there is no astigmatism, the most important spot distortion to avoid. Only a small amount of non-orthogonality (less than 0.05°) is acceptable. This is maintained by inserting a single layer sub-yoke inside the main yoke and in series with one deflection axis. This component is rotated until nonorthogonality is reduced to a level set only by the accuracy of the instruments being used to measure the defect.

The character-writing minor yoke has only a few microhenrys inductance. The deflection angles are extremely small and the minor yoke doesn't distort the focused spot. Orthogonality of the deflection axes is the same as for the major yoke, within 0.05°.

The minor yoke is close behind the major yoke to keep the off-axis distance of the electron beam minimal as it enters the major deflecting fields. Vertical and horizontal deflection axes of the minor yoke accurately parallel the corresponding deflection axes of the major yoke. This eliminates—without shielding—cross coupling between the two yokes and preserves the quality of the page of print.

Corrected positions

However, the sweep signals for the subraster generated by the minor yoke must be corrected so character size is independent of location—another requirement imposed by the flat faceplate. Both the horizontal and vertical subraster dimensions depend on horizontal and vertical location. Without correction the same angle would produce a longer beam scan near the edge of the tube than in

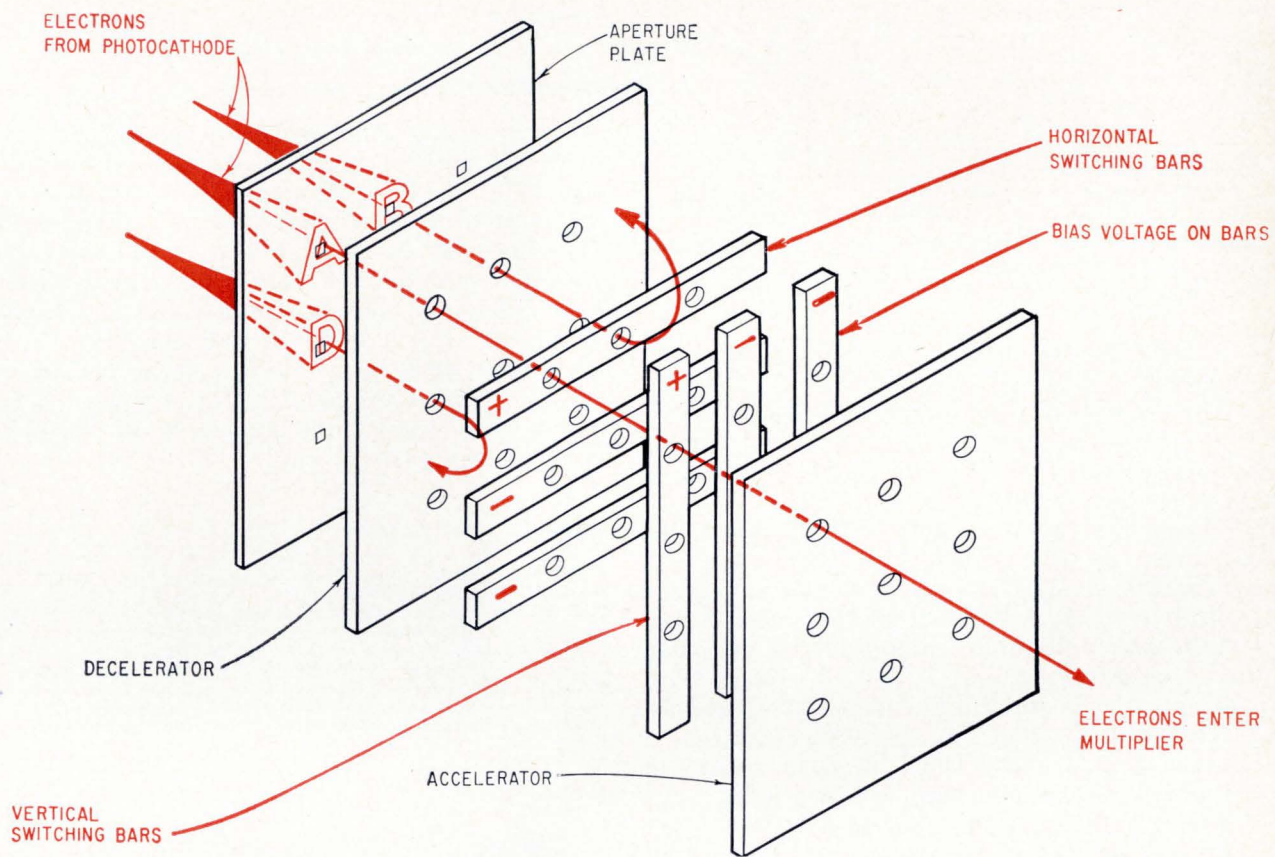

High voltage applied to one horizontal and one vertical switching bar select a beam carrying the video signal for a single character.

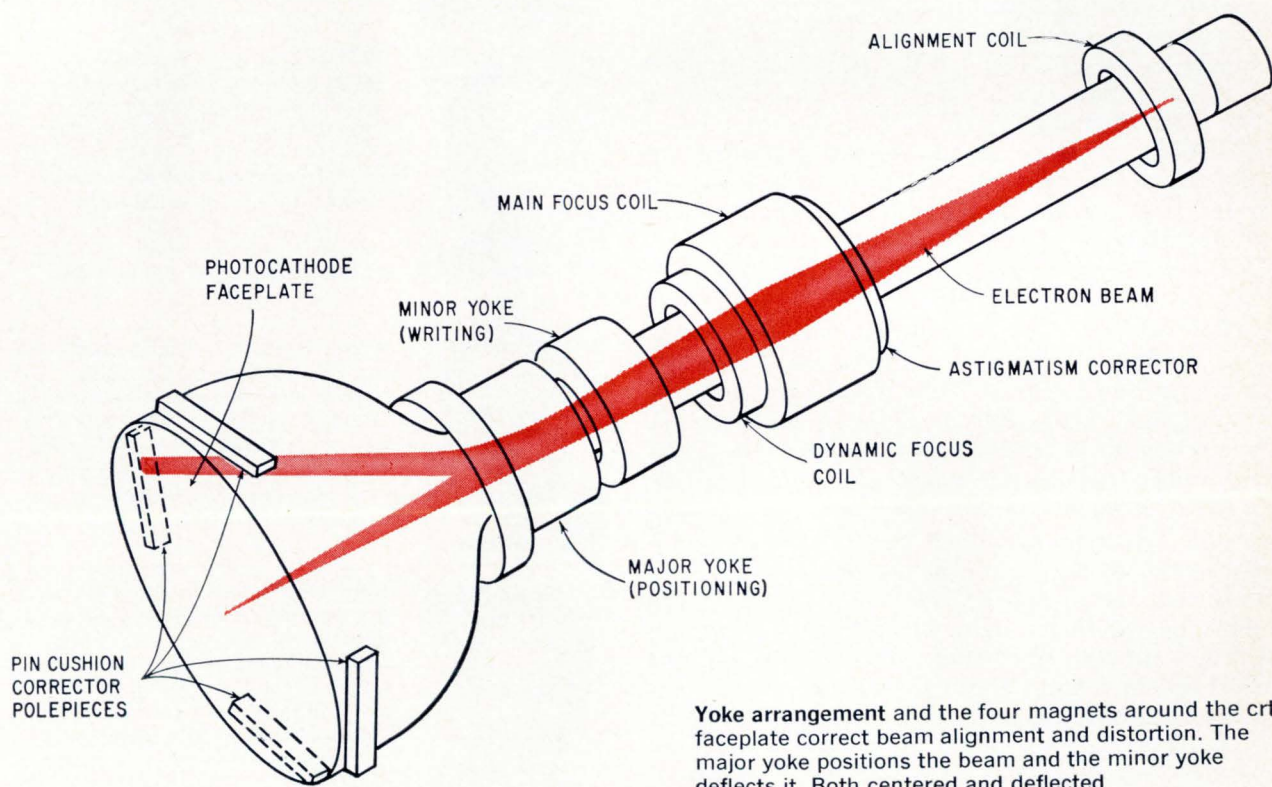

Yoke arrangement and the four magnets around the crt faceplate correct beam alignment and distortion. The major yoke positions the beam and the minor yoke deflects it. Both centered and deflected beams are shown.

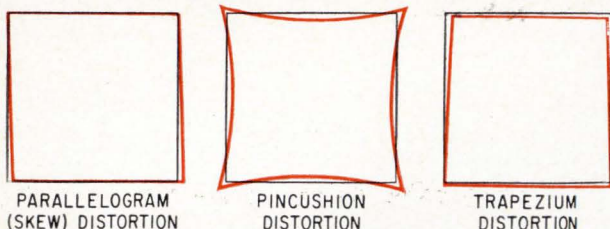

Correction of these raster faults on the crt yields displays with edges straight to within 1 mil over a 5-in-long display. Opposite sides are parallel to 2 mils.

the center and the character would become shorter and wider.

The correction is a function of $K_1H^2 - K_2V^2$, where H and V are the horizontal and vertical voltages, respectively, K_1 and K_2 are constants of the deflection systems.

The squared terms are derived from the function generators used to provide focus modulation and are added into the sweep generator amplitude control reference voltages. Deflection of the electron beam is uniform to within 0.1% for deflection angles of 20° .

Residual magnetism in the major deflection yoke is low enough so that spot displacement is only a fraction of its diameter when the beam returns to the undeflected position from full deflection.

The ferromagnetic material also permits very rapid and precise deflection of the spot between all positions on the tube face.

Raster geometry

Four separate magnetic pole pieces placed close to the phosphor plane of the crt correct pin cushion distortion, the most eye-jarring defect in a crt raster. This distortion is particularly noticeable where an uncorrected raster appears to have bowed sides. In the crt, sides of the raster are straightened to within 1 mil; corners are also located to the same accuracy.

Usually, a pin cushion corrector is close to the deflection yoke on the faceplate side where it requires less power and doesn't make the faceplate end of the tube bigger. This couldn't be done here because the correction and yoke fields would interact, distorting the deflected spot.

Parallelogram distortion is eliminated by making sure the horizontal and vertical deflections are orthogonal. Other faults, like trapezium distortion, are dealt with by aligning precisely the correction, focus, and deflection components of the tube. The undeflected beam must, for example, land orthogonally on the phosphor screen. Adequate magnetic shielding prevents stray fields from influencing the position of the beam.

A number of the currents and voltages also must be extremely stable. Possibly the most important are the alignment coil currents and the final anode voltage. Upon these depend the location of the electron beam with respect to the focus coil, main deflection yoke, and pin cushion corrector. An incorrectly positioned beam may lead to only a slight loss of resolution but the effect

upon raster shape, when the accuracy must be within 0.01%, could be disastrous.

Bright display

The faceplate and luminescent phosphor plane of the crt must be unusually uniform and blemish-free. Otherwise, the slightest fault would show up as broken or distorted characters. A fine-grain P24 phosphor ($ZnO:Zn$) is used. This material's bright emission spectrum fits well with high contrast film. The phosphor is also rugged and withstands high peak current densities and ages slowly. It emits more light than other fast decay phosphors such as a P16 ($CaMgSiO_3:Ce$), for example. Variation in light output due to granularity, or phosphor noise, is less than 2% rms.

References

1. J.K. Moore, et al., "Image Scanning Apparatus," U.S. patent No. 3,274,581, Sept. 20, 1966.
2. B.R. Linden, "A Survey of Work at CBS Laboratories on Photoelectric Image Devices," *Advances in Electronics and Electron Physics*, Academic Press, (1962) Vol. 16, p. 311.
3. Kenneth D. Granzow, "Homogeneity of the Magnetic Field of a Helmholtz Coil," Sandia Corporation Monograph, July 1960.
4. "Reference Data for Radio Engineers," Fourth Edition, International Telephone and Telegraph Corp., 1956, p. 140.

The authors



Robert A. Botticelli is a project engineer at CBS Laboratories, where he has been active in developing and producing the Linotron tube. He has a master's degree in electrical engineering from the University of Connecticut.



Patrick F. Grosso, manager of the cathode-ray tube technology section in the electron physics department at CBS Labs directs efforts in the design and fabrication of high resolution crt displays. He has a bachelor's degree in chemistry from Iona College and has done graduate work at the University of Connecticut.



Arthur Sansom is a senior physicist in CBS Labs' electron physics department where he is developing cathode-ray and line scan tubes, as well as deflection yokes and focus coils. He has a bachelor's degree in physics from the University of London.



Robert E. Rutherford Jr., general manager of the electron physics department, has been designing and developing cathode-ray image tubes for the last 15 years. In addition to the tubes for the Linotron system, he's responsible for developing the line-scanning tubes aboard the lunar orbiter satellites.



Any knob will turn the equipment on... What you need is a knob to turn the user on!

You're an electronic designer, right?

And the things you do have to be functional and economical and practical—but beautiful, right?

So, okay, you know the problem.

The company comes up with a new gimmick to revolutionize the electronic industry and they give it to you to package. You sweat over it for weeks; squeezing out the fat; streamlining; building in clean, modern lines.

And, when you are finished, it is functional, economical and practical—but beautiful.

So you build it.

And what is it that the user (and buyer)

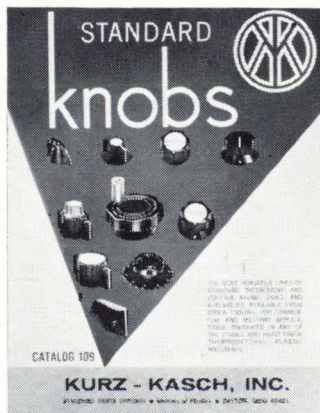

sees first, last and most often?

The knobs. If *they* don't turn him on, the whole design leaves him cold.

Kurz-Kasch knobs turn on all sorts of electronic devices produced by 3000 original equipment manufacturers. They also turn on users and designers. They're functional and economical and practical—but beautiful.

Write for the free 1967 Kurz-Kasch Designer Catalog and see what we mean.



Kurz-Kasch, Inc.
Standard Parts Division
Dayton, Ohio 45401

Reader's Choice

IEE bright, legible, wide-angle readouts:

Any characters desired

Any colors or combinations

Any input, BCD or decimal

Any input signal level

Any mounting, vertical or horizontal

Many sizes

Many configurations

Many lamp lives (to 100,000 hours)

Many brightness choices

Many options and accessories

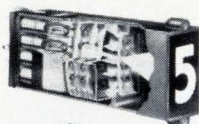

Standard Readouts: Rear projection principle, like all IEE readouts. A lamp in the rear of the unit illuminates one of the 12 film messages, and projects it to the front viewing screen. Unbeatable readability and versatility.

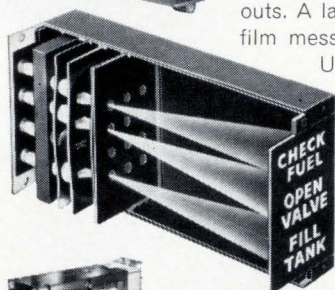

Large Screen Readouts: For reading distances up to 100 feet. Maximum character size $3\frac{3}{8}$ ".

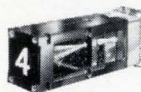

Miniature Readouts: Only 1" wide x 1-5/16" high, yet can be read at 30 feet because of clarity of one-plane projection. Character size: $\frac{5}{8}$ ".



Micro-Miniature Readouts: Only $\frac{1}{2}$ " wide x $\frac{3}{4}$ " high, but 20 foot viewing distance and maximum 175° viewing angle because of front-plane display. Character size: $\frac{3}{8}$ ".



Hi-Brite Readouts: Special lens system increases character brightness 50%. Particularly good when high ambient light conditions exist.

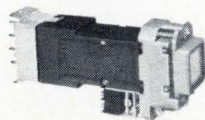

Cue-Switch Readouts: Rear projection readout with push-button viewing screen. Combination switch and display device.



Bina-View Readout: Accepts binary or teletype code, decodes, and displays the proper character.



Status Indicator Readout: Displays up to 12 different messages, individually or in combination. Viewing screen only 3 sq. in.



Indicator Assemblies: Available with up to 11 rear projection readouts, for indicating seconds, minutes, hours, days, etc.

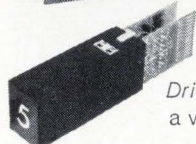

Driver/Decoder Module: Designed to work with IEE Readouts. Accepts a variety of binary codes for decimal conversion.

The new IEE Display Devices catalog gives complete information and specifications on these products, and their accessories. Ask for it.



"I-double-E", the world's largest manufacturer of rear projection readouts.

Industrial Electronic Engineers, Inc. 7720 Lemona Avenue, Van Nuys, California

Terrain-following radar that doesn't scan continuously

System housed in a startlingly small package points a beam at a fixed angle below plane's flight path. 90,000 miles of flight tests prove scanning is not necessary for safety

By Ellsworth O. Snyder

Electronics Division, the General Dynamics Corp., San Diego, Calif.

It took three years of flight-testing to settle the controversy over whether a terrain-following radar's antenna pattern should or should not scan the terrain ahead of the ground-hugging aircraft. But the perseverance paid off with the development of a system—so small it can be packed into a pint-sized black-nosed "bomb"—visible under the fuselage of the aircraft in the photo below. This system does not scan.

Production of three models of this radar which

weighs 58 pounds and is 33 inches long—only a fraction of the size of conventional terrain-following radars—recently began for the United States and British air forces.

The General Dynamics Corp. system, the AN/APN-170, is small because it does not scan. It continually points a beam at a fixed angle below the aircraft's flight path. When General Dynamics was developing the system, critics argued that this boresight technique wasn't safe—that if the air-

Navy test pilot in an A4C Skyhawk checks equipment while General Dynamics engineers look on. The terrain-following radar system is contained in the black-nosed "bomb" slung beneath the fuselage.

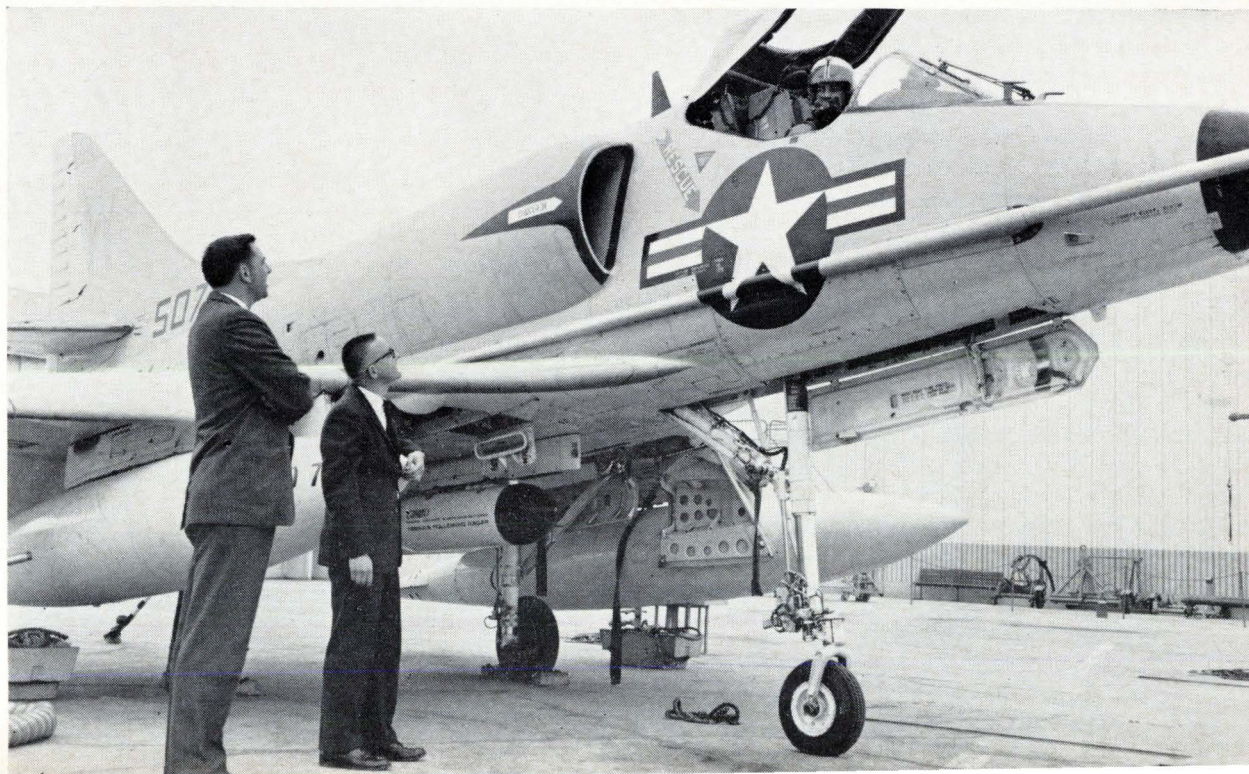

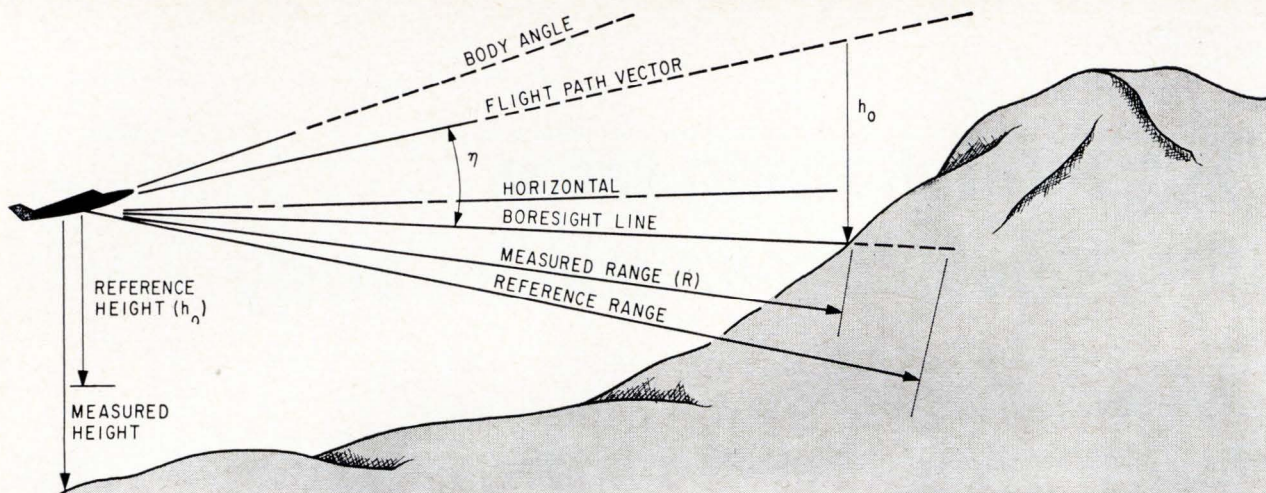

Radar antenna points at the ground ahead of the moving aircraft. The radar and altimeter return signals are compared with a reference range and height, to determine changes needed in the flight path vector to steer the aircraft over the crest of the hill. The larger angle η , the higher the aircraft flies.

craft maneuvered sharply at low altitude the radar might lose contact with the ground long enough for the plane to crash.

It hasn't happened in 90,000 miles of flight testing at altitudes as close as 200 feet above the ground. The system has been checked out over deserts, mountains, forests, water, and through clouds and rain. The radar's computing system guides the plane until ground contact resumes—and the system checks itself continually for malfunctions; if trouble occurs, the plane climbs automatically and the pilot takes over.

The elimination of scanning and the apparatus scanning requires, makes the radar less expensive, more reliable, and simpler to maintain. The beam pattern on the ground is only a succession of short pulses along the flight path, making it extremely difficult for enemy electronic countermeasures to jam the radar.

The system was designed to plug into the standard 250-pound-bomb rack of military aircraft, such as the light attack planes that bomb and strafe at low altitudes. It can also be made to hang under the fuselage or slip into the nose of a reconnaissance drone, terrain-following missile, bomber or cargo plane. Aircraft speed can range from subsonic to about $2\frac{1}{2}$ mach.

On the beam

The radar beam directed along the boresight line (as illustrated above) moves vertically as the pilot or the automatic control system steers the aircraft.

Normally, the angle η between the boresight line and the plane's direction of movement (flight path vector) is a fixed number of degrees determined by a reference height and a preset reference range, R_0 . The antenna angle is related to these references by the equation

$$\beta = \sin^{-1} \frac{h_0}{R_0}$$

The analog computer in the radar system calculates from measurements of actual range and height the rate at which the aircraft should pitch up or down to clear the terrain at the reference height.

The angle η can vary during flight. The pilot can select a reference height of 200 feet or higher. Also, the aircraft trim and its angle of attack will change with alterations in speed and load.

The antenna's gimbal is controlled by a servo-system whose inputs are the pilot's height selector switch and the angle of attack sensor. The loop has a low bandwidth, so it will respond only to long-term changes in angle of attack.

The entire system is solid state, except for the magnetron in the transmitter and local oscillator. Operating frequency is in the K_u band (15.35 to 17.25 gigahertz). Pulses are transmitted through a pair of feed horns and an 8-inch reflector at a rate of 2,000 pulses a second. Each pulse is 0.4 microsecond long.

Pitch rate commands

Return signals from the ground are received through the two feed horns and are summed and differenced in intermediate-frequency channels. Each time the difference signal changes polarity (crosses zero), a single video pulse is produced. The time between transmission of a pulse and the zero-crossing point is an analog of the range to the ground.

The 8-inch reflector produces an effective beamwidth of $\frac{1}{2}^\circ$ in elevation. If the terrain is receding, the video pulse corresponding to the nearest terrain is used for range determination (range does not normally change rapidly on rising terrain but even a small difference in beam angle can greatly increase range to falling terrain).

In azimuth, the range is the nearest ground within the $\pm 4^\circ$ beamwidth. The wider azimuth angle compensates for aircraft drift. An azimuth steering control can be added to the system to correct for drift angle.

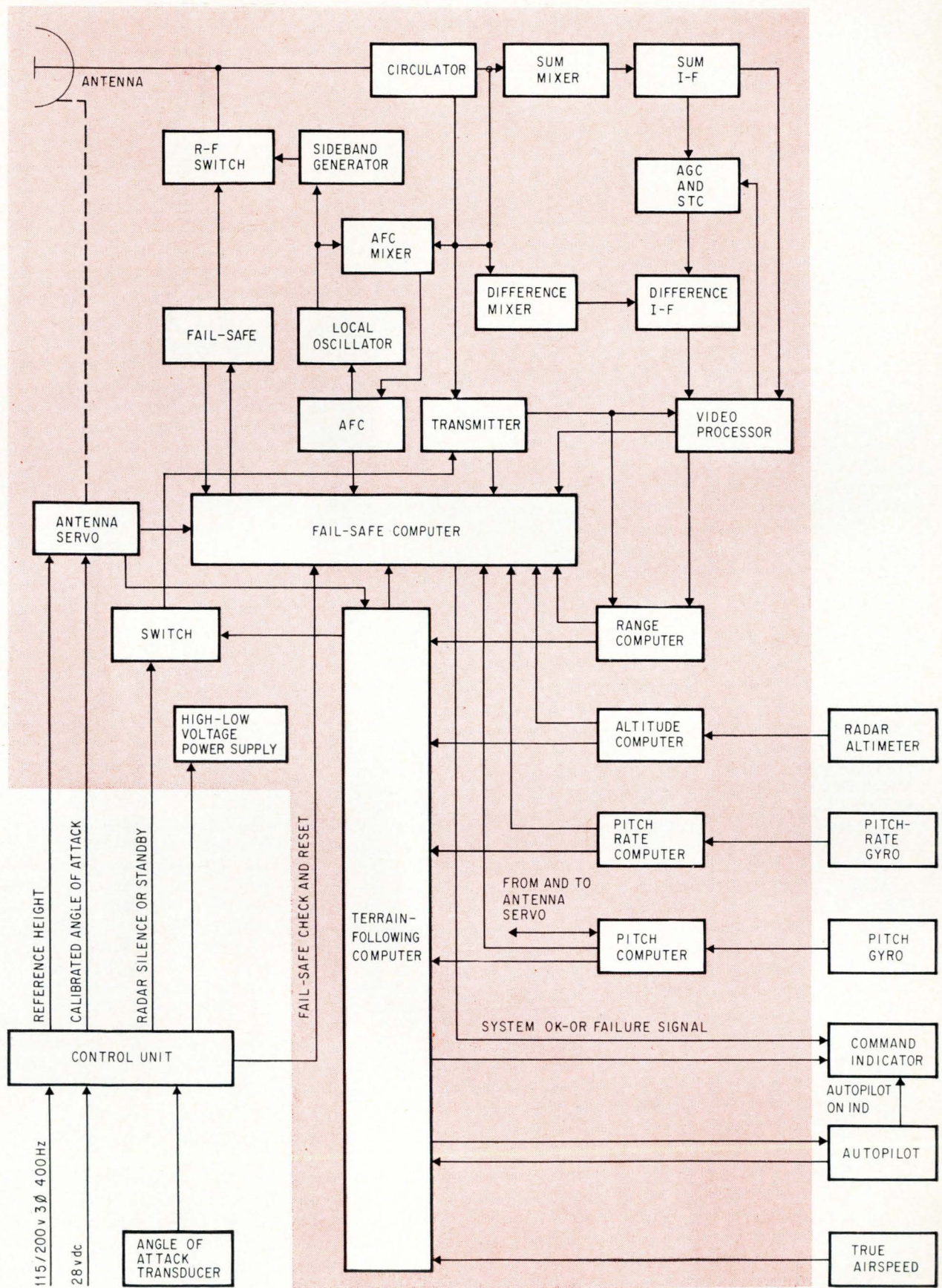

Terrain following portion of the computing system calculates the flight path changes needed to keep the plane a preselected distance above the ground, while the fail-safe portion monitors system performance. Subsystems outside of the tint block are flight-control modules normally carried on military aircraft and not part of the terrain-following radar. They provide data that the computer requires to generate control signals.

Terrain following—a short history

Before terrain-following radar was invented, pilots flying close to the ground relied on their eyes and the seat of their pants for guidance.

Conventional mapping radar allowed them to see hills and valleys in murky weather, but they had to compare the radar displays with maps before deciding when to climb or descend—a hazardous procedure in a fast aircraft.

The first breakthrough was the clearance-plane display, which “painted” on the radarscope the terrain above a preselected altitude to warn the pilot of approaching hills. These displays evolved into the terrain-avoidance systems that are now operational on the B-52 bomber, the R5A reconnaissance plane and the F-104 and F-105 fighters.

The method of gathering azimuth steering data for terrain avoidance is a good one—azimuth scanning of a narrow, verticle monopulse radar beam. Processing of off-boresight return signals gives vertical angle measurements. However, the narrow vertical coverage of the beam makes it difficult to obtain the vertical steering data needed if the aircraft is to follow the terrain closely.

Hugging the ground. Terrain following improved with development of radars that scan a narrow monopulse beam through a wide vertical angle. Ascent and descent commands are computed from a range and angle measurement of the terrain ahead. As a backup for the pilot, an E-scope displays the angle or height of the terrain profile contrasted with range.

The radar can be switched to a horizontal scan if the pilot wants a clearance-plane display for terrain avoidance. The AN/APQ-99 in the RF-4C and the AN/APQ-115 in the A7A attack plane also provide a mapping display. Two identical

radars are sometimes used in a plane so that terrain avoidance and terrain following can be done simultaneously.

Because the antennas of these radars can scan horizontally or vertically, supersonic aircraft can be guided over any type of terrain.

The AN/APN-170 does not have that mission flexibility because it does not have a scanning antenna. But it is a simpler system mechanically and it also gives the aircraft greater immunity from enemy countermeasures. The beam is harder to detect since it does not repeatedly sweep an area on the ground. It takes a brief look at each spot, but the look is longer than a scanning radar's. Therefore, the AN/APN-170 obtains more ground returns during each look period, has a higher signal-to-noise ratio, and sees the terrain more clearly.

The latest thing. The most recent advance is the phase interferometer, a radar that takes a broad look at the terrain and shows it to the pilot on a psuedo three-dimensional display. It can be used for both terrain avoidance or terrain following and to create other desired pilot displays.

Terrain is illuminated by a wide vertical beam that is scanned mechanically only in the horizontal plane. The angle and range to all the terrain in the beam pattern is sensed in just one pulse period. Azimuth angle and elevation angle, or height, provide the first two dimensions of the display.

To show the third dimension, range, the elevation angle at each of several fixed ranges are presented as the beam scans in azimuth. These terrain profiles, transverse the aircraft velocity vector, guide the pilot in azimuth. The profiles are generally varied in intensity, so they are in shades of gray that help the pilot interpret

the display.

An “impact point” can be displayed to tell the pilot how to steer vertically but he generally relies on command and reference signals superimposed on the display. For automatic terrain following, vertical command data is processed with autopilot signals. This type of radar is being used in the A6A, C-5A, CH-53A, and in the new integrated avionics systems for helicopter (IHAS) and light attack aircraft (Ilaas).

Generations to come. Electronically scanned, phased-array radars are being developed. These multiple-beam systems can gather more data than conventional radars. Better computing algorithms and control techniques are also being studied. If array radar proves to be accurate enough, planes could be automatically steered over or around obstacles at lower altitudes and higher speeds. The hazards of “terrain clobber” and detection by enemy defense will be lessened.

The Army Electronics Command at Fort Monmouth, N.J. is working on systems that scan 360 degrees. Helicopters need such systems because they must fly very low and make tight turns. Laser systems are also being developed in an effort to improve angular resolution and detect small targets.

The Navy's development centers are the Naval Avionics Facility in Indianapolis, the Naval Ordnance Testing station at China Lake, Pasadena, Calif., the Aerial Materials Laboratory at Northwestern University, Evanston, Ill.

Many other organizations and individuals have contributed to radar development. But the pioneer in all aspects of low-level flight systems is the Cornell Aeronautical Laboratory, in Buffalo, N.Y., supported principally by the Air Force.

A new range determination is made with each pulse transmitted. Each range sample is stored in a detector until the next measurement is made. The output of the detector is restricted to useful range rates, which keeps noise in the system down.

Measured range is compared with the reference range and a pitch-rate signal is generated. The reference range is a system constant based upon the aircraft's flight characteristics, such as its rate of climb, and the worst terrain the aircraft will

encounter. In addition, the height above ground measured by an altimeter is compared with the reference height, and a second pitch-rate signal is generated. A majority-voting circuit compares the two pitch-rate signals and selects the more positive or less negative of the two.

One more computation is required to produce the pitch-rate command signal. The output of the voting circuit is compared with the aircraft's actual pitch rate, obtained by the computer from other

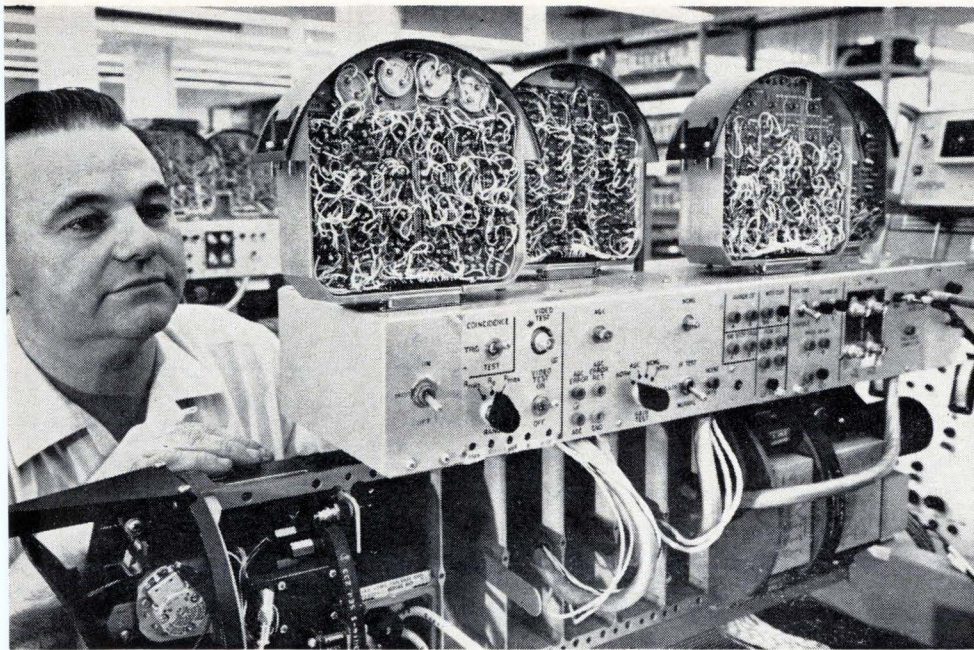

Radar system taken apart for tests and adjustment. The antenna, its gimbal drive, and the transmitter are at the left and the power supply is at the far right. Plug-in signal processing modules are on top of the test rack.

Production models of the AN/APN-170. Technicians at the General Dynamics San Diego facility tighten tie-down bolts before final assembly of the radar in its pod.

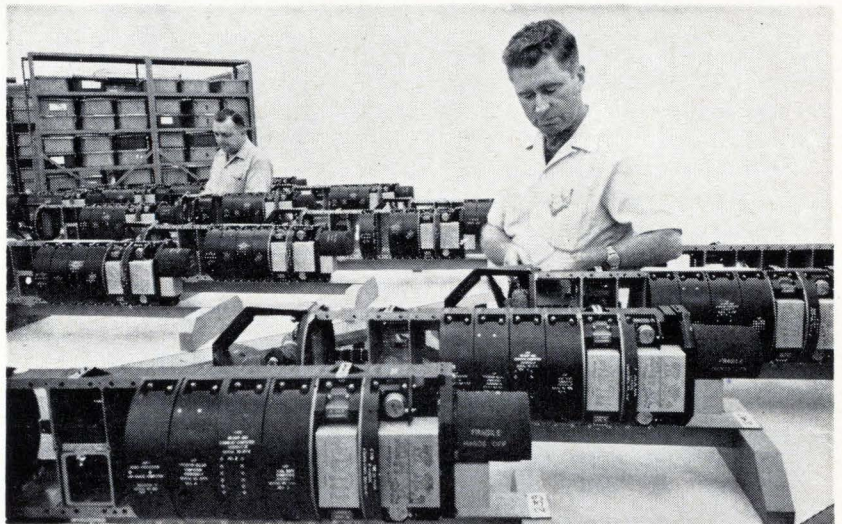

sensors on the aircraft. The error, or difference, between the two rates is the amount of adjustment required.

The error signal is applied to a cockpit indicator, such as a zero-center flight director, to guide the pilot if he is flying manually. The signal can also modulate a 400-hertz carrier wave to provide an input to an autopilot or be applied to an elevator control system. The time it normally takes a pilot and the controls to react is compensated for in the command signal processing.

The selection of the more positive pitch signal is an extra margin of safety, since it tends to put the plane into a steeper climb or shallower dive. As another precaution, the computer takes into account the dive-angle limit of the type of aircraft carrying the radar and eases the pitch-rate command to zero as the dive angle approaches the safe limit. Otherwise, a continuing negative pitch rate would produce a steeper and steeper dive.

Suppressing the vertical side lobes in the beam

pattern and concentrating the transmitted beam energy close to the boresight line prevents returns from the ground below the aircraft, or from high terrain to either side of the flight path from interfering with the boresight returns. This raises the signal-to-noise ratio and improves ranging accuracy.

Side lobes are kept a minimum of 25 decibels below the power of the main beam by the shape of the reflector and feed horns. In addition, an r-f absorber is used to help control the shape of the beam and minimize the effect of the aircraft body on the beam.

The reflector and feed horn shape also keeps null depth low, contributing to the effective sharpness of the vertical beam width. Null depth is the difference in power and phase angle between two adjoining beam patterns. A difference channel null 24 db below the sum channel peak is typical in the AN/APN-170.

When the plane approaches the top of a hill,

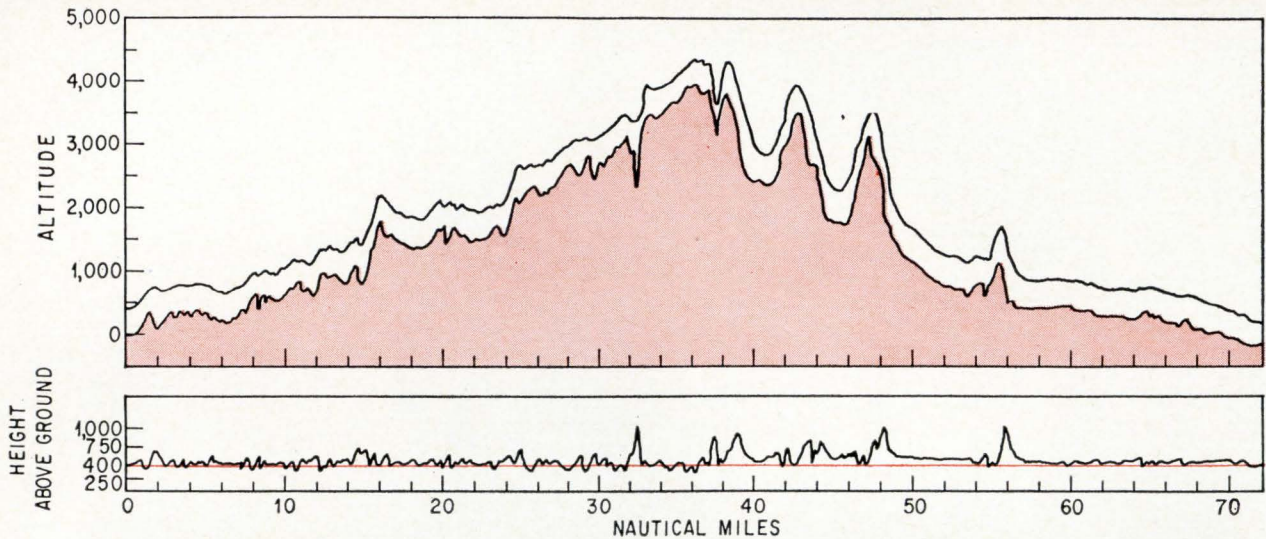

Flights are simulated in a computer to aid in system design and performance predictions. The Laguna Mountains near San Diego are profiled in color. The line above the mountains is the simulated flight path of a plane guided by the radar. How well the plane held the desired height of 400 feet, at a speed of 250 knots, is indicated on the bottom chart.

the beam will point into space. To prevent the plane from nose-diving to get the beam on the ground again, the computer calculates how long it will take the plane to fly over the crest of the hill at the reference height and does not issue a pitch-down command until that time has elapsed. At the moment radar contact is lost, the aircraft's position, velocity, and climb angle are stored in the memory and used in the computation.

The plane's velocity vector is held constant, so its climb will be aimed at a point higher than the reference height over the expected position of the crest. The excess is computed so that as the plane passes over the crest it levels out to the reference height. The pitch negative continues until the radar altimeter generates a pitch-up signal. Then, normal terrain following resumes.

Return signals will also be lost when the plane is skimming above calm water or barren desert flats. The radar beam will bounce forward. In this situation, the altimeter provides the control signal until the radar detects an obstruction.

Fail-safe

The computing system has redundant circuitry and is designed for fail-safe operation. Should a malfunction occur, the computer sends a pitch-up command to the flight control system. A cockpit light alerts the pilot and he takes over control of the climbing aircraft.

Receiver performance is continually monitored during flight. The system tests itself by sampling the radio-frequency signal from the local oscillator and shifts r-f frequency to the transmitter output frequency. The test signal is made slightly higher in amplitude than the receiver threshold and it is delayed so that it has the same r-f time history as a typical target at a fixed range.

This signal is fed into the receiver input wave-

guide at the end of every pulse period and processed in the same way as real target signals. If the output of the video stage has the same time and amplitude as the test references, the system's accuracy, gain, and continuity are known to be good.

The computer checks air speed, pitch, pitch rate, and aircraft angle of attack against preset limits and continually monitors the autopilot's error signals. For the pilot, there is a go-no-go indicator; for maintenance men there are latching flag-failure indicators to pinpoint trouble spots. All of the radar circuits are replaceable cordwood encapsulated modules on nine plug-in chassis.

Simulation proves design

The original design was "flown" hundreds of thousands of miles in computer simulations as a preliminary to flight tests and to correlate flight test data. The profiles of one simulated flight over the Laguna Mountains near San Diego, Calif. and an actual flight over the same path are displayed above. Simulation is used now to determine the modifications needed to tailor the radar operation to a particular type of aircraft, to show the user how the system is expected to perform, and to compare predicted and flight performance as a measure of design validity.

The author



Ellsworth O. Snyder designs control and digital programming systems for terrain-following and stationkeeping radar. Before he joined the General Dynamics Corp. in 1960, he worked on radar, control, and counter-measures equipment at the Naval Research Laboratory in San Diego, Calif.

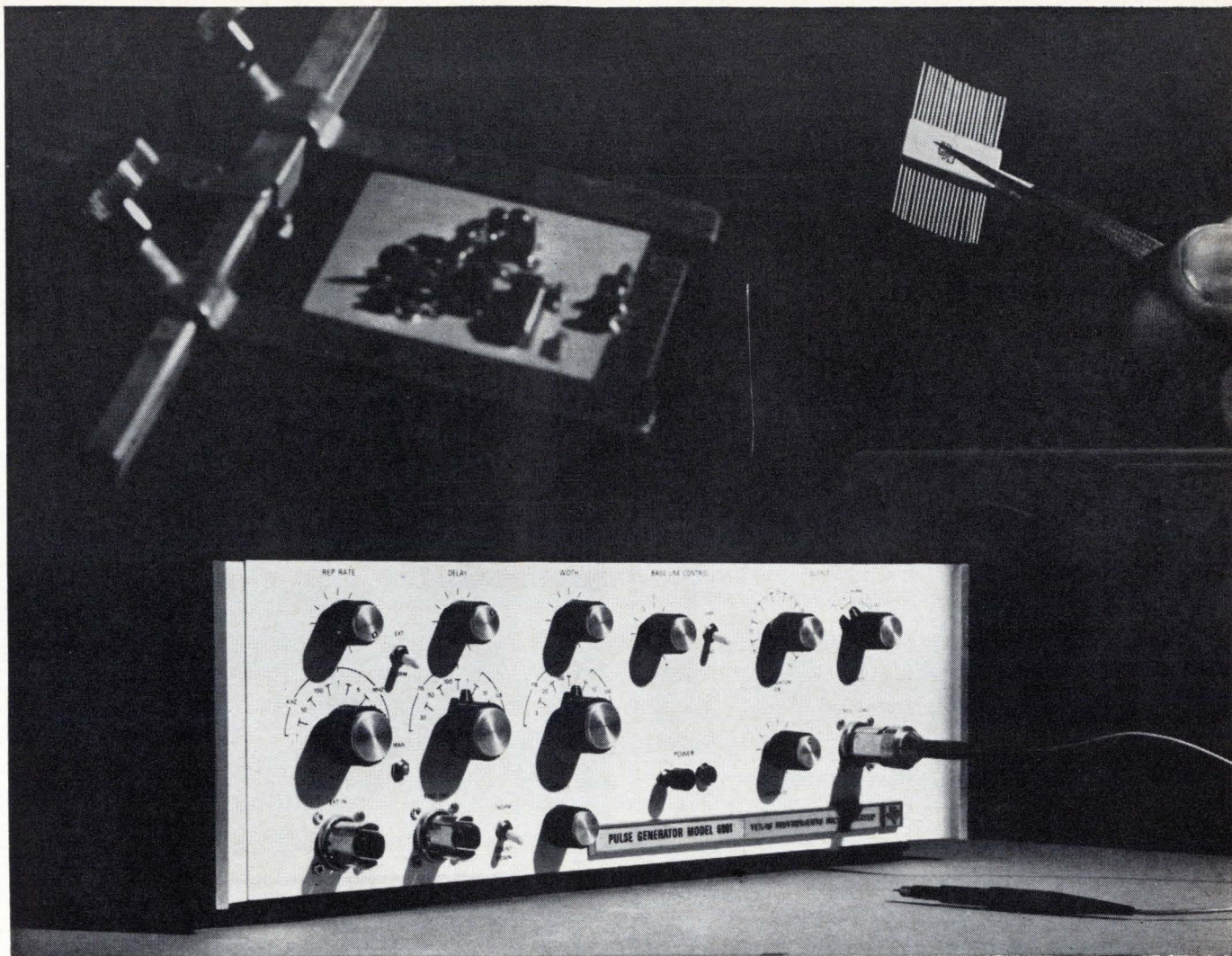

Why You Need a Special Pulse Generator for State of the Art Circuit Design



With high speeds and critical design parameters, you need the best test instruments to be sure your designs will be optimum. The TI Model 6901 Pulse Generator gives outputs from 1 KHz to 0.1 GHz; independent amplitude and baseline controls; jitter less than 0.1% of period + 50 psec; and countdown synchronization output.

The 6901 makes your designing simpler, too. Because the pulse amplitude of the generator can be changed without affecting DC offset, you can use the offset instead of an external bias supply for your circuit.

All this, and a price of only \$1950. For more information, contact your TI Field Office, or the Industrial Products Group, Texas Instruments Incorporated, 3609 Buffalo Speedway, Houston, Texas 77006.

TEXAS INSTRUMENTS
INCORPORATED

827

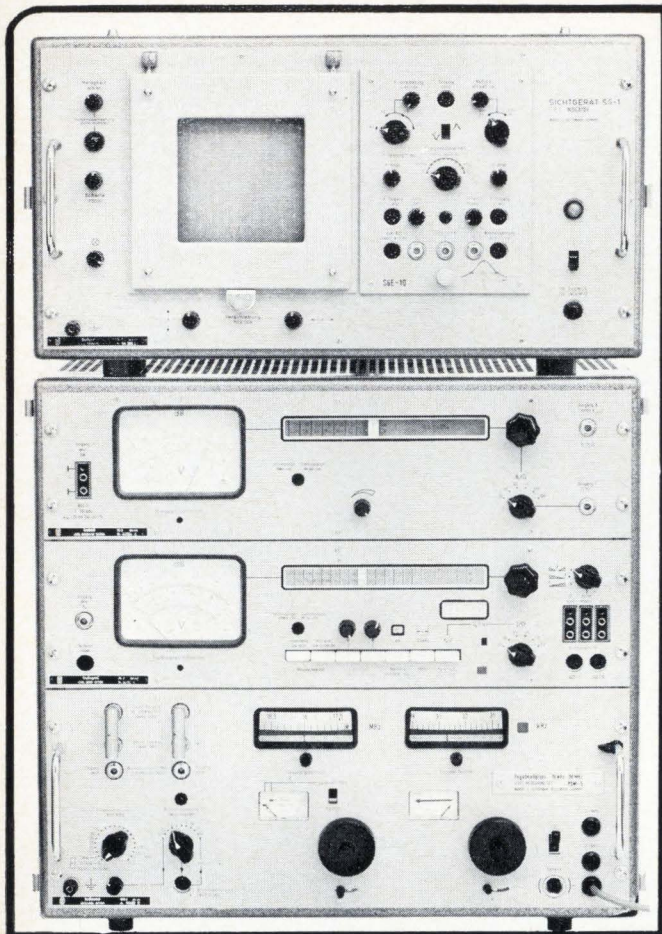

-130 db
Sensitivity
Sweep System
10 kHz-36 MHz

THE NEW WANDEL u. GOLTERMANN MODEL WM50

OFFERS FILTER MANUFACTURERS AND DESIGNERS A UNIQUE INSTRUMENT FOR LABORATORY AND PRODUCTION APPLICATIONS PROVIDING:

- **100 db FULL SCREEN DYNAMIC RANGE (LOGARITHMIC)** 0 db reference can be set from +20 to -30 db. Linear presentation also selectable from the front panel.
- **0.02 db RESOLUTION** through built-in times 10 scale expansion with zero suppression - one db full screen. Expanded scale meter accessory is also available.
- **SYNTHESIZER TYPE FREQUENCY CONTROL** for setting center frequency to ± 10 Hz accuracy.
- **± 17.5 Hz TO ± 17.5 MHz SWEEP RANGE** in nineteen adjustable ranges, with sweep rates adjustable down to essentially zero.
- **ELECTRONIC CURSOR** line can be switched in to measure level at any point on the display with meter accuracy (markers can also be displayed to measure frequency).

TEL-COM
INSTRUMENTS, INC

U.S. Agents for Wandel u. Goltermann

17715 CHATSWORTH STREET • GRANADA HILLS, CALIF. 91344 • PHONE (213) 360-2278
 2171 MORRIS AVENUE • UNION, NEW JERSEY 07083 • PHONE (201) 964-1373

WuG also manufactures a complete line of transmission measuring equipment including frequency selective voltmeters, level generators, delay distortion measuring systems, attenuators and noise loading systems.



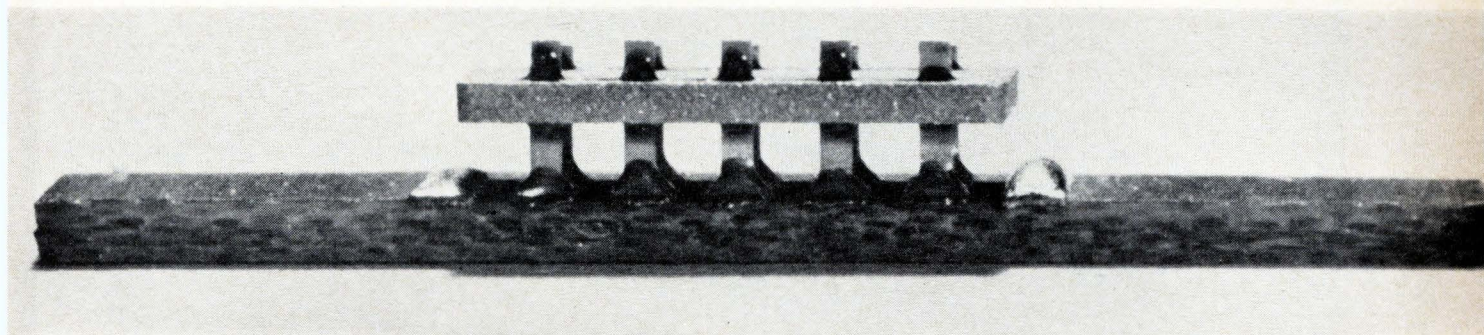

Manufacturing

Batch packaging speeds system assemblies of IC's

Package sheets permit the preparation of up to 100 integrated circuits as a unit, while axial-lead designs allow the economical assembly of the bits and pieces of a system by a dunking in hot peanut oil

By Robert B. Lomerson

Flying L Co., Saginaw, Texas

Difficulties faced by a systems engineer in designing and choosing integrated circuits for a complex electronic system have their counterparts on the production line—the problems of economically assembling the bits and pieces without restrictions on how many circuit leads the designer can use or how closely he can put the circuits together. What's needed are batch-packaging and batch-assembly techniques as efficient as the batch-fabrication procedures used to make IC's.

New package designs put the assembler in sight of his goal. Scores of packages as small as conven-

tional flatpacks, $\frac{1}{4}$ by $\frac{1}{8}$ inch, can be packed tightly together on a printed circuit board, and their leads can be soldered simultaneously to the board by immersion of the entire assembly in hot peanut oil. This quick and inexpensive process is possible because the leads—whether on packages for monolithic IC's, hybrid IC's, or large monolithic arrays¹—emerge at right angles to the bottom of the packages. The distance between package leads can be as small as 5 mils (0.005 inch).

The axial-lead designs have also led to the development of batch-fabricated matrixes—or sheets—of 100 packages, a number that is expected to grow to 200. These package matrixes can be handled as a unit during the production, hermetic sealing, and testing of the IC's. Afterwards, the matrix can be cut into individual packages or groups of packages, magnetically “glued” into place on a circuit board, and mass soldered in hot oil.

French-fried flatpacks

The reflow method of soldering has jokingly been called “french-frying the flatpacks,” but it is a safe

The author



Robert B. Lomerson founded the Flying L Co. to exploit his maverick packaging ideas. He studied geology, but soon switched to ceramics and metals. He was manager of packaging at Westinghouse Electric Corp. and earlier worked on packaging at Texas Instruments Incorporated.

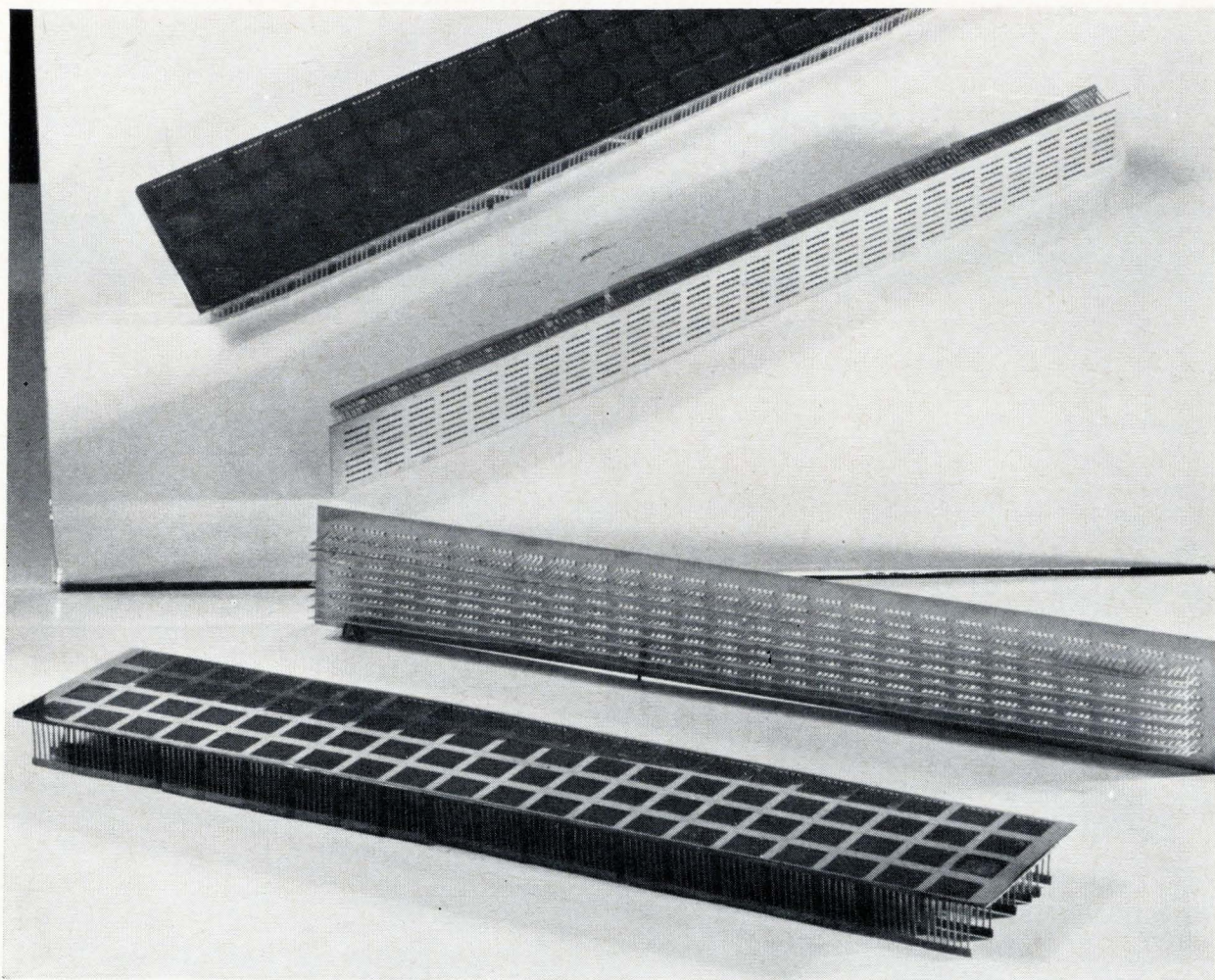

Matrixes of 80 Isopaks (front) and 100 Axpaks. Isopaks have a glass insert on which thin-film circuits or leads for flip-chip monolithic circuits can be deposited. Mirror image of the Axpak matrix, in the center, shows the axial leads sealed in glass-filled slots.

and extremely economical way of making IC assemblies. It takes only a few minutes and requires very little tooling. A complex package—for example, the 60-lead package on page 141—can be soldered as quickly as can a package with 14 leads. The technique of making solder joints with hot oil has long been used in other applications.

While planar circuit board assemblies are most economical, the packages can also be assembled individually in very compact, three-dimensional assemblies. The cost of the 3-D assemblies should be about one-tenth the cost of conventional 3-D modules of stacked flatpacks or planar modules made by attaching flatpacks to multilayer circuit boards. The cost of a package worth of interconnections is expected to run as low as 10 cents, against the \$1 or more for other high-density interconnections.

The savings result from merging the 3-D and multilayer approaches into a new form of wiring matrix. Instead of stacking the flatpacks, tiny circuit boards are made and stacked; the packages plug into the sides of the stack. Four-stack modules can contain as many as 16 IC packages in 0.122 cubic inch. A density of 130 packages per cubic

inch can be achieved if the stacks are plugged into a circuit board.

Axial-lead packs

Both the package and stack types of matrixes are being developed to exploit the Flying L Co.'s Axpak for monolithic IC's, and the Isopak with a glass substrate for hybrid IC's. The large-array packages are a special form of Isopaks.

All have leads emerging from the base at right angles to the base. When the leads are cut short, the packs can be butt-soldered to a circuit board or put into a stack. With radially bent leads, they can be assembled in conventional ways.

When these packages were made as individual units, the cost of a 1/4-by-1/8-inch flatpack was 44 cents.² Mass-produced in matrix form, they would cost about 7 cents, compared with 25 cents for a conventional flatpack, excluding tooling for custom production.

Methods of hermetically sealing IC's in the packages were developed in cooperation with the Hughes Aircraft Co. Several systems manufacturers are studying these mass-assembly techniques.

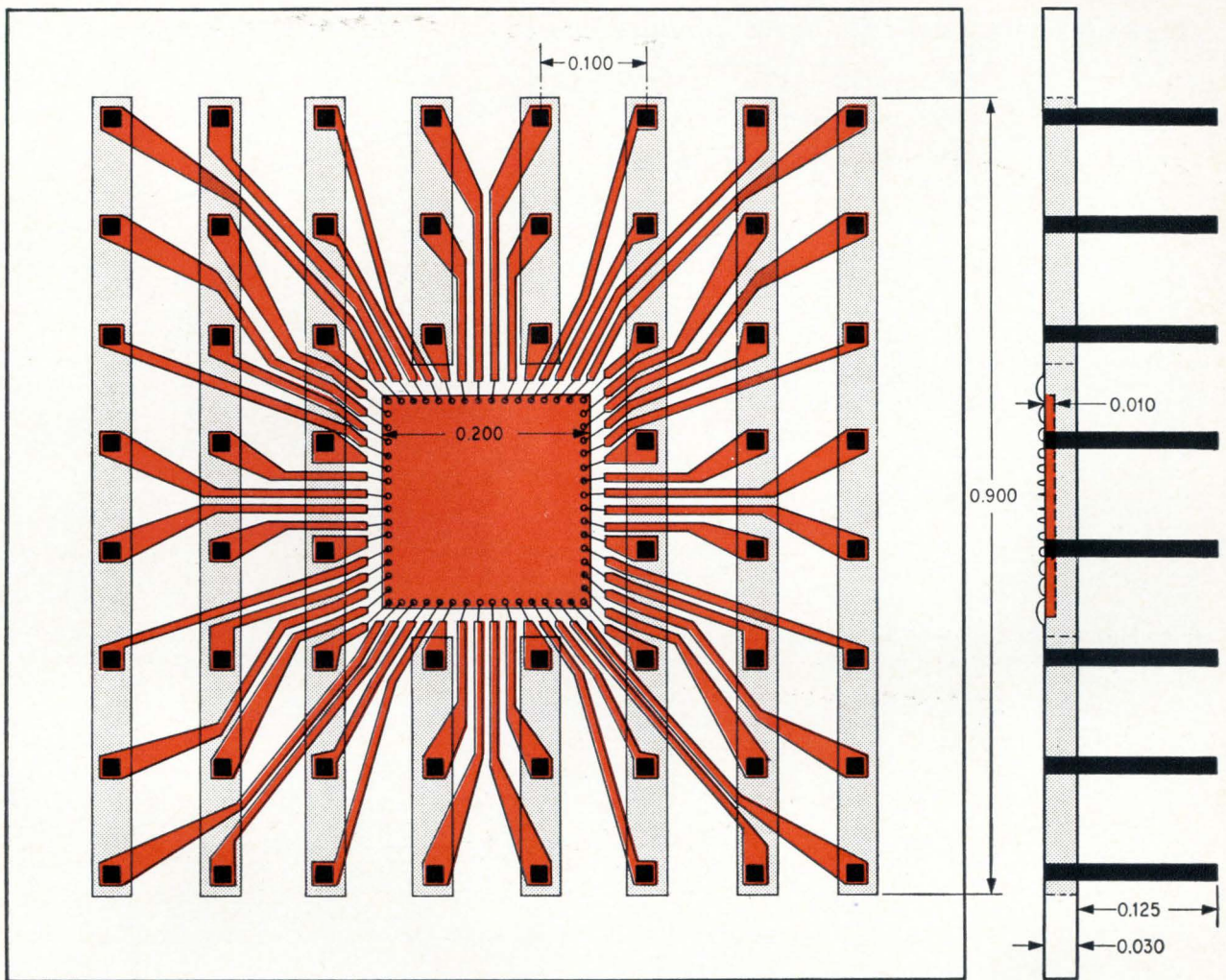

Complex package designed for large integrated-circuit array has leads spaced 100 mils apart. A special form of Isopak, it will have printed connection fingers (color) running from the circuit to square package pins.

The package designs run counter to the trend toward larger IC packages. In an effort to lower assembly costs, many systems manufacturers have adopted the molded dual in-line package (DIP), which is 0.7 inch long and has leads spaced 100 mils apart. However, the price for increased system size, reliability, wiring delay, and so on, may be too high. Then, the manufacturer must usually stick to flatpacks with 50-mil lead spacing in high-density assemblies that are costly to produce, and these assemblies impose thermal and other design problems.³

The matrixes and stacks sidestep the disadvantages of DIP's and flatpacks, and should make simple IC's in 10-lead and 14-lead packages competitive with multifunction IC's so far as cost and reliability. Lead spacing can be cut to 25 mils without making assembly difficult. The stacks won't even require soldering or welding; one version proposed would have friction contacts for the package leads.

Package matrixes

A standard Axpak matrix (page 140) is about 1 inch wide by 8 inches long and contains the bases

(headers) of 100 packages for monolithic IC's. Each ¼-by-⅛-inch package has 10 leads with 50-mil spacing; two more leads can go at the ends of each package to provide 14. With tighter spacing, additional leads can be placed on a ¼-by-⅛-inch package.

The leads, generally Kovar, molybdenum, or tungsten, are sealed with glass in slots in the 20-mil-thick base of Kovar foil. Projecting above the base, they can be used as IC lead-bonding posts. The leads and base are gold-plated. Package lids are nickel; a three-mil-square projection under the lid edge prevents weld splash during hermetic sealing.

If aluminum wire leads are to be bonded to the post tops, the tops are aluminized to avoid the aluminum-gold failure mode known as purple plague. Plating resist is applied to the matrix, lead tops are abraded with crocus cloth, aluminum is deposited on the tops, and the resist is removed.

A standard Isopak matrix contains 80 packages, each ⅜ inch square. The package base contains a glass insert, and the lead tops are lapped flush with the surface of this insert. The glass is a substrate

Packages can stand on a board, or squat

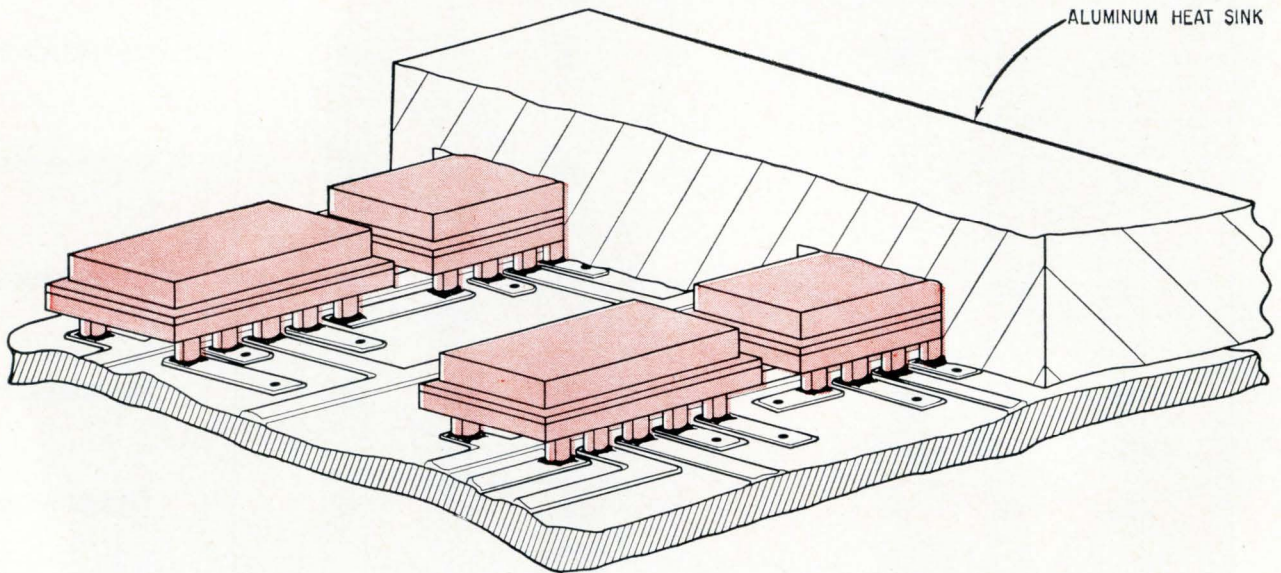

Cut short, the axial leads of the packages can be soldered to pads on a printed circuit board. Pads are precoated with solder, which flows around the leads when the assembly is heated. The heat sink cools the assembly during operation.

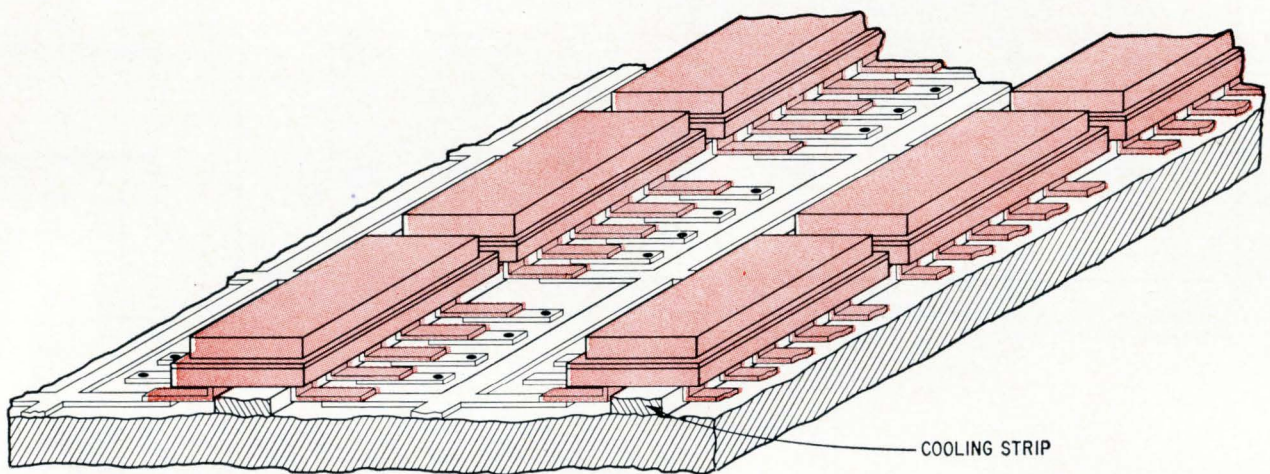

Bent radially, the package leads can be soldered to pads alongside the package or welded to the etched wiring.

for thin- or thick-film hybrid IC's or passive networks. As the network terminals can be deposited on the lead tops, additional wire leads aren't necessary. Flip-chip types of monolithic IC's can be face-bonded to film wiring on the glass.

Variations of these designs include packages 0.620 inch square with 20 leads, a package 1.1 inch square with 64 leads spaced 50 mils apart for large-scale integrated circuits, another LSI package with 160 leads in rows 30 mils apart and a lead spacing of 25 mils, and a package the size of the DIP but with as many as 30 leads. Under study are matrixes of 500 packages for transistors, matrixes for photodiode arrays with optical lenses sealed into the package lids, and matrixes for multiple-relay assemblies. A molded plastic carrier that extends Axpak size to standard DIP dimensions has also been designed. Axpaks are butt-soldered to a lead frame on the carrier, which then can be potted.

To check seal and plating quality, a package or two can be clipped from the matrix and destructively tested.

The IC manufacturer can handle the matrix as a unit during circuit die bonding, wire bonding, sealing, and leak and electrical testing. One or two packages from the matrix can again be given torture tests. The Weldmatic division of the Unitek Corp. supplies a machine suitable for automatic die bonding, while the welding department at Hughes Aircraft is designing a machine to automatically seal the packages in a controlled atmosphere.

Modules and kits

Integrated circuits can be packaged as custom assemblies if the circuit reject rate is low. For example, if five different IC's are needed in a module, each type can be placed in one row of the matrix. A matrix with 20 rows of 5 packages will yield 20

modules (minus test samples). This assumes that the Axpak bases are a common connection or the Kovar foil is electrically isolated, as in the Isopaks. The modules can be functionally or environmentally tested before the purchaser cuts the matrix apart.

The leads are prepared for soldering by cutting to a length of about 25 mils and lapping the cut ends square. A tooling plate that holds the leads snugly prevents damage to the gold plating. The plating helps the solder on the circuit board wet each lead to form a strong fillet.

If the assembly is to have a variety of circuits, the Axpak matrixes are cut apart with shears. Isopak matrixes are cut with a machine to protect the glass, but a shearable type with grooved cutlines is being tried out. A flash-plating of gold will prevent salt-spray corrosion of the exposed Kovar on the lead ends or package sides.

Circuits unaffected by magnetic fields can be kitted in assembly order on planar magnets; they won't fall off because Kovar is an iron alloy. At the assembly line, the circuits are transferred to a locating fixture, such as a molded plastic plate with rows of package-sized holes. The plate is put on the circuit board so the lead ends sit on pretinned solder pads on the circuit board. A planar magnet is placed under the board to hold the packages in position.

Fillets of solder

The entire assembly is immersed in hot peanut oil for about 1 minute, resulting in the simultaneous soldering of all the leads. Skeptics can try out the technique, called reflow butt-soldering, by following the directions on page 146. Washing with trichlorethylene removes the oil. The recommended spacing for this french frying is 25 mils, but leads separated by only 5 mils have been successfully flow soldered. Solder bridges won't form between the leads if the solder coating on the board is closely controlled.

Ultrasonic agitation of the oil may cause it to clean the assembly as well as melt the solder, help-

From matrix to board

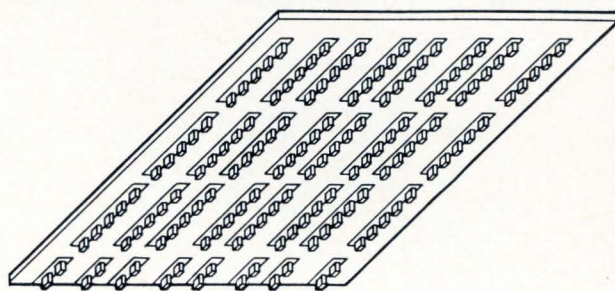

Underside of matrix, with leads cut for soldering.

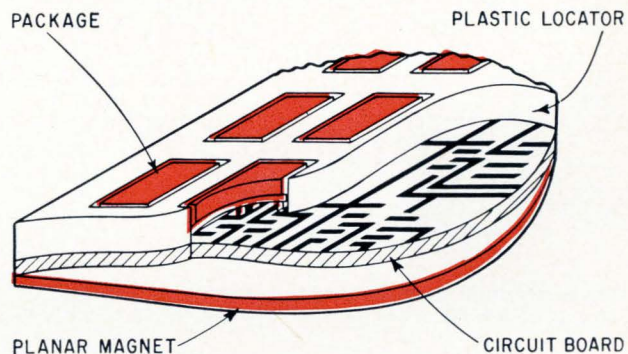

Individual packages are positioned for butt soldering by a molded locator as a planar magnet holds the packages in place. The same arrangement can be used to position packages during testing.

ing the filleting action and allowing closer lead spacing. Others have suggested this, but Flying L hasn't tried it.

Properly done, flow soldering results in well-formed solder fillets. A 10-lead package withstands a vertical pull of 2,700 to 3,000 grams, equivalent to 20,000 g's. Flatpacks with radial-leads soldered to lands alongside the package normally pull free at about 1,000 grams.

The extra strength not only increases reliability but is a plus in assembly. Groups of packages soldered in matrix form can be cut apart with a precision saw if it's necessary to electrically isolate

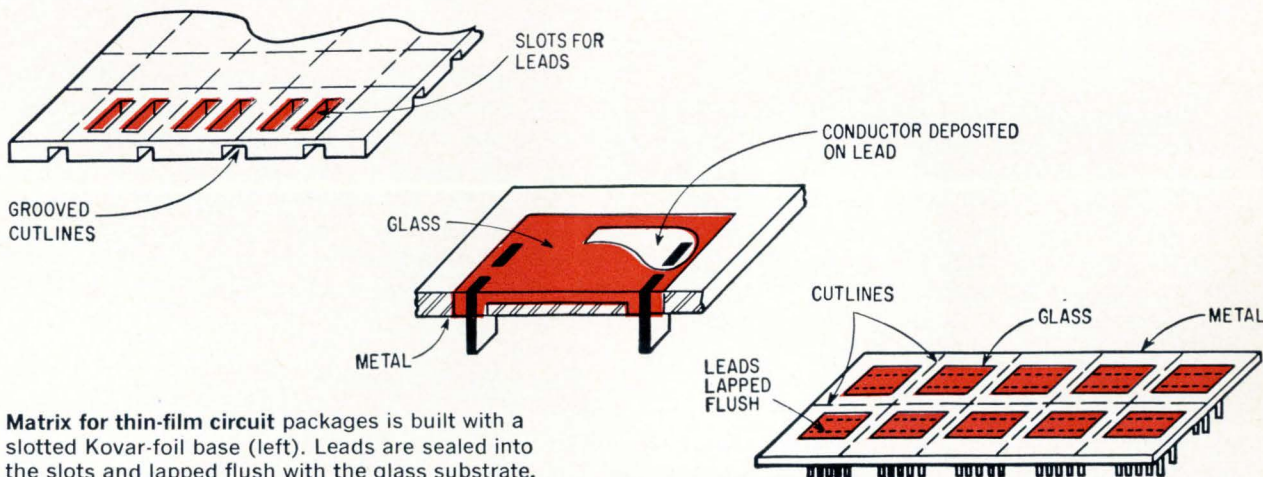

Matrix for thin-film circuit packages is built with a slotted Kovar-foil base (left). Leads are sealed into the slots and lapped flush with the glass substrate.

Stack assembly of miniature circuit boards

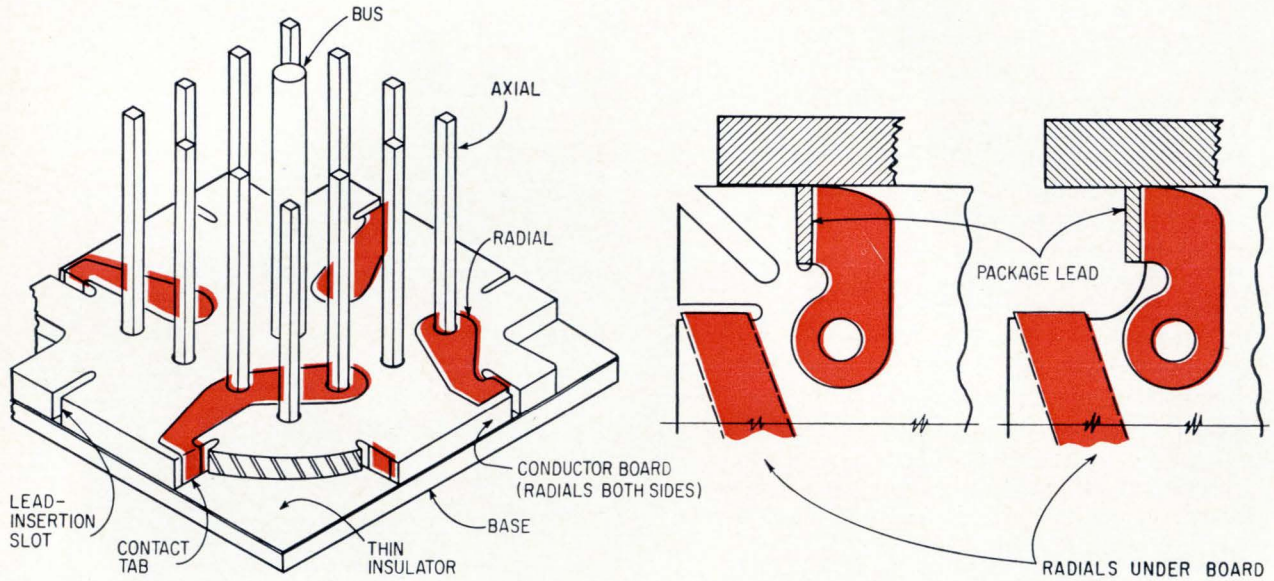

Stacks are built by putting radial layers over vertical interconnections, called axials. Open corners provide clearance for lead-soldering or welding tools, while the closed corners grasp the leads in a friction contact (upper right).

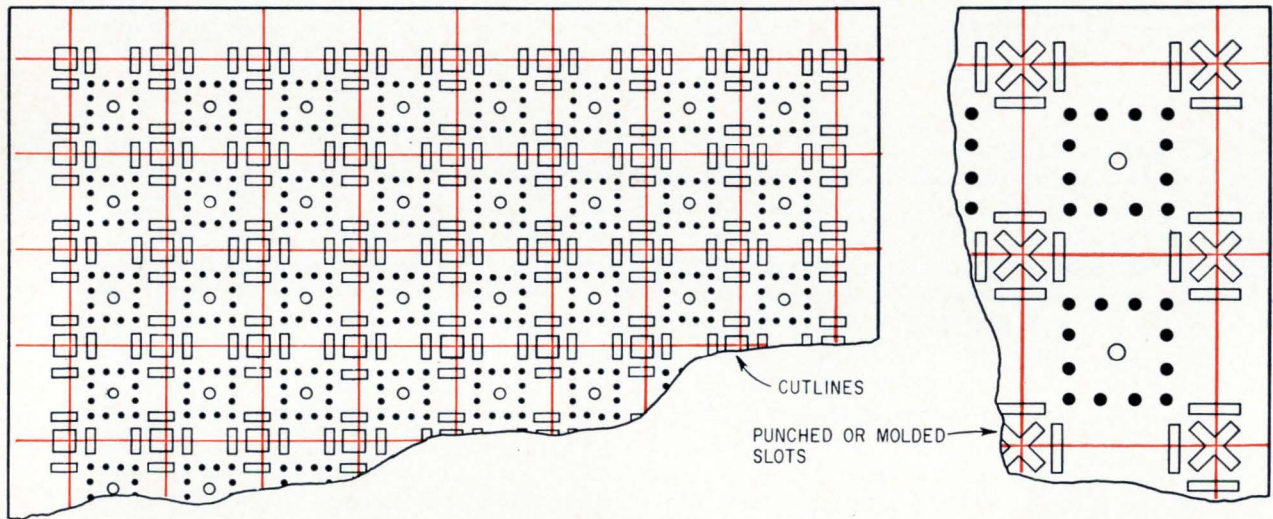

Matrixes for radials are cut apart at the colored lines before or after stacking. Friction-contact corners allow the use of the cut-apart boards as solder-contact types when the material between the two slots is snapped off.

packages or replace an IC that fails final testing.

In alternative techniques suitable for peanut-oil soldering, the assembler can: use a pneumatic or hydraulic hold-down and butt-solder the packages to both sides of a board; bend the leads radially to the board, bond the packages with adhesive, and solder, or follow the usual flatpack welding procedures; insert all the leads into slots in the board, crimp the leads to lands under the board and solder or weld; cut pockets and slots in the board, put the packages in the pockets and crimp, and solder or weld; or insert the leads between long, narrow printed circuit strips and solder.

Butt-soldering is swifter than mechanized assem-

bly of conventional packages. Also, printed wiring can be run under the packages, plated through holes are not required for lead insertion and soldering, and complex packages with several lead rows can be readily soldered. Individual packages can be resoldered, or removed for replacement, by heating the underside of the board with a hand iron. Portable reflow soldering machines, such as one made by Hughes, can be used for field replacement.

Butt-soldered assemblies can be cooled during system operation by a waffle-shaped heat sink placed over the package lids. The pocket-mounted assembly can be cooled by mounting two boards

Stacks and stacks on stacks

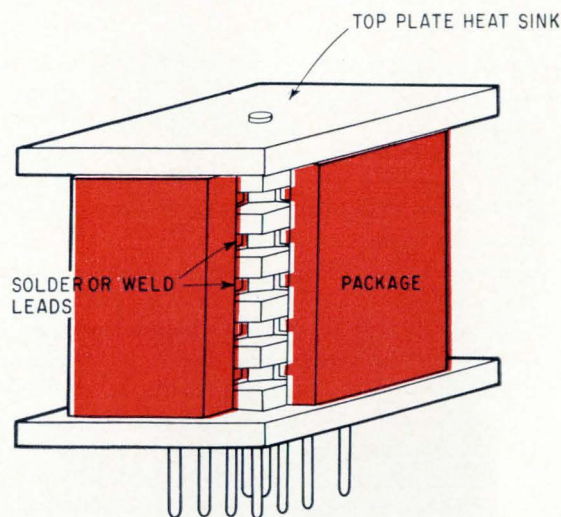

Single-story stack with open-contact corners.

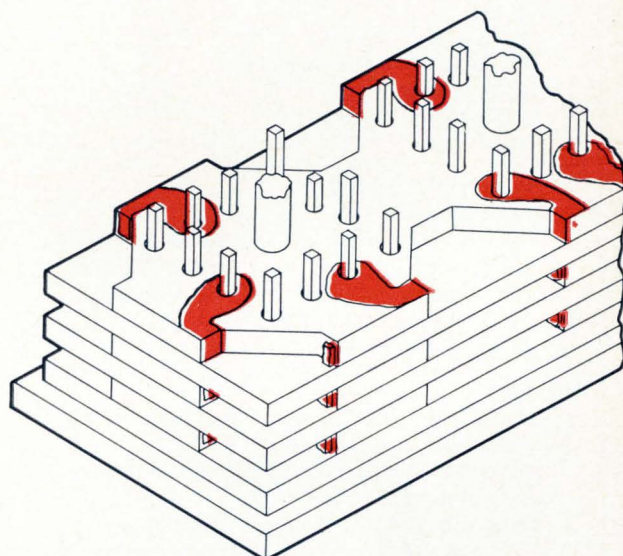

Stacks can be extended laterally into strips.

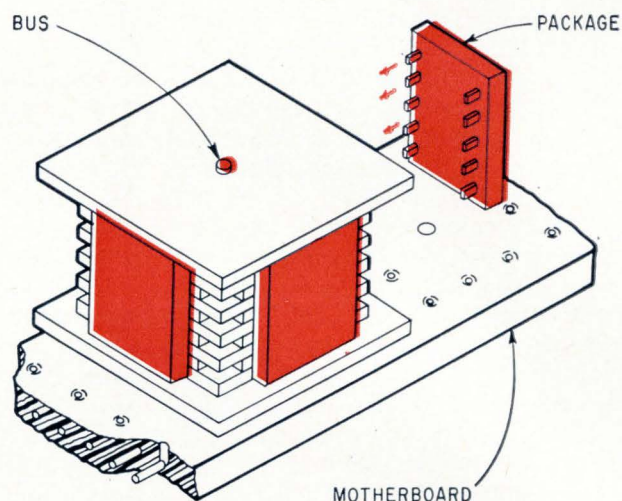

Motherboard interconnects stacks . . .

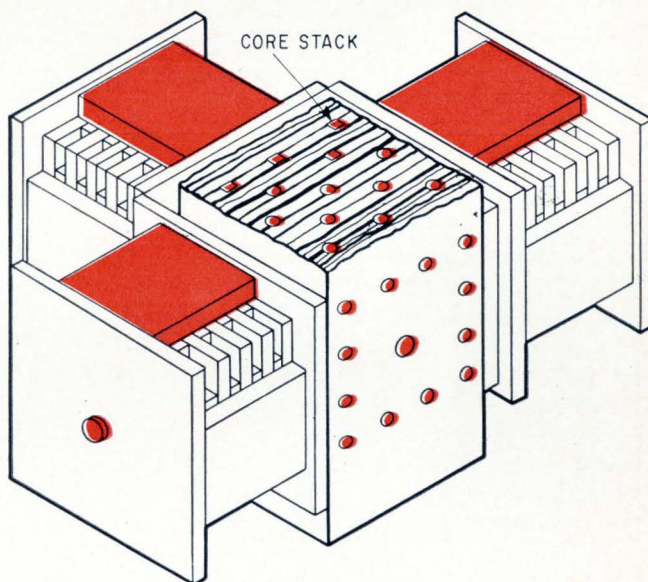

. . . or a core stack can be the interconnection.

face-to-face and putting a heat sink between them.

Single-story stacks

A single-story stack, the basic stack assembly, has as many printed circuit wiring layers, called radials, as there are leads on each side of the IC package. Insulator films go between the radials, which are pinned together with vertical interconnections called axials (upper diagram, page 144).

Prototypes are 0.370 inch square and 0.5 inch high, including a plug-in base; each of the four sides accepts a standard Atpak with 10 leads spaced at 50 mils. Stack dimensions vary with package size and lead spacing. Each radial-insulator pair is made

as thick as the lead spacing. A package with seven leads on each side, for example, requires a stack height of 0.3 inch (plus base) if lead spacing is 50 mils, and 0.15 inch if spacing is 25 mils.

Package leads plug into slots at the corners of the radials, which are isolated by the insulators. The slots allow the stack itself to be used as the production-line fixture for IC assembly.

Wiring complexity will have little effect on stack cost, since radials are made as printed wiring. For highly complex wiring, the radials could be miniature multilayer boards. One stack could be connected to others by a printed circuit motherboard, wrapped-joint wiring, or a special core stack. Little

Recipe for french-fried flatpacks

Equipment

Hot plate
Three 250-milliliter beakers
Thermometer
Small planar magnet

Materials

Peanut oil (59-cent jar)
Piece of pretinned circuit board
Solder, 50-50 or similar tin-lead eutectic alloy
Axpak with prepared leads, or flatpack with leads carefully trimmed, lapped, gold-plated and burr-free
Trichlorethylene or similar solvent

Directions

Half-fill two beakers with oil and heat to 210° C
Melt solder in one beaker of oil
Dip board in solder for 30 seconds and sling off excess solder
Put Axpak or flatpack on board and hold in place over solder pads with magnet under board
Immerse assembly in second beaker of oil for 1 or 2 minutes
Remove board, cool, and clean in solvent in third beaker

If fillet of solder is not good, try again. Check oil temperature, remove burrs from package lead, and put just enough solder on circuit board.

spacing is needed between stacks because signal wiring is buried in the stack insulation.

Radials will be made in matrixes of 2,000 per square foot, and corner and axial-pin holes will be preformed in plastic, glass-fiber, or ceramic blanks. The blanks can be plated with the radial conductor pattern, or plated all over if the matrixes are to be stocked for custom etching.

Pattern plating, or etching of the open corner board (used when leads are to be soldered or welded to the radials as in diagram, page 144), poses masking problems. Resist can be applied with a hairline brush in the corners of the prototypes, but a controlled printing of resist will be needed for mass production. Masking is no problem in the friction-contact boards, since the contact slots are isolated by the corner segment shown in the diagram. This type of board can be converted into an open-corner type by breaking off the corner segment after plating and etching. Dipping the matrix in resist retains the plating in the axial holes.

As an alternative to plating, radial conductors can be stamped from metal foil, pretinned, and bonded to the matrixes. For small-lot production, standardized stamped radials could be applied to radial blanks during stacking. Common connections can completely cover the radials, except for clearance holes around selected axials.

After the matrix is processed, it will be cut apart for assembly of individual stacks, sliced into strips for lateral stack assemblies, or left whole for mass stacking before the stacks are cut apart. The latter

approach is the basis for the 10-cent minimum stack cost estimate.

Stack assembly

The base is the stack's assembly fixture as well as its support and wiring terminal. On the plug-in side, copper axials extending through the base can dog-leg into a tight pin cluster, or out to 100-mil spacing for soldering into a circuit board. Stiff contact or wire-wrapping pins can be butt-welded to the ends of the axials.

Assembly consists of slipping the radials over the axials and the central bus and soldering axial-radial joints. The axials will be square (instead of round, as in prototypes) to swage into the round holes in the radials and to scrape off any oxide on the hole plating. Axials will also be pretinned, so heating the assembly in peanut oil or in an inert atmosphere will reflow the solder at the axial-radial joints.

The central bus has several functions. Under the stack, it guides the pin cluster into a socket. In the stack, it strengthens the assembly and conducts heat to a top plate or heat sink. If necessary, it can be a tube for coolant flow, and it can also be terminated at the top to accept a stack-unplugging tool.

The stacks are self-jigging—Axpak or Isopak leads fit snugly into the corner slots. The packages need not be held in place by fixtures if joints are to be soldered or welded. If only friction contacts are needed, a small metal can placed over the stack will retain the packages. Conventional cooling strips can be glued to the stack sides under the IC packages. Any type of stack can be potted in plastic.

Only single-story stacks have been made, but there is no reason why multiple-story stacks and lateral combinations shouldn't follow. Multiple-story stacks offer the highest packaging density, with each story accepting four IC packages.

If extra layers are added to the stack, greater freedom in axial-radial wiring layout can readily be achieved by inserting up to eight additional axials near the periphery of the radials, by putting short axial sections between layers, or by making some radials multilayer.

Stacks may be plugged into motherboards to make large planar assemblies, or into stacked interconnection cores for 3-D assemblies, as shown on page 145.

Two package positions are lost between each pair of stacks when strips of radials are stacked as lateral assemblies, but packaging density would be improved in small systems by the elimination of a motherboard or other form of external interconnection. The laterally extended stacks can also accept the IC array packages with 60 or more pins.

References

1. Samuel Weber et al, "LSI: the technologies converge," *Electronics*, Feb. 20, 1967, pp. 123-182.
2. "Flatpacks fried in peanut oil," *Electronics*, Aug. 22, 1966, p. 167.
3. Jack J. Staller, "The packaging revolution, part I: form and function interact," *Electronics*, Oct. 18, 1965, p. 72, and "Part II: design and manufacturing overlap," *Electronics*, Nov. 1, 1965, p. 75.

AMELCO's new 807BE OP AMP has a total input offset voltage of only 3.0 mV! (-55°C to +125°C)



The 807 is the newest addition to Amelco's successful line of monolithic operational amplifiers—unsurpassed in drift performance and now available from stock at only \$45.00* in TO-5s or flat packs.

If your application demands GUARANTEED drift performance, we invite you to compare the 807 specs with any monolithic available. You won't find anything to compare with our spec limits of 50 nA INPUT OFFSET CURRENT, 5 $\mu\text{V}/^\circ\text{C}$ OFFSET VOLTAGE DRIFT, OR 500 nA INPUT BIAS CURRENT! See for yourself:

PARAMETER	CIRCUIT TYPE			UNITS
	807BE	709A	1533	
Input Offset				
Voltage (25°C)	2.5	5.0	5.0	mV
Voltage (-55°C to +125°C)	3.0	6.0	6.0	mV
Voltage Drift (untrimmed)	10	note	note	$\mu\text{V}/^\circ\text{C}$
Voltage Drift (trimmed)	5.0	note	note	$\mu\text{V}/^\circ\text{C}$
Current	50	200	150	nA

Note: Both 709A and 1533 list no guaranteed value for this parameter. Worst case calculations of $\frac{11\text{mV}}{180^\circ\text{C}}$ show that devices with Drift of 60 $\mu\text{V}/^\circ\text{C}$ would be in spec.

\$45.00 isn't much to pay for the world's best monolithic op amp. You'll pay three to four times that much for an equivalent module-type op amp—hardly what we'd call a bargain! Your best buy is really our 807 data sheet. It's free.

*QUANTITIES 100 AND UP

AMELCO SEMICONDUCTOR

DIVISION OF TELEDYNE, INC. • 1300 TERRA BELLA AVENUE • MOUNTAIN VIEW, CALIFORNIA • Mail Address: P.O. Box 1030, Mountain View, California • Phone: (415) 968-9241 / TWX: (415) 969-9112 / Telex: 34-8416 • REGIONAL OFFICES: Southwest—Suite 213, 8621 Bellanca Ave., Los Angeles, California 90045, (213) 678-3146 • Northwest—1300 Terra Bella Ave., Mountain View, California, (415) 968-9241 • East—27 Traphagen Road, Wayne, New Jersey, (201) 696-4747 • Southeast—711 Magnolia Avenue, Orlando, Florida 32803, (305) 423-5833 • Northeast—805 High Street, Westwood, Massachusetts 02090, (617) 326-6600 • Midwest—650 West Algonquin Road, Des Plaines, Illinois, (312) 439-3250 • Canada—Deskin Sales, Montreal, Quebec, (514) 384-1420.

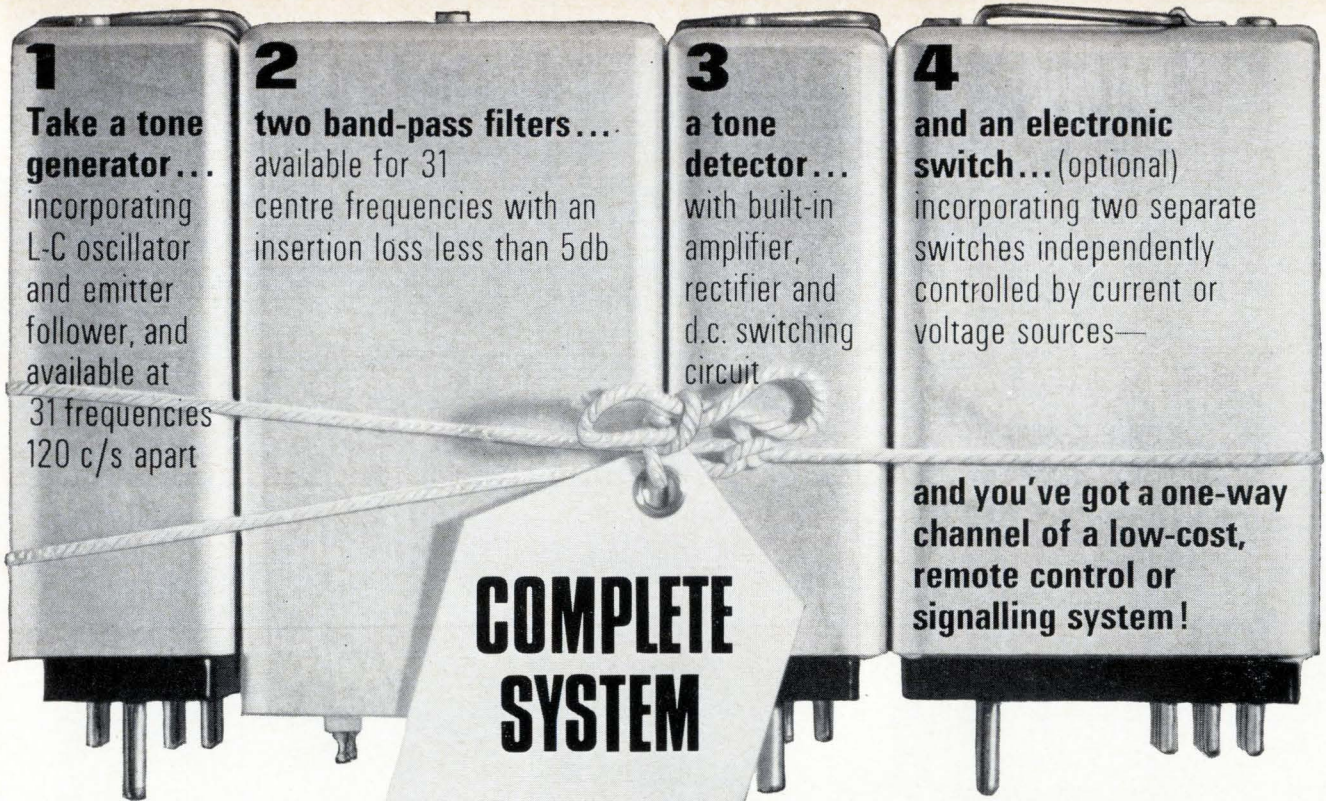

1 Take a tone generator... incorporating L-C oscillator and emitter follower, and available at 31 frequencies 120 c/s apart

2 two band-pass filters... available for 31 centre frequencies with an insertion loss less than 5db

3 a tone detector... with built-in amplifier, rectifier and d.c. switching circuit

4 and an electronic switch... (optional) incorporating two separate switches independently controlled by current or voltage sources—

COMPLETE SYSTEM

and you've got a one-way channel of a low-cost, remote control or signalling system!

Could it be simpler?

Four miniature transistorised units which enable you to build up your own remote control or telegraph system.

Up to 31 channels in the 540 to 4,000 c/s range.

Suitable for wire or radio link.

Plug into B.P.O. type-3000 relay bases or our universal chassis.

Low pass filter (2.7 or 2.3 kc/s) just added to the range.

Hybrid and line transformers available. Off-the-shelf delivery for common types.

Want to know more? Just write or telephone to:

Plessey Incorporated

170 Finn Court

Farmingdale, Long Island

New York 11735

Tel: 516 MY 4-7377 Telex: 126519

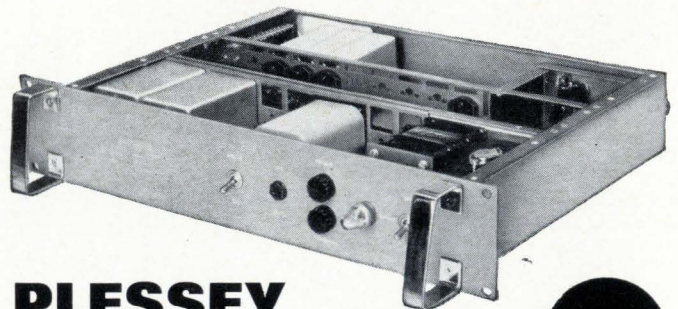
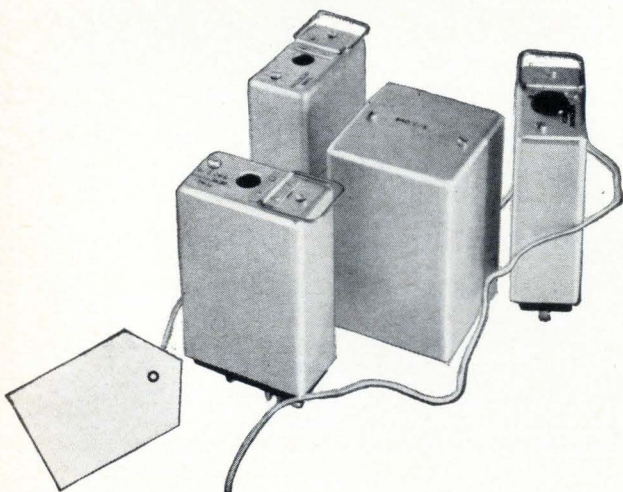

PLESSEY
Electronics



PE(RT)6 US

SCR'S

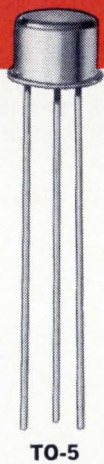

IRC can match your SCR needs

IRC silicon controlled rectifiers are value-engineered for optimum price and performance characteristics.

- Ratings from 25 to 700 volts, and 1.25 to 35 amps
- Mil types meet MIL-S-19500/108B (JAN)
- Choice of popular industrial types
- High-speed switching types
- Triggering types

All types are now immediately available from stock.

If you specify or buy silicon controlled rectifiers, you should know about IRC's SCR line. For new semiconductor catalog, prices and samples, write to: IRC, Inc., Semiconductor Division (formerly North American Electronics), 71 Linden St., West Lynn, Mass. 01905.

 <p>ZENER DIODES</p> <p>MIL and industrial types, temperature-compensated types, 1-watt DO-7, and solid construction Poly-Sil packaging.</p>	 <p>AXIAL LEAD RECTIFIERS</p> <p>AR16 thru AR24 replaces 363 JEDEC devices for 50 to 1000V/.25 to 1A needs. Costs less than stud-mounted types.</p>	 <p>RECTIFIERS</p> <p>Complete choice, including sub-miniature, fast recovery and high power types. All popular configurations.</p>	 <p>HIGH CURRENT RECTIFIERS</p> <p>All JEDEC "1N" types available—in forward or reverse polarity. Ratings from 100 to 275 amps, to 1400 PIV.</p>
--	---	---	--



Rewarding engineering opportunities are immediately available.

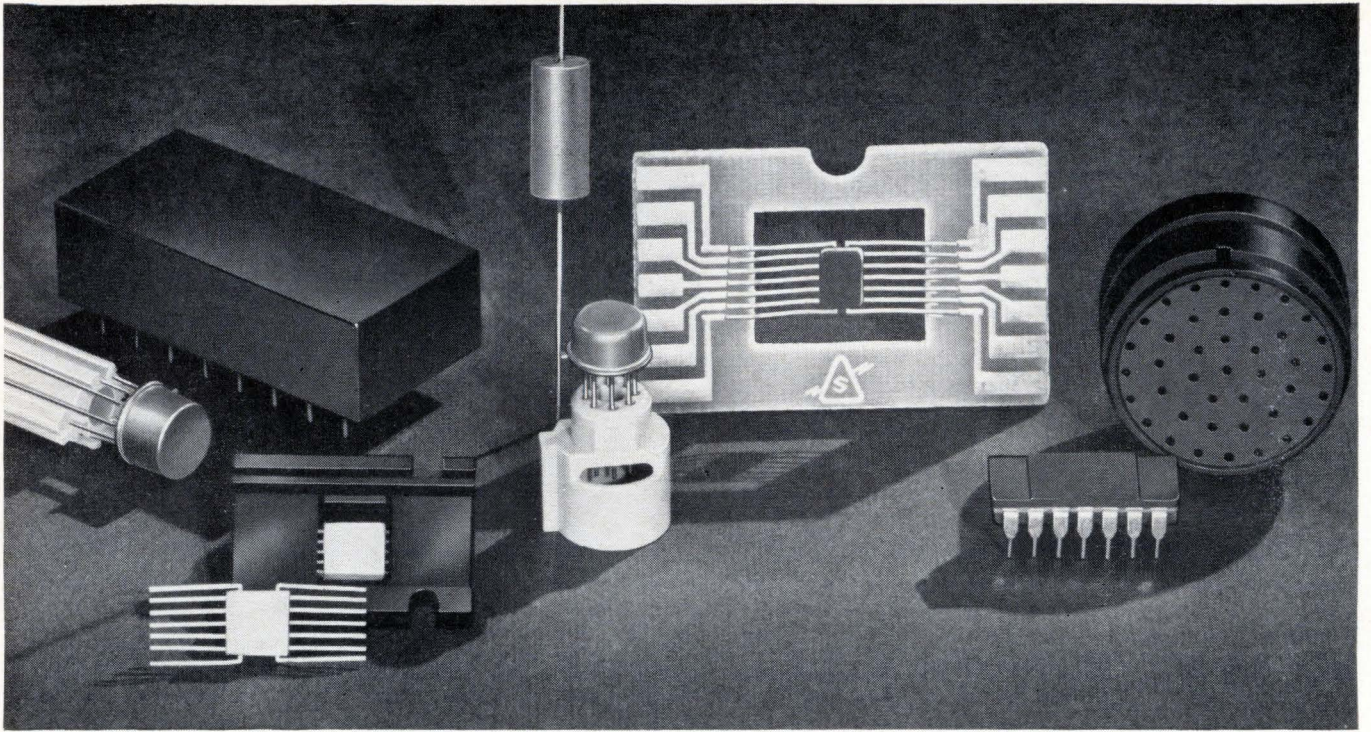

Good marking . . . makes the difference

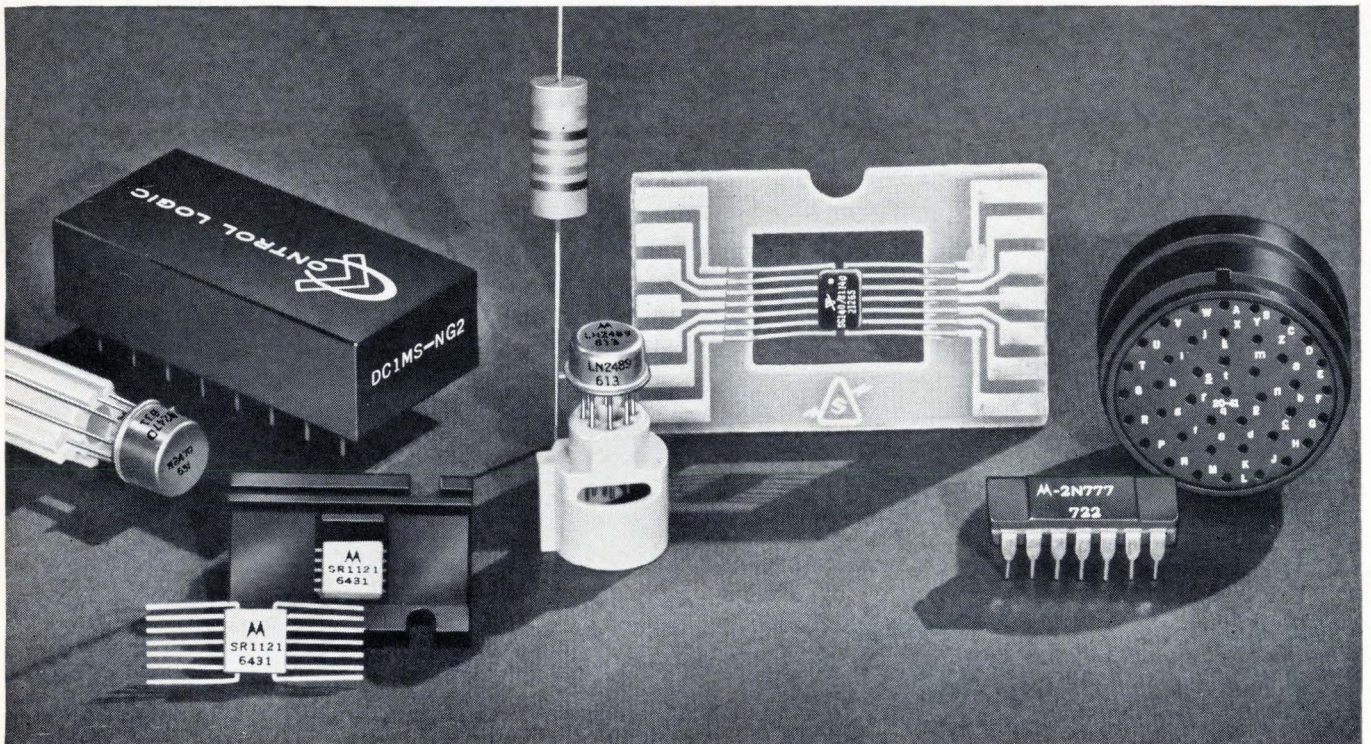

Don't waste time improvising and experimenting. Call in a Markem man and get acquainted with today's broadest line of marking equipment. Machines capable of putting several bands on a miniature diode; combining sequential numbering with identification; printing 14 characters plus trademark in an area 0.125" in diameter; printing integrated circuits in or out of carrier, registered to tab; and employing new techniques to meet severest durability specs. Whether your problem is size, speed or cost, we can help. Write Markem Machine Company, 305 Congress Street, Keene, New Hampshire.

EQUIPMENT AND TECHNOLOGY TO HELP YOUR PRODUCT SPEAK FOR ITSELF

MARKEM[®]



new disciplines in DC

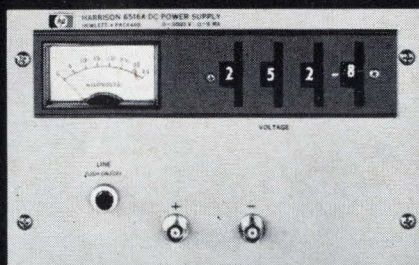

take the high voltage models with all-silicon circuitry

3 Power Supplies Offer Choice of Voltage, Performance, Price

High Voltage

Select the model with 0 to 1600 volts DC output at 0 to 5ma. Regulation, less than 0.01%, and less than 5mv p-p ripple and noise. Stability better than 0.05%.

Model 6515A — 3½" High, Half-Rack Width. Price \$235.

Higher Voltage + 4-Digit Voltage Programmer

Add 1400 volts and get 0 to 3000 volts at 0 to 6ma, plus a 4-digit front panel programmer for selecting the output voltage. Ripple and noise less than 5mv p-p, stability better than 0.05%.

Model 6516A — 5¼" High, Half-Rack Width. Price \$295.

5-Digit Voltage Programmer + Better Regulation, Stability

Add an all solid-state temperature-controlled oven and sophisticated circuit refinements, plus another digit of resolution to the output programmer, and achieve stability and resettability of 0.01%, regulation of 0.001%, and less than 1mv p-p ripple. Output is 0 to 3000v DC at 0 to 6ma.

Model 6110A — 5¼" High, Half-Rack Width. Price \$495.

Low p-p Ripple and Noise • Line and Load Regulation An Order of Magnitude Better Than High Quality Laboratory Supplies • Output Continuously Adjustable Down to Zero • Self-Protecting — Current Limit Circuit • Low Output Impedance • Less Than 100 μsec Load Transient Recovery • No Overshoot on Turn-On, Turn-Off or AC Power Removal Floating Output — Ground Either Positive or Negative Terminal • Half-Rack Width — Rack Mounting Hardware Available.

Contact your nearest Hewlett-Packard Sales Office for full specifications



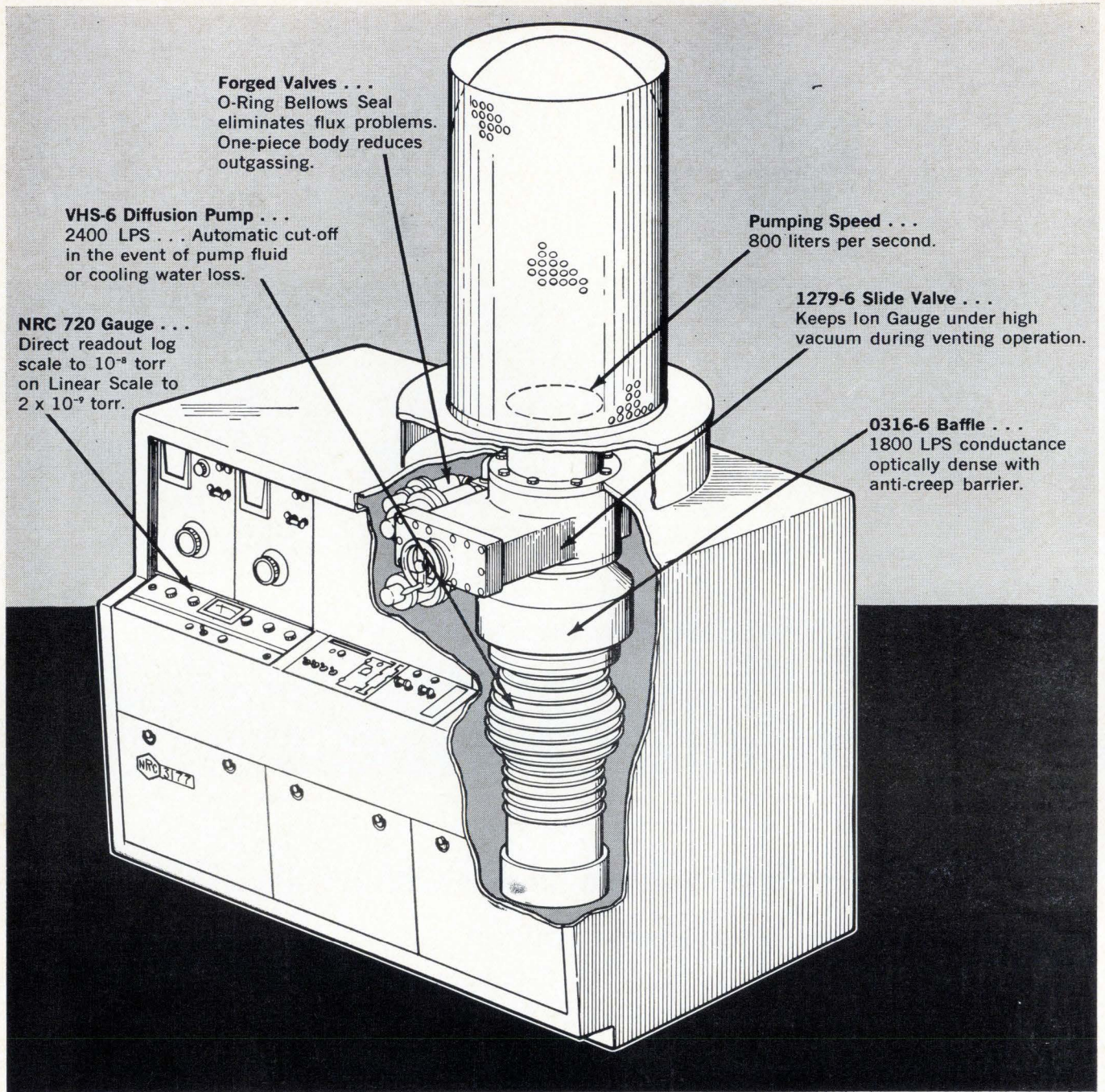

A vacuum coater is only as good as its components . . . that's why we design our own to deliver performance where it counts – in repeatable, demonstrable, dependable operations that never fail because someone else's diffusion pump, baffle or gauge didn't work properly. It's easier to deliver when you make the whole package.

If you have faith in the components, you have faith in the coater – write today for NRC's complete line of coater literature . . .

NRC EQUIPMENT DIVISION
NATIONAL RESEARCH CORPORATION
 A SUBSIDIARY OF NORTON COMPANY 
 160 Charlemont Street, Newton, Massachusetts 02161

Look what's happened to the sweep generator.
The new Telonic 2003 is virtually a

DESIGN-IT-YOURSELF SWEEPER,

for all primary circuits are modular plug-in units.



Initially, you may select frequency ranges from

DC TO MICROWAVE

in wide or narrow bands; attenuators up to 109 dB for 50 or 75 ohm matching; frequency markers that offer a wide selection of harmonic and fixed types; mode programming for square or sine output, sweep width, single sweep presentation, or recording; and detector modules of both passive and active types with 60 dB dynamic range.

Then, when test requirements change, you can alter the instrument parameters instantly by changing one or more modules.

The 2003 system, with this inherent flexibility, can be used universally for swept frequency applications. Is it possible that this is the first instrument that can't become obsolete?

Specifications and complete details are available on request.

Telonic INSTRUMENTS
A DIVISION OF TELONIC INDUSTRIES, INC.

60 No. First Ave., Beech Grove, Indiana 46107
Tel: (317) 787-3231 TWX: 810-341-3202

REPRESENTATIVES THROUGHOUT THE U.S., CANADA AND OVERSEAS. BRANCH OFFICES IN MAIDENHEAD, ENGLAND, FRANKFURT, GERMANY, AND MILAN, ITALY.

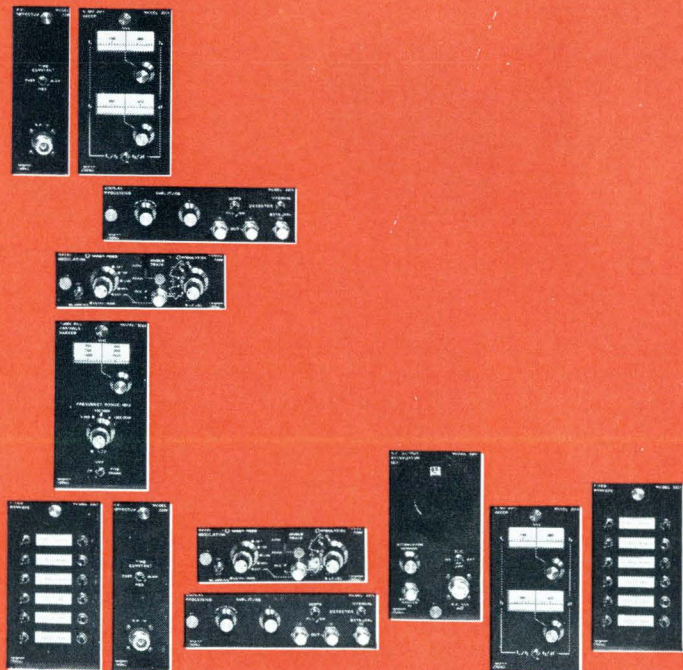

ORDINARY 5 AND 10 AMP RELAYS MIGHT PERFORM LIKE THE NEW SIGMA SERIES 50.

If they had these features.

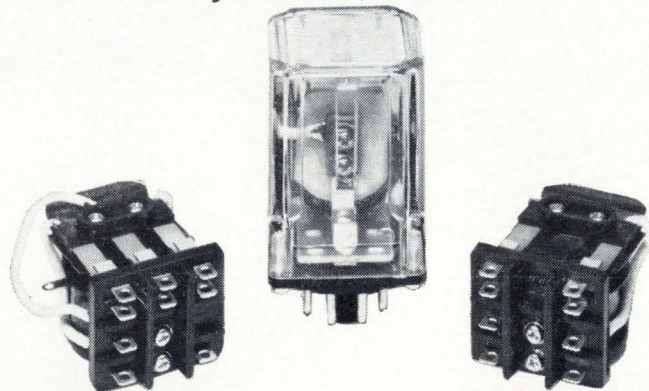

New 1, 2 and 3 pole Sigma Series 50 relays have four advantages over ordinary relays of this type.

Longer Contact Life: Slots in contact base between fixed contacts eliminate build-up of vaporized contact material and leakage paths. This prevents premature failure and is particularly effective at higher loads.

Coil Lead Breakage Eliminated: Molded phenolic bobbin assures positive mechanical interlock with frame preventing coil rotation and lead breakage.

Greater Motor Efficiency: Adjustable armature hinge permits optimum seating of armature on pole face. Assures precise contact alignment as well as maximum use of drive circuit power.

Better Adjustment Stability: Contact base and

armature support made of diallyl phthalate. This material does not deform under mechanical and thermal stresses.

We'd like to give you a new Sigma Series 50— or any of our other standard relays. Test and compare it against the brand you may now be using. It's the best way we know to prove what we say about Sigma relay performance. Just circle our reader service number on the reader service card. We'll send you the new Sigma relay catalog and a "free relay" request form. Return the form to us and your Sigma representative will see that you get the relay you need.

Need fast delivery? The UL listed Series 50 is available off-the-shelf from your Sigma distributor.

SIGMA DIVISION  SIGMA INSTRUMENTS INC
Assured Reliability With Advanced Design / Braintree, Mass. 02185

Heat Dissipation Bonus of Beryllia Worth An Extra Two Cents?



Coors Beryllium Oxide Ceramic offers you the bonus of 10 times the thermal conductivity of aluminum oxide ceramic—approximately the heat transfer qualities of aluminum metal. Ordinarily, beryllia is thought to be too expensive, except for designs where maximum heat dissipation is an essential. However, we find the additional cost of using beryllia in small metallized assemblies adds only a few cents to the total cost of the completed part. For an “extra two-cents worth” Coors offers a beryllia-to-metal assembly that allows you to use more power . . . or allows you even further miniaturization than with alumina . . . or gives you longer component life—or a combination of all three. When you design micro-substrate assemblies—Consider Coors Metallized Ceramics—and get the bonus of beryllia’s thermal conductivity. Write for Coors Metallizing Data Sheet 9502, or call the Coors “hot line”—303/279-4533, Ext. 351.

*consider
Coors metallized
ceramics*

Coors

CERAMICS

ALUMINAS • BERYLLIAS • MAGNESIAS • SPECIAL OXIDES

Coors Porcelain Co., Golden, Colo.



THIS COORS
METALLIZED BERYLLIA
MICRO-COMPONENT
DISSIPATES THE SAME
QUANTITIES OF HEAT

AS THIS COORS
METALLIZED ALUMINA
MICRO-COMPONENT

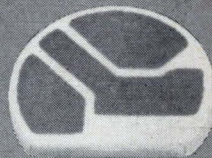

**Does anybody
know
you're there?**

Maybe you feel that your professional growth is stunted because your company is ignoring you and your ideas. Maybe what you have to say isn't being heard because it gets filtered through too many layers of management. Possible? Then look into what NCR has to offer.

Heavily financed R&D. New laboratory facilities being built nearly every year. Programs combining theoretical and applied research with practical results in view. Aggressive management (on your side). And professional advancement encouraged through company-sponsored programs that help let everybody know what you're doing.

If this is what you're looking for, read what we're looking for. For these positions, no special

level is required. Ph.D. background is preferred for many, and some areas of responsibility involve potential for management or technical director.

Senior Circuit Designer. Familiar with solid state circuitry, creative, desires to work at advanced development stage.

Thin Film Chemist or Physicist. Materials research, device development.

Advanced Development Planning Specialists. Military R&D.

Operations Research Specialists. Commercial applications.

Integrated Electronics Engineer. Advanced concepts for computer development.

And a second group of positions:

Research Chemists. Project-leader capability, background in physical chemistry, polymers.

Test Equipment Design Engineers. B.S. or M.S.E.E. with some experience.

Mechanical Design Engineers. Small-mechanism experience desired.

NCR will listen to you. Write to T. F. Wade, Executive and Professional Placement, The National Cash Register Company, Dayton, Ohio 45409. Describe your background and interests. Then we'll arrange for more detailed conversation.

An Equal Opportunity Employer.

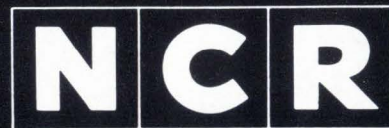

THE NATIONAL CASH REGISTER CO. DAYTON, 45409 ©

EMI/RFI-SHIELDED PUSHBUTTON SWITCHES

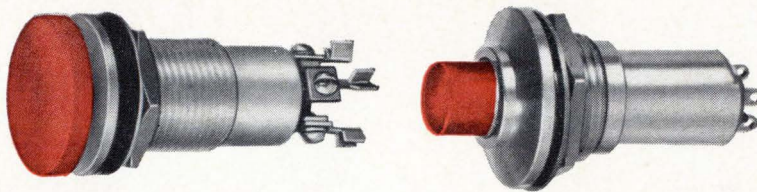

Four models, one with wide button. Choice of two and four circuit momentary, plus DPDT push-push. Ratings of 1 to 10 amps at 28 vdc; 1 amp at 120 vac.

SUBMINIATURE EMI/RFI-SHIELDED INDICATOR LIGHTS



Dome, flat and flush mounting. Lens diameter of $7/32"$, $.22"$ and $.383"$ respectively; 5v and 28v. Six lens colors, plus clear.

STANDARD EMI/RFI-SHIELDED INDICATOR LIGHTS

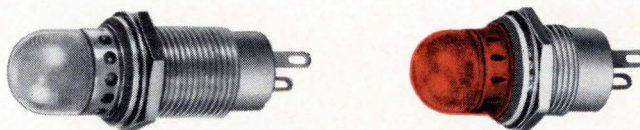

Translucent and transparent dome-type lenses. Incandescent, standard neon and high-intensity neon lamps in all popular voltages. Six lens colors, plus clear.

These EMI/RFI-shielded switches and indicator lights available at Control Switch distributors now!

Still more new EMI/RFI-shielded components on the way.

Need shielding from EMI/RFI leaks in panels and systems? Look to Control Switch . . . first to introduce the types of shielded switches and lights shown above. Now we are deep into the development of still other shielded components. Tell us your requirements. We may be working

on the component you need and be able to help you fast. Order EMI/RFI-shielded switches and lights from your Control Switch distributor, or contact us direct.

FREE BULLETIN!

Check number on Reader Service Card corresponding to number at left below for our Bulletin on EMI/RFI-shielded components. While you're at it, get all the items listed below.

- #483 EMI/RFI-shielded Component Bulletin 62A
- #484 Condensed Switch Catalog 100
- #485 Basic Snap-Action Switch Catalog 110
- #486 Toggle Catalog 180
- #487 Indicator Light Catalog 120
- #488 Hermetic Switch Catalog 130
- #489 Switchlite Catalog 220
- #490 Pushbutton Catalog 190

C
CONTROLS
COMPANY
OF AMERICA
CONTROL SWITCH DIVISION
1420 Delmar Drive, Folcroft, Pennsylvania 19032
A Subsidiary of
 General Precision Equipment Corp.

small



smaller



smallest



G.E.'s new wet slug tantalum capacitor gives you the performance of the CL64 in only 1/2 the case size

Get the highest volt-microfarad product per unit weight and volume of any capacitor you can buy with General Electric's new 69F900 wet slug tantalum capacitor. How? General Electric reduced the case size of the military type (CL64) wet slugs by 1/2 (it's even smaller when compared to solids). Electrical characteristics and performance remain essentially the same. G.E.'s new 69F900 answers the need for a commercial wet slug capacitor with the high volumetric efficiency demanded by modern high density applications.

G.E.'s new addition to its complete line of tantalum wet slug capacitors has excellent high capacitance retention at low temperatures and can be

RATING	CASE SIZE	VOLUME
50V, 30μf		
solid (CS12)	.341 x .750	100%
wet slug (CL64)	.281 x .681	58%
69F900	.145 x .600	15%
15V, 80μf		
solid (CS12)	.341 x .750	100%
wet slug (CL64)	.281 x .681	58%
69F900	.145 x .600	15%
6V, 180μf		
solid (CS12)	.279 x .650	100%
wet slug (CL64)	.281 x .641	100%
69F900	.145 x .600	25%

stored to -65°C . Its wide operating range is -55°C to $+85^{\circ}\text{C}$. And it meets the parameters of larger military wet slugs: vibration to 2000 Hz, 15g acceleration!

The new sub-miniature 69F900 capacitor is fully insulated and has a low, stable leakage current. Voltage ratings are available from 6-60 volts; capacitance ranges from 3.3-450 microfarads.

Choose from a complete line of G-E wet slug tantalum capacitors to fill your slim, trim circuit needs. Write for GEA-8369 for details about the 69F900 and the other capacitors in General Electric's complete wet slug tantalum line, or ask your G-E sales engineer. **Capacitor Department, Irmo, South Carolina.**

ELECTRONIC COMPONENTS DIVISION

GENERAL  ELECTRIC

430-28A

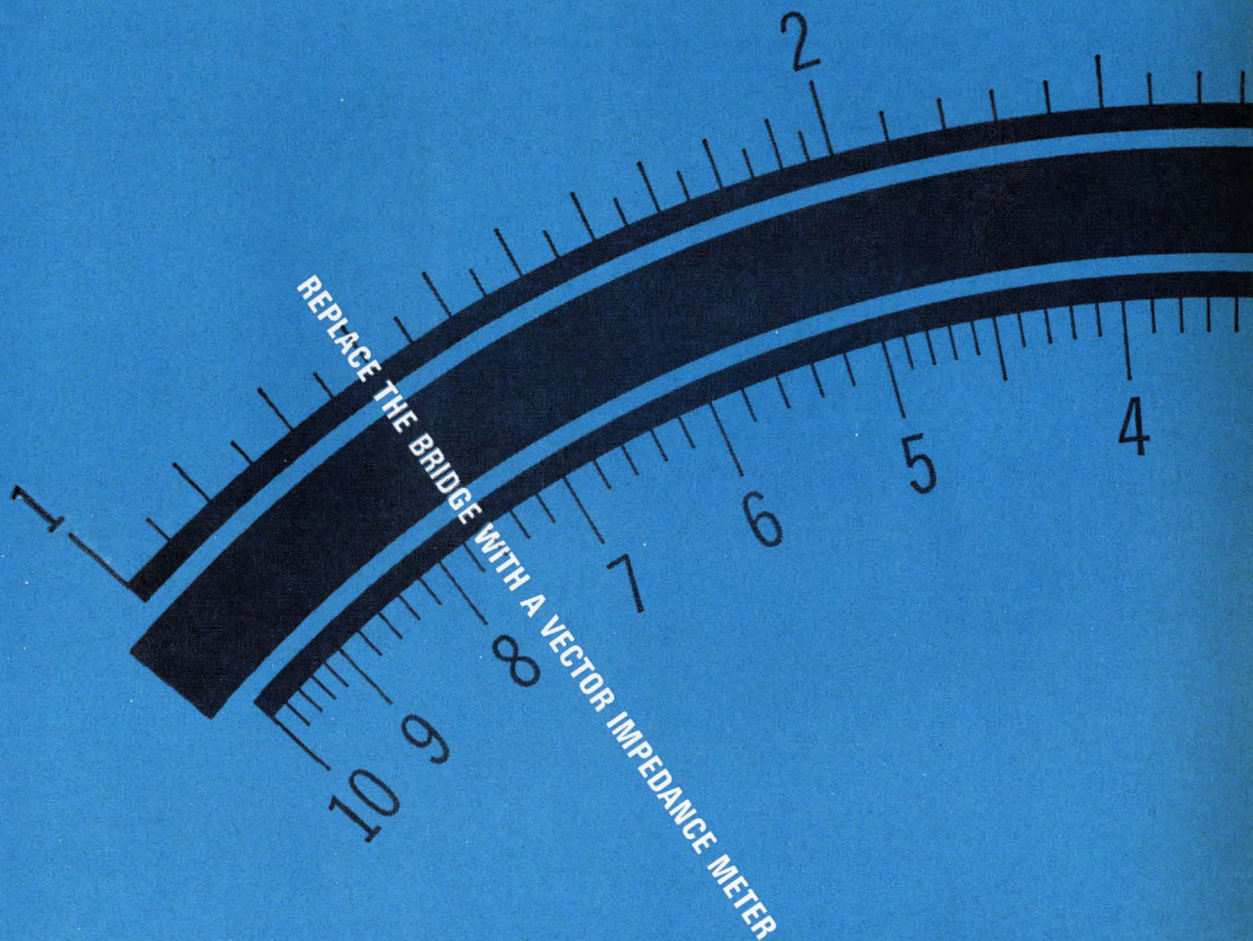

Vector Impedance Meter makes measurements in seconds

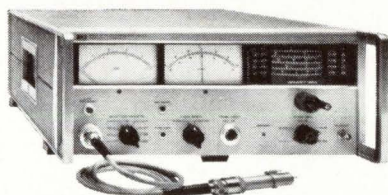

MODEL 4815A OFFERS DIRECT READOUT OF HIGH FREQUENCIES IN OPERATING CIRCUITS

The 4815A offers direct readout of impedance and phase angle measurements from 500 kHz to 108 MHz with continuous tuning. Probe on five-foot cable simplifies in-circuit measurements. Price: \$2,650.00. Complete specifications are yours on request.

Now there's no excuse for not making all the impedance measurements that previously have been too bothersome to make. The Hewlett-Packard 4800A Impedance Meter eliminates bridge balancing and nulling. It does for AC measurement what the ohmmeter does for DC testing. Just plug it in and read it. The 4800A may be mechanically swept to produce measurements over its full frequency range. You get direct readings of impedance and phase angle from 5 Hz to 500 kHz. Analog outputs of frequency, impedance and phase are available for X-Y recording.

The 4800A is an all solid-state integrated vector impedance *system* that reads out directly in Z and θ . Low-level signal strength prevents overloading of the test component. Price: \$1,490.00. For complete specifications, contact your local Hewlett-Packard field engineer or write: Hewlett-Packard, Green Pond Road, Rockaway, N.J. 07866.

HEWLETT  **PACKARD**
measuring instruments
for science and industry



Information Technology
Mission Simulation, Display Technology

Radar and Fire Control
Airborne Systems and Simulators

Navigation, Stability, Guidance & Control
Stability and Control, Computer Design,
Servo Analysis

Electronic Systems
ECM, Penetration Aids

Electronic AGE
Microwave and Computer Design

Electronic Laboratories
Circuit Design, Flight Test
Instrumentation

Electrical Installation Design



These are a few of the long range programs at the Fort Worth Division of General Dynamics. Here you will find a highly diversified engineering and research organization assigned to the 111 programs or other advanced aircraft projects; missile assignments, space systems, mission analysis or other R&D.

You'll enjoy living in modern, metropolitan Fort Worth where superior housing, cultural advantages, a variety of sports and other recreation, graduate studies at one of three major universities, and mild weather are all part of an attractive package.

Call collect—817 PE 2-4811 extension 3551 or send a résumé of your education and experience to J. B. Ellis, Industrial Relations Administrator, Engineering, General Dynamics, Fort Worth Division, P. O. Box 748E, Fort Worth, Texas. An equal opportunity employer.

F-111A • F-111B • FB-111 • RF-111 • MARK II • F-111K

BORON COMPOSITE STRUCTURE
*and other advanced
aircraft and space programs*

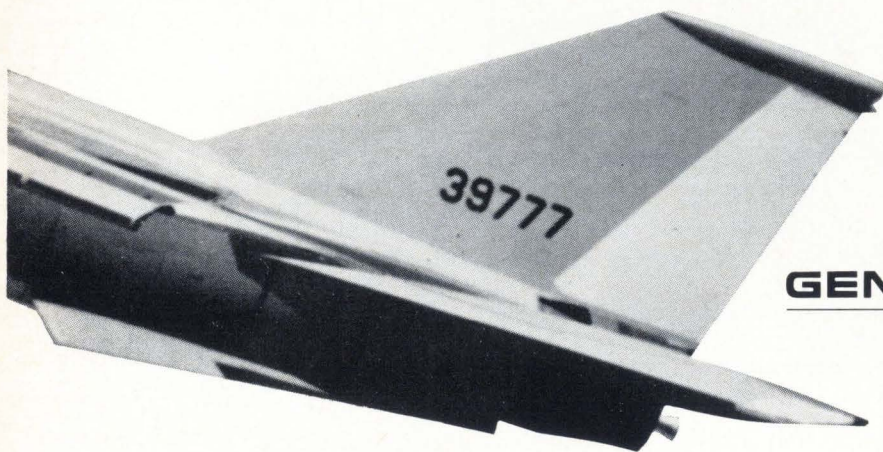

GENERAL DYNAMICS
Fort Worth Division

This is the lighted pushbutton switch with aerospace quality at commercial prices!

The MSC Series 12 Lighted Pushbutton Switch embodies aerospace quality and engineering features that reduce installation costs, increase performance and simplify maintenance . . . yet it is priced to compete with commercial grade units. Compare the features listed below. From the exclusive Twist/Lock front end removal that permits easy lamp, legend or color filter change without tools (and without the hazard of accidental switching during replacement), to the internally bussed common ground lamp circuits that cut installation time and costs by reducing solder connections, you'll find better features for better performance. You'll discover why the Series 12 has been specified for computers, data processing equipment,

industrial controls and commercial equipment where dependable, long-term performance is the prime consideration. You'll pay no more. Why settle for less?

GET THE 20-PAGE CATALOG 2001

It details all of the many options offered by the versatile MSC Series 12 to solve any switching problem. Use the reader service card or write on your letterhead for an operating demonstration by your regional MSC specialist . . . in your office!

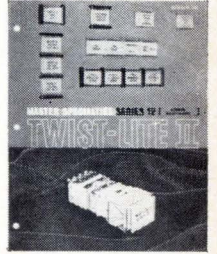

Series 12

TWIST-LITE® II LIGHTED PUSHBUTTON SWITCH

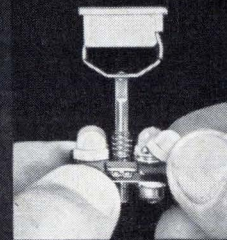

COMPLETELY REMOVABLE FRONT-END ASSEMBLY
Will not actuate switch when replaced.

4-LAMP VERSATILITY

INDIVIDUAL COLOR CONTROL

SILICONE RUBBER COLOR FILTERS
for uniform light intensity and disbursement

SNAP-ON SWITCH MODULES
RATED AT
5 AMPS/125 OR 250 VAC

INTERNALLY BUSSED COMMON GROUND LAMP CIRCUITS
Requires fewer solder connections

OPTIONAL HOLDING COIL FOR ELECTRICAL INTERLOCK

12 MOUNTING OPTIONS
Spring clip or colored barriers for styling versatility

FULL DISPLAY TO 4-WAY SPLIT
Legends supplied with order

SNAPS INTO PANEL CUTOUT
No tools or hardware required



EXCLUSIVE FRONT RELAMPING
with Twist/Lock safety
No tools required.

Master MSC Specialties Company

1640 MONROVIA • COSTA MESA • CALIFORNIA 92627



(714) 642-2427 • TELEX 6-78433 • OFFICES IN PRINCIPAL CITIES.

25 YEARS IN
INFORMATION DISPLAY

**if you could
find a more
stable
polyester film
you'd use
it.**

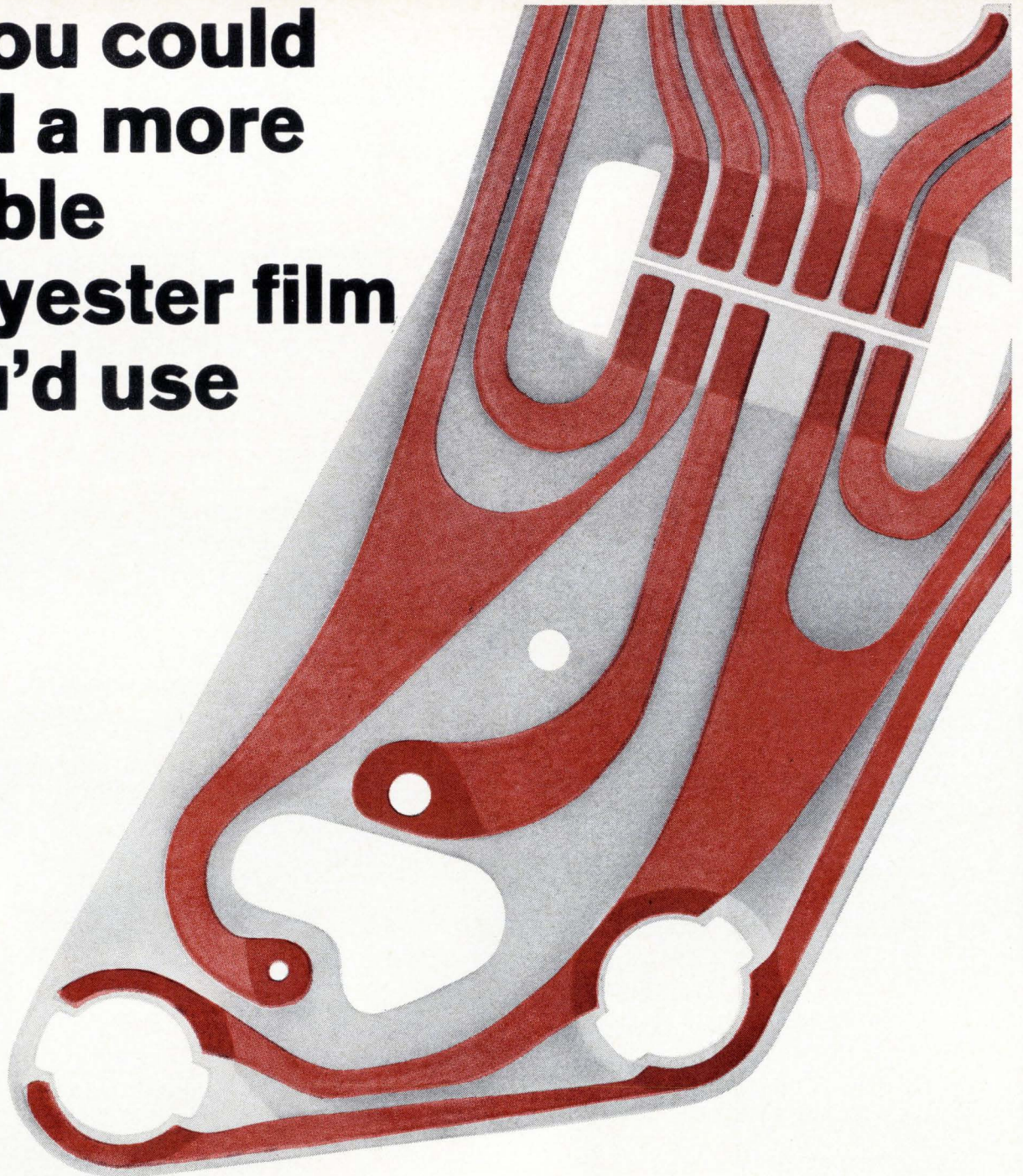

right?

Users report a measurable stability advantage with Celanar polyester film. In printed circuits Celanese polyester film means less shrinkage—hence a more reliable circuit.

Celanar has other substantial advantages, too. Its tensile (pull) strength is 30% stronger than other films. And Celanar film is the cleanest, freest from contamination, in the industry. We produce Celanar in a "White Room" where air filtration systems effectively trap dirt specks as tiny as 0.3 microns—infinitesimal as the point of a needle.

What's more, we lean over backwards to supply

Celanar film in the roll lengths, widths and gauges most convenient for you. Ship it with temperature recording flags, even impact recorders where necessary, to assure your receiving quality as high as we produce.

Those are reasons why major automotive manufacturers use Celanar film for under-the-dash printed circuitry. And why you should know the full facts about Celanar film. All it takes is a letter to: Celanese Plastics Company, Dept. 133-D, P. O. Box 629, Linden, New Jersey 07036. Celanese® Celanar®



Celanese Plastics Company is a division of Celanese Corporation.

Probing the News

Computers

French press baits Bull

Since its takeover by GE, the French computer maker has been plagued by calls for nationalization; it has been further shaken by recent layoffs and product withdrawals, but it sees profits ahead this year or in 1968

By Peter Kilborn

Paris Bureau

"Bull-GE attracts as big a press as Brigitte Bardot," says the company's secretary general, Jean Perriquet. But if publicity helps keep Bull big at the box office, headlines have brought nothing but trouble for Compagnie des Machines Bull-General Electric.

Bull became a popular corporate fall guy for the French press when the General Electric Co. took control of the company in July 1964. At the time, Bull, as the only major all-French computer maker, was something of a symbol of national technological prestige. So much so that President Charles de Gaulle seriously considered nationalizing Bull when, overextended finan-

cially, it stood on the verge of collapse.

De Gaulle, though, couldn't see his way clear to pay the \$43 million it would have cost to keep Bull French. So in came a well-heeled U.S. corporate giant, and the French press had "L'affaire Bull" to clamor about.

Bad press. Since the takeover, the country's newspapers—from the prestigious, respected *Le Monde* to the brash, leftist *Nouvel Observateur*—have been running tales of woe about Bull-GE. Hardly a week goes by that the company doesn't have to issue disclaimers to journalistic speculations that General Electric brass in the U.S. plans to slash

Bull's work force or stop making computers in France altogether.

One effect of Bull-GE's bad press has been to depress the price of its shares on the Paris Bourse. Even worse, say Bull-GE executives still struggling to steer the company out of the red, is the psychological impact on potential customers in France. The government, especially, they feel, will shy away from spending public money to buy hardware from a company often played up as being run—with little consideration for its French workers—by GE executives in Phoenix, Ariz.

I. Making headlines

The current splurge of stories

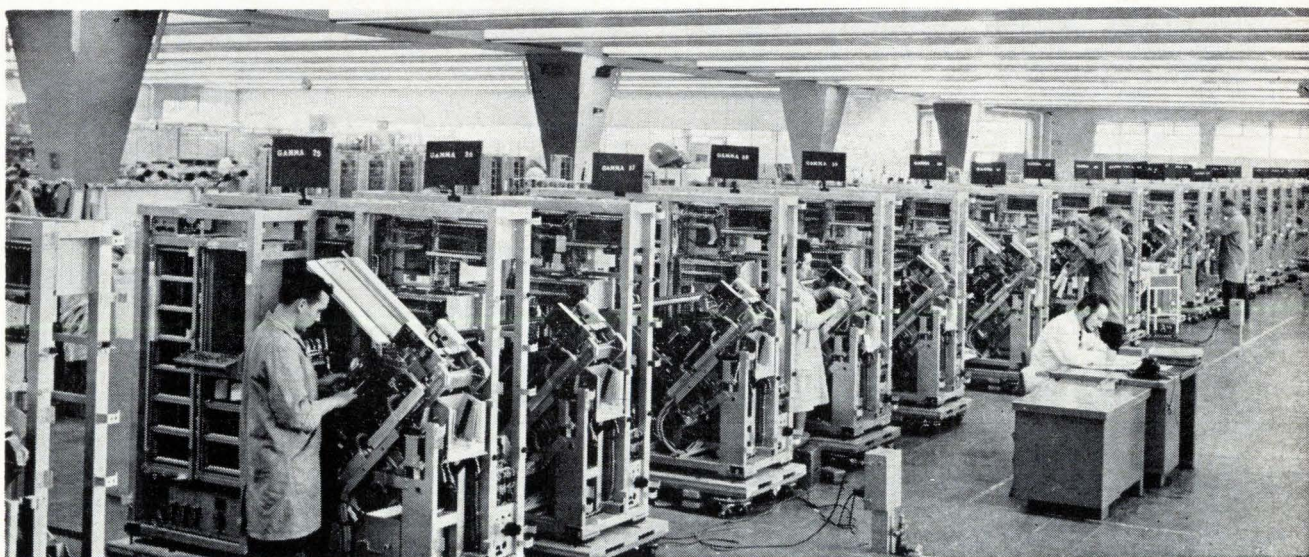

Relative calm along Bull-GE's Gamma 10 computer production line belies the hard knocks handed the company by France's xenophobic press. In print, journalists have speculated on just about everything from the possibility of further cuts in the work force to the prospect that General Electric may be set to pull out of France altogether.

about Bull-GE started last fall. Word leaked out at that time that the company had withdrawn from service a GE 600 leased to a government-owned utility, Electricité de France. Bull-GE confirmed that it had recalled the computer because of software problems. About the same time, the French weather agency disclosed that it had decided not to take a GE 600 it had on option.

These two setbacks touched off a flurry of reports that layoffs were in the offing at Bull-GE's French plants, but the company's management denied this and pointed out that the computers came from the U.S. Layoff rumors continued, however. Last Christmas Eve, Le Monde reported that the company soon would let go several hundred employees. Bull-GE again issued a denial.

Pink slips. But this time Le Monde had the story essentially right. A fortnight later, Bull-GE announced that its domestic work force of 11,000 would be reduced by 1,000, mostly by attrition. But 200 workers were laid off immediately and the work week of some 2,000 employees in the Paris region was cut back from 45 hours to 42½.

And Bull-GE had other bad news to report in mid-January. Up

Plan-Calcul

In its struggle to get into the black, Bull-GE will come up against some strong domestic competition, a situation indirectly of its own making.

When President de Gaulle realized he couldn't keep the Compagnie des Machines Bull under French control and reluctantly let the General Electric Co. rescue the near-bankrupt company, he ordered his aides to draw up a plan for an independent computer industry controlled by French money, manned by French engineers, and supplied by French components manufacturers.

The scheme, called the Plan-Calcul, went into effect officially at the first of this year. But even before then, the de Gaulle government had made major strides toward its goal. Last year, through pressure and persuasion, it brought together the main French firms still in the digital computer business. The upshot: a single joint company to develop an all-French computer and a second company to produce peripheral equipment. At the same time, two major French semiconductor concerns were pressured into working together on integrated circuits for computers.

Czar. Plan-Calcul puts France's drive for independence in computers under the control of a new agency headed by 45-year-old Robert Galley, the man who successfully united industry behind another of de Gaulle's ambitious projects—construction of a \$1 billion enriched-uranium plant at Pierrelatte. Over the next four years, Galley will have about \$130 million to spend on computer development and the establishment of a software school. The companies involved in Plan-Calcul will ante up at least as much as the government to develop the all-French computers.

Galley will hold the purse strings as far as government computer buying goes. Government planners say computer sales and rentals in France this year will total \$250 million; government business accounts for some 60% of the market.

Although the U.S.-controlled companies that now dominate the French market (the International Business Machines Corp.'s share is in the vicinity of 60%) won't be shut out, the new French computer company will by the nature of things be a preferred supplier to the government. The firm, Compagnie Internationale pour l'Informatique (INFI), expects to deliver its first Plan-Calcul-sired machine late next year or in early 1969.

New generation. The computer will be a third-generation type similar to the medium-range machines in the IBM 360 line, according to Jacques Maillet, INFI's president. By 1972, INFI plans to

have a fourth-generation machine ready for market. Maillet won't discuss it except to promise that it will be "profoundly different" from the first INFI machine.

Until its first computer is ready, INFI will produce and market units designed by its parent companies. They are CSF (Compagnie Générale de Télégraphie sans Fil), Compagnie Générale d'Electricité, the Schneider industrial group, and Inter-technique S.A. Digital computer sales of these companies last year totaled \$34 million and a spurt to \$44 million is predicted for this year.

Inputs and outputs. For the peripheral equipment for its Plan-Calcul computers, INFI will turn to another joint company, Société Sperac (for Systèmes et Périphériques Associés au Calculateurs). Sperac's parent companies are Compagnie Française Thomson-Houston-Hotchkiss Brandt and Compagnie des Compteurs.

Edouard Guignonis, Sperac's president, says his company will be much smaller than INFI. When Sperac has its plant running in about two years, it will employ only 250 people; by then, INFI will have a work force of about 3,000.

Sperac will concentrate initially on such near peripherals as magnetic-tape and disk memories and remote units for time-shared computers. Guignonis thinks Sperac's prospects may be even brighter than INFI's. "Our position is much more specific than INFI's," he says. "What we have in mind is a series of devices. Also, our market is much bigger."

Components question. Most observers feel that INFI and Sperac can get a competitive French computer on the market by 1968. "The French have succeeded every time they've attempted something like this," notes Jacques Dontot, president of the French electronics trade association and managing director of Thomson-Houston. "I think they'll do all right," says an unworried IBM executive who feels there will be room in the market for everyone.

But there's some doubt that French semiconductor makers will be able in the next few years to supply INFI with integrated circuits at competitive prices and still make a profit. The U.S. semiconductor manufacturers who have set up plants in France all have eyes on the computer market. And as far as INFI is concerned, the Plan-Calcul doesn't dictate a "buy-French" policy. Although the goal is an all-French computer—components included—INFI expects to buy at least 30% of its active components from French subsidiaries of U.S. firms this year and to continue purchasing at about that level during 1968.

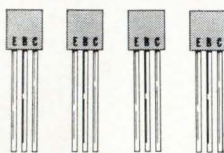

What's Here Besides The World's Four Best-Performing Low-Level Complementary Silicon Plastic Transistors?

Economy, that's what!

TRY THEM. See if you don't blaze new design paths within a wide range of tough circuit applications . . . and, simultaneously, lick "tight budget" problems with Motorola's significant, state-of-the-art achievement — the NPN/PNP 2N3903-06 silicon annular* transistor series. The data here signifies a new era in plastic capability for fully-specified 100 μ A to 100 mA performance of the highest level! Check the chart — see what we mean.

. . . And Check these Budget-Minded Prices!

NPN	PNP	1000-Up Quantities
2N3903	2N3905	\$.37
2N3904	2N3906	.41

We're stocked and ready with "production-run" quantities. So, whatever your need — demonstration samples or quick delivery on a large quantity order, contact your Motorola sales representative or nearest authorized distributor. For more technical information, write Motorola Semiconductor Products Inc., Dept. TIC, Phoenix, Arizona 85001.

*Annular semiconductors patented by Motorola Inc.

EVALUATE AND COMPARE THESE COMPLEMENTARY SPECIFICATIONS:

	NPN — 2N3903/4			PNP — 2N3905/6		
	Type	Min	Max	Type	Min	Max
BV_{CEO} ($I_C = 1 \text{ mAdc}$)		40 Vdc			40 Vdc	
h_{FE} ($I_C = 0.1 \text{ mAdc}, V_{CE} = 1 \text{ Vdc}$)	2N3903	20	—	2N3905	30	—
	2N3904	40	—	2N3906	60	—
($I_C = 1.0 \text{ mAdc}, V_{CE} = 1 \text{ Vdc}$)	2N3903	35	—	2N3905	40	—
	2N3904	70	—	2N3906	80	—
($I_C = 10 \text{ mAdc}, V_{CE} = 1 \text{ Vdc}$)	2N3903	50	150	2N3905	50	150
	2N3904	100	300	2N3906	100	300
($I_C = 50 \text{ mAdc}, V_{CE} = 1 \text{ Vdc}$)	2N3903	30	—	2N3905	30	—
	2N3904	60	—	2N3906	60	—
($I_C = 100 \text{ mAdc}, V_{CE} = 1 \text{ Vdc}$)	2N3903	15	—	2N3905	15	—
	2N3904	30	—	2N3906	30	—
f_T ($I_C = 10 \text{ mA}$)	2N3903	250 MHz		2N3905	200 MHz	
	2N3904	300 MHz		2N3906	250 MHz	
$C_{ob}(V_{CE} = 5 \text{ Vdc}, I_E = 0, f = 100 \text{ kHz})$			4.0 pF			4.5 pF

— where the priceless ingredient is care!



MOTOROLA
Semiconductors

NEW EG&G SILICON DIFFUSED PHOTODIODE

- HIGH QUANTUM EFFICIENCY
- WIDE SPECTRAL RANGE • FAST RESPONSE TIME • LOW NOISE

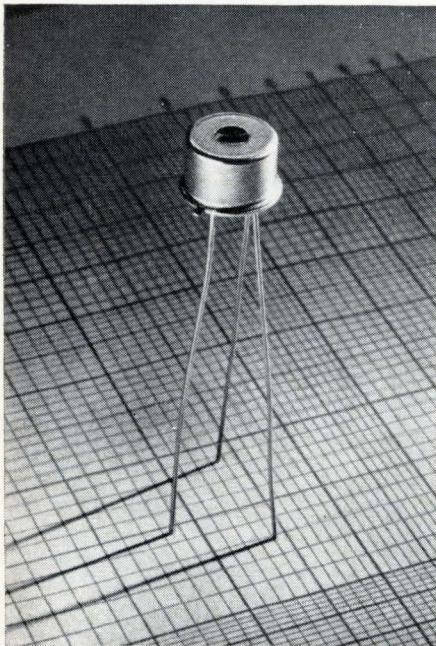

SGD-100 PHOTODIODE

The SGD-100 Photodiode — successor to the popular SD-100 — offers greater sensitivity and lower noise characteristics. Embodying EG&G's improved diffused guard ring design, the SGD-100 has a wide spectral range with an unusually high response in the "blue" region, fast response time and high quantum efficiency. The photodiodes are hermetically sealed in a TO-5 package.

Sensitivity 0.5 $\mu\text{A}/\mu\text{W}$ at 0.9 microns
(70% quantum efficiency)
Spectral Range 0.35 to 1.13 microns
Capacitance 7 picofarads at 90V
Rise Time 4 nanoseconds
Leakage 0.2 μA at 90V
NEP (0.9 μ , 10³, 1) 7.9×10^{-13} watts
Linearity of Response over 7 decades

Applications include CW, pulsed light and laser detection and measurement, star tracking, optical navigation, communication and guidance, and range-finding systems. The new SGD-100, also available in calibrated versions, is in quantity production for fast delivery at low price.

For information, write: EG&G Inc., 166 Brookline Avenue, Boston, Massachusetts 02215. Telephone: 617-267-9700. TWX: 617-262-9317.



against software troubles around the world with its 600 line, General Electric management decided to drop two medium computers well along in development at Bull-GE, the Gamma 140/141 and the Gamma 145. General Electric described the move as part of an effort to streamline its global computer operations; chauvinistic French financial writers, however, saw the decision as a setback for French technology and a harbinger of further layoffs.

Bull-GE's top echelon pinned the blame for the double dose of trouble on its own over-enthusiasm. Explained the company's president, Henri Desbrueres, "We tried to do too much too fast." And H. Brainard Fancher, the American whom General Electric installed as Bull-GE's general manager, said "We were too ambitious."

Clamor. But the unions representing Bull-GE workers insisted the layoffs and the withdrawal of French-developed machines stemmed from the machinations of GE officials in the U.S. And as they had when the first affaire Bull broke into print in mid-1964, union officials clamored for nationalization of the company. The de Gaulle government, with which GE had negotiated its recent moves, of course, didn't respond. But the campaign for nationalization continues, and Bull-GE almost weekly has to cope with press reports, apparently union-inspired, that mass layoffs are in the works at its plants, located at Belfort, Lyons, and Angers.

On the Paris stock exchange, Bull stock plummeted from about 130 francs in December to 75 francs in January, and has hovered at that level since.

But Bull-GE management is less concerned about the downturn in investors' confidence in its future than it is about customer confidence. More than anything else, it is concerned about how the government will react to the spate of speculation—unfounded, Bull claims—about further layoffs. Under the Plan-Calcul that went into effect this year, all government buying of data-processing gear will be channeled through the office of a computer czar who will have the key say-so on about 60% of the French domestic market. The government eventually will throw most of its



New face. H. Brainard Fancher, the American president of Bull-GE, will get much of the credit if the company sustains its recovery.

business to a new, all-French computer maker, Compagnie Internationale pour l'Informatique, but the new company won't be able to meet the data-processing needs of government agencies for some time.

II. Coming back

Bull maintains that the French press has overlooked the progress the company has made since GE took control. With the U.S. parent calling the shots, Bull-GE has managed to hold a 25% slice of the French market and has bettered its position elsewhere in Europe and in Latin America. And, says Perriquet, "In a little over two years we've changed our entire product line."

The concern currently produces the GE-400 as well as the domestically designed Gamma 10 and Gamma 55, both small computers. Bull-GE has delivered more than 1,000 Gamma 10's, on which deliveries began soon after General Electric took over. The Gamma 55, introduced last October, already shows signs of selling fast, according to Perriquet. "It has no competition as a computer for management of small enterprises," he says, "because it's just above the top of the Friden line and just under IBM's 360's."

Peripherals. Perriquet considers the company's expanding line of peripherals equally promising. These products include card readers and punchers, printers, magnetic-tape handlers, and punched-

tape readers. And Bull-GE has cathode-ray-tube input units and crt displays in development along with optical recognition systems and integrated-circuit successors to existing computers.

Peripherals represent a vital sector for the firm, says Perriquet, because clients that can't use its computers often buy its supplementary hardware, and Bull-GE also sells such equipment to other manufacturers. Further, peripherals bring in immediate income rather than rentals spread out over several years. Leasing arrangements were primarily responsible for killing the Gamma 140, says Perriquet. Since it took control of Bull, GE has poured more than \$100 million into the company, and presumably it decided that returns on a further investment to put the Gamma 140 into production would be too slow in coming.

The belt-tightening that doomed the Gamma 140 and the Gamma 145, though, may yet turn Bull-GE into a money maker. During its first 18 months under GE aegis, the company had a loss of \$50 million, most of it spent to fend off bankruptcy. Last year's loss is a top secret, but a knowledgeable source puts it at about \$20 million. Bull-GE now sees a chance of edging into the black late this year or in 1968.

Over there. If Bull-GE does turn the corner, much of the credit will go to Fancher, the man GE sent over to run the operation. Along with giving a new look to the product line, Fancher has provoked a metamorphosis in company thinking.

"The French have the habit of working with too little information and too much intuition," concedes Perriquet. Fancher introduced long-range planning to Bull, a company that long has been strong in technology but weak in management. Above all, he set up a separate department to handle the company's finances, previously lumped in with administration.

Americans now hold the top financial jobs at Bull-GE and still another man from the parent firm will soon take charge of the marketing division. Apart from that, Bull-GE remains essentially French, although you'd scarcely realize it from reading the company's press clippings.

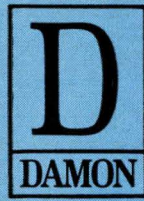

TC/VCXO

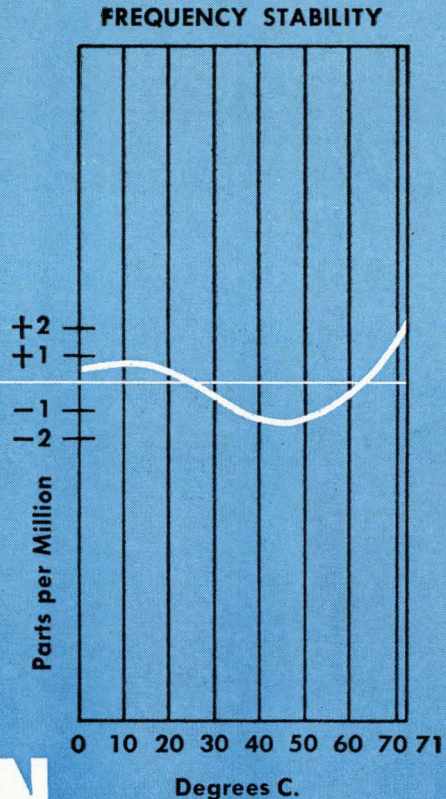

NO OVEN TC/VCXO

Frequency Stability
within $\pm 2 \times 10^{-6}$
over 0 to 71°C range



Typical TC/VCXO Model 5968WA
Center Frequency: 6.8 MHz
Size: approx. 2½" L x 1½" W x ¾" H

If space and power are limited in your telecommunication system, consider the advantages of the Damon Temperature Compensated Voltage Controlled Crystal Oscillator (TC/VCXO). This rugged, miniaturized unit provides a frequency deviation of ± 100 Hz about center frequency and maintains a stability comparable to that of an "ovenized" unit without the need for added circuitry and power.

The illustration, above, shows a frequency stability curve for a simple Damon TC/VCXO. To achieve comparable frequency stability an "ovenized" unit would require more space and more power.

Tight temperature compensation is only one example of Damon VCXO capability. Low noise, small size and increased reliability are other Damon VCXO accomplishments. Perhaps your telecommunication system suggests new VCXO problems? Consultations between circuit designers and Damon engineers are the best route to proper VCXO selection. As a starter, may we invite you to write for the Damon VCXO Brochure. Damon Engineering, Inc., 240 Highland Avenue, Needham Heights, Mass. 02194 (617) 449-0800.

DAMON

Electronic cops to monitor satellites

U.S. will use a variety of radar and sensing techniques to check on violations of the proposed UN ban on weapons in space

By Thomas Maguire, Boston Regional Editor,
and William Hickman, Electronics Washington bureau

Because the weapons ban included in the proposed outer space treaty has no provisions for detection, policing will depend on sharp eyes and ears from earth. Although it lacks teeth, the United Nations-sponsored pact—now before the U.S. Senate for ratification—is expected to be signed by the major powers.

A worldwide network of space-

tracking radar stations; the Ballistic Missile Early Warning System; the Navy's space surveillance radar fence across the Southern U.S.; and several new radars and optical sensors will provide the eyes and ears for this nation. Also available in aiding detection of treaty violations are improved radar signature analysis, better calibration techniques, and the use of interferometric

techniques and technology.

In addition to indicating a satellite's size and weight, space-tracking systems can determine its speed, precise orbit, shape, center of gravity, the kind of antennas it carries, and if there are any protuberances. This data, when coupled with intelligence from other sources, could tell a great deal about a satellite's mission.

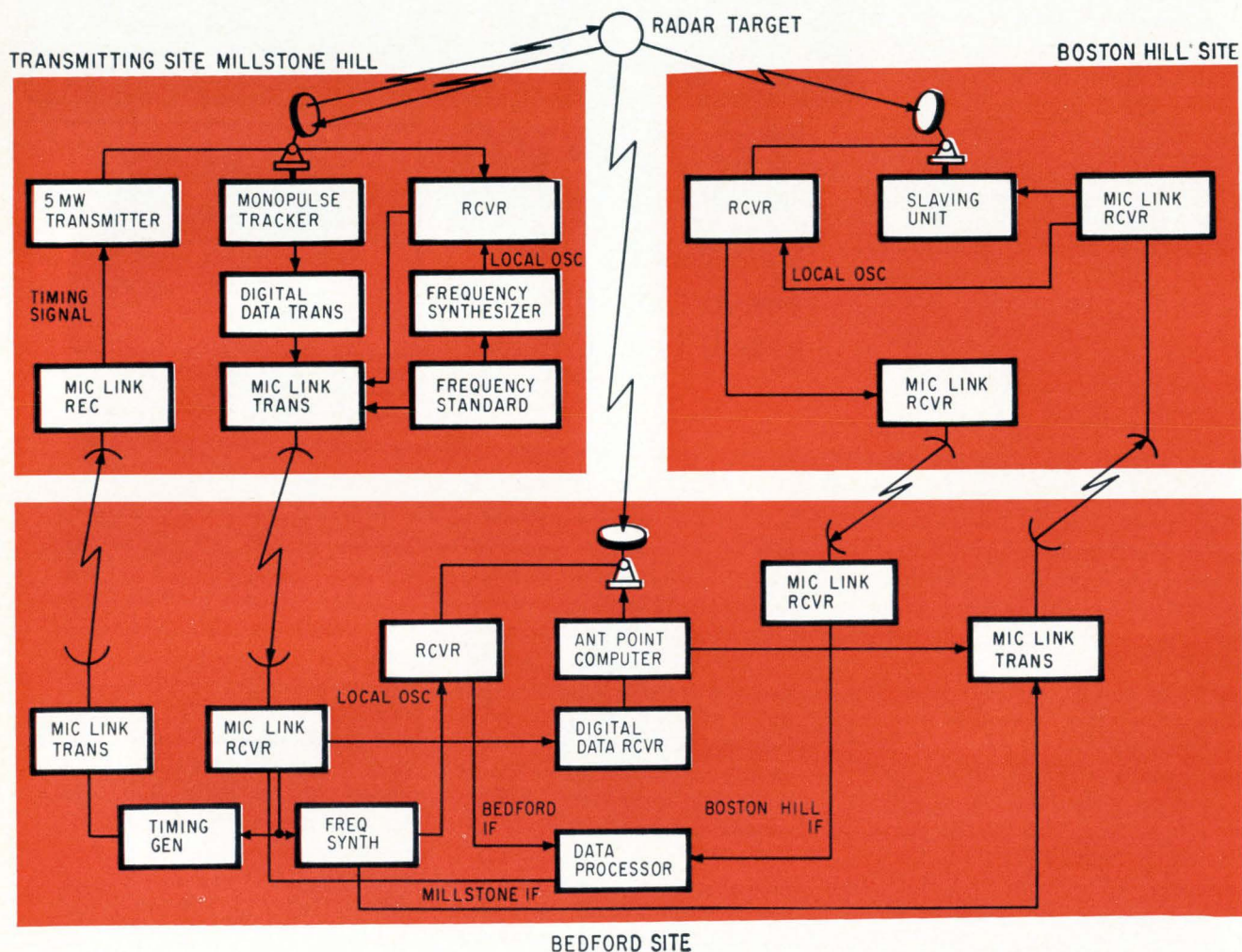

Triple play. Three-site interferometer in Massachusetts tracks satellites and space probes for the Space Defense Center. Interferometric techniques permit accurate measurement of angles and provide a great deal of information on targets.

A spokesman for the State Department's Arms Control and Disarmament Agency says: "We would not attempt to detect a warhead on every launch. But if the Soviets launched a number of satellites of the same configuration at about the same time, we would become suspicious and probably assume that they were up to some kind of wrongdoing."

I. A hard look

Details on how much can be learned and how fast with present technology are still closely guarded secrets, but the over-all goal of development work isn't.

"We'd like to know as much about the target as we would if we were standing next to it," says Col. Thomas O. Wear, director of the Air Force Space Systems Defense Program Center at Hanscom Field, Mass. The program has a key role in the Defense Department's efforts to refine techniques for ground identification of satellites. An experimental radar network in Northeastern Massachusetts is one of the center's important tools.

The network is a three-site radar interferometer—the only such phase-coherent system in the free world—with stations at Millstone Hill in Westford, Boston Hill in North Andover, and the Bedford headquarters of the Mitre Corp.

Interferometric techniques enable the measurement of angles with great accuracy and provide a great deal of information about the target. The network is a radar adaptation of the optical interferometer, a device in which the interference of light beams is used for measurements. Because the wavelengths are known, measurement of very small distances and thicknesses can be achieved. Similarly, since the wavelengths of the transmitted signals in the radar are known precisely, the interference pattern is a potential source of precise information about the target from which they return.

Mitre, the nonprofit company that does systems engineering for the Defense Department, uses the interferometer to obtain precise orbit determination and other information about satellites. The target illuminator is the Millstone Hill X-band radar, with its 84-foot dish. Millstone Hill is operated by the



Millstone Hill radar antenna, measuring 84 feet in diameter, is key part of interferometer. MIT's Lincoln Laboratory operates the facility.

Massachusetts Institute of Technology's Lincoln Laboratory. The Boston Hill and Bedford stations are operated by Mitre.

The Millstone Hill transmitter uses a 12-horn monopulse system for tracking. The system is completely coherent with all local-oscillator frequencies as well as with the transmitted frequency derived from an extremely stable single frequency standard. Operating at 1,295 megahertz, the system has a peak power of 5 megawatts with a nominal pulse length of 1 millisecond and a repetition frequency of 30 pulses per second. Signals received at Millstone Hill and Boston Hill are transmitted by microwave link to Bedford where they are time-multiplexed with the Bedford

receiver's output and applied to a sequential doppler processor. This preprocesses the return signals in sequence and records the radar parameters on magnetic tape for computer processing and, subsequently, evaluation.

One goal of the program is to determine the ultimate limitations of radar interferometry measurements set by propagation characteristics, the stability of components, and target scintillation phenomena.

"As the satellite population density increases," Wear points out, "radars with poor resolving power won't be able to distinguish between old and new satellites, between the known and a possible unknown." For this reason, attempts

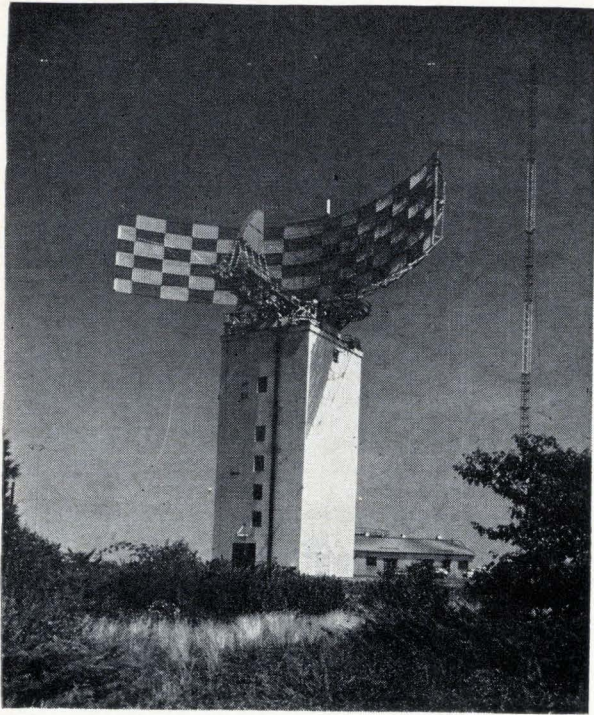

Master/slave. Antenna at Boston Hill is slaved to Millstone site and transmits signals by microwave link to the Bedford facility.

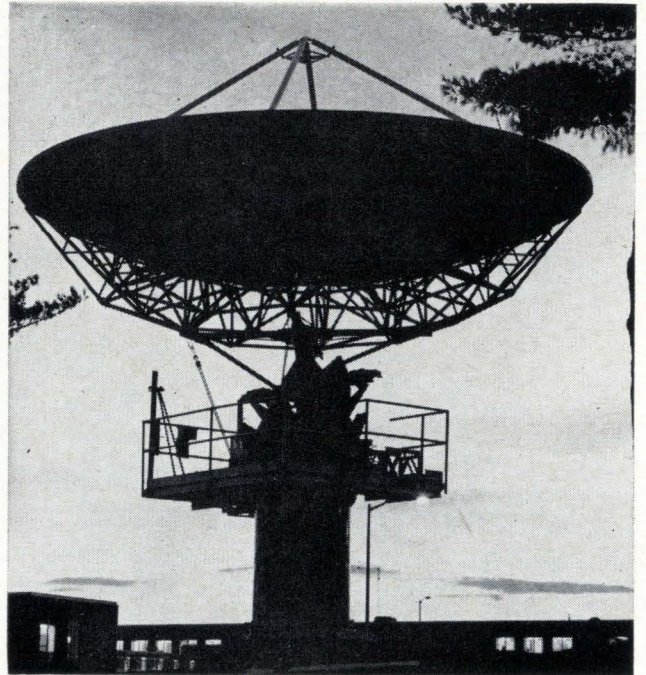

At Bedford, signals from Millstone and Boston Hill are time-multiplexed with station's output and applied to a sequential doppler processor.

are being made to push accuracy and resolution beyond present limits.

The Millstone Hill radar, which went on the air before the first Sputnik was launched, is the prototype of many of today's tracking radars. It is usually used one day a week to track satellites and other targets for the Space Defense Center at Colorado Springs, Colo. It is also used for tracking Soviet space probes and satellites.

The interferometer is not intended to improve detection but to obtain better orbital information about a satellite after it is detected. "Radar is still in its infancy," says Roger Manasse, head of Mitre's radar technology department. "We're still doing only 1% of what is theoretically possible."

One purpose of the Mitre program, says Manasse, is to "push the radar art to the point where we can truly say we have run into some basic limitations."

Radar specialists are reluctant to speculate on what may be possible in ground identification of satellites. But current programs include

radar signature interpretation, computation of physical shapes from cross-section patterns, and radar imaging—processing the outputs of widely spaced antenna elements of a large array to build up a microwave image of a satellite.

II. New ear, new eye

A new phased-array radar, expected to be completed by the fall, will join the nation's space defense network as a spacetrack sensor feeding information to the North American Air Defense Command headquarters at Colorado Springs. The FPS-85, located at Eglin Air Force Base in Florida, will detect and track both satellites and missiles [Electronics, June 27, 1966, p. 133].

An optical sensor that has been plagued by development problems and was shut down is expected to be reopened soon. This is the FSR-2, the \$5-million optical surveillance unit built at Cloudfcroft, N.M. [Electronics, Sept. 20, 1965, p. 25]. Its job is to detect and track satellites against a background of stars at distances beyond the range

of radar. A fiber optics system transmits the light collected by the telescope to a group of image-orthicon tubes for video data processing.

"Its performance was marginal," says Wear. "We tried to use off-the-shelf hardware but it became clear that more development was needed."

In the corrective program, both image orthicons and vidicons are being tried. "If the system becomes operational," says Wear, "a vidicon will probably be used because it is simpler in operation."

One approach under consideration is the use of an intensifier-vidicon tube that is believed capable of having a sensitivity equivalent to the orthicon while preserving the simplicity of the vidicon.

After the prototype is demonstrated, the Defense Department will decide whether to go ahead with completion of the Cloudfcroft facility and whether to build additional "eyes" of this type.

In a separate facility at Cloudfcroft, a team from the Aerospace Research Laboratory at Wright-Patterson Air Force Base in Ohio

Three Ways To Phase Out Potentiometer / Dial Problems

1 MODEL 3600 KNOBPOT® PRECISION POTENTIOMETER

2 MODEL 3640 KNOBPOT® SENIOR PRECISION POTENTIOMETER

3 MODEL 3650 DIGITAL KNOBPOT® PRECISION POTENTIOMETER

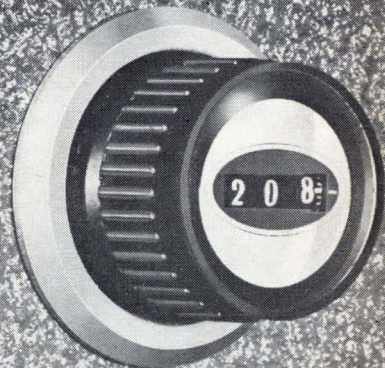
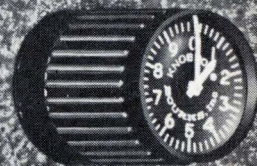

FACTORY PHASED • GUARANTEED ACCURACY • NO AMBIGUITY

Here is how you can eliminate the time and expense of assembling conventional potentiometer/dial combinations. The Bourns KNOBPOT® potentiometers give you everything you need in a self-contained unit. Installation is easy with no separate dial to attach, no complicated mounting procedure and no phasing. Just drill two holes, put the unit on the panel, and tighten the nut.

These units are **more accurate** than the best potentiometer/dial combination, yet cost no more! Many configurations cost less than \$20.00 each in low production quantities. Select the unit which fits your design requirements... the Model 3600 or 3640 KNOBPOT® potentiometer, or the new digital readout Model 3650.

All units are available in quantity with a complete line of accessories: color snap rings, colored MIL-SPEC knobs, locking brakes and recessed mounting brackets.

For further information on the Bourns KNOBPOT® Potentiometers and their accessories, contact your nearest Bourns representative or the factory direct. These products stocked in depth at your local Bourns authorized distributor.

SPECIFICATIONS	Model 3600	Model 3640	Model 3650
Standard Resistances	100Ω to 250KΩ	100Ω to 500KΩ	100Ω to 500KΩ
Dial Accuracy*	±0.50% All resistances	100-200Ω ±0.20% 500-5K ±0.15% 10K-20K ±0.12% 50K-500K ±0.10%	100-200Ω ±0.20% 500-5K ±0.15% 10K-20K ±0.12% 50K-500K ±0.10%
Repeatability	±0.10%	±0.05%	±0.05%
Power Rating	1.5W at 25°C	2.5W at 25°C	2.5W at 25°C
Max. Operating Temperature	-65°C to +85°C	-65°C to +85°C	-25°C to +85°C
Dimensions (in front of panel) ¾" dia.	1" long ¾" dia.	1½" long 1¼" dia.	1¾" long 1¼" dia.

*Includes the Linearity of the Potentiometers



BOURNS, INC., TRIMPOT DIVISION • 1200 COLUMBIA AVE., RIVERSIDE, CALIF.
TELEPHONE (714) 684-1700 • TWX: 910 332-1252 • CABLE: BOURNSINC.

TRIMPOT® and Precision Potentiometers • Miniature Relays • Electronic Modules • Microcomponents.

DO YOU USE MAGNETS?

Save Time and Costs With RFL High-Quality Magnetics Equipment



CHARGE

MODEL 2470-350 magnetizes with variable energies of up to 440 watt-seconds. Handles a wide range of materials, including Alnico, Ticonal and Barium Ferrite, using wire-wound fixtures, easily fabricated for virtually any configuration.

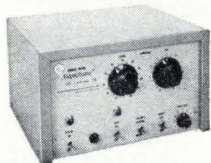

STABILIZE

MODEL 889B Magnetreater® demagnetizes and stabilizes almost any permanent magnet assembly, to specific flux levels, to within fractions of a per cent. Power level equivalent to 50 KVA.

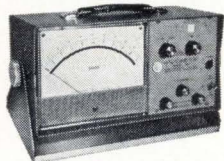

MEASURE

MODEL 750 Gaussmeter—A wide-range Hall-effect gaussmeter capable of flux density measurements from .02 gauss to 50 kilogauss in 24 full-scale ranges. Measures permanent magnetic fields, DC and AC to 400 Hz.

Send for full details, or call Earle Seely



Units may be combined as a complete "SYSTEM" for charging, treating, and measuring, without removing material from fixture.

RFL Industries, Inc.

FORMERLY RADIO FREQUENCY LABORATORIES, INC.
Instrumentation Div. • Boonton, N. J. 07050
Tel: 201-334-3100 / TWX: 710-987 8352 / CABLE RADAIRCO, N. J.

... testing laser range measurements to determine satellite orbits ...

is conducting a program of photoelectric observation of satellites.

Checkout. Another Aerospace Research Lab project is being conducted in Sulphur Grove, Ohio, under the direction of Kenneth Kissell. Kissell's efforts, designated Project 7114, are simply studies of the light reflected from an orbiting satellite, using techniques similar to those of low-light-level television. With his jury-rigged 24-inch lens telescope, Kissell can determine the color of an object in space, its tumble rate, whether it has been charred in launching, and its precise configuration. Resolution is sufficient to determine, for instance, whether the satellite has solar paddles, antennas, or other protuberances.

Kissell believes that a computer program can be written to sound an alarm when a satellite of suspicious configuration is detected. His group is now working on developing basic techniques for such an effort.

The Defense Department is also funding work in the use of lasers for satellite tracking. At the Millstone Hill station, a high-power ruby laser and a 10-inch reflecting

telescope have been mounted on a Nike-Ajax missile radar tracker for experiments in optical surveillance. The Smithsonian Astrophysical Observatory in Washington is also testing the accuracy of laser range measurements in the determination of satellite orbits. Also under investigation is the possibility of applying lasers to the observatory's Baker-Nunn camera network.

III. Missile studies

Regardless of an international treaty banning weapons in outer space, the U.S. is vitally concerned about what the Soviet Union is putting into orbit. And there is a considerable difference of opinion as to what constitutes a space vehicle. A ballistic missile, for example, leaves the atmosphere at some point in its flight and becomes, at least in theory, a spacecraft. Since launching such a weapon would immediately abrogate all treaties, the question of definition is moot from a diplomatic standpoint. However, there is still a great deal of interest in the technology involved.

The Advanced Research Projects Agency, a Pentagon unit operating

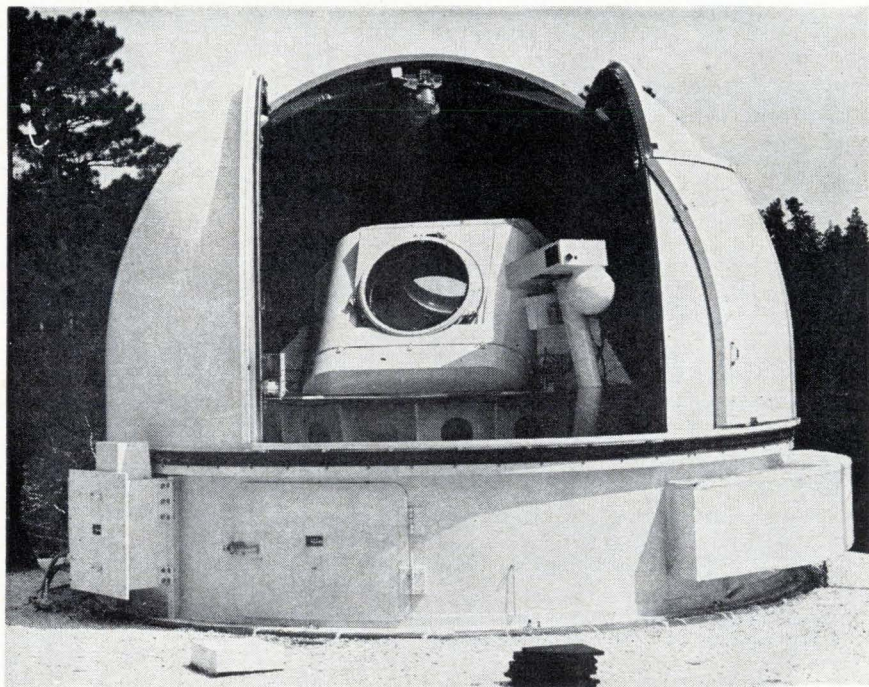

Shuteye. The old FSR-2 optical sensor which was unable to detect and track satellites at distances beyond radar range, is again under development.



DIAL DANA... BEFORE YOU BUY A DVM

No need to regret a decision based on catalog claims — not when you can see for yourself why the Model 5400 is the fastest selling digital voltmeter in the 0.01% class... dial your area code number for a demonstration today.

201 201: 687-8737	302 301: 946-0300	408 415: 968-7116	516 516: 433-1421	714 714: 297-4619	International Offices
201 201: 542-1441	303 303: 934-5505	412 412: 892-2953	517 313: 892-2500	714 213: 684-2840	
202 301: 946-0300	305 305: 723-6924	413 617: 648-2922	518 315: 454-9377	716 716: 271-7430	
203 203: 246-5686	309 312: 539-4838	414 414: 547-5131	602 602: 959-2115	717 717: 761-0577	
205 205: 881-3721	312 312: 539-4838	415 415: 968-7116	603 617: 648-2922	802 617: 648-2922	
206 206: 763-2755	313 313: 892-2500	417 913: 648-4173	606 513: 298-7203	805 213: 684-2840	
207 315: 454-9377	314 314: 837-0597	419 216: 885-5616	607 315: 454-9377	812 317: 253-1681	
212 201: 687-8737	315 315: 454-9377	501 214: 231-6541	609 215: 265-3250	814 412: 892-2953	
213 213: 684-2840	316 913: 648-4173	502 317: 253-1681	612 612: 537-4501	815 312: 539-4838	
214 214: 231-2573	317 317: 253-1681	503 206: 725-2700	614 216: 885-5616	816 913: 648-4173	
215 215: 265-3250	318 713: 528-6904	504 205: 881-3721	616 313: 892-2500	817 214: 231-6541	
216 216: 885-5616	319 319: 365-6635	505 505: 265-7766	617 617: 648-2922	904 305: 783-9407	
217 312: 539-4838	401 203: 246-5686	507 612: 537-4501	618 314: 837-0597	912 215: 881-3721	
218 612: 537-4501	402 913: 648-4173	512 713: 528-6904	703 301: 946-0300	913 913: 648-4173	
219 312: 539-4838	404 404: 261-5459	513 513: 298-7203	712 319: 365-6635	914 914: 769-1811	
301 301: 946-0300	405 214: 231-6541	515 319: 365-6635	713 713: 621-0040	916 415: 968-7116	

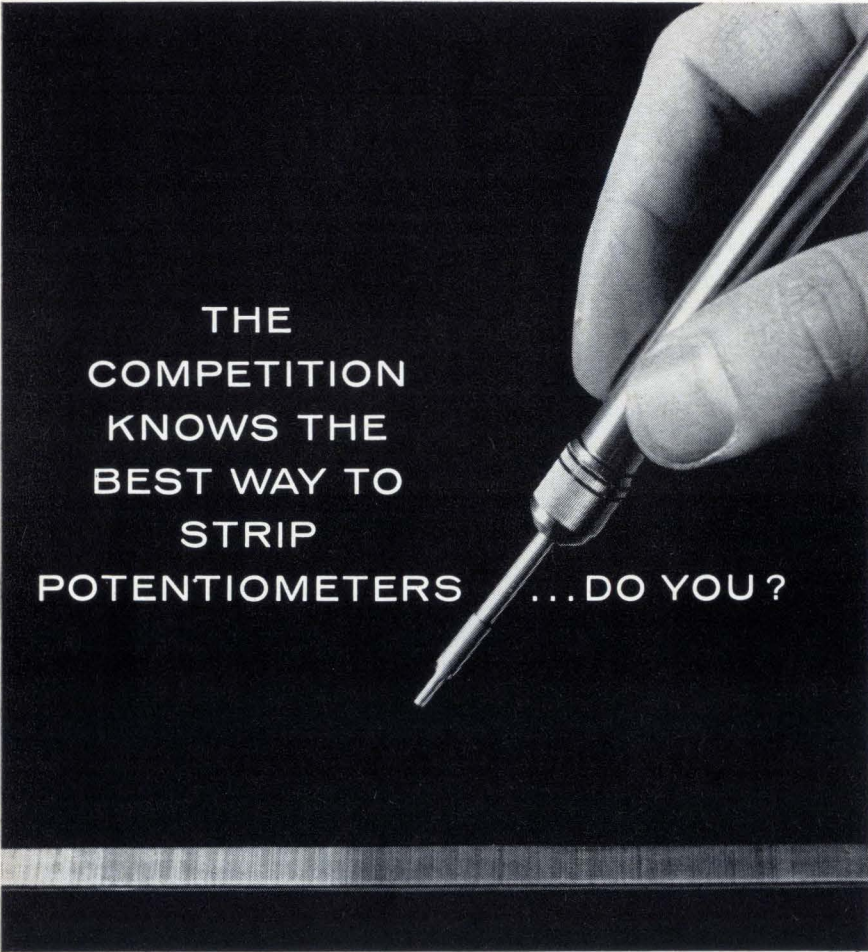

THE
COMPETITION
KNOWS THE
BEST WAY TO
STRIP
POTENTIOMETERS ... DO YOU?

If you're still trying to strip potentiometers without an S. S. White Airbrasive unit, you're a victim of unfair competition. For 90% of your competitors know how to do it the easy, cheap, fast, and uniform way—the Airbrasive way. Airbrasive directs a precisely-controlled jet of graded abrasive particles at supersonic speeds for cool, shockless, non-distorting abrasion. Cuts away varnish without altering the electrical properties of substrate winding wire. Result: Faster stripping; fewer rejects; more uniform product.

One company cut rejects by 65%; time from 30 minutes to 2 minutes. This has been the typical experience of the industry.

Other Airbrasive applications include: adjusting microresistors; lead cleaning; micromodule fabrication; dicing germanium; shaping semiconductor materials, all flashing and deburring operations. Airbrasive is easily automated, adapts to use with jigs, lathes, templates. It can cut, abrade, machine, drill, deburr any hard, brittle refractory material.

Investment is low—less than \$1,000 sets you up.

If you're still skeptical, call us collect for an Airbrasive demonstration or send us samples of your problem-child for a free evaluation. All your competitors can't be wrong.

SEND FOR BULLETIN 6407A—Complete Information

S. S. WHITE, COMPANY, INDUSTRIAL DIVISION, Dept. EU,
201 East 42nd Street, N.Y., N.Y. 10017, Telephone 212 661-3320



S.S. WHITE[®]



under the Director of Defense Research and Engineering, is working on a project dubbed AMOS—ARPA midcourse observatory station—for tracking missiles. The station has three telescopes: two with 45-inch lenses and one with a 60-inch lens. They are located at Haleakala crater on Maui Island in Hawaii. The agency's project manager says the facility has two missions.

The major mission involves studies of the signatures of missiles at their midcourse. These include optical studies of U.S. missiles fired down the Pacific test range toward the Kwajalein atoll in the Marshall Islands. This course puts the missile's apogee over the Haleakala station. An ARPA source says a great deal is known about missiles in their launch phase and extensive studies have been going on during the terminal phase. But little is known about what happens and what the missile's signature is like at midcourse.

The station will be tracking the missiles when they are outside the atmosphere and, hence, roughly in the same position as an orbiting satellite. The ARPA project manager says he knows of no plan to use the AMOS for satellite studies. However, he points out that the facility is capable of checking on satellites that pass within its viewing range. The agency also is responsible for the Defender project, an antiballistic missile effort complementing the Nike-X program.

AMOS's secondary mission involves unclassified research in astrophysics and geophysics. The agency says the station will be made available to universities and other research groups on a time-sharing basis when not being used for defense research projects.

The University of Michigan is the prime contractor for AMOS. The facility is now being debugged and the agency says it is 90% completed. Work started in 1963 and the total cost will run about \$5 million. The dormant volcanic mountain site where it is located is 10,000 feet above sea level. The University of Hawaii and the National Bureau of Standards also operate atmospheric-studies facilities at Haleakala.

Although primarily an optical viewing facility, AMOS is designed to be versatile and television cam-

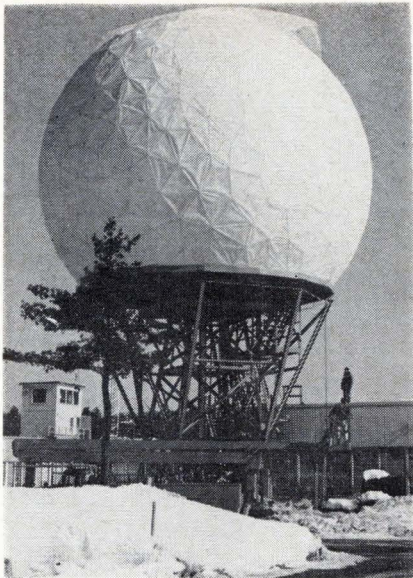

Under cover. Antenna at Mitre Corp.'s Bedford site now sports a radome.

eras or spectrographs could be integrated into the system for additional studies.

According to ARPA, the unique fact about the AMOS facility is its location. Similar stations are located in several other places, but AMOS is the only one situated to monitor missiles at midcourse in the Pacific test range.

IV. Toothless

According to a State Department official, the teeth in the space treaty are political rather than practical. Both the U.S. and the Soviets would be deterred primarily by worldwide public opinion.

The treaty does not bar research and development of weapons in space systems and would only be violated if a system is launched. Presumably, says the State Department source, both countries will continue to investigate the possibility of launching such weapons. But he guesses, based on Pentagon studies, that weapons in space will never prove feasible for either side.

The spokesman says the U.S. has no present intention of reviving studies of a satellite system for in-orbit inspection. If this were to be done, the system probably wouldn't be used for routine checks. As he explains it, "going up to and opening the door" of a satellite would be unacceptable to both sides. For the foreseeable future, all inspection of orbiting spacecraft will be done from the ground.

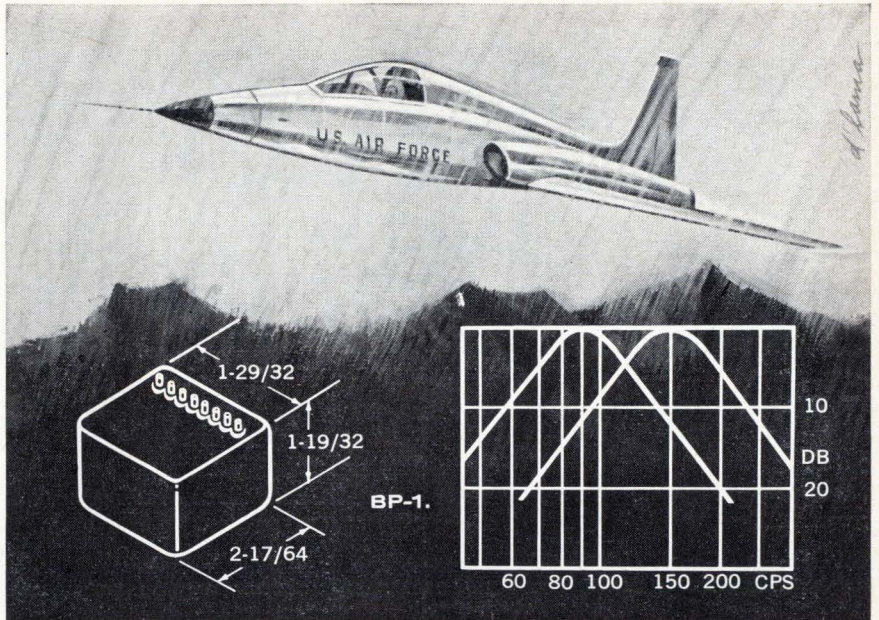

FILTER RELIABILITY—PROVEN IN 10⁶⁺ AIR HOURS

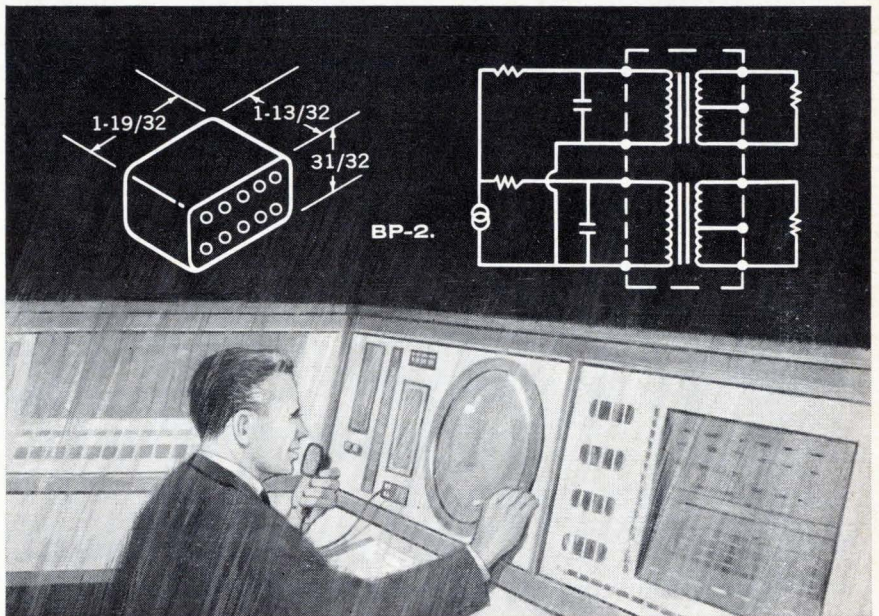

Before aerospace technology fostered the formal concept of reliability, the aircraft industry translated their requirements for filter performance to ADC in terms of *dependability*. ■ Illustrated here are two of the many types of dependable ADC filters that have operated in various aircraft electronic equipment during the past decade ■ ADC's filter design staff combines computer-assisted design techniques with years of experience in the highly important area of optimum selection of network components ■ This combination assures you the most economical and dependable solution to your filter problems.

SPECIFICATIONS

BP-1. 90 and 150 cps pass band filter for use in commercial air-borne ILS system. Constructed for extreme reliability over -40°C to $+72^{\circ}\text{C}$ temp. range, and under all environmental conditions of Mil-F-18327B.

BP-2. Dual 30 cps tuned transformer, for Omni Range radio. Has ultra-stable primary to secondary phase characteristics from -55°C to $+85^{\circ}\text{C}$, and over 5 db input range.

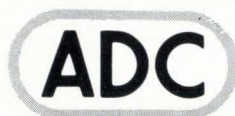

ADC PRODUCTS

A DIVISION OF MAGNETIC CONTROLS CO.

6405 CAMBRIDGE STREET • MINNEAPOLIS, MINN. 55426

Here's a sample of the values you'll find in BURR-BROWN'S 1967 Operational Amplifier line

SPECIFICATIONS		PRICE
MODEL NO.	KEY SPECIFICATIONS	
3009/15	General Purpose — $\pm 10V$, 5mA; $\pm 20\mu V/^\circ C$ maximum, $-25^\circ C$ to $+85^\circ C$; 10KHz full power bandwidth: 5mA maximum quiescent drain.	\$ 25.00
3015/15	General Purpose — Smallest $\pm 10V$, 50mA unit on market. 1.2" x 1.8" X 0.6"	\$ 65.00
3003/15	General Purpose — $\pm 10V$, 20mA. Input drift: $1\mu V/^\circ C$ (typ), $3\mu V/^\circ C$ (max.); differential input — non chopper; $3\mu V$ rms input noise.	\$ 95.00
1556/15	FET Input — low drift, $5\mu V/^\circ C$ (max). 10V, 20mA. 100KHz full power bandwidth. 50pA bias current.	\$125.00
3010/25	Chopper Stabilized — 1MHz full power. Ultra low drift: $0.5\mu V/^\circ C$ (max.). No external drive required. Bias current drift: $.5pA/^\circ C$ (typ). 10mA quiescent drain.	\$175.00
3013/15	Wideband — Fast — fast settling time: $< 1.5\mu sec$. 10 MHz bandwidth. 8mA quiescent drain (max.). Differential input impedance: 10^{11} Ohms.	\$ 95.00
1901/19	Military Type — encapsulated amplifier. Meets MIL-STD-202C and MIL-STD-810. 10V, 20mA. 5mA quiescent drain.	\$ 95.00

Demonstrator units are available on all of these models. Contact your Burr-Brown Representative. Most of these units are in Burr-Brown Jet-Stock for immediate shipment from your local representative's office.

Get the complete story in our 16-page short-form catalog... it contains information on Burr-Brown operational amplifiers, instrumentation amplifiers, function modules, active filters, power supplies and complete accessories. It's available, now, from your Burr-Brown Representative... or, use this publication's reader service card.

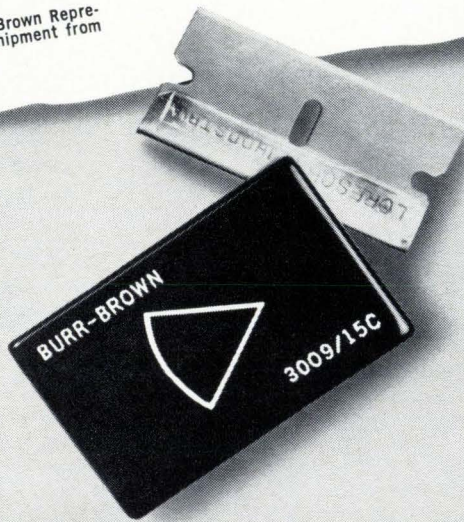

BURR-BROWN RESEARCH CORPORATION

International Airport Industrial Park • Tucson, Arizona 85706
TELEPHONE: 602-294-1431 • TWX: 910-952-1111 • CABLE: BBRCORP



Operational Amplifiers
Instrumentation Amplifiers
Function Modules
Analog Simulators
Geophysical Instruments

ENGINEERING REPRESENTATIVES: ALABAMA, HUNTSVILLE (205) 534-1648 / ALASKA, ANCHORAGE (907) 272-5231 / ARIZONA, PHOENIX (602) 254-6085 / CALIF., LOS ANGELES (213) 665-5181, SAN FRANCISCO (408) 245-3321 / COLO., DENVER (303) 388-4391 / CONN., MILFORD (203) 874-9222 / FLORIDA, ORLANDO (305) 425-2764 / ILLINOIS, CHICAGO (312) 286-6824 LA., NEW ORLEANS (504) 834-6598 / MD., SILVER SPRING (301) 588-8134 / MASS., BOSTON (617) 245-4870 / MICH., DETROIT (313) 353-3822 / MINN., MINNEAPOLIS (612) 781-1611 MO., ST. LOUIS (314) 524-4800 / N.C., GREENSBORO (919) 273-1918 / N.J., CAMDEN (609)

365-2450 / N.M., ALBUQUERQUE (505) 255-1638 / N.Y., ALBANY (518) 436-9649, BINGHAMTON (607) 723-9661, BUFFALO (716) 632-2727, MT. VERNON (914) 968-2200, NEW HARTFORD (315) 732-3775 / OHIO, CINCINNATI (513) 761-5432, CLEVELAND (216) 884-2001, DAYTON (513) 277-8911 / OKLA., TULSA (918) 835-2481 / OREGON, PORTLAND (503) 292-8762 / PENN., PITTSBURGH (412) 243-6655 / TEXAS, DALLAS (214) 363-1671, HOUSTON (713) 928-5251, UTAH, SALT LAKE CITY (801) 466-8709 / WASH., SEATTLE (206) 622-0177 / CANADA, TORONTO (416) 293-7011, VANCOUVER (604) 736-6377

Sony scores with IC for small radio

Chip with nine transistors, four diodes, and 14 resistors is forerunner of similar, higher-powered devices for applications in other consumer goods

By Charles Cohen

Electronics Tokyo bureau

Engineers at Japan's Sony Corp. are puzzled by the general failure of the U.S. and foreign consumer electronics industry to use integrated circuits in its wares. In their opinion, such a step is both logical and advantageous. Last year, the company underwrote its conviction and introduced the first miniature radio built around a monolithic IC [Electronics, Oct. 17, 1966, p. 222]. Now, more ic-equipped Sony consumer goods are on the drawing boards.

Sony crammed the equivalent of nine transistors, four diodes, and 14 resistors on the silicon chip used in the radio. There are also three discrete transistors in the radio along with the integrated circuit. One is a silicon unit for the converter stage and there is a pair of complementary symmetry germanium transistors for the push-pull output stage. Sony contends that the addition of this trio's functions to the IC would have increased costs without providing any particular advantages.

In the works. The intermediate-frequency amplifier part of the IC uses four transistors, in two groups of two, with the first two forming a Darlington connection. Reverse automatic-gain control is applied to the base of the input transistor.

The remainder of the nine transistors are used in the audio amplifier where one functions as a temperature-compensating device. Three of the four diodes operate as

forward-biased voltage regulators, while one serves as the second detector. Gain of the two i-f amplification stages and the loss in the second detector totals about 32 decibels—about normal for a radio of this type. The second-detector loss alone is higher than usual because transformer coupling cannot be used. However, the increased gain of the i-f amplifier compen-

sates for this deficiency.

I. For men who know

Radio engineers, rather than semiconductor designers, worked on the integrated circuit used in Sony's radio through the laying out of components on the chip. However, semiconductor experts handled the detail and design of masks.

According to Sony, the rationale

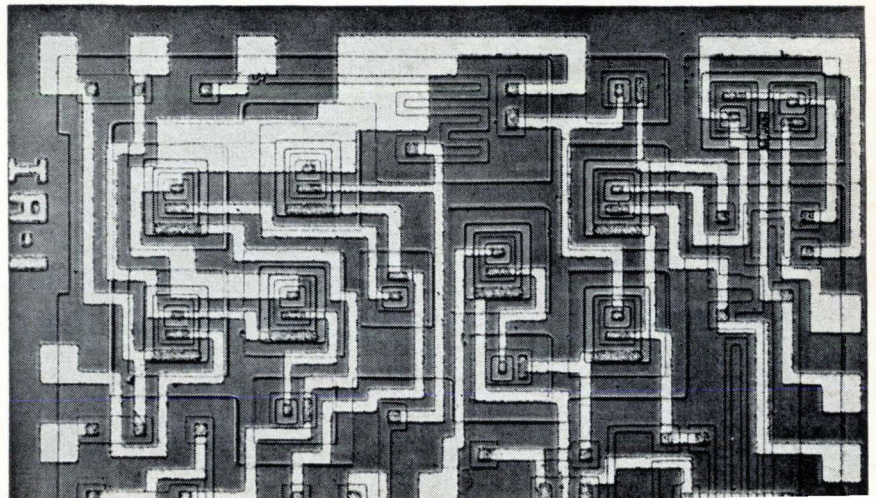
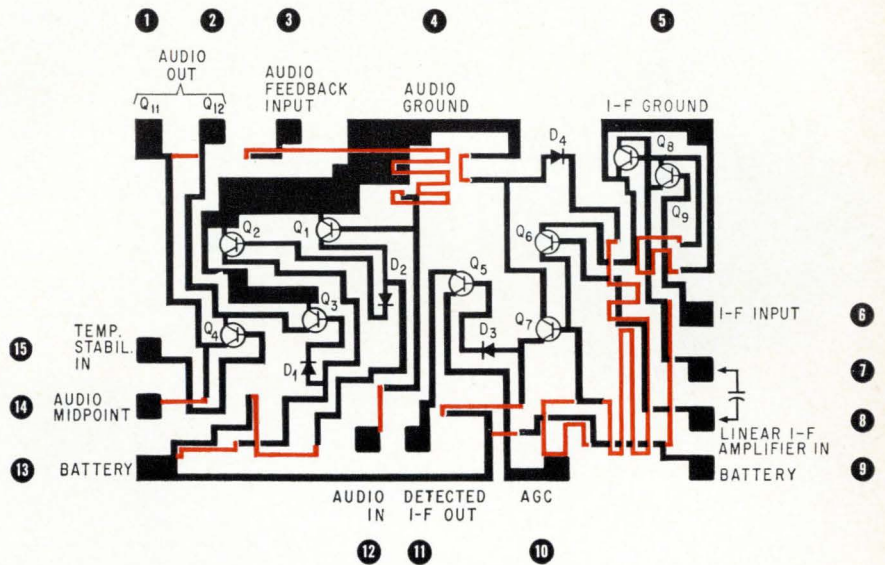

Chip for Sony's radio integrated circuit has nine npn transistors, four diodes, and 14 diffused resistors (shown in color). Transistors Q_1 , Q_2 , and Q_3 are audio stages; Q_4 is a temperature stabilization unit; Q_5 a detector; Q_6 and Q_7 i-f linear amplifiers; and Q_8 and Q_9 a Darlington i-f agc stage.

NOW IN 4-POLE*

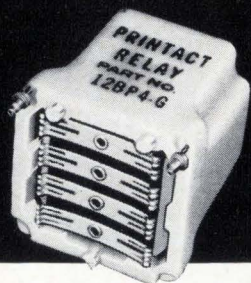

THE HIGHLY RELIABLE, LOW COST

Printact®

standard and latching
magnetic relays

- NO SPRINGS ■ NO WIRING
- NO SOCKETS ■ NO SOLDERING
- NO MECHANICAL LINKAGE

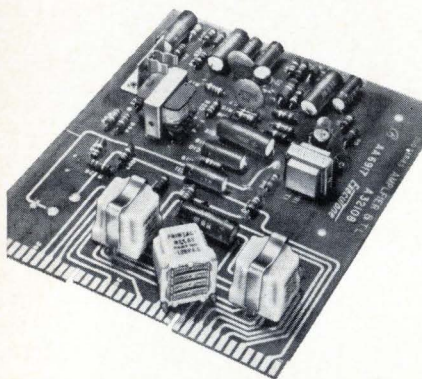

Plugs into your PC Board. Uses Plated Conductors as the fixed contacts.

Exclusive PRINTACT design saves space, weight, cost and installation time . . . with excellent reliability. 100 million cycles mechanical life, rated for up to 10,000,000 cycles depending on load from dry circuit to 2 amps, res. Coils available for 6, 12, 24 and 48 vdc. Time: 7 to 10 ms. Temperature: -30 to +95°C.

Quality features include: double-break contacts; balanced armature, enclosed housing, plug-in application; encapsulated coil; self-wiping contacts and inherent snap-action. Weight: 1 oz. in compact 7/8" cube.

*Switches up to 4 form A plus B, or 4 form C.

For more data and prices, write:

Executone

PRINTACT RELAY DIVISION
47-37 Austell Place
Long Island City, N.Y. 11101

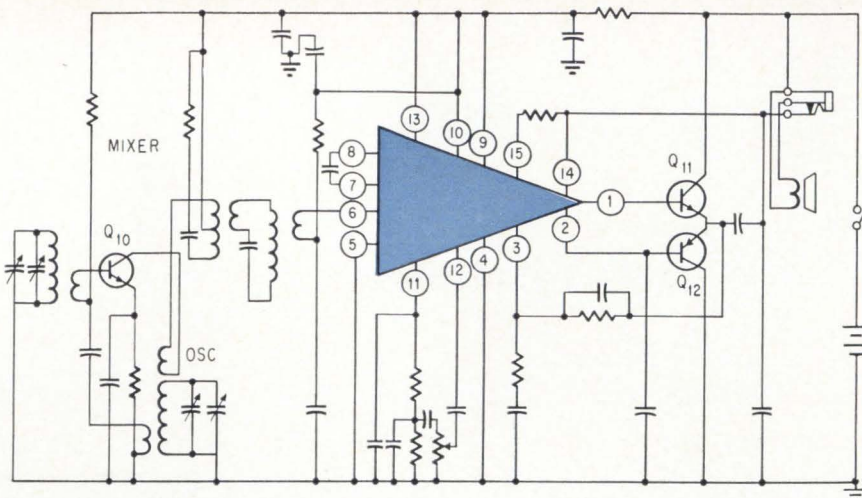

Sony's IC fits into its radio circuit along with three discrete transistors. Q₁₀ is a silicon npn unit in the converter stage. Q₁₁ and Q₁₂ are complementary germanium devices for the transformerless output stage. Numbered terminals correspond to those in the chip shown on page 177.

for having radio engineers do the layout is persuasive. After years of experience with printed circuit boards, they are completely familiar with the interaction among components. For example, the i-f and audio amplifier sections of the integrated circuit use separate grounds. They do so because the common impedance of about 100 milliohms in the metalization could render the ic unstable. Radio engineers realize the existence of this potential pitfall, but a semiconductor designer might be inclined to believe that such a low resistance value could have a negligible effect upon the circuit's performance.

Follow-ons. Sony engineers profess to be mystified by the fact that American and Japanese firms are not producing consumer goods with integrated circuits. [The General Electric Co. and the Philco-Ford Co. in the U.S. as well as Japan's Matsushita Electrical Industrial Co. have all introduced IC-equipped radios since Sony stole its march.] The company claims that its radio presented no more difficulties than the average new product and it is planning to introduce a new tape recorder and several more radios with ic's this year. These products will, however, probably have to use different

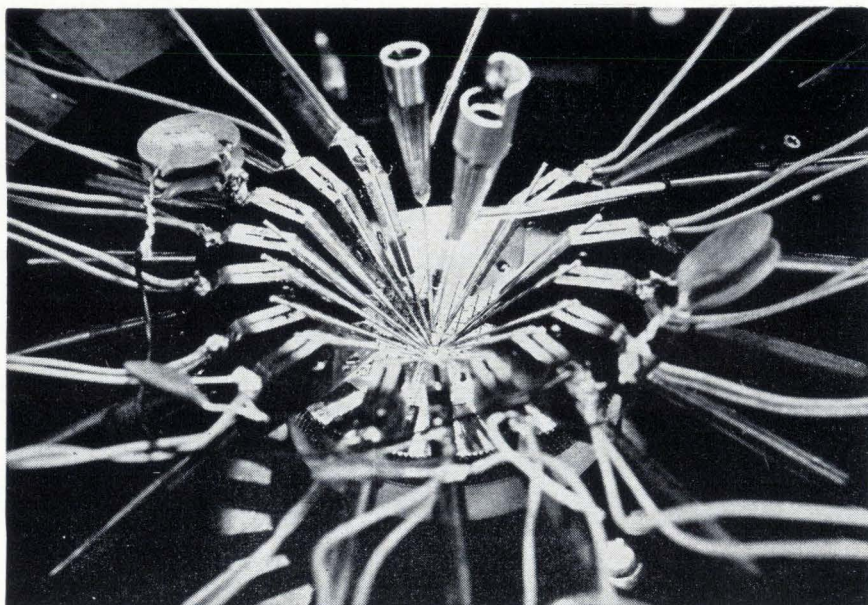

Finished IC's on silicon slice are probed after completion of aluminum internal connections. Bypass capacitors are used because circuits are tested under dynamic operating conditions.

chips. The slice incorporated in the radio was designed to operate at 2 to 2.8 volts. Low voltage is usual in a miniature pocket radio but not in most other wares.

II. Packaging

Sony's IC package measures 6.5 millimeters by 8.5 mm by 4 mm; there are 16 external leads. The chip mounts on a glass header and is encapsulated in epoxy. Over-all dimensions of the radio, which includes a rechargeable battery, are 31 mm by 58 mm by 18 mm.

In terms of volume, the case takes up more room than any of the other items used in the radio. Other components that consume space, in decreasing order, are: the speaker, bar antenna, variable capacitor, printed circuit board, ear-phone jack, two i-f transformers, volume control, oscillator coil, the IC, and tantalum capacitor.

Sound-pressure level of the speaker, normalized to the level that would be obtained at one meter from a speaker of identical efficiency with an input of one watt, is 93 db.

Sensitivity of the Sony radio is 50 db per meter—about equivalent to that of a quality pocket unit with six transistors and better than that of many miniatures with seven and eight transistors that are now on the market. With an input of 60 db per meter, the signal-to-noise ratio of Sony's radio is about 20 db. This compares with about 17 to 18 db for a good miniature unit and 20 to 23 db for pocket-sized assemblies. Adjacent channel selectivity, the rejection ratio for a signal 10 kilohertz from the carrier to which the radio is tuned, is 23 db. The norm for a miniature radio is about 17 db.

Postponement. Sony appears to have shelved plans for mass-marketing its radio in the U.S. although it had expected to do so by this spring. No more than a test-market batch has reached American shores. The principal difficulty centers on the unsettled patent status of the integrated circuit. [For substantially similar reasons, the Hayakawa Electric Co. Ltd. has held off marketing its desk calculator with an IC memory in the U.S.] Japan's Ministry of International Trade and Industry is attempting to resolve the situation.

ANTENNA and TOWER INSULATORS by LAPP

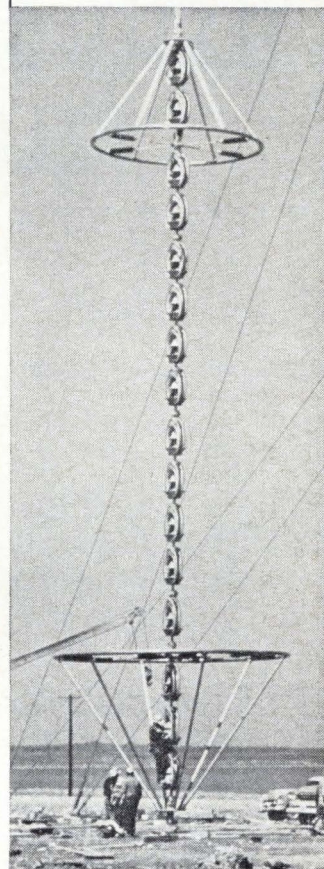
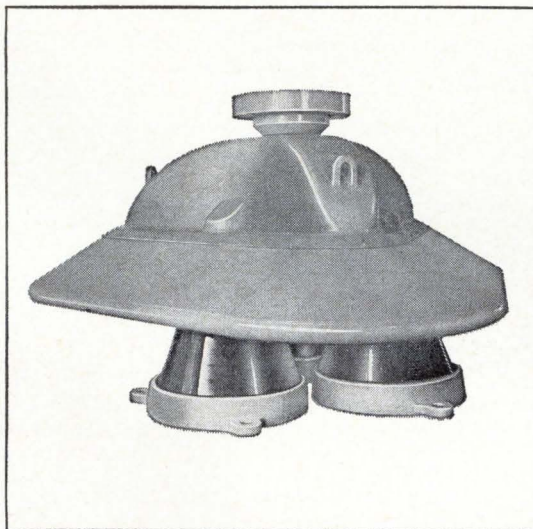
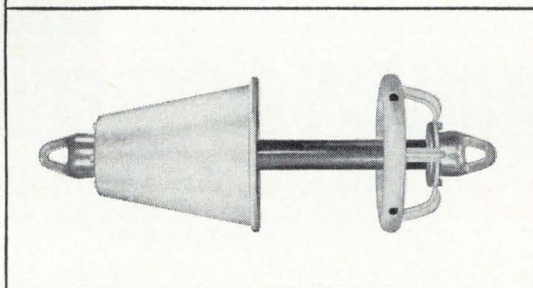
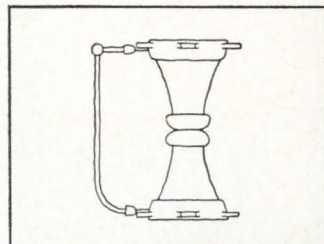
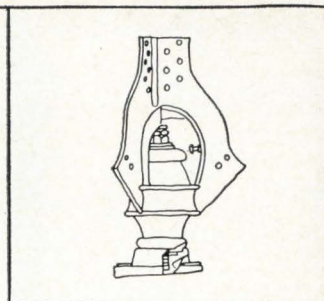

Lapp insulators support most of the world's large radio towers, both self-supporting and guyed masts. Lapp has designed and built base insulators from 80,000 lbs. to 9,000,000 lbs. ultimate strength. Lapp strain insulators have been made from 1200 lbs. to 620,000 lbs. ultimate strength. □ Lapp is also a dependable supplier of entrance, spreader and stand-off insulators for transmission lines. Other Lapp insulators and our gas filled capacitors are used in transmitters and coupling networks. □ Difficult insulating problems are welcome here at Lapp. We've been solving them for almost a half century. Write Lapp Radio Specialties Division, Lapp Insulator Co., Inc., 204 Sumner St., LeRoy, N. Y. 14482.



**FIELD
TESTED**

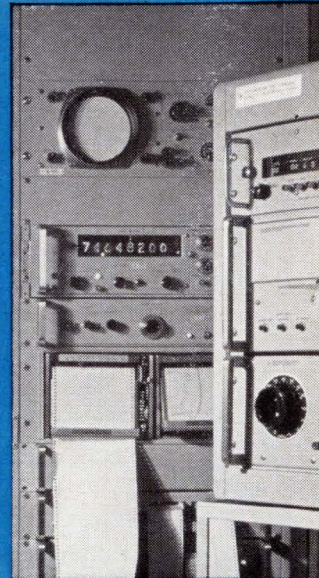
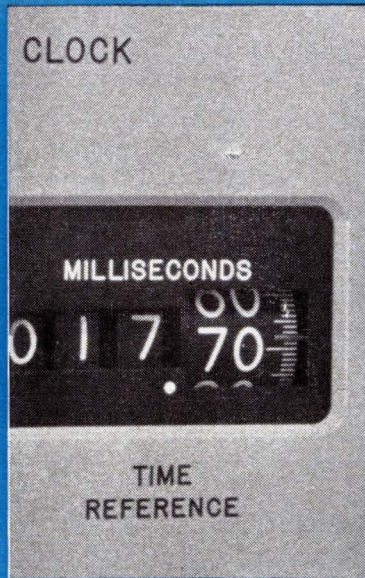
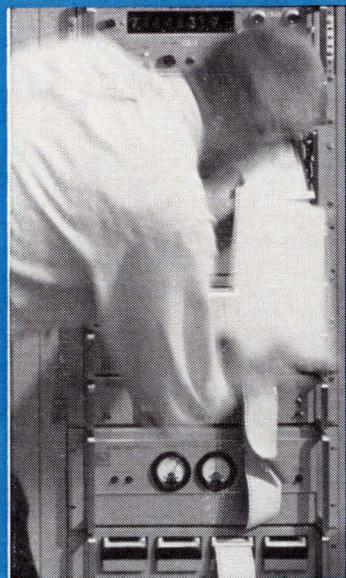

RELIABILITY IN FREQUENCY AND TIME STANDARDS

From Hewlett-Packard, your ONE Complete Source for Instruments and Systems

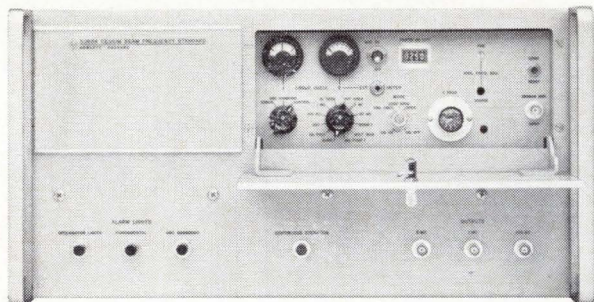

Atomic standard provides 1×10^{-11} accuracy

Model 5060A Cesium Beam Standard is a compact, primary frequency standard which offers unprecedented performance in a portable package. A new long-life Cesium 133 Resonator insures a long-term stability of $\pm 1 \times 10^{-11}$. Operation is from standard ac power or from a 24 v dc source.

The 5060A features high reliability and a rugged, spectrally pure precision quartz oscillator (max. aging rate, 5×10^{-10} /day) which can be operated independently of the cesium resonator. Atomic or UT_c frequencies are supplied on order. Outputs 5 MHz, 1 MHz, 100 kHz sinusoidal, 100 kHz clock drive. Signal to noise ratio at 5 MHz is at least 83 db at rated output (125 Hz BW) for a guaranteed minimum of 10,000 hours of cesium resonator operation. \$15,500.

Solid-state quartz oscillators

Model 106A and 106B Quartz Oscillators provide a long-term stability of better than 5×10^{-11} per 24 hours. Heart of the 106A/B is a 2.5 MHz quartz oscillator housed in a sealed proportionally controlled double oven with all temperature-sensitive circuitry inside. Total frequency change is less than $\pm 1 \times 10^{-10}$ for a 0° to 40°C ambient

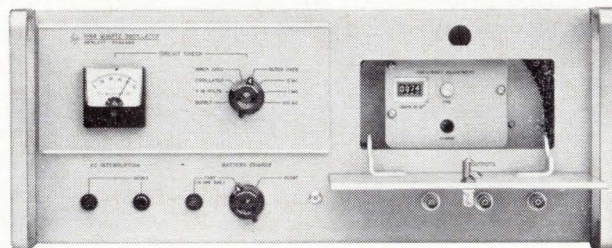

change. Buffered 5 MHz, 1 MHz and 100 kHz outputs are provided, plus 100 kHz output to drive frequency divider and clock. hp 106A, \$3450; hp 106B, \$3900.

Models 107AR and BR feature hermetically sealed oscillators with 5×10^{-10} /24 hours maximum aging rate and 5 MHz quartz crystal resonators. They meet vibration and shock requirements of MIL-E-16400E, are completely water-tight and will remain stable with ± 1 part in 10^{10} between 0°C and 50°C . Outputs at 5 MHz, 1 MHz, 100 kHz sine, 100 kHz clock drive. hp 107AR, \$2400; hp 107BR, \$2750.

"A" and "B" models of the 106A/B and 107AR/BR are identical except for their power requirements. "B" models operate from 115 or 230 v ac (50 to 1000 Hz) or from an external 22 to 30 v dc supply or an internal standby battery. "A" models require an external supply voltage of 22 to 30 v dc. All have a voltage control feature allowing $> 2 \times 10^{-8}$ frequency control for locking to an external source.

Model 100E Quartz Oscillator is available for applications requiring less sophisticated frequency standards. Maximum aging rate is 5×10^{-8} /week. Ideal for production, test and lab use. Output frequencies are 10 Hz, 100 Hz, 1 kHz, 10 kHz, 100 kHz, 1 MHz sinusoidal and 10 Hz, 100 Hz, 1 kHz, 10 kHz pulse and a timing comb. \$1250.

Model 101A Quartz Oscillator is a low-priced model with maximum aging rate of 5×10^{-8} /week. Outputs are 1 MHz and 100 kHz sinewaves. \$600.

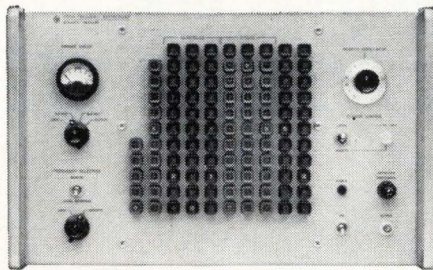

High-performance frequency synthesizers with fast switching

A broad range of spectrally pure, stable test signals is available from any one of four frequency synthesizers from Hewlett-Packard. Instruments feature $<20 \mu\text{sec}$ switching time and frequency increments as small as 0.01 Hz. Maximum aging rate of internal oscillator is ± 3 parts in 10^9 /day. Spurious signals are 90 db down in two models. Digital pushbutton and remote frequency selection may be used with internal or external oscillator. Direct synthesis translates the oscillator's stability and spectral purity to the output. Four models vary in range (dc to 1, 10 or 50 MHz, and 0.1 to 500 MHz) and output increments. \$6500 to \$13,500.

ious signals are 90 db down in two models. Digital pushbutton and remote frequency selection may be used with internal or external oscillator. Direct synthesis translates the oscillator's stability and spectral purity to the output. Four models vary in range (dc to 1, 10 or 50 MHz, and 0.1 to 500 MHz) and output increments. \$6500 to \$13,500.

Doublers and mixers

Model 10514A Double-Balanced Mixer mixes, modulates and phase detects with low noise, high efficiency and low intermodulation. Input 200 kHz to 500 MHz, output dc to 500 MHz. \$180. Printed circuit Model 10514B, \$150.

Model 10515A Frequency Doubler extends the range of signal sources with low spurious content and very flat response. Input 500 kHz to 500 MHz, output 1 MHz to 1 GHz, \$120.

Calibrate against the U.S. frequency standard

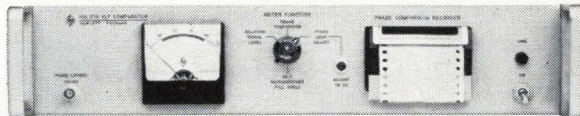

Model 117A VLF Comparator makes accurate comparisons between local frequency standards and the 60 kHz signal from U.S. N.B.S. Station, WWVB. Accuracy approaches 1 part in 10^9 over an 8-hour period. The 117A provides a continuous record of instantaneous differences in phase. Includes antenna, with preamp and 100 ft. cable. \$1300. Built-in and external time scale translators available.

Rapid, precise frequency comparison

Model 8405A Vector Voltmeter can make frequency comparisons to 1×10^{-13} of typical standard frequencies of 1 MHz and above in just several minutes. Many other uses, too. \$2500.

Frequency divider and clock

Model 115BR Frequency Divider and Clock displays time, generates precise time signals. Operates from quartz or cesium beam frequency standard. Water-tight, rugged, for mobile use; outputs of 100, 10 and 1 kHz, 1 pps ticks, 1 pps pips. \$2750.

Model 115CR for lab applications not requiring auxiliary outputs. \$1500.

Standby power supply for protection from external power failure

Model 5085A Supply for 5060A Cesium Beam and other standards. 24 v dc 2 amps, max. (2.5 a for 30 min.). 25 amp-hour battery derated to 18 a-h. \$1250.

Portable atomic standard systems

Model E20-5060A "Flying Clock" System includes 5060A Atomic Standard, special 115BR Divider and Clock, and a very versatile power supply with ac or dc input and internal 8-hour standby capacity. Similar systems are periodically flown around the world by hp to correlate time to within $1 \mu\text{sec}$ at many of the world's timekeeping centers. See Hewlett-Packard Journal, April 1965 and July 1964 for details on the world's most accurate portable time standards system.

Hewlett-Packard has devoted the efforts of an entire division to the development of better and more accurate frequency and time systems. Hundreds of engineers and technicians are specially trained and ready to help you with your particular application.

For a complete discussion of frequency and time standards write for a free copy of the 100-page HP Application Note #52. Complete specifications and data are available from your HP field engineer, or write Hewlett-Packard, Palo Alto, Calif. 94304. Europe: 54 Route des Acacias, Geneva.

HEWLETT  PACKARD

1484R

ANY OF FIVE PROTECTIVE CIRCUITS IN ONE EASILY OPERATED SWITCH

Series Trip

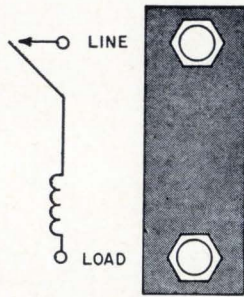

Airpax APL circuit protectors are manufactured in five circuit configurations. Each is available in any of 10 time delays, in any of 16 standard trip levels, and rated for a maximum of either 50 vdc, 250 vrms at 60 Hz, or 250 vrms at 400 Hz. This choice gives you great flexibility in protective design.

Shunt Trip

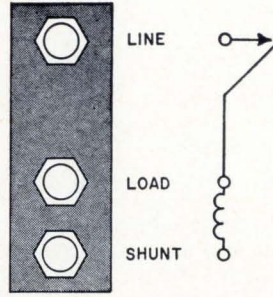

Shunt trip provides you with several possibilities. For example, you can program an external shunt across the coil to change trip level for different operating modes of your equipment.

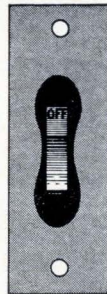

To the operator its an ON-OFF switch. To you its a design simplifier.

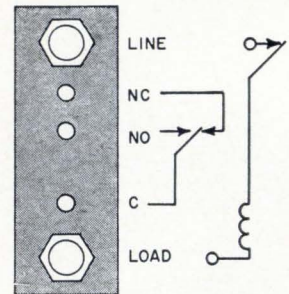

Remote Indication

A switch built into Type APL-RE protector transfers up to 5 amperes in a separate signalling circuit.

Relay Trip

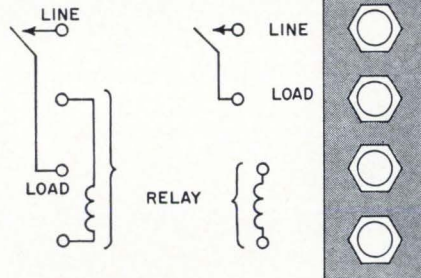

In protector Types APL-4 and -5, coil and contacts terminate at separate pairs of terminals. With this configuration, you can control current in one circuit (up to 50 amperes) by a different current in a separate circuit (50 ma to 50 amps).

FOR LOADS FROM 50 MA TO 50 AMPS

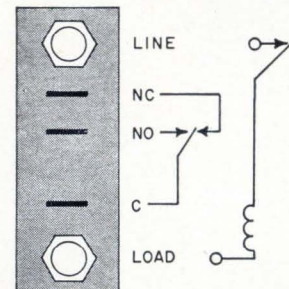

Remote Operate

Auxiliary contacts built into Types RO and -RO1 handle up to 10 amperes. This spdt switch operates simultaneously with the main contacts. Used to switch a remote load, this feature provides you with means for interlocking and protecting related loads.

AIRPAX ELECTRONICS

CAMBRIDGE, MARYLAND 301-228-4600

Sputtering modules plug into line

Deposition chambers for dielectrics and metals couple together so that integrated-circuit substrates can pass continually through process

There's many a slip betwixt the lab and the production line when a ticklish process like sputtering a new dielectric composition onto an integrated circuit is being developed. But the problems of converting a lab technique into a production method will be sidestepped by a sputtering system that Consolidated Vacuum Corp. plans to introduce in June.

The production lines will be built with separate sputtering chambers, each a self-contained subsystem complete with vacuum pumping apparatus, controls, and a transport mechanism for the substrates. One module can be used in the lab to develop a process, then taken into the factory and coupled to other modules to extend the production system. The procedure can be used by the manufacturer, for example, to deposit an additional metal film on the IC substrates. Often, a process is developed in a small bell jar system in the lab; but then it must be scaled up in a production system, a company spokesman says.

Consolidated Vacuum says the system is the first off-the-shelf, in-line sputtering system developed for the electronics industry. Whether one or several deposition chambers are in the line, substrates can be fed in at one end and removed in a controlled atmosphere chamber at the other end. The substrates are not exposed to airborne contaminants between deposition cycles. Vacuum within the system can be maintained for weeks at a time, adds the company, overcoming the problem of contamination of the chambers themselves.

Only few in-line systems are now in use in the industry, the company notes, and they were custom-built. The conventional bell jars used by most companies must be opened to the atmosphere after a batch of substrates has been processed. [A

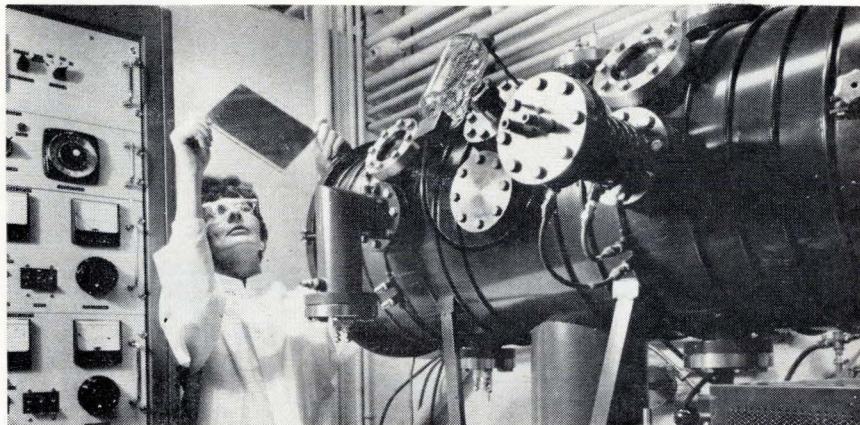

bell jar system manufacturer, however, claims a tetrode-sputtering technique deposits a purer film—see p. 228.]

“We feel the Plasma Vac 400 system will be an important breakthrough,” says William E. Finney, Consolidated Vacuum’s president. “It will provide real production capacity for the first time.”

The company has also modified its sputtering elements so that each chamber contains two sputtering stations. The user can select direct-current triode sputtering, diode sputtering, or radio-frequency sputtering. In all, the basic sputtering mechanism is generation of ions in a gas, usually argon, acceleration of the ions to a target material, and sputtering of atoms from the target onto a nearby substrate. Diode and d-c sputtering are generally used to deposit metals, while r-f sputtering deposits dielectrics.

Another feature is “crossfire” sputtering. Sputtering elements are built in pairs, creating a dual discharge that results in higher ionization efficiency and a more even deposition on the substrate. This allows deposition onto multiple substrates or large substrates, typically 6 inches square. The ionized gas is confined by the channel through which the transport mechanism passes. Sputtering can be

done upwards, with the substrate facing down, or downwards.

The transport mechanism that carries substrates through the chambers can be indexed so that the substrates will pause for a given time in each sputtering station. Sputtering time can also be controlled. To speed up the rate, or to prevent pinholes, the same material can be deposited in two stations. If different pressures are required in adjacent stations, valves can be installed in the transport between stations.

A basic two-chamber system, with vacuum pumps, power supply, transport, and controls is tentatively priced at \$65,000. Consolidated Vacuum plans to introduce the system June 6 at a symposium on sputtering that the company will cosponsor with the University of Rochester. The prototype, shown above, is a single-chamber system.

Specifications

Substrate area	6 sq. in., typically
Power input	230 v, 40 amps, 50/60 hz, 3-phase
Water	0.3 gal. per min.
Gas	argon, or as required

Consolidated Vacuum Corp., a subsidiary of the Bell & Howell Co., 1775 Mt. Read Blvd., Rochester, N.Y. 14603
Circle 349 on reader service card.

Measuring voltage without touching the circuit



Noncontacting instruments are used to make electrical measurements in cases where loading effects could cause measurement errors. But these sensors are generally bulky, and their inherent noise limits them to measuring voltages above 10 volts.

The Victoreen Instrument Co. is offering a noncontacting voltmeter that is free of these restrictions. The series 5050 Proximity Voltmeter is small and lightweight, and can measure direct-current voltages as low as 1-volt full scale. Maximum voltage range is 1,000 volts full scale, and accuracy is $\pm 1\%$.

A dynamic capacitor contained in a cylindrical probe connected to

the voltmeter senses, through a hole in the probe, the electrical field generated by the device being measured. Comparison of the voltage from the specimen with the voltage of a reference plate within the probe creates a difference voltage across the capacitor. This voltage is then amplified and fed back to the reference plate until the difference is cancelled; the readout of the feedback voltage is then the absolute value of the specimen's voltage. At the same time, the difference voltage is fed to the probe to bring the probe tip to the voltage level of the specimen and thus eliminate the effects of field distortion.

Victoreen uses a vibrating refer-

ence element instead of a motor-driven chopper to alternately place the reference and specimen in front of the dynamic capacitor. In addition to allowing a reduction in the size of the probe, this approach frees the instrument from internally generated brush noise, permitting sensitivity down to 1 volt full scale. Elimination of a motor allows the circuitry to be all solid state.

The instrument is available with two probes. The model 5051-25 high-resolution probe resolves spot charges as small as 0.075 inch in diameter, and the model 5051-35 high-sensitivity probe measures down to 1 volt with a resolution of 0.2 inch spot diameter.

Victoreen says the voltmeter can be used to test circuits and to measure the electrostatic charge buildup on missile and aircraft skins. It can also measure the surface potentials of plastics, paper, fabrics, semiconductors, and insulating or conducting materials. In fact, the company says the instrument is sensitive enough to distinguish between the printing and background of an electrostatic copy.

Specifications

Range	$\pm 1, 3, 10, 30, 100, 300, 1,000$ volts full scale
Accuracy	$\pm 1\%$
Response speed	10 milliseconds rise time from 10% to 90%
Price	\$1,795 including the high sensitivity probe, \$1,895 with both probes

Victoreen Instrument Co., 10101 Woodland Ave., Cleveland, Ohio 44104 [350]

New products in this issue

183 Sputtering modules plug into line

184 Measuring voltage without touching circuit

Components

186 Tiny timer makes it big

186 Sealed stepping relay

186 Photomultiplier tube

188 Surface thermocouples

190 Crossbar selector switch

190 Modular logic relay

192 Surge-protection device

194 Vacuum capacitor

194 Compact versatile relay

196 Metalized Mylar capacitors

Semiconductors

198 Monolithic operational amplifier

198 IC's in plastic packages

198 Metal-oxide FET

200 Operational amplifier for \$15

200 Plastic-packaged silicon rectifiers

202 Hybrid IC amplifiers

Instruments

204 Digits added to analog traces

205 Sweeper improves synthesizer

206 Portable r-f wattmeter

208 Measuring r-f signal intensity

210 Checking capacitor data

Subassemblies

214 Adjustable delay line

214 Differential d-c amplifiers

214 Modular telemetering system

214 Elapsed time indicator

217 Isolated power supplies

217 Sequential timers

217 Regulated lab supply

218 Telemetry power pack

219 D-c to a-c inverters

Microwave

221 GaAs diodes break noise barrier

222 EMI measurements extended

223 Step recovery varactor

224 Iris-coupled filter

225 Telemetry bandpass filters

225 Frequency multipliers

226 Two-cavity klystrons

Production equipment

228 Tetrode sputters purer thin films

228 Semiconductor wafer fracturer

230 Photoresist spinner

Materials

233 Prepreg bonds circuit layers

233 Semiconductor-grade silicon tetrachloride

233 Acrylic-base thermosetting coating

In Making Masks for
Electronic Components...
...there's no
Margin for Error!

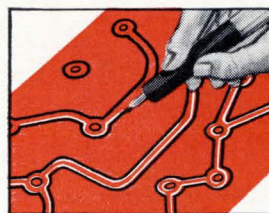

With sharp blade, outline the areas to be masked. Do not cut through the backing sheet. The Ulano Swivel Knife does the job quickly, easily.



Now carefully peel off the film as outlined leaving a completed photo mask, positive or negative, that corresponds exactly to the desired pattern.

**THAT'S WHY EXPERIENCED DESIGNERS
AND ENGINEERS ALWAYS INSIST ON...**

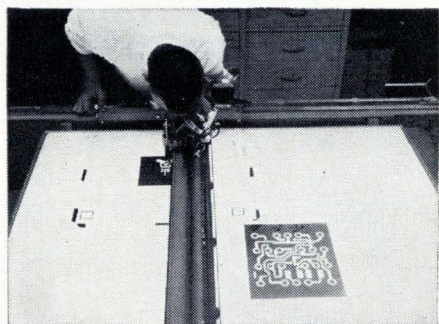

RUBYLITH™

HAND-CUT MASKING FILM FOR THE GRAPHIC ARTS

**THE KNIFE-CUT, LIGHT-SAFE MASKING FILM
LAMINATED TO A STABLE POLYESTER BASE**

The most versatile line of hand-cut masking films, including

**.0075—RUBYLITH 75 DR* .005 RUBYLITH 5 DR
.005 AMBERLITH 5 DA**

These new, thick Ulano films provide the positive answers where exact register assumes a critical importance.

**Available in sheets only, cut to your specifications.*

by

Ulano™

ulano™

610 DEAN STREET, BROOKLYN, N. Y. 11238

NEW YORK • CALIFORNIA • CHICAGO • ZURICH

In Europe: ULANO A. G., Untere Heslibachstrasse 22, Kusnacht 8700, Switzerland

Write on your letterhead for special electronic test kit (no charge) No. 4148

Catch 1 μ s
voltage peaks
with PEAK LOK

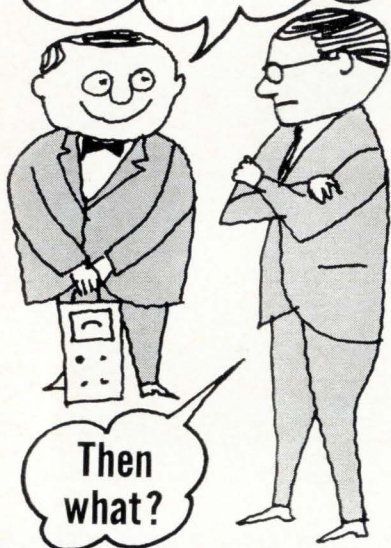

Here's what! PEAK LOK measures and holds voltage peaks as brief as 1 μ s with 1% absolute accuracy. And PEAK LOK holds its reading until it's reset or a higher voltage peak occurs . . . no matter what the time span.

Use PEAK LOK to monitor damaging transients in component life tests, catch overweight items in a production run, read peak acceleration in a vibration test, check for momentary overloads in your electrical circuits . . . or anywhere else precise determination of voltage peaks can help solve your instrumentation problem.

Monitor positive, negative or bipolar peaks in any of nine ranges from 0.1 to 1000 volts. High voltage probes are available to extend range to 30 KV. You can check the reading on the mirror-backed meter, or use the analog output for data logging.

PEAK LOK is remotely programmable and can operate on batteries if desired.

Priced at \$695, PEAK LOK is available from stock, of course.



For a data sheet, contact PEAK LOK Sales, Dept. 113, La Jolla Division, Control Data Corporation, 4455 Eastgate Mall, La Jolla, California 92037. Phone (714) 453-2500.

LA JOLLA DIVISION

**CONTROL DATA
CORPORATION**

4455 Eastgate Mall, La Jolla, Calif.

New Components and Hardware

Tiny timer makes it big

Now available in production quantities, a tiny electrolytic cell meets military specifications, provides wide-range accurate timing, and fits into a package the size of a tantalum capacitor. The timer, a liquid electrolyte E-cell made by the Bissett-Berman Corp. [Electronics, Nov. 16, 1964, p. 67] gives 5% accuracy over intervals from fractions of a second up to as much as 1,500 hours.

In operation, the current through the device electroplates silver from an anode to a cathode. During the transfer of silver, the cell impedance is low and the voltage drop across the cell is about 10 millivolts. When all the silver has been removed from the anode, the voltage suddenly increases to about 1 volt. This is more than enough to trigger a directly coupled SCR or transistor. The cell can be recharged any number of times by reversing the current and plating the silver back on the anode.

Charge capacities are available from 4 microamp hours to 1,500 microamp hours. A 3,000 microamp hour unit is about to go into production. Current ratings are between 1 microamp and 3.5 milliamps. The desired timing interval is obtained by choosing the proper combination of the cell's charge capacity and current.

One application beyond simple timing is in a very low frequency oscillator in the range of 1 cycle per hour, per day or even per week, where two cells are connected so that one discharges while the other charges.

The unit is available in versions with two or three leads in a package that measures $\frac{3}{4}$ inch long by $\frac{3}{8}$ inch in diameter—or in a package without leads that plugs into a coaxial socket.

The two-lead version has only one timing range, but the three-lead version provides two anodes for two different timing ranges. An outer anode is for use up to 1,500 microamp hours, while a center anode handles up to 480 microamp hours.

The company says that E-cells

have been tested by users for severe shock and vibration performance.

Specifications

Charge capacities	4 μ a-hr to 1,500 μ a-hr
Current	1 μ a to 3.5 ma (at 70° C)
Minimum stop voltage	700 mv at 3 μ a
Storage temperature	—60° C to 60° C
Delivery	2-3 weeks
Price	\$25 (1-9) units to \$4 in large quantities

The Bissett-Berman Corp., Box 655, Santa Monica, Calif. [351]

Hermetically sealed stepping relay

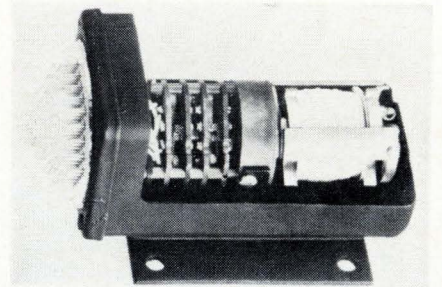

The aerospace industry is expected to benefit from a small stepping relay designed and manufactured to meet the requirements of MIL-R-6106. The G13 series, in a hermetically sealed enclosure, is available as a standard with 12 positions and 4 decks. Special modifications can be made for other output requirements.

Standard stepping motor voltages are 6, 12 and 28 v d-c. Contacts are rated at 10 amps resistive and 6 amps inductive. Basic enclosure size is 3 9/16 in. x 1 7/8 in. x 1 15/16 in. with various mounting and terminal configurations available.

Giannini-Voltex, 12140 East Rivera Rd., Whittier, Calif., 90606. [352]

Photomultiplier tube has fast response

Designed with a two-inch cathode, a tetrode-focused photomultiplier features fast response with high collection efficiency. Typical pa-

Winchester Electronics Means Service:



Stock in depth from
28 national distributors.



Engineering assistance from 25
regional and overseas offices.



On time factory delivery
of standard and custom needs.



Easy-to-specify handbook
of standard connectors.



Make a Few Gallons of hot, Pure Water do the work of thousands

... with Barnstead microelectronic cleaning equipment

You cut rejects of integrated circuits, transistors, diodes and other semiconductor materials with hot rinses of particle-free, ultra-pure water. You minimize purification expense and usage of heat and water — at the same time!

Instead of dumping used hot, pure water down the drain, Barnstead equipment continually repurifies it, to be used over and over again.

Barnstead makes a variety of microelectronic cleaning stations, including open or cabinetized, dust-free types, and built-ins for clean rooms. They incorporate rinses of 18-megohm water, often combined with chemical baths, ultrasonic cleaners and Freon rinses.

Ask us about this or *any* pure-water need, including stills, demineralizers and associated equipment.

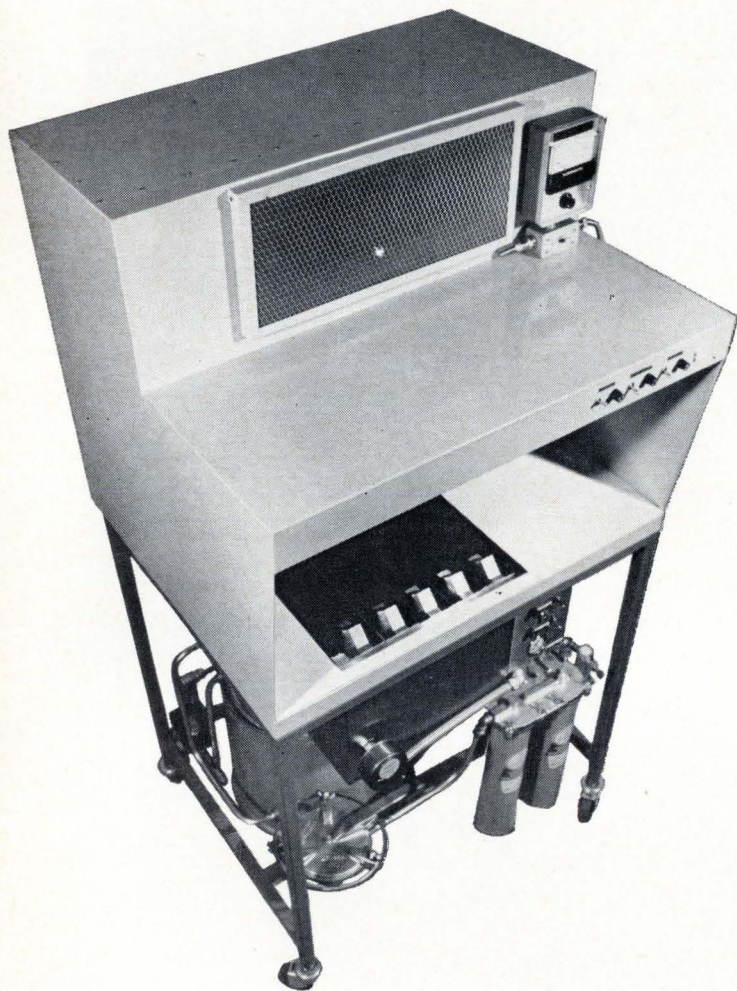

Helping you get more out of water!

Barnstead

A subsidiary of Ritter Pfaudler Corporation
423 Lanesville Terrace, Boston, Mass. 02131

New Components

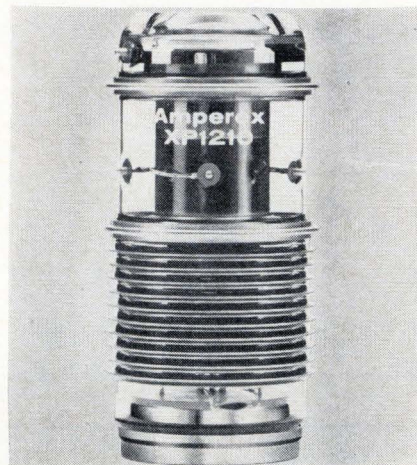

Parameters (voltage dependent) are: electron transit time of 18 nsec, risetime of only 0.6 nsec, collection efficiency of more than 90% at 5,300 amps, average luminous sensitivity of 60 $\mu\text{a/lumen}$, nominal gain of 10^8 and nominal dark current of 14×10^{-17} amps/cm².

Its sealed-disk stack design, reduced light feedback and advanced dynode connection techniques combine with the opaque and linear-focused dynode geometry to produce extremely low signal-to-noise ratios. Operated at potentials as high as 8 kilovolts, the XP1210 shows no tendency toward producing corona.

Amperex Electronic Corp., Hicksville, L.I., N.Y., 11802. [353]

Surface thermocouples exhibit fast response

A thin flat junction allows a line of miniature surface thermocouples to respond in 1 millisecond or less.

Wires leading from the hot junction are 0.005-in. diameter. Standard length is 1 ft., although other lengths are available on request.

The surface thermocouple is available in a variety of conventional thermal elements and is supplied with Teflon-covered separate leads, nylon-covered duplex leads, bare wire leads, fiberglass-covered duplex leads, or ceramic-insulated metal-covered leads.

Thermal elements available in the new surface thermocouples include: iron/constantan, copper/

it's proper to profit in Iowa

Take trained help for example . . . The labor picture is bright and clear for profitable electronic development and manufacturing in Iowa. Readily trained men and women workers available, many educated by an area system of vocational schools and colleges. Technological training provided by space-age scientists in state universities and private colleges. There is no state indebtedness or inequitable taxing to slow down future growth. State revenue spending is **right** for industry . . . directed toward projects that will further growth and progress. Communities, state and county officials and existing industry in Iowa are **profit-minded!**

Send for the facts on the profit potential for **you** with an Iowa plant.

115 OF FORTUNE'S TOP 500 HAVE SOLVENT IOWA LOCATIONS

CONFIDENTIAL		
IOWA DEVELOPMENT COMMISSION Dept. 547, 250 Jewett Building Des Moines, Iowa 50309		
		
Name _____		
Firm _____		
Address _____		
City _____	State _____	Zip _____

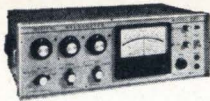

Model 660 DIGITAL GAUSSMETER with digital readout — analog output; Accuracy $\pm 0.25\%$ to 10 kG, 1% to 30 kG; Stability $\pm 0.005\%$ /°C nominal temperature dependence between -20°C to $+60^\circ\text{C}$.



Model 240 INCREMENTAL GAUSSMETER with 100X Scale Expansion; 1 Part in 10^4 Ultimate Resolution; Accuracy $\pm 1\%$ FS to 10 kG; 5 V dc Auxiliary Output; Self-Calibrating.



Model 620 PRE-CALIBRATED GAUSSMETER with Pre-calibrated probes (no recalibration necessary when probes are changed); Built-in Calibration Accuracy of $\pm 0.3\%$; Accuracy $\pm 0.50\%$ FS to 10 kG, 1% to 30 kG.



Model 120 HIGH SENSITIVITY GAUSSMETER with 0.1 GAUSS FS Sensitivity; Accuracy 1% to 10 kG; measures Fields dc to 400 Hz W/Mod. Kit; Self-Calibrating.



Model 110A PORTABLE GAUSSMETER with ac Line or battery operation; Zero-center meter; all solid state; 10 Ranges — 1 to 30,000 G FS; Self-Calibrating.

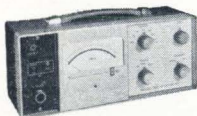

Model 300 HIGH FIELD GAUSSMETER with 2.50% accuracy to 30 kG; Offers extended range to 100 kG; Self-Calibrating.



Model 350 AC FIELD GAUSSMETER with direct readout of ac FIELDS; frequency bandwidth control; Spectrum Analysis possible.

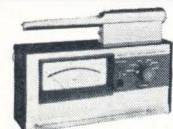

Model 150 GENERAL PURPOSE GAUSSMETER with simple, economical, battery operated circuitry; $\pm 3\%$ FS Accuracy to 10 kG.

GOLD SEAL GUARANTEE

All ceramic-encapsulated transverse probes guaranteed one year against breakage

there are

8

"Best Ways"

to
measure
magnetic
fields

—and we provide
all eight!

If none of our eight off-the-shelf Hall effect gaussmeters quite fits your application — if you need a more complex, more sophisticated instrument or system to measure, control or even automate your R & D, Test & Inspection or Production Control operation — just give the word. We'll show you the best way to solve your problem.

F. W. BELL

Leaders in Hall Effect
Components, Instruments
and Systems

F. W. BELL, INC.
1356 Norton Ave.
Columbus, O. 43212
Ph: 614-294-4906
TWX: 810-482-1716

New Components

constantan, chromel/constantan, chromel/alumel, platinum/platinum-10% rhodium, platinum/platinum-13% rhodium, tungsten/tungsten-26% rhenium, and tungsten-5% rhenium/tungsten-26% rhenium.

Science Products Corp., Route 46, Dover, N.J. 07801 [354]

Selector switch aids broadcast engineers

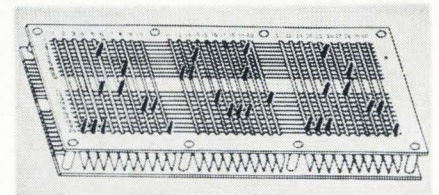

A crossbar selector switch is fast and eliminates any need for soldering, clips, pins or cumbersome connecting wires.

The C10-03A has 30 sliders and 20 p-c strips for a total number of 600 crosspoints. Since it requires a small amount of space for installation, the switch is suited for numerous communications applications.

List price is \$46.50 each, with quantity discount starting at 25% on 25 pieces.

Cherry Electrical Products Corp., 1650 Old Deerfield Road, Highland Park, Ill., 60035. [355]

Modular logic relay is long-lived, tiny

A rated life of 10 million operations is offered in an ultrasensitive logic relay. Models 16 and 17 relays consist of an integrated solid state amplifier and a reed switch output. Size is $1\frac{3}{8} \times \frac{5}{8} \times \frac{3}{4}$ in. Weight is 0.3 oz.

Standard units are for operation on 6, 12 or 24 v d-c, consuming less than 200 mw. They do not require standby current. Nominal signal pull-in voltage is 0.7 v d-c at 50 μa . Output configurations include spst, dpst, and spdt. The output is electrically isolated from

ARNOLD IS



TAPE WOUND BOBBIN CORES

**Standard Cores of 4-79 Mo-Permalloy and Deltamax
on Ceramic or Stainless Steel Bobbins . . .**

engineered for use in sophisticated data processing systems, high frequency magnetic amplifiers, static inverters, timing circuits, shift registers, ring counters, pulse transformers and as static magnetic memory elements. All tapes are rolled on a beta-ray controlled Sendzimir mill in standard gages of 1, 1/2, 1/4 and 1/8 mil and slit to standard widths of 0.031, 0.0625, 0.125 and 0.250. Cores are wound on semi-automatic machines, then annealed at extremely high temperatures in specially designed dry hydrogen atmosphere furnaces to obtain the final magnetic properties. Arnold maintains complete control over all phases of fabrication. Melting, processing, rolling and slitting of raw materials (nickel iron) to winding, annealing and final test are all "in-plant" functions.

Write for Catalog TC-108B.



ARNOLD
SPECIALISTS in MAGNETIC MATERIALS

THE ARNOLD ENGINEERING COMPANY, Main Office: MARENGO, ILL.
BRANCH OFFICES and REPRESENTATIVES in PRINCIPAL CITIES

New Components

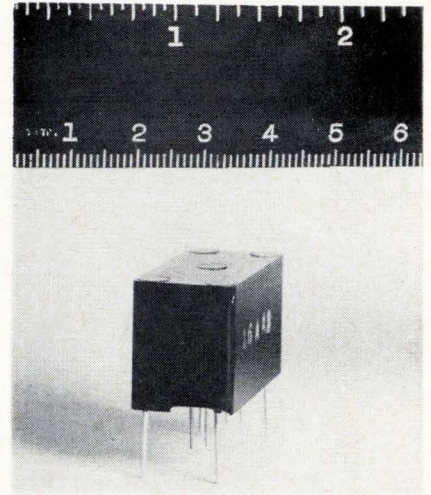

either the power or signal source. Contact power ratings are 15 w a-c or d-c up to 135 v.

Response time of better than 1 msec suits the relay for use as a logic relay, time delay relay (either slow acting or slow release), temperature controller, or meter relay. It may also be used as an a-c detector from hz to Mhz with a suitable signal rectifier and bypass capacitor.

Model 16 is an on-off type and model 17 is a latching type. Units are epoxy encapsulated and will operate from -40° to 100°C .

Prices start at \$6.30 for a quantity of 1 to 9. The 100-lot price is \$4.72.

Sensitak Instrument Corp., 531 Front St., Manchester, N.H., 03102. [356]

Ceramic components protect against surges

Circuit applications where high voltage surges occur are expected to benefit from the Spark Gap ceramic protection device. The unit will not sustain an arc with a continuous voltage of 400 v d-c superimposed on a 10-kv discharge.

Spark Gap capacitance is 0.5 pf maximum; insulation resistance is 10,000 megohms at 25°C , 500 v d-c for 1 minute; arc over voltage rating, 1,000 to 2,000 v d-c; high-voltage cycling test, 50 discharges at 10,000 v d-c from a 0.01- μf capacitor.

The solid ceramic protective

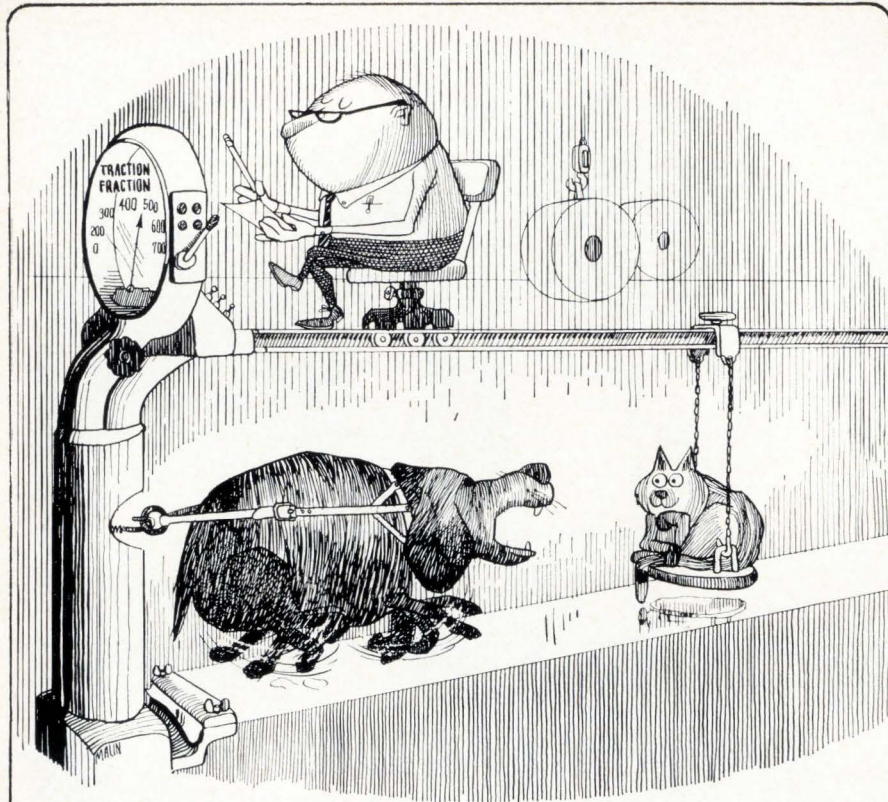

HOW SLICK IS SLICK?

Republic Foil has the answers when it comes to aluminum foil for capacitors. We measure the coefficient of friction of the foil surface because the degree of slickness has a direct bearing on performance in capacitor winding machines. By measuring surface friction and other values and working closely with customers and winding machine manufacturers we produce maximum performance foils; for example, Electro-Dry, Electroslik and Silwynd.

Engineering foils to meet the needs of capacitor manufacturers is a specialty at Republic. Controlled slickness is just one of the extras we build into capacitor foil products to meet ever higher standards of quality.

It's part of the process we call . . . FOILSMITHING.

WRITE FOR technical report E100, "Coefficient of Friction on Aluminum Foil Surfaces."

THE LEADING MANUFACTURER OF A COMPLETE LINE OF PLAIN & ETCHED CAPACITOR FOIL

- Electro-Dry[®], Silwynd[®], Electro-Slik[®], Electrogage[®]
- LIGHT GAGE FOIL for paper and film wound capacitors
- ETCHED ANODE & CATHODE FOIL
- PLAIN FOIL FOR ETCHING
- PLAIN FOIL for electrolytic capacitors, coil winding.
- FULL TECHNICAL SERVICE

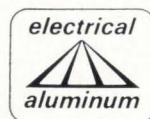

REPUBLIC FOIL INC.

General Offices, Danbury, Conn. 06813: Tel. 203-743-2731

BRANCH SALES OFFICES

Chicago, Ill. 312-545-2142 • Salisbury, N. C. 704-633-6020 • Cleveland, Ohio 216-871-6268
WEST COAST — Electrical Specialty Co., 213 E. Harris Ave., So. San Francisco, California
2820 E. 12th Street, Los Angeles, California 90023

PLANTS - Danbury, Conn. - Salisbury, N. Carolina - Somerville, Mass.

Four ways to put the damper on component failure.

They're our 3M Brand Inert Fluorochemical Liquids —FC-43, FC-75, FC-77, FC-78—and the one whose properties are best for cooling your component will make it as reliable as a coolant can make it.

That's because our Inert Liquids are far more efficient at removing heat—a prime cause of component failure — than either air or other dielectric coolants. Now your component can operate at lower temperatures and with increased reliability.

You can also rely on our Inert Liquids for other important properties. High on the list are high dielectric strength, high temperature stability, chemical inertness, compatibility, and nonflammability.

All of which makes 3M Brand Inert Liquids as good for test bath applications as they are for cooling. You can rely on that.

3M Chemical Division

Dept. KAX-467, St. Paul, Minn. 55119

Send me all the details about 3M Brand Inert Liquids.

Name _____

Address _____

Company _____ Title _____

City _____ State _____ Zip _____

Chemical Division **3M**
COMPANY

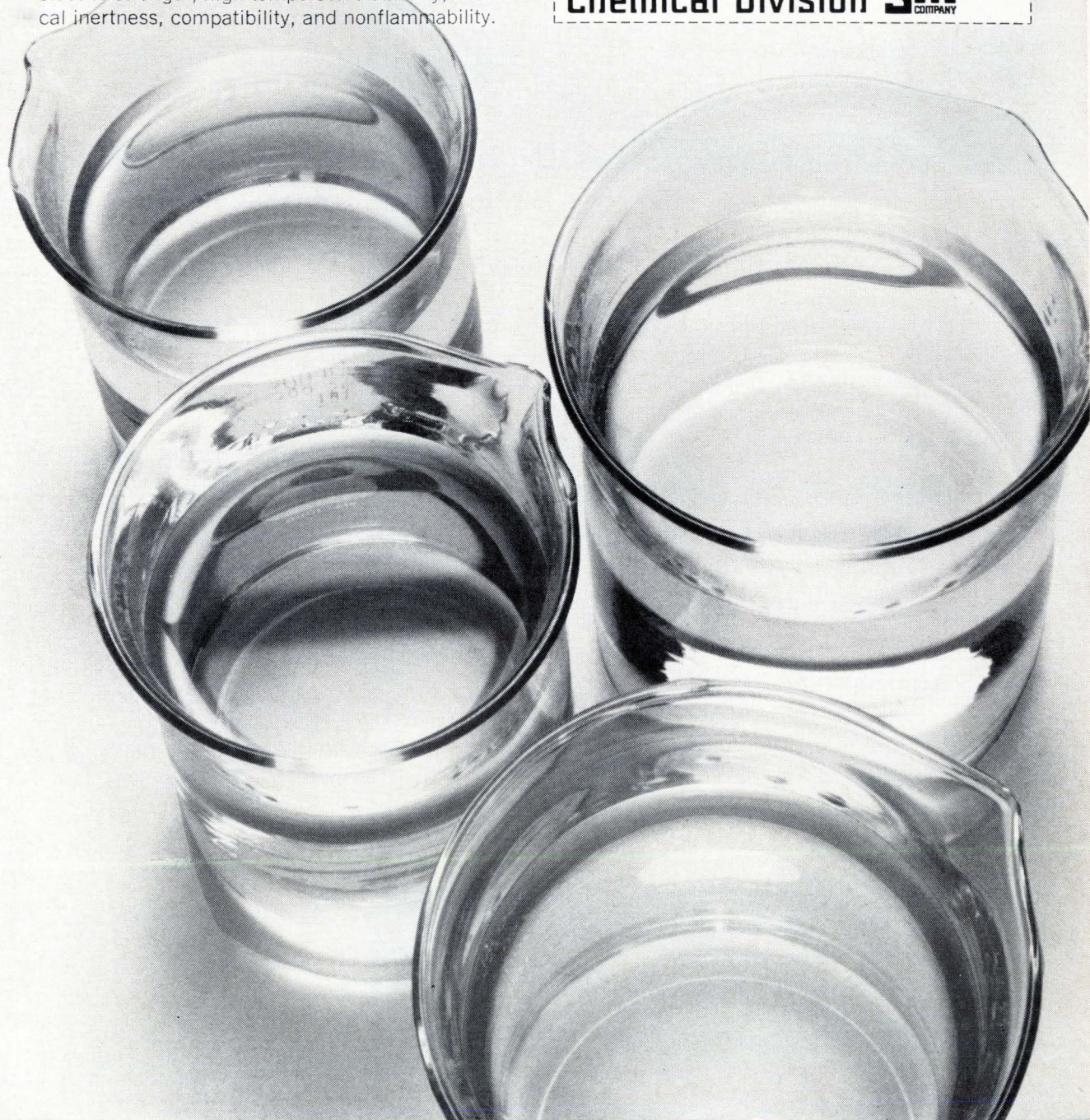

best delivery

WITHIN THE INDUSTRY

FROM THE LEADERS IN MINIATURE SOLID TANTALUM CAPACITORS.

MINITAN[®] ECONOTAN[®]
solid tantalum capacitors

- PROTOTYPES: SAME DAY DELIVERY.
- 1000 PIECES FROM OUR CATALOG WITHIN ONE WEEK.
- PRODUCTION QUANTITIES TO MEET YOUR SCHEDULE STARTING IN TWO WEEKS.



COMPONENTS, INC.

MAINE DIVISION

SMITH STREET / BIDDEFORD, MAINE / 207-284-5956

New Components

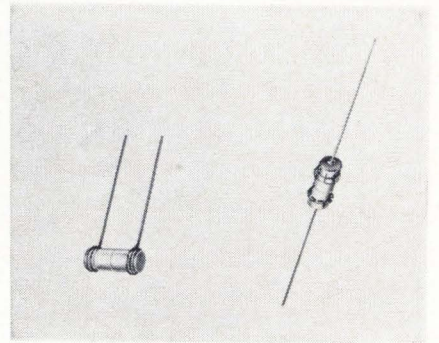

components are available in either axial-or radial-lead types. The axial-lead units are available reel-packed for automatic insertion.

Erie Technological Products Inc., Erie, Pa. [357]

Vacuum capacitor resists vibration

High resistance to vibration is a feature of a new vacuum-variable capacitor. The CVCC2500 will withstand vibration of 5 g from 55 to 500 hz. This is especially significant for high-Q circuits. Average capacitance shift under these conditions is 1.5 pf, which is small in a unit that has a capacitance range of 25 to 2,500 pf.

This capacitor is well suited for communications systems in aircraft, marine vessels, or land-based vehicles. It offers a wide capacitance-change ratio, high voltage withstand, and high r-f current rating in addition to being vibration resistant. Voltage rating is 5 kv peak; current rating, 70 amps rms at 16 Mhz.

ITT Jennings division of International Telephone and Telegraph Corp., 970 McLaughlin Ave., San Jose, Calif., 95108. [358]

Versatile relay saves mounting space

A compact relay fits four-pole, 10-amp double-throw contacts in 20% less panel space than occupied by earlier three-pole models.

In addition to saving valuable mounting space, Type 811 relays feature plug-in or quick-disconnect

Tips on cooling off hot transistors

See how circuit designers use IERC heat dissipators to protect semiconductors...improve circuit performance and life.

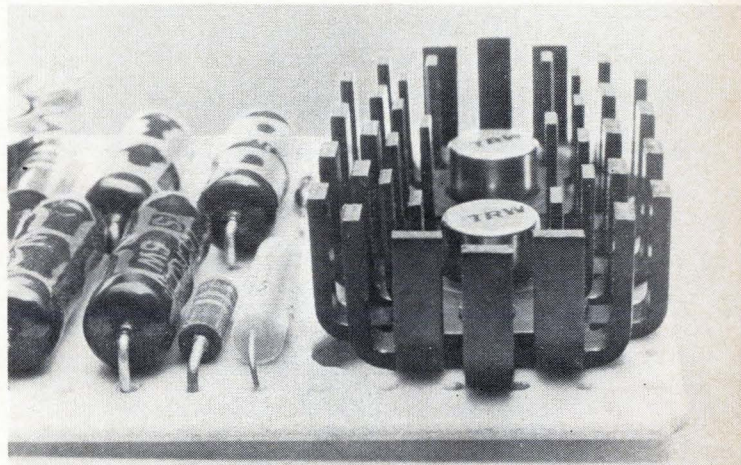
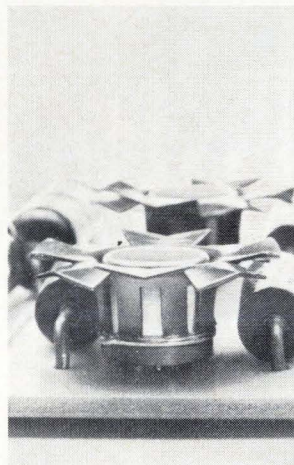
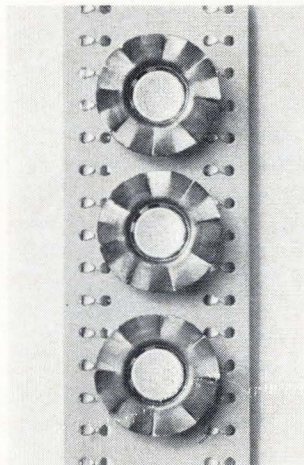

Fan-top dissipators for TO-5 and TO-18 cases drop temperatures dramatically; cost just pennies. T-shape adds almost nothing to board height; allows components to snuggle close to transistors. Spring fingers provide fast, press-on installation.

To cool off low-to-medium power transistors in TO-5 and TO-18 cases, use IERC's efficient LP's. Patented, staggered-finger design maximizes radiation and convection efficiency, radiates heat directly to ambient. Available in single or dual mounting for thermal mating of matched transistors.

IERC Thermo-Link Retainers provide efficient thermal links between transistors and chassis or heat sinks. (Also, excellent dissipation when used on p-c boards.) Integral BeO washers reduce capacitance up to 2/3. Fast, no-snap installation; transistors are firmly held.

New! Dissipators and retainers for plastic and epoxy transistors. 3 new series for RO-97A, RO-97 and X-20's. Permit a jump of 10% to 33% in operating power.

Free 8-page short form catalog discusses IERC's complete line of dissipators, retainers and tube shields. Gives specifications, prices, how to order. Send for your copy today.

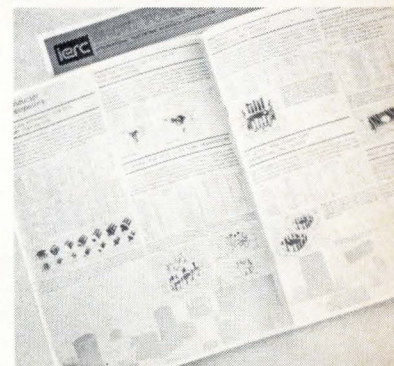
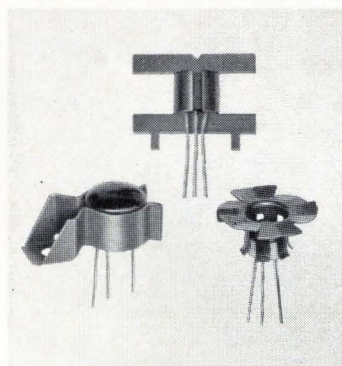
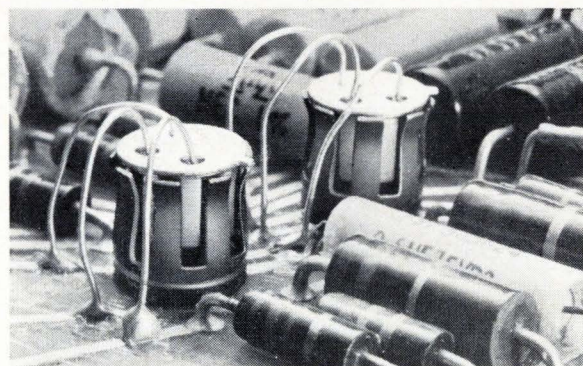

Special insulating coating — Insulube 448, a special non-hygroscopic finish developed by IERC, combines excellent dielectric properties, 50 K megs insulation resistance, and high heat emissivity. Also protects against salt spray, fungus, etc.

Tough heat dissipating problem? IERC engineers welcome your letter-head inquiry for specific information or assistance in selecting heat dissipators.

ierc
SEMICONDUCTOR
HEAT DISSIPATORS

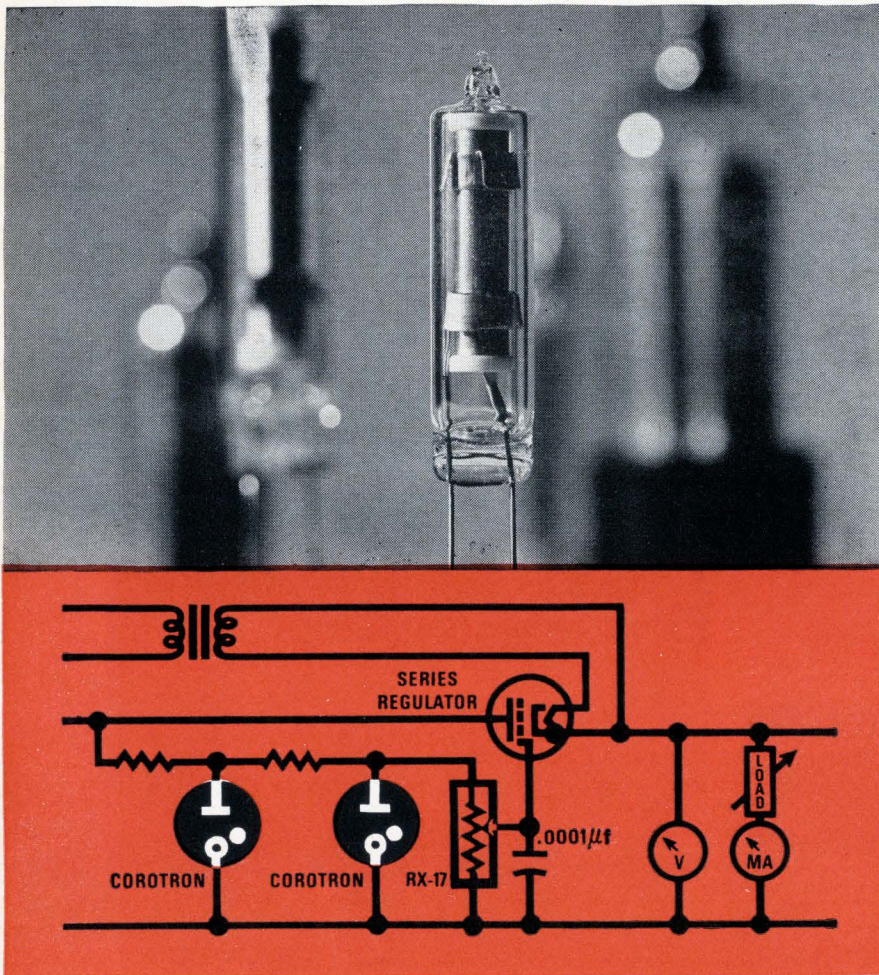

REFERENCE AND REGULATION TO 30KV

Voltage regulation can never be better, nor more stable, than the reference voltage. And you'll never find a better reference than Victoreen diodes, high-voltage equivalents of Zener diodes. But, unlike Zeners, Victoreen HV diodes are available in voltage ranges from 350 to 30,000 volts.

Unexcelled as a stable reference voltage source, a Victoreen HV diode can also be used alone as a simple shunt regulator, as a DC coupling element, etc. For Space-Age applications, you get a lot of bonuses, too — small cubage, light weight, resistance to high heat, high vibration and high accelerations to 2000g in some models. Victoreen HV diodes are unaffected by ambient light.

From the positively exotic to the commercial, if you have a voltage regulation problem in the range of 350 - 30,000 volts, quickly contact our Applications Engineering Department.

Components Division
THE VICTOREEN INSTRUMENT COMPANY
 10101 WOODLAND AVENUE • CLEVELAND, OHIO 44104
EUROPEAN SALES OFFICE GROVE HOUSE LONDON RD. ISLEWORTH, MIDDLESEX, ENGLAND



7324-A

New Components

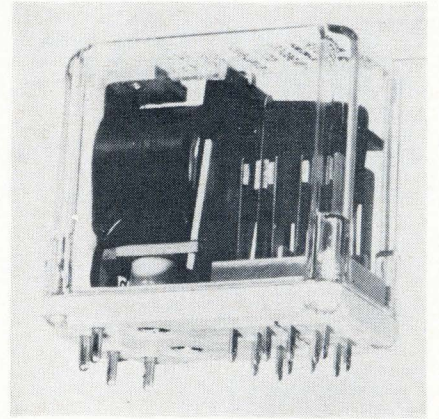

terminals, arc barriers between adjacent poles, silver-cadmium-oxide contacts, a full-load contact life of more than 500,000 operations, a Lexan dust cover, and a molded coil.

Prices range from \$4.50 to \$9, depending on quantity. Delivery time is two weeks.

Cook Electric Co., 2700 N. Southport Ave., Chicago 60614. [359]

Modular capacitors of metalized Mylar

High volumetric efficiency is achieved by a series of epoxy-encased metalized Mylar capacitors designed for p-c boards.

Designated the series 217A, the capacitors meet a wide range of requirements: voltage ratings in 100, 200, 400 and 600 v; any desired capacitance value from 0.001 μf up; and capacitance tolerances as required from 20% to as tight as 1%. Case style, said to be new for metalized Mylar capacitors, is rectangular with radial lead spacing on a 0.1-in. grid.

The epoxy-encapsulated modular construction affords superior protection against humidity and makes the 217A units almost invulnerable to rough handling.

Many values in the new series are carried in stock for immediate shipment. Delivery on special custom orders can be made within five weeks. Price will vary with specifications.

Electro Cube Inc., 1710 S. Del Mar Ave., San Gabriel, Calif. [360]

Designed AS An Industrial...

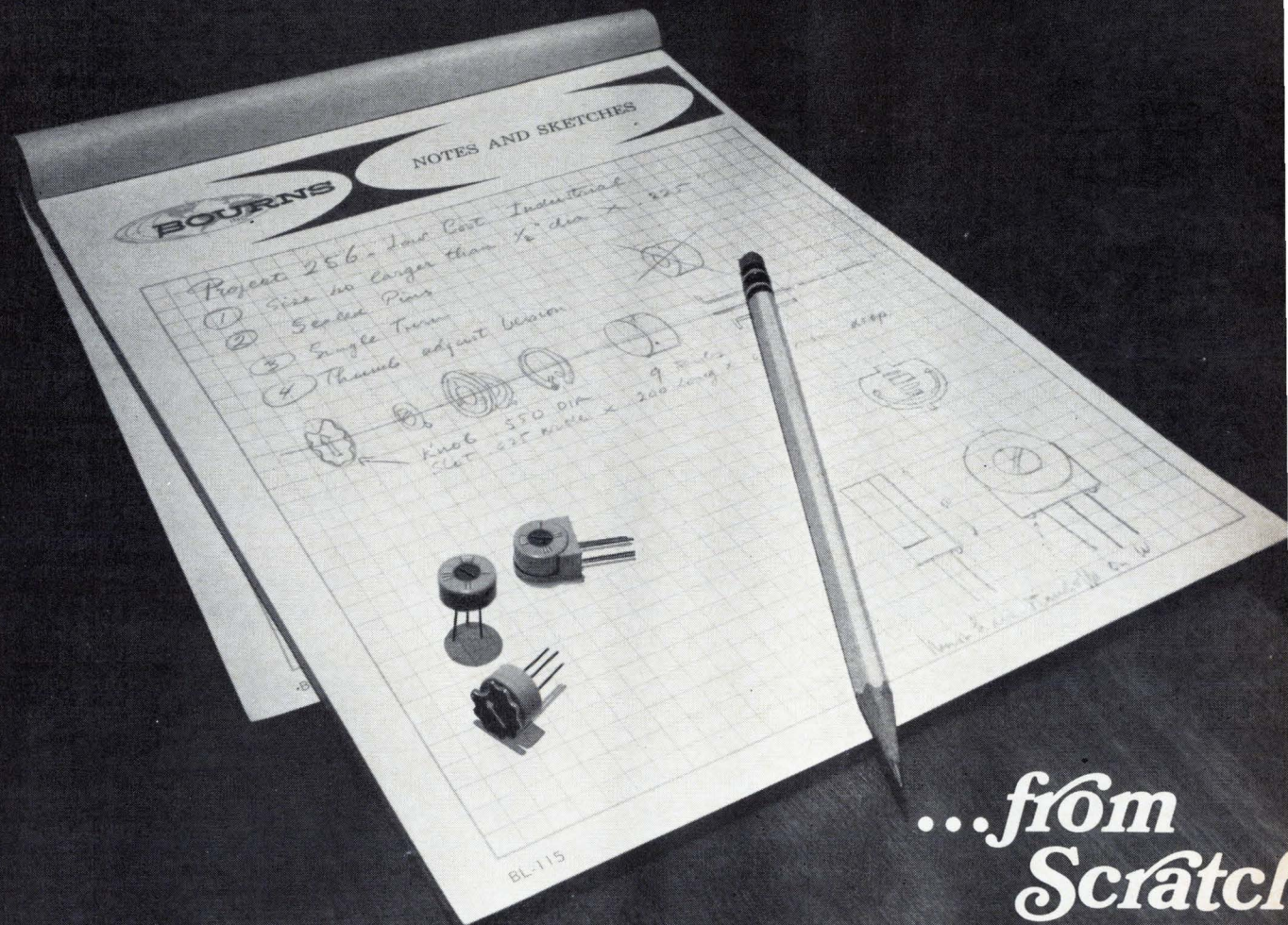

...from
Scratch

The Model 3365 TRIMIT® adjustment potentiometer is an industrial unit . . . designed from the ground up for industrial applications. It is brand new! This low cost single-turn wirewound unit is available in two printed circuit styles . . . each style is also available with thumb adjustment knob. Standard and special resistances are from 10 ohms to 50K. Resistance tolerance is $\pm 5\%$. It is small . . . $\frac{1}{2}$ " diameter by less than $\frac{1}{4}$ ". It is light weight . . . approximately 0.05 oz., in an all-plastic case.

There are several other points we would like to mention about the Model 3365. Its pins are sealed, its terminals gold plated, making it suitable for production fluxing and soldering processes employed on printed circuit boards. The exclusive SILVERWELD® process is used, thus eliminating vulnerable single wire terminations.

We think you will be even more impressed when you have read the complete, detailed specifications and technical data . . . they are available to you by contacting your nearest Bourns office or representative, or writing the factory direct.



SPECIFICATIONS:

Standard Resistance Range	10 to 50K ohms
Resistance Tolerance	$\pm 5\%$ standard
Resolution	0.08 to 0.88%
Power Ratings:	
40°C Ambient	0.5 watt
105°C Ambient	0 watt
Operating Temperature Range	-55 to +105°C
Temperature Coefficient	70 PPM/°C
Humidity, MIL-STD-202, Method 103	100 megohms min. insulation resistance
Shaft Torque	8 oz-in max.
Mechanical Adjustment	280° nominal



BOURNS, INC., TRIMPOT DIVISION • 1200 COLUMBIA AVE., RIVERSIDE, CALIF.,
TELEPHONE 714 684-1700 • TWX: 910-332 1252 • CABLE: BOURNSINC.



Cramped for space?

Use Couch 1/7-size Relays

Space/weight problem? The new Couch 2X 1/7-size crystal can relay gives you tremendous savings in space and weight. 0.1" grid — plus many outstanding specs — *all in micro-miniature*. Thoroughly field-proven in electronics and space applications.

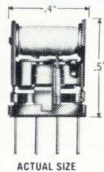

	2X (DPDT)	1X (SPDT)
Size	0.2" x 0.4" x 0.5"	same
Contacts	0.5 amp @ 30 VDC	same
Coil Operating Power	100 mw 150 mw	70 mw 100 mw
Coil Resistance	60 to 4000 ohms	125 to 4000 ohms
Temperature	-65°C to 125°C	same
Vibration	20 G	same
Shock	75 G	same

Broad choice of terminals, coil resistances, mounting styles. Write for detailed data sheets.

RUGGED ROTARY RELAYS  Dynamically and Statically Balanced

COUCH ORDNANCE INC.

3 Arlington St., North Quincy, Mass. 02171, Area Code 617, CYPress 8-4147 • A subsidiary of S. H. COUCH COMPANY, INC.

New Semiconductors

Operational amplifier on a single chip

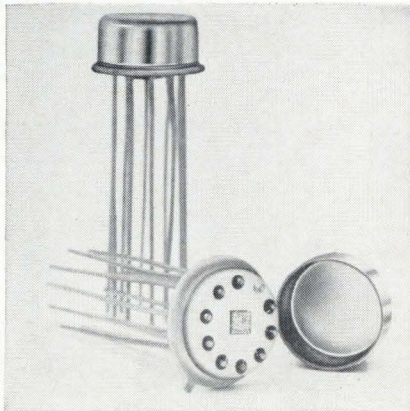

Three desirable characteristics of an operational amplifier are achieved in a new single-chip monolithic integrated circuit: ultra-low offset voltage and current along with excellent thermal stability and high common mode rejection. The device may be used in many instrumentation applications as a single or dual input amplifier.

Input offset voltage is typically 1 mv; maximum, 2.5 mv. Input offset current is typically 30 na; maximum 50 na. Input offset voltage drift is typically 3 $\mu\text{V}/^\circ\text{C}$; maximum, 10 $\mu\text{V}/^\circ\text{C}$. Input offset current drift is 0.5 na/ $^\circ\text{C}$. Common mode rejection ratio is typically -90 db; maximum, -80 db.

Operating temperature range of the CMC-5-3-807-4 is -55° to $+125^\circ\text{C}$. Maximum operating voltage is ± 15 v. Power supply requirements are ± 15 v at 7.5 ma. Continental Device Corp., 12,515 Chadron Ave., Hawthorne, Calif., 90250. [361]

Integrated circuits in plastic packages

Two new ic's offer more performance per dollar than any other operational amplifier on the market, according to the manufacturer. These monolithic silicon devices, offered in a 14-lead dual in-line plastic package, permit simple insertion and high packing densities.

Both devices, the CA3029 and CA3030, are designed for telemetry, data processing, instrumentation, and communication equipment. They offer, respectively, open loop voltage gains of 60 db and 70 db typical, common mode rejection ratios of 94 db and 103 db typical, and have typical maximum output-voltage swings of 6.75 v and 14 v peak-to-peak.

The CA3029 and CA3030 are priced at \$5 and \$5.75 each, respectively, in quantities of 1,000 and up.

Radio Corp. of America, Harrison, N.J., 07029. [362]

Enhancement mode metal-oxide FET

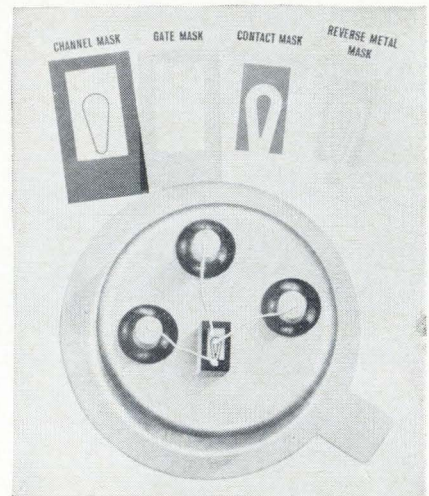

High stability and low noise characterize a metal-oxide, enhancement mode field effect transistor. An insulated gate, P-channel device in a TO-72 package, it is meant for high-impedance applications such as electrometers and vtvm input stages.

The HA2000—called a MOXET—has a gate input resistance on the order of 10^{15} ohms with breakdown rating of ± 80 v, thus eliminating the need to protect the gate with additional diode. High-frequency characteristics suit it for oscillator or tuned-amplifier service up to the Ghz range. In switching applications turn-on and turn-off times are typically less than 1 nsec.

The unit is available in evalua-

Plessey will design and make any memory stack

Whether you want single memory planes or stacks, Plessey can produce them. They can design them from basic applications data alone, or produce them direct from your own design. They can produce in quantity or as a special "one-off".

Performance-tested Plessey stacks are enabling large, high-speed systems to be developed for operation in the increasingly arduous environments imposed on modern computers, and the extensive facilities available for the design, manufacture and testing of stacks have been specially developed to cater for these stringent performance requirements.

This is one of the reasons why many leading international buyers come to Plessey.

If you have a memory problem or an unusual requirement involving stacks Plessey will solve it, write or telephone...

Plessey Components Group,
The Plessey Company Limited,
Matrix Division,
Wood Burcote Way,
Towcester, Northamptonshire, England
Tel: Towcester 312. Telex 31628.

PLESSEY
Components

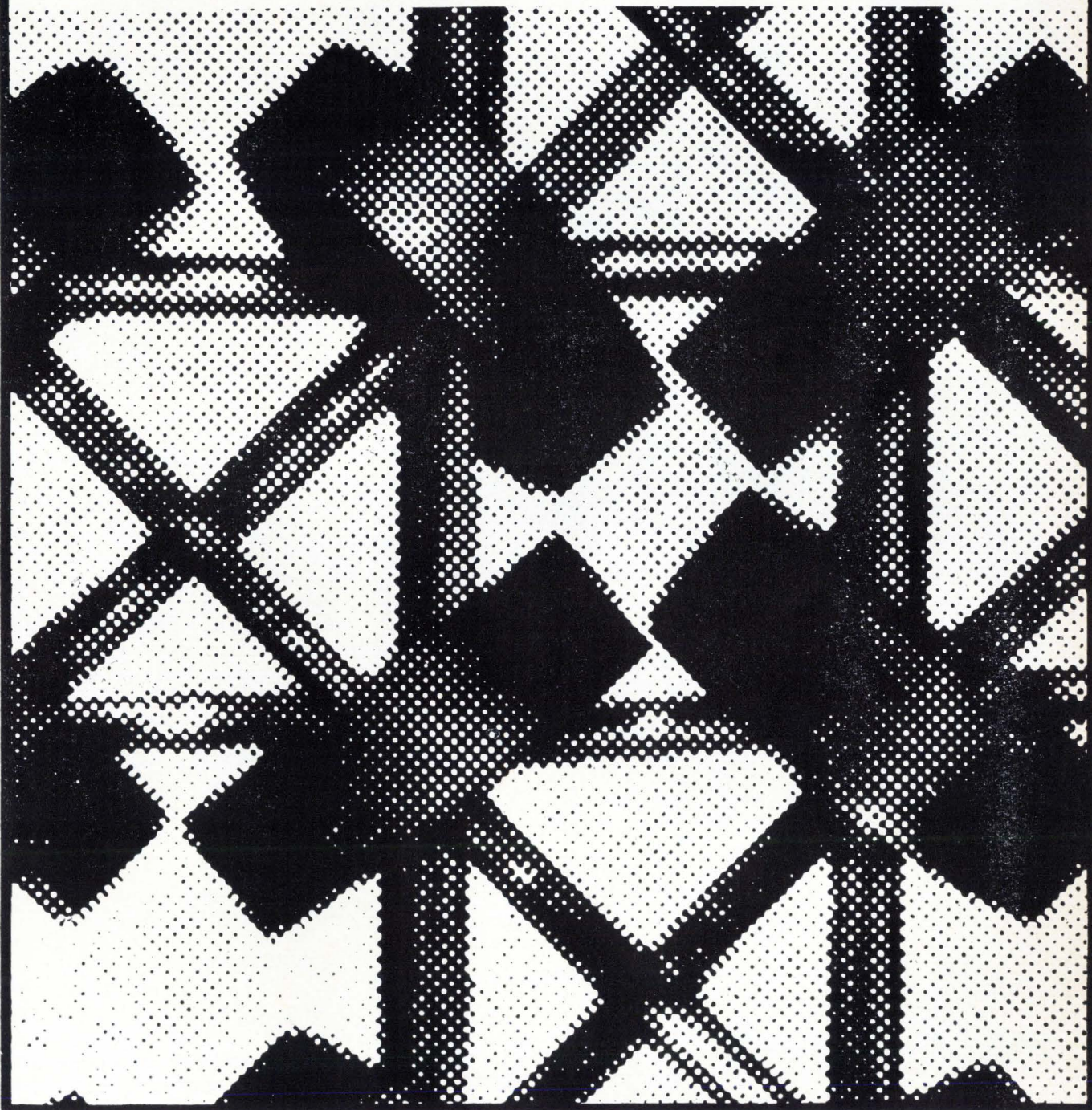

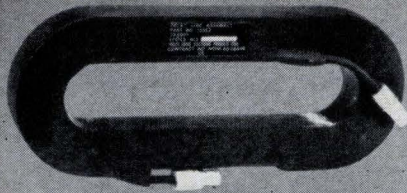

An encapsulated delay line, used between 8 and 12 Gc, exhibits 100 ns of delay. The overall unit weighs less than 8 pounds and the cable is 70 feet long. The cable is .270" diameter, 50 ohm impedance, with an irradiated polyethylene core. Output connectors are TNC Males.

To achieve 122 nanoseconds of delay and fit tight confines, a pancake configuration measuring 11" x 7" x 3/8" containing 45 feet of .141", Phelps Dodge Electronics 50 ohm miniature semi-rigid coax was potted for use with an airborne radio altimeter.

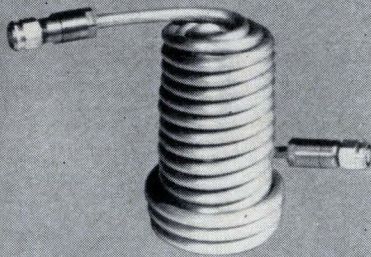
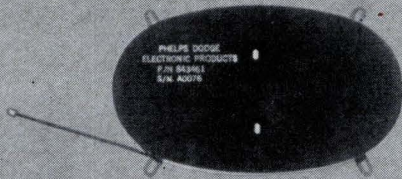

High density delay line is approximately 5" tall. Approximately 13 feet of cable exhibit 20 nanoseconds delay. The cable is a .270" diameter with a polyethylene dielectric and 50 ohm impedance. Connectors are TNC Male.

Dual section potted delay line is used for radar calibrating at an operating frequency of 1600 megacycles. The outer race accounts for 980 ns; an inner nest exhibits 61.1 nanoseconds of delay. Aluminum jacketed 50 ohm coaxial cable is .215" diameter with an irradiated polyethylene core. Weight is 25 pounds for the 16" diameter, 3" high package.

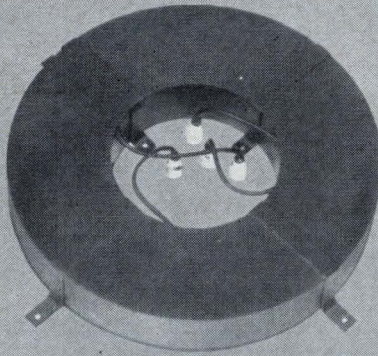

Standard delay line available off-the-shelf for calibration of oscilloscopes, altimeters, radar systems and similar applications. The Foamflex cable unit measures 8 1/2" x 21" x 19" and offers a standard delay of 500 ns, calibrated to ± 0.25 ns.

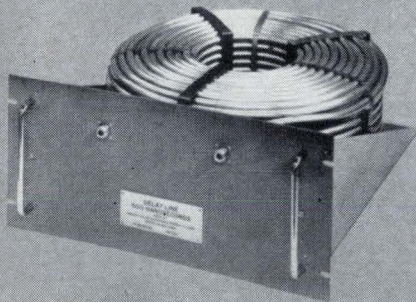

Suddenly signal delay problems are simple

The capability of Phelps Dodge Electronics coaxial cable delay lines to consistently and uniformly meet $\pm .02$ nanosecond delay tolerances in an endless variety of configurations can help solve complex black box problems.

But, that's not all. Here is broader band operation, lower attenuation per nanosecond of delay, greater stability at microwave frequencies. All conventional packaging techniques are available: containers, shock mounting, standard rack-panel

mounting, strapping, potted or encapsulated coils, with mounting brackets and connectors. Delay lines can also be chemically-treated, painted, or enclosed in standard or customized racks or carrying cases. Design parameters: frequencies from 60 CPS to 12 Gc, power from milliwatts to kilowatts, impedances from 50 to 125 ohms, delays from .020 to 1.0 microseconds.

Want more detail? Write for Bulletin DL, Issue 2.

PHELPS DODGE ELECTRONIC PRODUCTS
NORTH HAVEN, CONNECTICUT



New Semiconductors

tion quantities at \$17.05.

Hughes Semiconductor Devices, 500 Superior Ave., Newport Beach, Calif., 92663. [363]

Operational amplifier offered for \$15

An open-loop voltage gain of at least 30,000 at a price of \$15 is available in a silicon monolithic integrated operational amplifier.

Another feature of the MC1433 is a typical output voltage swing of ± 13 v with a power supply voltage of only ± 15 v. Thus the outstanding voltage gain is used at higher input levels and the usable output signal is larger than with operational amplifiers having more restricted voltage swing.

The MC1433 is applicable as a summing amplifier, an integrator, or for any job requiring an amplifier with operating characteristics as a function of external feedback components. The unit also serves as a voltage amplifier where a high-gain, low-distortion device is required.

Temperature stability is assured by the low temperature drift of $\pm 8 \mu\text{v}/^\circ\text{C}$. The input offset voltage is a maximum of 7.5 mv at 25°C , and can be adjusted to zero by externally varying the potential on one of the leads.

This monolithic operational amplifier is available in both the 10-pin metal can as the MC1433G and in the 1/4x1/4-in. ceramic flatpack as the MC1433F. Both models operate over the commercial-industrial temperature range of 0 to $+75^\circ\text{C}$.

Prices in lots of 100 to 999 for the MC1433G are \$15 each; for the MC1433F, \$19 each.

Motorola Semiconductor Products Inc., Box 955, Phoenix, Ariz., 85001. [364]

Silicon rectifiers in plastic packages

High operating and surge currents of a double series of plastic silicon rectifiers permit maximum flexibility for the circuit designer. One

“You can be sure if it’s Westinghouski.”

Did you know that the practice of using brand names and trademarks on products is under attack in this country?

That certain governmental actions and judicial rulings are moving implacably toward the possible destruction of brand-name marketing?

The great debate that is going on points up the issue of what trademarks and brand names really mean. But, there is, I believe, more instructive value in a look at Soviet experience with branded products than in all the tangled rhetoric expounded by lawyers, economists, professors, businessmen, and politicians in recent years.

A few years ago several Russian factories manufactured identical 17-inch TV sets. On more than one occasion, even though consumers were clamoring for more sets, many simply were not being bought. Inventories piled up. After a good deal of fruitless and wasteful searching for an explanation, the answer came. Because the public could not identify the factory source of any one 17-inch set, and one factory habitually produced “lemons,” soon sales of all 17-inch TV sets fell. This refusal to buy was the public’s only way to protect itself. But it threw the Soviet central economic plan badly out of kilter. Even worse, it caused a lot of public discontent with Soviet officials.

Factory Marks. It was at this point that Soviet trademarks began to appear. At first,

their function was little more than to identify (for the convenience of the authorities) the factory source, but the result was far more than the Russians bargained for. Here is what trademarking did:

(1) It enabled the consumer to choose the output of a plant with a good reputation, and to avoid the plant with a poor one.

(2) Though the sales of the factory with the poor reputation fell, and therefore it failed to meet its economic plan, this caused less economic dislocation than when the entire industry’s sales had slumped previously.

(3) It resulted in consumer discontent being shifted from the political (Party) authorities to the trademarked plant with the poor quality.

(4) It created a form of consumer sovereignty—a way of giving the consumer the power to reward quality and punish shoddiness—by enabling him to identify easily the source (trademark) of the output.

In sum, trademarking rewarded quality and efficiency, and punished shoddiness and waste, by making it easy for the quality producer to sell his product because the consumer had developed confidence in his trademark. From experience, the consumer had, in effect, learned that “You can be sure if it’s Westinghouski.”

Further Developments. The Russians have, since this incident, expanded the practice of trademarking, or branding, the output of different plants. Soviet plant managers now guard the integrity and reputa-

tion of their trademarks with the vigor of Cossacks bearing down on revolutionaries. They safeguard the purity of their brands as sedulously as they watch their operating expenses. Their houses depend heavily on what happens to both of these.

The fact that the Russians have adopted brand names and, now, advertising simply reflects the fact that they are more responsive to the dictates of economics, technology, and good sense than to the muddled abstractions of obsolete philosophers. Moreover, the Russians have learned that with brand names, instead of economic planners having to establish arbitrary quality standards and hire engineers to enforce them, the sovereign consumer automatically establishes and enforces the high standards.

The net result has been not only an almost automatic and continuing improvement in Soviet consumer-product quality and design, but also an accelerating tendency to use brand-name advertising as a means of reassuring consumers about the quality and desirability of particular brands and therefore raising their sales and profitabilities.

The Soviet experience clearly demonstrates how the consumer can use the brand as a means of protecting himself and of punishing the producer of trademarked products that do not meet consumer expectations.

From an article by Professor Levitt, “Branding on Trial,” in the Harvard Business Review, March-April 1966.

Magazine Publishers Association

An association of 365 leading U.S. magazines

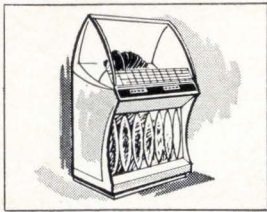

Juke Box

THERMISTORS



Astronaut Power Pack

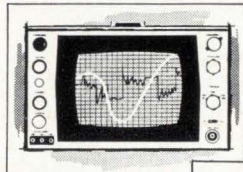

Computer

Micro-wave Instrumentation

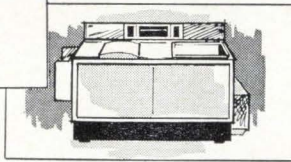

Xerox 2400 Copier/Duplicator

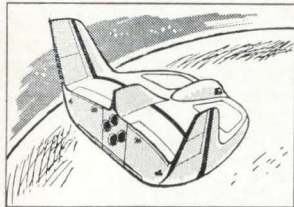
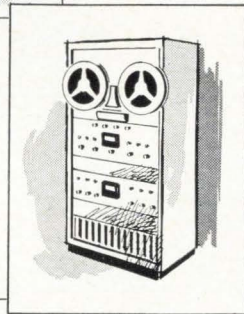

Martin Soft Landing Re-entry Vehicle

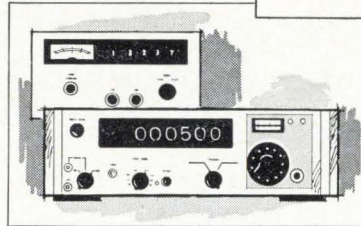

Digital Voltmeter

for every application

- BEADS • BULBS
- DISKS • WASHERS
- GLASS PROBES • RODS
- CRYOGENIC THERMISTORS
- SENSOR ASSEMBLIES
- THERMISTOR CATHETERS
- MILITARY GRADE
- THINISTORS®
- Thin film thermistors

From office business machines and juke boxes to computers and CATV distribution systems, engineers and designers have discovered that VECO thermistors can do the job better, with greater reliability and often at lower cost than conventional devices.

If your products require PRECISE temperature measurement, control or compensation with FAST RESPONSE it will pay for you to investigate VECO thermistors. VECO supplies a wide range of standard thermistors in various sizes, shapes, temperature coefficients and resistance values.

VECO's engineering staff is available to assist you in product application and circuit design. Write for Catalog MPG 681

VECO First in Progress • First in Service

J-7739



VICTORY ENGINEERING CORP.

136 Springfield Ave., Springfield, N. J. 07801
Tel: 201-379-5900 TWX 710-983-440

New Semiconductors

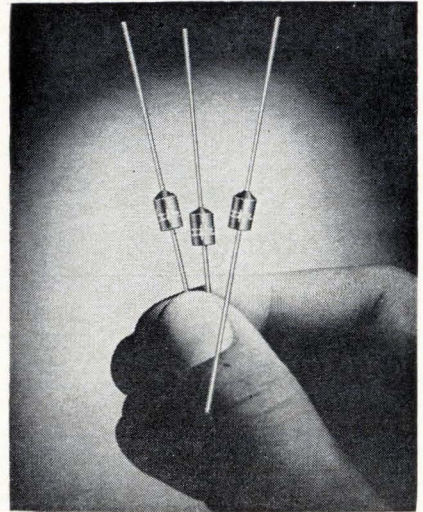

series, the IR/20A is rated at 2 amps while the JEDEC series, 1N4816 through 1N4822 and 1N5052 through 1N5054, is rated at 1.5 amps.

Both series are offered in the plastic DO-27 package at ratings from 50 to 1,000 volts.

International Rectifier Corp., 233 Kansas St., El Segundo, Calif., 90245. [365]

Two hybrid IC amplifiers

Hybrid operational amplifiers have been developed that offer input current, input offset voltage, and output current characteristics that are superior to those of their monolithic counterparts, the manufacturer claims. The units reportedly have an operating range of -55° to $+125^{\circ}\text{C}$, said to be wider than their counterparts.

Typical input offset voltage at 25°C with a $\pm 12\text{-v}$ supply voltage is 5 mv for the type NS7560 and 1 mv for the NS7560A. Typical input bias currents are 40 na and 10 na, respectively. With a programmed gain of 10, the gain is flat within 1 db to over 1 Mhz. The output stage has a standby current of about 3 ma with the $\pm 12\text{-v}$ supply voltages. No additional components are required to obtain $\pm 50\text{-ma}$ peak outputs.

National Semiconductor Corp., Danbury, Conn., 06810. [366]

Special Introductory Offer to new members of the electronics and control engineers' book club

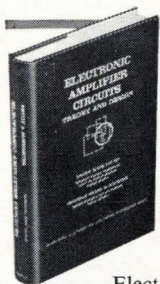

Pub. Price
\$10.50
Club Price
\$8.95

Electronic Amplifier Circuits by J. M. Pettit and M. M. McWhorter. Code #723

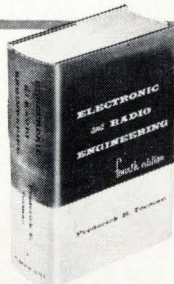

Pub. Price
\$16.75
Club Price
\$14.25

Electronic and Radio Engineering by F. E. Terman. Code #509

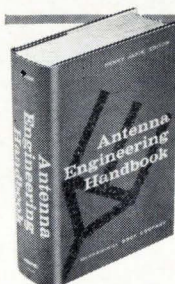

Pub. Price
\$25.00
Club Price
\$17.95

Antenna Engineering Handbook by Henry Jasik. Code #290

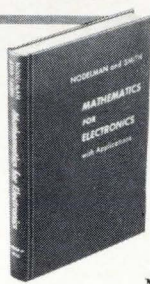

Pub. Price
\$7.00
Club Price
\$5.95

Mathematics for Electronics with Applications by H. M. Nodelman. Code #850

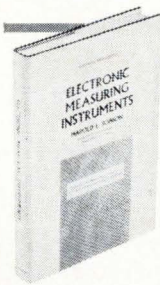

Pub. Price
\$7.50
Club Price
\$6.40

Electronic Measuring Instruments by H. E. Soisson. Code #565

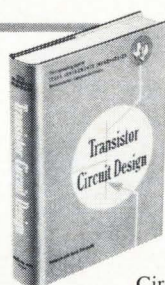

Pub. Price
\$15.00
Club Price
\$12.75

Transistor Circuit Design by the Engineering Staff of Texas Instruments, Inc. Code #737

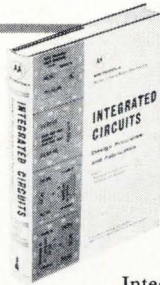

Pub. Price
\$12.50
Club Price
\$10.65

Integrated Circuits by the Engineering Staff of Motorola, Inc. Code #525

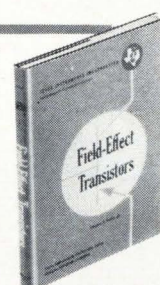

Pub. Price
\$10.00
Club Price
\$8.50

Field-Effect Transistors by L. J. Sevin. Code #355



Special \$1.00 bonus book comes to you with your first club selection

SAVE TIME AND MONEY BY JOINING THE electronics and control engineers' book club

Here is a professional club designed specifically to meet your day-to-day engineering needs by providing practical books in your field on a regular basis at below publisher prices.

HOW THE CLUB OPERATES. Basic to the Club's service is its publication, the *Electronics and Control Engineers' Book Club Bulletin*, which brings you news of books in your field. Sent to members without cost, it announces and describes in detail the Club's featured book of the month as well as alternate selections which are available at special members' prices.

When you want to examine the Club's feature of the month, you do nothing. The book will be mailed to you as a regular part of your Club service. If you prefer one of the alternate selections — or if you want no book at all for that month — you notify the Club by returning the convenient card enclosed with each *Bulletin*.

As a Club member, you agree only to the purchase of four books over a two-year period. Considering the many books published annually in your field, there will surely be at least four that you would want to own anyway. By joining the Club, you save both money and the trouble of searching for the best books.

MAIL THIS COUPON TODAY

electronics and control engineers' book club
582 PRINCETON ROAD
HIGHTSTOWN, N. J. 08520

Please enroll me as a member of the Electronics and Control Engineers' Book Club and send me the two books indicated below. I am to receive the higher priced of the two for just \$1, and my first selection at the special Club price. These books are to be shipped on approval, and I may return them both without cost or further obligation. If I decide to keep the books, I agree to purchase as few as four additional books during the next two years at special Club prices (approximately 15% below list).

Write Code # of higher priced selection here

Write Code # of lower priced selection here

NAME _____

ADDRESS _____

CITY _____

STATE _____ ZIP _____

(This offer good in United States only) E33015

Want to . . .
 TURN IT ON?
 TURN IT OFF?
 RECORD IT?
 SWITCH IT?
CYCLE IT?
 REVERSE IT?

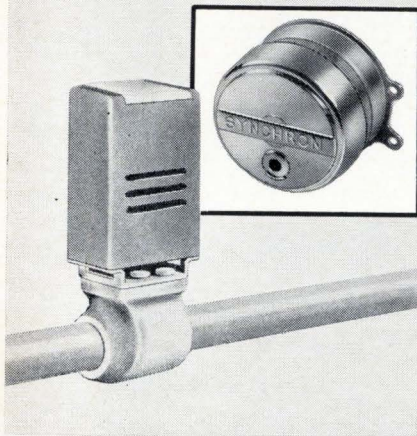

turn the job over to **SYNCHRON® MOTORS!**

The list above is only the start of the jobs done by Synchron Motors. In every area from time-recording instruments to motion-display drives, Synchron Motors serve you automatically. Whether you're starting a new design now, planning a modification, or just looking for a better component, call on Hansen Manufacturing Co. — for SYNCHRON Motors and for help in your application. Do it before you're in a hurry for the information — write now for specifications on the Synchron Motors that are likely to interest you.

Booth No. 3103 Design Engineering Show



HANSEN REPRESENTATIVES: CAREY & ASSOCIATES, Houston, Tex., R. S. HOPKINS CO., Sherman Oaks, Calif., MELCHIOR & MACPHERSON, INC., San Carlos, Calif., THE FROMM CO., Elmwood Park, Ill., H. C. JOHNSON AGENCY, INC., Rochester, N. Y., WILSON ELECTRIC CO., Essex, Conn., Narberth, Pa., and New York, N. Y. EXPORT DEPARTMENT, 64-14 Woodside Ave., Woodside, N. Y.

New Instruments

Digits added to analog traces

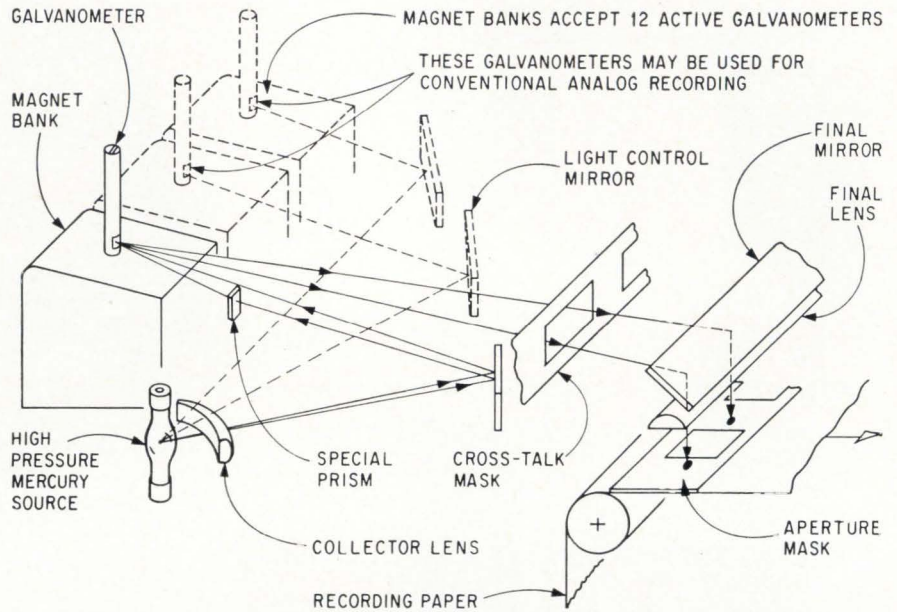

Optical system of oscillograph is modified to record digital data by addition of a special prism, a cross-talk mask, and an aperture mask. The light beam is split by the prism and is bent around the edge of the aperture by the galvanometer to write a vertical line on the recording paper. The cross-talk mask prevents stray light from going through the aperture mask.

Oscillograph traces can be interpreted with the help of time reference points on the side of the paper, but there are occasions when digital information is needed for accuracy. The Test Instruments division of Honeywell Inc., has developed for its Visicorder oscillograph line two digital printing accessories that use an oscillograph's own galvanometers to generate characters at the left-hand margin of the recording. [Electronics, March 20, p. 54]. The alphanumeric characters can convey any type of information the owner chooses, but Tommy N. Tyler, engineering supervisor at Honeywell's Denver plant, thinks the most popular use "will be to print real-time data on time at the side of the oscillograph's analog record."

On a sweep through a frequency spectrum, for example, the model 1204 Galvo-Printer could note the exact time at which the signal increased in frequency by a decade. The alternative would be to measure the distance along the graph paper, an approach that has built-in inaccuracies.

The 1204 can print up to six digits in a row, using one oscillograph galvanometer per digit. The model 1207 parallel-to-serial converter can take the six digits and feed them one at a time to a single galvanometer, producing a readout that runs down the paper, and saving five galvanometers for their normal duty of printing waveforms. Each digit is generated by a single integrated-circuit logic card taking binary-coded decimal data. The data may be continuous, but the 1204 inhibits print commands until paper speed has left a space between lines.

Honeywell's chief aim was to achieve printout of one alphanumeric character per galvanometer, so as not to cut down the number of analog channels available on the oscillograph. Its approach was to pass the beam of light from each galvanometer mirror through a prism, splitting it into two beams that diverge to about 1/8 inch apart when they reach the plane of the graph paper. A mask with an 80-mil square hole normally blocks the V-shaped beams from the pho-

to-sensitive paper.

By deflecting the galvanometer just enough to send beams past the edge of the 80-mil hole, the 1204 can generate both vertical sides of an alphanumeric. Horizontal lines are produced by deflecting one beam clear across the hole. Deflection, at the rate of 5 kilohertz, is produced by a full-wave oscillator whose peak-to-peak oscillation is just enough to send the beam of light across the hole; a half-wave oscillation will stop the beam at the very edge of the hole.

The bottom edge of the line of digits, which is printed first since the paper flow is upward, corresponds to the precise time the print command was received. With the serial converter, it is the bottom edge of the lowest digit that corresponds to the print command time.

Price of the 1204 is \$1,350 to \$2,700, depending on the number of channels—one to six—the customer wants. The serial converter costs \$750.

Specifications (Model 1204)

Maximum digits per line	
With 1612 Visicorder	36 (42 special)
With 1508 Visicorder	24 (28 special)
With 906 Visicorder	1
Printout	0-9
Input data format	8-4-2-BCD standard
Input data voltages	
Logical 1	+4 to +60 v
Logical 0	+1.5 to -60 v
Data line impedance	20,000 ohms shunted with 30 pf
Minimum on time after print command 1 usec	
Time to start print cycle after print command	Less than 0.5 usec
Data input lines required	5 digits (4 signal and common)
Power Size	80 watts/6 digits 3½x18x19

Honeywell Inc., Test & Instrument division, 4800 East Dry Creek Road, Denver, Colo. 80217 [371]

Sweeper extends synthesizer uses

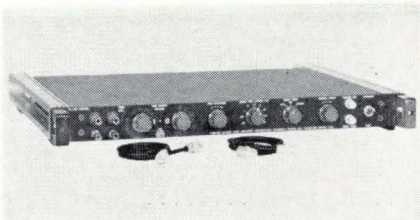

Designed for use with the manufacturer's family of frequency synthesizers, a sweep and marker gen-

New! -- Ballantine Solid State True RMS Voltmeter

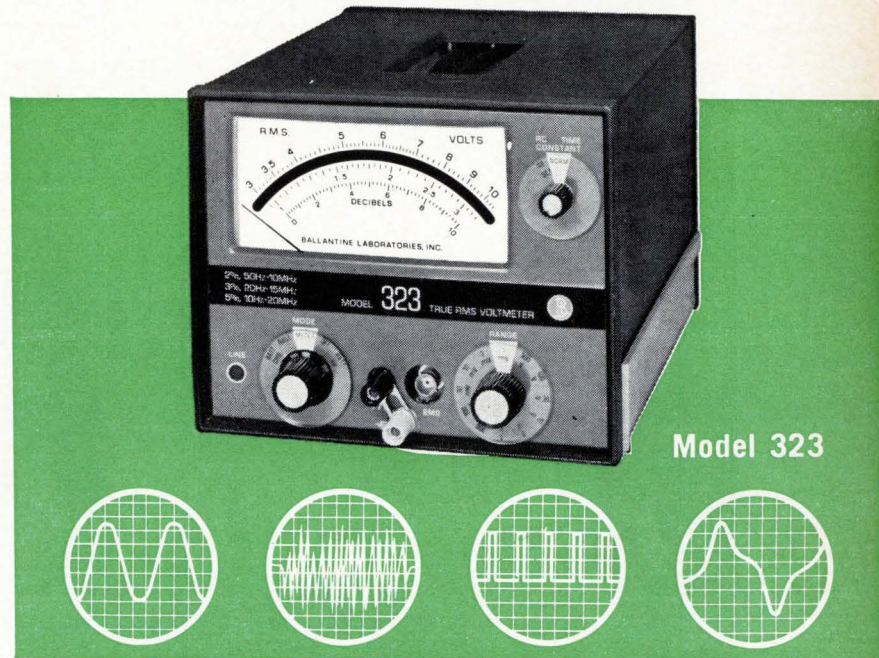

Measures from 10 Hz to 20 MHz regardless of Waveform

Ballantine's new Model 323 is a rugged, all-solid-state voltmeter for True RMS measurements for 10 Hz to 20 MHz . . . and for a wide variety of waveforms. Use it as a completely portable instrument isolated from line effects (due to built-in rechargeable batteries), or plug it into the power line. (Model 323-01 is for use on power line, only.)

FEATURES:

- ★ Measures True RMS of sine waves, square waves, noise voltages and a range of pulses
- ★ Frequency range of 10 Hz to 20 MHz
- ★ Voltage range of 300 μ V to 330 V. (As null detector to 70 μ V)
- ★ Unmatched accuracy: 2% of indication, 50 Hz to 10 MHz; 3% of indication, 20 Hz to 15 MHz; 5% of indication, 10 Hz to 20 MHz. Ballantine's accuracy of 2% means 2% of the actual indication, whether at the top or bottom of a scale
- ★ Operates from built-in rechargeable batteries or line power
- ★ Ideal for recorder applications — DC output of 0.1 to 1.0 V for each range simultaneous with meter reading
- ★ Crest factor: 5 at full scale to 15 at down scale
- ★ Separate isolated signal and case grounds
- ★ Optional 80 dB Attenuator Probe, Model 1301, for operation up to 10,000 V

Prices: Model 323, \$520 (Battery & Line)
Model 323-01, \$485 (Line only)



BALLANTINE LABORATORIES INC.
Boonton, New Jersey

Write for complete technical data today

CHECK WITH BALLANTINE FIRST FOR DC AND AC ELECTRONIC VOLTMETERS/AMMETERS/OHMMETERS, REGARDLESS OF YOUR REQUIREMENTS. WE HAVE A LARGE LINE, WITH ADDITIONS EACH YEAR. ALSO AC/DC LINEAR CONVERTERS, AC/DC CALIBRATORS, WIDE BAND AMPLIFIERS, DIRECT-READING CAPACITANCE METERS, AND A LINE OF LABORATORY VOLTAGE STANDARDS FOR 0 TO 1,000 MHZ.

New Instruments

erator supplies a control voltage for the synthesizers' continuously adjustable decade and also supplies center-frequency and side markers for visual monitoring of the frequencies generated. A synchronized constant-amplitude sweep voltage is also available for horizontal deflection of the display device.

Time for a one-way sweep of up to 10 continuous-decade divisions is 0.02 to 60 seconds in 9 steps. The synchronizing output is ± 6.6 v into 50 ohms. Markers can be set from 1 to 5.9 continuous-decade divisions in 0.1-division steps.

Type 1160P2 costs \$495. General Radio Co., West Concord, Mass., 01781. [372]

R-f wattmeter reads directly

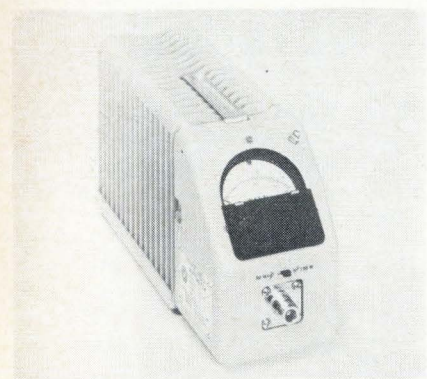

An addition to the manufacturer's Termaline family is a portable r-f wattmeter and integral load for design, service and maintenance of transmitters in the 2- to 30-Mhz range when the system cannot be terminated in its antenna.

Model 6155 consists of a logarithmic coaxial-line load resistor—which serves as a 150-watt dummy load—within a finned radiator, and a voltmeter circuit coupled to a direct-reading meter calibrated in watts. The meter has squared scales for easy downscale reading. A slide switch selects either the 50-w or the 150-w scale, and the meter housing can be detached from the load for remote reading.

R-f power is indicated directly,

SOLA ELECTRIC SIB

DIVISION OF SOLA BASIC INDUSTRIES

DISTRIBUTORS

ALABAMA, Birmingham
James W. Clary Co.
M-G Electronics & Equip.

ARIZONA, Phoenix
Sterling Electronics

CALIFORNIA, Glendale
R. V. Weatherford Co.

CALIFORNIA, Los Angeles
Kierulff Electronics, Inc.
Newark-Electronics

CALIFORNIA, Mountain View
Brill Electronics

CALIFORNIA, Oakland
Brill Electronics
Elmar Electronics

CALIFORNIA, Palo Alto
R. V. Weatherford Co.

CALIFORNIA, Riverside
Electronic Supply

COLORADO, Denver
Newark-Denver
L. B. Walker Radio Co.

COLORADO, Grand Junction
Radio & Electronic Supply

CONNECTICUT, Bridgeport
Sprague Elec. Supplies, Inc.

CONNECTICUT, Hartford
Electrical Supplies, Inc.

CONNECTICUT, Waterbury
Bond Radio Electronics, Inc.

D. C., Washington
Capitol Radio Wholesalers
Electronic Wholesalers

FLORIDA, Jacksonville
Southeast Electronics

FLORIDA, Miami
Electronic Equipment, Inc.

FLORIDA, Orlando
Hammond Electronics, Inc.

FLORIDA, Pensacola
Grice Electronics, Inc.

GEORGIA, Atlanta
Specialty Distr. Co., Inc.

GEORGIA, Hapeville
Electro Tech, Inc.

HAWAII, Honolulu
Honolulu Electrical

ILLINOIS, Chicago
Allied Radio Corp.
Electronic Distr., Inc.
Newark Electronics Corp.

ILLINOIS, Oak Park
Melvin Electronics, Inc.

ILLINOIS, Peoria
Klaus Radio & Electric Co.

ILLINOIS, Schiller Park
Pace Electronics

INDIANA, Evansville
Ohio Valley Sound

INDIANA, Indianapolis
Graham Electronics
Radio Distributing Co.

INDIANA, So. Bend
Radio Distr. Co., Inc.

IOWA, Davenport
TCR Distributors

KANSAS, Kansas City
Precision Electronic

KENTUCKY, Lexington
Radio Electronics Equip.

KENTUCKY, Louisville
P. I. Burks Co., Inc.
E & H Electric Supply Co.

LOUISIANA, Lafayette
Lafayette Radio Equip. Co.
Ralp'h's of Lafayette, Inc.

LOUISIANA, New Orleans
Electronics Prod. Corp.
Radio Parts, Inc.
Southern Radio Supply Co.

LOUISIANA, Shreveport
Koelman Sales Co.

MARYLAND, Baltimore
Electronics Wholesalers,
Inc.

MASS., Boston
A. W. Mayer Co.
Radio Shack Corp.

MASS., Cambridge
Electrical Supply Corp.

MASS., Newton
Cramer Electronics, Inc.

MASS., Springfield
Soundco Electronic

MICHIGAN, Ann Arbor
Wedemeyer Electronic

MICHIGAN, Kalamazoo
Electronic Supply Corp.

MICHIGAN, Detroit
Radio Specialties Co.
Cadillac Electric Supply Co.

MICHIGAN, Flint
Shand Electronics, Inc.

MICHIGAN, Grand Rapids
Newark Industrial Elect.

MICHIGAN, Jackson
Fulton Radio Supply Co.

MICHIGAN, Lansing
Fulton Radio Supply Co.

MINNESOTA
Minneapolis

MINNESOTA, St. Paul
Gopher Electronics Co.

MISS., Jackson
Ellington Electronic
Teague Electronics

MISSOURI, Kansas City
Burstein-Applebee Co.

MISSOURI, St. Louis
Walter Ash Radio Co.
Electric Components
for Industry Co.

NEBRASKA, Omaha
Radio Equipment Co.

NEW JERSEY, Springfield
Federated Purchaser, Inc.

NEW MEXICO, Albuquerque
Kierulff Electronics

NEW YORK, Binghamton
Federal Electronics, Inc.

NEW YORK, Buffalo
Radio Equip. Corp.
Summit Distributors

NEW YORK, Farmingdale, L. I.
Arrow Electronics, Inc.

NEW YORK, L. I. City
H. L. Dalis, Inc.

NEW YORK, Lynbrook, L. I.
Peerless Radio Distr., Inc.

NEW YORK, New York
Milo Electronics
Terminal Hudson Elect.

NEW YORK, Poughkeepsie
Chief Electronics Inc.

NEW YORK, Rochester
Requa Electrical Co.
Simcona Electronics

NEW YORK, Rome
Rome Electronics, Inc.

N. CAROLINA, Asheville
Freck Radio & Supply

N. CAROLINA, Charlotte
Electro-Tech, Inc.

N. CAROLINA, Greensboro
Carolina Radio Supply

N. CAROLINA, Raleigh
Southeastern Radio

N. CAROLINA, Winston-Salem
Electronic Wholesalers, Inc.

OHIO, Akron
The Sun Radio Co.

OHIO, Cincinnati
Newark-Herrlinger
Hughes-Peters, Inc.

OHIO, Cleveland
Pioneer-Standard Elect.
Radio & Electronic Parts

OHIO, Columbus
Hughes-Peters, Inc.

OHIO, Dayton
The John A. Becker Co.
Sreppo Electronics Div.

OHIO, Lima
Lima Radio Parts Co.

OHIO, Toledo
Warren Radio Co.

OHIO, Youngstown
Ross Radio Co.

OKLAHOMA, Oklahoma City
Radio Supply, Inc.

OKLAHOMA, Tulsa
Radio, Inc.
S & S Radio Supply

OREGON, Medford
Verl G. Walker Co.

OREGON, Portland
Consolidated Electrical
Lou Johnson Co., Inc.
United Radio Supply, Inc.
Platt Electric Supply Inc.

PENNSYLVANIA, Erie
Warren Radio, Inc.

PENNSYLVANIA, Harrisburg
Pytttronic Distr. Co.

PENNSYLVANIA, Philadelphia
Herback & Rademan, Inc.

PENNSYLVANIA, Pittsburgh
Cameradio Co.
McCullough Electric Co.
Radio Parts Co., Inc.

PENNSYLVANIA, Reading
Geo. D. Barbey Co.

PENNSYLVANIA, State College
Alvo Electronics Distr., Inc.

PENNSYLVANIA, West Chester
West Chester Electronics

RHODE IS., Providence
Wm. Dandreta & Co.

S. CAROLINA, Charleston
Wholesale Radio Supply Co.

S. CAROLINA, Columbia
Dixie Radio Sy. Co., Inc.

S. CAROLINA, Greenville
Carolina Radio Sy. Co., Inc.

TENNESSEE, Kingsport
Radio Electric Supply

TENNESSEE, Knoxville
Roden Electrical Sy. Co.

TENNESSEE, Memphis
Bluff City Distr. Co.

TENNESSEE, Nashville
Electra Distr. Co.

TEXAS, Corpus Christi
Electronic Equip. & Engr.

TEXAS, Dallas
Texas Instruments
Wholesale Electronic

TEXAS, El Paso
Midland Specialty Co.

TEXAS, Houston
Busacker Electronic Co.
W. H. Curtin & Co.
Harrison Equip. Co., Inc.
Sterling Electronics, Inc.

UTAH, Provo
Central Utah Electronics

UTAH, Salt Lake City
Standard Supply Co.

VIRGINIA, Charlottesville
Virginia Radio Supply

VIRGINIA, Norfolk
Priest Electronics, Inc.

VIRGINIA, Richmond
Meridian Electronics, Inc.

WASHINGTON, Seattle
Seattle Radio Supply, Inc.
Western Electronics, Inc.

WASHINGTON, Spokane
Northwest Electronics, Inc.

WASHINGTON, Tacoma
C & G Electronics Co.

WASHINGTON, Walla Walla
Inland Electronic Sy.

W. VIRGINIA, Charleston
Charleston Elec. Sy. Co.
Mountain National Corp.

WISCONSIN, Appleton
Valley Radio Distr.

WISCONSIN, Madison
Satterfield Electronics, Inc.

WISCONSIN, Milwaukee
Radio Parts Co., Inc.

To order reprints: Fill in, cut out coupon below, insert in envelope and mail to: **Electronics Reprint Dept., 330 W. 42nd Street, New York, N.Y. 10036**

Reprint order form

For listing of reprints available see the Reader Service Card.

Communications Satellites, Parts I and II.

Send me reprints of Key no. **R-90a** at \$1.25 each.

For reprints of previous special reports fill in below:

Send me reprints of Key No.(s) @ ¢ each.
(For prices, see Reader Service Card)

Name

Number of street

City, State, Zip Code

need 48 CV transformers in 48 hours?

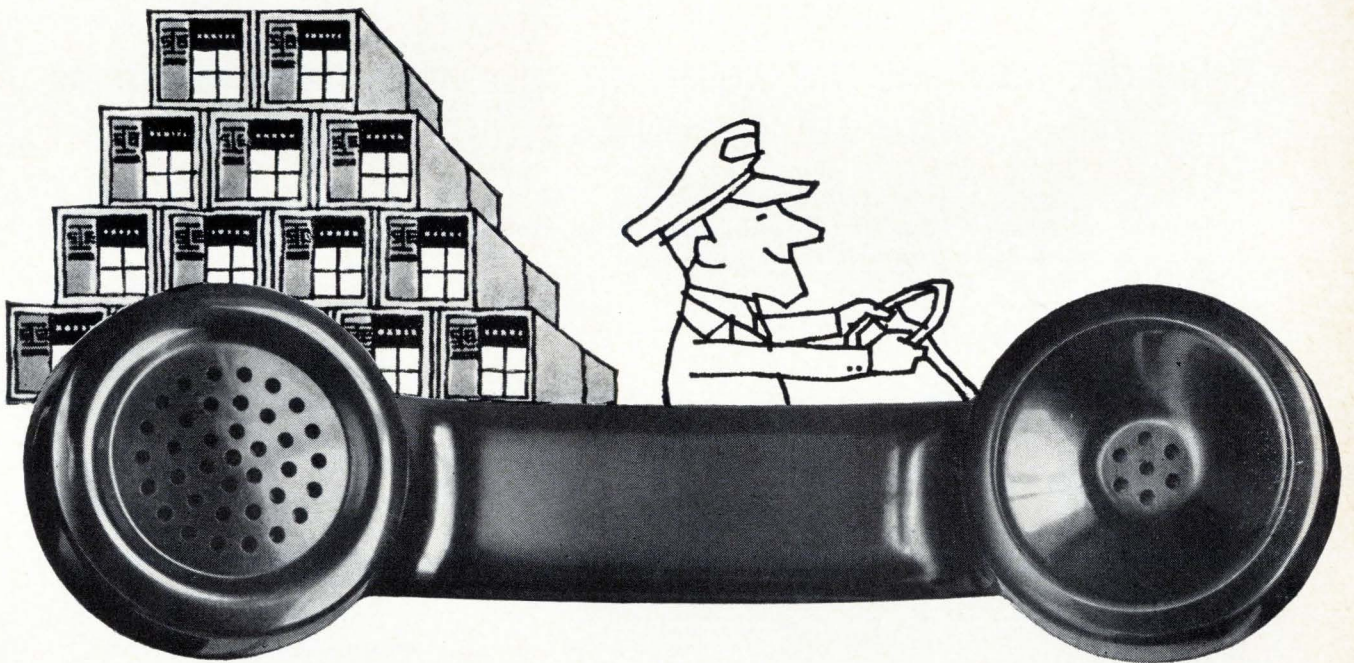

call your Sola distributor

Sola answers your tough ones. Through stocking distributors across the nation.

Choose from 100 different off-the-shelf CV designs: normal harmonic CV's in ratings from 15 va to 10,000 va, sinusoidal CV's from 30 to 7500 va, and multiple output CV's from 40 to 450 va.

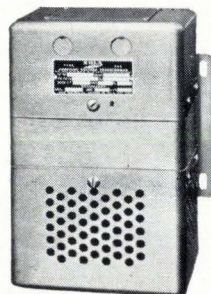

They all regulate automatically, within $\pm 1\%$ for variations up to 15%. Responding in $1\frac{1}{2}$ cycles.

For quick delivery, call your nearest Sola distributor. Or write to us for copy of catalog CV-100 describing the line: 1717 Busse Road, Elk Grove Village, Illinois 60007.

SOLA ELECTRIC **SEB**
DIVISION OF SOLA BASIC INDUSTRIES

OTHER DIVISIONS: ANCHOR ELECTRIC • ENGINEERED CERAMICS • HEVI-DUTY ELECTRIC • LINDBERG HEVI-DUTY • NELSON ELECTRIC

without calibration adjustment or charts, with a full-scale accuracy of $\pm 5\%$ from 2 to 30 Mhz. The load is a precision 50-ohm termination from d-c to 1,000 Mhz with a vswr of less than 1.10.

The company's quick-change connectors offer a choice of any common r-f cable connector at the time of order or in the field, eliminating the need for performance-degrading adaptors. Female N is normally supplied.

Bird Electronic Corp., 30303 Aurora Road, Cleveland, Ohio, 44139. [373]

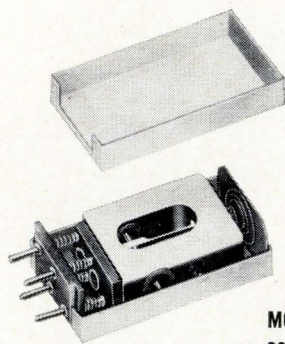

MODEL RF20
contactless resonant
reed encoder/decoder
 $1\frac{1}{32} \times \frac{1}{8} \times 1\frac{1}{32}$

REMOTE CONTROL SWITCHING WITH AUDIO SIGNALS

An audio tone can be generated by an electronic oscillator or resonant reed encoder circuit, then transmitted by wire or radio. The tone activates a resonant reed relay to perform a control function.

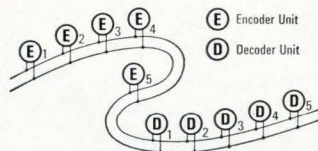

A single pair of wires, or a leased telephone line, can carry the audio signals for a complete control system.



For inaccessible areas or mobile installations, a radio transmitter and receiver system can carry the signals.

Bramco reeds permit over 50 selective control frequencies within the 67 to 1600 cps spectrum. This is assured by: (1) the narrow response bandwidth of about 1% for decoders and (2) the high accuracy of Bramco reed encoders (1/10 of 1% of design frequency).

A big advantage of reeds in control switching is that they are ideally suited for simultaneous and sequential coded tone systems. The actual number of control functions possible in such a system is virtually unlimited. For example, over 3300 individual control functions are possible with only 16 frequencies coded sequentially in groups of three.

Compared to other types of tone filters, resonant reeds are small and inexpensive. They give more control functions per spectrum, per size, per dollar.

If you work with controls that select, command, regulate, or indicate, you should know about how it can be done with audio signals. We custom design and stock a broad line of encoder/decoder components and modules.

For literature write Bramco Controls Division, Ledex Inc., College and South Streets, Piqua, Ohio, or call 513-773-8271.



BRAMCO CONTROLS DIVISION, LEDEX INC.
College and South Streets, Piqua, Ohio 45356

Instrument measures r-f signal intensity

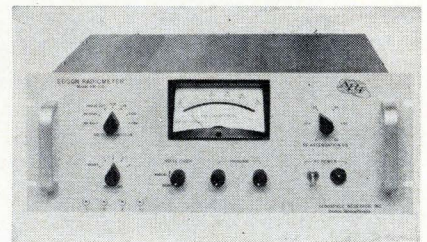

A technique of continuous calibration enables the Edson Radiometer to measure the intensity of radio-frequency signals, either random or coherent, to a precision of 0.1 db. This is done by switching a detector between the input signal and the output noise of a temperature-limited thermionic diode. The error difference between these levels is demodulated and used to control the diode output to reduce this error to zero. This closed-loop servosystem effectively eliminates gain variations in the detector and amplifier circuitry from affecting the measurement accuracy.

Both the short- and long-term stabilities of the instrument are 0.1 db.

Model ER-110 may be used for ionospheric absorption measurements with extraterrestrial radio noise, propagation path studies and other applications where high stability is required in the frequency range of 3 to 120 Mhz. It requires a tunable detector, such as a communications receiver, to select the frequency and bandwidth of the measurement. Other models

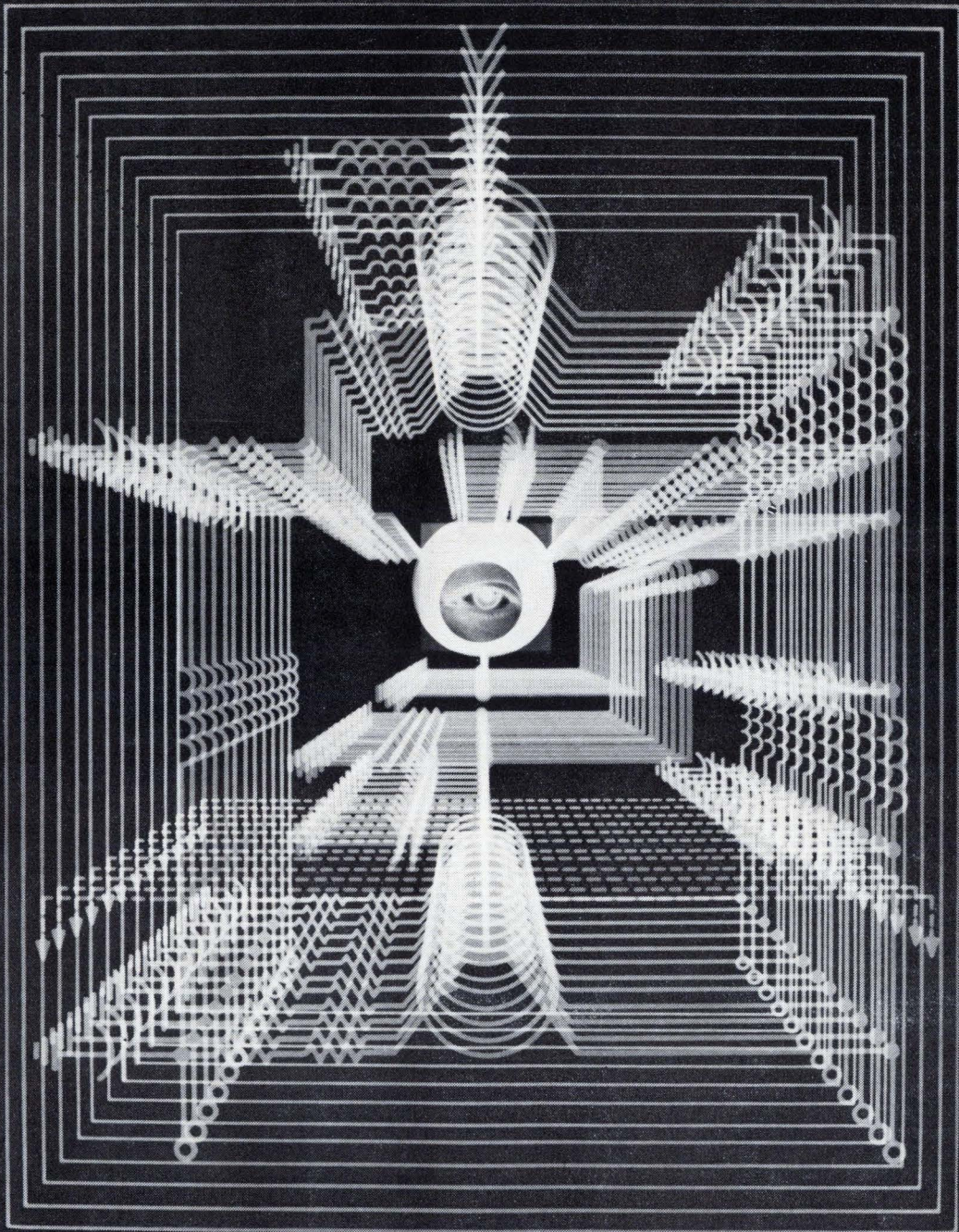

Look into the vehicles of opportunity at Lockheed...for circuit designers.

Opportunity broad enough to interest every circuit designer, that's the sweep of electronics assignments at Lockheed. Big, wide-ranging programs that extend from deep sea to deep space. And with ever-growing commitments comes an increasing need for new concepts and major technical advances in flight controls, communications, antennas and state-of-the-art electronics checkout equipment in both spacecraft and fleet ballistic missiles. In addition to its major vehicle programs... Agena, Poseidon, and Polaris, Lockheed is involved in deep submersibles; unique advanced land vehicles; information systems for states and hospitals; and many other technically alluring programs. For complete information, write Mr. R. C. Birdsall, Professional Placement Manager, P.O. Box 504, Sunnyvale, California. Lockheed is an equal opportunity employer.

LOCKHEED
MISSILES & SPACE COMPANY
A GROUP DIVISION OF LOCKHEED AIRCRAFT CORPORATION

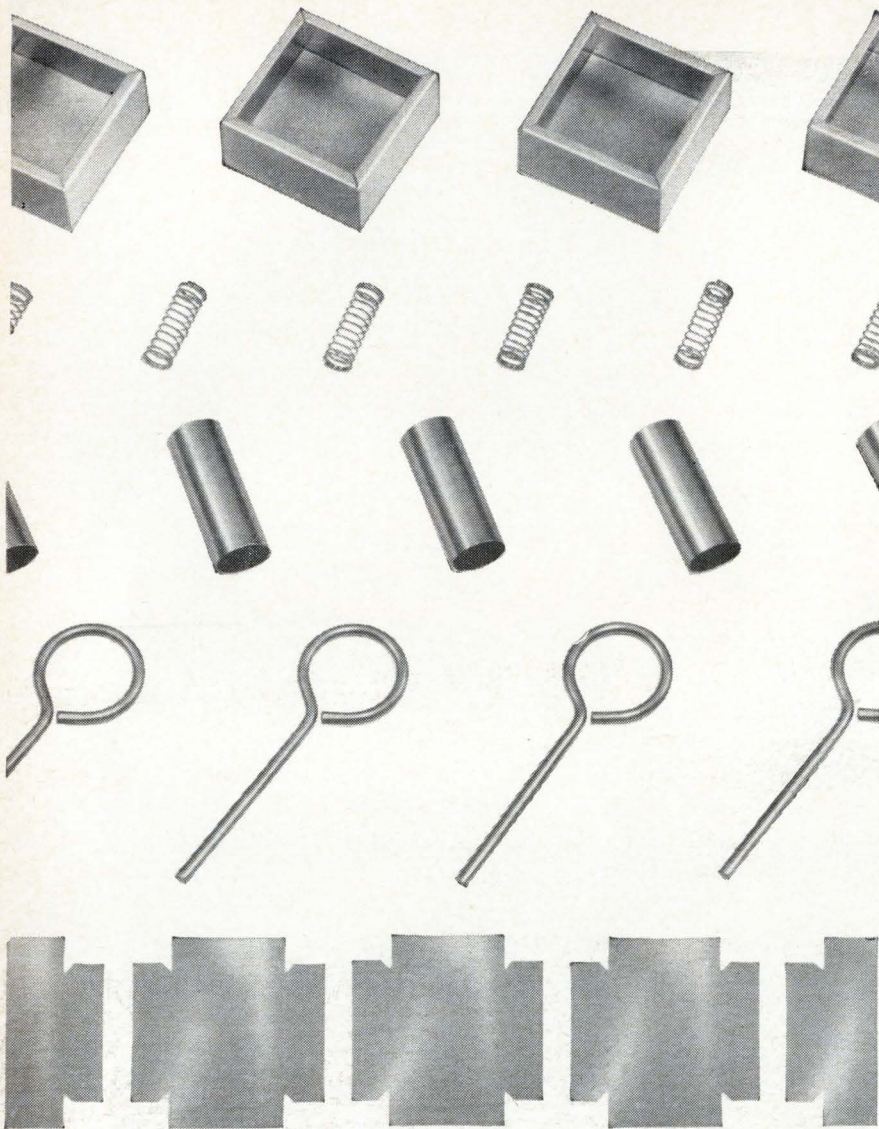

DUPLICATE THESE PARTS AND MORE IN YOUR OWN PLANT WITHOUT DIES!

Here's a way to produce short runs of simple parts quicker than an order can be processed to get them "outside." Versatile Di-Acro "Die-less Duplicating" equipment sets up quickly for cutting stock to size and forming it to die accuracy — without costly dies. Get full information in the new "Die-less Duplicating" catalog. See your distributor or write us.

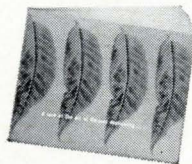

di-acro **DI-ACRO**
 division of
 434 EIGHTH AVENUE
 LAKE CITY, MINNESOTA 55041



New Instruments

are available with self-contained receivers.

The Edson Radiometer is priced at \$1,295.

Aerospace Research Inc., 130 Lincoln St., Brighton, Mass., 02135 [374]

Logger system checks capacitor data

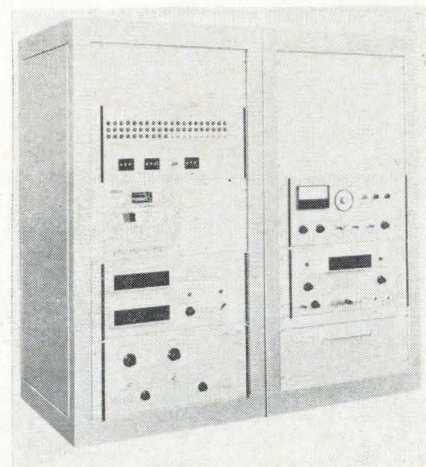

Automatic 120- and 1,000-hz measurements of capacitor performance are possible with this data logger system. Model 5380 performs soak and scanning functions, and provides digital read-out, printout, and go/no-go measurements on each parameter.

Capacitors are mounted on plug-in epoxy printed circuit test cards and inserted into the system. After the soak time, adjustable up to five minutes, the system automatically starts the tests. Capacitance, dissipation factor, and d-c leakage tests are conducted simultaneously. Following the automatic scan, the operator may scan any position manually and conduct individual tests. A memory failure indicator panel provides a numbered display for all test capacitors falling outside selected digital limits. Parameters are also recorded on an integral printer, with out-of-limit readings printed in red.

Model 5380 can test a total of 50 capacitors (three tests each) in three minutes, exclusive of soak time.

Micro Instrument Co., 12901 Crenshaw Blvd., Hawthorne, Calif. 90250. [375]

New *Linde* welding techniques solve most assembly problems.

Laser Welding: LINDE LWM-1—industry's first laser welder that makes precise reproducible welds on a production basis. Use it where the weld area may be smaller than a mil. The LWM-1 features low total heat input but high energy density. Since all this energy comes from the laser light beam, there is no physical contact with the work itself. All that is needed is a line of sight. The welder joins metals like copper, nickel, tantalum, stainless steel, molybdenum, titanium and others. It will join dissimilar metals of widely varying mass and thermal conductivity.

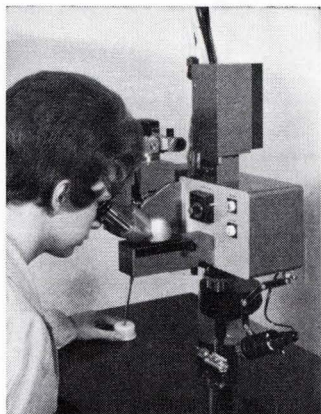

The LINDE LWM-1 is easy to use. The 25:1 ratio micro-manipulator makes precise positioning a simple operation. The binocular viewer in combination with a turret arrangement of three objective lenses gives a continuous view of the weld area at 20, 40 and 100 power of magnification. A shutter protects the operator at the moment the weld is made. LWM-1 adapts readily to automated welding and digital tape controls.

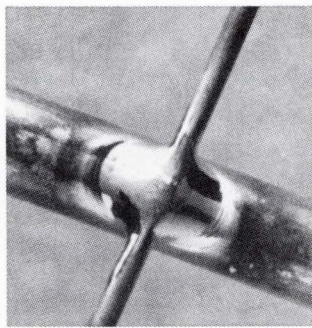

Cross weld between 0.005-in. diameter tungsten and 0.020-in. diameter nickel wires.

Plasma Needle Arc Welding: LINDE PWM-4—the practical, economical way to make high quality fusion welds on thin metals and miniature components. Plasma needle arc welding uses a constricted arc jet which extends more than 1/2 inch beyond the torch nozzle. The needle-like arc is extremely stable and easy to use: melting action remains constant despite great changes in arc length. Current values can be set so that burn-through is impossible. The angle of the torch and the long arc permit an unobstructed view while welding.

Plasma needle arc welding eliminates electrode contact and corrosive fluxes in the weld area; and these, combined with inert gas shielding and the highly stable arc, produce high quality welds without the limitations imposed by other commonly used processes.

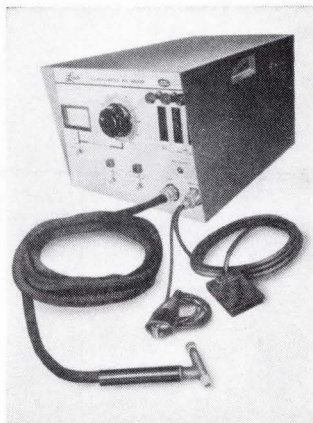

LINDE PWM-4 plasma needle arc welder—a complete package, including power supply/control unit designed for bench mounting. Uses conventional power and water supplies. Foot switch provides on-off arc control; 10-ft. service line connects torch to control unit.

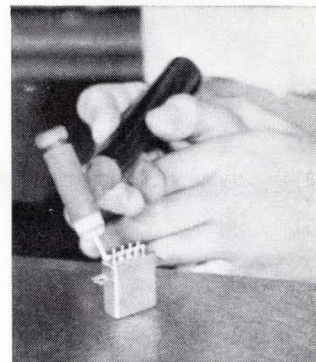

Repair welding of hermetically sealed relay case, using LINDE plasma needle arc torch.

For more information write Union Carbide Corporation, Linde Division, 270 Park Ave. New York, N. Y. 10017.



**The Series 5000
tests integrated
circuits. It
remembers 900 tests
(or more), performs
them in any order,
makes 100 parameter
checks per second,
and gives you
answers in any
medium or format.
Check on it.**

FAIRCHILD
INSTRUMENTATION

Adjustable delay line mounts on p-c boards

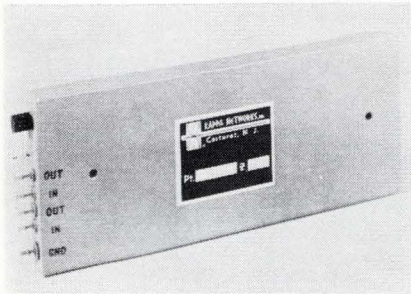

A lumped-constant delay line featuring a dielectric strength of 2,500 v d-c is suited for p-c board mounting. It is secured in a fiberglass package of $\frac{1}{2} \times 2\frac{5}{8} \times 6$ in.

Model 20E402 has a nominal delay of 3.5 μ sec at an impedance of 1,500 ohms and a rise time of 0.2 μ sec. It allows adjustment by screwdriver over a range of $\pm 0.1 \mu$ sec with a resolution of less than 1 nsec.

Unit price is \$75 in small quantities and substantial discounts are available in larger quantities. Delivery time is from four to five weeks.

Kappa Networks Inc., 165 Roosevelt Ave., Carteret, N.J., 07008. [381]

Variable gain differential amplifier

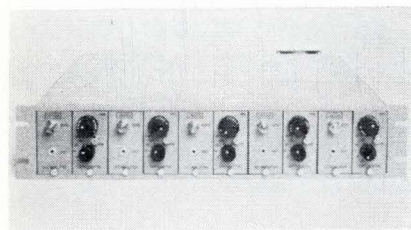

Common-mode voltage and isolation worries are eliminated by new differential d-c amplifiers. Five model 501 amplifiers may be mounted in a model 103E rack adapter, occupying only $3\frac{1}{2}$ inches vertically.

Specifications include ± 500 -volt common-mode rejection, 120-db isolation, and a 10-turn potentiometer that adjusts the gain continuously over any of 5 ranges whose

maximums are 10 to 1,000. The amplifier's output is ± 10 volts and is adjustable from 50 to 150 milliamperes. Its response is $\pm 1\%$ from d-c to 5 kilohertz, and ± 1 db up to 20 khz. Its linearity is 0.05%; noise at room temperature is 4 microvolts maximum at full bandwidth. A multiturn potentiometer permits zero adjustment at the output over a ± 2 -volt range.

Price of the amplifier is \$450 each; the rack adapter (complete with all connectors), \$125 each. Instrumentation Amplifiers & Supplies Inc., 29 Newton Road, Plainview, N.Y., 11803. [382]

Telemetry system offers modular design

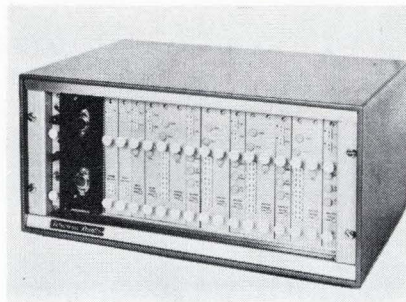

A solid-state tone-frequency multiplexing system provides up to 30 voice frequency channels between 420 and 3,900 hz. The system is suitable for the continuous transmission of analog, on-off supervisory, and remote control signals.

Information may be transmitted over telephone lines, radio links, carrier channels, or a pair of wires.

Measurement data is transmitted over an analog channel with high accuracy, with an error of 1% or less. The system uses a pulsed frequency system in which the level of the measured quantity determines the number of pulses per second of the particular channel frequency. The d-c output at the receiver is directly proportional to the number of pulses per second received.

Indication and control functions are handled by on-off channels made up of highly selective tone

generators and receivers. One channel is used for each function. Grounding a tone generator energizes the reed relay in the output of the tone receiver.

The AC-30 telemetering system can be expanded from a minimum of one channel to a maximum of 30 by adding modules.

Among its many applications are the remote control and supervision of meteorological stations, radio and tv stations, and microwave-link repeater stations.

Teletron Ltd., 16 Herbert St., Dublin 2, Ireland. [383]

Elapsed time indicator fits in small space

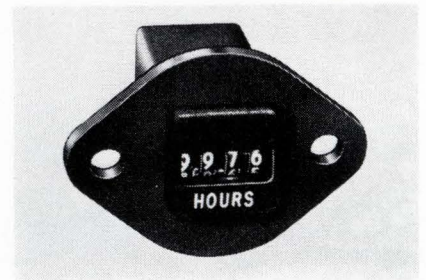

Occupying little more than a quarter cubic inch, a square-faced elapsed-time indicator provides easy readability at 48 inches or more. The self-contained and hermetically sealed unit displays four 0.078-in. white-on-black digits through a glass faceplate for presentation of elapsed hours from 0000 to 9999. Readings in tenths of hours, 000.0 to 999.9, can also be specified.

Designed for installation in all types of equipment and systems where space is at a premium, the DC-3215 combines a tiny counter and a 400-hz, 115-v half-watt motor. The elapsed time indicator is unitized and ruggedized to meet environmental requirements of MIL-M-7793C, and appears on the Bureau of Weapons list of qualified products.

Weighing about one ounce, the unit is available with a mounting flange, as illustrated, having $\frac{1}{8}$ -in. holes on $\frac{1}{2}$ -in. centers; but the 0.5 x 0.5 x 1.09-in. package is also available with other mounting provisions or with no flange at all.

The DC-3215 also features an operating indicator between the thousands and hundreds wheels

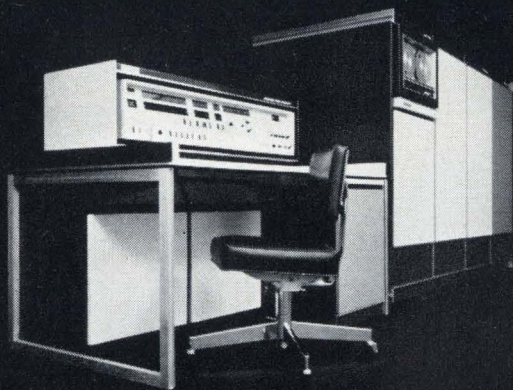

The Series 5000 tests integrated circuits. It remembers 900 tests (or more), performs them in any order, makes 100 parameter checks per second, and gives you answers in any medium or format. Check on it.

FAIRCHILD
INSTRUMENTATION

FAIRCHILD INSTRUMENTATION/A Division of Fairchild Camera and Instrument Corporation ■ 475 Ellis, Mountain View, California 94040, (415) 962-2011 ■ FAX: 910-379-6944

The System:

The Fairchild Series 5000 is an automatic test system for integrated circuits. It performs DC and dynamic tests using the new DTVM (Digital Time Voltage Measurement) technique, and makes up to 100 parameter measurements per second in a single socket. All you do is insert the device, manually or automatically. The 5000 stores 45 test sequences of 20 tests each on a magnetic disc, and performs them in any order you choose. It even performs subroutines on the basis of previous test results. You can change tests on the disc, or change discs, in minutes. And you can choose from a complete range of capabilities and configurations.

The Options:

You can get an extra disc for the 5000 to increase its test capacity from 900 to 1800 tests. Or you can get it with a computer tie-in, in which case its test capacity would be limited only by the size of the computer's memory. You can get the 5000 with a variety of automatic handling equipment, and with special facilities for testing performance in extreme environments. The basic system gives you GO/NO GO indications and digital readout, but you can add units to record the tests and their results on cards, punched tape, magnetic tape, or typewriter. You can get equipment to automatically sort the devices on the basis of test results. And our new packaging technique makes all these options fully compatible with the basic system.

Contact us for further information. We'll fit one to your needs.

Fairchild Instrumentation Field Sales Offices

U. S. A.

4546 El Camino Real
Los Altos, California 94022
(415) 941-3111

5410 West Imperial Boulevard
Los Angeles, California 90045
(213) 678-3166
TWX: 910-328-6177

50 Jericho Turnpike
Jericho, L. I., New York 11753
(516) 333-9311
TWX: 510-222-4479
2105 Gulf-To-Bay Boulevard
Suite #4
Clearwater, Florida
(813) 446-4619
TWX: 810-866-0436

8517 39th Avenue, North
New Hope, Minnesota
(612) 544-5220
113 Gentry Road
Hoffman Estates
Roselle, Illinois 60172
(312) 894-2060

EUROPE

FAIRCHILD INSTRUMENTATION LTD.
Grove House, 551 London Road
Isleworth, Middlesex, England
Tel: 560-0838
TELEX: 24693

Grunwalderstrasse 99
Munich 90, West Germany
Tel: 49 18 47
Cable: FAIRINTA MUNICH

FAIRCHILD
INSTRUMENTATION

FAIRCHILD INSTRUMENTATION/A Division of Fairchild Camera and Instrument Corporation ■ 475 Ellis, Mountain View, California 94040, (415) 962-2011 ■ TWX: 910-379-6944

There are only a few hundred people in this country working on gravity gradient stabilization. They're assaulting basic principles, analysis, hardware and total system requirements. But seldom all four.

Dr. Vladimir Chobotov has a rare assignment. He has to know who's doing what, where, why and when. He's a Staff Engineer at Aerospace.



The Aerospace Corporation performs systems engineering and provides technical direction for the U.S. Government on military space and missile programs. For information about technical positions, contact the Aerospace Corporation, an equal opportunity employer. Write to Stephen D. Robinson, P.O. Box 95085, Los Angeles, California 90045.

THE AEROSPACE CORPORATION

New Subassemblies

which provides continuous evidence of operation. The unit is suited for both direct visual reading and for installations requiring various types of optical recording.

Jewel bearings are provided in high speed stages to assure maximum operating accuracy and reliability under widely varying environmental conditions.

Bowmar Instrument Corp., Fort Wayne division, 8000 Bluffton Road, Fort Wayne, Ind. [384]

Isolated supplies in solid state package

The latest addition to the company's family of miniature isolated power supplies is the SuperMite. Model 3569 is just slightly larger than the original Mighty Mite yet provides completely variable voltage from 0 to 30 v at 1/2 ampere.

Outstanding feature of the 3569 is its complete isolation from a-c power line and from ground, thus making it immune from line transient or common mode interference. Production models of the SuperMite are coming off the line with less than 100 pv of peak-to-peak ripple which suits them for use with sensitive IC's.

Although capable of putting out 1/2 amp at 30 v, the Super Mite is only 2 1/2 in. wide and 7 1/4 in. deep. The all silicon, solid state package weighs 4 1/2 lbs. The 3569 is a completely self-contained supply with a heavy duty, 6-ft power cord.

The unit is priced at \$129.

Systems Research Corp., 2309 Pontius Ave. Los Angeles, Calif., 90064. [385]

Versatile, compact sequential timers

Two compact and simply-designed timers, can be operated automatically, manually, or by external triggering. One can program six and the other, 10 sequential events.

The duration of each event programmed is adjustable from 0.2 to 20 seconds, with repeatability

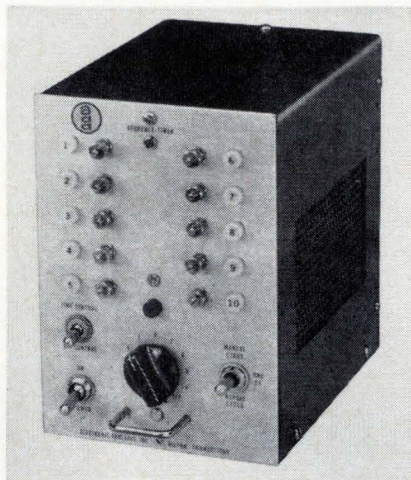

within 2%. Individual panel lights indicate the event being timed. Single cycle or repeat cycle modes are provided and manual stepping and clearing to home position is a standard feature. A rotary switch permits event by-passing when it is desired.

The units can be used as either timers or sequencers. They operate on 115 v a-c and can be used modularly with other units made by the producer.

Automation Devices, division of Electro-Mechanics, Inc., 160 Whiting St., New Britain, Conn. [386]

Design cuts cost of miniature supply

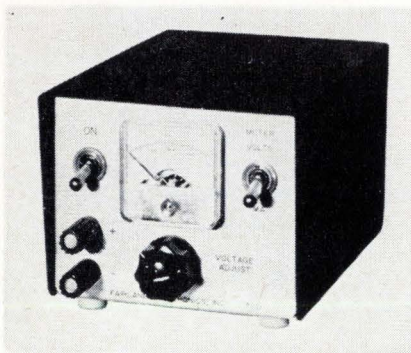

Designed for use in the engineering laboratory and in production test equipment, a regulated 0-30 volt power supply combines high performance, quality components, and low cost. Reliability is obtained through simple but effective circuitry and the operation of all



Aerospace Corporation performs systems engineering and provides technical direction for the U.S. Government on military space and missile programs.

SPACE COMMUNICATIONS SYSTEMS ENGINEER Responsible for manned spacecraft communications and data handling systems engineering which includes coordination of subsystem and user requirements, interface definition, specifications preparation review and technical direction of manned spacecraft contractors and subcontractors. Requires a sound communications background and familiarity with space systems. Space vehicle design, experience in tracking, telemetry, command, and voice communication systems is desirable. A balance between analytical and practical engineering experience is preferred.

CONTROL SYSTEMS ANALYST Perform analyses and program support in such areas as flight control systems, attitude control systems, terminal guidance systems and flight test planning.

SIMULATION SYSTEM ENGINEER Responsible for system design of manned spacecraft simulators, both part-task and full-system. Responsibilities include equipment, software, and operations procedures.

COMPUTER SYSTEMS ENGINEER Responsible for trajectory and orbit related computational support. Would also perform analysis of flight operations requirements, the evaluation of existing computer and software systems, the definition of support systems, and the technical coordination review of the implementation of these systems. Requires experience with trajectory and orbit computations and software systems design for communications and control systems.

RADAR SYSTEMS ENGINEER Performs analysis and program support on advanced radar systems. Analytical and hardware design experience required in phased array, pulse compression, receiver signal processing, current pulse, cw and pulse doppler techniques as applied to airborne and missile radar systems.

If you have an advanced degree and a minimum of five years experience, contact Aerospace Corporation, an equal opportunity employer. Write to Stephen D. Robinson, P. O. Box 95085, Los Angeles, Calif. 90045

AEROSPACE CORPORATION



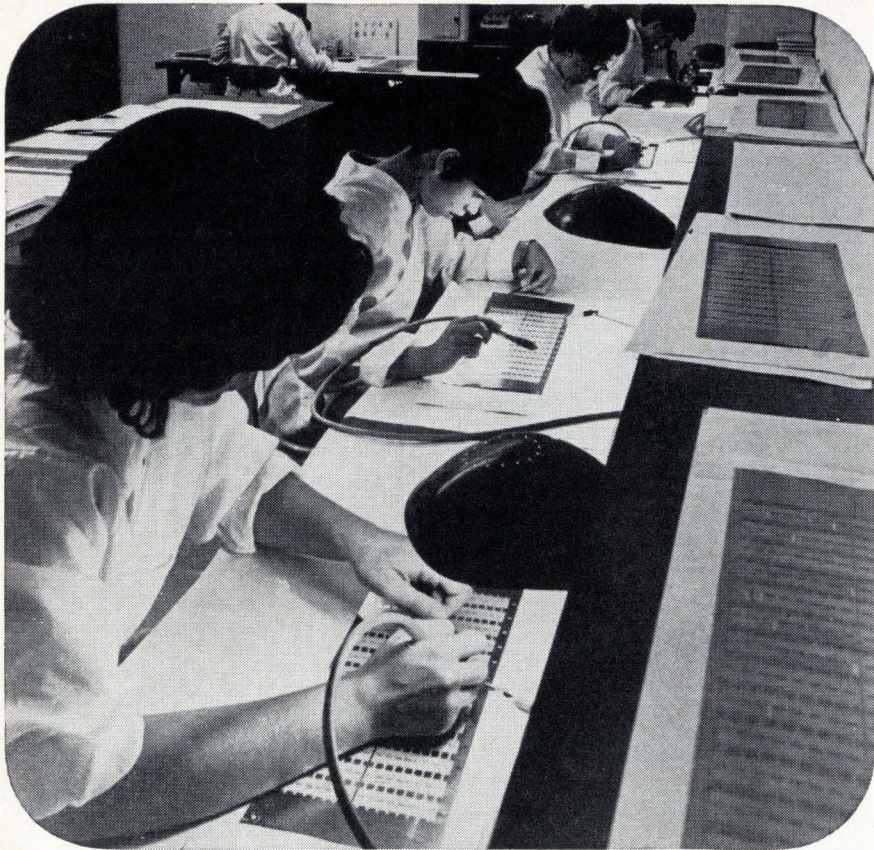

**who produces foil
that cuts
magnetic core
production time
by more than 93%?**

By changing production from a mechanical process to frets (frame style laminations) photoetched from Hamilton precision-rolled moly permalloy, stainless steel and beryllium copper, a manufacturer of magnetic head cores cut production time from five days using 12 operators to two days using two operators.

This strip and foil furnished by Hamilton Precision Metals is precision rolled to give it the excellent surface and ultraclose tolerances required for photoetching. Hamilton's unique capability produces foil as thin as 70 millionths and precision strip up to 0.100" thick with tolerances as fine as $\pm 5\%$ or better.

Hamilton Precision Metals is your prime source for ultra-precision-rolled metals in mass production quantities. 7 proprietary metals, 12 pure metals and 112 commercial alloys are available from Precision Metals. Write today for new 48-page data book.

HAMILTON PRECISION METALS

division of Hamilton Watch Company, Lancaster, Pa. 17604

New Subassemblies

electrical components well within their ratings.

The output terminals are not grounded; either positive or negative terminal may be grounded. Automatic current limiting at 350 ma affords short-circuit protection.

Line and load regulation is better than 10 mv and ripple and noise is 3 mv maximum. Transient response is 50 μ sec. Output is rated at 0 to 30 v d-c at 300 ma with an input of 108 to 132 v a-c at 60 to 400 hz.

The model 730 measures 4 x 4 $\frac{3}{8}$ x 7 $\frac{1}{2}$ in. Price is \$95 with five-day delivery.

Fairlane Electronics, Box 335, Long Valley, N.J., 07853. [387]

**Telemetry power pack
small and stable**

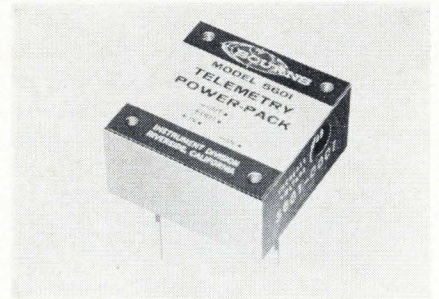

Designed for advanced instrumentation applications where miniature size and exceptional environmental performance are mandatory, a telemetry power supply measures 1x1x0.5 in. and weighs 0.6 oz. Model 5601 features reverse polarity, overvoltage and short-circuit protection. It has output voltage adjustability, output isolated from input, and excellent regulation.

Output voltage is 5 v d-c at 100 ma; input voltage, 24 to 32 v d-c; output voltage adjustment range, 4.9 to 5.2 v d-c; and temperature range, -55° to $+100^{\circ}$ C.

In addition, the new model is sealed for humidity and salt spray, and meets stringent environmental requirements of MIL-STD-202. Vibration is rated at 20 g and shock at 100 g.

All units are guaranteed by the manufacturer. They undergo 100%

in-process and final inspection, besides a 100-hour burn-in prior to shipment.

Bourns Inc., 6135 Magnolia Ave., Riverside, Calif., 92506. [387]

D-c to a-c inverters show high stability

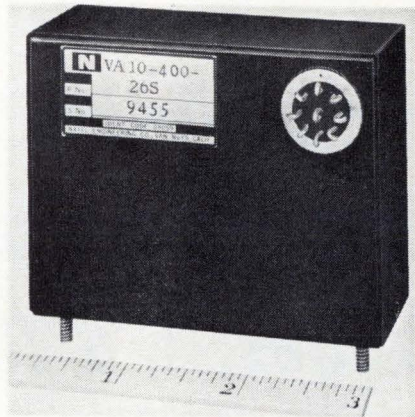

Gyro applications, power source for carrier systems, precision source for laboratory, and ground support systems are typical uses for a line of d-c to a-c inverters. Called the series 400, the inverters offer excellent amplitude and frequency stability under simultaneous excursions in temperature (-55° to $+71^{\circ}$ C), and variations in d-c supply voltage (28 ± 3 v d-c).

When used in laboratory or limited temperature environments, the inverters operate as precision a-c sources. For more stringent applications, 0.002% to 0.02% frequency stability is available.

The inverters deliver a low-distortion sine wave output from a d-c input. Standard models display amplitude stability of better than 1% and frequency stability better than 0.25%, even while experiencing full rated variations in temperature and input voltage. Regulation is within 1% from no load to full load (0° to $+50^{\circ}$ C) and 3% from -55° to $+71^{\circ}$ C. In addition, all models are protected from polarity reversal and inadvertent short circuits. A short circuit can be sustained indefinitely with a recovery time of 0.5 sec maximum.

Price of the inverters is \$300 each. Delivery takes 30 days. Natal Engineering Co., 7129 Gerald Ave., Van Nuys, Calif. 91406 [388]

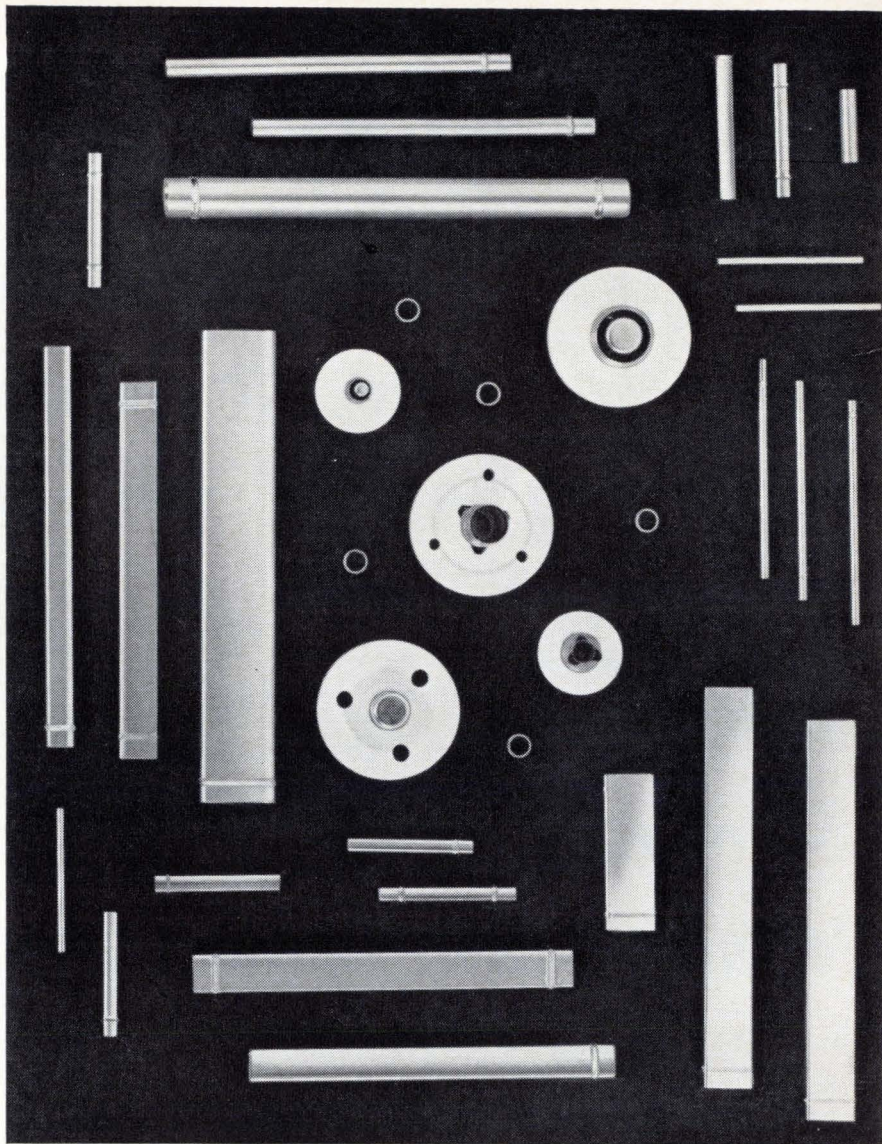

YES, WE ARE INDEPENDENT!

We Are The World's Leading Independent Maker of Nickel Cathodes.

Every cathode that we fabricate is for our customers. And we have two large plants that are producing a variety of cathodes including seamless, Weldrawn, disc, lockseam and lapseam.

Superior offers you cathodes in a wide choice of materials for your most exacting requirement. We are pioneers in creating new designs and in developing and using new materials for improved performance.

Do you have a copy of Superior Catalog No. 51? Send for it today. Dept. 2500.

Superior Tube 

The big name in small tubing

NORRISTOWN, PA. 19404

West Coast: Pacific Tube Company, Los Angeles, California

Johnson & Hoffman Mfg. Corp., Carle Place, N. Y.—an affiliated company making precision metal stampings and deep-drawn parts

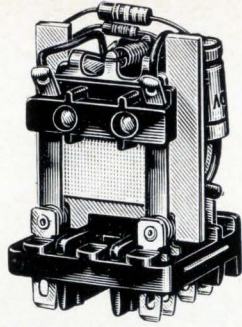

This new solid state time delay relay could be the biggest \$12.50 relay value you've ever seen. Timing tolerance is $\pm 5\%$. Internal dpdt relay is rated at 10 amperes. Fixed timing ranges: 1, 5, 10, 30, 60 and 120 seconds. Quick-connect/solder terminals. Remember...only \$12.50!

This new solid state time delay relay (CU Series) is an outstanding value. It is designed for delay on operate applications in machine tool controls, copiers, office equipment, coin-operated machines, process controls and a host of others. Both AC and DC models are available.

Mounting versatility is a feature of the CU Series. Standard .187" quick-connect terminals are pierced for solder connections. Or, using the special socket, you can enjoy plug-in convenience.

Resistor-Adjustable Models Available

Any timing period up to 120 seconds may be obtained with the use of a resistor applied to two terminals provided on these models. These are available at a slightly higher price. The same wide range of mounting choices is available.

CU SERIES SPECIFICATIONS

Types Available: Fixed time delay on operate and resistor adjustable.

Voltages: AC: 24 and 120.

DC: 24.

Temperature Range: Recommended for normal indoor use.

Fixed Timing Tol.: $\pm 5\%$ at 25°C.

Transient Protection: Yes.

Reset Time: 100 milliseconds.

Repeatability: $\pm 3\%$.

Internal Relay: DPDT, 10 ampere @ 28V DC or 120V AC resistive. KU Series.

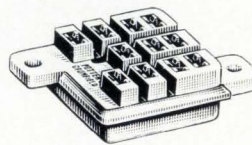

NYLON SOCKET

Special nylon socket is rated at 10 amperes. Choice of solder or printed circuit terminals. Sold separately.

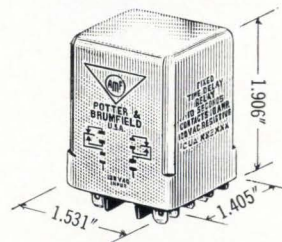

LEXAN CASE

CU Series time delay relays are housed in heat-resistant high-impact Lexan cases. Push-to-test button for manual circuit checking may be specified.

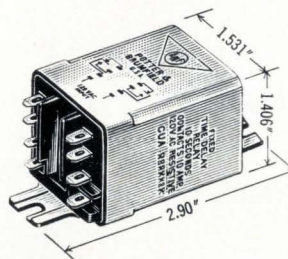

FLANGED CASE

A special flanged case is available for mounting time delay relays directly to chassis. Mounting is on 2.50" centers. Socket cannot be used with this case.

P & B solid state time delay relays are stocked by leading electronic parts distributors.



POTTER & BRUMFIELD

Division of American Machine & Foundry Company, Princeton, Ind. 47570
Export: AMF International, 261 Madison Avenue, New York, N.Y. 10016

GaAs diodes break noise barrier

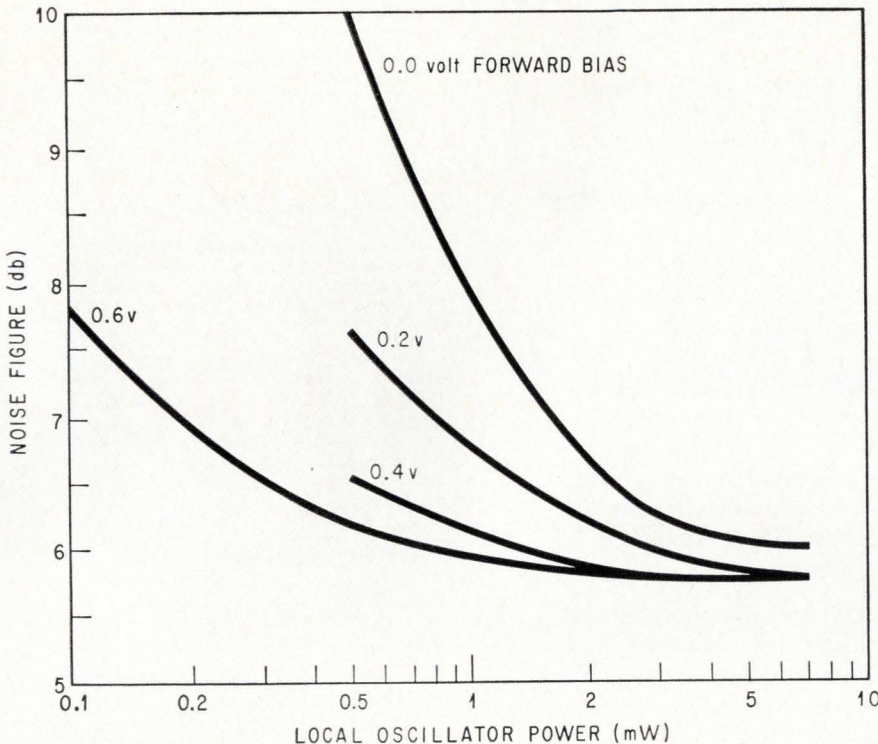

Schottky-barrier diodes made of gallium arsenide aren't new, but Texas Instruments Incorporated has introduced a series of such devices offering the lowest 9-giga-hertz noise figure available—0.5 decibel lower than the best competing GaAs diodes and as much as a full db lower than similar silicon units.

As in all Schottky-barrier mixer diodes, electrons are majority carriers in the new π units, which are designated TIXV08 through TIXV-19. The company has apparently exploited GaAs' high electron mobility and traded some burn-out resistance for noise figures as low as 5.5 db and operation across all of X band. TI guarantees 6-db noise.

The specification includes 1.5-db intermediate-frequency noise and is measured relative to a 15.9-db argon noise source traceable to the National Bureau of Standards.

A π spokesman states that a 6-db noise figure can mean enough added sensitivity in some applications to allow receiver-front-end operation without a radio-frequency preamplifier. He cites this potential

cost saving as a key advantage.

Diodes with higher noise figures are offered at lower cost. Nine other units in the series have 6.5-, 7.0- or 7.5-db noise levels.

Compared to point-contact diodes, the junction devices are both more rugged (there is no fragile whisker to break) and harder to burn out. Point-contact devices can be destroyed by 1- to 3-erg pulses, but the large junction area of the Schottky-barrier diodes keeps current density lower and raises burn-out level to 5 ergs.

However, π 's new diodes can't compete in this regard with silicon units and some noisier GaAs diodes which have burnout ratings as high as 10 ergs. Also, the π diodes require 4 to 7 milliwatts of local-oscillator drive power, against only 1 or 2 mw for silicon diodes.

The new series is available in three package styles: two pill-prong packages and a cartridge design. The first two, type B with a 0.33-picofarad case capacitance and type C with 0.18 pf, are for strip-transmission-line and coaxial mounts. The type-E package is de-

**P&B DRY REED
CLIP FILE**

Need to isolate integrated circuits from interface noise?

Use this circuit with
P&B Dry Reed Relays . . .

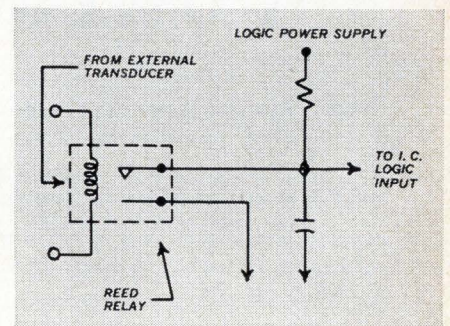

Do you need to isolate integrated circuit logic inputs from interface noise? A reed relay can do this job quite handily due to its inherent isolation between input and output. Also, P&B reed relays have low contact resistance, long life and short bounce times.

Full line—up to 5 reeds per module

JR standard size and JRM miniature reed relays are available in assemblies of 1 to 5 switches. Both sizes come in a complete range of coil voltages and various combinations of Form A, B and C contact arrangements.

Bobbin flange supports terminals for stress protection

P&B reed relays employ an unusually sturdy terminal configuration. Extensions of the molded coil bobbin support the cross-shaped terminal pins. Stresses that otherwise would be transmitted to the reed extensions are confined, instead, to the bobbin thus protecting the glass-to-metal seal of the capsule.

Send for data sheets giving complete specifications. Contact your local P&B representative or the factory direct for complete information.

P&B Dry Reed Relays are now available from authorized electronic parts distributors.



POTTER & BRUMFIELD
Division of American Machine & Foundry Co.
Princeton, Indiana 47570

LOOKING FOR AN

ADJUSTABLE OUTPUT



REGULATED D.C. POWER SUPPLY?

Every laboratory needs a source of regulated direct current. These power supplies represent the most popular designs that have been developed for laboratory or research use. The D.C. output is adjustable over the range indicated.

Acme Electric adjustable D.C. Output Power Supplies feature reliability, with all solid state components individually tested for their stability under continuous duty service.

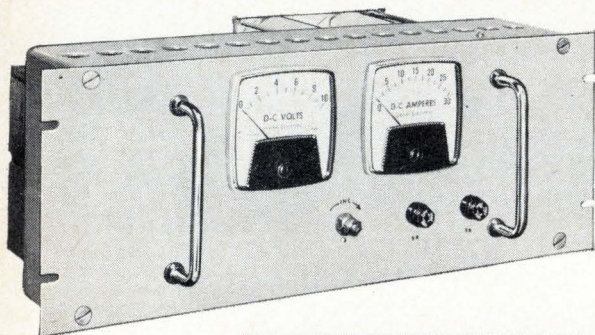

Type PS-57350 can be supplied for use on 208 volt. D.C. output is continuously variable over a range of 0-7 volts. D.C. output capacity 15 amps. Maximum ripple 2%. Maximum line regulation $\pm 1\%$. Maximum load regulation $\pm 4\%$.

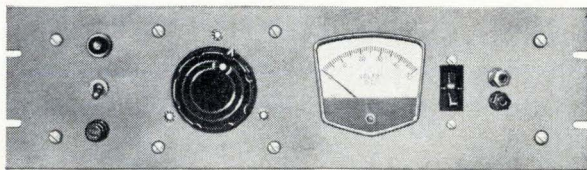

Type PS-39600. Input voltage range 102-138. D.C. output continuously variable over a range from 0-50 volts. D.C. current 0.5 amps. Maximum ripple RMS -1% . Maximum line regulation $\pm 1\%$. Maximum load regulation $\pm 4\%$.

These are but two of the many standard adjustable D.C. output and regulated D.C. output power supplies illustrated and described in Bulletin 175. Write for your copy.

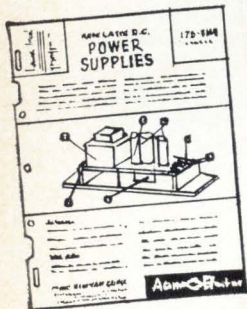

Acme **ACME** Electric

314 WATER STREET
CUBA, NEW YORK 14727



New Microwave

signed for waveguide installations and has a 0.55-pf case capacitance.

Specifications

All units at 9.375 Ghz:	
Single-pulse burnout	5 ergs
Forward current	100 ma, dc
IF impedance	230 ohms max 180 ohms typ
Vswr	1.5 max 1.3 typ
Delivery	Stock
TIXV08 (type B), -12 (type C), -17 (type E)	
Noise figure	6.0 db max
Price in quantities of 100	\$49.20
TIXV09, -13, -17	
Noise figure	6.5 db max
Price in quantities of 100	\$38.40
TIXV10, -14, -18	
Noise	7.0 db max
Price in quantities of 100	\$28.80
TIXV11, -15, -19	
Noise	7.5 db max
Price in quantities of 100	\$23.10
Texas Instruments Incorporated, Box 5012, Dallas, Texas [391]	

Range stepped up for EMI scanning

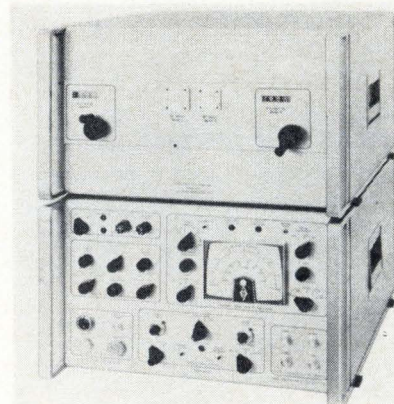

Electromagnetic interference (EMI) measurements are extended into the 10- to 22-GHz band by an automatic scanning frequency selection unit. Called the EMA-910-12, the model complements the currently available 1- to 10.5-GHz frequency selection unit (EMA-910-10). Used in combination with the basic EMA-910-11 data evaluation unit, the new model enables rapid and precise electromagnetic compatibility analyses and field intensity measurements in accordance with Federal and military specifications.

The EMA-910-12 is a super-heterodyne receiver that converts the input signals down to a 240-Mhz intermediate frequency used by the data evaluation unit. Except for two klystrons supplying funda-

mental frequency for the local oscillator, the frequency selection unit is completely solid state.

The combination unit can be tuned manually in two bands, 10 to 15.2 Ghz and 15.0 to 22 Ghz. Four i-f bandwidths can be selected: 0.5, 1.0, 5.0, and 10 Mhz. Sensitivity is -92 dbm at 0.5 Mhz. Automatic band switching allows any sector of the frequency range to be swept.

Peak detectors that hold the signal 0.01, 0.1, 0.5, and 5 sec are included in the unit. These are useful for recording peak signals on instruments having limited frequency response. The unit can be push-button calibrated with disconnecting input leads. The case provides 120 db of shielding. Operating power for the EMA-910-12 is provided by the data evaluation unit. The rack-mounted version measures 17 x 20 x 10³/₄ in. The unit sells for \$14,950. Delivery takes 150 days.

The Singer Co., Metrics division, 915 Pembroke St., Bridgeport, Conn. [392]

Step recovery varactor gives 1 w at 10 Ghz

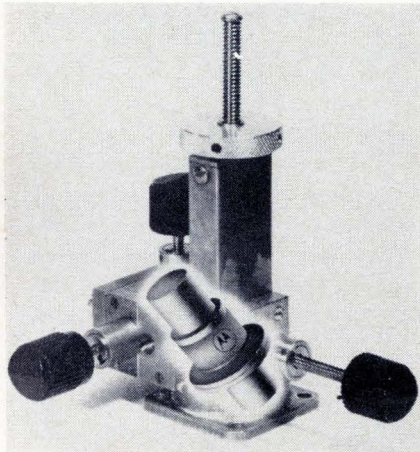

A step recovery varactor that delivers one watt at 10 Ghz operates with a minimum efficiency of 38.5% when doubling from 5 Ghz to 10 Ghz. The 1N5157 can be used in the radar band of 8.5 to 9.6 Ghz as a driver for high power tubes or as a multiplier for solid-state local oscillators. It is also applicable in microwave link communications equipment for both transmitter and local oscillator signal sources. In other equipment the device can be employed as a single source up

fearless distributor on the moon needs a tube to get back...

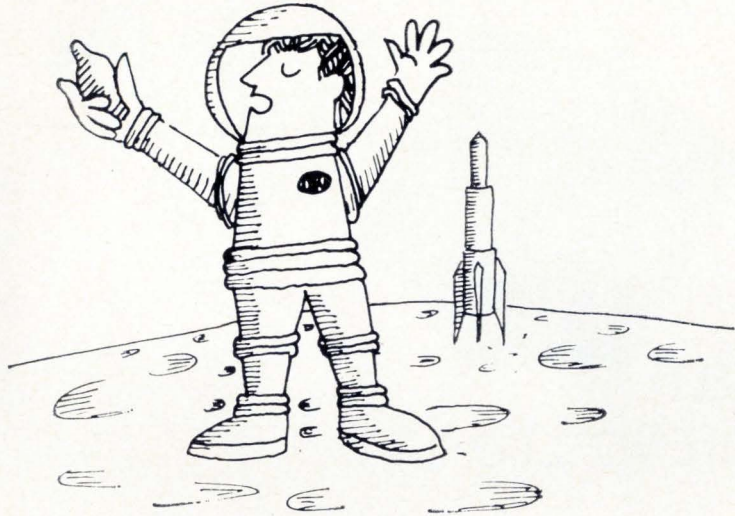

get on the hot-line (212) 533-5580

Get out of the "no-bid" habit and get with the action. Join the profit-making distributors who have found Transitube the reliable source for current, original boxed industrial electron tubes and semiconductors from every major manufacturer in the industry—all at below distributor cost. We are the distributor's supplier (not his competitor) A phone call lets you enter a competitive bid on any quotation.

Tubes and semiconductors can be supplied to meet commercial or military specifications. Immediate delivery is assured from our comprehensive stock, housed within our modern 30,000 sq. foot warehouse.

Get on the "hot-line"—we're waiting for your call.

Transitube Inc., 300 Park Ave. South, New York 10010, phone: (212) 533-5580, cable address: Transitube, New York.



TRANSITUBE

Circle 223 on reader service card

To order reprints: Fill in, cut out coupon below, insert in envelope and mail to: **Electronics Reprint Dept., 330 W. 42nd Street, New York, N.Y. 10036**

Reprint order form

For listing of reprints available see the Reader Service Card.

Communications Satellites Part I

Send me reprints of Key no. R-89 at 50¢ each.

For reprints of previous special reports fill in below:

Send me reprints of Key No.(s) @ ¢ each.

(For prices, see Reader Service Card)

Name

Number of street

City, State, Zip code

It took Hughes
engineers $3\frac{1}{2}$ years to
create the
SYNCOM
story.

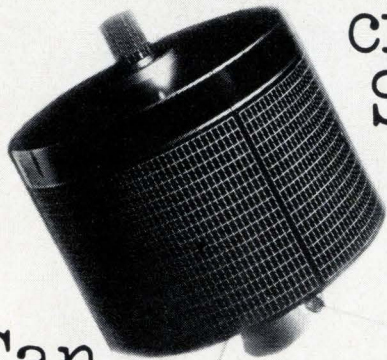

Can
you write it?

Hughes Field Service and Support is urgently seeking qualified E.E.'s for a dual challenge—to your engineering know-how and to your writing ability. You will be closely associated with the latest and most advanced aerospace projects. As a Systems Writing Engineer, your assignment will be to **communicate** your knowledge of these projects.

The Syncom series is just one example of the magnitude and significance of the projects involved. Other subjects include space vehicles, weapons systems, electronic computers, guided missiles, radar and communications, programmed instructional devices, and systems trainers.

You will research drawings, specifications, and reports; you will interview project engineers and make first-hand examinations and inspections. Then you'll interpret and analyze this data and write engineering publications for use by other engineers on allied projects.

This is a demanding position and an important one. If you wish to rapidly broaden your engineering knowledge and gain systems-oriented technical experience, if you have a B.S.E.E. or a B.S. in Physics—and if you can write—please send your resume at once to: Mr. B. P. Ramstack, Hughes Aircraft Company, P.O. Box 90515, Los Angeles, California 90009. U.S. citizenship required.

HUGHES
HUGHES AIRCRAFT COMPANY
FIELD SERVICE & SUPPORT DIV.
An equal opportunity employer

New Microwave

to 13 Ghz with over 100 mw of output power.

Thermal resistance from junction to case is $38.5^\circ/\text{watt}$ maximum and the reverse breakdown voltage is a minimum of 20 v d-c. These two characteristics are largely responsible for the power handling capability of the 1N5157. The Q factor is 3,600 measured at 50 Mhz and 6 v d-c of reverse bias. The unit is housed in the company's case number 46.

The 1N5157 is available at \$47 each in lots of 1 to 99, and \$31 each in lots of 100 and up.

Motorola Semiconductor Products Inc., Box 955, Phoenix, Ariz., 85001. [393]

Iris-coupled filter maintains high Q

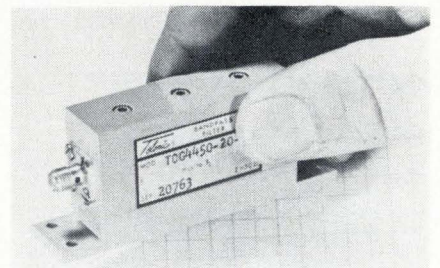

A small filter that maintains high Q and has low insertion loss uses iris-coupling between quarter-wavelength resonant cavities. Cavity diameters are reduced by an exponentially tapered post permanently fixed to the cavities' ground plane, and length is reduced by capacitively loading the tapered post.

The Model TCG filters are supplied with miniature coaxial connectors, and are available in two to six sections with frequencies from 2 to 6 Ghz and with 3-db bandwidths from 0.3% to 3%. They exhibit a vswr of only 1.5:1 up to 4 Ghz, and 2.0:1 from 4 to 6 Ghz. A typical four-section filter with 2% bandwidth at 4 Ghz has a maximum insertion loss of 1 db. The over-all size of such a filter is $3\frac{1}{4} \times 1\frac{1}{2} \times 3\frac{1}{2}$ in.

The devices are constructed to precision bored aluminum blocks; controlled finishing minimizes insertion loss. Vswr bandwidths

range from 0.5 to 0.9 of the 3-db bandwidth, with 30-db form factors from 5.5 to 1.7.

The filters are priced from \$215 to \$396 each with significant quantity discounts. Delivery takes six to eight weeks.

Telonic Engineering Co., Box 277, Laguna Beach, Calif. [394]

Bandpass filters benefit telemetry

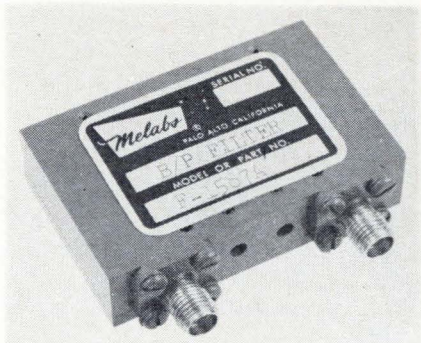

Interdigital filters designed for telemetry applications feature low insertion loss and steep skirts. The F-1587A bandpass filter, for example, covers the 1.435 to 1.535 Ghz range with a maximum insertion loss of 1 db. Skirt rejection is at least 20 db at 1.335 and 1.635 Ghz and at least 50 db at 1.1 and 1.8 Ghz. Vswr is 1.5:1 maximum. Capable of handling 20 watts, the unit measures 2 x 1.3 x 0.5 inches. It is equipped with osm connectors.

In the 2.2 to 2.3 Ghz band, the F-1588A filter offers similar characteristics. Rejection is at least 20 db at 2.1 and 2.4 Ghz and at least 50 db at 1.95 and 2.6 Ghz.

Either unit sells for \$195 and is available from stock.

Somewhat larger bandpass filters, handling up to 50 watts in the same frequency range, are available with comparable characteristics.

Melabs, 3300 Hillview Ave., Stanford Industrial Park, Palo Alto, Calif. [395]

Frequency multipliers cover wide range

Frequency ratios from $\times 2$ up to $\times 20$ are offered in a line of solid state microwave multipliers. Typical of the series is a $\times 6$ multiplier

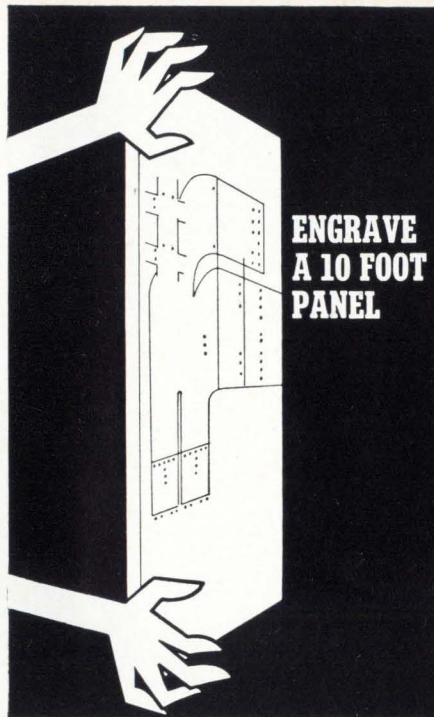

ENGRAVE
A 10 FOOT
PANEL

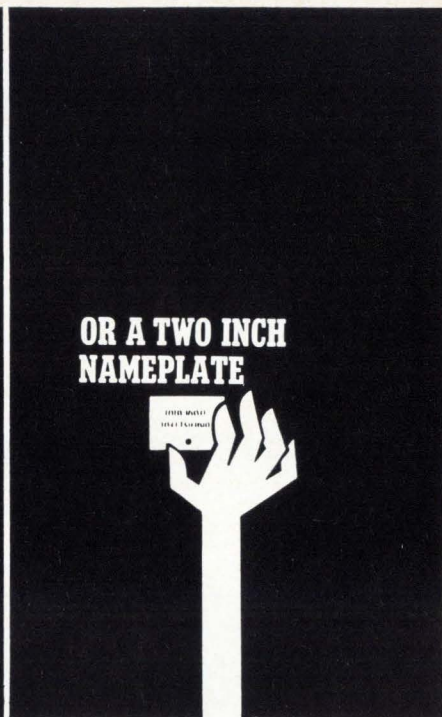

OR A TWO INCH
NAMEPLATE



The New Hermes Engravograph is a highly versatile pantographic engraving machine. Anyone in your plant can operate it—with big savings. Write for 24 page catalog to Dept. 156.



new hermes engraving machine corp.

20 Cooper Square, New York, N.Y. 10003 • Chicago, Atlanta, Los Angeles, Dallas, Montreal, Toronto, Mexico City

Circle 308 on reader service card

MEDIUM POWER SERVO REPEATER 893A/GT-879A

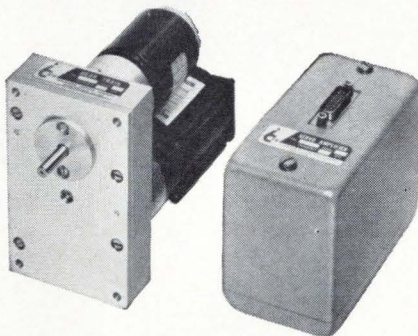

- Follows 60 cps, 3 wire synchro data
- 100 rpm max., 350 oz./in. stall torque
- 10 watts shaft output
- Requires only 117v, 60 cps

A light-weight servo system for medium power loads with precision gearing and solid state electronics. For heavy duty industrial and military applications.

WRITE FOR OUR GENERAL CATALOG describing our complete line of Servo Systems, Servo Amplifiers and Servo Testers.

INDUSTRIAL CONTROL COMPANY
CENTRAL AVENUE AT PINELAWN FARMINGDALE, L. I., N. Y. 516-694-3000

NORTON Magnetic Tape Heads



SERIES 4500

Crosstalk—50 DB
+75°C Temperature Operation

Send now for complete technical literature.

NORTON

ASSOCIATES, INC.

10 Di Tomas Court, Copiague, N.Y. 11726
Phone: 516 598-1600

HOW

To Solve YOUR Semiconductor Encapsulation Problems

HYSOL has more answers than anyone in the business.

HYSOL's HYFLO® epoxy molding powders have solved the problems of transfer molding encapsulation of a wide range of semiconductors, from simple to the most sophisticated.

New HYSOL liquid epoxy systems, compatible with almost every type of semiconductor, open new doors for casting or potting for short or long runs and extremely delicate items.

We have devoted thousands of laboratory man hours finding answers to the kind of encapsulation problems you may be facing right now. Our laboratories are ready to tackle new problems, as technology progresses, just as we have done in the past for scores of leading electronic component manufacturers.

For application engineering help, write, wire or phone HYSOL today. For technical data on standard semiconductor encapsulation products, ask for bulletins E-258, E-259 and E-500.

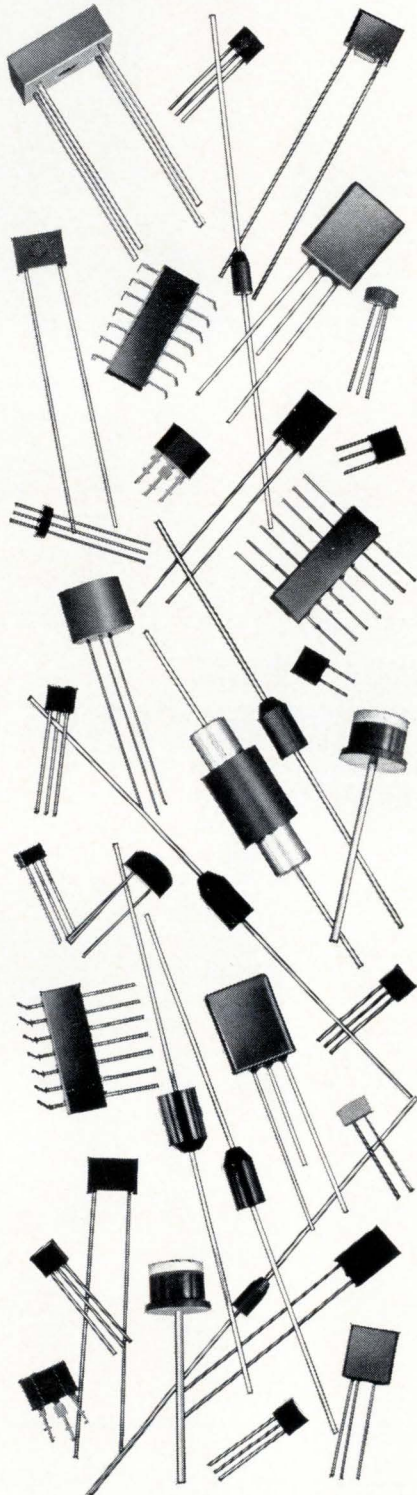

New Microwave

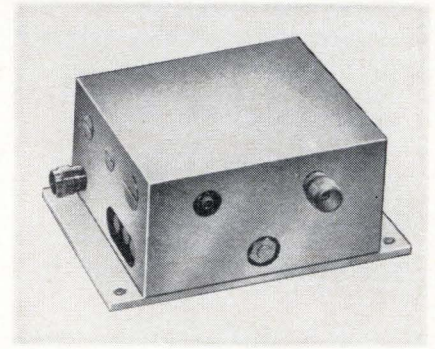

(Resonatron 3802-1300) which delivers 5 watts at 1.03 Ghz from a 25-watt input.

Higher multiplication ratios are available from the manufacturer with electrical and mechanical requirements to customer specifications.

Trak Microwave Corp., Tampa, Fla. [396]

An 8-ounce klystron delivers 10 watts

Two-cavity klystron oscillators featuring stability and long life are available for use as fixed-frequency, X-band power sources in low-noise c-w navigators and parametric amplifiers. Specified c-w output levels from 1 to 10 watts are supplied at any specified frequency between 8.2 and 12.4 Ghz. Maximum dimensions of this 8-ounce tube are 1.2 x 1.650 x 3 in.

Each tube-model VA-536 is factory tuned and adjusted for optimum operation into a matched load. The desired power output determines the beam voltage, which is established at the factory.

Typical beam voltage for 2-w output is 750 v d-c; for 14-w output, 1,250 v d-c. For the same outputs, typical beam currents are 45 and 95 ma d-c; typical temperature coefficients, 30 and 40 khz/°C; typical beam voltage modulation coefficients, 130 and 65 khz/v; heater voltage, 6.3 v; and typical heater current, 0.75 amp.

Leads are molded to the tube to permit high-altitude operation without pressurization.

Varian Tube Division, 611 Hansen Way, Palo Alto, Calif., 94303. [397]

PROGRESSIVE PRODUCTS

HYSOL HYSOL CORPORATION • OLEAN, NEW YORK
THRU CHEMICAL RESEARCH Los Angeles, California/Hysol (Canada) Ltd., Ontario/London, England



Charge Amplifier **TRIPLETS!**

HIGH PERFORMANCE . . .

DCS Model GCA-1 Charge Amplifier with VCO and Galvo outputs . . . Built-in calibration.



WITH EXTRA FUNCTIONS...

DCS Model GCA-2 Charge Amplifier with servo control output and front panel meter.

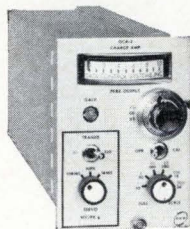

FOR MULTI-FUNCTION PIEZOELECTRIC TRANSDUCER SIGNAL CONDITIONING . . .

DCS Model GOC-5 Charge Amplifier/VCO combination. Compact for portable and field use.



AND... They're omniplugable

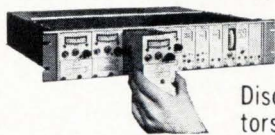

with DCS VCO's, Millivolt Oscillators, Low Level Amplifiers, Line Amplifiers, Discriminators, Crystal Oscillators, Translators, signal conditioning, calibrators, and magnetic tape recording equipment.

INTERESTED? Call our office nearest you for information and data bulletins on DCS Charge Amplifiers.

Or write directly to:

Dept. E 4-7, Data-Control Systems, Inc.
East Liberty Street, Danbury, Connecticut 06813
Telephone: 203-743-9241 TWX 744-1999



DATA-CONTROL SYSTEMS INC.
Instrumentation for Research

Sales Offices
Silver Spring, Md., Huntsville, Winter Park, Long Beach, Santa Clara,
Albuquerque
Copenhagen London Rome Paris Munich Amsterdam

Why are JFD Piston Trimmers used in Saturn Apollo Gemini Minuteman?

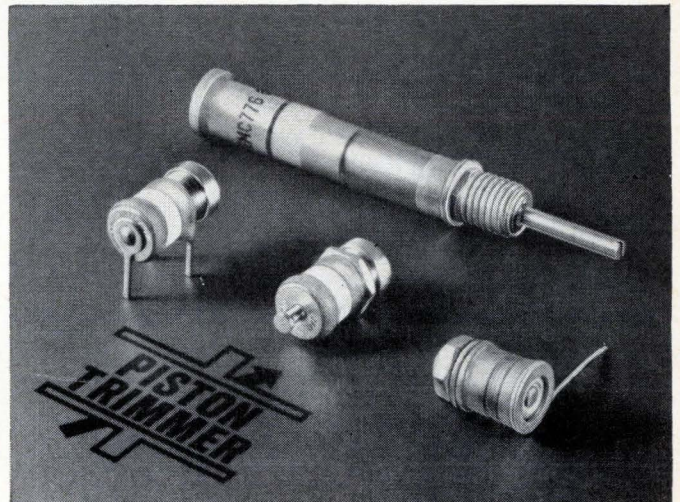

Capacitors shown enlarged 25%

JFD offers industry's largest selection of piston trimmer capacitors . . . over 3000 standard and special designs.

Choice of six dielectric materials.

Matched metalizing processes for homogeneous bonds.

Seven drive mechanisms engineered for greatest tuning linearity without reversals and for the ultimate in repeatability.

Among the panel-mount and printed-circuit piston capacitors offered by JFD are miniature telescopic types, three series of extremely high capacitance piston trimmers or tuners, inexpensive standard panel-mount piston capacitors, units for high-voltage applications, ultra-miniature trimmers, low-cost direct-traverse piston trimmers, differential and split-stator trimmers, and variable temperature-coefficient trimmers.

Write for catalog C-66.



"TODAY'S COMPONENTS BUILT FOR TOMORROW'S CHALLENGES"

JFD ELECTRONICS CO. / COMPONENTS DIVISION 15th Avenue at 62nd Street
Brooklyn, N. Y. 11219 / Phone 212-331-1000 • Sales Offices—Arcadia, Calif.
Chi., Ill. / Balt., Md. / Saxonville, Mass. / Bklyn., N. Y. / New Hartford, N. Y.
Cinn., Ohio / Phila., Pa. / Pitts., Pa. / Paris, France / Azor, Israel

INDUSTRIAL OPPORTUNITIES IN
MISSOURI

**ELECTRONIC
COMPONENTS
&
ELECTRICAL
MACHINERY**



Arthur D. Little, Inc.

**WRITE,
WIRE
OR PHONE
FOR THIS**

FREE

ARTHUR D. LITTLE REPORT

This free study by Arthur D. Little, Inc., presents an analysis of the Electronic Components and Electrical Machinery Industry. It reports on business structure, consumption, employment trends, location and market aspects, marketing opportunities, industry forecast, and equipment suppliers. Here's the fastest, most efficient way to determine whether Missouri industrial opportunities fit your growth needs. Just attach the coupon to your letterhead for your free copy.



**KEEP
MISSOURI
IN THE CENTER OF YOUR THINKING**

Mr. Henry C. Maddox, Director
Missouri Division of Commerce and
Industrial Development
Jefferson Building, Dept. E-4-7
Jefferson City, Mo. 65101
Phone 314-636-5133

Please send me a copy of the Elec-
tronic Components and Electrical
Machinery Report.

NAME _____ TITLE _____

COMPANY _____

STREET _____

CITY _____ STATE _____

New Production Equipment

Tetrode sputters purer thin films



tered atoms at 0.2 micron is 30 centimeters, while the distance between the target and the substrate is approximately 10 centimeters. Few of the sputtered atoms will collide with argon atoms in going from the target to the substrate. More material is deposited and less gas is trapped in the film.

A radio-frequency power supply will be available for dielectric deposition. Price of the sputtering system is about \$15,000. Availability is 8 to 10 weeks.

National Research Corp., 160 Charle-
mont St., Newton, Mass. 02161 [401]

**Machine fractures
semiconductor wafers**

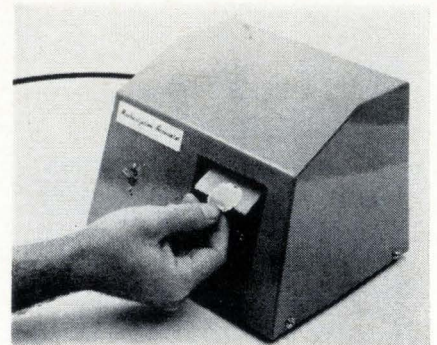

Semiconductor wafers are diced by an automatic wafer-fracturing machine after they've been scribed.

The machine is simple to operate. A wafer is first spray-coated on its reverse side with an air-drying emulsion to hold it together after fracturing; waxing it to a thin carrier sheet is an alternative method. The wafer is then inserted between a soft rubber endless belt on its upper, scribed, side and a flexible Teflon coated piece of clock spring steel on its bottom.

The wafer travels along the preset curvature of the flexible steel and is fractured as it passes over the bend radius. It emerges within three seconds fractured in one direction. It's rotated 90 degrees, and the process is repeated.

The model 1180 has a capacity of

A tetrode sputtering system deposits metal or dielectric films 1,000 angstroms thick in one minute. Film purity is higher, too, than in triode and diode sputterers, the National Research Corp. (NRC) reports. NRC is a subsidiary of the Norton Co. The tetrode configuration requires about one-tenth the normal pressure of gas in the vacuum chamber, resulting in fewer collisions between atoms of the gas and the sputtered material.

The tetrode configuration in the NRC 3197 system consists of an electron gun with two filaments (one is a backup), a source-material target, an anode, and an auxiliary anode or grid near the gun. The grid helps focus the beam.

A grid bias slightly less positive than the anode potential stabilizes electron injection and the voltage drop across the plasma (ionized sputtering gas, usually argon). This allows a higher target voltage, and more efficient use of ions from the plasma. Therefore, gas pressure can be lowered or deposition rates raised at the normal pressure. Sputtering pressures are 0.2 to 0.5 micron, compared with 1 to 10 microns in triode systems.

The mean free path of the sput-

The Material of Unlimited Uses...

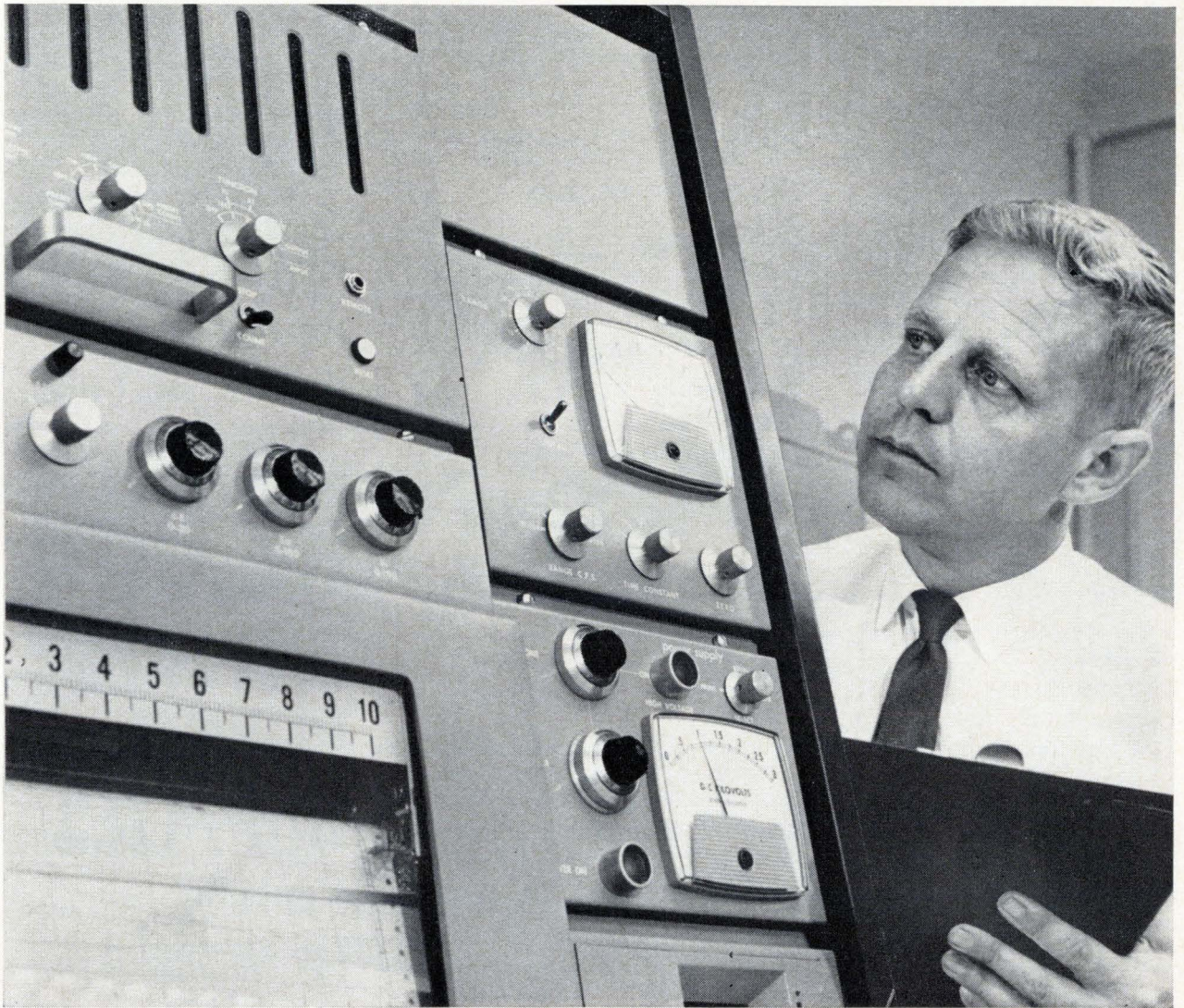

PICTURE YOUR VERY OWN ALLOY

We can. Down to the last quantitative detail, with this new X-ray emission spectrometer . . . and we're the only low-melting-point alloy producer to have one! You might have expected this, since we pioneered these alloys. Part of a complete analytical facility at our new bismuth alloy plant in Springdale, Conn., this fast-readout device is in continuous use for quality control, for identifying and analyzing raw materials, and for tailoring custom alloys to your every requirement. Call Cerro for straight talk and real action on fusible link, workholding, die-casting, dip molding and similar applications.

Whether you need a standard low-melting-temperature alloy or eutectic, an established "special" alloy, or one that hasn't yet been produced, come to Cerro with your end-use specs. In bismuth alloys, as in basic materials, Cerro means leadership.

For detailed information contact Cerro Sales Corporation, 300 Park Avenue, New York, N. Y. 10022 . . . R. Darnell (203) 327-0550

CERRO®

For Specific Plant Site Data, Complete and return this ad

(It's a coupon.)

Our staff of industrial development engineers will perform confidential plant site research on the Upper Texas-Louisiana Gulf Coast for you. Just check the subjects of most interest to you. We'll do the rest. All work and correspondence is held in strictest confidence, of course.

I want more information on:

- Taxes
- Labor Supply
- Transportation
- Electricity
- Natural Gas
- Water Supply
- Construction Costs
- Climate
- Available Plant Sites
- Cultural Facilities
- _____
- _____

Community size interested in _____

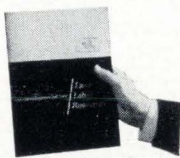

Send me your new, comprehensive, full-color brochure, "Upper Texas-Louisiana Gulf Coast—Land, Labor, Resources."

NAME _____
 TITLE _____
 COMPANY _____
 ADDRESS _____
 CITY _____ STATE _____ ZIP _____

Mail to:
 L. V. Dugas, Vice President
 GULF STATES UTILITIES COMPANY
 Department E-2
 Lock Drawer 2951
 Beaumont, Texas 77704



Production Equipment

300 to 500 wafers an hour, and is priced at \$325.

Mechanization Associates, 2622 Frontage Road, Mountain View, Calif. 94040 [402]

Photo resist spinner develops film, too

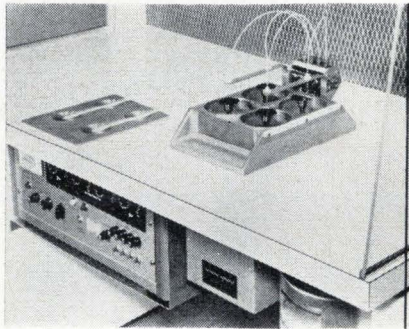

A machine that coats semiconductor wafers and IC substrates with photosensitive films can be programmed for use as a developer following the exposure of the photosensitive film.

According to the manufacturer, this is the first spinner on the market that enables loading of multiple spinner heads, rinsing of all wafers prior to resist coating, and applying the photo resist coating, each a simultaneous and automatic operation. The spinner also enables a selective programming for automatic developing of the pattern images following exposure.

Modular design permits expanding machine capacity in units of four spinner heads (4, 8, 12) for different production requirements. Each assembly of four spinner heads has a separate fluid drain/fume exhaust system which is kept clean by the automatic rinse cycle.

The spinner heads are independently driven by d-c servo motors with high acceleration. Electronic closed-loop feedback from each motor assures accurate speed control. Automatic dynamic braking prevents coasting at the end of the spin cycle.

Due to the machine's automatic features, one operator could handle the entire output of any current semiconductor production laboratory, the company says.

Headway Research Inc., 3713 Forest Lane, Garland, Texas 75040. [403]



Please send me the latest Acopian catalog that lists

62,000 DIFFERENT POWER SUPPLIES

available for shipment in 3 days.

Name _____

Title _____

Company _____

Address _____

City _____

State _____

ZIP _____

ACOPIAN CORP.
 EASTON, PENNSYLVANIA
 TEL: (215) 258-5441



NEW EFFICIENCY FOR ULTRASONIC TRANSDUCERS

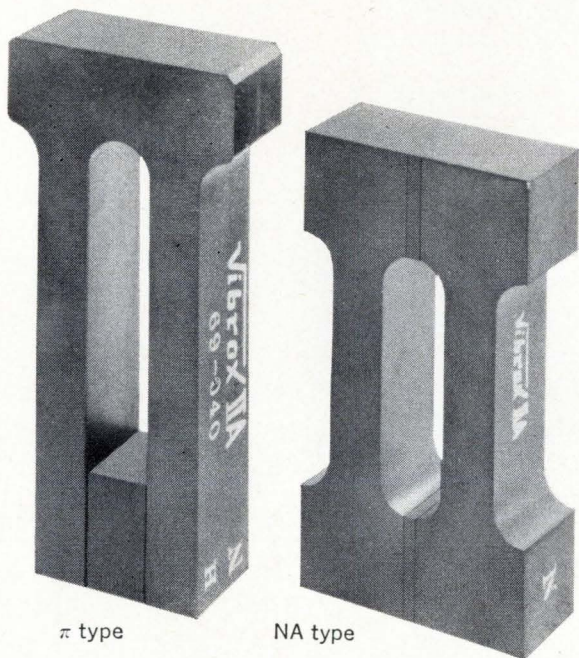

π type

NA type

Now, adding new efficiency to ultrasonic propagation, Tohoku Metal introduces VIBROX—unique *ferrite* magnetostrictive vibrators. Developed by Dr. Yoshimitsu Kikuchi of Tohoku University, VIBROX has minimum eddy current loss and a far greater electro-mechanical transduction efficiency than conventional vibrators. A wide range of application embraces ultrasonic cleaning and degreasing; metal, textile, and chemical processing; and echo-sounding and navigation devices such as depth-sounder, fish-finders, etc.

Tohoku VIBROX is supplied in two shape-types with nominal frequencies ranging from 15 to 100Kc. Termed NA and π respectively, both make use of associated permanent magnets to totally eliminate the need for DC bias — despite the fact that VIBROX is magnetostrictive.

For further information and brochures, write to:

Tohoku Metal Industries, Ltd.

7-4, GINZA-HIGASHI, CHUO-KU, TOKYO, JAPAN
Telephone: Tokyo (542) 6171 Cable Address: TOHOKUMETAL TOKYO

Lighted Pushbutton Switches

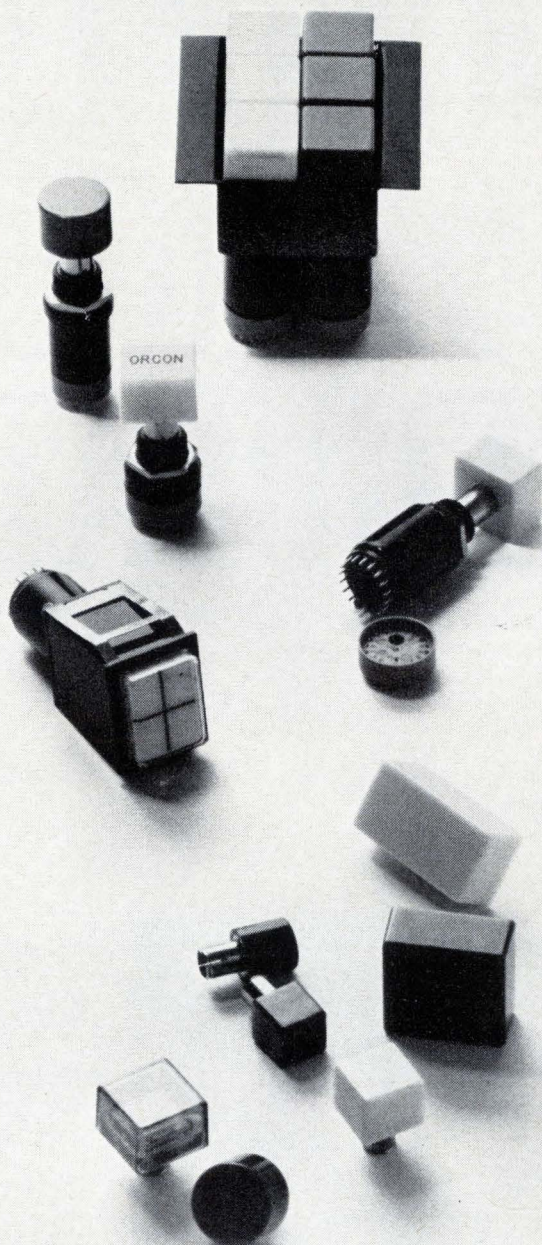

USECO offers greatest capacities, smallest sizes.

USECO'S ORCON switches combine exclusive multi-circuit capacity, isolated contacts, sliding-wiping action, independent light circuit and connector convenience in $\frac{3}{4}$ " and $\frac{11}{16}$ " diameter sizes. Standard and custom available. Plus indicator lights, ganged assemblies, multi-light units, adapters and accessories. For brochure, contact USECO, 13536 Saticoy Street, Van Nuys, Calif. 91409. (213) 873-3520.



Division of Litton Industries



MONOLITHIC VOLTAGE REGULATOR

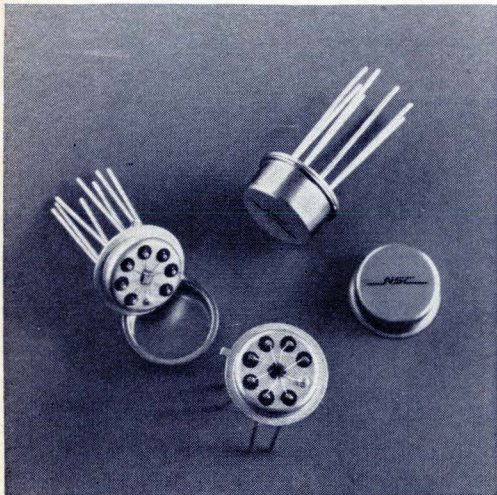

- Output adjustable from 2V to 30V.
- Output currents in excess of 5A using external power transistors.
- Can be used as either a linear or a high-efficiency switching regulator.

Visit us at the
Paris Electronics Show
Booth P104
and see new WSC devices
plus our broad product line.

The first of a new line of monolithic linear integrated circuits

This versatile regulator features regulation better than 1 percent for widely varying load and line conditions. Temperature stability is better than 1 percent over the full military temperature range. As a linear regulator, the LM100 provides current limiting, excellent transient response

and unconditional stability with any combination of resistive or reactive loads. As a switching regulator the circuit will operate at frequencies up to 100KHZ with efficiencies better than 85 percent.

The LM100 is immediately available from distributor stock.

NSC
MICROCIRCUITS DIVISION
NATIONAL SEMICONDUCTOR CORPORATION
2950 SAN YSIDRO WAY, SANTA CLARA
CALIFORNIA 95051 (408) 245-4320

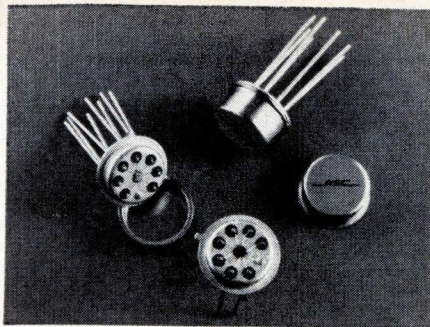

Available from your

NSC
distributor

EASTERN DISTRIBUTORS:

Arco Electronics Inc.
Community Drive
Great Neck, New York 11020
(516) 487-0500

R & D Electronics
71 Pearl Street
Cambridge, Massachusetts
(617) 868-6644 or 868-6645

State Electronic Parts
Corporation
36 Route 10
Hanover, New Jersey
(201) 887-2250

Herbach & Rademan, Inc.
1204 Arch Street
Philadelphia, Pa. 19107
(215) 567-4309

Connecticut Industrial
Electronics, Inc.
854 Main Street
Stamford, Connecticut 06902
(203) 325-3591

Gulf Semiconductors, Inc.
7495 N.W. 48th Street
Miami, Florida 33166
(305) 887-6541

Valley Electronics, Inc.
8809 Satyr Hill Road
Baltimore, Maryland 21234
(301) 668-4900

L. L. Schley, Inc.
108 Water Street
Watertown, Massachusetts
(617) 926-0235

Milgray Electronics, Inc.
160 Varick Street
New York, New York 10013
(212) 989-1600

Peerless Radio Corporation
19 Wilbur Street
Lynbrook, L. I., New York
(516) LY 3-2121

Summit Distributors, Inc.
916 Main Street
Buffalo, New York 14202
(716) 884-3450

New Materials

All-purpose prepreg bonds circuit layers

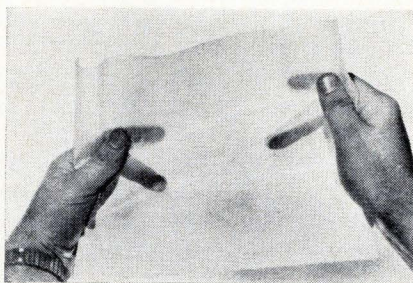

Multilayer printed circuit boards can be improved with a high bonding epoxy glass prepreg material, a woven fiberglass cloth that has been impregnated with a modified epoxy resin that was developed by the company. This epoxy resin system produces a strong bond to most smooth, untreated metal foil surfaces. Surfaces of copper, nickel, Kovar R, aluminum, and

steel require no special preparation, after degreasing. The prepreg is specifically designed for bonding to both the shiny and the dull sides of copper foil in multi-layer applications.

The material has been heat treated to bring it to a controlled polymerization level for maximum stability and high-bond, low-flow properties. Bonds of more than 10 lbs per inch are developed on internal ground planes and logic circuit planes. The bond strengths are attained with very little motion of the resin and, therefore, the material is suited for applications that require almost no flow.

In addition to high bonds, NELCO 3260 provides heat resistance and electrical insulation as well as the spacing needed to separate the discrete planes. It provides enough bulk and resin to fill the spaces between the copper areas. New England Laminates Co., 481 Canal St., Stamford, Conn. [406]

Semiconductor-grade silicon tetrachloride

Production quantities of silicon tetrachloride—a clear, nonflammable, low-boiling liquid—are available for use in the manufacture of epitaxial silicon wafers. This high-purity material enables device manufacturers to make uncompensated epitaxial depositions with consistent control of resistivity at levels above 50 ohm-cm, n-type. The silicon tetrachloride can also be doped with either n-type or p-type carriers to meet certain resistivity specifications.

To assure the highest possible levels of purity, rigid quality control measures are taken in the manufacture of the liquid, according to the producer. A sample of each lot is reacted to produce two polycrystalline silicon rods, which are then zone refined in one and 10 passes. The resistivity of the one-pass and 10-pass rods must be greater than 200 n-type and 2,000 p-type, respectively, if the lot is to be accepted.

The silicon tetrachloride is shipped in 9-liter Pyrex bottles with a 2-in. flange at the mouth; each bottle holds about 24 lbs. Dow Corning Corp., Midland, Mich. [407]

Thermosetting coating with acrylic base

A new thermosetting acrylic-base coating for electronic applications promises excellent resistance to chemical solvents, humidity, and salt spray.

Called HumiSeal type 1F30, it is recommended for high temperature use on components or p-c board assemblies. It has a maximum temperature rating of 320°F, but can withstand temperatures as high as 360°F on an intermittent basis. Electrical properties include a dielectric strength of 2,500 volts per mil and a dielectric constant of 2.7.

The coating doesn't require mixing, and can be applied by dipping, brushing or spraying. Columbia Technical Corp., Woodside, N.Y. 11377. [408]

"IF YOU DESIGN OR USE
INTEGRATED CIRCUITS...

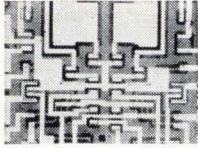

...DON'T MISS ARINC'S INTENSIVE
TRAINING PROGRAM."

4-DAY INTEGRAL ELECTRONICS COURSE

Plan to attend ARINC Research Corporation's highly acclaimed course designed to keep engineers and managers up-to-date on new developments in IE technology . . . presented four times in 1967:

CHICAGO	MAY 16-19
ORLANDO	JUNE 5-8
SEATTLE	SEPTEMBER 18-21
TORONTO	OCTOBER 16-19

With course instruction based on the comprehensive Motorola integrated circuits text and ARINC's own continuing study of more than 80 users and manufacturers, this Integral Electronics Course has become the standard of the industry.

The four-day course encompasses . . . Semiconductor Physics, Circuit Processing and Advanced IC Components, Parasitic Effect, Circuit Design Techniques, Hybrid Techniques, Packaging, Computer Analysis, Circuit Layout, LSI, Specifications, Reliability and Testing, Economics, System Applications, and more.

Send for complete course curriculum and registration information today. *Make your reservations now!*

TRAINING DIRECTORS: Inquire about our on-site training programs in integral electronics and systems effectiveness.

ARINC

RESEARCH CORPORATION

CLIP & MAIL TODAY FOR COMPLETE DETAILS...

To: Donald C. Rowe
Manager, Educational Programs
ARINC Research Corporation
2551 Riva Road
Annapolis, Maryland 21401

Name _____

Company _____

Street _____

City _____ State _____ Zip _____

New Books

Broadband tracking

Frequency Independent Antennas
Victor H. Rumsey
Academic Press, 150 pp., \$7.50

Frequency-independent antennas were first built successfully about a decade ago and have since found numerous applications in both military and civilian installations. The subject is of great interest to systems and antenna designers, and this volume, the first comprehensive summation of the theoretical and experimental work in this field, should be welcomed by them.

With a frequency-independent antenna, the radiation pattern and impedance remain almost unchanged with changes in frequency over a span of many octaves. The shape needed is one that can be defined with angles (which are expressed as ratios of distances) rather than lengths. In theory, such an antenna of infinite length could cover all frequencies from zero to infinity; in practice, the antenna must be truncated at a finite point and will therefore be able to cover only a limited, but relatively broad, bandwidth.

Rumsey, one of the pioneers in frequency-independent antenna design, introduces his topic with three chapters on basic concepts. He follows up with specific products of these concepts—the log-periodic antenna and the equiangular spiral, a special case of a log-periodic antenna—giving both detailed design information and data from which the reader may deduce the current states of development. The relationship between log-periodic and periodic structures has proven an extremely good basis for evaluating the suitability of specific geometries, and Rumsey describes this relationship in detail.

Although most frequency-independent structures haven't as yet succumbed to rigorous mathematical solution, some basic shapes have been thoroughly analyzed. As examples, Rumsey presents solutions to Maxwell's equations for idealized spiral and sinusoidal structures. These mathematical models lay the theoretical foundations for understanding the radiation mechanisms of equiangular

spiral and log-periodic antennas and their dependence on the design parameters.

Rumsey's monograph fills several needs. To the systems engineer, it will give an understanding of the principles and capabilities of frequency-independent antennas. To the antenna designer, it will serve as both a design manual and a useful reference. Most of the book could be understood by a beginning graduate student, but the chapters on solutions of Maxwell's equations require a somewhat deeper understanding of electromagnetic theory.

John J. Stangel

Sperry Gyroscope Division
Sperry Rand Corp.,
Great Neck, N.Y.

Two in one

Transform and State Variable Methods
in Linear Systems
Someshwar C. Gupta
John Wiley & Sons Inc., 425 pp., \$12.50

The idea of combining transform methods and state variables in a single book is a good one. However, though the concept is admirable, the author does not provide enough continuity between subjects and ends up with a book which is essentially divided into two parts. Gupta, an associate professor at Arizona State University, provides a working, rather than a rigorous, understanding of the subjects and includes many excellent examples to illustrate the theories. He has, however, omitted several topics, making the book's usefulness as a reference doubtful. If a second edition including the missing topics were prepared, the volume would be both a good text and a reference.

In addition to its suitability as a text for a senior level or first-grade graduate course, the book could also serve as an introduction for the practicing engineer. Most of the necessary mathematics are explained within the text, and the basic principles of complex variables are provided in an appendix. Solutions are given to the problems which follow each chapter, making the book useful for self-study.

The first part covers the delta

4-6 WEEKS DELIVERY

in Production Quantities or Prototypes

Netic & Co-Netic Magnetic Shields

Fabricated to your exact specifications in any size or configuration. Two typical applications shown. 2-3 weeks delivery on special order.

Permanently effective Netic and Co-Netic are the recognized world standard for dependable shielding. About 80% of all magnetic shield designs in use originated here. Netic and Co-Netic are insensitive to ordinary shock, have minimal retentivity, never require periodic annealing. Total quality is controlled during manufacture. Design assistance gladly given.



Photomultiplier & CRT Shields



MAGNETIC SHIELD DIVISION

Perfection Mica Company

1322 N. ELSTON AVENUE, CHICAGO, ILLINOIS 60622

ORIGINATORS OF PERMANENTLY EFFECTIVE NETIC CO-NETIC MAGNETIC SHIELDING

Circle 297 on reader service card

FREE TECHNICAL MICA MANUAL K-6

gives electrical and physical data on all types of mica

No tooling cost on numerous fabricated parts of natural and built-up mica.

Pre-punched insulating wafers to electrically isolate transistors, diodes, etc. from heat sinks.

Corrugated mica to reduce handling and fabrication costs for thermal elements.

All grades of mica offered.

Immediate delivery from stock on many items.

PERFECTION MICA CO.

1322 No. Elston Ave.

Chicago, Illinois 60622

Phone: 312, EV 4-2122

Circle 298 on reader service card

CARBON COMPOSITION AND WIRE-WOUND POTENTIOMETERS

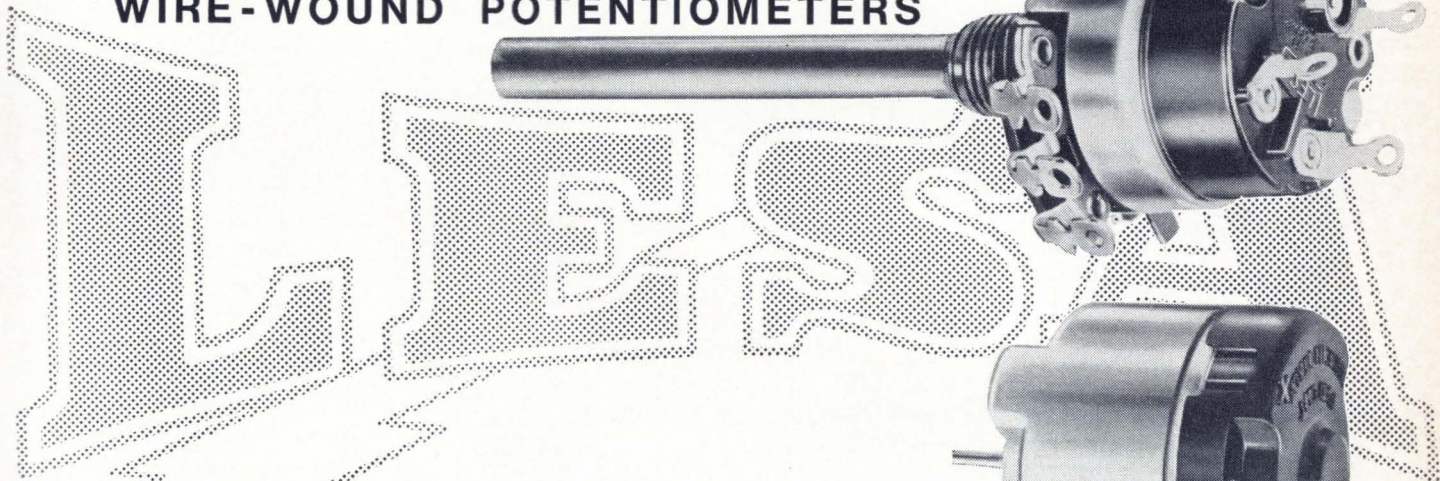

FRACTIONAL HP ELECTRIC MOTORS

AC. AND D.C. OPERATED, WITH OR WITHOUT SPEED REGULATOR



OF AMERICA CORP, 521 FIFTH AVENUE, NEW YORK, N.Y. 10017, TEL. 212 697.5838
 COSTRUZIONI ELETTROMECCANICHE S.p.A., VIA BERGAMO, 21, MILANO, ITALY
 DEUTSCHLAND GMBH, 1 WIESENTALSTRASSE, FREIBURG I/Br. WEST-GERMANY
 ELECTRA, S.A., VIALE PORTONE 27, BELLINZONA, SWITZERLAND
 FRANCE S.A.R.L., 19 RUE DUHAMEL, LYON, FRANCE



Instruments for the world of precision measurement

OPTO-METRIC offers the most complete line of advanced optical instruments for precision linear and angular measurement.

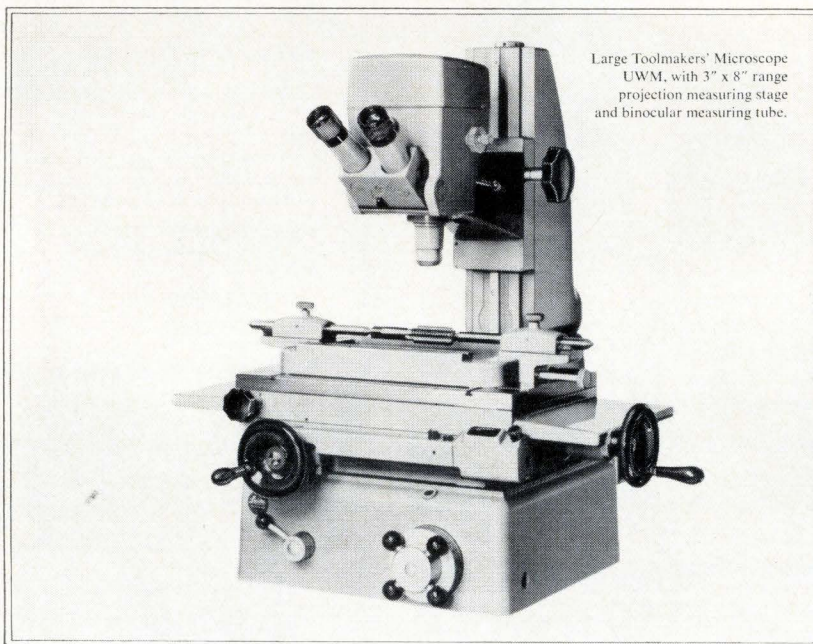

Large Toolmakers' Microscope UWM, with 3" x 8" range projection measuring stage and binocular measuring tube.

universal measuring machines that are truly universal

Leitz Toolmakers' Microscopes are available in a large variety of sizes and models, and with an extensive selection of flexible accessories. A wide choice of optics, reticles, stages and illuminations enables these versatile instruments to adapt to your every metrological problem. Measuring ranges of available stages extend from 1" x 1" up to 8" x 40"; readings from .00010" to .000020".

The full line of Toolmakers' Microscopes offers the incomparable Leitz *intermediate image system*, providing

unequaled convenience and maintained accuracy through every change in magnification. This system is unique with Leitz, and must be experienced to be fully appreciated. And the well-known Leitz craftsmanship is evident in the superior lens systems, precision machinery and flawless performance of each modular unit.

We would welcome the opportunity to help with your measurement problems. Whether for R & D or production control, Opto-Metric has an instrument to meet your exacting needs. Write for an OPTO-METRIC Catalog, c/o Technical Service Division, Dept. AM5.

OPTO-METRIC TOOLS, INC. 
A SUBSIDIARY OF E. LEITZ, INC., 304 HUDSON ST., N.Y., N.Y. 10013

Circle 236 on reader service card

To order reprints: Fill in, cut out coupon below, insert in envelope and mail to: Electronics Reprint Dept., 330 W. 42nd Street, New York, N.Y. 10036

Reprint order form

For listing of reprints available see the Reader Service Card.

Computer-aided Design: Part I, The Man-machine Merger.

Send me reprints of Key no. R-01 at \$1.25 each.

For reprints of previous special reports fill in below:

Send me reprints of Key No.(s) @ ¢ each.

(For prices, see Reader Service Card)

Name

Number of street

City, State, Zip code

New Books

function, convolution operations and the Laplace, the Z, the modified Z, and the zeta transforms and their applications. Curiously, the Fourier transform isn't included, and this leads, in a few instances, to slight deviations from the most generally used engineering approaches. For example, the author develops the Laplace transform inversion formula by relying on the delta function instead of extending the Fourier transform pair.

The discussion of stability is incomplete. The author merely presents, without proving, the Routh-Hurwitz and Lienard-Chipart criteria, and ignores both the Nyquist and the Bode criteria.

The sampling theorem is developed only as an application of Z transform theory; a comparison with Fourier methods would have been enlightening here.

A lucid discussion of state variable methods, including stability, leads off the second half of the book. This portion is useful for both review and reference purposes. The discussion of optimal time control and time-varying systems are only introductions, however. An examination of the Floquet theory in the treatment of time-varying system would have been helpful.

Irwin Share

Hofstra University
Hempstead, N.Y.

Basic digistry

Introduction to Digital Electronics

Arthur W. Lo

Addison-Wesley Publishing Co., 233 pp.
\$10.75

Expanding applications for low-cost digital integrated circuits are forcing almost every electronics engineer to "digitalize" his thinking to some degree. For example, digital IC's are making inroads even in the unlikely field of r-f signal sources; the most recent r-f frequency synthesizer is more than 70% integrated. A tyro in this field could well start his scrambling for practical information with this book.

Lo, one of the authors of an earlier transistor text, "Transistor Elec-

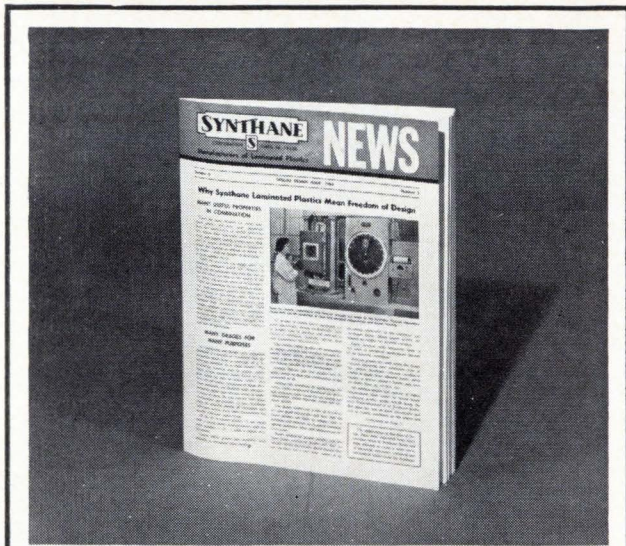

Free . . . tells how laminated plastics are used by designers in over 25 mechanical, electrical, electronic and chemical applications. An excellent guide for the man who is curious to know how laminated plastics can also help him. Write Synthane Corporation, 36 River Road, Oaks, Pa. 19456 for your copy of the Special Design Issue of Synthane News.



Laminated Plastic Sheets, Rods, Tubes and Fabricated Parts

Circle 299 on reader service card



Highest-quality copper-clad laminates for multi-layer printed circuits

Laminated plastics for multi-layer printed circuits have to be a special breed—very thin, made to exacting tolerances, uniform, free of voids and pinholes, suitable for etching and all soldering operations.

Synthane Thin Laminated grades G-10 and FR-4 are highest-quality fabric epoxy laminates. All produced under exacting clean room conditions. Write for leaflet. Synthane Corporation 36 River Road, 666-5011 (Area Code 215).



Laminated Plastic Sheets, Rods, Tubes and Fabricated Parts

Circle 300 on reader service card

DIGITEC® single range d c MILLIVOLTMETER

0.1%
full
scale
accuracy

6 standard
single range
models:

- Model 401, 100 MV
- Model 402, 200 MV
- Model 404, 400 MV
- Model 451, 10 MV
- Model 452, 20 MV
- Model 454, 40 MV

From \$430

Stocking Representatives
Throughout the World



Model 401 (shown)

- 100.0 MV
- 2% Calibrated over range
- 0.05% Full scale linearity
- AC Rejection 50DB @ 60 Hz
- Options Available include BCD Output, Auto Polarity, Retransmitting Pot
- Delivery: stock to 6 wks.

DIGITEC®

by UNITED SYSTEMS CORPORATION

918 Woodley Road

Dayton, Ohio 45403

IF YOU CAN'T IDENTIFY THIS

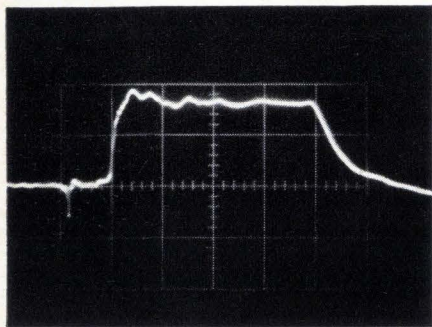

IT'S NO WONDER,

because you've probably never seen fiducial marks generated this way before.

HOW COULD YOU?

We used the TRW Model 46A Trigger Delay Generator, just coming on the market. It's brand new, with some inherited virtues of its predecessor, TRW Model 2A—**nanosecond accuracy**, high power trigger to override random noise, clear digital display, selectable triggering threshold—**plus plug-in capability** so you buy exactly the triggering input you need, exactly the sensitivity and spectral range your application calls for.

ASK US FOR A TECHNICAL DATA BULLETIN AND APPLICATION NOTES

giving the characteristics of the TRW Model 46A and the plug-ins, and illustrating how you can use the TRW Trigger Delay Generator, as we did, to generate fiducial marks, to measure delay lines, calibrate oscilloscopes, and trigger the TRW Image Converter Camera or countless other laboratory instruments.

TRW INSTRUMENTS

139 Illinois Street, El Segundo, California
AC 213, 679-9101 Extension 22884.

Dept. E-367

Developers and manufacturers of state of the art diagnostic instruments for basic and applied research.

New Books

tronics" (with Endres, Jawels, Waldhauer and Cheng), discusses all the basic switching devices, from transistors through cryoelectric, optoelectronic, and magnetic-logic equipment, and presents just enough information on each to give the reader at least an understanding of the fundamentals.

If you know a little about digital electronics, it's a book worth having on your shelf. A long list of references at the end of each chapter further enhances the book's value.

Recently published

Antenna Theory and Design, Vol. 2: The Electrical Design of Antennae, H. Paul Williams, Sir Isaac Pitman & Sons, 795 pp., \$14.70

In this combination textbook-handbook are real design examples compiled from technical journals. Relevant design parameters are given for antennas ranging from the long wave to the microwave bands. This is the second, revised edition of a 1950 book, with the subject of noise the most drastically revised and expanded topic.

Broadcast Antenna Systems Handbook, edited by Verne M. Ray, Tab Books, 158 pp., \$7.95

Starting with the FCC application form, the book details both engineering considerations and Governmental regulations concerning the design and operation of antenna systems for a-m, f-m, and tv stations. The material originally appeared as a series of magazine articles.

Linear Automatic Control Systems with Varying Parameters, A.V. Solodov, American Elsevier Publishing Co., 270 pp., \$15

Translation of a Soviet monograph on the basic theory of linear control systems including block diagram transformations, methods of determining impulse response functions and dynamic errors, and inverse systems.

Digest of Literature on Dielectrics: Vol 29—1965, National Academy of Sciences—National Research Council, Washington, 445 pp., \$20

Abstracts of 1965 journal articles on dielectrics, listed by categories: instrumentation and measurements, molecular and ionic interactions, conduction phenomena, ferroelectric and piezoelectric materials, high polymeric materials, inorganic insulation, and several categories of applications. Also included are tables of dielectric constants, dipole moments, and dielectric relaxation times.

Radioisotope Instruments in Industry and Geophysics, Bibliography Series No. 20, International Publications Inc., 411 pp., \$8.50

Abstracts of published material on the design and applications of radioisotope instruments are listed according to technique and field of application. This International Atomic Energy Agency compilation covers books, journal articles, company and governmental publications, and other bibliographies published between 1960 and 1964.

INTRODUCING

A New Member of
The
Transformer Electronics Co.
Family of
Miniature Regulated

POWER SUPPLIES

THE 6 WATT
9589 SERIES
(23 Models)

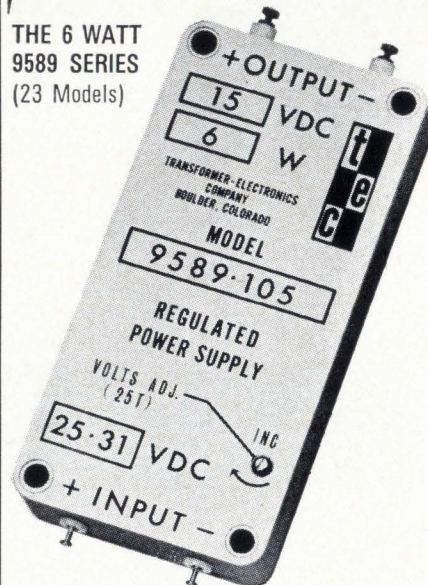

Output Power Capability:	6 watts
Operating Temperature:	-55°C to +100°C
Input Voltage:	25-31vdc
Line Regulation:	0.1%
Load Regulation:	<3% (½ to full load)
Output Ripple:	<0.6% p-p
Efficiency:	>46%
No Load Current:	<75 ma
Voltage Adjustability:	±10%
Volume:	4.3 cu. in. (1.75" x 3.5" x .7")
Weight:	7 oz.
Voltage Range:	5 to 5000vdc;
	±15, ±25, ±50, ±100

Other T. E. C. Power Supplies—**1 WATT**, 9583 Series; **3 WATT**, 9567 Series; **10 WATT**, 9584 Series—Write or Call for complete details.

TRANSFORMER ELECTRONICS COMPANY

BOULDER INDUSTRIAL PARK
BOULDER, COLORADO

TWX 303 443-2561 PHONE (303) 442-3837

POWER SUPPLIES • INVERTERS
CONVERTERS • TRANSFORMERS

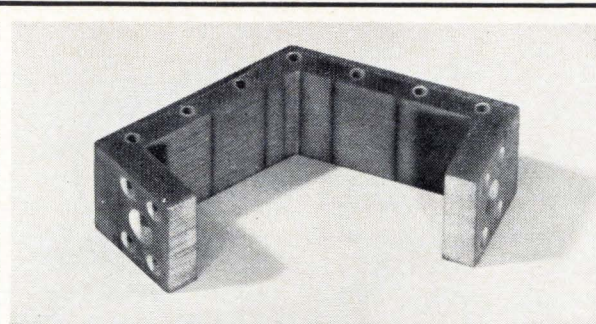

Bracket for electronic switching device—of glass epoxy Synthane.

Try this better way to buy laminated plastics parts

- Single responsibility
- We make the materials—Synthane sheets, rods and tubes
- We have the largest shop in the U.S. for the exclusive fabrication of laminates—much of the equipment specially designed or modified for the purpose
- We have 38 years of experience—all in handling laminated plastics
- We make our own dies, jigs and fixtures—often essential for producing a first-class job
- We relieve you of production problems and our techniques often save you time, material and money
- We're prepared to fabricate 1 or 1,000,000 parts, large, medium or small, simple or complicated

SYNTHANE
CORPORATION **S** OAKS, PA. 19456

Laminated Plastic Sheets, Rods, Tubes and Fabricated Parts

Circle 301 on reader service card

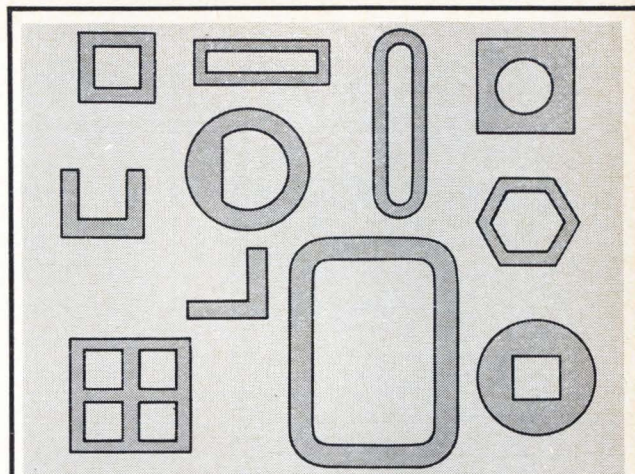

Laminated plastic tube forms with direct-from-mill advantages

Synthane laminated plastic tubes do not have to be round. Synthane produces all the shapes above and many more—to your order—in phenolic, melamine and epoxy grades. Round tubes are available in a wide range of diameters, wall thicknesses and grades from our Instant Stock. Most complete laminated plastics fabrication facilities in the U. S. Contact Synthane Corporation, 36 River Road, Oaks, Pa. 19456.

SYNTHANE
CORPORATION **S** OAKS, PA. 19456

Laminated Plastic Sheets, Rods, Tubes and Fabricated Parts

Circle 302 on reader service card

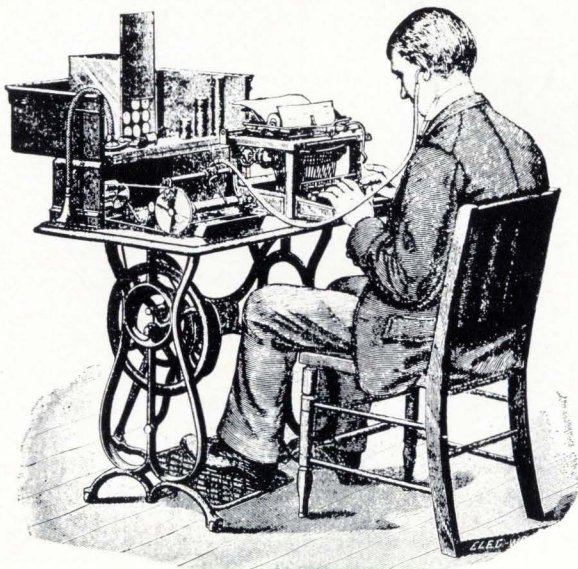

JUST DICTATE...

FEDERATED DELIVERS!

MOST COMPLETE ACROSS THE
BOARD INVENTORY OF

IOR INTERNATIONAL

RECTIFIER SEMICONDUCTORS

FEDERATED PURCHASER INC.

Your broadline distributor for whatever you need . . . whenever you need it! There's a Federated warehouse close to you.

SPRINGFIELD, NEW JERSEY.....	155 U.S. Route 22 (201) 376-8900
SHREWSBURY, NEW JERSEY.....	483 Broad Street (201) 741-8811
ALLENTOWN, PENNSYLVANIA.....	936 Union Boulevard (215) 437-4481
SILVER SPRING, MARYLAND.....	1310 Apple Avenue (301) 588-6830
LOS ANGELES, CALIFORNIA	11820 W. Olympic Blvd. (213) 477-8274 (213) 272-8771

ELECTRICAL DISTRIBUTOR: JOSEPH KURZON, INC. 112 West 31st St., New York, N. Y. 10001



COMPUTER TALK

by W. Henry du Pont, President

SCI-TEK

COMPUTER CENTER, INC.



TO THE MAN WHO THINKS HE NEEDS A COMPUTER and feels that the investment is more than he can afford now.

SCI-TEK has the answer for you with our SATELLITE SYSTEM. We supply you with the hardware you require and a direct data line to our large scale 1107 computer in Wilmington.

The cost is low because you share the 1107 with other clients of SCI-TEK and yet you have the convenience of a complete computer center right in your office.

Does the SCI-TEK SATELLITE SYSTEM require highly skilled technical people at my installation? The answer is no. The SCI-TEK SATELLITE SYSTEM'S extremely simple to operate. It does not require any programming, and only minimal additional programming of the SCI-TEK COMPUTER is needed. By merely referring to a brief instruction book, your personnel will be able to properly operate it in a few hours.

Will the SCI-TEK SATELLITE SYSTEM work with engineering and scientific problems? The SCI-TEK SATELLITE SYSTEM was developed to fill a need for this service. Programs in COBOL, FORTRAN, ALGOL or other source language can be written locally and quickly transmitted to SCI-TEK for compilation. Almost immediately the results are returned to your facility, saving you valuable time between your need and the response.

For detailed information on the SCI-TEK SATELLITE SYSTEM, contact us today. No obligation, of course.

SCI-TEK

COMPUTER CENTER, INC.

1707 GILPIN AVENUE

WILMINGTON, DELAWARE 19806

Phone: (302) 652-3967

Technical Abstracts

Logically versatile

An integrated threshold gate
J.J. Amodei; R.O. Winder, D. Hampel
and T. R. Mayhew
Radio Corp. of America, Princeton,
N.J., New York and Camden, N.J.

Threshold gates now appear much more practical than they have in the past because they can be built as integrated circuits, whose elements are inherently more uniform than discrete components. A threshold gate is a logic gate whose output depends on some combination of the inputs, or other than all (AND) or any one (OR). Some of the inputs may be weighted more heavily than the others.

Two such threshold gates have been designed and fabricated, and both are packaged in a single 14-lead flatpack. One is a simple majority gate with three inputs and true and complement outputs. The true output is up when any two of the three inputs are up. The other gate has five inputs, two with a weight of 2 and three with a weight of 1 and true and complemented outputs. The total input weight is 7; the true output is up when inputs with a weight of 4 or more are up, in any combination.

By properly interconnecting the pins on the flatpack, the single package can represent a full binary adder, a complete register stage, or any of a large number of other logic functions, at considerably less cost than with conventional AND/OR/NOT or NAND/NOR logic, and with substantially better noise margin. The circuit delay is 11 nanoseconds worst-case and 5 to 6 nsec average.

Presented at the International Solid State Circuits Conference, Philadelphia, Feb. 15-17.

High fidelity IC

A high performance 3-watt monolithic Class-B power amplifier
T.M. Frederiksen and J.E. Solomon
Motorola Semiconductor Products
Division, Phoenix, Ariz.

Designed specifically to keep costs down, an all-silicon monolithic audio amplifier has been fabricated that performs as well as a high-quality high fidelity amplifier built with discrete components.

The Class-B circuit can deliver 3 watts of sine wave power to a direct-coupled load, with less than 0.3% of total harmonic distortion over a frequency range of 20 hz to 20 khz. Using conventional all-diffused process technology, the amplifier occupies a single 45 by 60 mil chip.

All the active devices on the chip are npn types. The output stage is a variation of the diode-coupled totem-pole amplifier. This configuration is particularly well-suited to integration because it requires no output transformer or complementary output transistors.

Operation of the output stage relies upon the diode coupling circuitry to activate only the upper or lower output transistor of the totem pole for the positive or negative swing, respectively. Quiescent current in the output transistors is held to zero because the design introduces a dead band at the output, the range of which is equivalent to the voltage drop across one diode. With feedback, the effective dead band is greatly reduced and results in very little output distortion, even at lower levels.

Stability with variation in temperature and d-c condition is good, enhanced by a differential input amplifier with symmetrical bias circuitry and a unity gain d-c feedback loop.

Typical characteristics when operating from ± 12 volt supplies with a 16-ohm load include a standby current drain of 16 ma, input impedance of 10 kilohms and output impedance of 0.2 ohm, voltage gain of 10 decibels and gain stability within ± 0.5 db from -55°C to $+125^\circ\text{C}$.

Presented at the International Solid-State Circuits Conference, Philadelphia, Feb. 15-17, 1967.

SOS with numbers

Silicon-on-sapphire complementary MOS memory systems
J.F. Allison, J. R. Burns, and
F.P. Heiman
RCA Laboratories, Princeton, N.J.

The advantages of complementary metal-oxide semiconductor devices have been combined with those of silicon-on-sapphire fabrication

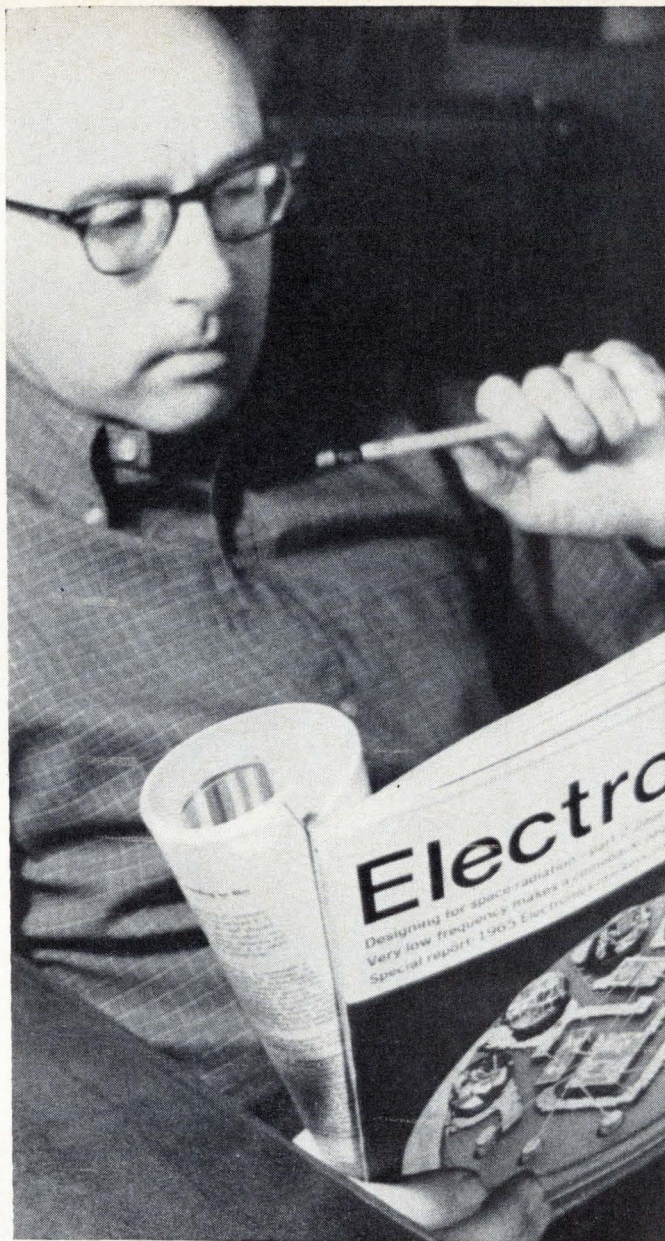

Great editorial is something he takes home

(What a climate for selling!)

Electronics

A McGraw-Hill Market-Directed Publication
330 West 42nd Street, New York, N.Y. 10036

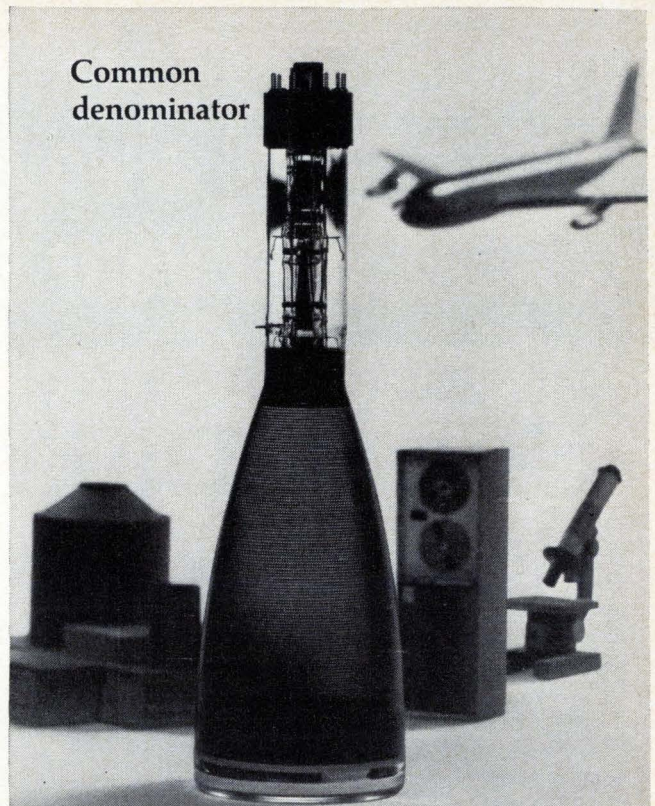

Common
denominator

What's a CRT got to do with Planes, Power Plants, Punch Tape and Physiology...? Plenty!

Planes need a CRT with resistance to extreme shock, severe vibration and high altitudes.

For Power Plants—the Atomic kind—a 5-inch tube with helical resistance winding to insure a smooth voltage gradient is needed.

Punch Tape Computer Systems call for a 19-inch model with an aluminized screen for increased light output.

Physiological studies demand a CRT able to display four phenomena simultaneously.

FTC builds them all. Tomorrow our ever-growing list of industrial applications may include CRT's to help make peanuts, parachutes, petticoats—or your product. Write today for the complete **FTC** capability story.

GENERAL
ATRONICS®
**GENERAL
ATRONICS**
ELECTRONIC TUBE DIVISION
PHILADELPHIA • PENNSYLVANIA 19118
Cable: ATRONIC

(Sales representative areas available in U.S. and abroad.)

**EMPLOYEES
WANTED!**

INQUIRE INSIDE

Is this sign
always on
your door?

GET RID OF IT IN

South Dakota

INDUSTRY is finding a new and untapped personnel pool in SOUTH DAKOTA where a day's work for a day's pay is still a way of life. Alert, eager, trainable people with a literacy rate of 98.5 per cent . . . absenteeism is among the nation's lowest. You get into production fast and you maintain high quality standards when you have this kind of labor supply. Let us show you how SOUTH DAKOTA can fill your needs — and keep them filled.

- Free Port Law
- Abundant Water
- Available Power
- Low Corporate Tax Rates

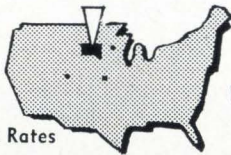

GET THE SOUTH DAKOTA STORY
CONTACT:

ROBERT H. MARTIN, DIRECTOR
Industrial Development Expansion Agency
Room 401 Pierre, South Dakota 57501
Phone 224-5911 Extension 307 AC 605

Circle 285 on reader service card

Technical Abstracts

techniques to produce memories that dissipate very little power when quiescent, permit loose tolerances on device parameters, operate at high speeds, and retain the necessary isolation between n-type and p-type transistors. The total read-write time of one of the memory cells is 6 nanoseconds, compared with 50 nanoseconds or more for a similar circuit in bulk silicon.

In conventional mos technology, a suitable pattern of p-type material is deposited on an n-type bulk silicon substrate (or n on p); an insulating layer of silicon oxide is deposited over the p-regions; and strips of metal are laid down over the oxide, making contact with the p-regions through holes in the oxide. Although the mos technique has distinct advantages over conventional bipolar technology, the switching speed is limited when only one type of transistor is used, and complementary devices require isolation.

In sos technology, a thin film of single-crystal silicon is grown on a substrate of aluminum oxide (sapphire), whose crystal structure is similar to that of silicon. From that point, sos technology is the same as mos. However, because the layer of silicon is so thin—about a micron (1/25,000th inch)—capacitance between the drain and the source is reduced from 2 to 0.02 picofarad.

A memory cell is made of four complementary pairs of mos transistors and two n-type transistors for output gates, following an earlier design. Nine of these cells were laid down in a 3-by-3 array on a single chip 80 by 80 mils, with interconnections that made the array effectively a single 9-bit word.

Presented at the International Solid-State Circuits Conference, Philadelphia, Feb. 16.

Microwave IC's

Miniature integrated-hybrid harmonic generators for microwave frequencies
M. Gilden
Microwave Associates Inc.
Burlington, Mass.

One of the major advantages of the hybrid approach to microwave integrated circuits is the flexibility it offers in circuit design. Flexibility is particularly important with harmonic generators, which use non-

Telrex

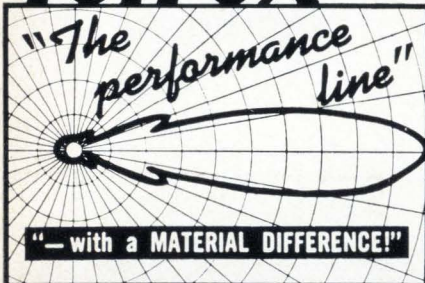

Telrex Communication Engineering Laboratories provides the Most Technically-Perfected, Finest Communication Arrays — Precision Engineered, Manufactured, Tuned, Matched, Calibrated and "Balun" Fed for "Balanced-Pattern" and Maximum S.N Ratio.

**Telrex "Beamed-Power"
"Balanced-Pattern"**

ANTENNAS AND ANTENNA SYSTEMS

The Standard of Comparison, and the Choice of the Discriminating, Successful, Communication Engineer.

Telrex Antennas and Antenna Systems provide Optimum Performance and Reliability per element, per dollar, from 500 Kc to 1500 Mc.

Send for free Military, Commercial Tech Catalog CMS67, illustrating Antennas and Systems, Rotator-Selsyn-Indicator Systems, "Baluns," Towers, Masts and Accessories.

COMMUNICATION **telrex** LABORATORIES
Engineering
SYSTEMS SINCE 1921
ASBURY PARK, N.J. 07712, U.S.A.



actual size
Model A1-21

Mite-size miniature 7/16" indicator

These tiny indicators are compact, rugged, versatile and easy to read. They feature a microminiature moving coil core magnet mechanism. A1-21 Indicators operate in -55°C to $+85^{\circ}\text{C}$ environments and are sealed against dirt and dust. Choice of pointer or flag display in a wide variety of electrical sensitivities and functions. Size: 7/16" in diameter, 31/32" in length. Weight: 11.5 grams. Write today for complete information.

AMMON

AMMON INSTRUMENTS, INC.
345 Kelley Street, Manchester, N.H. 03105

Low Prices and Stock Delivery DC to 60 Cycle Power Inverters!

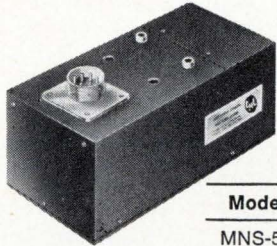

The CML Series MNS provide low distortion sine wave outputs at 115 V rms with power ratings of 50 VA to 2 KVA, input of 22-30 volts DC.

Model	Output VA	Price
MNS-50	50	\$ 370
MNS-100	100	395
MNS-500	500	870
MNS-1000	1000	1,525
MNS-2000	2000	2,700

- Frequency regulation of 0.5%
- Overload & Short Circuit Protection
- Protected Against Input Polarity Reversal
- High Efficiency

Write today for Bulletin DA-65



CML, Inc.

A Subsidiary of Tenney Engineering, Inc.
350 Leland Avenue • Plainfield, New Jersey
Telephone (201) 754-5502 • TWX: 201-756-2064

Circle 287 on reader service card

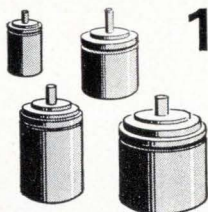

1001 uses for STEPPER MOTORS

Because their output is in discrete increments, Cedar stepper motors have many advantages over conventional motors for precise positioning applications. They are bi-directional and have high torque output. They can be run at high stepping rates or as slow as you wish. Because shaft rotation is incremental, damping is not required.

Some of the applications for which stepper motors have been used are: replace motor-tachometers in servo systems, control missile ailerons, shutter control on high-speed cameras, open loop positioner in checkout systems, high-speed counter in such applications as rapid firing weapons, replace ultra low-speed dc motors, incremental tape handlers, and digital-to-analog and analog-to-digital conversion equipment.

The uses for stepper motors are as unlimited as your imagination. New applications are constantly being discovered. What new use will you next make of stepper motors? Let us know about your ideas; we'll be happy to work with you.

Cedar Stepper Motors are available in sizes 5, 8, 11 and 15 in both permanent magnet and variable reluctance types, and with a wide variety of stepping angles. All meet the full requirements of MIL-E-5272. For free booklets on stepper motor application ideas, write or call:

CEDAR
ENGINEERING DIVISION

CONTROL DATA
CORPORATION

5806 West 36th Street, Minneapolis 16, Minnesota. Phone 929-1681

Circle 243 on reader service card

FIVE GUESSES...

WHAT ARE THEY?

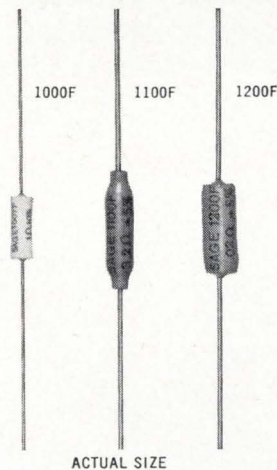

ACTUAL SIZE

CAPACITORS?
DIODES?
INDUCTORS?
RESISTORS?
FUSES?

If you said resistors you'd be right of course. And if you said fuses you'd be right again.

That's right, FUSIBLE RESISTORS.*

This new adaptation of miniature power resistors comes from SAGE ELECTRONICS, a leading producer of standard silicone and custom designed wirewound resistors.

As the name implies, SAGE type F units are special, dual-function resistors... custom-made, typically in fractional or very low ohm values.

*PAT. PENDING

HERE'S THEIR DUAL FUNCTION...

1. Act as long-life, highly stable, fixed resistors up to specified current level.
2. Safely and permanently blow circuit open within a specified time interval if critical current level is exceeded.

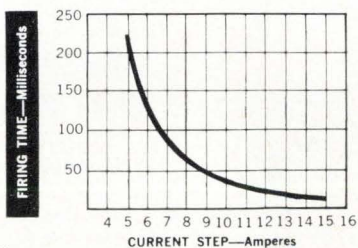

Graph shows representative results on a SAGE 1000F 112 part.

For a prompt analysis of your application, contact us, outlining details of resistance value, fusing time and current.

Or for specifics of environmental performance, body size, etc., write, wire or phone for a copy of Catalog R-66.

SEE OUR SPECIFICATIONS IN
VSMF
THE MICROFILM CATALOG FILE



SAGE

SAGE ELECTRONICS CORP.
BOX 3926 • ROCHESTER, N. Y. 14610

PHONE: 716-586-8010

Ceramic Capacitors

MOLDED CERAMIC TUBULARS

for computer applications. The ultimate in reliability (failure rate 0.001%/1000 hours at 85° C and twice rated voltage.)



DISC CERAMICS

for all commercial and military applications. New production techniques give Skottie a big edge in price, quality and delivery. Ask for a quote and find out if it's not so.

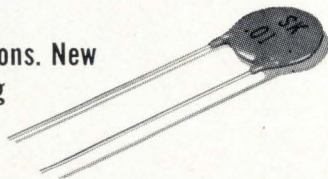

Do you have a problem in ceramic capacitors with special designs, quality, reliability, guaranteed delivery or price? If you do, it might pay you to look into Skottie Electronics. We specialize exclusively in the design and manufacture of ceramic dielectric capacitors. Skottie is a major supplier of ceramic capacitors to the largest computer and radio/TV manufacturers in the world.

Sure we do the military and commercial standards. But in ceramics, when you have special needs (particularly design or delivery) we think you'll find Skottie Electronics your best supplier. Representatives in major cities throughout the United States.

SKOTTIE ELECTRONICS, INC. / Archbald, Pennsylvania 18403
Phone 717-876-1686 TWX-510-656-2979

Circle 288 on reader service card

NOW! APPLY KODAK PHOTO RESISTS this new AEROSOL way



QUICK
CONVENIENT
ECONOMICAL

Three types to suit all your etching needs now available at local industrial photo dealers

TYPE-P containing Kodak KPR* —for copper, copper-clad laminates, other metals. 16 oz. \$5.95

TYPE-M containing Kodak KMER* —for aluminum, stainless steel, titanium, other metals. 16 oz. \$5.95

TYPE-T containing Kodak KTRF* —for high resolution etching of thin films. 16 oz. \$6.95

*KPR, KMER, KTRF are products of Eastman Kodak Co.

INDUSTRIAL CHEMICAL
SPECIALTIES CORPORATION
75 Hillside Rd., Fairfield, Conn.

Please rush me more information on Spray Resist products and, also, name of nearest dealer:

NAME _____

COMPANY _____

CITY _____ STATE _____

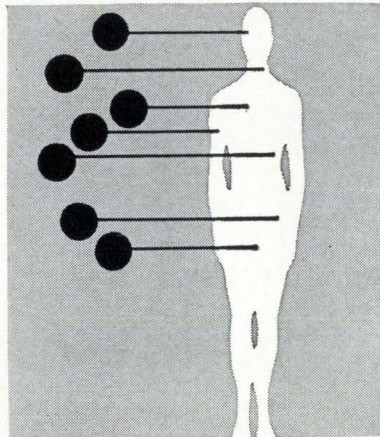

Know the seven danger signals that may mean cancer.

1. Unusual bleeding or discharge.
 2. A lump or thickening in the breast or elsewhere.
 3. A sore that does not heal.
 4. A change in bowel or bladder habits.
 5. Hoarseness or cough.
 6. Indigestion or difficulty in swallowing.
 7. Change in a wart or mole.
- None of these is a sure sign of cancer. But if one lasts more than 2 weeks, see your doctor at once. It's worth it in peace of mind alone.

American Cancer Society

THIS SPACE CONTRIBUTED BY THE PUBLISHER

Technical Abstracts

linear elements such as varactor diodes.

Unpackaged diodes working in a microstrip high dielectric constant substrate, for example, can significantly reduce the size of microwave harmonic generators. A series of X band multipliers were built on substrates only one-half inch square and delivered up to 50 milliwatts continuous wave power and 250 milliwatts peak pulse power. The transistor drivers may also be located on the same substrate.

The microstrip transmission lines were made with etched silver conductors on a 20-mil-thick alumina substrate. Alumina's dielectric constant, 9, allows quarter- and half-wavelength structures to be reduced to one-third the size they would have with air dielectric.

The unpackaged varactor diode was placed on a 50-mil disk which rests on the microstrip pad, and a spring clip contacts the other side of the diode. This affords easy replacement of the diodes during evaluation. The clip also provides inductance for resonating the diode at the X band output frequency.

Additional filtering would be required for most applications. The extra filters can also be built on the substrate, etched out of the silver conductor layer, and might take the form of cavity-coupled half wavelength resonators. Structures of this type were found to have bandwidths of several hundred megacycles at X band and 20 db rejection for adjacent harmonics, but the filter's insertion loss subtracts from the X band output.

Pulse operation was used to establish the upper limits of the output power. A nine-times multiplier provided up to 250 milliwatts with a 30-volt varactor at 9.49 Ghz. A continuous wave, six-times multiplier provided up to 50 milliwatts at the same output frequency.

A completely integrated source was also built on the half-inch square substrate using a Fairchild transistor, type 1038 in a TO-46 package, for the oscillator. This source delivered 5 to 10 milliwatts at 9.5 Ghz with an input of 1.5 watts.

Presented at the International Solid-State Circuits Conference, Philadelphia, Feb. 15-17.

TERMINAL BLOCKS

CURTIS

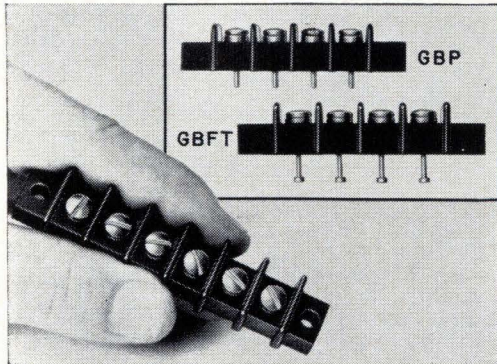

FEED-THRU GB-SERIES

Versatile flat base feed-thru terminal blocks with choice of interior turret-type solder terminals or .062 dia. printed circuit pins. Inserts are bright tin plated for excellent solderability, conductivity, and long shelf life.

Rated — 20 amps, 300 volts.

Available — 1 to 18 terminals, 7/16" center-to-center terminal spacing. #6-32 screw connections accept up to #12 AWG wire.

FREE! Full details, descriptions and prices in new Curtis 24-page illustrated catalog.

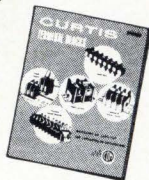

CURTIS DEVELOPMENT & MFG. CO.
3203 N. 33rd St. • Milwaukee, Wis. 53216

Circle 289 on reader service card

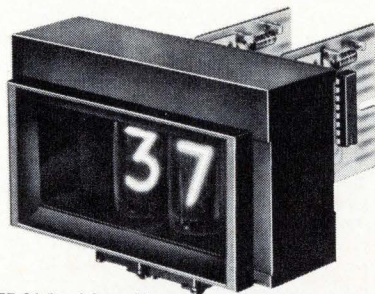
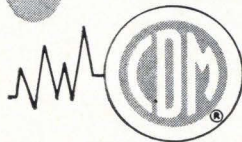

National NL-BEZ-84 Bezel Assembly

TTL IC Drivers for NATIONAL[®] Readout Tubes

From stock: Decoder/Driver, Decimal Counter/Driver and Decimal Counter/Driver with Latching Memory.

■ 15 MHz Counting Rate ■ For all side and end view National readout tubes.

NATIONAL REQUEST BULLETIN

ELECTRONICS, INC.
a varian subsidiary

PHONE: (312) 232-4300 • GENEVA, ILLINOIS 60134

Circle 290 on reader service card

The idea here is economy in Instrumentation Lighting

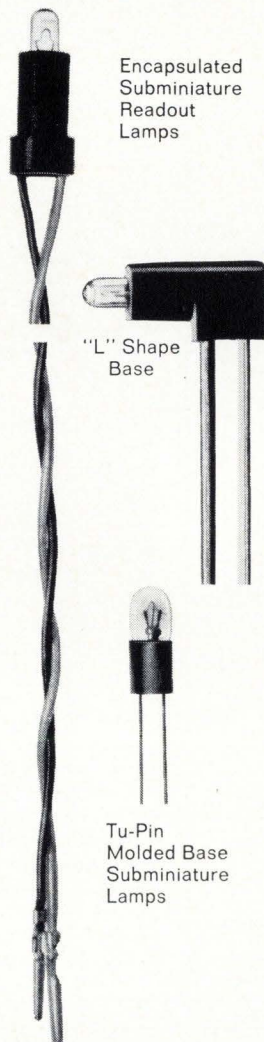
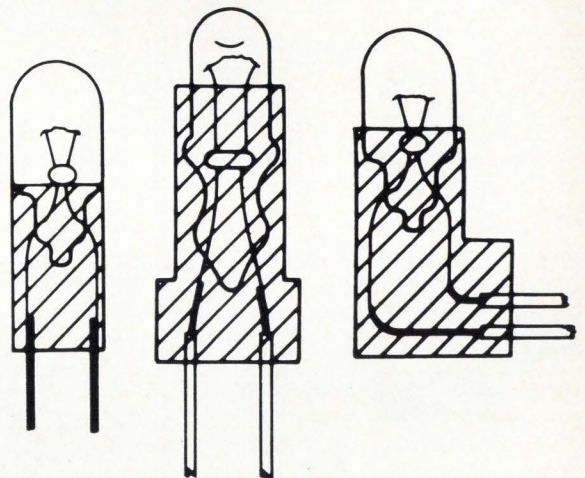

Encapsulated
Subminiature
Readout
Lamps

"L" Shape
Base

Tu-Pin
Molded Base
Subminiature
Lamps

Wherever small bulbs are used for instrument illumination or computer applications, equipment manufacturers will find economy in the Tung-Sol concept. If circuit board type of mounting is practicable, Tung-Sol molded base lamps can provide high reliability with real manufacturing economy. No mounting receptacle is required so you don't have that cost. In addition, the Tung-Sol molded base lamp is more reliable because it completely eliminates the usual cemented-on metal, or plastic, base. Installation is as simple as soldering-in a semiconductor. In fact, the Tung-Sol Tu-Pin lamp can be applied by automated equipment. Tung-Sol can also mold bases to special configurations and can harness to your specifications. Let's discuss your application in the design stage. Chances are we can save you even more on your assembly costs. Try us. Tung-Sol Division, Wagner Electric Corporation, One Summer Ave., Newark, N.J. 07104.

TUNG-SOL[®]
**MOLDED BASE
SUBMINIATURE LAMPS**

Circle 245 on reader service card

DELEVAN Provides The Broadest Range of COILS AND TRANSFORMERS For Today's Design Applications

MICRO i

- Size .100/.150/.250 sq. x .065 h
- Inductance .015 to 1000 uh
- Miniaturized for integrated circuits
- Magnetically Shielded
- Good L and Q Stability with temperature



MOLDED FIXED COILS

- Size — as small as .100 D x .25 L
- L Range .15 to 150,000 uh
- Molded Encapsulation
- Low Cost

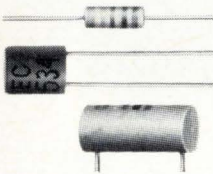

FIXED SHIELDED COILS

- Size — .155 dia. x .375 L
- L Range .10 to 10,000 uh
- Complete Electro-magnetic Shielding
- Transfer Molded Epoxy Encapsulation



MOLDED TUNABLE COILS

- L Range .10 to 70,000 uh
- Tuning Range Approximately 3:1
- Extremely Fine Tuning
- Molded Encapsulation for environmental protection



SHIELDED TUNABLE COILS

- Size .375 x .500
- Range .10 to 10,000 uh
- Stable Q
- Electro-magnetic Shielding
- Ideal for P. C. mounting

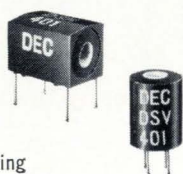

Environmentally proven to conform to MIL-C-15305
Operating temperature range -55 to +125°C
For military and space applications
Manufactured under strict quality control
MIL-Q-9858
Industries largest volume producer

Delevan Electronics Corporation / Division  **AMERICAN PRECISION INDUSTRIES, INC.**

270 QUAKER RD. / EAST AURORA, N.Y. 14052
TELEPHONE 716/652-3600 TELEX 091-293

OTHER DIVISIONS OF AMERICAN PRECISION INDUSTRIES, INC.:
BASCO, INC. • ELECTRO-MECHANICAL PRODUCTS DIVISION

New Literature

Protective coating. Alpha Metals Inc., 56 Water St., Jersey City, N.J. Bulletin 5b-26 describes Sealcoat No. 933, a single component urethane-type system to provide post-soldering environmental protection for p-c boards and other modular electronic work.
Circle [420] on reader service card.

Coil winders. Geo. Stevens Mfg. Co., 6001 N. Keystone Ave., Chicago 60646, has released a two-color, two-page catalog that illustrates and describes two coil-winding machines.
[421]

Solder stripper. MacDermid Inc., Waterbury, Conn., has prepared a usage and instruction sheet on Metex tin-lead remover, a one-step solder stripper designed to give maximum rates for dissolving solder from p-c boards with minimum attack on copper.
[422]

Coaxial cable. Phelps Dodge Electronic Products Corp., 60 Dodge Ave., North Haven, Conn. 06473. A 12-page technical bulletin describes Foamflex, a semiflexible, aluminum sheathed, air-dielectric coaxial cable.
[423]

Carbon dioxide laser. Seed Electronics Corp., 258 East St., Lexington, Mass. 02173, has available an eight-page report "On the significance and use of CO₂ lasers".
[424]

Dielectric strength testers. Associated Research Inc., 3777 W. Belmont Ave., Chicago 60618. Two models of dielectric strength testers for determining high-voltage leakage, insulation breakdowns, and faults of motors, cables, capacitors, and other electronic components are described in bulletin 4-1.8.
[425]

Safety discharge units. Hopkins Engineering Co., P.O. Box 191, San Fernando, Calif. 91341. A brochure called "Elimizap" discusses the prevention of hazardous shock conditions now possible with the use of a line of rfi filter/capacitor discharge safety units.
[426]

Computers for circuit design. Scientific Data Systems, 1649 17th St., Santa Monica, Calif. 90404. Bulletin 64-79-07B describes CIRC, a company-developed computer program to assist in circuit design engineering.
[427]

Woven plated-wire memory. General Precision Inc., Librascope Group, 808 Western Ave., Glendale, Calif. A 16-page illustrated brochure provides technical information on a high-speed magnetic memory that is woven like cloth on a loom.
[428]

Tubeaxial fans. Eastern Air Devices Inc., 385 Central Ave., Dover, N.H. 03820. Specification sheet 303.1 contains

illustrations, performance curves, schematics, and a rating table for a line of 6-inch tubeaxial fans.
[429]

Laser system. TRG, a division of Control Data Corp., Route 110, Melville, N.Y. 11746, has issued an eight-page brochure on the model 300 high-power laser system.
[430]

IC oscillators. Monitor Products Co., 815 Fremont, South Pasadena, Calif. A four-page catalog describes 31 sub-miniature crystal-controlled IC clock oscillators for industrial and aerospace applications.
[431]

Regulated d-c supplies. Borg-Warner Controls, a division of Borg-Warner Corp., 825 Nash St., El Segundo, Calif. 90245, has published a bulletin on MA-type high-current, magnetic transistor-regulated d-c power supplies.
[432]

A-c/d-c converters. Natel Engineering Co., 7129 Gerald Ave., Van Nuys, Calif. 91406, has announced a preliminary specification sheet on a complete line of multirange, low-level a-c-to-d-c converters.
[433]

Transmission measurement. Philco-Ford Corp., Sierra Electronic operation, 3885 Bohannon Drive, Menlo Park, Calif. 94025, has released a 12-page illustrated catalog (TM-125) describing a line of transmission measurement equipment.
[434]

Switching relays. James Electronics Inc., 4050 N. Rockwell St., Chicago 60618, offers engineers a general catalog providing relay and high-speed switching solutions for multiplexing, direct digital control, and data sampling of measurements such as stress-strain, temperature, and pressure.
[435]

Strip-chart recorders. Rustrak Instrument Co., Municipal Airport, Manchester, N.H. 03103. A catalog and price list covers a complete line of miniature strip-chart recorders for current, voltage, power, events, pressure, and temperature.
[436]

Test modules. Honeywell Inc., Computer Control Division, Old Connecticut Path, Framingham, Mass. 01701, offers a brochure on the series 2000 line of 20-Mhz test modules designed for memory testing, telemetry timing, and circuit evaluation.
[437]

Light pen. Information Control Corp., Abacus Division, 1320 E. Franklin St., El Segundo, Calif. 90245. An 11-page application note develops principles for the characterization of light pen sensitivity.
[438]

Video tape life. Ampex Corp., 401

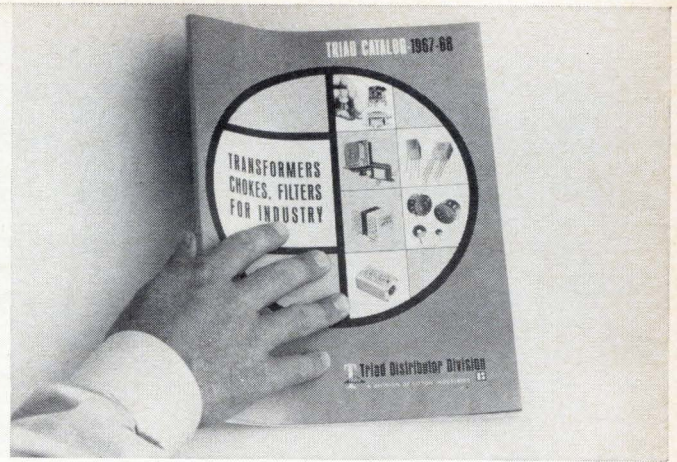
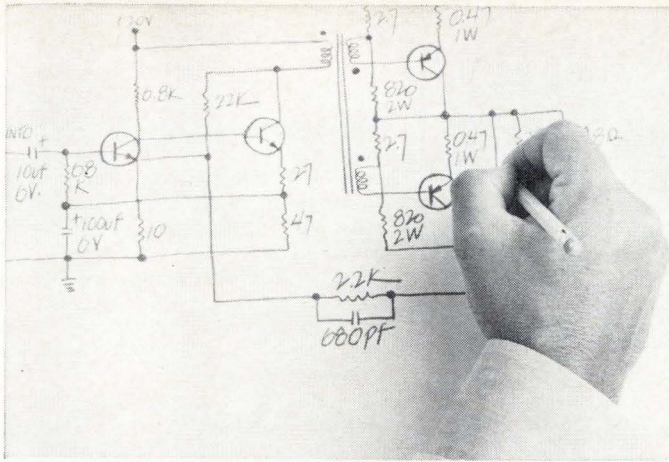

When your design is just an idea, don't specify a special transformer...

Until you've checked your TRIAD catalog.

You'll find more than 1700 transformers ready off-the-shelf for immediate delivery. One may fit your need, cut costly sampling, and get prototypes on their way faster. Try TRIAD first for standard transformers—and custom made items, too. TRIAD has the resources and the skill to solve your transformer, inductor and filter problems. And make your ideas pay off. TRIAD Distributor Division, 305 North Briant St., Huntington, Indiana.

Triad Distributor Division
of **Litton Industries**

Circle 291 on reader service card

Fast, precise, versatile
TERMINAL SETTING with
ELECTROSET

NOW 5 MODELS to choose from!

- Black & Webster's widely used ELECTROSET sets terminals and contacts, automatically or semi-automatically, for faster production, easier operation and fewer rejects. Feed rates up to 70 terminals per minute are attainable.
- Five different models now offer maximum efficiency for setting solder or turret terminals, seamed and seamless pins, flat terminals, wire-wrapped terminals, Teflon®-insulated terminals, and many others.
- Options include air or electrical staking; tube or track feeds. Impacts to 3,500 lbs. or pressures to 800 lbs. with air heads. Light-beam locator assures exact positioning of terminal or contact.
- For complete information, write: Dept. 297

BLACK & WEBSTER, INC.

281 WINTER STREET, WALTHAM, MASSACHUSETTS 02154

Circle 292 on reader service card

3/4" GEARHEAD MOTOR

Now you can get up to 300 oz. in. torque from a precision miniature gearmotor only 3/4" in diameter. Globe's Type SD permanent magnet d.c. motor with integral planetary gearhead provides 19 standard ratios, wound for 4 to 50 volts. Armatures can be wound to produce any speed-torque combination within the capacity of the motor. Can meet environmental and other applicable portions of MIL-M-8609. Request Bulletin SDG.

Speed Reduc. Ratio	Max. Cont. Torque Oz. In.	L	Speed Reduc. Ratio	Max. Cont. Torque Oz. In.	L
14.58	3.0	2 ³ / ₄	733	100	2 ⁵ / ₈
22.08	4.5		1108	150	
33.28	7.0		1853	200	
55.66	10	2 ⁵ / ₈	2799	300	3 ¹ / ₈
84.11	14		4230	300	
127.1	21		6391	300	
192	30	2 ⁵ / ₈	10689	300	3 ¹ / ₄
321	45		16150	300	
485	70		24403	300	
			36873	300	

GLOBE

Globe Industries, Inc., 2275 Stanley Ave.
Dayton, Ohio 45404, Tel.: Area 513 222-3741

24 HOUR delivery on many units

Circle 247 on reader service card

Low-Frequency Spectrum Analyzer

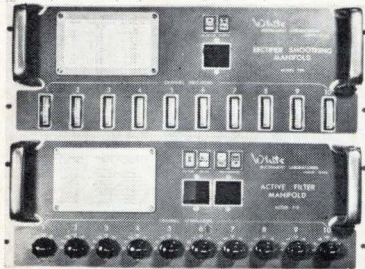

- ★ Infrasonic through audio frequencies
- ★ Continuous coverage from .005 cycle
- ★ Simultaneous ten channel readout
- ★ Operates in real time—no storage, no data acquisition delay

★ MODEL 110 ACTIVE FILTER MANIFOLD PROVIDES 10 PARALLEL FILTER CHANNELS

Convenience of plug-in filters, active or passive. Choice of filter bandwidths: 1 octave, 1/2 octave, 1/3 octave and specials. Gain up to 50 db, calibrated controls, 10 volts rms output. Prewhitening input section option: notch filter, 1/f network, band limiting networks—

★ MODEL 120 RECTIFIER SMOOTHING MANIFOLD PROVIDES 10 RECTIFIED AND FILTERED OUTPUTS

Simultaneous ten channel ac to dc conversion. Choice of low pass filter integrating times. Plug-in subassemblies for full flexibility. Ten channels of high level output to drive recorders or other devices.

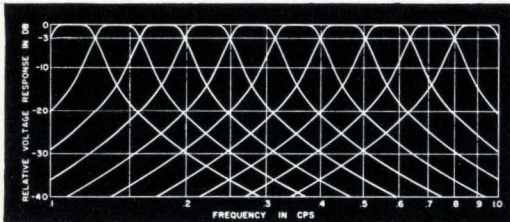

White
INSTRUMENT LABORATORIES,
INCORPORATED

Plant 5500 Balcones Drive • Phone Area 512 GL 3-6621 • Box 9006, Austin, Texas 78756

- ★ Quick deliveries on standard sets. Write for comprehensive literature on low frequency filters, active and passive. Prompt delivery—Moderate prices.

Circle 293 on reader service card

New Literature

Broadway, Redwood City, Calif. 94063. Tips on extending the life of video tape through proper handling and storage are contained in bulletin No. T059. [439]

Isolators and circulators. Raytheon Co., 130 Second Ave., Waltham, Mass., has available a bulletin describing Ku-band isolators and circulators for airborne applications. [440]

Multiple switches. American Zettler Inc., 697 Randolph Ave., Costa Mesa, Calif. 92626, offers a brochure on series T-596 multiple switches of both square and round-button types, either illuminated or nonilluminated. [441]

Teflon tubing. Zeus Industrial Products Inc., 195 Nassau St., Princeton, N.J. 08540, has issued a specification chart on extruded Teflon tubing. [442]

Epoxy coating powders. Armstrong Products Co., Warsaw, Ind. A four-page brochure covers the full line of Vibro-Flo epoxy resin coating powders. [443]

Sinusoidal oscillators. Solid State Electronics Corp., 15321 Rayen St., Sepulveda, Calif. A two-page bulletin discusses the models S-100 and S-200 silicon transistor sinusoidal oscillators, which are epoxy encapsulated units designed to create a sine wave signal source. [444]

Electrolytic capacitors. STM Corp., 2904 Chapman St., Oakland, Calif. 94601. Bulletin FCH-67 provides data on aluminum-foil capacitors that will be useful to designers and others specifying or using electrolytic capacitors for industrial applications. Copies may be obtained by letterhead request.

Operational amplifiers. Fairchild Instrumentation, a division of Fairchild Camera & Instrument Corp., 475 Ellis St., Mountain View, Calif. 94040, has available a six-page catalog describing its complete line of solid state silicon operational amplifiers. [445]

Multiple-device transistors. Motorola Semiconductor Products Inc., Box 955, Phoenix, Ariz. 85001, has prepared a comprehensive selection guide that compares characteristics of 132 different types of silicon annular multiple-device transistors. [446]

Tape recorder/reproducer. Genisco Technology Corp., 18435 Susana Road, Compton, Calif., 90221. Solid state logic control and other advanced design features of a portable magnetic-tape recorder/reproducer are described in data sheet 10-276A. [447]

High-power electronics. Cober Electronics Inc., 7 Gleason Ave., Stamford, Conn. 06902. A 12-page booklet en-



LOOK!

PERFORMANCE ENGINEERING
has been at work on the
BINARY TWO GUN OSCILLOSCOPE

- NEW POWER SUPPLY — Extends tube and component life.
- NEW WEIGHT — only 20 LBS.
- NEW PRICE — only \$795.00.

Write for complete specifications.

We Are Authorized to Up Date
or Repair Your
PACKARD BELL
Model 5Mc-2P Scope



BINARY ELECTRONICS
of California

1429 STATE COLLEGE BLVD.
ANAHEIM, CALIF. 92806 714-772-3070
a division of
Avionic Structures, Inc.

High Reliability Instruments

meguro



MAK-658

Dist. meter

— for AUDIO LABS and PRODUCTION —

FEATURES:

- Efficiency is achieved in measurements by elimination input level and balancing adjustments for each change in the frequency; errors due to personal factors are reduced.
- The null network for the fundamental frequency suppression (patent applied for) has such a characteristic that makes possible the determination of the distortion due to frequency modulation in tape recorders.

• Catalog sheet on request



MEGURO DENPA SOKKI K.K.
(Meguro Electronic Instrument Co., Ltd.)
No. 5, 1-2-chome, Chuo-cho, Meguro-ku, Tokyo, Japan
TEL 711-7191-7 Cable: MEGURODENPA TOKYO

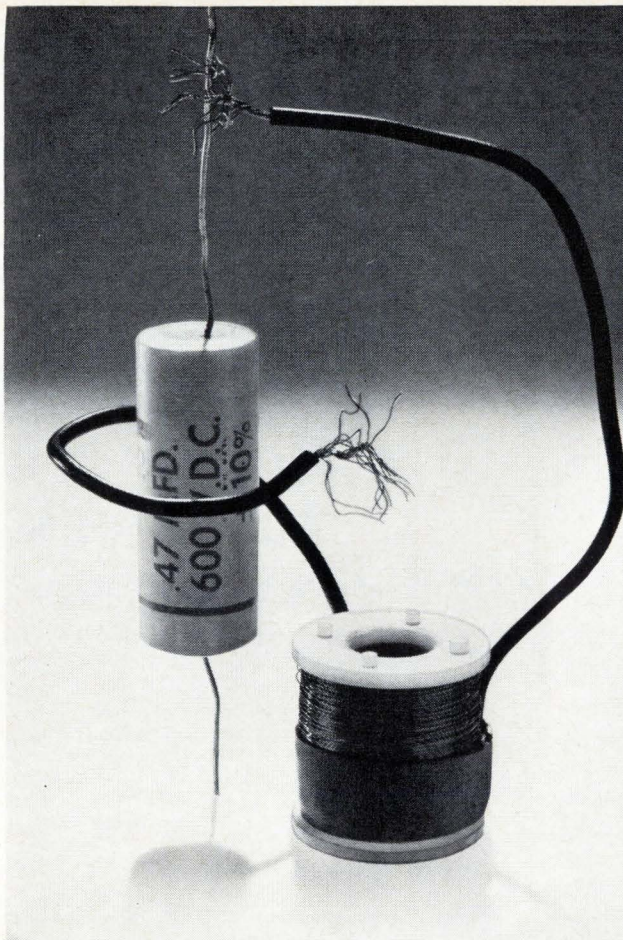

These new heat-shrinkables devour vinyl spec by spec.

Yet cost no more. That's because new Insultite® CP-150 and Insultite SRT are polyolefins. Heat-shrinkable, irradiated polyolefins that provide protection at a polyvinyl price. New CP-150 insulates and encapsulates any subject. And is particularly ideal for commercial, automotive, appliance, and computer applications. From 3/64" to 2" I.D. In black. As for new SRT? This clear, tough, thin-wall polyolefin is perfect for components subject to shock and strain and where visual identification is important. From 3/16" to 2" I.D. Write for free samples today. (Specify diameters, please.)



ELECTRONIZED CHEMICALS CORPORATION

A subsidiary of High Voltage Engineering Corporation
Burlington, Mass. 01803, Area Code 617-272-2850

E.C.C. heat shrinkables are recognized under UL component file E39100.

Circle 295 on reader service card

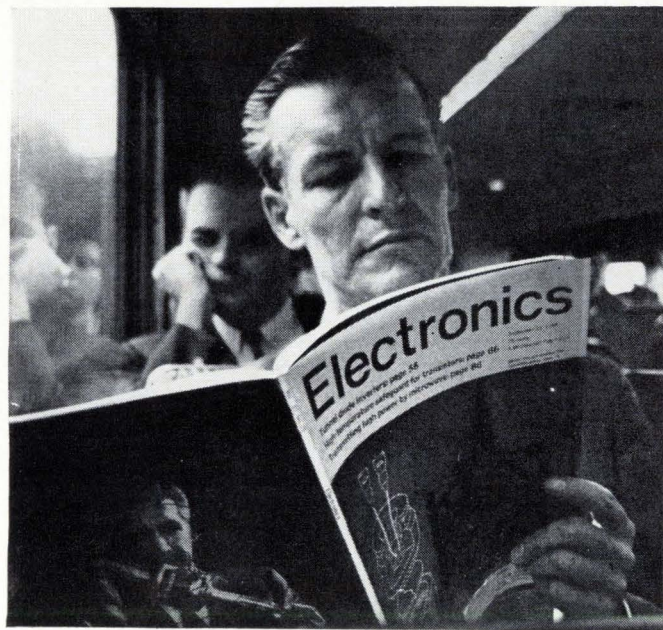

Great editorial is something he takes to work

(What a climate for selling!)

Electronics

A McGraw-Hill Market-Directed Publication
120 West 12th Street, New York, N.Y. 10036



Spectra - Physics

The leading producer of gas laser products

including:

7 He-Ne models 0.1—50 mw
model 140 argon ion 2 w
model 150 CO₂ molec.
laser 100 w

A complete line of laser accessories

Exhibition at *Salon de Physique*

For more information contact

Spectra-Physics S.A.
18, rue Saint-Pierre
P.O. BOX 142
1701 Friborg, Switzerland

Spectra-Physics GmbH
Landkronstrasse 46
61 Darmstadt, Germany

DIMO A99

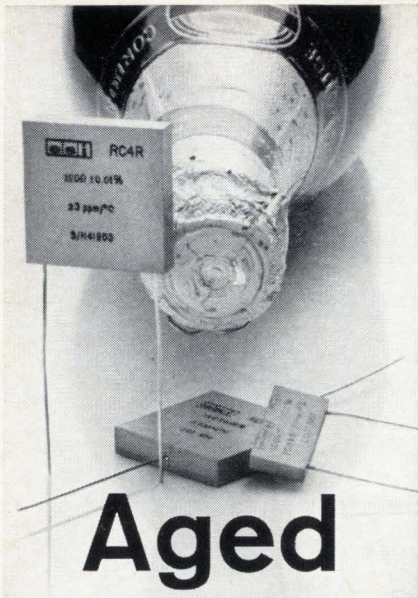

Aged

Our precision resistors are aged to improve reliability, and we guard the process like a vintage champagne maker. Ageing is just one of many extra steps that make our precision components the most reliable you can specify. A few of our components are described briefly below.

1. Precision Wire-Wound Card Resistors

Consider ESI resistors whenever small changes in the resistive element can affect the performance of the final assembly. Initial accuracy to $\pm 0.0015\%$. Yearly stability to ± 10 ppm.

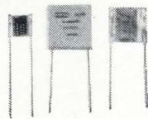

2. Dekastat® Decade Resistors

Designed for use with dc and at audio frequencies, these multi-decade resistors feature an accuracy of $\pm 0.02\%$. All units carry a two-year guarantee.



3. Dekapot® Resistive Voltage Dividers

These rapid-setting potentiometers have a terminal linearity up to 0.002%. Kelvin-Varley circuitry provides constant input impedance.



4. Dekatran Transformer Voltage Divider

The patented coaxial dial is easy to read and adjust. Accuracy of 0.001% and long-term stability are achieved through gapless toroidal cores of very high permeability.



esi

Electro Scientific Industries, Inc.
13900 NW Science Park Drive
Portland, Oregon 97229

New Literature

titled "High-Power Electronics" features products at powers above 5 kw and up to several megawatts. [448]

Argon-ion laser. Beckman Instruments Inc., 2500 Harbor Blvd., Fullerton, Calif. 92634. Bulletin 7109 contains advance product information on a low-power, pulsed argon-ion laser. [449]

Foam chart. Emerson & Cuming Inc., Canton, Mass. 02021. A chart suitable for notebook or wall mounting lists the properties of 18 different foams including polyurethane, polystyrene, epoxy, silicone, and ceramic. [450]

Pressure-to-frequency converter. Solid State Electronics Corp., 15321 Rayen St., Sepulveda, Calif., 91343, has available a bulletin describing the model OS-1005 silicon transistor Osciducer, an ultraminiature pressure-to-frequency converter. [451]

Coaxial directional couplers. PRD Electronics Inc., 1200 Prospect Ave., Westbury, N.Y., 11590. A date sheet contains an illustrated description of the 4410 series coaxial directional couplers, which are convenient devices for extracting a known fraction of power in a coaxial system. [452]

Ultrahigh vacuum furnaces. Varian Associates, Vacuum division, 611 Hansen Way, Palo Alto, Calif., 94303, offers an 18-page brochure giving descriptions, specifications, and operating principles for a line of ultrahigh vacuum furnaces. [453]

Resistors. Shallcross Manufacturing Co., Preston St., Selma, N.C., 27576. Precision wirewound and power resistors for military and commercial applications are presented in publication LA-192, a four-color, 44-page catalog. Copies may be obtained by request on company letterhead.

Pulse transformer parameters. Contemporary Electronics, 4838 W. 35th St., Minneapolis, Minn., 55416. A six-page brochure discusses definition, measurement, and specification of pulse transformer parameters. [454]

Multilayer circuit boards. Methode Electronics Inc., 7447 W. Wilson Ave., Chicago, Ill., 60656, has issued a check list to guide the engineer and designer in specifying a multilayer circuit board that will meet the ultimate and complete requirements of the end product. [455]

Battery pack connectors. ITT Cannon Electric, 3208 Humboldt St., Los Angeles, Calif., 90031, has published a four-page technical bulletin describing environmental-resistant miniature electrical connectors used on batteries and portable communications equipment. [456]

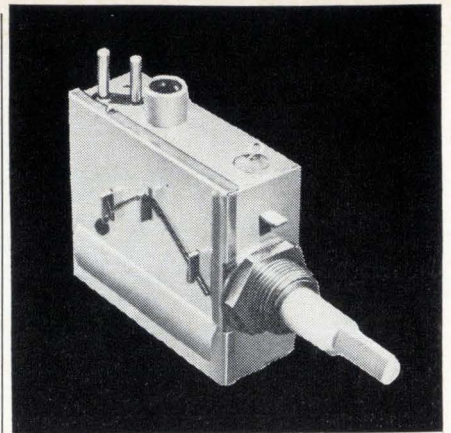

MITSUMI UHF TV TUNER

outrating international tuner standards!

Far outrating the FCC and VDE specifications, which are widely prevailing in the World as telecommunication standards, the MITSUMI UHF tuner only radiates spurious signals less than 33.5 dB below the reference field strength. Material, plating, soldering, as well as the proprietary circuit design are the technical achievements by MITSUMI based on a long-term fundamental research.

By virtue of high compactness, light-weight, outstanding durability and overall use of silicon transistors, the MITSUMI TV-tuner has made possible of minimum frequency drift due to temperature variation. And also, the MITSUMI TV-tuner is made available to tube-type TV sets.

Specifications	Model	UHF TV tuner
		UK-A32 for American channel
Gain (dB)		-10 min.
Noise figure (dB)		14 max.
Image ratio (dB)		30 min.
IF rejection (dB)		60 min.
Frequency stability		Temperature Stability :
		700 kc at 25 - 65° C
		Voltage stability :
		±100kc at 11V ±1V
Outer dimensions (mm)		51 × 62.5 × 24.5

Specifications	Model	UHF TV tuner
		U-ES12B for European channel
Gain (dB)		-10 min.
Noise figure (dB)		16 max.
Image ratio (dB)		35 min.
IF rejection (dB)		55 min.
Frequency stability		Temperature stability :
		800kc at 20 ± 30° C
		Voltage stability :
		±400kc at 11V ±1.1V
Outer dimensions (mm)		46.5 × 50 × 19

MAIN PRODUCTS

- Polyethylene variable capacitors
- IF Transformers
- Micromotors
- Synchronous motors
- Front-end FM tuners
- UHF & VHF TV tuners
- CdS photoconductive cells
- Trimming potentiometers
- Various types of coils
- Various types of sockets
- Trimmer capacitors
- Various types of terminals
- Fuse holders



MITSUMI

MITSUMI ELECTRIC COMPANY, LIMITED

1056 Koadachi, Komae-machi, Tokyo 415-6211
302, Cheong Hing Bldg., 72 Nathan Road,
Kowloon, Hong Kong 666-925

Marienstrasse 12, Dusseldorf, W. Germany.

MITSUMI ELECTRONICS CORPORATION

11 Broadway, New York 4, N.Y. 10004. HA5-3085
333 N. Michigan Avenue, Chicago, Ill. 60601
263-6007



AGE engineering is the art of anticipation

Keeping ahead of this one requires a special sophistication

The F-111 places heavy demands on the foresight of an AGE engineer.

This—the most advanced combat aircraft in the U.S. arsenal—has already been extended to several versions. Ground- and carrier-based fighters. Attack bomber. Reconnaissance craft. Our AGE engineers, who pioneered and developed AGE for the original F-111, are now committed to a still more challenging task: developing equipment to test all aircraft configurations—present and future—so that as new avionics systems and aircraft missions are defined, the additional test needs can be met without major redesign. Necessarily, the equipment will require an expanded depth of testing capability, combined with a high degree of compactness and rugged construction for deployment and usage in all areas of the world.

The magnitude of the systems and design problems to be encountered really comes into focus when you consider the complexity of Aerospace

Ground Equipment: it's a highly-automated test and fault-location system which includes a video station, radar/receiver/transmitter modulator station, indicator/controls station, central air data computer station, radar servo and indicator station, computer station, 'penetration aids station, attitude and rate station, UHF communications station, HF communications station, TACAN station, HF communications flight-line tester, IR station, UHF guidance station and digital station—each sophisticated enough to test state-of-the-art equipment.

And this is only one of the programs our AGE laboratory is "writing the book" on. Other programs include internal and external checkout systems for missiles such as Atlas, Nike-Zeus and Polaris . . . flight-line and depot systems for terrain-following radar . . . SSB equipment . . . automated vehicular trouble-shooting systems, and many more.

Obviously, if any of these areas dovetails with your interests, we have a lot to talk about. (You'll quickly see why so many engineers like the growth atmosphere of the Electronics Division.)

If you'd prefer to move in another direction, send us your resume anyway. We have rapidly expanding study and development programs going in ASW, radio communications, data equipment, navigational aids, tracking equipment and countermeasures. Opportunities are wide open. Direct your resume, in confidence, to Mr. L. A. Corwin, Dept.101.

GENERAL DYNAMICS
Electronics Division

1400 N. Goodman Street, Rochester, New York 14601
An Equal Opportunity Employer (M&F)

PCM HEAD

Can You Direct A PCM TELEMETRY DEVELOPMENT TEAM?

Salary to \$20,000

The position to be filled is a TOP spot with an established expanding Philadelphia area based division of a large nationally-known company.

The individual we seek is a graduate engineer preferably with an advanced degree and solid experience in airborne instrumentation systems, analog (FM/FM) and digital (PCM/FM) and associated hardware. He is outstanding, creative and inventive . . . able to lead and inspire men . . . and fully abreast of developments in his field.

If you feel your qualifications meet the high standards specified above and are looking for an opportunity to MOVE UP and AHEAD, professionally and financially, send your resume in the strictest confidence to:

J-82 P.O. BOX 2068
Philadelphia, Pa., 19103

An Equal Opportunity Employer

Overseas Employment OPPORTUNITIES

For Electrical Engineers With the Foreign Service Of the United States

The U.S. Department of State needs experienced Electrical Engineers for career appointments in the Foreign Service. These assignments are unique and exciting in the field of technical security. Your family may accompany you overseas. Considerable temporary duty travel permits visiting interesting areas of the world.

REQUIREMENTS:

- (1) BS or MS in Electrical Engineering;
- (2) Accept assignment world-wide, minimum tour of duty is two years;
- (3) Qualify for highest security clearance;
- (4) Be an American citizen for a minimum of five years. If married, spouse must be an American citizen;
- (5) Excellent health; and (6) Two to four years professional experience. Starting Salaries \$7,974 to \$12,810 (plus overseas allowances). Send completed Federal Employment Form 57 (available at any U.S. Post Office) and resume to:

Office of Security, Department of State
Washington, D.C. 20520.

APRIL OPENINGS

Cadillac Associates is the nation's largest executive and professional placement service. If you wish to find out your true worth in the electronics field, contact us. Our staff is versed in your particular discipline and can show you the openings now available—coast to coast. Our service is completely confidential and free to the applicant. Here are a few of the many positions now open:

ELECTRONIC PKGNG. ENGR. \$15,000
Design and packaging of electronic circuits.

ELECTRONIC CIRCUIT Des. Eng. \$17,000
Microelectronics, miniaturization techniques.

AIRBORNE ELECTRONIC Sys. \$14,000
Design and analysis airborne defense systems.

NAVAL WEAPONS Sys. . . \$14,000
Perform naval weapon control syst. anal.

TEST EQUIP. DES ENGR. . . \$12,500
Automatic test equip. utilizing solid state techs.

ELECTRO-MECH. ENGR. . . . \$13,000
Assignment on solid state transduction components.

PROJECT ENGINEER \$12,500
Exp. in solid state or electronic power supplies.

E. W. MOORE

CADILLAC ASSOCIATES, Inc.
29 E. Madison Bldg., Chicago, Ill. 60602
Financial 6-9400

CIRCLE 966 ON READER SERVICE CARD



E.E.'s

For FEE PAID positions
throughout U.S.

SEND RESUME TODAY
(if none, send coupon for
confidential application.)

ATOMIC PERSONNEL, INC.
Suite L, 1518 Walnut St., Phila., Pa.
Experienced Engineers
Working Full Time for You!

Name _____
Address _____
City _____ State _____

AN EMPLOYMENT AGENCY FOR ALL TECHNICAL FIELDS

PROFESSIONAL SERVICES

GIBBS & HILL, Inc.

Consulting Engineers

Systems Engineering

Operations Research • Development
Field Studies • Design • Procurement
Power • Transportation • Communications
Water Supply • Waste Treatment

393 Seventh Avenue New York 1, N. Y.

Donald C. Harder, Inc.

Magnetic Component Engineers

Reactors—Transformers—Filters
Serving the Research Laboratory

2580 K Street, San Diego, Calif. 92102
Phone (714) 239-8021

Overseas Employment OPPORTUNITIES

For Electronic Technicians With the Foreign Service Of the United States

The U.S. Department of State needs experienced Electronic Technicians for career appointments in the Foreign Service. These assignments are unique and exciting in the field of technical security. Your family may accompany you overseas. Considerable temporary duty travel permits visiting interesting areas of the world.

REQUIREMENTS:

- (1) Electronics certificate from a technical or service school;
- (2) Accept assignment at any Foreign Service post, minimum tour of duty is two years;
- (3) Qualify for highest security clearance;
- (4) Be an American citizen for a minimum of five years. If married, spouse must be an American citizen;
- (5) Excellent health; and (6) Two to four years of experience. Starting salaries \$7,201 to \$10,667 (plus overseas allowances). Send completed Federal Employment Form 57 (Available at any U.S. Post Office) and resume to:

Office of Security, Department of State
Washington, D.C. 20520.

YOU'RE H!RED

Do you need electronics engineers or technical management men? Electronics magazine is the way to recruit them. Electronics is designed specifically for the working engineer. 68,000 subscribers and an additional 133,000 pass-along readers turn to it to keep up with their industry. You can find the man that meets your qualifications with an advertisement in the Employment Opportunities Section.

For rates & information write: Electronics, a McGraw-Hill Publication. Classified Advertising Division, Post Office Box 12, New York 10036.

In electronics it's Electronics magazine to sell used equipment!

Your advertisement will produce Results in Electronics. Engineers turn to Electronics magazine for the latest technical developments — and for the latest buying information. You can reach them inexpensively in Electronics Searchlight Section.

For information:
Searchlight Section
Classified Advertising Division
Post Office Box 12
New York 10036



SEARCHLIGHT SECTION

• CLASSIFIED ADVERTISING • BUSINESS OPPORTUNITIES
• USED OR SURPLUS EQUIPMENT

AUTOTRACK ANTENNA MOUNT

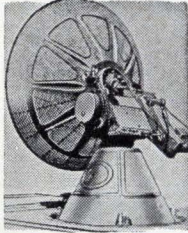

360 degree azimuth, 210 degree elevation sweep with better than 1 mil. accuracy. Missile velocity acceleration and slewing rates. Amplidyne and servo control. Will handle up to 20 ft. dish. Supplied complete with control chassis. In stock—immediate delivery. Used world over by NASA, USAF, MP-61-B. Type SCR-584. Nike Ajax mounts also in stock.

PULSE MODULATORS

MIT MODEL 9 PULSER 1 MW—HARD TUBE
Output 25kv 40 amp. Duty cycle .002. pulse lengths .25 to 2 microsec. Also .5 to 5 microsec. and 1 to .5 microsec. Uses 6C21. Input 115v 60 cycle AC. Mfg. GE. Complete with driver and high voltage power supply. Ref: MIT Rad. Lab. Series, Vol. 5, p. 152.

2 MEGAWATT PULSER
Output 30 kv at 70 amp. Duty cycle .001. Rep rates. 1 microsec 600 pps. 1 or 2 msec 300 pps. Uses 5948 hydrogen thyratron. Input 120/208 VAC 60 cycle. Mfr. GE. Complete with high voltage power supply.

250 KW HARD TUBE PULSER
Output 16 kv 16 amp. Duty cycle .002. Pulses can be coded. Uses 5D21, 715C or 4PR60A. Input 115 v 60 cy. AC \$1200 ea.

18 MEGAWATT PULSER
Output 150KV at 120 amps. Rep rate: 50-500 PPS. Pulse length: 5 nusec. 15KV 120 amp. into pulse transformer. Rise time 1.5 nusec. Filament supply 5V 80 amp. incl. 17.5KV 1.5 amp DC power supply. Input: 220V 60 cy AC.

VARIAN KLYSTRONS
V-45: .15W output CW 9 to 10 KMC
VA-800: 10 KW output CW 1.7 to 2.4 KMC
VA-806H: 1KW output CW 7.5 to 8.5 KMC
T.W.T.
VA-137C: 5KW Peak. 350 W avg. .87 to 1.0 KMC
RCA-1154: 10 MW output 1.5 to 4.5 KMC
RCA-1161: 1 Watt output 1.9 to 4.1 KMC

SCR 584 AUTOTRACK RADARS
Our 584s in like new condition, ready to go, and in stock for immediate delivery. Ideal for telemetry research and development, missile tracking, satellite tracking. Fully Desc. MIT Rad. Lab. Series. Vol. 1, pps. 207-210, 228, 284-286. Comp. Inst. Bk available \$25.00 each.

MICROWAVE SYSTEMS

L BAND RF PKG.
20 KW peak 990 to 1040 MC. Pulse width .7 to 1.2 micro sec. Rep. rate 180 to 420 pps. Input 115 vac incl. Receiver \$1200

200-225 mc RADAR SYSTEM
1 Megawatt output. 200 nautical mile range for long range detection of medium and high altitude jet aircraft as well as general search. Complete system in stock. Input 120/208 V. 60 cy. Type TFS-28.

C-BAND RADAR
250 KW output. C-band. PPI indicator. 5C22 thyratron modulator. Antenna hi gain parabolic section. Input 115 volts 60 cycle AC. complete \$2750.00

5 MEGAWATT C-BAND
Klystron RF package delivering nominal 5 megawatt pulse RF. Complete with pulser and power supply.

500 KW L BAND RADAR
500 kw 1220-1359 msc. 160 nautical mile search range P.P.I. and A scopes. MTI thyratron mod 5J26 magnetron. Complete system.

100 KW X BAND RADAR
Complete 100 kw output airborne system with AMTI. 5C22 thyr. mod. 4452 magnetron. PPI. 360 deg as sweep. 60 deg. elev. sweep. gyro stabilizer, hi-gain revr. Complete with all plugs and cables.

AN/GPG-1 SKY-SWEEP TRACKER
3 cm. automatic tracking radar system. Complete package with indicator system. Full target acquisition and automatic tracking. Input 115 volts 60 cycle. New. In stock for immediate delivery. Entire System 6' long, 3' wide, 10' high. Ideal for Infrared Tracker. Drone Tracker, Missile Tracker. R. & D.

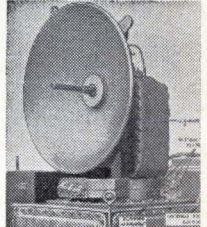

500KW S BAND RADAR
250 miles search 115V 60 cy AC. Mfg. G.E.

RADAR AUTO-TRACK & TELEMETRY ANTENNA PEDESTALS
3 & 10 CM. SCR 584 AUTOTRACK RADARS. M-33 RADAR
TPS-1D SEARCH. APS-45 TPS-10D HT. FINDERS. WX RADARS.
PPN-32GCA. APS-10 APS-15B APS-27 (AMTI) SEARCH. ■ ■ ■
APR-102 DOPPLER. DOZENS MORE. CARCINOTRONS. PFM'S.
25-5-1-2-3-6 MEGAWATT PULSE MODULATORS. CAVITIES.
PULSE TRANSFORMERS. IF STRIPS. WAVEGUIDE. BENDS
200 MC. 1 KMC. 3 KMC. 6 KMC. 9 KMC. 24 KMC. RF PKGS.
RADIO RESEARCH INSTRUMENT CO.
550 5TH AVE., NEW YORK 36, N. Y. JU 6-4691

CIRCLE 967 ON READER SERVICE CARD

ELECTRON TUBES

KLYSTRONS • ATR & TR • MAGNETRONS
SUBMINIATURES • C.R.T. • T.W.T. • 5000-
6000 SERIES
• SEND FOR NEW CATALOG A2 •
A & A ELECTRONICS CORP.
1063 PERRY ANNEX
WHITTIER, CALIF.
696-7544

CIRCLE 968 ON READER SERVICE CARD

free catalog
POTTING APPLICATORS
MANUAL AND DISPOSABLE
6cc 12cc 30cc
FOR POTTING, ENCAPSULATING, AND
SEALING OF MINIATURE COMPONENTS
PHILIP FISHMAN COMPANY
7 CAMERON ST., WELLESLEY 81, MASSACHUSETTS

CIRCLE 969 ON READER SERVICE CARD

SPOT WELDING TWEEZERS

TWI - 36" Lead \$11.65
AC and Stored Energy Power Supplies
and Welding Heads
EWALD INSTRUMENTS CORP.
KENT, CONN. 06757

CIRCLE 970 ON READER SERVICE CARD

R.U. 1
answering more than
advertisement? Then please send a
separate reply to each box number. It
will help you get an answer sooner.

FOR SALE



When you have used electronics equipment to sell, advertise in Electronics Searchlight Section for fastest results.

For information:
Searchlight Section
Classified Advertising Division
Post Office Box 12
New York 10036

It's hard to sleep nights when you know what we know.

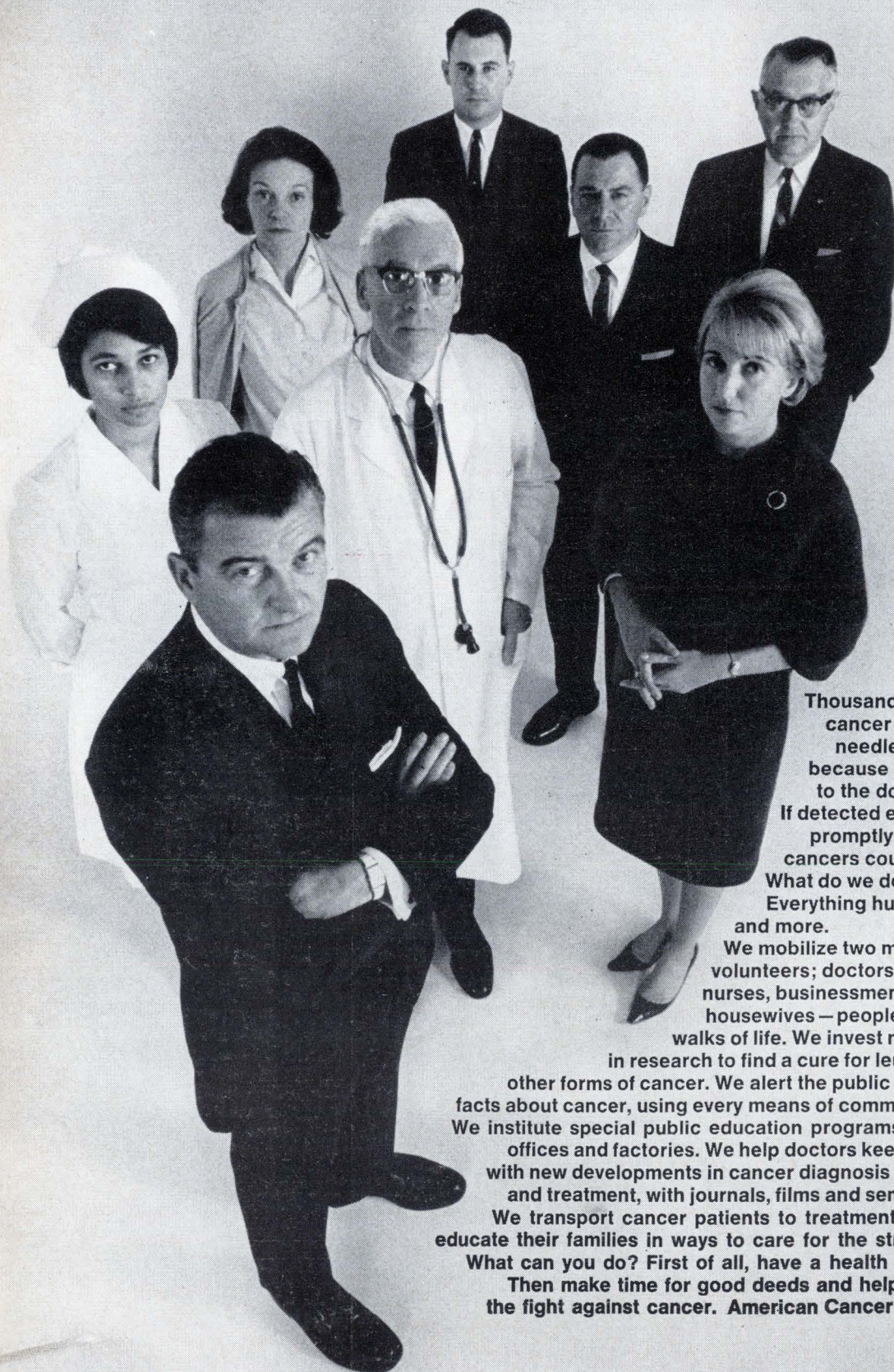

Thousands of cancer patients will die needlessly this year because they did not go to the doctor in time. If detected early and treated promptly, half of all cancers could be cured. What do we do about this? Everything humanly possible, and more.

We mobilize two million dedicated volunteers; doctors, scientists, nurses, businessmen, union leaders, housewives — people from all walks of life. We invest millions in research to find a cure for leukemia and other forms of cancer. We alert the public to vital facts about cancer, using every means of communication. We institute special public education programs in business offices and factories. We help doctors keep up with new developments in cancer diagnosis and treatment, with journals, films and seminars. We transport cancer patients to treatment centers and educate their families in ways to care for the stricken. What can you do? First of all, have a health checkup. Then make time for good deeds and help us in the fight against cancer. American Cancer Society

THIS SPACE CONTRIBUTED BY THE PUBLISHER AS A PUBLIC SERVICE/PHOTO: PHILLIP GOTTHEIL

Hold the unbeatable hand for EMI measurements from 1 to 22 GHz

1-22 GHz
emc
1-22 GHz
Digital
Display
Unit
Model 3100

1-22 GHz
emc
1-22 GHz
Frequency
Call-Up
Unit
Model 8010

10-22 GHz
emc
10-22 GHz
Frequency
Selection
Unit
Model 910-12

1-10.5 GHz
emc
1-10.5 GHz
Frequency
Selection
Unit
Model 910-10

1-22 GHz
emc
1-22 GHz
Data
Evaluation
Unit
Model 910-11

the EMA-910 system

SINGER
INSTRUMENTATION

has stacked the deck for you ... HERE'S HOW →

the unbeatable hand for

automatic EMI measurements from 1 to 22 GHz

The revolutionary **EMA-910** system has changed the entire electromagnetic analysis "deck". It's designed to give you maximum convenience and precision for automatic spectrum surveillance . . . electromagnetic compatibility analysis . . . and field intensity measurements, in accordance with all FCC, Federal, and Military specifications.

The basic electromagnetic analyzer consists of:
 Model 910-11, 1-22 GHz Data Evaluation Unit
 Model 910-10, 1-10.5 GHz and/or
 Model 910-12, 10-22 GHz Frequency Selection Units.

- These instruments give you the assurance of:
- -100 dbm narrowband sensitivity (1-10.5 GHz)
 - -92 dbm narrowband sensitivity (10-22 GHz)
 - Four accurate bandwidths, 0.5 MHz, 1.0 MHz, 5.0 MHz, and 8-10 MHz
 - Automatic signal level discrimination
 - Automatic scanning; remotely programmable
 - Sector scan over any range
 - Automatic band switching
 - "Hold-and-Dump" true peak detection
 - Pushbutton calibration without disconnecting input signal leads
 - 120 db case shielding

The **Frequency Call-Up Unit, Model 8010**, gives you automatic remote tuning for spectrum surveillance of any 10 pre-selected signals. Additional 10-channel units may be added as required. Operation is as simple as pushing buttons to command the basic analyzer system to automatically scan to the selected frequencies.

The **Digital Display Unit, Model 3100**, provides simultaneous dual-channel digital readout of frequency (in GHz) and signal amplitude (in db above μV) on "Nixie" tubes (four digits per channel). The amplitude information display is automatically compensated for inserted r-f attenuation, eliminating the time normally required for adding attenuation factors, as well as possible operator errors in meter reading. The unit also "holds" the data for manual notation, digital recording, or computer input (using either 1-2-2-4 or 1-2-4-8 binary-coded decimal outputs).

BASIC ELECTROMAGNETIC ANALYZER

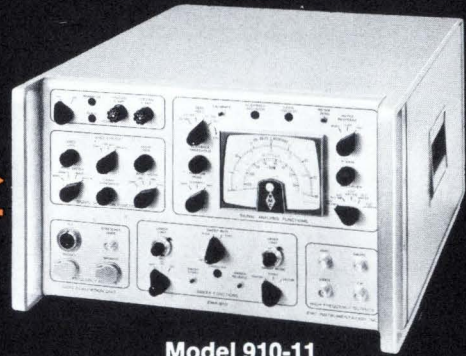

Model 910-11
1-22 GHz Data Evaluation Unit

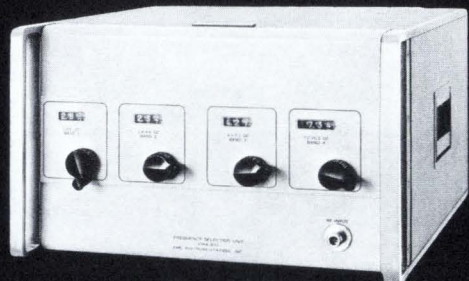

Model 910-10
1-10.5 GHz Frequency Selection Unit

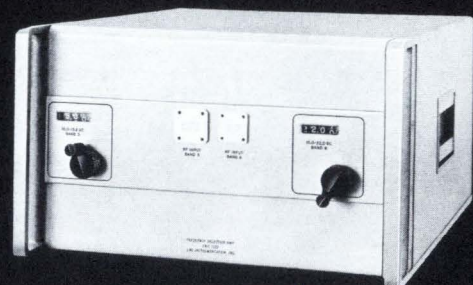

Model 910-12
10-22 GHz Frequency Selection Unit

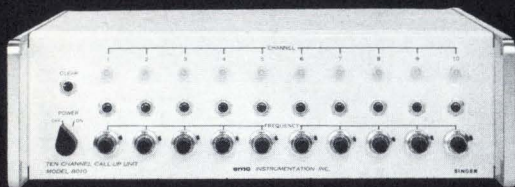

Model 8010
1-22 GHz Frequency Call-Up Unit

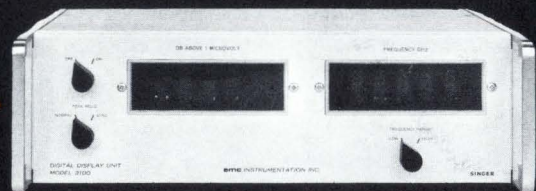

Model 3100
1-22 GHz Digital Display Unit

Call or write for a demonstration or complete technical data.



EMPIRE • GERTSCH • PANORAMIC • SENSITIVE RESEARCH

SINGER
INSTRUMENTATION

EMC Instrumentation Inc., A Subsidiary of THE SINGER COMPANY • Engineering/Manufacturing; 7338 Varna Ave., N. Hollywood, Calif. 91605
 Sales Offices; EMPIRE/EMC, THE SINGER COMPANY, METRICS DIVISION • 915 Pembroke St., Bridgeport, Conn. 06608 U.S.A. • (203) 366-3201

Newsletter from Abroad

April 3, 1967

Large electronic exchanges in sight for Great Britain

The British Post Office very likely will order its first large electronic telephone exchange before the month is out. **Post Office officials and negotiators for the contractor, Associated Electrical Industries Ltd., have settled everything but the price—expected to be about \$5.5 million.**

The large exchange developed by AEI can handle between 20,000 and 30,000 subscribers. Called the TXE-3, it has a stored control program and uses 11 small computers—10 for switching and one for diagnostic tests. By contrast, the electronic switching systems in service in the Bell Telephone system use just two computers.

British telephone officials expect to let seven other contracts for large electronic exchanges once they've negotiated a price for the first one, destined for London. The Post Office already has under way a large-scale program to equip antiquated exchanges with TXE-2 electronic hardware, which can handle up to 2,000 subscribers [Electronics, Jan. 9, p. 254].

French Post Office may take new line

The Centre National d'Etudes des Telecommunications, research arm of the government-run telephone system, has started to look at ways of bettering the lot of data transmitters.

Like would-be telephone subscribers, users of data transmission equipment have troubles getting the lines they want. And except for a few special circuits that carry extra-high rates, the data-transmission lines available can handle only speeds up to 50 bands—too slow for computers. And the Post Office has limited its effort so far to leasing lines for data transmission. As a result only some 300 coding-decoding units are currently in service in France.

A switch in Post Office policy on data transmission is in the offing. The research agency is looking at the problem with an eye toward lower rates, faster speeds and a service that would include transmission equipment along with the lines themselves. **But the improvements in data-transmission service won't become widely available for another three years at least.**

IC patents snag stalls Japanese in export markets

Japanese manufacturers who hustled into production of integrated-circuit radios and desk calculators are fretting over a setback in their export plans. **At the behest of the powerful Ministry of International Trade and Industry, they are holding off on exports until a long-standing snarl over IC licenses is untangled.** The basic U.S. patents are held by Texas Instruments Incorporated and the Fairchild Camera & Instrument Corp.

Hardest hit by the ministry's "administrative guideline" that effectively bans exports of IC hardware is the Sony Corp. Sony put a pocket IC radio on the U.S. market last fall [see related story p. 177]. But after selling out a first small batch, **Sony stopped shipments even though company marketing experts figure they could have sold about 100,000 IC radios in the U.S. this year.**

Unless the patent hassle ends within the next six months or so the Hayakawa Electric Co. will have headaches. Hayakawa plans to step up its output of IC desk calculators to 5,000 monthly by September and is counting on export markets to absorb 70% of its production. **The unsettled patent situation—if it drags on too long—could turn into a**

Newsletter from Abroad

major drawback for Japanese manufacturers, who need export markets to justify heavy investments for IC production.

Texas Instruments looms as the most troublesome stumbling block for the Japanese. Because it has been consistently rebuffed by the trade ministry in its bid to set up a wholly owned subsidiary in Japan [Electronics, Nov. 28, 1966, p. 193], Texas Instruments has dragged its heels in license negotiations with Japanese manufacturers. The company sees its basic U.S. patent covering integrated circuits as a wedge to eventually get into Japan on something like its own terms. The Japanese agency sees otherwise, especially since TI's application for Japanese IC patents has been bogged down in administrative procedures and may not be granted before another five years or so.

Fairchild has a Japanese patent on the planar process, which no one contests. Fairchild has licensed its rights under the patent to the Nippon Electric Co. and Nippon, backed by the government, has quietly been signing sublicensing arrangements—at a royalty rate said to be 4.5%—with other Japanese companies. MITI presumably will lift its export ban when the domestic patent problem involving planar-process licenses is cleared up. The trade ministry feels Texas Instruments most likely then would risk antitrust action in the U.S. if it refuses licenses on its patents. Fairchild and Texas Instruments have a cross-licensing agreement covering integrated circuits but it specifically excludes Japan.

Britain to back only two or three native IC makers

As part of its drive to keep Britain competitive with the U.S. in integrated circuits, the Wilson government plans to speed a shakeout among native producers. The government is prepared to spend some \$15 million to help British companies get into large-scale IC production. But technology minister Anthony Wedgwood Benn says the support will be limited to "perhaps two or three" industrial groups.

Prime benefactors of the government's shakeout policy apparently will be Ferranti Ltd., The Marconi Co., and Elliott-Automation Ltd. Both Ferranti and Marconi, one of the companies in the English Electric group, already are in volume production of British-designed IC's. Elliott produces circuits based on designs of the Fairchild Camera & Instrument Corp. but has its own IC designs in the works. Within a few years, these three companies most likely will wind up as the only major all-British IC makers, competing with subsidiaries of U.S. producers and Mullard Ltd., owned by Philips Gloeilampenfabrieken N.V.

Soviets discount far-out broadcasts

Soviet information-theory specialists say there's no chance of radio contacts with civilizations on stars outside the galaxy that includes the earth. The outer limit for communicating with outer civilizations, their studies show, is between 500 and 1,000 light years. And the limit applies only if the outer beings deliberately send out powerful "call signals."

For their analysis of extraterrestrial communications, the Soviet scientists assumed that the identification signals would contain only a few tens of units of binary information. To pick up the broadcasts, if they ever are aired, the Soviets think the best bet would be a combination of multichannel receivers—many narrow bands with pass frequencies between 1 hertz and 0.1 hz—coupled to a pencil-beam antenna pointed toward a sector of the sky where there's a star that might have intelligent life on it.

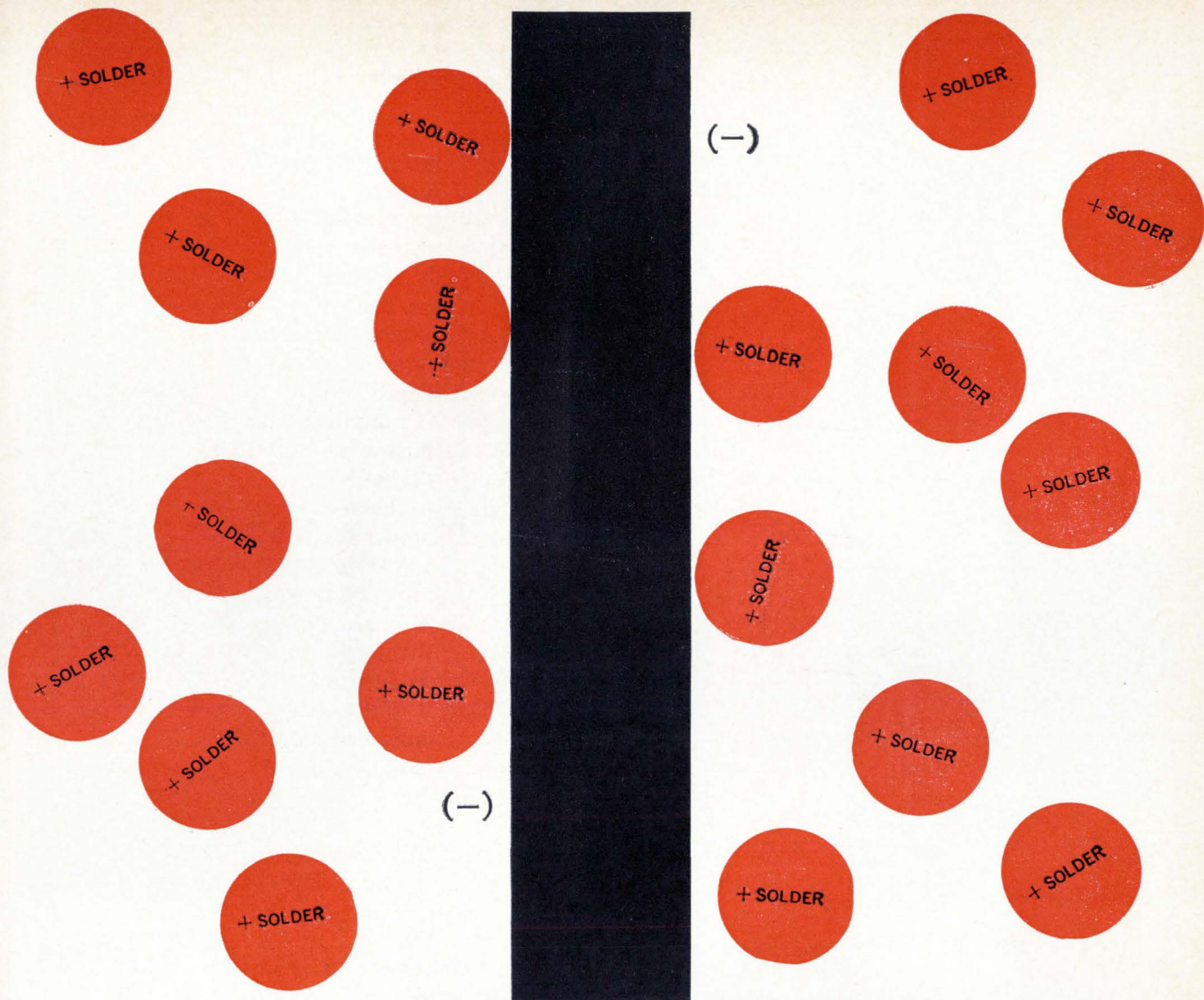

We could solder-plate 100,000,000,000 miles of wire
and not vary .0002"

(Hot-dipped wire could never be that precise.)

Up till now all known solder-coated wire was hot-dipped.

That meant lack of uniformity. And plenty of waste. But we've developed a way to solder-plate wire that will hold coating thickness to minimums. We can solder-plate (in a variety of baths) or tin-plate any diameter wire from .010" through .060". We can solder-plate or tin-plate ribbon from .005" x .020" through .050" x .080".

And we can hold a plating thickness range of .0002" on plate thickness up to .0005" minimum (for example: .00025" - .00045" or .0005" - .0007").

There are no more thin areas that become unsolder-

able due to "non-wetting." Coatings on pigtailed can now retain their solderability even after extended baking or curing times. And solderability is retained even after an extended "shelf-life" when hot-dipped wire normally goes bad.

What else? Well, we think that many faults you've ever found with hot-dipped wire, our solder-plated wire will correct.

Give us a call, and we'll send you some.

Sylvania Electric Products Inc., Parts Division, Warren, Pennsylvania 16365. Phone 814-723-2000.

SYLVANIA
SUBSIDIARY OF
GENERAL TELEPHONE & ELECTRONICS **GTE**

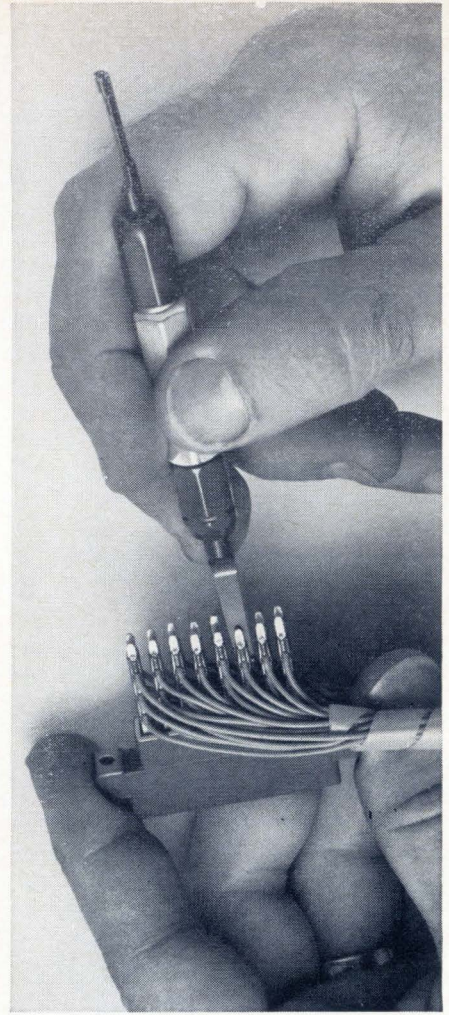
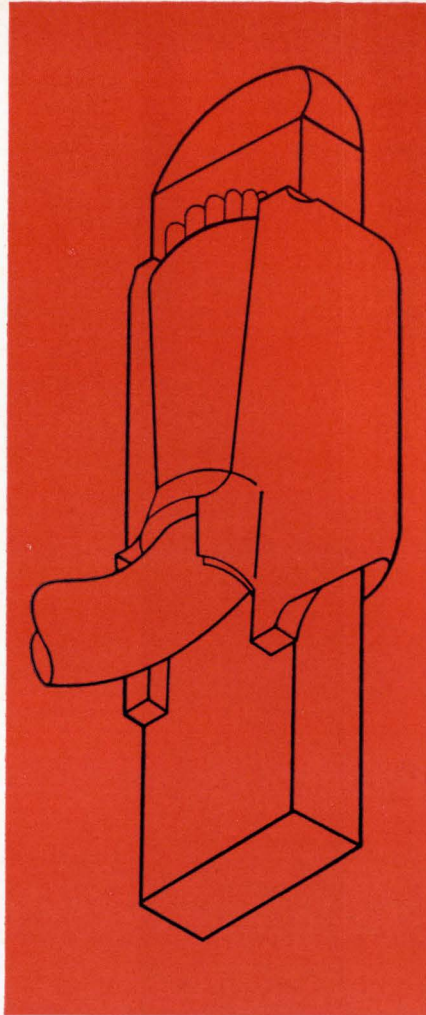
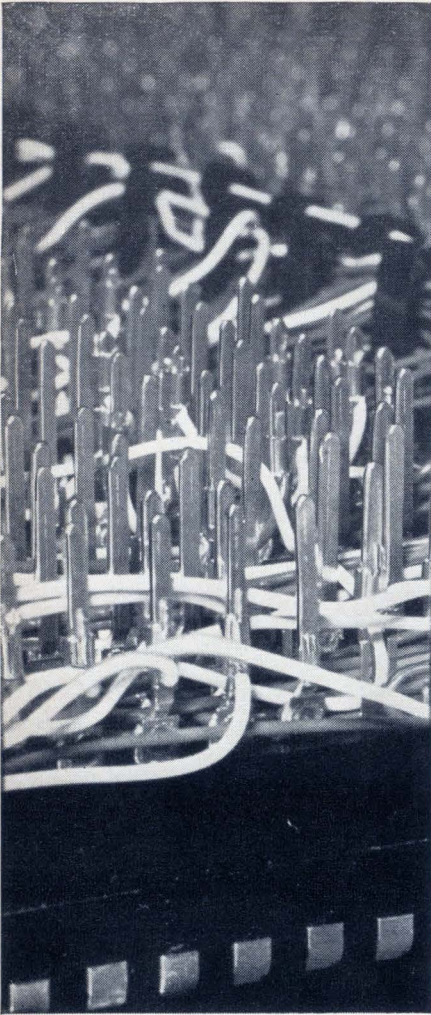

Some pointed facts about wiring

1. Ours is the only point-to-point wiring technique designed for both solid and stranded wire, bulk or pre-cut, and other types, such as enamel insulated wire. Production flexibility is further enhanced by the variety of TERMI-POINT tools which range from lightweight pneumatic and hand application devices to fully automated high-speed equipment. Since head-on insertion, not wrapping or twisting, is utilized in our technique, these tools require a minimum of working space, permitting grid densities to .100" . . . even tighter in future generation products!

2. TERMI-POINT wiring devices are fully compatible with other production methods . . . although our plated chamfered post was designed specifically for TERMI-POINT clips. These posts are available in several sizes, including the new miniature .022" x .036" rectangular post. Mating TERMI-POINT clips are applied over the mandrel and onto the post in a manner which "irons" the wire. Clips are made of fine grain phosphor bronze and incorporate integral springs. The combination of the ironed wire and the integral spring produces a gas-tight connection—without nicking either post or wire!

3. TERMI-POINT clip terminations are the easiest to service of any production wired devices. Individual connections may be tested non-destructively in the field using simple hand tools, without damage to the post involved or adjacent posts. Unlike wrapped connections that require a dozen or more steps to replace, the bottom TERMI-POINT clip on a 3-high post can be removed with a quick twist of the extraction tool. Upper clips slide into position on the post, and the new connection is applied on top. Posts can be used many times without deterioration.

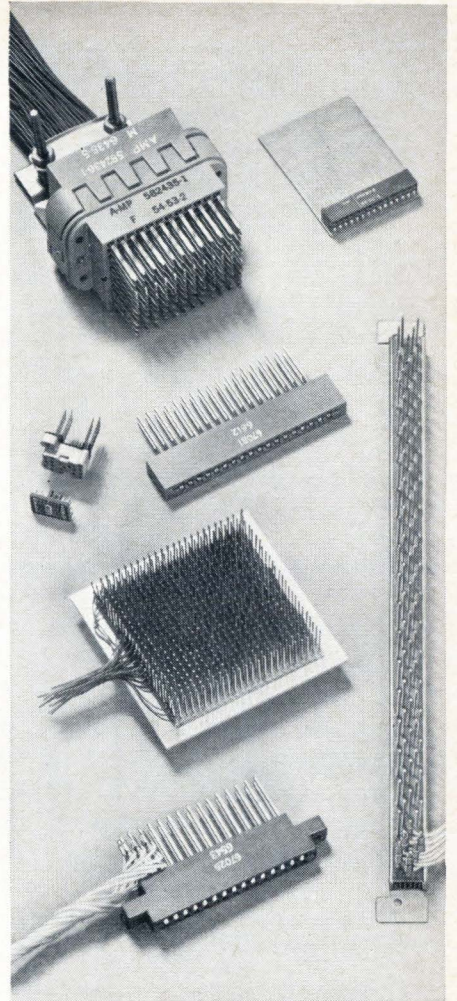

with TERMI-POINT[★] clips and tools

4. Automated TERMI-POINT tooling offers the highest production speed in the industry. Programmed by punched paper tape, our Automatic Wiring Machine can completely terminate a 10-inch lead in four seconds—faster than any other automated technique. In addition, it takes up one-third the space and weight*, and provides the high efficiency of a moving applicator over a stationary work bed. High speed coupled with the ability to use bulk wire results in lowest applied cost of any point-to-point wiring method. (Customer panels can be produced on this machine at our Harrisburg plant, saving manufacturers capital investment. Ask for information on our pre-wired panel service.)

*TERMI-POINT automatic wiring machine information:

Weight—approx. 4500 lbs.

Size—approx. 8' x 10'

Speed—over 1000 programmed wires in a one hour period

5. We've developed the broadest line of products that have been made available for any automatic technique. Associated products include one and two-piece printed circuit connectors, rack and panel connectors, flat pack receptacles, modular interconnection devices, transition and relay blocks, bus bars, and dual disconnects. Reliability is second to none in the industry. And AMP accepts total responsibility for its technique, its products and the performance of customer connections.

Write today for detailed literature on this advanced concept in point-to-point wiring and the family of products we've developed for it.

★Trademark of AMP INCORPORATED

AMP
INCORPORATED
Harrisburg, Pennsylvania

AMP products and engineering assistance are available through subsidiary companies in: Australia • Canada • England • France • Holland • Italy • Japan • Mexico • Spain • West Germany

SCIENCE / SCOPE

The new TOW anti-tank guided missiles were successfully fired from Army helicopters during recent tests conducted by the Army Missile Command and Hughes at Redstone Arsenal. They scored hits on both moving and stationary targets more than a mile away. TOW is being developed as a second-generation helicopter anti-tank weapon. One reason for its increased accuracy is a new stabilized sight, also developed by Hughes, which permits the gunner to hold a bead on the target even while the pilot is maneuvering to avoid ground fire.

Hughes has completed ground terminals for the Defense Communications Agency's satellite network in Hawaii, the Philippines, Southeast Asia, Ethiopia, West Germany, and Fort Monmouth, N.J. These ground stations, linked by 15 satellites dispersed in random 21,000-mile orbits around the equator, comprise the first military satellite communications network and insure uninterrupted two-way radio between U.S. forces anywhere in the world.

A computer that "learns" in much the same way an animal does has been built by Hughes as part of a long-range research program in artificial intelligence. It has already learned to recognize letters and numerals and to differentiate between sounds. Its ability to search photographs for structures of a particular kind, now being applied under a NASA contract, may lead to an automatic method of classifying the visual appearance of other planets.

Television's first international art auction was relayed via Early Bird to an audience of millions in Europe and the U.S. The auction followed NBC's Sunday night special, "Bravo Picasso!", a biography of the artist through his paintings housed in the Grand et Petit Palais in Paris and a two-city exhibition at Dallas-Ft. Worth. Picasso donated a painting to the auction, with proceeds earmarked for the restoration of Italian art damaged in last November's floods.

Hughes' new line of commercial-industrial lasers will be marketed in the U.S., its territories and possessions, and Canada by Beckman Instruments, Inc. Sales efforts will be concentrated on laboratories and academic institutions using lasers for research, experimental, or educational purposes. Hughes laser welders will continue to be marketed by the Airco Welding Productions division of Air Reduction Co., Inc.

A microminiature airborne computer designed by Hughes, the HCM-205, is being considered for several advanced programs. Its memory is 8,192 words, expandable to 16,384; its weight is 13.3 lb. It has an 18-bit word length, can perform about 125,000 operations per second, and features "large array" microcircuits and high-density packaging techniques.

Several advanced programs at Hughes have important and immediate opportunities for engineers: electro-optical, microcircuit, space systems, information processing, circuit design, communications/radar systems. Requirements: at least two years of applicable experience, an accredited engineering or scientific degree, U.S. citizenship. Please send your resume to: Mr. J.C. Cox, Hughes Aircraft Co., Culver City, Calif. Hughes is an equal opportunity employer.

Creating a new world with electronics



Electronics Abroad

Volume 40
Number 7

Great Britain

Firing-line computer

In most of the world's armies, the field artillery aims its big guns today much as it did in the first World War—making painstaking calculations on paper to figure out where to point the guns to lay shells on target.

Command-post men in Britain's Royal Artillery, though, are about ready to throw away their graphs, card calculators, logarithm tables and the like. To aim the army's big guns, the Ministry of Defense has ordered 76 computer systems from Elliott Space and Weapon Automation Ltd., a subsidiary of Elliott-Automation Ltd.

Each system is worth about \$85,000 and so the army will spend \$6.5 million for firing-line computers mounted in armored track carriers. But the payoff will be substantial. For one thing, the computer system halves the number of men needed to direct a battery of six guns. For another, training time for artillery fire-control men will be cut from several weeks to seven days. Above all, with the computers a battery can be ready to fire six minutes after the guns are set up. The old way required up to 40 minutes of preliminary calculations.

By the numbers. The Elliott system, built around a 920B digital computer having a computation time of 23 microseconds and a memory of 8,000 words of 18 bits, can handle up to eight guns although the normal British battery has only six. Because the British usually control their guns individually, instead of by battery as does the U. S. Army, a separate channel is assigned to each gun.

To aim the guns with the help of the computer, the system operator slips into place a cassette with

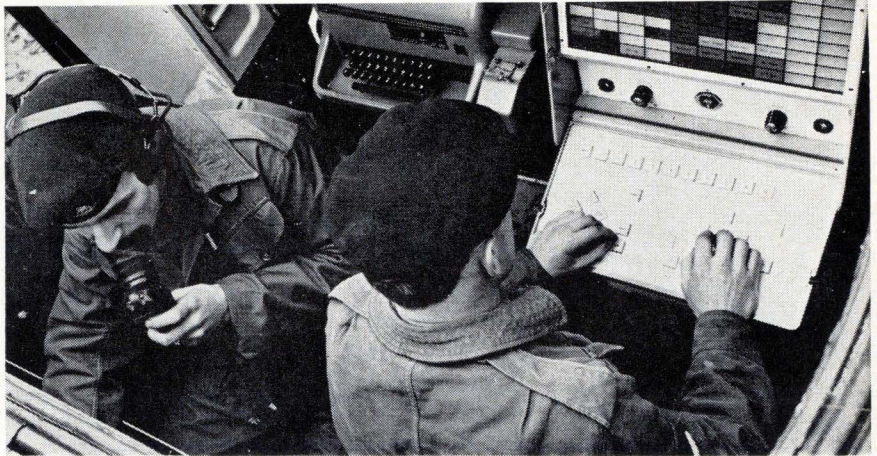

Ready, aim, fire. Officer in armored command-post vehicle relays aiming orders to gunners. Gun positions are calculated by artillery computer from data punched into keyboard.

the program for the type of field piece used by the battery. Then, by means of a keyboard, he feeds in the individual characteristics—muzzle velocity, offset from the theoretical center of the battery, and the like—for each gun. After that, atmospheric conditions are entered into the system and it is ready for target information.

So there can be no mistake, the system then lights up in sequence command panels that show what target data should be fed in by keyboard for each step of the calculation. The battery fire-control officer sings out the information to the man at the keyboard. As a double check, the data he punches into the system shows up on the display where the officer can see them. When all the information has been fed in, the system computes the azimuth and elevation for each gun and displays the information. The control officer relays the information by telephone, usually about 12 seconds after the target data starts feeding in.

Looking ahead. The next logical step in artillery fire control for the British would be to control the training and pointing drives of each gun directly by the computer.

But the army sees an on-line system as a long way off. Complex and expensive hardware would be necessary to control a battery's six guns individually.

The U.S. Army, which already has an off-line artillery fire control system, doesn't look like a potential customer for Elliott's system. But Elliott sees a chance for exports to other NATO countries. According to the company, no other West European army has a computer control system for front-line artillery.

Better grasp

A helping hand for amputees in Britain is coming from the country's Atomic Weapons Research Establishment at Aldermaston.

The National Health Service, which spends some \$3 billion yearly to keep Britons alive and healthy, has turned over to the weapons-research facility the job of bettering a prosthetic hand originally developed at a London hospital by a team headed by Dr. Alastair H. Bottomley.

Like the prosthetic limbs already developed in Russia, the United States and West Germany, the

Bottomley hand is controlled by electromyographic (EMG) potentials, low-level voltage signals transmitted to muscles when the brain orders them to contract or relax. The potentials are picked up by electrodes on the skin over the flexor and extensor muscle groups of the forearm. They are amplified, rectified and smoothed to obtain a direct-current drive signal for the motor that actuates the prosthetic hand.

Latest version of the Bottomley hand, displayed a fortnight ago at a medical electronics show in London, uses discrete circuits but thin-film integrated circuits are on the way. Already, the Aldermaston prosthesis group has developed an experimental version of a thin-film single-channel amplifier. It amplifies EMG potentials 100,000 times, giving an output between 0.5 volt and 1 volt. The common mode rejection of the amplifier is 60 decibels.

High-powered market

So far, Japan's Hitachi Ltd. and the Nippon Electric Co. have had to themselves the world market for commercial high-power electromicroscopes—production models operating at 500 or 1,000 kilovolts.

But competition for the Japanese is on the way from the United States, Holland and particularly Great Britain. There, backed with \$224,000 from the Ministry of Technology and a trio of orders from government research institutes, Associated Electric Industries Ltd. is going into production of a 1,000-kilovolt microscope.

The first three machines, each to cost around \$475,000, will go to the U.K. Atomic Energy Authority, the National Physical Laboratory, and the Science Research Council. AEI expects to corner several more British orders and sees a potential export market of perhaps 20 machines over the next three years.

Cavendish copy. Except for modifications needed to handle the higher power, AEI's production instrument will closely resemble the 750-kilovolt electronic microscope put into service at Cambridge Uni-

versity's Cavendish Laboratory last summer. Like their forerunner, the production versions will have five magnetic lenses, two condensing lenses in front of the specimen and three imaging lenses behind it. The operating range will be from 100 to 1,000 kilovolts with stability of one part in 100,000 over the whole range. The resolution will be better than 10 angstroms.

Unlike the Cavendish installation, however, the AEI microscopes will have the electron generator and accelerator enclosed in pressurized tanks for a more compact layout. Even so, the microscope column and accelerator tank will be 16 feet high and weigh about six tons.

AEI will buy the high-voltage generators needed for the microscopes from Emil Haefely and Co., a Swiss firm.

Under observation. The high-power microscopes most likely will be used principally to view living organisms like bacteria. At about 1,000 kilovolts, the radiation effect of an electron beam is at a minimum. But the instruments may head to better magnetic materials and semiconductors. At very high voltages, thick specimens of material can be viewed. The very thin specimens used in low-power electron-microscopes often belie the true characteristics of the bulk material from which they are sliced.

France

Laser-beam monitor

Many a surgeon has been reluctant to work with a laser in the operating room because there's no way to constantly check on the energy in the applied beam without interrupting it. Unless the energy level is known, there's always a danger of overburn.

Now, though, a French researcher has come up with a pair of detectors that can gauge a laser's output without intruding on the beam. And a French instruments maker, Schneider Radio-Télévision, has developed a digital

joulemeter to pair with the detectors. Both the detectors and the joulemeter will be on display at the Mesucora instruments and automation show that will run for a week in Paris starting April 14.

Piezoelectric. Marc Bruma, director of the laser laboratory of the Education Ministry's Centre National de la Recherche Scientifique, headed the team that developed the laser-energy detectors. One is a flat thin-film device, the other a hollow ceramic cylinder. Bruma won't disclose the materials used for the detectors, but he says they combine both semiconductor and piezoelectric properties.

The thin-film detector, he says, has the faster response and can pick up Q-switched laser pulses with durations from 10 to 100 nanoseconds. Placed alongside a laser beam, the thin-film device acts as a low-impedance current generator.

The ceramic cylinder, when a laser beam passes through it, acts as a voltage generator with an impedance higher than 1 megohm. The cylinder picks up only longer pulses, down to a minimum of 2 of 3 milliseconds. But unlike the thin-film detector, the cylinder can integrate the power of a laser beam over the full pulse. A typical detector cylinder is about an inch long and has an inside diameter of $\frac{3}{4}$ inch.

Both types of detectors, Bruma explains, react to the electromagnetic wave that accompanies a laser pulse.

Memory. Output of the transducers is recorded by the joulemeter developed by Schneider. It can log and print out laser pulses at rates up to one per second. Without the printer, the rate bounces up to between 35 and 50 pulses per second.

Like Bruma's sensors, the joulemeter has a range of 0.1 to 100 joules and a resolution of 0.1%. Essentially, the instrument consists of a digital voltmeter coupled to a linear analog memory. When the laser pulse has a short duration the memory stores the peak power voltage input from the detector until the voltmeter can respond. The voltmeter's response time is several milliseconds.

Japan

Best possible speed

Most tape-recorder manufacturers turn to mechanical engineers for the design of their tape drives and wind up with an array of idlers, pulleys, belts, and a mechanical governor to keep the tape sliding past the recording and playback heads at the right speed.

Japan's Sony Corp., however, has gone the electronics way. In its better tape recorders, the tape-drive capstan is the drive-motor shaft itself. Motor speed, and therefore tape speed, is kept constant by a servosystem. And to change tape speeds, all that's needed is to switch frequency-selective circuits in the servoamplifier. The servocontrol eliminates mechanical sources of wow, flutter, and slip. Just as important, it makes possible slow-running, long-wearing drive motors.

Sony first used the servocontrol on a \$200 three-speed tape recorder and a hi-fi turntable, both introduced on the American market last year. Now Sony has simplified the servocontrol and will have a \$130 two-speed recorder using it on the U.S. market later this month or in May. The recorder already is being sold in Japan.

On the shaft. Input for the speed control servoamplifier comes from a frequency generator in the drive motor. The generator field, recording-tape magnetic material molded

with a binder into a ring, is tucked into the motor flywheel and so spins at the same speed as the capstan that drives the tape. The field, magnetized to have 90 pole pairs, induces into the generator armature coil a voltage that is applied to the servoamplifier.

For a tape speed of 1 7/8 inches per second, the drive motor runs at 227 revolutions per minute and

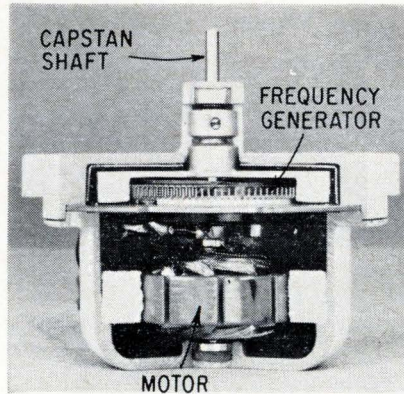

Frequency generator field is mounted on tape-recorder motor drive shaft. Pancake coil sandwiched between toothed armatures develops output voltage proportional to motor speed.

the generator develops an output of 3 volts at 341 hertz. The motor speed and generator output double for a tape speed of 3 3/4 inches per second. By comparison, mechanically governed direct-current tape recorder motors usually operate at either 2,400 or 3,000 rpm and alternating-current motors at 1,500 or 1,800 rpm. The slower the speed, the less the wear and the lower the noise.

Discriminating. The output of the frequency generator in the drive motor is fed to a discriminator in the servo circuit to develop a d-c signal for the amplifier that powers the motor. To ward off any tendency to flutter because of mechanical eccentricity of the frequency generator, its output is clipped by a pair of diodes in the starter circuit.

Crucial to the speed regulation is the discriminator's active low-pass filter. The kingpin stage is a twin-T filter whose gain plummets as the frequency of the input signal rises. Slight increases in drive motor speed, then, are countered by a drop in the voltage output of the amplifier that powers the motor. Actually, there are two active low-pass filters in the discriminator. One is switched in for 1 7/8-ips tape speed, the other for 3 3/4-ips tape speed.

The output of the twin-T filter goes to a two-transistor a-c amplifier and the amplified signal is then fed to a thermistor temperature compensation circuit that corrects for variations in gain over the temperature range of 0°C to 50°C. Final stage of the discriminator—a voltage doubler and rectifier—controls the d-c amplifier that powers the motor. A zener diode regulator keeps the power supply voltage for the servoamplifier circuits constant over a range from 8.5 volts to 15 volts.

The gain of the d-c amplifier, in the final analysis, sets the speed at which the tape-drive motor will be held since it transforms the dis-

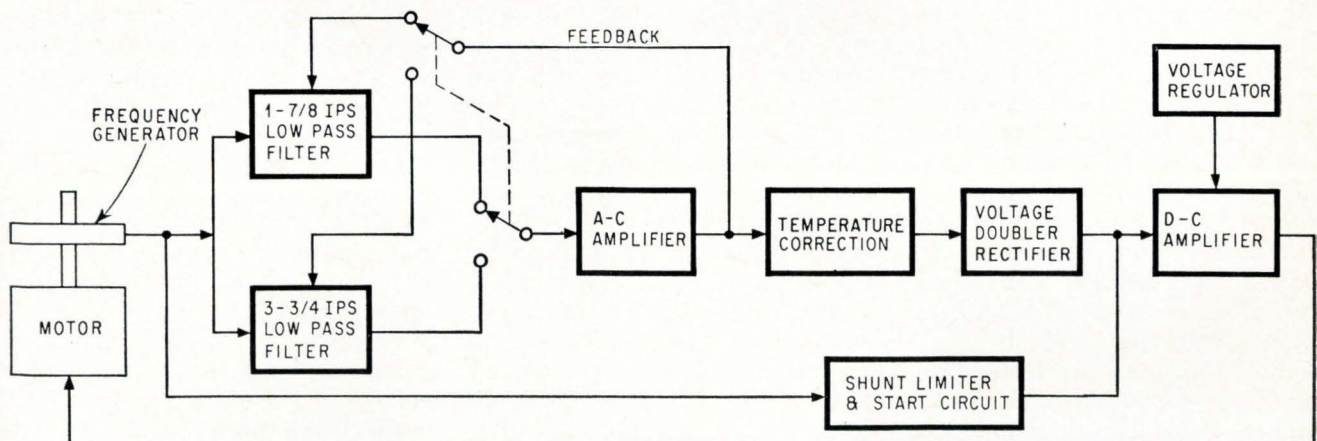

Running smoothly. Servocontrol for tape-recorder motor keeps tape speed constant and eliminates idlers, belts, and pulleys. Tape speed—either 1 7/8 or 3 3/4 inches per second—is set by switching in corresponding active low-pass filter.

criminator output into a drive voltage for the motor. As a result, a simple volume control in the amplifier makes it possible to vary the playback speed, say, to change the pitch when someone wants to play a musical instrument accompanied by the recorder or to slow down the music while learning a dance step.

Getting started. Since the servo-amplifier input comes from a frequency generator on the motor, a separate source is necessary to feed an input signal to the d-c amplifier and get the motor running. This is handled by a starter circuit, basically a silicon transistor stage whose output is fed to the amplifier through a germanium diode. When the motor gets up to speed, the starting circuit is disconnected. This is because the discriminator output raises the voltage level at the d-c amplifier input to the point where the germanium diode in the starting circuit is reversed biased and can no longer conduct.

Ohayo gozaimasu

Sharp-eared visitors to Expo 67, the world's fair that opens late this month in Montreal, will hear some strange sounds as they saunter through the Japanese pavilion.

The sounds will come from a voice synthesizer that Fujitsu Ltd. has developed as an audible output for its computers. To add to the fun at the fair, Fujitsu has programmed the demonstration computer—a Facom Series 230 Model 20—to translate from English into Japanese. When "good morning" is fed into the computer by typewriter, the printed-out response is "ohayo gozaimasu" and at the same time the robot-sounding voice of the synthesizer says it in Japanese.

Accent on sounds. Fujitsu quite frankly admits there's nothing particularly special about the translation program. It's limited to 8,000 single words and 2,000 colloquial phrases and sentences. But Fujitsu has made a stride forward with its voice synthesizer. With few exceptions, most synthesizers devised so far for computer read-

outs use a prerecorded vocabulary of words; Fujitsu's system builds words from the basic sounds in the language. If the computer program is adequate, then, it can sound any Japanese word.

Fujitsu expects one day computer systems with voice synthesizer readout will be used to automatically answer telephone queries about stock-exchange prices, airline seat reservations, inventories, and the like. Voice synthesizer response, though, won't become widespread until electronic exchanges become prevalent since the query inputs would have to come from telephone sets with touch-tone dialing.

Prerecorded. To get a voice synthesizer capable of saying anything, Fujitsu prerecorded 107 basic Japanese sounds on a computer memory drum. They include the five vowels, a raft of vowel-consonant combinations, and the final consonant "n". Rather than extracting the sounds out of words, Fujitsu had a woman pronounce the basic sounds as single syllables and recorded them that way.

Even when a word contains variations on the basic sounds, the synthesizer can pronounce them. To say "Kyoto", for example, where the first "o" is long and the second one short, the synthesizer pieces together "Kyo-o-to". To double a consonant, the system simply leaves a short gap before it, tricking the ear into hearing it twice. Although it sounds eery at first, the synthesizer speaks very understandably.

Hefty memory. Along with a 65,000 bit core memory, the talking computer at Montreal will have four tape handlers and two magnetic drum units. The 8,000 words in the translation vocabulary will be packed into two tape units. The third tape handler stores program information and the fourth will collect English words not in the translation vocabulary so it can be revised if necessary. The tape handlers all have 10 blocks each with a capacity of 32,000 digits of four bits.

Colloquial phrases and sentences are stored on one magnetic drum along with some additional

programming information. The second drum holds all the basic sounds.

The larger memory capacity for the basic sounds (the drum has 16 blocks of 32,000 four-bit digits) is needed because the individual sounds have a duration of 140 to 340 milliseconds and are sampled at a rate of 12 kilohertz. The normal voice sampling rate for a telephone channel is 8 khz. Because the synthesis from basic sounds inherently makes for unnatural speech, Fujitsu opted for higher-than-telephone quality to avoid further degradation.

East Germany

Coming up fast

This year's Leipzig Spring Fair confirmed what Western electronics experts long have suspected—there's no end in sight for the electronics boom in the German Democratic Republic.

At the Fair, a window on East Germany's kingpin industries, government officials reported that electronics and electric equipment last year showed the fastest growth of any sector of the country's economy. Output of the electrotechnical industries—electronics equipment accounts for about one third—hit \$2.12 billion in 1966, a gain of 8.7%. By comparison, total East German industrial production climbed 6.2% last year.

The upsurge in electronics figures to continue over the next few years. To keep their \$33 billion economy moving, government planners are stressing automation as a way to cope with a chronic labor shortage. And electronics rates high with the planners because the industry is a heavy exporter. A full quarter of East German electronics production is sold abroad. Most goes to other East-bloc countries but there's a drive on to sell more hardware to Western countries.

Strengths. From what they saw and heard at Leipzig last month, Western observers judged the East



**Now the
industry-
accepted TTL
has a double,
pin for pin...**

**Westinghouse TTL.
Available now.**

The new direct replacement for industry-accepted SUHL II is here. Westinghouse TTL is a true mechanical and electrical replacement, pin for pin. Here's a second source TTL that can help keep your products competitive into the 1970's. □ Circuits now available in industry standard dual-in-line and flat packages include: 6G241 Dual NAND/NOR Gate; 6G221 Quadruple NAND/NOR Gate; 6F251 JK Flip-Flop, AND input; 6F261 JK Flip-Flop, OR input. □ For evaluation quantities, contact your Westinghouse Electronic salesman. Or phone Westinghouse at (301) 796-3666. Or write Westinghouse, Molecular Electronics Division, Box 7377, Elkridge, Maryland 21227.

You can be sure if it's Westinghouse



J-09141

Circle 267 on reader service card

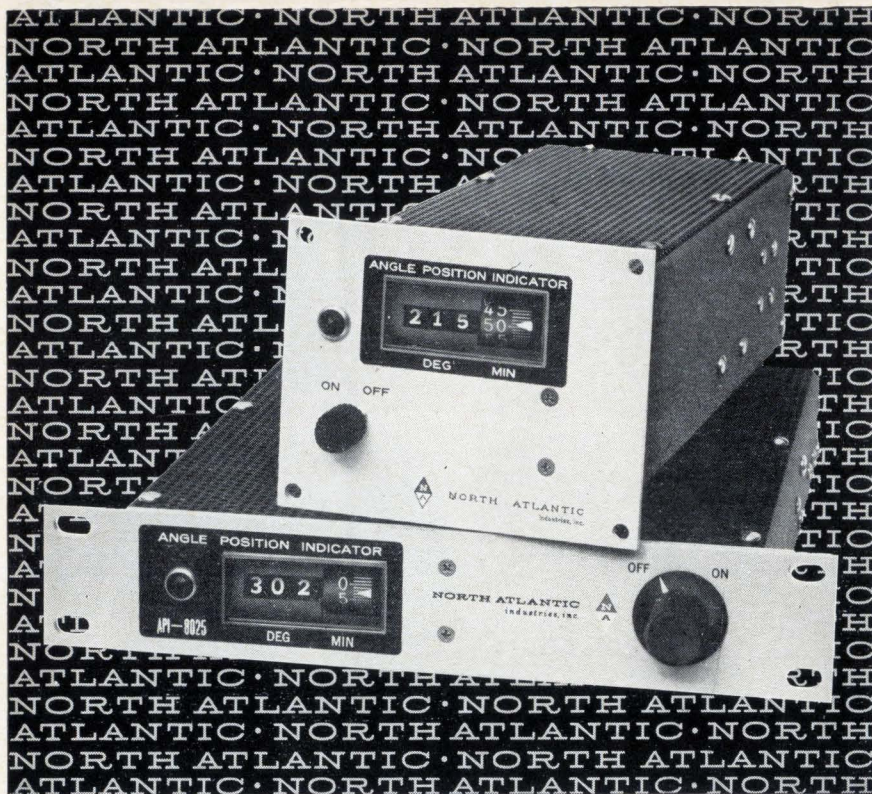

how to measure resolver or synchro position with 30 second repeatability

In both production test and ground checkout systems, North Atlantic's high performance Angle Position Indicators provide exceptional operator ease and precision in the measurement of synchro and resolver position. Features include digital readout in degrees and minutes, 30 second resolution, continuous rotation, plug-in solid-state amplifier and power supply modules. Due to the design flexibility of these units, they can be readily provided with a variety of features for specific requirements. Typical units in this line incorporate combinations of the following features:

- Single Synchro or Resolver Input
- Dual Synchro or Resolver Inputs
- Retransmit Synchro, Resolver, Potentiometer, or Encoder
- 2-Speed Synchro Input
- Multi-frequency Inputs
- DC Input
- 0-999 Counter

BASIC SPECIFICATIONS

Range	0°-360° continuous rotation
Accuracy	6 minutes (standard)
Repeatability	30 seconds
Slew Speed	25°/second
Power	115 volts, 400 cps
Size	API-8025 1¾" h x 9½" w x 9" d
	API-8027 3½" h x 4¾" w x 9¾" d



Your local North Atlantic representative has complete data on the API line. Call him today or write direct for technical literature.

NORTH ATLANTIC industries, inc.
TERMINAL DRIVE, PLAINVIEW, L. I., NEW YORK • Overbrook 1-8600

Germans weak in computers and semiconductor technology but strong in communications and industrial equipment.

In radio and television broadcast transmitters, for example, the East Germans have made their mark with 100 installations around the world. And East Germany is the leader of an East-bloc effort to develop electronic telephone exchanges. A 400-subscriber exchange using time-division multiplexing now is under test in East Berlin. Another indication of the country's communications capability: the industry's research institute has begun to concentrate its effort on modulation methods for communications through waveguides and by laser beams.

World class. Although output of automated machines for electronics production still is small—some \$11 million worth last year—what is produced is world class. VEB Elektromat now has in production a tape controlled electron-beam trimming machine that can turn out thin-film resistors accurate to 0.5% at a rate of one every 2.5 seconds. The machine was developed jointly with the Manfred von Ardenne Research Institute [Electronics, March 7, 1966, p. 110]. Elektromat also is doing well in export markets with its program-controlled wiring harness maker, its stator winder, and its automatic resistor grinder.

At the fair it was evident that much effort is going into automating machine tools. About half the heavy equipment on display was designed to fit into automatic production lines. And of 13 machine tools with program control, 6 were numerical. The most noteworthy numerical control machine was a profile grinder with continuous contour control using polar coordinates. The system is accurate to 0.003 millimeter and has a repeatability of ±0.002 mm.

Semiconductor struggle. East German officials frankly admit they're well behind the West in components, especially semicon-

Looking at Leipzig. Communications equipment is a forte of the East German electronics industry and there was plenty of it to see at the mid-March Leipzig Fair.

ductors. After considerable difficulty, they managed to get two semiconductor plants on-stream last year and produced 36 million diodes. Mass production of silicon planar epitaxial devices is scheduled to start later this year, and the goal is to double the output of semiconductor devices by 1970.

Even then, East Germany most likely will still have to turn to Russia and Western countries for highly sophisticated semiconductor components. The big drawbacks are a tight supply of high-quality semiconductor materials and lack of access to Western production know-how. Currently, the East German industry imports about a quarter of the semiconductor devices that it consumes.

Computer lag. Another soft spot is computers. Although the long-awaited East German medium computer, the Robotron 300, finally is in production, only five machines will be made this year. The planning for 1968 calls for an additional 25 or so. The computer is roughly in the same class as the 1410 model of the International Business Machines Corp., which has been on the market for six years.

The Robotron 300 is produced at VEB Rafena Werke in Radeburg, a plant gradually being shifted over from television-set production to data processing equipment pro-



by **AD-YU**
ELECTRONICS, INC.

249-259 TERHUNE AVENUE, PASSAIC, N. J.
Phone (201) 472-5622 • CABLE: ADYU PASSAIC

PRECISION PHASE METER TYPE 406

Most Popular Direct Reading Phase Meter

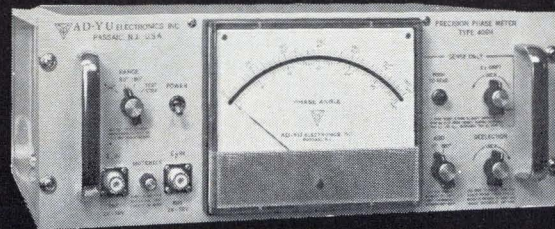

FEATURES:

- Direct reading in degrees.
- No amplitude adjustment of either signal voltage.
- No frequency adjustment from 1 cps to 500 kc.
- No ambiguity at zero reading.
- Meter reading independent of the ratio of input signal amplitudes.

USES:

- Phase checking in production lines.
- Plot phase curve for networks, amplifiers, systems.
- Measure fractional degree in the vicinity of zero.

SPECIFICATIONS:

- FREQUENCY RANGE** — Type 406, 8 cps to 100 kc; Type 406H, 8 cps to 500 kc; Type 406L, 1 cps to 100 kc.
- FULL SCALE RANGE:** 0-12, 0-36, 0-90, and 0-180 up to 360 degrees.
- ACCURACY:** $\pm 0.25^\circ$ relative, $\pm 0.3^\circ$ or 2% absolute.
- INPUT VOLTAGE:** 0.05 volt to 90 volts without adjustment.

DIGITAL PHASE METER TYPE 524A3

± 0.03 Degree Accuracy, 20 CPS to 500 KC

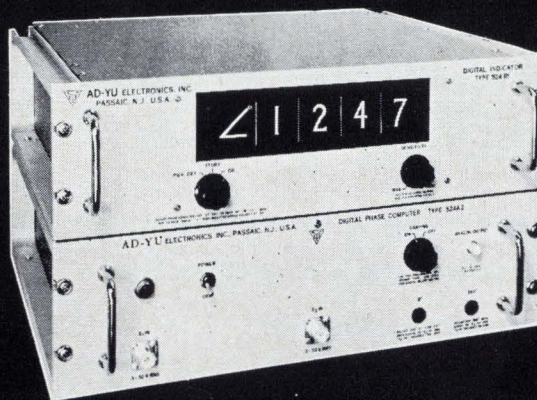

FEATURES:

- Phase reading directly in degrees in 5 digits (or 4 digits).
- No amplitude adjustment from 0.3v to 50v.
- No frequency adjustment up to 500 kc.
- Analog output available for recorder or programmable system.

USES:

- Plot phase vs. frequency curve of unknown network.
- Plot envelope delay curve with RF sweep oscillator.
- A standard phase meter with 5-digit readout.

Type 524A3 with indicator. Computer alone (bottom panel) can produce analog output to drive recorder and d.c. digital voltmeter. Price \$999.

WORLD FAMOUS FOR PHASE AND TIME MEASUREMENT 0.001 CPS TO 18 GC

WIDEBAND PRIMARY PHASE STANDARD, TYPE 209
50 CPS To 10 KC



VIDEO AND RF PHASE METER, TYPE 422A
50 CPS To 10 MC

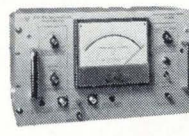

MICROWAVE PHASE AND TIME DETECTOR, TYPE 206A
1 GC To 8.2 GC

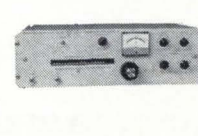

DUAL-CHANNEL SYNCHRONOUS FILTER, TYPE 1034
2 CPS To 20 KC

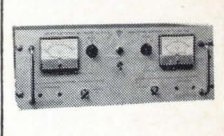

See Booth No. 3142 EF at the MESUCORA SHOW in Paris, France

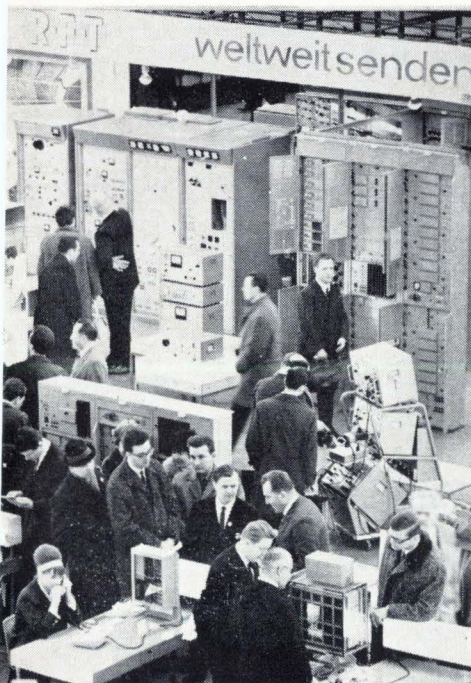

BIAX[®] and Core

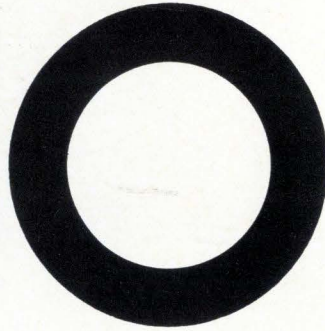
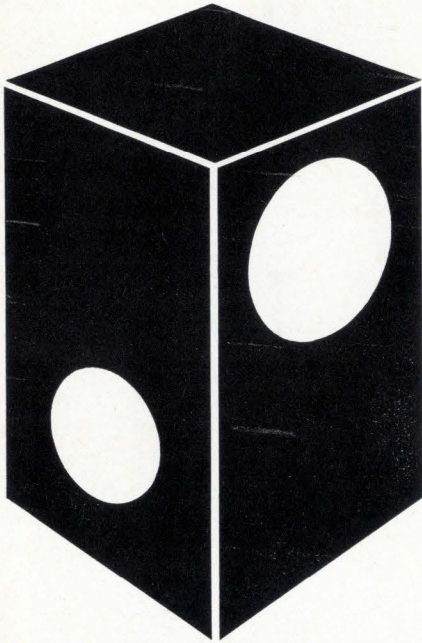

*Two ways to remember
Raytheon Computer.*

Raytheon Computer now makes DRO core memories as well as NDRO BIAX memories. The new 300 Memory System is a 900 nanosecond, 2½D core memory for large capacity, high-speed random access storage. Systems come in 8K and 16K modules with word lengths to 72 bits and are delivered complete with power supply and built-in self-tester. If you need an 8K or 16K memory with 28 bits or less, we can ship you a system in just a few weeks.

Since the first of this year, engineering sales representatives throughout the U.S. and Canada have been primed on both core and BIAX memories. If you'd like fast answers on prices, technical details and delivery, call any one of them today.

Visit us in booth "K" at SJCC.

ALABAMA
CURRIE AEROSPACE ASSOC.
Huntsville (205) 536-5650

CALIFORNIA
WILLIAMS, HEDGE & MARTIN
Costa Mesa (714) 540-3244
From L.A. (213) 944-3257
Palo Alto (415) 941-3505

COLORADO
AZTEC ENTERPRISES, INC.
Englewood (303) 761-0101

CONNECTICUT
J & J ASSOCIATES
Hamden (203) 624-7800

FLORIDA
CURRIE AEROSPACE ASSOC.
Orlando (305) 855-0843

ILLINOIS
PIVAN ENGINEERING
Chicago (312) 539-4838

INDIANA
PIVAN ENGINEERING
Indianapolis (317) 846-5805

IOWA
PIVAN ENGINEERING
Cedar Rapids (319) 365-6635

MASSACHUSETTS
J & J ASSOCIATES
Waltham (617) 899-0160

MICHIGAN
WKM ASSOCIATES, INC.
Detroit (313) 892-2500

MINNESOTA
PIVAN ENGINEERING
Minneapolis (612) 537-4501

MISSOURI
HARRIS-HANSON CO.
Kansas City (816) 444-9494
St. Louis (314) 647-4350

NEW JERSEY & MET. NEW YORK
KENNETH E. HUGHES CO., INC.
Fort Lee (201) 944-1600
N.Y. Phone (212) 695-0082

NEW MEXICO
AZTEC ENTERPRISES, INC.
Albuquerque (505) 268-6421

NEW YORK
DB ASSOCIATES, INC.
De Witt (Syracuse) (315) 446-0220
Lancaster (716) 835-6186

PENNSYLVANIA
WKM ASSOCIATES, INC.
Pittsburgh (412) 892-2953

TEXAS
CAREY-WOLF CO.
Houston (713) 643-2114

WISCONSIN
PIVAN ENGINEERING
Waukesha (414) 547-5131

CANADA
RAYTHEON CANADA, LTD.
Waterloo (519) 745-6831

duction. When the Radeburg plant is completely converted, all tv-set manufacture will be concentrated in a single plant at Stassfurt. This plant currently turns out 280,000 sets a year but later will be expanded to a capacity of 500,000 sets annually.

West Germany

Best on the field

An Austrian physicist working on his own in West Germany has made a significant advance in magnetic field measurement.

The physicist, 49-year-old Hermann Heidenwolf, has developed a magnetometer that can spot near-infinitesimal fields—as low as 10^{-5} gamma. Until Heidenwolf came along with his new device, the best magnetic field measuring instrument was the rubidium vapor magnetometer, sensitive to 10^{-2} gamma. By contrast, the earth's field in the United States runs around 55,000 gamma.

Heidenwolf maintains that his magnetometer can pick up submerged or buried objects at depths at least 10 times greater than was previously possible. Along with finding shipwrecks, iron-ore deposits and archeological sites, the new magnetometer will be used in a wide range of military and space applications. Heidenwolf predicts. And it one day may be the bane of motorists, since it could be used to check the speed of cars on highways. Heidenwolf says the instrument can be produced to sell for \$750 to \$1,000.

On the beam. The magnetometer is built around a special cathode-ray tube that Heidenwolf calls a "mytron". In the tube, the electron beam passes between a pair of pole pieces and is deflected by the induction field in the gap between them. The amount of deflection, a function of the field strength being checked, is picked off a pair of differential electrodes.

A good deal of the instrument's sensitivity comes from a magnetic concentrator that bundles lines of

RAYTHEON

Raytheon Computer, 2700 S. Fairview St., Santa Ana, Calif. 92704

magnetic force much as an optical system focuses light rays. To keep the high-permeability materials of the concentrator from becoming irreversibly magnetized, the instrument has a control network that powers a compensating coil.

Concentrated. The mytron is about 7 inches long and a little less than 1 inch in diameter. At one end is a pair of collector electrodes placed side by side; at the other end is the anode. About halfway between the anode and the electrodes are the pole pieces, separated by a slit 0.7 millimeter wide and 29 mm long.

The tube itself is housed inside two cylinders made of Ultraperm, a nickel-rich alloy (produced by Vakuumschmelze AG) with a permeability that runs as high as 1 million. The Ultraperm cylinders in effect amplify the field being measured by a factor of 10,000 and the field thus changes the permeability of the pole pieces and the induction field in the gap between them.

As a result, the electron beam moves off its normal centerline axis and because of the shift of the beam the two collector electrodes become charged unequally. The difference is amplified and applied to the compensating coil to produce a field that drives the electron beam back toward the centerline. The beam path, however, never quite coincides with the centerline and the small residual potential difference between the electrodes is fed to a galvanometer or oscillograph to measure the field strength.

Because of the self-compensation, the magnetometer is not affected by variations in the permeability of the concentrator caused by temperature changes. And drifts in the density of the electron beam have virtually no effect on the accuracy of the measurements.

Normal variations in the earth's magnetic field, though, would make accurate measurements impossible were a single magnetometer used alone. Because of the high sensitivity, the magnetometers must be operated in pairs interconnected so that the effects of the earth's field cancel out.



livability

(an industrial location advantage)



There's pleasant living for you and your employees when you locate your plant in prosperous WESTern PENNSylvania. Ski on nearby slopes . . . fish for wary trout and bass . . . hunt big and small game . . . water-ski . . . golf . . . listen to music by a top symphony orchestra . . . go to art festivals, operas, big-league ball games and straw hat theaters . . . or visit reminders of an historic past. Large and small industrial sites are available, many on rivers and streams. There's room to spread out . . . to live and grow. This four-season livability . . . plus 100% financing at low, low interest rates . . . fair tax climate . . . pre-production training of a work force, usually at no cost to you . . . gives WESTern PENNSylvania a top combination of plant-location values.

West Penn Power

Part of the Allegheny Power System 

Area Development Department, Room 764
WEST PENN POWER—Greensburg, Pa. 15601

Phone: 412-837-3000

In strict confidence, I'd like to know more about WESTern PENNSylvania's:

- | | |
|---|--|
| <input type="checkbox"/> Four-Season Livability | <input type="checkbox"/> Fair Tax Climate |
| <input type="checkbox"/> Financing Plans | <input type="checkbox"/> Pre-Production Training |
| <input type="checkbox"/> Please have your Plant Location Specialist call. | |

Name _____ Title _____

Company _____

Address _____

City _____ State _____ Zip Code _____ Phone _____

Electronics advertisers

April 3, 1967

■ Acme Electric Corp.	222	■ DuPont de Nemours & Co., Freon Div.	67	Iowa Development Commission	189
Scheel Adv. Agency, Inc.		Batten, Barton, Durstine & Osborn, Inc.		L.W. Ramsey Adv.	
■ Acopian Corp.	230	■ DuPont de Nemours & Co., Mylar Div.	83	□ ■ ITT Jennings Mfg. Co.	OAS 9
Mort Barish Assoc.		Batten, Barton, Durstine & Osborn, Inc.		West, Weir & Bartel, Inc.	
■ Adage, Inc.	82	■ DuPont de Nemours & Co., Teflon Div.	60	ITT Semiconductors Division	274
Stone and Manning Adv., Inc.		Batten, Barton, Durstine & Osborn, Inc.		Neals & Hickok Inc.	
■ ADC Products	175	■ Durant Mfg. Co.	74	□ ITT Standard Telephones & Cables Ltd.	OAS 11
John Gompper & Assoc.		Franklin Mautner Adv.		Brockie Haslam & Co.	
■ Ad Yu Electronics, Inc.	269				
P & G Adv.					
■ Aerospace Corp.	216, 217	■ E G & G, Inc.	166		
Faust/Day Inc. Adv.		Culver Adv., Inc.		■ J F D Electronics Co., Components Div.	227
■ Airpax Electronics, Inc.	182	■ Electro Scientific Ind.	250	Delphi Adv., Inc.	
Welch, Mirabile & Co.		Nadler & Larimer, Inc.		■ Johnson Co., E.F.	32, 33
■ Amelco Semiconductor, Div. of Teledyne, Inc.	147	■ Electronized Chemicals Corp.	249	Midland Assoc.	
Sturges & Assoc.		Kenyon & Eckhardt, Inc.			
■ Ammon Instruments, Inc.	242	□ E M I Electronics Ltd.	OAS 16		
Culver Adv. Agency		Bonner Hodgson & Partners Ltd.		■ Kurz-Kasch, Inc.	129
■ AMP, Inc.	260, 261	■ Erie Technological Products Co., Inc.	3rd Cover	Sabatino Adv., Inc.	
Garceau, Hargrave & McCullough, Inc.		Altman-Hall Assoc.			
■ Amperite Co.	48	■ Executone, Inc., Printact Relay Div.	178		
H.J. Gold Co.		J.A. Richards		■ Lapp Insulator Co.	179
■ Amphenol Corp., Connector Div.	18, 19			Wolff Assoc.	
Marsteller, Inc.		■ Fairchild Instrumentation	212, 213, 215	■ Ledex, Inc., Bramco Controls Div.	208
■ Arinc Research Corp.	234	Faust/Day, Inc.		Yeck & Yeck, Inc.	
S.G. Stackig, Inc.		■ Fairchild Semiconductor, Inc.	12, 13	■ Lesa of America Corp.	235
■ Arnold Engineering Co.	191	Faust/Day, Inc.		Zam & Kirshner, Inc.	
Burton Browne Adv.		□ Farbenfabriken Bayer A.G.	OAS 2	■ Litton Industries Inc. Triad Distributor	247
		Werbeagentur Clemens H. Pocht		West, Weir & Bartel, Inc.	
■ Babcock Relays, Div. of Babcock Electronics Corp.	69	■ Federated Purchaser, Inc.	239	■ Litton Industries, USECO Div.	231
Leland Oliver Co.		March Adv., Inc.		West, Weir & Bartel, Inc.	
■ Ballantine Laboratories	205	■ Ferroxcube Corporation of America	68	■ Litton Industries, Inc., Winchester Electronics Div.	187
Lang-Lawrence Adv.		Solow Wexton		West, Weir & Bartel, Inc.	
■ Barnstead, Sub. of Ritter Pfaudler Corp.	188			■ Lockheed Missiles & Space Co.	209
Creamer Trowbridge & Case, Inc.		■ General Atomics Corp.	241	McCann Erickson	
□ ■ Beckman Instrument International	OAS 8	Garceau, Hargrave & McCullough, Inc.		□ L T T	OAS 17
Hixson & Jorgensen, Inc.		■ General Aniline & Film Corp., Photo & Repr. Div.	51	Promotion Vente Publicite	
■ Belden Mfg. Co.	59	Hazard Adv. Co., Inc.			
Fensholt Adv., Inc.		■ General Dynamics, Fort Worth Div.	160	■ McCoy Electronics Co., Sub. of Oak Electro/Netics Corp.	76
■ F.W. Bell, Inc.	190	Glenn Adv., Inc.		Buchen Adv., Inc.	
Wheeler, Knight & Gainey, Inc.		■ General Electric Co., Capacitor & Components Div.	158	■ McGraw-Hill Book Co.	203
■ Binary Electronics of California	248	George R. Nelson, Inc.		■ Machlett Laboratories, Div. of Raytheon Co.	11
■ Black & Webster	247	■ General Electric Co., Component Capsules Div.	71	Fuller, Smith & Ross, Inc.	
Larcom Randall Adv., Inc.		George R. Nelson, Inc.		■ Magnetic Shield, Div. of Perfection Mica Co.	235
■ Borg Warner Corp.	72	■ General Electric Co., Electronic Components Sales Operation	30, 31	Burton Browne Adv.	
Ingersoll Products Div.		George R. Nelson, Inc.		■ P.R. Mallory & Co., Mfg. Division	8
Connor-Sager Assoc.		■ General Radio Co.	6	Aitkin-Kynett Co.	
■ Bourns, Inc., Trimpot Div.	171, 197	Horton, Church & Goff		□ Marconi Co. Ltd.	OAS 19
Lester Co., The		■ Globe Industries, Inc.	247	Hampshire House Ltd.	
■ Burr-Brown Research Corp.	176	Odiorne Industrial Adv.		■ Marconi Instrument	70
N.A. Winter Adv. Agcy.		■ Gulf States Utilities Co.	230	Armand, Richards Adv.	
■ Burroughs Corp., Electronic Components Div.	86	Aylin Adv. Agcy.		■ Markem Machine Co.	150
Conti Adv. Agcy., Inc.				Culver Adv., Inc.	
		■ Hamilton Watch Co.	218	■ Master Specialties Co.	161
■ CML, Div. of Tenney Engineering Co.	243	Beaumont, Heller & Sperling, Inc.		William E. Wilson Co.	
Keys, Martin & Co.		■ Hansen Mfg. Co.	204	■ Meguro Electronic Instrument	248
■ Cambridge Thermionic Corp.	84	Keller-Crescent Co.		General Adv. Agcy.	
Chirurg & Cairns, Inc.		■ Heinemann Electric Co.	16	■ Microdot, Inc.	15
■ Cedar Engineering, Div. of Control Data Corp.	243	Thomas R. Sundheim, Inc.		Gumpertz, Bentley & Dolan Adv.	
Colle & McVoy Adv.		■ Hewlett-Packard, Colorado Springs Div.	17	□ Milo International, Div. of Milo Electronics Corp.	OAS 18
■ Celanese Corporation of America, Celanese Plastics Div.	162	Tallant/Yates Adv., Inc.		Industrial Marketing Assoc.	
West, Weir & Bartel		■ Hewlett-Packard, Frequency & Time Div.	180, 181	■ Minnesota Mining & Mfg. Co., Chemical Div.	193
■ Cerro Sales Corp.	229	Lennen & Newell Inc.		Young & Rubicam, Inc.	
Feely Adv. Agcy., Inc.		■ Hewlett-Packard, Harrison Div.	151	■ Minnesota Mining & Mfg. Co., Scotchpar Div.	78
□ Compagnie des Compteurs	OAS 10	Healy Adv. Agcy.		Klau-Van Pietersom Dunlap, Inc.	
S.P.I.		■ Hewlett-Packard, Loveland Div.	56, 57	■ Missouri Commerce & Industrial Div.	228
■ Components, Inc.	194	Tallant/Yates Adv., Inc.		Frank Block Assoc.	
Creative Adv. Agcy.		■ Hewlett-Packard, Microwave Div.	1	■ Mitre Corp.	28
■ Computer Measurements Co.	58	Lennen & Newell, Inc.		The Bresnick Co.	
The Bowes Co.		■ Hewlett-Packard, Rockaway Div.	159	■ Mitsumi Electric Co. Ltd.	250
■ Consolidated Electro-dynamics Corp., Sub. of Bell & Howell	62	Culver Adv., Inc.		Sanko Tsushinsha Ltd.	
Hixson & Jorgensen, Inc.		■ Hewlett-Packard, Sanborn Div.	2	■ Motorola Communications & Electronics, Inc.	80
■ Control Data Corp., La Jolla Div.	186	Culver Adv., Inc.		K & A, Inc.	
Barnes Champ Adv.		■ Hughes Aircraft Co.	224, 262	■ Motorola Semiconductor Products, Inc.	55, 111, 165
■ Control Switch, Div. of Control Co. of America	157	Foote, Cone & Belding, Inc.		Lane & Bird Adv., Inc.	
Harry P. Bridge Co.		■ Hysol Corp.	226		
■ Coors Porcelain Co.	155	Barber & Drullard, Inc.		■ National Cash Register	156
Tallant/Yates Adv. Inc.				Allen Dorsey & Hatfield	
■ Couch Ordnance, Inc., Couch Co. Div.	198	■ Image Instruments, Inc.	50	■ National Electronics, Inc.	245
Culver Adv., Inc.		L.K. Frank Co., Inc.		Connor-Sager Assoc.	
■ Curtis Development & Mfg. Co.	245	■ Indiana General Corp., Ferrites Div.	24	■ National Research Corp., Equipment Div.	152
Keck Adv. Agcy.		Griswold & Eshleman		S. Gunnar Myrbeck & Co.	
		■ Industrial Chemical Specialties	244	■ National Semiconductor Corp.	232, 233
■ Damon Engineering, Inc.	167	Robert A. Paul Adv.		Michel-Cather, Inc.	
L.K. Frank Co., Inc.		■ Industrial Control Co.	225	■ New Hermes Engraving Machine Corp.	225
■ Dana Laboratories, Inc.	173	Beecher Assoc.		Lester Harrison Adv.	
E.L. Van Deusen Co.		■ Industrial Electronic Engineers	130	■ North Atlantic Industries, Inc.	268
■ Data Control Systems	227	Gumpertz, Bentley & Dolan, Inc.		Murray Heyert Assoc.	
Bodge-Eade, Inc.		■ International Electronic Research Corp.	195	■ Norton Associates, Inc.	225
■ Delevan Electronics Corp.	246	Van Der Boom, McCarron, Inc. Adv.		J.J. Coppo Co.	
Stahlka, Fallier & Klenk Adv.		■ I R C, Inc.	149		
■ Di-Acro Corp., Div. of Houdaille Industries, Inc.	210	Gray & Rogers, Inc.			
Charles E. Brown Adv.					



Advertising sales staff

Frank E. LeBeau [212] 971-6464

Advertising sales manager

Wallis Clarke [212] 971-2187

Assistant to sales manager

Donald J. Austermann [212] 971-3139

Promotion Manager

Atlanta, Ga. 30309: Michael H. Miller, 1375 Peachtree St., N.E. [404] TR 5-0523

Boston, Mass. 02116: William S. Hodgkinson McGraw-Hill Building, Copley Square [617] CO 2-1160

Chicago, Ill. 60611: Robert M. Denmead, J. Bradley MacKimm, Ralph Hanning, 645 North Michigan Avenue, [312] MO 4-5800

Cleveland, Ohio 44113: William J. Boyle, 55 Public Square, [216] SU 1-7000

Dallas, Texas 75201: Richard P. Poole, 1800 Republic National Bank Tower, [214] RI 7-9721

Denver, Colo. 80202: Joseph C. Page, David M. Watson, Tower Bldg., 1700 Broadway, [303] 255-5484

Detroit, Michigan 48226: Ralph Hanning 856 Penobscot Building [313] 962-1793

Houston, Texas 77002: Kenneth George, 2270 Humble Bldg., [713] CA 4-8381

Los Angeles, Calif. 90017: Ian C. Hill, John G. Zisch, 1125 W. 6th St., [213] HU 2-5450

Minneapolis, Minn. 55402: J. Bradley MacKimm, 1104 Northstar Center [612] 332-7425

New York, N.Y. 10036

500 Fifth Avenue

Donald R. Furth [212] 971-3615

James R. Pierce [212] 971-3616

Stanley J. Kail, Jr. [212] 971-3617

Philadelphia, Pa. 19103: Warren H. Gardner, Jeffrey M. Preston, 6 Penn Center Plaza, [215] LO 8-6161

Pittsburgh, Pa. 15222: Warren H. Gardner, 4 Gateway Center, [412] 391-1314

Portland, Ore. 97204: James T. Hauptli, 218 Mohawk Building, 222 S.W. Morrison Street, Phone [503] 223-5118

Rochester, N.Y. 14534: William J. Boyle, 9 Greylock Ridge, Pittsford, N.Y. [716] 586-5040

St. Louis, Mo. 63105: Robert M. Denmead The Clayton Tower, 7751 Carondelet Ave. [314] PA 5-7285

San Francisco, Calif. 94111: James T. Hauptli, 255 California Street, [415] DO 2-4600

London W1: John W. Patten, Edwin S. Murphy Jr., 34 Dover Street, Hyde Park 1451

Milan: Robert M. Saidel 1 via Baracchini Phone: 86-90-656

Frankfurt/Main: Gerd Hinske, Dieter Rothenbach, Elsa-Brandstroem Str. 2 Phone: 72 01 81

Geneva: Michael R. Zeynel, 1, rue du Temple Phone: 31 95 60

Paris VIII: Denis Jacob, Kenneth Davey, 17 Avenue Matignon Phone: 359 6637

Tokyo: Nobuyuki Sato, 1, Kotohiracho Shiba, Minato-Ku [502] 0656

Osaka: Ryoji Kobayashi 163, Umegae-cho Kita-ku [362] 8771

Business department

Wallace C. Carmichael, Manager

[212] 971-3191

Stephen R. Weiss, Production Manager

[212] 971-2044

Thomas M. Egan, Assistant Production Manager [212] 971-3140

Dorothy Carmesin, Contracts and Billings

[212] 971-2908

Circulation and research

Milton Drake, Manager [212] 971-3485

Isaaca Siegel, Assistant Circulation Manager

[212] 971-6057

David Strassler, Assistant Research Manager

[212] 971-6058

Chloe D. Glover, Research Associate

[212] 971-6057

Electronics buyers' guide

George F. Werner, General Manager

[212] 971-2310

Regina Hera, Directory Manager

[212] 971-2544

Thomas M. Egan, Production Manager

[212] 971-3140

Opto-Metric Tools, Inc. 236
L.W. Frohlich & Co.

Pek Laboratories 7
Sturges & Assoc.

Phelps Dodge Electronics Products Corp. 200
Smith, Dorian & Burman, Inc.

■ **Philbrick Researches, Inc.** 34, 35
Culver Adv., Inc.

□ **Philips Eindhoven, N.V.** OAS 1, 3, 5, 20
T.A.G. De La Mar

Plessey Electronics Co., Ltd., Transistorized Signalling Units 148
Roles & Parker Ltd.

Plessey Electronics Co. Ltd., Matrix Div. 199
Roles & Parker Ltd.

■ **Polarad Electronics Corp., Polarad Electronics Instrument Div.** 75
Mort Barish Assoc., Inc.

■ **Potter & Brumfield, Div. of Amer. Machine & Foundry Corp.** 220, 221
Grant, Schwenck & Baker, Inc.

Princeton Applied Research Corp. 38
Mort Barish Assoc.

Radio Corporation of America 4th Cover, 22, 53
Al Paul Lefton Co.

Raytheon Co., Components Div. 36
Fuller & Smith & Ross, Inc.

Raytheon Computer Co. 270
Martin Wolfson Adv.

■ **Republic Foil, Inc.** 192
The Graphic Group

R F L Industries, Inc., Instrumentation Div. 172
Josephson, Cuffari & Co.

The Rowan Controller Co. 79
Electronic Adv., Inc.

Sage Electronics Corp. 243
Mathison Adv., Inc.

■ **Sanders Associates, Inc. Flexprint Products Div.** 77
Chirurg & Cairns, Inc.

Sanders Associates, Inc., Microwave Div. 20, 21
Chirurg & Cairns, Inc.

Scientific Data Systems 81
Doyle, Dane, Bernbach, Inc.

Sci-Tek Computing Center, Inc. 240
Stanley, Richard, Fredrick, Inc.

Semicon, Inc. 52
L.K. Frank Co., Inc.

□ **Sesco** OAS 13
Maurice Ridart Editions Techniques & Publicite de Firmes

Sigma Instruments, Inc. 154
Marschalk Co., Inc.

Signetics Corp., Sub. Corning Glass Works 9
Cunningham & Walsh, Inc.

Singer Co., Metrics Div. 255, 256
Hepler & Gibney, Inc.

Skottie Electronics 244
Patrick J. Lahey, Inc.

Sola Basic Industries, Sola Electric Div. 206, 207
Marsteller, Inc.

□ **Solarton Electronic Group Ltd.** OAS, 6 7, 14, 15
Southern Adv. Ltd.

Sollitron Devices, Inc., Transistor Div. 37
Haselmire Pearson Adv.

Solutec Corp. 73
Neals & Hickok, Inc.

□ **Souriau & Cie** OAS 4
Ariane Publicite

South Dakota Industrial Development Expansion Agency 242
Maurice Paulsen Adv.

Spectra Physics 249
Deutsche Industrie Marketing Organisation

□ **S.P. Elettronica** OAS 12
Jones, Maher Roberts Adv.

Spectrol Electronics Corp. 27
Jones, Maher Roberts Adv.

Sperry Electronic Tube, Div. of Sperry Rand Corp. 64
Neals & Hickok, Inc.

The Sprague Electric Co. 5, 10
Harry P. Bridge Co.

■ **Stackpole Carbon Co., Electronic Components Div.** 112
Meek & Thomas, Inc.

■ **Superior Tube Co.** 219
Gray & Rogers Adv.

Sylvania Electric Products, Inc., Parts Div. 259
Tatham-Laird & Kudner, Inc. Adv.

Sylvania Electric Products, Inc., General Telephone & Electronics Tatham-Laird & Kudner, Inc. Adv. 61

Synthane Corp. 237, 239
Arndt, Preston, Chapin, Lamb & Keen, Inc.

Tektronix, Inc. 47
Hugh Dwight Adv., Inc.

Tel-Com Instruments, Inc. 138
Gross Adv. Service

Telonic Instruments 153
Jansen Assoc.

Telrex Communication Engineering Laboratories 242
Geo. Homer Martin Assoc.

Tempress Research Co., Inc. 63
Hal Lawrence, Inc.

Texas Instruments, Incorporated 137
Robinson-Gerrard, Inc.

■ **Times Wire & Cable, Div. of International Silver Co.** 54
Mohr & Co., Inc.

Tohoku Metal Industries Ltd. 231
Hakuhodo, Inc.

■ **Torotel, Inc.** 14
Spangler Adv. Inc.

Transformer Electronics Co. 238
Dacey, Wolff & Weir

■ **Transitube, Inc.** 223
Herbert Arthur Morris Adv.

TRW Instruments 238
Fuller & Smith & Ross, Inc.

TRW (Systems) & Semiconductors 45
Fuller Smith & Ross, Inc.

■ **Tung Sol, Div. of Wagner Electric Corp.** 245
E.M. Freystadt Assoc.

The Victoreen Instrument Co. 196
Palm & Peterson, Inc.

Ulano & Co., J. 185
Byrde, Richard & Pound, Inc.

Union Carbide Corp., Electronics Div. 29
J.M. Mathes, Inc.

Union Carbide Corp., Linde Div. 211
J.M. Mathes, Inc.

United Systems Corp. 237
Adv. & Merchandising, Inc.

United Transformer Co. 2nd Cover
Philip Stogel Co.

■ **Unitrode Corp.** 49
Silton, Huffman, Inc.

Victory Engineering Corp. 202
BRM Black-Russell-Morris

Westinghouse/Med. 267
ITSM Div. of McCann-Erickson

Westinghouse, Semiconductor Div. 85
ITSM Div. of McCann-Erickson

West Penn Power Co., Area Development Dept., Allegheny Power System 271
Fuller & Smith & Ross, Inc.

S.S. White Co., Airbrasive Div. 174
W.L. Towne Co., Inc.

■ **White Instrument Laboratories** 248
Wilson & Assoc.

Classified Advertising

F.J. Eberle, Business Mgr.

PROFESSIONAL SERVICES 252

EMPLOYMENT OPPORTUNITIES 251-252

EQUIPMENT (Used or Surplus New) For Sale 252

ADVERTISERS INDEX

A & A Electronics Corp 253

Atomic Personnel Inc. 252

Cadillac Assocs. 252

Ewald Instruments Corp. 253

Fishman Co., Philip 253

General Dynamics, Electronics Div. 251

Radio Research Instrument Co. 253

U.S. Department of State 252

■ For more information on complete product line see advertisement in the latest Electronics Buyers' Guide

□ Advertisers in Overseas Advertising Section following Newsletter from Abroad

The Predictables.

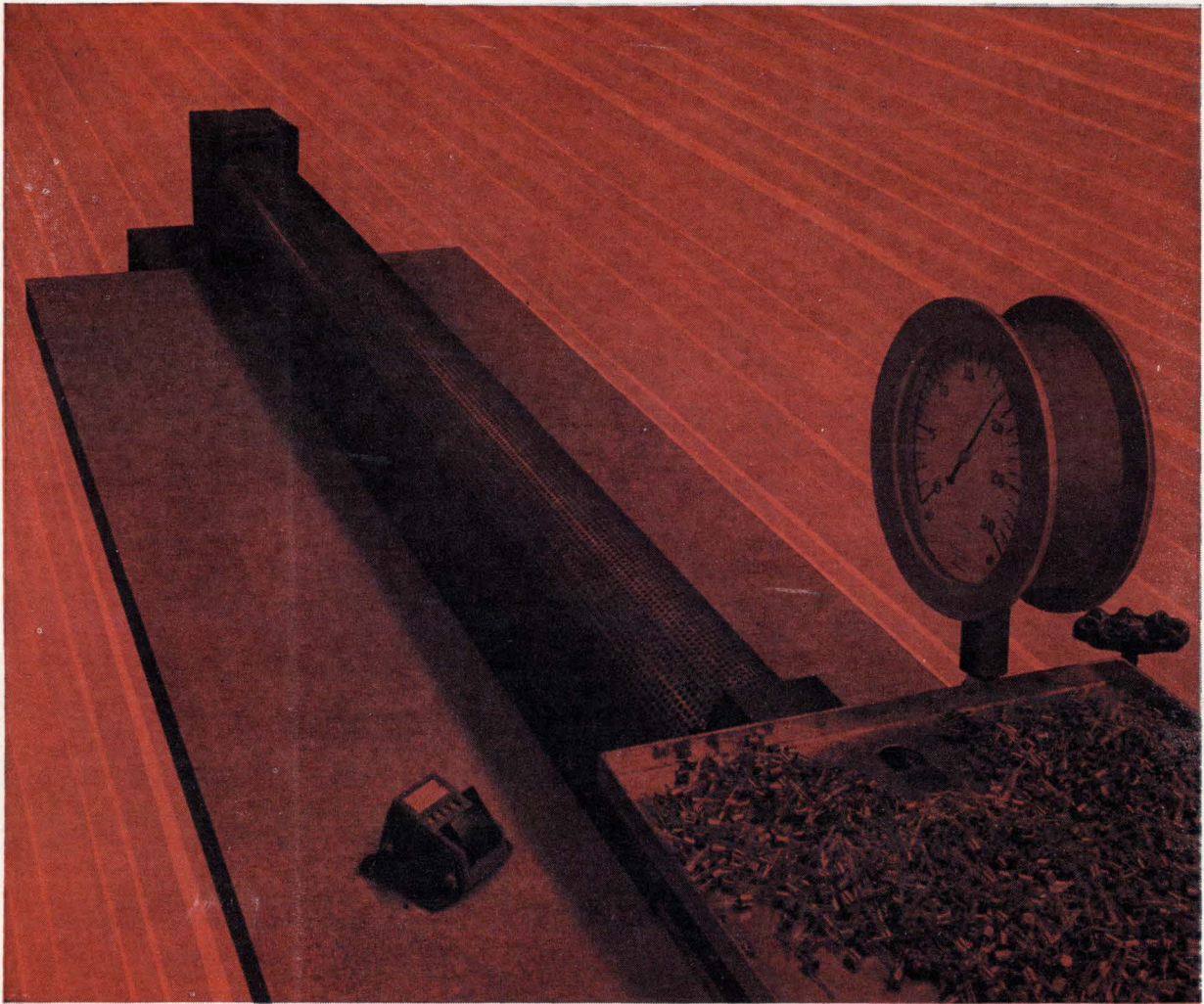

NPN planars from ITT are "shot from guns" to prove they can take more abuse than they'll ever get

Before any ITT small signal transistor goes to final test, our "air rifle" slams it against a plate with 30,000 G's of shock. Then every ITT "predictable" is automatically tested for up to 256 DC & dynamic parameters.

That means you can buy popular transistors like the 2N2222, 2N2369A, 2N3725 and 2N3014 families

with complete confidence. If there's one out of spec, we find it . . . you don't. The ones you get from your ITT distributor or factory representative will be 100% reliable. Why not order some today? ITT Semiconductors is a Division of International Telephone and Telegraph Corporation.

transistors **ITT**

FACTORIES IN WEST PALM BEACH, FLORIDA; PALO ALTO, CALIFORNIA; LAWRENCE, MASSACHUSETTS; HARLOW AND FOOTSCRAY, ENGLAND; FREIBURG AND NURENBERG, GERMANY