

LIBRARY
UNIVERSITY OF TENN. MED. UNITS
ALBANY

OCT 18 1967

Electronics®

w/10 2/9/72

Linear IC's — operational amplifiers: page 86

Broader use of scattering parameters: page 100

Using a scope for computer display: page 120

October 16, 1967

\$1.00

A McGraw-Hill Publication

Below: The military integrates a 3-dimensional radar, page 111

NO LONGER
CURRENT SHELF





DI-T200™ SERIES

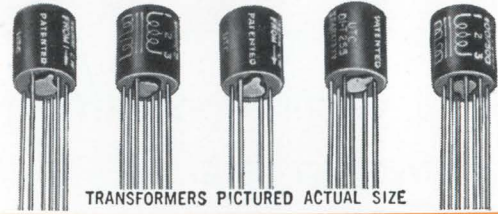

ULTRAMINIATURE TRANSISTOR TRANSFORMERS & INDUCTORS

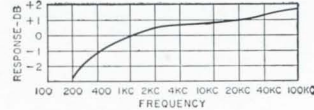
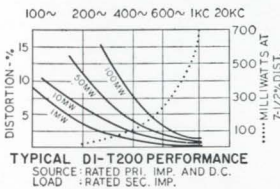

- ➔ **DUMET LEADS**
(gold plated, weldable and solderable)
- ➔ **STRAIGHT PIN TERMINALS**
(printed circuit application)
- ➔ **HIGHEST PERFORMANCE**
for size in the industry
- ➔ **METAL ENCASED**
(Grade 4, Ruggedized)

| Type No. | Pri. Imp. | DCma [†] in Pri. | Sec. Imp. | Pri. Res. | Mw Level | Application |
|----------|---------------------------|--|---|-----------------------|----------|---------------------------------------|
| DI-T225 | 80 CT 100 CT | 12 10 | 32 split 40 split | 10 | 500 | Interstage |
| DI-T230 | 300 CT | 7 | 600 CT | 20 | 500 | Output or line to line |
| DI-T235 | 400 CT 500 CT | 8 6 | 40 split 50 Split | 50 | 500 | Interstage |
| DI-T240 | 400 CT 500 CT | 8 6 | 400 split 500 split | 50 | 500 | Interstage or output (Ratio 2:1:1) |
| DI-T245 | 500 CT 600 CT | 3 3 | 50 CT 60 CT | 65 | 500 | Output or matching |
| DI-T250 | 500 CT | 5.5 | 600 CT | 35 | 500 | Output or line to line or mixing |
| DI-T255 | 1,000 CT 1,200 CT | 3 3 | 50 CT 60 CT | 110 | 500 | Output or matching |
| DI-T260 | 1,500 CT | 3 | 600 CT | 90 | 500 | Output to line |
| DI-T265 | 2,000 CT 2,500 CT | 3 3 | 8,000 split 10,000 split | 180 | 100 | Isol. or interstage (Ratio 1:1:1) |
| DI-T270 | 10,000 CT 12,000 CT | 1 1 | 500 CT 600 CT | 870 | 100 | Output or driver |
| DI-T273 | 10,000 CT 12,500 CT | 1 1 | 1,200 CT 1,500 CT | 870 | 100 | Output or driver |
| DI-T276 | 10,000 CT 12,000 CT | 1 1 | 2,000 CT 2,400 CT | 870 | 100 | Interstage or driver |
| DI-T278 | 10,000 CT 12,500 CT | 1 1 | 2,000 split 2,500 split | 620 | 100 | Interstage or driver |
| DI-T283 | 10,000 CT 12,000 CT | 1 1 | 10,000 CT 12,000 CT | 970 | 100 | Isol. or interstage (Ratio 1:1) |
| DI-T288 | 20,000 CT 30,000 CT | .5 .5 | 800 CT 1,200 CT | 870 | 50 | Interstage or driver |
| DI-T204 | Split Inductor (2 wds) | § .1 Hys @ 4 maDC, §§ .025 Hys @ 8 maDC | § .08 Hys @ 10 maDC, § .02 Hys @ 20 maDC | DCR 25Ω DCR 6Ω | | |
| DI-T208 | Split Inductor (2 wds) | § .9 Hys @ 2 maDC, §§ .2 Hys @ 4 maDC | § .5 Hys @ 6 maDC, § .1 Hys @ 12 maDC | DCR 105Ω DCR 26Ω | | |
| DI-T212 | Split Inductor (2 wds) | § 2.5 Hys @ 2 maDC, §§ .6 Hys @ 4 maDC | § .9 Hys @ 4 maDC, § .2 Hys @ 8 maDC | DCR 630Ω DCR 157Ω | | |
| DI-T216 | Split Inductor (2 wds) | § 4.5 Hys @ 2 maDC, §§ 1.1 Hys @ 4 maDC | § 1.2 Hys @ 4 maDC, § .3 Hys @ 8 maDC | DCR 2300Ω DCR 575Ω | | |

[†]DCma shown is for single ended usage (under 5% distortion—100mw—1 KC) ... for push pull, DCma can be any balanced value taken by 5W transistors (under 5% distortion—500mw—1KC) DI-T200 units have been designed for transistor application only ... not for vacuum tube service. U.S. Pat. No. 2,949,591 other pending. Where windings are listed as split, 1/4 of the listed impedance is available by paralleling the winding. §Series connected; §§Parallel connected.

ALL STOCK UNITS MIL TYPE TF4RX Class "S" Available on Special Order

High Power Rating up to 100 times greater.
 Excellent Response twice as good at low end.
 Low Distortion reduced 80%.
 High Efficiency up to 30% better ... compare DCR.
 Moisture Proof hermetically sealed to MIL-T-27B.
 Ultraminiature Size 5/16 Dia. x 3/8" H, 1/15 Oz.

The unique structural design of the DI-T200 series transformers and inductors provides the excellent electrical characteristics, high reliability and wide application possibilities inherent in the UTC DO-T family of miniaturized units. The DI-T200 series units employ the same high quality design found in UTC's DO-T, DI-T, and PIP lines. This unique transformer structural concept affords unprecedented power handling capabilities coupled with extremely small size. Further, the high degree of reliability has been dynamically proven in the field. These characteristics are basic in the structure, which is ruggedized, hermetically sealed, employing a completely rigid bobbin, eliminating stress and wire movement. The turns are circular in shape rather than square, eliminating turn corner stress, and effecting uniform wire lay. The coil wire and external lead are rigidly anchored terminal board fashion, employing no tapes and brought out through strain relief. The curves illustrated indicate the superior performance of these units compared to similar size units now on the market.

The leads are uninsulated 1" long, .016 D Dumet wire, spaced on a .1" radius circle to conform to terminal spacing techniques of the "TO-5" case semiconductors and micrologic elements.

IMMEDIATE DELIVERY FROM STOCK

Write for catalog of over 1,300 UTC TOP QUALITY STOCK ITEMS IMMEDIATELY AVAILABLE from your local distributor.



UNITED TRANSFORMER CO.

DIVISION OF TRW INC. • 150 VARICK STREET, NEW YORK, N. Y. 10013

IN CANADA: A. C. SIMMONDS & SONS LIMITED, AGINCOURT, ONTARIO

Circle 1 on reader service card

THE SWEEPER THAT THE USER DESIGNED

Clean, Functional, Simple

User convenience and ease of operation were the chief criteria for the front-panel design of the Hewlett-Packard 8690 Series Sweep Oscillators; in fact, you can see the simplicity at a glance.

Features that make this sweeper simple to use include push-button function selection, plug-in RF units for your required frequency coverage, and a high-resolution, 13-inch snap-in frequency scale. Both frequency coverage and operation modes are presented quickly and logically. Independently adjustable START/STOP sweep lets you examine a broad span rapidly. Then, just push the MARKER sweep push button to bracket any portion of the frequency range. You also have calibrated ΔF sweep for high resolution with narrow sweeps.

Choose plug-in RF modules from 1 to 40 GHz and 0.1 to 110 MHz. PIN diode modulation leveling is available from 1 to 12.4 GHz. Model 8690 main frame is \$1550, RF plug-ins start at \$1575. Price depends on modulation and frequency range.

For complete information on these clean, functional, simple sweepers, call your local HP field engineer or write Hewlett-Packard, Palo Alto, California 94304; Europe: 54 Route des Acacias, Geneva.

HEWLETT  PACKARD

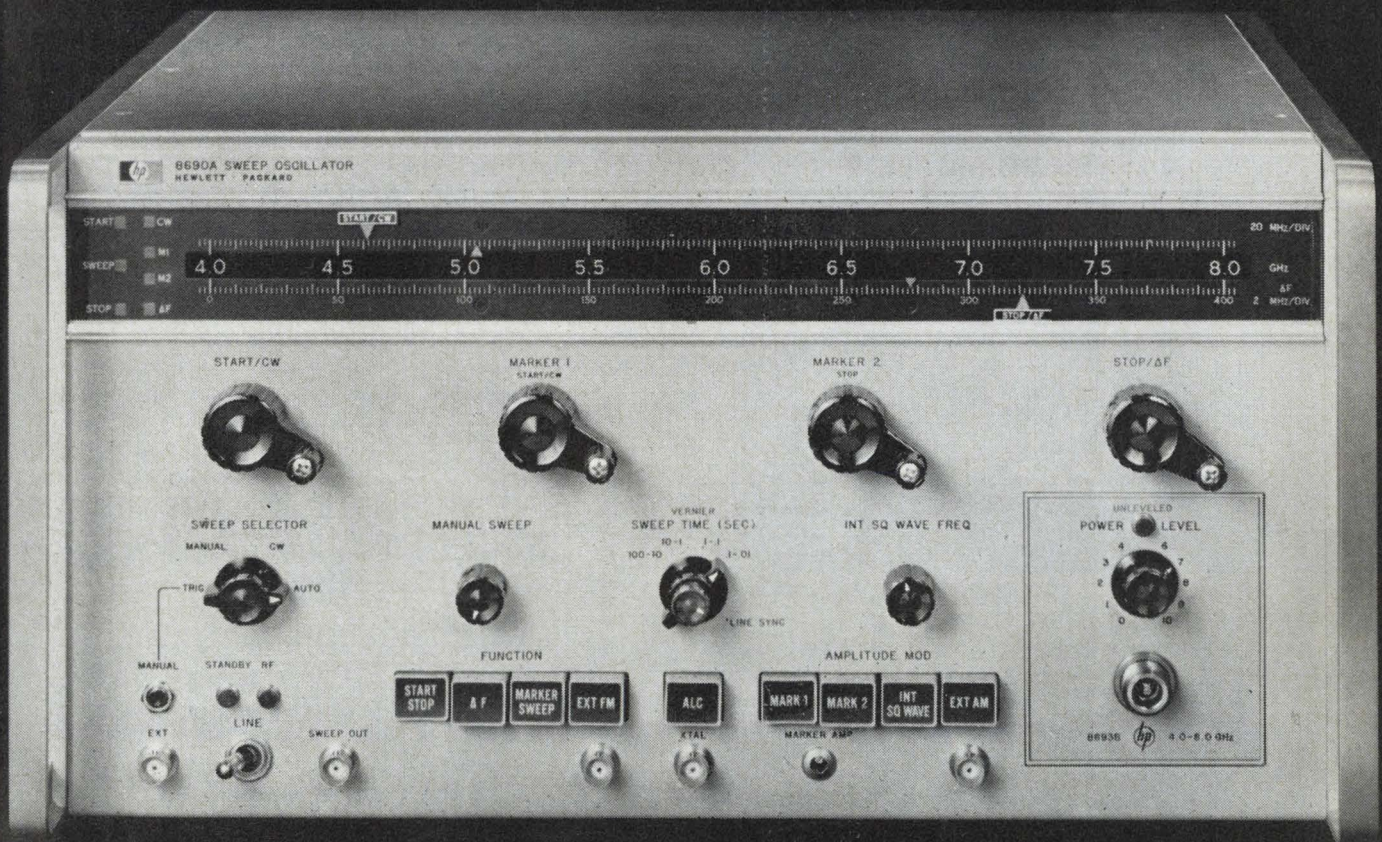

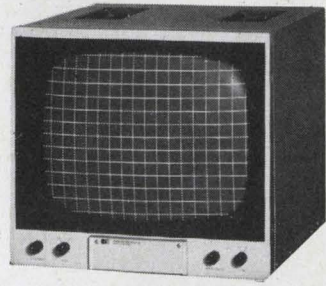

hp VIDEO MONITOR

THE NEW STANDARD OF PERFORMANCE

Advanced Circuit Techniques Achieve Increased Reliability and Improved Picture Quality

MAINTENANCE FREE OPERATION

All Solid State Circuitry • No periodic alignment or adjustment required • Highest quality components and workmanship.

EASE OF OPERATION

Display linearity independent of size adjustment • Unique deflection circuits have feedback **active** over entire raster • No sync controls — synchronization is automatic on both North American and CCIR Standards.

IMAGE QUALITY

Displays $\text{sine}^2 T/2$ pulse without distortion (62.5nsec) • Feedback **active** over full video band • Unity interlace results from novel sync circuitry • Keyed back porch clamp assures less than 1% black level shift for 100% video amplitude change • Less than 1.5% geometric distortion overall.

OTHER IMPORTANT FEATURES

Fully regulated high voltage and low voltage power supplies • Balanced input with loop-through facility • 46 db input common mode rejection.

Model 6946A—Price \$950.

Contact your nearest Hewlett-Packard Sales Office for full specifications.

HEWLETT  **PACKARD**

COMMUNICATION INSTRUMENTS

100 Locust Ave., Berkeley Heights, New Jersey 07922
Telephone 201-464-1234 TWX 710-984-7972

Circle 2 on reader service card

BRIGHTNESS

LINE

News Features

Probing the News

- 139 **Apollo 4's time of trial**
145 **Long-term R&D goes on short rations**
151 **Post Office cancels old ways**

Electronics Review

- 41 **Solid state:** Best of two worlds; They're at it again; Laminated transistor
42 **Avionics:** Fly by the numbers; Right perspective
44 **Advanced technology:** Unchanging picture . . . Moving light; Transistor twosome; Golden isolation
46 **Consumer electronics:** Solid savings
48 **Communications:** New muscle for CATV
50 **Software:** Late-late showing
50 **Military electronics:** Calling the shots
54 **For the record**

Electronics Abroad

- 231 **Great Britain:** One for the road; Well wired; The big picture
232 **France:** Chamber made; Color for computers
234 **West Germany:** PALette
236 **Japan:** Fast-blooming hybrids; Color's bright
238 **Around the world**

New Products

- 165 **Picture looks brighter for computer displays**
172 **New components review**
172 **New components:** Hybrid servoamp drives aerospace motors; Power modules replace hot tubes; Construction makes the big difference
181 **New semiconductor review**
181 **New semiconductors:** Triacs threaten SCR market
184 **New instruments review**
184 **New instruments:** Controller backs computers; Poland manufactures scope for export
191 **New subassemblies review**
191 **New subassemblies:** New twist on light; Fuel cells go down to the sea
197 **New microwave review**
197 **New microwaves:** Receiver in splendid isolation
201 **New production equipment review**
201 **New production equipment:** Tailor-made windings for precision pots

Technical articles

I. Design

- Integrated electronics** 86 **Linear IC's: part 4**
Inside the operational amplifier
Most popular of linear IC's, the operational amplifier can perform many kinds of computing functions as well as control and detection jobs
Mark B. Leeds, solid state editor
- 91 **Foggy specs blur designs**
An engineer who uses integrated operational amplifiers needs a lot more information than the manufacturer's specifications
Everett L. Harris Jr., Zeltex Inc.
- Circuit design** 95 **Designer's casebook**
▪ Single diode reduces ripple in d-c power supply
▪ Backward diode plus FET detects low currents
▪ Digital IC's shrink reversible counter
▪ FET boosts impedance of d-c feedback amplifier
▪ Combined feedback builds gain and input impedance
- Design theory** 100 **Quick amplifier design with scattering parameters**
Extending the use of s-parameters and the Smith chart to the general case
William H. Froehner, Texas Instruments Incorporated

II. Application

- Military electronics** 111 **Air traffic cop eyes 'bandits,' too (cover)**
Designed for the Air Force, first solid state 3-D radar uses digital signal processing to compute and display aircraft altitude, bearing and range
- Computers** 120 **Do-it-yourself display brightens the outlook for low-cost CAD**
Simple interface unit turns oscilloscope into computer display
Jerry Shumway, Friden Inc.

Departments

- | | | | |
|-----|------------------------|-----|------------------------|
| 4 | Readers Comment | 25 | Electronics Newsletter |
| 8 | People | 69 | Washington Newsletter |
| 14 | Meetings | 204 | New Books |
| 16 | Meeting Preview | 209 | Technical Abstracts |
| 23 | Editorial | 215 | New Literature |
| 225 | Newsletter from Abroad | | |

Electronics

Editor-in-Chief: Lewis H. Young

Associate managing editors

Technical: Donald Christiansen
News: Robert Henkel
Copy: Sally Powell

Senior associate editors

John F. Mason, Joseph Mittleman, Stephen E. Scrupski, Harry R. Karp

Department editors

Advanced technology: Stephen E. Scrupski
Avionics & Space: Alfred Rosenblatt
Computers: Wallace B. Riley
Consumer electronics: John Drummond
Design theory: Joseph Mittleman
Industrial electronics: Harry R. Karp
Instrumentation: Carl Moskowitz
Military electronics: John F. Mason
New Products: William P. O'Brien, Stephen Fields
Solid state: Mark B. Leeds
Staff writer: Howard Wolff

Section editors

Electronics abroad: Arthur Erikson
Electronics review: Stanley Zarowin
New Products: H. Thomas Maguire
Probing the news: Eric Aiken

Regional bureaus

Domestic

Boston: James Brinton, manager; Robin Carlson
Los Angeles: Lawrence Curran, manager; June Ranill
San Francisco: Walter Barney, manager; Mary Jo Jadin
Washington: Robert Skole, manager; William D. Hickman, Paul Dickson, Patricia C. Hoehling

Foreign

Bonn: John Gosch
London: Michael Payne
Tokyo: Charles Cohen

Copy editors

James Chang, Frederick Corey

Graphic design

Art director: Saul Sussman
Assistant art directors: Ann Mella, Valerie Betz
Production editor: Arthur C. Miller

Editorial secretaries: Claire Benell, Lynn Emery, Kay Fontana, Patricia Gardner, Lorraine Longo

McGraw-Hill News Service

Director: John Wilhelm; Atlanta: Fran Ridgway; Chicago: James Rubenstein;
Cleveland: Arthur Zimmerman; Dallas: Marvin Reid;
Detroit: J. Wirgo; Houston: Robert E. Lee; Los Angeles: Michael Murphy, Gerald Parkinson
Pittsburgh: Louis Gomolak
San Francisco: William F. Arnold
Seattle: Ray Bloomberg; Washington: Arthur L. Moore, Charles Gardner,
Herbert W. Cheshire, Seth Payne, Warren Burkett, James Canan, William Small

McGraw-Hill World News Service

Bonn: John Johnsrud; Hong Kong: Don Kirk; London: John Shinn;
Mexico City: Bruce Cross; Milan: Ronald Taggiasco;
Moscow: Howard Rausch; Paris: Peter Kilborn;
Rio de Janeiro: Wes Perry; Tokyo: Marvin Petal

Reprints: Susan Nugent

Circulation: Milton Drake

Publisher: Gordon Jones

Electronics: October 16, 1967, Vol. 40, No. 21

Published every other Monday by McGraw-Hill, Inc. Founder: James H. McGraw 1860-1948.
Printed at 99 North Broadway, Albany, N.Y. 12207; second class postage paid at Albany, N.Y.

Executive, editorial, circulation and advertising addresses: McGraw-Hill Building, 330 W. 42nd Street
New York, N.Y. 10036. Telephone (212) 971-3333. Teletype TWX N.Y. 710-581-4235. Cable address:
MCGRAWHILL N.Y.

Subscriptions solicited only from those professionally engaged in electronics technology. Subscription rates:
qualified subscribers in the United States and possessions and Canada, \$8.00 one year; \$12.00 two years,
\$16.00 three years; all other countries \$25.00 one year. Non-qualified subscribers in the U.S. and
possessions and Canada, \$25.00 one year; all other countries \$50.00. Air freight service to Japan \$50.00
one year. Single copies: United States and possessions and Canada, \$1.00; all other countries, \$1.75.

Officer of McGraw-Hill Publications: Joseph H. Allen, President; Bayard E. Sawyer, Executive Vice-President;
J. Elton Tuohig, Senior Vice-President-Operations; Vice Presidents: John R. Callahan, Editorial;
John M. Holden, Marketing; Paul F. Cowie, Circulation; Angelo R. Venezian, Production; Jerome D. Luntz,
Planning & Development; Robert M. Wilhelmy, Controller.

Officers of the Corporation: Donald C. McGraw, Chairman of the Board; Shelton Fisher, President;
L. Keith Goodrich, Robert E. Slaughter, Executive Vice Presidents; Donald C. McGraw, Jr.,
Senior Vice-President; John J. Cooke, Vice-President & Secretary; John L. McGraw,
Vice-President & Treasurer.

Title © registered in U.S. Patent Office; © Copyright 1967 by McGraw-Hill, Inc. All rights reserved. The contents
of this publication may not be reproduced either in whole or in part without the consent of copyright owner.

Subscribers: The publisher, upon written request to our New York office from any subscriber,
agrees to refund that part of the subscription price applying to copies not yet mailed.
Please send change of address notices or complaints to Fulfillment Manager; subscription
orders to Circulation Manager, Electronics at address below. Change of address notices
should provide old as well as new address, including postal zip code number. If possible,
attach address label from recent issue. Allow one month for change to become effective.

Postmaster: Please send form 3579 to Fulfillment Manager, Electronics,
P.O. Box 430, Hightstown, New Jersey 08520

Readers Comment

Collision causes

To the Editor:

As a private pilot, a reader of Electronics since 1941, a student of air disasters, and an engineer who has tried several times to "sell" the FAA, I want to comment on your editorial "Frightening testimony" [Aug. 7, p. 23].

The Eastern/TWA collision near Westchester last autumn was not, as you imply, between two planes flying at the same altitude. The Eastern plane was at an assigned altitude 1,000 feet below the TWA craft, but climbed steeply upon seeing the other aircraft. The controller did not have false information.

Also, it was a similar panic climb, and not an "emergency maneuver" ordered by a controller that caused the prior Eastern accident at Kennedy Airport. In both cases the pilots had unreliable horizon information, and thought they were on collision courses.

Electronic collision-avoidance systems are splendid for those who can afford them, provided, of course, that they work. But after 25 years of trying, we still don't have reliable radars, nav/com systems, omniranges, or even televisions. Perhaps it will turn out that anti-collision systems will serve only to give air crews a false sense of security, and to occupy them when they should be looking out the window.

The suggestion that air traffic control messages be acknowledged by pushbutton has several flaws. Chief amongst these is the obvious fact that there is no way of knowing that a clearance has been received correctly. Air traffic control procedures are based on an echo check routine, in which the acknowledging pilot states exactly what he is to do, and in what sequence.

Three-D radar is badly needed at major airports and in areas of high traffic density. The reason for not having it is budgetary. One wonders how many radars could be bought for the amount of the FAA's commitment in the unnecessary, unwanted, and unmanageable SST.

Also, one suspects, if the FAA

Obviously from Sprague Electric!

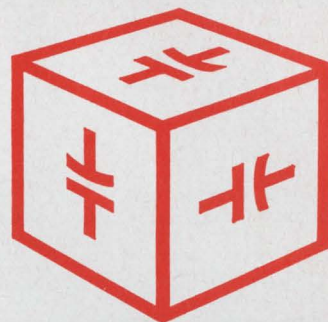

**Higher CV product per cubic inch
than any other solid tantalum capacitor!**

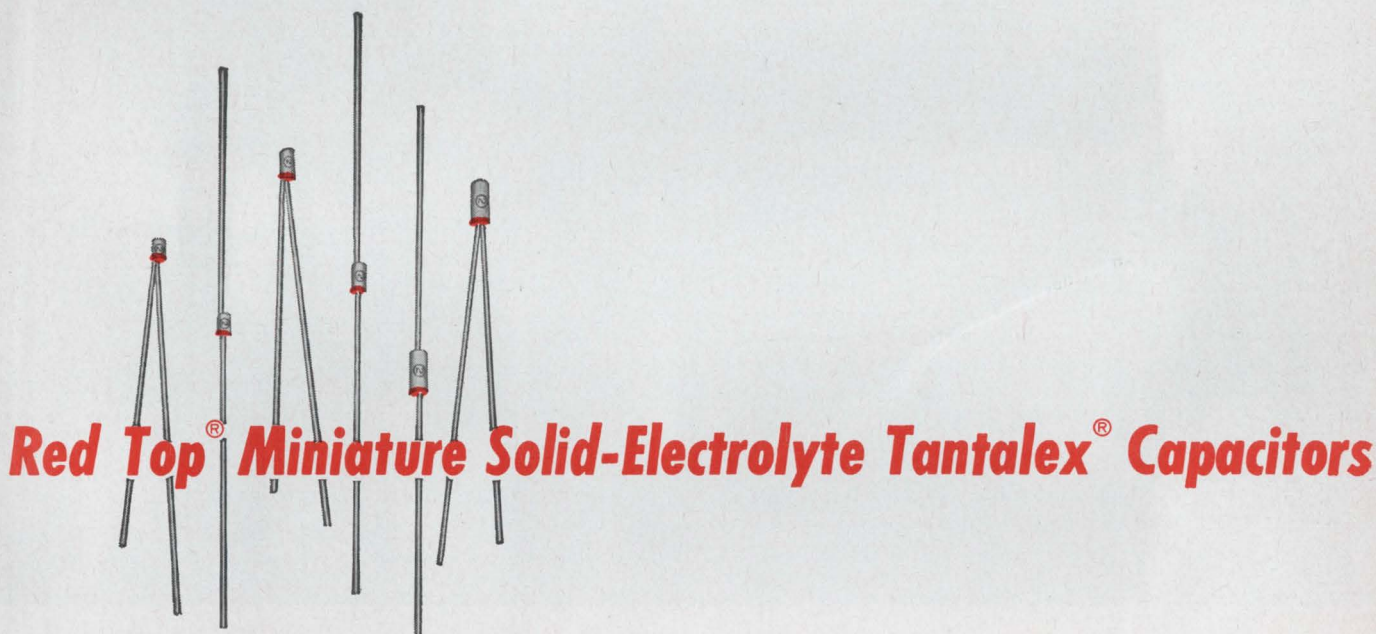

Red Top® Miniature Solid-Electrolyte Tantalex® Capacitors

Red Top® Capacitors are TOPS when your circuit design calls for reliable, low-cost, commercial/industrial solid tantalums for printed wiring boards, packaged circuit modules, and other applications where miniaturization is a must.

Their special construction employs a metal case and plastic resin end seal, providing the price advantages but eliminating the mechanical disadvantages often associated with molded capacitors, such as "off-center" units with consequent "thin" walls, secondary cathode connection prior to molding, and limited humidity resistance.

Red Top® Capacitors are ideally suited for today's circuit design requirements which demand filtering at specific locations. Their small size permits "salting" or "sprinkling" wherever needed:

With capacitance values that range from 68 μF to .016 μF in voltage ratings from 2 to 100 WVDC, Sprague Red Top® Capacitors are available with axial or "single-ended" leads.

For complete technical data, write for Engineering Bulletin 3536A to Technical Literature Service, Sprague Electric Company, 35 Marshall Street, North Adams, Massachusetts 01247.

SPRAGUE COMPONENTS

CAPACITORS
TRANSISTORS
RESISTORS
INTEGRATED CIRCUITS
THIN-FILM MICROCIRCUITS
49C-7138

PULSE TRANSFORMERS
INTERFERENCE FILTERS
PULSE-FORMING NETWORKS
TOROIDAL INDUCTORS
ELECTRIC WAVE FILTERS

CERAMIC-BASE PRINTED NETWORKS
PACKAGED COMPONENT ASSEMBLIES
BOBBIN and TAPE WOUND MAGNETIC CORES
SILICON RECTIFIER GATE CONTROLS
FUNCTIONAL DIGITAL CIRCUITS



Sprague and '®' are registered trademarks of the Sprague Electric Co.

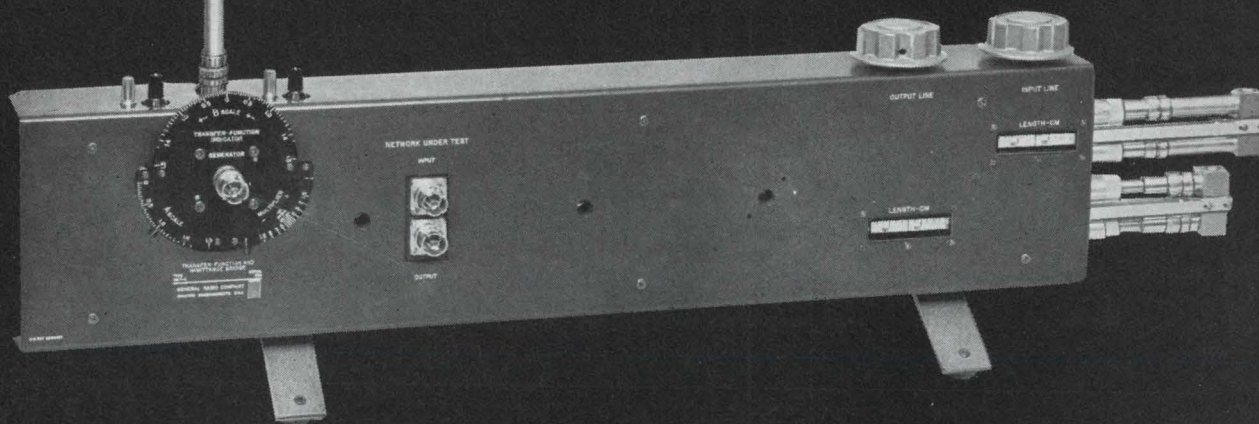
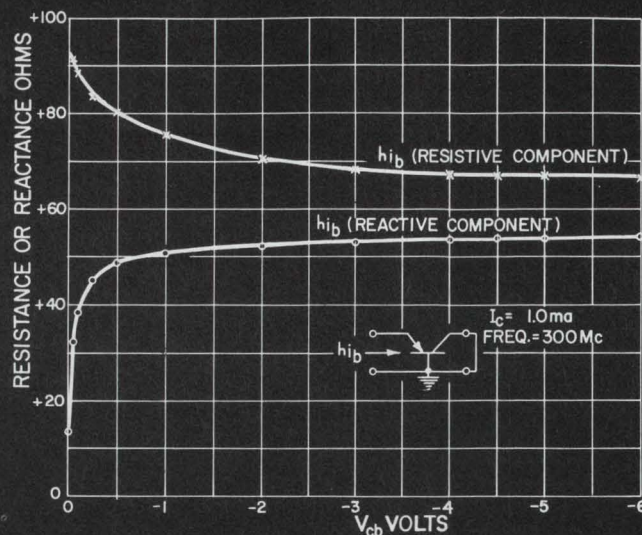

Measure transistor h and y parameters directly without resorting to the "New Math."

If you use h and y parameters in your design work, you can measure them directly with the 1607-A Transfer-Function and Impedance Bridge. You can measure h_{ob} , h_{oe} , h_{ib} , h_{fe} , h_{ib} , h_{ie} , h_{rb} , h_{re} , y_{ob} , y_{oe} , y_{ib} , y_{fe} , y_{ib} , y_{ie} , y_{rb} , y_{re} , as well as all open-circuit impedance parameters directly, without using mathematical transformations that could degrade data accuracy. These measurements can be made over a broad 25-MHz to 1.5-GHz range.

Since the 1607-A uses adjustable lines settable to half and quarter wavelengths, both open- and short-circuit conditions can be easily established. Eight specially designed, electrically invisible mounts for almost all popular transistor configurations provide a readily defined reference plane for measurements. No measurement corrections need be made for the parasitic effects of the leads with

2-inch leads can be measured without correction (the mount "swallows" the leads). The transistor can even be mounted with some of its lead length exposed to simulate its eventual connection in the circuit. In this way, the parasitic effects of the leads can also be considered.

Price of the 1607-A is \$1995; transistor-mount prices range from \$75 to \$145. For a complete description of the 1607-A, request our Engineering Reprints E107 and E109. Write General Radio Company, 22 Baker Avenue, W. Concord, Massachusetts 01781; telephone (617) 369-4400; TWX 710 347-1051.

GENERAL RADIO

Circle 6 on reader service card

were to get seriously interested in computer control of air traffic some other Government agency might try once more to palm off the SAGE system on them, and this time it might work.

Richard Windels

Darien, Conn.

More on loops

To the Editor:

The article "Down-to-earth Army antenna" by Kenneth H. Patterson [Aug. 21, p. 111] describes an interesting and practical piece of gear. The article would have been even better if it contained more about why these loop antennas can be expected to perform as well as they do.

The tests conducted in the Alleghenies involved ionospheric skywave propagation. The conditions for the Vietnam tests are not stated, although high-frequency skyway is essential for getting out of mountain valleys and is probably the most efficient means of communicating out of a concealed jungle site. Thus, in its most important uses, this loop would radiate a high-angle skywave for communication out to a few hundred miles in the lower part of the h-f spectrum.

For short-distance skywave, polarization is horizontal (not vertical) insofar as reflection from the ground is concerned, exactly as in the case of the horizontal dipole. In fact, in all cases of skywave at any vertical angle for the loop and the dipole, the resultant of the direct and reflected waves is determined by the same plane-wave Fresnel reflection coefficients for the same height of radiating ele-

ments and involve the same reflection loss. In fact there is more nearly a null overhead when the loop is lower than the dipole.

What makes the relatively inefficient loop perform comparably as well as the dipole is the fact that the dipole as a circuit element, when near the ground, suffers ohmic losses caused by its near-field lines of force penetrating the surface of the earth. On the other hand, the near field of the small loop is closely contained and thus not subject to much ground loss. One can understand this by noting that in the limiting case of a small r-f inductor within an inch of a chassis its ohmic losses may be comparable to such losses for the coil in free space.

One possible disadvantage of the loop is its high Q. In some uses, broadband modulation would be attenuated at the edges of the passband. The necessity for tuning and matching for very small frequency changes is compensated by the use of automatic circuitry, leaving wide-band coverage as an advantage.

Loops are capable of receiving and transmitting ground waves. In communication over open country and especially from high sites or over sea water, a vertically polarized ground wave may be the best mode at short distances in the lower part of the h-f spectrum, depending upon interference and atmospheric noise. Here, vertical polarization is by far the best. The plane of the loop must be oriented to coincide with the plane of propagation. Performance should then be compared with that of a vertical dipole or monopole.

Richard Silberstein

Boulder, Colo.

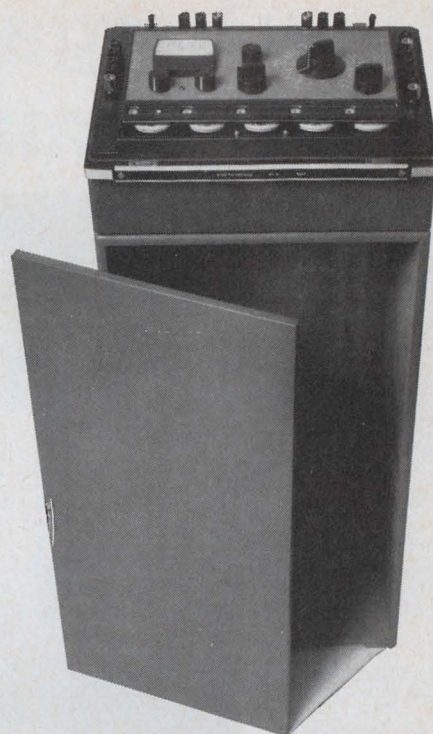

We thought of putting a false bottom on it.

We toyed briefly with the idea of making our PVB (Potentiometric Voltmeter-Bridge) bigger than it had to be. We were worried about the skeptics who wouldn't believe we could combine seven high-accuracy measurement functions in a portable case the size of a typewriter.

But we resisted temptation. We designed the PVB as compact as solid-state technology permits. And we said to the skeptics, "Seeing is believing. If you don't think that one \$875 instrument can deliver 0.02% accuracy or better on voltage, resistance, current and ratio measurements—just watch."

The skeptics watched and they became believers. They passed the word along to friends and made the PVB one of our best sellers. (If word hasn't reached you yet, write us direct.) They showed us this instrument has more uses than even we knew—including potentiometric temperature measurement, checking of dc power supplies, measuring pH and calibration applications galore.

We should have known that false bottoms went out with the bustle. ESI, 13900 NW Science Park Drive, Portland, Oregon 97229.

Electro Scientific Industries **esi**

SUBSCRIPTION SERVICE

Please include an Electronics Magazine address label to insure prompt service whenever you write us about your subscription.

Mail to: Fulfillment Manager
Electronics
P.O. Box 430
Hightstown, N.J. 08520

To subscribe mail this form with your payment and check new subscription renew my present subscription

Subscription rates: qualified subscribers in the U.S.: 1 year \$8; two years, \$12; three years, \$16. Non-qualified: 1 year \$25. Subscription rates for foreign countries available on request.

CHANGE OF ADDRESS

ATTACH LABEL HERE

If you are moving, please let us know five weeks before changing your address. Place magazine address label here, print your new address below.

name _____

address _____

city _____

state _____

zip code _____

New bargain in performance!

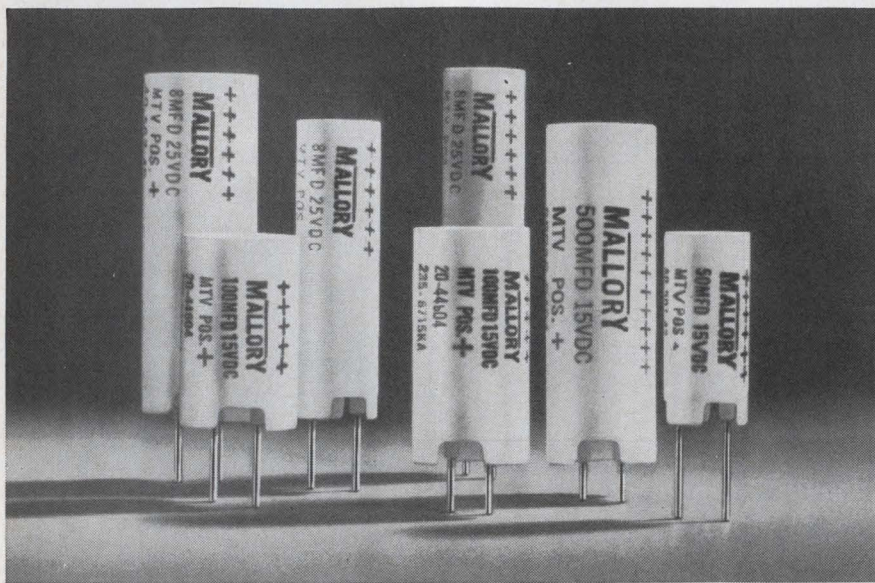

Molded case electrolytics for vertical mounting.

Meet the MTV... newest member of the unique Mallory family of molded case aluminum electrolytic capacitors. It's designed for vertical mounting, with built-in standoffs that facilitate soldering and ease in cleaning printed circuit boards.

Temperature performance? Good stability down to -30°C , excellent life at rated 65°C ... or intermittent 85°C operation.

Reliability? Just ask for our data—the most and best you ever saw for an economy-priced capacitor.

Price? Lower than metal case types and most epoxy-sealed plastic tubulars.

Ratings? Up to 1000 mfd at 3 WVDC and 115 mfd at 50 WVDC. Nine case sizes: diameters of .375" and .500"; lengths .812" to 1.50".

For bulletin and prices, write or call Mallory Capacitor Company, a division of P. R. Mallory & Co. Inc., Indianapolis, Indiana 46206.

MALLORY

People

Eighteen months ago the Fairchild Camera & Instruments Corp. combined its Instruments and Semiconductor divisions, moving the advanced research section from Clifton, N.J., to Mountain View, Calif.—an expensive and, as it turned out, somewhat shortsighted decision. Now it's returning the oscilloscope section of the Instruments division to Clifton and combining it with the Electron Tubes division. Named to head the operation is 44-year-old **Frederick Walzer**, a veteran of the Allen B. Dumont Labs, which Fairchild acquired in 1960.

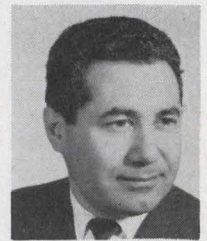

Frederick Walzer

Corrective. Fairchild's decision is its latest move to bolster its instruments sales. Until the late 1950's, Dumont was a leader in the oscilloscope market; the emergence of Tektronix changed all that. In the last few years, however, Fairchild Instruments has made a small comeback—but mostly because of new instruments other than oscilloscopes.

In addition, the move unyoking the oscilloscope section from the Instruments division and moving it to Clifton is Fairchild's way of tacitly admitting that it blundered 18 months ago when it stripped the Tubes division of its advanced research personnel.

Under the new setup Walzer will be responsible for developing a new line of oscilloscope products and related equipment. Fairchild plans to market its new instruments through independent sales representatives.

Background. Walzer, who left engineering school to enlist during World War II, has an extensive background in quality control engineering. At Dumont since 1949, he has worked in all phases of the electron tube business. He moved into management in 1956 as head of the Technical Products division.

In 1961, following Fairchild's acquisition of Dumont, he was named quality control manager for all tube divisions. He took over the

the new name in high-performance, low-priced computers

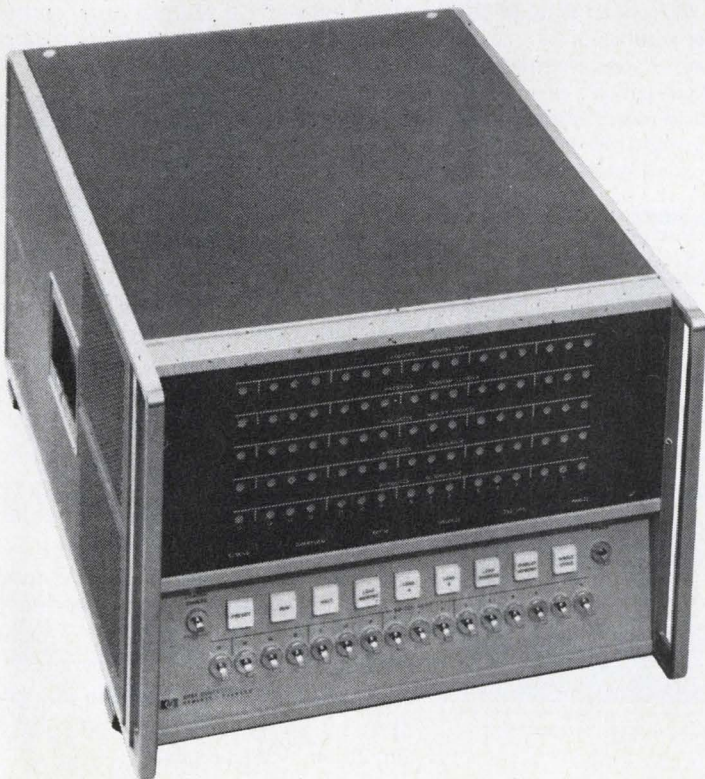

This new computer is the easiest to program and interface of all high-speed computers. It has 16-bit words, 4K expandable memory, 2 microsecond cycle time, plug-in I/O cards, multichannel priority interrupt, relocatable software and both FORTRAN and ALGOL compilers. Plug-in options including direct memory access and hardware multiply and divide are available. Peripherals such as high-speed disc memory and magnetic tape are standard. The price, with 4K memory and ASR-33 teletype: \$16,500.

To find out how easy the 2115A is to use—and its big brother, the 2116A, write to Hewlett-Packard, Palo Alto, California 94304; Europe: 54 Route des Acacias, Geneva.

06714

HEWLETT  PACKARD

Did You Know Sprague Makes 32 Types of Foil Tantalum Capacitors?

125 C TUBULAR TANTALEX® CAPACITORS



Type 120D polarized plain-foil
Type 121D non-polarized plain-foil
Type 122D polarized etched-foil
Type 123D non-polarized etched-foil

ASK FOR BULLETIN 3602C

Circle 332 on readers
service card

85 C TUBULAR TANTALEX® CAPACITORS



Type 110D polarized plain-foil
Type 111D non-polarized plain-foil
Type 112D polarized etched-foil
Type 113D non-polarized etched-foil

ASK FOR BULLETIN 3601C

Circle 333 on readers
service card

RECTANGULAR TANTALEX® CAPACITORS



Type 300D polarized
plain-foil
Type 301D non-polar-
ized plain-foil
Type 302D polarized
etched-foil
Type 303D non-polar-
ized etched-foil

ASK FOR BULLETIN 3650

Circle 334 on readers
service card

TUBULAR TANTALUM CAPACITORS TO MIL-C-3965C



CL20, CL21 125 C polarized etched-foil
CL22, CL23 125 C non-polarized etched-foil
CL24, CL25 85 C polarized etched-foil
CL26, CL27 85 C non-polarized etched-foil
CL30, CL31 125 C polarized plain-foil
CL32, CL33 125 C non-polarized plain-foil
CL34, CL35 85 C polarized plain-foil
CL36, CL37 85 C non-polarized plain-foil

Circle 335 on readers
service card

RECTANGULAR TANTALUM CAPACITORS TO MIL-C-3965C



CL51 polarized plain-foil
CL52 non-polarized plain-foil
CL53 polarized etched-foil
CL54 non-polarized etched-foil

Circle 336 on readers
service card

For comprehensive engineering bulle-
tins on the capacitor types in which
you are interested, write to:
Technical Literature Service
Sprague Electric Company
35 Marshall Street
North Adams, Mass. 01248

450-0101 R1

SPRAGUE®
THE MARK OF RELIABILITY

*Sprague® and ® are registered trademarks of the Sprague Electric Co.

People

Clifton operation two years ago and was made a corporate vice president of Fairchild last May.

For years a major subcontractor for military airborne antennas, Textron Inc.'s Dalmo Victor division is

now scanning the industrial horizon for new applications because prime contractors now tend to make their own. To direct the technical sweep, the company has appointed **Michael Apcar Jr.**, 39, as vice president of engineering.



Michael Apcar Jr.

Dalmo Victor is looking into electro-optics, especially low-light-level television, and infrared sensing of toxic gases for air pollution control.

Peace move. "A few years ago," Apcar recalls, "one of the things we set out to do was to get out of the position we were in"—primarily that of a military subcontractor. Capitalizing on its automated checkout equipment for the military, the company developed similar gear for diesel-electric locomotives. In still another move, it also opened a plant in Grants Pass, Ore., to make wiring harnesses and switching matrixes.

Now the company sees commercial applications for its successful military-antenna business. "The trend," Apcar says, "is toward the use of electronic scanners." Because Dalmo Victor built antennas for the hypersonic B-70 program, Apcar thinks there might be a market in supersonic transports. Meanwhile, the company is making antennas for the Apollo program and the F-111A.

Although the company's figures are buried in Textron's ledgers, Apcar says sales have doubled in the last five years. He looks for them to double again in the next five years as the company reduces its contract mix from the present 90% military to 75%. "Hopefully, 10 years from now, we'll be able to spin off new self-supporting civilian lines," Apcar says.



MACHLETT ML-8618 magnetically beamed triode requires 10 to 100 times lower drive

| | IN PULSE SERVICE | | IN RF TELEGRAPHY AMPLIFIER/OSCILLATOR SERVICE | |
|----------------|------------------|------------------------|--|------------------------|
| | ML-8618 | Conventional Triode | ML-8618 | Conventional Triode |
| Power Output | 6 megawatts | 6 megawatts | 200 kilowatts | 200 kilowatts |
| Driving Power | 2.5 kilowatts | 400 kilowatts | 0.7 kilowatts | 7.2 kilowatts |
| Filament Power | 2.5 kilowatts | 4.0 kilowatts | 2.5 kilowatts | 4.0 kilowatts |

RESULT: ML-8618 reduces pulse driving power by a factor of 100 or better.

RESULT: ML-8618 reduces rf driving power by a factor of 10 or better.



Machlett's exclusive development, magnetically beamed tubes like the ML-8618 give you these advantages:

- By magnetically controlling the trajectory, electrons from the cathode bypass the grid structure so that nearly all emitted electrons reach the anode.
- Grid current is very low because of the great reduction in grid interception—about 3% as compared to 25% in conventional triodes.
- Low grid current means that grid dissipation no longer limits tube power.
- Parallel plane electrode structure eliminates "shielded" portion of filaments, permits 360° of the cathode surface to face anode surface and complete use is made of the filaments emission surface—result is higher cathode current per watt of heating power.

For details, write The Machlett Laboratories, Inc., Springdale, Conn. 06879.



THE MACHLETT LABORATORIES, INC.

A SUBSIDIARY OF RAYTHEON COMPANY

First...



TYPE SMDH 0 - 50 MHz

PROGRAMMABLE DECADE RF SIGNAL GENERATOR (FREQUENCY SYNTHESIZER)



First With Commercial Frequency Synthesizer First With True UHF Synthesizer (0.47-1.0 GHz) **NOW, FIRST WITH PROGRAMMABLE RF SIGNAL GENERATOR**

In 1954 Rohde & Schwarz introduced a new type of signal source, continuously variable in frequency but with crystal stability. We called it the Type XUA Frequency Synthesizer. Hundreds of these instruments found homes in leading laboratories and production centers throughout the U.S.A. Most of them are still fully on the job. Since then we have developed 15 other models, including a complete series of Exciters for communications control of transmitters and high quality receivers.

We now take great pride in announcing our **Type SMDH**, an instrument which sets new standards of performance. This unit is more than just another synthesizer; it is a Programmable RF Signal Generator from 0-50 MHz. It provides variable calibrated output voltages (0.1 μ V-2.5V), modulation capability (AM & FM), and excellent stability (1 x 10⁻⁹/day). Since many applications of a synthesizer involve frequency multiplication, we have designed the Type SMDH to have the highest spectral purity -- 100 dB. To achieve this, a completely new method of internal shielding had to be developed. Also a new modular frequency standard was required with 130 dB signal/noise.

To meet the demands of automatic check-out systems and high speed production testing, we made the instrument programmable. Using a standard 10-line code, we can provide a new frequency in 100 μ s maximum time. We can actually "switch" frequencies in 20 μ s like other synthesizers; however, let's make an honest appraisal. In addition to switching the digits, there is time required for the command (the old frequency is still on during the command time), and filter recovery time to assure full spectral purity. This is true for any synthesizer. Also we've designed a Programmable Attenuator, Type DPHP, with a range of 0-99.9 dB using the 10-line code. You can now have the capability of both programmable frequency and level.

Another important feature is our eight digit, in-line display tube readout. Remember when industry abandoned the hard-to-read staggered column readout on counters? Our readout is operative even in the programming mode. This feature provides a visual check verifying the program. It spots any operator or equipment error. Switch from program to manual control with a program still on the line without any ambiguity in output frequency. Careful elimination of ground loops makes this possible.

We do not utilize phase locked loops which impair short term stability. Our reference holds $\pm 3 \times 10^{-11}$ /second. Included is an interpolation oscillator which can be used for search applications (continuously variable to 1.1 MHz) or as a vernier to the crystal digit decades. It provides an in-line numeric read-out from 0-111 with an additional 50 division vernier. Typical stability is one-half division on the vernier scale. Another feature is switchable automatic leveling to 0.5 dB. Type SMDH is all-silicon solid state design utilizing modular construction for easy servicing. An optional battery supply is available. Yet with all of the features of this Programmable RF Signal Generator, it is competitively priced with 50 MHz synthesizers.

For communication applications, our new No. 280 Programmable Exciter incorporates those specifications and features required for transmitter and receiver control, with the price savings passed on to the customer.

R & S maintains its philosophy of a well-balanced design — meaning the optimizing of all significant specifications. Judging from advertising, it appears that everyone is making frequency synthesizers today. But really good synthesizer design is a very tricky business. We should know; we've been designing them for 15 years — and after all, Rohde & Schwarz is still the leader. We're trying to maintain a stock position for immediate delivery, but with all its features and specifications we expect a heavy demand.

ROHDE & SCHWARZ

111 LEXINGTON AVENUE, PASSAIC, N. J. 07055 • 201 - 773-8010

Inquiries outside the U.S.A. should be made to: Rohde & Schwarz, Muehlendorfstrasse 15, Munchen 8, West Germany

RCL

SWITCH INFORMATION CENTER

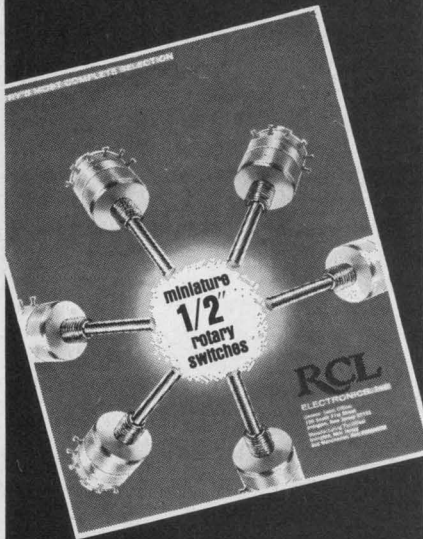

AN EASY-TO-READ
TECHNICAL CATALOG OF
INDUSTRY'S MOST
COMPLETE SELECTION
OF MINIATURE

1/2"

rotary
switches

WRITE FOR YOUR FREE COPY

RCL

General Sales Office
RCL ELECTRONICS, INC.
700 South 21st Street
Irvington, New Jersey 07111

Meetings

International Antennas & Propagation Symposium, IEEE; University of Michigan, Ann Arbor, **Oct. 17-19.**

International Electron Devices Meeting, IEEE; Sheraton-Park Hotel, Washington, **Oct. 18-20.**

Symposium on Switching and Automata Theory, IEEE; University of Texas, Austin, **Oct. 18-20.**

Conference of the Association of Data Processing Service Organization, Association of Data Processing Service Organization; Fairmont Hotel, San Francisco, **Oct. 19-20.**

Symposium of Adaptive Processes, IEEE; International Amphitheater, Chicago, **Oct. 23-25.**

Electronics Conference, IEEE; International Amphitheater and Sherman Hotel, Chicago, **Oct. 23-25.**

Meeting and Technical Display of the American Institute of Aeronautics and Astronautics; Convention Center, Anaheim, Calif., **Oct. 23-27.**

Business Equipment Manufacturers Association Exposition and Conference; New York Coliseum, New York, **Oct. 23-27.**

Conference on Effects of Diffuse Electrical Currents on Physiological Mechanisms with Application to Electroanesthesia and Electrosleep, Marquette University's School of Medicine and College of Engineering; Milwaukee, **Oct. 25-28.**

Symposium on Purposive Systems, American Society for Cybernetics and National Bureau of Standards; Gaithersburg, Md., **Oct. 26-27.**

Symposium on Hybrid Microelectronics, International Society for Hybrid Microelectronics; Somerset Hotel, Boston, **Oct. 30-31.**

Meeting on Electromagnetic Compatibility, Society of Automotive Engineers; Dallas Sheraton Hotel, Dallas, **Oct. 31-Nov. 1.**

Nuclear Science Symposium, IEEE; Statler Hilton Hotel, Los Angeles, **Oct. 31-Nov. 2.**

Asilomar Conference on Circuits and Systems, IEEE; Asilomar Hotel, Pacific Grove, Calif., **Nov. 1-3.**

Northeast Research and Engineering Meeting (Nerem), New England Section of IEEE; Sheraton-Boston Hotel, Boston, **Nov. 1-3.***

Product Assurance Conference, IEEE; Waldorf-Astoria, New York, **Nov. 2-3.**

Applied Superconductivity Conference and Exhibition, Atomic Energy Commission and University of Texas; Austin, **Nov. 6-8.**

Technical Conference, Society of Plastics Engineers, Nevele Country Club, Ellenville, N.Y., Nov. 6-7.

Reliability Physics Symposium, IEEE; Statler Hilton Hotel, Los Angeles, **Nov. 6-8.**

Short Courses

Institute on the transfer of technical information, the American University's Center for Technology and Administration, Washington; **Oct. 23-25,** \$175 fee.

Infrared technology, University of Michigan's School of Engineering, Ann Arbor; **Oct. 30-Nov. 3;** \$175 fee.

Theoretical developments in process control, Purdue University's Schools of Engineering; Lafayette, Ind.; **Nov. 6-17;** \$250 fee.

Call for papers

National Aerospace Electronics Conference, IEEE; Sheraton-Dayton Hotel, Dayton, Ohio, May 6-8, 1968. **Nov. 15** is deadline for submission of abstracts to William Baker, technical program chairman, 2227 Springmill Rd., Kettering, Ohio 45440.

Symposium on Microwave Power, International Microwave Power Institute; Statler Hilton Hotel, Boston, March 21-23, 1968. **Jan. 1** is deadline for submission of abstracts to Symposium on Microwave Power, Box 342, Weston, Mass. 02193.

Region 6 Conference, IEEE; Sheraton Motor Inn, Portland, Ore., May 20-22, 1968. **Jan. 5** is deadline for submission of abstracts to Program Chairman, IEEE Region 6 Conference, P.O. Box 831, Portland, Ore. 97207.

* Meeting preview on page 16.

THE CONNECTOR THING

A periodical periodical, designed to further the sales of Microdot Inc. connectors and cables. Published entirely in the interest of profit.

DICK TRUMMER WINS MICRODOT

You've thrilled to the fabled romances of Damon and Pythias, Pyramus and Thisbe, Procter and Gamble. Now, grab a hankie and read the tale of Trummer and Microdot.

BOY MEETS CONNECTOR

Once upon a time, as they say, there was a young Wisconsin lad with two compelling interests—space technology and rowing. Richard Owen Trummer pursued both interests at the University of Wisconsin, where he received his B.S.M.E. and coached the rowing team. Later, as a components engineer at AC Electronics, part of his job was to recommend the right components for inertial guidance systems. But an equally important part of the job was helping the people who make those components to do a better job for AC.

One component category of concern to Dick was connectors. That's how Dick Trummer came to know of Microdot. But wait! Even more breathtaking is the saga of how Microdot came to know Trummer.

ALL-TIME CHAMPION CONTEST WINNER!

Our current series of ads is now more than two years old; and almost every ad offers an opportunity to enter some sort of contest. For example, our very first ad in the series asked readers to compete in assembling our Microcrimp connectors in record time. Winners received prizes such as a Honda, a Schwinn bike and an Irish Mail.

That's when we first heard of Dick



Trummer. His speed in assembling our Microcrimp connector beat out all but two other contestants—and made him the proud owner of an Irish Mail. The fact that Dick didn't



TRUMMER'S NEW WINNER: THE HIGH DENSITY MULTI-PIN MARC 53

Here's why Dick Trummer considers MARC 53 a winner: It's the smallest and most flexible high density multi-pin on the market. It meets MIL-C-38300 Rev. A (USAF) and is NASA approved for manned space flight applications. It features "Posilock," the finest blind mating coupling mechanism ever devised, and "Posiseal"—the best environmental seal. (Ask Dick what we mean by the floating interfacial seal concept.) Contacts are completely scuff-proof. Our new MARC 53 RMD gives you a genuinely field serviceable version that takes mass-produced pre-crimped wires and requires neither insertion nor extraction tools for assembly. A color-sound film that tells you all about the assembly of MARC 53 is now available.

even know what an Irish Mail was, gave birth to a second contest in which we awarded lapel buttons reading "I know what an Irish Mail is!"*

After that, Trummer was hooked. In a way, so was Microdot. Every contest brought a Trummer entry. Most of them were excellent. And since we're honest folk, we had to judge without partiality. Result: Trummer also won a whole stack of Capitol record albums for a new idea on what to do with our Twist/Con concept. And by June of this year, the word was out among our loyal readers and contest entrants: GET TRUMMER!

And that's what we did.

As of September 1, Richard Owen Trummer has been appointed Military Products Manager of Microdot's Connector and Cable Products. In this capacity, Dick will act as technical liaison man between Microdot and many of its most important customers. (For one of Dick's new winners, see box on this page.)

Most important benefit: as a bona fide permanent employee of Microdot Inc., Dick Trummer is now ineligible to enter any of our "Connector Thing" contests. Once again, there's room at the top! So take pen in hand with renewed hope. With Trummer out of the way, anything is possible. Who knows. If you win enough contests, we may hire you.

RECENT CONTEST WINNERS (Other than Dick Trummer)

CARY A. MATUSZAK, R&D Technician at the Republic Division of Rockwell Mfg. Co., is the winner of our "Great American Cable" Contest. Happy viewing on your new Sony TV.**

WINNERS of our "Let Microdot Take You To The Movies" contest:

1. Grand Prize: ROBERT H. AILOR, NASA Redstone Arsenal
2. Runner Up: MARVIN SENTER, Litcom Division, Litton Industries

Honorable mention awards in the form of imitation "Oscars" go to—

R. H. KLEMM (Bethpage, N.Y.), G. E. FOGLEMAN (Washington, D.C.), PAUL KURLAND (Lansdale, Pa.), R. R. RIEBSAMEN (W. Palm Beach, Fla.), P. W. LANCASTER (Philadelphia), and—guess who—yep—RICHARD OWEN TRUMMER, formerly of Wisconsin. (That's it, Dick.)

*If you know, please write. We still have some buttons left.

**Winning slogan: "Microdot cable withstands the test of time."

MICRODOT INC. 
220 Pasadena Ave., S. Pasadena, Calif. 91030

Breakthrough by Dearborn!



100 μ F @ 50 V
in 1" x 3³/₁₆" metal-encased

METALLIZED POLYCARBONATE-FILM CAPACITORS

⊕ Capacitance range of Dearborn DIMIE® Series now extended to almost 18 times higher than previously-available values!

⊕ A new order of size and stability in capacitors for critical low-voltage miniaturized circuits.

⊕ Rated for operation at temperatures to +125 C without derating.

⊕ Low loss characteristics, high current-carrying capabilities—ideally suited for specialized a-c and r-f applications.

**For complete technical information,
write to Dearborn Electronics, Inc.,
Box 530, Orlando, Fla. 32802.**

Dearborn Electronics, Inc.
(a subsidiary of the Sprague Electric Company)

FOREMOST IN FILM CAPACITORS

10-7101R1

Meeting preview

Interest in millimeters

Boston, the center of the communications industry, will once again be host to the Northeast Electronic Research and Engineering Meeting (Nerem) Nov. 1 to 3 and, as expected, the main topic of the technical sessions will be communications. But this year, an unusual degree of interest is being focused on millimeter-wave technology. The interest in this area appears to stem from some researchers' belief that bulk-effect semiconductors will produce high powers above 30 gigahertz and the military's need for high-accuracy radar, wideband communications, and reconnaissance interferometers.

Wear and tear. In the session on millimeter waves, session six, F.J. Landkammer of Microwave Associates will unveil a 91.5-GHz mixer using Schottky-barrier diodes. A 94-GHz klystron local oscillator is used with the mixer to achieve a 3.5-GHz intermediate frequency with about 12 decibels of conversion loss. This is higher than the losses encountered with physically delicate point-contact diodes, but Landkammer bets on his silicon devices for reduced conversion loss and shock and vibration resistance.

Ben Senitzky of the Polytechnic Institute of Brooklyn took advantage of millimeter waves' high rate of interaction with gases to build modulators, amplifiers, and power measuring devices. Using a radio-frequency pump source and a tube filled with hydrogen cyanide, Senitzky built a 238-GHz parametric amplifier with a 21-megahertz gain-bandwidth product.

L. R. Wicker and J. E. Degenford of Westinghouse Electric and Ernest Wantuch of Fairleigh Dickinson University will describe latching ferrite phase shifters from 35 to 94 Ghz. Using nickel zinc ferrite, they've been able to build 35-GHz shifters that can achieve 200 degrees phase shift per inch of length.

Diamonds for power. In session two, C. B. Swan of the Bell Telephone Laboratories will review the latest developments in high-power, continuous-wave Impatt oscillators.

Adlake Mercury Wetted Relay — Application Data

Measurement of "Dynamic Contact Noise" for Low Level Signal Applications



**Adlake AWCS
26000 Series Relay —
2 Switch Form C**

In small signal applications, such as computers, telemetric systems, strain gauges, etc. generated emf. within the system's relays must be taken into account.

Dynamic Contact Noise is a "coined" phrase used to indicate an undesired generated emf. upon contact closure. It is the result of mechanical oscillation of the armature—caused by the impact of the armature on the stationary contacts — sweeping the coil flux.

Typical illustrations of this noise are shown in the oscillograms, with the relay being driven at nominal voltage in the test circuit shown below. The frequency and amplitude are integral functions of system bandwidth and coil drive conditions.

The slight ripple seen at the end of each trace is not noise, but due to resolution of test equipment and test circuit.*

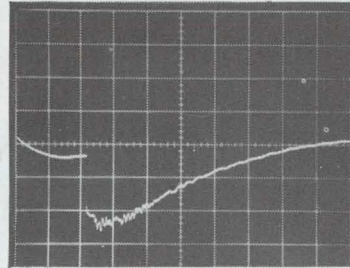

FIGURE 1

Horizontal Deflection 1.0 ms/cm
Vertical Deflection 20 μ V/cm
Systems Bandwidth .06–60 Hz.

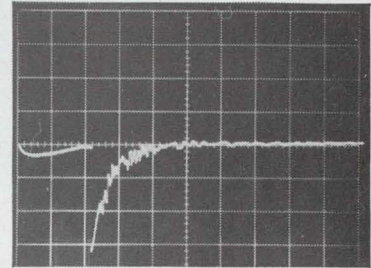

FIGURE 2

Horizontal Deflection 1.0 ms/cm
Vertical Deflection 100 μ V/cm
Systems Bandwidth .06–600 Hz.

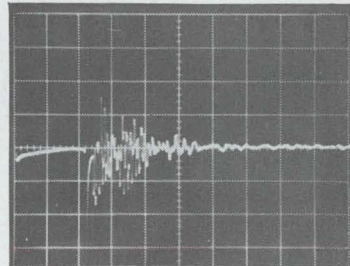

FIGURE 3

Horizontal Deflection 1.0 ms/cm
Vertical Deflection 200 μ V/cm
Systems Bandwidth .06–6K Hz.

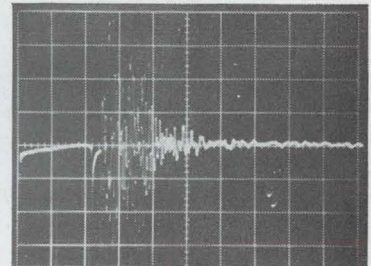

FIGURE 4

Horizontal Deflection 1.0 ms/cm
Vertical Deflection 200 μ V/cm
Systems Bandwidth .06–60K Hz.

TEST CIRCUIT

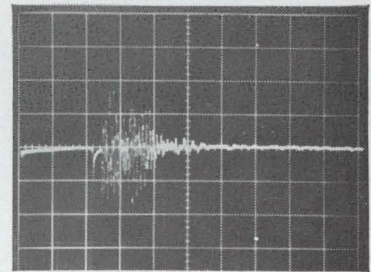
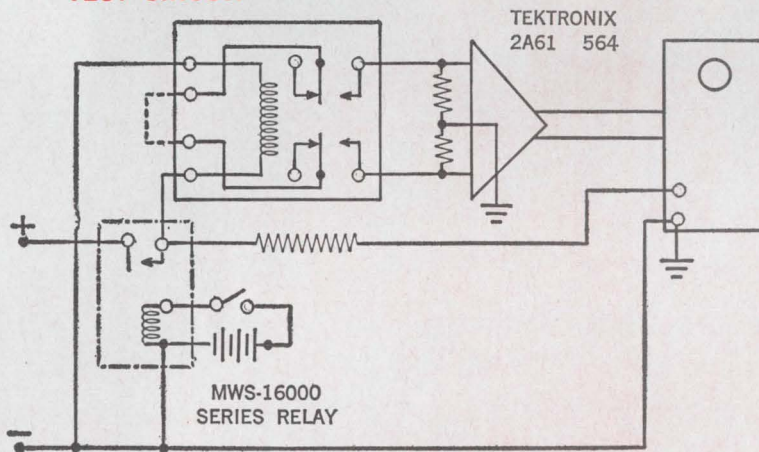

FIGURE 5

Horizontal Deflection 1.0 ms/cm
Vertical Deflection 500 μ V/cm
Systems Bandwidth .06–100K Hz.

* If you have a problem regarding relay applications to a particular system our engineering staff is ready to help you. Contact Mr. Le Roy Carlson, Chief Project Engineer.

Backed by sound research and disciplined engineering, Adlake applies the industry's broadest line of mercury displacement and mercury wetted relays to the creative solution of design circuit problems. However unique or special your application, Adlake can assist you in

developing it. For prompt, personal and knowledgeable attention to your relay needs, contact the one source that is the complete source in the mercury relay field. Contact Adlake today for catalog and further information.



THE ADAMS & WESTLAKE COMPANY

A SUBSIDIARY OF ALLIED PRODUCTS CORPORATION

ELKHART, INDIANA 46514 • AC 219 • 264-1141

TRANSPORTATION EQUIPMENT • ARCHITECTURAL PRODUCTS • MERCURY RELAYS • DOORS AND ENTRANCES • CONTRACT MANUFACTURING

Major Price/Performance Breakthrough
for New Economy
in Industrial, Military, and Commercial Equipment

RCA's MAX VALUE PHP LINE

Performance/Hermeticity/Price

High-Performance
Silicon N-P-N Amplifiers
and Switches
in High-Temperature,
High-Dissipation
Hermetic Packages

at prices
as low as

19¢ 1000+
2N5183



PHP

RCA's MAX VALUE line now brings you the results of RCA's most successful silicon planar and epitaxial technologies at unprecedented savings... Performance/Hermeticity/Price. Contact your RCA Field Repre-

sentative for more information. Or write RCA Commercial Engineering, Section CN10-1 RCA Electronic Components and Devices, Harrison, N.J. 07029. Check your RCA Distributor for his price and delivery.

†1000 plus quantities, OEM prices shown.

*RCA's MAX VALUE line offers military-type reliability control. For each type marked with the asterisk, production lots are subjected to and meet the mechanical, environmental, and life-test requirements of Military Specification MIL-S-19500.



2N5179
 PHP Price **39¢†**
LOW-NOISE UHF AMPLIFIER
 TO-72

20mW min oscillator output @ 500 MHz; 4.5 dB max NF @ 200 MHz; 15 dB min neutralized power gain @ 200 MHz; $f_T = 1\text{GHz}$ min $C_{cb} = 1\text{ pF}$ max.
 *Plus RCA Reliability Control



2N5180
 PHP Price **29¢†**
LOW-NOISE VHF AMPLIFIER
 TO-104

4.5 dB max NF @ 200 MHz; 12 dB min unneutralized power gain @ 200 MHz; $f_T = 900\text{ MHz}$ typ; $C_{cb} = 1\text{ pF}$ max.

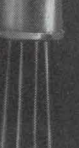

2N5181
 PHP Price **27¢†**
HIGH GAIN RF AND IF AMPLIFIER
 TO-104

Max usable gain = 24 dB typ @ 200 MHz (neutralized); 3.5 dB typ NF @ 200 MHz; $f_T = 700\text{ MHz}$ typ; $C_{cb} = 0.34\text{ pF}$ max; new terminal arrangement for max isolation between collector and base terminals.



2N5182
 PHP Price **24¢†**
HIGH-GAIN RF AND IF AMPLIFIER
 for low-current applications
 TO-104

Max usable gain = 24 dB typ @ 200 MHz (neutralized); 4.5 dB typ NF @ 200 MHz; $f_T = 700\text{ MHz}$ typ; $C_{cb} = 0.34\text{ pF}$ max; new terminal arrangement for max isolation between collector and base terminals.

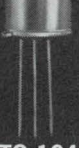

2N5183
 PHP Price **19¢†**
1-AMPERE GENERAL PURPOSE AMPLIFIER
 TO-104

$h_{FE} = 50$ min @ $V_{CE} = 1\text{V}$, $I_C = 300\text{ mA}$; $V_{CE0} = 18\text{ V}$ max; $V_{CE}(\text{SAT}) = 0.5\text{ V}$ max @ $I_C = 300\text{ mA}$, $I_B = 15\text{ mA}$; $f_T = 200\text{ MHz}$ typ; Planar epitaxial construction.

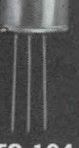

2N5184 †
 PHP Price **27¢†**
HIGH-FREQUENCY HIGH-VOLTAGE AMPLIFIER
 TO-104

$V_{CE0} = 120\text{ V}$ max; $I_C = 50\text{ mA}$ max; $f_T = 100\text{ MHz}$ typ; $C_{cb} = 3.5\text{ pF}$ max.



2N5185
 PHP Price **31¢†**
HIGH-FREQUENCY HIGH-VOLTAGE AMPLIFIER
 TO-104 with integral radiator

1 watt dissipation capability; $V_{CE0} = 120\text{V}$ max; $I_C = 50\text{ mA}$ max; $f_T = 100\text{ MHz}$ typ; $C_{cb} = 3.5\text{ pF}$ max.

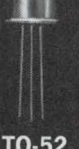

2N5186
 PHP Price **24¢†**
HIGH-SPEED SWITCH
 TO-52

$V_{CB0} = 10\text{V}$ max; $t_{on} = 25\text{ ns}$ max @ $I_C = 10\text{ mA}$, $I_B = 1\text{ mA}$; $t_{off} = 25\text{ ns}$ max @ $I_C = 10\text{ mA}$, $I_B = 1\text{ mA}$; $V_{CE}(\text{SAT}) = 0.3\text{V}$ max @ $I_C = 10\text{ mA}$, $I_B = 1\text{ mA}$.
 *Plus RCA Reliability Control

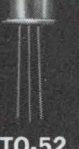

2N5187
 PHP Price **27¢†**
MEDIUM-CURRENT HIGH-SPEED SWITCH
 TO-52

$V_{CB0} = 25\text{V}$ max; $t_{on} = 18\text{ ns}$ max @ $I_C = 100\text{ mA}$, $I_B = 10\text{ mA}$; $t_{off} = 21\text{ ns}$ max @ $I_C = 100\text{ mA}$, $I_B = 10\text{ mA}$; $V_{CE}(\text{SAT}) = 0.5\text{V}$ max @ $I_C = 100\text{ mA}$, $I_B = 10\text{ mA}$.
 *Plus RCA Reliability Control



2N5188
 PHP Price **33¢†**
HIGH-SPEED HIGH-VOLTAGE 1/2-AMPERE SWITCH
 TO-39

$V_{CB0} = 60\text{V}$ max; $t_{on} = 35\text{ ns}$ max @ $I_C = 150\text{ mA}$, $I_B = 15\text{ mA}$; $t_{off} = 50\text{ ns}$ max @ $I_C = 150\text{ mA}$, $I_B = 15\text{ mA}$; $h_{FE} = 20$ min @ $V_{CE} = 1\text{V}$, $I_C = 500\text{ mA}$ (pulsed).
 *Plus RCA Reliability Control



2N5189
 PHP Price **39¢†**
HIGH-SPEED HIGH-VOLTAGE 1-AMPERE SWITCH
 Similar to TO-39

$V_{CB0} = 60\text{V}$ max; $t_{on} = 40\text{ ns}$ max @ $I_C = 1\text{A}$, $I_B = 100\text{ mA}$; $t_{off} = 70\text{ ns}$ max @ $I_C = 1\text{A}$, $I_B = 100\text{ mA}$; $h_{FE} = 15$ min @ $I_C = 1\text{A}$, $V_{CE} = 1\text{V}$.
 *Plus RCA Reliability Control

RCA'S MAX VALUE SAMPLER

22 PHP Transistors for only \$3.95. (Optional distributor resale price). 2 evaluation samples of each transistor in RCA's new MAX VALUE line, packaged to let you check the outstanding performance of this economy line at your RCA distributors from Sept. 5, 1967 for a limited time only. Order your QK2100 Sampler today. This offer is limited to an evaluation quantity.



RCA Electronic Components and Devices

The Most Trusted Name in Electronics

MAGNETIC TAPE RECORDING

For thirty years, CEC has been the pioneer and recognized leader in data instrumentation. The analog and digital magnetic tape recorders described here, plus accessories, represent the most complete tape line available today and are the latest reasons why CEC continues to dominate the field.

VR-3700—New from CEC, this recorder has special magnetic heads which extend its frequency range to 2.0 MHz—plus 500 KHz for FM—at the traditional cost of a 1.5 MHz unit. The first and only 2.0 MHz laboratory recorder that combines versatility and reliability at a budget price.

- ☐ Magnetic recording heads guaranteed to exceed 1000 hours. CEC's unique, solid metal pole-tip design has eliminated the inherent deficiencies of lamination and rotary head design.

- ☐ Failsafe DC Capstan Drive assures dramatically-improved flutter and TDE performance.

- ☐ All-Electric Tension Control. Solid-state amplifiers for improved linear tension control and greater reliability.

- ☐ 15-inch reel capacity.

- ☐ Automatic 8-speed transport with electrically selectable electronics.

- ☐ Phase-lock capstan control electronics included for improved speed accuracy.

- ☐ Convertible from mid to wideband recording. New plug-in heads offer easy interchange of headstacks up to 42-channel capacity.

VR-3400—Identical in specifications to the VR-3700 transport but with midband electronics. However, should eventual data handling requirements call for a 2.0 MHz response, the VR-3400 may be converted

to a VR-3700 by a simple exchange of heads and electronics. This modestly-priced recorder will readily meet the vast majority of laboratory requirements.

VR-3300—Unmatched for applications where ruggedness and mobility must be combined with outstanding performance.

- ☐ 100 cps to 300 KHz direct frequency response; dc to 20 KHz FM frequency response.

- ☐ Dual capstan drive system provides closed-loop speed and tension control equal to standard laboratory systems.

- ☐ Interchangeable record and reproduce electronics and heads with CEC's VL-2810 Continuous Loop Recorder/Reproducer.

- ☐ Six-speed record/reproduce system.

DR-3000—CEC's "universal" digital recorder now offers another *first*—plug-to-plug compatibility with IBM 729 and 2400 Series tape handlers. Result: state-of-the-art performance at approximately half the cost of comparable digital tape systems.

- ☐ Fully IBM compatible with full plug-to-plug compatibility at all speeds and densities, 7 or 9 channels.

- ☐ Only low-cost transport with straight-line loading for rapid, easy tape handling.

- ☐ Unique, all-metal-front-surface heads are guaranteed for a minimum of 2500 hours of tape passing.

- ☐ Dual capstans with positive drive precludes tape slippage and assures gentle tape handling.

- ☐ Simplified parts provisioning and service with complete interchangeability of parts, regardless of speed requirements.

- ☐ Compact, rugged design with unique tape buffering provides the only high-speed system mountable in a 19" or 24" rack.

VR-2600 PCM—Features the most advanced electronic circuitry of any PCM recorder. Due to internal clock correction and skew correction circuitry, no delay lines are required. This eliminates the necessity for frequent readjustment and a pulse display unit. Once the VR-2600 has been set up, it may be operated for extremely long periods with no readjustment whatsoever.

- ☐ All solid-state electronics, pushbutton controlled for operation without readjustment at six electrically selectable tape speeds from 120 to 3¾ ips.

- ☐ Packing density 1000 bpi.

- ☐ Individual speed accuracy $\pm 0.20\%$.

- ☐ Accessories include edge track voice recording/reproducing, shuttle control and monitoring equipment, including both meter and oscilloscope presentation.



VR-3700



VR-3400



VR-3300

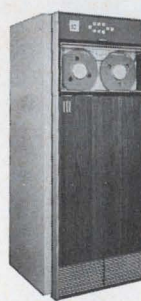

DR-3000

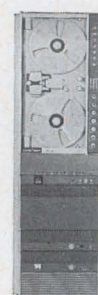

VR-2600 PCM

1967

| | VR-3700 | VR-3400 | VR-2600 PCM | VR-3300 | VL-2810 | DR-3000 | VR-5000 |
|----------------------------------|------------------------|------------------------|-------------------------------------|--------------------|--------------------|--------------|---------------------|
| TAPE SPEEDS | 8 speeds to 240 ips | 8 speeds to 240 ips | 7 speeds to 120 ips (in two ranges) | 6 speeds to 60 ips | 6 speeds to 60 ips | up to 75 ips | 8 speeds to 240 ips |
| TAPE SPEED ACCURACY | ±.02% Phase-Lock Servo | ±.02% Phase-Lock Servo | ±0.2% | ±0.25% | ±0.20% | ±0.3% | ±.05% |
| REEL SIZE MAXIMUM | 15 inch | 15 inch | 14 inch | 10½ inch | Loop | IBM | 16 inch |
| DIRECT FREQUENCY RESPONSE | 400 Hz 2.0 MHz | 300 Hz 600 KHz | 1000 BPI | 100 Hz 300 KHz | 100 Hz 300 KHz | — | 400 Hz 2.0 MHz |
| FM FREQUENCY RESPONSE | dc 500 KHz | dc 40 KHz | — | dc 20 KHz | dc 20 KHz | — | dc 500 KHz |

VL-2810—Specifically designed for data reduction or data monitoring and storage where machine work-load is heavy.

▣ Accommodate tape loop runs from 2 to 75 feet at six tape speeds from 1½ to 60 ips.

▣ VL-2810 handles data in the range from dc to 20 KHz via FM techniques, and from 100 cps to 300 KHz employing direct techniques.

▣ Utilizes ½" tape for up to 7 channels, or 1" tape for up to 14 channels, using IRIG geometry.

▣ Accessories include selective erase equipment providing erasure of any combination of 7 to 14 tracks, without removal of the tape loop from the machine. Bulk erase equipment also available.

VR-5000—CEC's finest new recorder, the advanced VR-5000 2.0 MHz System has a flutter correction capability five times more effective than any other instrumentation recorder known today. The unique Dual Inertia[®] (DATA LOCK™) tape drive provides the low flutter introduction advantages of high mass recording coupled with the flutter correction and low TDE (±0.4 μsec./120 ips) advantages of low mass reproduce under wideband servo control. Consequently, the VR-5000 is the only recorder capable of translating the ideal system concept into a working reality—*high mass recording and low mass reproduce.*

▣ A 3% flutter component at 50 Hz will be reduced at least 20 db; a 1% flutter component at 200 Hz at least 16 db. Thus flutter components from dc to beyond 200 Hz are, for all practical purposes, effectively eliminated.

▣ Capstan servo phase-lock capture range is sufficient to lock on a ±30% recorded speed error occurring at a 50Hz rate or a quasi-static speed error of +50%–100%.

▣ Longer tape life, fewer "drop-outs", and better amplitude stability are assured by the VR-5000's unequaled servo system, which holds tape tension variations to such a low value they cannot be measured with gages presently available.

▣ Positive air pressure tape buffering (patent pending) prevents recording errors due to reel perturbations, while solving the contamination and "sticktion" problems normally associated with vacuum systems. This system, combined with closed loop reel servos, provides 40db of reel to head area isolation.

▣ A high inertia flywheel is inserted into the drive system during the record mode to achieve an absolute minimum of recorded flutter components.

▣ Tape speed accuracy of ±.05% with tape servo, machine-to-machine.

*PATENT PENDING

CEC DataTape[®] Accessories

The Monitor Oscilloscope is used with tape recorder/reproducers, or any multi-channel instrumentation system to provide visual display of electrical signals ranging in frequency from dc to 3,000,000 cps. Unique features of this unit include up to 500 KHz sweep rate and modular construction.

The Type TD-2903 Automatic Tape Degausser is designed to erase data signals from magnetic tape wound on reels up to 14" in diameter and tape widths from ½" to 2". A reel of 1"-wide instrumentation tape recorded at saturation level is erased to a nominal 90 db below normal level.

The Dynamic Tape Tension Gage permits accurate tension measurements directly while the recorder is in operation ... helps keep your recorder in proper operating condition through routine maintenance adjustment.

CEC Computer & Analog Tapes

All CEC Computer Tapes are well within allowable tolerances of the reference tape used by the computer industry—and all are certified "drop-out free" for the first pass, and remain so for many more. Because of CEC's nation-wide field force and warehousing facilities, tape generally can be delivered within 24 hours. CEC Analog Tape is available in all frequency bandwidths, meets or exceeds the most critical specifications, and offers the same delivery advantages.

For complete information about any of these products, call your nearest CEC Field Office, or write Consolidated Electro-dynamics, Pasadena, California 91109. A subsidiary of Bell & Howell. Bulletin Kit 320-X4.

CEC/DATATAPE PRODUCTS

 **BELL & HOWELL**

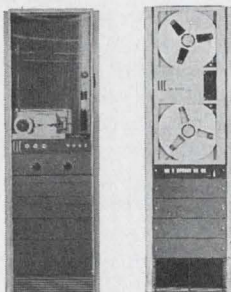

VL-2810

VR-5000

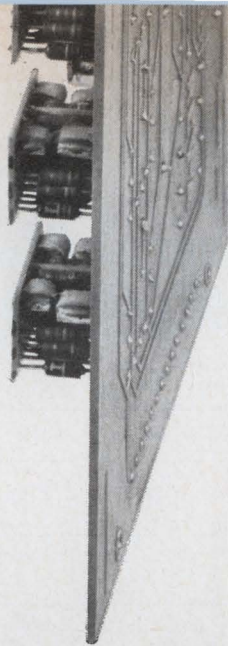

One shot with parylene covers everything.

There are a lot of ways to make a "conformal" coating. Dipping, spraying, fluid bed . . . you name it.

But only one way, vapor deposition, gives you a *perfect* conformal coating all over in one shot, every time. No matter how dense the circuitry or how complex the component, a uniform and continuous coating is deposited. (Vapor deposition of BAKELITE parylene is an exclusive process from Union Carbide.)

Here's why. With parylene, you're not coating with a liquid. You're vapor-depositing a polymer. There are no solvents to

evaporate, no opacifying fillers, no additives, no baking, no drying. And no multiple coatings are needed to make sure it's pin-hole free. (This means that you can save as much as 10 hours in coating time.)

Parylene conformal coatings can be as thin as 0.002 mil or as thick as 3 mils or more. And they won't, they can't run, sag, bloom, blister, wrinkle or blush.

What else? As a conformal coating, parylene is a primary dielectric, an unsurpassed moisture barrier, resists softening at high temperatures, and its chemical resistance is outstanding.

If you have a circuit or component that you think might benefit from this new plastic why not let our development custom coating service make a trial run for you. Why take our word for it?

(If you haven't heard, parylene production units for your own use are available, with a license, from Union Carbide.)

For additional information about our BAKELITE parylene, please write to Union Carbide Corporation, Dept. EM-10, 270 Park Avenue, New York, New York 10017.

**UNION
CARBIDE**
PLASTICS

BAKELITE is a registered trademark of Union Carbide Corporation.

Editorial

Who's to judge?

For years, the telephone companies have stoutly resisted the violation of their lines by so-called foreign attachments—devices of any kind made by companies other than themselves. The utilities have reasoned that any outside gear, no matter how well it performs alone in laboratory tests, could foul up telephone operations by introducing noise, crosstalk, unwanted voltages, or tiny faults that would be magnified as they traveled through the huge telephone system.

Until now, the Federal Communications Commission has supported the utilities in this view. The FCC has agreed that since a telephone company is responsible for operating its system, it should determine what equipment is used. Attempts by an outsider to get its gear into a telephone system usually involve a long and costly legal process: filing a complaint with the commission, appearing at a hearing before a trial examiner, and then fighting off court appeals if it wins. The procedure can take three to five years.

Last month, after just such a legal rigamarole, the FCC surprised everybody by radically changing its policy on foreign attachments. The agency had ruled against the phone companies before, so the shocker came not with the ruling—that the Carterphone, a device to facilitate the interconnection of telephones and mobile radios shouldn't be barred from telephone lines—but in the testimony. The Common Carrier Bureau, which rides herd on the utilities, offered the view that it was unfair to force electronics firms to go through this time-consuming and costly litigation every time a new device is invented. Now the FCC has gone on record that it wants tariffs changed so that “. . . customer-provided equipment may be attached so long as it is not hazardous or detrimental to telephone service . . .”

But wanting the change and bringing it about are two different things. The big question is: who is to say that the equipment is or is not detrimental?

Although AT&T insists that it will voluntarily and at no charge study any foreign attachment—and even recommend design changes to make the device acceptable to Bell System companies—inventors insist the phone company is not an impartial observer.

The testimony in the Carterphone case shows how disagreements develop. At the hearing, the telephone companies claimed:

- That the Carterphone inherently alters frequency response, thereby affecting the quality of sound in both directions, and that it would destroy the system's side-tone feedback, a factor that tends to keep speech outputs at desirable levels. But the examiner noted that users of the Carterphone had expressed no dissatisfaction with the quality of communications.

- That use of the device could cause crosstalk, which can occur when the system input reaches 100-104 decibels above reference acoustic pressure. The examiner concluded that this would not be a problem of great

magnitude because misuses of the Carterphone that would cause the crosstalk were no more likely than the misuse of equipment supplied by the telephone companies.

- That the Carterphone might malfunction. The examiner held that any equipment could fail, but that the device had not shown itself to be prone to failure.

- That more frequent calls, longer times to complete connections, and the extension of telephone calls by private radio into distant toll zones would impose an unpredictable burden on the telephone system and bring a consequent increase in costs. This argument, according to the examiner, was purely conjectural.

- That uneven maintenance of Carterphones and the radio systems they connect into the telephone system would inevitably cause communication failures, and that initial complaints would be directed to telephone companies, who would then have to conduct expensive investigations to establish their innocence. A simple test call, not an expensive investigation, would probably suffice, the examiner suggested.

- That since the Carterphone is designed for use only with today's most common type of handset, it would be useless with handsets of other designs and could thus create consumer resistance to equipment innovations. Although this was the one point the telephone companies backed with concrete evidence, the examiner believed the evidence was too scanty to justify a finding that the Carterphone represented a threat to present or future phone service.

Although these are technical and economic arguments that seemingly can be resolved by evidence, a bias such as the telephone companies must have could easily alter the conclusion. So Electronics agrees with those who say the telephone companies cannot be the final judge of foreign attachments. Still, in its present understaffed condition, neither can the FCC.

But there are at least three other possible solutions.

- 1) Require the manufacturer of a foreign device to submit to the FCC complete test data on the performance and reliability of its gear as it operates on telephone lines, not as it worked in the manufacturer's engineering department. The test and report procedures would be similar to those the Food and Drug Administration requires of drug manufacturers before the introduction of a new drug.

- 2) Or, assign to a Government laboratory with a good technical reputation, such as the National Bureau of Standards, the responsibility for performing such tests and studies. An objection to this is that even the NBS is subject to political pressures in its evaluation of commercial products.

- 3) Or, expand the Common Carrier Bureau of the FCC, adding competent technical people and equipping a laboratory to perform the tests. FCC Commissioner Nicholas Johnson has already made such a proposal, and it makes sense since the bureau is intimately acquainted with both the technical and economic problems of operating the telephone system.

The FCC's newly declared policy is sure to spur a flock of new equipment developments. What's needed now are technical procedures to evaluate these developments outside the law courts.

In fact, it was being thrown for a loss by laminated steel recording heads. Steel heads couldn't cope with high frequencies. Or measure up to gap definition requirements. Then we substituted the Indiana General Ferramic® O-6 ferrite.

High frequency ceased to be a problem. Our O-6 ferrite has a range through the high frequencies, and maximum permeability of 6000. Plus high saturation, low loss, and a high Curie point.

Gap definition improved, too. Ferramic O-6 has an extremely fine grain crystal structure. It can be manufactured in complex configurations to finishes in the micro-inch range, providing the close gap definition required for high signal efficiency. And, as a bonus advantage, Ferramic O-6 heads have an operating life 5 to 10 times longer than laminated steel.

But the use of O-6 ferrite material isn't limited solely to video or audio tape heads.

Its many advantages are equally applicable to disc, drum, and tape peripheral equipment for digital memory recording/reproduction processes.

You can get an instant playback of our Ferramic O-6 ferrite specifications by writing Mr. K. S. Talbot, Manager of Sales, Indiana General Corporation, Electronics Division/Ferrites, Keasbey, New Jersey.

INDIANA GENERAL 

**Instant video replay
wasn't gaining ground until
Indiana General got in the game.**

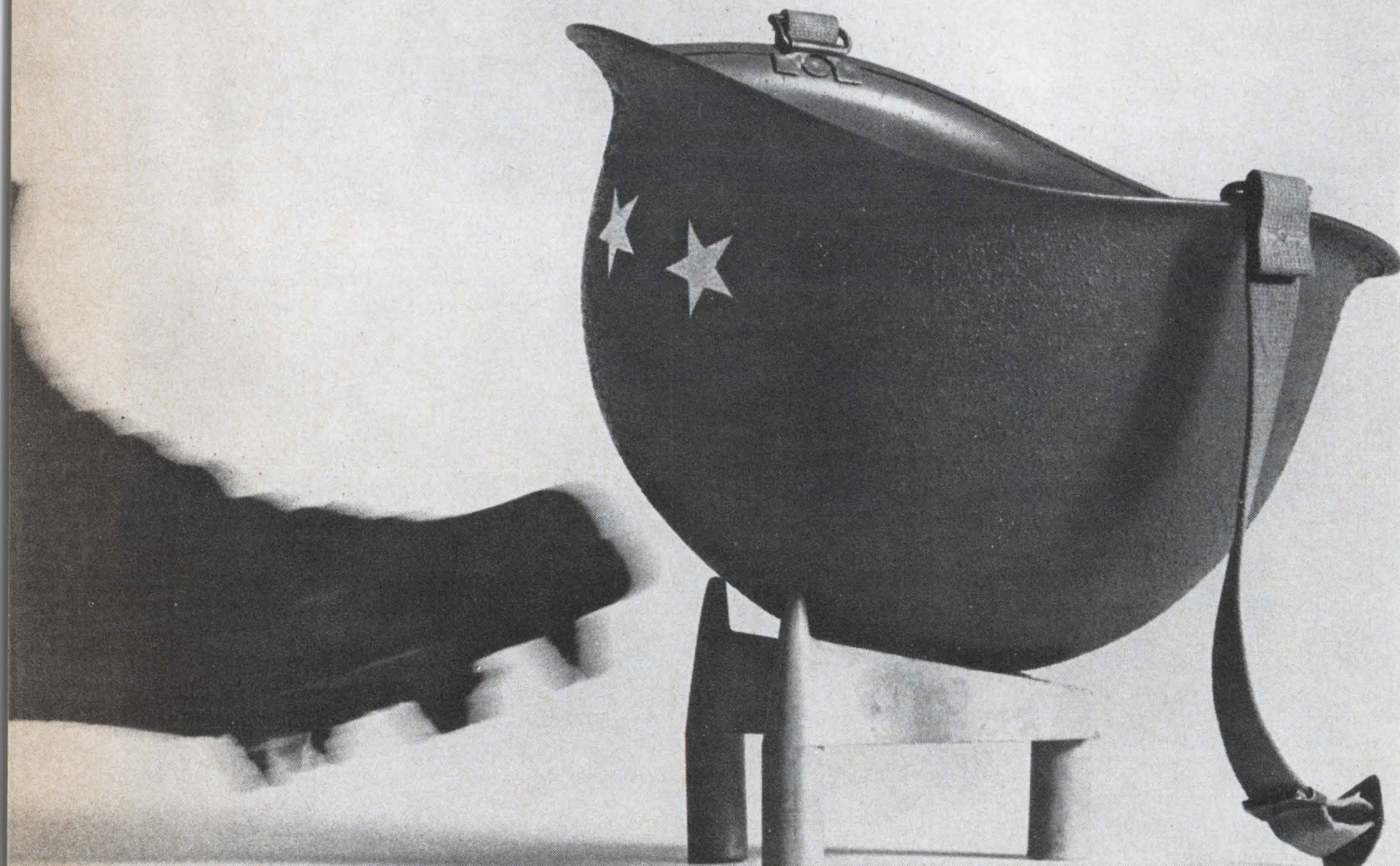

Electronics Newsletter

October 16, 1967

Pontiac ready to tune in IC's

The Pontiac division of General Motors, which already has chalked up a first with its IC voltage regulator [Electronics, Oct. 2, p. 137], also will be the first auto maker to put an IC into a car radio. The silicon monolithic device, produced by Delco Radio, will be used as an i-f amplifier in Delco's am/fm receivers to be offered to buyers as an option this winter.

Philco-Ford, meanwhile, has finished tests of its IC car radio. The IC also is a silicon monolithic device used as an i-f amplifier in an am/fm set. But Philco, unlike Delco, has been stymied by the cost barrier. The result, industry insiders predict, is that because of the higher cost of using IC's Philco won't be able to sell Ford on switching and the Ford project won't get past the test stage for a while.

Trio of radars eyed for space tracking

The next generation of space surveillance sensors could come out of a new series of tests now being set up at the Air Force's Rome, N.Y., Air Development Center. Three new radars, including optical and super-high-frequency sensors, will be operated alongside each other in comparative tests.

First to be ready—before the end of this year—is a high-power, S-band (3,350 megahertz) radar that will attempt to get high range resolution by a pulse-compression technique. The second sensor is an optical radar using a carbon-dioxide-nitrogen laser transmitting at 10.6 microns. This infrared frequency is better in haze and fog than the 0.6- or 1.06-micron frequencies previously considered for this application. The carbon-dioxide tracker will be ready in two months for limited tests.

The third is S-band radar that will try for high resolution by using very-short pulses and brute-force power to get them to the target and back. The main problem has been generating sufficient power. Rome believes, however that a relativistic beam linear accelerator it has designed will provide up to 1,000 megawatts without difficulty. Operation of this radar is two years off.

New MOS IC's bar drift in linear jobs

A family of metal oxide semiconductor, monolithic linear integrated circuits that don't exhibit the drift problems typical of other prototype MOS linear devices has been developed at RCA Laboratories. Instabilities that usually crop up in MOS elements at higher operating voltages and temperatures are eliminated by an internal d-c feedback arrangement that uses an MOS element as a voltage-controlled resistor.

Included in the new IC line are seven-stage and 11-stage amplifiers. Over-all gain of the seven-stage unit is 60 decibels with a bandwidth of 1 megahertz—modest in comparison to the levels attained by bipolars but sufficient for many analog applications. An RCA engineer says yields and performance are running high enough to warrant a production go-ahead, but he wouldn't specify when RCA will market the new line.

Vidicon-laser camera system

A satellite camera system that can take pictures of the earth with almost seven times the resolution of present space cameras has been developed by the Radio Corp. of America's Defense Electronic Products division, Princeton, N. J. The picture, from signals sent by a new type of vidicon

Electronics Newsletter

tube, is reproduced with a scanning laser beam.

The tube, called a return-beam vidicon, differs from a normal vidicon in that, like an image orthicon, it uses a return scanning beam to generate a video signal. System resolution now is 5,000 tv lines per picture, but the theoretical limit is 8,000. RCA notes that present space cameras have a resolution of 800 lines. The picture taken by the vidicon is traced in a 9-by-9-inch format on photographic film by a continuous-wave, helium-neon laser. The recording spot, intensity modulated by the video signal, is moved across the film by a rotating lens assembly.

RCA is considering proposing the system for the advanced Tiros M weather satellite it's building for NASA. Or it could fit into the Earth Resources Orbiting Satellite (EROS) being contemplated by the Interior Department as a means of observing crops, forests, topography, and mineral resources.

Company jets land inertial navigators

Orders from the general aviation field—an unexpected customer—are giving new wings to the commercial inertial-navigator business. Prospects had seemed dim after Pan Am recently canceled its program to install Sperry SGN-10 units in its big jets.

But corporations, expected to pass up the inertial systems because of their expensive price tags, have started ordering them for company aircraft. Litton Industries has chalked up nine orders for its \$100,000 LTN-51 system. Most will go on Grumman Gulfstream jets. One of the Litton customers is Canada's Home Oil Co., which is turning to inertial navigation because many of the airports it uses lack en route radio-navigation aides.

Industry organizes laser association

While the Electronic Industries Association spent months deliberating whether it should form a full subdivision on lasers or a committee on laser engineering, 31 laser manufacturers took action. They met in Washington to lay the groundwork for an organization that will be called the Laser Industry Association (LIA). Its purpose: To serve as a focal point for the dissemination of information on laser technology and to change the public's image of the device as a "death ray."

Many EIA members were at the laser group's organizational meeting but an EIA spokesman confidently predicted that the laser group his association eventually sets up will be able to lure back any members who defect to the newer association.

EIA faces a split over tariff, quotas

A battle is shaping up within the Electronic Industries Association over proposals to set import quotas on equipment and components and to boost the tariff on imported color television tubes. The clash, between the organization's "protectionist" parts division and its consumer products division, which includes importers, is expected when EIA groups meet in Los Angeles Oct. 25.

A bill has already been introduced in Congress to return the tariff on color tv tubes to 30% Jan. 1 from its present 12% level. And the parts division has prepared a bill for submission to Congress that would limit imports of consumer electronics products and components to 1966 levels. Despite opposition from EIA "free traders," the parts division is already looking around Capitol Hill to find a Congressional sponsor for the quota measure.

9 1N771A 1N773A 1N96A 1N118 1N141 1N270-JAN 1N277-JAN 1N287 1N298 1N500 1N771B 1N77
3 1N278 1N288 1N450 1N699 1N772 1N774A 1N98A 1N120 1N250 1N276 1N279 1N289 1N497 1N77
9 1N777 1N3666 1N781 1N781A 1N34A 1N88 1N126 1N198B 1N56A 1N89 1N128 1N67A 1N90 1N18
1N116 1N198 1N86 1N117 1N695 1N996 1N3287-J 1N695A 1N3125 1N3592 1N995 1N3287 1N9

1 1N662A 1N818 1N905A 1N908A 1N3064 1N3066 1N3956 1N252 1N663 1N903 1N906 1N914 1N306
3A 1N906A 1N914A 1N3068 1N891 1N626 1N811 1N904 1N907 1N916 1N3124 1N3069 1N627 1
6 1N3124 1N3069 1N627 1N812 1N904A 1N907A 1N916A 1N3062 1N815 1N659 1N813 1N905 1
04 1N662 1N814 1N461 1N462 1N87 1N905A 1N908A 1N3064 1N3066 1N395
6 1N914A 1N3068 1N891 1N626 1N811 1N904 1N907 1N916 1N3124 1N3069 1N627 1N812 1N904A 1

6 1N749 1N752 1N755 1N758 1N95 1N95B N5 1N965B 1N746A 1N749A 1N752A 1N755A
2 1N964 1N702 1N747 1N750 1N75 1N960A 1N962A 1N964A 1N702A 1N

HOT LINE

6A 1N759A 1N958B 1N960B 1N962B 1N964B 1N703 1N748 1N751 1N754 1N757 1N957 1N959 1N961
8A 1N751A 1N754A 1N757A 1N957A 1N959A 1N961A 1N963A 1N965A 1N704 1N704A 1N710A 1N
2A 1N725A 1N766 1N1931 1N1937 1N705 1N711 1N714 1N717 1N720 1N723 1N761 1N767 1N1932 1

0 1N956 1N3947 1N4805 1N4811 1N951 1N3182 1N3949 1N4806 1N4812 1N952 1N3555 1N4801 1
56 1N4802 1N4808 1N4814 1N954 1N3945 1N4815 1N955 1N3946 1N4804 1N4810
05 1N4811 1N951 1N3182 1N3949 1N4806 1N3555 1N4801 1N4807 1N4813 1N953 1
14 1N954 1N3945 1N4803 1N4809 1N4810 1N950 1N956 1N3947 1
82 1N3949 1N4806 1N4812 1N952 1N8555 1N953 1N3556 1N4802 1N4808 1

99 1N1200B 1N1202 1N1203B 1N1205 1N1345 1N119A 1N1200R 1N120
06R 1N1342A 1N1343R 1N1345A 1N1199 1N1205B 1N1341 1N1342B 1N1
01A 1N1202R 1N1204A 1N1205R 1N1345R 1N1200 1N1201B 1N1
41B 1N1343 1N1344B 1N1346 1N1200A 1N1204R 1N1206A 1N1341R 1N1343
46B 1N1348 1N1613A 1N1615A 1N2246A 1N2258A 1N2262A 1N1346R 1N1348

8 2N1202 2N1502 2N2269 2N3612 2N3618 2N1157A 2N2738 2N538A 2N1203
13 2N4242 2N1759 2N575 2N2730 2N2733 2N539 2N9AM-JAN 2N2870 2N3614 2N4243 2
34 2N539A 2N1262 2N2266 2N301 2N3615 2N4244 2N75-USA 2N2732 2N2735 2N540 2N
16 2N4245 2N574 2N575A-USA 2N2736 2N540A 2N1 2N3611 2N3617 2N4246 2N574A
5 3N37 3N48 3N49 3N50 3N51 3N52 2N538 2N1202 2N269 2N3612 2N3618 2N4247 2N574

7A 2N935 2N721 2N1025 2N1036 2N1197-USA 2N1 2N1259 2N328A 2N936 2N722 2N
254 2N1275 2N328AM-JAN 2N937 2N726 2N1027 2 0 2N1230 2N1255 2N1469 2N329A
32 2N1221 2N1231 2N1256 2N1474 2N329AM-JA 95 2N1034 2N1196 2N1222 2N1232 2
40 2N1024 2N1035 2N1197 2N1223 2N1258 2N147 991 2N1477 2N2551 2N1654 2N3413

5 2N271 2N1025 2N1036 2N1197-USA 2N1228 2 9 2N328A 2N936 2N722 2N1026 2N
40 2N929 2N2460 2N2466 2N2518 2N2523 2N740 2461 2N2483 2N2519 2N2524 2N759 2
520 2N3117 2N760A 2N930A 2N2464 2N2515 2N2 2N760B 2N2459 2N2465 2N2516 2N2522

466 2N2518 2N2523 2N740A 2N929A 2N2461 2N 9 2N2254 2N759 2N930 2N2462 2N2484
30A 2N2464 2N2515 2N2521 2N3340 2N760B 2 5 2N2516 2N2522 2N740 2N929 2N460 2
40A 2N929A 2N2461 2N2483 2N2519 2N2524 2 2N2462 2N2484 2N2520 2N3117 2N760A

32 2N2697 2N2814 2N3055 2N3597 2N3746 70 2N4864 2N2633 2N2698 2N2877 2N
071 2N4865 2N2634 2N2811 2N2878 2N3748 2N4150 2N4866 2N2657 2N2812 2N
749 2N3772 2N4862 2N2658 2N2 3745 2N3750 2N3773 2N4863 2N2632 2N
97 2N3746 2N3751 2N4070 2N 2N2877 2N3149 2N3598 2N3747 2N3752 2N
311 2N2878 2N3150 2N3599 2N4866 2N2657 2N2812 2N2879 2N3151 2N

Part 1 WE-Part 2 18-Part 3 140-Part 4 .8-Part 5 1555-Part 1 WE-Part 2 18-Part 3 140-Part 4 .8-Part 5
Part 1 WE-Part 2 18-Part 3 140-Part 4 .8-Part 5 1555-Part 1 WE-Part 2 18-Part 3 140-Part 4 .8-Part 5
Part 2 18-Part 3 140-Part 4 .8-Part 5 1555-Part 1 WE-Part 2 18-Part 3 140-Part 4 .8-Part 5 1555-Part
2 18-Part 3 140-Part 4 .8-Part 5 1555-Part 1 WE-Part 2 18-Part 3 140-Part 4 .8-Part 5 1555-Part
Part 2 18-Part 3 140-Part 4 .8-Part 5 1555-Part 1 WE-Part 2 18-Part 3 140-Part 4 .8-Part 5

114 HMS234 HMSJ112 HMS232 HMSQ205010 HMSI14 HMS314 HMS112 HMSQ200510
24 HMS22 HMS20100 HMS205005 HMS134 HMS334 HMS132 HMSQ201010 HMSQ200520 HMS
201 HMS2 HMS2 HMS2 HMS2 HMSQ205005 HMSZ0104 HMSZ0520 HMSZ2504 HMSZ0110
2 HMS2 HMS2 HMS2 HMS2 HMSZ0140 HMSZ1010 HMSX2540 HMSZ0504 HMSZ1020 HMSZ0510
234 HMSJ112 HMS232 HMSQ200505 HMSQ20510 HMSI14 HMS314 HMS112 HMSQ200510 HMSQ205

96 1N1409 1N1730A 1N1733A 1N2383A 1N3053 1N3059 1N597 1N1410 1N1731 1N1734 1N2384 1N
41 1N1731A 1N1734A 1N2384A 1N3055 1N3061 1N1406 1N1412 1N1732 1N2382 1N2385 1N3056 1N
382A 1N2385A 1N4057 1N1408 1N1730 1N1733 1N2383 1N3052 1N3058 1N596 1N1408 1N1413 1N
97 1N1409 1N730 1N2382 1N3053 1N3058 1N598 1N1410 1N1731 1N2383 1N3054 1N3059 1N1406 1
055 1N3060 1N1407 1N1412 1N1733 1N2385 1N3056 1N3061 1N1150 1N2490 1N1237 1N2630 1N
000 HA2010 HA2001 HA2020 HA2000 HA2010 HA2001 HA2020 HA2000 HA2010 HA2001 HA2020 HA
020 HA2000 HA2010 HA2001 HA2020 HA2000 HA2010 HA2001 HA2020 HA2000 HA2010 HA2001 HA
001 HA2020 HA2000 HA2010 HA2001 HA2020 HA2000 HA2010 HA2001 HA2020 HA2000 HA2010 HA
010 HA2001 HA2020 HA2000 HA2010 HA2001 HA2020 HA2000 HA2010 HA2001 HA2020 HA2000 HA



HOT, YOU BET WE ARE..

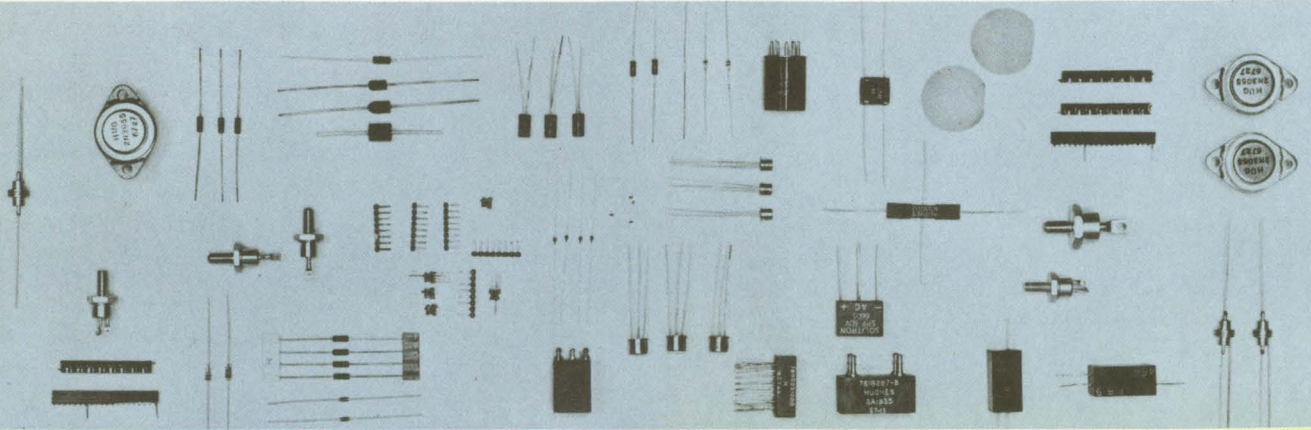

1. Germanium Diodes:

All are featured in DO-7 glass packages; the same patented* subminiature diode glass package that was first introduced by Hughes Semiconductors in 1951. Included are a vast selection of standard gold bond and fast recovery computer gold bond germanium diodes from which to choose.

*Patent No. 2694168

2. Silicon Diodes:

Featuring the microglass pill or "pellet" (HMG series) — the smallest hermetically sealed diode in the industry. The devices in this category are primarily silicon computer and core driver diodes. They are also produced in the DO-7 subminiature glass package (HD series) and in the micro dual-stud 500 milliwatt packages (HDS series). Featured also are ultra high speed silicon diodes in the DO-7 package.

3. Silicon Zeners:

Two processes are available, alloy and diffused, and package sizes from DO-7 to DO-4 give the broad line of Hughes zeners a power range from 250 mW to 15 watts and a voltage range from 2.0 volts to 200 volts. Temperature compensated zeners are now available in the 1.5 — 3.0 watt range with voltages from 8.0 to 200 volts.

4. Silicon Capacitors:

In this category both silicon alloy and diffused processes produce a broad line of voltage variable capacitors in the DO-7, DO-14, and special molded packages covering a capacitance range from 3 pf to 1000 pf and a voltage range from 15 volts to 200 volts. "Q" ratings up to 1000 may be obtained.

5. Silicon Power Rectifiers:

This is the industry-famous Golden Line of Hughes rectifiers. The line features fast switch and standard types from 500 milliamps to 6 amperes and in voltages up to 1200 volts. Fast switch versions exhibit switching times as low as 75 nanoseconds.

6. Germanium Power Transistors (PNP):

Hughes now features a complete line of PNP power transistors from 3.5 to 200 amperes. These transistors feature low leakage, very low saturation voltages and compact packaging.

RED HOT!

For starters, take a look at the fourteen categories previewed below. They represent over fourteen-thousand individual devices that are available for sale... all meet their specifications and all are competitively priced. **Notice has been served, our policy is to offer the broadest line of semiconductors at the best prices in the industry.**

Whether you're a designer or buyer, check us out! Fill out and mail the attached request for the new Hughes Product Selector. For "immediate ordering" call the Hughes **HOT LINE (800) 854-3280 toll free**... or if located in California dial **(714) 548-0671**.

7. PNP Silicon Alloy and PNP Diffused Transistors:

PNP Silicon alloy transistors are available in military and industrial types in the TO-5 and in the coaxial 1 watt packages. Symmetrical V_{CB} , C_{CE} and V_{EB} characteristics up to 200 volts are uniquely available in these devices. PNP diffused silicon planar transistors are produced for high speed switch, general purpose, and small signal amplifier applications in both TO-18 and TO-5 packages.

8. NPN Silicon Planar Transistors:

A family of NPN low-noise, small-signal transistors is available in TO-18 and TO-46 package configurations.

9. NPN Silicon Power Transistors:

A broad line of NPN Silicon Power Transistors is introduced featuring single diffused, planar, planar epitaxial, and isotaxial processes. Collector current ratings from 2 amperes (in TO-46, TO-5 and TO-66 packages) to 100 amperes (in an MT-49 package) are available. Low saturation voltages and exceptional secondary breakdown characteristics are features of these lines. Power darlington with gains up to 10,000 are also available.

10. R. F. Noise Diodes and Modules:

This category contains radio frequency noise diodes featuring performance from 20 cycles per second to 100 megacycles per second developing an output up to .5 microvolts per one cycle bandwidth of gaussian noise voltage. Modules incorporating these devices are effective white noise sources which may be energized by a D.C. voltage and can produce a noise voltage with a flat frequency spectrum across a 5 cycle to 500 megacycle bandwidth with up to 100 millivolts level of random white noise output.

11. Metal Silicon Junction Diodes:

These metal silicon junction Schottky barrier hot carrier diodes feature characteristics suitable to UHF mixer applications where their low noise and high conversion efficiency make extremely high sensitivity a reality. These devices feature capacitance ratings of less than .5 pf and a single sideband noise figure of typically less than 6.5 db at 890 megacycles.

12. Semiconductor Materials:

Both silicon and germanium materials are available in Czochralski, float zone or zone melt ingots, slices, lapped wafers, etched wafers, dice, epitaxial wafers (silicon only), or polished wafers. Tight process controls and the latest equipment and methodology enable us to meet exacting tolerances and custom requirements.

13. Metal Oxide Semiconductor Field Effect Transistors:

This line of "P" channel, enhancement mode field effect transistors features application capabilities as digital switches, low drift D.C. amplifiers and general purpose D.C. amplifiers. All units are individually sealed in the TO-72 package.

14. Special Assemblies:

The Hughes special assembly line features a broad range of soldered or welded, open or encapsulated modular assemblies ranging in size from semiconductor chip and microglass diode modules to large power rectifier stacks. Featured are high-voltage rectifier tube replacements for airborne systems radar modulators, high power silicon rectifier stacks for ground based radar charging circuits, cartridge rectifiers for high voltage power supplies, and matched pair and bridge assemblies for discrimination and rectification requirements. Solid-pak modules feature Hi-Pak circuitry consisting of flame-sprayed deposited copper interconnections joining high voltage rectifier chips on a common heat sink element in an integrated and encapsulated power assembly.

FOR RED HOT ORDERS CALL

your nearest HOT LINE specialist:

SALES OFFICES

Hillside, New Jersey (201) 289-7600
Long Island, New York
(516) 781-4420
Minneapolis, Minnesota
(612) 544-2759
Newport Beach, Calif.
(714) 548-0671
Parkridge, Illinois (312) 823-5192
Washington, D. C. (202) 234-9300

REPRESENTATIVES

BROCKTON, MASSACHUSETTS Forsberg Sales (617) 522-6300
CHARLOTTE, NORTH CAROLINA F. C. Nickerson Co. (704) 399-3673
CLEVELAND, OHIO R. G. Sidnell & Co. Inc. (216) 221-1313
DALLAS, TEXAS J. Y. Schoonmaker, Inc. (214) 357-8481.
DAYTON, OHIO R. G. Sidnell & Co. Inc. (513) 293-1194
DECATUR, GEORGIA F. C. Nickerson Co. (404) 377-1575
HAZELWOOD, MISSOURI Technical Representatives, Inc. (314) 521-1000
HOUSTON, TEXAS J. Y. Schoonmaker, Inc. (713) 926-9510
HUNTSVILLE, ALABAMA F. C. Nickerson Co. (205) 881-9565
LITTLETON, COLORADO Simpson Associates (303) 798-8439
OLATHE, KANSAS, Technical Representatives, Inc. (913) 782-3775
PORTLAND, OREGON L. A. Lawson (503) 232-0161
SAN ANTONIO, TEXAS J. Y. Schoonmaker, Inc. (512) 342-0251
SYRACUSE, NEW YORK C. W. Floring & H. R. Murray, Inc. (315) 446-5555
TAMPA, FLORIDA F. C. Nickerson Co. (813) 833-4321
WICHITA, KANSAS Technical Representatives, Inc. (316) 682-4140

DISTRIBUTORS

ALBUQUERQUE, NEW MEXICO Kierulff Electronics, Inc. (505) 268-3901
ATLANTA, GEORGIA Jackson Electronic Supply Co., Inc. (404) 355-2223
AUSTIN, TEXAS Sterling Electronics, Inc. (512) 452-0271
BALTIMORE, MARYLAND Kann Ellert Electronics, Inc. (301) 889-4242
BIRMINGHAM, ALABAMA MG Electronics & Equipment Co., Inc. (205) 837-0350
BROCKTON, MASS. Forsberg Electronic Distributors, Inc. (617) 522-6300
BUFFALO, NEW YORK Summit Distributors, Inc. (716) 884-3450
CEDAR RAPIDS, IOWA Deeco, Inc. (319) 365-7551
CHICAGO, ILLINOIS Newark Electronics Corp. (312) 638-4411
CLEVELAND, OHIO Pioneer Standard Electronics, Inc. (216) 432-0010
COLUMBUS, OHIO Electronics Marketing Corp. (614) 299-4161
DALLAS, TEXAS Sterling Electronics, (214) 357-9131
DENVER, COLORADO Kierulff Electronics, Inc. (303) 825-7033
FARMINGDALE, L. I., NEW YORK Arrow Electronics, Inc. (516) 694-6800
HOLLYWOOD, CALIFORNIA Hollywood Radio & Electronics, Inc. (213) 466-3181
HOUSTON, TEXAS Sterling Electronics Inc. (713) 666-3811
HOUSTON, TEXAS Wofford Electronics Company (713) 644-1838
INGLEWOOD, CALIFORNIA Newark Electronics Company, Inc. (213) 678-0441
JACKSON, MISSISSIPPI Ellington Electronic Supply, Inc. (601) 355-0561
KNOXVILLE, TENNESSEE Bondurant Brothers Company (615) 523-9144
LOS ANGELES, CALIFORNIA K-Tronics (213) 685-6802
LUBBOCK, TEXAS R & R Electronic Supply Company (806) 765-5737
MIAMI, FLORIDA Electronic Equipment Co. (305) 635-0421
MINNEAPOLIS, MINNESOTA The Lew Bonn Company (612) 339-9461
MT. VIEW, CALIFORNIA Elmar Electronics, Inc. (415) 961-3611
NASHVILLE, TENNESSEE Electra Distributing Company (615) 255-8444
NEW ORLEANS, LOUISIANA Sterling Electronics, Inc. (504) 522-8726
NEW YORK, NEW YORK Milgray Electronics, Inc. (212) 989-1600
NEW YORK, NEW YORK Terminal Hudson Electronics, Inc. (212) 243-5200
ORLANDO, FLORIDA Electro-Air of Florida, Inc. (305) 241-5461
PALO ALTO, CALIFORNIA Kierulff Electronics, Inc. (415) 968-6292
PHILADELPHIA, PENNSYLVANIA Radio Elec. Service Co. of Penn. (215) 925-6900
PHOENIX, ARIZONA Kierulff Electronics, Inc. (602) 273-7331
ROCKVILLE, MD. Pioneer Washington Electronics, Inc. (301) 427-3300
ST. LOUIS, MISSOURI Electronic Components for Industry Co. (314) 647-5505
SALT LAKE CITY, UTAH W. H. Bintz Company (801) 363-5821
SAN ANTONIO, TEXAS Sterling Electronics, Inc. (512) 735-9173
SAN DIEGO, CALIFORNIA Western Radio & Television Supply Co. (714) 239-0361
SAN FRANCISCO, CALIFORNIA Deere Electronics, Inc. (408) 257-3040
SEATTLE, WASHINGTON Kierulff Electronics, Inc. (206) 763-1550
TULSA, OKLAHOMA Radio, Inc. (918) 587-9124
WINSTON - SALEM, NORTH CAROLINA Kirkman Electronics, Inc. (919) 724-0541

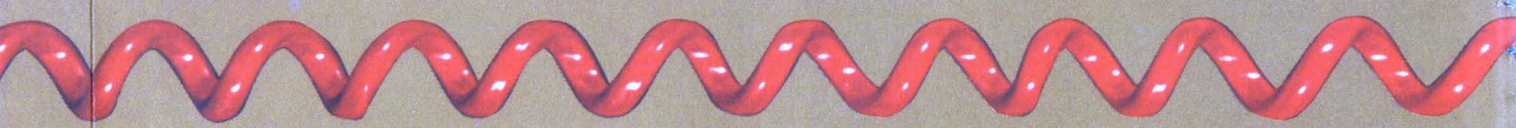

Hughes **H** Semiconductors

HUGHES

HUGHES AIRCRAFT COMPANY

EMI FILTER *BREAKTHROUGH*

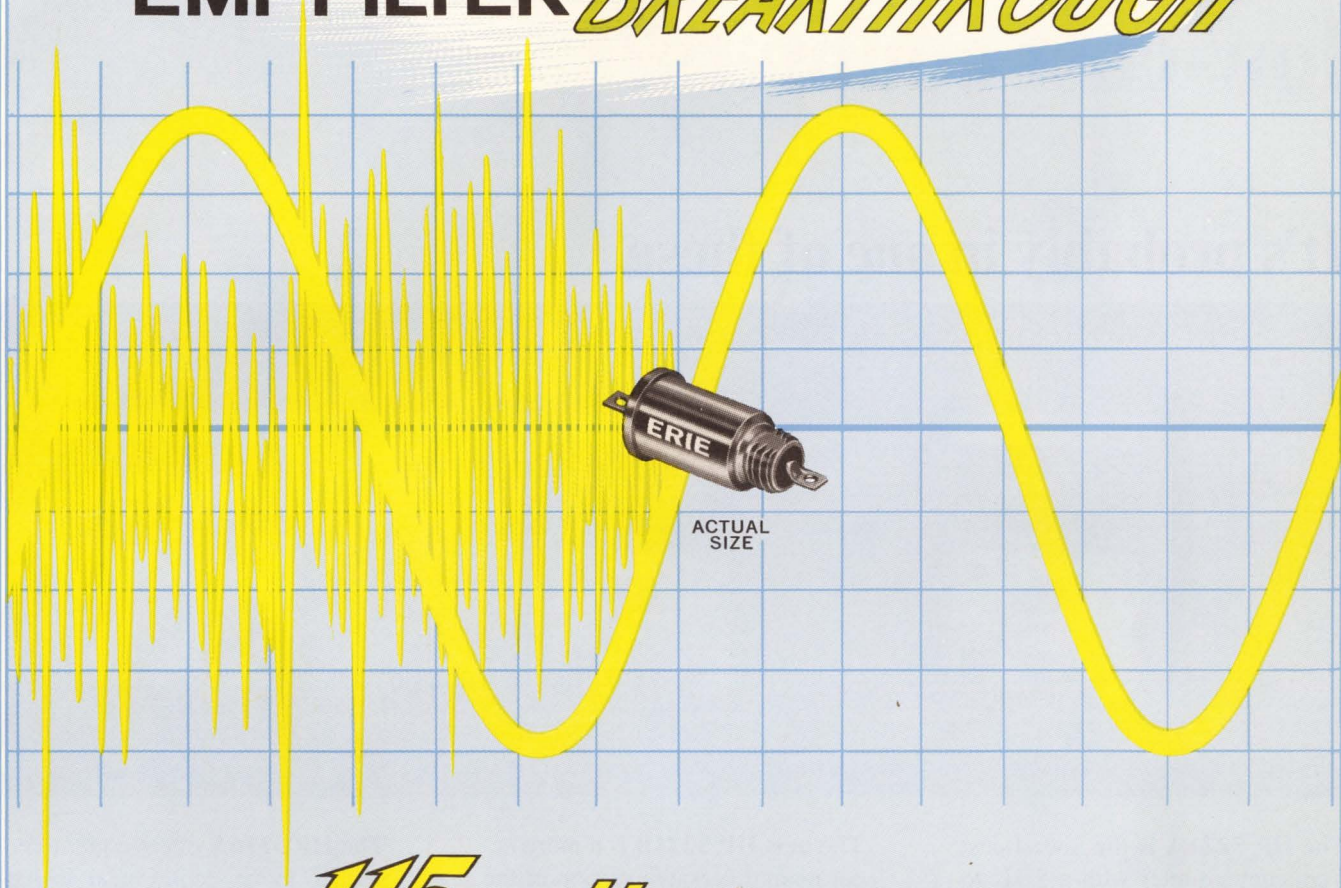

ERIE *115 volt ac* LINE FILTERS

**SMALLER and LIGHTER THAN ANY OTHER
LINE FILTER AVAILABLE!**

- **DESIGNED FOR OPERATION IN . . .**
400 Hz lines @ 85°C
60 Hz lines @ 125°C
- **INSERTION LOSS GUARANTEED FROM . . .**
-55°C to +125°C @ rated current
- **TYPICAL INSERTION LOSS . . .**
30 db @ 150 kHz
80 db @ 1 MHz and up



These hermetically sealed ERIE EMI Power Line Filters represent a substantial reduction in size and weight without sacrifice in performance through the use of a sophisticated state of the art dielectric. Most measure less than 1 inch long and weigh less than 10 grams, making these tiny Filters perfect for power supply applications where reliability, size, and weight are design considerations.

The broad line of ERIE EMI Filters economically provides optimum performance for virtually any environment. For detailed specs see your local ERIE applications engineer or write for Catalog 9000.

ERIE

TECHNOLOGICAL

PRODUCTS, INC.



Erie, Pennsylvania

What are you looking for in low-cost counters?

It's probably in one of these.



The HP 5221A is the lowest cost frequency counter with a 5 Hz to 10 MHz counting range, and it's perfect if you only want to measure frequency or totalize. Time base is controlled by power line frequency. Gate times are 0.1 and 1 second. Maximum input sensitivity is 100 mV, with sensitivity control on the front panel. Input impedance is 1 M Ω /30 pF. It's only 6¼"Hx5⅛"Wx11"D. Four-digit readout is standard. Price: \$350. Add \$75 and \$125 for 5- and 6-digit versions, respectively.

The new HP 5221B is a more accurate and versatile version of the 5221A. Five-digit readout is standard, and the time base is a crystal oscillator. Gate times are 0.01 to 10 seconds, and BCD output (for printers, etc.) is standard. There is a front-panel sensitivity control: also a stepped attenuator for higher input voltages. Counting range is 5 Hz to 10 MHz. Price: \$700. Add \$75 for 6-digit version.

The HP 5216A offers a great versatility in an economical instrument. It measures frequency, time interval, period, multiple period average, frequency ratio, multiple ratios, and will totalize. It has 7-digit readout, 3 Hz to 12.5 MHz frequency range, 10 mV input sensitivity, 1 M Ω /50 pF input impedance and a crystal time base. Size is 6¼"H x 7¾"W x 11"D. Price: \$925.

All models have readout storage for a non-changing display during each gate interval. And, for speed in reading, needless zeros to the left of the first significant figure are automatically suppressed by unique, HP integrated circuits.

For more information call your local HP field engineer or write Hewlett-Packard, Palo Alto, Calif. 94304; Europe: 54 Route des Acacias, Geneva.

HEWLETT  **PACKARD**
ELECTRONIC COUNTERS

**Environment Proof
is what we call it.**



Tough New Arrival

The Stackpole Series 100 miniature rotary switch is here! New, compact 1 1/8" diameter body size. Totally enclosed to protect against exposure, contact contamination and production damage. Explosion-proof. Ideally suited for today's rugged demands and space applications.

Reliability and long life are assured by Stackpole's unique mode of switching—field proven

in the larger Series 600 switch. Internal intermixing of electrical functions and interconnection of decks and terminals provide unprecedented switching versatility. Inherently economical — Stackpole enclosed rotaries are competitively priced with open deck, clip type switches. This new versatility and economy encourage complete freedom of design and afford the use of enclosed rotary switches for all applications.

Sample switches, made to your exact specifications, are shipped in 2 to 3 days and production quantities in 2 to 3 weeks. For prompt quotations and samples, send your wiring diagrams or specifications to: Electro-Mechanical Products Division, Stackpole Carbon Company, St. Marys, Pa. 15857. Phone: 814-834-1521. TWX: 510-693-4511.

Now in two sizes

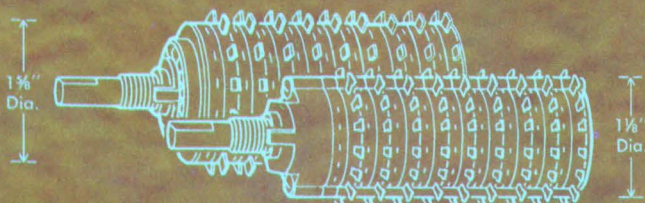

 **STACKPOLE**
ELECTRO-MECHANICAL
PRODUCTS DIVISION

Discover the widest range of gold-plated specialty wire available.

From thick to thin. So thin, in fact, it has to be weighed to be measured.

We start with the highest-quality base stock, draw and then plate it with a bright, ductile, temperature-resistant 24K gold. The deposit is 99.5% pure. Its porosity is minimal. Its solderability is excellent. And it's resistant to discoloration. If that's not enough, our specially designed electroplating equipment and rigid quality control give a completely uniform plating

around the wire—and from spool to spool.

We have a total capability to produce practically anything you want. Deposits from 5 to 200 millionths of an inch in thickness can be plated on almost any temper or diameter specialty wire or ribbon to your specification.

If you'd like to see what we can do with wire or ribbon, send for a sample today. Write: Sylvania Electric Products Inc., Parts Division, Warren, Pennsylvania 16365.

SYLVANIA
SUBSIDIARY OF
GENERAL TELEPHONE & ELECTRONICS **GTE**

ribbon, send for a sample today. Write: Sylvania Electric Products Inc., Parts Division, Warren, Pennsylvania 16365.



Some of your experiments are all wet.



It's still experimental, but one of the best ways to communicate under water is to modulate a green laser beam.

Because, to it, water is just about invisible.

So, among other things, we make a frequency-doubling lithium niobate crystal. Its remarkable ability is to take a perfectly simple infra-red laser beam...

And turn it green with nearly 100% efficiency.

But crystals and related products are only one of the up-front activities that keep Union Carbide on the frontiers of electronics. We are also leaders in the research, development and production of laser systems, solid state devices, fuel cells, and solid tantalum and foil-film capacitors.

They're among the many reasons to consult Union Carbide before your advanced projects reach the breadboard stage.

UNION CARBIDE
ELECTRONICS
Union Carbide Corporation, Electronics Division,
270 Park Avenue,
New York 10017.

An Equal Opportunity Employer

THREE WAYS TO SOLVE YOUR PHASE SHIFTING PROBLEMS



Now you can obtain three different types of continuously variable phase shifters from one source — Merrimac. These three allow you to shift phase manually, electronically, or with extreme accuracy. All take advantage of novel* lumped element circuit concepts developed originally by Merrimac.

To meet your special requirements, Merrimac can also supply **custom-engineered** phase shifters. Send us your specifications and we'll do the rest!

Write or phone for more details on both standard and custom-engineered phase shifters and other Merrimac IF, RF and microwave components.

* U.S. Patents Applied For

PS-3 SERIES

Applications: Phase trim adjustment and "line stretching".

Description: PS-3 models are manually controlled.

Specifications: Center frequencies between 1 MHz and 200 MHz, bandwidth 10%, insertion loss less than 1 db, VSWR 1.5:1 max., impedance 50 ohms, phase shift range 0° to 180° min., connectors BNC standard (others available).

PSE-3 SERIES

Applications: Antenna beam steering, automatic phase control, and phase modulation.

Description: PSE-3 models are electronically (voltage) controlled.

Specifications: Center frequencies between 1 MHz and 200 MHz, bandwidth 10%, insertion loss less than 1 db, VSWR 1.5:1 max., impedance 50 ohms, phase shift range 0° to -180° min., connectors BNC standard (others available).

R AND RA SERIES (RESOLVERS)

Applications: Precise phase measurements and control, and as a continuously variable phase standard.

Descriptions: R Series models are capable of producing precise electrical phase shifts which vary directly as the mechanical angular displacement of direct reading dial drives; RA Series models are integrated resolver amplifiers exhibiting no insertion losses.

Specifications: Single frequency in the range 500 KHz to 100 MHz, phase continuously variable 0° to 360°, rotation continuous, accuracy $\pm 0.2^\circ$, resolution $\pm 0.1^\circ$, VSWR less than 1.2:1, impedance 50 ohms (other impedances available).



MERRIMAC RESEARCH AND DEVELOPMENT, INC.

41 FAIRFIELD PLACE, WEST CALDWELL, N. J. 07006 • 201-228-3890

In-Out.

Takes seconds.
Yank the dead component.
Shove in a new one.
Snap in wafers
for DIP's
and TO 5 cans
with 8, 10
and 12 leads—
Color coded.
Gold or tin plated
spring sockets
grip leads tight.
Low profile.
Low maintenance.

AMP



AMP INCORPORATED
Harrisburg, Pa. 17105

Please send me more information on Miniature Spring Socket Wafers.

NAME _____
COMPANY _____
ADDRESS _____
CITY _____
STATE _____
ZIP _____

PUT YOUR IDEAS INTO ACTION WITH THE HELP OF AMP ENGINEERING . . . WORLDWIDE

Circle 37 on reader service card

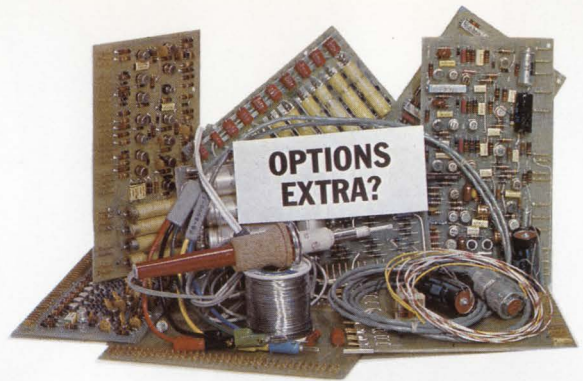

Why pay \$1640 for a Cimron when you can get a 4-digit DVM for \$1000?

Because, aren't many of the features you consider necessities sometimes labeled extra price options? By the time you add them to the stripped down model, you pay more anyway. Cimron's Model 6650 has options, too—but the base price starts you off strong with more of the features you call necessities. Like auto ranging and polarity. Like 5th digit overrange; like an accuracy of .01% F.S. for 6 months; and IC's. It also has

ratio, 10 KM ohm input impedance, blanking, filters and expandable functions. And versatility! It comes with computer outputs so you can use it as an analog-to-digital converter in computer systems work; sample rate is 1000 readings per second. That's customer concern, the extra built into every Cimron instrument. Model 6650, just \$1640. For details, write Cimron, Department A-110,1152 Morena, San Diego, California 92110.

CIMRON[®]
A Division of
Lear Siegler, Inc.



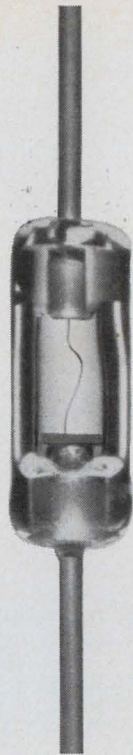

**Remember
The Whisker
Contact?
It Was Before
The S-Bend.**



**Remember
The S-Bend?
It Was Before...**

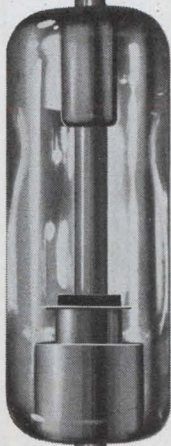

RamRod

**The First New Zener Diode Construction In 9 Years...
Gives You Safe, Sure, Lead-To-Die Contact!**

A new reliability "plus" has been added to 250 mW and 400 mW zener diodes . . . called RamRod* zener diodes! Now, with RamRod devices you get:

- straight-through lead alignment that prevents S-bend mismatches, shorts to substrates and parameter shift due to contact resistance and pressure change
- increased power dissipation through direct, more massive lead-to-metal-over-oxide-die soldered contact
- continuous device operation when subjected to shock or vibration

The reasons are state-of-the-art:

RamRod design is simplicity itself which yields increased reliability and non-variability of assembly; thermal expansion coefficients are closely matched and a perfected final seal process achieves, simultaneously, a glass-to-glass hermetic seal and metallic solder bond of the lead to die with less than *half* the compressive load on the die as that required for sealing S-bends.

Reliability and electrical stability of RamRod units are so superior that not one device selected at random from production runs has failed above-and-beyond Mil-S-19500-type tests like 10,000 G step stress shock, 225°C, liquid-environment, thermal shock excursions at 25°C/

sec change and 100 G variable frequency vibration at 100 to 2000 Hz.

Motorola has supplied reliability-proven RamRod types since 1965:

| MILITARY TYPES | | |
|----------------|-------------------------|-----------------|
| 1N746 Series | 400 mW, 2.4 to 200 V | MIL-S-19500/127 |
| 1N962 Series | | MIL-S-19500/117 |
| 1N4370 Series | | MIL-S-19500/127 |

| INDUSTRIAL TYPES | | |
|------------------|-------------------------|--------------------------|
| ¼ M2.4AZ Series | 250 mW, 2.4 to 200 V | ±5% to ±20% Tolerance |
| 1N4099 Series | 250 mW, 6.8 to 100 V | ±5% Tolerance |

Send for a new RamRod reliability report and data sheets today: Box 955, Phoenix, Arizona 85001. Contact your franchised Motorola distributor for evaluation units.

*Trademark of Motorola Inc.

-where the priceless ingredient is care!



MOTOROLA
Semiconductors



Tuned Amplifier/Oscillator is Six Instruments in One

- LOW-NOISE AMPLIFIER
- WAVE ANALYZER
- DISTORTION ANALYZER
- LOW-DISTORTION OSCILLATOR
- SENSITIVE AC VOLTMETER
- ALLPASS DELAY PHASE SHIFTER

The PAR Model 110 Tuned Amplifier/Oscillator is a versatile high-gain, low-noise, low-distortion frequency selective amplifier operating over the frequency range of 1 Hz to 110 kHz with Q variable from 1 to 100 with no gain change. It provides four outputs simultaneously: a second order (resonance) bandpass; a second order band-reject (notch) providing rejection of the center frequency in excess of 100 dB; a second order allpass characterized by an amplitude response which is flat with frequency and a phase lag which increases monotonically with frequency; and a flat output. Each of the 600 ohm outputs is capable of providing 5 volts rms into a 5K ohm load. A front panel AC voltmeter permits measurement of any one of the four outputs.

The instrument can function as a wave analyzer with bandwidth adjustable from 1% to 100%; as a flat

or selective AC voltmeter with sensitivity ranging from 10 microvolts to 5 volts rms full scale; as a distortion analyzer to measure distortion levels as low as 0.1% (as low as 0.001% when used in conjunction with a second Model 110); as a low-noise amplifier (typical noise figure of 1 dB) with voltage gain ranging from 1 to 10^4 ; as a stable general-purpose low-distortion oscillator providing up to 5 volts rms into 600 ohms, capable of being synchronized by an external signal; and as an AC-DC converter with ground-based output.

Price: \$1195. Export price approximately 5% higher (except Canada).

For additional information, write for Bulletin T-140 to Princeton Applied Research Corporation, Dept. D, P.O. Box 565, Princeton, New Jersey 08540. Telephone: (609) 924-6835.



PRINCETON APPLIED RESEARCH CORP.

Solid state

Best of two worlds

The two pillars of monolithic integrated circuits, bipolar and metal oxide semiconductor (MOS) transistors, have been successfully combined in a single structure. Designated the MOS-BI by its developers, Westinghouse's Molecular Electronics division, the new monolithic contains 8 MOS FET's, 4 bipolars, and 4 diffused resistors on a 40-by-40-mil substrate.

The report of the Westinghouse device follows by only a few weeks word that Fairchild Semiconductor had apparently achieved a way to produce a similar device [Electronics, Oct. 2, p. 25]. Although Westinghouse won't disclose when it will market its MOS-BI, it's been learned that Fairchild plans to offer its device soon.

New applications. Combining the two devices opens up an entirely new IC capability in both digital and linear applications. The MOS technology offers higher packing density, higher impedance levels, and better noise properties than bipolars. On the other hand, bipolars are more stable, operate faster, and are more rugged in terms of current-handling abilities, driving capabilities, and transient immunity.

Previous efforts to wed the two devices ran into severe problems because of the different diffusion steps required by each; simultaneous fabrication of the devices often resulted in poor isolation between the units and marked instabilities in the MOS elements.

Westinghouse engineers overcame these problems by wedding an enhancement-mode p-channel MOS with an npn bipolar, using modified resistivity epitaxies. These structures are more compatible than the other possible combina-

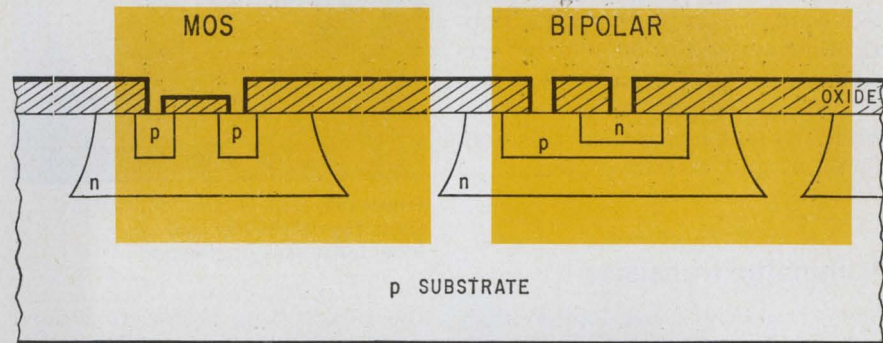

Side-by-side. Active element mainstays of integrated circuits, bipolar transistor and metal oxide semiconductor field effect transistor, coexist on same monolithic substrate. Called the MOS-BI, the combination will be used to bring about digital and linear IC's with the best advantages of both devices.

tions—those involving depletion-mode MOS's, n-channel MOS's, and npn bipolars, according to Karl K. Yu, a senior engineer at the Westinghouse division.

Yu indicated the configuration did not require any extra diffusion steps, or a need to invert the silicon surface to permit the isolation.

The initial MOS-BI circuit provides a triggering function. The p-type diffusion forming the base of the npn also forms the source and drain sections of the MOS FET. Turn-on voltage of the MOS elements ranges from 4 to 6 volts; current gain of the bipolars is modest, 10 to 30.

They're at it again

Watching the activities of the National Semiconductor Corp.—with its top staff of former Fairchild Semiconductor executives—has become an engineers' pastime on the San Francisco Peninsula second only to watching topless waitresses—and almost as breathtaking. National has already made bold forays into the linear and metal oxide semiconductor fields; next month it will invade still another growing semiconductor market by introducing a dual binary flip-flop utilizing transistor-transistor logic.

The circuit is billed as an improved version of what National believes is the fastest-selling TTL product made by Texas Instruments. By no coincidence, the designer of that circuit (TI's SN7473), Jeff Kalb, joined National several months ago.

Nod to Dallas. "We'll have a full line of TTL circuits," says Donald T. Valentine, National's new marketing manager. "We chose a complex circuit instead of a simple gate to start with in order to get on the current level of technology." Valentine adds that the company decided to make this particular line because it believes that TI has the best position in the TTL market.

Texas Instruments markets the dual binary in both commercial and military versions, and in both 14-lead and 16-lead dual in-line packages. National will follow suit, but its DIP will have a glass-to-metal seal that it claims offers better hermeticity characteristics.

Departures. The new circuit also incorporates two changes from TI's design. The operation of TTL circuits is so fast that the clock lines can go negative as they drop from positive to ground, which can cause the flip-flop to lose information. The National series will be clamped to avoid this problem. The company will also guarantee 15-nano-

second clock skew—the sum of the minimum propagation delay and the widest pulse that won't trigger a flip-flop.

To accommodate its integrated-circuit production, National has leased another 15,000 square feet of space across the street from its first Santa Clara, Calif., plant. Fabrication and diffusion will be carried out in the old plant, which has 20,000 square feet, while the new building will house final assembly facilities and executive offices.

Laminated transistor

Two heat sinks are better than one—at least that's the approach being taken by transistor designers at the Radio Corp. of America in an Air Force-supported study aimed at developing a new way to build a high-power radio-frequency transistor. The transistors, formed on two separate slices that are then laminated, also include a ballast resistor in series with the emitter to reduce secondary-breakdown difficulties, and glass hermetic seals around the edges to protect the junctions. Lead inductance also is substantially reduced with the new design.

Still in the laboratory stage, the r-f transistors have yet to demonstrate better performance than RCA's standard overlay transistors, but they deliver in the 10-to-100-watt range into a load at frequencies from 10 to 100 megahertz.

In series. In one wafer of the transistor the n-type collector and

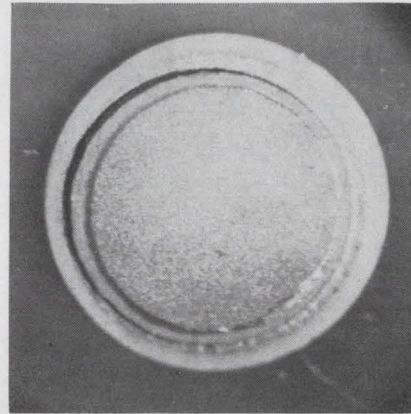

Power pill. Disc-shaped laminated transistor offers low lead inductance, easy packaging.

the p-type base layers are formed over an n+ substrate. The other wafer holds the n-type emitter stripes, which are separated with dielectric isolation. An internal resistive layer is added in series with the emitter sites to act as the ballast resistor. The second wafer also carries a p+ region for use as the base contact, as shown in the diagram below.

The two wafers are then laminated and fused under temperature and pressure. The emitter-base junction is formed by diffusion of emitter impurities into the base region. Edges of the devices are then covered with glass. The use of hermetic glass seals on the sides of the transistor eliminates the need for a package. With this construction, the same size pellet can be used for high power, or the pellet can be made smaller for the same power as devices now available to users.

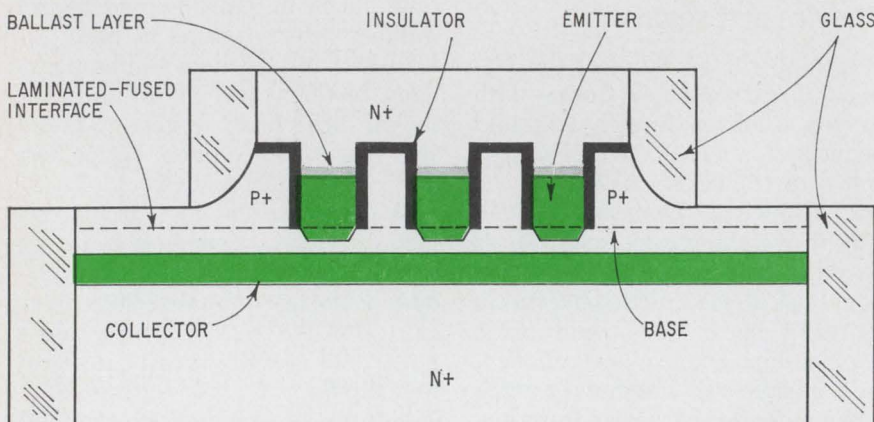

Two halves. RCA's laminated overlay transistor gives higher power at high frequencies because two sides are available for heat-sinking.

Avionics

Fly by the numbers

The first air-data computer developed for use in the Navy's Integrated Light Attack Avionics System (ILAAS) has just been delivered to Sperry Rand Corp.'s Systems Management division by Garrett AiResearch Manufacturing Co., Torrance, Calif. The design, the first all-digital unit available, will supply eight outputs for the ILAAS central computer.

About 80% of the circuitry is made up of monolithic and hybrid integrated circuits (there are about 300 flatpacks in the system), and some of the circuit manufacturing and packaging techniques are unusual. The packaging and heat sinking design gets the entire computer into a box 8 by 5 by 15 inches that weighs 23 pounds. The system operates on about 75 volt amps.

It accepts inputs of static and total pressure, total temperature, and angle of attack. From these, it calculates altitude, altitude rate, differential pressure, air-density ratio, mach number, true air speed, true angle of attack, and dynamic pressure.

The Conrac Corp. has built a much smaller air-data computer system, which also makes extensive use of IC's and weighs about 3 pounds. But it only has six outputs, three of them analog and three digital.

High and fast. Since the Garrett system is designed for a high-speed, high-flying aircraft, it's much more sophisticated than the air-data equipment included in the Integrated Helicopter Avionics System (IHAS) being developed by Teledyne Inc. Teledyne uses a converter, which accepts three inputs (static pressure, total pressure, and indicated temperature outside the aircraft) and converts them to digital serial words that are supplied to the IHAS central computer upon interrogation. Also, the ILAAS system has to maintain an altitude accuracy of ± 20 feet up to 50,000 feet, compared with 20,000 feet for IHAS.

Since one of the requirements of

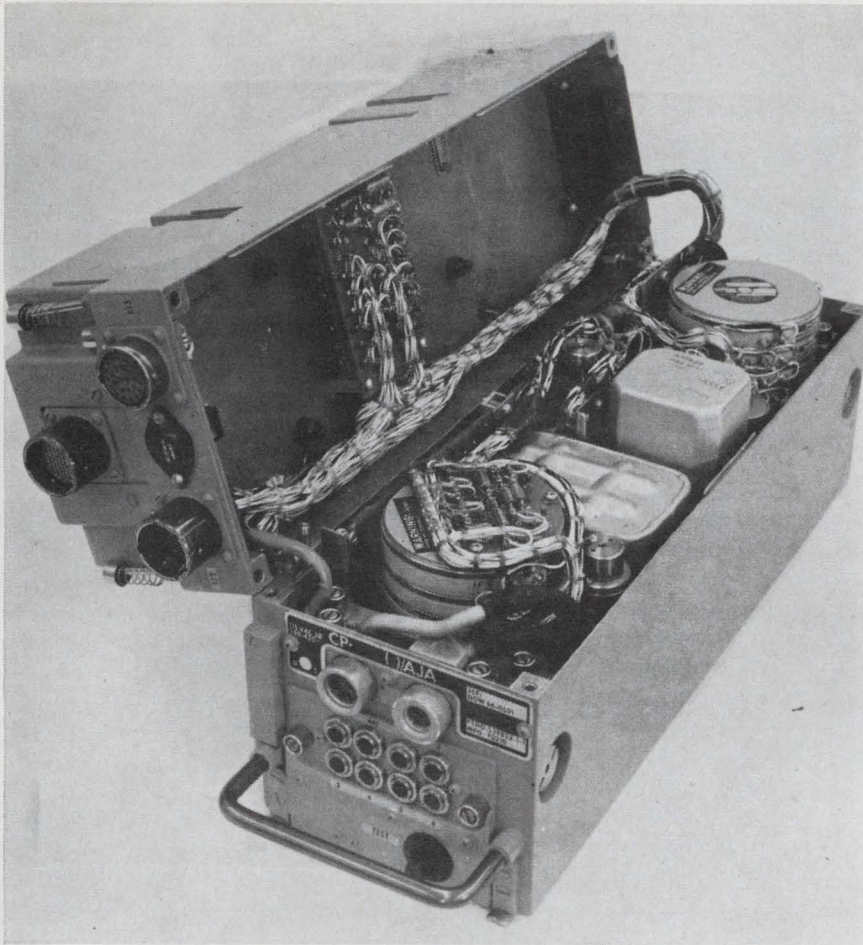

High logic. This 23-pound air-data computer, developed for the Navy's ILAAS system, provides eight outputs for the central computer.

the ILAAS system is that there be no flight line test equipment, the air-data computer is made up of five modules, each of which can be easily replaced, and there is a self-check system that indicates a faulty module. The entire ILAAS system will check itself out at the push of a button in the pilot's cabin, the air-data computer indicating failures in any of the five modules by pop-out buttons on the front of the computer.

Garrett has a contract to deliver four systems to Sperry for bench testing. Flight testing is scheduled to get under way by year's end and will probably be done aboard an A-6 aircraft.

"One of the reasons we are using hybrids rather than monolithics is that we had to combine bipolar and unipolar transistors," explains Earl Blevis, of the Flight and Electronic Systems department. "For example, the multiplexer in the digital mod-

ule uses a monolithic logic gate as the input and is then buffered by a pair of bipolar transistors. The output is a pair of field-effect devices (unipolar transistors). It wouldn't be possible to handle all this with monolithics alone."

Keep cool. Garrett has an interesting heat-sinking technique for the densely packed modules; each card has 24 IC DTL logic flatpicks (12 on each side), and there are five conducting layers on each card.

When all five layers have been laminated, the heat sinks are laminated in strips running from top to bottom on both sides of the card. The flatpicks are mounted so that they straddle the heat sinks, which are riveted to an aluminum rail on top of the card. This rail, in turn, is bolted to the outer case, making it possible for the heat to be transmitted from the circuits to the outer case.

Right perspective

Visual flight simulators for training a pilot or astronaut must generate images that are as close as possible to what exists in the three-dimensional world. Most simulators do this by projecting films or slides, or televising a carefully constructed replica of the terrain that is to be flown over. At the Electronics Laboratory of the General Electric Co., Syracuse, N. Y., information stored in the memory of a digital computer is being used to generate scenes in color on a television display. There are no tv cameras, films, slides, models, or drawings in the system.

The scenes are accurate enough to be used for a variety of tasks. So far, the system can simulate, in proper perspective, a plane's approach to an aircraft carrier or to an airport, an enemy plane as seen by the pilot of an attacking plane during a dogfight, and objects such as NASA's lunar module, command and service modules for the Apollo program, and the surface of the moon. It has also been programmed to simulate a street scene to demonstrate the system's usefulness in architectural training and urban planning.

Point of view. By manipulating an aircraft-type control stick, an operator can see the computer's visualization of a scene from any vantage point. For example, he can land on the carrier's flight deck, or fly past the carrier's superstructure, or pass beneath the carrier's flight deck. No matter what he does, the computer senses his instantaneous location and recomputes the exact perspective and size of the ship as it would appear to him at that point in space and time. This procedure is repeated up to 30 times per second, so that a smooth, continuous motion is presented on the screen.

The first system built by GE is being delivered this month under a \$2 million contract to NASA's Manned Spacecraft Center, Houston. There it will be used by the Guidance and Control division primarily for evaluating the performance of control systems designed for the Apollo program,

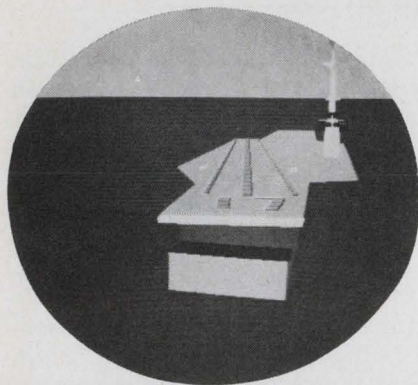

Carrier landing. Plane's approach to carrier is simulated on display . . .

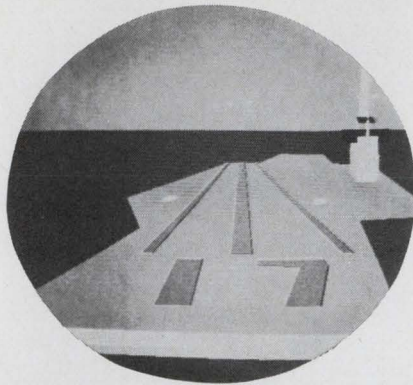

. . . as computer calculates changes in position and perspective . . .

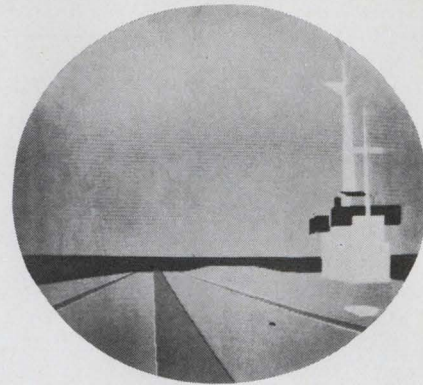

. . . and pilot brings his plane safely down on the flight deck.

rather than for training astronauts.

Too close? NASA doesn't consider the imprecise nature of the pictures a handicap to its work. "We really don't have to see every nut and bolt on the vehicles when we're concerned with aligning and docking the lunar and the command and service modules," points out Donald C. Cheatham, assistant chief of the Guidance and Control division. "We just need enough detail to give us the proper visual clues for moving one vehicle relative to the other."

The GE system can generate up to 40 different objects in any one scene, involving up to 240 straight or convex edges. A numerical description of the vertices of the object are stored in a Raytheon 520 computer. A 4,000-bit core memory stores the mathematical relationships needed to make perspective calculations. Ten-megahertz, emitter-coupled logic is used to make the calculations rapidly enough for continuously updating the high-resolution color screen.

Advanced technology

Unchanging picture . . .

Drawing on lessons learned working with Xerox copy systems, two engineers at Electro-Optical Systems Inc., a Xerox subsidiary, have come up with an image display that can hold a picture for relatively long periods.

Image storage is nothing new. In the past 10 years, several experimental devices capable of retaining a picture burned into them have been developed. Most have employed two active layers—an electro-luminescent layer to produce the image and a photoconductive layer, either cadmium sulfide or cadmium selenide powder, to maintain the image. But storage panels of that type have a variety of shortcomings. For one thing, output brightness in most cases is limited because too high a voltage spoils the image contrast, causes self-triggering, or produces electrical breakdown. For another, viewing time is limited and brightness and contrast fade considerably during viewing. Finally, unless special measures are taken, the stored image has to be allowed to vanish completely—but slowly—before a new one is stored.

Better timing. Now the Electro-Optical team—Benjamin Kazan and J. S. Winslow—has applied the principle of field-effect conductivity control to produce a solid state image panel overcoming most of those shortcomings. The storage and control features of the panel are based on the special field effect properties of zinc oxide, which are also used in Xerox Electrofax copying.

The new device, like its predecessor, has a control layer and a phosphor powder layer to generate the image. But it's the zinc oxide in the control layer that makes the difference. The zinc oxide is first pulsed with a negative charge,

which erases the old image without emitting light. The panel is then exposed to an image which produces a stored charge pattern on the zinc oxide surface. That pattern creates a conductive pattern, which in turn determines the luminescence level of the phosphor layer.

Brightness, say the developers, is as high as 20 foot-lamberts, compared with only a few foot-lamberts of the older methods. Maximum contrast ratio is about 100 to 1, with between 400 and 800 lines on the 12-by-12-inch panel. Best of all, an image can be retained for about an hour and then erased quickly, simply by recharging the zinc oxide with another negative-charged input.

. . . moving light

Most solid state light-emitting arrays require two sets of decoding circuits—one for each dimension—and the cost of such circuits often limits the size of the array. Such limitations have been eased by Basil W. Hakki and his team at Bell Telephone Laboratories. They have invented a light-emitting array that they call a SALS device (solid state acousto-electric light scanner) for alphanumeric image display or as a scanning light detector. Decoding circuits are needed for only one dimension.

The device consists of a glass substrate with a layer of n-type cadmium sulfide on it and rows of p-type cuprous sulfide on top of that. An acoustic domain—a con-

TRW
announces

**50 W at
500 MHz**



ACTUAL SIZE

28 Volts...5dB Gain...60% Efficiency!

TRW announces a major breakthrough in communication transistor technology with the introduction of this high efficiency, high gain 50 watt/500 MHz device.

In high power military aircraft transmitters, a single 2N5178 will do the job formerly requiring vacuum tubes or multiple-transistor circuits. The 2N5178 is also

well suited for use in radar pulse circuits.

This state-of-the-art device employs a patented cellular construction in a grounded emitter strip-line package comparable in size to the TO-37. A 25-watt version, type 2N5177, is also available.

For evaluation quantities and complete technical details, con-

tact any TRW distributor or TRW Semiconductors, 14520 Aviation Blvd., Lawndale, Calif. 90260. Phone: 679-4561, TWX: 910-325-6206. *TRW Semiconductors Inc. is a subsidiary of TRW INC.*

TRW[®]

centrated vibration traveling at the speed of sound—generates the light as it scans the array.

Wireless. The moving acoustic domain does most of the work of the circuitry because only each row of cuprous sulfide, rather than each element, must be reached by an electric current from outside. All the circuitry that is needed is an amount equal to the square root of the total number of elements in the array. For example, one 141 x 141 array of p-n junctions (about 20,000) would require only the circuitry needed to reach each of the 141 rows.

The high-field acoustic domain is formed in the piezoelectric cadmium sulfide by pulsing the SALS device with an electric field strong enough to raise the electron drift velocity above the velocity of sound in the material. Such a high field forms an acoustic domain, with about 200 volts across it.

The domain moves through the cadmium sulfide and as it passes each p-n junction, its voltage causes reverse breakdown at the leading edge of the domain and heavy forward conduction at the trailing edge. The resulting current flow through the junction excites red light emission.

Hakki will report on the array this week at the International Electron Devices Meeting in Washington.

Transistor twosome

Efforts to develop higher-frequency transistors have always been handicapped by the necessity of using the same material for the base, emitter, and collector. But researchers at Carnegie-Mellon University in Pittsburgh are studying a promising method of fabricating so-called heterojunction transistors using germanium for the base and collector, and either gallium arsenide or zinc selenide for the emitter.

Moving holes. The heterojunction transistor is based on a 1951 patent by William Shockley, one of the original transistor developers, and later detailed by Herbert

Kroemer, then of RCA Laboratories, in a 1957 paper in the Proceedings of the Institute of Radio Engineers. Kroemer showed that if the emitter material has a wider energy band gap than the base, then the emitter efficiency—the ratio of injected current from the emitter into the base to the total current crossing the emitter-base junction—can be significantly increased. With an npn transistor, for example, electrons injected into the base face a low potential barrier, while holes tending to cross back from the base into the emitter face a high barrier.

Thus, since the injection of holes from the base into the emitter is minimized, the base can be heavily doped to produce a low resistivity. A low-resistivity base enhances the frequency performance, since one of the basic frequency-determining factors in the operation of the transistor is the base resistance-collector capacitance time constant. In conventional transistors, the base could not be heavily doped—instead, the emitter is more heavily doped than the base in order to raise the efficiency level of the emitter.

The heavy base-doping also reduces chances of secondary breakdown, since it helps to reduce debiasing effects at the base-emitter junction.

Power pack. The wide band gaps offered by the two emitter materials, 1.43-electron volts for gallium arsenide and 2.6 for zinc selenide, are both significantly greater than germanium's band gap, 0.72, and account for the improved performance.

One of the problems with the gallium arsenide is that the arsenic, during epitaxial deposition of GaAs on the germanium p-type base region, tends to form a thin layer of n-type material over the base, since arsenide is one of the basic donor atoms for germanium. However, this is overcome with the heavy doping of the p-type base region, which tends to swamp out the n-type effects.

In preliminary tests, both the GaAs and the zinc selenide transistors have produced current gains of between 15 and 30.

Golden isolation

Designers of monolithic integrated circuits generally have to choose between low cost and high performance when selecting a method of isolating the various elements on the substrate. But a pair of International Business Machines Corp. researchers have come up with a process they say costs less than beam-lead and dielectric isolation techniques and outperforms that old standby, p-n junction isolation.

The new method, developed by Joseph Chang and Madhukar Vora at IBM's Hopewell Junction, N.Y., facility, calls for the deposition of a layer of lightly doped n-type silicon over the usual p-type substrate. Then, after the transistors are formed, gold is diffused into the extra layer to enhance its resistive characteristics and thus improve insulation.

Chang and Vora say the new process holds down parasitic capacitances between elements and substrate to 1/10th the level allowed by the p-n junction method, thereby keeping operating frequencies near their maximums and reducing unwanted feedback. The p-n "bathtub" junction around each element approximates an insulator when it's reverse-biased but has a high component-to-substrate capacitance.

The researchers also assert that the new method provides only 1/100th the substrate resistivity obtained with p-n junction isolation, and only 1/1000th the unwanted crosstalk.

Consumer electronics

Solid savings

What's holding back the design of all-transistor large-screen television sets is the lack of high-voltage transistors. So, makers of black-and-white tv sets use transistors in low-power signal functions and vacuum tubes for the high-voltage and deflection circuit functions. There is a way to get rid of tubes: add a power transformer and rectifier and

TEKTRONIX

Type 547 sweep-switching oscilloscope

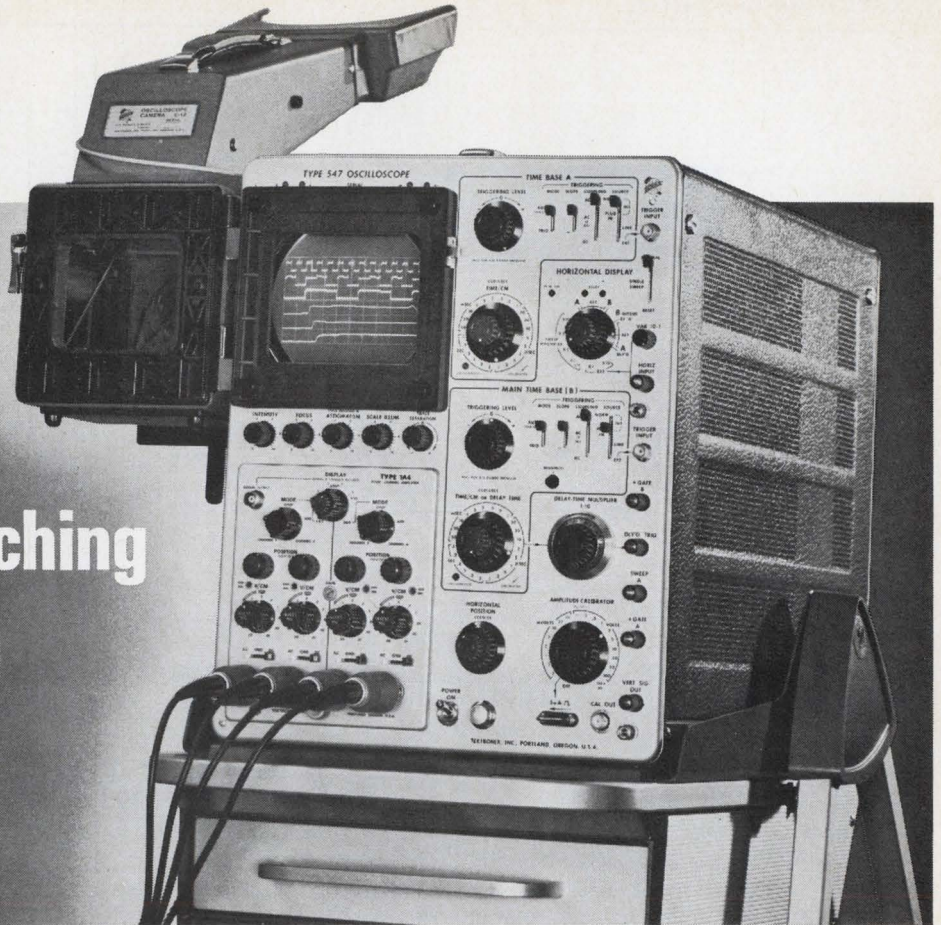

The Tektronix Type 547 is a 50-MHz, 7-ns sweep-switching oscilloscope that offers dual-beam measurement capabilities with most repetitive signals. A complete selection of plug-ins permits you to change your oscilloscope performance to meet your changing needs.

The sweep-switching feature of the Tektronix Type 547 Oscilloscope and the vertical switching of the new Type 1A4 Four-Channel plug-in provide two independent dual-trace oscilloscope systems that time-share the same CRT. The identical sweep systems provide 2% calibration from 5 s/cm to 100 ns/cm, extending to 10 ns/cm ($\pm 5\%$) with the horizontal magnifier. The calibrated sweep delay range is from 100 ns to 50 s and sweep-switching provides alternate displays of the delayed and delaying sweeps.

With the Type 1A4 Four-Channel Plug-in, the Type 547 has a 7-ns risetime and DC-to-50 MHz bandwidth over its 10 mV/cm to 20 V/cm calibrated range. You can also select from 50-MHz dual-trace plug-ins, differential plug-ins with bandwidths to 50 MHz, sub-nanosecond sampling and TDR plug-ins, and four spectrum analyzer plug-ins covering the spectrum from 50 Hz to 10.5 GHz.

| | |
|--|--------|
| Type 547 Sweep-Switching Oscilloscope | \$1875 |
| Type 1A4 Four-Channel Plug-in | \$ 780 |
| Type 1S1 Sampling Plug-in | \$1175 |
| Type 202-2 Scope-Mobile® Cart | \$ 135 |
| Type C-12 Camera | \$ 460 |
| Type C-12 Camera Adapter (016-0226-00) | \$ 15 |

U. S. Sales Prices FOB Beaverton, Oregon

Four Signals—Two Sweeps

Using alternate vertical and horizontal display modes, Ch 1 and Ch 2 are locked to A Sweep (100 ns/cm) and Ch 3 and Ch 4 are locked to B Sweep (2 μ s/cm). This provides dual-beam measurement capabilities with most repetitive signals.

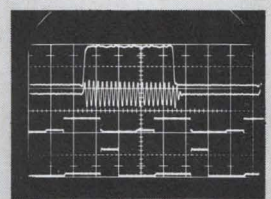

Three Signals—Delayed Sweep

Increased convenience is provided with sweep-switching in the delayed sweep mode. You alternately view both the delaying sweep (2 μ s/cm), intensified by the delayed sweep, and the delayed sweep (100 ns/cm). With the Type 1A4 Plug-in, eight traces can be displayed.

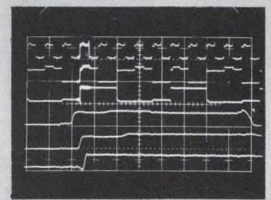

Sampling

More measurement functions are available with the Type 547's complete selection of plug-in units. The Type 1S1 Sampling Plug-in features 0.35-ns risetime, internal triggering and up to 100 ps/cm sweep speed.

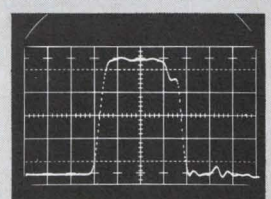

For a demonstration, contact your nearby Tektronix field engineer or write: Tektronix, Inc., P. O. Box 500, Beaverton, Oregon 97005.



Multi-trace, differential,
sampling and spectrum analysis

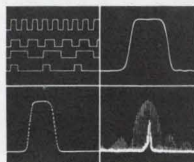

... in all Tektronix 530-540-550-series
plug-in oscilloscopes

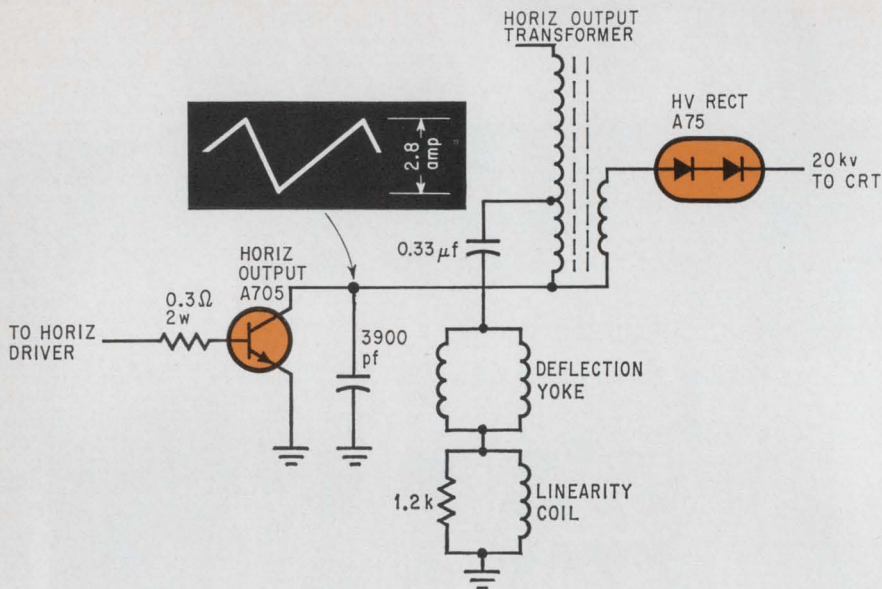

Horizontal output. The application of high-voltage transistor A705 and diode A75 simplifies solid state tv by eliminating power transformer.

filtering system—an effective but expensive alternative.

Boost. Last week, however, the Amperex Electronic Corp. demonstrated a transformerless solid state 23-inch tv set. The developmental receiver, containing 30 transistors and 10 diodes, operates directly from the line. Making this possible is a new high-voltage transistor, the A705, which operates with a collector-base voltage of 1,400 volts and will cost about \$2.50. By contrast, the highest-voltage transistor commercially available now operates at 700 volts and costs about twice as much. Elimination of the transformer and rectifier and filtering system means an additional dip in manufacturing cost of \$1.50 to \$2 a set.

A silicon npn type, the transistor has a mesa collector structure and a planar emitter. It is used as a horizontal output amplifier and doubles as a damper, thus eliminating a separate damper diode across the collector circuit, without any deterioration in horizontal linearity.

The A705 has an extremely fast turn-off characteristic. When operated with an inductance of 25 microhenrys, the peak collector current switch-off time is about 0.8 microsecond. The A705 drives a tapped flyback transformer with a deflection yoke and linearity coil connected as shown in the sche-

matic. The base-emitter diode is reverse-biased by the driver transformer (not shown) during the fly-back period.

Another unusual feature of the receiver is that it employs an A75 silicon high-voltage rectifier which delivers 20,000 volts to a 23FPS4 picture tube. Most high-voltage rectifiers used in large-screen receivers are vacuum tubes, while small-screen solid state receivers generally have a large selenium rectifier stack. The A75 will be offered for sale when Amperex can make its price competitive with vacuum tube rectifiers.

Communications

New muscle for CATV

On the surface, the meeting of the National Cable Television Association at Philadelphia's staid Warwick Hotel last week was just another regional meeting of the trade group that represents the operators of community antenna television systems. What made it notable was the presence of Federal Communications Commissioner Nicholas Johnson. As recently as last June, the group had run into trouble getting a commissioner to appear before its more important annual

meeting. Finally, Commissioner Lee Loevinger agreed to appear. But since then there's been a falling out at the FCC over CATV.

Johnson was at the meeting to blow the whistle on some of his fellow commissioners for a stalemate that has persisted almost all year on CATV litigation. For the first time, he publicly charged the commission with doing nothing to clarify the many complex problems involving CATV and with passing the buck to Congress.

What the majority of commissioners hopes is that Congress will pass copyright legislation that will put many CATV systems out of business and thus end the problem for the FCC.

Until this summer, Johnson was just another commissioner with no strong views one way or another on CATV. But he was angered in September when the commission turned down a proposal for a CATV test in Philadelphia—after the FCC had itself raised the question of a test in an area like Philadelphia 18 months before when it assumed jurisdiction for regulating CATV.

Rebuke. Johnson told the trade group that the long-run interests of CATV and the FCC should not diverge substantially. Almost as a rebuke to his fellow commissioners who voted down the Philadelphia test, he said: "We both want to see the future of CATV determined by research, analysis, and national planning, rather than by the present combine of emotional arguments, political squabbles, factual ignorance, obsolescing policy assumptions, and lawyers' speculations."

Johnson's switch to the side of CATV against the broadcasters may mean a lot more action out of the FCC because three commissioners are now considered friendly to the medium; four make a majority.

Until Johnson's change in Philadelphia, Loevinger and Robert Bartley had been the only commissioners who leaned toward helping CATV interests. Two others, Kenneth A. Cox and Rosel H. Hyde, feared that encouraging CATV would damage the status quo of broadcasting so they have consistently voted against it. Since neither of the remaining two com-

new . . .

smaller . . .

4 amp

50-100 nanosec.

ultra-fast recovery

controlled avalanche

high voltage epitaxial

rectifiers

THE UNIQUE UNITRODE CONSTRUCTION

With the silicon die metallurgically bonded between terminal pins of the same thermal coefficient, the hard glass sleeve is fused to the entire outer silicon surface. Result — a voidless, monolithic structure.

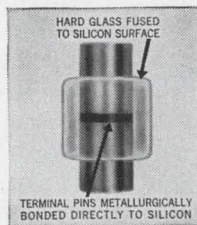

ACTUAL SIZE

the only
lead mounted 4 amp with
100 nanosec. max recovery
PIV's to 250 V
80 amp surge capacity
Full power operation
at frequencies up to
100 kHz square wave
and 350 kHz sine wave
1/10 the size . . .
1/14 the weight of
a comparable stud-mount.

Check 323 Readers Service Card

ACTUAL SIZE

2 amp
typically 50 nanosec. recovery
PIV's to 250 V
25 amp surge capacity
Full power operation
at frequencies up to
100 kHz square wave
and 350 kHz sine wave
1/7 the size . . .
1/3 the weight of
comparably rated devices.

Check 323 Readers Service Card

UNITRODE®

580 PLEASANT ST., WATERTOWN, MASS. 02172
TELEPHONE (617) 926-0404 TWX (710) 327-1296

missioners, Robert E. Lee and James J. Wadsworth, are committed strongly against CATV, either might be persuaded to support CATV.

Software

Late-late showing

Two years late in coming up with software for its System 360 computer line, the International Business Machines Corp. is now a year behind schedule in developing the time-sharing software package for its model 67. The company is releasing the first small software package that will give the 360/67 some time-sharing capability.

Until now, users of the 360/67 were confronted with two choices: develop their own software or run their machines as if they were model 65's. (The 360/67 is really two connected 360/65's with some added hardware.) Meanwhile, users of other 360 machines who rely heavily on the company's software continue to have problems when their specific requirements are slightly out of line with the software specifications.

For example, a customer whose system configuration includes devices that cannot tolerate even momentary delays or whose application requires real-time response under all kinds of adverse conditions may find that IBM's operating system—the supervisory program dubbed os/360—won't quite do the job. Version 12 of os/360 is now in the hands of IBM's customers; IBM plans to release version 13 in October; and, although IBM won't say, in all probability three or four more versions will always be in the works until the 360's successor is announced in 10 years or so. If enough customers begin having trouble with instant response, IBM will probably feel compelled to bring out versions that are better for their particular applications.

Can't keep up. A case in point is the Boeing Co's experience at its Simulation Center in Huntsville, Ala. Boeing has connected a Xerox Computer Adapter [Electronics,

Dec. 12, 1966, p. 58] to its 360/67. With this machine, a Xerox LDX transmitter loads graphic data into a computer, and an LDX receiver prints computer-generated graphic data; the LDX equipment is the same as that used in transmitting graphic data over a telephone line. (LDX stands for long distance xerography.) Although the adapter is a commercially available product of the Xerox Corp., no units have been shipped except to Boeing because the manufacturer is refining the hardware development.

Boeing has experienced no serious difficulty with its hardware. But, lacking the IBM software designed for the 360/67, it is running its system partly as two 65's and partly with its own modifications to the standard os/360. Boeing finds that os/360 can't keep up with the demands of the LDX terminals. A single page contains approximately 144,000 eight-bit bytes of data, and the computer's main memory can't spare this much room at one time in the Boeing installation. Although the computer has over a million bytes of core storage, about half of this is occupied most of the time by a portion of the operating system. (The operating system itself occupies 8 million bytes, including compilers and other accessory programs, most of which at any one time are kept on a magnetic drum; segments of the system are sloshed in and out of main memory as needed.) The remainder is shared by four concurrently running programs plus a control program that supervises input-output for the four problem programs.

Hiccup. The computer handles the data being transferred to or from the LDX units only part of a page at a time, and busies itself with one of the other programs in between times. This works well as long as everything is running smoothly. But if an error occurs anywhere in the system, the operating system stops whatever it may be doing and tries to recover the lost data. This takes only a few milliseconds—the machine only hiccups—but it can throw the LDX adapter out of synchronism.

All input-output operations are

independent of the central processor after they have once been initiated, because the input-output channels have direct access to the memory. When the operation is finished, the device interrupts the processor, which can then give another instruction to the device if desired—unless an error has been detected. If any other input-output operations are in progress, they continue undisturbed; but when they are finished, their interrupts are not honored until the error routine is out of the way.

Thus when the LDX adapter finishes reading or printing the first part of a page of data, it interrupts the processor to ask for more—while a motor in the transmitter or receiver keeps the paper moving. Ordinarily the operating system has another block of memory all set up, and need only tell the channel the starting address for that block, so that the flow to or from the adapter is continuous. But if the interrupt comes in the middle of a hiccup, it may not be answered right away and the output page will have a gap in it, or some input data will be passed over.

To overcome these difficulties, Boeing is trying to modify the operating system in two ways: it has to insure that the LDX adapter has the highest priority of all input-output devices; and it has to guarantee this priority even over that of the error routines. Any other input-output device can afford to wait a while—even if continuous motion is involved, as in the case of a magnetic disk or drum, the worst penalty is a 30-millisecond delay for a single revolution.

Military electronics

Calling the shots

The military is now testing radars that can count near-misses on a rifle range and measure the accuracy of air-to-air missiles and antiaircraft fire and pilot strafing. Built by Sanders Associates Inc.'s Radar/Ordnance Systems division, Bedford, Mass., the systems have

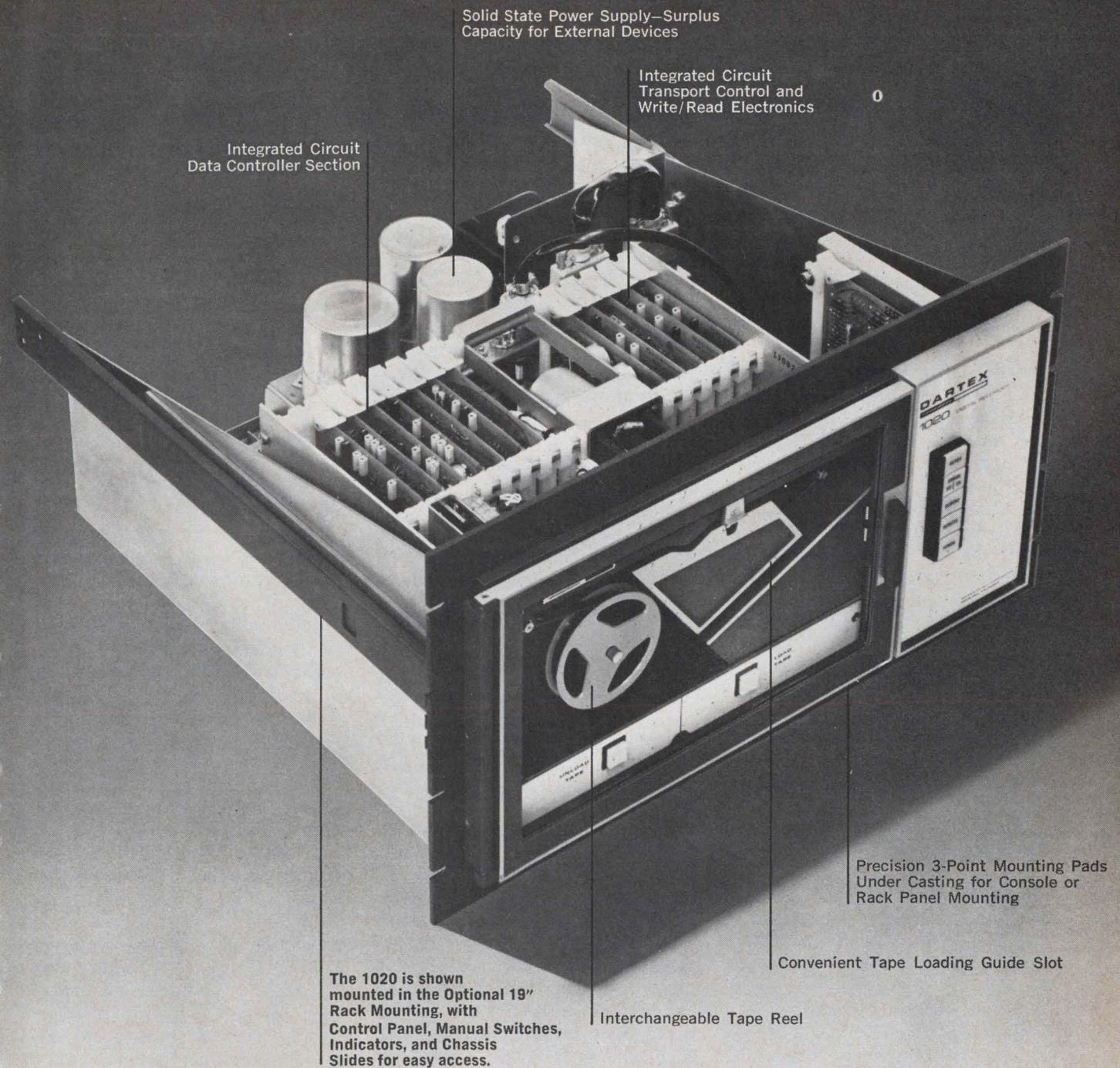

The 1020 is shown mounted in the Optional 19" Rack Mounting, with Control Panel, Manual Switches, Indicators, and Chassis Slides for easy access.

Rewrite Machine

Basically, our new Tally 1020 Incremental Magnetic Tape Unit transfers data asynchronously at 120 characters per second and continuously at 1600 characters per second. □ We call it a rewrite machine because, uniquely among all incremental units, the Tally 1020 can back space and rewrite a single character (or block of characters) anywhere on the tape. □ Other features include error checking, simplified construction and maintenance, 280,000 character storage on a single 3" reel, and low tape wear because of single capstan drive. □ So if your data problems involve data transmission, computer input/output, numerical control, or the like, it will pay you to investigate the modern low cost Tally 1020.

Please address Tom Tracy, Tally Corporation, 1310 Mercer Street, Seattle, Washington 98109. Phone: (206) MA 4-0760. In Europe and the U.K., address Tally/APT, Ltd., 6a George Street, Croydon, Surrey, England. Phone: MUN 6838.

TALLY

been christened Rascore, for radar scoring system.

Rascors come in four varieties:

- Rascore-M, for installation aboard target drones to measure the effectiveness of air-to-air, surface-to-air missiles, or for pilot training.

- Rascore-AA, which would perform the same function for conventional ground-based anti-aircraft fire.

- Rascore-S, a pilot-training system that gives real-time measurements of a pilot's strafing accuracy.

- And Rascore-AP, which would be installed near target dummies and used to gauge the effect of infantry rifle fire.

All four are short pulses (as short as 10 nanoseconds), high repetition rate (as high as 12.5 megahertz) coherent radar systems.

Rascore-M is the most complex, and after three years in development is about one year away from operational status, according to Sanders. Two units are about to be tested at the Naval Missile Center, Point Mugu, Calif.; two more are scheduled for delivery within 60 days.

Know the enemy. Rascore-M must compete in the market with tracking cameras and drone-borne continuous-wave radar systems already developed. But Sanders' Nicholas Senio, ordnance section manager, believes that Rascore will be able to offer better sensitivity than c-w radar and that Rascore's real-time telemetered readout will outclass the optical systems, which require film processing and interpretation.

Aboard a target drone, Rascore-M provides near-spherical coverage with a radius of about 275 feet. Within this sphere, it can measure range to intercepting missiles to within ± 2.5 feet at its maximum range and to ± 1.25 feet at ranges below 35 feet.

The system requires no transponder or corner reflector aboard the intercepting missile. Some miss-distance indicating systems usually require these added devices, which can degrade missile performance. This ability to work with noncooperative targets gained the interest of Hughes Aircraft Co.,

which planned to purchase Rascore-M to evaluate its version of Sam-D, but Hughes lost that contract.

Spotting rounds? Though developed in-house, Rascore-AA is being evaluated now at Point Mugu for the Defense Department's Joint Task Force 2 and the Sandia Corp. It's capable of spotting anti-aircraft rounds of the standard NATO rifle caliber to 57-mm anti-aircraft shells—and scoring them at the rate of 3,000 rounds per minute as they whiz past at up to 3,800 feet per second.

Both Rascore-M and AA operate at about 1.78 Ghz and have peak output powers of only 1.5 to 2 watts. Pulse compression in the receiver adds the power in each group of 255 pulses to achieve effectively higher output power. In both, real-time data is relayed to the ground using IRIG telemetry coding.

Rascore-S is the highest-powered system of the lot and uses the only non-solid state component in the line, a 4-watt magnetron. Its dish antenna is aimed at strafing targets and the pilot's hits are recorded and printed out in real time. Its prime application would be for ground-support pilot training. Accuracy is ± 1 foot and special circuitry eliminates ricochets from a pilot's count.

Antipersonnel. Rascore-AP, another in-house development, has already met requirements set by the Army's Combat Development Command at Fort Ord, Calif., and should find its way into obstacle courses for advanced infantry training. Four units are due for November delivery. The Army is most interested in Rascore-AP's ability to spot rounds that miss the target but come close enough to make a soldier dive for cover. This is called suppressive fire and Rascore-AP is the first system capable of measuring it in real time. Rascore-AP's prime competition is acoustic detection—but these systems spot only supersonic rounds—Rascore can locate subsonic ones as well.

Coupled with a computer, Rascore-AP would trigger stand-up or falling motions among a series of targets, even though the targets

themselves were never touched. Computer readouts would also measure the effectiveness of squads or platoons in combined action, another first, as well as giving insight into the best weapons mix for a unit.

Rascore-AP is the lowest-powered of the four systems, operating at 70 milliwatts peak power at a 3-Mhz repetition rate. Its maximum range of two yards allows the units to be used close together, simulating groups of enemy infantry. Twin dipole antennas give the system a half hemispheric coverage facing incoming fire with the target dummy in the center of the sphere.

Though all four Rascors are based on the same general engineering approach, Rascors-M and -AA are the most complex, and required a solution to a tricky problem—range ambiguity.

Where am I? Long-range radar systems with low repetition rates can transmit a relatively long pulse, time return, then transmit again; they always know what pulse they're working on. But the short-pulsing, high-repetition rate Rascore systems must operate at very short ranges, and without extra signal processing could get pulses confused and generate false information.

Sanders got around this by dividing the radar system's pulse stream into sections 255 pulses long and then applying a binary code to each of these sections—each pulse either begins with 0 degrees phase or at 180 degrees, indicating either a binary 1 or 0.

In the transmitter, a single transistor oscillator is followed by a varactor tripler to generate the 1.78-Ghz output frequency. This is then passed to a coding and pulsing switch controlled by a shift register. The shift register also feeds its code to digital correlators in the receiver.

Successive pulse sections will match in only one of the receiver's correlators at any given time. Thus the sequence of incoming pulses and the range from which they returned can be determined without ambiguity. Fine range determination is given by a set of range gate



TWO DUAL R-S FLIP-FLOPS COMBINE TO FORM A 6 ns MASTER-SLAVE SHIFT REGISTER!

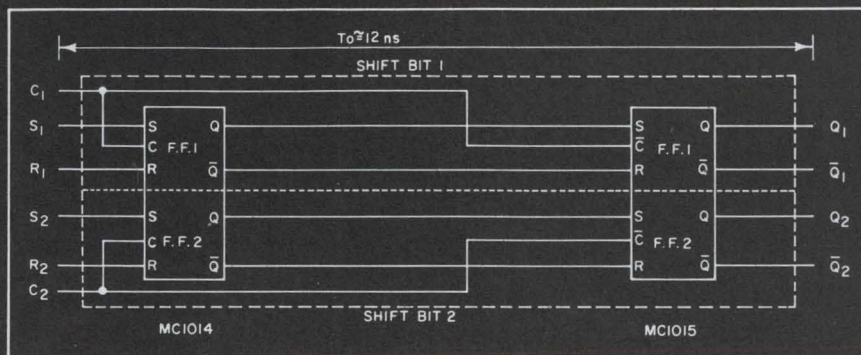

(MECL II MAKES IT POSSIBLE!)

Two new additions to the growing MECL II line of integrated circuits, MC1014P and MC1015P, can be used as positive-gated and negative-gated R-S flip-flops, respectively. Two levels of gating are accomplished with only 2 ns increase in propagation delay. As a result, a single phase, clocked Master-Slave type of shift register with a 6 ns total propagation delay may be obtained as shown.

The MC1014P, in addition to teaming with MC1015P for shift register functions, is also useful as a dual storage element. It contains two dc Set-Reset flip-flops with a positive clock input provided for each flip-flop. MC1015P operates with a negative clock input.

Both new circuits exhibit typical propagation delays of 5.0 ns, operating over the 0 to +75°C temperature range. Both provide typical power dissipa-

tion of 125 mW at an operating frequency of 80 MHz. Minimum dc fan-out of 25 for each output is guaranteed!

Available in the 14-pin Unibloc* plastic package, these circuits bring to 27 the total number of MECL II functional elements — in the fastest, most flexible logic line available. All are fully compatible with the MECL 300/350 series; and, have the same logic levels and power supply requirements as the coming, ultra-high-speed MECL III line.

For data sheets and application notes, circle the reader service number or write to us on your company letterhead.

*Trademark of Motorola Inc.



MOTOROLA
Semiconductors

—where the priceless ingredient is care!

We just took a great step backwards



(with three new, forward-looking unitized DVMs)

Trymetrics' new 4243 Digital Multimeter with AC, DC and OHM readings—auto polarity—full four digit—0.1% (\$850) . . . a tremendous step backwards. And so are the 4240 DVM (\$695) and 4230 DVM (\$595).

We started with our Model 4100: stored display—precision .01%, four-digit DVM and its full range of plug-ins for the price of an ordinary 3-digit job—just \$740 with the $\pm 9.999v$ DC head; \$1045 with a complete multimeter head; and eight other plug-ins to choose from. For an encore, the only way to go was down.

Down \$195 to \$850 for the versatile 4243 Digital Multimeter: DC-AC-OHMS .01% — auto polarity $\pm 999.9mv$ to $\pm 999.9v$. Same 4-digit stored display—no plug-ins. Sorry—unless you don't need plug-ins.

Down again, \$155, to \$695, for the 4240 DVM. Same high accuracy, same stored display, same $\pm 999.9mv$ DC to $\pm 999.9v$ DC 4-digit measurements. But, no AC or OHMS—unless, of course you don't need AC or OHMS.

Once more, down, to \$595 for the Trymetrics 4230 DVM. Still the same precise 4-digit unit with readings $\pm 9.999v$ DC to $\pm 999.9v$ DC. Don't buy this one if you need to measure in the low millivolts.

You don't need true 4-digit readout with .01% accuracy at a 3-digit, .05% price? Sorry—but we can't keep backtracking forever. May we send you our new catalog that shows ALL our models, all our plug-in versatility, all our reasons for going backwards?

PRICES SLIGHTLY HIGHER IN EUROPE.

TRYMETRICS
Corporation
A SUBSIDIARY OF TRYGON ELECTRONICS, INC.
204 Babylon Tpke., Roosevelt, L.I., N.Y.
Phone 516-378-2800 11575

Electronics Review

switches between the video amplifier and correlator sections of the receiver.

Rascore-M offers doppler as a growth feature. With moving targets the binary pulses won't quite line up in the correlators and the output will be a series of amplitude-modulated pulses. By demodulating these, range information is derived. To get velocity, the frequency of the demodulated signal would be measured.

Coming up. Sanders' staff engineer, Eugene Heft, believes that Rascore-AA and -M could make good ground-fire detectors for helicopters, and that Rascore-S could score artillery fire. Most interestingly, he says, Sanders has had nibbles from several Nike-X subcontractors. This could mean that Rascore could be used in evaluation of the upcoming thin missile-defense system. But if so, it would take a complete redesign of Rascore-M.

For the record

Testing. Mariner 5, which is expected to pass within 2,500 miles of Venus on Oct. 9, will carry a payload of scientific instruments designed to determine the planet's atmospheric and ionospheric conditions. Three ultraviolet photometers will determine the gaseous composition of the atmosphere from the top of the clouds to an altitude of several thousand miles. In another experiment, a dual-frequency radio signal emanating from the Palo Alto, Calif., earth station will provide the spacecraft's sensors with occultation data on the ionosphere's altitude, thickness, and day-night variation. A similar experiment, using an S-band radio contained in the craft, will measure the atmospheric density.

Third down. Texas Instruments Incorporated, which predicted earlier this year a rise in earnings for the autumn, now says that third quarter and total 1967 earnings will be "down significantly" from last year's. Mark Shepherd Jr., π president, blamed the troubles on semiconductor business. Specifically,

earnings were hurt by smaller-than-expected profits in the integrated circuit field, and a π decision not to cut back on expenses for future IC programs.

Wide, wide world. During the next six months two satellite systems, which are expected to collect data on everything from animal migration to worldwide meteorological patterns, will be tested by the Goddard Manned Spaceflight Center. The systems—Interrogation Recording and Location System (IRLS) and the Omega Position Location Equipment (OPLE)—both use remote ground or airborne platforms, ground stations, and satellites. The IRLS satellite, which travels in a 90-minute earth orbit, will use triangulation with known orbital parameters to locate the platform positions, while the OPLE satellite, which travels in a synchronous orbit, uses the Navy's Omega navigational system. IRLS, which has just been given the green light by NASA for a second model to be launched in 1970, is expected to be used primarily for studying weather patterns, animal migrations, and other natural phenomena. OPLE, on the other hand, will be used more for navigation, air traffic surveillance, and space flight reentry positioning.

Operational. Braniff Airlines is now using Bunker-Ramo's cathode-ray tube visual display reservations system at strategic sites with tie-ins, from its Dallas headquarters, to three other participating airlines—Central, Southern, and Trans-Texas.

All set. The world's fastest typesetting machine, Linotron [Electronics, April 3, p. 113], a joint effort by CBS Labs and Mergenthaler Linotype, has been put to work in the Government Printing Office.

Vacancy. NASA's Deputy Administrator Robert C. Seamans Jr. will step down at the first of the year to return to industry. Seamans, who agreed to take the job for two years but stayed for seven, has not announced where he will work next nor has the agency appointed his successor. NASA watchers say the odds-on favorite for the post is Homer E. Newell, who stepped into the No. 3 spot as associate administrator the day before Seamans announced his resignation.

Another new (MOS) FET from RCA...3N142

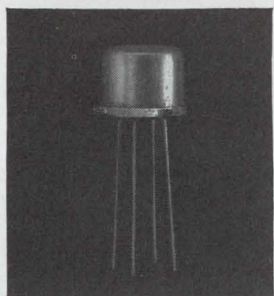

100 MHz
65¢ (1000+)

- ✓ 100 MHz power gain 17 dB typ.
- ✓ feedback capacitance 0.2 pF max.
- ✓ transconductance 7,500 μ mho typ.
- ✓ for military/industrial applications

RCA's GROWING FAMILY OF N-CHANNEL, DEPLETION TYPE (MOS) FET's
FOR INDUSTRIAL & MILITARY APPLICATIONS

| Single-Gate Types | Typ 200MHz G_{21} | Typ 200MHz N.F. | Typ E_{fs} (μ mho) | Max C_{iss} | Max I_{css} | Min V_{OS} | Case | Price (1000+) | Applications |
|------------------------|---------------------------|-----------------------|---------------------------------|------------------|------------------|-----------------|---------------|------------------|---|
| 3N128 | 18dB | 3.5dB | 7,500 | 0.2pF | 50pA | 20V | TO-104 | .88 | RF Amplifier, Mixer, Osc. High Input Impedance Timing Circuits, Electrometers, Instrumentation & Controls |
| 3N138 | (Zero offset) | | 6,000 | 0.25pF | 10pA | 35V | TO-72 | 2.00 | Chopper and Multiplex Equipment, Transmission Gates |
| 3N142. | 17dB* | 2.5dB* | 7,500 | 0.2pF | 1nA | 20V | TO-104 | .65 | RF Amplifier, Mixer, Osc. and General Purpose Amplifier |
| Dual Gate Types | | | | | | | | | |
| 3N140 | *18dB | 3.5dB | 10,000 | 0.03pF | 1nA | 20V | TO-72 | .98 | 200MHz RF Ampl. |
| 3N141 | 18dB | — | 10,000 | 0.03pF | 1nA | 20V | TO-72 | .94 | 200MHz Mixer and Product Detector |

* unneutralized power gain
* 100MHz

The new RCA 3N142 N-channel depletion type insulated-gate (MOS) FET offers complete versatility from DC to 100 MHz and beyond. Its high input resistance (10^{12} typ.) and low gate leakage current make it ideal for low frequency timing circuits, industrial controls and instrumentation equipment. High transconductance and low feedback capacitance, coupled with excellent thermal stability, provide outstanding performance in RF amplifier, mixer and oscillator applications up to 175 MHz. Because it features low cross modulation, reduced spurious responses, minimum oscillator feedthrough and large signal handling capability with-

out diode-current loading, the 3N142 offers today's greatest value in MOS transistors.

Why not get the complete story of the price and performance advantages of the RCA 3N142 (MOS) FET? Your RCA Field Representative will be glad to answer your questions and supply information on other single and dual-gate (MOS) FET's. For additional technical data, write RCA Commercial Engineering, Section EN10-1, Harrison, N.J. 07029. See your RCA Distributor for his price and delivery.



RCA Electronic Components and Devices

The Most Trusted Name in Electronics

Look who's now

big in MOS.

Prodded by Dan Izumi, we now make the fastest, lowest-powered two phase shift register in the whole wide world.

We call it the MM400. He calls it the Izumi 400. Call it what you like, it's still the world's best dual 25 bit dynamic register. Primarily because it uses only -10 volt VDD and -16 volt clock voltage. That's at least a good 11 volts under any other. And guaranteed operation is at 1MHz over a temperature range that goes up to 125° centigrade.

There's also very little power dissipation — typically 40mw at 1 MHz operation — making it just perfect for ground systems,



instrumentation, airborne computers and a variety of other applications. Price is an inscrutable \$40 in 100 lots. Send for details or get them off the shelves of our distributors. Ask for the Izumi 400. See if they know what you mean.

National Semiconductor Corporation, 2950 San Ysidro Way, Santa Clara, California 95051, (408) 245-4320.

National Semiconductor



Off-the-shelf PMT from Amphenol

PMT means Precious Metal Tip, a wrought gold dot welded to printed circuit connector contacts. PMT is 100 times thicker than ordinary contact plating. We have 22 different PMT connectors that will work for 20 years, and they're all standard production items. Pre-tensioned contacts spring back to position insertion after insertion —without damaging P.C. boards. You'll pack about twice as many contacts in the same space, too: 56 in a No. 28 connector, 36 in a No. 18. PMT could be your best printed circuit connector buy. Call your nearest Amphenol Sales Engineer or write to **Amphenol Connector Division**, 1830 S. 54th Avenue, Chicago, Illinois 60650

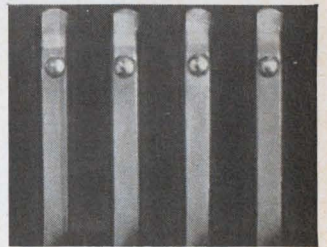

Cut-away Amphenol PMT connector shows welded gold dots on contacts



TM

AMPHENOL

Circle 59 on reader service card

NOW... BEAM LEAD DIODES in flip-chips, axial-lead microdiodes and multi-diode modules

You can now select from General Instrument's line of Beam Lead diode products, flip-chips, axial-lead microdiodes, and a complete line of multi-diode modules—all providing the extreme reliability of the Beam Lead structure.

The Beam Lead Technology:

General Instrument's Beam Lead devices consist of gold bonding leads extending beyond the edges of the chip—in cantilever form. Securely bonded to the silicon and its passivating layer, Beam Leads make ohmic contact through a highly stable and low resistance platinum alloy. Beam Leaded devices are prepared on the slice in a batch process, thereby lowering costs and providing the utmost uniformity between Beam Lead interconnected devices. Beam Lead technology creates a total chip/bond system which is unusually rugged and yields extremely reliable package bonds by a variety of techniques.

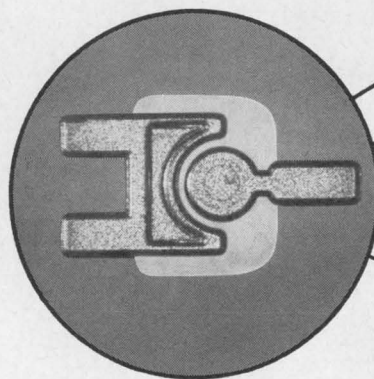

only from General Instrument

For information in Europe, write to: General Instrument Europe, Via Turati 28, Milano, Italy.

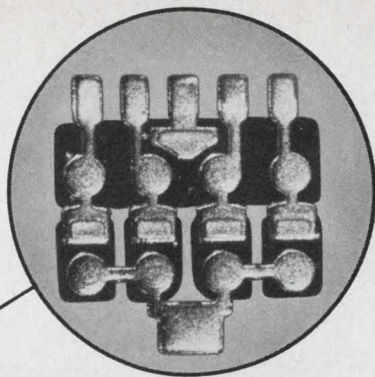

now available in...

Chips and Chip Arrays—for use in flip-chip bonding in a wide range of electrical parameters and circuit configurations. The cantilevered Beam Leads permit economic assembly to substrates without the use of eutectics, aluminum or thermal wire bonding. No bonding energy need be transmitted through the chip itself and, once formed, the bond is visually available for inspection. Discrete diode chips as well as diode arrays containing two to eight air isolated junctions are available.

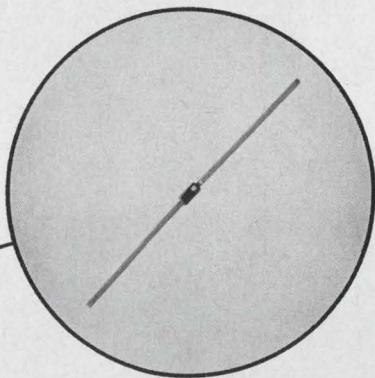

and in...

Beam Lead Microdiodes—in a small plastic axial-lead Microdiode which exceeds MIL moisture specifications. The Microdiode body measures only 40x40x80 mils. It has half inch long gold plated Kovar ribbon leads (5x20 mils). Life tests performed on General Instrument's Microdiode indicate a typical ΔI_r less than $1.5 \times I_r$ (orig.) at PRV and 25°C after 2000 hours at 150°C operating conditions.

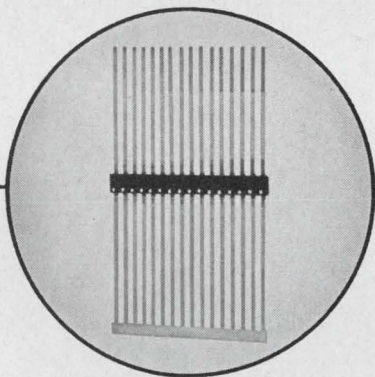

and in...

Beam Lead Microdiode Strips—as modular diode strips on 50 mil centers. The strip may comprise from two to twenty diodes in any combination of common anode, common cathode or discrete interconnections. They can be easily used to form large diode matrices for switching applications.

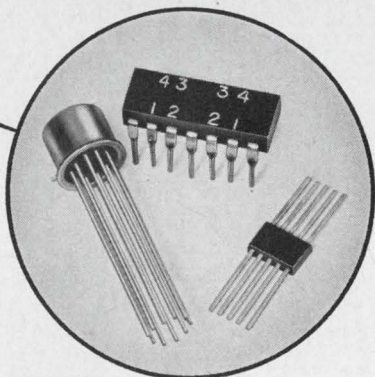

and in...

Beam Lead Diode Modules and Arrays—in any circuit configuration and in plastic or hermetic packages—both flat pack and dual in-line. The extreme stability and long life provided by Beam Lead bonding is assured. The use of Beam Lead isolation between junctions allows the production of switching and core driver modules with faster response times than obtainable by the usual monolithic approaches.

Write for full information.

GENERAL INSTRUMENT CORPORATION • 65 GOUVERNEUR STREET NEWARK, NEW JERSEY

Electronics | October 16, 1967



Circle 61 on reader service card 61

Meet Trygon's Jolly Clean Giant

Trygon's New EAL Series Laboratory Power Supply

- This is Trygon's new EAL wide-range laboratory power supply — four models in the most commonly used laboratory voltage ranges. At \$99, it's a giant.
- And it's a clean giant. Clean output, with ripple less than .5mv rms, plus rock-steady .01% regulation, .05% stability.
- Clean, compact all-metal case, too, that doesn't waste an inch of bench space. The switchable volt/ammeter, concentric coarse and fine voltage controls, pilot light and output terminals (fully floating output) are all on the front panel.
- Put our jolly clean giant to work for you. Just write your order neatly on the order blank below. We'll take care of the rest.

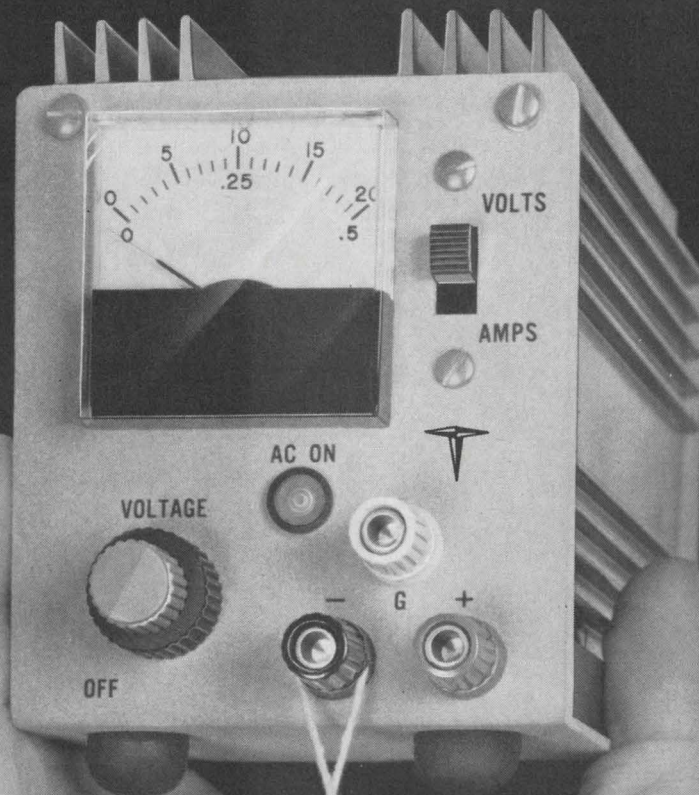

\$99.00



TRYGON ELECTRONICS, Inc.
111 Pleasant Ave., Roosevelt, L.I., N.Y. 11575*

I need the following EAL unit(s).

| Qty. | Model | Rating |
|-------|------------|--------------------|
| | EAL 10-1 | 0-10 VDC @ 1.0 Amp |
| | EAL 20-500 | 0-20-VDC @ 500 ma |
| | EAL 32-300 | 0-32 VDC @ 300 ma |
| | EAL 50-250 | 0-50 VDC @ 250 ma |

Name _____ Title _____

Firm _____

Address _____

City _____ State _____ Zip _____

Purchase Order Attached. Contact us for Purchase Order.
 Please send Trygon Power Supply Handbook.

*Prices slightly higher in Europe: Trygon GmbH, 8 Munchen 60, Haidelweg 20, Germany.



From Westinghouse...
the only 0.5 mil
resolution CRT in a
"plug-in" package...
no design or
assembly headaches.

It's simply not economical for you to design and assemble yokes, shields, and CRT's as well as Westinghouse does in its unique "plug-in" packages. For example, the assembly above. It's a fiber-optic CRT package with 0.5 mil resolution that meets mil-specs on shock and vibration. And it's ready to operate. You save many, many hours of engineering and technician time.

This is only one of many Westinghouse CRT packages. For details, write. We have over 400 vacuum electronics engineers who want to help you. Westinghouse Electronic Tube Division, Elmira, New York 14902.

You can be sure if it's Westinghouse



Now an instant Core Memory ...just plug in and solder

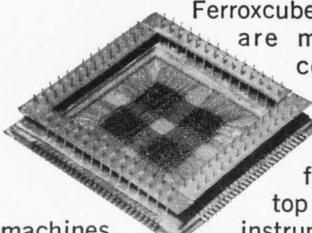

Ferroxcube Platrices are magnetic core matrices specially designed for desktop business machines, and industrial control equipment. Not only are they priced far below conventional core memory planes; they save you even more money on assembly costs.

Platrices are provided with plug-in

connection pins for quick and simple direct mounting on printed circuit boards. You mount a Platrix as you would a transistor: push the leads through the board and solder. To illustrate, we built this mockup out of clear plastic so you can see both the pins and the Platrix itself.

The expensive cut frames of conventional planes are eliminated by a simplified yet rigid frame of glass-epoxy laminate. For high resistance to shock and vibration, the cores are fixed to a base plate of this material by a special lacquer.

Stacks of up to four Platrices can be supplied with series connected drive lines terminated at the bottom of the stack. Low drive currents allow use of simple drive and selection circuits. Platrices are available in 8 standard configurations with bit capacities from 256 to 1,024, but we can be persuaded to make other sizes if you really need them.

Platrices. Reliable. Simple. Inexpensive. Bulletin 6007 tells all. Write for it today.

Ferroxcube 

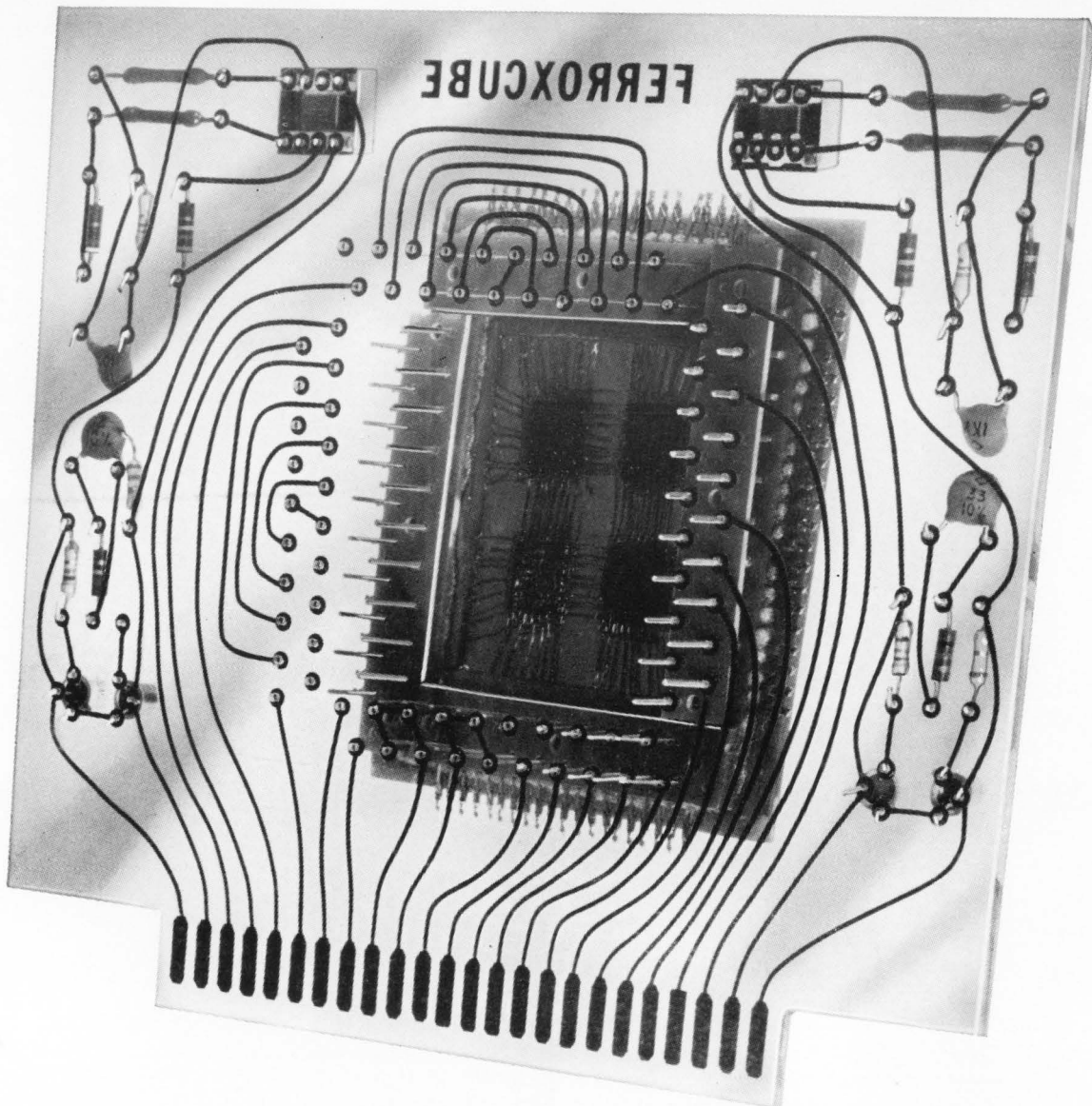

Albuquerque—Electronic Enterprises, (505) 256-1585; Baltimore—Eastern Components, (301) 322-1412; Dayton—(513) 253-3158; Detroit—(313) 342-7722; Encino, Cal.—(213) 788-2060; Englewood, Col.—(303) 771-2000; Houston—Noakes Engineering, (713) 529-6213; Irving, Texas—Noakes Engineering, (214) 255-0441; Minneapolis—(612) 888-4681; Northlake, Ill.—(312) 261-7880; Orlando—Col-Ins Co., (305) 423-7615; Philadelphia—Eastern Components, (215) 927-6262; Phoenix—(602) 265-1792; San Francisco—Wm. J. Purdy Agents, (415) 863-3300; Saugerties, N.Y.—(914) 246-2811; Union, N.J.—(201) 964-1844; Waltham, Mass.—(617) 899-3110; Toronto, Ontario—Philips Electron Devices, Ltd., (416) 425-5161.



We cross examine every IC at 14 points... and that's just the beginning.

Early in production, every Sylvania IC is 100% DC tested on our fully automated 14-point probe.

At the end, each Sylvania IC must pass final operational tests in four consecutive, temperature-controlled chambers from -55°C to 125°C .

And there's no let-up in testing in between. All bonds are air-blasted and mechanically tested prior to package sealing. All packages are baked at 300°C to insure absolute dryness before sealing.

After sealing, all units are aged at 300°C for

60 hours. Then all IC's are temperature cycled from -65° to 200°C , centrifuged at 20,000 Gs in the Y_1 plane, and all packages are 100% leak tested for hermetic seal.

These tests are far more comprehensive and thorough than any performed by our competitors. And we minimize errors in the first place with our fixed production process.

Sylvania Semiconductor Division, Electronic Components Group, Woburn, Mass. 01801.

SYLVANIA

SUBSIDIARY OF

GENERAL TELEPHONE & ELECTRONICS GTE

Circle 65 on Reader Service Card

| | | | | | | | | | | |
|-----|-----|-----|-----|-----|-----|-----|-----|-----|-----|-----|
| 1 | 2 | 3 | 4 | 5 | 6 | 7 | 8 | 9 | 10 | 11 |
| 12 | 13 | 14 | 15 | 16 | 17 | 18 | 19 | 20 | 21 | 22 |
| 23 | 24 | 25 | 26 | 27 | 28 | 29 | 30 | 31 | 32 | 33 |
| 34 | 35 | 36 | 37 | 38 | 39 | 40 | 41 | 42 | 43 | 44 |
| 45 | 46 | 47 | 48 | 49 | 50 | 51 | 52 | 53 | 54 | 55 |
| 56 | 57 | 58 | 59 | 60 | 61 | 62 | 63 | 64 | 65 | 66 |
| 67 | 68 | 69 | 70 | 71 | 72 | 73 | 74 | 75 | 76 | 77 |
| 78 | 79 | 80 | 81 | 82 | 83 | 84 | 85 | 86 | 87 | 88 |
| 89 | 90 | 91 | 92 | 93 | 94 | 95 | 96 | 97 | 98 | 99 |
| 100 | 101 | 102 | 103 | 104 | 105 | 106 | 107 | 108 | 109 | 110 |
| 111 | 112 | 113 | 114 | | | | | | | |
| 115 | 116 | 117 | 118 | | | | | | | |
| 119 | 120 | 121 | 122 | | | | | | | |
| 123 | 124 | 125 | 126 | | | | | | | |
| 127 | 128 | 129 | 130 | | | | | | | |
| 131 | 132 | 133 | 134 | | | | | | | |

NON-STOP TO 135 MHz!

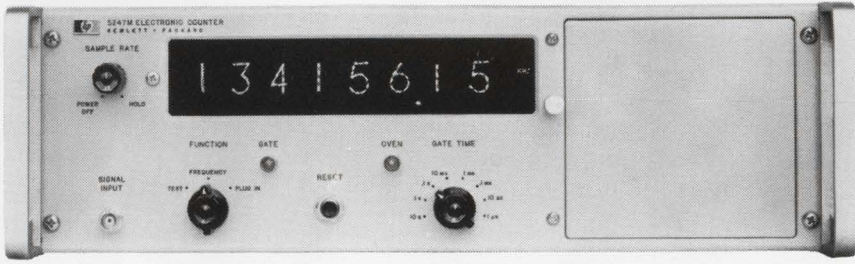

- PLUS—ultra-stable, fast warm-up time base**
- PLUS—plug-in measurements to 18 GHz**
- PLUS—versatility as a frequency standard**
- PLUS—100 mV to 10V input range without adjustment**

The new Hewlett-Packard 5247M Electronic Counter makes direct frequency measurements 10 Hz to 135 MHz with no tuning, changing of accessories or adjustments of any kind. Further, it accepts signals over the wide input amplitude range of 100 mV to 10 V rms without any level adjustment. Additional plug-ins let you measure frequency to 18 GHz. Ultra-stable, fast warm-up time base increases accuracy of your measurements and extends the time between calibrations.

Typical warm-up is one hour to reach 5 parts in 10^9 ; aging rate is < 5 parts in $10^{10}/24$ hours. The spectrally pure 5 MHz time base output is available whenever the line cord is plugged in and serves as an excellent secondary frequency standard well buffered against line and load changes. Price: \$3000.

The 5247M is another addition to the popular HP plug-in electronic counters. For information on the 5247M call your local HP field engineer or write Hewlett-Packard, Palo Alto, California 94304; Europe: 54 Route des Acacias, Geneva.





Precise people make precision products

The red carpet is symbolic of our regard for those who make Tempress the sort of organization it is today . . . technically sound, service oriented, and one hundred percent dedicated to the development and production of high precision products. It requires very special people to deliver, day in and day out, in quantities sufficient to satisfy the burgeoning semiconductor industry, using materials such as tungsten carbide, diamonds, and sapphires at ten thousandths tolerances: capillary tubes, probe contact needles, flame-off torches, diamond scribes, diamond lapping points, and the new automatic scribing machine. They receive the red carpet

treatment, because we realize that the Tempress product can be had from only the finest people, working under ideal conditions . . . and they, in turn, reserve a large portion of that carpet for our customers, whose requirements and whose loyalty are the ultimate reasons for the Company's existence. We have already put in our order for a larger carpet, as this one was outgrown while the picture was being taken.



TEMPRESS

Tempress Research Co., 566 San Xavier Ave., Sunnyvale, Calif.

Circle 67 on reader service card

THIS IS THE ONLY SYSTEM/360-COMPATIBLE DIGITAL INCREMENTAL MAGNETIC TAPE RECORDER YOU CAN BUY. (THE REASON IS CBD.)

Why is CALMA's Model 800 the only 9-channel, 800bpi, SYSTEM/360-compatible digital incremental magnetic tape recorder currently available? Because no other recorder manufacturer can meet the maximum character spacing variation specifications of the major computer makers.

CALMA's unique CBD (Constant Bit Density) controller guarantees character spacing variations of less than 2%.

The Model 800 will collect your sporadic (0-500 characters per second) digital data on SYSTEM/360-compatible magnetic tape.

Those of you without SYSTEM/360 can have all the advantages of CBD in our Model 600 (7-channel, 556bpi, 0-500cps) and Model 200 (7-channel, 200bpi, 0-500cps) digital incremental recorders.

Detailed technical information is available. Write, phone, or circle our number on the reader service card for your copy of CALMA Bulletin DR.



346 Mathew Street
Santa Clara, Calif. 95050
Phone: (408) 244-0960

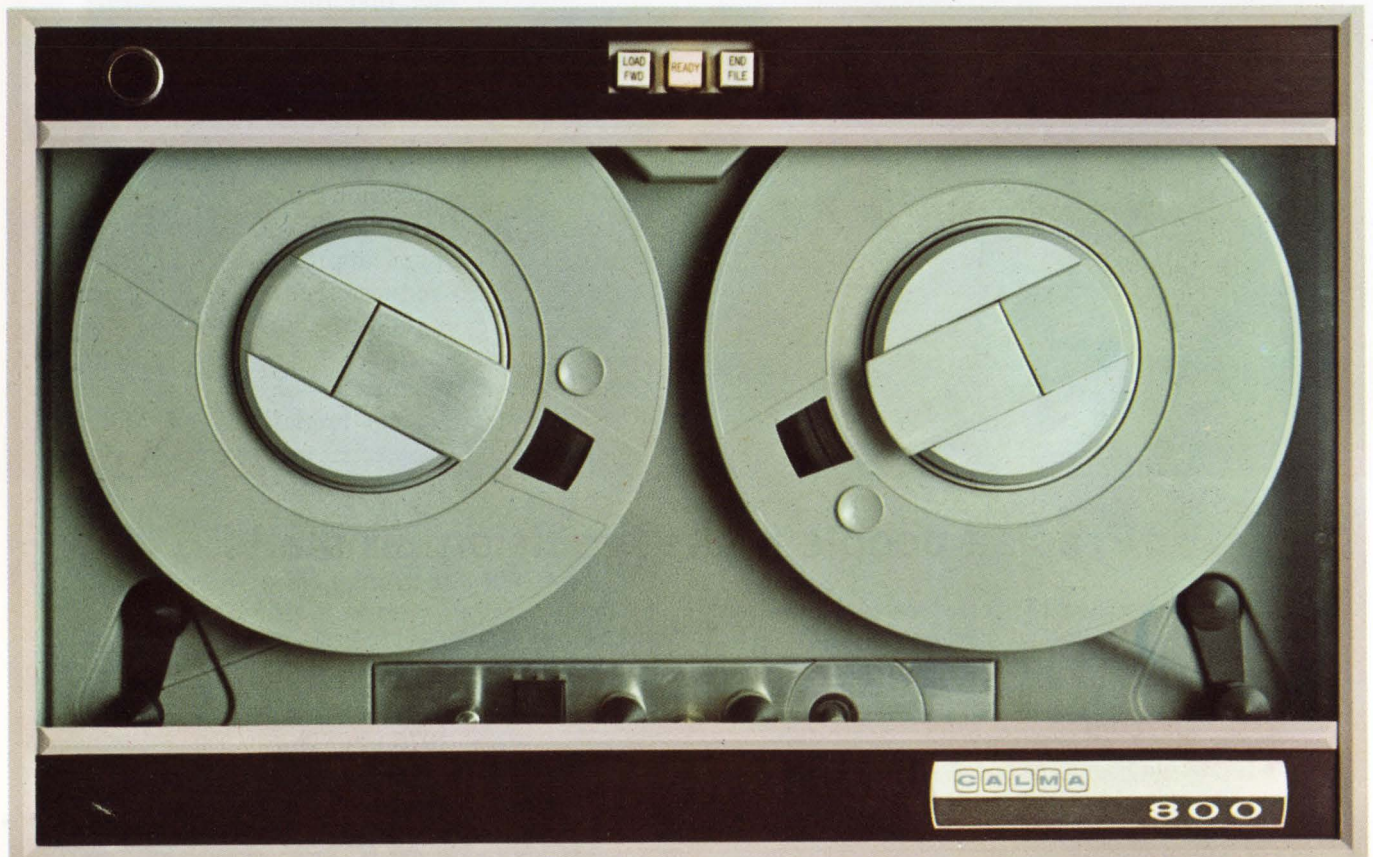

Washington Newsletter

October 16, 1967

Weigh miniaturized electronic-warfare system from TRW

The Pentagon is evaluating TRW Systems' unsolicited proposal to build an electronic-warfare system small enough to fit in any attack or fighter aircraft. Existing equipment is so large that it usually requires a separate electronic-warfare plane to accompany attacking aircraft on combat missions.

TRW's bid is typical—most electronic-warfare designs originate from unsolicited proposals. Company-funded thus far, the proprietary TRW system already has been breadboarded. In production, the vhf system would cost from \$20,000 to \$35,000.

Fully automatic, the system employs high-powered miniaturized transmitters—packaged in a 35-pound, 1 cubic-foot box—that deliver up to 500 watts. The system would scan its frequency, recognize and identify a signal from a hostile source, discard other signals, turn on its power, and jam the sensor—after the pilot flips a single switch.

TRW has recently established a 200-man laboratory in Redondo Beach, Calif., to research and produce electronic-warfare equipment. **The annual market for this gear is estimated in excess of \$300 million.**

Still no date set For FAA briefing

The Federal Aviation Administration still has problems fixing a date for its first conference to brief electronics firms on future requirements for terminal air traffic control [Electronics, Aug. 21, p. 59]. The FAA this spring planned to have the conference in August; and then it was hoped for September. **Now the FAA is shooting for November, but is still not definite.** Biggest hold-up is the fact that the FAA itself isn't positive what its future needs will be and is having problems trying to figure out what to tell the electronics firms.

Freeze on spending cools Omega outlook

Navy officials seeking a go-ahead for full-scale deployment of the Omega navigation system now fear that the Administration's military spending freeze may push the operational date deep into the 1970's. Omega advocates have been pressing for top-level Pentagon approval of the system for more than two years, but their formal request reached the desk of Defense Secretary McNamara at the same time as did orders for the deferral of outlays not related to the Vietnam war.

Even if McNamara approves the Omega concept—and he may this week—he isn't likely to request money for its implementation until Vietnam spending subsides. The Navy had hoped that an approval would mean \$40 million in the fiscal 1969 budget to improve the system's very-low-frequency transmitter network and to equip ships with the receivers. With the transmitters fully operational, the door for a \$1 billion receiver market would be opened [Electronics, March 20, p. 50].

IBM studies future flying 'war room'

The Pentagon has awarded IBM's Federal Systems division a \$230,000 contract to study the first element of an advanced strategic military command and control system for the post-1975 era. **The order calls for a design study of an airborne emergency command post for the projected world-wide military command system.**

Such a command post—probably installed aboard a giant C-5A Galaxie

Washington Newsletter

aircraft—would replace the one now in a Boeing 707 based at Andrews Air Force Base, Md. Other emergency command posts are in a hardened site in a Maryland mountain and aboard two Navy ships operating off the Virginia coast; all could take over “war-room” functions if the primary command center in the Pentagon were destroyed.

IBM is just starting the study, but indications are that the design will include larger and faster data processors.

Riding a moonbeam

An S-band beacon on the moon will be used to calibrate the antennas of U.S. telemetry terminals on earth. **Researchers have given up on a range-calibration satellite because of problems in stabilizing it with necessary precision.** Astronauts will set up the beacon during their first lunar landing. It will have sufficient power to send out signals for two to three months.

Law groups framing new patent bills

The controversial “first to file” tests in the Administration’s patent reform bill [Electronics, May 29, p. 60] have held up that bill and will undoubtedly keep it from being passed this session. **However, two alternatives will be posed in the separate bills being framed for presentation by the American Bar Association and the American Patent Law Association.** The two bills, expected to be unveiled before winter, for the most part duplicate the Administration bill, but will have provisions for filing which are closer to the existing patent office “first to invent” rule.

Wanted: New ground communications link

Conventional communications have been ruled out as links between vehicles and control centers of the high-speed ground transportation system planned by the Department of Transportation. **The reason: An overcrowded frequency spectrum.**

DOT is looking into surface wave transmission lines, leaky waveguides and modulated laser beams for links to the automatic controls. Studies of the surface wave transmission lines have gone farther than the other systems so far. Government researchers are investigating field configuration, transmission line design, the effects of supporting structures, methods of coupling between vehicles and control centers, and ways to increase the data capacity.

Addenda

Robert M. Lowe, a lawyer, has been named to head the Transportation Department’s office of telecommunications. His group’s first assignment will be to study transportation communications and satellite navigation. The department is still searching for a research and development chief . . . Air Force research and equipment needs for the Vietnam war are going to get more attention. Brig. Gen. William S. Charsell will head a new office that will take over many of the tasks previously assigned to the limited war offices of the Air Force Systems Command divisions . . . The first mechanically despun satellite antenna will get its initial flight test aboard the ATS-C spacecraft scheduled for launching into a stationary orbit Nov. 7. The Sylvania-built antenna is designed to provide an 18-decibel gain, compared with the 13-db gain being registered by the electronically despun antenna aboard the ATS-1. Sylvania is also developing a more sophisticated mechanically despun antenna for Comsat’s Intelsat 3 global satellite system.

Only DuPont makes a complete line of high-quality, tailored solvents to meet your critical cleaning needs...

FREON®

Fluorocarbon Solvents

FREON solvents are exclusively tailored to meet particular cleaning needs. Some are azeotropes—materials which when combined act as one compound, giving off only pure vapors at one specific boiling point. This makes them ideal for use in vapor degreasers. Others are special compounds—blended for maximum cleaning efficiency. Regardless of their tailored properties, *all* FREON solvents offer low surface tension for improved cleaning penetration . . . high density for floating away particulate matter . . . excellent purity and stability for reuse after simple distillation and filtration. FREON solvents are nonflammable and low in toxicity . . . special exhaust systems are rarely needed. And FREON solvents are *selective*—they clean without harming most commonly-used component materials.

FREON® TF (boiling point*: 117.6°F.)

A pure chemical (trichlorotrifluoroethane) used to dissolve oil and grease and to float away small particles with exceptional safety to metals, plastics and elastomers. It is also the base for other FREON compounds in Du Pont's family of tailored solvents.

FREON® PCA (boiling point: 117.6°F.)

FREON Precision Cleaning Agent is an ultra-high purity grade of FREON TF packaged under white room conditions. It has an extremely rigid specification for particulate matter and a maximum total residue specification of no more than one part per million . . . both soluble residue and particulate matter. This solvent is especially suited for flushing operations where extreme cleanliness is required.

FREON® TA (boiling point: 110.5°F.)

A patented azeotrope of FREON TF and acetone, compounded for increased solvency toward a broader range of more polar and higher molecular weight contaminants such as polymeric materials. Its uses include removing mold release agent from plastic and elastomer parts and cleaning electrical and electronic components.

FREON® TMC (boiling point: 97.7°F.)

A patented, very stable azeotrope of FREON TF and methylene chloride particularly well suited for removing rosin-type flux from electrical and electronic components. It is stronger than FREON TF, but gentle enough for use with most metals, plastics and elastomers.

*All boiling points given at one atmosphere pressure.

FREON® TC (boiling point: 117.3°F.)

A patented azeotrope of FREON TF and chloroform for use where a solvent stronger than FREON TF is required, but with greater component material compatibility than FREON TMC:

FREON® T-P 35 (boiling point: 120.0°F.)

A patented blend of FREON TF and isopropyl alcohol, good for both organic and polar soils. It is highly compatible with very active metals, an excellent drying agent and ideal for flushing hydraulic piping.

FREON® T-WD 602 (boiling point: 112.0°F.)

A water-in-oil emulsion for cleaning both water and oil-soluble soils. It is compatible with most plastics, elastomers (except silicones), coatings and metals.

* * *

A complete line of tailored solvents is exclusive with FREON fluorocarbons, available only from Du Pont. For more information, mail the coupon below.



Better Things for Better Living... through Chemistry

Du Pont Co., Room 5390, Wilmington, Del. 19898
Please send me more information on FREON _____
solvent(s) for use in cleaning _____

Name _____

Company _____

Address _____

City _____ State _____ Zip _____

(In Europe, mail to: Du Pont de Nemours International S.A., "Freon" Products Div., 81, Route de l'Aire, CH 1211 Geneva 24, Switzerland.)

We call it a Hertzmeter.

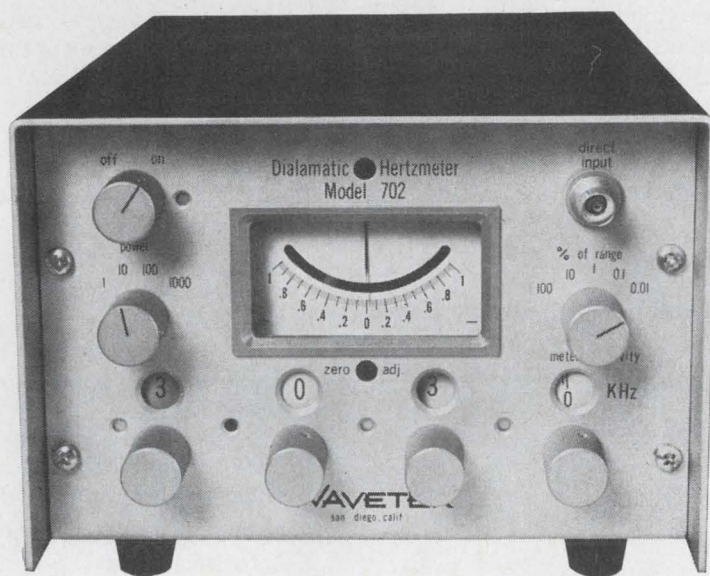

Hertzmeter?

That's right. Hertzmeter.

When you invent a unique instrument, you give it a unique name. Here's what's so special about it.

The Hertzmeter can measure, monitor and tune frequency. Easily and accurately. It combines the advantages of digital precision with analog continuity.

We were going to call it a Differential Frequency meter because it's a lot like a differential voltmeter. Only it's more so.

The Hertzmeter is fast, because it uses Wavetek's Transfermatic Switch* and non-saturating null amplifier. Measurement of low frequencies is particularly fast. Incidentally, the frequency range is 5 Hz to 100 MHz, with accuracy of $\pm 0.01\%$.

The Hertzmeter also has a recorder output for monitoring deviations from 100% full scale down to a maximum resolution of ± 1 ppm.

You can get yourself a Hertz-

meter for as little as \$795. Or you can get a more versatile instrument that measures dc voltage in addition to frequency for \$1,095. We call this one a Voltmeter/Hertzmeter.

If you buy one, you can call it whatever you like.

*Patent applied for.

WAVETEK®

8159 Engineer Rd., San Diego Calif. 92111, Tel. 279-2200
P.O. Box 651, San Diego Calif. 92112, TWX 910-335-2007

DON'T SPEC A SINGLE TURN UNTIL YOU'VE SEEN THE 6 new INFINITRON[®] CONDUCTIVE PLASTIC ELEMENT PRECISION POTENTIOMETERS FROM BOURNS

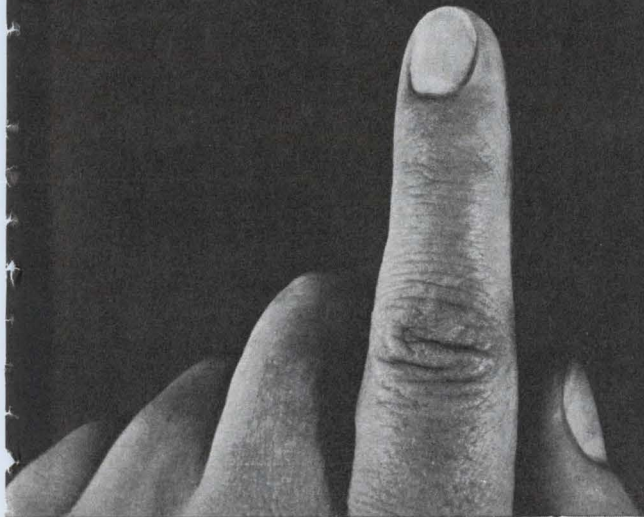

The new Bourns units are available in $\frac{7}{8}$ ", $1\frac{1}{16}$ " and 2" diameters with either bushing or servo-mount lids. Standard linearity is 0.5% with special linearities on request. Rotational life of the new conductive plastic units is 50,000,000 shaft revolutions and temperature range is -55°C to $+125^{\circ}\text{C}$. All have outstanding resistance to humidity and exceed the moisture resistant requirement of MIL-R-39023. Most are available in ranges of 100 to 1,000,000 ohms. All models are manufactured to the stringent quality specifications you have come to expect from a Bourns product line. As with all products manufactured by Bourns, every single INFINITRON unit is guaranteed by the Bourns Reliability Assurance Program,

which includes individual inspection to published electrical and physical characteristics. Standard units are ready to ship off-the-shelf to fit your production or engineering requirements. . . special resistance values, taps, electrical angles and mechanical stops are available upon request.

Don't gamble in down-time, extended deliveries, etc., and don't speculate on quality and specifications! Investigate all the outstanding specs offered by the six new INFINITRON conductive plastic precision potentiometers from Bourns! For complete technical data contact your nearest Bourns office, representative or write the factory direct.



Circle 73 on reader service card

BOURNS, INC., TRIMPOT DIVISION • 1200 COLUMBIA AVE., RIVERSIDE, CALIF.
TELEPHONE (714) 684-1700 • TWX: 910 332-1252 • CABLE: BOURNSINC.

TRIMPOT[®] and Precision Potentiometers - Miniature Relays - Electronic Modules - Microcomponents

Why the big swing to silicone molded devices?

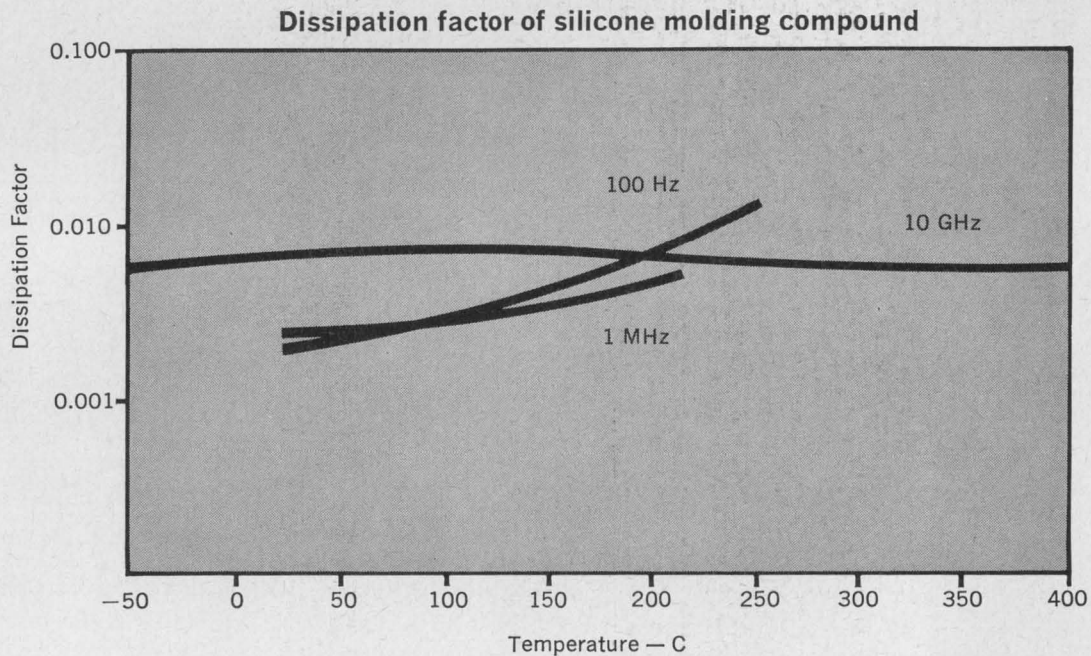

Why the big swing to silicone molded devices? . . . Electrically stable materials over a wide range of temperatures from low to high frequencies—as shown graphically above. Silicone molded packages do not limit the design or performance of high frequency semiconductor devices. Design characteristics will not drift due to changing electrical properties of the molded package.

That's why the rapid growth in the number of devices—from simple diodes to integrated circuits—packaged in silicone molding compound. Of course, there are other important reasons.

No derating necessary. Devices packaged in silicone molding compounds can be operated at their full power potential. This enables designs with a higher device density per given volume. For example, one manufacturer reduced the size of a power diode to 1/30th of its glass packaged counterpart. Compared to other plastic materials, the package size is from 1/5th to 1/3rd smaller, since derating due to package stability is not required.

No cracking — Dow Corning silicone molding compounds—unlike other organic thermal setting plastics—are virtually unaffected by heat and thermal shock. For example, a power resistor molded in Dow Corning® 307 molding compound was subjected to repeated cycling from -65 C to 350 C without damage to the packaging material or the device. Dow Corning® brand molding

compounds subjected to 1000 hours at 300 C (572 F) show no significant change in physical and electrical properties.

Will not burn. Silicone molding compound is inherently non-burning. Thus components packaged in silicone molding compound will not constitute a fire hazard. No flame snuffers are needed . . . a source of ionic contamination for devices packaged in organic plastic materials. With silicone molding compound there are no ionic or polar constituents when properly used, to affect junction performance.

Low water absorption—Dow Corning silicone molding compounds have low water absorption even after long aging at maximum operating temperatures.

Competitive Price. Silicone molding compound costs only a fraction of a cent per device. Thus, it enjoys a substantial price advantage over metal cans and glass packages.

Manufacturing Economies. Transfer molding enables devices to be packaged with minimum of manual labor and supervision. Good mold release and minimum flash assure high production rates and reduced de-flashing costs.

For technical data on why the swing to Dow Corning silicone molding compounds in device packaging, write Dept. 3734, Electronic Materials Division, Dow Corning Corporation, Midland, Michigan 48640.

200,000 OHMS PER VOLT

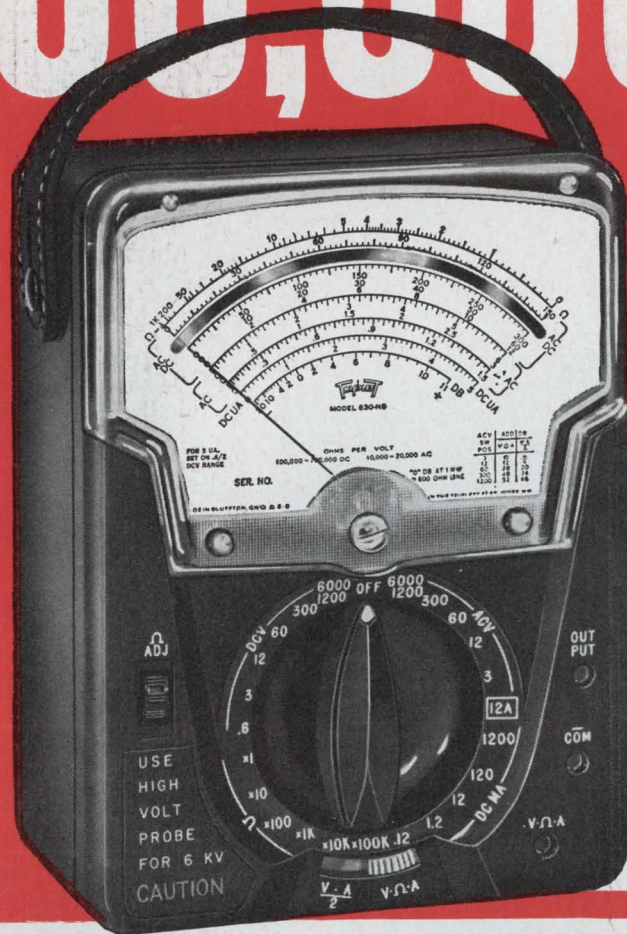

Model 630-NS
VOLT-OHM-MICROAMMETER

TRIPLET SUSPENSION MOVEMENT

*no pivots . . . no jewels . . .
no hair springs . . . thus NO FRICTION.*

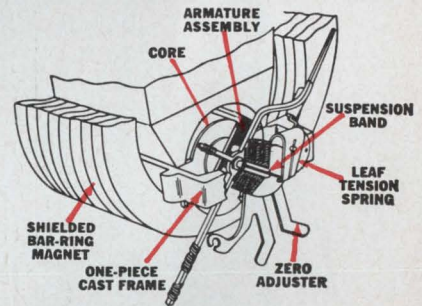

\$10500
SUGGESTED
U.S.A. USER NET

FACTS MAKE FEATURES

- 1** 200,000 OHMS PER VOLT D.C. for greater accuracy on high resistance circuits. 20,000 OHMS PER VOLT A.C.
- 2** 5 μ SUSPENSION METER MOVEMENT. No pivots, bearings, hair-springs, or rolling friction. Extremely RUGGED. Greater sensitivity and repeatability.
- 3** 62 Ranges, usable with frequencies through 100 Kc. Temperature compensated. 1 $\frac{1}{2}$ % D.C. ACCURACY, 3% A.C.

Low voltage ranges and high input impedance make the 630-NS especially useful in transistor circuit measurement and testing. Input impedance, at 55 volts D.C. and above, is higher than most vacuum tube voltmeters.

The unit is designed to withstand overloads and offers greater reading accuracy. Reads from 0.1 μ a on 5 μ a range. Special resistors are rigidly mounted and directly connected to the switch to form a simplified unit. Carrying cases with stands are priced from \$11.00.

TRIPLET ELECTRICAL INSTRUMENT COMPANY, BLUFFTON, OHIO

62 RANGES

| | |
|--------------------|---|
| D.C. VOLTS | 0-0.6-3-12-60-300-1200 at 100,000 Ohms/Volt. 0-0.3-1.5-6-30-150-600 at 200,000 Ohms/Volt. 0-0.150 at 60 μ a |
| A.C. VOLTS | 0-3-12-60-300-1200 at 10,000 Ohms/Volt. 0-1.5-6-30-150-600 at 20,000 Ohms/Volt. |
| DB | -20 to 77 in 10 ranges. |
| D.C. MICRO-AMPERES | 0-5 at 300 MV. 0-60-600 at 150 MV. 0-120 at 300 MV. |
| D.C. MILLI-AMPERES | 0-6-60-600 at 150 MV. 0-1.2-12-120-1200 at 300 MV. |
| D.C. AMPERES | 0-6 at 150 MV. 0-12 at 300 MV. |
| OHMS | 0-1K-10K-100K (4.4-44-440 at center scale) |
| MEGOHMS | 0-1-10-100 (4400-44,000-440,000 Ohms center scale) |

OUTPUT: Condenser in series with A.C. Volt ranges.

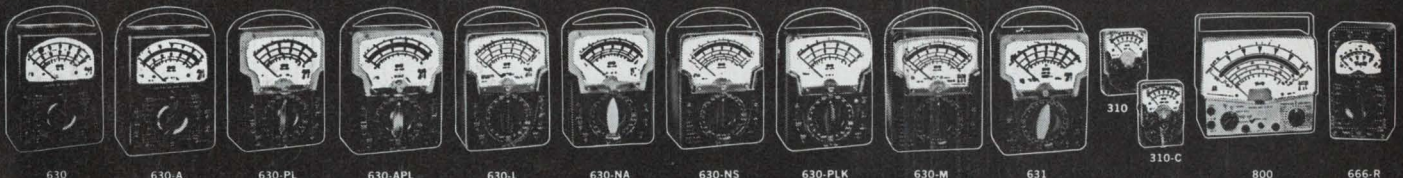

THE WORLD'S MOST COMPLETE LINE OF V-O-M'S. AVAILABLE FROM YOUR TRIPLET DISTRIBUTOR'S STOCK.

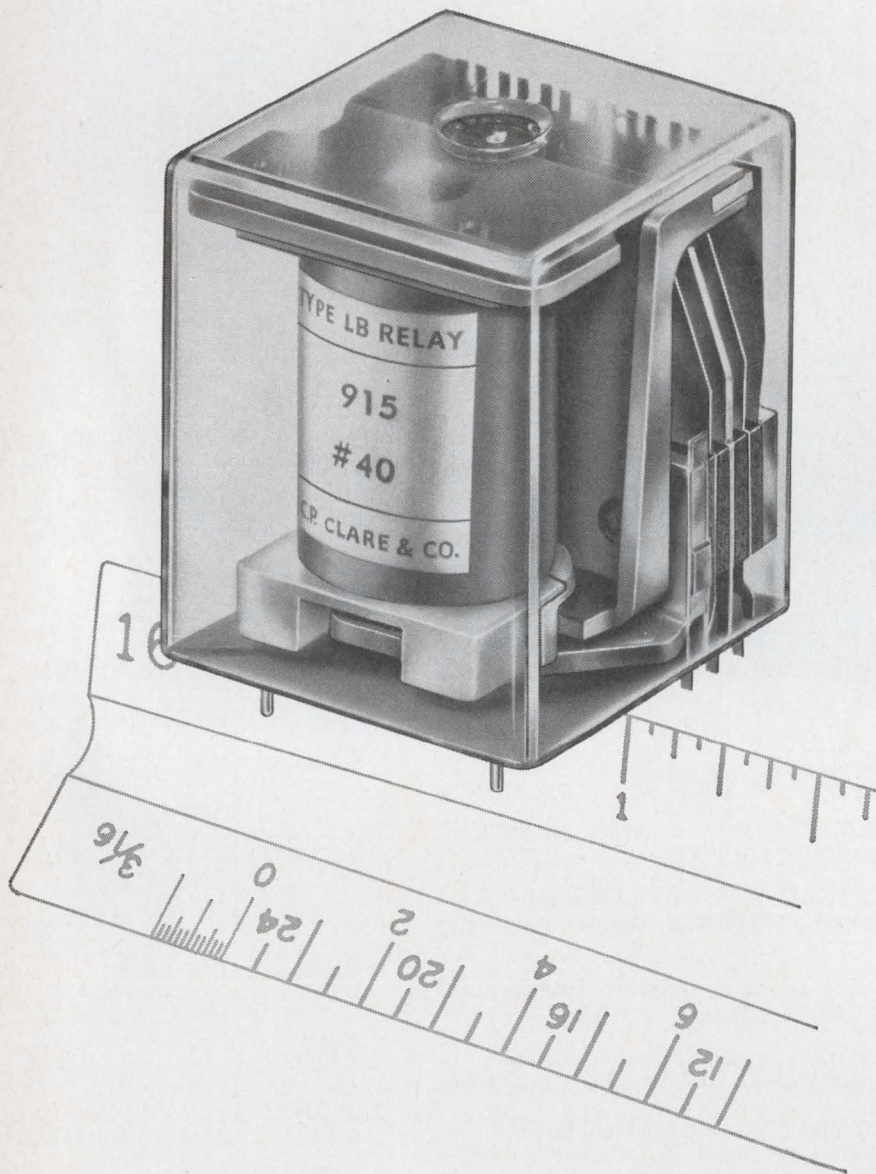

industrious

Small wonder the Clare LB Telephone Type Relay is kept busy—at 1.33 cu. in., it is unmatched for switching capacity and contact versatility—realistically priced!

You can design around 2 amp. to low level operation . . . using up to six Form C contacts . . . or Forms A, B, or D. Twin contacts assure reliable performance . . . with no adjustment needed. Use Type LB for direct pcb mounting . . . Type LBP for mounting with socket. With completely automatic manufacture and adjustment, you can depend on these industrious relays for consistent high quality...maintenance-free, long life operation.

For design information, circle reader service number—or ask Clare for Data Sheet 552B . . . Write Group 10N5.

C.P. Clare & Co., Chicago, Illinois 60645

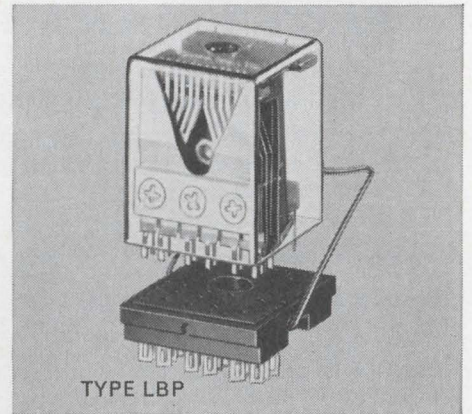

- Long life: up to 50×10^6 operations
- Contact Versatility: 2 amp. to low level . . . twin contacts for reliability . . . up to 6 Form C with A, B and D available
- Stable, adjustment-free operation
- Variety of terminals—pcb, direct plug-in, solder

CLARE MINIATURE TELEPHONE TYPE RELAYS

for process control, computer peripheral equipment, communications,
digital instruments, business machines, ground support equipment

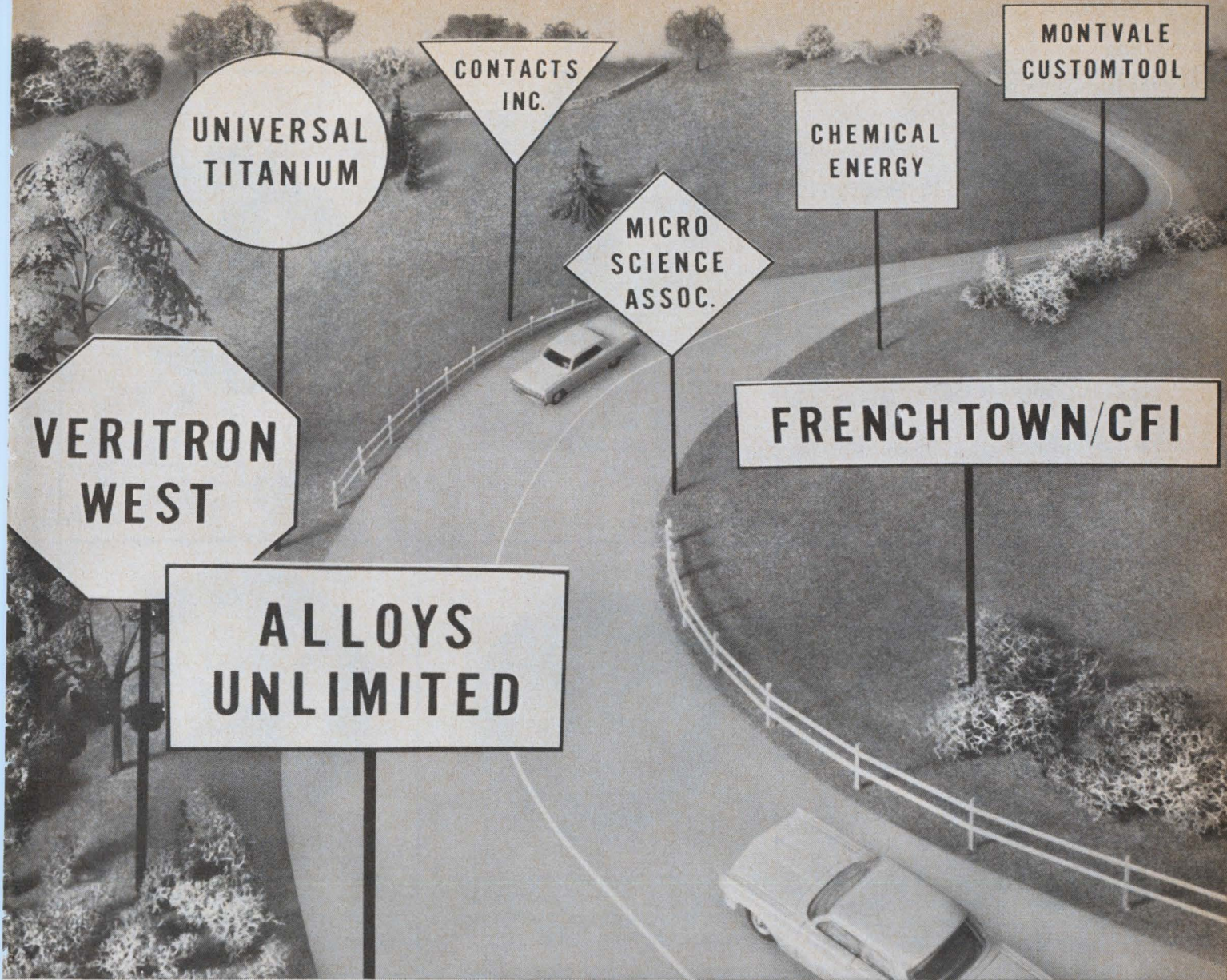

On the road to better products you often see signs of Alloys Unlimited

Firmly established as the number one supplier of component materials for the semiconductor and microelectronics industry, Alloys Unlimited has evolved to become a leading producer of a broad spectrum of materials and precision parts for a wide range of industrial uses. These include chemical milled parts and titanium products for the aircraft and aerospace industry—electrical contacts, assemblies and precision stampings for the computer, relay, switch, appliance and automotive fields—and ceramics for wear-resistant applications. Perhaps these unique technological skills can help make *your*

products even better. At your disposal are metallurgical laboratories, precision stamping facilities, tool and die makers, ceramicists and an experienced team of scientists and engineers who can work with you to solve design hang-ups.

If you'd like to know more about the many ways we can assist you, write Marketing Department, Alloys Unlimited, Inc., 320 Long Island Expressway South, Melville, New York 11746, or call (516) 694-7900.

We may be just the company you've been looking for.

IMPROVING THE PRODUCTS OF OTHERS—THROUGH MATERIALS TECHNOLOGY

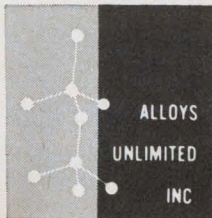

HIGH PURITY ALLOYS Alloys Unlimited, Inc. / Melville, New York
SEMICONDUCTOR & IC PKGS Veritron West, Inc. / Chatsworth, California
CERAMIC PARTS Frenchtown/CFI, Inc. / Frenchtown, New Jersey
ETCHED METAL PARTS & CUSTOM IC PKGS Micro Science Assoc. / Mountain View, Cal.
PRECISION STAMPINGS Montvale Customtool, Inc. / Montvale, New Jersey
ELECTRICAL CONTACTS Contacts, Inc. / Wethersfield, Connecticut
TITANIUM Universal Titanium Corp. / Los Angeles, California
CHEMICAL MILLED PARTS Chemical Energy Co. Inc. / San Diego, California

**familiar faces
from the
world's broadest
line of
indicating
relays**

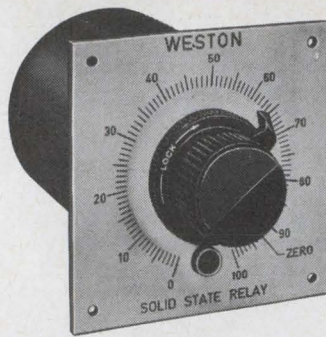

Model 1062 Control Relay—no moving parts, not even relay contacts; voltage ranges from 0-1 volt, current ranges from 0-100 μ a; 200-millisecond response time with 0.5% repeatability typical; zero adjust and trip indicator on 320° scale.

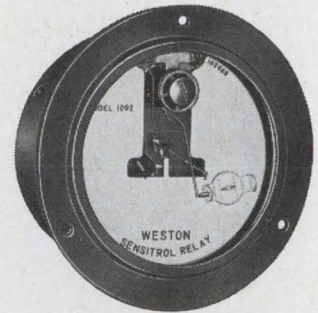

Model 1092 Sensitrol® Relay—low cost; all purpose; magnetically shielded; wide range adjustability; ideal for use in engineering breadboard circuits.

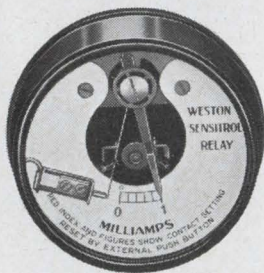

Model 705 Sensitrol® Relay—highly sensitive; surface or flush mounted; single or double, fixed or adjustable contact; ranges as low as 0.5-0.5 μ a.



Model 723 Sensitrol® Relay—sealed; shielded; internal reset; solder terminals; single or double magnetic contact; ranges as low as 1-0-1 μ a.

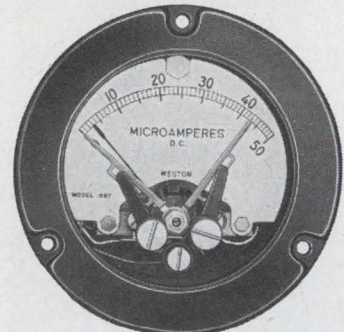

Model 1097 Ruggedized 3½" Relay—Load Current Contact Aiding type fully meets applicable portions of military ruggedized spec; sealed; long scale; shielded; solder terminals; single or double adjustable contacts.

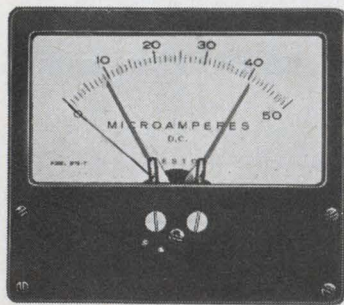

Model 1075 Photronic* Relay—operates without physical contact; single or double adjustable set points; continuous reading beyond set point; taut band frictionless mechanism; solid state switching circuit; ranges from 10 μ a.

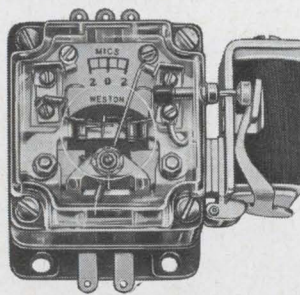

Model 813 Miniature Relay—compact and lightweight; sensitive and Sensitrol (magnetic) contacts; single or double contact; ranges as low as 2-0-2 μ a.

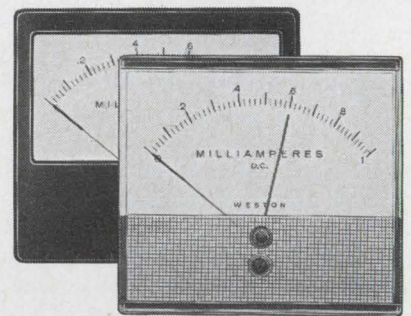

Model 1930/1940 Photronic* Relay—3½" and 4½" in either bakelite or plastic front; low cost; add-on power supply and solid state switching circuit; shielded; non-physical, adjustable contact.

*Photronic is a Trademark of Weston Instruments, Inc.

Weston Instruments, Inc. • Newark Division • Newark, N.J. 07114

WESTON® prime source for precision... since 1888

SOLDERABILITY

It means easier,
more reliable
electrical connections.

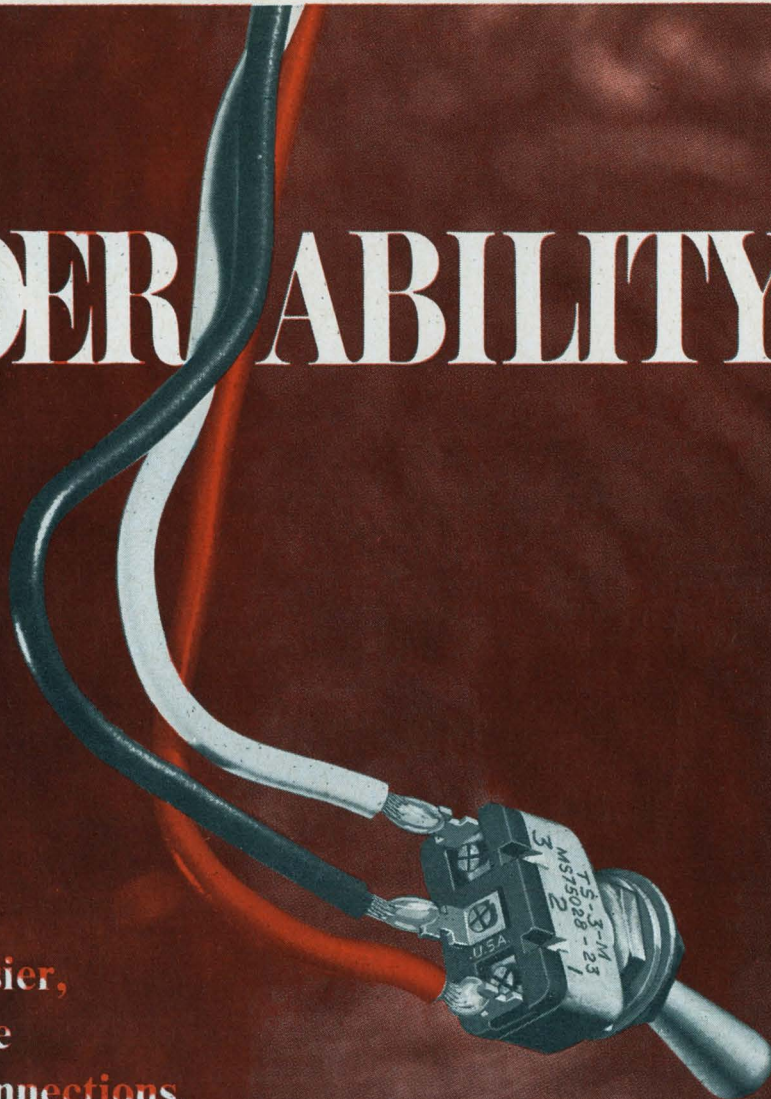

PHOTO TWICE SIZE

Oversized, gold-plated terminals make soldering these Arrow-Hart subminiature switches a snap.

You also get exceptional versatility of installation, because these are combination solder, quick-connect and single-turret terminals.



ACTUAL SIZE

Movable contacts are rhodium plated for long mechanical life. Stationary contacts are gold-plated silver for long shelf life and superior performance on low-energy circuits. Contacts are rated 5 amps at 125

volts AC and 29 volts DC. For design versatility, you get a wide choice of bat and ball levers, including seven colored types. Two or three position. Maintained or momentary contacts. Arrow-Hart subminiature switches are available to meet MIL-S-3950-C, MS-75028 and MS75029 specifications.

It all adds up to the performance, versatility, and installation ease you need for all types of instrumentation and other applications that call for maximum capability in minimum panel space. Write for complete technical information on subminiature toggle and push button switches. The Arrow-Hart & Hegeman Electric Company, 103 Hawthorn Street, Hartford, Connecticut 06106.

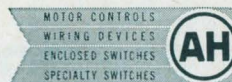

QUALITY SINCE 1890

ARROW-HART

The Arrow-Hart & Hegeman Electric Company, Hartford, Connecticut 06106

BUY BETTER ELECTRICALLY • BUY BETTER ELECTRICALLY

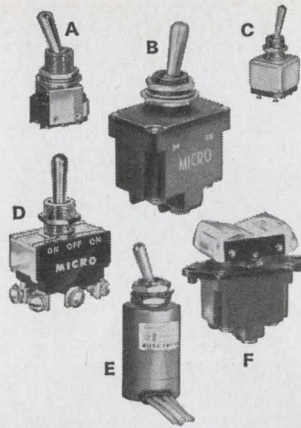

A AT Series Assemblies
—Combine up to 12
SPDT Switches.

B TL Series—Meets
MIL-S-3950A.
Momentary, maintained,
pull-to-unlock. 1, 2, or
4 pole.

C TW Series—Miniature,
5 amp. SPDT or DPDT,
2 and 3 position.

D TS Series—Up to 25
amp. 1 or 2 pole.

E ET Series—Magnetic-
hold, remote-release.
Environment-proof.

F TP Series—Rocker-
actuated, 20 amp. 1, 2,
or 4 pole.

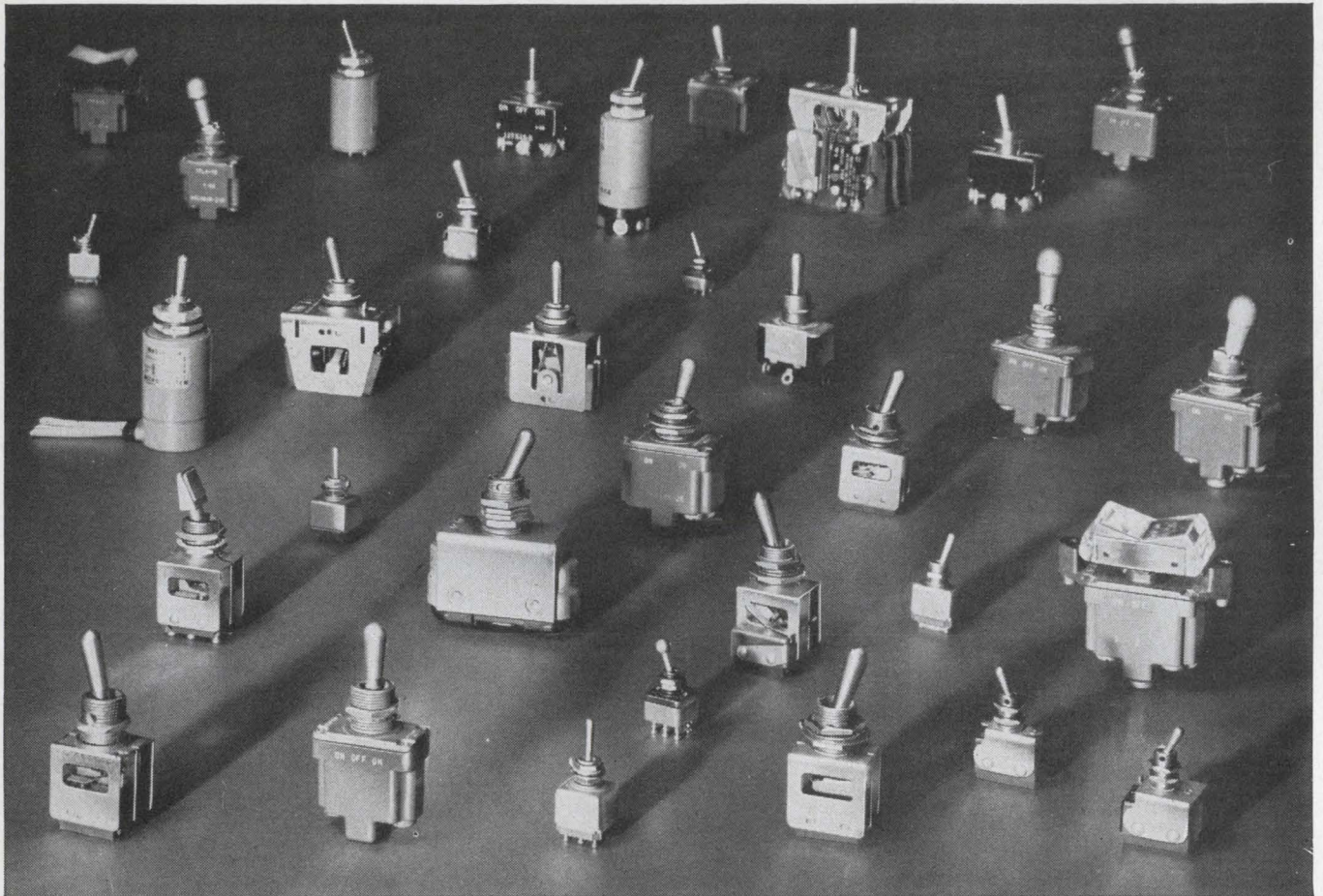

Here's a little extra design freedom in toggle switches

You are free to select the exact combination of features you need when you look in the broad MICRO SWITCH line. Size, circuitry, capacity and toggle action to answer most any requirement. Special features too, right off the shelf. For example, environment-proof construction, magnetic-hold-in, electric memory and dry circuit capabilities.

You may even pick up some extra design ideas as well—ways to simplify circuit design, combine functions in fewer controls, improve operator efficiency.

Catalog 73 gives details. Call a Branch Office or Authorized Distributor (see Yellow Pages, "Switches, Electric"). Or write . . .

MICRO SWITCH
FREEPORT, ILLINOIS 61032
A DIVISION OF HONEYWELL

HONEYWELL INTERNATIONAL—Sales and service offices in all principal cities of the world. Manufacturing in United States, United Kingdom, Canada, Netherlands, Germany, France, Japan.



What takes the guesswork out of Ed Brzana's job?

Hallicrafters takes deserved pride in its blue-ribbon reputation. That's why they class Instrument Calibration and Control Services Lab Manager Ed Brzana as a VIP. In an average week, Ed supervises certification of 460 instruments, making sure they hew to stringent accuracy specifications. On his schedule, he has no time to debate questionable r-f power readings.

To dispense with guesswork, Ed relies on a Sierra Model 290C RF Power Calorimeter. Hallicrafters' ability to measure r-f power from DC to 10 Gc within a 1% limit of error has established the 290C as the company's standard for both military and commercial product lines. In a typical day, QC engineers use the 290C to calibrate r-f wattmeters for working standards, run incoming acceptance tests on Carcinotron tubes, and perform acceptance tests for the military on Hallicrafters-built ALT 13, 15, and 16 jammers.

Many delivered products now receive acceptance checks on a 290C. Maybe some of yours! At today's high cost of r-f generation, you can't afford either to fall short of specs or give away excess power. For further information, write to Sierra/Philco, 3885 Bohannon Drive, Menlo Park, California 94025.

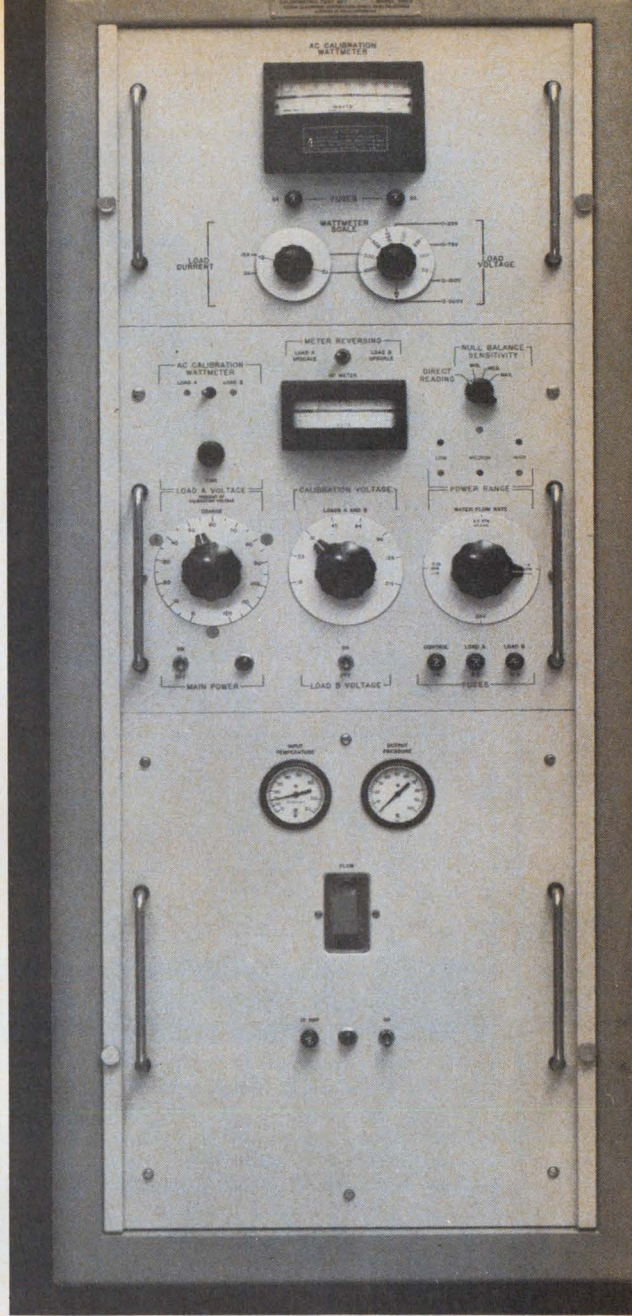

This r-f power standard from Sierra



PHILCO-FORD CORPORATION
Sierra Electronic Operation
Menlo Park, California • 94025

Circle 81 on reader service card



Not in the same league... New Varactor Bridge Op Amps Achieve 10 Fold Improvement Over the Best FET's

- Bias Current — 0.5 pA max.
- Noise Current — 0.01 pA, p-p
- Comm. Mode Impedance — $10^{13}\Omega$
- Price (1-9) — \$110.00

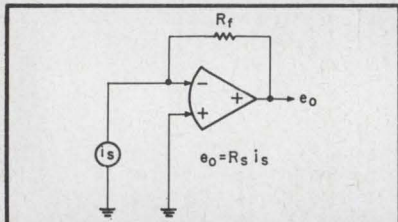

Measure Picoamp Current Signals

With bias current drift of only 0.05 pA/°C and noise of 0.01 pA the 302 can resolve signal currents as low as 10^{-14} amps. Applications include flame detectors, phototubes, nuclear detectors, semiconductor testing, measuring insulation resistance and capacitor leakage, ion gauges, and ion chambers.

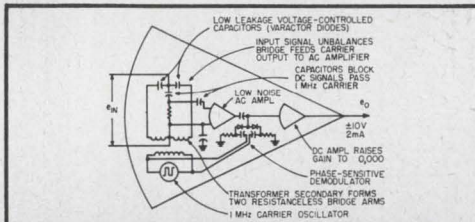

How Model 302/303 Works

Amplifier input, e_{IN} , varies varactor capacitance, unbalances bridge and develops carrier voltage output proportional to bridge unbalance. After AC amplification, carrier voltage is phase sensitively demodulated to restore correct polarity, then further boosted by DC amplifier. Matched varactor diodes operated with low level carrier signal give extremely small bias current (0.5 pA). High quality capacitors and high transformer insulation gives 10^{13} ohms common mode impedance.

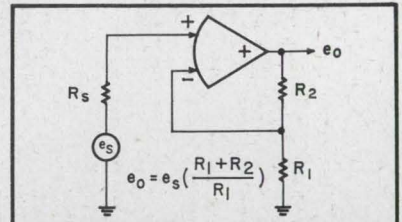

Measure Voltage Signals from Megohm Sources

Model 303 achieves input impedance of 10^{13} ohms for measuring voltage signals from source impedances (R_s) as high as 10^{10} ohms. Low bias and noise currents give negligible errors with large source impedance. Applications include measuring potentials from pH electrodes, electrochemical cells, vacuum tubes, piezo-electric crystals and high resistance potentiometers.

Models 302/303 reduce the varactor bridge circuit to a practical electrometer operational amplifier and offer you the advantages of this circuit technique in a reasonable price range. The primary benefits of the varactor bridge circuit are the ultra low bias current (0.5 pA) and noise current (0.01 pA), which are ten to one hundred times lower than the best FET op amps. Input impedance is also extremely high — 10^{13} ohms.

The varactor bridge circuit provides the only solid state amplifier which approaches the performances of vacuum electrometer tubes and yet does not suffer the excessive voltage drift and noise, aging, microphonic and overload recovery problems usually associated with these tubes.

You will be hearing more and more about varactor bridge amplifiers. Send for six (6) page brochure and application note telling what these new amplifiers can do for you.

Specifications

| | |
|--------------------------------|------------------|
| Bias Current, max.* | 0.5 pA |
| Current Drift, max.* | 0.05 pA/°C |
| Current Noise, p-p, dc to 1 Hz | 0.01 pA |
| Input Impedance, CM. | $10^{13}\Omega$ |
| Voltage Noise, p-p, dc to 1 Hz | 2 μ V |
| Voltage Drift, max. | 60 μ V/°C |
| Rated Output, min. | $\pm 10V @ 2 mA$ |
| Open Loop Gain, min. | 10,000 |
| Unity Bandwidth | 20 kHz |
| Price (1-9) | \$110.00 |

*doubles each 10°C



ANALOG DEVICES, 221 FIFTH STREET, CAMBRIDGE, MASS. 02142

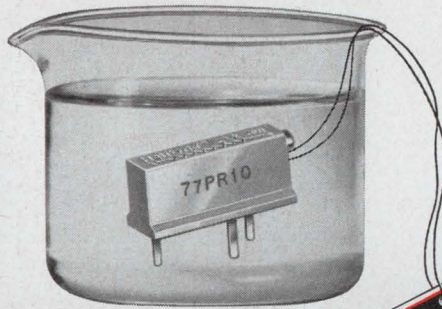

617/492-6000

Designed Sealed Delivered



Helipot's New Model 77P Cermet Trimming Potentiometer

Here's the new Model 77P, the first low-cost, general purpose trimmer with a sealed housing and cermet resistance element! DESIGNED to wider performance parameters than any other adjustment potentiometer in its price range. It is directly interchangeable with competitive Models 3067 and 3068—SEALED to permit p.c. board solvent cleaning and potting without trimmer contamination or failure—DELIVERED from local stock at the low list price of \$1.95. In large quantities, Model 77P sells for as little as \$1.10. ■ Compare Model 77P specifications with those of unsealed trimmers, then call your local Helipot representative for an evaluation sample.

| |  Helitrim Model 77P |  Model 3067 Wirewound |  Model 3068 Carbon |
|----------------------------|---|--|---|
| Resistance Range, ohms | 10 - 2 meg | 50 - 20K | 20K - 1 meg |
| Resolution | Essentially Infinite | 1.7 (100) to 0.3 (20K) | Essentially Infinite |
| Sealing | Yes | No | No |
| Power Rating, watts | 0.75 | 0.5 | 0.2 |
| Maximum Operating Temp. °C | 105 | 85 | 85 |



INSTRUMENTS, INC.
HELIPOT DIVISION
FULLERTON, CALIFORNIA • 92634

INTERNATIONAL SUBSIDIARIES: GENEVA; MUNICH; GLENROTHES, SCOTLAND; TOKYO; PARIS; CAPE TOWN; LONDON; MEXICO CITY

Burroughs eliminates a sizable point

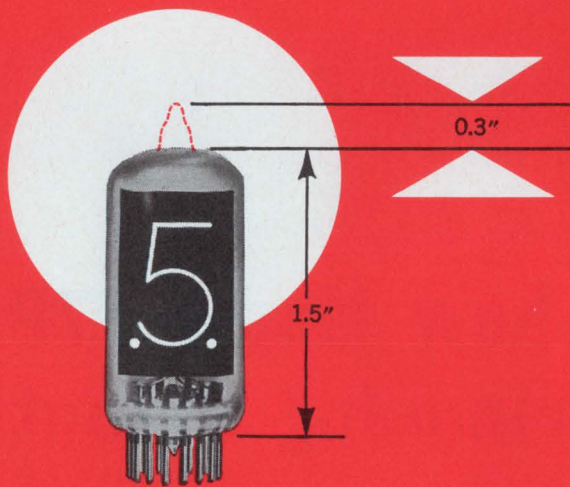

The B5440A series NIXIE® tubes are real space savers.

Now, you can shrink your instruments in both height and cost and assure the highest reliability. Burroughs has improved their side viewing NIXIE tube by rounding off the bulb to save you 16 $\frac{2}{3}$ % panel height and to reduce the possibilities of breakage. Burroughs design with extra stem pins and "hidden" tubulation offer these additional advantages:

- Smallest side-viewing tube in low cost category
- Pins directly solderable to PC boards
- Smallest sockets for every type of mounting

- Ultra long life and high reliability characteristics
- Built-in "keep alive" for rapid ionization - particularly useful in strobe applications (optional)
- Fine mesh wrap-around screen for better readability
- Two decimal points left and right (optional)
- Electrically interchangeable with Burroughs B-5440 series

Only Burroughs manufactures NIXIE Tubes

 **Burroughs Corporation**

Technical Articles

**Linear IC's: part 4
Inside the
operational amplifier
page 86**

The most popular of the linear integrated circuits is the operational amplifier—about six of every 10 linear IC's designed into systems are operational amplifiers. They perform just about any kind of computing function, and can also compare, regulate, control and even process communication signals. The IC operational amplifiers are more useful than their discrete component forerunners because of a more complex makeup that gives excellent balance and versatile differential inputs.

**Quick amplifier design
with scattering parameters
page 100**

In designing transistorized circuits for use above 100 megahertz, an engineer almost has to turn to s-parameters and the Smith chart instead of conventional transistor parameters. In the September 5, 1966 issue, Electronics published one of the first articles on the use of s-parameters in amplifier design, but it considered the special case of an input impedance matched to a load. This article describes how to use the s-parameter technique for the general case.

**Air traffic cop watches
out for 'bandits' too
page 111**



The Air Force's newest 3-D radar uses digital signal processing to zero in on a plane's range, bearing and altitude. Among its unusual features is a computer-designed beam-sharing system that will make the radar exceptionally accurate. Designed so the transmitting and receiving circuitry can be transported by helicopter, the system is the first solid state 3-D tactical radar;

it contains about 3,000 integrated circuits. For the cover, Vincent Pollizzotto photographed the antenna of the new 3-D radar as it searched the skies in a practice run at the Baltimore facility of the Westinghouse Electric Corp., where it was designed and built.

**Do-it-yourself display
brightens the outlook for
low-cost computer-aided
design
page 120**

A simple interface unit turns a conventional laboratory oscilloscope into an effective display for a computer—and costs only about \$1,500. To simplify both designing and programming, the equipment uses an elementary form of digital-to-analog conversion, a network of resistances scaled in powers of 2. With incremental conversion, the picture is built up on the oscilloscope screen by a series of small, overlapping spots of light.

**Coming
October 30**

- Conversational approach to pattern recognition
- More on hardening circuits against radiation
- Computer aid on the ocean floor

Linear IC's: part 4

Inside the operational amplifier

With component restrictions offset by radical designs, this jack-of-all-trades is by far the most popular analog circuit

By Mark B. Leeds

Solid state editor

About six of every 10 monolithic linear integrated circuits designed into systems since 1965 have been operational amplifiers. It was the advent of the operational amplifier that year, in fact, that picked the whole field of linear monolithics out of the doldrums and set it on the road to success.

The popularity of the circuit is easily explained. It performs just about any kind of computing function—addition, subtraction, integration, differentiation, sign and scale changes, calculation of fractional and higher-order powers—and can control, compare, process, regulate, and detect both linear and nonlinear signals.

In addition, the operational amplifier is suitable for communications applications. By appropriate choice of feedback components, the circuit can provide the peaked response required by various types of shaping amplifiers, or the flat, wideband response of video amplifiers.

The ic op amp is more complex than its discrete semiconductor counterpart, is at least its functional equal, and offers some fundamental advantages—superior tracking, for one. As with most amplifier circuits, the monolithic linear ic has a finite and negative feedback characteristic. This feedback—from the output to the input through a resistor, diode, or complex network—improves gain stability and reduces frequency distortion and output nonlinearities.

This is the fourth installment in the linear integrated circuit series. Previous articles have covered an overview of the field, evolution, differential amplifiers, and gating circuits for power control. In future issues the series will focus on communications applications, putting operational amplifiers to work, and comparing various types of amplifiers.

It's also the key to the circuit's response. If the amplifier has a gain of 5,000 or more and an input impedance greater than 50 kilohms, signal processing is a function solely of the feedback and the external source impedance. The user's choice of feedback or source components, therefore, determines whether the amplifier adds signals, compares them, generates new ones, or performs any number of other tasks.

Outside job

As a black box, the circuit has two input terminals and a single-ended output. The input configuration is the familiar differential arrangement, the basic building block of most linear ic's [Electronics, Sept. 18, p. 96]. Most monolithic operational amplifiers contain at least two differential stages, and display the balance, tracking, selectivity, and other features imparted by a differential network. Functionally, such an amplifier magnifies the differences between signals applied to its inputs. The amplifier's input impedance is, for all practical purposes, infinite with respect to both the impedances of a signal source and the feedback element. Thus, any number of input signals can be applied simultaneously without causing interaction between external generators.

Of the circuit's two input terminals, one inverts a positive voltage, causing a negative output; inputs at the other terminal aren't reversed. When voltages are applied to both terminals, the output is positive or negative depending upon the relative magnitudes of the input signals.

The input terminals are designated inverting and noninverting, respectively (see schematic on p. 87). The differential inputs complement one another, thereby enhancing some applications, and making the over-all circuit that much more versatile.

The maze

To the uninitiated, the schematic of any linear IC appears awesome in comparison with that of a comparable discrete unit. This complexity stems from the designer's attempts to provide functions within the limitations of IC components, and performance features beyond those of discrete semiconductors.

Integrated-circuit elements are limited both in type and value, a drawback particularly acute in linear IC's. There are no workable inductors, resistor and capacitor values are restricted, individual tolerances are wide, and truly complementary devices are rare.

Designers have therefore been forced to evolve special design techniques [Electronics, Aug. 7, p. 100] to circumvent these limitations. Typical of these methods is the use of active current sources in place of large resistors, of differential and emitter-coupled amplifiers in place of large by-pass capacitors, and of npn-element cascodes in place of zener diode and complementary-transistor level-shift stages.

Of course, such unique advantages of monolithic IC's as close matching of active and passive elements, excellent thermal coupling, and economy of active devices, go a long way toward offsetting component restrictions. Linear IC's have better over-all balance and lower offsets than their discrete counterparts, greater uniformity of response to temperature changes, and fewer and smaller parasitics.

Framework

A popular IC op amp, the μ A709 shown below, has three stages—input, coupling, and output—and contains 14 transistors and 15 resistors, about three times the number of components in a comparable discrete amplifier.

Matched transistor elements Q_1 and Q_2 form the differential input circuit and are driven by the current source Q_{10} – Q_{11} . Q_{10} is identical to Q_{11} but is connected as a diode. The 2.4-kilohm resistor in the emitter of Q_{11} establishes the magnitude of the current source. Because the entire source circuit's temperature response is equal and opposite

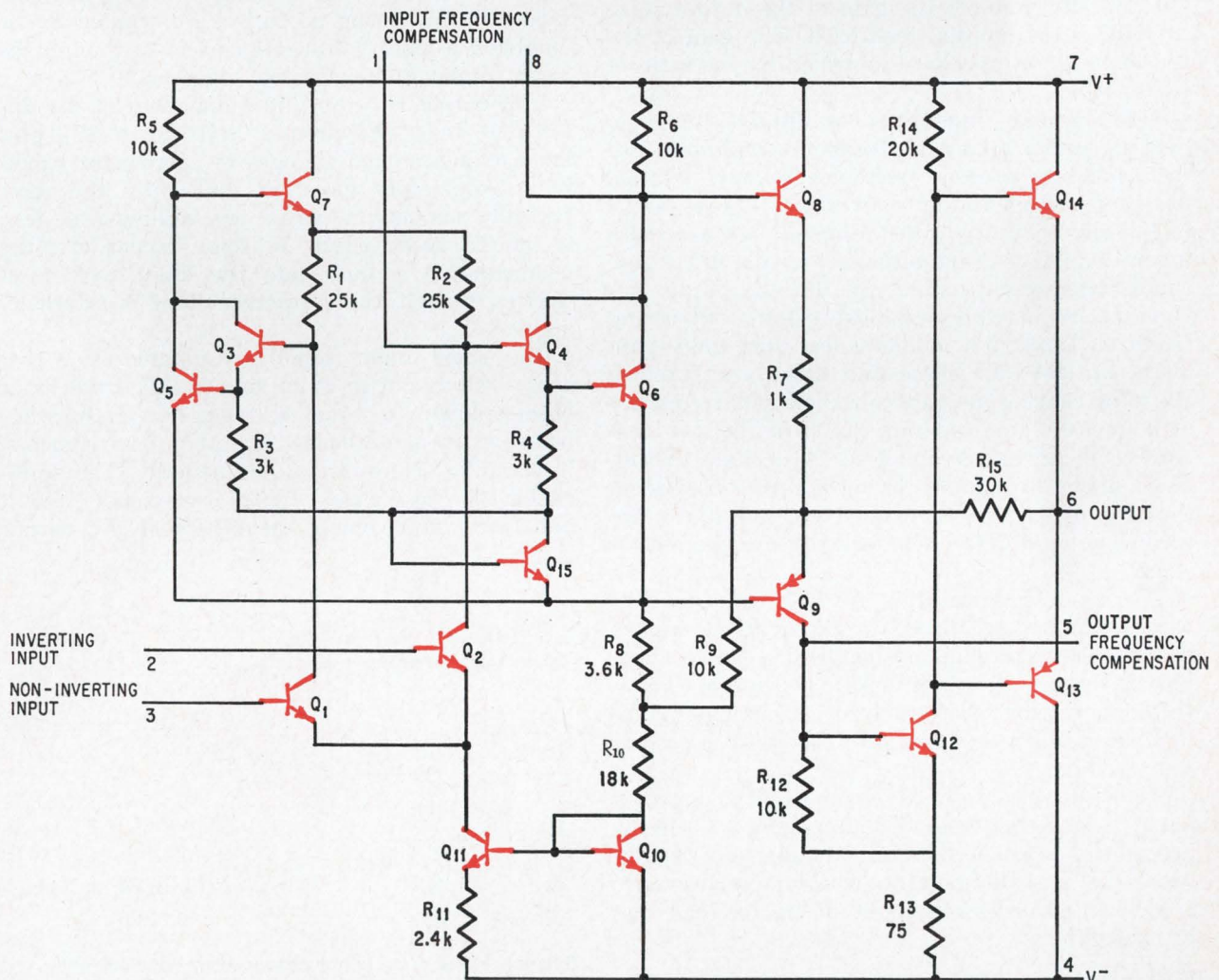

Complex. Monolithic operational amplifiers have more components than their discrete counterparts in order to meet functional requirements within chip limitations (such as the lack of large resistors and capacitors), and to provide extra performance benefits. Schematic here is that of the widely used μ A709.

to that of the differential stage, the gain of the first stage remains constant as temperature varies.

The second stage, a differential amplifier formed by the Q_3 - Q_5 and Q_4 - Q_6 Darlington pairs, converts the double-ended output of the first stage to single-ended, and buffers the output stage. The Darlington connections, which help prevent loading of the input stage, are supplied by a constant-current source, Q_{15} , that connects to the same voltage divider chain that feeds the current source of the first stage. Emitter-follower Q_7 isolates the Q_5 balanced-biasing side of the amplifier from the first stage; Q_8 , another emitter-follower, prevents loading of the second stage by the output stage. Resistors R_5 and R_6 , the collector loads for the second-stage differential pair, smooth out power-supply variations.

In the four-transistor output stage, Q_9 is a pnp level-shifter that restores the d-c level of the output driver that feeds the complementary class-B output stage formed by Q_{13} and Q_{14} . The current-gain of these last three transistors is limited by injection efficiency so that chip current is held down if the output is momentarily short-circuited. Resistor R_{12} limits current leakages from Q_9 and Q_{12} , and R_{13} reduces the gain of the output stage to stabilize its internal feed-back. The gain of the last stage is principally established by the ratio of R_{15} to R_7 .

Any amplifier, monolithic or discrete, tends to oscillate under high-gain, feedback conditions, but this tendency is easily overcome by two external frequency-compensating networks. The best points in the circuit to apply the compensation are those where a high transfer resistance exists and where small, external capacitors can thus be used.

Simple RC networks establish external off-setting feedback loops that maintain less than unity gain at the critical 180° phase-shift point, and stabilize the IC by causing the gain to roll off with frequency at a low and uniform rate. Each of the two networks can provide as much as 60 decibels of roll-off, sufficient to handle the most severe oscillation the circuit might experience. In addition, the second network offsets the parasitics of the output stage.

The exact compensating resistor and capacitor values can be optimized for a particular case so that both over-all gain and bandwidth can be maximized. Integrated-circuit makers provide optimum-value curves that are based on various gain-bandwidth conditions and that take the chip's parasitics into account.

With discrete designs, compensation networks have to be determined experimentally—a lengthy procedure, especially if optimal values are sought. Also, the best temperature-tracking performance is at least an order of magnitude poorer than that of monolithics.

Best case

The ideal operational amplifier would have infinite voltage gain, input impedance, and fre-

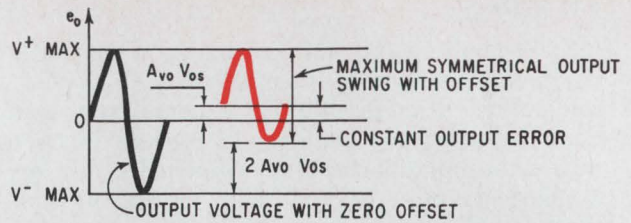

Excursions. Output of an IC op amp is nominally limited by the saturation and cutoff levels of the output stage. But if the error-inducing offset voltage isn't compensated for, maximum output swing is lessened. The magnitude of error is the product of open-loop gain, A_{vo} , and the amplitude of offset, V_{os} .

quency response, and no output impedance or noise. There would be no output voltage when there was no input voltage, and input and output voltage ranges would be unrestricted.

This ideal doesn't exist, of course, but departures from the ideal are predictable, and can be offset in most cases.

For example, one of the most significant operational-amplifier characteristics is input offset voltage; it can be a source of errors in the output signal and a factor in limiting the output signal swing. When biasing potentials are applied to the amplifier, a finite output appears even though the input terminals are shorted together.

This output is caused by imbalances in the differential stages [Electronics, Sept. 18, p. 97], plus finite tolerances and changes in component values with temperature variation. But since the error typically amounts to only a few millivolts or less, it can be easily offset. In some recent IC's, the compensation is built into the chip; with most devices, though, the correcting offset is externally applied.

The small input signal, designated V_{os} , that causes the output to go to zero is called the input offset voltage. Its value at room temperature appears on IC data sheets; for other environments, it has to be determined experimentally. The application of this offset signal overcomes circuit imbalances and centers the quiescent d-c output point.

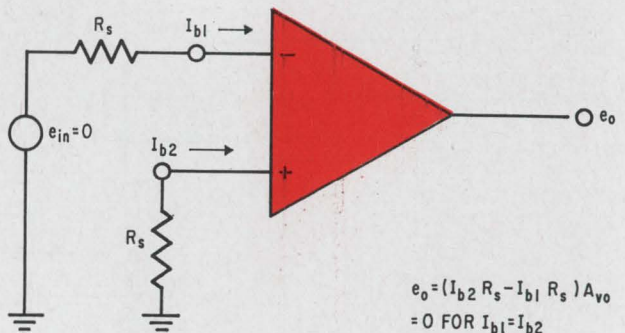

Balance. Finite outputs are produced by base current imbalances, even when an input voltage isn't applied. Current offset, the average of the two base currents, can be nullified by an equalizing source resistor or an external, oppositely applied, signal source.

The amplifier's finite input impedance is another potential source of error. Each input of the differential stage requires a small bias current that flows through the resistances of the signal sources.

Source resistors are rarely the same; in some cases where single-ended inputs are used, only one source resistor exists. In any case, the bias currents aren't nominally equal, and the potential drop they induce—in series with input signals to be processed—causes output errors. Because of the differential input, the error is expressed on data sheets as the average of the bias currents with no input voltage applied before equalization.

The effect can be canceled by inserting an equalizing resistor in the appropriate input lead to make the two bias currents match. Or an external current, designated the input offset current, I_{os} , can be made equal to the difference between the base currents, and applied to nullify their imbalance.

Of all the deviations from the ideal, the most important to compensate for is drift—changes in voltage, current, and gain levels with temperature. There are four major types of drift in the IC—the voltage and current offsets, the base-to-emitter drops of the transistor elements (V_{BE} 's), and the transistors' current gains, (h_{FE} 's)—and, happily, they can be handled fairly easily. Both V_{os} and I_{os} are functions of the entire chip; V_{BE} and h_{FE} involve individual chip elements. The answers to all four come merely from experimental determination of the offsets needed for the temperature swings encountered.

Resistance

Though IC operational amplifiers have a nominally high input impedance, loading problems cannot be ignored as there are two input resistances—differential and common mode. Differential input resistance is defined as the resistance into either input terminal with the other input grounded; common-mode type is the resistance between inputs and ground with both inputs shorted together.

Common-mode input resistance is usually high, typically 20 to 100 megohms. Compared to source resistors, it's essentially infinite and has little effect on circuit operation. But the differential input resistance, which may be as low as a few thousand ohms or as high as hundreds of megohms depending on the amplifier type, does affect closed-loop gain. Since it is in parallel with the source resistance, it can reduce the feedback factor by as much as 50% when it is of the same order of magnitude.

Output resistance, designated R_o , is the resistance seen looking into the output terminal with the output voltage at null. A finite value usually a few hundred ohms in magnitude, R_o comes into play in open-loop applications—comparators, for instance. When capacitive loads are being driven, the load and R_o together establish a time constant that limits the rise time of the output signal; the larger the R_o value, the slower the rise time.

For any kind of load, finite R_o restricts the magnitude of the output current. It's not important

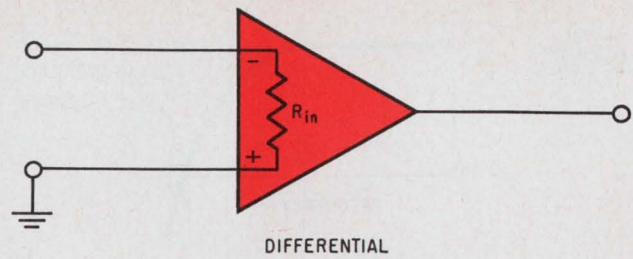

DIFFERENTIAL

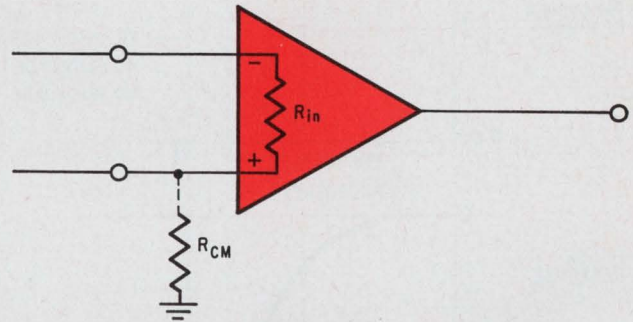

COMMON MODE

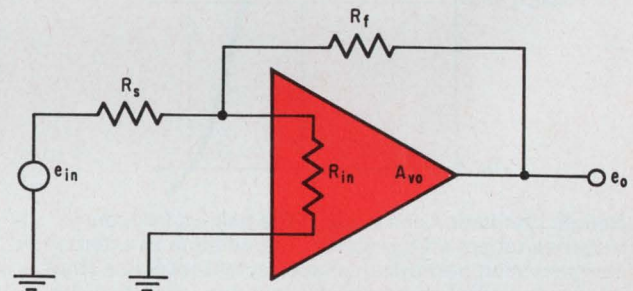

FEEDBACK

| | | FACTORS | |
|--------------------|--|-------------------------|---|
| | | $R_{in} = \infty$ | $R_{in} \neq \infty$ |
| ATTENUATION FACTOR | | $\frac{R_f}{R_s + R_f}$ | $\frac{R_f \parallel R_{in}}{(R_f \parallel R_{in}) + R_s}$ |
| | | $\frac{R_s}{R_s + R_f}$ | $\frac{R_f \parallel R_{in}}{(R_s \parallel R_{in}) + R_f}$ |

Modes. Differential input resistance (top), common-mode input resistance (middle), and feedback resistance (bottom) must be considered when using op amps. Usually, R_{in} is much larger than R_s (generator resistance) and R_f (feedback resistance).

in closed-loop applications, however, because it's largely reduced by the loop gain of the circuit.

The open-loop voltage gain, A_{vo} , is the ratio of the maximum loaded output swing to the change in input voltage needed to drive the output from zero to this maximum. It's an important factor when a high level of accuracy is required, because high gain in open-loop operations causes a smaller difference voltage between the input signal and the reference. Open-loop voltage gain fixes the input range required to change the output level from saturation to cutoff, a factor called resolution in the case of comparators.

The open-loop gain of any operational amplifier

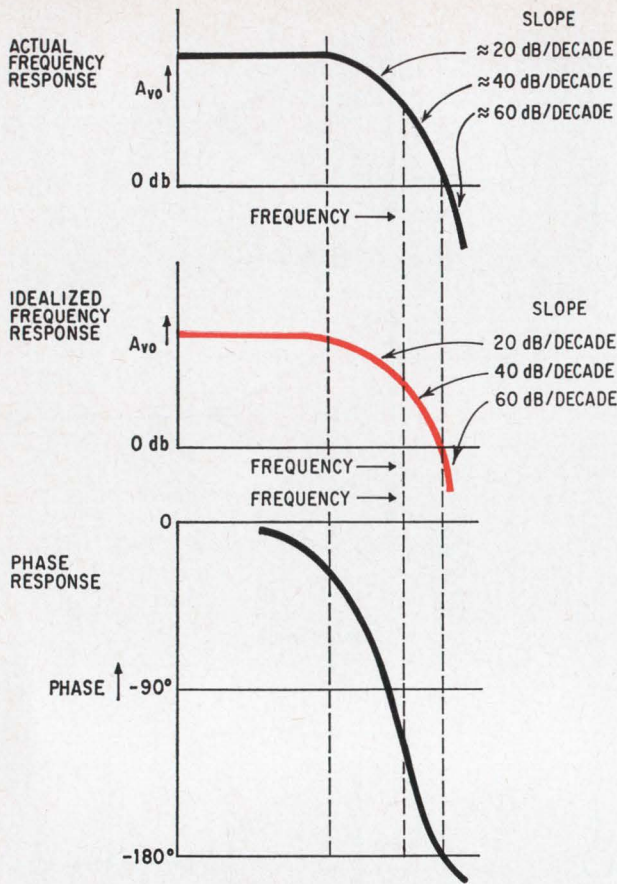

Rolloff. Oscillation can occur if the gain-vs-frequency response tapers off too slowly. The addition of external compensation networks reshapes actual response (top) into a more ideal characteristic (middle), such that the gain at the point where the phase shift (bottom) is -180° is zero db or less.

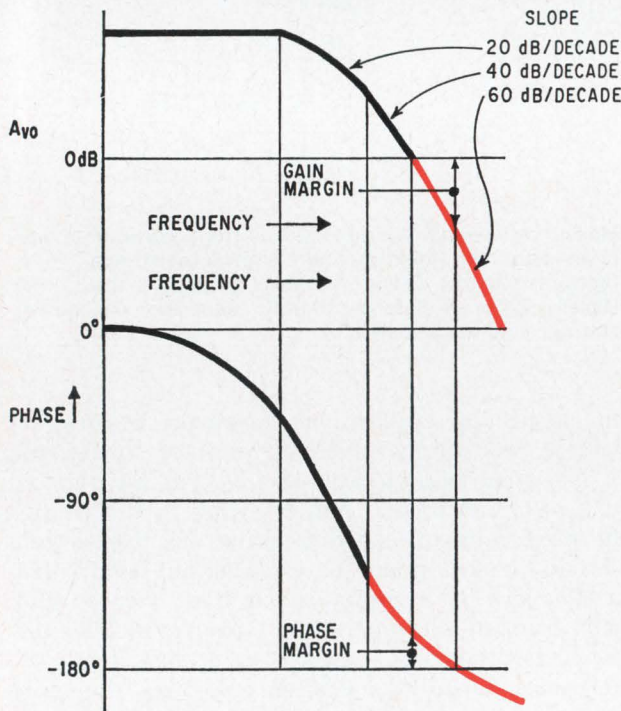

Margins. Stability is guaranteed if the gain is finite and negative where the phase is 180° (gain margin), and crosses the zero-db point where the phase is less than 180° (phase margin).

circuit also establishes the closed-loop gain. The latter is given by $A_{cl} = \beta A_{vo} / (1 - \beta A_{vo})$, where β is that portion of the output fed back to the input, and A_{vo} is the open-loop gain.

Ideally, the gain from one input to the output should be equal and opposite to the gain from the other. If the same voltage were applied to both inputs, therefore, the output wouldn't change. In practice, however, equal changes in both inputs produce an output.

Common-mode rejection ratio, CMRR, is the ratio of the maximum allowable change in common input voltage, V_{cm} , to the maximum change in input offset voltage accompanying this change. Consider an amplifier with a common-mode input voltage range of ± 10 volts, a 60-db (1,000 volts/volt) open-loop gain, and a CMRR of 80 db (10,000 volts/volt). The output change if the inputs are driven over the full common-mode range is the offset change, $V_{cm}/CMRR$, or 1 mv, multiplied by the gain of 1,000—1 volt.

Power

Another cause of output error—the biasing power supply—is unrelated to the input and therefore occasionally overlooked. Changes such as ripple will introduce both d-c and a-c output signals, but, regulator circuits, either external or on the chip, can compensate for them. If the IC has a high power-supply-rejection ratio—1 mv/V is typical—external regulator circuits may not be necessary.

Among other amplifier characteristics to consider is the limit on output drive capability. Maximum output power, P_o , usually occurs at some intermediate voltage below the rated output maximum; its value is the product of the voltage at this point and the maximum available output current.

Also, the relationship between output and input isn't completely linear, either in signal level or load, but distortions are less severe in closed-loop operation than in open because of attenuation introduced by the feedback factor.

The maximum voltage that can be applied to either input of the amplifier with respect to ground is the input voltage range, V_{cmr} , sometimes called the input common-mode voltage range. Exceeding the specified V_{cmr} limit, which is usually less than the maximum allowable output swing, can damage the amplifier.

Differential input voltage, V_{diff} —the maximum voltage that can be applied between the two input terminals—is, in turn, lower than common-mode input voltage rating. In an inverting configuration with the amplifier's noninverting input grounded, V_{diff} is the maximum voltage that can be applied to the inverting input.

Response

The gain-vs-frequency response is the key to both a-c and d-c operation, and as mentioned earlier, is the means by which oscillation is avoided. In the typical open-loop frequency response curve at the

left, the 3-db bandwidth is the frequency at which the open-loop gain has decreased to 0.707 (-3 db) of its midband value. The 0-db bandwidth is the frequency at which the open-loop gain is unity.

When the feedback gain, βA_{v_o} , equals -1, the closed-loop gain becomes infinite and the amplifier oscillates. To counter this, compensating networks geared to the shape of the amplifier's frequency and phase responses must be added; of particular importance here are the break points or corner frequencies.

Each corner reflects a transfer-characteristic pole capable of contributing 90° of phase shift. The most critical point coincides with a phase shift of 180°. If the gain is at least unity, the inversion introduced by the shift at that point makes the feedback positive and the circuit action regenerative. To compensate, the feedback network, acting in tandem with the external compensating network, must therefore provide a gain of less than unity where the phase response becomes 180°. Looked at another way, the 0-db point must be reached

before the phase shift reaches 180°.

Gain margin is the difference between the gains at 180° and at 0-db; as long as this margin is finite, the phase shift at the 0-db point cannot have reached 180°. Similarly, phase margin is the difference between the phase at 0-db gain and at 180°. The gain-vs-frequency response on page 90 shows gain and phase margins, plus bandwidth, for a typical case.

Capacitances are present at the nodes within the amplifier and at the compensation terminals. Because of the finite amount of current available to charge capacitances, the rate of change of output voltage declines as output signal levels increase.

Slew rate, or ρ , is defined as the maximum rate of change of output waveform when the amplifier is overdriven. It's expressed as $\rho = 2\pi f V_p$, where V_p is the maximum sinewave output swing and f is the frequency at which any output swing greater than V_p will limit the rate. Slew rate is also affected by the compensation capacitors used to stabilize the amplifier at different closed-loop gains; as the gain increases, so does slew rate.

Integrated electronics II

Foggy 'specs' blur designs

Engineers using IC operational amplifiers must have a grain of salt handy when they approach manufacturers' product specifications; terms are often misleading and stated parameters ambiguous

By Everett L. Harris Jr.

Zeltex Inc., Concord, Calif.

The rating game—a contest in which integrated-circuit manufacturers use specifications to make their products appear a bit better than their rivals, —can negate the best designs of engineers. This specsmanship is widespread; the meanings of such ostensibly definitive terms as "maximum" and "minimum" can vary from maker to maker even when the same product is involved. Among linear IC's, the practice is particularly common in data sheets on operational amplifiers.

Two "709" operational amplifiers supplied by different manufacturers may have very different

characteristics. Identical input signals, loads, and biasing supplies may damage one and hardly trouble the other. Until standards become universal, therefore, the engineer will have to consider each IC and each manufacturer's data sheet individually to determine what the specifications mean, and to adjust his system design accordingly.

The situation isn't hopeless, though. Parameter designations, at least, are pretty well standardized; the engineer's problem is to pin down the conditions under which the given values apply, and then to translate this information into values that would

hold under the conditions applied to his system.

The first thing to note is precisely how the specifications are stated. Ratings are sometimes presented as maximum or minimum extremes, at other times as typical values. Also, the term "maximum" can mean the greatest amount the amplifier can tolerate, or the greatest amount under which it can operate properly. Common-mode input voltage is one specification liable to this confusion.

For another thing, parameters are usually given for a specific set of power-supply voltages and a particular ambient temperature (usually 25°C) that the amplifier itself isn't going to be used at. This is important when one remembers that it's not uncommon for the output current capability of some IC's to decrease by as much as 40% when the temperature drops from +25°C to -25°C.

D-c gain—the ratio of the d-c amplifier output voltage to its d-c input voltage—varies with load. The specification is usually given at no load, but the gain will drop as full load is approached.

Rated output voltage and current are rarely achieved simultaneously in any circuit. In fact, maximum power output can conceivably occur when neither the voltage or current are at their respective maximums. Before installing an IC operational amplifier in a system, its actual maximum available outputs must be measured.

If the IC is driving a device with lower voltage ratings than its own, some form of overvoltage protection may be needed. Unless a voltage limiter is employed, the IC output voltage, particularly under small and no-load conditions, can sometimes swing to within a volt of the power supply. Also, if a pair of IC terminals is temporarily short-circuited, the IC may deliver a short-term output current of many times its rated value, conceivably damaging itself and the system.

Further, unless the value of the feedback resistor, which always appears as an additional load between the output and ground, is at least 10 times higher than the nominal load, it cannot be ignored in determining output levels.

Not as easy as rolling off

The product of the gain and the bandwidth is often assumed to be constant with increasing frequency. But such is the case only if the amplifier gain rolls off at a constant rate of 6 decibels per octave. Often the rolloff rate is greater, particularly

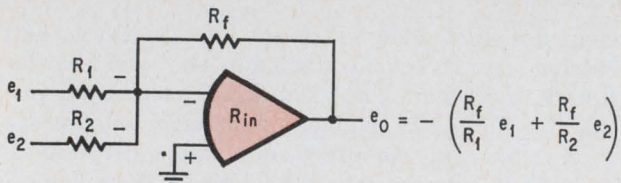

Triangle. If input impedance isn't greater than feedback and source resistances in the amplifier, gain and bandwidth are reduced. In this adder inverter circuit, R_f , R_1 , and R_2 should all be at least an order of magnitude smaller than R_{in} for the output to be an exclusive function only of external resistor ratios, and for high gain-bandwidth and minimum distortion.

at high frequencies, and the unity open-loop gain therefore doesn't necessarily coincide with the frequency of the gain-bandwidth product.

The thing to look for here is whether the gain-bandwidth product is put at the frequency where the open-loop gain is unity, or if it's specified at a much lower frequency.

For negative feedback, the nominal phase shift from output to input is 180°. If the shift equals or exceeds 360° at the frequency where loop gain equals unity, the amplifier will oscillate. Even if the shift is slightly less than 360°, the amplifier, though nominally stable, will be subject to overshoots and ringing for step inputs.

Phase shift is a function of the rate of gain-vs-frequency rolloff. A rolloff of 6 db per octave gives 270° of shift and a stable closed-loop characteristic. A continued rolloff of 12 db per octave, however, will ultimately approach 360° of phase shift.

The gain-frequency curves on the data sheet give some idea of whether the amplifier will be stable at all values of closed-loop gain. They also specify what compensation networks are needed for specific gain conditions. But they don't show what capacitances from junction to ground and from output to ground—or combinations of these capacitances—can be tolerated. Nor do they indicate the values of input and feedback impedances that yield stability. These must be determined experimentally.

The phase margin often specified represents the limiting condition for oscillation-free operation only if it's the margin at unity open-loop gain. Otherwise, external compensation may be required. Also, phase margin decreases with capacitive loading (both on the summing junction and at the output), and further compensation may be needed—usually phase shift networks built on an ad hoc basis.

Generally, an amplifier with a very high gain-bandwidth product needs such compensation for frequency stability at some (usually low) values of closed-loop gain. The resulting achievable closed-loop bandwidth is considerably less than one might estimate from the manufacturer's stated gain-bandwidth product, and the IC will probably be unsuitable for certain wide-bandwidth or fast-response applications.

Full-power output frequency is the maximum frequency at which the amplifier can produce its rated output voltage and current; gain-bandwidth product only applies for small signals. Thus an amplifier with a specified 10-Mhz gain-bandwidth product and a rated output voltage of ± 10 volts will probably be unable to produce a ± 10 -volt output at 10 Mhz, or even at 1 Mhz.

Sometimes the specification is given merely as "full output frequency," usually meaning the highest frequency at which rated output voltage can be obtained with no load on the amplifier. If the amplifier drives its rated load, the undistorted full-power output frequency will be less than the specified full output frequency.

With differential amplifiers, the full output fre-

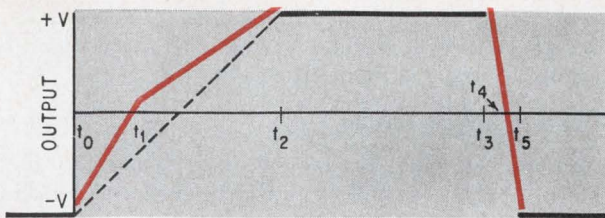

Going rate. Segmented slope of the amplifier response curve gives rise to a nonconstant slew rate. The IC's output response to a square-wave input, shown here, has four distinct slopes, as measured against the five time intervals (t_0 - t_5). Some makers specify the fastest of these (between t_0 and t_1 in the positive direction); a more realistic rating would be the average rate (between t_1 and t_2).

quency is usually given only when the amplifier is driven as an inverter. For a positive-follower configuration, this frequency level—different than in the inverter case because a new value of feedback prevails—has to be experimentally determined.

Even the basic definition of full output frequency isn't precise. It's usually taken as the frequency at which distortion is just observable in a sine-wave output, but occasionally it's the frequency for which a sinewave input is completely transformed into a triangular-wave output just within the rated peak-to-peak output voltage swing.

Slew rate

The response for a step input will often have a rise time much longer than that indicated by the gain-bandwidth product. This rise time is limited by the amplifier's slew rate—the maximum rate at which the amplifier output voltage will move when the input is driven by a square wave or step signal.

In a typical amplifier output resulting from a square-wave input, shown above, the rate of output voltage change isn't constant between $-V$ and $+V$, and negative-going response is faster than either of the two sections with a positive-going response.

One can thus calculate the slew rate at least four different ways: fastest for the positive direction, $V/(t_1-t_0)$; slowest for the positive direction, $V/(t_2-t_1)$; average for the positive direction, $2V/(t_2-t_0)$; and optimum for the negative direction, $V/(t_4-t_3) = V/(t_5-t_4)$.

As the results of these calculations can differ by as much as 100%, it's important to know which one the manufacturer has specified, and to account for any external compensation empirically. These networks reduce the slew rate, which is usually stated for inverter configurations with no external compensation and no load. The rate will slow as the load is increased, and may be different for the IC in a follower configuration.

Slew rate and full output frequency are related; a true-value slew rate, $\rho = 2\pi fV$, where V represents the zero-to-peak output voltage. The quantity $2\pi fV$ is the maximum rate of change of a sine wave of zero-to-peak voltage V , and frequency, f .

Spurious responses are caused by the amplifier's

nonlinear condition when it slews. Various capacitances in the amplifier become charged through overdriven transistors, causing peculiar overshoots and long recovery times—critical phenomena if the application requires minimum settling time. The settling time for linear operation can be predicted from the closed-loop bandwidth, but if the amplifier is allowed to operate in the slew-limited mode, an experimental determination is again called for.

Imperfect common-mode rejection is a major cause of error in amplifiers driven as positive followers. Common-mode error isn't usually linear with input voltage, and some manufacturers specify the common-mode rejection ratio (CMRR) at some low value of common-mode voltage. CMRR is a function of frequency and amplifier load, diminishing with increases in both frequency and load. Since a worst-case (maximum frequency, full load, and rated voltage) CMRR is rarely given, the working value must be established by the designer in the actual circuit.

Input impedances

There are two types of input impedance associated with a differential operational amplifier—differential and common-mode. Differential input impedance is the frequency-dependent impedance seen between the two input terminals when the amplifier is operated without external feedback; common-mode impedance is seen between both input terminals tied together and the input ground.

For operation in the inverting mode, only the differential type is important. If this impedance is in the same range as, or smaller than, the input summing impedance ($R_1, R_2/[R_1+R_2]$ in the circuit on page 92), loop gain and closed-loop bandwidth are reduced, and voltage drift and noise increase.

Differential input impedance will drop with increasing frequency. In addition, most amplifiers have at least a few picofarads of capacitance across the input, and a few more from the external connections. The sum may be as much as 10 pf, representing an impedance of 16 kilohms at 1 Mhz. If this impedance isn't much larger than the source and feedback resistance, the circuit won't function

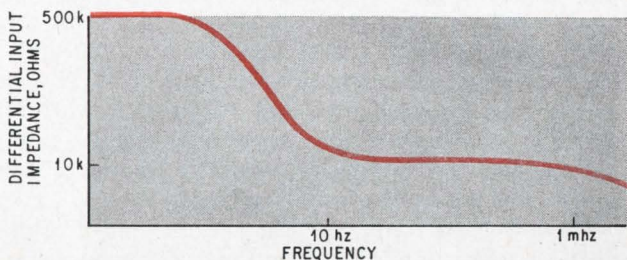

Plot. Differential input impedance isn't constant with operating frequency in IC amplifiers; input capacitance lowers it as frequency increases. Makers usually specify only the maximum input impedance value, a practice that can mask inadequate gain at high operating frequencies.

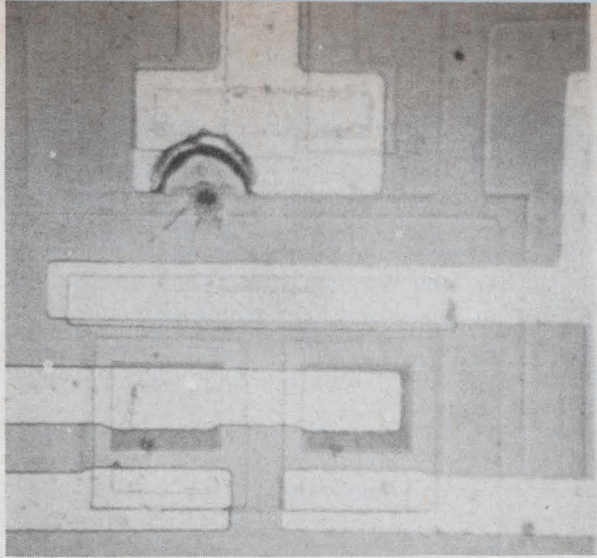

Gap. Damage to IC's elements caused by overvoltage is evident. Excessive transients on power supply line causes arcing across transistors with consequent erosion of isolation between collectors, bases, and emitters. Manufacturer's data sheet was ambiguous about maximum voltage ratings of IC, and user neglected to protect against transients.

as a true operational amplifier.

The currents flowing in the inputs of the amplifier carry various designations. Some manufacturers refer to offset current as the average of the two quiescent input currents, a practice that can mislead the user, particularly if the input current is adjusted externally. The adjustment makes possible currents of the opposite polarity at each input, producing an average current near zero.

In most monolithic amplifiers with double-ended input, input bias current is treated as the average of the two input currents, and offset current as the difference of the two currents.

Drift

Offset voltage is that input voltage needed to bring the output to zero. The drift of this voltage and offset current with temperature is the major source of closed-loop d-c drift with temperature, and it should be noted that drift specifications may apply to the entire operating temperature range of the amplifier or only to a limited range.

A common misconception relates to the units in which voltage and current drifts are measured— $\mu\text{V}/^\circ\text{C}$ and $\text{nA}/^\circ\text{C}$, respectively. These imply that the offset voltage and current vary linearly with temperature, and that the drift for any arbitrary temperature change can be calculated by multiplying the temperature variation by the drift/ $^\circ\text{C}$. From this, the user might infer that voltage and current drifts can be reduced to arbitrarily small values merely by restricting the ambient temperature range over which the amplifier operates.

However, not only are the voltage and current drifts usually nonlinear functions of temperature, but they may not even move in the same direction over the entire temperature range. Further, there is a lower limit to the achievable drift, often called constant environment stability. In other words, even if it were possible to keep the ambient tem-

perature, power-supply voltages, and other environmental factors completely constant, there would still be a small amount of residual drift.

Power-supply rejection

Another potential cause of error relates to the external biases. Too few of the operational amplifier's performance characteristics are specified as functions of the power-supply voltages, despite the fact that biasing is just as important a factor as input, load, and compensation. The most commonly specified parameter is the sensitivity of offset voltage to changes in supply voltage. This specification may apply when both biases are varied together in a tracking manner; in other cases, it may apply when each power supply is varied individually. The frequency range of power-supply variations is covered by the power-supply rejection specification, a rating [see p. 90] expressing the immunity of the IC to variables in the power supply, such as ripple. Most amplifiers don't reject high frequencies appearing on the power-supply leads as well as they reject low frequencies.

Frequently missing from data sheets is an indication of the degree of accuracy and regulation required of power supplies. Most manufacturers characterize their amplifiers at particular values of supply voltages, without tolerance figures. Few indicate just how accurately these voltages must be maintained to achieve the performance claimed, and few state how high the voltage transients can become before the amplifier is permanently damaged.

A great deal of specsmanship is applied to the subject of noise. Noise value can be specified as a zero-to-peak, peak-to-peak, or rms quantity. Peak and peak-to-peak wideband noise are difficult to measure quantitatively, and the measurement of rms wideband noise requires a true rms-reading meter. Unfortunately, there is no direct mathematical term for the conversion of a peak-to-peak wideband noise reading to an rms value. As a rough guide, one can divide the 99% peak-to-peak noise by five to estimate the rms noise.

Bandwidth is another area where noise specsmanship comes into play. The most commonly used bandwidth here is 10 kHz, but this should be checked if it's not explicitly stated. If the noise is truly white noise (usually a good approximation in this frequency region) the noise voltage will vary directly with the square root of the bandwidth. Doubling the bandwidth will increase the noise voltage by the square root of two, for instance.

The author

Everett L. Harris, Jr., with Zeltex since 1965, is a senior project engineer specializing in operational amplifier design and application. A registered professional engineer and holder of an MSEE from the U. of Cal. at Berkeley, Mr. Harris was previously the chief engineer with Alpha Scientific Labs. His current responsibilities also include developmental work on hybrid analog-to-digital subsystems.

Designer's casebook

Designer's casebook is a regular feature in Electronics. Readers are invited to submit novel circuit ideas, packaging schemes, or other unusual solutions to design problems. Descriptions should be short. We'll pay \$50 for each item published.

Single diode reduces ripple in d-c power supply

By Takao Kawabata

Mitsubishi Electric Corp., Amagasaki, Japan

One diode added between two filter capacitors reduces the ripple in a d-c power supply.

Diode D_1 replaces the resistor in an RC filter, blocks the charge on capacitor C_2 and prevents it from flowing back to C_1 when voltage E_1 drops with the ripple frequency. Thus voltage E_2 does not follow E_1 , and the ripple of E_2 is reduced without a d-c voltage drop common in conventional RC filters.

This circuit arrangement is especially effective when current I_1 is much greater than I_2 , and when the load requires a large pulse current.

In the first case, the time constant formed by $R_{L2}C_2$ is made considerably longer than that for $R_{L1}C_1$. This prevents E_2 from dropping even when E_1 falls with the ripple frequency. In the second case, a large pulse voltage drop ΔE_1 occurs, but D_1 prevents E_2 from following the voltage drop of E_1 , and a low ripple results.

An advantage of the circuit is that E_2 can be used as a low-ripple power source for low-power level controls.

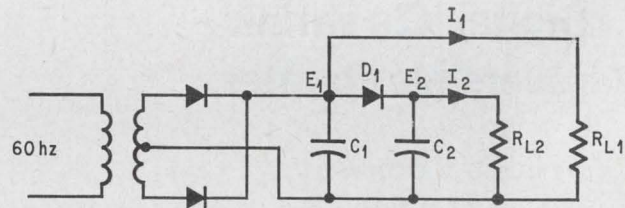

Charge blocker. Charge on capacitor C_2 cannot flow back to capacitor C_1 because diode D_1 blocks it whenever E_1 falls with ripple frequency.

Backward diode plus FET detects low currents

By Emanuel Elad

Lawrence Radiation Laboratory, Berkeley, Calif.

A discriminator that detects 1-microampere currents with an accuracy of 1% is possible by driving a field effect transistor with the output from a backward diode. When the input signal exceeds a preset threshold, the sum of the currents through the backward diode switch the diode to its high voltage state, generating a pulse; the pulse is then amplified by the FET output stage.

In tests of the circuit, the detection threshold was varied from 1 to 30 μa by adjusting helipot R_1 ; variability is limited only by a peak current of the backward diode, which is 40 μa for D_1 . Temperature stability of the variable threshold is better than 1% in the -10° to $+60^\circ\text{C}$ range; D_1 has a negative resistance region that is thermally stable at low current, and zener diode D_2 , which determines the stability of the threshold current,

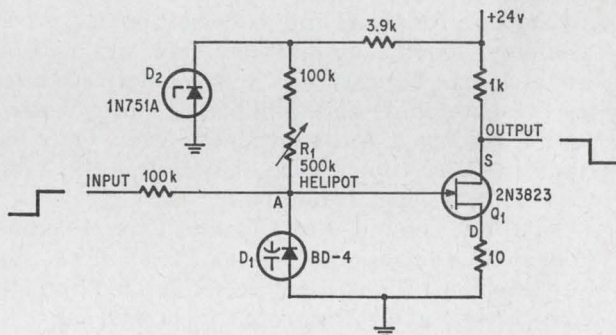

Low current detector. Input current pulses combine at point A and switch D_1 into its high voltage state.

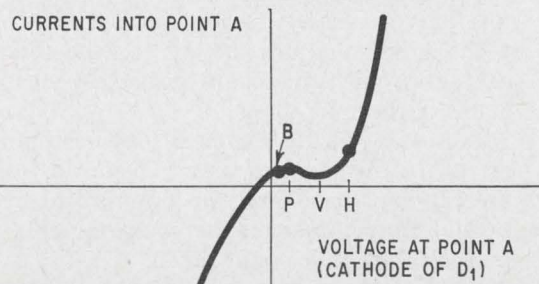

Backward diode characteristic. When an input pulse exceeds the present threshold, D_1 switches from bias point B to point H in its high voltage region.

is stable over a wide temperature range.

Threshold jitter is negligible because the current drawn by the gate of FET Q_1 is less than 0.1 nanoampere. Since Q_1 is normally on the circuit has a fast response, typically 0.1 μ sec, for pulses.

When a pulse of input current exceeds the threshold, determined by the R_1 setting, D_1 switches to its high voltage state. As D_1 switches, it generates a positive pulse at point A; this pulse corresponds to a shift on the backward diode characteristic from the bias point B to a point H in the high voltage region. The pulse generated at the gate of Q_1 produces a corresponding negative pulse at its drain.

Digital IC's shrink reversible counter

By Louis J. Brocato*

Surface Division, Westinghouse Electric Corp., Baltimore

A reversible counter built entirely with digital integrated circuits (primarily NAND gates), takes up less than 1/7th the space of its discrete-component counterpart and switches in 150-nanoseconds.

Although the counter displays the difference between an error signal and its correction, it has other computer circuit applications. For example, the counter may be used as a serial adder, subtractor, or comparator. It also produces a pulse when its count reaches a predetermined level. Only four stages of the counter are shown, but the design represents a general solution.

The unit combines two identical serial counters that share a single set of flip-flops but reset in opposite directions. Thus, input pulses applied to the top half of the circuit (the count up input) are gated through the counter so that each pulse is added to the previously counted pulses; the pulse count is represented by the condition (0 to 1) of the four flip-flops as sensed by the output lines (FF1 out, FF2 out, FF3 out, and FF4 out) on the count up side of the circuit. Pulses are added by changing the states of these flip-flops.

Pulses applied to the count down input affect the circuit in the same manner. They add by resetting the flip-flops in a direction opposite to that sensed by the output lines on the count up side; thus, the pulses subtract or count down.

Electrically, pulses are added by switching a flip-flop from its 0 to its 1 state if it was previously in its 0 state. If, however, the flip-flop was formerly in

* Now with the Armed Forces Radiobiology Institute, Bethesda, Md.

its 1 state, the pulse is added by passing an overflow pulse (or carry bit) up to the next stage and then resetting the flip-flop to 0.

To count up, an incoming pulse is inverted by amplifier A_1 and applied to terminal 2 and NAND 1, which again inverts the pulse and sends it to both terminal 1 of NOR 1 and terminal 2 of line-drive amplifier LD. The pulse from NAND 1 triggers LD, which puts out a positive pulse and enables NAND 2, NAND 3, and NAND 4. The positive pulse placed on terminal 12 of these three gates prepares them to fire off a carry bit.

The NAND 1 pulse is also sent to NOR 1 where it is inverted and applied to flip-flop 1 and terminal 1 of NAND 2. If flip-flop 1 was previously in the 0 condition it is set to 1 and the sequence ends.

If flip-flop 1 was previously in the 1 state, however, this condition will have been sensed from terminals 1 and 2 of flip-flop 1 and a positive enabling signal will have been placed on terminal 2 of NAND 2. With terminals 2 and 12 of NAND 2 both enabled, the incoming pulse from terminal 5 of NOR 1 fires NAND 2, sending the carry bit up.

While NAND 2 is firing, the pulse from NOR 1 is still entering flip-flop 1, which is constructed to fire only when the signal is decreasing. Here it is reset to 0 by the trailing edge of the positive pulse from NOR 1. Thus the firing of flip-flop 1 is delayed by a length of time equal to the pulse width, giving NAND 2 a chance to fire off the carry bit before flip-flop 1 changes state and eliminates the positive enabling signal on terminal 2 of NAND 2. With the carry bit sent up to the next stage and flip-flop 1 reset to 0, the addition sequence ends.

The sequence is the same at the next three stages. Count down pulses applied to terminal 1 of amplifier A_2 are handled in the same manner by the lower half of the circuit.

When all flip-flops are in the one state, the signals at terminals 12, 2, 1, and 3 of NAND 5 are all positive; NAND 5 then fires a negative pulse which disables terminal 12 of NAND 1, inhibiting the entrance of additional up pulses until a down pulse resets one of the flip-flops to 0. In the same manner NAND 5' closes the circuit to down pulses coming into NAND 1' when all the flip-flops are at 0. The inputs to NAND 5 and 5' may be wired to set the upper and lower limits at any points within the counter's range.

Terminal 3 of NAND 5 (and terminal 9 of NAND 5') are add on lugs for connecting additional lines to the gate. Since some internal circuitry is bypassed, the diode-capacitor networks are required.

A numerical example illustrates the counter's operation. When the flip-flops are set at digital 7:

$$\begin{array}{cccc} \text{FF}_1 \text{ or } (2^0) & \text{FF}_2 \text{ or } (2^1) & \text{FF}_3 \text{ or } (2^2) & \text{FF}_4 \text{ or } (2^3) \\ 1 & 1 & 1 & 0 \end{array} \quad (1)$$

an incoming up pulse generates a carry bit which

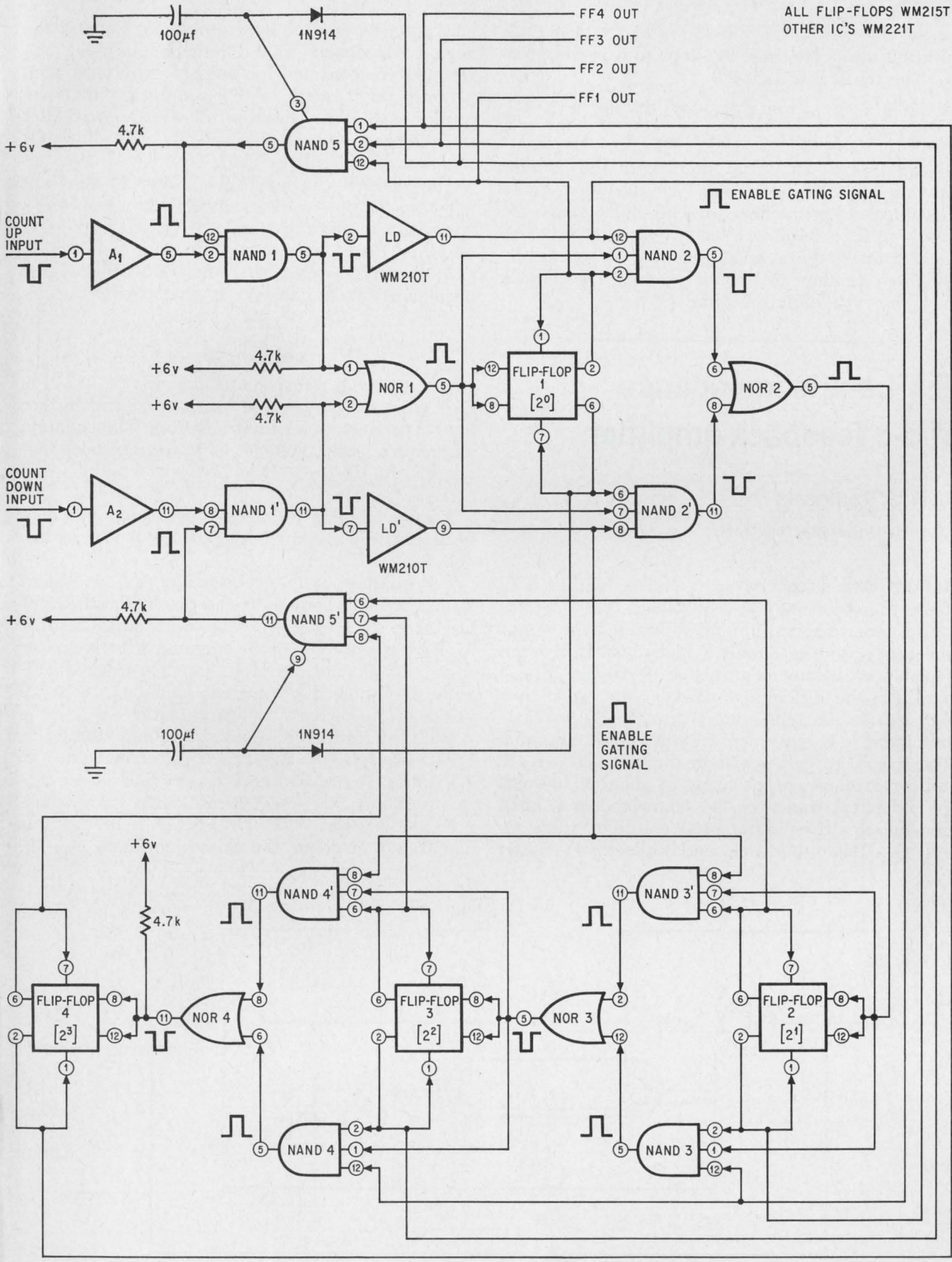

ALL FLIP-FLOPS WM215T
OTHER IC'S WM221T

Count up. Pulses are inverted in amplifier A₁, reinverted in NAND 1 and applied to line driver LD and NOR 1. Line driver LD then enables NAND 2, NAND 3 and NAND 4. NOR 1 inverts the pulse from NAND 1 and applies it to NAND 2 and flip-flop 1.

travels through to the flip-flop 4 and sets it to 1, resetting the other three flip-flops to 0 in the process. The result is a digital 8:

$$\begin{array}{cccc} \text{FF}_1 \text{ or } (2^0) & \text{FF}_2 \text{ or } (2^1) & \text{FF}_3 \text{ or } (2^2) & \text{FF}_4 \text{ or } (2^3) \\ 0 & 0 & 0 & 1 \end{array} \quad (2)$$

Now, if a down pulse enters with the counter showing digital 8 as in line (2), the down pulse encounters 0's in the first three flip-flops; hence the down pulse generates a carry bit which passes through to flip-flop 4 and resets it to 0, setting the first three flip-flops to 1 in the process. The counter then shows a digital 7 (line (1)).

FET boosts impedance of d-c feedback amplifier

By N.C. Voulgaris

Columbia University, New York

Stability and simplicity are achieved with a field effect transistor in a d-c amplifier that operates over a wide temperature and supply voltage range. The FET gives the circuit a high open-loop input impedance, making it attractive as an operational amplifier; the differential pair Q_2 and Q_3 deliver high gain while remaining thermally stable. Thus the circuit is a convenient building-block amplifier with a voltage gain equal to the ratio of $-R'/R$, and a maximum output swing of about ± 10 volts.

Field effect transistor Q_1 , connected as a common-source drives differential amplifier stage Q_2 and Q_3 . Drain-to-source and collector-to-emitter

bias voltages are set by zener diode D_1 and the negative feedback. The differential amplifier, Q_2 and Q_3 , compensates for voltage drift with temperature, and capacitor C_1 suppresses high-frequency oscillations. Emitter-follower Q_4 is a buffer stage between Q_3 and the load, R_L , and allows Q_3 to attain a high voltage gain.

The value of the feedback resistor R' does not influence the bias voltages; at quiescent conditions FET's gate is grounded and the output voltage is also zero. Hence, there is no voltage drop across R' .

At low frequencies, the amplifier's small-signal open-loop voltage gain, A_o , is given by:

$$A_o = g_m(1 + h_{fe2})h_{fb3} \left[\frac{R_1 R_3}{R_1 + h_{ie2} + h_{ib3}(1 + h_{fe2})} \right]$$

where g_m is the transconductance of FET, Q_1 ; r_d is Q_1 's drain resistance; and h_{fe} , h_{fb} , h_{ie} , and h_{ib} are hybrid parameters for the transistors. The equation assumes a unity voltage gain for Q_4 and that $r_d \gg R_1$, $R_2 \gg h_{ib3}$, $(1/h_{oe2}) \gg h_{ib3}$, and $(1/h_{ob3}) \gg R_3$.

A large value for the open-loop voltage gain may be attained by maximizing g_m for Q_1 as well as h_{fe2} and R_3 .

For instance, if Q_1 is biased at $V_{GS} = 0$ and $V_{DS} \gg V_P$ (where V_P is the pinch-off voltage of Q_1), then $g_m = g_{m0}$. By choosing a small resistor for R_2 , transistor Q_2 can be operated at high emitter current so that h_{fe2} is large and h_{ie2} is small. Finally, if Q_3 has high current gain h_{fb3} , at small values of the currents, R_3 can be large.

With the resistance values shown and with $g_m = 2,500 \mu\text{mhos}$, $h_{fe2} = 280$, $h_{ie2} = 3.7$ kilohms, $h_{oe2} = 7.5 \mu\text{mhos}$, $h_{ib3} = 55$ ohms, $h_{ob3} = 0.02 \mu\text{mho}$, $h_{fb3} = -0.996$, $A_o = -24,000$; the actual value measured at 1 kHz was $-22,700$. When R is 100 kilohms and R' is 1 megohm, the closed loop gain is -10 .

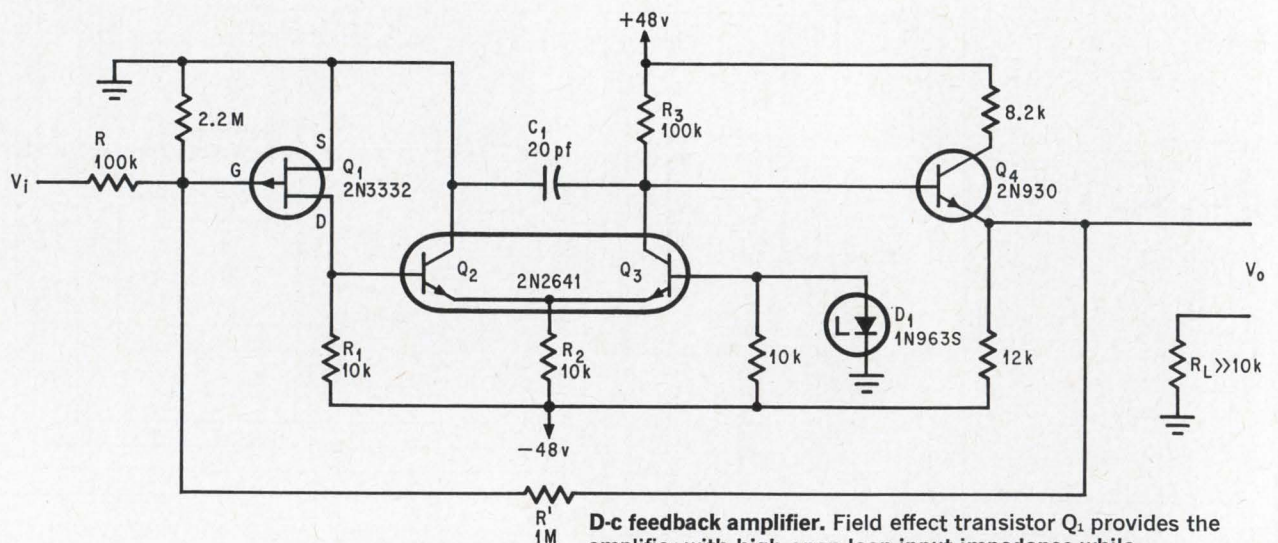

D-c feedback amplifier. Field effect transistor Q_1 provides the amplifier with high open-loop input impedance while differential transistors Q_2 and Q_3 provide high gain over a wide temperature range.

Combined feedback builds gain and input impedance

By George P. Klein*

Reeves Instrument Division, Garden City, N.Y.

Positive and negative feedback combined in a bootstrap amplifier supply high input impedance and high voltage gain. In conventional transistor amplifiers negative feedback furnishes high input impedance, but does not yield high voltage gain.

Negative feedback is provided by R_5 and R_2 in a conventional amplifier. Placing R_5 in the emitter leg of Q_1 increases the input impedance, but also reduces the voltage gain. Expressions for the voltage gain and input impedance are given by equations 1 and 2 respectively.

$$A_V = \frac{R_1 R_2 R_3 h_{fe}}{R_s [R_1 R_2 + R_5 (h_{fe} + 1) (R_1 + R_2)] + R_1 R_2 R_5 (h_{fe} + 1)} = 1.62 \quad (1)$$

$$Z_{IN} = \frac{R_1 R_2 R_5 (h_{fe} + 1)}{R_1 R_2 + R_5 (h_{fe} + 1) (R_1 + R_2)} = 3.16 \text{ k} \quad (2)$$

The input impedance is dependent on the feedback resistor R_5 , the current gain h_{fe} of transistor Q_1 , and the values of the biasing resistors R_1 and R_2 . Bootstrapping is accomplished by interchanging resistor R_5 and R_4 .

Since C_1 passes all frequencies, positive feedback passes from the top of R_5 to the base of Q_1 via R_2 . Because the bottom of feedback resistor R_5 is common to both input and output, negative feedback is still present.

The voltage gain expression of the modified stage is:

$$A_{V_{FB}} = \frac{R_2 R_3 h_{fe}}{R_2 (h_{ie} + R_s) + R_5 (h_{fe} + 1) (R_2 + R_s)} \left[1 + \frac{R_2 R_s}{R_2 (R_1 + R_s) + R_1 R_s} \right] = 2.29 \quad (3)$$

The new voltage gain is higher than in the conventional case because of the positive feedback. The equation for input impedance is also changed:

$$Z_{IN_{FB}} = \frac{R_2 R_5 (h_{fe} + 1)}{R_2 + R_5 (h_{fe} + 1)} = 3.75 \text{ k} \quad (4)$$

Dividing equation 3 by 1 yields an expression for comparing the gain of the modified stage with the gain of the conventional configuration.

$$\frac{A_{V_{FB}}}{A_V} = 1 + \frac{R_1 R_s}{R_2 (R_1 + R_s) + R_1 R_s} = 1.414 \quad (5)$$

* Now with Alphanumeric Inc., Lake Success, N.Y.

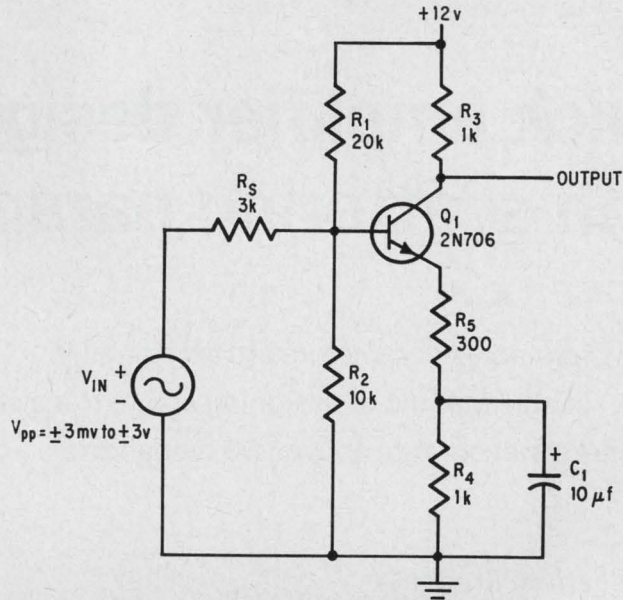

Conventional amplifier. Negative feedback furnished by R_5 increases the stage's input impedance but reduces its voltage gain.

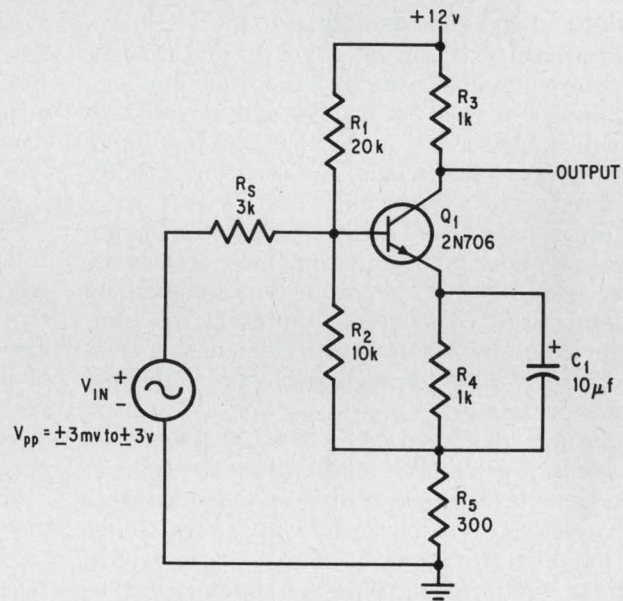

Modified circuit. Positive feedback supplied by bootstrapping resistor R_4 increases both the input impedance and the voltage gain.

Equation 5 indicates a 41.4% improvement. However, the improvement diminishes as the source impedance approaches zero.

The improvement ratio for input impedance is:

$$\frac{Z_{IN_{FB}}}{Z_{IN}} = 1 + \frac{R_2 R_5 (h_{fe} + 1)}{R_1 R_2 + R_1 R_5 (h_{fe} + 1)} = 1.187 \quad (6)$$

Equation 6 shows an 18.7% improvement. Input impedance is independent of the source and depends on the value of R_5 and the current gain of Q_1 .

Quick amplifier design with scattering parameters

Smith chart and s parameters are combined in a fast, reliable method of designing stable transistor amplifiers that operate above 100 megahertz

By William H. Froehner

Texas Instruments Incorporated, Dallas

Bandwidth, gain, and stability are the most important parameters in any amplifier design. Designing for one without considering the other two can mean a mediocre amplifier instead of one with high performance. A reliable technique for predicting bandwidth, determining gain, and assuring stability uses scattering or s parameters.

Scattering parameters make it easy to characterize the high-frequency performance of transistors. As with h, y, or z parameter methods, no equivalent circuit is needed to represent the transistor device. A transistor is represented as a two-port network whose terminal behavior is defined by four s parameters, s_{11} , s_{12} , s_{21} , and s_{22} .

For designs that operate under 100 megahertz the problem of accurately representing the transistor is not acute, because transistor manufacturers provide relatively complete data in a form other than s parameters. However, at frequencies above 100 Mhz the performance data is frequently incomplete or in an inconvenient form. In addition, h, y, or

z parameters, ordinarily used in circuit design at lower frequencies, cannot be measured accurately. But s parameters may be measured directly up to a frequency of 12.4 gigahertz. Once the four s parameters are obtained, it is possible to convert them to h, y, or z terms with conventional tables.

Defining the terms

Because scattering parameters are based on reflection characteristics derived from power ratios they provide a convenient method for measuring circuit losses. Representing a network in terms of power instead of the conventional voltage-current description can help solve microwave-transmission problems where circuits can no longer be characterized using lumped R, L, and C elements.

When a network is described with power parameters, the power into the network is called incident, the power reflected back from the load is called reflected. A description of a typical two-port network based on the incident and reflected power is given by the scattering matrix. To understand the relationships, consider the typical two-port network, bottom of page 101, which is terminated at both ports by a pure resistance of value Z_o , called the reference impedance. Incident and reflected waves for the two-port network are expressed by two sets of parameters (a_1, b_1) and (a_2, b_2) at terminals 1-1' and 2-2' respectively. They are

$$a_1 = \frac{1}{2} \left[\frac{V_1}{\sqrt{Z_o}} + \sqrt{Z_o} I_1 \right] = \text{input power to the load applied at port 1} \quad (1a)$$

$$b_1 = \frac{1}{2} \left[\frac{V_1}{\sqrt{Z_o}} - \sqrt{Z_o} I_1 \right] = \text{reflected power from the load as seen from port 1} \quad (1b)$$

Looking back

This is the second major article on scattering parameters to appear in Electronics. In the first, "Scattering parameters speed design of high-frequency transistor circuits," [Sept. 5, 1966, p. 78], F.K. Weinert described how to use the technique in a special case where the input impedance is matched to the load. This condition always results in an unconditionally stable amplifier. In practice, this ideal condition is not always possible.

In this article, author W. H. Froehner describes how to use the technique more generally—when the input impedance is not matched to the load and the scattering parameter s_{12} does not equal zero.

$$a_2 = \frac{1}{2} \left[\frac{V_2}{\sqrt{Z_0}} + \sqrt{Z_0} I_2 \right] = \text{input power to the load applied at port 2} \quad (1c)$$

$$b_2 = \frac{1}{2} \left[\frac{V_2}{\sqrt{Z_0}} - \sqrt{Z_0} I_2 \right] = \text{reflected power from the load as seen from port 2} \quad (1d)$$

Hence, the scattering parameters for the two-port network are given by

$$\begin{aligned} b_1 &= s_{11}a_1 + s_{12}a_2 \\ b_2 &= s_{21}a_1 + s_{22}a_2 \end{aligned} \quad (2)$$

Expressed as a matrix, equation 2 becomes

$$\begin{bmatrix} b_1 \\ b_2 \end{bmatrix} = \begin{bmatrix} s_{11} & s_{12} \\ s_{21} & s_{22} \end{bmatrix} \begin{bmatrix} a_1 \\ a_2 \end{bmatrix} \quad (3)$$

where the scattering matrix is

$$[s] = \begin{bmatrix} s_{11} & s_{12} \\ s_{21} & s_{22} \end{bmatrix} \quad (4)$$

Thus, the scattering parameters for the two-port network can be expressed as ratios of incident and reflected power waves.

$$s_{11} = \left. \frac{b_1}{a_1} \right|_{a_2=0} \quad s_{12} = \left. \frac{b_1}{a_2} \right|_{a_1=0} \quad (5)$$

$$s_{21} = \left. \frac{b_2}{a_1} \right|_{a_2=0} \quad s_{22} = \left. \frac{b_2}{a_2} \right|_{a_1=0}$$

The parameter s_{11} is called the input reflection coefficient; s_{21} is the forward transmission coefficient; s_{12} is the reverse transmission coefficient; and s_{22} is the output reflection coefficient.

By setting $a_2 = 0$, expressions for s_{11} and s_{21} can be found. To do this the load impedance Z_0 is set equal to the reference impedance R_{ML} . This conclusion is proven with the help of the terminating section of the two-port network shown above with the a_2 and b_2 parameters. The load resistor Z_0 is considered as a one-port network with a scattering parameter

$$s_2 = \frac{Z_0 - R_{ML}}{Z_0 + R_{ML}} \quad (6)$$

Hence a_2 and b_2 are related by

$$a_2 = s_2 b_2 \quad (7)$$

When the reference impedance R_{ML} is set equal to the load impedance Z_0 , then s_2 becomes

$$s_2 = \frac{Z_0 - Z_0}{Z_0 + Z_0} = 0 \quad (8)$$

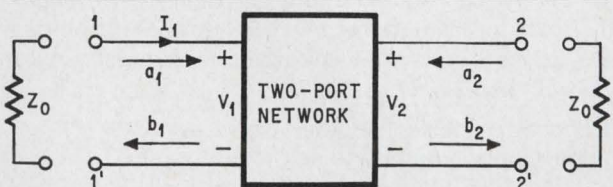

Defining the s parameters. Ratios of incident waves a_1 , a_2 and reflected power waves b_1 , b_2 for ports 1 and 2 define the four scattering parameters.

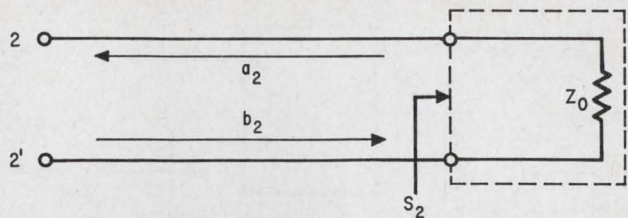

Impedance matching. By setting a_2 equal to zero the engineer can determine the s_{11} value. The condition $a_2 = 0$ implies that the reference impedance R_{MS} is set equal to the load impedance Z_0 .

so that $a_2 = 0$ under this condition. Likewise, when $a_1 = 0$, the reference impedance of port 1 is equal to the terminating impedance; $R_{MS} = Z_0$.

By defining the driving-point impedances at ports 1 and 2 as

$$Z_1 = \frac{V_1}{I_1}; \quad Z_2 = \frac{V_2}{I_2} \quad (9)$$

s_{11} and s_{22} can be written in terms of equation 9.

$$\begin{aligned} s_{11} &= \left. \frac{b_1}{a_1} \right|_{a_2=0} \\ &= \frac{\frac{1}{2}[(V_1/\sqrt{Z_0}) - \sqrt{Z_0} I_1]}{\frac{1}{2}[(V_1/\sqrt{Z_0}) + \sqrt{Z_0} I_1]} = \frac{Z_1 - Z_0}{Z_1 + Z_0} \end{aligned} \quad (10)$$

$$s_{22} = \frac{Z_2 - Z_0}{Z_2 + Z_0} \quad (11)$$

In the expression

$$s_{21} = \left. \frac{b_2}{a_1} \right|_{a_2=0}$$

The condition $a_2 = 0$ implies that the reference impedance R_{ML} is set equal to the load Z_0 . If a voltage source $2E_1$ is connected with a source impedance $R_{MS} = Z_0$, as seen on page 102, a_1 can be expressed as

$$a_1 = \frac{E_1}{\sqrt{Z_0}} \quad (12)$$

$$\text{Since } a_2 = 0, \text{ then } a_2 = 0 = \frac{1}{2} \left[\frac{V_2}{\sqrt{Z_0}} + \sqrt{Z_0} I_2 \right]$$

$$\text{from which } \frac{V_2}{\sqrt{Z_0}} = -\sqrt{Z_0} I_2$$

Consequently,

$$b_2 = \frac{1}{2} \left[\frac{V_2}{\sqrt{Z_0}} - \sqrt{Z_0} I_2 \right] = \frac{V_2}{\sqrt{Z_0}}$$

Hence,

$$s_{21} = \frac{V_2}{E_1} \quad (13)$$

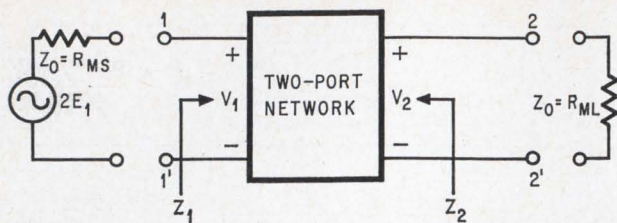

Finding s_{21} . By connecting a voltage source, $2E_1$, with the source impedance, Z_0 , parameter s_{21} can be evaluated.

Similarly when port 1 is terminated in $R_{MS} = Z_0$ and a voltage source equal to $2E_2$ having an impedance of Z_0 is connected to port 2

$$s_{12} = \frac{V_1}{E_2} \quad (14)$$

Both s_{12} and s_{21} are voltage-ratios and therefore have no dimensions. For a passive network, $s_{21} = s_{12}$. Parameters s_{11} and s_{22} are reflection coefficients and are also dimensionless.

Stabilizing an amplifier

Since the s parameters are based on reflection coefficients, they can be plotted directly on a Smith chart and easily manipulated to establish optimum gain with matching networks. To design an amplifier the engineer first plots the s -parameter values for the transistor on a Smith chart and then, using the plot, synthesizes matching impedances between a source and load impedance.

Stability or resistance to oscillation is most important in amplifier design and is determined from the s parameters and the synthesized source and load impedances. The oscillations are only possible if either the input or the output port, or both, have negative resistance. This occurs if s_{11} or s_{22} are greater than unity. However, even with negative resistances the amplifier might still be stable.

For a device to be unconditionally stable s_{11} and s_{22} must be smaller than unity and the transistor's inherent stability factor, K , must be greater than unity and positive. K is computed from

$$K = \frac{1 + |\Delta|^2 - |s_{11}|^2 - |s_{22}|^2}{2|s_{21}s_{12}|} \quad (15)$$

Plotting circles

Stability circles can be plotted directly on a Smith chart. These separate the output or input planes into stable and potentially unstable regions. A stability circle plotted on the output plane indicates the values of all loads that provide negative real input impedance, thereby causing the circuit to oscillate. A similar circle can be plotted on the input plane which indicates the values of all loads that provide negative real output impedance and again cause oscillation. A negative real impedance is defined as a reflection coefficient which has a magnitude that is greater than unity.

The regions of instability occur within the circles

whose centers and radii are expressed by

$$\begin{aligned} \text{center on the input plane} &= r_{s1} \\ &= \frac{C_1^*}{|s_{11}|^2 - |\Delta|^2} \quad (16) \end{aligned}$$

$$\begin{aligned} \text{radius on the input plane} &= R_{s1} \\ &= \frac{|s_{12}s_{21}|}{|s_{11}|^2 - |\Delta|^2} \quad (17) \end{aligned}$$

$$\begin{aligned} \text{center on the output plane} &= r_{s2} \\ &= \frac{C_2^*}{|s_{22}|^2 - |\Delta|^2} \quad (18) \end{aligned}$$

$$\begin{aligned} \text{radius on the output plane} &= R_{s2} \\ &= \frac{|s_{12}s_{21}|}{|s_{22}|^2 - |\Delta|^2} \quad (19) \end{aligned}$$

where

$$C_1 = s_{11} - \Delta s_{22}^* \quad (20)$$

$$C_2 = s_{22} - \Delta s_{11}^* \quad (21)$$

$$\Delta = s_{11}s_{22} - s_{12}s_{21} \quad (22)$$

In these equations the asterisk represents the complex conjugate value. Six examples of stable and potentially unstable regions plotted on the output plane are on the opposite page. In all cases the gray areas indicate the loads that make the circuit stable.

The first two drawings, A, and B, show the possible locations for stability, when the value of K is less than unity; C and D are for K greater than unity. When the stability circle does not enclose the origin of the Smith chart, its area provides negative real input impedance. But when the stability circle does enclose the origin, then the area bounded by the stability circle provides positive real input impedance.

Drawings E and F indicate the possible locations for stability when the value of K is greater than unity and positive. If the stability circle falls completely outside the unity circle, the area bounded by this circle provides negative real input impedance. But if the stability circle completely surrounds the unity circle then the area of the stability circle provides positive real input impedance.

When K is positive

The design of an amplifier where K is positive and greater than unity is relatively simple since these conditions indicate that the device is unconditionally stable under any load conditions. All the designer need do is compute the values of R_{MS} and R_{ML} that will simultaneously match both the input and output ports and give the maximum power gain of the device.

Reflection coefficient of the generator impedance required to conjugately match the input of the transistor = R_{MS}

$$= C_1^* \left[\frac{B_1 \pm \sqrt{B_1^2 - 4|C_1|^2}}{2|C_1|^2} \right] \quad (23)$$

Stability examples

(A) CONDITIONALLY STABLE $K < 1$

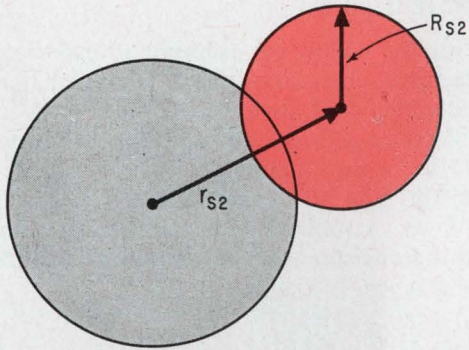

(B) CONDITIONALLY STABLE $K < 1$

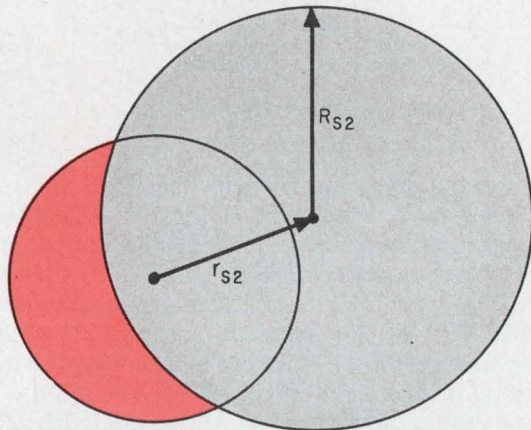

(C) CONDITIONALLY STABLE $K > 1$

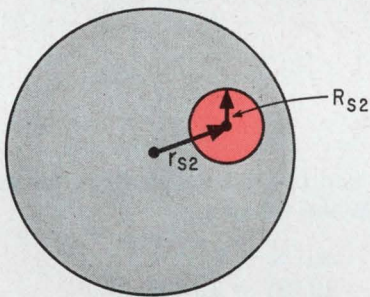

(D) CONDITIONALLY STABLE $K > 1$

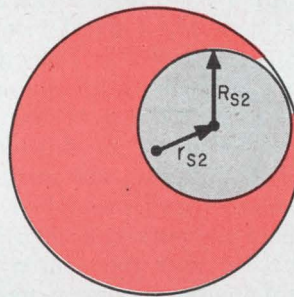

(E) UNCONDITIONALLY STABLE $K > 1$

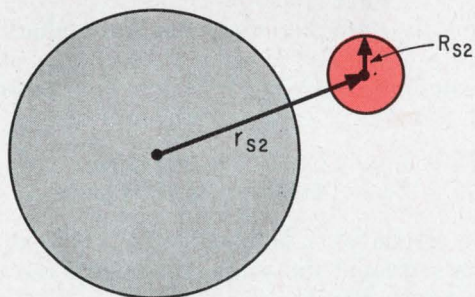

(F) UNCONDITIONALLY STABLE $K > 1$

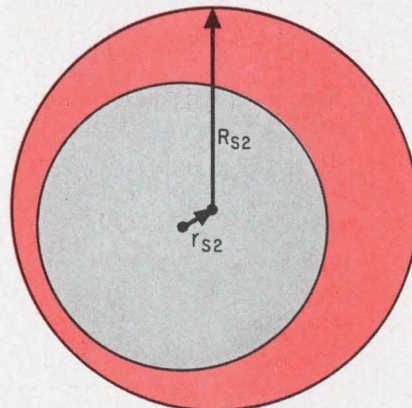

Controlling oscillation. Stability circles are superimposed on the output plane. Load impedances chosen from gray areas will not cause oscillation. Colored areas represent unstable loads.

where

$$B_1 = 1 + |s_{11}|^2 - |s_{22}|^2 - |\Delta|^2 \quad (24)$$

and

Reflection coefficient of that load impedance required to conjugately match the output of the transistor = R_{ML}

$$= C_2^* \left[\frac{B_2 \pm \sqrt{B_2^2 - 4|C_2|^2}}{2|C_2|^2} \right] \quad (25)$$

where

$$B_2 = 1 + |s_{22}|^2 - |s_{11}|^2 - |\Delta|^2 \quad (26)$$

and C_1 and C_2 are as previously defined.

If the computed value of B_1 is negative, then the plus sign should be used in front of the radical in equation 23. Conversely, if B_1 is positive, then the negative sign should be used. This also applies in equation 25 for B_2 . By using the appropriate sign only one answer will be possible in either equation and a value of less than unity will be computed.

The maximum power gain possible is found from the relationship

$$G_{MAX} = \frac{|s_{21}|}{|s_{12}|} |K \pm \sqrt{K^2 - 1}| \quad (27)$$

Once again the plus sign is used if B_1 is negative and the minus sign if B_1 is positive. This maximum power gain is obtained only if the device is loaded with R_{MS} and R_{ML} expressed as reflection coefficients. These values are plotted directly on a Smith chart that has been normalized to the reference impedance, ($Z_0 = 50$ ohms, in this case). The actual values of R_{MS} and R_{ML} are read from the Smith chart coordinates and multiplied by Z_0 . A lossless transforming network can then be placed between the transistor and the source and load terminations to obtain the maximum gain.

If a power gain other than G_{MAX} is desired, constant gain circles must be constructed. The solution for contours of constant gain is given by the equation of a circle whose center and radius are

The center of the constant gain circle on the output plane = $r_{02} = \left[\frac{G}{1 + D_2 G} \right] C_2^* \quad (28)$

The radius of the constant gain circle on the output plane = R_{02}

$$= \frac{(1 - 2K|s_{12}s_{21}|G + |s_{12}s_{21}|^2 G^2)^{1/2}}{1 + D_2 G} \quad (29)$$

where

$$D_2 = |s_{22}|^2 - |\Delta|^2 \quad (30)$$

$$G = \frac{G_p}{G_o} \quad (31)$$

$$G_o = |s_{21}|^2 \quad (32)$$

and $G_p =$ desired total amplifier gain (numeric)

After a load that falls on the desired constant gain circle has been selected, a generator impedance is selected to achieve the desired gain.

The value for the generator impedance that simultaneously matches the input load is given by

$$r_1 = \left[\frac{s_{11} - r_2 \Delta}{1 - r_2 s_{22}} \right]^* \quad (33)$$

where

$r_2 =$ the reflection coefficient of the load picked.

To prove stability

With the following example it can be demonstrated that when a positive K is greater than unity, the amplifier will always be stable.

Objective: Design an amplifier to operate at 750 Mhz with a maximum gain using a 2N3570 transistor. The bias conditions are $V_{CE} = 10$ volts and $I_C = 4$ milliamperes. Scattering parameters for this transistor were measured and found to be

$$s_{11} = 0.277 \angle -59.0^\circ$$

$$s_{12} = 0.078 \angle 93.0^\circ$$

$$s_{21} = 1.920 \angle 64.0^\circ$$

$$s_{22} = 0.848 \angle -31.0^\circ$$

Solution: Compute the values for the maximum gain, and the load impedances R_{MS} and R_{ML} .

$$\Delta = s_{11}s_{22} - s_{12}s_{21} = 0.324 \angle -64.8^\circ$$

$$C_1 = s_{11} - \Delta s_{22}^* = 0.120 \angle -135.4^\circ$$

$$B_1 = 1 + |s_{11}|^2 - |s_{22}|^2 - |\Delta|^2 = 0.253$$

$$C_2 = s_{22} - \Delta s_{11}^* = 0.768 \angle -33.8^\circ$$

$$B_2 = 1 + |s_{22}|^2 - |s_{11}|^2 - |\Delta|^2 = 1.537$$

$$K = \frac{1 + |\Delta|^2 - |s_{11}|^2 - |s_{22}|^2}{2|s_{12}s_{21}|} = 1.033$$

$$D_2 = |s_{22}|^2 - |\Delta|^2 = 0.614$$

Since B_1 and B_2 are both positive, the negative sign is used in the following:

$$G_{MAX} = |s_{21}| |K - \sqrt{K^2 - 1}| = 19.087 = 12.807 \text{ db}$$

$$R_{MS} = C_1^* \left[\frac{B_1 - \sqrt{B_1^2 - 4|C_1|^2}}{2|C_1|^2} \right] = 0.730 \angle 135.4^\circ$$

$$R_{ML} = C_2^* \left[\frac{B_2 - \sqrt{B_2^2 - 4|C_2|^2}}{2|C_2|^2} \right] = 0.951 \angle 33.8^\circ$$

R_{MS} and R_{ML} are plotted on the Smith chart on the opposite page. The actual values of R_{MS} and R_{ML} can now be read from the Smith chart coordinates as Z_s and Z_L .

$$R_{MS} = Z_s = 9.083 + j 19.903 \text{ ohms}$$

$$R_{ML} = Z_L = 14.686 + j 163.096 \text{ ohms}$$

These results were obtained with a computer and do not represent the actual reading of the coordinates on the Smith chart.

A lossless matching network can now be inserted between a 50-ohm generator and the transistor to provide a conjugate match for the input of the transistor. To conjugately match the output of the transistor a lossless matching network can be inserted between the transistor and a 50-ohm load. With the transistor's input and output conjugately

Strip-line design

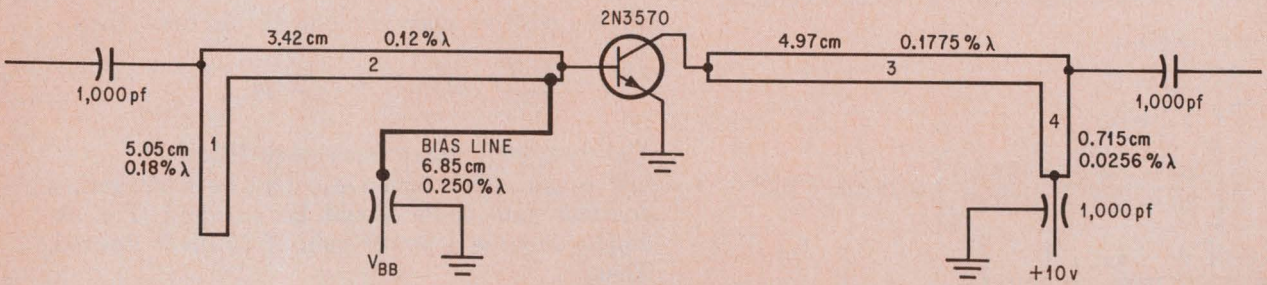
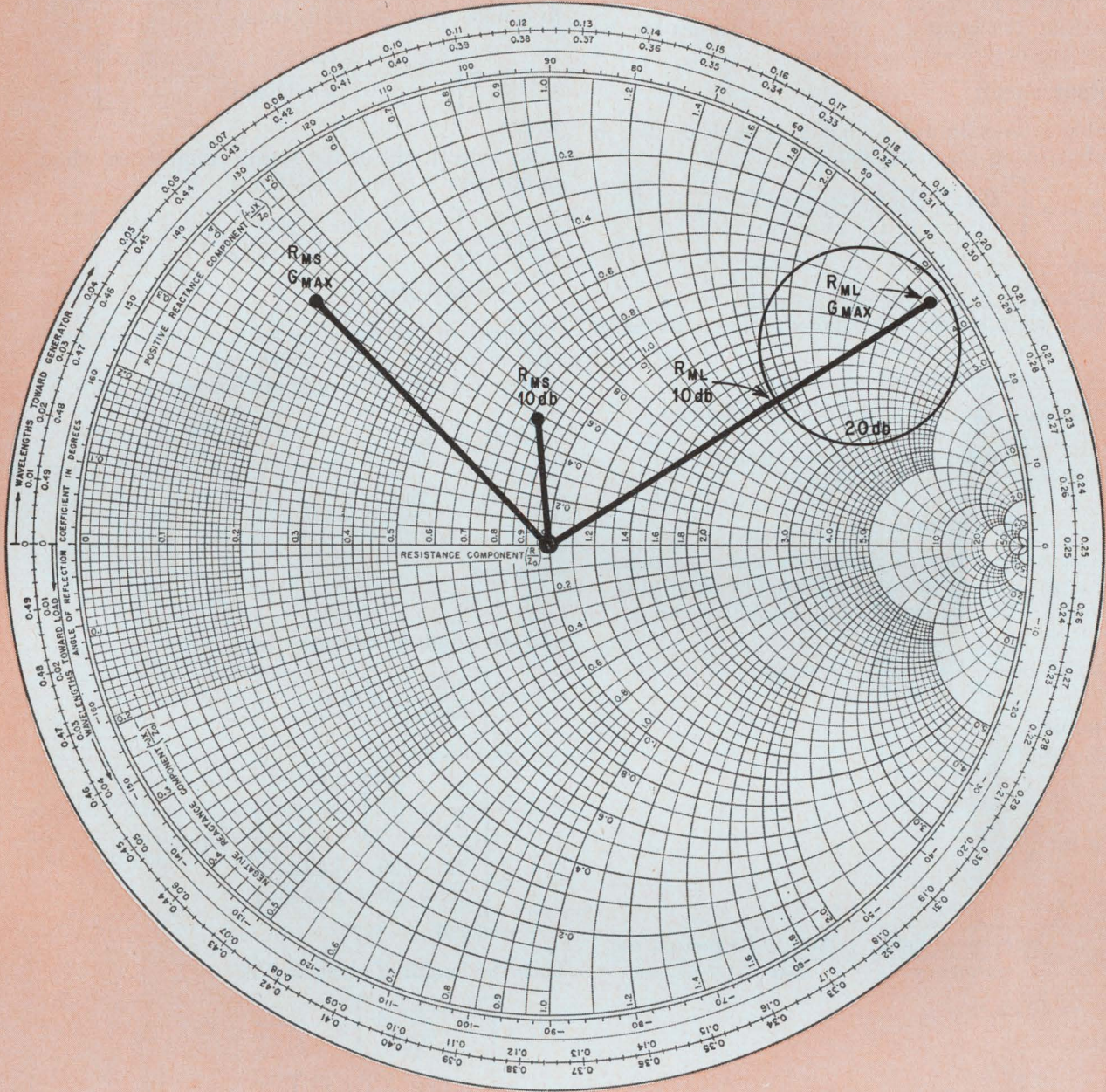

Design example. Graphical plot of a 750-MHz amplifier design using a 2N3570 transistor. Completed circuit uses strip lines to match the input and output to the transistor.

matched, a maximum power gain is achieved.

In this example Teflon transmission lines, using $\frac{1}{16}$ " Teflon Fiberglass p-c board, were chosen for matching the input and output. The values for the lines are determined as follows:

Output circuit

Step 1. Transform R_{ML} to $50 \pm jz$ ohms or $20 \pm jb$ mmhos using the relationship

$$jb = \pm \left[\frac{|R_{ML}|^2 (Y_o + G_L)^2 - (Y_o - G_L)^2}{1 - |R_{ML}|^2} \right]^{1/2}$$

where

jb = reactance of the parallel stub

Y_o = characteristic admittance of the transmission line

G_L = real part of load admittance

In this case Y_o and $G_L = 20$ mmhos. Hence,

$$jb = \pm \left[\frac{(0.951)^2 (20 + 20)^2 - (20 - 20)^2}{1 - (0.951)^2} \right]^{1/2}$$

$$= \pm 123.5 \text{ mmhos}$$

The negative sign was chosen for a shorted inductive stub to keep the over-all length below $\lambda/4$.

Step 2. Find the lengths for elements 3 and 4.

$$\tan \beta L = \frac{-Y_o}{jb} = \frac{20}{123.5} = 0.162$$

therefore,

$$\beta L = 9.2^\circ$$

but

$$\beta = \frac{2\pi}{\lambda}$$

and

$$\lambda = \frac{\text{velocity of light}}{\text{frequency}} = \frac{300 \times 10^6 \text{ meters/sec}}{750 \times 10^6 \text{ hz/sec}}$$

$$= 40 \text{ cm/hz}$$

Hence,

$$L = \frac{9.2^\circ}{360^\circ} \times 40 \text{ cm} = 1.02 \text{ cm}$$

For element 4

$$L_4 = (1.02)(0.7) = 0.715 \text{ cm}$$

where λ on Teflon Fiberglass $\frac{1}{16}$ " = $(0.7) (\lambda_{\text{free air}})$

For element 3

$$\Gamma = \left[\frac{Y_o - Y_L}{Y_o + Y_L} \right]$$

$$= \left[\frac{20 - (20 - j 123.5)}{20 + (20 - j 123.5)} \right] = 0.953 \angle 162^\circ$$

$$L_3 = \left[\frac{\theta_\Gamma - \theta_{R_{ML}}}{720^\circ} \right] \lambda (0.7)$$

$$= \left[\frac{162^\circ - 33.8^\circ}{720^\circ} \right] (40)(0.7) = 4.97 \text{ cm}$$

Input circuit

Step 1. Transform R_{MS} to $50 \pm jz$ ohms or $20 \pm jb$ mmhos using the relationship

$$jb = \pm \left[\frac{|R_{MS}|^2 (Y_o + G_s)^2 - (Y_o - G_s)^2}{1 - |R_{MS}|^2} \right]^{1/2}$$

where

G_s = real part of the source admittance which in this case is 20 mmhos. Hence,

$$jb = \pm \left[\frac{(0.730)^2 (20 + 20)^2 - (20 - 20)^2}{1 - (0.730)^2} \right]^{1/2}$$

$$= \pm 42.8 \text{ mmhos}$$

The positive sign was chosen for an open capacitive stub to keep its length below $\lambda/4$.

Step 2. Find the lengths of elements 1 and 2.

$$\cot \beta L = \frac{Y_o}{jb}$$

$$= \frac{20}{42.8} = 0.467$$

therefore,

$$\beta L = 65^\circ$$

and the length of element 1 is

$$L_1 = \left[\frac{65^\circ}{360^\circ} \right] (40)(0.7)$$

$$= 5.05 \text{ cm}$$

$$\Gamma = \left[\frac{Y_o - Y_s}{Y_o + Y_s} \right]$$

$$= \left[\frac{20 - (20 + j 42.8)}{20 + (20 + j 42.8)} \right]$$

$$= 0.730 \angle -137^\circ$$

Thus the length of element 2 is

$$L = \left[\frac{\theta_\Gamma - \theta_{R_{MS}}}{720^\circ} \right] \lambda$$

$$= \left[\frac{-137^\circ - 135.4^\circ}{720^\circ} \right] (40)$$

$$= - \frac{272.4}{720^\circ} \times 40$$

Since a positive angle is required, add 360° , then

$$L_2 = \frac{87.6^\circ}{720^\circ} (40)(0.7) = 3.42 \text{ cm}$$

The completed circuit is on page 105.

If a gain other than G_{MAX} had been desired, a constant gain circle would be required. For example, suppose a power gain of 10 db is desired. Thus,

$$G_p = 10 \text{ db}$$

and

$$G_o = |s_{21}|^2 = 3.686 = 5.666 \text{ db}$$

Discrete-component design

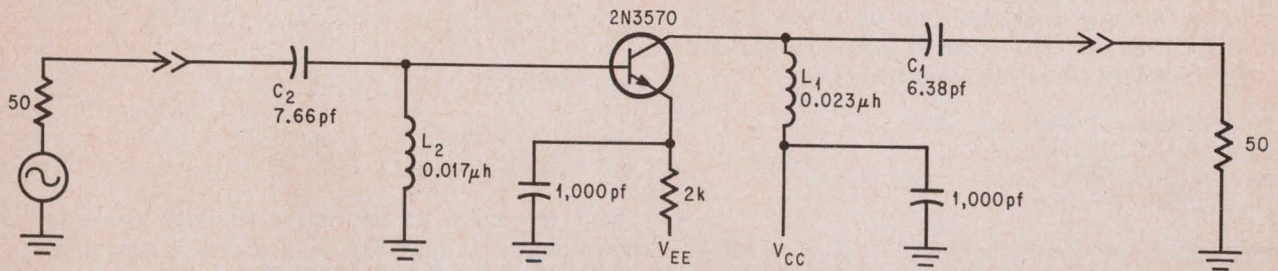
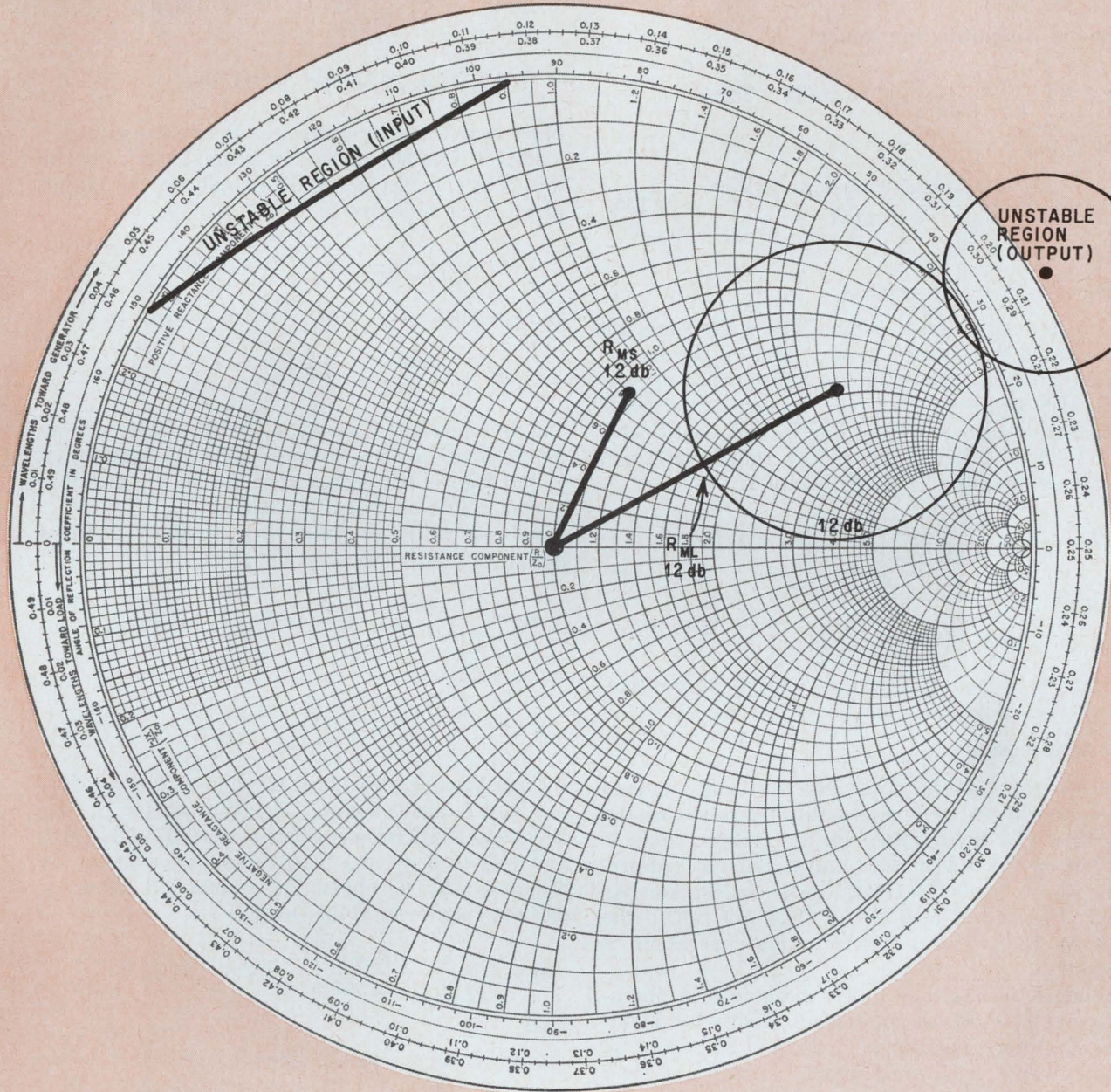

Design example. Graphical plot of a 500-MHz amplifier design using a 2N3570 transistor. Matching is achieved with discrete components whose values are determined from the Smith chart plot.

then

$$G = \frac{G_p}{G_o} = 2.713 = 4.334 \text{ db}$$

Now by computing the center

$$r_{o2} = \left[\frac{G}{1 + D_2 G} \right] C_2^* = 0.781 \angle 33.851^\circ$$

and radius

$$R_{o2} = \frac{(1 - 2K |s_{12}s_{21}| G + |s_{12}s_{21}|^2 G^2)^{1/2}}{1 + D_2 G} = 0.136$$

where

$$D_2 = |s_{22}|^2 - |\Delta|^2 = 0.614$$

a constant gain circle, which shows all loads for the output that yield a power gain of 10 db, can be constructed directly on the Smith chart on page 107. The R_{ML} picked in this example was $0.567 \angle 33.851^\circ$, and read off the Smith chart coordinates as $89.344 + j 83.177$ ohms. The source reflection coefficient required with this load is

$$R_{MS} = \left[\frac{s_{11} - R_{ML}\Delta}{1 - R_{ML}s_{22}} \right]^* = 0.276 \angle 93.329^\circ$$

Hence,

$$Z_s = 41.682 + j 24.859 \text{ ohms.}$$

Since K is greater than unity and B_1 is positive, unconditional stability is assured for all loads.

Alternate design

When the value of K is less than unity, a load must be chosen to assure stable operation of the amplifier. To accomplish this a stability circle is plotted on the Smith chart and examined to determine those loads that may cause oscillation. As long as a load is picked that does not fall in the area of the stability circle, stable operation is assured.

When K is less than unity, the gain of a potentially unstable device approaches infinity by definition. Therefore, equations 23, 25, and 27 cannot be used. Instead, a G_p must first be chosen and then the same procedure as used for $K > 1$ is followed.

The amplifier must be protected from oscillating by careful selection of the load impedance as demonstrated in this example.

Objective: Design an amplifier using a 2N3570 transistor that has a power gain of 12 db at 500 Mhz. The bias conditions are $V_{CE} = 10$ volts and $I_C = 4$ milliamperes. The s parameters are

$$\begin{aligned} s_{11} &= 0.385 \angle -55.0^\circ \\ s_{12} &= 0.045 \angle 90.0^\circ \\ s_{21} &= 2.700 \angle 78.0^\circ \\ s_{22} &= 0.890 \angle -26.5^\circ \end{aligned}$$

Solution: Compute the values of G , R_{MS} , and R_{ML} .

$$\begin{aligned} \Delta &= s_{11}s_{22} - s_{12}s_{21} = 0.402 \angle -65.04^\circ \\ C_1 &= s_{11} - \Delta s_{22}^* = 0.110 \angle -122.395^\circ \\ B_1 &= 1 + |s_{11}|^2 - |s_{22}|^2 - |\Delta|^2 = 0.195 \\ C_2 &= s_{22} - \Delta s_{11}^* = 0.743 \angle -29.881^\circ \end{aligned}$$

$$\begin{aligned} B_2 &= 1 + |s_{22}|^2 - |s_{11}|^2 - |\Delta|^2 = 1.483 \\ D_2 &= |s_{22}|^2 - |\Delta|^2 = 0.631 \end{aligned}$$

$$K = \frac{1 + |\Delta|^2 - |s_{11}|^2 - |s_{22}|^2}{2|s_{12}s_{21}|} = 0.909$$

$$G = \frac{G_o}{G_p} = 2.174 \text{ or } 3.373 \text{ db}$$

Since K is less than unity it is necessary to pick a load that does not cause oscillation. To accomplish this, first consider a stability circle on the output plane. This circle has a center at

$$r_{s2} = \frac{C_2^*}{|s_{22}|^2 - |\Delta|^2} = 1.178 \angle 29.881^\circ$$

and a radius of

$$R_{s2} = \frac{|s_{12}s_{21}|}{|s_{22}|^2 - |\Delta|^2} = 0.193$$

and is represented as the unstable region on the Smith chart on the previous page. As long as an output load is not picked that lies in the unstable region, stable operation is assured.

The constant gain circle that yields 12.0 db of power gain now has a center at

$$r_{o2} = \left[\frac{G}{1 + D_2 G} \right] C_2^* = 0.681 \angle 29.881^\circ$$

and a radius of

$$R_{o2} = \frac{(1 + 2K |s_{12}s_{21}| G + |s_{12}s_{21}|^2 G^2)^{1/2}}{1 + D_2 G} = 0.324$$

By constructing this constant gain circle, an output load is again chosen. The R_{ML} chosen on the circle had a reflection coefficient of $0.357 \angle 29.881^\circ$, and was read off the Smith chart coordinates as $85.866 + j 35.063$ ohms. The source reflection coefficient required for this load is

$$R_{MS} = \left[\frac{s_{11} - R_{ML}\Delta}{1 - R_{ML}s_{22}} \right]^* = 0.373 \angle 64.457^\circ$$

Thus,

$$Z_s = 52.654 + j 41.172 \text{ ohms}$$

Now a look at the stability circle plotted on the input plane is required to see if the value of R_{MS} assures stable operation. The circle on the input plane has a center at

$$r_{s1} = \frac{C_1^*}{|s_{11}|^2 - |\Delta|^2} = 8.372 \angle -57.605^\circ$$

and a radius of

$$R_{s1} = \frac{|s_{12}s_{21}|}{|s_{11}|^2 - |\Delta|^2} = 9.271$$

Only a portion of the input stability circle is shown due to its size. The shaded area is unstable.

Since R_{MS} does not fall inside this circle and R_{ML} does not fall inside the output circle stable operation is assured.

The complete circuit, bottom of page 107, was

constructed from this data. Values for the matching components were obtained using the following procedure.

Output circuit

Step 1. Transform R_{ML} to $50 \pm jz$ ohms or $20 \pm jb$ mmhos. Since individual components are used for matching it is necessary to convert R_{ML} to its parallel equivalent circuit by adding -180° to a positive angle, or $+180^\circ$ to a negative angle.

Therefore,

$$R_{ML1} = 0.357 \angle -150.119^\circ$$

Using the formula

$$Y_L = \left[\frac{1 + R_{ML1}}{1 - R_{ML1}} \right] Y_0$$

where $Y_0 = 20$ mmhos

$$Y_L = 10 - j4.08 \text{ mmhos}$$

Converting the Y_L admittance to an impedance yields $Z_L = 100 - j245$ ohms.

Step 2. Compute the value for the capacitor from the relationship

$$X_c = \sqrt{(R_p - R_s)R_s}$$

where

$$R_p = \text{real part of } Z_L = 100$$

$$R_s = \text{load impedance} = 50$$

therefore,

$$X_c = \sqrt{2500} = 50$$

and

$$C_1 = \frac{1}{2\pi f X_c} = 6.38 \text{ pf}$$

Step 3. Compute I_1 from

$$X_{L1} = \frac{R_s^2 + X_c^2}{X_c} = \frac{(50)^2 + (50)^2}{50} = 100$$

The total X_L is

$$X_{LT} = \frac{(X_{L1})(X_L)}{(X_{L1} + X_L)} = 71$$

where

$$X_L = 245 \text{ ohms} = \text{imaginary part of } Z_L$$

hence,

$$L_2 = \frac{X_{LT}}{2\pi f} = 0.023 \mu\text{h}$$

Input circuit

Step 1. Transform R_{MS} to $50 \pm jz$ ohms or $20 \pm jb$ mmhos. To do so convert R_{MS} to its parallel equivalent circuit by adding -180° to a positive angle, or $+180^\circ$ to a negative angle.

Therefore,

$$R_{MS1} = 0.373 \angle -115.543^\circ$$

Using the formula

$$Y_s = \left[\frac{(1 + R_{MS})}{(1 - R_{MS})} \right] Y_0$$

where $Y_0 = 20$ mmhos

Compute Y_s . Thus,

$$Y_s = 11.8 - j9.4 \text{ mmhos}$$

or

$$Z_s = 84.7 - j106.4 \text{ ohms}$$

Step 2. Compute C_2

$$X_{C2} = \sqrt{(R_p - R_s)R_s}$$

where

$$R_p = \text{real part of } Z_s = 84.7 \text{ ohms}$$

$$R_s = \text{source impedance} = 50 \text{ ohms}$$

Thus,

$$X_{C2} = 41.6 \text{ ohms}$$

and

$$C_2 = \frac{1}{2\pi f X_c} = 7.66 \text{ pf}$$

Step 3. Compute L_2

$$X_{L2} = \frac{R_s^2 + X_{C2}^2}{X_{C2}} = \frac{(50)^2 + (41.6)^2}{41.6}$$

$$= 102 \text{ ohms}$$

$$X_{LT} = \frac{(X_{L1})(X_L)}{(X_{L1} + X_L)} = 52.2 \text{ ohms}$$

where

$$X_L = \text{imaginary part of } Z_s = 106.4 \text{ ohms}$$

hence

$$L_2 = \frac{X_{LT}}{2\pi f} = 0.017 \mu\text{h}$$

Bandwidth, the third important design factor, is dependent on the Q of the circuit. There are no magic formulas for accurately predicting bandwidth in all cases. Many LC combinations provide the same complex impedance at the center frequency but yield different Q's and bandwidths.

If the inherent bandwidth, Q, of a transistor loaded with a particular LC combination yields a bandwidth that is greater than desired, adding LC elements narrows the bandwidth and keeps the gain constant. But if the inherent bandwidth is narrower than desired, a gain reduction or different LC combination changes the bandwidth.

The author

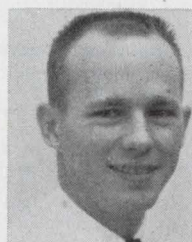

William H. Froehner, who started working at TI in 1964, designs high frequency measurement and test equipment. In the last 18 months he has been applying the scattering parameter technique to design high frequency amplifiers.

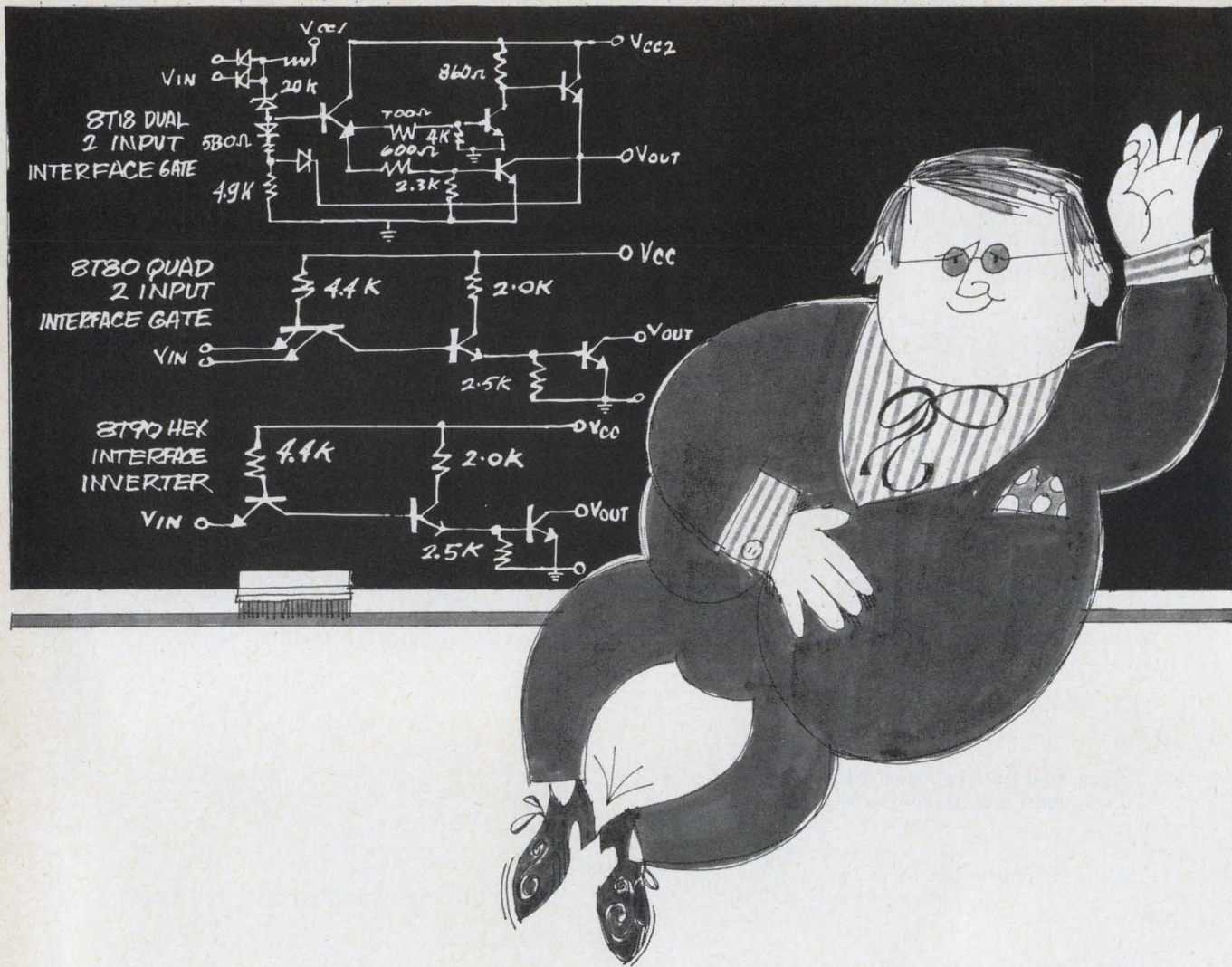

EUREKA! Signetics solves the IC interface problem.

We've just saved you time and money and simplified your system design procedures. There are three new interface elements in the DCL series. They are designed specifically to match system levels of up to 30 volts with DCL levels of 5 volts. In addition to their obvious application in level translation and buffering, they may be used as lamp, relay and line drivers.

Hooray! No more special discrete component designs at interfaces. Signetics has done it again! Just circle the number on the bingo card, or write, and we'll be happy to send you the data sheets on the 8T18 Dual 2-Input Interface Gate, 8T80 Quad 2-Input Interface Gate, 8T90 Hex Interface Inverter.

**SIGNETICS
INTEGRATED
CIRCUITS**

A SUBSIDIARY OF CORNING GLASS WORKS
811 East Argue Avenue
Sunnyvale, California 94086

SIGNETICS SALES OFFICES: Metropolitan New York (201) 992-3980; Upper New York State (315) 469-1072; Southwestern (214) 231-6344; Western Regional (213) 272-9421; Eastern Regional (617) 245-8200; Mid-Atlantic (609) 858-2864; Southeastern (813) 726-3734; Midwestern Regional (312) 259-8300; Northwestern (408) 738-2710.

DISTRIBUTORS: Compur at all locations listed below. Semiconductor Specialists, Inc. (312) 279-1000; Terminal Hudson Electronics (212) 243-5200; Wesco Electronics (213) 684-0880; Wesco Electronics (405) 968-3475; Hammond Electronics (305) 241-6601; Avnet Electronics Corp. of Massachusetts (617) 272-3060.

DOMESTIC REPRESENTATIVES: Jack Pyle Company (415) 349-1266. Compur Corporation at the following locations: Alabama (205) 539-8476; Arizona (602) 947-4336; California (213) 245-1172; California (415) 697-6244; Colorado (303) 781-0912; Connecticut (203) 288-9276; Florida (305) 855-3964; Illinois (312) 775-5300; Maryland (301) 484-5400; Massachusetts (617) 969-7140; Michigan (313) 476-5758; Minnesota (612) 922-7011; Missouri (314) 428-5313; New Jersey (609) 429-1526; New Mexico (505) 265-1020; New York (518) 436-8536; New York (607) 723-8743; New York (716) 684-5731; New York (201) 471-6090; North Carolina (919) 724-0750; Ohio (216) 333-4120; Ohio (513) 878-2631; Texas (214) EM 3-1526; Texas (713) 649-5756; Washington (206) 725-7800.

INTERNATIONAL SALES: France, Germany, Italy, Belgium, Holland, Luxemburg, Spain—Sovcor Electronique, 11, Chemin de Ronde, Le Vesinet, (S.-&O.) France. United Kingdom, Ireland, Sweden, Denmark, Norway, Switzerland, Austria, Portugal—Electrosil Ltd., Lakeside Estate, Colnbrook-By-Pass Slough, Buckinghamshire, Great Britain. Australia—Corning, 1202 Plaza Building, Australia Square, Sydney, N.S.W. 27-4318. Canada—Corning Glass Works of Canada, Ltd., Leaside Plant, Ontario, Canada (416) 421-150. Israel—Optronix, P.O. Box 195, Ramat-Gan, Israel 724-437. Japan—ASAHI Glass Co., Ltd., Corning Products Sales Dept. No. 2, 3-Chome Marunouchi, Chiyoda-ku, Tokyo, Japan.

Air traffic cop eyes 'bandits,' too

First solid state 3-D radar uses digital signal processing to zero in on a plane's range, bearing and altitude; Air Force is planning to install the new system at its forward bases

"Bandit at 33,000 . . . bearing, three-two-zero . . . range, 150 miles and closing fast!"

Sound like a line from an old John Wayne war movie? Perhaps. But it could also be what an operator of a tactical three-dimensional radar says. For, in effect, it sums up the many military roles of 3-D radar: detecting enemy aircraft and missiles, guiding interceptor aircraft and missiles, and controlling air traffic. The radar does all this by computing and displaying a target aircraft's altitude as well as its bearing and range.

The Air Force's newest 3-D radar is the AN/TPS-43, which has several design features that set it apart from others in its class. Among these is the unusually shaped array of feedhorns shown below, part of a computer-designed beam-sharing system that is expected to make the radar exceptionally accurate.

Built by the Westinghouse Electric Corp. as part of the Air Force's 407L tactical air control system, the radar was designed so that all the transmitting and receiving circuitry fit into a housing that is easily transportable by helicopter. In so doing, the company came up with the first solid state, 3-D tactical radar. About 70% of the search- and altitude-processing circuits are monolithic and hybrid integrated circuits—about 3,000 ic's in all. Its moving target-indicator subsystem is also the first to operate digitally, the company claims.

The Air Force plans to deploy the 3-megawatt radar at forward air bases, primarily to control the traffic of friendly aircraft and to detect intrusions by unfriendly planes.

A new coding technique and a narrower signal bandwidth—2.9 to 3.1 megahertz—makes the TPS-

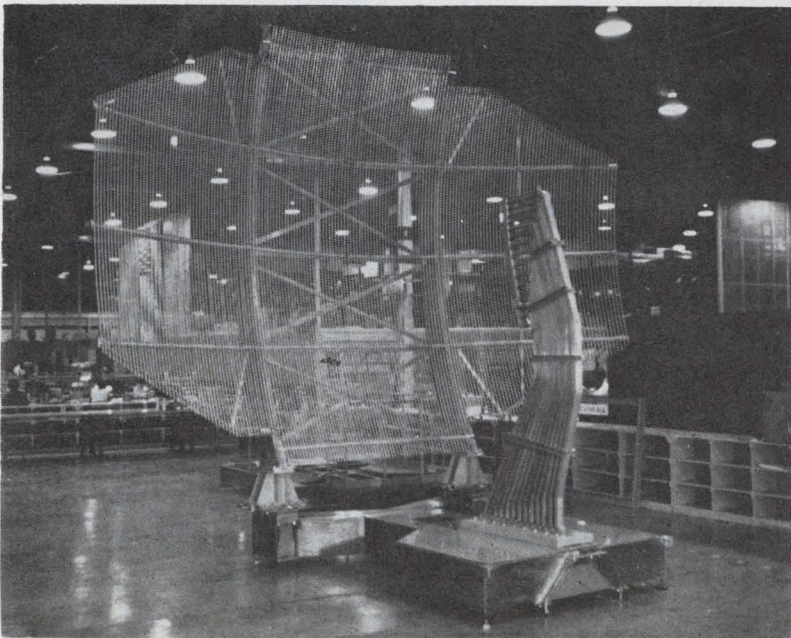

Prototype. Set up on test stand at Westinghouse Defense and Space Center in Baltimore, AN/TPS-43 has feedhorn array mounted in front of 20-by-14-foot reflector. A second S-band antenna, for sidelobe signals, which would be mounted behind the feedhorn assembly, isn't shown.

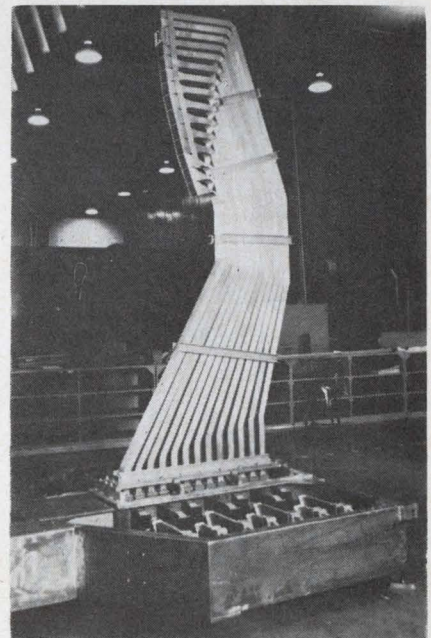

Horn array. Antenna feedhorns stand on base containing transmission waveguide and a stripline matrix that feeds six receivers.

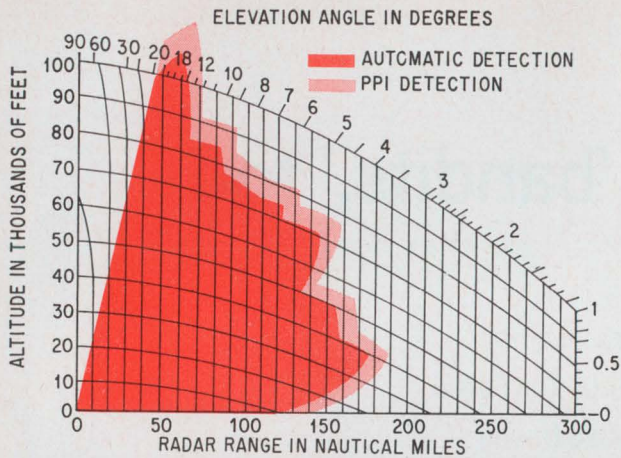

Three-dimensional. Search coverage of antenna-beam pattern. Azimuth is determined by pedestal rotation.

43 less susceptible to countermeasures than previous 3-D radars and contributes to the accuracy.

Air Force specifications require the radar to be capable of detecting aircraft at ranges up to 150 miles and altitudes up to 75,000 feet, and to compute the height to within $\pm 3,000$ feet. Westinghouse's engineers claim the system will surpass these specifications.

Moreover, because of the high percentage of IC's, they expect a mean time between failure of 200 hours—about 10 times the reliability, they say, of previous systems of this type. The only

tubes in the set are the modulator-driver thyatron, transmitter power amplifier and driver, traveling-wave tubes in the receiver, and the cathode-ray tube of the plan position indicator (PPI).

Under an \$18.5-million contract with the Air Force System Command's Electronic Systems Division, Westinghouse's Surface division is providing two prototypes and 17 production models of the system.

Shared apertures

There are 15 feedhorns in the array. When the radar is transmitting a pulse, the horns radiate in concert and a unified beam fans out from the parabolic reflector to cover a narrow slice of sky. As indicated by the range-elevation plot at the left, the elevation coverage is from 0.5 to 20° above the horizon. The horizontal beam pattern is narrow—about 1.1°—for accurate bearing or azimuth discrimination.

In the receive mode, the radar's return signals are viewed as being in six overlapping beams, shown below. Two or more feedhorns jointly receive each beam, and each beam shares one or more horns with adjacent beams. There are six receivers in the system. The basic beam-stacking technique was devised several years ago by the company and used in earlier three-dimensional radars.

For the TPS-43, however, the designers came up with the new microwave subsystem shown on

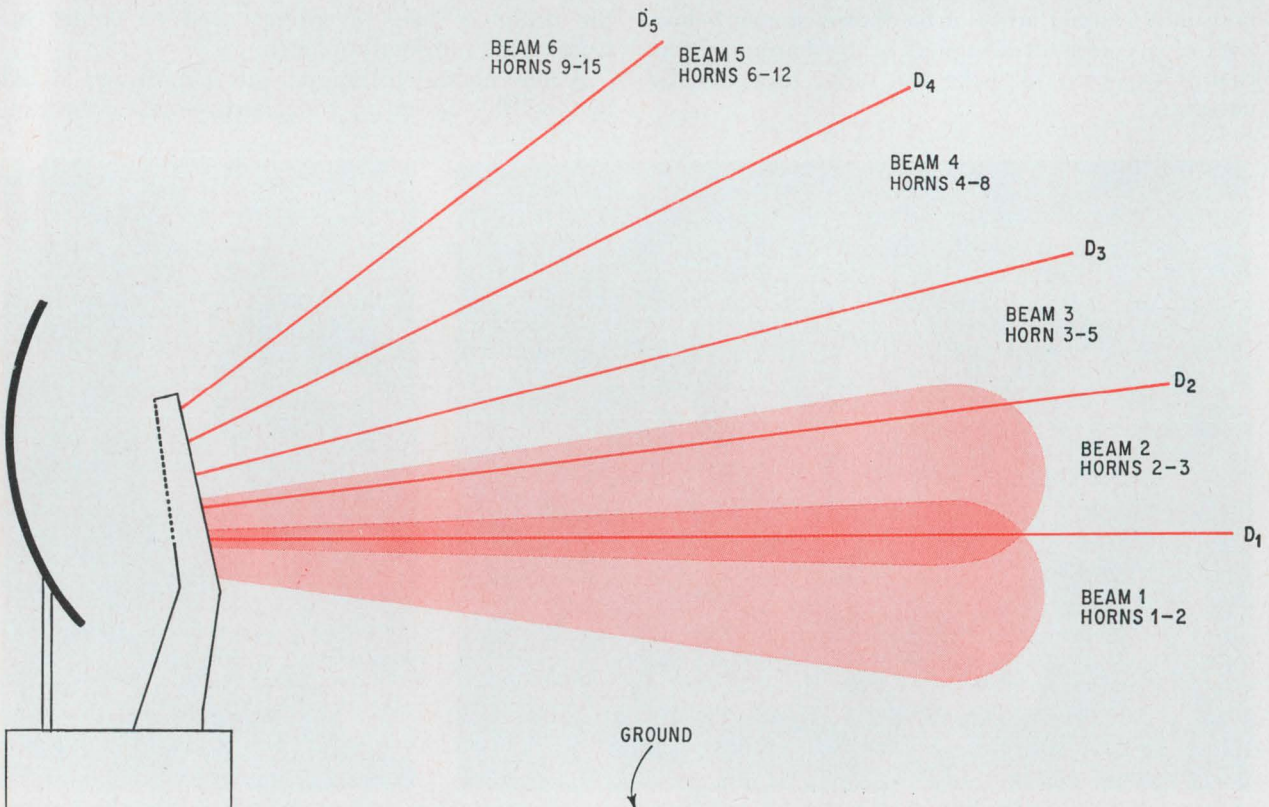

Overlapping beams. Five pairs of receive beams are formed by the overlapping of adjacent beams. Difference curves D_1 through D_5 must be approximately straight lines for accurate height interpolation. Tinted area is the lowest beam pair.

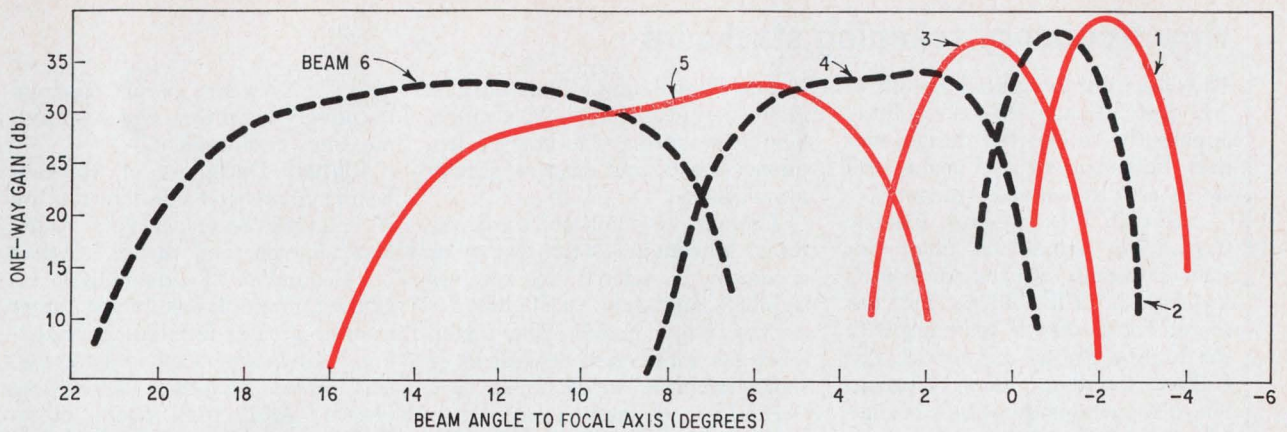

Beam shapes. Beams 4, 5, and 6 were deliberately distorted to make the difference curves between beams as straight as possible.

this page, which separates transmission and receiving functions. Waveguide is now needed only to handle the transmitter's high-power output. Large pieces of waveguide are no longer required in the receiver's beam-forming matrix. To combine the energy received by each group of horns and feed the radar's receivers, a matrix made of stripline is used.

Beam alignment

The separation of transmitting and receiving functions enabled Westinghouse's engineers to optimize the antenna design for both the transmission and reception of radar signals.

As a transmitter, the rps-43 operates much like a conventional two-dimensional radar. The feedhorns aim energy at the paraboloid antenna to form a cosecant-squared beam pattern.

In the receive mode, beam 1—the beam closest to the horizon—uses horns 1 and 2. Beam 2 shares horn 2 with beam 1 and horn 3 with beam 3. Beam 3 uses horns 3 through 5, beam 4 uses horns 4 through 8, beam 5 uses horns 6 through 12, and beam 6 uses horns 9 through 15. Antenna gain ranges from 39.2 decibels for beam 1 to 32.6 db for beam 6.

To prove the aperture-sharing concepts and design the antenna, the engineers employed a digital computer. With it, they evaluated the beam-diffraction patterns for a given set of reflector and feedhorn parameters. After beam patterns for an initial set of conditions were computed, the parameters were modified to resolve the differences between the computed and desired patterns.

The biggest design problem was shaping the beams for proper coverage and overlap within the 0.5-20° elevation pattern. To make the difference curve between any two adjacent beams approximate a straight line—necessary for high accuracy in elevation—the vertical shapes of the beams were adjusted. In stacked-beam radars, the difference curves are straightened by making each beam's aperture overlap and physically interfere with its neighbor. Since each beam in the rps-43

shares several apertures, the horn grouping for each beam was first designed as though the others weren't present. Then, as the array was built up, the apertures overlapped.

Another consideration in designing a multihorn array is that a beam's elevation angle is determined by the angle between the focal axis of the antenna and a line drawn from the feed point to the center of the antenna. Only one feedhorn can be placed at the focal point of a parabolic reflector; the others in the array must be displaced. Although displacement of the horns is necessary in achieving high elevation angles, it has a drawback: the farther the horns are from the axis, the smaller the reflector area they can

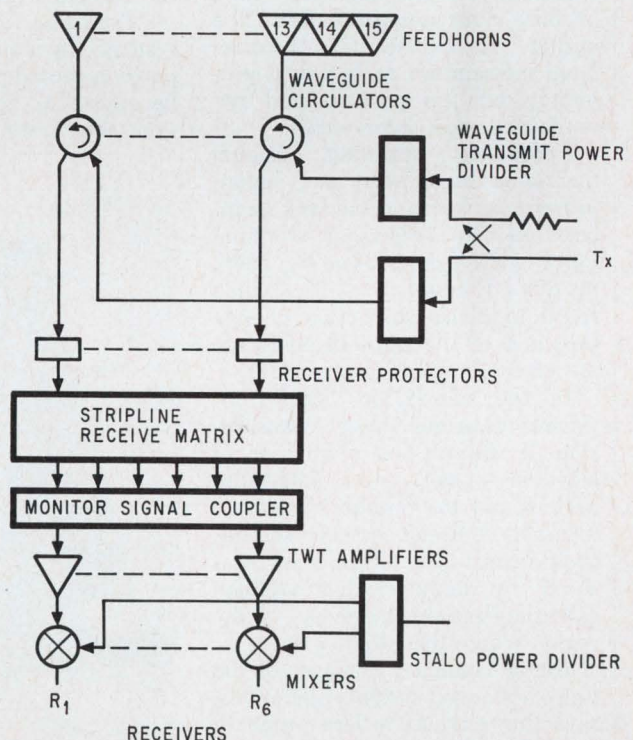

Microwave subsystem. Waveguide-power divider feeds transmitted power to feedhorns. Return signals are routed through circulators and stripline to receivers. The use of stripline cuts antenna weight.

How frequency scanning stacks up

The advent of integrated circuits in 3-D tactical radar has done little, apparently, to end the design contest between stacked-beam and electronically scanned systems.

Although Westinghouse Electric Corp. has scored a point for stacked beams with the Air Force's AN/TPS-43, ITT Gilfillan Inc. has scored for electronic scanning with the Marine Corps' AN/TPS-32. The Gilfillan system, like Westinghouse's, contains thousands of digital integrated circuits.

The first of these height-finding, air-defense radars is now undergoing acceptance tests at the West Coast plant of the International Telephone & Telegraph Corp. subsidiary. Eventually, it will be tried out as the primary sensor in the Marines' tactical-data system.

The TPS-32 is a follow-on to the Navy's AN/SFS-48, which has been in service in Vietnam for more than a year. But the new radar is more than a microminiature, younger brother of the SFS-48, says Neil T. Keyes, manager of Gilfillan's tactical-radar operation.

Keyes says the TPS-32 is the first frequency-scanning system conceived from the start as a fully automatic sensor. It processes both radar and IFF (identification friend or foe) data automatically. "The output," he explains, "is a correlated message for each target, providing data on position and IFF without human intervention."

Frequency scanning. Digital techniques have been used before in frequency-scanned radars, members of the electronic-scanning family [Electronics, June 27, 1966, p. 80]. Frequency shifts, which result in phase shifts that change direction of the transmitted beam, are often computer controlled.

In the TPS-32, a digital programmer manages power transmission. It controls—as a function of elevation—peak power, interpulse period, and the number of hits on a target. A target is seen by multiple beams. Its altitude is measured by finding what Gilfillan calls the "center of gravity" of the region where the target is seen.

Irving Hammer, manager of the firm's advanced systems operations, says this method is less prone to error than the stacked-beam method of finding altitude by comparing amplitudes of signals in adjacent

beams. Direct comparisons can't be made, because the TPS-32's range, height-measuring accuracy, frequency band, and scan sensitivity are classified.

There is, he points out, a receiver for each beam in a stack, so angular accuracy is related to receiver stability and how well the receivers' gains match. The match must be maintained regardless of signal strength, he continues, so a stacked-beam system is more susceptible to jamming. "You can't depend on getting instantaneous amplitude comparison, and you lose one of your three dimensions—target altitude."

Hammer and Keyes also contend that the shape of the lowest beam in a stack continually varies because of radiation reflected from the ground. "If you can't predict the shape of the lowest beam, you can't accurately measure the amplitude of the signal from the two adjacent beams," Keyes says.

Keyes claims further that a frequency-scanned radar's planar-antenna array can provide optimum illumination throughout the area of coverage. He contrasts this with the stacked-beam problem of being able to put only one horn at the reflector's focal point.

"Typically, in a stacked-beam system, the horn at the optimum position provides the lowest beam," he adds. "As you go up in elevation, side lobes become very poor

and the system doesn't operate effectively in an electronic counter-measures environment."

Clutter. Designers of stacked-beam systems concede that the use of multiple receivers is a drawback, but contend that it is offset by a number of advantages, including lower losses, more target returns, greater freedom in changing frequencies to avoid jamming, and better indication of moving targets. And, they claim cross-polarization reduces weather clutter.

Keyes says special emphasis was given to clutter reduction in the TPS-32 design, and that the system now being tested "successfully eliminates clutter by combining a sophisticated moving-target indicator and three-dimensional blanking of the residue."

Integrated circuits. Most of the digital IC's in the TPS-32 are diode-transistor logic (DTL) circuits, with some transistor-transistor logic (TTL) in driver and timing circuits. DTL costs less, Keyes explains.

In the digital portions of the radar, the IC's are packaged in throwaway modules of six IC's each, to simplify maintenance. Seven types of these modules are used and inexperienced maintenance men can easily replace them. Field troops could handle 90% of the troubles that could occur in the system, Keyes says.

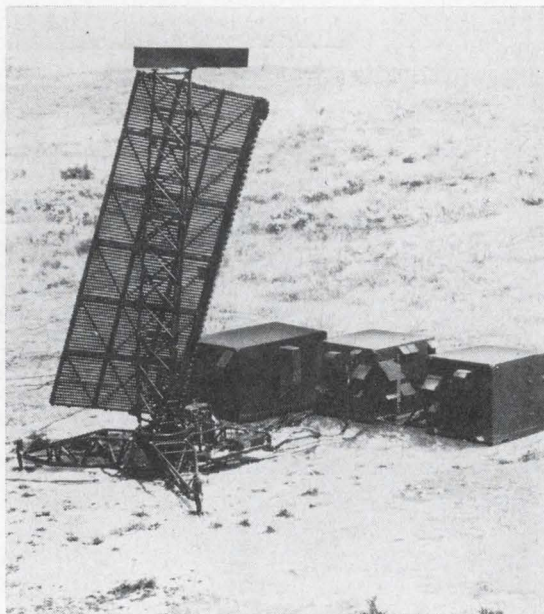

Bigger system.

Frequency-scanning AN/TPS-32 is much larger than the stacked-beam AN/TPS-43. Its antenna is 30 feet high and circuitry is packaged in three helihuts, one measuring 12 by 7 by 7 feet and the other two 8 by 7 by 7 feet.

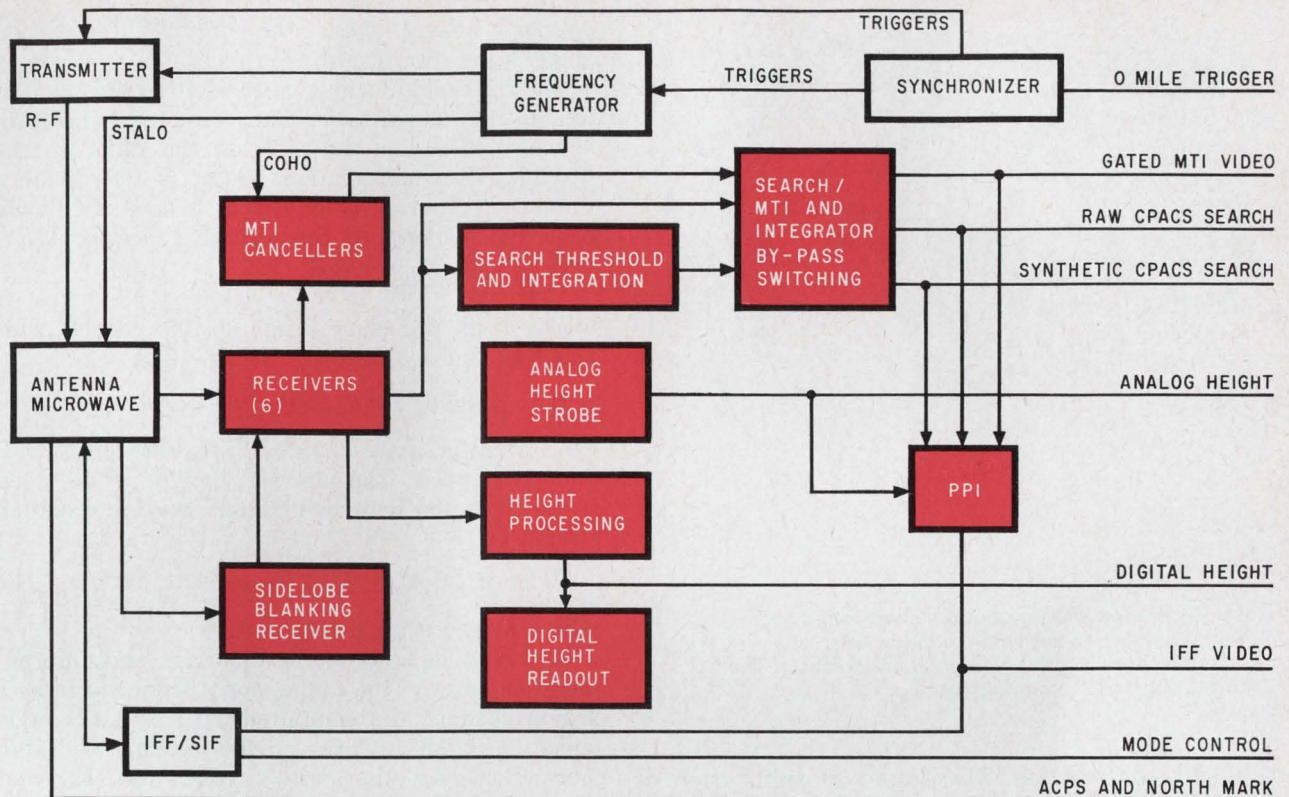

Radar system. Except for traveling-wave tubes and the PPI cathode-ray tube, receiver circuits (in color) are solid state and computing is done digitally.

use and the broader the reflected beam.

Westinghouse's engineers overcame the difficulty by placing the horns above and below the focal axis as shown by the curves on page 113, thus limiting the beam size, and then tilting the antenna to aim the low beams near the horizon.

Signal processing

As a receiver, the TPS-43 starts out as a collection of six radar receivers whose outputs are merged through an intricate processing and computing sequence (above, and p. 116). After amplification in the radio-frequency and intermediate-frequency stages, the signals are pulse-compressed. Each signal is then divided between a search channel, which examines the video for moving targets, and a channel that determines target height. In both channels, the signal processing is digital. A digital shaft encoder on the antenna pedestal indicates target bearing.

To detect and display moving targets, the analog signals are digitized and stored in a ferrite-core memory. A digital two-pulse canceller compares the phases of two successive returns. If the phase has not shifted between pulse periods, it means the target is stationary and it is cancelled.

Lane Letsch, a Westinghouse project engineer, says the digital technique eliminates the frequency-drift problems of analog moving-target-indicator circuits. These generally use quartz delay lines to hold a pulse for phase comparison with the following pulse. Frequency variations could be

read as phase shifts, falsely identifying a stationary or slow-moving object as a moving aircraft—a real target.

Pulse compression and phase coding are done by a classified technique, which Westinghouse calls Cpacs (coded-pulse anticlutter system). It shortens the length of received pulses—as do other pulse-compression techniques—to improve ranging accuracy. Altitude accuracy is also improved, since range is a factor used to compute target height. In addition, Cpacs helps prevent false target identification and reduces the effects of meteorological and other natural disturbances.

Sidelobe cutout

Reference signals for sidelobe blanking are obtained from a second S-band antenna. This is a dipole array forming a 12-by-51-inch rectangle that is mounted on the back of the feedhorn assembly. The beam pattern overlaps the main antenna's azimuth sidelobes.

Signals picked up by the sidelobe antenna are processed like the signals in the main receiver channels, except that the sidelobe receiver's gain is about 1 db higher. A difference amplifier compares the return-signal energy in the sidelobe channel with the signal energy in the main channel. If the sidelobe-signal level is greater, the supposed target is in the sidelobes and the logic circuitry blanks it from the radar's display.

Beam splitting or amplitude monopulsing—a common radar technique—is the basis for the

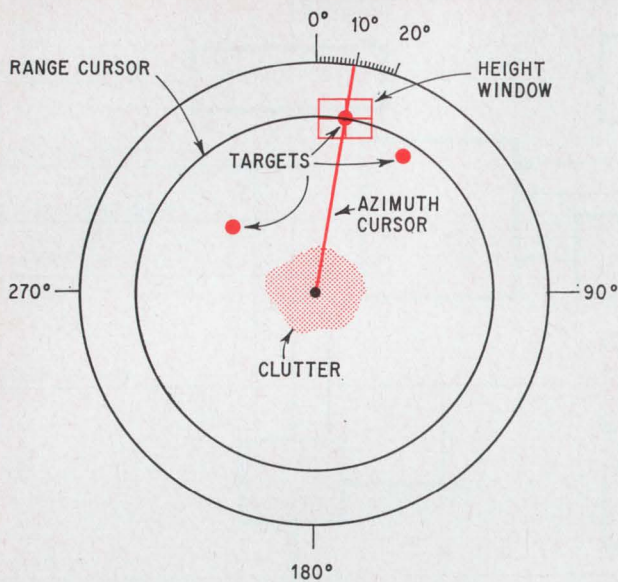

Height window. Radar operator uses range and height cursors to set height window over a selected target on the plan position indicator. The target altitude is then displayed.

height computation. Westinghouse splits each of the receiver's six input channels in two so that the sum and difference of the radar return energy in adjacent beams can be computed.

From among the five beam-pairs, a peak selector chooses the pair that contains the greatest signal energy. The selector's output is used to establish the target base-height angle, θ_B . The difference in the radar energy in each of the

selected beams yields the target interpolation angle, θ_i , as shown on facing page.

The base-height angle is formed by the centerline of the beam pair that contains the return signals and a line drawn from the radar to the horizon. The interpolation height is the distance the target aircraft is above or below the beam centerline. Therefore the aircraft's height, H , is

$$H = R \sin (\theta_B + \theta_i)$$

where R is the slant range to the target. This equation can be extended to show that

$$H = R \sin \theta_B \cos \theta_i \pm R \sin \theta_i \cos \theta_B$$

but since θ_i is small, it is safe to assume $\cos \theta_i = 1$, and $\sin \theta_i = \theta_i$. The aircraft's height would then be equal to the base height plus the interpolation height, or

$$H = R \sin \theta_B \pm K_1 \theta_i R \cos \theta_B$$

where K_1 is a scale factor of θ_i .

However, in addition to the base and interpolation angles and the range signal from the radar's search channel, the computer receives a tilt-angle signal, θ_T , from a sensor on the antenna pedestal. Corrections for the earth's curvature, K_e , and atmospheric bending of the radar beam are pre-calculated and stored on pin boards in the computer's memory-circuit banks.

Actual aircraft altitude is the sum of all these variables, or

$$H_T = [\theta_T + RK_e + \sin \theta_B + (K_1 \cos \theta_B) \theta_i] R$$

plus site elevation.

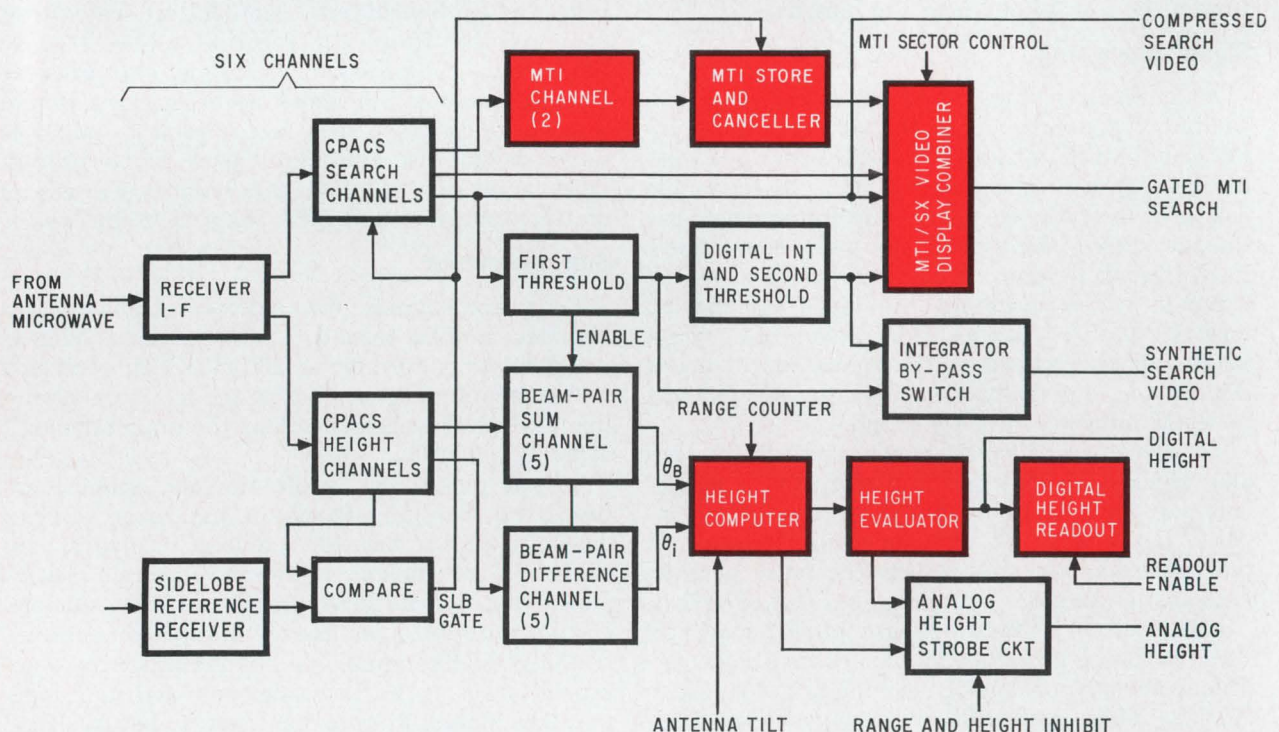

Receiver. Each of the six input channels is split so target altitude and radar video can be processed separately. Moving targets are detected and height computed with the digital subsystem shown in color.

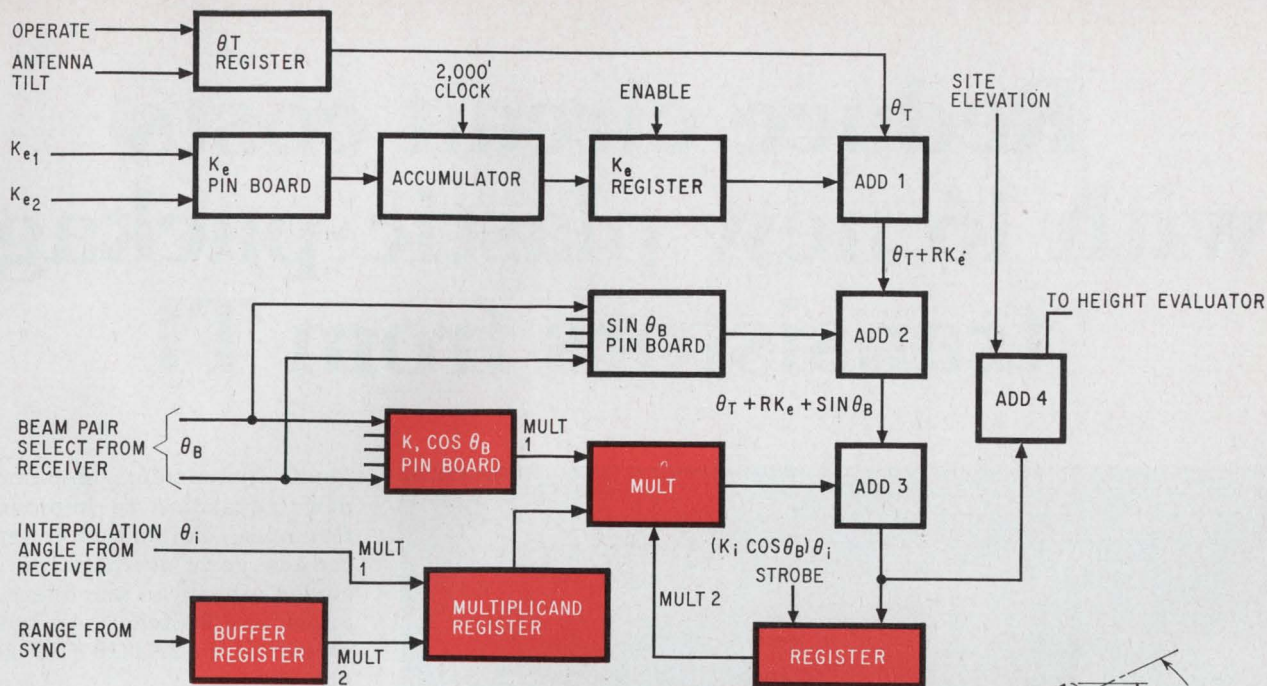

Height computer. Constants and variables processed by the computer are defined at right. The computer selects the correct set of beam constants, then sums them and multiplies by range in the tinted blocks.

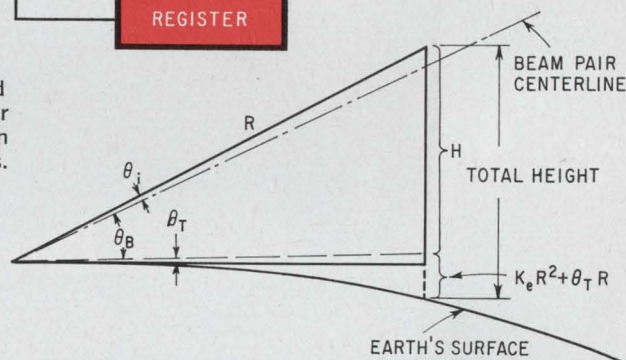

Each time the radar beam strikes a target the computer calculates the target's height. A logic circuit at the output of the height computer selects the average of the three most consistent altitude calculations for display.

Three videos

At a control station remote from the radar unit, Air Force traffic controllers will be able to display any of three video outputs: raw undigitized, synthetic, or gated moving-target-indicator video. The raw-video display, the most sensitive of the three, is used for ordinary radar search purposes. For automatic tracking, the operator usually employs the synthetic-video output because the radar signal is integrated over a finite time period to lower the false-alarm rate. In high-clutter areas, however, he may choose to display a gated output. In this instance, he selects the sector in which he wants to detect moving targets in clutter; raw video is displayed in all other areas.

To determine an aircraft's altitude, the operator merely flips a toggle switch on the control panel and turns on a window—whose width in azimuth is 10 nautical miles and length in range is 4 miles—like that shown on the preceding page.

By manipulating the range and azimuth cursors, the operator places the window over the target. This sets up the range and azimuth gates in the digital height-evaluation circuit. He then presses a button that causes the data in these gates to be sent into a register. After the register is

decoded, the height is displayed numerically.

To obtain the relative altitude between two targets, the height window is positioned over the second target. By depressing a relative-height switch, the altitude data on this target is inserted into a second register. Then the data in the two registers are subtracted one from the other and the difference displayed. The radar operator can also use a wedge-shaped height window, 5° wide and 4 nautical miles long. It is useful in determining the relative altitude of close-in targets.

To keep the radar's downtime low, the TPS-43 has a built-in manual test system that checks the radar even while it's operating. A low-level signal from the frequency generator is coupled into the low-noise traveling-wave tube at the input of each receiver channel. The radar processes the signal as if it was an actual return. By using the test signal, technicians can set amplifier gains and adjust threshold levels. If the signal is not being processed correctly, a fault is indicated.

The radar's electronics (transmitter, receiver, processors, and so forth) are contained in a 7-by-7-by-9-foot hut, and the antenna and microwave assembly are mounted on a separate pallet. Total weight of each is about 3,500 pounds. Multi-conductor cables and flexible waveguide interconnect the hut, antenna, and control station.

Reduce circuit costs with 16 new plastic-package transistors from TI

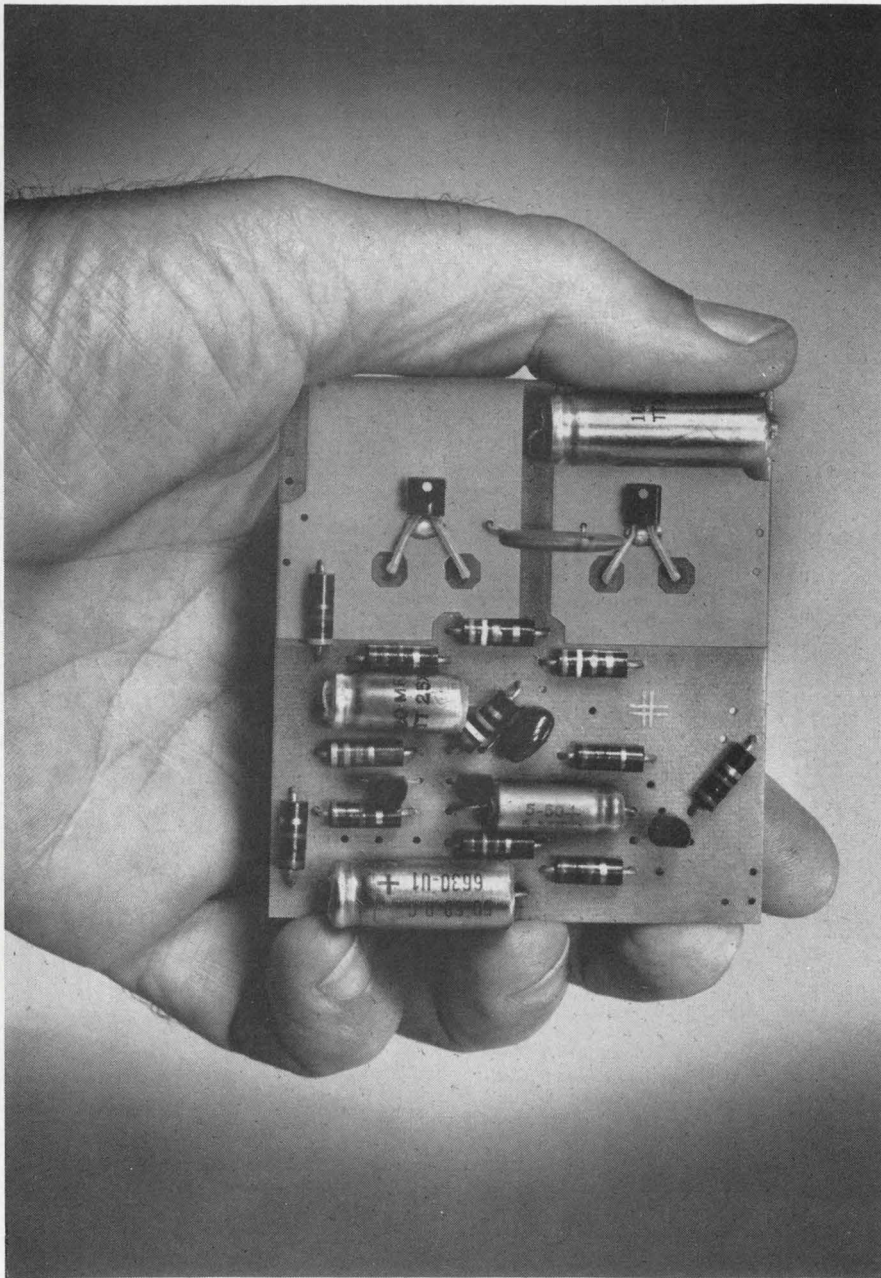

Texas Instruments announces 16 new transistors to improve performance, simplify circuitry and reduce your product costs. Included are silicon amplifiers, oscillators and switches. An economy version of the 2N4416 FET is available, too.

All the new transistors are offered in TI's exclusive SILECT™ economy plastic package. Lead configurations include: in-line, TO-18, and high-frequency. The new HF arrangement provides improved isolation and lower feedback capacitance for VHF and UHF devices.

TI's SILECT package, backed by 30,000,000 hours of testing, is fully capable of meeting military specifications. Reliability has been found to be equivalent to metal-can devices tested under the same conditions.

High-dissipation SILECT package eliminates heat sinks

Here are the first economy small-signal transistors to feature power dissipation of 1.6 watts at 25°C case temperature—nearly twice that of devices with comparable packages. Specially processed, high-thermal conductivity leads achieve this added dissipation. Designated as NPN types TIS90 and TIS92, and PNP types TIS91 and TIS93, these complementary devices are also available in matched pairs (TIS90M/TIS91M and TIS92M/TIS93M).

The new, high-dissipation packaging allows plastic transistors to be used in applications formerly

restricted to metal-case, medium power devices or to the use of elaborate and expensive heat sinks.

An effective heat sink can be obtained *at no extra cost* by leaving an area of copper on the face of the etched circuit board and connecting the high-conductivity collector lead to it (as shown at left).

The complementary pairs are designed for low-cost audio driver and output circuits up to two watts for phonograph applications.

Electrical characteristics are similar to the 2N2222 NPN and 2N2907 PNP families.

Circle 325 for data sheet.

New high-frequency FET doubles previous frequency capability

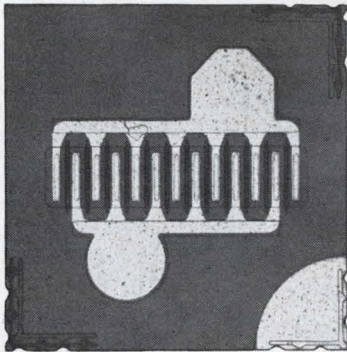

The new TIS88 silicon FET—plastic-encapsulated equivalent of the 2N4416 also offered by TI—features a frequency capability twice that of similar devices previously available in low-cost plastic packages. The high-performance FET operates up to 400 MHz with 10 dB minimum power gain. High transconductance and low feedback capacitance make this new

device especially useful for consumer, industrial and military applications, including FM RF amplifiers, cascode-connected VHF amplifiers and sonobouy input amplifiers. Performance characteristics include a low noise figure (4 dB maximum at 400 MHz) and low leakage ($I_{GSS} = 1nA$ maximum).

Circle 326 for data sheet.

New low-cost NPN devices for TV and audio applications

TIS83. Designed for use in UHF tuners, the new TIS83 transistor features a high injection current ($I_{osc} = 2.5$ mA minimum at 930 MHz). Transconductance is high ($Y_{fs} = 70$ mmhos at 200 MHz), permitting use with Schottky-barrier or AFC diodes.

Circle 328 for data sheet.

TIS84-85. New TIS84-85 transistors are designed for RF amplifiers and first and second video IF applications. They feature low noise figures (3.3 dB max @ 200 MHz for the TIS84), low feedback capacitance (0.4 pF maximum) and excellent forward AGC characteristics. The AGC control-voltage range is narrow, making only one device necessary for both IF sockets. The 100-mil B-E-C high frequency pin configuration isolates input and output circuitry.

Circle 329 for data sheet, which includes 10 performance curves and two application circuits.

TIS86-87. New TIS86-87 high-frequency silicon transistors are designed for such TV applications as mixers, reverse-AGC IF, and third IF. Feedback capacitance is

low at 0.45 pF maximum, permitting unneutralized IF-stage design. Real and imaginary parts of y-parameters at 45 and 200 MHz simplify circuit design. Pin configurations are 100-mil, B-E-C.

Circle 330 for data sheet.

TIS94-99. This is a complete family of low-noise, low-to-medium current SILECT transistors for use in hi-fi audio amplifiers and general purpose low-frequency applications. They feature excellent Beta linearity to 100 mA, high current gain, low noise figures and high breakdown voltage (65 V min $V_{(BR) CEO}$ for the TIS96 and TIS99).

Circle 331 for data sheet.

New economy semiconductor designer's kit

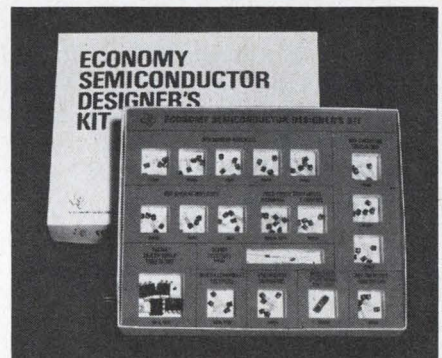

TI's new designer's kit enables you to evaluate a wide variety of 94 economy semiconductors for only \$24.50*—less than one-fourth their usual low cost. Order your kit TODAY from your authorized TI distributor.

*suggested manufacturer's retail price



TEXAS INSTRUMENTS INCORPORATED

Do-it-yourself display brightens the outlook for low-cost CAD

Simple interface unit turns conventional laboratory oscilloscope into an effective display for a computer—and costs only \$1,500

By Jerry Shumway

Friden Inc., San Leandro, Calif.

Advocates of computer-aided design are drawing a steadily growing following. But even more engineers would be attracted if the cost of ready-made CAD systems, which normally is \$10,000 or more, wasn't prohibitive to some companies.

Engineers at Friden Inc., a subsidiary of the Singer Co., wanted to take advantage of CAD as a design tool, and they also wanted to gain experience in the design of displays as a component in electronic calculators. So they designed a flexible home-made display system that could be built inexpensively and connected to a computer easily. Friden engineers put about \$1,500 worth of components into an assembly to which they connected a conventional laboratory oscilloscope and an old computer. The resulting system is capable of displaying engineering drawings, design curves, and similar graphics.

To simplify both designing and programing, Friden used an elementary form of digital-to-analog conversion—a network of resistances scaled in powers of 2. With incremental conversion, the picture is built up on the oscilloscope screen by a series of small, overlapping spots of light.

The display is used in designing a calculator having a cathode-ray tube display as its output. Friden's engineers simulate the design in an International Business Machines Corp. 1620 computer. The operator uses an external keyboard as he would an electronic calculator's keyboard; the computer makes the calculations and displays the results on the oscilloscope screen as they would appear on the calculator's crt. With simulation, the designer can alter the calculator's specifications merely by changing the computer's program. For example, the display can have five rows of 15 digits each instead of four rows of 10,

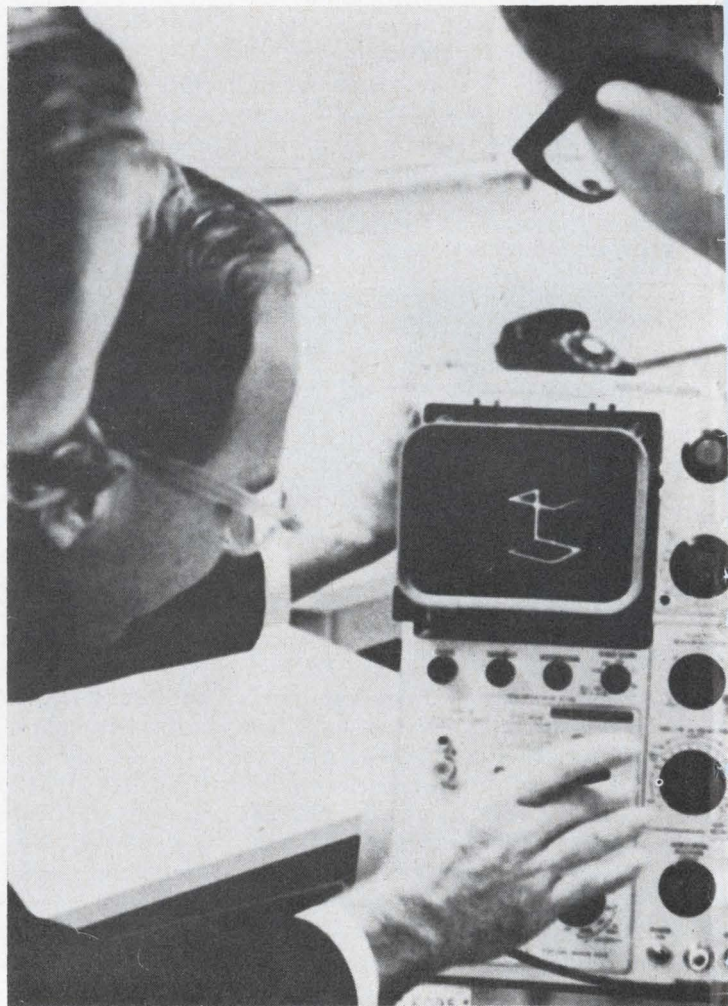

Rotating display. Outline of a cube appears on an ordinary laboratory oscilloscope, controlled by a computer and a special interface unit.

or an exponential function can be added corresponding to one of the keys on the keyboard.

Unlike some commercially available display systems, the Friden system lacks the capability of instructing the computer directly through the display. However, this can be added by means of a light pen and some more circuitry. Provision has been made for adding a buffer memory and special conversion functions to the basic display.

Spots of light

Each word or digit transmitted from the computer causes the cathode ray to move a slight distance in any one of eight directions, or to turn on or off. To draw a line, the beam is on while it is moved through successive points; to end a line, the beam is turned off when it is moved to the next point or points and on again to start a new line.

The typical spot size on the display is about 0.02 inch. The screen area used for the display is about 3 inches square, divided into 1,024 horizontal and vertical increments. A single incremental movement of a spot is therefore about one-seventh its own diameter.

In some display systems, each new word from the computer is the absolute address of a specific point on the crt screen. Although these systems are faster than Friden's and can display more information without flicker, the full coordinate addresses require longer data words or multiple words and more complex interface logic.

With the oscilloscope's centering and deflection-gain controls, the operator can select any part of the display for expansion and closer examination—a feature lacking in most commercially available systems except through program modification. A standard oscilloscope camera is used to make hard copies of the displayed images.

The simplicity of the system can be attributed, at least in part, to the incremental mode itself. This mode enables the display to be programmed the same way as the system's digital plotter. In fact, it was because of the plotter that the company designed the interface with the incremental mode. But despite offering this advantage, the mode has one major drawback: in the absence of an external buffer memory, it heavily loads the computer.

This disadvantage crops up when the oscilloscope display is viewed directly. Like most crt displays, the Friden system requires continuous refreshing—retransmitting data from the computer. Unless refreshing occurs at least 30 times per second, the oscilloscope display tends to flicker noticeably. Flickering is the fading of that part of the display that is traced first, before the tracing of the later parts has been completed. The price paid for refreshing is the slowing of the computer's concurrent operations by making the machine take time out from them for retransmission.

Because of the flickering and refreshing problems, the designers considered using a storage oscilloscope for the display. With this instrument,

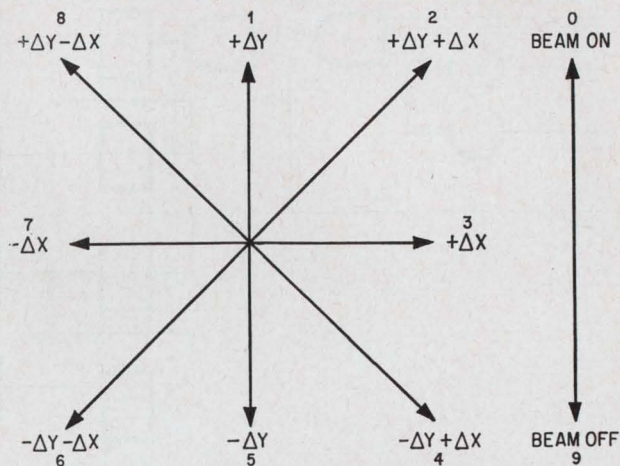

Direction. A single digit transmitted from the computer directs oscilloscope's electron beam to move in one of eight directions, or to turn on or off.

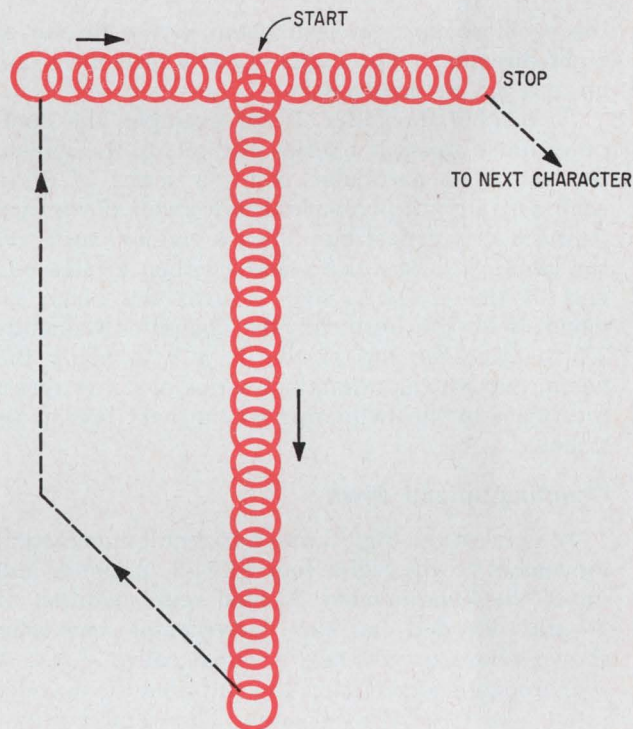

Step by step. A series of overlapping spots can be put together to display any character, here a T, or graphic outline.

the picture can be traced just once and a storage grid just behind the screen retains the pattern indefinitely by secondary emission of electrons. The pattern is erased by a signal from a pushbutton or other source that removes the power from the storage grid. This approach was rejected because the display is difficult to change quickly—erasing takes a large fraction of a second.

By the numbers

The IBM 1620 memory is organized in four-bit binary-coded decimal digits. If the data transmitted from a particular memory location to the display interface is one of the digits 1 through 8,

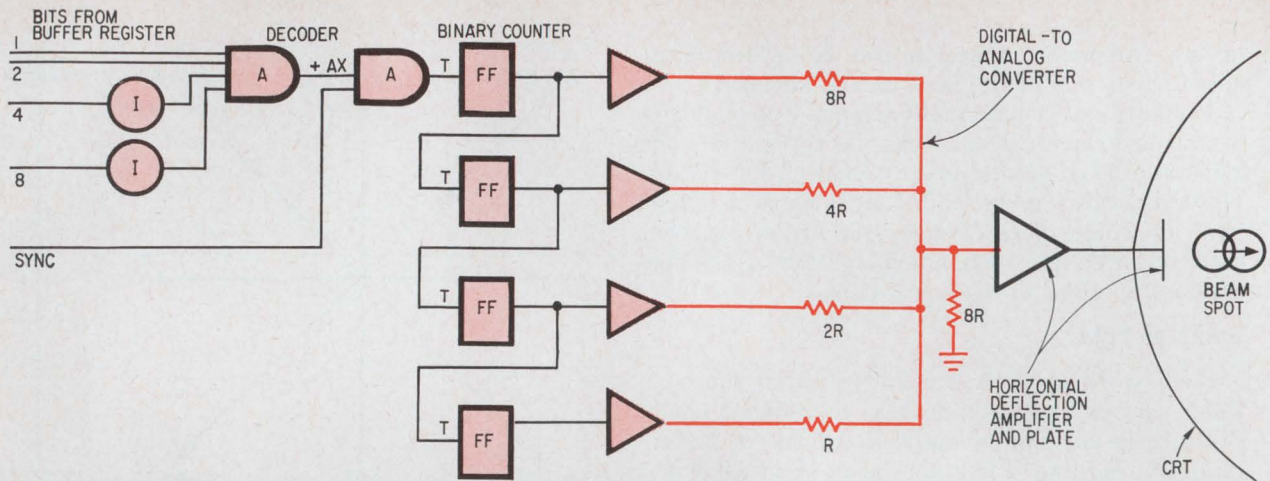

Incremental conversion. A digit received from the computer is decoded into a signal that steps a counter up or down. A digital-to-analog converter alters the deflection voltage in the oscilloscope tube to match the counter contents.

the oscilloscope's electron beam moves in one of eight directions. The digits 0 and 9 turn the beam on and off, respectively.

To display the letter T, for example, the computer must transmit a series of digits to the screen. Starting at a particular point, a series of 5's—each causing an incremental movement downward—traces the vertical bar. Then a single 9 turns off the beam. A series of 8's and 1's then locates one end of the crossbar, and 0 turns the beam on again. With the beam on, the computer transmits 3's to trace the top of the T, a 9 to blank the beam, and in this example a series of 4's to direct the beam to the beginning of the next line to be traced.

Counting up and down

To convert the digit 3 into horizontal incremental movement to the right, four bits—1, 2, not-4, and not-8, the binary-coded decimal representation of 3—are decoded in the incremental converter shown above to generate a signal called $+\Delta X$. A synchronizing signal gates the output of the decoder to add $+1$ to a binary counter. The counter drives a digital-to-analog converter, which is simply a series of resistors with a common connection and with values related by powers of 2. The resulting voltage is the input to the horizontal deflection amplifier, which deflects the beam to the right on the oscilloscope screen.

In the same way, the digit 7 is decoded, but this adds -1 to the binary counter. When the counter counts down, the output of the digital-to-analog converter decreases and the electron beam is deflected to the left, by a corresponding increment $-\Delta X$.

The decoder, up-down counter, and digital-to-analog converter are duplicated for the vertical axis. The digit 1 is decoded for an upward increment; a downward motion results from a digit 5 transmitted from the computer.

For diagonal motions, the digits 2, 4, 6, or 8

are decoded and both counters are stepped in the appropriate direction. The beam moves farther in a diagonal direction than in the orthogonal directions by a factor of $\sqrt{2}$, but the same amount of time is allotted for it.

To turn on the crt's electron beam, the digit 0 is decoded to set a beam control flip-flop. The decoded digit 9 resets the flip-flop and turns the beam off.

In the complete interface unit on the facing page, the buffer register temporarily stores the data from the computer during the decoding process. Although included in the design in anticipation of possible expansion of the system, this register isn't necessary in a simple incremental system.

The timing control is a clock and decoder that generate pulses to set and reset the buffer register, step the x and y binary counters up or down, and trigger a monostable multivibrator that momentarily turns off the electron beam while transients from the digital-to-analog converter decay. This blanking action lasts for about 3 microseconds—long enough to prevent the transients from degrading the display but short enough to prevent the blank time from decreasing the display's intensity.

In the Friden unit, new digits can be transmitted from the computer no oftener than once every $10 \mu\text{sec}$, which is the duration of the 1620 computer's storage cycle. Other factors that limit the rate are the particular circuits in the interface unit and the bandwidth of the oscilloscope's deflecting amplifiers.

A synchronizing signal from the computer rises on the data-sync line to start the timing control. This signal rises after a digit has been placed on the data lines, allowing time for transients on those lines to decay at the input to the buffer register. The timing control sets the flip-flops in the register, then sends a transfer response signal back to the computer. This tells the computer that the data has been accepted and that it

can therefore turn off the data-sync and digit signals. Thus the data transfer is asynchronous—the interface unit timing is independent of the computer timing.

Pause that refreshes

Although the display must be continually refreshed because of flickering, retransmission takes place from a reserved area of the computer memory. As a result, the screen can be temporarily blanked during high-priority computations without necessarily altering the data to be displayed. New data for display can be moved into the reserved area at any time regardless of whether a display is in progress.

If refreshing is to occur often enough to prevent noticeable flicker when the display is to be viewed directly, the number of points in the display is limited. The minimum refreshing rate depends on many parameters, including intensity, type of phosphor on the screen, size of screen, and ambient light level. A refreshing rate slow enough to allow some flickering may be permissible as long as the display remains legible. In most systems, the minimum is between 25 and 50 per second.

Since the 1620 can produce a new increment every 10 μ sec, its maximum increment rate is 100 kilohertz. Thus, 100,000 increments must generate a complete display enough times per second to prevent flicker. If the refreshing rate is 25, the maximum number of increments permissible in a single display is $100,000/25 = 4,000$.

To generate any reasonably complex graphic or alphanumeric display, the electron beam must zigzag across the screen a great deal, and the 4,000 or so increments are used up rather quickly. Therefore the full 1,024-position resolution of the display is not always useful. When that happens, the effective resolution can be decreased and the picture enlarged by manipulating the centering and deflection-gain controls. This increases the total length of the displayed line without in-

troducing flicker. But it also decreases the resolution, makes the lines grainy, reduces spot overlapping, and can lose details of small figures.

Often, the beam can be returned quickly from the right side of the screen to the left side, or from the bottom to the top, by stepping it forward until the counter overflows. The beam then returns to the opposite side of the screen in one increment.

Figuring the flicker

The tendency of a proposed display to flicker can be estimated in advance by determining the number of lines, N , that can be generated across the face of the display with the formula:

$$N = \frac{R}{2^M F}$$

where R = increment rate, F = frame rate, and M = number of changing bits in the counter as the lines are generated. For example, if $R = 100,000$, $F = 25$, and $M = 9$, then 7.8 lines across the display can be generated. If the unchanging bit is the most significant or high-order bit in the counter, then the lines will occupy only one half of the unenlarged display. If the lines are centered by changing the program that generates the display, the high-order bit will change once during the tracing of each line, but the net effect is the same. The easiest way to center the display is with the oscilloscope controls.

The formula is intended to predict the amount of flicker at a particular refreshing rate, rather than to describe any specific display. In general, the 7.8 lines would consist of four lines drawn in the normal or forward direction and three lines plus in reverse, as with a retrace. The formula makes no allowance for spacing between horizontal lines or for vertical movement of the beam in any particular display.

In alphanumeric displays, the number of characters that can be presented without flicker de-

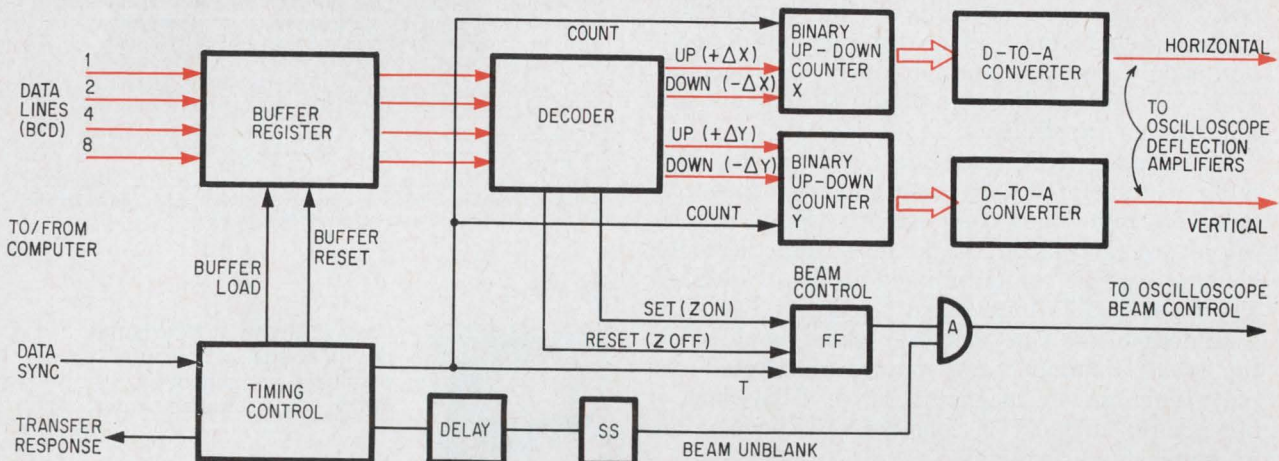

Interface. Data from the computer moves through the converter to the oscilloscope over the paths in color. The decoder converts each digit into a pulse that steps one or both counters up or down. The count is converted into a deflection voltage for the oscilloscope crt. Control signals are routed over the other paths.

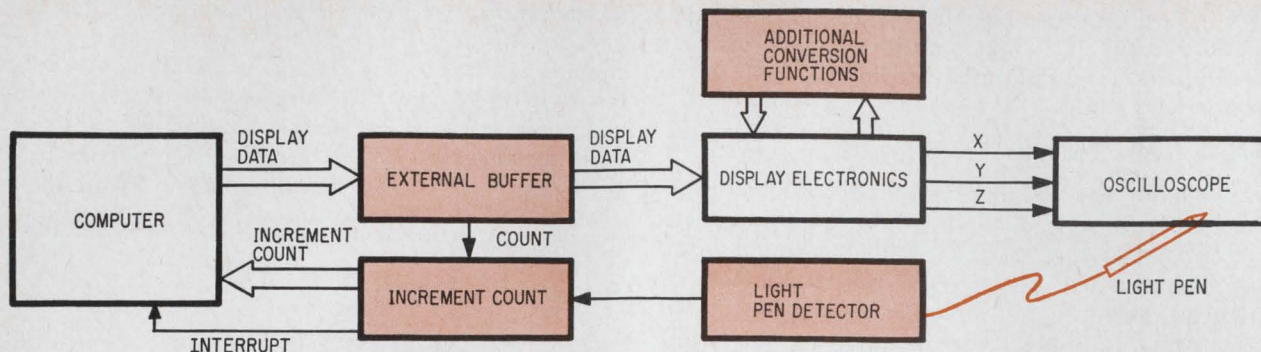

Expandable display. The basic system comprises the display electronics connected directly to a computer and an oscilloscope. Other functional units (color) can be added to improve the system's performance.

depends on the maximum number of increments, rather than the available area on the screen. If the average character requires 30 increments for tracing, then with the previously assumed increment and refreshing rates, the maximum number of characters that can be displayed is $4,000/30 = 133$.

Time exposure

When hard copy is desired, the operator can mount a standard oscilloscope camera and form the picture once. As long as the camera shutter remains open, the length of time required to form the picture is unimportant, and any number of points can be included in the display.

With a camera, the screen area becomes the factor that limits the number of characters. For a 3-inch square display area and a 0.02-inch spot, the number of resolvable elements (tangent non-overlapping spots) is $(3/0.02)^2 = 22,500$. If a single character, including the space between it and adjacent characters, occupies an 11-by-11-element square, the maximum number of characters that can be displayed is $22,500/121 = 186$. (A 3-inch square on a page of *Electronics* contains about 1,000 characters.)

Improving the capabilities

The basic incremental display built at Friden could be, and quite possibly will be, expanded by adding such features as an external buffer memory, a light pen, and special conversion functions. These all add to the cost of the system but also improve its capability.

An external buffer memory enables the computer to transfer display data once and then continue on with other computations. Thus, refreshing of a single display is possible from the buffer memory and the computer need not be overloaded. The most flexible form of such a buffer would be a random-access core memory, which would allow the greatest number and most sophisticated display functions. A magnetostrictive delay line or other serial memory is considerably cheaper, but its applications are limited.

With a light pen added to the system, the operator can flag any part of the displayed data. The flag can interrupt the computer program, which

takes any appropriate action depending on the part of the display indicated and on any other signals received concurrently. The light pen merely generates a pulse when the spot traverses that part of the screen directly under it. In an incremental system, this is most useful to the computer when combined with the increment count or the contents of the two 10-bit counters. And a light pen is more likely to be feasible if the display system has a buffer memory, and perhaps also has enough logic ability to execute a few simple functions without involving the computer.

Special conversion functions can be added to the basic interface unit to move the beam more than one step at a time. These can reduce the time to move the beam when it is off, therefore displaying more data per frame. Sixteen different combinations of signals are available on the four BCD lines. Ten of these are already committed for the eight directions on the screen and the beam on-off signal, leaving six to implement the special conversion functions. Additional control signals would require the addition of more lines to the computer.

Bibliography

- D.R. Haring, "The beam pen: a novel high-speed, input-output device for cathode-ray tube display systems," *Proceedings, Fall Joint Computer Conference; American Federation of Information Processing Societies*, volume 27, 1965, p. 847.
- R.E. Turnage Jr., "The perception of flicker in cathode-ray tube displays," *Information Display*, May/June 1966, p. 38.
- Carl Machover, "Family of computer-controlled crt graphic displays," *Information Display*, July/August 1966, p. 43.
- N.A. Ball, H.Q. Foster, W.H. Long, I.E. Sutherland, R.L. Wigington, "A shared-memory computer-display system," *IEEE Transactions on Electronic Computers*, October 1966, p. 751.

The author

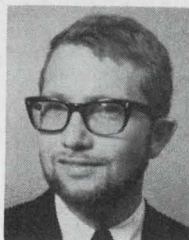

Jerry L. Shumway directs the design of special computer peripheral equipment at Friden Inc.'s research center.



RAYTHEON

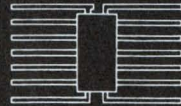

RAYTHEON

RAYTHEON

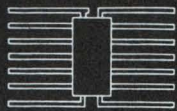

RAYTHEON



RAYTHEON

High Alumina Seal

A little something you can depend on!

We guarantee our MIL Spec glass to Kovar seals to 5×10^{-8} cc/sec Helium. You see, our Raytheon developed high alumina glass has the same coefficient of thermal expansion as Kovar. And since both expand and contract alike with temperature change, they permit a matching seal rather than a compression seal. That's just one of the little things you can depend on when your IC's come from Raytheon Company, Semiconductor Operation, 350 Ellis Street, Mountain View, California 94040.

RAYTHEON

Nobody but AE makes a Class E relay with all these terminals.

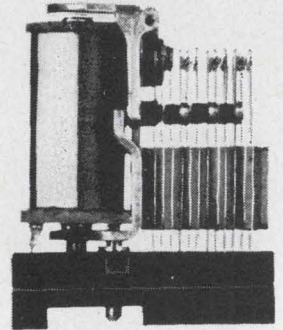

Take your pick:

1 *Solderless Wrap Terminals* eliminate the hazards of soldering. No splashes, heat or clippings. Faster, easier connections. And the technique is easy to learn.

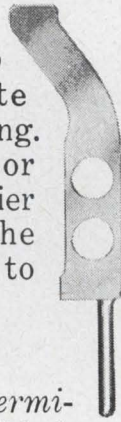

2 *Taper Tab Terminals* accept solderless, slip-on connections which are crimped to each wire lead. Easy to connect or disconnect. Simplify circuit changes and relay substitutions.

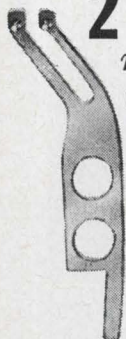

3 *Solder Terminals*—the conventional way. For chassis and rack mounting where quick-connect methods aren't needed.



4 *Printed Circuit Terminals* can be inserted directly into PC cards or boards. All terminals are soldered at one time by "flowing." This process can be automated.

You can get AE Class E relay with several types of plug-in sockets, too—that further in-

crease the number of mounting options.

But don't select the Class E relay because of wiring convenience alone. This is a miniaturized version of the premium-quality Class B—with most of its best features. Perfect contact reliability exceeding 200 million operations is common. That's why, even with ordinary solder terminals, the Class E is the most popular *quality* relay of its size!

For helpful information on the full line, ask for Circular 1942. Just write the Director, Relay Control Equipment Sales, Automatic Electric Company, Northlake, Illinois 60164.

AUTOMATIC ELECTRIC

SUBSIDIARY OF
GENERAL TELEPHONE & ELECTRONICS **GTE**

Only new Lambda LP Series lab power supplies provide all these big system features in a small, low-cost package.

Starting at only \$114.

- High power output—up to 28 watts.
- Wide voltage range versatility—0-10 VDC up to 0-250 VDC.
- Bench or rack use—without adapters.
- Unusually wide automatic current limiting—from 1% (or 5 MA) to 105% of rated output current.
- Two meters for voltage and current.
- Both coarse and fine adjustment of voltage and current.
- Over-temperature protection by thermal relay—prevents overheating.
- Convection cooled—no blower failures.

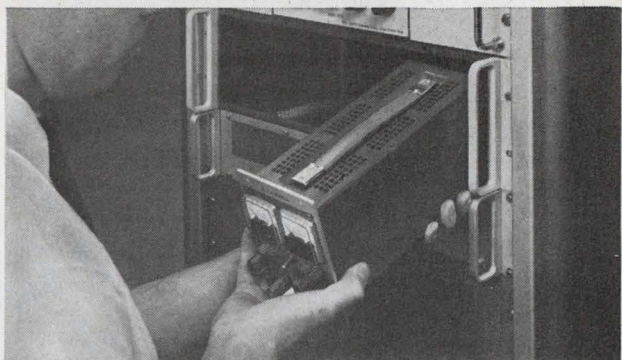
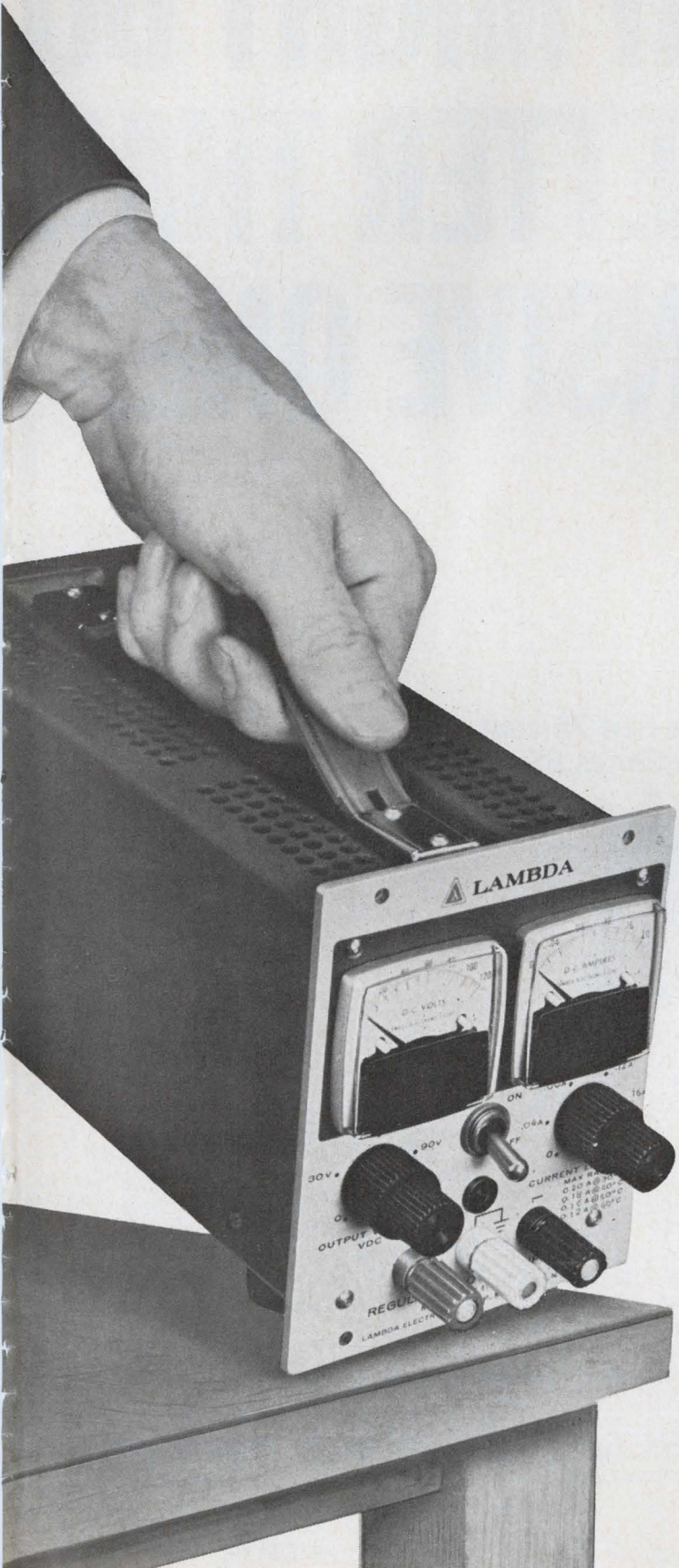

You can mount up to 4 units in a standard LRA-1 or LRA-2 rack adapter.

Other features

- Regulation (line or load): .01% + 1 MV.
- Ripple: 500 μ V RMS, 1.5 MV p-p
- Temperature coefficient: .015% + .5 MV/ $^{\circ}$ C.
- CV/CC with automatic crossover.
- A-C input: 105-132 VAC 45-440 Hz (ratings based on 57-63 Hz operation).
- All Lambda power supplies are guaranteed for 5 years.

Select from six models

| Model | Voltage Range | MAX. CURRENT AT AMBIENT OF: | | | | Price ¹ |
|--------|---------------|-----------------------------|-----------------|-----------------|-----------------|--------------------|
| | | 30 $^{\circ}$ C | 40 $^{\circ}$ C | 50 $^{\circ}$ C | 60 $^{\circ}$ C | |
| LP 410 | 0-10 VDC* | 2A | 1.8A | 1.6A | 1.4A | \$129 |
| LP 411 | 0-20 VDC* | 1.2A | 1.1A | 1.0A | 0.8A | 119 |
| LP 412 | 0-40 VDC* | 0.70A | 0.65A | 0.60A | 0.50A | 114 |
| LP 413 | 0-60 VDC* | 0.45A | 0.41A | 0.37A | 0.33A | 129 |
| LP 414 | 0-120 VDC | 0.20A | 0.18A | 0.16A | 0.12A | 149 |
| LP 415 | 0-250 VDC | 80MA | 72MA | 65MA | 60MA | 164 |

*Overvoltage Protection available as an accessory—\$40.00 each.
¹Prices are for non-metered models. For metered models, add suffix (FM) and add \$10.00 to price.

SEND FOR COMPLETE LAMBDA CATALOG

LAMBDA
 ELECTRONICS CORP.
 515 BROAD HOLLOW ROAD • MELVILLE, L.I., NEW YORK 11746 • (516) 894-4200
 A SUBSIDIARY

A LOW-COST 1 AMP SPDT RELAY MIGHT DO THE JOB BETTER THAN AN EXPENSIVE ONE.

If it's the new 75-cent Sigma Series 65.



New Sigma Series 65 miniature relays are specifically designed for low-level DC switching applications where economy is of major importance. Available in quantity for 75 cents, these general purpose relays include extra design benefits:

Superior Switching Performance: The precision knife-edge hinge design of the armature provides better magnetic coupling for full utilization of coil power. This results in heavier contact forces, lower contact resistance and better electrical stability.

Greater Mechanical Strength: Glass-filled nylon, not ordinary phenolic, is used to support contact members assuring long-term mechanical life and stability.

Better Thermal Stability: Use of high-grade, low-

temperature-coefficient materials assures excellent thermal stability over a wide temperature range up to 70°C.

We'd like to give you a new Sigma Series 65— or any of our other standard relays. Test and compare it against the brand you may now be using. It's the best way we know to prove what we say about Sigma relay performance. Just circle our reader service number on the reader service card. We'll send you the new Sigma relay catalog and a "free relay" request form. Return the form to us and your Sigma representative will see that you get the relay you need.

Need fast delivery? The Series 65 is available off-the-shelf from your Sigma distributor.

SIGMA DIVISION



SIGMA INSTRUMENTS INC

Assured Reliability With Advanced Design / Braintree, Mass. 02185

Sigma Instruments (Canada) Ltd., P.O. Box 43, Toronto 18

What heat-shrinkable tubing gives... predictable shrinkage? 175°C capability?

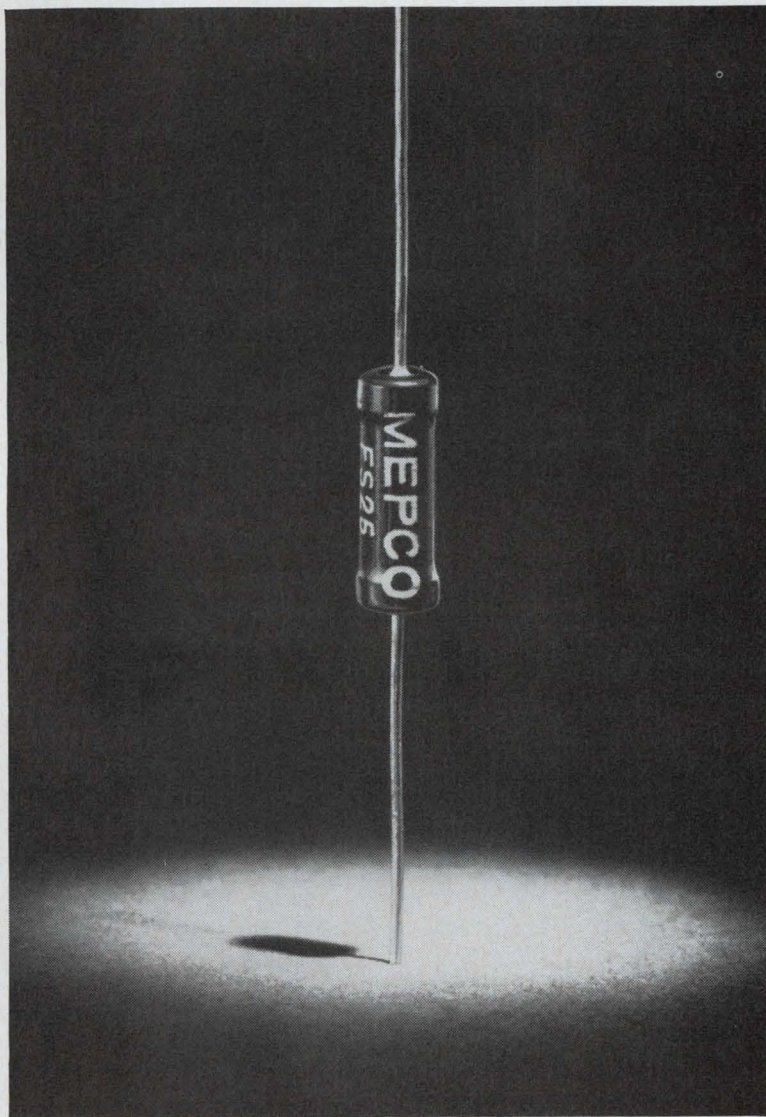

Kynar[®] the fluoroplastic that's tough!

Sleeving of Kynar on precision film resistors shrinks exactly 50%. That's what the MEPCO Co., Morristown, New Jersey, reports. Kynar resists high temperatures after shrinkage . . . has the chemical resistance to withstand cleaning solvents.

Do you . . . or should you . . . use heat shrinkable tubing? If yes, investigate tubing made with Pennsalt's Kynar . . . it's available in a range of diameters from Raychem Corporation as Thermofit* Kynar. Before you place your next order for conventional or shrinkable tubing, write or call Plastics Department, Pennsalt Chemicals Corporation, 3 Penn Center, Philadelphia, Pa. 19102. (215) LO 4-4700.

Kynar...the fluoroplastic that's tough!

*Registered trademark of Raychem Corporation



**Transistor
Mounting
Pads?**

Clips?

**Heat Sink
Adapters?**

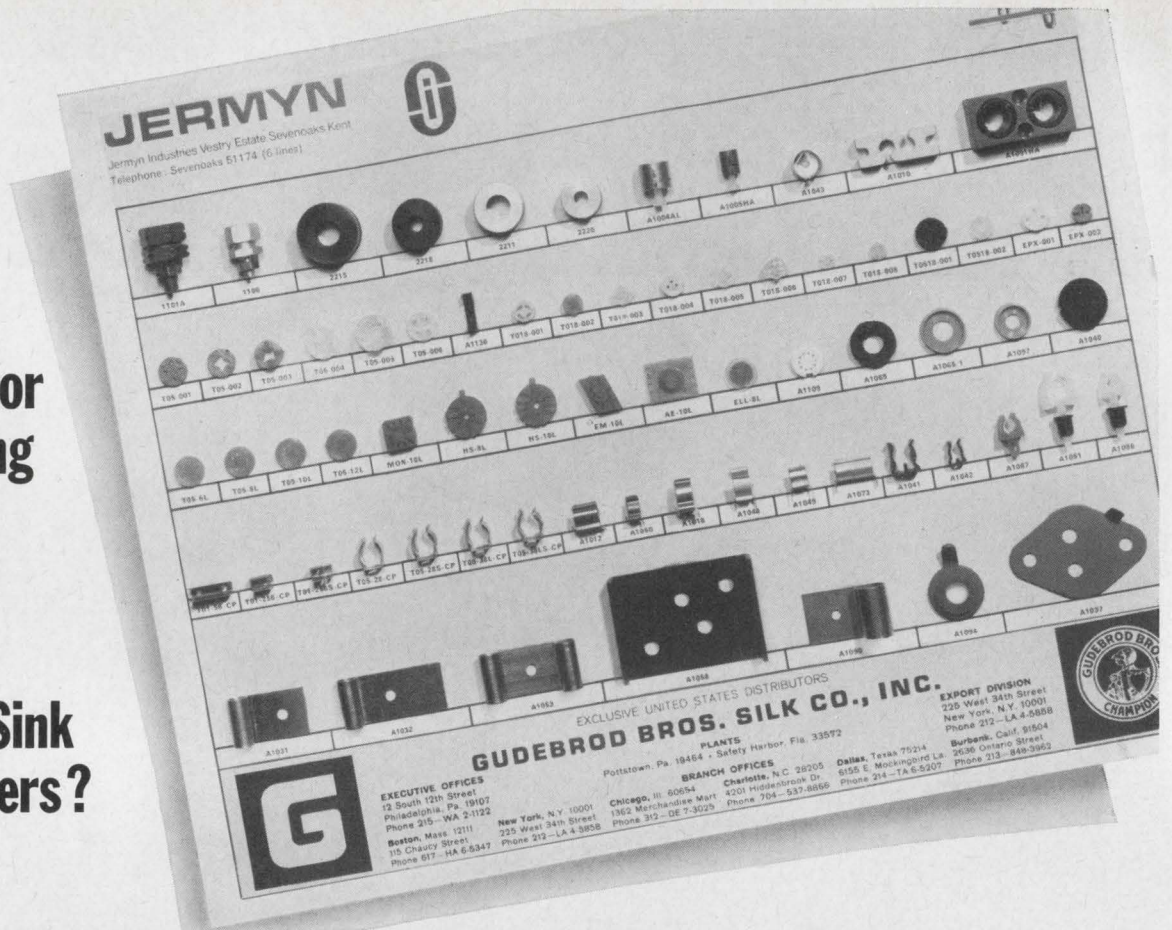

**GUDEBROD is your new, reliable source
for this important circuit hardware.**

**Precision made with traditional English
craftsmanship—by JERMYN Industries.**

**Stocked and sold exclusively in the
United States by GUDEBROD.**

**You ought to know more
about these products!**

Send for catalog now!

Gudebrod is now exclusive U.S. distributor for the electronic products manufactured by Jermyn Industries of Kent, England. Gudebrod feels it will be providing the industry with electronic hardware consistent with the high quality products manufactured by Gudebrod for nearly 100 years. Gudebrod will extend the same quality and depth of service it has become known for in lacing tapes. Write for the Catalog GJ100.



GUDEBROD BROS. SILK CO., INC.

FOUNDED IN 1870

Electronics Division

12 SOUTH 12th STREET, PHILADELPHIA, PENNSYLVANIA 19107

Area Code 215, WA 2-1122

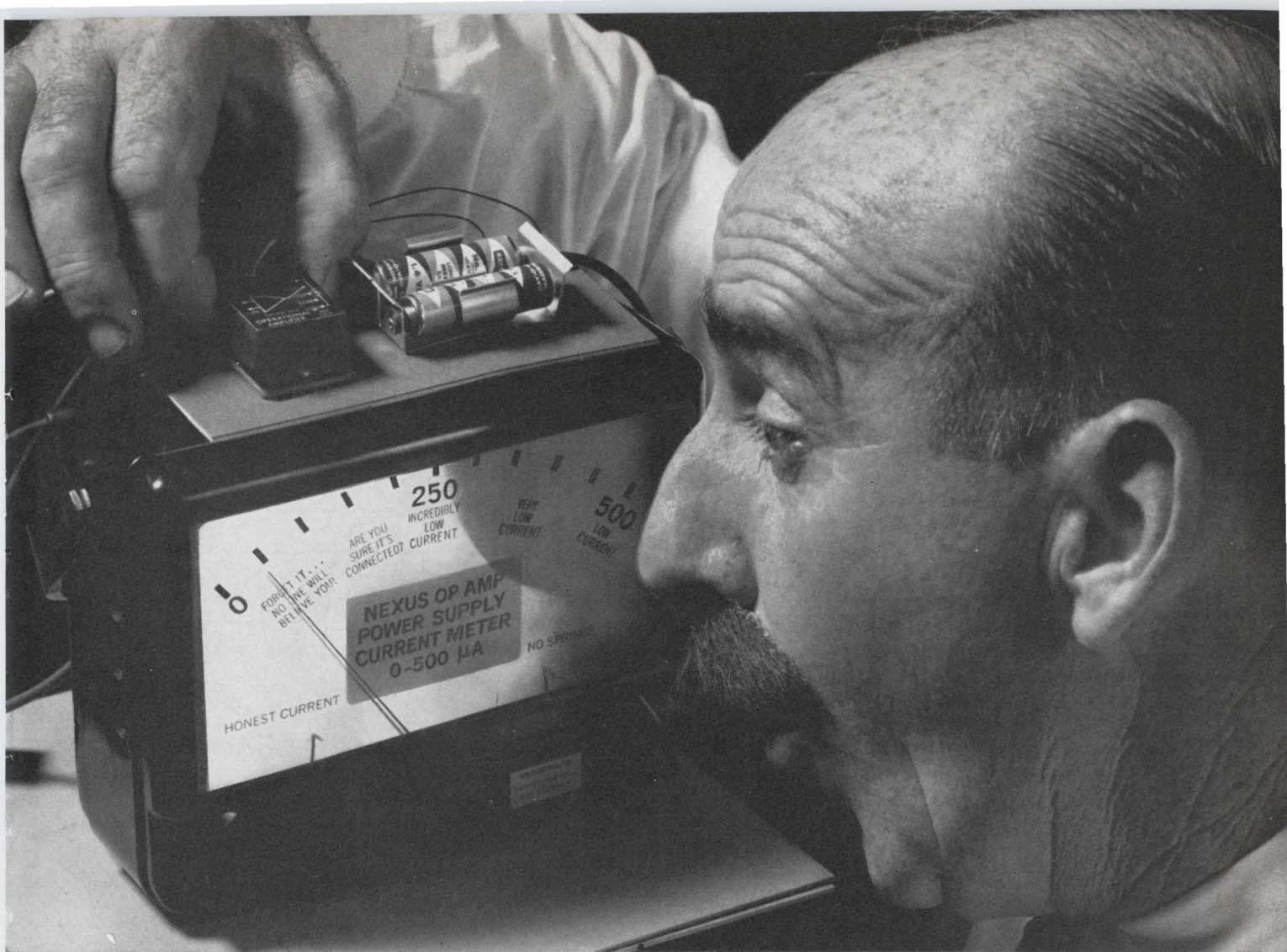

Either our instruments are kidding us or we've come up with the industry's **FIRST MICROPPOWER OP AMP**

This new, low-voltage universal op amp looks practically like an open circuit to a battery . . . yet performs heroically in all manner of instrumentation from 200 fathoms down, to 200 miles up.

The NEXUS Q-200 low-voltage operational amplifier produces *no significant battery drain* in its quiescent state. This means that a continuously-connected battery can be expected to last from 2 to 3 years under normal service . . . virtually its shelf life.

At the same time, the Q-200 provides *universal* operating characteristics, including broad power supply voltage range, and high demand output current capabilities. Price only \$35.00 in quantities of 1 to 9.

Rugged, reliable and hardworking, this tiny module is a natural for use in a broad variety of portable and remote electronic gear, such as oceanographic, aerospace and medical instrumentation.

The Q-200 is available for instantaneous shipment. Write or call for complete specifications.

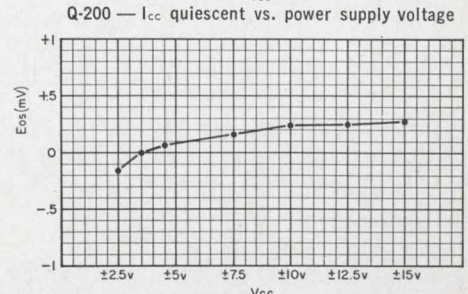
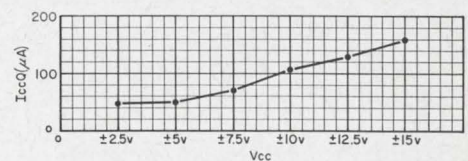

 **NEXUS**
A TELEDYNE COMPANY

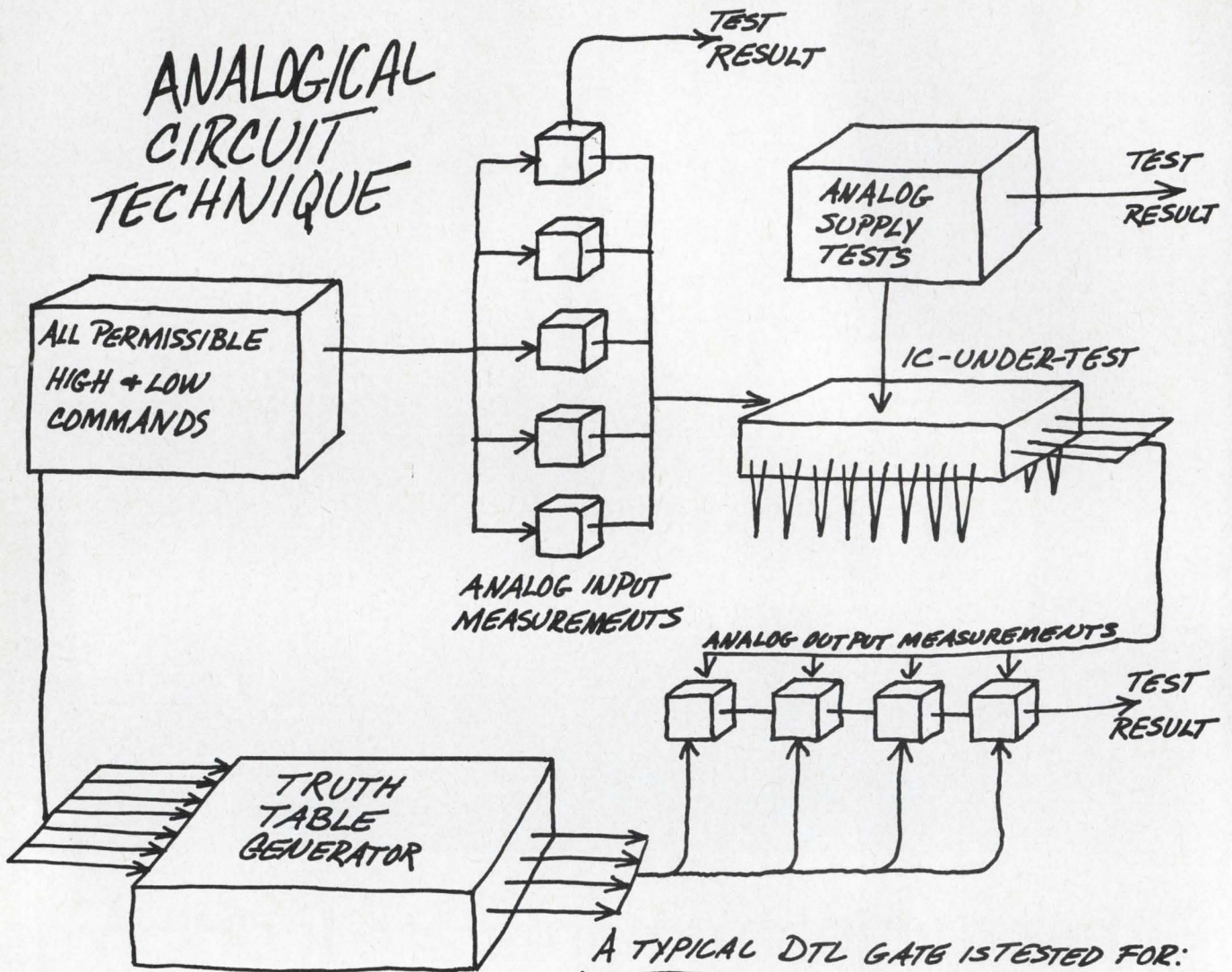

A TYPICAL DTL GATE IS TESTED FOR:

| | |
|--------------|----------------------|
| $I_{IN HI}$ | 5.1 mA MAX @ 4.1 V |
| $I_{IN LO}$ | 1.1 mA MAX @ 1.1 V |
| $V_{OUT HI}$ | 2.6 V MIN @ 0.12 mA |
| $V_{OUT LO}$ | 0.45 V MAX @ 12.0 mA |
| I_{CC} | 16 mA MAX @ 5.0 V |

Intriguing, isn't it, this new way of testing digital integrated circuits?

Now you can make sure ALL of your ic's will work — because you can make both parameter and functional tests simultaneously, and for all permissible combinations of inputs. □ It's done by exercising all the LOGICAL inputs on the ic-under-test and selecting the appropriate ANALOG measurements that should be made. 5,000 such measurements are made in 1/100 of a second.



TERADYNE

□ Even more exciting, our Analogical Circuit Technique is available on a little machine that weighs only 25 lbs. It's a cinch to program, and costs only about \$5,000. □ We call it ACT 1 (because of the fortunate acronym). □ To learn more about analogical testing, just write: ACT 1, Teradyne, 183 Essex Street, Boston, Massachusetts 02111.

SEE YOU AT NEC, BOOTH 749

you get a choice,

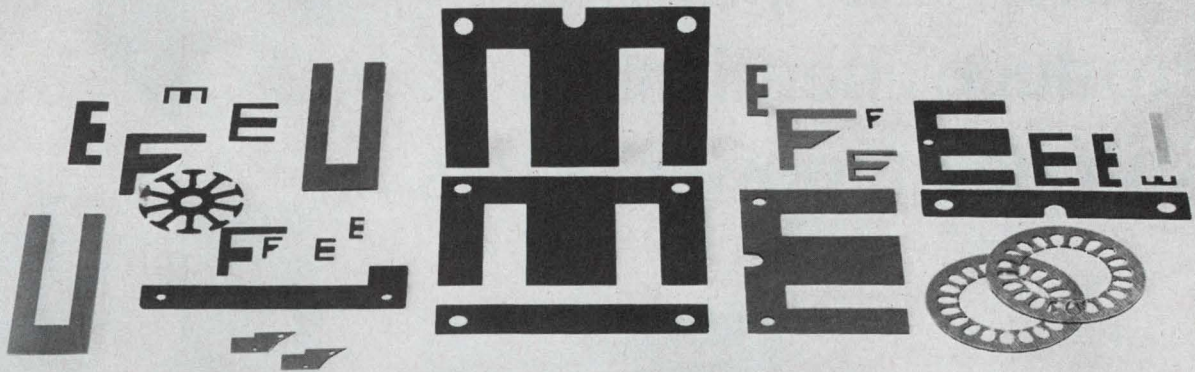

not a challenge

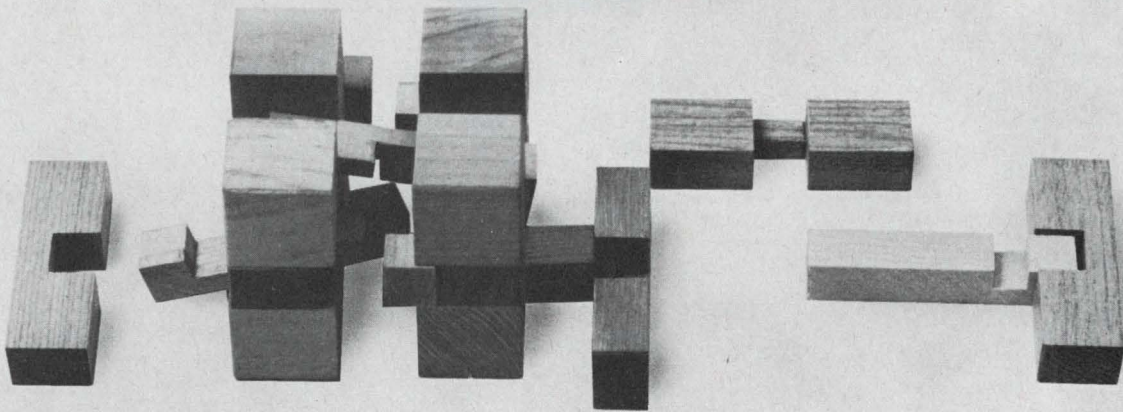

**51 standard shapes of laminations
simplify solid-state circuit design**

Magnetics maximizes your chances of finding laminations that dovetail precisely into your designs for transformers, chokes, reactors and transistor circuits. We offer 51 standard shapes in Permalloy 80, Alloy 48 and Orthonol®. Thicknesses of 0.004", 0.006", and 0.014" are available, with sizes ranging from DU-87 and EI-12 down to the

solid-state circuitry sizes—EI-093, EE-30-31, DU-63 and F-094.

All Magnetics' laminations are hydrogen-annealed and manufactured to guaranteed minimum permeability limits. In addition to the catalog shapes and sizes, we have the capability to make special shapes to fit specific needs, including rotors, stators and recording head laminations. Our photo-etch process is ideal for making

prototype-run laminations and small intricate configurations.

Furnishing a broad spectrum of shapes, sizes and materials is Magnetics' way of saving you valuable design time—we believe in giving our customers a choice, not a challenge. Complete information on Magnetics' laminations can be had by writing today for our Catalog ML-303-R, Magnetics Inc., Butler, Pennsylvania 16001

MAGNETICS inc.
®

Guard water purity...
 Produce chemicals...
 Run steam power plants...

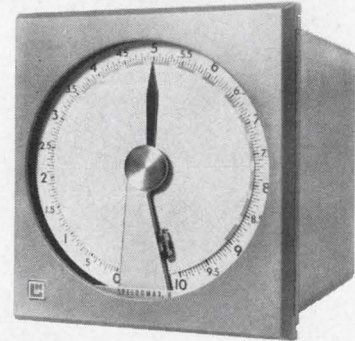
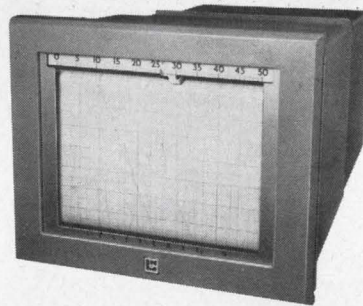
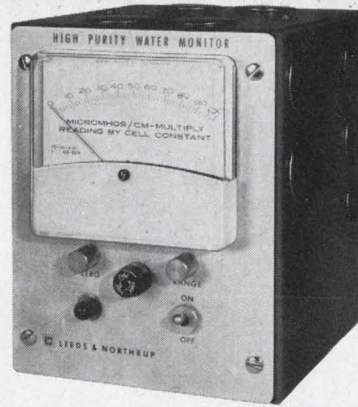

with help from
LEEDS & NORTHRUP

and Keystone
 Thermistors

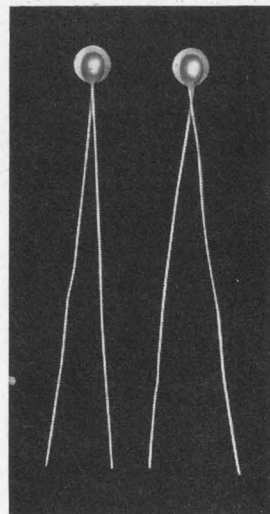

These tiny Keystone Thermistors are components of temperature compensators in a number of Leeds & Northrup Company electrolytic conductivity instruments—serving such applications as water purification, chemicals production, steam power generation and many other processes involving operation throughout a wide range of ambient temperatures. Let us consult with you on your thermistor requirements. KEYSTONE CARBON COMPANY, St. Marys, Pa. 15857.



in creative thermistor technology

Electronic Wholesalers ships TI Series 54/74 TTL in quantity

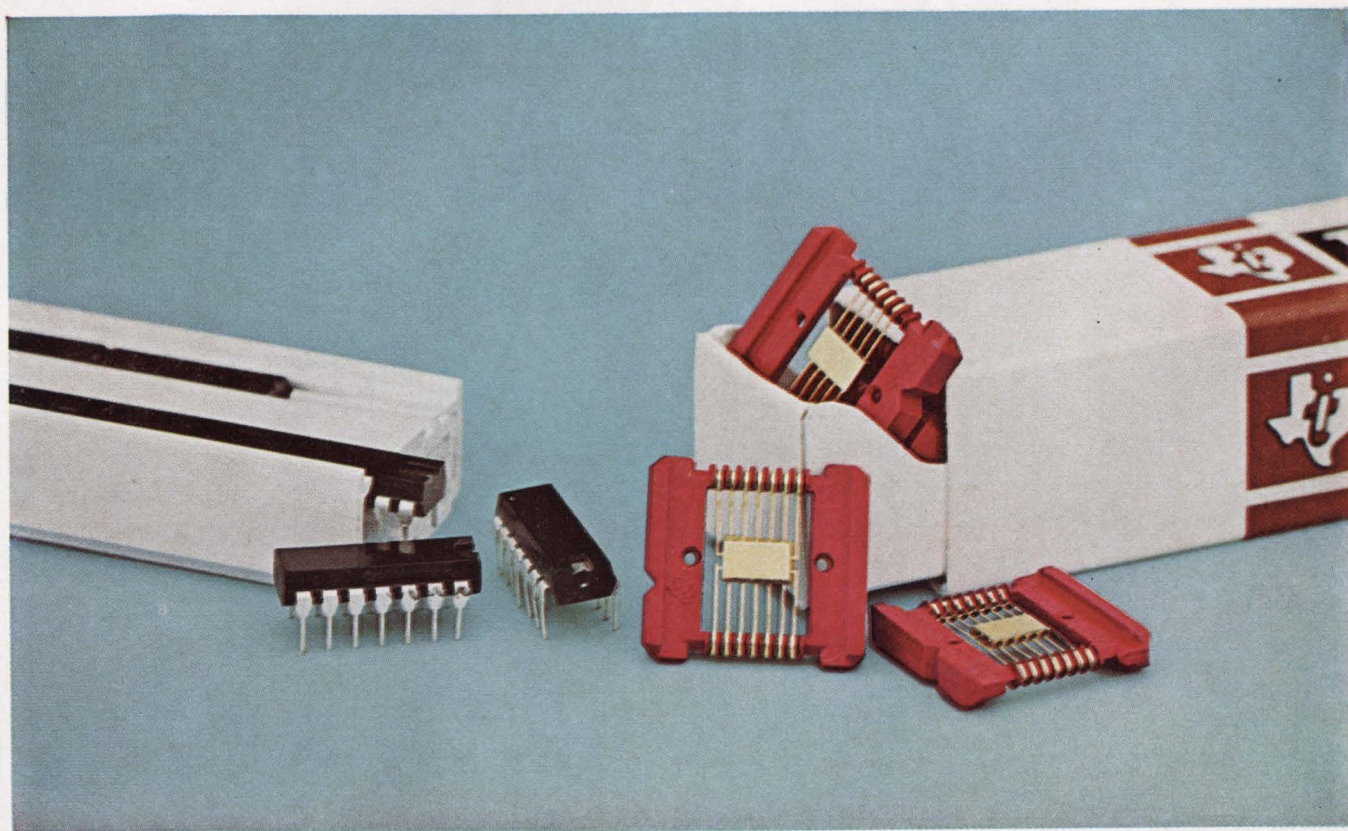

Use Series 54/74 integrated circuits from Texas Instruments in your new digital systems. You'll realize higher performance and substantial cost savings.

This family of TI circuits is the most versatile and complete in the industry, offering designers the broadest choice of speed, power dis-

sipation, performance and cost-per-function available today.

One hundred eighty different integrated circuits make up this family, including standard and high speeds, military and industrial temperature ranges, dual in-line and flat-pack designs, and 39 circuit functions. This broad selection

enables you to tailor digital system designs to your exact requirements.

There's no problem of *availability* when you specify TI devices. Our complete stocks enable us to make delivery of the devices you need... in the quantities you require... at the time you specify.

Call us *today!*



"SERVING THE ENTIRE SOUTHEASTERN U.S."

ELECTRONIC WHOLESALERS INC.

WASHINGTON, D. C.
2345 Sherman Ave., N.W., Phone 202-483-5200

BALTIMORE, MARYLAND
3200 Wilkens Avenue, Phone 301-646-3600

WINSTON-SALEM, N. C.
938 Burke Street, Phone 919-725-8711

MIAMI, FLORIDA
9390 N.W. 27th Avenue, Phone 305-696-1620

ORLANDO, FLORIDA
345 N. Graham Avenue, Phone 305-841-1550

HUNTSVILLE, ALABAMA
2310 Bob Wallace Avenue, S.W., Phone 205-534-2461

artful design idea and
so many fine features
at such a modest price

tilt·a·view
CABINETS

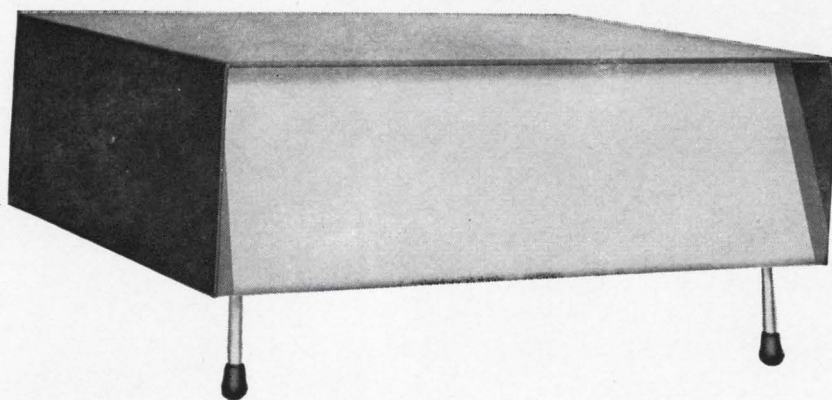

Innovated to permit the viewer of the action of meters, or the position of dials and recorders to select the most advantageous angle of vision. Employment of the detachable legs lowers or raises the position of the enclosure. It may be placed on desks, cabinets of various heights, or wall mounted.

Two piece steel construction allows immediate clear access to interior for installation and service of components. Inventive arrangement of vertical flanges and channels into which the top and bot-

tom sections interlock assures strength and rigidity. Fasteners at bottom secure the two elements. Body is finished in scratch resistant vinyl charcoal gray while panels are sand vinyl texture.

See these handsome new enclosures at your nearby authorized Bud distributor. If you don't know him, let us introduce you. Write us for his name. He can give you complete descriptive literature or we will be glad to send it to you.

your product *Belongs* in a **BUD** cabinet



BUD RADIO, INC.

4605 East 355 Street, Willoughby, Ohio 44094

the unbeatable hand for

automatic EMI measurements from 1 to 26.5 GHz

The revolutionary **EMA-910** system has changed the entire electromagnetic analysis "deck". It's designed to give you maximum convenience and precision for automatic spectrum surveillance . . . electromagnetic compatibility analysis . . . and field intensity measurements, in accordance with all FCC, Federal, and Military specifications.

The basic electromagnetic analyzer consists of:
Model 910-11, 1-26.5 GHz Data Evaluation Unit
Model 910-10, 1-10.5 GHz and/or
Model 910-12, 10-26.5 GHz Frequency Selection Units.

These instruments give you the assurance of:

- -100 dbm narrowband sensitivity (1-10.5 GHz)
- -92 dbm narrowband sensitivity (10-26.5 GHz)
- Four accurate bandwidths, 0.5 MHz, 1.0 MHz, 5.0 MHz, and 8-10 MHz
- Automatic signal level discrimination
- Automatic scanning; remotely programmable
- Sector scan over any range
- Automatic band switching
- "Hold-and-Dump" true peak detection
- Pushbutton calibration without disconnecting input signal leads
- 120 db case shielding

The **Frequency Call-Up Unit, Model 8010**, gives you automatic remote tuning for spectrum surveillance of any 10 pre-selected signals. Additional 10-channel units may be added as required. Operation is as simple as pushing buttons to command the basic analyzer system to automatically scan to the selected frequencies.

The **Digital Display Unit, Model 3100**, provides simultaneous dual-channel digital readout of frequency (in GHz) and signal amplitude (in db above μV) on "Nixie" tubes (four digits per channel). The amplitude information display is automatically compensated for inserted r-f attenuation, eliminating the time normally required for adding attenuation factors, as well as possible operator errors in meter reading. The unit also "holds" the data for manual notation, digital recording, or computer input (using either 1-2-2-4 or 1-2-4-8 binary-coded decimal outputs).

BASIC ELECTROMAGNETIC ANALYZER

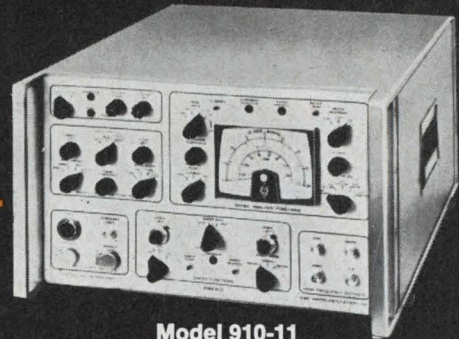

Model 910-11
1-26.5 GHz Data Evaluation Unit

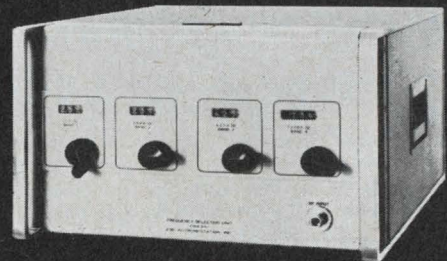

Model 910-10
1-10.5 GHz Frequency Selection Unit

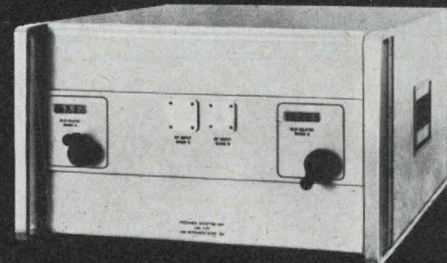

Model 910-12
10-26.5 GHz Frequency Selection Unit



Model 8010
1-26.5 GHz Frequency Call-Up Unit



Model 3100
1-26.5 GHz Digital Display Unit

emc

Call or write for a demonstration or complete technical data.

EMPIRE • GERTSCH • PANORAMIC • SENSITIVE RESEARCH INSTRUMENTATION

SINGER
INSTRUMENTATION

EMC Instrumentation Inc., A Subsidiary of THE SINGER COMPANY • Engineering/Manufacturing, 7338 Varna Ave., N. Hollywood, Calif. 91605 • (213) 875-0454
Sales Offices; EMPIRE EMC, THE SINGER COMPANY, METRICS DIVISION • 915 Pembroke St., Bridgeport, Conn. 06608 U.S.A. • (203) 366-3201 • TWX 710-453-3483

NEW LOWER PRICES

NEW TEST DATA FOR CTS INDESTRUCTIBLE CERMET SEMI-PRECISION RESISTOR NETWORKS

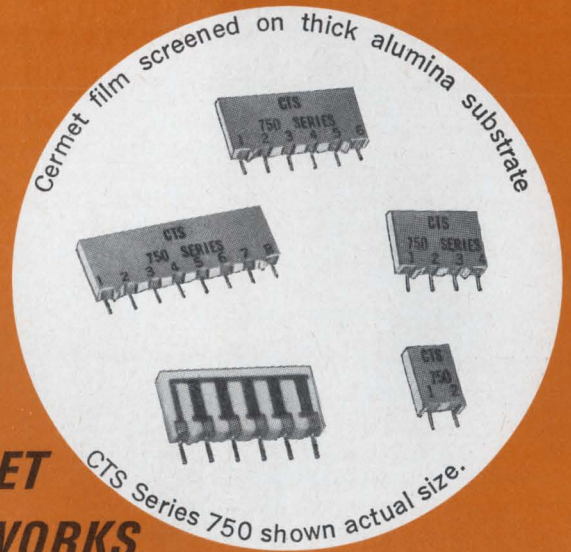

| Series 750 | 2-Pin (1 Resistor) | 4-Pin (3 Resistors) | 6-Pin (5 Resistors) | 8-Pin (7 Resistors) |
|---------------------|------------------------------|------------------------------|------------------------------|------------------------------|
| Total Module Load | 0.5 Watts | 1.0 Watts | 1.5 Watts | 2.0 Watts |
| Approx. 10,000 cost | 17¢ \$0.22 ea. | 18¢ \$0.24 ea. | 21¢ \$0.26 ea. | 26¢ \$0.31 ea. |

The data speaks for itself. Examine and judge its value for your application:

Extreme Stability and Reliability
High Power Capability: (Up to 1 watt per resistor)

- Space saving—a single module replaces up to 7 discrete resistors.
- Available in an infinite number of circuit combinations.
- Custom-built to your exact requirement.
- Ideally suited for cost-saving automatic handling.
- Cover coating unaffected by solvents.

| STANDARD MODULE SPECIFICATIONS FOR ALL SIZES | |
|--|-----------------------------------|
| Resistance Range | 50 Ω to 100K Ω |
| Resistive Tolerance | ±5.0% |
| TC | ±300 ppm/°C |
| Load Life: 0.1 W per resistor at 70°C, 1000 hrs. (Over 4,000,000 resistor hours) | ±0.40% Δ R max. ±0.20% Δ R av. |
| Moisture Resistance: .1 rated wattage at 70°C, 90-98% humidity, 1000 hrs. | ±0.50% Δ R max. ±0.20% Δ R av. |
| Insulation Resistance: measured wet after moisture resistance test, 200 VDC | 500 meg. Ω |
| Thermal Shock: 5 cycles, -63°C to +125°C, no load | ±0.10% Δ R max. ±0.03% Δ R av. |
| Short Time Overload: 2.5 times rated voltage, 5 sec. | ±0.25% Δ R max. ±0.05% Δ R av. |
| Low Temperature Exposure: -63°C, 4 hrs. | ±0.10% Δ R max. ±0.04% Δ R av. |
| Terminal Strength: 5 lb. tensile & compression, 30 sec. | ±0.10% Δ R max. ±0.03% Δ R av. |
| Effect of Soldering: 63/37 solder, 246°C, 2 sec. | ±0.10% Δ R max. ±0.05% Δ R av. |



founded 1896 Request Cermet Catalog

CTS
OF BERNE, INC.
BERNE, INDIANA

SUBSIDIARY OF
CTS CORPORATION • ELKHART, INDIANA

| Extra cost options | |
|---------------------|---------------------------------|
| Resistance Range | 10 to 49 Ω, 101K to 1 meg. Ω |
| Resistance Spread | Over 10 to 1 |
| Resistive Tolerance | ±0.5%, 1%, 2.5% |
| TC | ±150 ppm/°C |

Probing the News

Space electronics

Apollo 4's time of trial

Upcoming shot is crucial in the U.S. effort to put men on the moon before 1970; program's electronic design, largely unchanged by the capsule fire, still has problems

When the giant Saturn 5 rocket blasts off from Cape Kennedy for the first time—hopefully next month—NASA will be looking to regain momentum for its fire-stalled program to land men on the moon and bring them back by 1970. Increasingly, however, top space agency officials are doubtful about meeting the deadline.

Saturn 5 will carry an unmanned Apollo spacecraft; the first manned flight, originally slated for last February, is not expected to get off the ground before mid-1968 at the earliest. The fire that killed three astronauts last January has not affected the electronic design of the lunar craft, but it has impaired confidence in the over-all program. Even though the electronics design is five years old, this portion of the project continues to be plagued by a succession of petty problems.

There are also a number of big problems: late last month, North American Rockwell Corp., the prime contractor for Apollo spacecraft, announced it had replaced its assistant program manager for the first manned spacecraft and its assistant director of Apollo test and operations. The company says such personnel changes are not unusual for an organization of its size.

Trio. In the upcoming flight, designated Apollo 4, the three-stage Saturn 5 launch vehicle will carry command and service modules for earth-orbit missions as well as a dummy of the lunar module.

Principal mission of the Apollo 4 is to see whether the 364-foot-high Saturn 5—the only U.S. system capable of putting men on the moon—will work in flight. The National Aeronautics and Space Administration hopes to separate the

vehicle's three stages not only to demonstrate that the systems can operate under space-flight conditions but also to check out ground-support facilities.

I. Keeping in touch

High on the list of Apollo 4 priorities are comprehensive space tests of the new unified S-band com-

munications system. The manned space flight network will transmit both S-band tracking and telemetry commands. In addition, the omnidirectional antenna, flush-mounted on the command module that will be used on the flight to the moon, is due to be checked. Apollo 4 will not carry the S-band high-gain antenna, mounted on the service

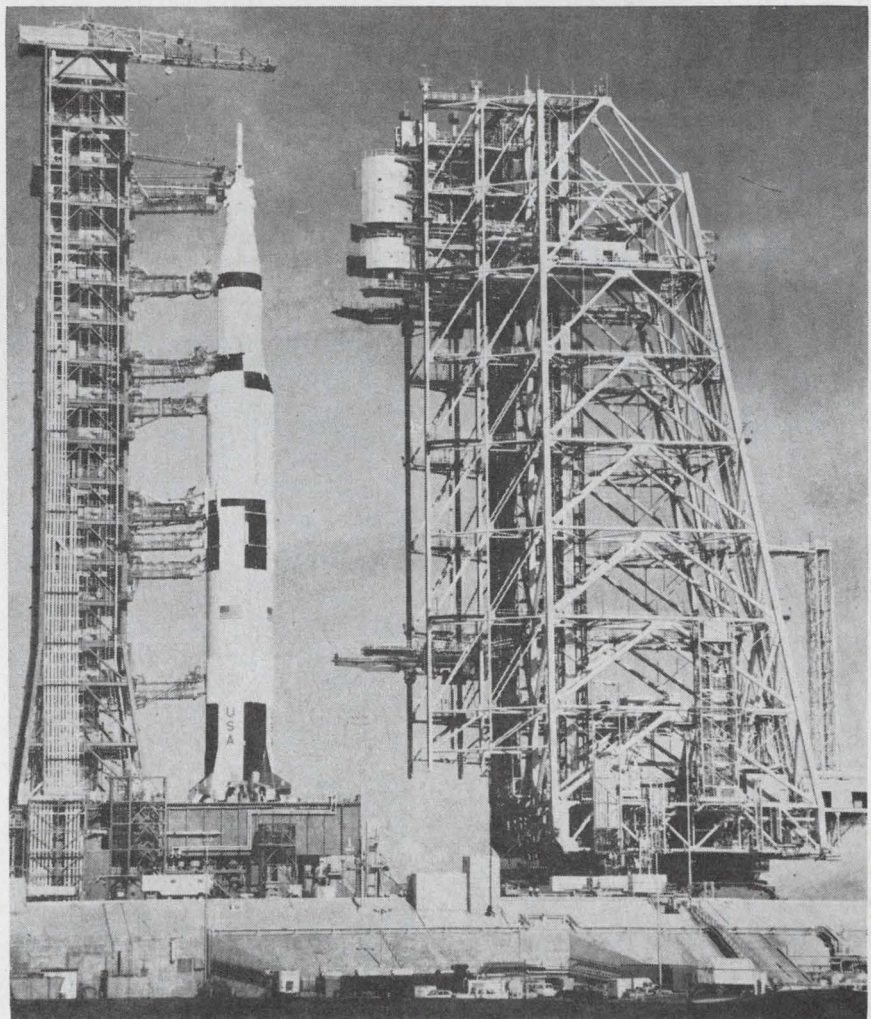

Towering achievement. The 364-foot-high Saturn 5 is set to boost unmanned Apollo 4 into an earth orbit next month; objective is a lunar landing by 1970.

AMPERITE

GLASS ENCLOSED Thermostatic DELAY RELAYS

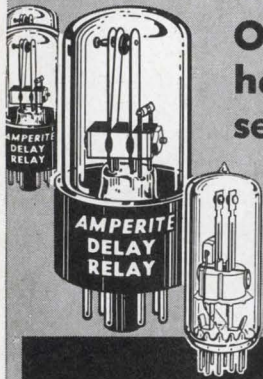

Offer true
hermetic
sealing —

— assure
maximum
stability
and life!

Delays: 2 to 180 seconds

Actuated by a heater, they operate on A.C., D.C., or Pulsating Current . . . Being hermetically sealed, they are not affected by altitude, moisture, or climate changes . . . SPST only — normally open or normally closed . . . Compensated for ambient temperature changes from -55° to $+80^{\circ}$ C. . . Heaters consume approximately 2 W. and may be operated continuously. The units are rugged, explosion-proof, long-lived, and inexpensive!
TYPES: Standard Radio Octal and 9-Pin Miniature . . . List Price, \$4.00
PROBLEM? Send for Bulletin No. TR-81.

AMPERITE

BALLAST REGULATORS

Hermetically sealed, they are not affected by changes in altitude, ambient temperature (-50° to $+70^{\circ}$ C.), or humidity . . . Rugged, light, compact, most inexpensive.

List Price, \$3.00

Write for
4-page
Technical
Bulletin
No. AB-51

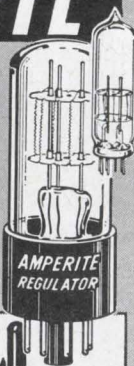
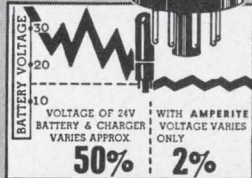

AMPERITE

600 PALISADE AVE., UNION CITY, N.J.

Telephone: 201 UNION 4-9503

In Canada: Atlas Radio Corp., Ltd.,
50 Wingold Ave., Toronto 10

. . . two communications blackouts are anticipated during reentry . . .

module set for manned flights, because it is not needed for earth-orbit missions.

Earth calling. Voice signals will be transmitted from ground stations via the S-band system and recorded in the spacecraft. Analog signals, simulating biomedical data from a manned spacecraft, will also be sent during the mission.

A C-band command and tracking system, used in earlier Apollo and Gemini space flights, will also be aboard the Block 1 earth-orbiting Apollo 4. However, this system will be phased out of Block 2 lunar mission manned capsules which will rely on S-band gear.

Communications subsystems aboard the command and service modules will be tested, using very-high-frequency omnidirectional antennas. Voice commands will be simulated by transmitting a 400-hertz signal that will be recorded on the spacecraft for subsequent evaluation. The modules will also carry 27 ultrahigh-frequency telemetry links for relaying commands and updating the computer.

Itinerary. Saturn 5's first stage will push Apollo 4 to an altitude of about 46 miles. After separation,

the second-stage rocket will fire, propelling the bird 115 miles above the earth. The third stage will accelerate Apollo 4 into an elliptical orbit with a 10,350-mile apogee.

The rocket in the service module will simulate an attempt to reach the moon by pushing the craft from its earth orbit to a distance of 11,400 miles from earth. At this point, Apollo 4 will head back, propelled by a second burn of the service-module engine, reentering the atmosphere at close to 25,000 miles an hour—about equal to the reentry velocity of a manned craft returning from the moon. Elapsed time of the mission will be approximately nine hours.

Quiet time. Engineers expect two communications blackouts during Apollo's reentry. While a great deal of work has been done in this area, NASA officials have now concluded they can live with the problem. "At this point, the astronaut is on his own," says one. "We can afford to wait a few minutes to learn if he's alive or dead." The first communications cutoff will occur when the spacecraft enters the atmosphere at about 400,000 feet. S-band communications will be lost; a few

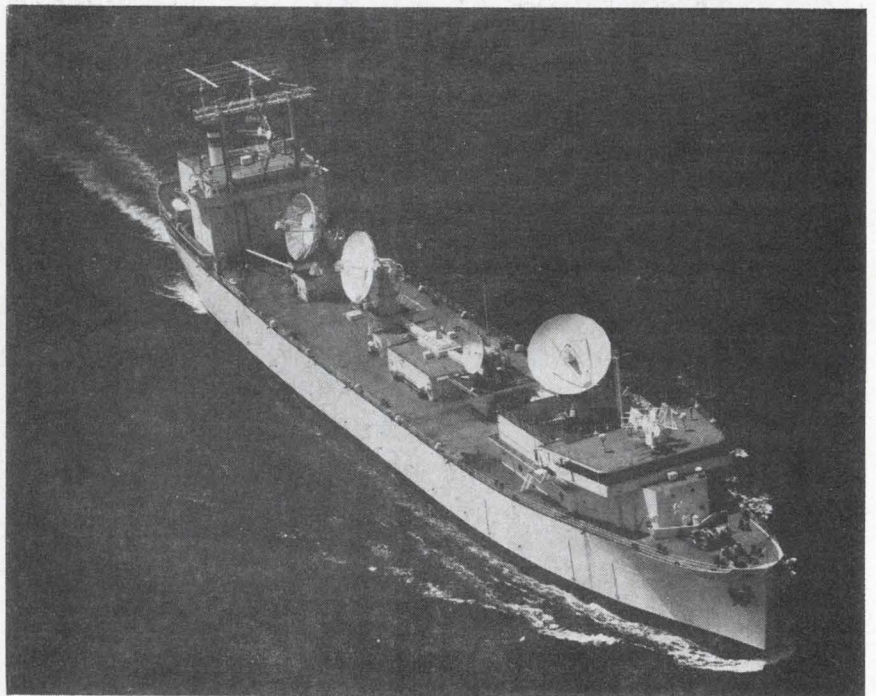

Sister ship. Tracking vessel, Redstone, is similar to the Vanguard which will be part of the space flight network for the Apollo 4 shot.

The numbers game

The numbering system for NASA's missions, launch vehicles, and spacecraft is confusingly complicated. Although the upcoming shot is designated Apollo 4, there was no 1, 2, or 3. The first three shots of the Apollo program, completed during 1966, were AS 201, AS 203, and AS 202, in that order. The AS designation referred to Apollo-Saturn I while the numbers called out the Apollo vehicles in the order they were built. The launch vehicle was the two-stage, upgraded Saturn I. The spacecraft destroyed by fire in January was the AS 204. In an attempt at clarity, NASA has switched to a numbering system similar to that used for the Gemini flights.

seconds later, C band will follow. The blackout should last about two and one-half minutes as the spacecraft hurtles down to below 300,000 feet. Communications should then be restored for about three minutes, when the spacecraft lifts up in its skip reentry and cools a little.

The second blackout, occurring from about 220,000 feet down to 100,000 feet, will last about a minute and a half. The plan, tried on one of the Gemini flights, to overcome the blackout by squirting water into the plasma stream in front of the spacecraft, has been abandoned for Apollo missions. The water added too much weight.

II. Check points

Of the 14 stations in the worldwide manned space flight network, 12 will be used for the Apollo 4 mission. New unified S-band installations with 30-foot diameter tracking antennas are on Merritt Island near the launch complex at Cape Kennedy. Similar facilities are on Antigua, Grand Bahama and Ascension Islands in the Caribbean, as well as on Guam in the Pacific. New 85-foot diameter dishes for deep space use are at Goldstone, Calif.; Madrid, Spain; and Canberra, Australia. There are also upgraded stations used during the Gemini shots in Bermuda; the Canary Islands; Canarvon, Australia; Guaymas, Mexico; Kawaii, Hawaii; and Corpus Christi, Tex.

After launch, Merritt Island will track Apollo for about five minutes,



how to measure resolver or synchro position with 30 second repeatability

In both production test and ground checkout systems, North Atlantic's high performance Angle Position Indicators provide exceptional operator ease and precision in the measurement of synchro and resolver position. Features include digital readout in degrees and minutes, 30 second resolution, continuous rotation, plug-in solid-state amplifier and power supply modules. Due to the design flexibility of these units, they can be readily provided with a variety of features for specific requirements. Typical units in this line incorporate combinations of the following features:

- Single Synchro or Resolver Input
- Dual Synchro or Resolver Inputs
- Retransmit Synchro, Resolver, Potentiometer, or Encoder
- 2-Speed Synchro Input
- Multi-frequency Inputs
- DC Input
- 0-999 Counter

BASIC SPECIFICATIONS

| | |
|-------------------------|-----------------------------|
| Range..... | 0°-360° continuous rotation |
| Accuracy..... | 6 minutes (standard) |
| Repeatability..... | 30 seconds |
| Slew Speed..... | 25°/second |
| Power..... | 115 volts, 400 cps |
| Size..... API-8025..... | 1¾" h x 9½" w x 9" d |
| API-8027..... | 3½" h x 4¾" w x 9¾" d |



Your local North Atlantic representative has complete data on the API line. Call him today or write direct for technical literature.

NORTH ATLANTIC industries, inc.
TERMINAL DRIVE, PLAINVIEW, L. I., NEW YORK • Overbrook 1-8600

Speaking of lab gases?speak to *Linde*

Dial (201) 925-8990. Our LINDE lab gas experts are ready to solve your Rare gas or gas mixture problems.

LINDE makes available the Rare gases: helium...neon...argon...krypton...xenon...and other ultra-high purity gases in glass bulbs and a variety of high pressure cylinder sizes.

LINDE also has gas mixtures of any number of gases and volatile liquids in high pressure cylinders. These mixtures are available in three grades:

- **LINDE Primary Standard Grade**—prepared by weight to the highest possible accuracy then calculated to mole percent.
- **LINDE Analyzed Grade**—mixed and analyzed to high laboratory tolerances.
- **LINDE Utility Grade**—prepared with a mixing tolerance of $\pm 10\%$ and an analysis accuracy of $\pm 5\%$ of the minor component. Available with or without analysis.

When you buy laboratory gases... LINDE is ready to serve you. **Call (201) 925-8990.** Union Carbide Corporation, Linde Division, 2365 East Linden Avenue, Linden, N. J. 07036.

LINDE is a registered trademark of Union Carbide Corporation.

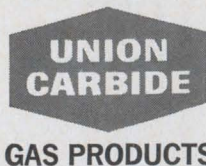

Uncertain schedule

After Apollo 4 there will be at least two more unmanned Apollo flights. Apollo 5 will test the lunar module to verify the ascent and descent control systems. It will be placed in earth orbit by an uprated Saturn I, in December at the earliest.

Apollo 6 will be the second flight test of the Saturn 5, putting an instrumented lunar module dummy and an unmanned command and service module in earth orbit. The mission will test the new command module escape hatch. If all goes well, the manned flights will begin with Apollo 7, which will be lifted into orbit by an uprated Saturn 1. The 10-day mission will evaluate crew and craft performance during a long flight. This was the job assigned to the ill-fated spacecraft that burned on the ground last January. Problems will probably hold this flight back until at least mid-1968.

Apollo 8 will be the first manned flight carrying the lunar module. It will be launched by Saturn 5 only if the unmanned Saturn 5 flights are letter-perfect. If either malfunctions, Apollo 8 will be unmanned.

If all goes well, Apollo 9 might head for the moon.

or halfway to Bermuda. The Bermuda station will keep track for about three more minutes. The tracking ship Vanguard, positioned between Bermuda and the Canary Islands, will follow the craft into orbit. The Vanguard will be the only one of five new instrumentation ships for the space flight network ready for Apollo 4.

For drill. Two of the eight new Apollo Range Instrumented Aircraft—electronics-laden C-135's—will also be ready for Apollo 4. The planes fly out of Marcus Island in the Pacific and will patrol the re-entry track. Their mission will be strictly a performance evaluation to locate the Apollo with nose-mounted radar and to store data transmitted from the spacecraft. The tapes will be sent to the Manned Spacecraft Center in Houston, Tex., for evaluation. Two or more of the planes will be ready when the next unmanned space shot, Apollo 5, goes up later this year; all eight are supposed to be on hand for the first manned Apollo when they'll retransmit data and voice via uhf to ground stations.

III. Jots and tittles

The Apollo fire left no fundamental problems for electronics manufacturers. "I can't think of anything in electronics or in electronic design that is a problem now," says Lee B. James, deputy director of the Apollo program for NASA. "Instead, we're stuck with some pretty mundane problems like soldering and welding."

The soldering headache was most apparent in the attitude and

translation control assembly on the lunar module. This assembly, built by the Radio Corp. of America's Aerospace Systems division, Burlington, Mass., developed hairline cracks in certain solder joints when subjected to the thermal cycling needed for applying and curing the urethane protective coating.

No electrical failure was involved, says an RCA spokesman. The cracks were discovered during visual inspection following quality testing. Stresses causing the cracks occurred in a connection between some of the cordwood modules and their motherboard, the RCA spokesman says. The cracks were eliminated by modifying the soldering procedures and using a more ductile solder with a higher ratio of lead to tin. Solder cracks were also reported in the flight control computer on the instrument unit for one of the Saturn 5 boosters.

Bulk effect. But James says he is having problems with production items that are not as good as the prototypes. And some of the systems are overweight, particularly the rendezvous radar for the lunar module, says another space agency official.

"The problem is that we went from breadboard to hardware without prototypes on the radar," he says. "And we have lost something in controlling the weight. I imagine we'll have to end up slacking off on some of the specifications in order to get the weight down."

James feels that electronics has contributed to weight problems because new packaging techniques have not been developed. For ex-

ample, potting compounds and electric connectors have not been reduced in weight. He also says that electrical connectors have been failing in tests. Typically, failures are due to bent or recessed pins, bad potting, and poor welds [Electronics, Oct. 3, p. 64]. Teflon, used to cover electrical wires as a safety precaution after the fire, is also causing a problem. According to James, this material scars and breaks easily. The space agency is now trying to give Teflon better handling characteristics.

James is also concerned with the potential problems of communicating and tracking at lunar distances. However, these are difficulties which will emerge and be worked out only in actual flight.

IV. Marking time

Meanwhile, half a world away the Russians are encountering problems of their own. Since the dawn of the space age, every anniversary of the 1917 revolution brings speculation that the Soviets are planning a commemorative space spectacular. Foreign diplomats in Moscow feel there will be some sort of splash again this fall because Nov. 7 marks the 50th year of Communist rule.

However, informed U. S. sources tend to doubt the Soviets have any manned flights scheduled for 1967. They are still making changes in the design of the Soyuz spacecraft, the one in which Soviet cosmonaut Komarov was killed, according to Edward S. Welsh, executive secretary of the President's National Space Council. Welsh feels the Soviets are not planning any manned missions until next year.

The tip-off to a manned flight, says Welsh, will be a Soyuz flight which will be either unmanned or will use an animal. He feels the Soviets would not send up an improved craft without testing it first. He predicts: "Next year the U. S. and the USSR will have manned flights, and both will be earth-orbit missions."

Contributions to this report were made by: Lawrence Curran, June Ranill, and Darrell Maddox in Los Angeles; Sue Butler at Cape Kennedy; Robert E. Lee in Houston; William Arnold in San Francisco; Paul Dickson in Washington; Howard Rausch in Moscow; and Alfred Rosenblatt in New York.

RECONNAISSANCE ... a very special ART

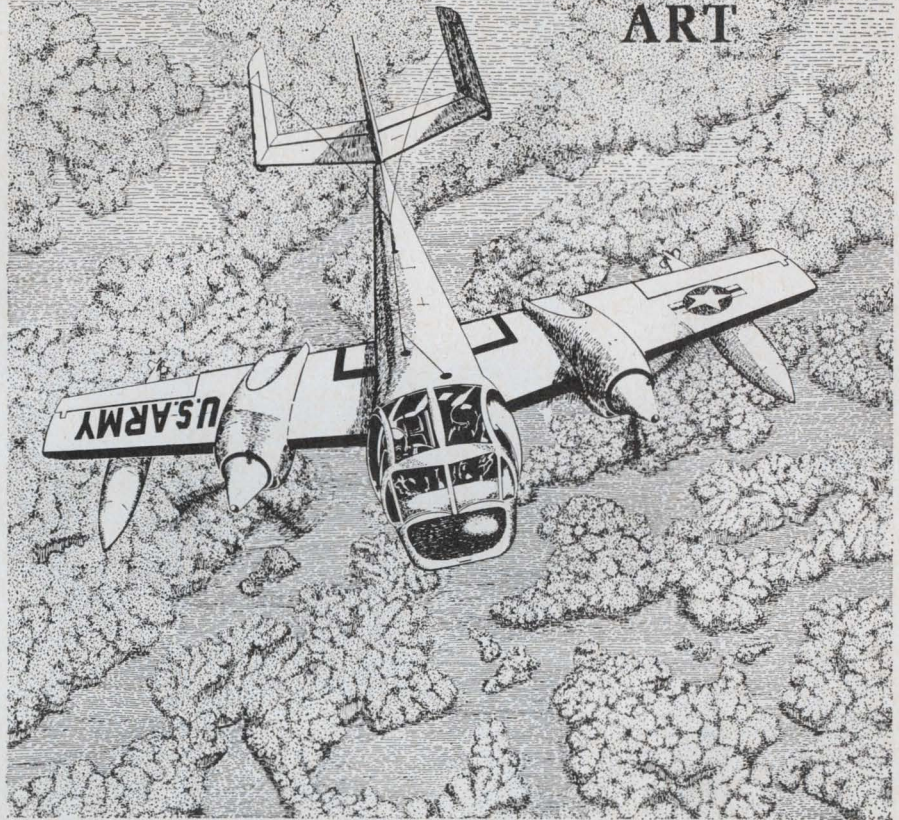

ATI's passive defense systems are employed on reconnaissance missions flown by the Army Mohawk.

Applied Technology Incorporated develops and manufactures electronic reconnaissance, surveillance, and active countermeasures systems. Because of aggressive leadership and a talented team of scientific and engineering specialists, ATI has secured a reputation for creativity, equipment reliability, and extremely quick reaction to customer needs.

Illustrated: Solid-State Signal Source designed for microwave applications requiring exceptional operating stability and spectral purity. Each unit is self-contained. Major applications include: frequency reference for doppler radar; stable receivers; laboratory reference standards; radiometric studies. Packaged in lightweight, 25 cubic inch, aluminum alloy housing.

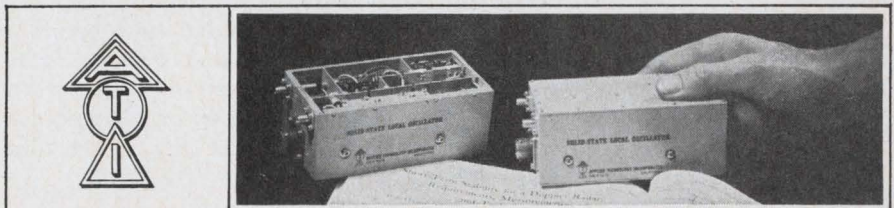

• Engineers • Designers

Join the Growing One. ATI has positions in many disciplines and on all levels.

APPLIED TECHNOLOGY INCORPORATED

3410 HILLVIEW AVENUE • STANFORD INDUSTRIAL PARK • PALO ALTO, CALIFORNIA 94304
TELEPHONE: (415) 321-5135 • TWX: 910 373-1218 • WASHINGTON, D. C. (703) 532-8188
LINCOLN AIR PARK WEST, LINCOLN, NEBRASKA: (402) 799-2411

ATI is an equal opportunity employer

ACTIVE COUNTERMEASURES • RECONNAISSANCE & SURVEILLANCE • SPECIAL COMMUNICATIONS TECHNIQUES

NOW...a full-sized **VOM** in a palm sized "package"

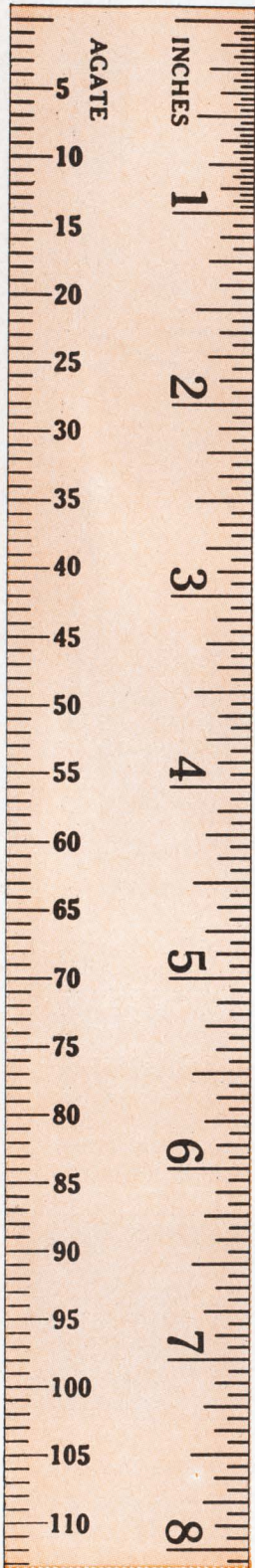

160 Volt-Ohm-Milliammeter
Complete with alligator clip
leads and operator's manual.
..... \$50.00



Carrying Case—
Cat. No. 2225.....\$ 9.50
Accessory Leads—
Probe Tip Lead—
Cat. No. 2055.....\$ 2.75

Simpson 160 Handi-VOM[®]

Simpson Handi-VOM gives you the ranges, the time-saving conveniences and the sensitivity of a full-sized volt-ohm-milliammeter—yet it's only 3-5/16" wide, weighs a mere 12 ounces. Recessed range-selector switch never gets in the way . . . polarity-reversing switch saves fuss and fumble. Self-shielded taut band movement assures high repeatability and freedom from external magnetic fields. Diode overload protection prevents burn-out—permits safe operation by inexperienced employees and students. The demand is BIG, so get your order in to your electronic distributor, TODAY!

RANGES

ACCURACY: $\pm 3\%$ FS DC, $\pm 4\%$ FS AC
DC VOLTS: 0-0.25, 1.0, 2.5, 10, 50, 250,
500, 1000 @ 20,000 Ω/v
AC VOLTS: 0-2.5, 10, 50, 250, 500, 1000
@ 5000 Ω/v
DC MICROAMPERES: 0-50
DC MILLIAMPERES: 0-1, 10, 100, 500
DB: -20 to +10, -8 to +22, +6 to
+36, +20 to +50
"0" REFERENCE: 1 MW into 600 Ω
RESISTANCE: Rx1, (30 Ω center)
Rx10, Rx100, Rx1K, Rx10K



DIVISION

Simpson
INSTRUMENTS THAT STAY ACCURATE

SIMPSON ELECTRIC COMPANY

5200 W. Kinzie Street, Chicago, Illinois 60644

Phone: (312) 379-1121

Export Dept: 400 W. Madison Street, Chicago, Illinois 60606, Cable, Simelco

IN CANADA: Bach-Simpson Ltd., London, Ontario

IN INDIA: Ruttonsha-Simpson Private Ltd., International House, Bombay-Agra Road, Vikhroli, Bombay

WORLD'S LARGEST MANUFACTURER OF ELECTRONIC TEST EQUIPMENT

Representatives in Principal Cities
... See Telephone Yellow Pages

Long-term R&D goes on short rations

Emphasis on immediately practical hardware for Vietnam is slowing the flow of Pentagon funds to advanced military and civilian projects

By Paul A. Dickson

Washington regional editor

An increasing number of advanced research projects with a high electronics content are being deferred or stretched out as a result of the Vietnam war. The stepped-up involvement of the U.S. in Southeast Asia has put a severe strain on the Federal budget, and funds are being channeled away from long-range programs—both civilian and military—and into conventional weaponry and support gear.

At the moment, the Pentagon's line is that the siphoning off of long-term R&D funds presents no particularly pressing problems for the present or the future. Suspicion is growing, however, that lasting dislocations, particularly in the electronics sphere, may result if some sort of balance is not restored.

Defense officials can point out that there's plenty of research money around for advanced hardware, but the fact is that these funds are going for equipment that is almost immediately useful in limited warfare. For example, contractors promising production designs within two years for electronic countermeasure and night-fighting equipment can just about write their own tickets with Armed Forces procurement people, but their industry fellows working in such related fields as light-sensitive materials are getting short shrift.

I. Treadmill to oblivion

Defense officials as well as interested observers are in general agreement on three major points:

- While long-range R&D projects are not, for the most part, losing ground, neither are they gaining any. Most are simply not expanding at the rates the services intended or industry expected. The word "defer" is in vogue to describe what's happening to fiscal 1968

spending as well as what will happen in the fiscal 1969 requests now being framed. "From a dollars-and-cents standpoint, most programs are not being cut back," says a Pentagon official. "But quite a few that many people expected to expand won't grow for a while."

- Among the programs feeling the deferral pinch are long-range air-defense systems, long-distance communications projects, and tactical data-processing equipment.

- The R&D projects which are 18 to 24 months from fruition are getting immediate and generous support from the military. However, "stated requirement"—Pentagonese

for "can we use it right away in Vietnam?" is the operative consideration in such cases.

II. Arrested development

In 1964, the Defense Department provided funds to develop a three-dimensional radar system that could be used by all the services. For the past three years, however, this project has languished in the status of advanced development objectives (ADO)—a phase in which engineers develop the required technology and test it against the military's specifications. For lack of available funds to move it out of the ADO category, the tri-service

Smaller slice of bigger pie

Government agencies, industrial firms, and universities—which do about 33%, 57%, and 10%, respectively, of the nation's research and development work—have all felt the effects of the slowdown in the funding of long-range programs. During the calendar 1958-1965 period, Federal and private expenditures for R&D in the U.S. grew at an average annual rate of 9.5%. Last year, however, when outlays hit \$22.4 billion, according to the National Science Foundation, marked the beginning of a deceleration in the rate of yearly gain. The foundation estimates R&D spending this year at \$24 billion, and puts the 1968 total at \$25 billion—a less than 7% average annual growth rate over the three-year span. As a rule of thumb, the Government picks up about two-thirds of the national tab for research, so it isn't overly difficult to detect where the slowdown originates.

Furthermore, the proportion of R&D funds allocated for defense purposes—defined as those supported by the Pentagon and certain programs of the Atomic Energy Commission—averaged about 50% of total annual R&D expenditures during the 1953-1961 period. Subsequently, however, defense outlays plummeted rapidly, accounting for just slightly more than 30% of the total during the past three years.

Part of the Pentagon's declining importance in the R&D scheme of things is attributable to the vast sums now appropriated for space and medical programs. Then, too, there is a larger pie to slice. But the fact remains that in absolute terms, spending has made little headway in recent years—indeed in the last decade.

Last year, Federal spending for R&D totaled \$17.1 billion, with an estimated \$7.5 billion coming from the Defense Department. These levels are expected to be about unchanged during 1967: \$16.6 billion and \$7.4 billion, respectively. The comparable figures for 1955—two years after the Korean truce and two years before the advent of the space age—were \$15.7 billion and \$6.8 billion.

part per million

accuracy

in a single package

DC
• VOLTS
• OHMS
• AMPS
• RATIO

DC Related
• °C
• STRAIN
• AC
• RF POWER

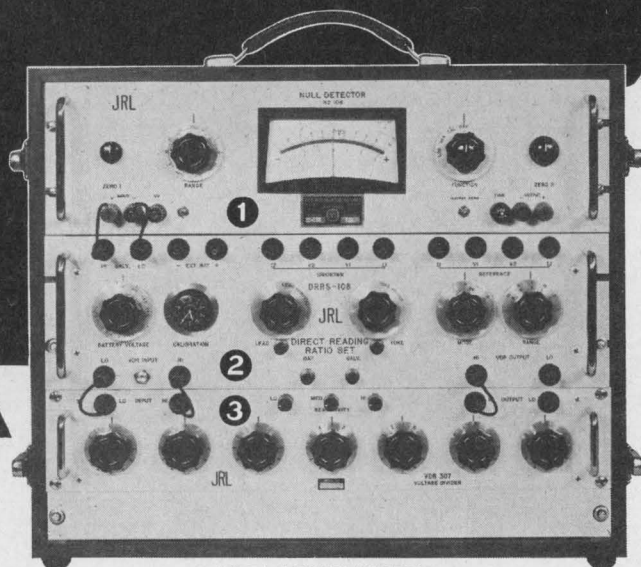

MV-1 MULTI-VIDER

The Julie MV-1 Multi-Vider™ is designed to provide multi-purpose, part per million accuracy in a low cost, easy-to-use package. The basic Multi-Vider is an integrated combination of a 1 ppm accurate divider and a high performance detector with provision for plug-in adaptors. Because of its unique divider-plug-in design the basic Multi-Vider offers the best measurement capability for all applications.

With only two plug-ins, the Julie Multi-Vider measures all four . . .

Resistance — Voltage — Ratio — Current

. . . to an accuracy of 6 places with 7-place sensitivity.

As shown above, the Julie Model MV-1 MULTI-VIDER consists of:

1. **NULL DETECTOR** — a superior general-purpose galvanometer with a sensitivity of $\pm 0.1 \mu\text{v}$.*

(*Optional preamplifier extends sensitivity to 1 nanovolt)

Price: \$800.00

2. **PLUG-IN** — Standard Julie plug-ins can be purchased for your individual requirements. They automatically convert the divider (below) to the best bridge or the best potentiometer at any price. They cover the complete measurement range — from nanohms to gigohms, picoamperes to amperes, and nanovolts to kilovolts.

Prices: \$1,700.00 (approx.)

3. **DIVIDER** — 1 part per million Kelvin-Varley Voltage Divider — The divider balance is always easy to obtain and the dials read ohms, volts, amps or ratio directly. Every reading has a resolution of 7 places and a basic accuracy of 6 places (0.0001%).

Price: \$900.00

Because of the divider, Multi-Vider performance is uniquely reliable — typical calibration interval is 2 years. Calibration back-up for the Multi-Vider costs only \$180. The divider is used to calibrate the detector and plug-ins. A \$180 DMR-105 resistor set calibrates the divider. Calibration is complete and simple to perform.



For more information or for a free opportunity to test the Multi-Vider in your company on your projects on your projects, write: Julie Research Laboratories, Inc., 211 West 61st Street, New York, N.Y. 10023 (212) 245-2727.

JULIE RESEARCH LABORATORIES, INC.

3-D radar remains on dead center.

Similarly, a new shipboard radar development project has been consigned to limbo because the Pentagon lacks R&D money to keep the program going. And the Navy's long-heralded ASMS, an advanced surface-to-air missile system, is still stuck in precontract definition work — ostensibly awaiting determination of its commonality with the Army's SAM-D anti-aircraft missile.

Delay lines. A West Coast source believes that the development of new reentry vehicles for the Pershing missile system may be delayed because of financial exigencies. Likewise, the long-planned Advanced Defense Communications Satellite Program (ADCSP) is being delayed as a result of war expenditures. Chances are, say some observers, that the Initial Defense Communications Satellite Program, now providing long-haul service between the U.S. and Southeast Asia, may be upgraded to fully operational status. But these observers are increasingly concerned about the time it's taking to decide whether or not to fund ADCSP.

A probable dropout is Program 120A, a scheme for an advanced intercontinental ballistic missile. A go or no-go decision on this project is expected within six months. Observers stress that the program's fate will depend to a large extent on the course of the war.

Military men are taking a harder look at some of technology's more futuristic recommendations. As a result, funds are in short supply for long-term programs to harness lasers and millimeter waves.

Civilian casualties. Targets aren't limited to the military. The National Institutes of Health, the National Aeronautics and Space Administration, and the National Science Foundation are all experiencing difficulty in securing as much money as they would like.

An economy-minded but defense-conscious Congress has been whacking away at NASA's new programs. Among the victims of the pruning are Voyager, the Apollo Applications Program, and Mariner. Similarly, the NSF, on its own, pared a \$130-million package of six proposed radio and radar astronomy programs to a pair of projects costing \$18 million.

Sense of balance. Most Pentagon

officials are inclined to pooh-pooh the contention that the piper must eventually be paid as a result of R&D fund diversions. "We'll probably come out about even. Some areas of technology are being pushed ahead rapidly, while others are falling behind," says Ernest C. Wood, assistant to the assistant director for communications and electronics in the Office of the Director of Defense Research and Engineering.

Others are not so sanguine about the long-term efficacy of this approach. "The impact is being absorbed by the smaller projects funded for less than \$1 million," says an executive of an East Coast military supplier. "The state of the art is being affected by current decisions." This source cites Fort Monmouth's recent award of a contract to ITT Gilfillan Inc., a division of the International Telephone & Telegraph Corp., to develop a conventional mechanical-scan radar for a countermortar system; the Emerson Electric Co.'s proposal of a phased-array unit was bypassed. "This is a prime example of a case where current needs made it impossible for the military to take a chance on state-of-the-art advancements," he says.

"Because of the DDR&E's insistence that projects have a stated requirement, there is an adverse impact on the long-range work being done at such places as the Army's Rome Air Development Center and the Air Force's Hanscom Field and Wright-Patterson base," says a knowledgeable industrial observer. "The 3-D radar will never be ready by the 1973 target date and will probably have to be thoroughly restudied before it can be built because of the current lag. And the Navy's ASMS has been taking a three-year shellacking."

III. Overhaul

Clearly, it's difficult, if not impossible, to secure funds for long-range projects not tied to existing systems. But equipment shortcomings revealed by combat have stimulated interim development work. For example, the success of North Vietnamese surface-to-air missile batteries against U.S. aircraft has shown that present electronic counter-measures gear isn't as effective as it was supposed to be. As a re-

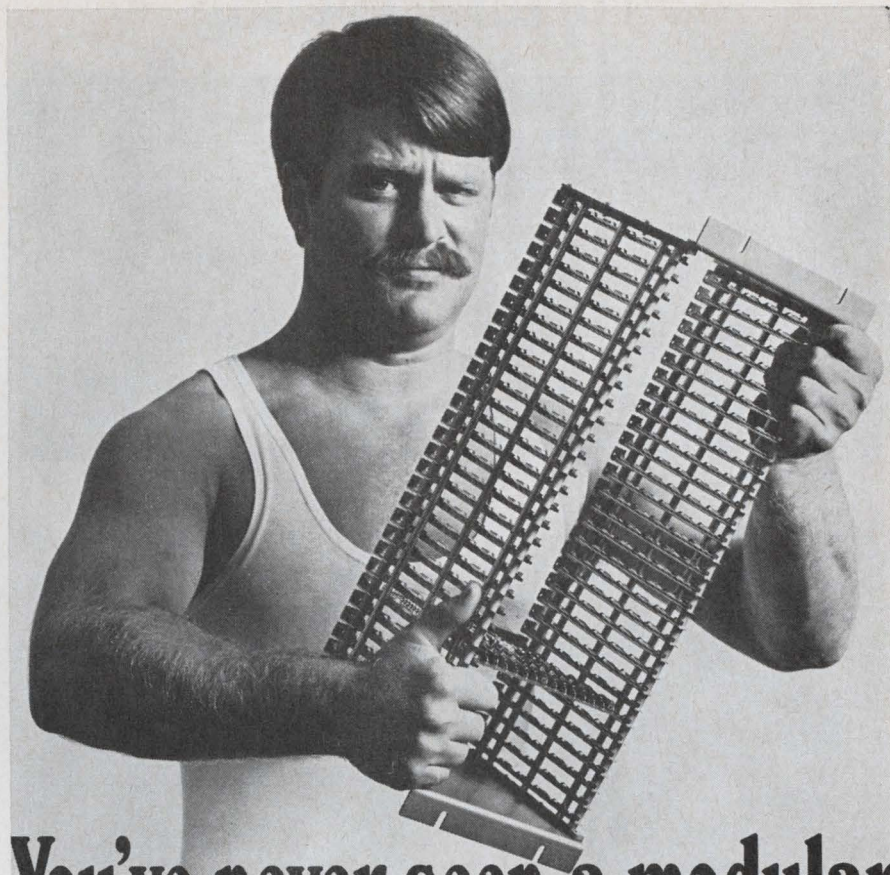

You've never seen a modular PCB rack this rugged. Before.

The card guides are stainless steel, and have multiple spring fingers for positive retention; all structural members are cold rolled steel, the support rods 3/16" in diameter, with additional 1/4" stiffener rods available to reinforce extremely long or heavy assemblies. ■ This is the Birtcher 56 Series rack—emphasizing high-density packaging (your choice of card spacings down to 3/8") and low profile (card height plus just 11/16"). It handles 1/16" and 3/32" boards, with retainers from 2" to 10" long, in 1" increments. The rack itself can be 2" to 25" long, and board spacers are available to any length, with .002" accuracy. Unusual thinness of the card guides promotes maximum air flow between cards, and their firm grip and stainless steel construction provide excellent retention and reliable electrical contact for grounding. Available in component form or fully assembled to your specifications.

EXTRA STRONG CARD RETENTION—These new stainless steel guides hold cards firmly with a series of spring-type grippers along the length of the guide. Design also provides smooth travel on insertion and withdrawal.

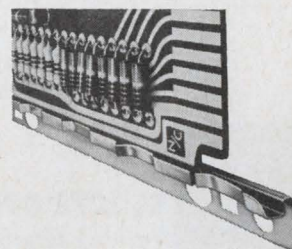

Write for data sheets on the 56 Series PCB Rack.

the BIRTCHER CORPORATION
INDUSTRIAL DIVISION

745 Monterey Pass Road • Monterey Park, California 91754 • (213) 268-8584

Torture Testing

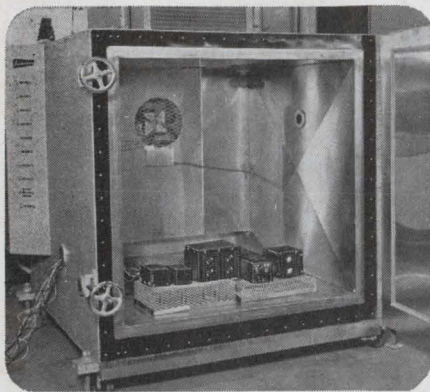

Humidity, Altitude,
Temperature Testing

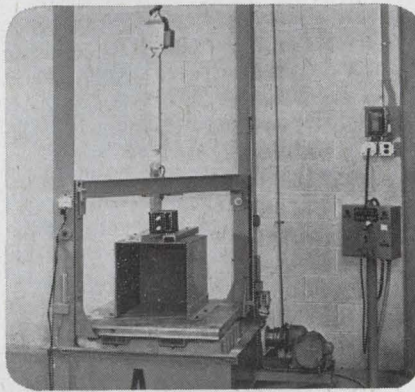

Shock Testing

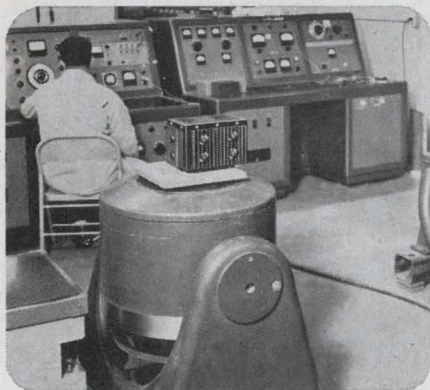

Vibration Testing

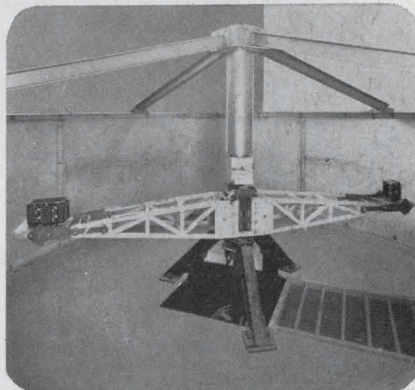

Acceleration Testing

helps certify ERA's Transpac[®] off-the-shelf MIL SPEC DC Power Modules

When you order and rely on ERA Transpac[®] off-the-shelf Mil Spec DC Power Modules you get a guarantee of conformity to military specifications backed by a rigorous program of actual environmental testing by one of America's leading independent testing laboratories.

You eliminate "special design" headaches . . . with "stock-order delivery" and at standard catalog prices! No engineering or prototype costs on any of 175 tested models. Repairable fully qualified 75°C silicon and 55°C germanium types, plus transparent-encapsulated "type-approval" models with hundreds of variations in each group.

Send for complete, new 1965 catalog showing ERA's full range of Mil Spec plus Standard Silicon and Germanium Transpac DC Power Modules with specs, sizes and prices.

NEW



ELECTRONIC RESEARCH ASSOCIATES, INC.

Dept. E, 67 Sand Park Rd. • Cedar Grove, N. J. 07009 • (201) CEnter 9-3000

SUBSIDIARIES: ERA Electric Co. • Advanced Acoustics Co. • ERA Dynamics Corp. • ERA Pacific, Inc.

. . . the lack of funds cannot
all be blamed on Vietnam . . .

sult, large sums are being expended to develop better systems and even improve such components as broad-band power tubes and microwave tubes. Night-vision apparatus is another area in which contractors have access to funds—always provided they can promise deliveries within two years. Deficiencies in avionics, some a decade or more old, have been underscored in combat engagements; massive doses of R&D funds are being applied in the search for correctives.

"A lot of new programs aren't going to start," says DDR&E's Wood. "Exploratory efforts have been slowed down in many areas so we can support near-term needs."

Army way. "In terms of dollars, not much is being affected, but the impact of not expanding R&D is quite evident," says Howard P. Gates Jr., assistant for electronics to the Assistant Secretary of the Army for research and development. Gates notes that funds for long-range tactical air defense systems are in short supply; the AN/rsq-73, for one, is feeling the pinch.

Long-range tactical communications programs like Mallard [Electronics, May 15, p. 153] and RADA, for random access discrete address, are being stretched out. "The Army is fighting to maintain these systems, but they will undoubtedly suffer from less funding," says Gates. "The cutbacks won't hurt them ultimately, but it'll be a fight to get operational by 1975 as originally planned."

Stepping on the tail. Also affected by the emphasis on economy are the three elements of ADSAF, (automatic data system within the army in the field)—a tactical artillery fire control system, a tactical intelligence operations system, and a combat service support system for administrative and logistical operations. Gates says the Army is battling harder to prevent a slowdown in this area than it is in other projects. He is resigned, however, to some slippage since all three projects are long-range.

IV. Priorities

New instrumentation that would test missile developments at the

White Sands Missile Range is also a deferred item, as are long-distance night-vision projects. Photo interpretation and processing will feel the current pinch for a long time; existing equipment and techniques will have to serve for at least another five years and perhaps 10. But night-vision work related to jungle warfare and base defense against infiltration is going full blast with plenty of R&D money being stoked in.

Vice Adm. H.C. Mason, vice commander of the Navy's Electronics Systems Command, feels his service has suffered less from staitened finances than others. However, he concedes that a tri-service radar, some communications programs, and ASMS have been deferred. Polaris submarine communications programs haven't been hampered, though, he says.

Another tack. A spokesman at the Air Force's Office of the Director of Development says: "Deferrals and the fact that we're not getting the funds we want cannot be blamed totally on the war." In some cases it is a matter of technology he explains, citing the case of the 3-D tri-service radar. This program, managed by the Air Force, is "difficult to administer since the services are having a hard time getting together on specifications," he says.

Awacs, for airborne warning and control system, is another Air Force program that was moving cautiously because of both technical and budgetary considerations. However, the decision to deploy a "thin" Nike-X system has restored it to fiscal favor [Electronics, Oct. 2, p. 63]. But certain air-defense projects are being postponed for lack of funds, as is work on voice-to-digital data communications systems.

Donald M. MacArthur, deputy director in charge of research and technology at DDR&E, administers projects that are seven to 20 years from fruition. "The war has underscored deficiencies in certain fields, and we're recognizing long-range areas that we must pursue," he says. However, MacArthur notes "less effort is [being expended] on research and technology now because the amounts of money we're getting are remaining constant. Due to such factors as inflation, this amounts to a slippage for us."

control/alarm short-cut

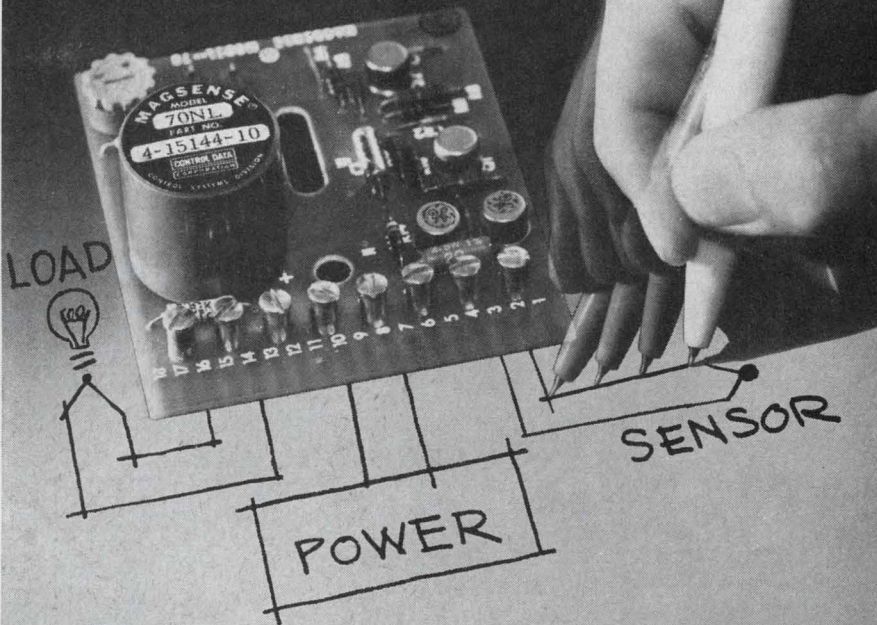

MAGSENSE

control/alarm for temperature, pressure, speed, flow

Here's the fast, easy way to solve your control/alarm problem. Hook up sensor, load and power source to a MAGSENSE® control/alarm module and adjust the setpoint. That's it. No time wasted designing and debugging a circuit. And while you're saving time you'll be saving money, getting *proven-in-service* reliability.

Capabilities? All MAGSENSE modules offer 100-billion power gain, accept inputs as low as 10 microvolts or 1 microamp *directly* without preamplification. Completely isolated inputs are unaffected by common mode voltages as high as 110vac, 60Hz or overloads as large as 1000-times full scale input. Typical accuracy is $\pm 0.5\%$ full scale. And they all

operate from a *single* DC power source (either 28v or 12v).

Options? The list includes remote and dual setpoints, adjustable hysteresis, choice of output action, transducer excitation voltage, and cold junction and copper compensation on thermocouple models. There's a MAGSENSE model for your application.

Price? Get MAGSENSE control/alarm modules for as little as \$35 in quantity. Compare that with the cost of developing and building your own circuit.

More information? Write or call, or circle the reader service number and we'll send you complete specifications and prices.

CONTROL DATA

CORPORATION

4455 Eastgate Mall, La Jolla, Calif.

MAGSENSE Sales, Dept. 211
Analog-Digital Systems Division
Control Data Corporation
4455 Eastgate Mall
La Jolla, Calif. 92037
Phone 714/453-2500

ARNOLD IS



TAPE WOUND BOBBIN CORES

Standard Cores of 4-79 Mo-Permalloy and Deltamax
on Ceramic or Stainless Steel Bobbins . . .

engineered for use in sophisticated data processing systems, high frequency magnetic amplifiers, static inverters, timing circuits, shift registers, ring counters, pulse transformers and as static magnetic memory elements. All tapes are rolled on a beta-ray controlled Sendzimir mill in standard gages of 1, 1/2, 1/4 and 1/8 mil and slit to standard widths of 0.031, 0.0625, 0.125 and 0.250. Cores are wound on semi-automatic machines, then annealed at extremely high temperatures in specially designed dry hydrogen atmosphere furnaces to obtain the final magnetic properties. Arnold maintains complete control over all phases of fabrication. Melting, processing, rolling and slitting of raw materials (nickel iron) to winding annealing and final test are all "in-plant" functions.

Write for Catalog TC-108B.



ARNOLD
SPECIALISTS in MAGNETIC MATERIALS

THE ARNOLD ENGINEERING COMPANY, Main Office: MARENGO, ILL
BRANCH OFFICES and REPRESENTATIVES in PRINCIPAL CITIES

Post Office cancels old ways

Officials seek aid of electronics industry in speeding mail handling and delivery; a substantial market is shaping up

By Robert Skole

Manager, Washington Bureau

Aircraft and trucks have replaced the Pony Express, but the U.S. mail is otherwise handled today pretty much as it was a hundred years ago. Ben Franklin, the father of the postal system, would feel at home in most of America's post offices. However, it's obvious to the public, the Congress, and the Post Office Department itself that with mail volume at 80 billion pieces a year and increasing at the rate of 3 billion pieces annually, fundamental changes are needed.

The new postal officials trying to give meaning to brave new words about bringing the postal system up to date are just beginning to breach the agency's bureaucratic barrier, and their efforts are opening a giant and relatively untouched market for electronics.

How large this market can become is anybody's guess, but systems-oriented firms will get some idea on Nov. 3 in Washington when Post Office research and engineering brass outline what they're up to now and what future needs will be. The word "systems" is the key: that the Post Office is one large system is apparent, but a systems approach to solving postal problems has never been applied.

I. Forwarding the mail

To get industry thinking of the Post Office as a systems customer is the job of Leo S. Packer, assistant postmaster general in charge of the agency's new Bureau of Research and Engineering. Packer, a former engineering manager at the Xerox Corp., himself is evidence that a fresh attitude toward modernization is sweeping the department. Hired about a year ago, he was told that one of his major projects was to interest industry in doing business with the

Post Office. And to give him some cards to play, the budget makers set aside \$23 million for research and engineering in fiscal 1968, compared with \$16 million last year and \$9 million the year before.

Initiation. During his first year, Packer learned quickly why industry has generally shunned the Post Office for many years. For one thing, the ponderous workings of bureaucracy created maddening delays in the simplest procurements. For another, it was almost impossible for outside engineers and developers to get technically competent officials to listen to—and act on—proposals for new hardware or systems.

The upcoming conference with industry was originally scheduled for last spring, but Packer realized he wouldn't be able to gather a

high-level staff of engineering experts in time. "I didn't want to mislead people and disappoint them," he says. "There would have been disillusionment if we got people excited about making proposals and they found out there was nobody in the Post Office they could talk to."

After that false start, Packer established an Office of Industry Liaison within his bureau and named Kenneth M. Baker to head it. Baker, a former director of marketing at the Pennsalt Chemical Co.'s Equipment division, says his main task now is "to improve the image of the Post Office as a marketplace for sophisticated equipment and systems."

Down to earth. Another recent addition is Walter C. Scott, who was director of programs and resources in NASA's Office of Advanced Research and Technology.

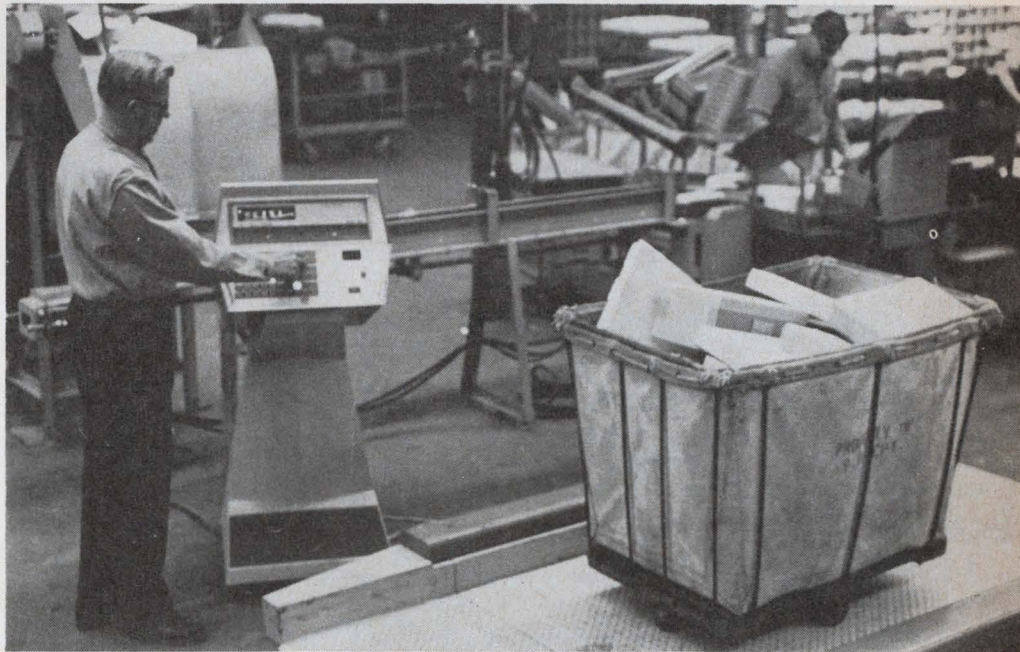

Weigh-in. Electronic scale is part of a \$33-million data system that will link 75 main post offices and 1,230 branch facilities.

feeling the pinch

{ for qualified
electronics
technicians? }

New electronics equipment demands technicians with a wide range of specialized skills. Men who understand the "why" of electronics... can install, maintain, troubleshoot and repair the electronics gear you're using today and will be using in years ahead.

Qualified electronics technicians are scarce. But with a Cleveland Institute of Electronics Training Program you can soon develop an ample supply by up-grading your present staff of technical personnel. CIE "AUTO-PROGRAMMED" Courses are fast, economical, effective. What's more, they can be readily "tailored" to your specific training needs. Hundreds of companies use them... thousands of men are enrolled. Get free details fast. Mail coupon today. Cleveland Institute of Electronics, Dept. E-31, 1776 E. 17th St., Cleveland, Ohio 44114.

SEND COUPON TODAY

Cleveland Institute of Electronics

Dept. E-31, 1776 E. 17th St., Cleveland, Ohio

Gentlemen: I am interested in learning more about your Electronics Home Study Programs. Please send complete information.

Name _____

Title _____

Company _____

Address _____

City _____ State _____ Zip _____

Accredited Member, National Home Study Council.

... engineers couldn't find competent officials to act on proposals ...

Scott admits that he wasn't much interested when Packer offered him a Post Office job as assistant director of general research in the R&D section. But the prospects of applying aerospace-type management techniques to the problems of getting the mail through intrigued him. "I'm still not sure the job can be done," he says. "But we've made progress by establishing a research and development philosophy modeled after aerospace techniques. Our job isn't to develop hardware but technology."

Handle with care. As if Packer and his associates didn't have enough trouble with entrenched bureaucracy and reluctant companies, they also found that they can run afoul of the law if they carry modernization too far—Federal statutes direct that certain postal jobs be done by hand. Furthermore, every postmaster in the country is a political appointee who oversees the work of Civil Service employees.

Baker says: "We think of long-range solutions while the men in the post offices are worrying that Christmas is coming. It's pretty tough to phase out a system and replace it with a new one when you're just keeping ahead of demand now."

Help wanted. But the Post Office has plenty of technical problems for engineers to wrestle with. For example, the department envisions the day when it will not only be aided by alphanumeric zip-code and address readers, but by complete address registers in computers programed to sort mail according to letter carriers' frequently changing routes.

Despite the tempting challenges, however, the Post Office has had trouble attracting talented engineers to maintain its 1 to 5 ratio of in-house to outside research. Young engineer grads find more glamor in industry and aerospace programs than in the projects at the Post Office's temporary R&D facilities in Bethesda, Md.

II. Speed reading

The most sophisticated electronics projects undertaken so far—

in-house or out—have been aimed at developing alphanumeric readers. Working on a \$9 million contract, the Philco-Ford Corp.'s Communications & Electronics division is installing four reader-sorters at post offices in Detroit, Houston, Boston, and San Francisco. The Detroit and Houston units are already plugged in and are sorting 2,000 to 2,500 pieces of mail an hour. Philco-Ford says its electronic address reader, which employs a flying-spot, cathode-ray-tube scanner, can sort at least 75% of the daily intake of properly addressed mail. In addition, the company is scheduled to deliver within the next six weeks a script-numeric reader developed under a \$293,000 contract and containing a flying-spot crt scanner and a proprietary recognition system.

But the Post Office, concerned that Philco-Ford might take over the field of reader-sorters, has continued to seek industry bids on zip-code readers. Prototype zip-code readers have been submitted by the National Cash Register Co.; the Burroughs Corp.; and Rabinow Electronics Inc., a subsidiary of the Control Data Corp.; all have been rejected because they couldn't meet a requirement that the error rate be 2% or less. The postal R&D office soon will award a new contract to one of the companies for an improved version of its prototype, however.

Machine age. Another electronics market in the making at the Post



Matchmaker. Leo S. Packer heads effort to modernize the Post Office.

Office is data processing. Two years ago, the Post Office had 20 people managing its data processing program; it now has 150—mainly programmers and analysts. The data processing office is headed by Keith D. Carter, who spent 17 years at the Defense Department; he concedes that “up to now, it’s been a seat-of-the-pants operation.” But so far, his office has used computers to figure out the fastest route for an air mail letter, a process under which the machine might order a sack of mail to be moved on and off as many as four flights between, say, New York City and Birmingham, Ala.

This is just the start. The office is programming the routing of surface mail, and eventually would like to see computers handle the entire routing task—including the printing of destination tags for mail sacks and a precoded tag for each piece of mail so that it could be sorted automatically according to the carrier route at the point of destination.

Every letter bit. Now the Post Office is installing what it touts as the world’s largest computer-controlled data collection system. When fully installed in 1968 by the Control Data Corp. at a cost of \$33 million, the on-line system will link 75 major post offices and 1,230 branches, and have about 8,000 terminals. Each post office will have electronic “badge readers” to record employees’ work time, attendance, and types of jobs performed; also slated are alphanumeric input and output units, plus electronic scales. The scales, made for Control Data by the Hardy Scale Co. of Ogden, Utah, use strain gages and give weights to 1/100ths of a pound and can handle trays, hand trucks, or conveyors.

All data from the branches will be accumulated and transmitted to one of four teleconcentrator sites in New York, Washington, Chicago, and San Francisco, each equipped with a CDC 1700 computer. Information will then be transferred to CDC 3300 computers at centers in Paramus, N. J., and St. Louis in 2,400-bit-per-second lines. About 25 post offices and 300 branches in New York State and New England already are equipped; it’s expected that after the first 75 post offices

- THE ROCKET BELT
- THE HYDROSKIMMER
- FIRST COMMERCIAL NUCLEAR FUEL REPROCESSING PLANT
- FIRST AIR SUPPORTED STRUCTURES
- FIRST SUCCESSFUL IMPLANTABLE PACEMAKER FOR THE HUMAN HEART

- AND NOW THE FIRST SKY TAXI

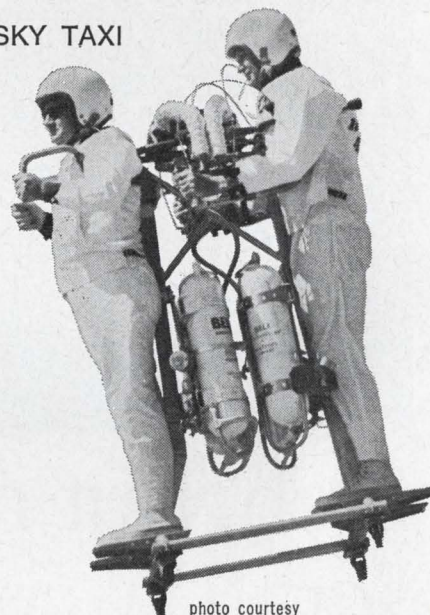

photo courtesy
Textron's Bell Aerosystems Co.

this is not the place for imitators

The list of recent and current major developments born on the Niagara Frontier in avionics, electronics and other modern scientific fields makes eye-opening reading for any company seeking the right “climate” for a new research facility or manufacturing site.

Here too, the exciting combination of art galleries, sports, schools and universities, closeness to over 100,000,000 people and the availability of good plant sites makes the Niagara Frontier a sound choice for you. But the very special quality this area offers you is the “can do” spirit that sparks innovations and accomplishments. Get the whole story . . . it’s yours for the asking . . . simply send in the coupon below!

**The future
is here
on the
Niagara
Frontier**

(BUFFALO AND
ERIE COUNTY, N. Y.)

Mr. Edward Rath
Erie County Executive
Erie County Hall, Dept. E-77
Buffalo, N. Y.

O.K. Mr. Rath. Send me your new book that tells why the Niagara Frontier (Buffalo and Erie County, N. Y.) is a profitable spot for our plant.

Name _____
Title _____
Address _____
City _____ State _____ Zip _____

Check if you want convention information.



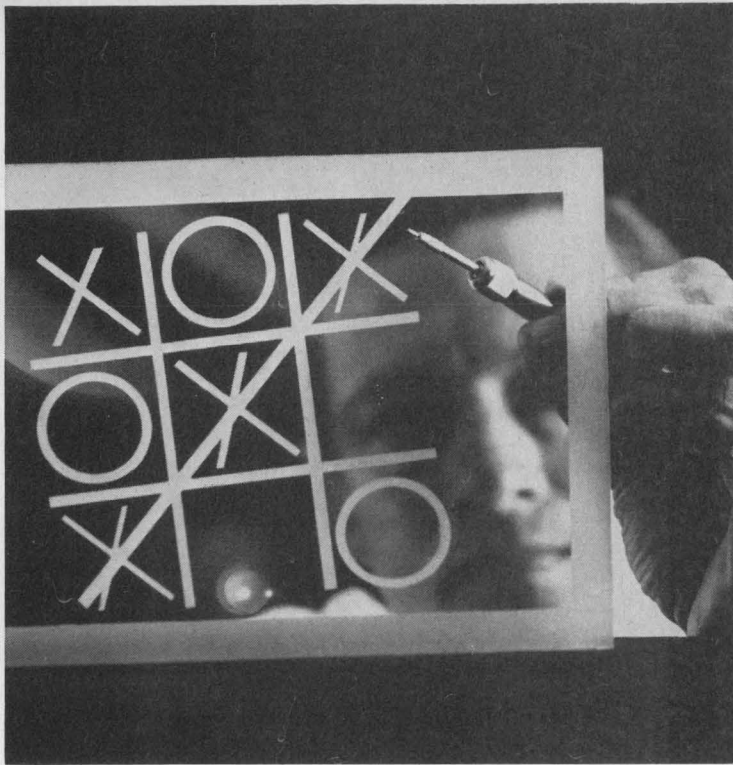

Etch, but don't scratch...with Airbrasive

Airbrasive is unsurpassed for preparing matte surfaces, etching patterns, or frosting any hard shiny surface. Our tic-tac-toe game could have been played free-hand but in order to demonstrate the accuracy possible, we cheated and masked it off with ordinary masking tape. For a production operation, you can use rubber or copper templates.

Airbrasive makes it easy to prepare surfaces for welding, soldering, adhesives; it is excellent for marking, getting rid of glare, decoration, or what-have-you. And it doesn't scratch, heat, strain, or otherwise modify the substrate mechanically, or electrically.

Airbrasive won't scratch your capital budget, either — less than \$1,000 will put a unit to work for you. It is versatile, too — other applications include deflashing, microdeburring, cutting, shaping, drilling hard, brittle materials — tungsten carbide, germanium, silicon, glass, to name but a few.

The secret of its cool, shockless process is a finely-controlled jet of gas-propelled abrasive particles. It's efficient, safe and simple to use.

Invite us up to see your etchings... or your shapes or your abrasions. We'll bring along an Airbrasive unit and show you how much better it works than the way you've been doing it.

SEE US AT BOOTH #622 NEC SHOW AND #2D67 NEREM SHOW

S. S. WHITE COMPANY, INDUSTRIAL DIVISION, Dept. EU,
201 East 42nd Street, N.Y., N.Y. 10017, Telephone 212 661-3320



S.S. WHITE

1470

are on line, 150 to 200 more will be cranked in at a cost of \$30 million.

III. In the wings

A fully computerized post office could be operating in 10 years, says Fred Hartman, a vice president of Rabinow. The firm, now vying for the contract for zip-code readers, developed the first mail-sorting machine in 1958. To handle that electromechanical unit, the operator had to memorize 276 code numbers for postal locations. However, the Post Office is testing a Rabinow unit that replaces human memory with a 2-million-bit electronic memory.

The firm also has proposed a study of a "video remoting" system that could sort mail by optical scanning without first having someone weed out the letters that can't be read by scanner. Those that defy the scanner would have their image projected on a screen by a strobe vidicon, and a clerk would direct the letter to its destination.

Down the chute. Another project in the works aims at developing speech recognition equipment. The Radio Corp. of America's Electronics Products division has a \$250,000 Post Office contract [Electronics, June 26, p. 52] calling for delivery next year of a unit that "hears" zip-code numbers on packages. If the device passes a two-month evaluation, RCA will build an engineering model.

Abraham Tersoff, chief of advance development for the Office of Research and Development, notes that current postal optical readers employ techniques developed years ago. He expects research contracts to be let next year for readers incorporating laser and holography technology. And Post Office engineers are also keeping their eye on developments in infrared technology.

Touchy subject. Another area of interest is facsimile, once a dirty word in postal circles. In 1959-60, the operation of an experimental fax link between Battle Creek, Mich., and Washington, using Western Union lines touched off a furor in Congress over alleged Post Office invasion of a sector served by private industry. However, says one engineer, "facsimile is just a half-dirty word today."

108 - Minute dining room, 1 with sink, kitchen 4251.
 110 - Sleeping room. References: 816, 8001, 801, 777.
 111 - Rm. Dkt. - Dishes, next bath, dining, bus, real, southern, references: 816, 8001, 801, 777.
 112 - Blvd. - Sleeping room, 100. Private bathroom. 816, 8001.
 113 - Sleeping room, refrigerator, 100. Pr. Convenient transportation. 816, 8001, 801, 777.
 114 - Room for rent, from shopping center location. 816, 8001.
 115 - 2 single operators, 2 with sun, 100. Working adults. Reference: 816, 8001.
 116 - Bedroom, 100. Non-occupied, 100. 816, 8001.
 117 - Mississipi: Small, 100. Handy bath, settled, 100. 816, 8001.
 118 - 2 attractive bedrooms, completely private, convenient transportation. References: 816, 8001, 801, 777.

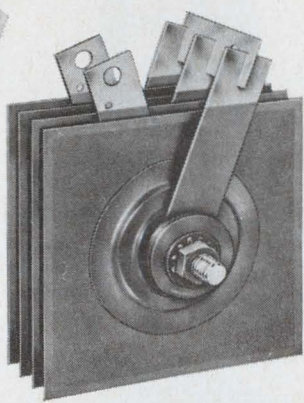

119 - Small room, 100. References: 816, 8001, 801, 777.
 120 - Worn, 100. Refrigerator, stove, 100. 816, 8001, 801, 777.
 121 - 100. 816, 8001, 801, 777.
 122 - Large, 100. Private bath, modern, 100. Near Parkway, 100. 816, 8001, 801, 777.
 123 - Large, 100. Excellent transportation, 100. Reasonable, 100. 816, 8001, 801, 777.
 124 - 100. 816, 8001, 801, 777.
 125 - 100. 816, 8001, 801, 777.
 126 - 100. 816, 8001, 801, 777.
 127 - 100. 816, 8001, 801, 777.
 128 - 100. 816, 8001, 801, 777.
 129 - 100. 816, 8001, 801, 777.
 130 - 100. 816, 8001, 801, 777.

Space To Let!

When you use Uni-Sel Selenium Rectifiers....

- Profit in space-saving with smaller physical sizes operating at higher current density...
- Profit in reduced cost with 45-volt quadruple density Uni-Sel...
- Profit with Higher Temperature Capability, 50% ratings at 70°C ambients.
- More information? Send coupon...

Send catalog data about 241
 Syntron Uni-Sel Rectifiers
 Name/Title _____
 Company _____
 Street _____
 City, State _____ Zip _____



New catalog with full information on Silicon Diodes and Assemblies.



SYNTRON COMPANY
 241 LEXINGTON AVE. • HOMER CITY, PA. 15748
 TELEPHONE 412-479-8011
 Sales Representatives Coast-to-Coast

67R9

Here's why you should now be using Datavue* Indicator Tubes

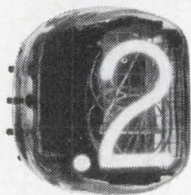

CK1904—Interchangeable with B59956 and NL809.

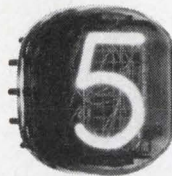

8422—Interchangeable with B5991 and NL8422.

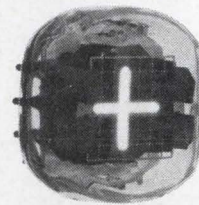

CK1903—Interchangeable with B5992 and NL5992.

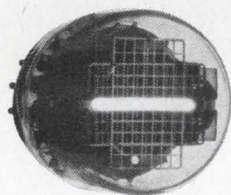

CK1901—Interchangeable with B5016 and NL5016; CK1902—Interchangeable with B5032, NL5032, B50911 and NL50911.

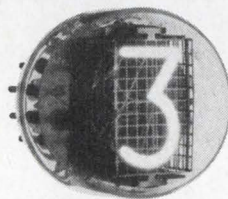

8421—Interchangeable with B5092 and NL8421; 8037—Interchangeable with B5031 and NL8037. Also available: 6844A.

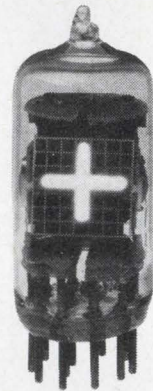

CK1900 (used with CK8650, CK1905, CK1906); CK1907 (used with 8754)—Interchangeable with NL843.



8754—Also available with right- and/or left-hand decimal points; Interchangeable with NL840/8754. Decimal-point types interchangeable with NL841, 842, 848.



CK1905; CK1906 (right-hand decimal point).



CK8650

These indicator tubes—just a few of Raytheon's wide selection—offer you advantages in design, economy and performance. For example:

You don't need to revise designs. Raytheon's Datavue round and rectangular end-view tubes conform to EIA ratings—interchange with other brands. And Raytheon also offers you a selection of side-view types—and "specials" with up to 12 characters, \pm signs, symbols, etc., to your specifications.

You can buy them at low cost. All Datavue Indicator Tubes are priced

competitively—or lower. Most side-view types, for example, cost less than \$5 each in lots of 500 or more.

Reliably trouble-free readouts. All Datavue characters are fully formed—not segmented. The fully formed characters are brightly displayed and easy to read—at distances up to 30 feet.

They last for years. They're made better because of Raytheon's experience—40 years of producing more than 100,000,000 cold cathode gas-filled tubes with carefully controlled electrical performance. Ultra-long-

life types, for example, have dynamic life expectancies of 200,000 hours or more.

They're readily available—in sample and production quantities. For samples, prices, or technical information, call your Raytheon regional sales office or distributor. Or write: *Raytheon Company, Industrial Components Operation, Quincy, Mass. 02169.* *Trademark of Raytheon Company

Industrial Components Operation—A single source for Circuit Modules/Control Knobs/Display Devices/Filters/Hybrid Thick-Film Circuits/Industrial Tubes/Optoelectronic Devices/Panel Hardware.



Lockheed's 417.



Lockheed makes the portable portable. At 28 pounds, including its self-contained batteries, the 417 recorder comes in at 50 pounds less than any comparable recorder. And the 417 measures up in more ways than weight. □ It starts off with a price tag as low as \$7000. It operates on 110/220 volts AC/DC, with a power consumption that goes down to 10 watts. It has an exclusive, rugged low-mass differential capstan drive for precision operation under

vibration in any position. It has phase-lock servomotor control; a simplified maintenance-free transport mechanism, frequency response of 100 kc direct 10 kc FM; and, scaling in at only 14" x 15" x 6", it can even fit under an airplane seat. □ We believe the 417 is the best portable recorder on the market. But check it out for yourself. □ Just ask for the Lightweight, one of a family of recorders for undersea, land, air and space applications.

The lightweight.

LOCKHEED ELECTRONICS COMPANY
A Division of Lockheed Aircraft Corporation, Edison, New Jersey

If it's so great, how come it's so cheap?

It's only \$5,000 because you said that's what it ought to cost. Our market research boys told us there was a tremendous need for an IC tester specifically designed for QC, QA, reliability testing, and everyday engineering evaluation. They also told us we could sell four times as many at \$5,000 as we could at \$7,500.

So we gave our design department a list of functions, a \$5,000 pricetag, and locked the door. Here's what came out: A \$5,000 IC tester that:

- Performs both pulse and dc parameter tests as well as functional tests without external equipment.
- Has a measurement accuracy of 1% (0.1% with an optional digital readout DMM.)
- Can be operated by a bright girl with half-a-day's training.
- Programs with thumbwheels in less than 60 seconds for most IC's.
- Has power supply accuracy of 0.1% \pm 1mv. (All supplies have adjustable current or voltage limiting and will both source or sink current.)

- Has Kelvin connections to the device under test.
- Has self powered, line-isolated modules.
- Has a complete line of device adaptors available.

How were we able to deliver so much machine per dollar? It was a snap. All we did was make every damn penny do a dime's work. We did it by committing to an annual agreement wherever there was a price advantage.

We did it by cutting out the fat. If a function was non-essential, it went. (This is one un-gilded lily.)

We did it with painstaking project engineering. For example, the loads module: We could have made 1% capacitive loads. But it would have cost three times as much, and no one knows what to do with capacitive accuracy of better than 5% anyhow. Another example: the thumb-wheel switches. We found a great one, but discovered the price included \$2 each for a pair of stainless-steel screws. We bought them knocked-down,

assembled them ourselves and used 6¢ screws instead.

Or the pulse generator. Ours is equivalent to two single-channel output units like the ones that Datapulse sells for \$775. They're great, but by sacrificing separate control and adjustment (which isn't necessary in our tester anyway) and the fancy case cut the price in half.

We found a terrific \$15 digital switch. But we didn't use it. We built one without superfluous extras for a buck and a half apiece.

We're handling the AC-switching with 32 controlled planar devices. This saves 192 reed relays, that is to say, greenbacks.

One thing we did was hardest of all. We cut the profit margin. We're honest-to-gosh taking only $\frac{3}{4}$ the typical profit.

One more thing. The 990 turns out to cost \$4,950 instead of \$5,000. Use the extra \$50 to take the little woman out to a show and dinner.

Write for complete technical data, or if you're in a hurry, call us collect.

Redcor's 990 IC tester

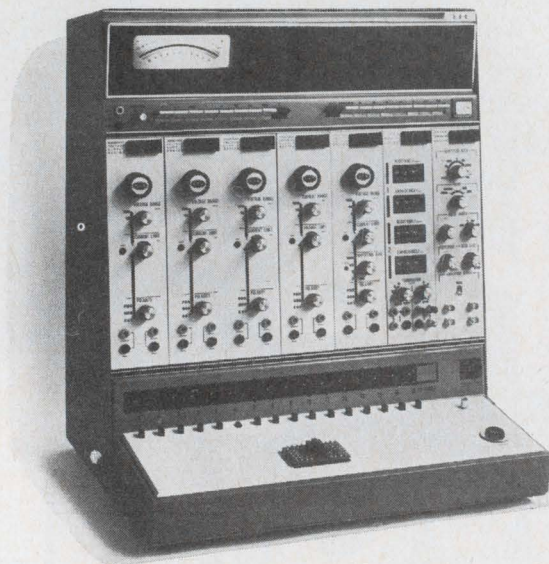

Redcor Corporation/7800 Deering Avenue/Canoga Park, California/(213) 348-5892/TWX 910-494-1228

Only Solitron offers a low cost 25 AMP Germanium Power Transistor!

We'll even send you one Free!

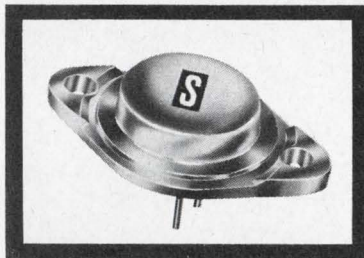

With the introduction of a new, low cost 25 Amp PNP Germanium Power Transistor, Solitron provides the industry a device with power capability of 106 Watts. This transistor also complements and expands Solitron's wide line of germanium high reliability and commercial transistors. Identified as the SDT3080 Series, the device is available in a TO-3 or TO-41 case. It is a general purpose transistor for use in military and industrial inverters, converters, switches, regulators, control circuitry and audio amplifier applications.

Specifications for the SDT3080 family:

Minimum Gain of 10 @ 25 Amps

V_{CB0} = 40-80 V

V_{CEx} = 40-80 V

V_{CE0} = 30-50 V

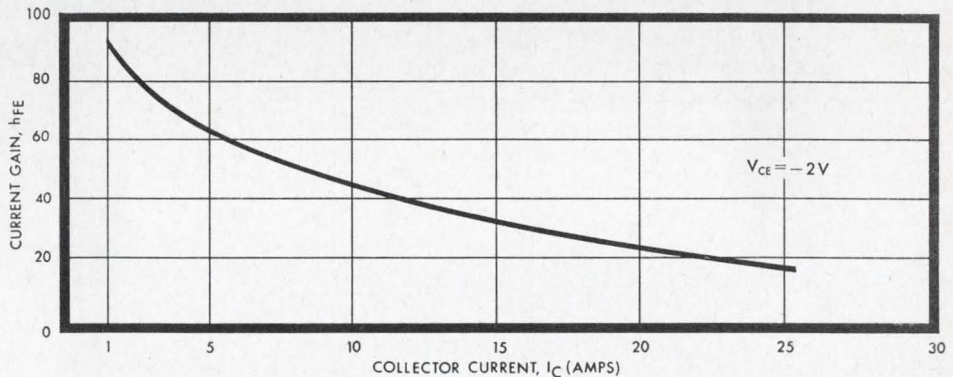

*When you think of semiconductors...
think Solitron!*

Fill out this coupon and attach it to your letterhead. Upon receipt, we will immediately send you a free sample of SOLITRON'S SDT3080.

Solitron DEVICES, INC.

1177 BLUE HERON BLVD./RIVIERA BEACH, FLA.
PHONE: (305) 848-4311 / TWX: (510) 952-6676

NAME _____ TITLE _____
COMPANY _____
ADDRESS _____
ZIP _____

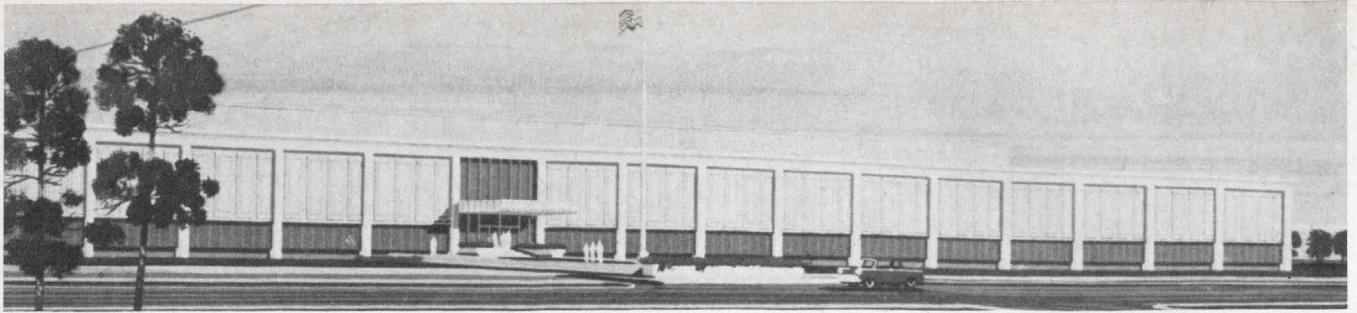

THE PLANT IN PERSPECTIVE

The Fort Worth Division of General Dynamics plant, located in the northwest quadrant of the Greater Fort Worth area, is one of the largest and best equipped facilities in the country. The 600 acre site contains well over 100 buildings. More than 100 acres of floor area are enclosed; 75 acres are under the roof of the main building. Of primary interest in the Fort Worth Division's current \$37 million facility expansion program is the new \$8 million Engineering and Office Building, encompassing 581,400 square feet and covering 12 acres.

Numerous laboratories are provided for performing tests and experiments in a wide range of disciplines. In addition to the well equipped Engineering Test Laboratories, there are several other major laboratories:

- Advanced Mechanics Lab
- Analog Computer Lab
- Antenna Range
- Biological Lab
- Cryogenic Lab
- Design Aids Lab
- Digital Computer Lab with an IBM 360 System
(Model 65/40 ASP) assigned to Engineering
- Extensive Electronics Labs
- Infrared Visual Ultraviolet Lab
- Instrumentation Lab
- Nuclear Science Labs
- Radar Scattering Range

Production facilities are continually being updated in order to capitalize on new techniques, materials, manufacturing processes, and services. The emphasis on staying abreast of the state of the art provides an ever increasing capability for the manufacture of high performance aerospace vehicles.

Situated in an area where employees have a choice of urban, suburban, rural, or lakeside living, the air conditioned plant can be rapidly reached from all parts of Fort Worth.

Find room for thought and career potential . . . and room for better living in smog-free Fort Worth, where the cost of living is low, and where metropolitan advantages exist alongside year-around outdoor recreational areas in a temperate climate.

Call Collect — 817-732-4811, Extension 3551; or send a resume of your education and experience to Mr. J. B. Ellis, Industrial Relations Administrator-Engineering, General Dynamics, Fort Worth Division, P. O. Box 748E, Fort Worth, Texas 76101. An equal opportunity employer. U. S. Citizenship required.

GENERAL DYNAMICS
Fort Worth Division

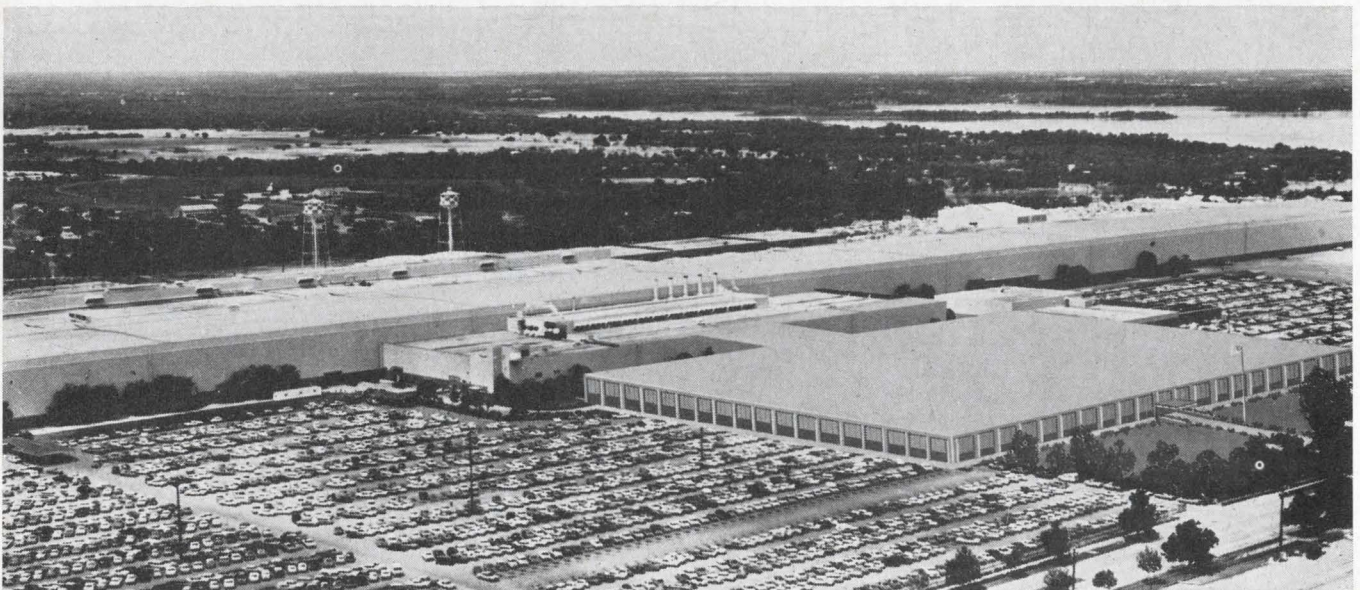

Design engineer Bob Alden searched for nearly an hour to find he didn't have the information he needed.

Chances are 10 to 1 he'd have found it in less than 5 minutes in the new Sweet's Industrial Information System*

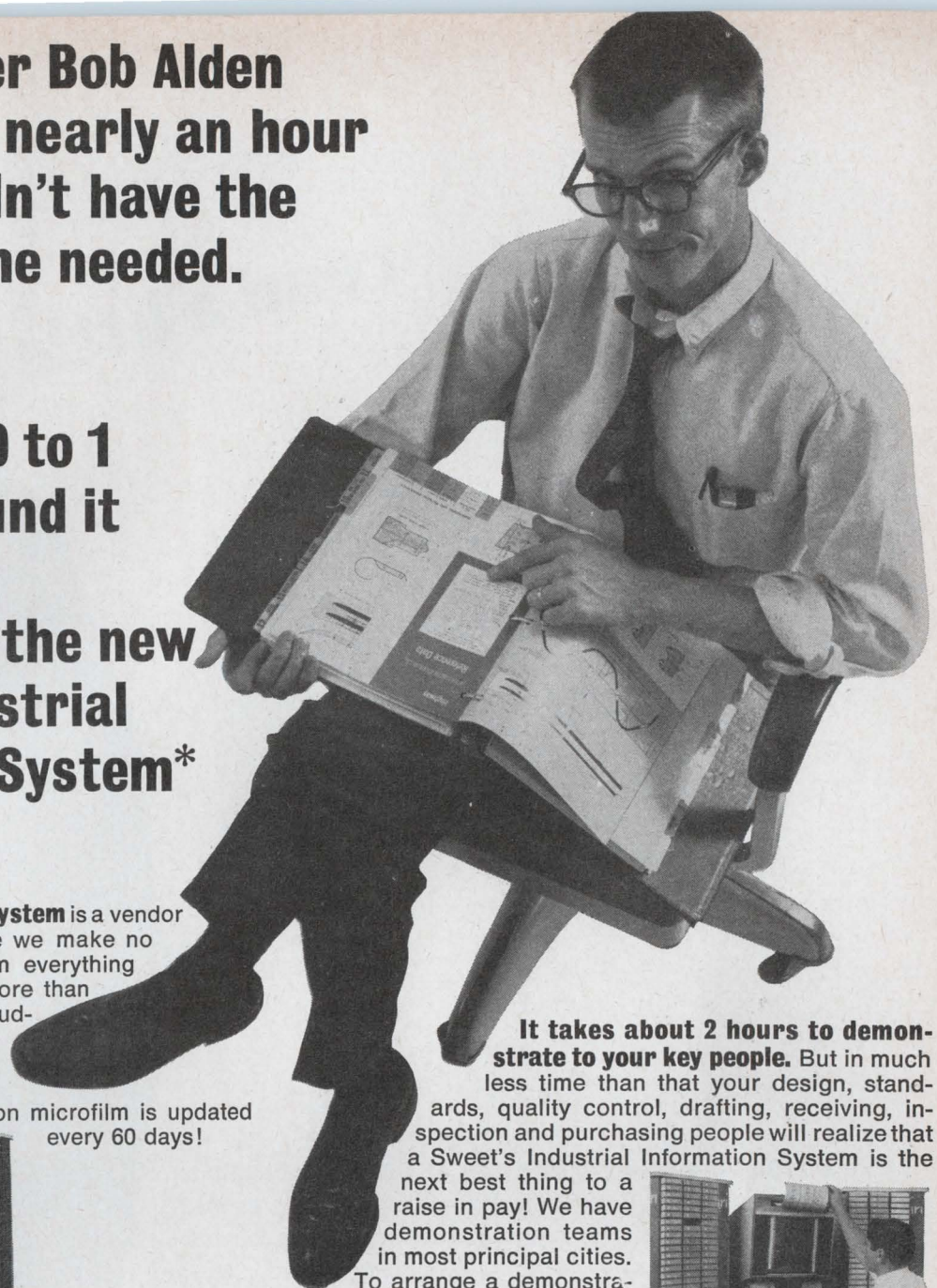

Sweet's Industrial Information System is a vendor catalog file on microfilm. Because we make no charge to vendors, and microfilm everything they have in print, Sweet's has more than 600,000 pages of vendor data including application notes, reliability tests, price lists and names of distributors and reps. What's more, the Sweet's vendor catalog file on microfilm is updated every 60 days!

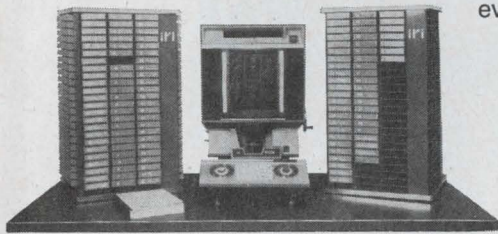

Small wonder.

In addition, the Sweet's system is tailored to your needs by adding the vendors you want – at no extra cost. We start with a basic file of the most wanted information. Update it regularly, and then—to top it off—"personalize" the file by adding the complete vendor information you request. It also reduces storage area by 98%, cuts redundancies in design efforts and increases sources and use of standard items.

You can install a Sweet's vendor catalog file on an annual subscription for less than the cost of a file clerk. Sweet's vendor catalog files are in use in plants with as few as fifty employees. The "user-orientated" idea not only provides current knowledge of the component state-of-the-art, but also expedites the purchasing function. Because of its complete coverage, more than 60% of our recent installations have replaced other microfilmed vendor catalog systems.

S Sweet's Industrial Information System

A new McGraw-Hill Information Service

It takes about 2 hours to demonstrate to your key people. But in much less time than that your design, standards, quality control, drafting, receiving, inspection and purchasing people will realize that a Sweet's Industrial Information System is the next best thing to a raise in pay! We have demonstration teams in most principal cities. To arrange a demonstration, send the coupon today, or call collect: George Stevens, (212) 971-3941.

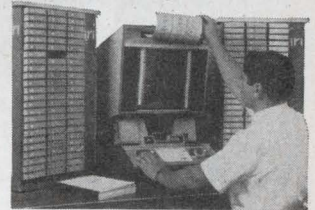

Find it fast. Make a print-out in 6 seconds.

SWEET'S INDUSTRIAL INFORMATION SYSTEM
330 W. 42nd St., New York, N. Y. 10036
Dept. #B-41

- I'd like to see a demonstration of the Sweet's Industrial Information System. Have your representative call me for an appointment.
- I'm not ready for a demonstration at this time, but please send further information.

Name _____ Title _____
 Company _____
 Address _____
 City _____ State _____ Zip _____
 Telephone _____ Ext. _____
 Number of employees at this location _____

We have have not had experience with a vendor catalog file on microfilm.

In addition to the Vendor Catalog File on microfilm we're interested in Mil Specs Mil Standards.

* formerly IPI Information Retrieval Incorporated

read a little



Pay a Little. The price is as small as the product. It's a miniature rear projection readout, and it costs as little as \$14.00. The new IEE Series 345 Readout requires very little space, but it offers the readability and versatility available only with rear projection readouts. And the price is comparable to other types of readouts with limited messages and cluttered displays.

The Series 345 operates on the rear projection principle. A lamp in the rear of the unit illuminates one of the 11 film messages, and projects it to the front viewing screen. A single plane display on the non-glare screen, so you get no distortion or confusion. It is very versatile, since anything that can be put on film can be displayed on the screen. You can display a variety of messages or colors.

The Series 345 has a front plug-in feature. It can be quickly inserted into the housing. It can be just as easily removed to insert a new readout with a different display, or to replace a lamp.



Series 345 Readout: $\frac{1}{2}$ " wide x $\frac{3}{4}$ " high. Six digits will fit in a 3" wide panel space. Depth, $2\frac{1}{2}$ ". Character height, $\frac{3}{8}$ ". Weight, $\frac{3}{4}$ oz. Six available colors, including white, amber, yellow, blue, red or green.

Straight decimal input. Vertical and horizontal viewing angle 175° with V-1 viewing screen, or 160° with standard screen.



"I double-E," the world's largest manufacturer of rear projection readouts.
Industrial Electronic Engineers, Inc., 7720 Lebona Ave., Van Nuys, California

SPEER COMPONENT COMMENTS

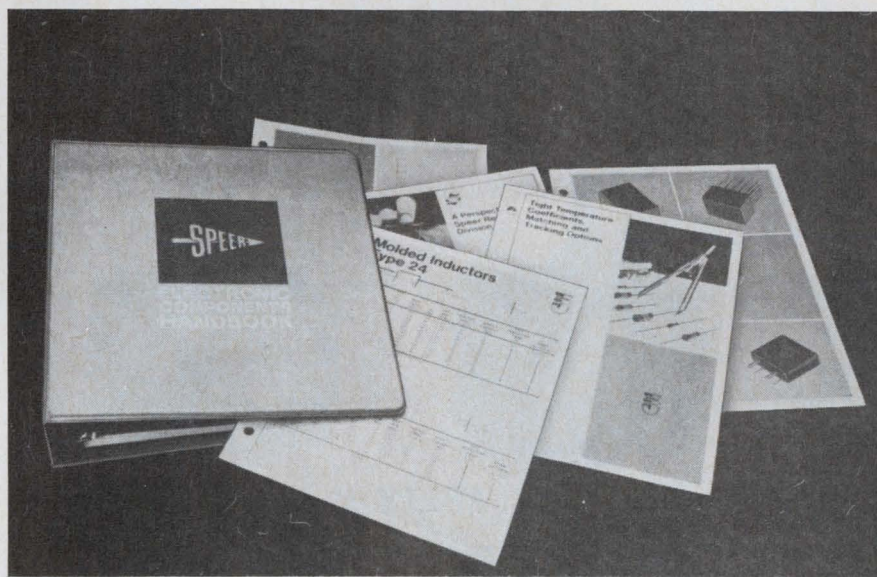

Over 2 pounds of electronics lore that you may not already have

Does your company have a copy of the new 94-page Speer Electronic Components Handbook? It's 2 pounds and 5 ounces of useful electronics information plus up-to-date data on our inductors, capacitors, carbon composition resistors and JXP precision resistors. (Actually, much of the Handbook's total weight consists merely of a heavy loose-leaf binder. But look at it this way. The binder contributes both permanence and — paradoxically — flexibility. As data becomes obsolete, you'll receive revised pages which you'll be able to substitute immediately.)

Here, in one handy Handbook, is everything—from how our composition resistors are made to how our MIL Conformance Program for inductors operates.

Ask your Speer representative for a free copy of this weighty reference work. When he stops by with it, he'll also give you some interesting tips on how to get the most value from it.

If you need the name and address

of your representative, just mail us the coupon.

How to correct for Typical Error #5 when you're testing inductors

From time to time, we've been highlighting the various test errors that are commonly made when measuring inductance and Q in accordance with MIL-C-15305. There are eight errors in all.

Error #5? Failing to apply the Correction Factor when it's applicable.

Inductance values of 10 μ h and lower must be corrected. Use of the TFA Test Fixture (also standardized by MIL-C-15305) should give a α -0.06 μ h factor.

For still more errors—and their "correction factors"—stay with us.

How the curious economics of precision resistor technology can benefit your commercial products

As you may already know, TCs of ± 2 PPM/ $^{\circ}$ C and tolerances of

$\pm 0.02\%$ are available upon request with our JXP precision resistors.

But did you also know that you don't have to pay more to start enjoying this greater precision?

Curiously enough, you'll pay less—particularly if the precision resistors you're now using are of the "wire-wound" type.

JXP metal film resistors reflect important Speer advances in evaporated metal film technology. As a result, they can be produced to tighter tolerances than wire-wounds at significantly less cost for most resistance ranges. And they automatically incorporate faster response and settling times at no additional cost—making them especially ideal for high frequency and high-speed computer applications.

JXPs can benefit your commercial products in other surprising ways as well. (Also your military products, needless to say.) Mail the coupon for complete information.

AIRCO Speer Electronic Components

St. Marys, Pa. 15857

Rush the name and address of the Speer representative who has my company's free copy of your weighty Electronic Components Handbook.

Rush complete information on your surprising JXP precision resistors.

Name _____

Title _____

Company _____

Street _____

City _____ State _____ Zip _____

THESE CIRCUIT PROTECTORS ARE ENTIRELY MAGNETIC TRIP

Hermetically sealed AP Protectors meet or exceed MIL-C-39019. They repeatedly rupture 300A 250V AC, 500A 125V AC, 500A 50V DC, have magnetic time delay, but open a 1000% overload in 4 milliseconds. There is no trip at 100G shock or 20 G vibration, carrying rated current. Available 10 MA to 20A, with a wide variety of circuit combinations, delay curves and auxiliary signal circuits. Ask for bulletin 16E-4.

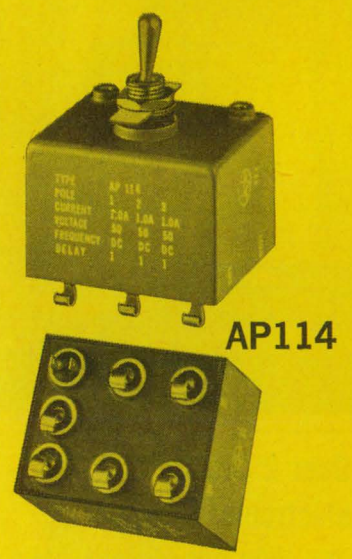
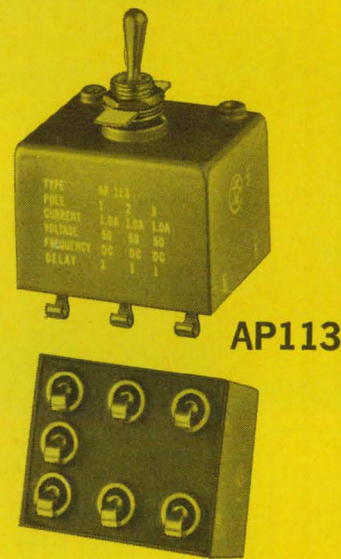
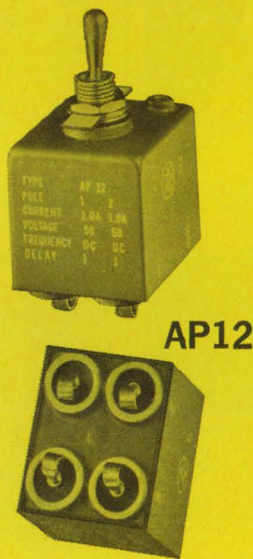
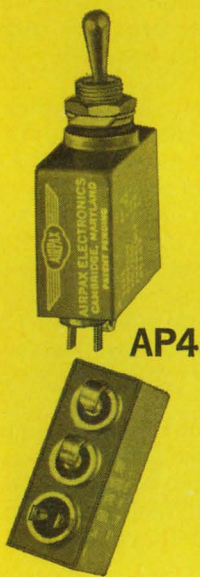
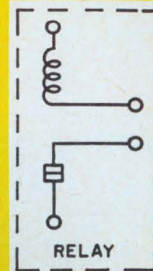
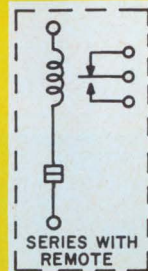
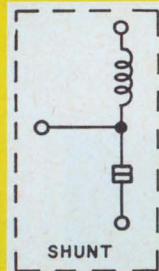

Type UPL1, UPL11, and UPL111 are Underwriters' Laboratory recognized for appliance protection.

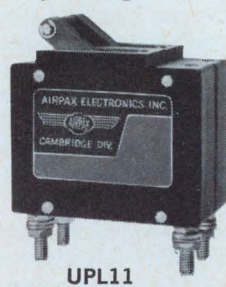
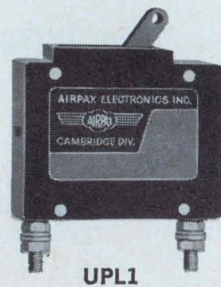

UL RATED at:

.050-50.0 Amps, 50V DC.; .050-50.0 Amps, 120V AC, 60 Hz.; .050-20.0 Amps, 240V AC, 60 Hz.

Series units with enclosed remote switches are available in any combination of delays (Fast — 0.4 to 4.0 sec., Slow — 4.0 to 40 sec., Motor Start — 1.0 sec. at 600%) or UL listed ratings are available in a single pole, two pole or a three pole appliance protector.

AIRPAX ELECTRONICS Cambridge, Maryland 21613 (301) 228-4600

New Products

New computer peripherals

Picture looks brighter for computer displays

Storage crt's that provide long-lasting images make displays handy tools in applications ranging from airline reservation systems to seismic-plot analysis

Next week at the National Electronics Conference in Chicago, Tektronix Inc. the nation's biggest manufacturer of oscilloscopes, will announce a major diversification into peripheral equipment for computers. As its first offering along this line, the company will introduce two models of a cathode-ray-tube display capable of holding alphanumeric or vector information for several hours. These displays, which use the storage tube Tektronix developed for special versions of oscilloscopes, have been priced at \$2,500 and \$1,050—without character generators. They are intended for applications that require many readout stations, applications such as time-sharing systems or automated teaching by computer.

With the timing of its announcement, Tektronix barely edged out two other companies who have eyed the same segment of the graphic-display market. In Los Angeles, the Conrac division of the Conrac Corp. is about to announce graphic-display equipment for computers with a price tag of \$7,000—but this gear includes a character generator and keyboard. And in New Hampshire, Sanders Associates has started producing still another piece of equipment that will do the same job as the Tektronix or Conrac devices.

Behind this sudden upsurge of activity is a realization that more users of computers want the kind of computer readout that only a cathode-ray tube can provide. Tektronix, for example, decided to enter the market after many customers tried to buy its 564 oscilloscope for computer-display purposes, or the cathode-ray storage tube alone. Albert L. Landsperger, director of marketing at Conrac, predicts that 120,000 crt-display units will be in service, driven by computers, by 1971. That would amount to nearly \$800 million worth of displays.

I. Plane seats to optics

Almost everywhere computers are being used these days there is a demand for the crt display. Even before product introduction, Conrac has an order for 2,000 devices—with an option for 2,700 more—from Trans World Airlines, which will use them with its computer-reservation system being built by the Burroughs Corp. United Airlines has ordered 2,200 Conrac units for a new reservation system.

A computer-graphics system at Beckman Instruments Inc. aids engineers in designing monochromators, optical devices that separate a broad energy spectrum into narrow bands, Studying traces on a crt, which is connected to a

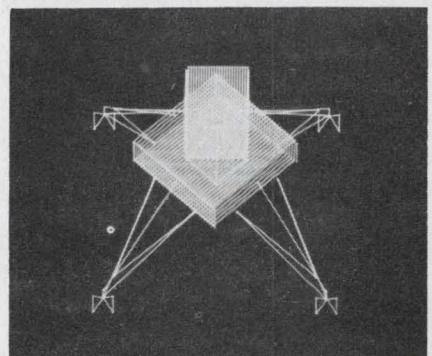
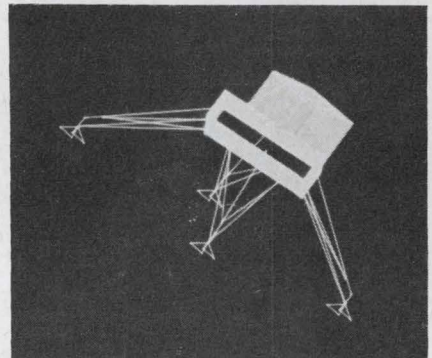
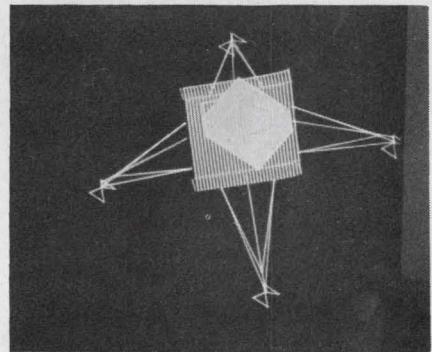
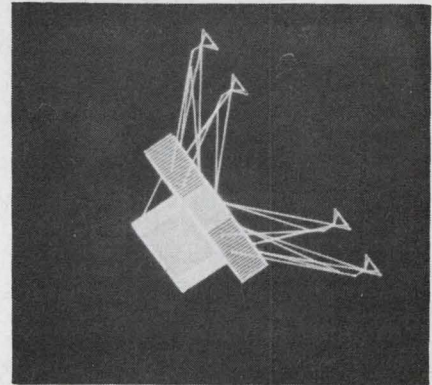

Looking up. In sophisticated computer-graphic terminals, images can be rotated, even made to fly. Adage system presents views of lunar model for study of flight conditions.

Tektronix stores graphics in the tube

Four years ago, when the Tektronix Type 564 storage oscilloscope was introduced, researchers working with time-shared computers quickly saw its potential as an operator-oriented computer graphics display.

Two years ago, the company's newly appointed director of research and production, C. Norman Winningstad, took aim at the computer-peripheral market. Tektronix worked with the Massachusetts Institute of Technology's Project MAC (Multi-access Computer), and lent an early version of its storage cathode-ray tube to MIT researchers for evaluation.

This crt retains the image of an electrical event after the event. As in conventional crt's a gun scribes the input signal on the tube's fluorescent screen with an electron beam. A second gun sprays the screen with slow-moving electrons, holding the written areas bright and the unwritten areas dark. This characteristic—bright trace on dark background—is called bistability.

Erasing. The screen is erased by writing the whole screen bright with a positive pulse, then dark with a negative pulse.

Tektronix modified its earlier storage crt, added circuits, and packaged two storage-display units. It shipped a production model of its new Type 611 storage-display

unit to Project MAC, and lent another to the University of California at Santa Barbara, where time-shared computer work is also under way. Evaluation quantities are available, says Tektronix, for delivery in 90 days.

No memory. The Type 611, has an 8 $\frac{1}{2}$ -by-6 $\frac{1}{8}$ -inch display area. The bistable crt in the unit eliminates the memory usually needed to refresh the image, a modification that probably will reduce the 611's cost as well as the fees for use of data-transmission lines from remote computers to the display terminal.

The MIT engineers are still hoping for an 11-by-11-inch storage crt, but will build a prototype terminal around the Tektronix unit [Electronics, June 27, 1966, p. 48]. The full terminal is scheduled for initial tests in December. MIT will build about 10 and then try to interest some company in manufacturing them under a license.

Unlike crt's that must be refreshed frequently to prevent flicker, the bistable tube's image is constant and retains the selected operating mode. It requires 0.5 second to erase a stored image.

The 611 flat-faced tube is electromagnetically deflected to preserve small spot size, a method that usually gives rise to such problems as nonlinearity, and pincushion and

barrel distortion. Although they won't say how, Tektronix claims it found the right answers.

A write-through feature enables the operator to position the writing beam to any point on the crt screen without storing the new trace or erasing any previously stored traces.

Resolution of the 611 is 500 stored line pairs vertical, 400 stored line pairs horizontal. Dot writing time is 20 microseconds.

The erase, nonstore, write-through, and view modes are remotely programmable through contacts on the rear panel. Switches on the front panel provide manual control of erase and view functions.

The long view. Maximum recommended viewing time is 15 minutes, but images can be held under conditions of reduced brightness for about an hour. If held longer than that, some traces will remain.

The 611 sells for \$2,500, its smaller companion, the 601, for \$1,050. But neither stands alone as a display terminal. A workable graphic system would require at least a character generator, a keyboard, and a communications-line interface, so that a system using the 611 would cost about \$7,000 with hardware.

Tektronix Inc., P. O. Box 500, Beaverton, Ore. 97005. [338]

Displaymates. Tektronix Type 601 storage display unit, left, retains nonfading alphanumeric and graphic information on 3.2-by-4 inch screen. Type 611 has a 6.5-by-8 inch screen, offers write-through traces that can be viewed without being stored and without disturbing previous graphics.

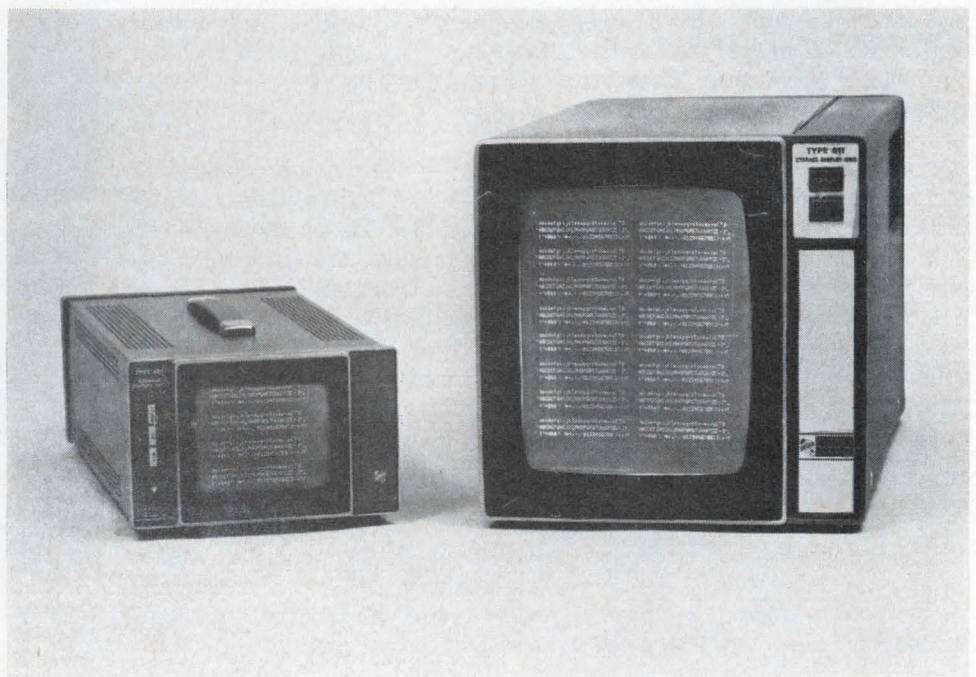

digital computer that stores data and makes calculations, the engineer gets a visual pattern of both the monochromator's image plane and the rays striking the plane. With this system, he rapidly arrives at the best design for the required optics. The model of the design is in the computer, and the engineer interacts—based on what he sees on the crt—with the model.

Searching the file. Other, simpler kinds of crt displays are in use on a more widespread basis. They are primarily used to give the viewer, at his request, access to computer-stored information. Such inquiry stations, for example, display pages of inventory information. But, normally, the viewer cannot use his display to interact with the computer to change the inventory situation.

The interacting system and the inquiry station demonstrate the breadth of computer-graphic-system capabilities. Two years ago, a survey showed 35 types of computer-graphic systems available, but few were sold in quantity. According to one group, greater interest in these systems would result if costs were lower for such hardware as crt displays, character generators, digital computers, and communications links. And, this group argues, there must be a greater availability of low-cost computer programs. Another group contends that proof of an extensive market is needed to stimulate product and systems makers to develop what's needed.

II. Big systems emerge

Now market studies have been made, and new products and systems are being offered. These include large-scale computer-graphic equipment for analyzing complex data and for modeling dynamic systems.

From such studies has come the conclusion that three kinds of graphic display equipment are needed:

- sophisticated equipment that will do anything the user wants from rotating the angle of viewing of an automobile design to plotting several variables simultaneously.

- simple, low-cost equipment that will display limited amounts of information such as a customer's balance to a bank teller or an addi-

Computer graphics reinforce man's skills

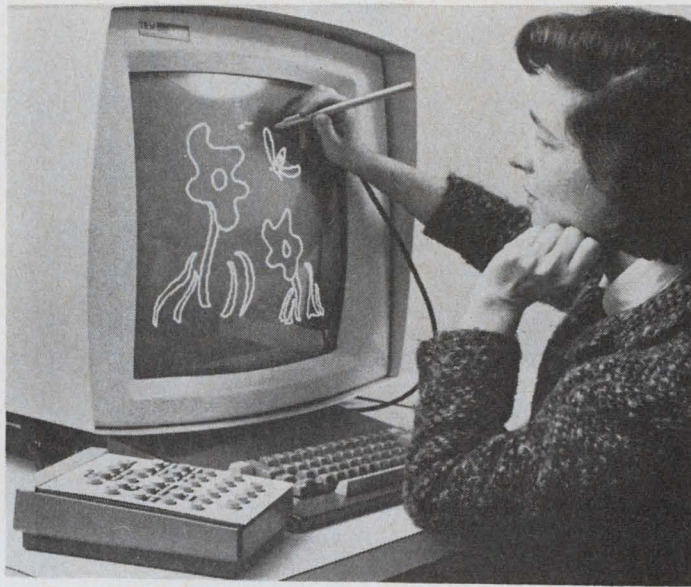

Textile designer uses computer-stored weaves, concentrates on designing novel patterns with light-pen input.

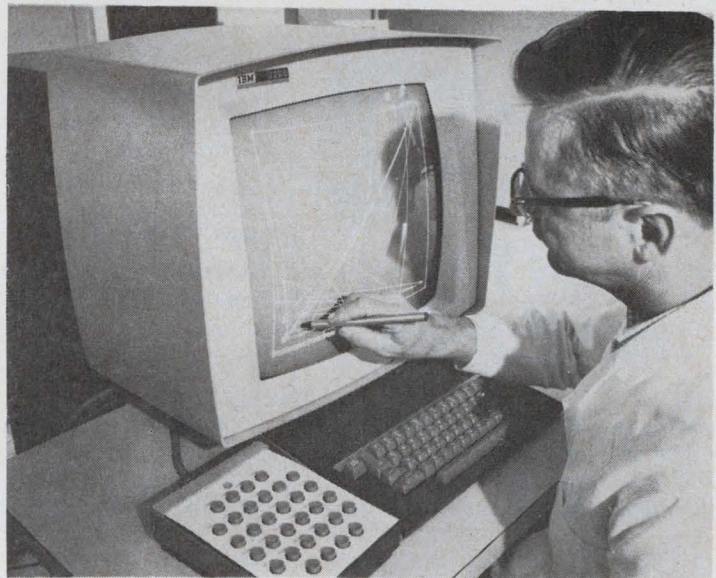

Drug researcher determines where drug goes after it enters body, then makes mathematical tests on computer model.

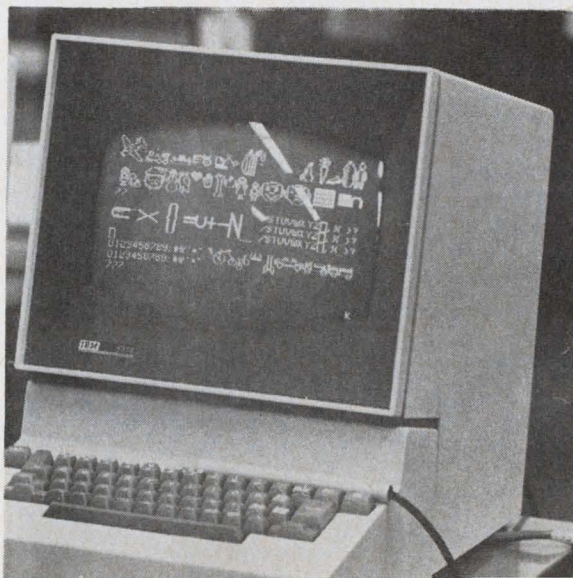

Student station teaches California school children. Education applications of graphic displays are expected to expand as prices come down.

INTEGRATED CIRCUITS?

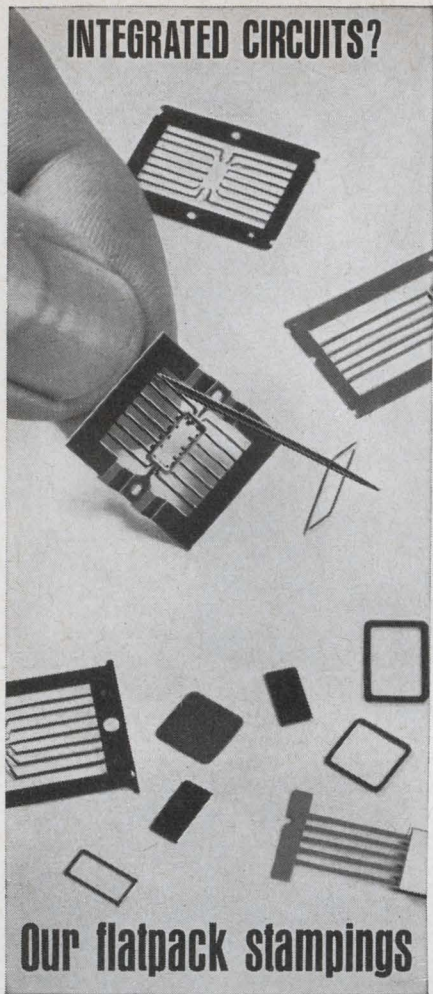

**Our flatpack stampings
give you
that critical edge**

Must metal parts for integrated circuits be produced by chemical etching . . . slowly . . . expensively?

No. Volkert stamps and forms these thin, critically precise components—in high volume, and at less cost. No secondary forming is needed.

Volkert's specialized facilities meet your most exacting tolerances for lead frames, frames and bases. We are aware of your design and production requirements as to burr, flatness, finger widths and center distances. And we work with Kovar, Rodar and clad materials. Lead frames can be formed in a continuous strip for automatic assembly.

For your next big job, in flatpacks or any other microminiature electronic components, think Volkert. Where your small stampings get that critical edge. Call or write today.

Volkert STAMPINGS, INC.

Subsidiary of The Stanley Works

222-35 96th Avenue
Queens Village, L.I., N.Y. 11429
Telephone 212-464-8400

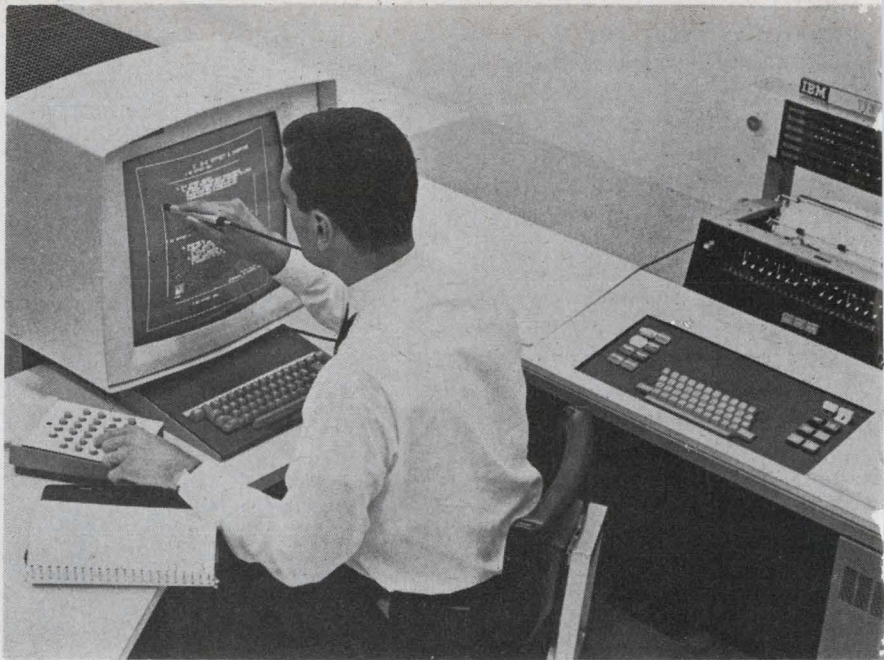

Expanding the line. Even small computers can provide graphics readout. For its 1130 computer system, IBM adds new functions to its 2250 display, now called 2250 Model 4.

tion or subtraction to a student.

▪ systems that fit in between these two extremes in cost and performance.

Just how much users are willing to pay for a low-cost system is still one of the big unknowns of graphic displays. Last year, at MIT's Project Mac, the time-sharing study

group, John Ward estimated that \$5,000 would be the highest price that group would be willing to pay for a graphic display that included crt, character and vector generator, and link to telephone lines. Now Ward believes the minimum price will have to be upped to at least \$10,000 to get equipment that will

Conrac refreshes display with delay line

Conrac's terminal contains a cathode-ray tube, delay-line local memory for image refreshing, desk-type keyboard, electronic character generator, and buffer to interface the unit with a communications link like a telephone company data set—at 1,200 or 2,400 bits per second.

The crt face is 12 inches measured across the diagonal, and displays characters 0.200-in. high. Repetition rate is 60 hertz, synchronized to line frequency to minimize flicker.

Priced at just under \$7,500, the Conrac equipment is aimed at computer-graphic-systems makers. But the company anticipates the unit price will be considerably less in production quantities.

The Conrac display includes two types of alphanumeric-pattern generators to suit customer preference. One plug-in card produces

dot-matrix characters, each matrix made up of 5 by 7 dots. In this format, the crt can display 24 rows of 37 characters per row, for a total of 888 characters. Another card offers stroke-written, starburst characters in 16 rows of 37 characters per row, for a total of 592 characters.

Related to the character generator are internal decoding and control logic. Control logic, for example, positions the cursor—which shifts the start position of an alphanumeric sequence on the crt screen. The integrated circuit logic is based on diode-transistor logic and transistor-transistor logic configurations.

The keyboard has 64 positions, for alphanumeric characters, punctuation, and editing functions like carriage-return mode.

Conrac Corp., Conrac Div. Covina, Calif. 91722 [339]

satisfy the requirements of a time-shared computer.

Researchers who have studied the educational market believe that school boards could not possibly afford that much money for each display since every student ought to have one. For such applications, the price probably will have to be under \$1,000 and maybe even under \$500.

Thus at Tektronix, marketers believe the first buyers of graphic displays for automated teaching will be in the colleges which have more money available for such expenditures and which can restrict their use to a few special courses.

Engineers and scientists are starting to use the sophisticated computer graphic systems in applications that lets them use their unique creative abilities, with the computer and display interacting with them—cutting elapsed time from problem to visual answer.

Adage Inc.'s vice president, Irving R. Schwartz, predicts sales of these systems reaching \$50 million in 1968, at an average cost of about \$200,000 a system. To meet the demand, the company has unveiled its Adage Graphic Terminal that uses the company's Ambilog 200 computer with both analog and digital capabilities.

Oil hunt tool. Adage recently sold two such terminals to a major oil company. They will be used as remote graphic stations, linked to the user's large digital computer, for analyzing seismic-data plots. The system will be operating shortly after the first of the year.

The International Business Machine Corp., which pioneered the computer-graphics market, now is adding more functional capabilities to its 2250 display terminal, calling it the IBM 2250 Model 4. The new display offers upper and lower case alphanumeric, subscripting and superscripting, and hardware-assisted programable-character generation. It sells for \$115,000, and leases for \$2,400 a month.

Alone or attached. Computer programs are the lifeblood of a graphics system. How much this software is needed depends on the kinds of jobs the terminal will do and the equipment configuration.

In one configuration of the IBM 2250/1130, the system operates on a stand-alone basis. Located phys-

"The best way to find out whether you need a still or a demineralizer is to talk to the company that makes both."

Being the only company that manufactures complete lines of both stills and demineralizers makes it pretty easy for us to be objective.

If your product or process requires extremely pure water with bacteria, organic, non-ionizable, gaseous and other impurities removed — one of Barnstead's 200 or so stills is in order. (They range from ½ to 1000 gph and larger.) But if you can get along with a demineralizer, we have a wide selection of those too — about 100, in mixed-bed, two-bed and four-bed types (with capacities to 3000 gph and more.)

If you don't know what kind of purification equipment to use, we'll be glad to analyze your raw water and make a recommendation. But whatever your requirements, you can be sure of getting just what you need to do the job, whether a still, demineralizer, or complete custom-engineered system. And we *guarantee* the purity you need.

Are you facing a decision about water purification? Consult the experts first. Barnstead Still and Sterilizer Co., 499 Lanesville Terrace, Boston, Massachusetts 02131.

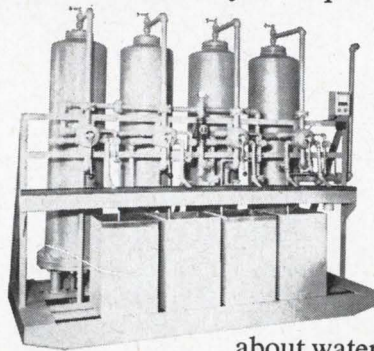
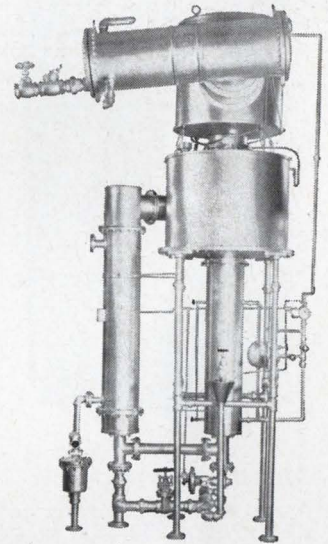

Barnstead

Ritter Pfaudler Corporation

Now Cover the

ULTRASONIC SPECTRUM

with the new
MULTISONS® series
of BROAD BAND
POWER GENERATORS

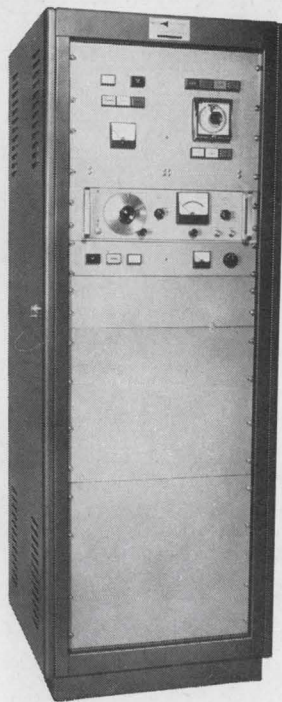

- Bandwidth 10 kcps to 1 mcps
- Average standard power outputs available: 100, 250, 500 and 1 KW (within 3 db)
- Choice of four impedances: between 18 and 2400 ohms
- Push-pull low harmonic distortion driver and output stages
- Standard parts used exclusively
- All power circuits fuse protected
- Maximum accessibility to all sections for ease of servicing tubes
- Variable D.C. bias for magnetostrictive transducers
- Plug in 60 min. timer for automatic programming

Write for Bulletin 105



PIONEERS
IN APPLIED
SONICS AND
ULTRASONICS

MACROSONICS CORPORATION

1001 Roosevelt Avenue
Carteret, New Jersey
Phone 201-541-4131

Software expands job range . . .

ically close to each other, the computer and the display unit operate from data stored in the computer's disk and core memories. For this stand-alone configuration, two programs are used: the Disk Monitor Systems 2 (DSM) is the control, which assists the programmer in establishing flow and timing in get-

ting information into the computer and out to the display console, and the Graphic Subroutine Package (GSP) for the 1130 computer, which lets the user enter his specific jobs in Fortran.

In the attached configuration, the 2250/1130 can be connected to an IBM 360 computer, model 40 and



Dynamic interaction. Adage Graphics Terminal lets user examine, modify, and experiment with images representing designs and problems. Rapid access allows engineers and scientists to interact with computer-stored information.

Adage terminal adds motion to image

A general-purpose system, the Adage Graphics Terminal can produce dynamic images of three-dimensional objects that move continuously. Basic elements are a high-resolution (1,000 lines) crt display, a hybrid computing array, a digital processor, a transmit/receiver interface, and systems programs for graphics operations and communications.

Complex pictures are created by processing multiple-image definitions for display on the crt. Each image—represented in core memory as a structured-data list—is under the control of the user, who interacts with the terminal through a command language. Manipulations of images include repositioning, scaling, rotating, transforming, and dissecting.

Using subprograms, which are executed each time an image is displayed, the operator adds motion to the image, such as a picture of the lunar module flying through space.

Spare the computer. Adage

offers three models of its terminal, ranging in price from \$75,000 to \$250,000. In all three, image refreshing and manipulation are accomplished at the terminal. Loading of a central computer's memory and multiplexing facilities, as well as transfer of bits between computer and terminal, are kept to a minimum. Thus a low-cost communications link like a data-phone line is adequate.

The top-of-the-line Model 50 terminal includes a crt console, 16,000-bit core memory, data-phone interface, and a disk memory for storage of image and program libraries. The console has operator's controls for image translation, rotation, and scaling.

Terminal options include hard-copy display recorder and analog-input tablet. Software packages include a monitor, a graphics interpreter, image subprograms, basic communications, and remote interface modules.

Adage Inc., 1079 Commonwealth Ave., Boston, Mass. 02215 [340]

up, through a communications adapter, thus making the power of a large, remote computer available for advanced display problems.

In this configuration, the computer-graphics terminal is just one of many input/output terminals sharing the central computer. Thus the computer must execute a variety of programs either within a specified time in the computing cycle or when a given event (an interrupt) occurs. Over-all programming thus becomes much more complex, to the point that software often isn't available by the time a computer is ready for installation. IBM now has available its OS/360 software for multiprogramming applications like the remote computer-graphics system. To ensure continuous display, the OS/360 program gives the graphics terminal highest-priority access to the computer.

III. Refresh without pause

In conventional crt tubes, the image disappears unless refreshed—usually 40 times per second for flicker-free display. If, for example, the tube face can display a maximum of 800 characters and each character requires 10 bits, all of this must be refreshed 40 times a second. The over-all bit rate is so high that transmission directly from a computer's memory would require excessive capacity and an extremely wide communication band. Instead a local memory such as a delay line is used to refresh an image. Thus, only new data is called for from the computer. This cuts down cost, which is affected by length and bandwidth of communication links. Most systems can now operate satisfactorily at a rate of 2,000 bits per second, the bandwidth of data-phone service.

In the wings. As exotic as some of the computer-graphics terminals are right now, new developments will continue. Methods of providing graphic inputs are limited. Adage's Schwartz says his company is developing a graphic input to scan 100 lines per inch. Due some time next year, this additional equipment is expected to be priced under \$2,000 with its associated software package. With such a unit, scanning and analyzing seismic-activity plots will be easier and faster.

HIGH VOLUME COMPONENT TESTING?

Only **Associated** gives you so much capacity in a chamber so low priced!

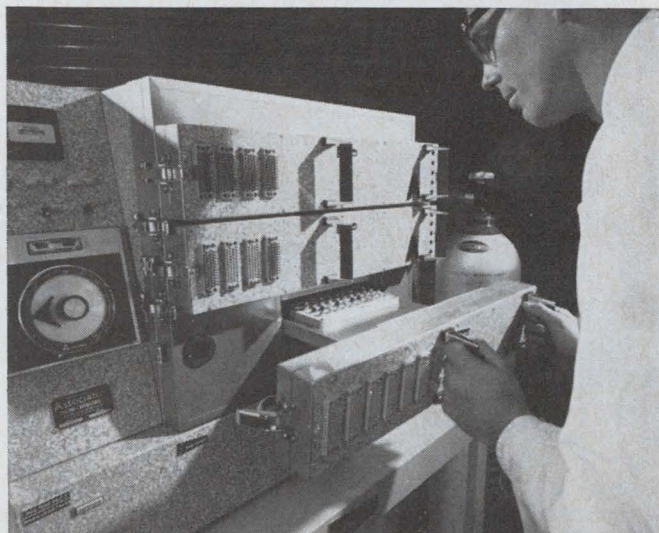

Dollar for dollar, Associated's complete line of component test tray chambers offers you versatility, efficiency and performance unavailable in any comparably-priced unit. Designed for rapid, accurate incoming and production testing of transistors, diodes and integrated circuits, these chambers provide features developed through years of actual test experience in Associated's own laboratories.

For example, you get:

- 225 axial lead component capacity!
- 10^{12} ohms insulation resistance, pin-to-pin!
- Low temperature gradients across tray!
- Widest variety of test trays available—2-wire, 4-wire, axial lead and transistor trays!
- All trays in stock!
- All Kelvin type wiring!
- Either $\pm 1/4^\circ\text{F}$ or $\pm 2^\circ\text{F}$ control!

Yet with all these features, prices start at just \$1765, complete. Options include solid-state and mechanical programmers; integral and remote scanners; and choice of CO₂ or cascade refrigeration. Write today for our complete catalog, showing the full range of Associated Environmental Test Chambers and Test Equipment. Circle the Reader Service Card or write us at Dept. E-5.

**ASSOCIATED TESTING
LABORATORIES, INC.**

200 Route 46, Wayne, New Jersey
(201) 256-2800



New Components Review

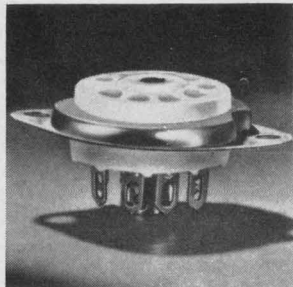

Miniature tube sockets (7- and 9-pin) are offered with TFE bodies and brass hardware. Contacts are silver-plated beryllium copper (also available with cadmium or nickel plate) and tabs are solder-dipped. Sockets are available in shield- or saddle-base types and in bottom-mounting type. Specifications meet MIL-S-12883A. Chemelec Products Inc., 8 Fellowship Rd., Cherry Hill, N.J. [341]

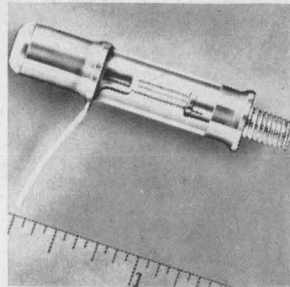

Piston trimmer capacitor 1616D works over a frequency range of 1 to 30 Mhz. R-f voltage level is 3,100 v peak at +25° C derated to 2,500 v peak at +200° C. Capacitance is variable from 0.5 to 5 pf, and temperature range is from -55 to +200° C. Turning torque is 1-10 in. oz. Insulation resistance is 10⁹ megohms. JFD Electronics Co., 1462-62d St., Brooklyn, N.Y. [342]

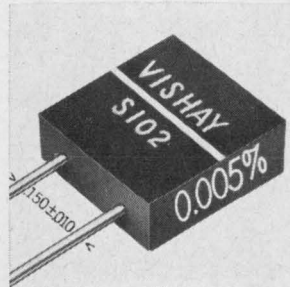

Standard absolute resistance tolerance of 0.005% is offered in a line of precision resistors. Temperature coefficient is 0±1 ppm (0° to 60° C). Shelf-life stability is 25 ppm/year; load-life stability 0.030% at 125° C, 2,000 hours. Standard resistance range is from 30 to 30,000 ohms. Price is \$4.56 each in 100-lot quantities. Vishay Resistor Products, 63 Lincoln Highway, Malvern, Pa. [343]

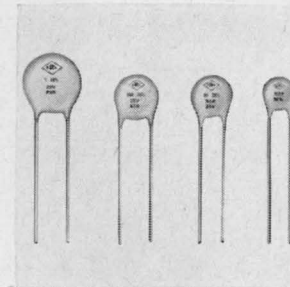

Ultra-Kap disk capacitors rated at 16 v and 25 v are offered with values of 0.01, 0.022, 0.033, 0.05, 0.068, and 0.1 µf. Leakage resistance is 10 megohms. Max. dissipation factor is 5% at 1 khz. Disk diameters vary from 0.290 in. to 0.760 in., and all units have a max. thickness of 0.156 in. Centralab Electronics Division, Globe-Union Inc. 5757 N. Green Bay Ave., Milwaukee. [344]

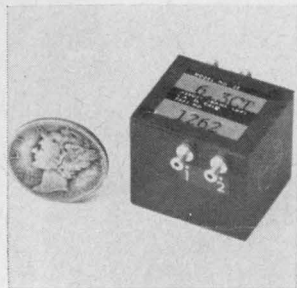

Miniature 400-hz power transformer model 2E, encased in dialyphthalate, develops voltages of 5 to 150 v a-c with a power rating of 2 w. Suited for aerospace and industrial use, the unit measures 0.87 x 0.74 x 0.78 in. It meets MIL-T-27A specs, and operates at a max. of 105° C. Price is \$14.40. Abott Transistor Laboratories Inc., 5200 W. Jefferson Blvd., Los Angeles. [345]

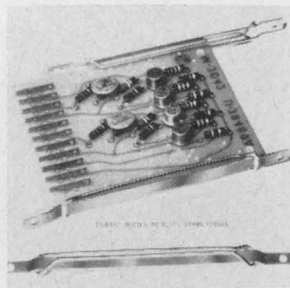

All-steel p-c board guides, series 90, provide a positive grip for vertical or horizontal mounting. They come in a wide variety of sizes in increments of 1 in. Guides are available with 1, 2, or 3 wires and with an extra mounting hole in the center. Effective grip is 2 in. per wire. Finish is cadmium plate per QQP-416, Type I. Taurus Corp., Academy Hill, Lambertville, N.J. [346]



Image intensifier WX-30677 has a brightness gain of 200 min. The single-stage device is electrostatically focused and has a 40-mm fiber optic input and a 25-mm fiber optic output. The tube is used in low light level television where it is coupled to the camera. Prices range from \$5,000 to \$6,000 each for 5 to 10 units. Westinghouse Electronic Tube Division, Elmira, N.Y. 14902. [347]

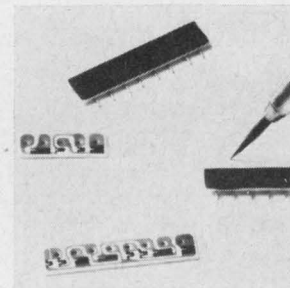

Eight tin-oxide film resistor networks, series 1000, range in overall length from 1.230 to 0.355 in. Resistors on a single network range from 2 to 9. Resistance values range from a minimum of 20 ohms to a maximum of 250 kilohms depending on tolerance (1, 2, or 5%). Temperature coefficient of 150 ppm is typical from -55° to +165° C. Corning Glass Works, Raleigh, N.C. [348]

New components

Hybrid servoamp drives aerospace motors

Integrated circuit device takes up only a quarter-inch; \$200 price could limit applications of functional block

A licensing agreement with the Canadian Marconi Co. gives the Bulova Watch Co.'s Electronics division what is said to be the first commercially available hybrid microelectronic servoamplifier. The device incorporates a hybrid integrated circuit developed by the

Canadian firm for in-house use.

The servoamplifier will drive motors ranging from sizes 5 to 11 in the 3½-to-4-watt category. It is less than ¼ cubic inch in volume, has an output impedance of only 1 ohm, and has an efficiency of 90% to 95%.

The major factor limiting its application is cost—about \$200 each in quantities of less than 25, compared with about \$75 for standard servoamplifiers in Bulova's inventory.

"We still have to determine what part of the market this leaves for it," says Nick Sakellarios, Bulova's sales manager for servo products. "If small size and reliability are the chief needs, the price won't be an obstacle."

For aerospace systems. The device is a functional electronic block developed for Marconi systems. Bulova acquired U.S. market rights because it felt that the unit could

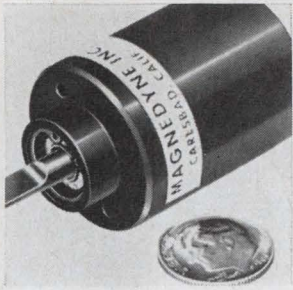

General-purpose, 400-cycle motor model 210 measures $1\frac{1}{8}$ x $1\frac{3}{8}$ in. and produces a 3 oz.-in. torque. It is offered in 3 versions: a 2-phase, 6-pole, servomotor; a single-phase, 6-pole, capacitor-type induction motor; and a 3-phase, 4-pole induction motor. A double-disk clutch that isolates rotor inertia is available. Magne-dyne Inc., 5580 El Camino Real, Carlsbad, Calif. [349]

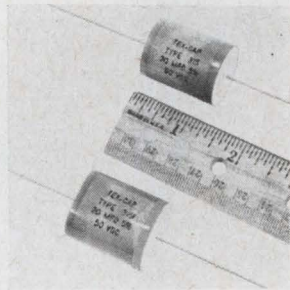

Tiny metallized Mylar capacitors types 315 (tubular) and 315F (oval) have a 75 v d-c rating, in addition to the standard 50 v d-c. They operate within a temperature range of -55° to $+85^{\circ}$ C at rated voltage, and up to 125° C with 50% derating. Insulation resistance equals or exceeds 15,000 megohms- μ f at 25° C. Texas Capacitor Co., 7830 Westglen Dr., Houston. [350]

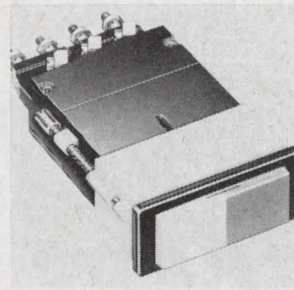

Split-action switch series 03 uses T-2 lamps with lens caps available in six colors and is rated at 10^6 cycles. Silver contacts are rated at 12 amps, 120-v a-c or $\frac{1}{2}$ amp, 120-v d-c. Switching combinations are spdt with momentary or maintained contacts and positive push-button action. It can be panel-mounted in a $\frac{7}{8}$ x $1\frac{5}{8}$ in. hole. Truco Inc., Box 95, Simsbury, Conn. [351]

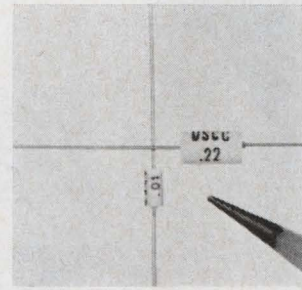

Ceramic capacitors in the C20 series range from 220,000 pf in a 0.140 x 0.250 in. package down to 10 pf in a 0.080 x 0.150 in. size. Capacitance change with temperature is nominally less than $\pm 15\%$ from -55° to 125° C. The 50 v d-c units are for packaging in filtering, bypass, and blocking applications. U.S. Capacitor Corp., 2151 N. Lincoln St., Burbank, Calif. [352]

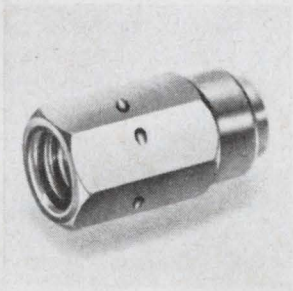

Dust cap 50-001-9028 seals 50-ohm, screw-on jacks of the MIL-C-22557 ConheX series. It is supplied with three 0.025-in. diameter lockwire holes in the corners of the hex. The cap is engineered to stay put under severe vibration and prevents unwanted contaminants from entering the jack to which it is attached. Sealectro Corp., 225 Hoyt St., Mamaroneck, N.Y. 10543. [353]

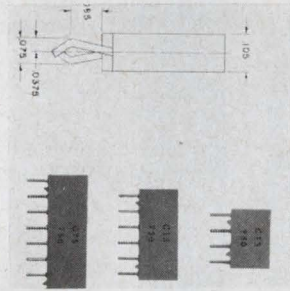

A longer formed lead on the series 750 cermet resistor networks snaps into place instantly and holds the module in a rigid upright position during wave soldering into p-c boards. The lead is for 0.058-in.-diameter holes in boards from $\frac{3}{64}$ in. to $\frac{3}{32}$ in. thick. Prices range from 19 cents for a 4-pin 3-resistor unit to 26 cents for an 8-pin 7-resistor unit. CTS of Berne Inc., Berne, Ind. [354]

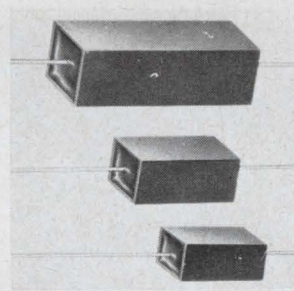

Epoxy-encased, metallized polycarbonate capacitors series 22B are suited for use in many wave filter, discriminator, and critical timing circuits. They are available in 200, 400, and 600 v ratings in sizes from 0.17 x 0.29 x 0.42 to 0.56 x 0.72 x 1.75 in. Capacitance values range from 0.001 to 3 μ f with tolerances from 20% to 1%. SEI Manufacturing, Northridge, Calif. 91324. [355]



The Trans-O-Netic time-delay relay has a time interval repeatability of $\pm 2\%$ at 70° F and 115 v a-c (unaffected by line variations from 100 to 135 v a-c). Standard time range for the delay-on-make model is 1 to 60 sec; for the delay-on-break, 1 to 30 sec. Prices are \$20 and \$26 respectively. Heinemann Electric Co., 252 Magnetic Drive, Trenton, N.J. 08602. [356]

serve the needs of customers making such aerospace hardware as inertial navigation systems, target-intercept computers, pitch-and-roll indicators, vector analog computers, and drift-angle indicators.

The servoamplifier uses a hybrid thin-film ic combined with several discrete components, chiefly tantalum capacitors. The discretos and the hybrid portion of the amplifier are potted into a single structure that takes up only 0.236 cubic inch.

Sakellarios says a Bulova competitor has a monolithic ic servoamplifier that is "marginally smaller" than the Marconi device, but he claims it is only 50%-55%

efficient, and requires large control-phase tuning capacitors outside the ic package. These tuning capacitors, typically $\frac{1}{2}$ -inch diameter and $1\frac{1}{2}$ -inches long, aren't needed in the Bulova amplifier because of its low output impedance. "Besides cutting the weight of the device, we also reduce interconnections with their inherent unreliability," says Sakellarios.

According to Dan Rosenthal, Canadian Marconi's applications engineer, an electronic ripple filter in the module will work with the most inexpensive, crude, and non-regulated power supply—an ordinary transformer, for example, with

four diodes and a capacitor.

Cuts signal loss. The preamplifier is followed by an active phase shifter that provides a 90° controlled phase shift, reduces signal loss and, according to Rosenthal, requires less space than a passive phase shifter would.

The power amplifier employs a quasi-complementary-pair bridge circuit that increases efficiency when the device is in cutoff. "This type of circuit nominally gives less than $\frac{1}{4}$ -watt internal power dissipation," says Rosenthal. "The kind of efficiency it provides is inherent in this type of output stage, and doesn't require the use of a center-

RMC

DISCAPS

the complete
Ceramic Disc
line

Over the years Radio Materials Company has maintained its leadership in the production of ceramic disc capacitors. A complete line offering outstanding quality has been the key to continuing growth.

STANDARD

Type C, B, BA, JF, JL and JE

SUBMINIATURE

Type SM, BT, TA and Magnacaps

GREENCAPS

Type CG, JG, and BG

SPECIAL

U.L. Listed Discaps, T.C. High Voltage, High K High Voltage and Dual Section By-Pass

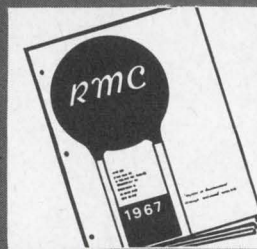

*Send for
Your
Catalog Today!*

Write on your letterhead for a copy of the RMC catalog that lists the complete line of RMC DISCAPS.

DISCAP
CERAMIC
CAPACITORS

RMC

RADIO MATERIALS COMPANY
A DIVISION OF P. R. MALLORY & CO., INC.
GENERAL OFFICE: 4242 W. Bryn Mawr Ave., Chicago 46, Ill.
Two RMC Plants Devoted Exclusively to Ceramic Capacitors
FACTORIES AT CHICAGO, ILL. AND ATTICA, IND.

... 90% efficiency
claimed for unit ...

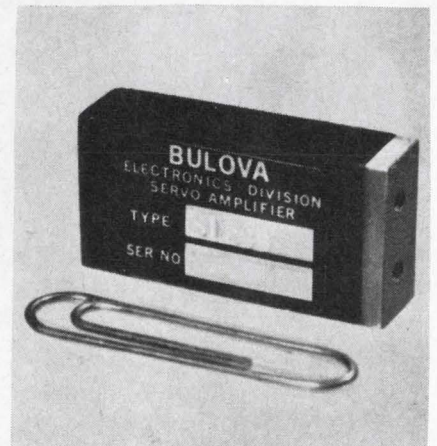

Power block. Canadian-made servo amplifier will drive motors with ratings up to 4 watts.

type motor. The output swings symmetrically about one-half the power supply voltage, so we can keep very tight control over the performance parameters."

The waveshape of the output is basically sinusoidal up to saturation, according to Sakellarios, then it essentially becomes a square wave. He adds, "Because of the tight control we have over input-output characteristics, this amplifier could form the basis for very high power servoamplifiers—possibly 30 to 40 watts."

Because of high efficiency and "careful thermal design," only 10% of the input power is lost as heat, says Sakellarios.

The servoamplifier is being manufactured, and qualification testing has begun. Bulova expects to have production quantities available in three to four months.

Specifications

| | |
|----------------------------------|--|
| Operating frequency | 400 hz, ± 20 hz |
| Input impedance | 10,000 ohms min. |
| Input signal | 26 v max. at max. gain |
| Voltage gain | 2,500, ± 1 db V/V _{max.} , adjustable down |
| Gain stability | ± 2 db |
| Phase shift (linear region) | $90^\circ \pm 10^\circ$ |
| Phase shift (through saturation) | $90^\circ \pm 20^\circ$ |
| Voltage output | 26 v rms at 28 d-c input, $\pm 5\%$ |
| Power output | 4 watts |
| Input power | (28 v d-c, $\pm 10\%$) 4.2 watts at rated output 250 mw at zero signal |
| Temperature range | -55 to 125°C |

Bulova Watch Co., Electronics Division,
61-20 Woodside Ave., Woodside, N.Y.
11377. [357]

New components

Power modules replace hot tubes

High-voltage solid state
diodes proved in radar;
industry is next

In replacing tubes with solid state devices to minimize overheating and other problems, one of the major roadblocks that still remain is the high-voltage, high-current rectifier tube. Companies have tried to produce a solid state diode—or series of diodes—to perform this function in radar and communications equipment, but the devices failed. The latest attempt, by the Unitrode Corp. has succeeded in military systems. Industrial and commercial targets are next.

Unitrode's diode modules, which look like a series of doorbell-shaped units combined with a tube-type base and an anode cap, were successfully tested for 10,000 hours at the FPS-26A height-finder radar installations in Canada. Satisfied with the results, the Air Force installed doorbells in both the FPS-6 and FPS-20 long-range air defense radars. Initially, the doorbells cost more than tubes. Since they last almost indefinitely, preventive maintenance costs are eliminated. The Air Force has found that the break-even point is about six months. And the tubes run cooler so equipment cabinets are 30 to 50°C cooler.

Continental Electronics, Dallas, will use the modules to replace mercury-vapor rectifier tubes in its high-power transmitters, and the Aluminum Co. of America is preparing to install them in electrostatic dust precipitators.

Self supporting. Unitrode's approach was to design a series of modules that could be stacked together and combined with a tube-type base and an anode cap. These bases and caps allow a stack of modules to be combined at the equipment site into a complete, self-supporting assembly that fits into the same socket as the tube. Shunting resistors, capacitors, and

for maximum **SOLID CARBIDE** drilling precision

SERIES 125 - 1/8" SHANK SOLID CARBIDE CIRCUIT BOARD DRILLS

the rigid stability
of 1/8" shanks
with EVERY size drill

Series 125 Circuit Board Drills are made with Metal Removal Company specifications of point configuration (Four Facet Point), helix angle, very fine flute finish and exacting size tolerances.

The Series 125 Circuit Board Drill
is an advancement of drill design to its present optimum. Among many features, it offers:

- Strength and rigidity of the 1/8" shank permits location and hole size tolerance to close limits.
- Drill bushings completely eliminated where used with precision spindles and collets.
- Also available in double end style with 1/8" shanks.
- 1/8" common shank size for all drill diameters eliminates inventory of collets for each size drill.
- Drill point is concentric to drill diameter within .0005"; drill diameter to shank concentricity is within .0003".
- Permits ultra high speed drilling at rates up to 150,000 RPM and 15 feet per minute feed.
- Can be manufactured with geometry variation for clearances required for fast feed, high RPM operation.

For complete information write for Bulletin CB66.

THE METAL REMOVAL COMPANY

1859 West Columbia Avenue
Chicago, Illinois 60626

Plants Located in CHICAGO • LOS ANGELES • SAN JUAN



MASTER TOOL AND WHEEL MAKERS FOR THE WORLD

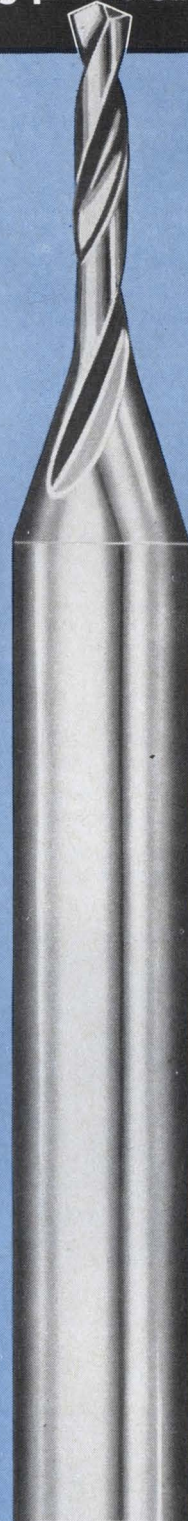

Mechanization is the understatement with this *Instant* film cartridge system

KAHLE
engineered!



This unique KAHLE development utilizes only 5 basic equipments

**Produces 600 cartridges per hour
For black-and-white and color film
Equipment available for
Super 8 cartridge production**

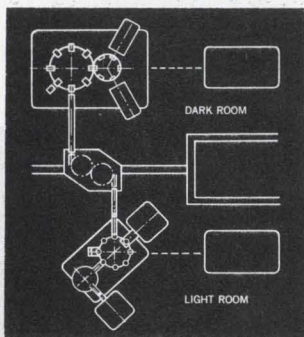

Take spools of raw material, a label and some plastic components — use an 'automation-mix' of seventy-seven separate operations — and produce loaded film cartridges at a high volume rate... that's KAHLE engineering at work!

Whatever your mechanization requirements, KAHLE automatic and semi-automatic machines can be developed to do your job more efficiently and economically... with strictest quality control throughout. Consult KAHLE today — save time and money by letting professionals build your specialty production equipment for automation!

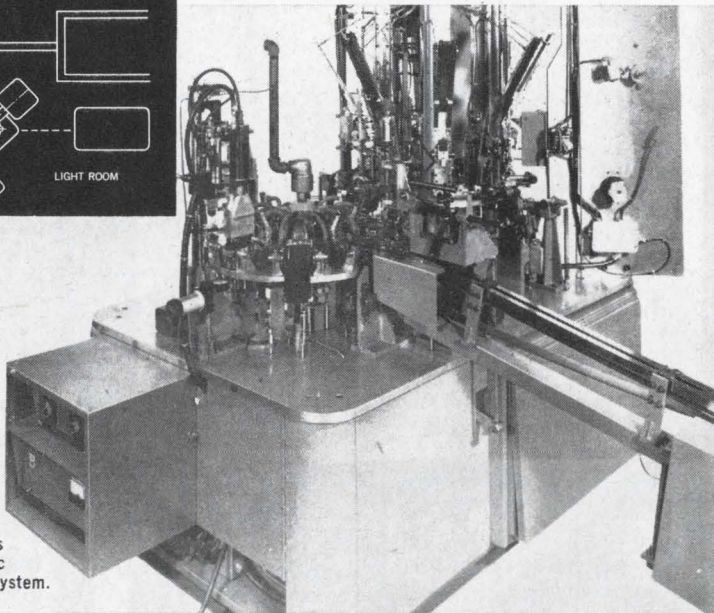

Typical of all KAHLE equipment which is tested, subject to customers' approval before shipment, this film cartridge finishing machine is one of the five basic equipments in the system.

For Over 30 Years, Designers and Builders of Automatic and Semi-automatic Equipment for High Speed Production

KAHLE ENGINEERING COMPANY

3324 Hudson Avenue, Union City, N. J. 07087

Telephone: (201) 867-6500

KAHLE EUROPEA—Via Spartaco 16, Caravaggio (Bergamo), Italy

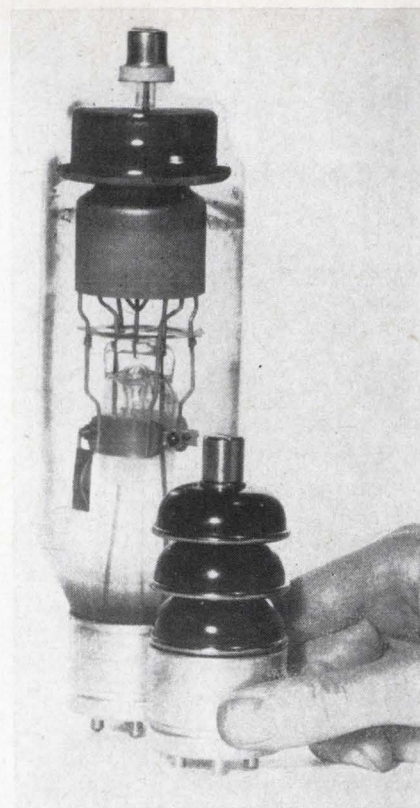

Solid and cool. Stack of doorbell shaped diodes eliminates tube maintenance woes.

additional hardware aren't needed. Usually, there is no change in circuit wiring. The supplier has to stock only a few types of modules to handle a broad range of tube types.

Five different peak-inverse-voltage ratings, from 2.5 to 15 kilovolts per module, and continuous-current ratings up to 6.6 amps in air are available. These ratings enable the engineer to fill a wide range of power-supply and pulse-handling requirements.

Back and forth. The modules can handle high forward and reverse transients without failure or damage. Transients, that can cause tube-destroying arc-over or shorten the life of a rectifier tube, have no permanent effect on the doorbells. The module's monolithic, void-free diodes can carry as much energy in reverse-transient avalanche as in the forward direction, and the controlled avalanche ensures equal voltage division across the module's series diodes during avalanche.

The modules range in price from \$15.85 to \$53.60 each for single pieces; tube-type bases are \$4.50 each; and anode caps are \$1 each. Unित्रode Corp., 580 Pleasant St., Watertown, Mass. [358]

RG



Metal Glaze resistors offer .02% reliability and low cost

IRC Metal Glaze resistors now offer you a combination of proved reliability and economy that just can't be matched. You can upgrade your circuit designs and still keep the lid on costs.



- **RELIABILITY PROVEN DESIGN.** A design so conservatively rated that even at *twice rated load*, performance still far exceeds applicable MIL requirements.
- **RELIABILITY PROVEN BY TESTS.** After more than 4 million unit hours of testing, estimated maximum failure rate is .02%/1000 hours, full load @ 70°C, at 60% confidence. Failure is defined as $\Delta R > \pm 4\%$.
- **RELIABILITY PROVEN IN USE.** Millions used in a wide range of applications. No in-circuit failure—*catastrophic or otherwise*—has ever been reported.

Metal Glaze resistors offer other benefits, too: indestructible thick-film resistance element, plated-on copper

end cap, high-temperature soldered termination and a smooth, tough molded body that resists solvents, corrosion, and mechanical abuse.

For top resistor performance without any cost penalty, specify IRC Type RG. Write for data, prices, and sample. IRC, Inc., 401 N. Broad St., Phila., Pa. 19108.

CAPSULE SPECIFICATION

| |  |  |
|-------------|---|---|
| WATTAGE: | ¼ W @ 70°C | ½ W @ 70°C |
| RESISTANCE: | 51Ω thru 150K | 10Ω thru 470K |
| TOLERANCES: | ± 2%, ± 5% | ± 2%, ± 5% |
| TEMP. COEF. | ± 200ppm/°C | ± 200ppm/°C |
| IRC TYPE: | RG07 | RG20 |



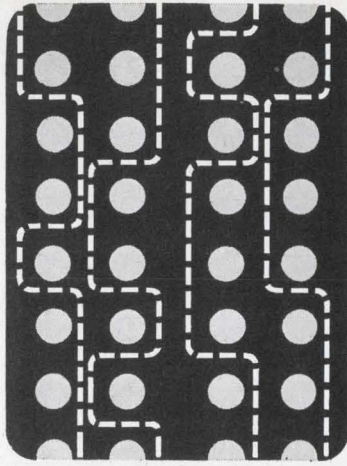

“BRAID-PAK” reduces cost of High-Speed Read-Only Memory Systems

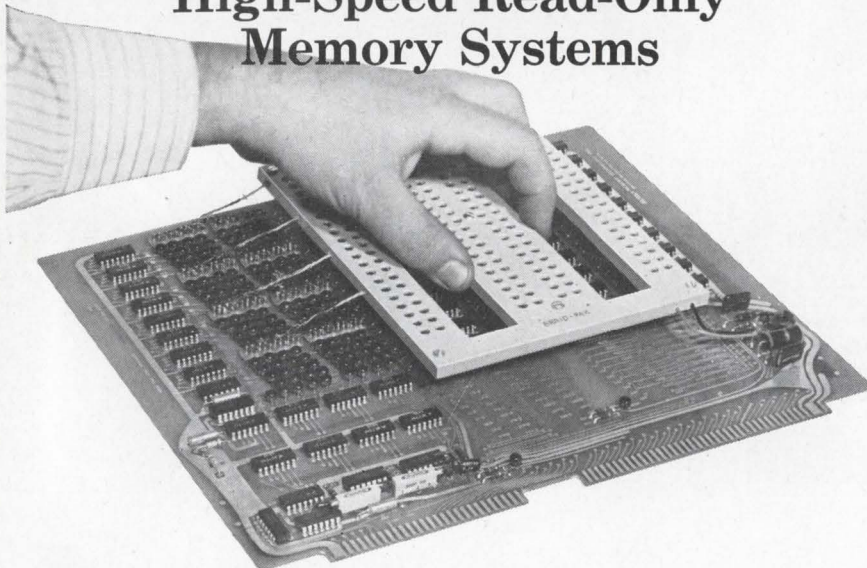

By combining the art of braiding with electronic logic, Memory Technology's new high-speed, read-only "Braid-Pak" Memory Systems cost significantly less, yet provide far better performance than systems using conventional storage techniques.

There are two classes of these non-volatile, high-speed, read-only braid transformer memory systems. One class provides capacities up to 10,000 bits. The other accommodates up to a million bits or more. The illustration shows the Model SBS-1B, a complete 10,240 bit Memory System on a 10" x 13.5" printed circuit board. The memory pro-

gram may be changed by simply replacing the "Braid-Pak" as shown. All inputs and outputs are buffered and feature DTL and TTL compatible integrated circuits with 500 nanosecond read-cycle and 200 nanosecond access times.

Applications include binary word generators for CRT displays, code conversion, pattern generation, computer micro-programming, look-up tables, industrial process control, high speed arithmetic computation, automatic typesetting, automatic machine controllers and other fixed read-only memory requirements. Write for data.



MEMORY TECHNOLOGY INC.
223 Crescent Street • Waltham, Massachusetts 02154 • Tel. (617) 891-8465

New components

Construction makes the big difference

Reed switch handles 15-amp inductive loads without contact bounce or arcing

Until now, reed switches were capable of handling nominal break ratings of only 15 volt-ampere at 250 volts with 1-ampere currents. To carry higher industrial loads, they needed elaborate protection circuitry. But Cutler-Hammer engineers have developed a new reed switch that handles much higher currents yet uses the same size glass envelope.

Called Powerreed, the new reed switch will make an inductive inrush current of 15 amps or 1,875 volt-amperes, and break current loads of 3 amps or 375 volt-amperes when operated at 125 volts a-c. At 250 volts a-c, the switch will make 10 amps and break 2 amps.

To achieve this capacity, Cutler-Hammer engineers departed from the conventional design of a solid armature reed and a solid stator reed. The new switch has separate members for current carrying and magnetic path. The Powerreed also has a fixed air gap between terminals and armature that assures fast dropout by reducing the effects of residual magnetism.

Cutler-Hammer Inc., Milwaukee [359]

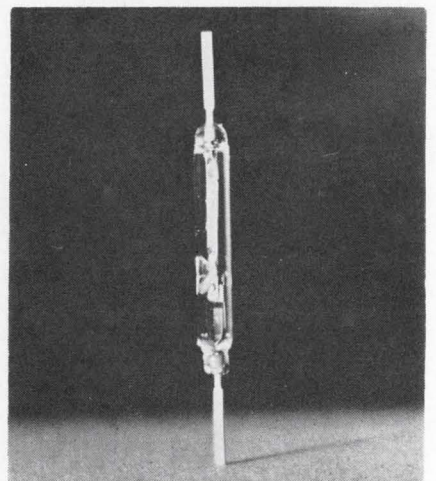

Heavy load. Reed switch has hinged, instead of solid, armature.

SPECTRALLY PURE FREQUENCIES up to 500 MHz

(Yes, 500)

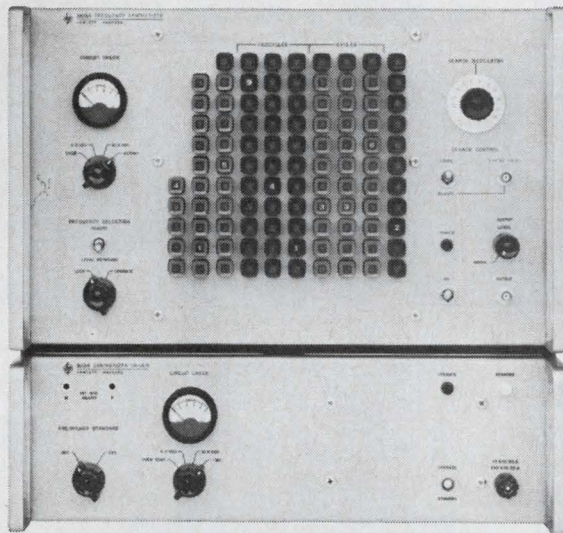

The new Hewlett-Packard 5105A Frequency Synthesizer generates spectrally pure frequencies from 0.1 MHz to 500 MHz in 0.1 Hz steps—a frequency range 10 times higher than previously available by direct synthesis.

Now you can get rapidly switched UHF signals without multiplication and without the accompanying noise increase. Spurious signals are at least 70 dB below the selected output. The 5105A affords extremely rapid digital frequency selection either remotely (typical switching time, 20 microseconds) or from the front-panel pushbuttons. An internal search oscillator provides continuous tuning. Output of the 5105A is $0 \text{ dBm} \pm 1 \text{ dB}$; phase modulating capability, dc to 1 MHz rate; frequency stability is at least 3 parts in 10^9 per day.

The 5105A uses direct frequency synthesis, with the output frequencies derived from a quartz crystal by arithmetic operations instead of by phase-locked oscillators. This provides faster frequency selection and fail-safe operation.

Model 5105A—\$9150.

Model 5110B driver, required for the synthesizer (will drive up to four 5105A's)—\$4350.

Need a lower frequency model? 1, 10 and 50 MHz models are also available.

Call your local field engineer or write for complete information to Hewlett-Packard, 1501 Page Mill Road, Palo Alto, California; Europe: 54 Route des Acacias, Geneva.

HEWLETT  PACKARD

VERSATILE

You name it

CAPABLE

The Paul Bunyan of 3M Recorders

AFFORDABLE

We're almost
ashamed of the
low price

MODEL 34

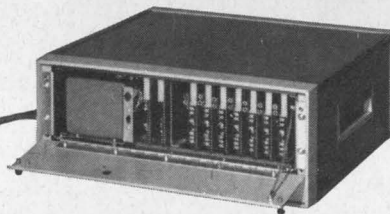
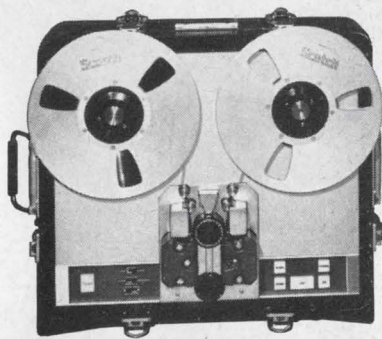

VERSATILE—With direct frequency response to 600 kHz, and IRIG FM to 80 kHz, the Mincom Model 34 does many things in many ways. Rack-mounted or in

easily portable carrying cases. $\frac{1}{4}$, $\frac{1}{2}$ or 1-inch tape. 10 $\frac{1}{2}$ -inch or 7-inch reels. Speed options: $\frac{1}{16}$, $\frac{1}{8}$, $3\frac{3}{4}$, $7\frac{1}{2}$, 15, 30, 60 or 120 ips.

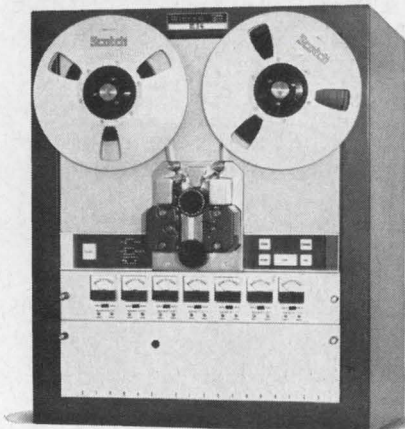

CAPABLE—Practically the only thing that's *not* an option is 3M quality — that's standard on all configurations of the Model 34. Starting with the Isoloop Drive® on the tape transport (the same as on recorders costing several times as much), Model 34 can record 7 or 14 channels of the cleanest data for over twelve hours. All types of record/reproduce modules are interchangeable, allowing any channel combination desired. Push-button controls. Dynamic braking in all modes. Fail-safe braking for AC failure. End-of-tape sensing. Solid state electronics. Input/output meters.

AFFORDABLE—As you can see, there are a lot of different ways to configure a Model 34 — and there are just as many prices.

But this we can be definite about: Model 34 is *the* recorder for people who've always wanted 3M quality — but couldn't afford it *before*. Give us a call.

Revere-Mincom Division **3M**
COMPANY
300 SOUTH LEWIS ROAD • CAMARILLO, CALIFORNIA 93010

New Semiconductor Review

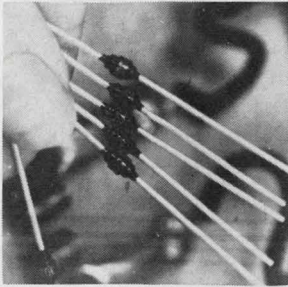

Ultrafast recovery rectifiers operate at full power to 100 khz square wave and are available in both 3- and 4-amp ratings with piv's to 200 v. The devices have recovery time of less than 100 nsec. They withstand surges to 80 amps for 8.3 msec and have leakages under 5 μ a. Price is \$4.05 (100 quantity). Unitrode Corp., 580 Pleasant St., Watertown, Mass. 02172. [436]

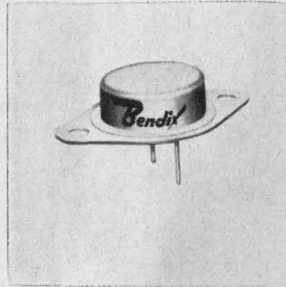

Five d-c voltage regulator modules in series BN-4100 have output voltages of 5, 6, 12, 18, and 25 v. A full 1 amp output is obtained between -30° and $+125^{\circ}$ C. Temperature coefficient is 0.1%/ $^{\circ}$ C. Load regulation is $\pm 2\%$. Maximum power dissipation is 15 w at 25° C case. Price: \$6.60 each for quantities of 100 to 499. Semiconductor Division, Bendix Corp., Holmdel, N.J. [437]

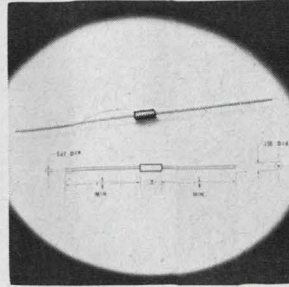

Silicon rectifiers RMC160A-RMC300A and RMC160B-RMC300B offer piv's between 1,600 and 3,000 v and a forward current rating of 350 ma. They are for use with square-wave inputs of 5,000 to 40,000 hz and sine-wave inputs to 300 khz. The RMC300A series has a recovery time of 200 nsec; the RMC300B, 300 nsec. Electronic Devices Inc., 21 Gray Oaks Ave., Yonkers, N.Y. [438]



Microminiature, convertible pellet diodes are silicon devices suited for thin or thick film use and p-c board insertion. Units are whiskerless, and occupy approximately 1/50th of the volume of standard subminiature DO-7 packages. Typical specifications are 4 pf and 4 nsec. Prices start at 79 cents each in 100 lots. Micro Semiconductor Corp., 11250 Playa Court, Culver City, Calif. [439]

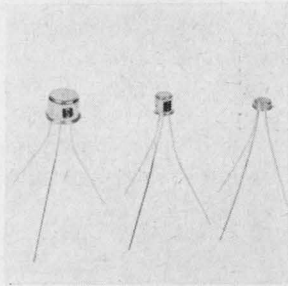

Small-signal, pnp epitaxial base amplifier and chopper transistors offer low offset voltages and low dynamic impedance. Gain is 60 at 1 ma; leakage, less than 1 na. Amplifier series are 2N327A-9A, 2N935-7, 2N1025-6, 2N938-40, and 2N1469; choppers, 2N1917-18, 2N941-2, 2N1921, 2N945, 2N2944-6, and 2N3217-9. Solitron Devices Inc., Blue Heron Blvd., Riviera Beach, Fla. [440]

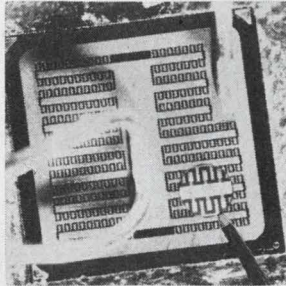

Power transistor 2N5000 combines a series of discrete emitters with an integrated feedback resistor system. The series is in 4 package configurations (either npn's or pnp's) with a capability of 60 to 80 v. The 6- to 30-w device operates to 60 Mhz with beta guaranteed at 3 points (50 ma, 1 amp, and 2 amps). Fairchild Camera & Instrument Corp., Mountain View, Calif. [441]

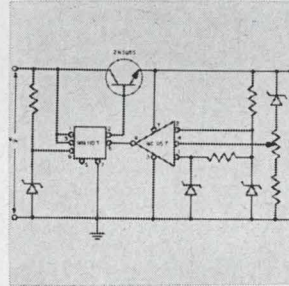

IC voltage regulator WM110T combines, in a TO-3 package, a reference diode and sensing amplifier, followed by Darlington connected series regulator power transistors on a single silicon chip. The unit's low diode resistance is 14 ohms at 5 ma. Regulation is within 2% for an 8- to 48-v output. Molecular Electronics Division, Westinghouse Electric Corp., Elkridge, Md. [442]

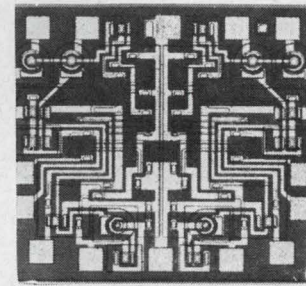

Multifunction packaging is brought to linear IC's by dual operational amplifier MC1535. Open-loop voltage gain of the 2 amplifiers in the monolithic device is within ± 1 db. Input offset voltage at 25° C is 1 mv. Common-mode rejection ratio is 90 db. Price for the metal can is \$8.50; the ceramic flat-pack, \$15. Motorola Semiconductor Products Inc., Box 13408, Phoenix, Ariz. [443]

New semiconductors

Triacs threaten SCR market

The cost of full-wave solid state control is now approaching that of half-wave control

When it comes to power control devices for consumer applications, semiconductor makers are expending a lot of brain power trying to guess in what direction to turn. One company, Motorola Inc.'s Semiconductor Products division, has decided on at least one course

it will take. The company is turning to a plastic-packaged triac (triodode a-c switch) and associated trigger, which it believes will replace the transistor and silicon controlled rectifier in many applications and dominate full-wave a-c consumer-power control.

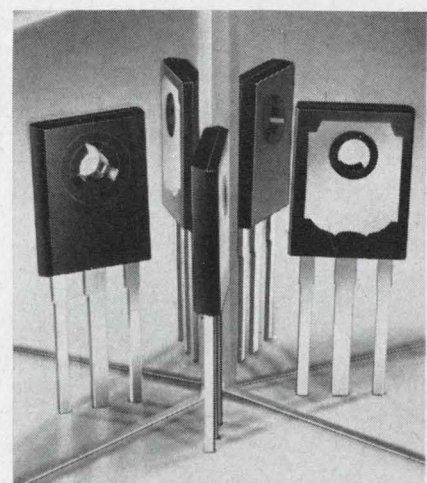

Plate. Metal plate acts as a heat sink for 8-amp triacs.

Hydraulic-magnetic
time-delay relays offer
certain distinct advantages.

You'd never think that
price would be one of them.

The advantages are important ones:

A continuous duty coil that permits the
time-delay relay to double as a load relay.

A delay device much less affected by ambient
temperature changes than thermal elements.

An optional recycling time only 15%
as long as the delay. Regardless of the
frequency of repetition.

You naturally would expect to pay more—
not less—for this kind of construction.

But the fact is that our Silic-O-Netic[®]
Time-Delay Relay costs considerably less
than most other types on the market.

How much less? It depends on the quantity.

Drop us a line. We'll send you Bulletin 5006,
so you can decide which of our
five models best fits your needs.

Then ask us for a quote. We think
you'll be pleasantly surprised.

Heinemann Electric Company, 2800 Brunswick Pike,
Trenton, New Jersey 08602



HEINEMANN

3783

"The triac-type thyristor has been around for about three years in commercial applications," says Jack C. Haenichen, Motorola's operations manager for thyristors and microwave devices, "but it hasn't taken off yet in consumer applications because of its high price."

Under a dollar. The Motorola device is an outgrowth of the firm's metal-packaged triacs, which have been selling for about \$1.25 in production quantities. Putting the silicon chip into a plastic package will lower the price to less than a dollar. "We haven't made enough of them yet to say how much under a dollar the price will be," Haenichen says. But he's convinced the price of the plastic-packaged version, called the Mac 11, will open the door to a broad range of appliances in the 8-ampere category. Heretofore, Haenichen says, thyristor prices have restricted the applications to appliance makers' top-of-the-line models.

The Mac 11 will be introduced before the end of the year. Hermetically sealed metal triacs now represent an annual market of five million units.

In line with chips. The 32-year-old Haenichen explains that Motorola's reason for putting the triac in a plastic package is to bring package cost more in line with chip cost. "Packaging costs have been dominant in semiconductor power devices up until now. Although the chip is big in a power device, it hasn't represented 50% of the device cost—it's been more like 20%, with the package accounting for the balance. With plastic packaging, the chip cost is about half the device cost, and some customers may want to buy chips only and save the packaging cost." However, he believes packaged devices will be in greater demand for consumer products. "You have to get into the semiconductor assembly business to use chips only," he says.

The new devices have a peak blocking voltage of 50 to 400 volts, and a maximum rms conduction current of 8 amperes. Peak surge current is 100 amperes; peak gate power, 10 watts; and average gate power, 0.5 watt. Chip size of the Mac 11 is 120 mils square.

Motorola Semiconductor Products, Box 955, Phoenix, Ariz. 85001 [444]

MEPCO TRIMMING POTENTIOMETERS

Ultra-stable Film Element—Infinite Resolution

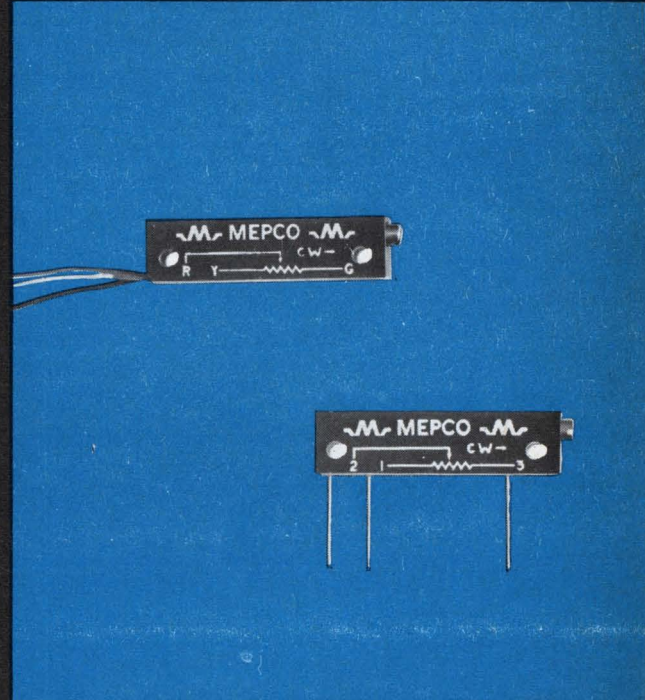
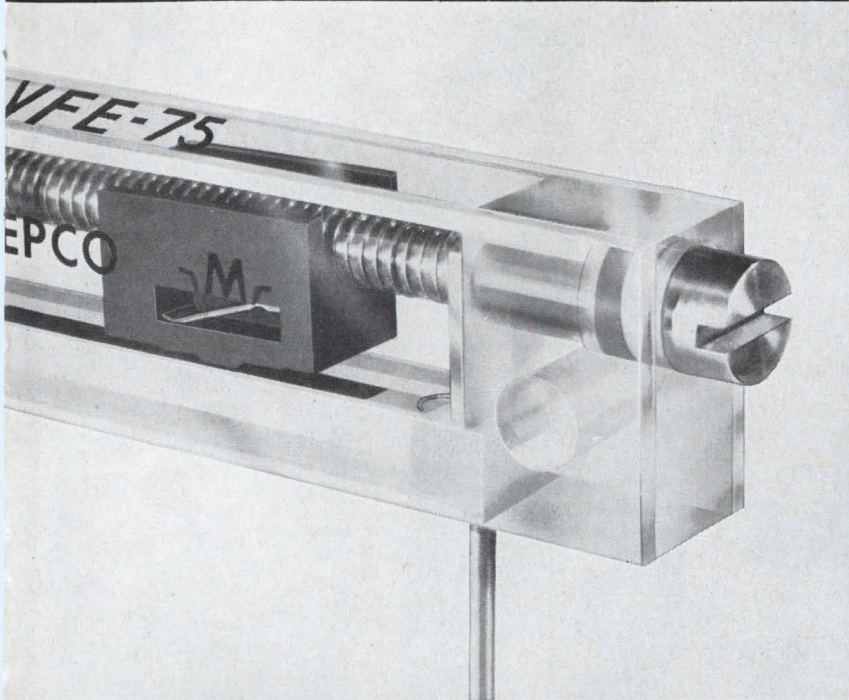

- MEPCO'S **Accutrim** Potentiometer exceeds requirements of MIL-R-22097C, Char. B.
- Temperature Coefficient ± 200 PPM; All resistance ranges; -55°C to $+125^{\circ}\text{C}$; $\frac{3}{4}$ watts at 70°C .
- Longer Resistance Element Life assured by matching of unique slider with Fired Film Element
- Range: 100 ohms to 1 megohm
- Excellent high frequency characteristics
- Clutching life greater than 100,000 cycles
- Pin type leads molded integrally in case; Also available with flexible leads
- All welded termination construction
- High power stress capability
- One Piece stainless steel lead screw
- Precision molded case
- Sealed construction

For technical data, write or call Mepco, Inc.,
Columbia Rd., Morristown, New Jersey 07960
(201) 539-2000. TWX: 710-986-7437 O.E.M. Sales Offices
from Coast to Coast.



A Heritage of Reliability
Resistors... Potentiometers... Microcircuits... Capacitors

Circle 183 on reader service card

New Instruments Review

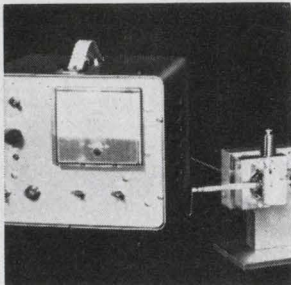

Self-calibrating, the 3403 tests bond strength in fine wires used in connecting terminals to IC and transistor chips. Its full-scale range can be adjusted over a wide value but usually a 0-to 10-gram range is adequate. Wires whose bond strength is no more than a fraction of a gram can be tested. Price is about \$2,000. Transmetrics Inc., Box 2055, Newport Beach, Calif. [361]

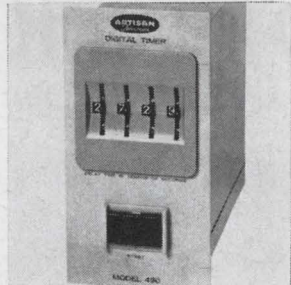

Digital timing control 490 assures readings of 0.1-sec resolution with no potentiometer settings. Time delay accuracy is better than 0.5%; repeatability better than 0.1%. Designed for panel mounting or in original equipment, the unit is suitable for photographic, welding, and lab uses. Prices start at \$134. Artisan Electronics Corp., 5 Eastmans Rd., Parsippany, N.J. [362]

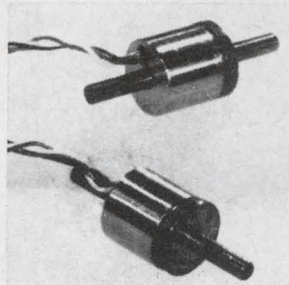

Differential pressure transducer SA-SD M-6HP has the same volume pressure cavity on each side of the diaphragm. Transducer body is 0.290 x 0.270 in. Pressure stems are 0.063 in. o-d and extend 0.188 in. The unit uses bonded strain gages in a 4-arm bridge and provides sensitivity up to 20 mv/v. Scientific Advances Inc., 1400 Holly Ave., Columbus, Ohio. [363]

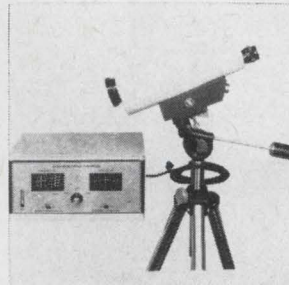

Photoelectronic pyrometer EP-1 measures temperatures of remote targets at 700° to 3,000°C. Sensitivity is better than 1°C at all temperatures and reaches 0.1° at 1,000°C. Temperature readout is in 2 expanded scales: 700° to 1,500°C, and 1,400° to 3,000°C. Response time is 5 msec. Price is \$4,950; delivery, 60 days. Barnes Engineering Co., 30 Commerce Rd., Stamford, Conn. [364]

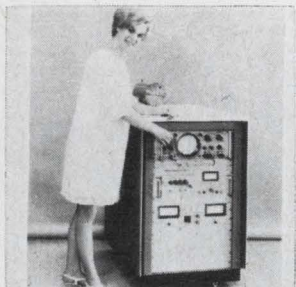

Laboratory mass spectrometer QUAD 160, with quadrupole design, offers linear mass resolution from 1 to 250 atomic mass units (amu). It sweeps the mass range from 10 to 250 amu in 100 msec to 10 minutes. Resolution is better than unity, using the 10% valley definition. Price is \$13,850. Electronic Associates Inc., 4151 Middlefield Road, Palo Alto, Calif. 94303. [365]



Digital frequency meter 8220, with measurement to 500 Mhz and 7-digit resolution, is a compact unit for communications applications and industrial and lab uses. No tuning adjustments are needed for direct reading across the 10-hz to 500-Mhz range. Price is \$1,695. Fairchild Instrumentation Division, Fairchild Camera & Instrument Corp., Mountain View, Calif [366]

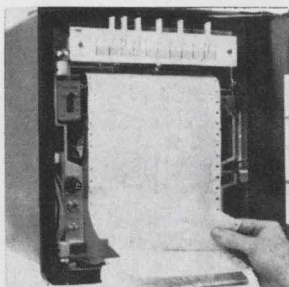

Modular construction of the solid state ERB series strip-chart recorders offers manufacturers of original equipment flexibility of application and easy servicing and replacement of parts. The series receives measurements from d-c mv and ma sources. Single pen and multipoint models are available. Scan-fold strip charts are 7 3/8 in. wide. Foxboro Co., Mechanic St., Foxboro, Mass. [367]

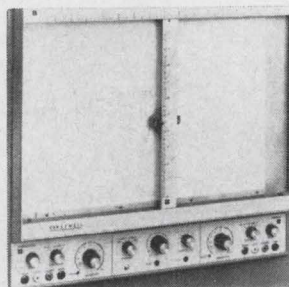

X-Y graphic recorder 550 is a general-purpose lab tool that measures low-level d-c or I-f analog data to determine functional or time-varying relationships. Sensitivity from 100 μ v/in. eliminates the need for preamplification. True differential input permits measurements of grounded or ungrounded sources. Honeywell Inc., 4800 E. Dry Creek Rd., Denver, Colo. [368]

New instruments

Controller backs computers

Pressed by DDC, analog units find new uses in interface and emergency roles

Even the most enthusiastic industrial backers of direct digital process control find it prudent to hedge their bets.

Thus, when the Humble Oil & Refining Co., the chief domestic subsidiary of the Standard Oil Co. (New Jersey), awarded contracts

last month for control equipment to outfit a modernized and expanded refinery in Bayway, N.J., the package included a \$1 million order for analog instrumentation. Motorola Inc. won the analog order, the largest single item of which is the company's new Universal Computer

Control Station (vccs), while the General Electric Co. will furnish three GE/PAC 4020 digital computers.

The project, which will involve more than 500 direct digital control loops, is the latest example of a trend among oil concerns. For an expanded refinery at Coryton, England, the Mobil Oil Co. awarded Motorola a \$200,000 contract for analog control stations and transmitters to interface with a Ferranti-Argus direct digital control (ddc) computer system. And the American Oil Co. is using analog control stations to backstop an IBM 1800 digital system at its

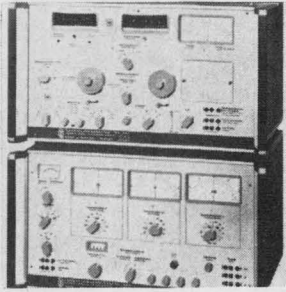

Instrumentation for measuring envelope delay functions instantly upon turn-on, yielding stable, reproducible results, even where data transmission circuits being tested may be hundreds of miles long. Model LD2 was developed for the 200-hz to 600-khz range. Sensitivity is 1 μ sec at all frequencies. Tel-Com Instruments Inc., 6 Great Meadow Lane, Hanover, N.J. [369]

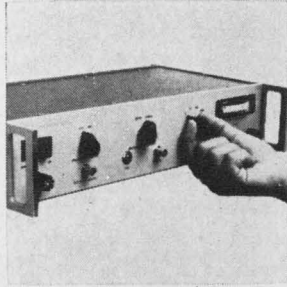

Spectrum generator BSSG-1 permits precise measurement of signal-to-noise ratio, frequency calibration, and relative gain. The instrument generates discrete spectral lines of equal amplitude (± 2 db) with 50- or 100-khz spacing, and provides output of 1,000/100/10/1 μ v absolute into 50 ohms. Squires-Sanders Inc., Martinsville Rd., Liberty Corner, Millington, N.J. 07946. [370]

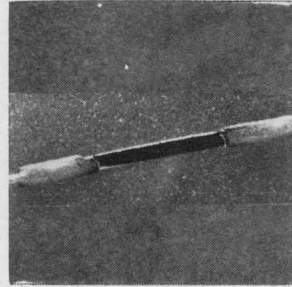

A semiconductor strain gage with a theoretical detection limit of 100 picostrain is for industrial and commercial use. One picostrain is equal to 10^{-12} in./in. strain. Mean time between failures is 100,000 hours. At 500 microstrain, the unit withstands over 50 million operations without degradation. Electro-Optical Systems Inc., 300 N. Halstead St., Pasadena, Calif. [371]

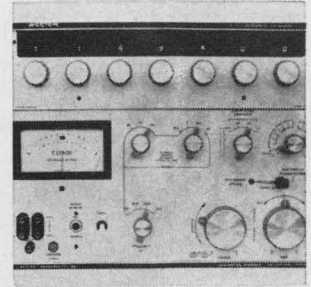

Instrument calibrator 166 uses a fractional scale-divider for swift calibration over a meter range without resetting full-scale values or amplitude controls. A-c and d-c voltages to 1,100 v, currents to 11 amps, and resistance to 11 megohms are possible with 6-digit resolution. Accuracy is 0.1% of reading for d-c voltages. Weston Instruments Inc., 17 Hartwell Ave., Lexington, Mass. [372]



Thermocouple gage controls TG-7 and TG-27 use solid state design and construction and modular 1/4-rack size that is adaptable to bench use with 4 rubber feet. Pressure range for the TG-7 is 1 to 1,000 millitorr; for the TG-27, 0 to 20 torr. Dimensions of both are 5 3/16 x 4 5/32 x 11 in.; weight is 6 3/4 lbs. Veeco Instruments Inc., Terminal Drive, Plainview, N.Y. 11803. [373]

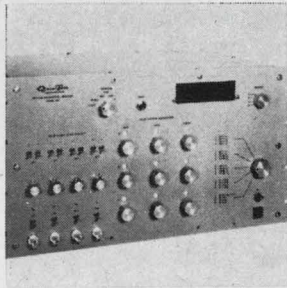

Impulse distribution analyzer model 318 measures the amplitude and width of random or repetitive pulses and stores the number of times that pulses of certain pre-selected widths or amplitudes occur in a given time. It is intended to measure interference on data transmission channels caused by cross-modulation. Quan-Tech Laboratories Inc., 43 S. Jefferson Rd., Whippany, N.J. 07981. [374]

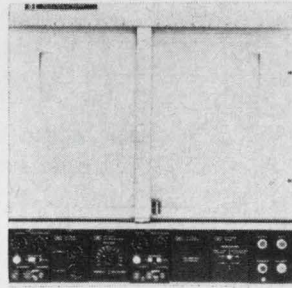

X-Y recorder 7004A, plots one variable as a function of another on 11- x 17-in. paper, and accelerates along either axis more than 1,000 in./sec². Slewing speed is greater than 30 in./sec. Plugins now available are a d-c coupler, d-c preamp, filter, d-c offset, null detector, and time base. Others will be available soon. Hewlett-Packard Co., 1501 Page Mill Rd., Palo Alto, Calif. [375]

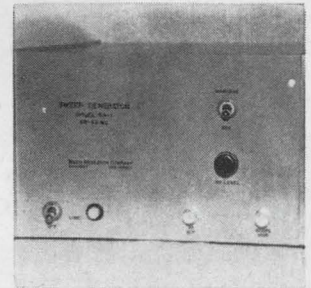

Tv/i-f sweep generator model 64-1 is completely solid state to assure reliability. A built-in electronic attenuator allows greater than 15-db control of the r-f level from its maximum of 1 v rms into 75 ohms. A linear preset sweep covers the 39-to-49-Mhz range with zero retrace line. Price is \$540. Radio Research Co., 189 Mt. Pleasant Ave., Rockaway, N.J. [376]

Whiting, Ind., refinery.

Playing safe. The reason for the trend toward analog backups is clear enough. Few process control engineers—and even fewer plant managers—are willing to entrust an expensive processing operation completely to a possibly capricious digital computer. They may appreciate the advantages DDC offers in control capability, but they want standby analog equipment—automatic or manual—to take over process control if the computer conks out.

Motorola's new control station serves not only as a DDC backup, but, at the flip of a switch, as a

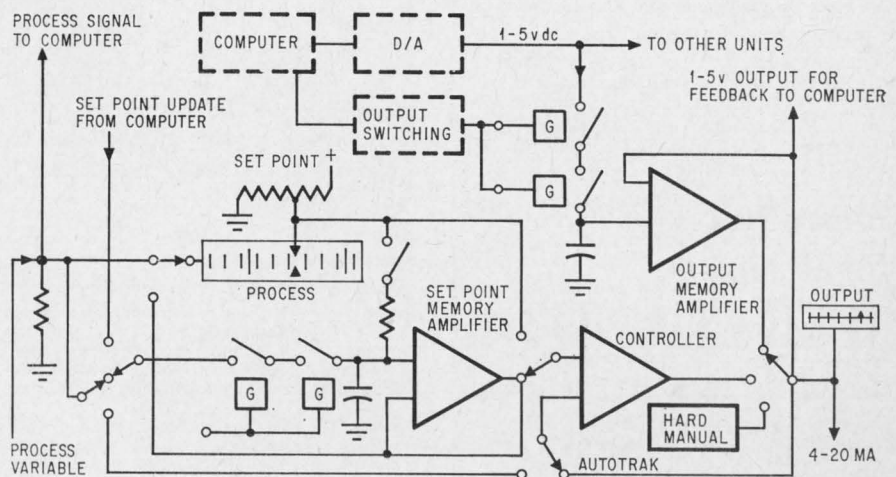

Options. Front-panel switches and plug-in modules suit the basic analog controller for DDC backup, supervisory-computer, and automatic or manual control.

Why MARYLAND?

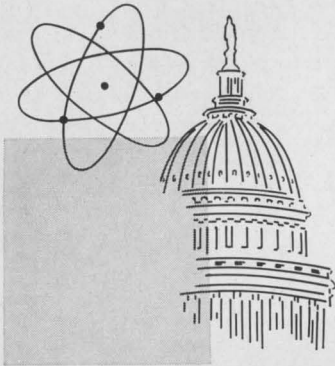

Proximity to federal agencies in Washington, D.C. affords the unique advantage of constant personal contact with government officials working with science-oriented industry. Such contact is an increasingly important locational criterion.

No other state is as convenient to as many Federal agencies as Maryland. For example, Maryland's major government scientific installations include NASA, AEC, NIH, the National Bureau of Standards, plus some 20 others.

Are there other reasons why R&D activities and science-oriented industries should consider locating in MARYLAND?

Yes... emphatically!

The availability of personnel, particularly engineers and scientists, is recognized as a chief criterion governing the location of any science-oriented industry.

There are almost 30,000 scientists and over 25,000 engineers living and working in Maryland and the District of Columbia.

There are 39 four-year colleges and universities in Maryland and the District of Columbia. Graduate and post-doctoral programs considered most significant to research and science industry are available.

Shouldn't you locate in MARYLAND?

Get All The Facts.

MARYLAND DEPARTMENT OF ECONOMIC DEVELOPMENT DIVISION E

State Office Bldg. • Annapolis, Md. 21404

Write, Wire Or Phone Collect

... analog station stands between computer and process, smooths out rough spots in control ...

conventional analog controller and as a set point station to interface with supervisory digital computers. The prototype was evaluated by outside control engineers—notably from Humble and American Oil—some of whose ideas were incorporated into the final design.

The uccs has independent outputs for computer control, analog automatic control, and manual control. Its designers reasoned that a digital process-control computer takes from one to three years to become fully operational, and that the analog station can be used to get a new processing plant on stream during this breaking-in period. When the digital computer is ready to take over, the station is put into the computer-control mode—one station at a time until all loops are under computer control.

Ever ready. In this role, the analog station stands between computer output and process, and compensates for transient disturbances. Off line, the controller automatically tracks the computer output. And as an option, the set point memory amplifier can track the value of the process variable so that, should the computer have to disengage, the last value stored in the memory amplifier could serve as the set point for the analog controller.

Another option provides for a "soft" changeover. Here, the desired set point leaks through an R-C time constant circuit into the set point memory amplifier, ensuring that the process will shift to a safe operating level without a bump should the computer transfer control to the analog station. Available time constants are 1,2,3,4, and 5 minutes.

Specifications

| | |
|----------------------|---|
| Input | 1-5 v d-c, incremental or pulse amplitude |
| Outputs | 4-20 ma d-c continuous signal |
| Front-panel controls | Set-point adjust and automatic/computer/manual switch |
| Power | 24 v d-c; battery backup available |
| Size | Two UCCS units fit into standard Motorola 3"x9" instrument module |
| Price | \$300-\$400 per loop, depending on options |

Hard manual control uses an internal current source set between 4 and 20 milliamperes. The process variable thus changes rapidly to the desired value. On hard manual, feedback to the output memory amplifier gives a continuously updated value for the condition of the process variable, making for a smooth return to automatic computer control.

Motorola Instrumentation & Control Inc., P. O. Box 5409, Phoenix, Ariz. 85010 [377]

New instruments

Poland manufactures scope for export

60 Mhz unit priced to compete with Western scopes

"Poland's best electronic instrument." That's how one Warsaw trade official describes a partially-transistorized oscilloscope being produced for export. Horizontal and vertical plug-in units boost the versatility of the instrument, designated the OSA 601.

Metronex, the official Polish trade agency, says 100 units have thus far been exported—all to Communist nations. Of the 100, 20 are in use at the highly regarded Joint Nuclear Research Institute at Dubna, near Moscow.

Made at the Experimental Plant of Nuclear Technology in Warsaw, the oscilloscope is priced in the Soviet Union at 4,200 rubles, which is about \$4,666 at the official but inflated exchange rate. Soviet-bloc countries, however, generally sell equipment for about half the "ruble price" if payment is in hard currency. This would make the oscilloscope competitively priced with U.S. instruments having comparable specifications. All dials on the

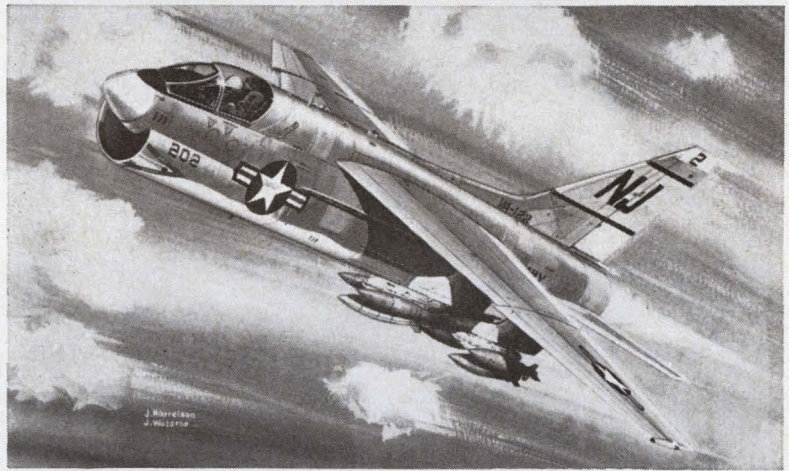
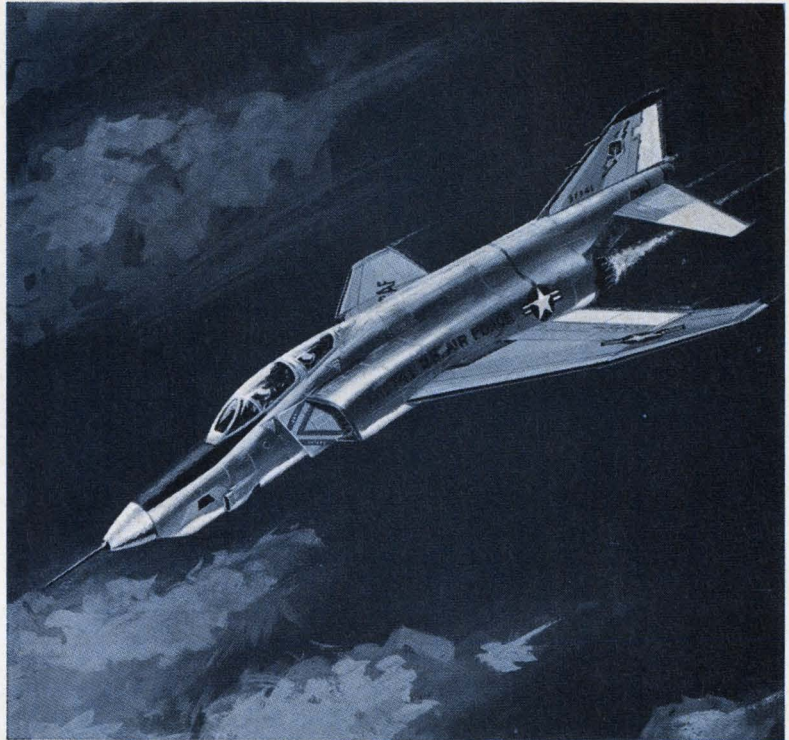

Sperry Rand Corporation has solved a unique oscillator application problem for multi-mode radars on the RF-4C and the A-7A. Texas Instruments Incorporated, prime contractor for both radar systems, needed a dual function tube — one which could serve as local oscillator in the radar, and would also work in the test and check-out circuit.

Sperry suggested the SRU-2161, and tests proved they were right. Today every AN/APQ-99 (for the RF-4C) and AN/APQ-116 (for the A-7A) system carries two of these Sperry reflex klystron oscillators.

The SRU-2161 delivers 50 mW at Ku band, while operating from a 300 V power supply. Since the oscillator has Sperry's unique adjustable reflector voltage, both tubes in the system can be driven from a single power supply. Mode shapes can be controlled to comply with the exacting tolerances of both systems.

If you need unusual performance from klystron oscillators, Sperry is the place to look. Contact your Cain & Co. representative, or write Sperry Electronic Tube Division, Sperry Rand Corporation, Gainesville, Florida 32601.

SPERRY
MICROWAVE ELECTRONICS AND
ELECTRONIC TUBE DIVISIONS
CLEARWATER AND GAINESVILLE, FLORIDA



Why multi-mode radars for RF-4C and A-7A depend on dual-purpose oscillators from Sperry... the first name in microwaves.

You name the meter. Ideal has it.

(or we'll make it for you)

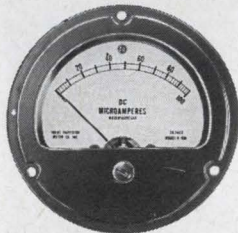
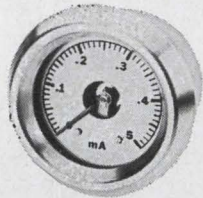
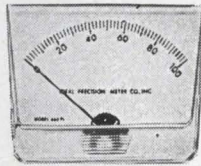
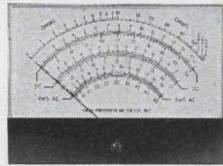

If one concentrates long and hard enough on panel meter development and engineering, one becomes expert.

IDEAL meters are used by all the Military and by leaders in defense and industry. For everything in meters—ruggedized or commercial, custom and stock, 1/2" to 7"—you can count on IDEAL, the proven leader.

Write for free 32-pg. catalog. Ideal Precision Meter Co., Inc., 218 Franklin St., Brooklyn, N.Y. 11222. (212) EVergreen 3-6904.

Circle 250 on reader service card

WE'VE SIMPLIFIED PHOTOCELL- LAMP DESIGN

New Clairex® PHOTOMODS® combine selected photoconductive cells and lamps into one compact module ready for use as noiseless pots, circuit isolators, automatic gain controls and for numerous other control applications. 11 standard PHOTOMODS are now available combining hermetically sealed CdS and CdSe photocells coupled to 5000 hour lamps rated at 6, 12, 24, and 120 volts. Custom PHOTOMODS are also available based on your specific control and signal circuit parameters.



For additional design data request technical bulletin ITD 465.



INC. ■ 1239 BROADWAY, NEW YORK, N.Y. 10001

... Tunnel diodes trigger to 100 Mhz ...

instrument are labeled in English. **Easy to use.** The scope provides a 60-megahertz bandwidth at sensitivity of 50 millivolts per centimeter. Tunnel-diode circuitry permits triggering to 100 Mhz. No stability control is necessary, and a beam-finder that automatically locates an off-screen spot is simple enough to be used by inexperienced operators.

Horizontal sensitivity, with bandwidth from d-c to 2 Mhz, is in three ranges: 0.3 volt per centimeter, 1 volt, and 10 volts. Time markers are provided for 5 and 20 nsec, accurate to +2%.

The vertical amplifier's bandwidth is reduced to 40 Mhz when the magnification is increased to 10:1. Rise time is 6 nsec at 1:1 and 9 nsec at 10:1. The signal delay of the main vertical amplifier is 150 μsec. Sensitivity is 50 millivolts per centimeter to 20 v/cm in sequence 1, 2 and 5 (1:1), or 5 mv/cm to 2 v/cm in 1, 2 and 5 sequence (10:1).

Calibration is by square wave of 1, 10 or 100 volts, with accuracy of ±2%. The oscilloscope measures 13 by 19 by 28 inches, and weighs 95 pounds without plug-ins.

At a recent exhibition of electronic and nuclear instruments at Dubna, the Polish trade agency also showed a few fully-transistorized instruments, including a stabilized power supply for general laboratory use where low-voltage, high-current-supply circuits are required. This instrument, labeled simply Type 204, operates at 3 amperes from 0 to 32 volts with remote-control capability. Output voltage is variable in steps of 0.1 volt.



Warsaw entry. All dials on Polish oscilloscope are labeled in English.

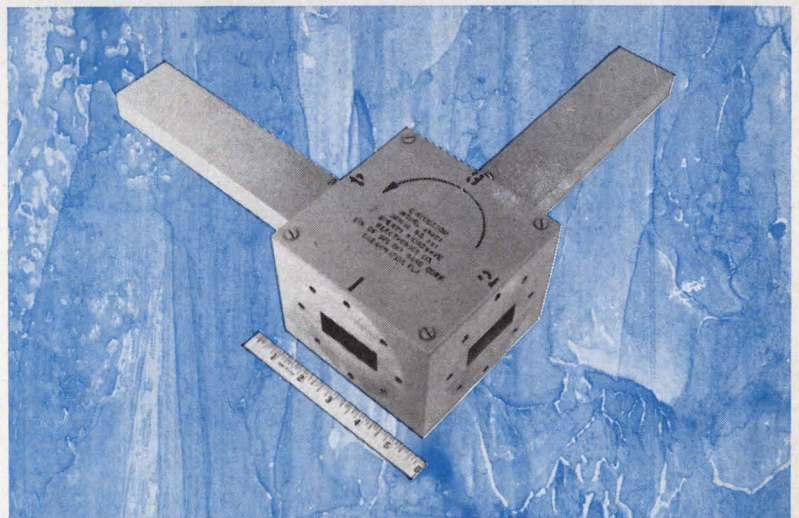
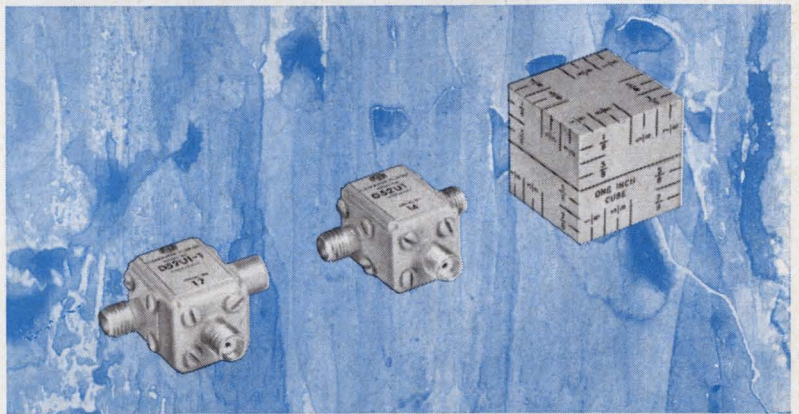
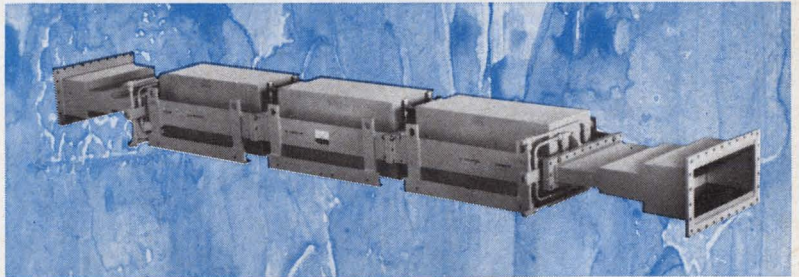
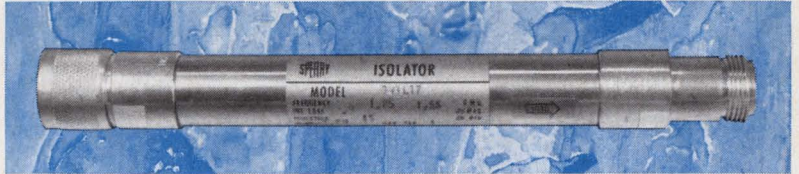
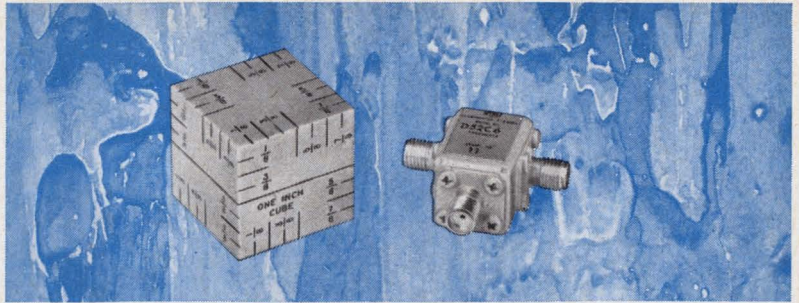

How much isolation does your microwave system need? How low must isolator insertion losses be?

Regardless of your answers, the right isolator or circulator is most likely to come from Sperry, no matter what frequency range you're working in.

After all, the coaxial isolator was invented at Sperry, and Sperry has set the pace in its development. Today the Sperry line is unquestionably the industry's most comprehensive.

You can get 217 models of standard Sperry isolators and circulators. Frequencies range from 0.1 to 40 GHz. Isolation can be as high as 40 db; insertion loss as low as 0.3 db. Remarkable custom development capability is also available.

Write for our new catalog and look over the line. Then, if you don't see exactly what you want, ask for it. Ask your Cain & Co. man or write Sperry Microwave Electronics Division, Sperry Rand Corporation, Box 4648, Clearwater, Florida 33518.

SPERRY
MICROWAVE ELECTRONICS AND
ELECTRONIC TUBE DIVISIONS
CLEARWATER AND GAINESVILLE, FLORIDA

The world's most comprehensive line of microwave isolators/circulators comes from Sperry... the first name in microwaves.



EE'S

with military communications
equipment experience

call us collect

area code 317/459-2808

Rapid expansion of our ground based and airborne military communications capability has created urgent requirements for electrical engineers (B.S. or M.S.) at Delco Radio.

Opportunities at all levels—beginning, through supervisory, with 2-10 years experience—in the following areas:

Digital communications in the HF, VHF, and UHF bands

Single side band design, HF, and VHF

Frequency synthesizer techniques in all frequency ranges

Wide range electronic tuning

Retransmission techniques

Secure communications techniques

Man-portable and vehicular battle area communications equipment

Acoustic transducers, antennas, and micro-electronics applications.

Call us collect for an interview or more information. Area Code 317/459-2808. Ask for C. D. Longshore. Or send your resume to Mr. Longshore, Supervisor, Salaried Employment, Dept. 204, Delco Radio Division of General Motors, Kokomo, Indiana.

DELCO RADIO

DIVISION OF GENERAL MOTORS • KOKOMO, INDIANA

An equal opportunity employer



MARK OF EXCELLENCE

New Subassemblies Review

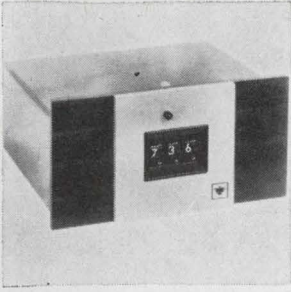

Combination timer/counter CT101 is designed for use on machine and process control panels, and eliminates the need for separate or outboard mounts. It accepts up to 30,000 counts per sec. Intervals from 10 msec to 9.99 sec, in 10-msec increments, can be timed with ± 0.01 -sec accuracy. Reset time is 8 msec. Eagle Signal Division, E.W. Bliss Co., 736 Federal St., Davenport, Iowa. [381]

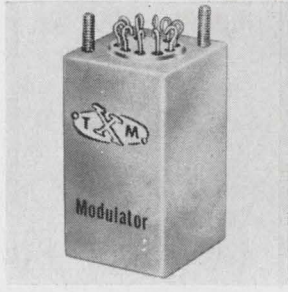

Sine-wave modulator model 152 offers proportional d-c to a-c conversion with 0.1% linearity. It accepts -7 to $+7$ v d-c input and provides a 0 to 1 v rms output into a 50-kilohm load. The unit drifts only 1 mv max. and has a gain stability of $\pm 3\%$. Operating temperature is -55° to $+85^\circ$ C. Price is \$120. Transmagnetics Inc., 134-25 Northern Blvd., Flushing, N. Y. [382]

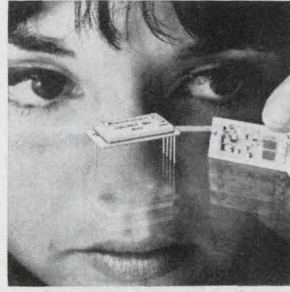

Hybrid d-c voltage regulators models 802 and 804 are short-circuit proof and externally adjustable from 9 to 21 v and 20 to 32 v respectively. Output regulation is $\pm 0.05\%$ for line and load variations. Load current is $\frac{1}{2}$ amp. Power rating is 1.8 w at $+25^\circ$ C. Operating temperature is -55° to $+125^\circ$ C. Beckman Instruments Inc., 2500 Harbor Blvd., Fullerton, Calif. [383]

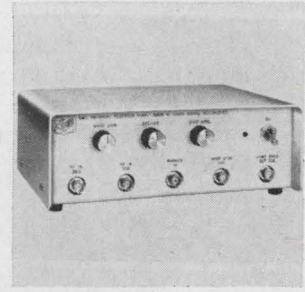

Multiplexer Mark 81, for use with general-purpose video sweep generators, allows increased usage of existing equipment in the adjustment of tv systems. It adds EIA tv sync pulses to the output of video sweeping oscillators. Output is a test signal in tv format for measuring response of video amplifiers. Price is \$390. Ball Bros. Research Corp., Box 1062, Boulder, Colo. [384]



Crowbar-type overvoltage protector model OVP-1, connected across the d-c output of a power supply prevents damage to the load caused by excessive voltage. It features dual voltage ranges, 3 to 24 v and 24 to 45 v, both adjustable. Continuous rating is 12 amps with heat sink, 2 amps in free air. Response time is 3 μ sec. Power Mate Corp., 163 Clay St., Hackensack, N.J. [385]

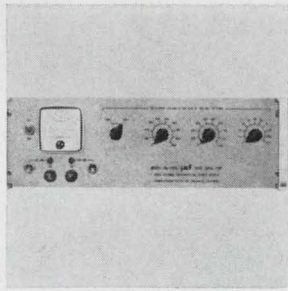

Regulated, 10-kv to 30-kv d-c power supply model 1579 furnishes low-noise and corona-free voltages for operating character generator or display crt's, photomultiplier tubes, and similar devices. Output current is 1 ma max. Regulation is 0.0025% for line or load variations. Ripple is less than 250 mv. Price is \$2,250. Power Designs Inc., 1700 Shames Dr., Westbury, N.Y. [386]

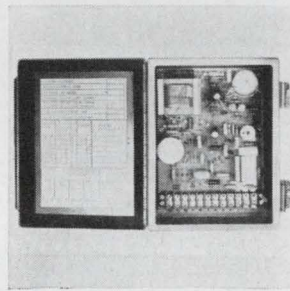

Millivolt to current converter series MAS100 is a magnetic-transistor amplifier that converts input signal spans ranging from 2 to 50 mv into output current ranges of 1 to 5, 4 to 20, or 10 to 50 ma. Accuracy is 0.1%; repeatability, 0.01% of span; linearity (d-c input/output), 0.05%; dead band, 0.1% of span. Airpax Electronics Inc., P.O. Box 8488, Fort Lauderdale, Fla. [387]

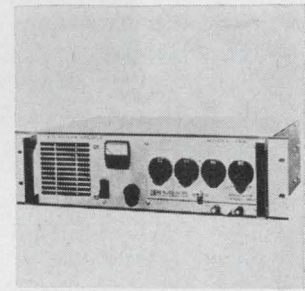

Precision a-c power source model 150 has an output of 0 to 150 v-a, 2 or 3 phase. The amplifier unit accepts any of 40 standard plug-in oscillators with fixed or variable output frequencies from 45 hz to 10 khz. Accuracies range from $\pm 0.1\%$ to $\pm 0.0001\%$. The unit measures $5\frac{1}{4} \times 19 \times 14\frac{1}{2}$ in. Weight is approximately 50 lbs. Elgar Corp., 8046 Engineer Rd., San Diego, Calif. [388]

New subassemblies

New twist on light

Torque transducer uses photocells as sensors

When the Vibrac Corp. started manufacturing magnetic parts for breaks and clutches used in small servosystems, it found that none of the available torque transducers could test its products.

Strain-gage units couldn't be used because the slip rings needed

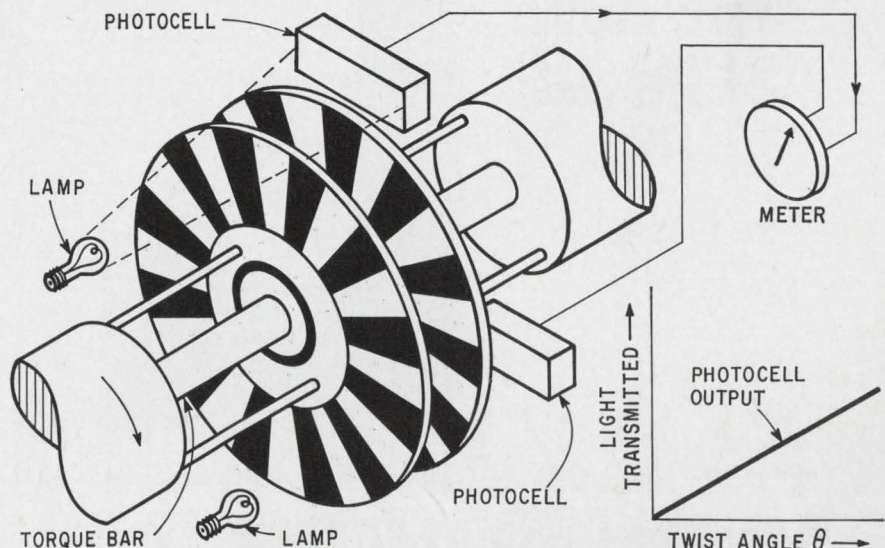

General Electric's sub-miniature Bi-Pin lamps have slimmed down a bit about the midsection. Now the base is no bigger around than the bulb. So you can locate GE's Bi-Pins on ¼ inch centers. Set them up more precisely, put light right where you want it.

GE Bi-Pin lamps plug in from the front and stay put. For printed circuits, indicator and switching applications, they do the same job as screw base, grooved base, midget flanged base or wire terminal lamps. And often save you money because they eliminate more expensive sockets.

Lamp type identification is clearly printed on the tough plastic base of every GE Bi-Pin lamp. No confusing color codes, no delays or chance for error. Another GE extra: a soldering vent slot for tighter, trouble-free contact.

You can get this base on any lamp in the T-1¼ size. For complete specifications, send for free illustrated data, #3-5593. General Electric Co., Miniature Lamp Department, M7-6, Nela Park, Cleveland, Ohio 44112.

THE NEW SLIM GE BI-PIN

its loss is
your gain

Miniature Lamp Department

GENERAL  **ELECTRIC**



... twisting shaft changes light output ...

to transmit the signal produced too much noise; magnetic transducers proved ineffective because they had a limited frequency response; and digital-optical sensors wouldn't work because they had to be used with constant-speed motors. "We were forced to design a new type transducer so we could test what we were making," says Roger Foskett, Vibrac's chief engineer.

The result is a simple optical test system that can also be used as a sensor for both on-line process control and system analysis. Designated the model TQ torque-measuring system, it senses the amount of transmitted light and records this on a meter.

Two discs, having alternating transparent and opaque sections, are mounted on a shaft. On one side of the discs there are two lamps; on the other side, two silicon photocells, which are connected to a meter.

Reading change. When no torque is applied to the shaft, half the light is transmitted to the cells. When the shaft is rotated, either more or less light is transmitted—depending on the direction of rotation. This changes the photocells' output and, thus, changes the meter reading. Since the no-torque reading corresponds to 50% transmission, the unit is operating in the linear portion of the photocells and

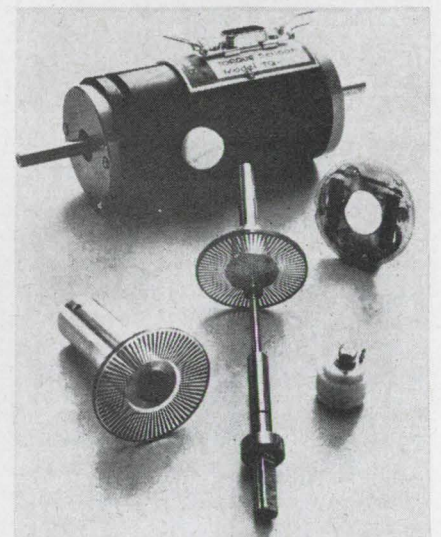

Slotted discs. Transducer, because of its simple construction, requires only one adjustment for calibration.

is accurate to 0.5% of full scale.

The transducer can also be used in liquid-process control by attaching a propeller to one side of the device and a motor to the other side. When the propeller is immersed in a liquid, the viscosity of the liquid can be determined. And since the output is a d-c voltage proportional to torque (or viscosity), it can be connected directly to a computer.

The complete measuring system—including transducer, display meter, power supply, and cables—is priced at \$745 for torque ranges of 10, 32, and 100 ounce-inches. The transducer is also available separately for \$450.

Specifications

| | |
|-----------------------------|--|
| Resonant frequency | 700 hz |
| Stiffness | 2,900 oz-in./radian |
| Overall moment of inertia | 1.5×10^{-5} oz-in.-sec ² |
| Linearity | 0.5% of full scale |
| Repeatability | 0.25% of full scale |
| Speed range | 0 to 8,000 rpm |
| Max. torque overload | 100% |
| Output at rated torque | $\pm 100 \mu\text{a}$ |
| Load resistance | 500 ohms max. |
| Shaft twist at rated torque | 0.6° |
| Lamp life | 4,000 hrs |

Vibrac Corp., Alpha Industrial Park, Chelmsford, Mass. [389]

New subassemblies

Fuel cells go down to the sea

Air-alcohol device powers a lighthouse off Japanese coast

Engineers at one Japanese company are preoccupied these days with the production of electricity without conventional generators. First, Matsushita came out with a new solar cell [Electronics, Sept. 18, p. 196], now it has introduced a commercial fuel cell.

Remote power sources are not in great demand in Japan. The country is small enough to run commercial power lines to almost any location. And where power lines can't be used, solar cells can. But an unusual situation developed when a power source was needed



E-CELL $\int i dt$ CIRCUIT GIVES α BATTERY RE-CHARGE

Problem: After using a battery irregularly over an unknown time interval, re-charge it with precisely the amount of energy you've drained off. A straightforward solution using the Bissett-Berman E-CELL* current-time integrating circuit shown below does the job this way: (1) In the RUN mode, the battery drain is continuously sensed at the meter shunt, causing a proportional quantity of plating material to be transferred to the E-CELL anode. (2) In the CHARGE mode, the Charger is operating while the E-CELL anode is being de-plated. (3) When the anode is completely de-plated, the E-CELL voltage drop triggers the SCR, automatically disconnecting the Charger.

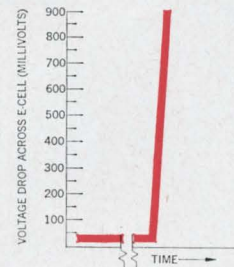
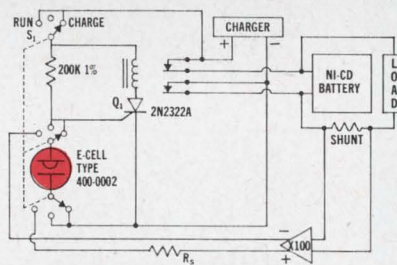

* The Bissett-Berman E-CELL™ is a unique "liquid state" electrochemical timing and integrating component now being manufactured in high volume on fully automatic production lines. E-CELLs are designed for single or repetitive use in generating time delays ranging from seconds to months, or integrating events from one to infinity, and consume only nanowatts. Patents applied for.



Actual size

E-CELLs are designed to meet or exceed the requirements of MIL-STD-202C for:

- Altitude:** Method 105C Test Condition B
- Solderability:** Method 208A
- Vibration:** Method 204A
- Thermal Shock:** Method 107B Test Condition A
- Seal:** Method 112 Test Condition C
- Terminal Strength:** Method 211 Test Condition A

For technical information and application notes, contact: Components Division, The Bissett-Berman Corporation, 3860 Centinela Avenue, Los Angeles, California 90066; Telephone: Area Code 213, 390-3585.

**BISSETT
BERMAN**



*for
maximal
performance
in critical
applications...*

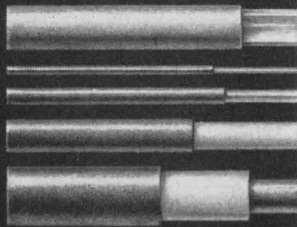

**COAXITUBE
PRE-FAB PARTS
& ASSEMBLIES**

Orders of Coaxitube can be furnished cut to size, stripped, preformed to shape or assembled with connectors to meet your exact specifications. Semirigid construction assures the retention of shape and closely held tolerances. We'll gladly send data or quote your needs . . . no obligation.

**. . . conversion efficiency
is about 75% . . .**

for a lighthouse in northern Japan. Power lines were not available and there wasn't enough sunlight to keep solar cells going. The fuel cell was a natural alternative.

Many types of fuel cells have been developed, but few units have been put to practical use. The most common type is the hydrogen fuel cell that has been used in the U.S. space program, but it has drawbacks. Hydrogen is expensive and there is the ever-present danger of explosion. Its principal asset is its conversion efficiency—about 85%. Matsushita's fuel cell uses a mixture of air and alcohol which is safe, inexpensive, and has an efficiency of about 75%.

Operation. Constant quantities of liquid methyl alcohol and air are fed to the fuel cell by a pump, which derives its power from the device. Ten cells are connected in series to form a block, and each cell has an output of 0.2 volt. The complete power supply consists of six blocks for a total output of 12 volts. This is fed to a chopper-type voltage regulator that keeps the output constant regardless of temperature changes. Total output power is 25 watts. The cell operates 24 hours a day charging a 48 amp-hour battery that is connected to the lighthouse beacon by a daylight switch. Initial tests indicate that the lighthouse can operate for a period of one year without refueling.

Chemistry. A single cell is composed of two chambers, one inside

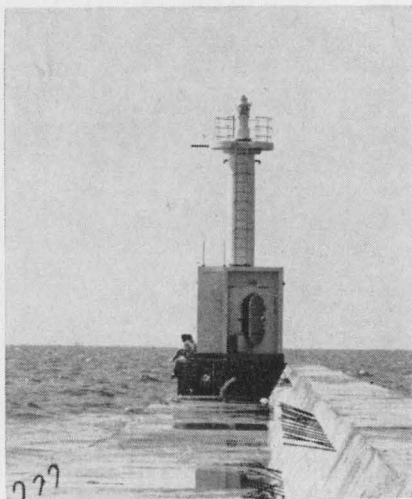

On the water. Fuel cells are in the base of the lighthouse.



**PRECISION
Semi-rigid
COAXITUBE**

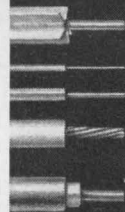

These high performance solid-jacketed cables offer broad frequency response, low attenuation, zero radiation and lowest possible VSWR. The splined, air-articulated types provide minimum attenuation and highest cutoff frequencies, eliminate periodicity phenomena, and insure phase stability in the order of 20 PPM/°C from 10°C to 40°C, and 35 PPM/°C from -40°C to +125°C. They also provide excellent external RF shielding. For critical applications in severe environments, your best decision is Precision.



PRECISION TUBE COMPANY, INC.
SPECIAL PRODUCTS DIVISION
North Wales, Pennsylvania 19454
Phone 215-699-4806 TWX 510-661-8427

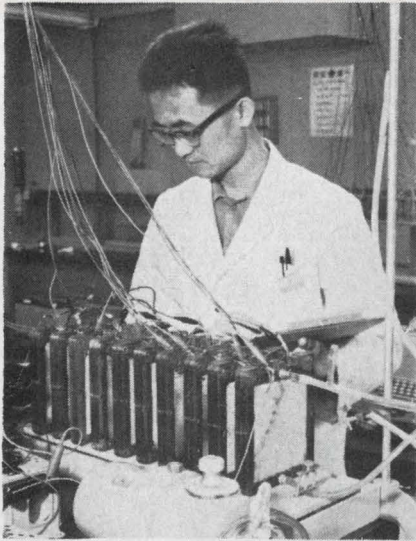

Bench model. Individual cells are series-connected providing 12 volts.

the other, separated by a layer of caustic potash. Air is pumped to the outer chamber while alcohol is fed to the inner one. A reaction takes place on the potash, and this produces water, potassium carbonate, and a flow of electrons.

The lighthouse, according to the U.S. Navy Hydrographic Office ocean charts, must be visible for eight miles in heavy fog or in clear weather. To achieve sufficient brightness from a 25-watt power supply, seems an impossible feat. Since common incandescent light sources couldn't be used because of their low efficiency, Matsushita engineers were left with the choice of either a quartz-iodide lamp or a xenon flash tube. The quartz-iodide lamp, even though it could supply the required brightness, was ruled out because it couldn't be turned off fast enough for the flashing beacon—the lamp takes too long to cool off. The xenon flash tube, because it is fired by a charged capacitor, can be triggered rapidly and runs cooler, therefore it was chosen. As a bonus—because the xenon works on a pulse principle—the battery has enough time between flashes to build up a sufficient charge to restore the capacitor.

Matsushita engineers see large-scale applications for fuel cells after further development. These include operatorless satellite stations and portable communication devices.

Matsushita Electric Industrial Co., Tokyo [390]

VERO PRODUCES The TOTAL PACKAGING SYSTEM

From Stock Delivery • 200 Standard Veroboards Plus Special Designs • 3 Different Card Frame Systems • 1000 Combinations of Module Racks • Save by Incorporating Vero Packaging Techniques in Your Production Design.



VERO ELECTRONICS INC.

176 Central Ave., Farmingdale, N. Y. 11703

Tel.: 516 MY 4-6550 • TWX 510-224-6425

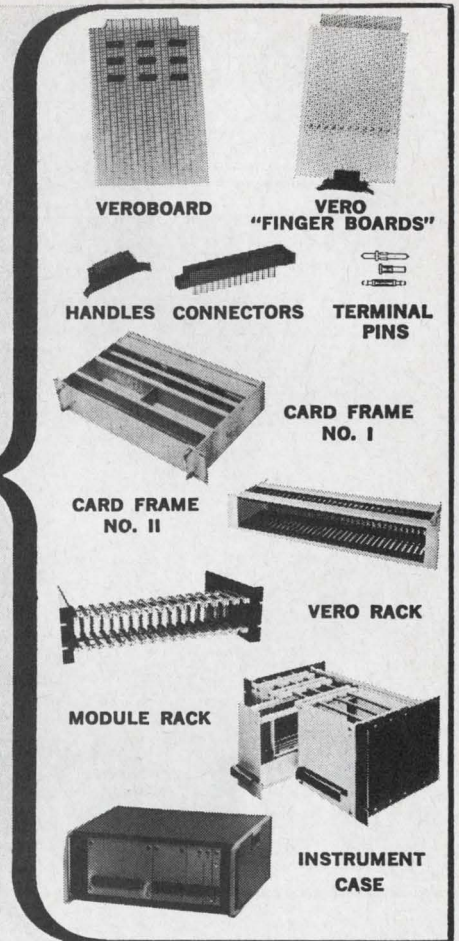

VEROBOARD

VERO "FINGER BOARDS"

HANDLES CONNECTORS

TERMINAL PINS

CARD FRAME NO. I

CARD FRAME NO. II

VERO RACK

MODULE RACK

INSTRUMENT CASE

Circle 251 on reader service card

**Ever need plug-in power supplies in a hurry?
Send for our 1967 catalog.
It lists 62,000 different types.
The one you need will be shipped in 3 days.**

(We've never failed to make good on this promise)

Acopian SINGLE OUTPUT REGULATED ALL SILICON POWER SUPPLIES
Ambient temperature rating 20 to 70°C.

Acopian SINGLE OUTPUT ALL SILICON POWER SUPPLIES
Ambient temperature

Acopian

Acopian Corporation, Easton, Pennsylvania, (215) 258-5441

Don't sit there
wishing your
 support people
 knew more
 electronics...

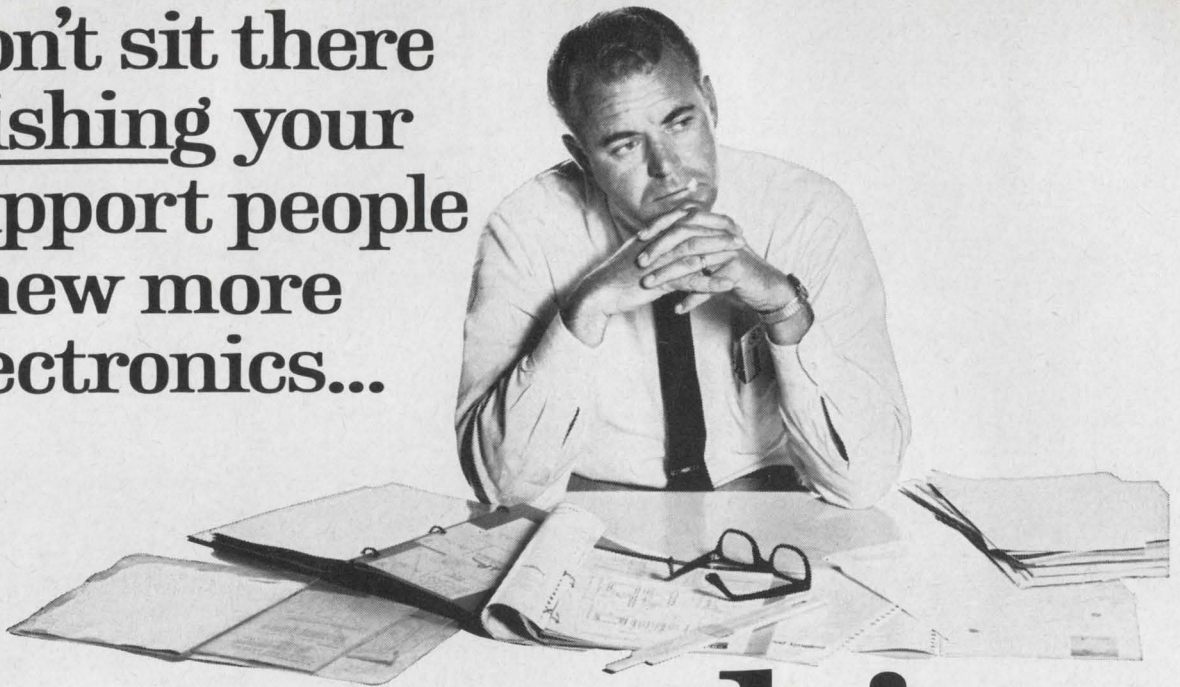

do something

Look over your men. Pick out a few who are intelligent enough to profit from more education in electronics, ambitious enough to work hard to get it. Send us their names and addresses. We'll send them complete information about CREI Home Study Programs in Electronics, tell them how these programs have helped thousands of young men increase their value to their employers. We'll explain how they can study at home, at their own pace, on their own schedule

without traveling to classes. We'll give them the names of the more than 80 leading scientists and engineers who help us develop and update programs related directly to the needs of industry.

Yes, we'll do all that. If you're lucky some of your men may enroll. Why not give it a try? Fill out the coupon and get it in the mail today.



CREI Programs cover these specialized areas of advanced electronics:

- Communications Engineering •
- Aeronautical and Navigational Engineering •
- Television Engineering •
- Computers • Nuclear Instrumentation and Control •
- Automatic Control Engineering •
- Missile and Spacecraft Guidance •
- Radar and Sonar Engineering •
- Nuclear Engineering Technology •
- Industrial Electronics for Automation •
- Computer Systems Technology.

CREI
THE CAPITOL RADIO ENGINEERING INSTITUTE

A Division of McGraw-Hill, Inc.
 Dept. 1842E, 3224 Sixteenth Street, N.W.
 Washington, D.C. 20010

Gentlemen: The men listed at right are high school graduates working in some phase of electronics. Please send them your FREE book, "How to Prepare Today for Tomorrow's Jobs" and complete information about CREI Home Study Programs.

And please send me the free brochure which tells how we can use CREI Home Study Programs to supplement our educational program for electronics personnel.

Name _____
 Title _____
 Company _____
 Address _____
 City _____ State _____ Zip Code _____

Name _____
 Address _____
 City _____ State _____ Zip Code _____

Name _____
 Address _____
 City _____ State _____ Zip Code _____

Name _____
 Address _____
 City _____ State _____ Zip Code _____

Name _____
 Address _____
 City _____ State _____ Zip Code _____

Name _____
 Address _____
 City _____ State _____ Zip Code _____

(Not enough room? Attach sheet of paper with additional names and addresses)

New Microwave Review

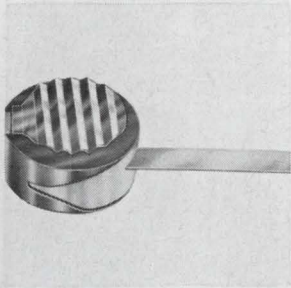

Pill terminations for stripline have built-in spring contacts that automatically compensate for variations in ground plane spacing. Units are designed for $\frac{1}{8}$ and $\frac{1}{4}$ in. spacings. Models rated at 1 w and 3 w are available with vswr of 1.1 max. (d-c to 4 Ghz), 1.25 max. (4 to 8 Ghz), and 1.35 max. (8 to 12 Ghz). Prices start at \$4.50. EMC Technology Inc., 1133 Arch St., Philadelphia. [401]

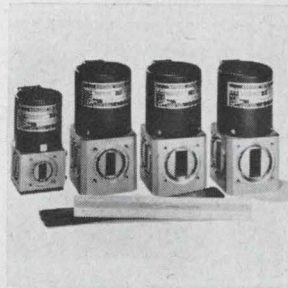

Solenoid operated, waveguide switches type GH, covering 7 to 18 Ghz, are available in WR-62, WR-90, WR-102, and WR-112. Vswr is 1.1:1; isolation, 60 db minimum; insertion loss, 0.2 db max; operating temperature, -54° to $+100^{\circ}\text{C}$. The GH is pressurized and has an antibounce braking device. Weight is 1.25 to 2.5 lbs. Transco Products Inc., 4241 Glencoe Ave., Venice, Calif. [402]

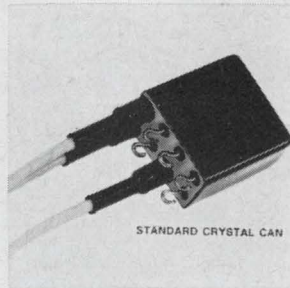

STANDARD CRYSTAL CAN

A miniature coaxial relay line is suitable as an antenna switch or channel selector in communications and radar equipment. The basic relay meets requirements of MIL-R-5757. Usable frequency range up to 1 Ghz. Standard units have a 50-ohm impedance with vswr of 1.15:1 max., insertion loss of 0.4 db max., and isolation of -40 db min. Hi-G Inc., Windsor Locks, Conn. [403]

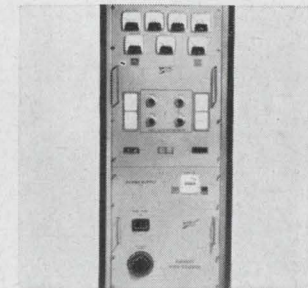

Klystron 1,000-w c-w amplifier systems have applications in mobile or transportable tropospheric forward scatter communications and in radar equipment. Ten individual systems cover frequency increments from 1.7 to 18 Ghz. Vswr is 2:1 max, output load; 1:1:1 max, input circuit. Microwave Cavity Laboratories Inc., 10 North Beach Ave., LaGrange, Ill. 60525. [404]

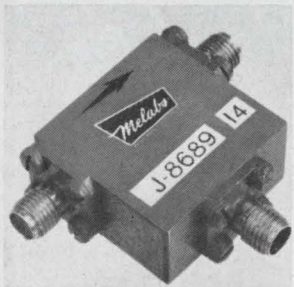

Miniature circulator model J-8689 operates at 555 Mhz. It has no more than 0.5 db of insertion loss and provides at least 20 db of isolation over its 33-Mhz bandwidth. Max. vswr is 1.25, and the unit handles 10 w. Size, excluding connectors, is $1\frac{1}{8} \times 1\frac{5}{8}$ in. Weight is approximately $1\frac{3}{4}$ oz. Melabs, 3300 Hillview Ave., Stanford Industrial Park, Palo Alto, Calif. [405]



Solid state local oscillator MA-82X15 for X-band radar systems operates in the 9.2-Ghz range with an output of 10 mw minimum, 20 mw typical. It is tunable both mechanically and electrically, with a range of ± 25 Mhz and ± 50 Mhz, respectively. Tuning sensitivity is 50 Mhz/v max., reducible by adjusting input impedance. Microwave Associates Inc., Burlington, Mass. [406]

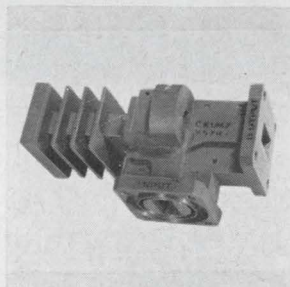

Waveguide junction circulator model CKuM7 is designed to operate at a peak power of 50 kw at a frequency of 16.6 to 17.1 Ghz. Average operating power is 50 w. The circulator achieves a min. isolation of 12 db and a max. insertion loss of 0.4 db. Max. vswr is 1.20:1. Cooling is not required. The unit weighs 5 oz. Raytheon Co., 130 Second Ave., Waltham, Mass. [407]

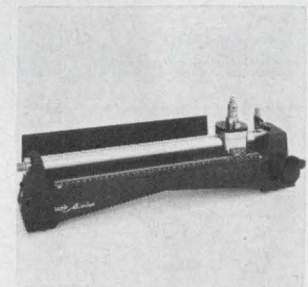

Microline model 6235 slotted line is designed for precise measurements of the impedance, vswr, and reflection coefficient of distributed and lumped elements at r-f frequencies from 395 Mhz to 8.5 Ghz. It has a characteristic impedance of 50 ohms, $\pm 0.1\%$, and meets requirements for testing of advanced coaxial systems. Narda Microwave Corp., Plainview, N.Y. 11803. [408]

New microwave

Receiver in splendid isolation

Radar protector handles 20 kilowatts with insertion loss of only 0.3 decibels

Every time a radar transmitter sends out a pulse, some of its power is reflected back from the antenna feed and, if not stopped, may enter the receiver and burn it out. The radar engineer's solution to this problem is the limiter, or receiver protector—a device insert-

ed in the transmission line between the antenna and the receiver.

A perfect protector would stop all unwanted power during transmission, then switch to a wide-open state during the system's receive cycle, allowing as much power as possible to enter the detector. Just

as high isolation is needed to protect the receiver, low insertion loss is required to keep system noise low and allow the receiver its maximum sensitivity.

Now, Microwave Associates Inc., Burlington, Mass., has produced a solid state, coaxial protector that handles 20-kilowatt, 10-microsecond pulses—isolating the receiver by some 100 decibels. Its insertion loss is only about 0.3 db across a frequency range of 400 to 1,100 megahertz—more than an octave.

The company developed the protector for the Jet Propulsion Laboratory of the California Institute of Technology, which will use it in a

**Would radiation-resistant transistors,
with predictable minimum changes
in gain, simplify your circuit
design problem?**

Consider it simplified.

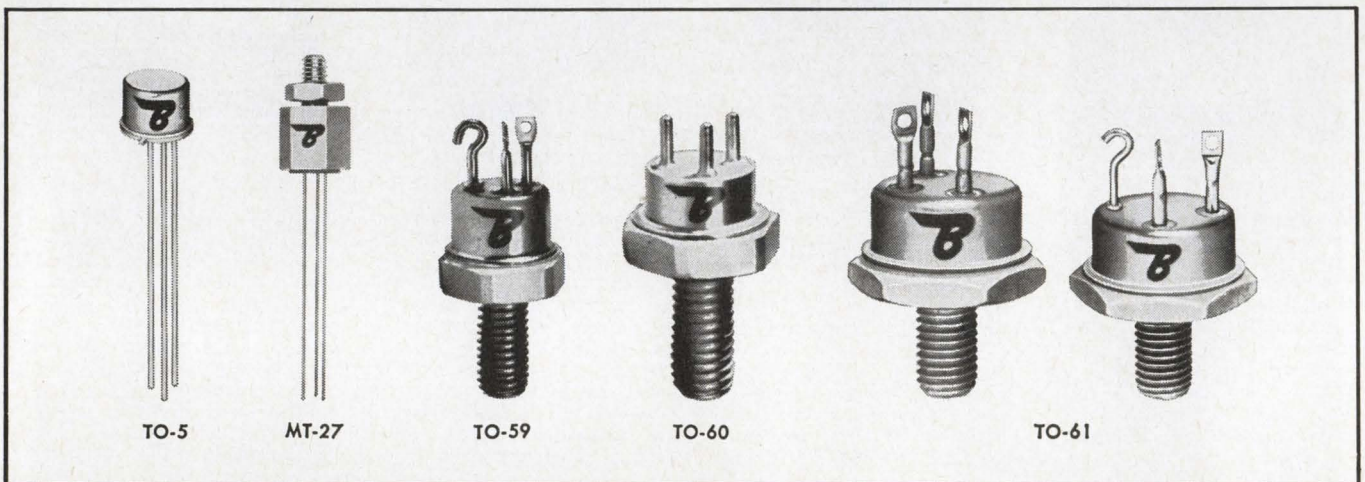

Minimum gain change *and* predictable gain change. Bendix has teamed these two unique features in the vital power transistor to bring you far easier circuit design. How? Bendix radiation-resistant, silicon power transistors boast base widths of 0.6 microns and superior process techniques with large area devices. More important, from the designer's view, the Bendix approach permits you to predict post-radiation gain of power transistors with VCEO's ranging from 40 to 100 volts and maximum current levels of 5, 10 and 25 amps. Exposure levels? You name them and we'll provide superior performance.

The prediction technique is as simple as $\Delta \frac{1}{h_{FE}} = K'\phi$. Here K' equals a function of base-width transit

time and device material. ϕ is equal to the level of exposure. Note that K' values for Bendix radiation-resistant types are specified at the right. Armed with this knowledge, you can design the circuit for optimum pre-radiation and post-radiation performance.

Now consider our credentials. Bendix is the leader in the field of radiation-resistant power transistors. We offer you 16 different types, six different packages, too: TO-5, MT-27, TO-59, TO-60, TO-61 collector-to-case and TO-61 isolated. Like more information? Just contact Bendix Semiconductor Division, Holmdel, New Jersey, and inquire about the BR100 and BR200 series of transistors.

Bendix **Electronics**

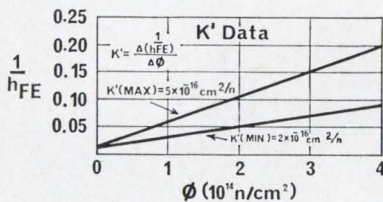
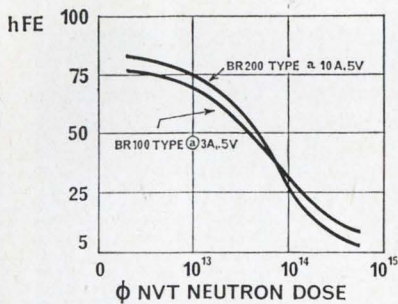

BENDIX REGIONAL OFFICES AND PHONE NUMBERS

Baltimore (Towson), Md.
(301) 828-6877

Chicago
(312) 637-6929

Dallas
(214) 357-1972

Detroit
(313) 548-2120

Greenwich, Conn.
(203) 869-7797

Holmdel, N. J.
(201) 946-9400

Los Angeles
(213) 776-4100

Minneapolis
(612) 926-4633

Los Altos, Calif.
W. W. Posey Co.
(415) 948-7771

Seattle
Ray Johnston Co., Inc.
(206) LA 4-5170

Syracuse, N. Y.
(315) 474-7531

Lexington, Mass.
(617) 861-8350

Export
Cable: "Bendixint"
605 Third Avenue, New York
(212) 973-2121

Ottawa, Ont.
Computing Devices of Canada
P.O. Box 508
(613) 829-1800

... unwanted power is reflected to antenna ...

radar-equipped sounding rocket. **Never before.** The designer, project engineer Paul Basken, says that the company has never before produced a solid state limiter with such a combination of bandwidth, power handling, and low loss. Solid state techniques had to be used, he says, because of the scarcity of reliable coaxial transmit-receive tubes. While most high-power limiters use these gas discharge devices, Microwave Associates' uses none, thus reducing size and weight, and adding ruggedness. Basken says that other protectors for this frequency range are from 10 to 100 times bigger than his company's 5-inch long, 5-ounce device. And even then, their power handling capabilities are limited to peaks of about 500 watts, he says.

Designated MA 8307-1L3S, the protector is a diode switch which shorts out the transmission line in response to a triggering signal from the transmitter. Unwanted power is reflected to antenna.

Limiting connectors. By dividing the switched energy among the nine high-power diodes, the limiter can handle the required power levels—in fact, power handling is limited only by the coaxial connector used. Large connectors like the HN and SC types allow utilization of the 20-kw peak power capability; with smaller connectors such as the type N, Basken recommends limiting power to about half that.

Isolation may even be better than 100 db—the company's test equipment won't permit reliable measurement beyond this point. Basken says that computer estimates show that the protector should be able to reach about 105 db.

Specifications

| | |
|---------------------------------|--------------------------|
| Frequency range | 400-1100Mhz |
| Power handling | 20 kw peak, 50 w average |
| Isolation (typical) | about 100 db |
| Insertion loss in receive state | less than 0.3 db |
| Switching time | about 1 μ sec. |
| Vswr | less than 1.3:1 |
| Operating temperature range | -60 to +100°C |
| Shock | 100 G for 10 msec. |
| Vibration | 10G, 20 hz to 2 khz |
| Acceleration | 15 G for 15 msec. |
| Price | \$850 |
| Delivery | 60 days |

Microwave Associates Inc., South Avenue, Burlington, Mass. [409]

DESIGN PROBLEMS? solve them with PIONEER PHOTOCELLS



CDS-9

A 1" photocell, especially designed for numerous applications in outside or inside lighting, flame control, and relay applications where the light source is incandescent. Proven by hundreds of thousands of photocell years of service.

hundreds of thousands of photocell years of service.

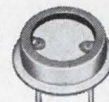

CDS-7

Has the same general characteristics as the CDS-9 but a smaller size ($\frac{1}{2}$ "") for use where space is at a minimum.

CDS-5

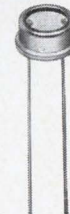

A very compact unit with a T.O. 5 housing, produced to your specifications.

Our engineering department will work with you on any special application of photosensitive layers.

STANDARD MODELS

Curves for load line design available for each model.

| CDS Type No. | 1 FC Simulated Daylight 50 V AC Mean* Output | Nominal Resistance 50 FC 2800° K Incand. | Max. Dark Current** or Min. Dark Resistance | Max. Dissip. | Max. Volt Dark |
|--------------|--|--|---|-------------------------------|----------------|
| 701 | 1.5 ma | | 25 ua | | 500 V |
| 702 | 3 ma | | 25 ua | all rated | 500 V |
| 703 | 6 ma | | 40 ua | $\frac{1}{4}$ watt continuous | 350 V |
| 710 | | 1330 ohms | 4 meg. | 1 watt | 500 V |
| 711 | | 670 ohms | 4 meg. | 1 minute | 500 V |
| 712 | | 330 ohms | 2.5 meg. | | 350 V |
| 901 | 1.5 ma | | 25 ua | All | 1000 V |
| 902 | 3 ma | | 25 ua | rated | 1000 V |
| 903 | 6 ma | | 40 ua | $\frac{1}{2}$ watt | 700 V |
| 904 | 12 ma | | 200 ua | continuous | 500 V |
| 910 | | 1330 ohms | 4 meg. | uous | 1000 V |
| 911 | | 670 ohms | 4 meg. | 2 watts | 1000 V |
| 912 | | 330 ohms | 2.5 meg. | 1 minute | 700 V |
| 913 | | 165 ohms | 0.5 meg. | | 500 V |

*Range of values in any category equal to $\pm 33\%$ of mean.
**Measured at 100 V, 5 seconds after 50 FC light extinguished.



The Material of Unlimited Uses...

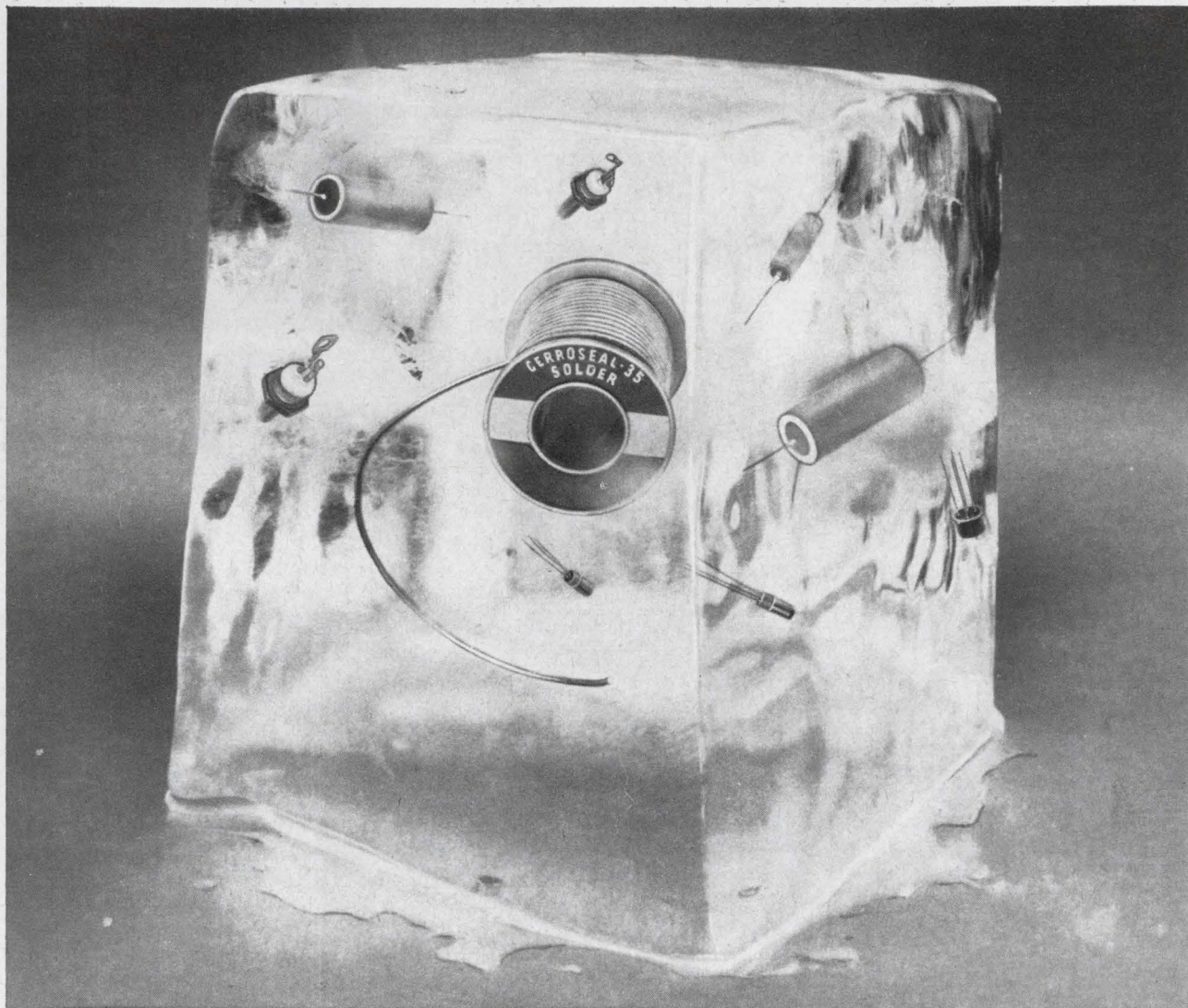

SOLDERING "UNSOLDERABLES"

is but one of the thousands of uses for low-melting-point bismuth alloys such as Cerroseal[®] 35. Cerroseal 35 melts between 238 and 260° F., and can be used with ordinary soldering techniques. When soldered with this versatile alloy, "Toughies" such as glass-to-metal, ceramic-to-metal and metal-to-metal seals stay tight even in a deep vacuum. Other Cerro Alloys, including specials made to your individual specs, are perfect for joining ultra-delicate parts like integrated circuits which cannot be heat-sunk during soldering. Low temperature soldering as cool as 117° F. can also be accomplished with certain Cerro Alloys.

For detailed information contact Cerro Alloy Dept., Cerro Copper & Brass Company, Stamford, Conn. 06907 . . . R.S. Darnell (203) 327-0550.

CERRO[®]

New Production Equipment Review

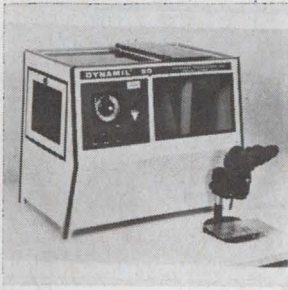

Dynamil 50 is a table model precision chemical etcher for lab and experimental etching, and for fabricating production quantities of thick-film masks. It etches workpieces up to 6 x 6 in. to 1 mil line/mil space tolerance with the VRP (vertical rotary planetary) spray-etching method. Weight is 40 lbs. Price is \$995. Western Technology Inc., 220 W. Central Ave., Santa Ana, Calif. [421]

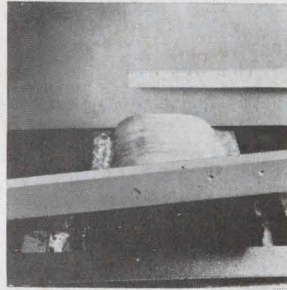

Series TT-X wave soldering system automatically processes p-c boards down to 1/32 in. thick, components, and other equipment. The solder module provides a standing fountain of solder that is 1 1/8 in. deep. The length of the wave can be 14 in. or longer, while the 4-in. width helps eliminate solder icicles and bridging. Hollis Engineering Inc., Nashua, N.H. 03060. [422]

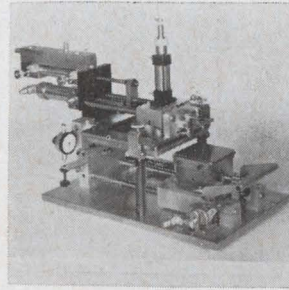

Screen printer model 100, for IC production, has a hand-operated carriage and adjustable squeegee travel time. It uses a 5 x 5 in. screen and accommodates substrates up to 3 x 3 in. Micrometer-type adjustments provide accurate x, y, z, orientation of the screen to the part. Controls can be mounted on or under the table. Precision Systems Co., Box 148, Somerville, N.J. [423]

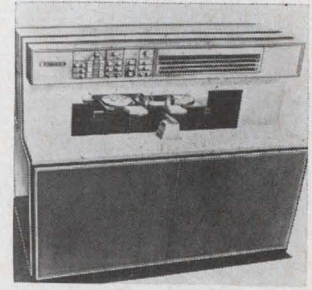

Micro-Bonder model 95002 automatically places and bonds semiconductor flip-chip elements to substrate IC's. Elements include a numerically controlled table, control logic electronics, a bonding transducer, and an automatic vacuum pencil transfer mechanism that is fed from one of three magazines. It handles 1,000 flip-chips per hour. Bulova Watch Co., Valley Stream, N.Y. [424]



A production-research oven has an operating range to 650°F and solid state controls with $\pm 1/2^\circ\text{F}$ sensitivity. The horizontal-air-flow, forced convection unit was originally designed for the use of IC manufacturers. Front-mounted controls allow independent adjustment for both fresh air intake and exhaust to 30 cfm. Despatch Oven Co., 619 S.E. Eighth St., Minneapolis 55414. [425]

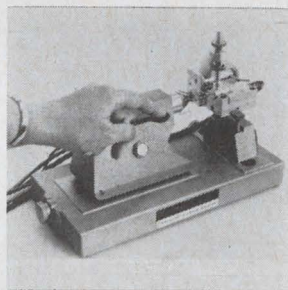

Bench fixture model 720, for use with the company's arc percussion welding system, has an automatic gap setting mechanism that allows up to 6 times as many welds per minute as previously possible. With a weld schedule established, materials to be joined need only to be placed in the fixture and the switch activated. Butt and other welds can be made. Sippican Corp., Mattapoisett, Mass. [426]



Resistance trimmer RU-1, for thick- and thin-film units, avoids the hazardous and cumbersome exhaust system of the abrasive dust method. It removes material by ultrasonically vibrating a diamond tip. The substrate is moved in the x or y direction automatically. Probes connect the resistor to a bridge circuit. Desired resistance is preset. Axion Corp., 6 Commerce Park, Danbury, Conn. [427]

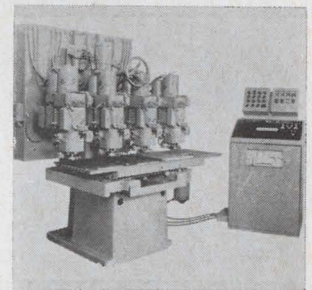

Drilling machine PCB has 4 spindles that simultaneously produce stacks of identical p-c boards. Infinitely adjustable hydraulic feed is pressure balanced to eliminate burrs and assure true holes. Positioning and drilling are tape controlled. Model 20 is for holes up to 16 x 20 in.; model 12, for 16 x 12 in. Leland-Gifford Co., 1001 Southbridge St., Worcester, Mass. [428]

New production equipment

Tailor-made windings for precision pots

Variation in resistance winding pitch can be introduced into control system by photoelectric scan of Mylar chart

Only two machines in this country can automatically wind potentiometers whose pitch—and therefore function—is accurate to within 0.01%, says David Rathje, president of Solatron Enterprises.

One was designed and built at Litton Precision Products Inc.'s

Potentiometer division to make windings for precision pots used in such applications as inertial guidance systems. The other, says Rathje, was made by his company for TIC of California, a subsidiary of the Bowmar Instrument Corp.

Solatron's machine has a photo-

electric curve follower and a feedback control system that can introduce nonlinear functions during winding of custom pots. The machine has been operating successfully at TIC for six months, and Solatron is now offering comparable machines to other companies that want to wind their own precision pots. But they'll have to wait six months for delivery and pay upwards of \$22,000.

"In this business," Rathje says in explaining the long delivery time, "you have to be sure of a customer before you start making the machine."

Feedback control. The winding

Who's crazy enough to tear down and rebuild \$100,000 worth of machinery just to turn out an 18-inch spherical commutator?

Some company called Poly-Scientific.

Sometimes we get pretty strange projects in the house. But we find a way to deliver—even if it means busting up our own expensive equipment to do it. And that's just what we did for a Navy job.

An 18-inch spherical sonar device required 53 concentric circles machined on its hand polished, three-microinch finish, silver contact surface. It then had to be quartered into 212 segments. Angular tolerance of segments .00025 inches.

Tough enough order. But with one additional catch: the Navy wanted it in a rush—there wasn't time to test new materials or new processes.

This meant we had to do with what we had—knowing there'd be warping and stress problems. We solved them. But we had to tear down and rebuild three machine lathes, design and develop our own feeds, cutting heads and bonding materials to do it. What's more, delivery was made in less time than promised.

It's been seven years since the first unit was installed in one of our nuclear subs. And it's still there. How satisfied was the Navy? Well, today Poly-Sci is still making these devices—and other, more sophisticated ones.

Care to have a crazy company like this working for you?

POLY-SCIENTIFIC 
A DIVISION OF LITTON INDUSTRIES

Filled epoxy formulated to Poly-Sci specs. Hardness compatible with silver segments to equalize wear from sliding brush contacts.

Cast aluminum frame with anodized finish.

Outline of conductive segments machined to true ellipse pattern.

.068" wide insulation.

.030" wide insulation.
Rings concentric within .004" TIR. Radius of adjacent rings from center of sphere equal within .0005".
Insulation and silver surface flush within .0005".

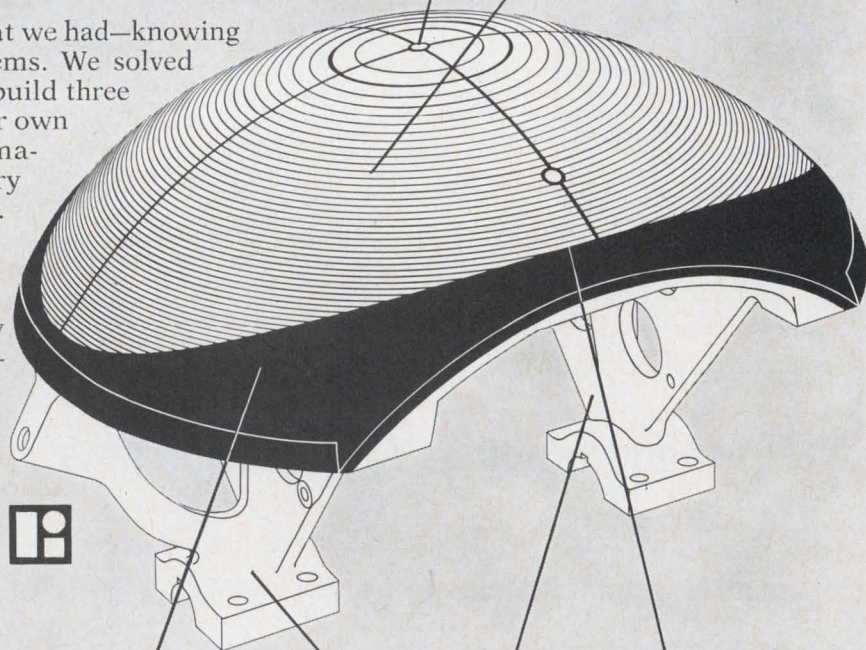

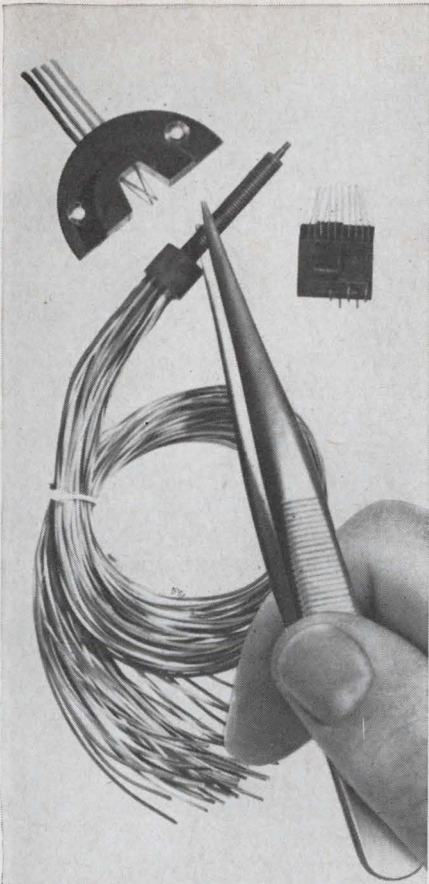

THE BIGGEST product line we offer includes slip rings, brush blocks and capsule assemblies of every size and shape—all tailored to meet your most stringent requirements. Whether it's over-all performance, long life, lot control, qualification testing, cost... or a little of all five.

We also place day-to-day emphasis on standard designs like our \$2.85 Delrin-insulated slip ring. And on developing new dielectric materials, new processes, and new products to improve circuit reliability—and to solve your slip-ring wear, contact noise, or size and weight problems.

So specify your problem to Poly-Sci. We'll specify your slip ring. Mail coupon or call Robert Gardner at 703/552-3011. Or TWX 710-875-3692. On the West Coast, call Jim Swallow, at 213/887-3361.

Poly-Scientific Division ★ ★
Litton Industries
1111 N. Main St., Blacksburg, Va.

I have a slip-ring problem. Tell me how Poly-Sci is qualified to solve it.

Name _____

Title _____

Company _____

Address _____

City _____ State _____ Zip _____

... simple chart plots custom windings ...

lathe's accuracy can be attributed to an improved control system that Solatron had devised several years ago for a \$50,000 winder [Electronics, Nov. 8, 1963, p. 80]. Besides cutting the price in half—partly by eliminating some special equipment in the old machine—the firm doubled accuracy. The older machine achieved a resolution of 0.015% to 0.02% in a 40-inch winding with a nominal pitch of 0.003 inch, compared with the new equipment's accuracy of 0.01%.

When linear windings are being made, the function generator is a slidewire potentiometer in the bed of the machine. Its linearity is better than 0.003%. A constant voltage is applied to the master potentiometer and a constant current is applied to the winding being made. The voltages generated by each are continuously compared. Any variation in the winding resistance from the desired value is immediately corrected by a servosystem that drives the lead screw of the winding lathe to vary the pitch of the winding.

Photoelectric follower. If a non-linear function is desired—that is, a variation in the winding pitch—a difference function is plotted in rectangular coordinates on a Mylar chart. A photoelectric line follower reads the chart. The motion of the follower is converted to an output that is summed with the voltage from the slidewire. Then, the feedback system controls the winding machine to reproduce the non-linearity in the winding.

Custom windings are easily prepared with this technique, Rathje says. "You just put the Mylar sheet on a drafting table and plot the difference function. It's an engineering design job instead of a time-consuming machining job, like making a special cam."

For greater flexibility in potentiometer slope ratios, the machine can be fitted with multiple de-reeling devices. Cuts can then be made in the main resistance wire and welded insert wires used to raise or lower the resistivities of selected sections of the winding.

Solatron Enterprises, 4079 Glencoe Ave., Venice, Calif. 90291 [429]

Cool Control Stabilize Calibrate More Precisely With EG&G Thermoelectric Modules

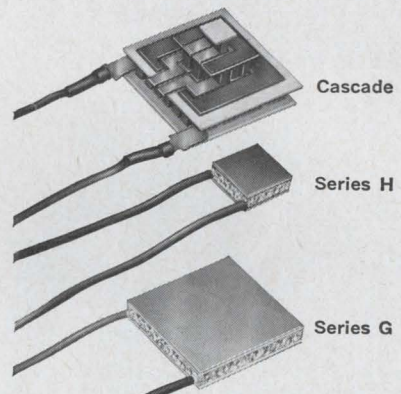

If you're involved with components such as Infra-red sensors, photomultiplier tubes, lasers, field-effect transistors, particle detectors, klystrons, dew-point indicators, the calibration of ferrite memory cores, transistors and thermistors, or the stabilization of oil baths, gyros, voltage standard cells and accelerometers, you'll be interested in EG&G's new thermoelectric modules.

These modules have a high breakdown voltage, compactness, rapid response, high cooling capabilities, and versatile physical design. Single-stage modules can achieve 65°C differentials from 27°C heat sink temperatures (85°C differentials from 100°C heat sink) and standard cascade units achieve 120°C differentials.

The Series H and Series G modules provide an unloaded temperature differential of 65°C at an electrical current of 9 amperes. Series H modules have a maximum loaded heat pump capacity of 3.9 watts, are ¼" thick and weigh 7 grams; Series G units have a heat pump capacity of 19.5 watts, are .210 ±.0005" thick and weigh 19 grams. Small single-stage modules are also available for direct attachment to a semiconductor chip inside a transistor case. For this purpose, modules with ¼" x ⅛" and ⅜" x ¼" cross-sections are available.

For more information, write EG&G, Inc., 166 Brookline Avenue, Boston, Mass. 02215. Phone: 617-267-9700. TWX: 617-262-9317.



\$1,000,000 INVENTORY OF ELECTRONIC TEST EQUIPMENT



Name brand test equipment fully calibrated with certificate of traceability if desired. Maintenance provided and all equipment is insured against fire, theft and damage in shipment. Short term rentals our specialty but yearly rental available. Fast delivery. Wide variety and depth. If you need equipment **NOW**, call Jim Powers or Frank Cassidy at (301) 424-2333. If you want a copy of our rental list or more information write:

RENTAL ELECTRONICS, INC.

16203 FREDERICK ROAD
ROCKVILLE, MARYLAND 20850

New Books

Off balance

Residue Arithmetic and Its Applications to Computer Technology
Nicholas S. Szabo and Richard I. Tanaka
McGraw-Hill Book Co., 223 pp., \$12.50

The authors have performed a valuable service with this book, the first in its field. They have surveyed magazines and journals and assembled an excellent list of references. However, in covering both residue-class arithmetic and its computer applications, they have tried to satisfy the divergent interests of two types of readers—mathematicians and engineers—and the task appears to have been too formidable.

The application of residue-class arithmetic to computer technology has been highly specialized. Operations such as general division, relative magnitude determination, and sign detection are still difficult to build into hardware that would be competitive with the equipment used for similar operations with ordered number systems, such as binary.

The book won't improve this situation, as it's strongly slanted toward theory at the expense of applications. The number theorist will undoubtedly say that the treatment of applications is fascinating, but the theoretical discussions are too elementary. The computer engineer, though, would probably find the applications oversimplified and the theory interesting, but with too few specific examples and too many formal mathematical proofs.

My personal preference would have been for shorter mathematical sections aimed at quickly giving the reader a working understanding of residue arithmetic. The major part of the book then could have been devoted to a description and evaluation of applications.

The best thing in the book is a description of the use of residue-class techniques for error checking. The most disturbing thing is the lack of good explanations of the many tables included.

H. Fleisher

International Business
Machines Corp.
Poughkeepsie, N.Y.

Basically complex

Integrated Electronics
K.J. Dean
Chapman and Hall Ltd., 132 pp., \$5.25

Too much and too little perhaps best describes K. J. Dean's "Integrated Electronics." For engineers with little knowledge of integrated circuits, the book may be too weighty. But for engineers working in this area, it may be too basic.

Although the author's knowledge of thin films, field effect transistors, digital and linear IC's is beyond question, his treatment of the material isn't. The section on linear amplifiers, for example, is too shallow to give an engineer even a start in applying such circuits. Then, too, because of its detail, the section doesn't invite casual reading.

Dean fares better in his chapter on logic circuits, which covers such schemes as diode-transistor-logic, transistor-transistor-logic, and current-mode-logic. It provides a fairly comprehensive discussion of the merits and problems of each circuit type. Although the engineer who must actually choose between these circuits will have to dig much deeper, this discussion will start him off in the right direction.

In the section on silicon diffusion, the author presents an excellent discussion of the techniques involved. Of particular interest to those working with IC's, the chapter can also benefit other engineers.

But the chapter on application of bistable elements quickly becomes so enmeshed in logic-design methods that few engineers would read it for a quick overview of the field. In fact, one wonders whether a quick overview of logic design would be of any use at all. Those working in the field need far more information than is presented, while those outside the field have little interest in it.

Recently published

Analysis and Design of Integrated Circuits,
Engineering Staff of Motorola Inc., McGraw-Hill Book Co., 539 pp., \$16.50

Intended as a companion piece to Motorola's earlier volume on IC's, this book deals with the steps involved in choosing a circuit configuration and completing the design. It also contains a comparison of the four basic

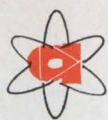

amerline corporation BOBBINS

SEND FOR OUR
**NEW CATALOG
TODAY!**



RADIO —

Moldcrafters of transformer bobbins oscillator I.F. and R.F. coil forms and stereo tape cartridges.

TELEVISION —

Producers of color yoke insulators, terminal boards, housing and convergence coil bobbins.

COMPUTER AND TELEPHONE —

Wide selection magnetic tape reels and containers, cartridges, disc packs, reed relay bobbins for computers, audio reels for tape recorders and players, bobbins for switching circuits and reed relays for telephone.

Complete line of patented Lead Slot bobbins.



AMERLINE CORPORATION
1800 FULLERTON AVENUE
CHICAGO, ILLINOIS 60614
(312) 348-4300 - TWX: 312-222-9410

Circle 251 on reader service card

9 of a series

TRANSICOIL SOLVES
SERVO PROBLEMS

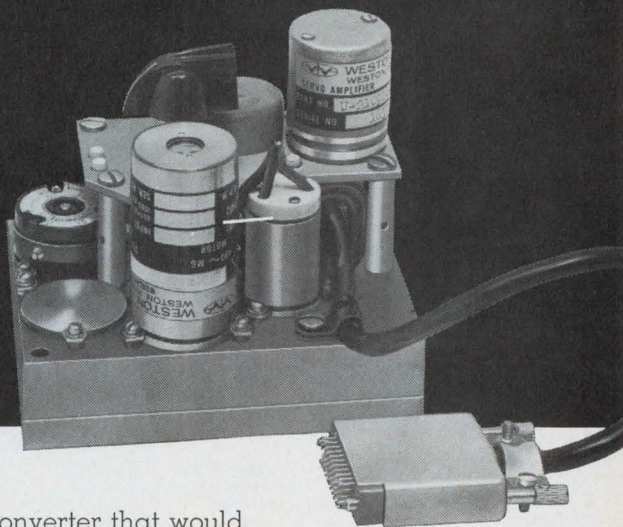
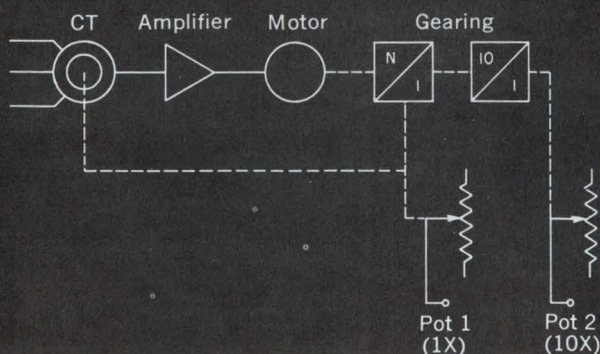

Transicoil synchro-to-DC converter

This customer's application required a 400-cycle synchro converter that would provide DC inputs to a flight test recorder. Mechanical design was critical, since the assembly had to fit an existing aircraft system, include calibration checking facilities, and provide for a digital output to be added later. □ To solve the problem Transicoil designed this unit with a switch-actuated calibration referencing circuit plus provision for later addition of a size 11 digital shaft encoder. □ Synchro data to the CT produces an error signal which is amplified and applied to the servomotor. This signal drives the system into agreement with a remote transmitter, and positions the output potentiometers as well.

PERFORMANCE: Input: 11.8V, 400 cps, 3 wire synchro ■ Outputs: DC @ 1X and 10X ■ Static Accuracy: 6' shaft positioning ■ Slew Speed: 25°/sec. ■ Power Required: 115V, 400cps; 28V DC ■ Size 4" x 3" x 3½"

Weston Instruments, Inc., Weston-Transicoil Division, Worcester, Pa. 19490
a Schlumberger company

WESTON® prime source for precision . . . since 1888

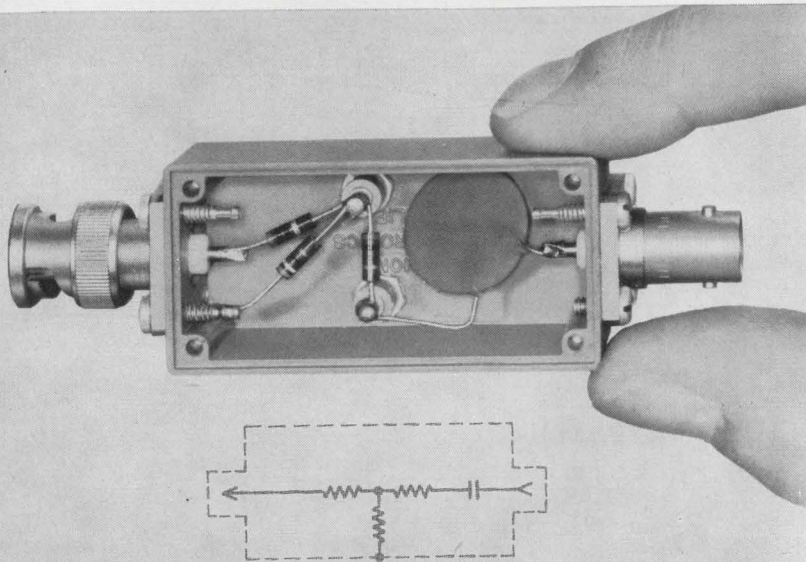

HERE'S A BETTER WAY TO PACKAGE, PROTECT, AND SHIELD CUSTOM TEST CIRCUITS

Use Shielded "Black Boxes," manufactured exclusively by Pomona Electronics, to package voltage dividers, attenuators, active, passive, isolation, impedance, and matching networks, or other specific test circuits. They're compact, rugged die-cast aluminum containers, supplied with aluminum covers secured by self-tapping screws for effective RF shielding. Available in 16 different connector combinations to match existing test equipment. Solder turret terminals provide permanent noise-free connections. Write for catalog.

POMONA ELECTRONICS CO. INC.

1500 East Ninth St. / Pomona, California 91766 / Phone: (714) 623-3463

Circle 252 on reader service card

ACTIVE FILTERS

TUBE: Plug-in feedback amplifier-network combinations for single-tuned or higher order band pass responses as illustrated. Center frequencies down to 0.005 cycle. Q's to 75. Widely used where LC filter sections are impractical. High pass, low pass and narrow notch response characteristics available.

TRANSISTOR: Integral transistorized amplifier-network units for single-tuned band pass responses. No external components required. Units will cascade for higher order responses. Center frequencies down to 0.01 cycle. Q's to 40. High pass, low pass and narrow notch response characteristics available.

PASSIVE FILTERS

LC FILTERS: Stable toroidal LC's—low, high, band pass and reject over wide impedance ranges in the audio frequency spectrum.

RC TWIN-T NETWORKS: Null frequencies 0.005 cycle to 50 kc in wide range of impedance levels. Useful for low pass filtering, harmonic rejection, feedback circuit.

- STANDARD FILTERS AND NETWORKS HERMETICALLY SEALED
- SPECIAL ENCAPSULATIONS AVAILABLE
- PLUG-IN OR STUDS FOR MOUNTING (OR BOTH)
- EARLY DELIVERIES—MODERATE PRICES
- PROMPT ENGINEERING ON INDIVIDUAL PROBLEMS

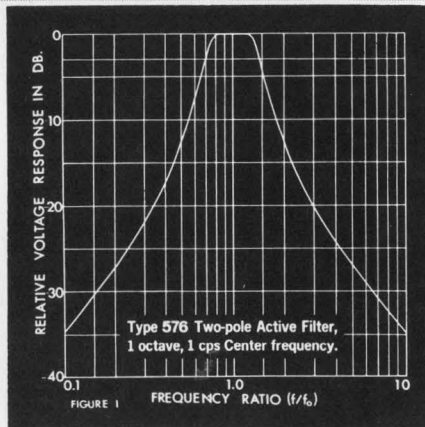

Write for technical bulletins describing filters in the audio spectrum and below, active and passive; Network Notes containing filter selection and application suggestions. Much performance information not yet published available on request. Ask about low-frequency spectrum analyzers.

White
instruments, incorporated

Phone Area 512 892-0752

P. O. Box 698 Austin, Texas 78767

New Books

types of logic circuits as well as design techniques for linear IC's.

Electronic Circuit Analysis, Vol. 2, Phillip Cutler, McGraw-Hill Book Co., 618 pp., \$10

This volume, an undergraduate text, stresses the development and application of equivalent circuits to basic amplifiers, four-terminal networks, feedback circuits, and rectifiers. Many illustrative problems demonstrate practical applications.

VLF Radio Engineering, A.D. Watt, Pergamon Press Inc., 700 pp., \$20

Offering the practicing engineer a detailed coverage of very-low-frequency radio, the book includes a compendium of basic antenna, propagation, and system information. It also deals with practical considerations, such as atmospheric noise, selection of transmitting and receiving antennas, and economic factors.

Universal Tables for Magnetic Fields of Filamentary and Distributed Circular Currents, Philip J. Hart, Elsevier Publishing Co., 489 pp., \$19

This rather specialized work minimizes the time and effort required in making magnetic-field determinations. It presents a new method of calculation based on a simple arithmetic operation.

Prediction Analysis, John R. Wolberg, D. Van Nostrand Co., 291 pp., \$10.95

Providing a basis on which to predict the standard deviation of the results of an experiment, the book is based on the least-squares method of data analysis. It also supplies the necessary background material in mathematics and statistics.

Thermoelectric and Thermodynamic Effects and Applications, T.C. Harman and J.M. Honig, McGraw-Hill Book Co., 370 pp., \$17.50

This book is directed at the scientist and engineer involved in thermoelectric and thermomagnetic effects. It covers the theory of such effects on metals, semimetals or semiconductors subjected to electric, magnetic, and temperature fields. It also includes a detailed presentation of the energy conversion processes.

Analysis and Design of Transistor Circuits, L.G. Cowles, D. Van Nostrand Co., 309 pp., \$9.75

Primarily concerned with practical design, this book includes charts, formulas, tables, and design data for transistor circuits. Special attention is given to thermal runaway and to field effect transistors.

Handbook of Numerical Methods and Applications, Louis G. Kelly, Addison-Wesley Publishing Co., 354 pp., \$14.50

The volume is designed as a handbook and reference for engineers and scientists programming their own computer problems. A great deal of the material included on numerical methods could only be found previously in many different books.

Handbook of Tables for Mathematics, third edition, Robert C. Weast and Samuel M. Selby, Editors, Chemical Rubber Co., 1,050 pp., \$16

This edition is about 400 pages thicker than the preceding one. Material has been added on matrixes and determinants, Laplace and Fourier transforms, Gamma functions, Boolean algebra, and ordinary and partial differential equations.

NEW

Cut down magnetic shielding problems with new full line of easy-to-use Netic Co-Netic Foils

**In world-wide use for:
R&D • Prototypes • Evaluation • Production**

Valuable technical assistance to customers is a way of life with our engineers. Immediate delivery from stock in any length, in .002", .004", .006" and .010" thickness, and in any width up to 19 3/4". Standard widths are 4", 15" and 19 3/4". Full details in Catalog SG-1. Just ask for it.

MAGNETIC SHIELD DIVISION/Perfection Mica Company

1322 N. ELSTON AVENUE, CHICAGO, ILLINOIS 60622

ORIGINATORS OF PERMANENTLY EFFECTIVE NETIC CO-NETIC MAGNETIC SHIELDING



Circle 253 on reader service card

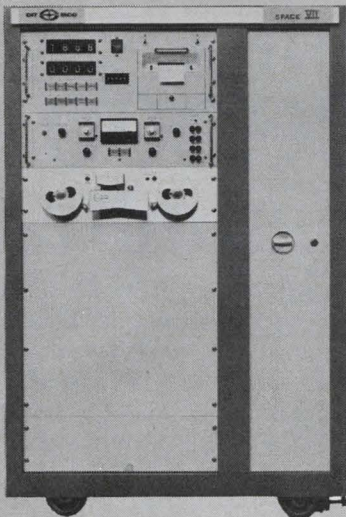

IT TAKES A LOT OF ADJECTIVES TO DESCRIBE THE SPACE VII...

Adjectives like FAST, ACCURATE, FLEXIBLE, RELIABLE, VERSATILE, ECONOMICAL and MANEUVERABLE. If you doubt for one minute that a humble wiring system analyzer from the middle west can live up to these labels, then try testing this tester for yourself. It was designed and developed (after thorough lab and field testing) especially to meet today's demand for speed, accuracy, versatility and economy. DIT-MCO's Space VII operates on the fully automatic tape input and printout concept. Design and construction are of the highest quality. The "total

speed" function of the Space VII gives you faster overall test time because of adaptation and hookup ease, rapid tape feed, speed of test plus speed of fault determination time, scan time, error recording and printout. With this advanced system you can test up to 2,000 terminations at a rate of more than 400 per minute! Electronic engineers who've tried it, call DIT-MCO's Space VII the best intermediate size testing system on the market. We won't disagree.

DIT MCO

DIT-MCO INTERNATIONAL
A DIVISION OF XEBEC CORPORATION
5612 BRIGHTON TERRACE
KANSAS CITY, MISSOURI 64130
TELEPHONE (816) 363-6288 TELEX 42-6149

IT'S NO WONDER APPROXIMATELY 90% OF ALL MAJOR MANUFACTURERS IN THE COMPUTER AND AEROSPACE INDUSTRIES ARE SATISFIED USERS OF DIT-MCO SYSTEMS.

Get Trouble-Free Fuse Protection
in Wet Locations with a

TRON

IN-THE-LINE
WATERPROOF
Fuseholder



FOR USE ON:

- Electronic Components at Missile Sites
- Marine Equipment
- Mobile Power Supply Units
- Yard Lights
- Military Field Applications
- Communications Equipment
- Any circuit operating in exposed locations.

FOR PROTECTION OF CIRCUITS
OF 600 VOLTS OR LESS

Watertight construction; resistance to damage by weather, water, salt spray or corrosive fumes permit use of TRON fuseholders in exposed locations where safety and long life are of vital importance.

TRON fuseholders are available to take two sizes of fuses, $1\frac{3}{32}$ " x $1\frac{1}{2}$ " and $1\frac{3}{32}$ " x $1\frac{3}{8}$ "; and take many sizes of solid or stranded wire.

Write for BUSS Bulletin SFH-11



BUSSMANN MFG. DIVISION, McGraw-Edison Co., ST. LOUIS, MO. 63107

Circle 209 on reader service card

BUSS



Write for BUSS
Bulletin SFB.

QUICK-ACTING FUSES

"Quick-Acting" fuses for protection of sensitive instruments or delicate apparatus;—or normal acting fuses for protection where circuit is not subject to current transients or surges.



BUSSMANN MFG. DIVISION, McGraw-Edison Co., St. Louis, Mo. 63107

Circle 209 on reader service card

BUSS: The Complete Line of Fuses and . . .



NEW from Cramer



ADJUST-A-LOK STOOLS

Adjust to every worker like fine tools!

Cramer Adjust-A-Lok is immediately adjustable to any workers height. Just release the safety stop, and lift or lower. It can be done just that quick. Since fatigue is a critical factor in efficiency of seated workers, it's just good economics to provide tools that minimize fatigue. With Adjust-A-Lok every worker can find his own most comfortable and efficient level. 6 seat styles and 5 base types provide 30 available models. For more information: write V. P. Sales, Cramer Industries, Inc., 625 Adams, Kansas City, Kansas 66105.

Industrial supplier
inquiries invited



Cramer—The leader in style and quality.

Our little black book has over 100,000 phone numbers.

You never had a black book like it. Over 1,500 pages. And those phone numbers! More than 100,000 telling you who to call/where to go, for the over 4,000 different product categories listed and advertised in the yellow pages of the Electronics Buyers' Guide. There's never been a buyer's directory like it. The new '68 edition will be coming your way in October. Look for the book in the black box. EBG for '68 . . . bigger, better and more useful than ever before.

Electronics Buyers' Guide

A McGraw-Hill Market Directed Publication,
330 West 42nd Street, New York, N.Y. 10036

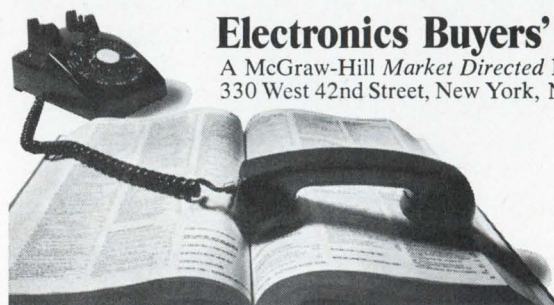

Technical Abstracts

Light conversation

A gallium-arsenide laser diode communicator
F. Terry Harris and
Donald P. Lubin, Radio Corp of
America, Burlington, Mass.
Dainis Karlsons, Radio Corp. of
America, Camden, N.J.

One deterrent to the use of the injection laser in a portable voice communication system has been power requirements. Now low-power switching circuitry appears to solve the problem. With two gallium-arsenide laser diodes producing outputs at invisible wavelengths for covert communications, the transmitter has a range up to two miles. It is adaptable to radar and ranging equipment.

The transmitter uses pulse frequency modulation by varying the drive circuit instead of relying on external optical modulation of the light beam. The laser diodes are

low-threshold types—13 to 15 amps—and their output wavelength—0.9 microns—is near the response peak of the silicon photodiode detector in the receiver.

The laser diode switching circuit uses two silicon controlled rectifiers. The scr's have different turn-on times so that the first fires about 400 nanoseconds before the second, and generates a high-current pulse by discharging a capacitor into the gate of the second scr. The second, which starts to turn on just as the current hits it, discharges a capacitor through the two laser diodes—series-connected for higher outputs. The switches thus produce the needed high-current, narrow drive pulses—30 amperes, 50 nanoseconds.

Although the prototype was designed using scr's, avalanche transistors with low series impedance would do a better job of reducing

power requirements. However, turn-on time characteristics of available avalanche transistors vary too much.

Presented at the ISA Conference, Chicago, Sept. 11-14.

Sonic boon

Strain-sensitive thin magnetic films
L.S. Onyshkevych
RCA Laboratories, Princeton, N.J.

Thin magnetic films that react to ultrasonic pulses are the basis for a new digital memory that's small and reliable, and could replace bulky tapes and discs. During readout and write-in the ultrasonic pulses momentarily strain the magnetic film and change its magnetization.

The film, a nickel-iron-cobalt alloy, is vacuum-deposited on a glass slide while a strong magnetic film is applied to initially orient the film. An ultrasonic transducer, coupled to one edge of the slide, launches a wave into the glass when it is energized. The wave travels down the slide, straining

Fuseholders of Unquestioned High Quality

BUSS SUB-MINIATURE FUSEHOLDER COMBINATION

For space-tight applications. Fuse has window for inspection of element. Fuse may be used with or without holder.

Fuse held tight in holder by beryllium copper contacts assuring low resistance.

Holder can be used with or without knob. Knob makes holder water-proof from front of panel.

Military type fuse FM01 meets all requirements of MIL-F-23419. Military type holder FHN42W meets all military requirements of MIL-F-19207B.

Write for BUSS Bulletin SFB

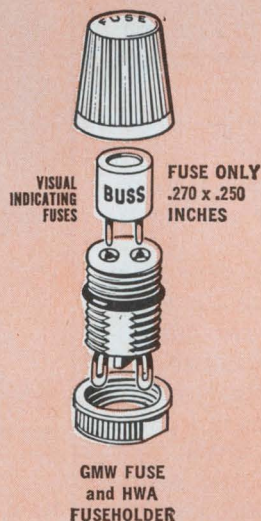

INSIST ON
BUSS QUALITY

BUSSMANN MFG. DIVISION, McGraw-Edison Co., ST. LOUIS, MO. 63107

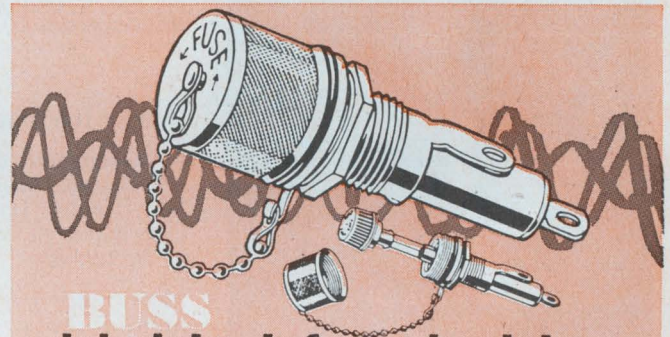

BUSS shielded fuseholders

PREVENT RADIO FREQUENCY INTERFERENCE

For use where fuse and fuseholder could pick up radio frequency radiation which interferes with circuit containing fuseholder — or other nearby circuits.

Fuseholder accomplishes both shielding and grounding.

Available to take two sizes of fuses — $\frac{1}{4}$ x $1\frac{1}{4}$ " and $\frac{1}{4}$ x 1" fuses.

Meets performance specifications of both MIL-I-6181D and MIL-F-19207B.

INSIST ON
BUSS QUALITY

BUSSMANN MFG. DIVISION, McGraw-Edison Co., ST. LOUIS, MO. 63107

The NEW CHAMP

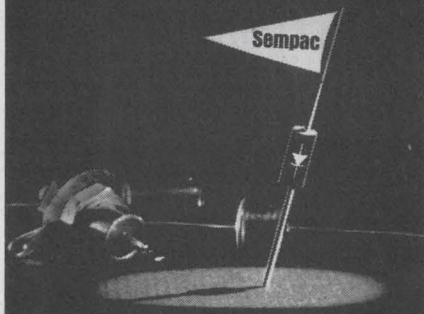

3 amp 55°C
No heat sink

6 amps if mounted
per MIL-STD-750A

Semtech's multi-purpose, high current, axial lead, silicon rectifiers are designed to eliminate packaging problems associated with lead mounted metal can and stud rectifiers.

Packaged in fully insulated "SEMPAC" cases the units are light weight, small (.375" long x .195" diameter), and easy to install.

Available in PIV ratings from 50 to 600 volts with a low reverse current of 10 μ A @ 25°C, an average rectified current of 3 amps at 55°C, NO HEAT SINKING required and a one cycle surge rating of 300 amps.

Equal area heat sinking is provided on both sides of the silicon junction with Tungstaloïd pins which match the thermal expansion characteristics of the silicon. The junction, Tungstaloïd pins, and solid silver (.04") leads are bonded



above 900°C. No solders are used in the construction of the rectifiers.

For more information contact your nearest representative and ask for Technical Bulletin No. E44. Economically priced, the units are available in large quantities.

SEMTECH CORPORATION

652 Mitchell Road, Newbury Park, California 91320
(805) 498-2111 / from L.A. (213) 628-5392 TWX: 910-336-1264

Central: 140 No. La Grange Road, La Grange, Illinois 60525
(312) 352-3227 • Eastern: 116-55 Queens Blvd., Forest Hills, N.Y., N.Y. 11375 (212) 263-3115 • European Sales: Bournes AG, Alpenstrasse 1, Zug, Switzerland (042) 4 82 72/73

Technical Abstracts

film memory elements and causing magnetization to shift. The changing flux induces a voltage in the sense lines deposited over the film and provides a serial nondestructive readout.

Output signals are about 0.5 millivolts, about the same as in electrically addressed magnetic thin-film memories.

For write-in, the ultrasonic pulse momentarily reduces the switching threshold of the film, allowing an impressed magnetic field to set it in a particular direction of magnetization.

Goals of the project are to produce 100-million-bit memories with 10 nanosecond bit rates, although present, small-capacity models are about four times slower. Speed depends primarily on the spacing of the magnetic elements, since the ultrasonic wave travels at a constant speed. Present spacing, about 5 mils from element to element, must be wide enough to avoid interaction of the strains from bit to bit.

Presented at 1967 International Congress on Magnetism, Boston, Sept. 11-15.

One for the road . . .

An investigation of highway automation R.E. Fenton, Ohio State University
R.L. Cosgriff, University of Kentucky
L.M. Blackwell, West Virginia Institute of Technology

More roads isn't the answer to the highway-safety problem. Nor is a less powerful auto engine. Perhaps the best hope lies in a completely automated vehicle.

Presently undergoing tests is a computer-guided auto that is automatically controlled in two modes: longitudinal, for acceleration and braking; and lateral, for steering. The automatic modes can be interchanged with manual control.

The longitudinal control maintains stability and proper spacing of the controlled auto with respect to the position of a vehicle ahead of it. When there are no other cars near the controlled vehicle, the vehicle moves at a speed chosen by the driver. Normal acceleration or deceleration is not allowed to exceed a gravitational force (g) of

Reed Relay Problems?

A special hi-reliability relay for the Hawk Missile.

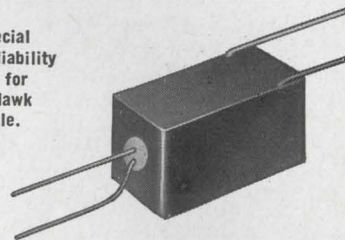

Can We Solve Your Problem?

Operating Inputs: low as 1mA. and 15mW.

Standard Coil Voltages: 6, 12, 24, 32, 48V in stock for immediate delivery.

Special Voltage or Resistance, multiple windings for flip flop, memory and crosspoint selection applications — to customer specifications.

Relay Contacts in Form A, B, C and latching. Also high vacuum type 5000V Form A.

Write for catalog and prices of our standard line of magnetic reed relays. For special requirements, give complete details for quotation.

Coto-Coil

COMPANY INC.

61 Pavilion Ave.
Providence, R. I. 02905
Phone: (401) 941-3355

Circle 254 on reader service card

LOW DENSITY

Low Dielectric Constant
RTV Silicone

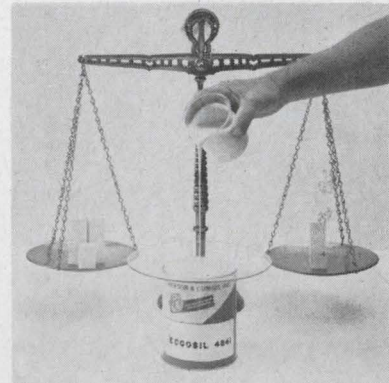

ECCOSIL 4641 is 40% of the weight of other RTV silicones—yet it pours and cures easily. Ideal for encapsulation, aerospace, hydrospace.

Send for FREE cured sample and new chart on complete Eccosil line.

Emerson & Cuming, Inc.



CANTON, MASS.
GARDENA, CALIF.
NORTHBROOK, ILL.
Sales Offices
in Principal Cities

EMERSON & CUMING EUROPE N.V., Oevel, Belgium



Get high power, low noise from 10 to 500 MHz

The Hewlett-Packard Model 230A Signal Generator Power Amplifier provides more than 4.5 watts power from 10 to 500 MHz. It is the ideal solution to high rf power requirements for applications such as receiver testing, wattmeter calibration, antenna testing, filter and component testing and attenuation measurements. The amplifier may be driven with any conventional signal source and will reproduce AM, FM and pulse modulation characteristics of the driver generator with minimum distortion. The instrument employs three tuned, cascaded stages of grounded-grid amplification fed from a regulated power supply. Price \$1350. Application Note 76 discusses high and low-level applications of the amplifier. For your copy of this application note or more information about the amplifier, contact your local Hewlett-Packard field engineer or write: Hewlett-Packard, Green Pond Rd., Rockaway, N. J. 07866.

HEWLETT **hp** PACKARD
SIGNAL SOURCES

1075

Circle 256 on reader service card



YOUR FREE DIRECTORY* OF

Japanese Electronics Manufacturers

AWAITS YOU AT BOOTH 334
International Amphitheater, Chicago
at the

NATIONAL
ELECTRONICS
CONFERENCE
October 23 to 25

*valuable source book with 100 pages listing manufacturers' names, addresses, product categories, overseas agents and representatives.

ELECTRONIC INDUSTRIES
ASSOCIATION OF JAPAN

Electronics Division
Japan Light Machinery Information Center
437 5th Ave., New York, N. Y. 10016 • (212) MU 6-0731

Circle 257 on reader service card

If You're Still Using A V.T.V.M. It's Time To Change ... Go Solid-State!

A Kit IM-16
\$44.95
Wired IMW-16
\$64.95

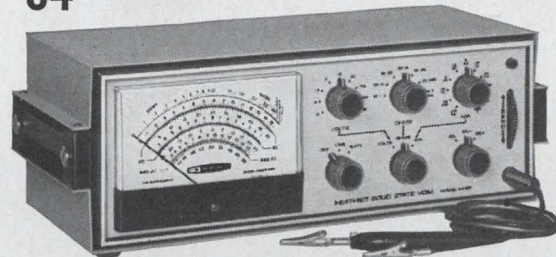
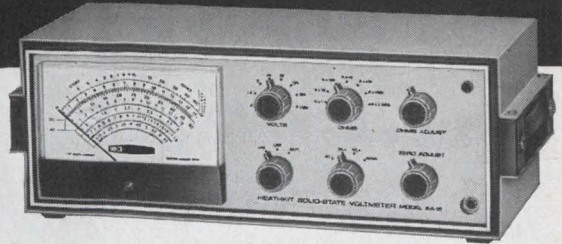

B Kit IM-25
\$80.00
Wired IMW-25
\$115.00

These New Heathkit® Solid-State Meters Feature State-Of-The-Art Performance At Prices You Can Afford

- Modern, stable, long-life solid-state circuitry
- New low-voltage ranges to accurately analyze modern transistor circuits
- Full capability to go "out on the job" . . . instant selection of internal battery power or 120/240 v. 50-60 Hz AC operation
- Exceptional accuracy . . . 3% on DC volts, plus a large, easy-to-read 6" meter face
- High impedance F.E.T. input for minimum circuit loading

A **New! Deluxe Solid-State Volt-Ohm Meter**
Features 8 DC and 8 AC voltage ranges from 0.5 v to 1500 v full scale; 7 ohmmeter ranges (10 ohms center scale) x1, x10, x100, x1k, x10k, x100k, & x1 megohm; 11 megohm input on DC ranges; 1 megohm on AC ranges; internal battery or 120/240 v 50-60 Hz AC power for portable or "in shop" use; large readable-across-the-bench 6" meter; separate switches for individual functions; single test probe for all measurements; modern, stable solid-state circuit-board construction.

Kit IM-16, 10 lbs. \$44.95; Wired IMW-16, 10 lbs. \$64.95

B **New! Deluxe Solid-State Volt-Ohm-Milliammeter**
All silicon transistors plus FET's. Features 9 AC and 9 DC voltage ranges from 150 mV to 1500 volts full scale; 7 ohmmeter ranges (10 ohms center scale) x1, x10, x100, x1k, x10k, x100k, & x1 megohm; 11 current ranges from 15 uA to 1.5 Amperes full scale; 11 megohm input on DC voltage ranges; 10 megohm input on AC voltage ranges; internal battery power or 120/240 v 50-60 Hz AC power for maximum versatility; easily readable 6" meter face; ±3% accuracy on DC volts; ±4% on DC current; ±5% accuracy on AC voltage and current; separate range switches "human engineered" for efficiency in actual use; modern circuit board construction; all solid-state components; easy to assemble.

Kit IM-25, 10 lbs. \$80.00
Wired IMW-25, 10 lbs. \$115.00

HEATH COMPANY,
Benton Harbor, Mich. 49022 Dept. 520-28
In Canada, Daystrom Ltd.

Please send my FREE 1968 Heathkit Catalog.

Enclosed is \$ _____, plus postage.

Please send model(s) _____

Name _____

Address _____

City _____ State _____ Zip _____

Prices & Specifications subject to change without notice.

TE-165

Circle 211 on reader service card

211

These two
heat-shrinkables
are hungry for
tough mil-spec
insulation problems.

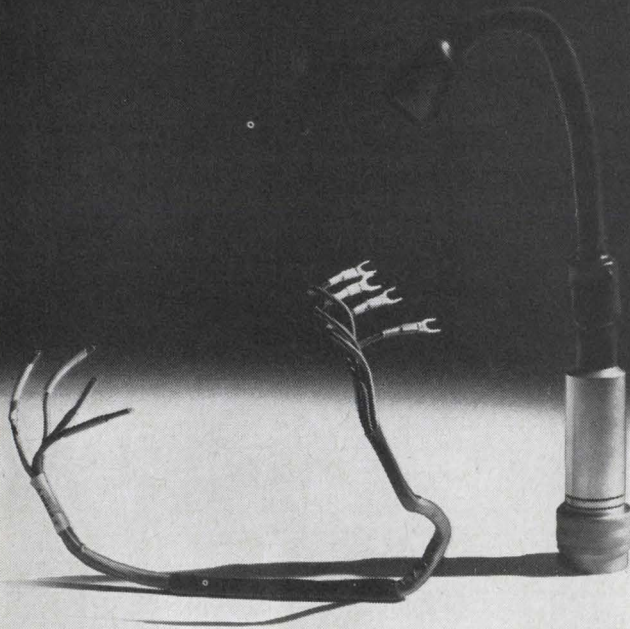

Feed them.

New Insultite® SR-350 eats up shock, strain and vibration like only a semi-rigid, irradiated polyolefin can. It combines superior dielectric characteristics with high structural strength. From 3/64" to 1" I.D.

Insultite FP-301, on the other hand, has a flexible polyolefin appetite that devours mil-spec applications. Quickly. Totally. From 3/64" to 4" I.D.

SR-350 meets classes 3 and 4 of MIL-I-23053A and NASA 276A. FP-301 meets classes 1 and 2.

Both are available in ten standard colors. Write today for free samples. (Specify diameters, please.)



**ELECTRONIZED CHEMICALS
CORPORATION**

A subsidiary of High Voltage Engineering Corporation
Burlington, Mass. 01803, Area Code 617-272-2850

E.C.C. heat shrinkables are recognized under UL component file E39100.

reduce
system size 7:1
with
MicroVersaLOGIC
IC Modules

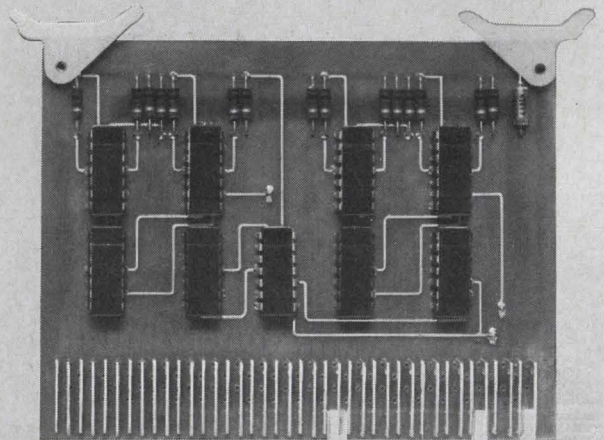

The complete MicroVersaLOGIC line gives you all the ready-made building blocks you need for anything from a register to an entire digital system—with a 7:1 size reduction because of MicroVersaLOGIC's high density IC packaging.

MicroVersaLOGIC also means increased reliability over discrete components, lower power requirements, greatly reduced costs. MicroVersaLOGIC features NAND, NOR logic with wired OR capacity at the collector, operates to 5v. logic levels, has excellent noise rejection of over 1v. There are over 20 basic module types, all meticulously designed and assembled to give you utmost reliability.

Our new MicroVersaLOGIC brochure will show you how easy and economical it is to design digital systems with MicroVersaLOGIC IC Modules. Write or call.



varian data machines

a varian subsidiary

Formerly Decision Control, Inc.

1590 Monrovia Ave., Newport Beach, Calif.
(714) 646-9371 TWX (910) 596-1358

Specifically
Engineered
for RF
Components!



A-27 Superfine
Q-max
EXTREMELY LOW-LOSS
RF LACQUER

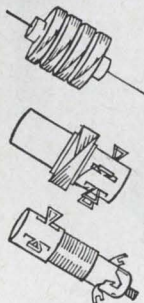

Q-MAX impregnating and coating composition penetrates deeply, seals out moisture, provides a surface finish. Q-MAX imparts rigidity and promotes stability of the electrical constants of high frequency circuits. Effect on the "Q" of RF windings is negligible.

Write for catalog today.

Q-max Corporation

MARLBORO, NEW JERSEY 07746

Telephone: (201) 462-3636

Circle 259 on reader service card

NOW!
APPLY KODAK
PHOTO RESISTS
this new **AEROSOL** way



**QUICK
CONVENIENT
ECONOMICAL**

Three types to suit all your etching needs now available at local industrial photo dealers

TYPE-P containing Kodak KPR* —for copper, copper-clad laminates, other metals. 16 oz. \$5.95

TYPE-M containing Kodak KMER* —for aluminum, stainless steel, titanium, other metals. 16 oz. \$5.95

TYPE-T containing Kodak KTRF* —for high resolution etching of thin films. 16 oz. \$6.95

*KPR, KMER, KTRF are products of Eastman Kodak Co.

**INDUSTRIAL CHEMICAL
SPECIALTIES CORPORATION**

75 Hillside Rd., Fairfield, Conn. 06430

Please rush me more information on Spray Resist products and, also, name of nearest dealer:

NAME _____

COMPANY _____

CITY _____ STATE _____

Circle 260 on reader service card

Technical Abstracts

0.1. In extreme cases, maximum is 0.8 g. In the manual mode, the auto can be operated with a single stick that provides steering, braking, and acceleration.

For lateral control, the vehicle homes in on a cable buried in the center of a controlled lane. The cable carries an alternating current that produces a magnetic field. The field induces a voltage in each of two tuned pickup coils that are mounted on the sides of the vehicle centerline. The difference between these voltages determines the location of the vehicle with respect to the centerline of the lane, and serves as an error signal to actuate the steering system.

Presented at the IEEE Automotive Conference, Detroit, Sept. 22-23.

... and one more

System for automatic vehicle control
J. Treiterer and R.M. Campbell
Ohio State University
Columbus, Ohio

Another method of automatic vehicle control that is under development uses an infrared source and a sensor to provide continuous information on the differential velocity and the distance between leading and trailing vehicles.

An infrared source, placed at the rear of a vehicle, produces a pulsed beam whose pulse frequency is a function of the vehicle speed. If the controlled vehicle is within 400 feet of the car ahead, it, by sensor, picks up the signal, locks on, and compares the leading vehicle's speed with its own. The speed difference is displayed on a meter in the controlled vehicle.

The intensity of the infrared signal from the preceding vehicle is measured to indicate the distance between the vehicles. This information also is displayed on the control panel.

No attempt was made to achieve fully automatic control of either the throttle or the brake by the infrared source-sensor system. The primary objective of the tests were to establish both the operating range and accuracy of the system.

Presented at the IEEE Automotive Conference, Detroit, Sept. 22-23.

**Why use
this much
gold**

**when
this much
will do?**

That's what we asked a customer recently. They had been using a gold-clad contact wire 66 millimeters long. We showed them how we could weld a much less expensive wire to the portion of the gold-clad wire that makes the contact. The result was a wire which contained approximately 9% of the gold the original wire contained. The savings to the customer amounted to \$75 per thousand pieces.

We're specially equipped for high speed, automatic welding of multi-piece lead wires for television and other electronic tubes, incandescent and fluorescent lamps, and soft and hard glass diode plug leads.

You never know—our capabilities and facilities may save you money.

G T I CORPORATION
Hadley Weld Plant
Saegertown Components Division
HADLEY, PENNSYLVANIA 15130

Circle 213 on reader service card

213

Isn't
this
the
darndest
cable
you
ever
saw?

It just goes to show you that Markel can make just about any cable you can dream up! We make not only a wide variety of standard constructions, including all standard RG/U coaxial cables, but also a tremendous number of special constructions to customers' specifications. These may provide single, twisted pair or multiple conductors—bare copper or with tin, silver or nickel coatings; may combine insulations of Teflon*, silicone rubber, fiberglass and nylon; braided metal shields; fillers, liners and jackets of various materials. Just give us your specs . . . we'll make your cable. For free samples, write:



L. FRANK MARKEL & SONS
Norristown Pa. 19404 • 215-272-8960
INSULATING TUBINGS AND SLEEVINGS
HIGH TEMPERATURE WIRE AND CABLE

*TM of DuPont

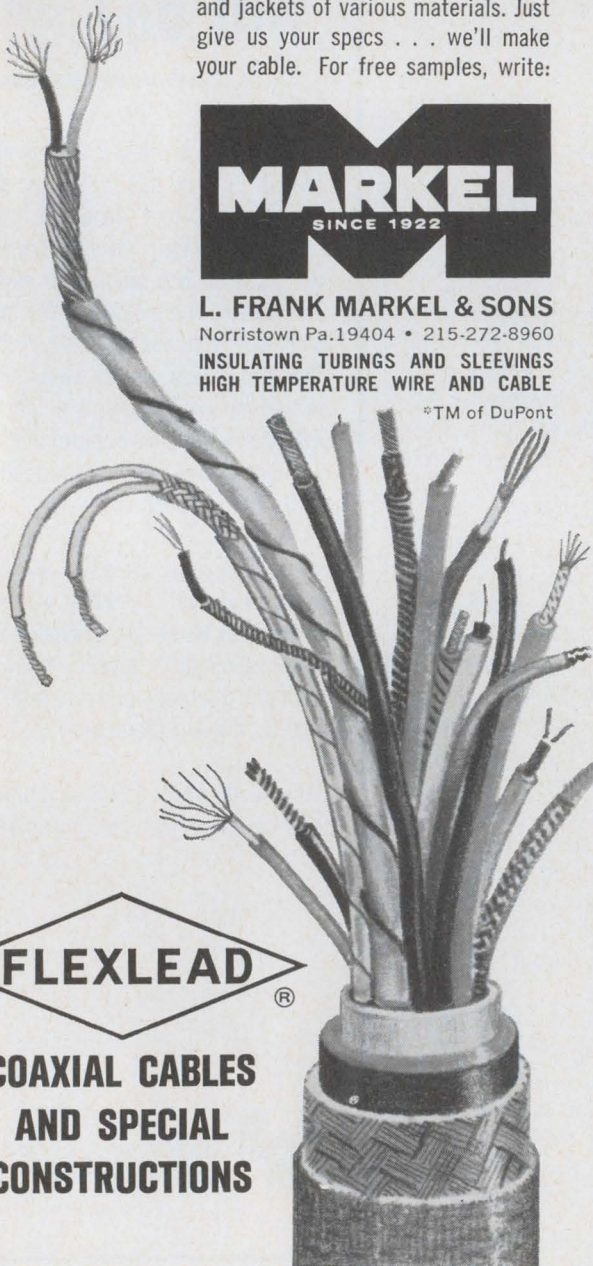

**COAXIAL CABLES
AND SPECIAL
CONSTRUCTIONS**

New... 3 instruments in 1

**DIGITAL VOLTMETER
ELECTRONIC COUNTER
ANALOG INTEGRATOR**

for \$950

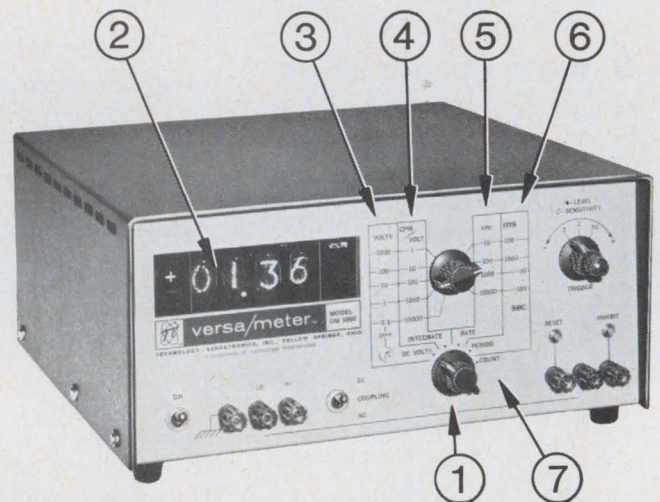

versa/meter™ Model DM 5000

- Five operating modes:** (1) 0.1% DC digital voltmeter; (2) analog integration; (3) rate and frequency measurement; (4) period and interval measurement; and (5) electronic counter.
 - Four-digit buffered display:** with automatic polarity, 100 μ V resolution, no flicker, over-range and mode indications.
 - DC voltages in five ranges:** ± 1000 V, ± 100 V, ± 10 V, ± 1 V, and ± 0.1 V; calibrated over-range to 40%.
 - Integration:** five full scale ranges—1, 10, 100, 1000, and 10,000 CPM/volt.
 - Rate and frequency:** four full scale ranges—10, 100, 1000, and 10,000 kHz.
 - Period:** four full scale ranges—99.99 ms, 999.9 ms, 9.999 sec., and 99.99 sec.
 - Counter:** from 0 to greater than 250 kHz with 1 count in 10^4 resolution.
- Other features:** no adapters or plug-ins required . . . 10 megohm floating input.

Write today for free Bulletin 701-B.



TECHNOLOGY/VERSATRONICS, INC.

A SUBSIDIARY OF TECHNOLOGY INCORPORATED
506 S. HIGH ST., YELLOW SPRINGS, OHIO 45387
TELEPHONE: 513/767-7365

New Literature

Barretter mount. Weinschel Engineering, Gaithersburg, Md., has published a data sheet on the model 926 barretter mount with built in noise suppressor. Circle 446 on reader service card.

Synchros. Clifton Division of Litton Industries, Marple at Broadway, Clifton Heights, Pa. Bulletin 200 covers the size 8, five-minute Silverline synchros. [447]

Crimping tools. Buchanan Electrical Products Corp., 1065 Floral Ave., Union, N.J. 07083. Twenty-page catalog T-102A describes and illustrates a line of cycle-controlled crimping tools. [448]

IC reliability. Texas Instruments Incorporated, 13500 N. Central Expressway, Dallas. Bulletins SC-9999 and SC-10211 deal with the reliability of integrated circuits. [449]

Operational amplifiers. GPS Instrument Co., 188 Needham St., Newton, Mass. 02164, has issued a catalog listing specifications and prices for 12 operational amplifier types. [450]

Stainless alloy wire. Fort Wayne Metals Inc., 3211 MacArthur Dr., Fort Wayne, Ind. 46809, has published monograph No. 4 dealing with scientific, aerospace, and military applications for its precision stainless alloy wire. [451]

Silicon power modules. Electronic Research Associates Inc., 67 Sand Park Rd., Cedar Grove, N.J. 07009. Catalog 145A is a four-page technical bulletin-catalog describing a line of silicon military-specification power modules. [452]

Crt catalog. Thomas Electronics Inc., 100 Riverview Dr., Wayne, N.J., announces a catalog containing specifications for a broad range of cathode-ray tubes and phosphor screens. [453]

Wirewound potentiometers. Continental-Wirt Electronics Corp., 26 W. Queen Lane, Philadelphia 19144. Bulletin 2080-67 covers a line of 3/4-in.-diameter, 3-w variable wirewound potentiometers. [454]

Shield tubing. Magnetic Metals Co., 2106 Hayes Ave., Camden, N.J., offers a technical bulletin on high permeability, seamless welded 80% nickel-iron alloy tubing for low-frequency electromagnetic shielding. [455]

Laminar flow work stations. Edcraft Industries Inc., 620 Commerce Rd., Linden, N.J. 07036, has available literature describing the CHL series console type, laminar flow work stations. [456]

Ferrite core press. Computer Test Corp.,

3 Computer Drive, Cherry Hill, N.J. 08034. The Multipak model 1104 ferrite core press is described in an illustrated 36-page instruction manual. [457]

Power supplies. Kepco Inc., 131-38 Sanford Ave., Flushing, N.Y. 11352. Catalog B-678 contains descriptive data on 22 power supply design groups. Included is a five-page glossary of terms employed in the data and applications sections. [458]

Precision potentiometers. Digilog Electronics Corp., P.O. Box 9368, Seattle, Wash. 98109, has available data sheets on single and multiturn precision pots, with illustrations, dimensions, specifications, and graphs of resolution vs total resistance and power rating vs ambient temperature. [459]

Gas lasers. Spectra-Physics Inc., 1255 Terra Bella Ave., Mountain View, Calif. 94040, offers a six-page, full-color catalog covering gas lasers and accessories. [460]

TTL IC's. Electronic Components Group, Sylvania Electric Products Inc., Seneca Falls, N.Y. 13148. A four-color mailing piece gives specifications for the entire SUHL I and II lines of TTL IC's. [461]

D-c tachometer. Helipot Division, Beckman Instruments Inc., 2500 Harbor Blvd., Fullerton, Calif. 92634. Data sheet 671129 describes the low-cost, temperature-compensated model 9011-2710-0 d-c tachometer. [462]

Modular products. Optical Electronics Inc., Box 11140, Tucson, Ariz. 85706, has released a 10-page catalog of modular products including operational amplifiers, linear amplifiers, analog function modules, and logarithmic amplifiers. [463]

Memory modules. Seaelectro Corp., 225 Hoyt St., Mamaroneck, N.Y. 10543. Bulletin DT-28 covers the RZ-90 series of six memory modules employing magnetostrictive delay lines in the RZ mode. [464]

Semiconductor test systems. Fairchild Instrumentation Division, Fairchild Camera & Instrument Corp., 475 Ellis St., Mountain View, Calif. 94040. A 12-page brochure covers a line of solid state device test systems. [465]

Computer measuring system. Potter Instrument Co., 151 Sunnyside Blvd., Plainview, N.Y. 11803. A newly-designed model Picomm computer-driven coordinate measuring system is described in a six-page brochure. [466]

High-reliability resistors. Corning Glass Works, Raleigh, N.C. 27602. An eight-page illustrated brochure details the performance characteristics of four

Seal • Solder • Braze

semiconductors and electronic devices with one machine

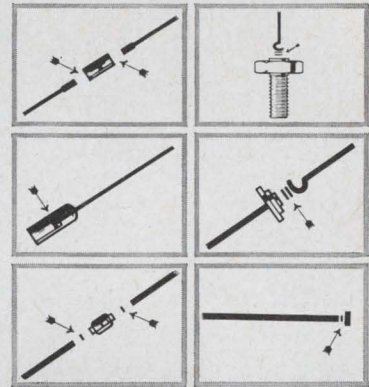

The new Dix infrared multispeed sealer does all three. It performs solder-down operations, glass-to-glass and glass-to-metal sealing, and many varied brazing operations. The DAP-500 Sealer will seal under vacuum or positive pressures in temperatures as high as 1200°C. and will handle all standard types and sizes of completed devices as well as component parts.

The DAP-500 is fast, too. It takes only ten minutes to seal as many as 675 double stud diodes at one time in an inert atmosphere.

The unit is small and compact, and takes up only 3' by 3' of floor space.

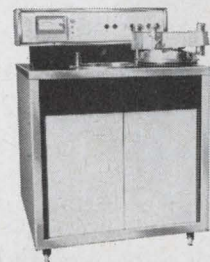

Write for additional information: GTI Corporation, Dix Engineering Division, 1399 Logan Avenue, Costa Mesa, California 92626.

GTI CORPORATION
Dix Engineering Division
1399 LOGAN AVE., COSTA MESA, CALIFORNIA 92626

NEW, high visibility alphanumeric readout

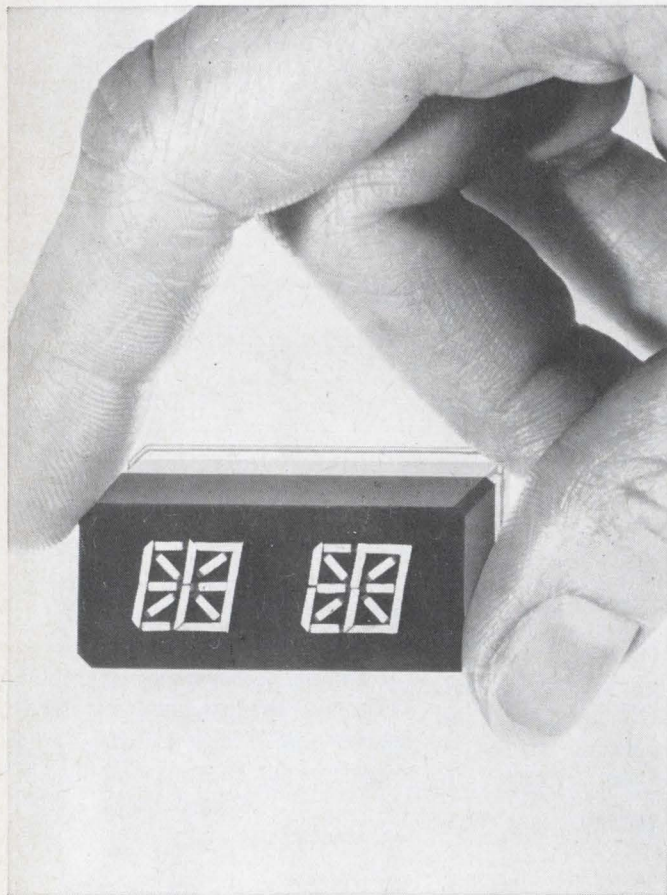

The 16-segment bar configuration of this new Tung-Sol readout, provides a potential of 65000 letter/symbol displays. This unit offers the same high visibility, clarity and sharp angle viewing that characterizes the Tung-Sol digital readout.

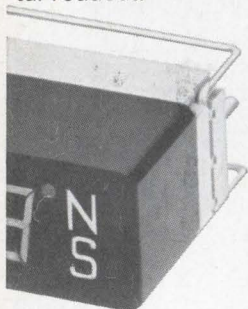

In addition to full alphanumeric display, fixed letter/symbol messages may be displayed in selected digit areas.

This new readout is compatible with the standard Tung-Sol digital unit. Use of the same lamp banks, voltages and mounting techniques, permits intermixing the readout blocks.

Write for detailed technical information. Tung-Sol Division, Wagner Electric Corporation, One Summer Ave., Newark, N.J. 07104.

TUNG-SOL®
ALPHANUMERIC READOUT

© REG. T.M., WAGNER ELECTRIC CORPORATION

Our little black book has over 100,000 phone numbers.

You never had a black book like it. Over 1,500 pages. And those phone numbers! More than 100,000 telling you who to call/ where to go, for the over 4,000 different product categories listed and advertised in the yellow pages of the Electronic Buyers' Guide. There's never been a buyer's directory like it. The new '68 edition will be coming your way in October. Look for the book in the black box. EBG for '68... bigger, better and more useful than ever before.

Electronics Buyers' Guide

A McGraw-Hill Market Directed Publication,
330 West 42nd Street, New York, N.Y. 10036



IC

INTEGRATED CIRCUIT POWER SUPPLIES

Write
today
for the
IC Brochure



Designed Specifically for
Original Equipment Applications.

THE IC PRODUCT LINE

After a careful analysis of existing power supply product lines, Wanlass Electric concluded that there was an important omission in these lines, namely, the low-cost quality supply for use by OEM's with their integrated circuits. The Wanlass IC line is aimed specifically at this market. This line features a quality series regulator but no frills... no expensive package, no unnecessary precision components, 0.25% regulation not 0.05%, 5 millivolts ripple not 1 millivolt, overvoltage protection is available as an option.

7.5 Amp Model \$105.00
15 Amp Model \$150.00

WANLASS ELECTRIC CO.

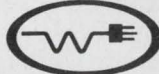

A Subsidiary of American Bosch Arma Corporation
2175 South Grand Avenue/Santa Ana, California 92705
Circle 262 on reader service card

HRS Connectors

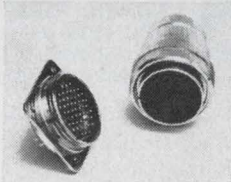
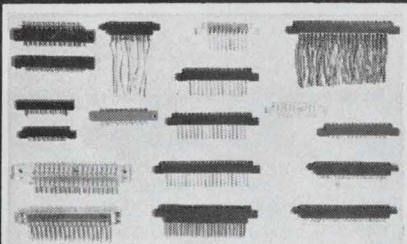

- * Cylindrical
- * Printed Circuit
- * Rectangular, Rack & Panel
- * Co-axial, Standard & Miniature

For detailed information, Please contact to,

HIROSE

ELECTRIC CO., LTD.

23, 5-5 Chome, Osaki, Shinagawa-Ku,
Tokyo, Japan Cable: BESELECONHIROSE

New Literature

styles of high reliability resistors. [467]

Bonding wire. Sigmund Cohn Corp., 121 So. Columbus Ave., Mount Vernon, N.Y. 10553. An eight-page brochure covers aluminum alloy bonding wires for the IC and semiconductor industry. [468]

Solid state supplies. Technipower Inc., Benrus Center, Ridgefield, Conn. 06877. Catalog 671 lists 4,159 standard models of solid state power modules and power supplies. [469]

Monolithic IC's. Texas Instruments Incorporated, 13500 N. Central Expressway, Dallas. A 48-page brochure describes a line of 180 TTL monolithic IC types, with 39 distinct circuit functions. [470]

Schottky-barrier diodes. Microwave Associates Inc., Burlington, Mass., has issued bulletin 4048 describing a series of X-band, Schottky-barrier junction diodes for use in broadband mixers. [471]

Commercial lasers. Scientific and Electro-Optical Equipment Dept., Westinghouse Electric Corp. P.O. Box 8606, Pittsburgh. 15221. Bulletin AD96-180 on commercial laser applications discusses welding of IC's, waveguides, and aerospace materials, as well as laser drilling of aluminum, titanium, and steel alloys. [472]

Magnet wire. Hudson Wire Co., Ossining, N.Y. Bulletin MW-1012 is a 16-page, illustrated engineering reference that describes and compares film-insulated copper magnet wire in sizes 20 through 44AWG. [473]

Log ratemeter. Hamner Electronics Co., Box 531, Princeton, N.J. 08540. Technical bulletin NR-15 describes a log ratemeter that measures integrated count rate. [474]

Modular instrumentation. McKee-Pedersen Instruments, P.O. Box 322, Danville, Calif. 94526. An eight-page brochure-catalog covers the series 1000 modular instrumentation system. [475]

Resistance welding control. General Electric Co., Schenectady, N.Y. 12305. Six-page bulletin GEA-8263 covers the CR175S solid state resistance welding control. [476]

Industrial thermal relays. G-V Controls Inc., Okner Parkway, Livingston, N.J. 07039, has issued a file folder on its line of industrial thermal relays. [477]

Hybrid IC's. WEMS Inc., 4650 W. Rosecrans Ave., Hawthorne, Calif. A 12-page brochure tells the story of a hybrid IC from the engineer's schematic to the final package. Copies may be obtained by request on company letterhead.

If you don't see the one you want, we'll make it for you.

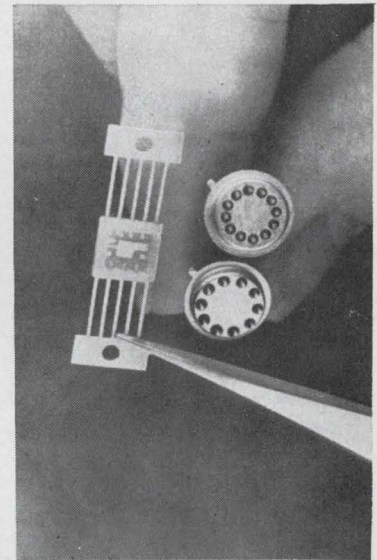

Multi-lead headers, "flat-paks," you name it—if it's not on our shelves, we'll make it for you. We produce a complete range of glass-to-metal, ceramic headers and packages for the semiconductor and associated industries. Our capability in glass-to-metal and ceramic technology is available to serve all your needs.

We've got the capabilities. Ask about them and our packages.

G T I CORPORATION
Providence Division
100 NIANTIC AVE., PROVIDENCE, RHODE ISLAND 02907

**RF CIRCUIT ENGINEERS
SYSTEMS ANALYSIS ENGINEERS
SYSTEMS INTEGRATION ENGINEERS
INDUSTRIAL ENGINEERS
DIGITAL ENGINEERS**

SEARCHING FOR

OPPORTUNITY instead of promises?

We can't promise you'll realize all your career objectives at ECI, but we will give you every opportunity. And we'll help you every way we can. The rest is up to you.

CHALLENGE instead of a chance?

Challenges lead to accomplishments. Chances don't necessarily lead to anything. If you like the satisfaction of accomplishing things, you'll like working at ECI. We're objective oriented.

GROWTH instead of a groove?

In our business you can't afford to stop learning ... to stop growing. At ECI you'll be pushing the state-of-the-art. There are few confining grooves when you explore the unknown.

And LOCATION too?

If you're going to like your job, you might as well like where you're living. We'll pit the St. Petersburg area against anyplace in the U.S. for stimulating, comfortable living.

INVESTIGATE ECI!

We have immediate openings in design and supervision. You'll work on systems and equipment in satellite communications, multiplexing, electronic switchboards, and advanced VHF/UHF communications using microcircuitry and state-of-the-art techniques.

Send your resume, in confidence, to K. S. Nipper, Supervisor of Professional Placement, Electronic Communications, Inc. Box 12248E, St. Petersburg, Florida 33733. (An equal opportunity employer.)



St. Petersburg Division
Electronic Communications, Inc.

LEGAL NOTICE

STATEMENT OF OWNERSHIP, MANAGEMENT AND CIRCULATION

(Act of October 23, 1962, Section 4369, Title 39, United States Code)

1. Date of filing: October 2, 1967.
2. Title of publication: **ELECTRONICS**.
3. Frequency of issue: Biweekly.
4. Location of known office of publication: 330 West 42nd St., City, County and State of New York—10036.
5. Location of the headquarters or general business offices of the publishers: 330 West 42nd St., City, County and State of New York—10036.
6. Names and addresses of publisher, editor, and managing editor: Publisher: Gordon Jones—330 West 42nd St., New York, N. Y.—10036; Editor: Lewis H. Young—330 West 42nd St., New York, N. Y.—10036; Managing Editor: None.
7. The owner is McGraw-Hill, Inc., 330 West 42nd St., New York, N. Y. 10036. Stockholders holding 1% or more of stock are: Paul T. Babson, 330 Beacon St., Boston, Mass. 02116; College Retirement Equities Fund, 730 Third Ave., New York, N. Y. 10017; Maxwell M. Geffen, 777 Third Ave., New York, N. Y. 10017; Donald C. McGraw, Elizabeth McGraw Webster, Donald C. McGraw, Jr. and Harold W. McGraw, Jr., Trustees under Indenture of Trust m/b James H. McGraw, dated 1/14/21 as modified; Donald C. McGraw and Harold W. McGraw, Trustees under an Indenture of Trust m/b James H. McGraw, dated 7/1/37 as amended; Donald C. McGraw, individually; Donald C. McGraw and Catharine McGraw Rock, as Trustees of the Estate of Mildred W. McGraw, all of 330 West 42nd St., New York, N. Y. 10036; Stanford E. Taylor, Hawk Dr., Lloyd Harbor, Huntington, N. Y. 11743.
8. Known bondholders, mortgagees, and other security holders owning or holding 1 percent or more of total amount of bonds, mortgages or other securities: None.
9. Paragraphs 7 and 8 include, in cases where the stockholder or security holder appears upon the books of the company as trustee or in any other fiduciary relation, the name of the person or corporation for whom such trustee is acting, also the statements in the two paragraphs show the affiant's full knowledge and belief as to the circumstances and conditions under which stockholders and security holders who do not appear upon the books of the company as trustees, hold stock and securities in a capacity other than that of a bona fide owner. Names and addresses of individuals who are stockholders of a corporation which itself is a stockholder or holder of bonds, mortgages or other securities of the publishing corporation have been included in paragraphs 7 and 8 when the interests of such individuals are equivalent to 1 percent or more of the total amount of the stock or securities of the publishing corporation.
10. Extent and nature of circulation:

| | Average No. Copies Each Issue During Preceding 12 Months | Single Issue Nearest to Filing Date |
|---|--|-------------------------------------|
| A. Total No. Copies printed.... | 77,481 | 78,982 |
| B. Paid Circulation | | |
| 1. Sales through dealers and carriers, street vendors and counter sales | | |
| 2. Mail subscriptions | 72,015 | 73,717 |
| C. Total Paid Circulation..... | 72,015 | 73,717 |
| D. Free distribution by mail, carrier or other means.... | 4,239 | 4,883 |
| E. Total Distribution | 76,254 | 78,600 |
| F. Office use, left-over, unaccounted, spoiled after printing | 1,227 | 382 |
| G. Total | 77,481 | 78,982 |

I certify that the statements made by me above are correct and complete.

McGRAW-HILL, INC.

By JOHN J. COOKE,
Vice President & Secretary

E.E.'s
For **FEE PAID** positions
throughout U.S.
SEND RESUME TODAY
(if none, send coupon for
confidential application.)

ATOMIC PERSONNEL, INC.
Suite L, 1518 Walnut St., Phila., Pa.
Experienced Engineers
Working Full Time for You!

Name _____
Address _____
City _____ State _____

AN EMPLOYMENT AGENCY FOR ALL TECHNICAL FIELDS

PROFESSIONAL SERVICES

Donald C. Harder., Inc.
Magnetic Component Engineers
Reactors—Transformers—Filters
Serving the Research Laboratory
2580 K Street, San Diego, Calif. 92102
Phone (714) 239-8021

DOWN THE INFORMATION

The Engineers and Scientists who help decision makers solve information problems.

The business of HRB-SINGER, INC. is information. We produce information systems which collect, process and analyze data. We develop electromagnetic and imaging systems and conduct studies in operations research, systems analysis and the decision sciences.

Business has been great, thank you...that's why we need capable engineers and scientists.

The key word is capable. You will participate in the many phases of system development...from feasibility study through system operation...and perform the various functions which transform raw data into productive information.

What do we offer?

Competitive salary. Exceptional fringe benefits including two (2) advanced degree plans. Rare opportunity for diversity of assignments. And a refreshing professional environment. Our main facility is adjacent to the Pennsylvania State University in State College, Penna. Our other facilities are located in Moorestown, New Jersey, Reston, Virginia and Rome, New York.

Interested? Send your resume in confidence to Oliver C. Goodman, Manager Professional Placement Dept., E-1, HRB-SINGER, INC., Science Park, P.O. Box 60, State College, Pennsylvania 16801.

Immediate openings exist in the following areas:
SOFTWARE DESIGN AND COMPUTER USAGE—involves analysis and operations research on electronic reconnaissance systems. EE or physics, preferably with advanced degree. 2 years industrial experience or military experience in communications and intelligence.

FIELD SERVICE—set up and technical coordination for electronic intelligence equipment. B.S.EE or physics degree with project direction experience essential on electronic reconnaissance equipment.

SOLID STATE CIRCUIT DESIGN—for infrared scanning systems, associated displays, and support equipment. EE or physics. 6 years experience including some responsibility for technical performance of the product.

ELECTRONIC SYSTEMS STUDY AND DESIGN—of radar feasibility, tracking systems, logic circuits and multiplexers. EE with advanced degree preferred. 5 or more years related experience.

MICRO-ELECTRONIC CIRCUITS—responsible for the design and fabrication of micro-circuits. EE or physics. 3 to 5 years experience with at least one year in integrated circuits.

an equal opportunity employer

HRB-SINGER, INC.

A SUBSIDIARY OF THE SINGER COMPANY

SINGER
INFORMATION SCIENCES

young

engineers —

*with or without specific
experience, you can be part
of the exciting nuclear power
program at the world's
largest shipbuilding complex*

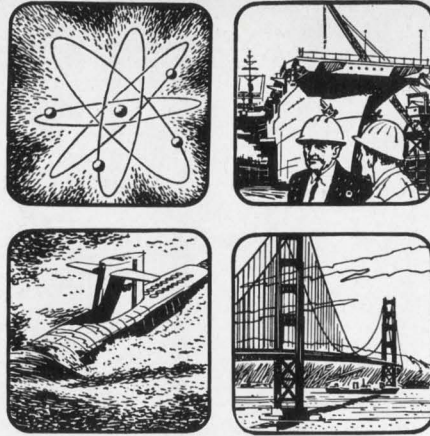

**YOU'RE
H!RED**

Do you need electronics engineers or technical management men? Electronics magazine is the way to recruit them. Electronics is designed specifically for the working engineer. 68,000 subscribers and an additional 133,000 pass-along readers turn to it to keep up with their industry. You can find the man that meets your qualifications with an advertisement in the Employment Opportunities Section.

For rates & information write: Electronics, a McGraw-Hill Publication. Classified Advertising Division, Post Office Box 12, New York 10036.

If you are a nuclear power engineer, or an electrical, chemical, general, marine, or mechanical engineer with or without experience in nuclear power engineering, the San Francisco Bay Naval Shipyard offers you the opportunity to work in these aspects of nuclear propulsion:

**FLUID SYSTEMS AND MECHANICAL ENGINEERING
CONTROL AND INSTRUMENTATION ENGINEERING
REACTOR ENGINEERING • TEST ENGINEERING
NUCLEAR QUALITY ENGINEERING
RADIOLOGICAL CONTROL • NUCLEAR REFUELLING**

Positions are located at Vallejo, California. This location has ready access to the full cultural advantages of San Francisco and the mild year-round climate of the Bay Area. All types of recreation from ocean surfing to skiing on the slopes of the Sierras are within easy driving distance.

Openings exist at Grades GS-5, GS-7, GS-9, GS-11 and GS-12. Salaries range from \$6,400 to \$12,000. These are career Civil Service positions with regular salary increases, generous benefits. Financial support for continued education available.

Send resume or Standard Form 57, Application for Federal Employment, to:

**Coordinator, Professional and Technical Recruitment
(Code 174-5-0)
Employment Division
San Francisco Bay Naval Shipyard
Vallejo, California 94592**

An Equal Opportunity Employer

U. S. Citizenship Required

MICROWAVE ANTENNA SPECIALISTS

Are you on Conductron's wavelength?

As Conductron expands its commercial and military activities such as the design and development of the EROS aircraft Collision Avoidance System—operational now in the military version, but also being adapted to commercial use; antennas for air navigation; and numerous classified communications, navigational and electronic warfare programs, our need for qualified microwave antenna specialists has become critical. Beginning with the Gemini and Mercury space programs, we have become a top name in flight simulation, and today are producing simulators for the Boeing 727, 737 and 747 aircraft as well as the Douglas DC8 and DC9, and the Lockheed Air Force C5A.

The S-Band Antenna at the NASA Manned Spacecraft Center in Houston, Texas was designed and developed by us. Employing a Cassegrain monopulse feed system, with a capability for tracking, the immediate purpose of the antenna was for use in the Apollo program. We thrive on this type of challenge, and are constantly looking for growth minded communications specialists who will help us make new inroads into existing technology.

If you want to learn more about Conductron-Missouri's outstanding growth opportunities and our excellent benefit programs including full tuition refund plan, send your résumé and salary requirements in confidence to Mr. Tom Walenga, Professional Employment, Dept. EM3.



CONDUCTRON - MISSOURI

Division of Conductron Corporation
2600 N. Third Street • Box 426 • St. Charles, Missouri 63301

We are and always have been an equal opportunity employer

BURROUGHS CORPORATION

The Burroughs Plymouth Plant is located in a delightful suburban community near Detroit and Ann Arbor. Because of the continued growth of our Commercial Products Program, there are several outstanding opportunities available on varied and interesting assignments.

ELECTRONIC ENGINEERS These positions involve the creating and investigating of new techniques and applying these concepts to the development of new business machines and future computer systems. Assignments include: Logic, with some circuit; Input/Output (particularly magnetic tape); Analog Circuits; Disk Memory.

LOGIC DESIGNERS Requires a background in the analysis of sequential systems with experience in the synthesis of input/output systems, particularly tape and disk, as well as a BSEE.

SYSTEMS DESIGNERS Requires experience in systems design of data communication and/or tape/disk systems, as well as a BS in EE or physical science.

For prompt and confidential consideration, please submit resume to:

Manager, Professional Personnel

41100 Plymouth Road

Plymouth, Michigan 48170



Wherever There's
Business There's



Burroughs

An equal opportunity employer

ELECTRONICS and COMMUNICATIONS ENGINEER

POSITION WITH leading investor-owned utility in Canton, Ohio, requires B. S. Degree in Electrical Engineering with a minimum of two years' experience in system communication engineering.

DUTIES will encompass the entire field of engineering problems concerning design, construction, maintenance and operation of system communication facilities including microwave, VHF radio, wire-line, telemetry, and digital data transmission.

If interested, please send resume and salary history in confidence to:

AMERICAN ELECTRIC POWER SERVICE CORPORATION

P. O. Box 487

Canton, Ohio 44701

An Equal Opportunity Employer

EMPLOYMENT OPPORTUNITIES

The advertisements in this section include all employment opportunities—executive, management, technical, selling, office, skilled, manual, etc.

Look in the forward section of the magazine for additional Employment Opportunities advertising.

— RATES —

DISPLAYED: The advertising rate is \$71.00 per inch for all advertising appearing on other than a contract basis. Contract rates quoted on request.

An advertising inch is measured 7/8" vertically on a column—3 columns—30 inches to a page.

Subject to Agency Commission.

UNDISPLAYED: \$3.30 per line, minimum 3 lines. To figure advance payment count 5 average words as a line. Box numbers—count as 1 line.

Discount of 10% if full payment is made in advance for 4 consecutive insertions.

Not subject to Agency Commission.

ADDRESS BOX NO. REPLIES TO: Box No.

Classified Adv. Div. of this publication.

Send to office nearest you.

NEW YORK, N. Y. 10036: P. O. Box 12

CHICAGO, Ill. 60611: 645 N. Michigan Ave.

SAN FRANCISCO, Cal. 94111: 255 California St.

POSITION WANTED

Operations Manager for New Radiation processing company. Must have extensive Linear Accelerator experience, 5 to 7 Mev. New \$200,000 building. East coast. P-4107, Electronics.

WHEN

Answering Advertisements
PLEASE do not send original letters, certificates or photographs. We cannot be responsible for their return. Please send photostat or carbon copies.

FIELD ENGINEERS

FOR EXTREMELY COMPLEX
ELECTRONIC EQUIPMENTS

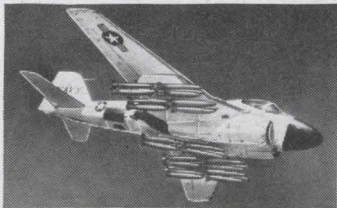

The A-6A Intruder designed by Grumman for the U.S. Navy is a unique avionic system including radars, digital computer, inertial platforms and integrated cockpit displays, which enable the aircraft to detect and destroy targets completely obscured by weather or darkness.

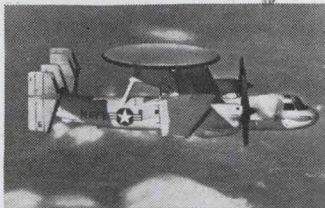

The E-2A Hawkeye designed by Grumman for the U. S. Navy is an early warning and control aircraft. Housing radar, IFF detection, tracking, height finding, radio relay, automatic surveillance and data link equipment, the E-2A can fly higher and for longer duration than any other carrier-based early warning aircraft in existence.

The two aircraft described above contain some of the most advanced electronic equipment yet devised. Comprehensive training at Grumman and subsequent field experience with the equipment will prove a "badge" of extremely high technical proficiency to the talented Electronic Field Engineers we are seeking. Possessing the mental outlook found in leaders everywhere, successful candidates will require all-around drive and a desire to understand and master "systems." He may be ready to team captain now or develop this capacity as his comprehension of the equipment is achieved.

These are challenging career positions for qualified Weapons or ECM Systems Engineers experienced in search and track radars, computers, inertial guidance systems who are familiar with digital techniques and transistor circuits. BS degree in Electronics or Physics (or equivalent), with a minimum of 6 years' experience desirable. In-plant training will be given to the applicants chosen.

To arrange an immediate interview
SEND COMPREHENSIVE RESUME TO Mr. George E. Kwak,
Manager, Engineering Employment, Dept. GR-76



GRUMMAN

AIRCRAFT ENGINEERING CORPORATION
Bethpage · Long Island · New York

An equal opportunity employer, (M/F)

"Put Yourself in the Other Fellow's Place"

TO EMPLOYERS - TO EMPLOYEES

Letters written offering Employment or applying for same are written with the hope of satisfying a current need. An answer, regardless of whether it is favorable or not, is usually expected.

MR. EMPLOYER, won't you remove the mystery about the status of an employee's application by acknowledging all applicants and not just the promising candidates.

MR. EMPLOYEE you, too, can help by acknowledging applications and job offers. This would encourage more companies to answer position wanted ads in this section.

We make this suggestion in a spirit of helpful cooperation between employers and employees. This section will be the more useful to all as a result of this consideration.

McGRAW-HILL, INC.

330 West 42nd St.,

Classified Advertising Division

New York, N. Y. 10036

SEARCHLIGHT EQUIPMENT LOCATING SERVICE

No cost or obligation

This service is designed to help you, the reader of Searchlight Section, to locate used or rebuilt equipment not currently advertised.

How to use: Check the ads in this Searchlight Section to see if what you want is advertised. If not, print clearly the specifications of the equipment and/or components wanted on the coupon below, or on your own letterhead.

This is a service to our readers. This publication does not buy, sell or stock equipment or materials of any type. Your requirements will be brought promptly to the attention of the used equipment dealers advertising in this section. You will receive replies directly from them.

Obviously, the list of such advertisers is limited by comparison with the over 68,000 subscribers to Electronics, all directly engaged in the electronics industry. A small 'Equipment Wanted' advertisement in the Searchlight Section will bring your needs to the attention of ALL who read Electronics. The cost is low . . . just \$35.50 per advertising inch — 7/8" x 2-3/16".

Electronics
Searchlight Equipment Locating Service
P.O. Box 12, New York 10036

Please help us to locate
the following used equipment:

NAME _____

TITLE _____ COMPANY _____

STREET _____

CITY _____ STATE _____ ZIP CODE _____

In electronics it's Electronics magazine to sell used equipment!

Your advertisement will produce Results in Electronics. Engineers turn to Electronics magazine for the latest technical developments — and for the latest buying information. You can reach them inexpensively in Electronics Searchlight Section.

For information:
Searchlight Section
Classified Advertising Division
Post Office Box 12
New York 10036

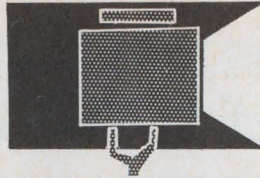

SEARCHLIGHT SECTION

- CLASSIFIED ADVERTISING • BUSINESS OPPORTUNITIES
- USED OR SURPLUS EQUIPMENT

AUTOTRACK ANTENNA MOUNT

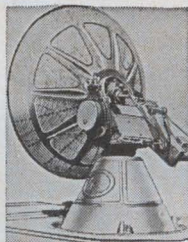

360 degree azimuth, 210 degree elevation sweep with better than 1 mil. accuracy. Missile velocity acceleration and slowing rates. Amplidyne and servo control. Will handle up to 20 ft. dish. Supplied complete with control chassis. In stock—immediate delivery. Used world over by NASA, USAF, MP-61-B, Type SCR-584, Nike Ajax mounts also in stock.

PULSE MODULATORS

MIT MODEL 9 PULSER 1 MW—HARD TUBE
Output 25kv 40 amp. Duty cycle .002. pulse lengths .25 to 2 microsec. Also .5 to 5 microsec. and .1 to .5 microsec. Uses 6C21. Input 115V 60 cycle AC. Mfg. GE. Complete with driver and high voltage power supply. Ref: MIT Rad. Lab. Series, Vol. 5, p. 152.

2 MEGAWATT PULSER
Output 30 kv at 70 amp. Duty cycle .001. Rep rates. 1 microsec 600 pps. 1 or 2 msec 300 pps. Uses 5848 hydrogen thyatron. Input 120/208 VAC 60 cycle. Mfr. GE. Complete with high voltage power supply.

250 KW HARD TUBE PULSER
Output 16 kv 18 amp. Duty cycle .002. Pulses can be coded. Uses 5D21, 715C or 4PR60A. Input 115 v 60 cy AC \$1200 ea.

18 MEGAWATT PULSER
Output 150KV at 120 amps. Rep rate: 50-500 PPS. Pulse length: 5 msec. 15KV 120 amp. into pulse transformer. Rise time 1.5 msec. Filament supply 5V 80 amp. incl. 17.5KV 1.5 amp DC power supply. Input: 220V 60 cy AC.

VARIAN KLYSTRONS
V-45: .15W output CW 9 to 10 KMC
VA-800: 10 KW output CW 1.7 to 2.4 KMC
VA-806II: 1KW output CW 7.5 to 8.5 KMC

IBM 704 IBM 650

These computers in stock for immediate delivery

SCR 584 AUTOTRACK RADARS

Our 584s in like new condition, ready to go, and in stock for immediate delivery. Ideal for telemetry research and development missile tracking, satellite tracking. Fully Desc. MIT Rad Lab. Series, Vol. 1, pps. 207 210, 228, 284-286. Comp. Inst. Bk available \$25 00 each.

MICROWAVE SYSTEMS

L BAND RF PKG.

20 KW peak 990 to 1040 MC. Pulse width .7 to 1.2 micro sec. Rep. rate 180 to 420 pps. Input 115 vac incl. Receiver \$1200

200-225 mc RADAR SYSTEM

1 Megawatt output. 200 nautical mile range for long range detection of medium and high altitude jet aircraft as well as general search. AN/TPS-28.

10 KW CW S-BAND

Complete 1700-2400 MCS RF system using VA-800 klystron. New.

SURVEILLANCE DRONE RADAR SYSTEM

X-Band tracking system with plotting boards. Type AN/MPQ-29. Drone also in stock.

5 MEGAWATT C-BAND

Klystron RF package delivering nominal 5 megawatt pulse RF. Complete with pulser and power supply.

500 KW L BAND RADAR

500 kw 1220-1359 msc. 160 nautical mile search range P.P.I. and A scopes. MTI. thyatron mod 5J26 magnetron. Complete system.

100 KW X BAND RADAR

Complete 100 kw output airborne system with AMTI. 5C22 thyr. mod. 4J52 magnetron. PPI, 360 deg as sweep, 60 deg. elev. sweep, gyro stabilizer, hi-gain revr. Complete with all plugs and cables.

AN/GPG-1 SKY-SWEEP TRACKER

3 cm. automatic tracking radar system. Complete package with indicator system. Full target acquisition and automatic tracking. Input 115 volts 60 cycle New. In stock for immediate delivery. Entire System 6' long, 3' wide, 10' high. Ideal for Infrared Tracker, Drone Tracker, Missile Tracker, R. & D.

500KW S BAND RADAR

250 miles search 115V 60 cy AC. Mfg. G.E.

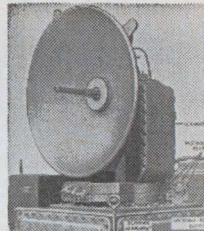

RADAR AUTO-TRACK & TELEMETRY ANTENNA PEDESTALS 3 & 10 CM. SCR 584 AUTOTRACK RADARS. M-33 RADAR TPS-1D SEARCH. APS-45 TPS-10D HT. FINDERS. WX RADARS. FPN-32GCA. APS-10 APS-15B APS-27 (AMTI) SEARCH. APN-102 DOPPLER. DOZENS MORE. CARCINOTRONS. PFM'S. .25-.5-1-2-3-6 MEGAWATT PULSE MODULATORS. CAVITIES. PULSE TRANSFORMERS. IF STRIPS. WAVEGUIDE. BENDS 200 MC. 1 KMC. 3 KMC. 6 KMC. 9 KMC. 24 KMC. RF PKGS.

RADIO RESEARCH INSTRUMENT CO.

550 5TH AVE., NEW YORK 36, N.Y. JU 6-4691

CIRCLE 966 ON READER SERVICE CARD

FOR SALE



When you have used electronics equipment to sell, advertise in Electronics Searchlight Section for fastest results.

For information:
Searchlight Section
Classified Advertising Division
Post Office Box 12
New York 10036

free catalog

POTTING APPLICATORS
MANUAL AND DISPOSABLE

6cc 12cc 30cc

FOR POTTING, ENCAPSULATING, AND SEALING OF MINIATURE COMPONENTS

PHILIP FISHMAN COMPANY
7 CAMERON ST., WELLESLEY 81, MASSACHUSETTS

CIRCLE 967 ON READER SERVICE CARD

R.U. 1

answering more than advertisement? Then please send a separate reply to each box number. It will help you get an answer sooner.

Rotron brings a new DIMENSION for LOW PROFILE cooling applications

Here's a fan that's just $3\frac{1}{8}$ " square! The only fan that fits a standard $3\frac{1}{2}$ " rack panel. Yet moves 35 CFM of air at free delivery. □ Pressure characteristics actually outperform larger conventional fan designs. □ Recommended where heat dissipation requires .05 to .075 inch of water at 25-30 CFM. □ Double flange construction for universal flush mounting. □ Operating temperature range -20°F to 140°F . □ Minimum maintenance for years of operating life. □ Costs as low as \$5.85 in quantity. Perfect for trend to compact instrumentation on standard $3\frac{1}{2}$ " rack panels.

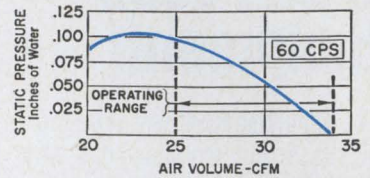
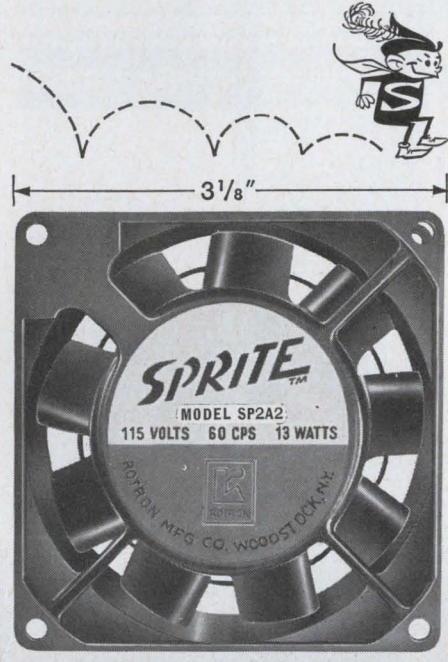

Aerodynamic design provides high pressure in range approaching free delivery.

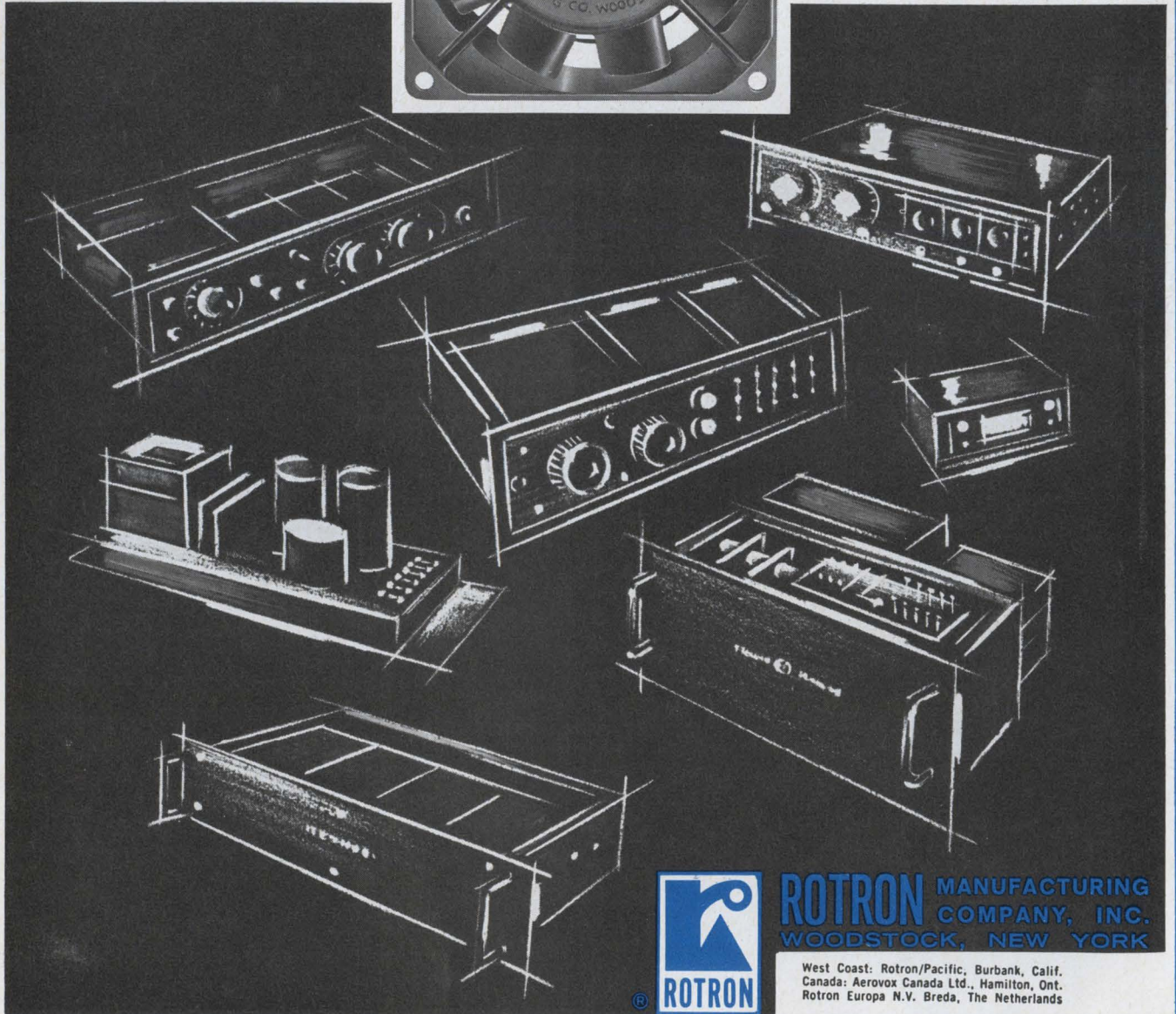

ROTRON MANUFACTURING
COMPANY, INC.
WOODSTOCK, NEW YORK

West Coast: Rotron/Pacific, Burbank, Calif.
Canada: Aerovox Canada Ltd., Hamilton, Ont.
Rotron Europa N.V. Breda, The Netherlands

Newsletter from Abroad

October 16, 1967

Merger moves sure to change scene in British industry

Britain's electronics industry figures to take on a new look no matter what the outcome of this month's bid by the General Electric Co. to take over Associated Electrical Industries.

If GEC prevails (GEC is not connected with General Electric in the U.S.), Britain will get a second billion-dollar electrical-electronics company. The first was formed this summer when English Electric took Elliott-Automation Ltd. into its fold [Electronics, July 10, 1967, p. 196]. **To stave off the merger with the smaller, more aggressive GEC, management of AEI most likely will promise stockholders a sweeping streamlining of its operations.** AEI has showed a low return on its \$530 million assets in recent years and its profits outlook is poor.

London stock-market watchers say it's too early to tell who'll win out in what presumably will turn out to be a long merger struggle. The odds seem to favor GEC slightly. **During the past six years the company has become one of the most profitable in Britain and now is returning 15.4% on its assets of \$320 million.** And the government's Industrial Reorganization Corp., set up to foster mergers, is pushing for the takeover.

However, insiders say there's about an even chance that the takeover will be blocked by an antimonopoly action. GEC and AEI both are members of Britain's "telecommunications club," which supplies most of the equipment for the country's telephone network. The two now account for 42% of the outstanding equipment contracts for the Post-Office-run system. GEC and AEI together would become the country's largest television-tube maker and threaten to dominate that segment of the electronics business. The merged pair also would hold an overwhelmingly strong position in some categories of heavy electrical equipment.

Hanoi trade team shops in France

The de Gaulle government may back its diplomatic support of North Vietnam with something more substantial. **Ten North Vietnamese technicians are now touring French electronics, automotive, and chemical plants, with an eye to possible purchases.**

The delegation's reception as official guests of the French government could signal an escalation in President de Gaulle's opposition to the U.S. role in Vietnam. He earlier had permitted Hanoi to set up a diplomatic mission in Paris, but until now had made no move to establish commercial relations with the North Vietnamese.

Most French electronics companies are silent about plans for hosting the group, although **the North Vietnamese are expected to window shop, at least, for defense electronics during their visit.** Several firms say they would rather not risk losing American business by trading with Hanoi.

U. S. gear may guide Anglo-French SST

Avionics insiders now think that production versions of the French-British Concorde supersonic transport most likely will carry American inertial guidance systems.

Originally, the plane's builders wanted to keep all the hardware on the SST either French or British. **But U.S. airlines that have ordered the planes, particularly, are pressuring for American navigation equipment.** The inertial guidance system for the first two Concorde prototypes was developed jointly by France's Sagem and Britain's Ferranti Ltd. How-

Newsletter from Abroad

ever, it turned out considerably more bulky than available U.S. equipment.

Avionics contracts for two pre-production versions of the Concorde will be awarded next month. **Litton Industries and the AC Electronics division of General Motors apparently have the inside track for the inertial guidance system.** If Litton gets the nod, Sagem and Ferranti will produce much of the hardware in collaboration with Litton. Bendix had the same sort of deal with France's Sfena and Elliott-Automation for autopilots for the first two Concorde prototypes.

Tough U.S. stand on missile deal stuns Japanese

Japan's defense agency has been taken aback by the hard line adopted by the Pentagon in negotiations for Japanese production of Nike and Hawk missiles. Some government officials in Tokyo even say that a U.S. demand for \$10 million in missile-development costs led to the suicide last week of Mikio Morita, head of the agency's procurement division.

In the past, Japan's major purchases of American arms have been subsidized under the U.S. military sales assistance program. **A Pentagon policy change was anticipated this time around, but the Japanese expected to be asked to pay only the full production cost of hardware. The additional development charge the U.S. wants came as a shock.** The Japanese defense agency's draft budget for the upcoming fiscal year takes into consideration only the cost of hardware. Morita apparently couldn't face up to trying to sell the finance ministry on an additional major expense he hadn't counted on.

Japan's present plans call for an outlay of about \$247 million to ready two Nike-Hercules battalions and two Hawk battalions by 1971. Sources close to the defense agency say it wants to arrange for complete domestic production of the Hawk. Only the airframe and engine of the Nike-Hercules would be produced in Japan.

Lufthansa and BEA cool on airbus

Avionics makers in Europe have begun to fret over the future of the European airbus, a project they'd hoped would mean considerable business for them starting in the early 1970's.

The French, British, and West German governments agreed this fall to go through with the first phase of the project. **But the 300-passenger short-haul jet may never get off the ground.** The reason: both Lufthansa and British European Airways are showing little enthusiasm for the project. Airbus project planners figured that Lufthansa, BEA and Air France would among them buy about 100 airbuses at \$10 million a copy during the 10 years starting in 1973. The export market—much less certain—was also estimated at 100 planes.

Air France is plumping strongly for the airbus, but there's little chance the plane will get into production unless Lufthansa and BEA are pressured into adopting the plane by their governments.

Bonn to banish electronic bugs

West German components makers will lose a small—but fast growing—market next year. The country's legislature has passed a law that forbids electronic eavesdropping.

The government decided to crack down on bugging after a rash of complaints, many from businessmen. It's estimated that some 10,000 eavesdropping devices, most made in two- or three-man shops, have been sold in the country.

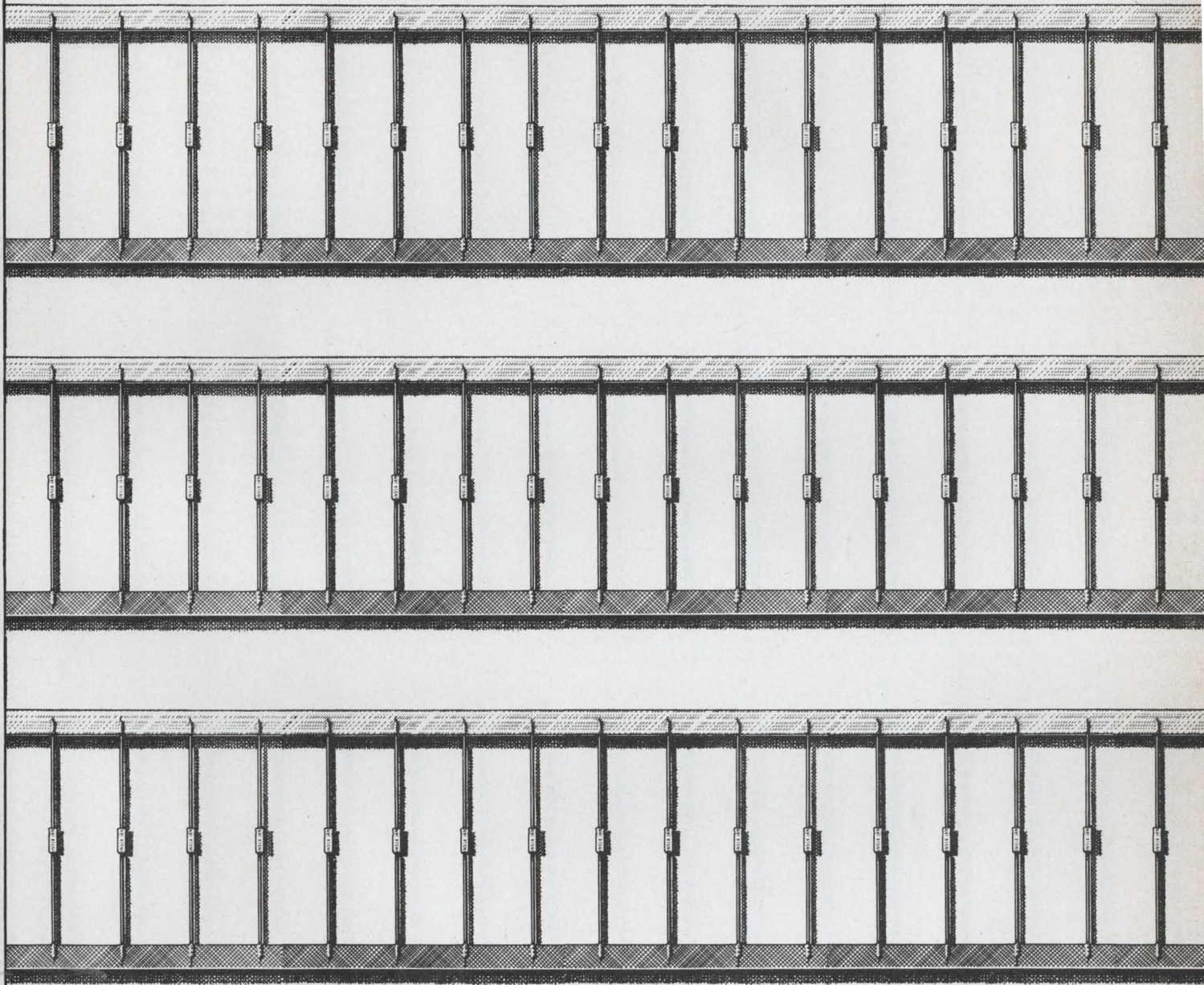

Since ITT makes 25,000,000

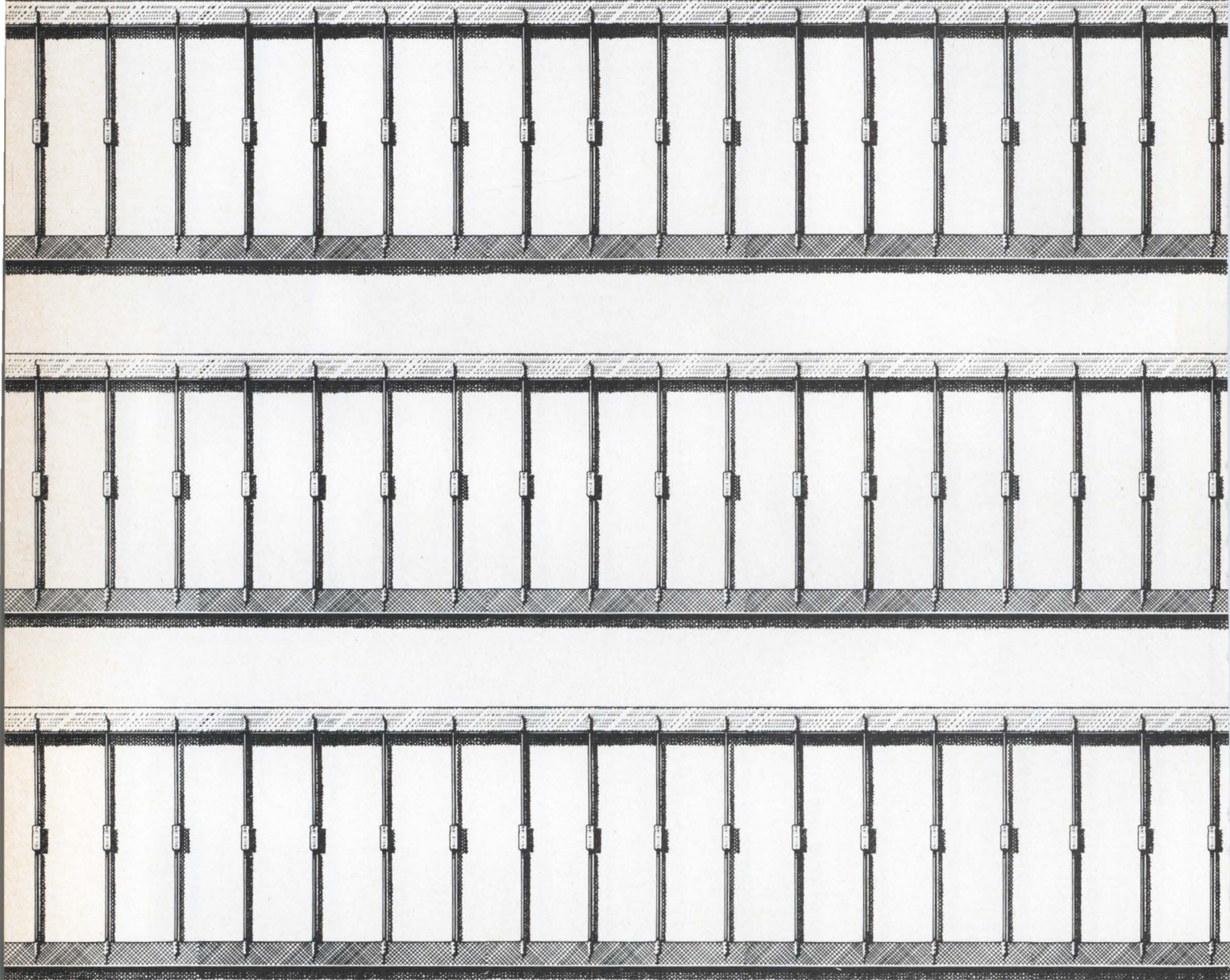

diodes monthly, they're available at

ITT SEMICONDUCTORS IS A DIVISION OF INTERNATIONAL TELEPHONE AND TELEGRAPH CORPORATION, 3301 ELECTRONICS WAY, WEST PALM BEACH, FLORIDA



ANY PART NUMBER
(silicon or germanium)

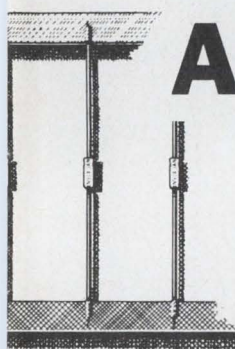

ANY SPEC IN
EITHER PACKAGE
(DO-7 or double-plug)



ANY QUANTITY

the industry's best price. Try us.

semiconductors **ITT**

FACTORIES IN WEST PALM BEACH, FLORIDA • PALO ALTO, CALIFORNIA • LAWRENCE, MASSACHUSETTS • ENGLAND • GERMANY • PORTUGAL • AUSTRALIA

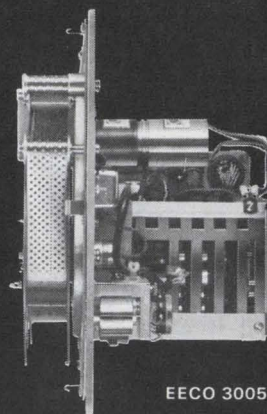
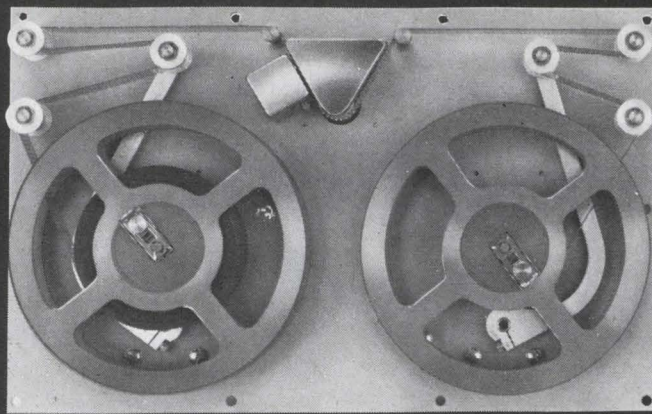

EECO 3005

No matter how you look at it...

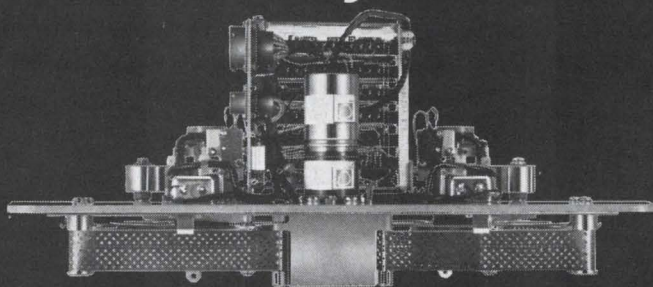

EECO series 3000 military paper tape readers give you less! Less bulk...less weight...less maintenance...all at less cost!

And there's more for you...modular design means *less* difficulty adapting the reader to your specific application...sprocket feed and photoelectric readout mean *less* tape wear... rugged MIL construction means *less* trouble in airborne, shipboard or mobile applications... solid state design—no clutches, brakes, belts or solenoids—means *less* maintenance...all this, and the broadest line of military photoelectric tape readers. Get the full story today—send for the complete EECO catalog of military tape readers.

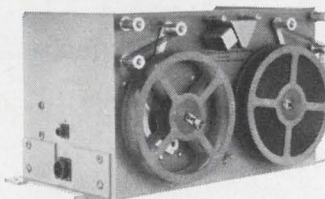

EECO 3004

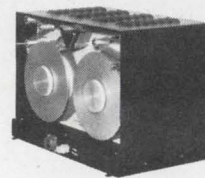

EECO 3002A



ELECTRONIC ENGINEERING CO. OF CALIFORNIA
P. O. Box 58, Santa Ana, Calif. 92702 • (714) 547-5501

Now, isn't that more for your money?

Great Britain

One for the road

As far as integrated circuits go, Joseph Lucas Ltd. is right up there with General Motors.

With its voltage regulator for the 1968 Pontiac, GM became the first U.S. automaker to put an IC under the hood [Electronics, Oct. 2, p. 137]. Lucas is now marketing a 28-amp automotive alternator with an IC voltage regulator tucked inside. Under the bonnets of British-built cars, Lucas generating equipment turns up more than half the time.

Like GM's Delco-Remy division, which developed the Pontiac unit, Lucas took a do-it-yourself tack to make sure the IC regulator would stand up to the rigors of under-hood conditions. The thick-film hybrid IC Lucas uses is produced by the company's semiconductor division.

Staying power. Lucas says the alternator-regulator package should see an automobile through at least 100,000 miles, a much longer life than can be expected for a conventional direct-current dynamo with a separate electromechanical regulator. Initial cost for an alternator, Lucas admits, is higher than for a d-c generator. Lucas won't say what price it will charge automakers for the alternator-IC regulator package; but the company hints the package will be more competitive than the alternators with separate transistor regulators it has had on the market for about a year.

Much the same. Fundamentally, the British and American IC regulators are very similar. Both, for example, use a zener diode as the voltage-sensing element that controls the rate at which the alternator charges the battery. And both use three transistors in the circuit that varies the field current supplied to the alternator.

Delco-Remy, however, put three

more diodes into its IC than Lucas did. These diodes, which provide self-excitation for the field at normal engine running speeds, are included in the rectifier pack in the Lucas alternator. Lucas kept these diodes off the IC largely because it had developed the pack for use with its transistorized regulator. And because the diodes were separate, Lucas could put the output transistor on the hybrid circuit rather than in a separate can as did Delco-Remy.

Hot and cold. Another major difference is that Lucas' circuit has no thermistor for temperature compensation. Instead of a Darlington pair for the output stage, the British regulator has two transistors. Thermal characteristics of the transistors, Lucas maintains, provide adequate compensation.

Substrate for the IC is a slab of alumina about 1-inch square and the whole regulator—potted in silicone rubber—is about $\frac{1}{16}$ -inch thick. The unit is mounted in an aluminum heat sink on one face of the alternator.

Well wired

The Plessey Co. has joined the ranks of memory makers who are convinced that plated wires will supplant the ferrite core as the workhorse element in computer stores.

Pilot production of plated-wire memory modules, already underway, is expected to step up to full production in a year or so. This would make Plessey—unless a competitor springs a surprise—the first European company to go for plated-wire memories in a big way.

In the U.S., the Univac division of Sperry Rand has opted for plated wire in its Univac 9000 series computers [Electronics, May 15, p. 101]. Honeywell Inc. also is looking into the technique and the National Cash Register Co. has something very similar in the rod memory used in its NCR 315 machine. All maintain that plated-wire memories are inherently faster and cheaper than core stores.

Forerunner. Plessey Co.'s initial plated-wire unit is a module of

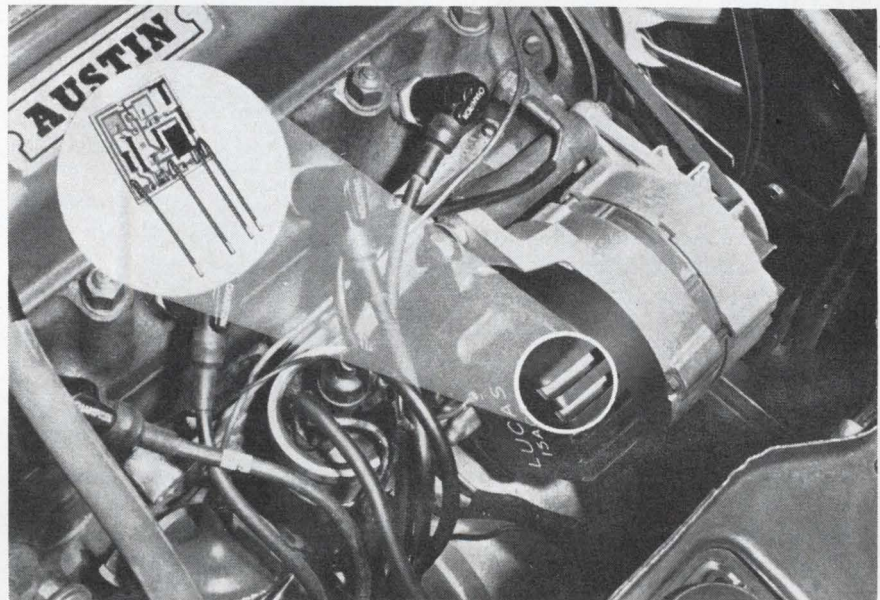

Hit the road. Integrated-circuit regulator tucks into Lucas automobile alternator. Four leads interface regulator and alternator.

102,400 bits grouped to form 1,024 words of 100 bits. The basic module will be used to build off-the-shelf stores in any size up to 16,000 words of 50 bits.

These first stores will have destructive readout with a cycle time of about 250 nanoseconds. Plessey plans to extend the line to much larger stores—up to 10 million bits—with nondestructive readout and cycle times of 1 microsecond or so. For smaller stores with nondestructive readout, the goal is a cycle time of 100 nanoseconds.

Thick and thin. A key difference between the destructive and nondestructive versions is the wall thickness of the magnetic film plated onto a substrate of 0.0065-inch diameter beryllium copper wire. For destructive readout, the wall thickness runs about 1 micron, about twice that for nondestructive operation. The thicker walls are easier to control on the plating line, hence Plessey's decision to start with destructive readout modules.

To be sure, the savings on the plating are offset by the fact that twice as many bit drive circuits are required in the memory to rewrite after destructive readout. But Plessey says the advantages outweigh this penalty with the smaller stores.

The lineup. In the destructive readout modules, two plated wires per bit are connected in a bridge circuit so that sense pulses add and cross-point noise cancels. In the normal 100-bit format, each word line makes two turns around the 100 pairs of plated wires.

To form the word lines, Plessey uses a printed-circuit technique to lay down 128 pairs of copper strips on an epoxy glass sheet. The sheet is later folded over to get the turn. Before folding, though, half the sheet is covered with epoxy resin into which 200 grooves are molded. The plated wires are slipped into the grooves. Eight of the folded sheets are mounted together to make up the 1,024-word module.

Thinning down. Plessey will use a different packaging technique for the nondestructive readout modules but still hasn't decided what it

will be. However, some of the kingpin parameters for the follow-on units are all but set. The wall thickness of the plated magnetic material will very likely be 0.39 micron and the word current about 350 milliamps (compared to 500 ma in the first modules). In tests, this combination gave steady 10-millivolt sense pulses regardless of the number of readouts. Pulse lengths ran between 60 and 80 nanoseconds, which would give a cycle time of about 100 nanoseconds.

The big picture

No matter how foul the weather, the harbormaster of the Tees estuary in northeast England has a clear picture of what's going on in the tanker-busy channel and the anchorage area offshore. To size up the situation when ordinary binoculars are no help, he simply turns to a large binocular-shaped display. It shows ships' position information from two radars projected onto a chart of the estuary.

Radar watches for harbors aren't new, but the builder of the Tees system, the Kevin Hughes division of Smith Industries Ltd., says it's the first to combine displays from overlapping radars into one big

picture. At Tees, two radar scanners about three miles apart feed position data to the control-tower display. One scanner is mounted hard by the control tower. Data from the remote scanner comes in over a microwave link.

Ship-position information from each radar is displayed initially on a separate 3-inch cathode-ray tube. Its image then is combined optically with a transparency of the chart and photographed on 16-mm film for projection onto 24-inch chart paper.

To match the two crt-chart combinations, Kevin Hughes mounted the two 16-mm projectors side by side and blanked off the overlapping portions of the beams.

France

Chamber made

Thin-film makers may be sputtering more and more now that a French engineer has found a way to lay down almost any binary compound on a substrate using a reactive technique.

Direct-current sputtering has been used for more than a decade, mainly to deposit metallic conduc-



Two for Tees. Harbormaster can check movements of all ships in Tees estuary on display that puts data from pair of overlapping radars onto a projected chart.

tors. In the past two years, the process has been extended to insulators like glass and quartz by radio-frequency techniques. Researchers have also spotted a third technique — reactive sputtering — that adds a chemical reaction to the process. But they've had trouble getting it to work.

In both d-c and r-f sputtering, the material destined to form the thin film is made the cathode in a discharge chamber. Ions in the discharging gas bombard the cathode and the dislodged molecules shower onto the anode to form a thin film. In both processes, the thin-film material is limited to compounds that can be readily put onto cathodes. In reactive sputtering, by contrast, the wanted compound is literally made in the sputtering chamber. The sputtered cathode material and a gas-carried second material combine chemically, close to the anode, and then form the film.

Inside job. Hydrides turn out to be excellent carriers for the second material. But hydrides of elements like antimony, arsenic and selenium are hard to handle because they are unstable. Jean Pompei, an engineer at La Radiotechnique-Coprim-RTS, has solved the problem by forming the hydrides inside the sputtering equipment.

Pompei's apparatus has two gas-discharge chambers. In the first one, a mixture of argon and hydrogen is discharged by an alternating current. This produces a jet of plasma over a plate coated with one of the two elements that make up the eventual thin-film compound — the antimony, say, for indium antimonide.

The hydride thus formed in the first chamber passes directly to the second. There, the hydride-argon mixture is discharged a second time and the compound's second element sputters off the cathode — indium in the case of indium antimonide. The sputtered indium atoms react with the ionized hydride to form indium antimonide.

Versatile. Chemical composition and physical structure of thin films deposited by the double-discharge technique can be closely controlled.

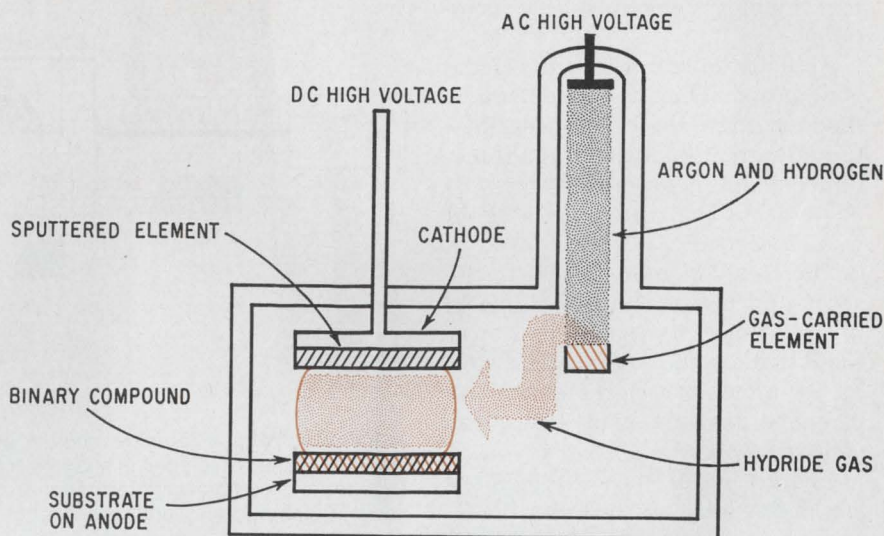

Two-step. Double discharge is key to French technique for reactive sputtering of binary compounds. Hydride forms when argon and hydrogen discharge in first chamber. Sputtered cathode material and hydride-carried element combine to form compound in second discharge chamber.

And the process has the advantage of using the same two gases — argon and hydrogen — no matter what the composition of the film. The type of compound formed can be varied with little trouble by changing the target plate in the first chamber and the cathode material in the second.

Pompei concedes that the process has its shortcomings. A major one is that film-thickness can be no more than 5,000 angstroms. And semiconductor films produced by the technique can't be doped.

Color for computers

A company set up under a scheme to give a country a strong domestic computer industry has to maintain a certain style. And Systèmes et Périphériques Associés aux Calculateurs, the peripherals producer formed for France's Plan-Calcul, came through handsomely at the International Office Equipment Show in Paris this month.

Sperac, a joint venture of Compagnie Française Thomson-Houston-Hotchkiss Brandt and the Compagnie des Compteurs, introduced at the show its first major new product — a cathode-ray-tube display that flashes letters, numbers, and symbols on the screen in as many as nine colors.

Sperac maintains that no other company in Europe offers a color crt display. In the U.S., the International Business Machines Corp. and others have color crt display units in development. American peripherals makers, though, apparently are working toward graphic displays rather than the less-complex alphanumeric unit Sperac offers. [See related story, p. 165.]

Easy to spot. Sperac can trot out a number of reasons for adding color to an alphanumeric crt readout. Used with a keyboard to query a computer, the display can put the questions in one color and the answers in another. In process control systems, the display could flash critical changes of state in color to warn the control system operator.

The company already has an order from a French steel maker for a system that will monitor the flow of orders through the plant. A network of 10 keyboard-equipped color crt units, Sperac says, costs between \$8,000 and \$9,000. For a comparable black-and-white system, the tab is \$6,000 to \$7,000.

Versatile. In large part, the relatively low extra cost for color is possible because Sperac uses for the display a standard color tube in a noncoded video receiver. A fixed-program signal generator drives the receiver on command from a

text memory linked to the computer.

Actually, Sperac offers two signal generators. One is based on a diode matrix; the other uses integrated-circuit logic and has a three-dimensional memory that stores 64 characters. The read time is about 1 microsecond.

The text memory uses ferrite cores and has a read-write time of 1.5 μ s. Since its speed is slower than that of the signal generator, the text memory stores characters in pairs as they come from the computer.

Characters in the text memory are defined by six bits for black-and-white display. Two additional bits are needed for four-color display and three additional bits for nine colors.

A variety of combinations of signal generators, text memories and display receivers is possible. A single signal generator, for example, can drive several receivers each with its own text memory. Or a series of receivers, without text memories and keyboards, can be linked to a common generator and text memory.

West Germany

PAlette

The trade-up to color won't be as costly for European users of video tape recorders as originally thought.

This month, Deutsche Philips GmbH will start selling for about \$1,750 a black box that turns its industrial black-and-white VTR into a color recorder. In the U.S., at present, the only color VTR available—high-cost studio units excepted—is the Ampex Corp.'s VR-7500C, which sells for \$4,500.

Deutsche Philips, a subsidiary of Holland's NV Philips' Gloeilamp-fabrieken, says it will cut the price of its color adapter once quantity production gets under way and will offer versions for home recorders soon. Grundig Radio-Werke GmbH and others have "low-cost" color recorders in the works. And the brass at Loewe-

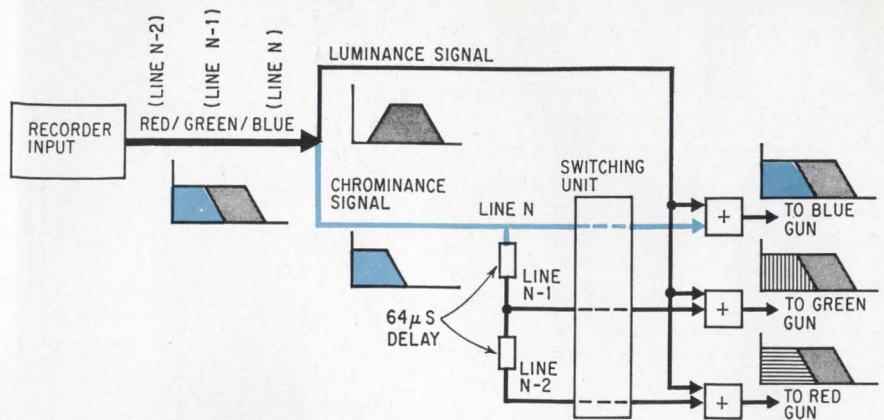

Tripal play. Tripal video tape recorder develops simultaneous signals for the three guns in a color receiver by passing line-sequential chrominance information through a pair of delay lines and a switching unit. Luminance signal is common for all three guns.

Opta GmbH is thinking about building a receiver with a color recorder built in.

The flurry of color VTR activity in West Germany was touched off by Walter Bruch, head of the television research laboratory at AEG-Telefunken AG. Bruch, inventor of the PAL (for phase alternating line) color transmission system adopted by most West European countries, developed a technique that makes it possible to squeeze chrominance information into a "monochrome" bandwidth of 2.5 megahertz. Deutsche Philips and the others have based their low-cost recorders on the technique, which Bruch calls Tripal.

One-by-one. For Tripal recording, the composite color video signal is decoded into red, green and blue signals. But rather than recording all three for each line of the tv picture, Bruch's method stores just one color signal per line. Red, green and blue color information is recorded sequentially on successive lines in a single channel.

Along with the single-color information for each line, the high-frequency components of the composite video signal are recorded to get a luminance signal. Since just one color signal—and a partial one—is handled at a time, a bandwidth of 0.6 Mhz will do for the chrominance channel. It is tucked into the low-frequency end of the Tripal composite signal, whose bandwidth is 2.5 Mhz and can be handled by monochrome recorders

built for home use.

Bright idea. If color signals were fed sequentially to the three guns in the receiver's picture tube, the viewer's eyes would average out the red, green, and blue over three lines and the colors would look all right. But with only one gun in action for each line, the picture wouldn't be bright enough.

To get around this, the Tripal system develops signals for all three guns for every line during playback. Three simultaneous color signals are obtained by running the sequential signals through two 64-microsecond delay lines.

When a line recorded with, say, blue color information is played back, the chrominance input from the recording head is switched onto the blue gun. The green information from the previous line—held up 64 μ s by the first delay line—is fed to the green gun. At the same time, the red signal that was present two lines before the blue has passed through both 64 μ s delays and is switched onto the red gun.

Only the lower-frequency color information is delayed and switched. The higher-frequency luminance signal for each line is fed to all three guns.

True blue. Deutsche Philips maintains that the color reproduction with Tripal recording matches that of studio units. However, the horizontal resolution suffers a bit because of the 2.5-Mhz bandwidth typical for home VTR's. And the vertical resolution is limited be-



A COMPUTER DESIGNED FILTER CAN MAKE YOUR ENGINEERING EASIER

Telonic RF and Microwave Filters cover such a wide range of frequencies, types, and performance characteristics that you don't have to design "around" them. Your specific requirements are programmed into an engineering computer, the filter designed and then produced to these precise parameters.

Basically modular, Telonic filters can be manufactured from elements in stock, providing another benefit in fast delivery*. With over 100,000 filter designs already produced, even so-called special types may already be standard. Here is the broad selection you have in designing—
Frequencies from 30 MHz to 12 GHz • Lowpass • Bandpass • Tubular
• Miniature • Cavity • Interdigital • Tunable

With that variety, quick delivery, and high performance, do you even need a second source?

*Three-day, Jet Order Service available

Telonic [®] **ENGINEERING CO.** A Division of
Telonic Industries, Inc.

Box 277 • Laguna Beach, Calif. 92652 • Tel.: 714-494-9401 • TWX: 910-596-1320

Representatives throughout the U.S. and foreign countries. Factory offices in Maidenhead, England, Frankfurt, Germany, and Milan, Italy.

• 52 page Filter Textbook •

Telonic's new catalog contains never before published data on filter-insertion loss, attenuation, physical size, frequency and bandwidth tolerances, and pass band relationships. Send for your copy.

More than a CATALOG



on VITREOSIL® PURE FUSED QUARTZ

More complete than most text books, the 48 pages cover Vitreosil pure fused quartz and Spectrosil, synthetic fused silica, the purest form of quartz known. Complete data on properties, applications, chemical behavior, and many others. Thermal American's full lines of products for industry, laboratory and special applications are illustrated and described. A 16 page list is pocketed in the rear cover.

If you use quartz—this book is a must for your library.

Write for your free copy today.

58



Electronics Abroad

cause three lines are always mixed. But the line-for-line luminance signals keep the vertical resolution tolerable for industrial and home recorders.

Japan

Fast-blooming hybrids

Japanese capacitor makers proved their adaptability at the annual Japan Electronics Show this month. Realizing that integrated circuits are fast making conventional components passé, most are rushing into production of hybrid thick-film circuits.

To be sure, the country's semiconductor producers turned up at the Osaka show with a panoply of monolithic ic's. But most were digital circuits for computers. A few monolithics designed for the sound-intermediate-frequency amplifier of television sets were in view. Export-oriented set makers, however, are queasy about monolithics. Still to be settled is the question of whether Texas Instruments Incorporated can block exports of equipment incorporating monolithics to the U.S. by a patient action. [Electronics, Sept. 18, p. 157].

The odds. Capacitor makers going into production of thick-film hybrids for consumer electronics equipment think they've got a safe bet. If Texas Instruments manages to keep Japanese monolithics out of the U.S., the market will go to the hybrid-makers by default. If TI loses out in its patent squabble with Japanese semiconductor makers, the thick-film hybrid producers figure they can best producers of monolithics in price and delivery.

Resistor manufacturers, oddly enough, haven't jumped onto the thick-film bandwagon en masse. The apparent reason: most resistor makers aren't as strong financially as capacitor makers. What's more, capacitor makers have the advantage of know-how in ceramic substrates—on which thick-film circuits are laid down—and they supply their own capacitors, the most

costly passive component.

Competing. Most leading Japanese capacitor makers had lines of thick-film hybrids for consumer electronics gear on their stands at the Osaka show. In most units, the active components were encapsulated transistors or diodes. The thick-film producers, though, are thinking about shifting to chips.

An exception is the Mitsumi Electric Co.; it already uses chips supplied by the Hong Kong plant of Fairchild Semiconductor. Mitsumi may graduate to production of its own chips to get an edge on the competition. Although it produces a line of digital circuits, Mitsumi sees consumer electronics as its main market. The company currently supplies thick-film preamplifiers to two producers of stereo sets.

On the rise. Tokyo Denki Co., a subsidiary of the Tokyo Shibaura Electric Co., says its hybrid-circuit sales now run from 30,000 to 40,000 units a month and are on an up-trend. About 70% of the circuits are digital, but Denki expects linears will soon dominate. Denki is dickering with its parent company to supply circuits for tv sets.

Other producers seeking business in thick-film hybrids are the Murata Manufacturing Co., Hokuriku Electric Co., Nichicon Capacitor Co., and Kyodo Electronic Laboratories Inc. Kyodo, however, is concentrating on sense amplifiers for computer memories.

Watching. Sitting on the sidelines so far is the Matsushita Electric Industrial Co., a giant in both consumer electronics and components. Matsushita, apparently, won't make its move until the situation in monolithics clears up. The company could jump into thick-film production fast.

Another company that's waiting it out is the Sony Corp. Like Matsushita, Sony could move into hybrid ic's fast.

Color's bright

Like their U.S. counterparts, Japanese color television set makers see a rosier outlook these days. Sales for the year will be consider-

The Predictables.



When ITT people ship your Series 930 DTL order you get on-time delivery.

More than 97% of your Series 930 DTL orders get delivered on time. How's that for predictability? We offer the same 15 circuit functions in the same packages as those people you've been having delivery problems with. Doesn't that justify a change?

To see how little trouble DTL buying can be, try the ITT "Predictables." Order off the shelf from your distributor or direct from your factory representative. Our shipping people may have to work late, but your receiving people won't.

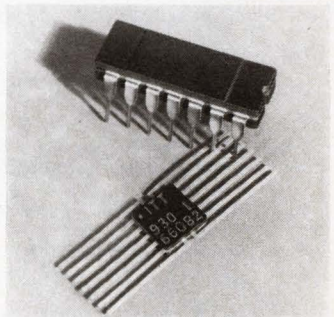

Integrated circuits **ITT**

FACTORIES IN WEST PALM BEACH, FLORIDA; PALO ALTO, CALIFORNIA; LAWRENCE, MASSACHUSETTS; HARLOW AND FOOTSCRAY, ENGLAND; FREIBURG AND NURENBERG, GERMANY

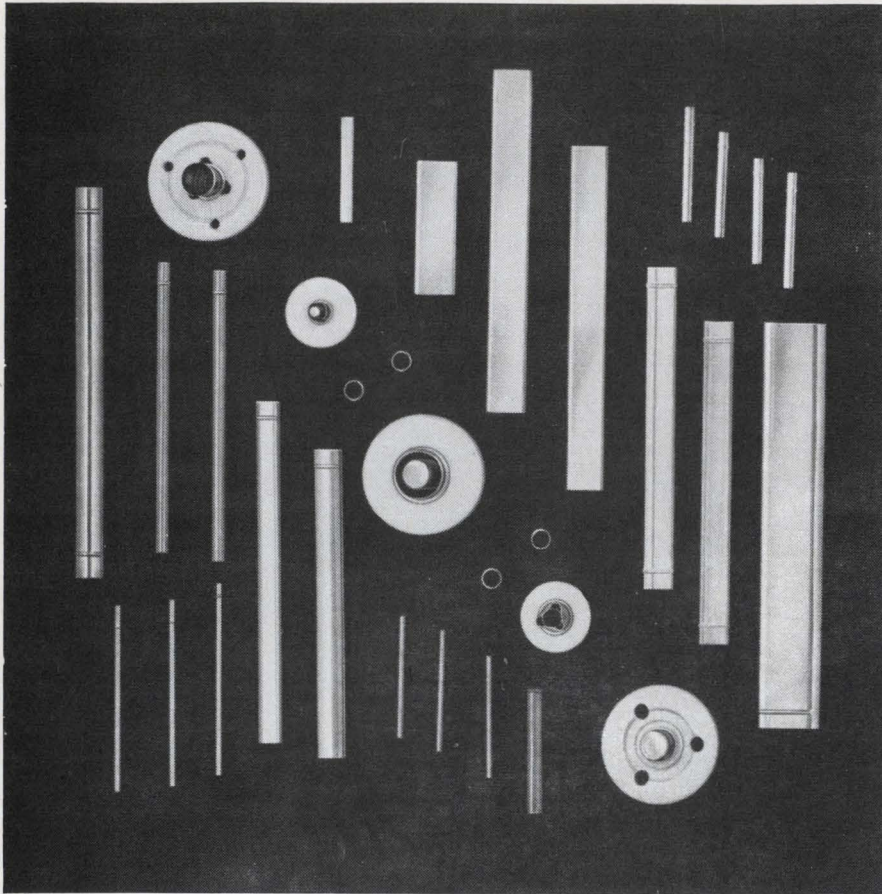

HOW RELIABLE ARE SUPERIOR TUBE'S CATHODES?

There's hardly a television set, radio, radar or any type of electronic equipment produced in the United States that doesn't use them.

Here are the reasons why Superior Cathodes are so widely used:

1. Superior is the world's leading independent cathode supplier offering the greatest variety of cathode types and materials.
2. Superior makes cathodes only for its customers . . . none for itself.
3. Superior has two large, modern plants, 500 miles apart, with identical facilities.
4. Superior delivers cathodes on time, every time.

When you specify or order cathodes consider Superior and protect yourself against delays in delivery.

Write today for your free copy of our Catalog 51. It belongs on your desk. Dept. 2500.

Superior Tube 

The big name in small tubing

NORRISTOWN, PA. 19404

West Coast: Pacific Tube Company, Los Angeles, California

Johnson & Hoffman Mfg. Corp., Carle Place, N. Y.—an affiliated company making precision metal stampings and deep-drawn parts

ably better than anticipated a few months ago.

The industry late this summer reached an output of 100,000 sets a month for the first time. As a result, the Electronics Industries Association of Japan predicts that color-set demand will reach 1.1 million in 1967. That's a 10% boost over the association's estimate made at the beginning of the year and twice last year's deliveries.

Best at home. A booming domestic market underlies the new estimates. Color-set exports, in fact, are running about 30% below what the industry association predicted in January. But domestic sales have zoomed beyond earlier expectations. Instead of 500,000 sets, the outlook now is for 750,000. The estimated export total for 1967 is 350,000 sets, nearly all to the U.S.

Sales of black-and-white receivers, too, figure to turn out better than the industry group earlier figured they would. The January estimate was 3.34 million sets for the domestic market and 1.9 million for exports. Both figures have been revised upward—to 3.5 million and 2 million, respectively.

Off the mark. The radio market, though, won't be as good as the industry thought at the outset of the year. Deliveries will run about 37.2 million sets, some 2.4 million fewer than the original estimate but nonetheless nearly 10% over the 1966 figure. The gain in dollar value will be even better since unit prices of exported radios are edging up. Japanese producers are turning to high-quality sets and leaving the cheap-set market to producers in Hong Kong, Taiwan, and elsewhere.

Around the world

Italy. Telecommunications equipment makers will get a big lift from the government's investment plans for 1968 to 1972. Nearly \$6 billion is earmarked by the plan for state-controlled industries, and some \$1 billion of it will go to modernize the country's telephone and telegraph network.

Electronics advertisers

October 16, 1967

| | | | | | |
|---|-----------|--|---------------|---|--------------------|
| ■ Acopian Corp. Mort Barish Associates | 195 | Dearborn Electronics, Inc., Sprague Electric Co. Div. Harry P. Bridge Co. | 16 | Indiana General Corp., Ferrites Div. Griswold & Eshleman | 24 |
| Adams & Westlake Co. Kasper & Associates, Inc. | 17 | Delco Radio Div., General Motors Corp. Macbill/Ross, Inc. | 190 | Industrial Chemical Specialties Corp. Robert A. Paul Advertising | 213 |
| Airco Speer Electronic Components Hazard Adv. Co., Inc. | 163 | Dit-Mco International, Div. of Xebec Corp. Martin Fromm & Assoc., Inc. | 207 | Industrial Electronic Engineers Gumpertz, Bentley & Dolan, Inc. | 162 |
| Airpax Electronics, Inc. Welch, Mirabile & Co., Inc. | 164 | Dow Corning Corp., Engineering Products Div. Church & Guisewite Advertising | 74 | I R C, Incorporated Gray & Rogers, Inc. | 177 |
| Alloys Unlimited Dunwoodie Associates, Inc. | 77 | ■ DuPont de Nemours & Co., Freon Div. Batten, Barton, Durstine & Osborn, Inc. | 71 | ITT Semiconductors Div. Neals & Hickok, Inc. | 227, 228, 229, 237 |
| Amerline Corp. Carlson Advertising Co. | 205 | | | | |
| ■ AMP, Inc. Garceau, Hallahan & McCullough, Inc. | 37 | | | | |
| Amperite Co. H. J. Gold Co. | 140 | | | | |
| ■ Amphenol Corp., Connector Div. Marsteller, Inc. | 58, 59 | E G & G, Inc. Culver Advertising, Inc. | 203 | Japan Lite Machinery Information Center Pace Advertising | 211 |
| ■ Analog Devices, Inc. Kenen Associates | 82 | Electro Scientific Industries Nadler & Larimer, Inc. | 7 | Julie Research Laboratories, Inc. Conti Adv. Agcy. | 146 |
| Applied Technology, Inc. The John Nelson Agency | 143 | Electronic Engineering Co. of California Jansen Associates | 230 | | |
| Arnold Engineering Co. Burton Browne Advertising | 150 | Electronic Research Associates, Inc. Josephson, Cuffari & Co. | 148 | | |
| Arrow Hart & Hegeman Electric Co. Chirurg & Cairns, Inc. | 79 | Electronized Chemicals Corp. Kenyon & Eckhardt, Inc. | 212 | Kahle Engineering Co. George Homer Martin Associates | 176 |
| Associated Testing Laboratories, Inc. Frank Best & Co., Inc. | 171 | Emerson & Cuming, Inc. Edwin F. Hall | 210 | Keystone Carbon Co. Downing Industrial Adv., Inc. | 134 |
| Automatic Electric Co., Sub. of General Telephone & Electronics Corp. Doyle, Dane, Bernbach, Inc. | 126 | Erie Technological Products Co., Inc. Altman-Hall Associates | 31 | Krohn-Hite Corporation L. K. Frank Co., Inc. | 241 |
| | | | | | |
| ■ Barnstead, Sub. of Ritter Pfaudler Corp Creamer, Trowbridge, Case & Basford | 169 | | | | |
| ■ Beckman Instruments, Inc., Helipot Div. Hixson & Jorgensen, Inc. | 83 | Ferroxcube Corporation of America Solow Wexton, Inc. | 64 | ■ Lambda Electronics Corp. Michel Cather, Inc. | 127 |
| Bendix Corp., Semiconductor Products Div. MacManus, John & Adams, Inc. | 198, 199 | | | Litton Industries, Inc., Poly-Scientific Div. West, Weir & Bartel, Inc. | 202, 203 |
| Birtcher Corp., The Guerin, Johnstone, Gage, Inc. | 147 | General Dynamics, Fort Worth Div. Glenn Advertising, Inc. | 160 | Lockheed Electronics Co. McCann-Erickson, Inc. | 157 |
| Bissett-Berman Corp. S. F. Associates | 193 | ■ General Electric Co., Electronic Components Sales Operation Robert S. Cragin, Inc. | 242 | | |
| Bourns, Inc., Trimpot Div. Lester Co., The | 73 | ■ General Electric Co., Miniature Lamp Div. Batten, Barton, Durstine & Osborn, Inc. | 192 | ■ Machlett Laboratories, Div. of Raytheon Co. Fuller & Smith & Ross, Inc. | 11 |
| Bud Radio, Inc. Allied Advertising Agency, Inc. | 136 | ■ General Instrument Corp., Semiconductor Products Div. Norman Allen Associates | 60, 61 | Macrosonics Corp. Carpenter, Matthews & Stewart, Inc. | 170 |
| Buffalo, Erie County, N. Y. Barber & Drullard, Inc. | 153 | General Radio Company Horton, Church & Goff, Inc. | 6 | ■ Magnetic Shield Div., Perfection Mica Co. Burton Browne Advertising | 207 |
| ■ Burroughs Corp., Electronic Components Div. Conti Adv. Agcy., Inc. | 84 | G.T.I. Corp. Meek and Thomas, Inc. | 213, 215, 217 | ■ Magnetics, Inc. Lando Adv. Agcy., Inc. | 133 |
| ■ Busmann Mfg. Div. of McGraw Edison Co. Henderson Adv. Co. | 208, 209 | ■ Gudebrod Brothers Silk Co., Electronics Div. Ramsdell-Buckley & Co. | 130 | ■ Mallory & Co., P. R., Mfg. Div. Aitkin-Kynnett Co. | 8 |
| | | | | ■ Markel & Sons, L. Frank George Moll Adv., Inc. | 214 |
| Calma Co. Saratoga Advertising | 68 | | | Maryland Dept. of Economic Development The Robert Goodman Agency, Inc. | 186 |
| Capitol Radio Engineering Institute Henry J. Kaufman & Associates | 196 | ■ Heath Company, Sub. of Schlumberger Ltd. Advance Advertising | 211 | Memory Technology, Inc. L. K. Frank Co., Inc. | 178 |
| Cerro Copper & Brass Co., Cerro Alloy Dept. Feeley Adv. Agcy., Inc. | 200 | Heinemann Electric Co. Thomas R. Sundheim, Inc. | 182 | Mepco Inc. Ray Ellis Adv. Corp. | 183 |
| Cimron, Div. of Lear Siegler, Inc. Phillips-Ramsey, Inc. | 38 | ■ Hewlett Packard, Dymec Div. Lennen & Newell, Inc. | 9 | Merrimac Research and Development, Inc. Walker & Gessell, Inc. | 36 |
| ■ Clairex Corp. Michel-Cather, Inc. | 188 | ■ Hewlett Packard, F & T Div. Lennen & Newell, Inc. | 32, 66, 179 | Metal Removal Co., The Advertising Producers Associates | 175 |
| Clare & Company, C. P. Reincke, Meyer & Finn Adv., Inc. | 76 | ■ Hewlett Packard, Harrison Div. Healy Adv. Agency | 2 | Microdot, Inc. Gumpertz, Bentley & Dolan Advertising | 15 |
| Cleveland Institute of Electronics Foote, Cone & Belding, Rapp & Collins Div. | 152 | ■ Hewlett Packard, Microwave Div. Lennen & Newell, Inc. | 1 | Motorola Semiconductor Products, Inc. Lane & Bird Adv., Inc. | 39, 53 |
| Consolidated Electrodynamics Corp. Sub. of Bell & Howell Hixson & Jorgensen, Inc. | 20, 21 | ■ Hewlett Packard, Rockaway Div. Culver Adv., Inc. | 211 | National Semiconductor Corp. Jay Chiat & Associates | 56, 57 |
| Control Data Corp., Analog-Digital Systems Div. Barnes-Champ Advertising | 149 | Hirose Electric Co., Ltd. Diamond Agency Co., Ltd. | 217 | ■ Newark Electronics Corp. Stral Adv. Co. | 240 |
| Coto Coil Co., Inc. Williams Co., The | 210 | Honeywell, Micro Switch Div. Batten, Barton, Durstine & Osborn, Inc. | 80 | ■ Nexus Research Laboratories Larcom Randall Adv., Inc. | 131 |
| Cramer Industries, Inc. Bryan/Donald Adv., Inc. | 208 | Hughes Aircraft Co. Foote, Cone & Belding | 27 to 30 | ■ North Atlantic Industries, Inc. Murray Heyert Associates | 141 |
| ■ CTS Corporation Burton Browne Advertising | 138 | | | | |
| | | | | | |
| ■ Dale Electronics, Inc., Sub. of Lionel Corp. Swanson, Sinkey, Ellis, Inc. | 3rd Cover | Ideal Precision Meter Co., Inc. Zam & Kirshner, Inc. | 188 | Pennsalt Chemicals Corp. Aitkin-Kynnett Co., Inc. | 129 |

free! new

1968 NEWARK INDUSTRIAL ELECTRONICS CATALOG

- Industry's Most Complete Buying Guide
- Over 70,000 items—500 Standard Brand lines
- 700 Pages
- Over \$7,000,000 Industrial Electronics Inventory— your assurance that NEWARK has it now.

NEW P&B CH SERIES SOLID STATE TIME DELAY RELAYS

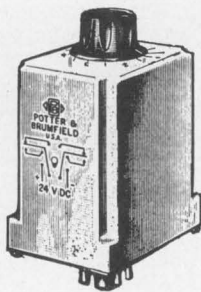

Cost saving answer to many industrial timing applications. Dial setting reference scale; operating temperature range of -10°C to -55°C with $\pm 10\%$ accuracy. Reset time in 100 milliseconds and repeatability is $\pm 2\%$. 24 types in stock.

Immediate delivery from stock—factory OEM prices
—fast efficient service from 10 Newark warehouses.

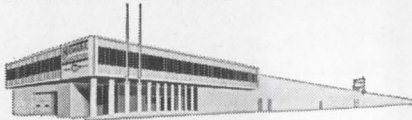

New Main Office & Warehouse

NEWARK 500 North Pulaski
Chicago, Illinois 60624

ELECTRONICS CORPORATION

AUTHORIZED P & B WAREHOUSES IN

- | | | |
|------------------------------------|---------------------------------------|---|
| ★ Chicago, Illinois (312) 638-4411 | Detroit, Michigan (313) 548-0250 | ★ |
| ★ Cincinnati, Ohio (513) 421-5282 | Los Angeles Area (213) OR 8-0441 | ★ |
| ★ Denver, Colorado (303) 757-3351 | Grand Rapids, Michigan (616) 452-1411 | ★ |
| Other Newark Warehouses in: | | |
| ★ New York City (212) 255-4600 | New Orleans, Louisiana (504) 834-9470 | ★ |
| ★ Dallas, Texas (214) BR 2-3571 | Houston, Texas Opening Soon | ★ |

- Pioneer Electric & Research Corp. K & A, Inc. 199
- Pomona Electronics Co. Buxton Advertising Agency 206
- Precision Tube Co. George Moll Adv., Inc. 194
- Princeton Applied Research Corp. Mort Barish Assoc., Inc. 40

- Q MAX Corporation George Homer Martin Associates 213

- Radio Corporation of America 4th Cover, 18, 19, 55
Al Paul Lefton Co.

- Radio Materials Co., Div. of P. R. Mallory & Co. Gallay Adv., Inc. 174

- Raytheon Co., Components Div. Fuller & Smith & Ross, Inc. 156

- Raytheon Semiconductor Botsford, Constantine & McCarty, Inc. 125

- RCL Electronics, Inc. Morvay Advertising Agency 14

- Redcor Corporation Smith-Klitten, Inc. 158

- Rental Electronics, Inc. Raymond E. Finn Advertising 204

- Revere-Mincom, Div. of 3M Company Reach, McClinton & Co. 180

- Rohde & Schwarz Walker & Gessell, Inc. 12, 13

- Rotron Manufacturing Co. Lescarboursa Adv., Inc. 224

- Semtech Corporation Burress Advertising 210

- Sierra Electronics Div., Philco Ford Hal Lawrence, Inc. 81

- Sigma Instruments, Inc. Marschalk Co., Inc. 128

- Signetics Corp., Sub. Corning Glass Works Cunningham & Walsh, Inc. 110

- Simpson Electric Co. Amerad Advertising Service, Inc. 144

- Singer Co., Metrics Div. Hepler & Gibney, Inc. 137

- Solitron Devices, Inc., Transistor Div. Haselmire Pearson Adv., Inc. 159

- Sperry Rand Corp., Microwave Components Neals & Hickok, Inc. 187, 189

- Sprague Electric Co., The Harry P. Bridge Co. 5, 10

- Stackpole Carbon Co., Electro-Mechanical Div. Meek & Thomas, Inc. 33

- Superior Tube Co. Gray & Rogers, Inc. 238

- Sweet's Industrial Information System Wank, Williams & Neylan, Inc. 161

- Sylvania Electric Products, Inc., Electronic Tube Div. Doyle, Dane, Bernbach, Inc. 65

- Sylvania Electric Products, Inc., Parts Div. Doyle, Dane, Bernbach, Inc. 34

- Syntro Company De Sales Advertising, Inc. 155

- Tally Corp. Bonfield Associates, Inc. 51

- Technology/Versatronics, Inc. Weber, Geiger & Kalat, Inc. 214

- Tektronix, Inc. Hugh Dwight Adv., Inc. 47

- Telonic Engineering Co. Jansen Associates, Inc. 235

- Tempress Research Co., Inc. Hal Lawrence, Inc. 67

- Teradyne, Inc. Quinn & Johnson Adv., Inc. 132

- Texas Instruments Incorporated Semiconductor/Components Division 118, 119, 135

- Albert, Frank, Guenther, Law, Inc., Don L. Baxter Division



- Thermal American Fused Quartz Kniep Associates 236
- Triplett Electrical Instrument Co. Burton Browne Advertising 75
- TRW Semiconductors, Inc. Fuller & Smith & Ross, Inc. 45
- Trygon Electronics, Inc. Kameny Associates, Inc. 62
- Trymetrics Corp. Kameny Associates, Inc. 54
- TungSol Div., Wagner Electric Corp. E. M. Freystadt Associates 216

- Union Carbide Corp. Group I— Chemicals & Plastics Div. J. M. Mathes, Inc. 22
- Union Carbide Corp., Electronics Div. J. M. Mathes, Inc. 35
- Union Carbide Corp., Linde Div. J. M. Mathes, Inc. 142
- United Transformer Co. Philip Stogel Co. 2nd Cover
- Unitrode Corp. Silton Brothers, Inc. 49

- Varian Data Machines Durel Advertising 212
- Vero Electronics, Inc. Adrian E. Clark Jr., Inc. 195
- Volkert Stampings Fred Wittner Co., Inc. 168

- Wanlass Electric Co. Leland Oliver Co., Inc. 217

- Wavetek Chapman, McQuiston, Michetti Advertising 72

- Westinghouse Electric Corp. Electronic Tube Div. McCANN/ITSM 63

- Weston Instruments, Inc., Transicoil Div. Arndt, Preston, Chapin, Lamb & Keen, Inc. 205

- Weston Instruments, Inc., Newark Div. Arndt, Preston, Chapin, Lamb & Keen, Inc. 78

- White Company, S. S., Airbrasive Div. W. L. Towne Co., Inc. 154

- White Instrument Laboratories Wilson & Associates 206

Classified Advertising

- F.J. Eberle, Manager
- PROFESSIONAL SERVICES 218
- EMPLOYMENT OPPORTUNITIES 218-222
- EQUIPMENT (Used or Surplus New) 223
- For Sale 223
- LEGAL NOTICE 218

ADVERTISERS INDEX

- American Electric Power Service Corp. 221
- Atomic Personnel, Inc. 218
- Burrough Corp., Plymouth, Michigan 221
- Conductron-Missouri 221
- Electronic Communications Inc. 218
- Phillip Fishman Co. 223
- Grumman Aircraft Engineering Corp. 222
- HRB-Singer 219
- Radio Research Instrument Co. 223
- U.S. Navy-San Francisco Bay Naval Shipyard 220

■ For more information on complete product line see advertisement in the latest Electronics Buyers' Guide

Advertising sales staff

Frank E. LeBeau [212] 971-6464

Advertising sales manager
Wallis Clarke [212] 971-2187
Assistant to sales manager

Donald J. Austermann [212] 971-3139
Promotion Manager

Atlanta, Ga. 30309: Michael H. Miller, 1375 Peachtree St., N.E.
[404] TR 5-0523

Boston, Mass. 02116: William S. Hodgkinson
McGraw-Hill Building, Copley Square
[617] CO 2-1160

Chicago, Ill. 60611: Robert M. Denmead,
J. Bradley MacKimm, Ralph Hanning,
645 North Michigan Avenue,
[312] MO 4-5800

Cleveland, Ohio 44113: William J. Boyle, 55 Public Square, [216] SU 1-7000

Dallas, Texas 75201: Richard P. Poole, 1800 Republic National Bank Tower,
[214] RI 7-9721

Denver, Colo. 80202: Joseph C. Page, David M. Watson, Tower Bldg., 1700 Broadway,
[303] 255-5484

Detroit, Michigan 48226: Ralph Hanning
856 Penobscot Building
[313] 962-1793

Houston, Texas 77002: Kenneth George,
2270 Humble Bldg., [713] CA 4-8381

Los Angeles, Calif. 90017: Ian C. Hill,
John G. Zisch, 1125 W. 6th St.,
[213] HU 2-5450

Minneapolis, Minn. 55402: J. Bradley MacKimm, 1104 Northstar Center
[612] 332-7425

New York, N.Y. 10036
500 Fifth Avenue
Donald R. Furth [212] 971-3615
James R. Pierce [212] 971-3616
Jeffrey M. Preston [212] 971-3617

Philadelphia, Pa. 19103:
Warren H. Gardner, Jeffrey M. Preston,
6 Penn Center Plaza,
[215] LO 8-6161

Pittsburgh, Pa. 15222: Warren H. Gardner,
4 Gateway Center, [412] 391-1314

Portland, Ore. 97204: James T. Hauptli,
218 Mohawk Building, 222 S.W. Morrison Street, Phone [503] 223-5118

Rochester, N.Y. 14534: William J. Boyle,
9 Greylock Ridge, Pittsford, N.Y.
[716] 586-5040

St. Louis, Mo. 63105: Robert M. Denmead
The Clayton Tower, 7751 Carondelet Ave.
[314] PA 5-7285

San Francisco, Calif. 94111:
James T. Hauptli, 255 California Street,
[415] DO 2-4600

London W1: John W. Patten, Edwin S. Murphy Jr., 34 Dover Street,
Hyde Park 1451

Milan: Pierre Braude,
1 via Baracchini Phone: 86-90-656

Frankfurt/Main: Pierre Braude,
Elsa-Brandstroem Str. 2
Phone: 72 01 81

Geneva: Pierre Braude,
1, rue du Temple Phone: 31 95 60

Paris VIII: Pierre Braude,
17 Avenue Matignon Phone: 359 6637

Tokyo: Nobuyuki Sato, 1, Kotohiracho
Shiba, Minato-Ku [502] 0656

Osaka: Ryoji Kobayashi 163, Umegae-cho
Kita-ku [362] 8771

Business department

Wallace C. Carmichael, Manager
[212] 971-3191
Stephen R. Weiss, Production Manager
[212] 971-2044

Thomas M. Egan,
Assistant Production Manager [212] 971-3140
Dorothy Carmesin, Contracts and Billings
[212] 971-2908

Circulation and research

Milton Drake, Manager [212] 971-3485
Isaaca Siegel, Assistant Circulation Manager
[212] 971-6057

David Strassler, Assistant Research Manager
[212] 971-6058

Chloe D. Glover, Research Associate
[212] 971-6057

Electronics buyers' guide

George F. Werner, General Manager
[212] 971-2310

Ray Smyth, Eastern Regional Manager
[212] 971-6538

Regina Hera, Directory Manager
[212] 971-2544

Thomas M. Egan, Production Manager
[212] 971-3140

NEW **KH** ALL-SILICON DIGITALLY TUNED VARIABLE FILTER FEATURES ULTRA LOW FREQUENCY 96 DB/OCTAVE SLOPE

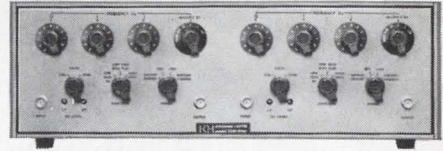

MODEL 3342 DUAL-CHANNEL, MULTI-FUNCTION FILTER provides low-pass and high-pass operation with 96 db attenuation slope or 48 db slopes as band pass or band reject filter. The digital frequency control provides cut-off frequencies from 0.001 Hz to 100 kHz with 2% calibration accuracy and excellent resetability. Size: 5¼" H x 19" W x 16½" D.

The new Krohn-Hite Series 3300 operates on either line or batteries, with 0.1% distortion and provides gain of 20 db.

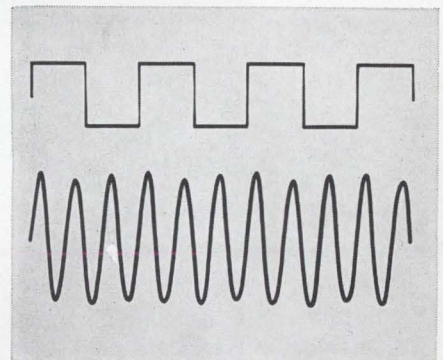

RECORDING ILLUSTRATES gain and selective response of Model 3342, in minimum band-pass operation, to a 0.01 Hz square wave. Output consists primarily of third harmonic component of input.

This kind of low-frequency performance is backed by other important specifications. Examples are:

Filter Characteristics: Either 4 or 8-pole Butterworth (maximally flat) and R-C for transient-free operation.

Digital Tuning: Six bands, 3 digits; rotary switches.

Maximum Attenuation: 80 db.

Dynamic Range: 80 db.

Input Impedance: 10 megohms.

Output Impedance: 50 ohms.

Write for Data

KH KROHN-HITE CORPORATION
580 Massachusetts Avenue, Cambridge, Mass. 02139
Telephone: 617/491-3211

New

96 db Slope

0.001 Hz to 100 KHz

Line/Battery Operation

Low Distortion

*NEREM Booth
1D22 and 1D23*



COMPONENT CAPSULES

Revolutionary advances in electronic tubes

"4+1" TUBE KIT IS DESIGNED TO HELP MAKE \$50 TV SETS POSSIBLE

Here, clearly, is the most economical and most compact black and white tube kit yet offered. Only 5 tubes are needed to perform all necessary tube functions except the tuner and picture tube. This new idea in electronic tubes is designed to help lower the price of monochrome sets.

Circle Number 90.

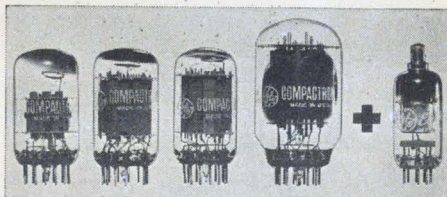

Y-1607B 17BF11 Y-1699B 33GY7A 1BC2

GE THICK-FILM MODULETRON . . . A BOLD NEW PACKAGING CONCEPT

Up to 75% of the passive elements in your TV receiver can now be included within this new compactron. Yet no circuit redesign is necessary; active tube elements remain unchanged. The GE Moduletron may offer savings as high as 50% on passive elements and installation costs.

Circle Number 91.



Takes passive elements off the circuit board and puts them inside the compactron

Need Black Hawk capacitors in a hurry?



Immediately available in volume quantities

Now you can specify Black Hawk capacitors for immediate delivery in 7 different case sizes and in 5 different voltage ratings—50, 100, 200, 400 and 600 VDC. Black Hawk capacitors feature molded encapsulation to provide a hard moisture-resistant shell around the capacitor roll and strengthen the welded leads. Other advantages include extended foil construction and very precise dimensions (± 0.005).

Circle Number 92.

Maximum energy product: 7,000,000 gauss-oersteds with GE Alnico 5-7

At 7,000,000 minimum gauss-oersteds, Alnico 5-7 gives you a 25% increase over conventional Alnico 5 . . . permits either greater magnetic performance in the same size material, or equal performance in a smaller and lighter magnet. High-energy premium priced Alnico 5-7 is excellent for applications requiring superior performance such as high-density meter movements, large dc motors and sophisticated speakers. GE engineers will gladly help you discover how to make the most efficient use of its properties. Circle Number 93.

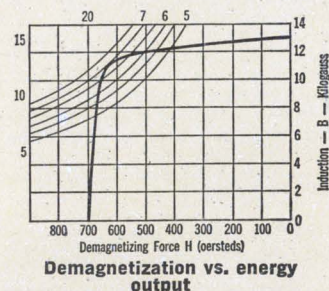

New 2-transistor Darlingtong amplifier costs as low as 35¢*

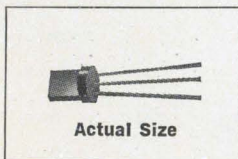

Actual Size

Use GE's new D16P NPN device (in monolithic structure) to simplify your audio amplifier circuits in pre-amps for phonographs and tape recorders. One D16P actually costs less than its discrete counterpart in these applications—two 2N3394's. D16P's provide single stage input impedance over 2 megohms with a 6-to-1 voltage gain at negligible distortion (less than 0.1%). For more information, Circle Number 94.

*In lots of 1,000 and up

WE MAY NOT OFFER EVERYTHING YOU WANT FROM ONE COMPONENTS SUPPLIER. BUT WE DO COME A LITTLE CLOSER THAN ANYONE ELSE.